

+ EVERYTHING YOU NEED TO KNOW TO GET STARTED WITH A HOME RECORDING SYSTEM +

# MUSIC TECHNOLOGY

## BASICS & BEYOND

BY PAUL WHITE EDITOR-IN-CHIEF SOUND ON SOUND

# SOS

SMART GUIDES

[www.sos-smartguides.com](http://www.sos-smartguides.com)

- Studio Setup /
- Computer Audio /
- Recording Software /
- Plug-in Effects /
- Software Instruments /
- Loops & Samples /
- Mic Techniques /
- EQ & Compression /
- Monitoring /

**PLUS** COURSES  
& CAREERS

Want to learn more?  
Explore all the options  
with our in-depth guide

[www.sos-smartguides.com](http://www.sos-smartguides.com)



\$9.99 USA Edition

**FREE**  
Online  
Video  
Tutorials

Buying the right gear  
for your needs

Using your computer  
to make music

Modern music production  
techniques explained

A photograph of two Shure KSM microphones mounted on stands in a recording studio. The microphones are silver and have a distinctive spider-like shock mount. They are positioned vertically, one above the other. The background is a dark blue wall with a wooden paneling below. A cello is visible in the background, slightly out of focus.

THE UTTERLY GLORIOUS FUSION OF TECHNOLOGY AND ARTISTRY.

**SHURE KSM MICROPHONES** Exquisite craftsmanship and exceptional engineering that sets a new standard of clarity and control. Ultra-sensitive, with extremely low self-noise and superior handling of high sound pressure levels. Pure audio mastery. Period.

[www.shure.com/americas](http://www.shure.com/americas)

© 2011 Shure Incorporated

**SHURE**<sup>®</sup>  
LEGENDARY  
PERFORMANCE™

World Radio History



**Buying Music Gear? Experience the**

**Sweetwater®**

**Difference!**

Sweetwater is your best source for music gear and technology. Why? Because we give you more than just great products at great prices. We're here to help you find exactly what you need and to get it to you when you need it. Plus, we're here for you after the purchase, with industry-leading service and support, outstanding online resources, and our own exclusive free 2-year warranty.



**Huge Inventory ▲**

Need it fast? We get it to you fast. In fact, most orders ship the same day! Our enormous warehouse is stocked with all the latest, greatest gear, so you get easy access to the best products available.



**Friendly, Expert Staff**

When you call Sweetwater, you get one-on-one communication with experts! Our Sales Engineers are musicians and engineers who can relate to you and your needs, so you get valuable advice and personal service from someone who knows the gear inside and out.

**Call Sweetwater today for the trusted service you deserve!**

**CALL US TODAY AT**

**(800) 222-4700**

World Radio History

## Check out Sweetwater's amazing online resources



### Visit Our Online Guitar Gallery

Check out our amazing Guitar Gallery and take a close-up, multiple-angle look at the guitar you want.

Sweetwater  
**Guitar Gallery**

### Award-winning Website

When you visit Sweetwater.com, you won't believe how easy it is to find great gear — and find out more about it. Our product pages showcase detailed images, in-depth descriptions, helpful demo videos, and more.



### Stay Connected

Connect with Sweetwater on YouTube, Facebook, and Twitter, and get daily updates on new gear releases, savings offers, exclusive product demos, and more.



[YouTube.com/SweetwaterSound](http://YouTube.com/SweetwaterSound)



[Facebook.com/Sweetwater](http://Facebook.com/Sweetwater)



[Twitter.com/SweetwaterSound](http://Twitter.com/SweetwaterSound)



# This unbeatable combination of coverage, service, and selection is all about you, and it's only at Sweetwater. Check us out today.



### Free 2-year Warranty

Want even more value for your money? You'll love the Total Confidence Coverage™ free 2-year warranty we add to your purchase. It's a Sweetwater exclusive!



### Free Shipping

We add value to your purchase with free shipping. You get what you want, when you want it. It's the best shipping deal you'll find anywhere!

**SweetCare**  
[www.sweetwater.com/support](http://www.sweetwater.com/support)  
Instant 24/7 Access

### Outstanding Online Resources

At Sweetwater.com we offer a huge pool of online guides, video demos, tech tips, and other resources, all of which you can access 24/7.



### Industry-leading Service and Support

Great value doesn't end with the sale. Sweetwater is here for you after your purchase, with a factory-authorized service department and top-tier tech support. When you have questions about your gear or software, we're here to help.

# Sweetwater

Music Instruments & Pro Audio

**(800) 222-4700 • Sweetwater.com**

World Radio History

# CONTENTS

**S/O/S**  
SMART GUIDES  
[www.sos-smartguides.com](http://www.sos-smartguides.com)

## + HOW TO USE THIS GUIDE 8

## + STUDIO SETUP 11

There are certain pieces of hardware you'll need to get started, such as microphones, speakers and an audio interface. In this section, I'll explore each part of the studio and offer advice to help you make the right choices.

CHOOSING A DAW	14
THE COMPUTER	22
GETTING THE GEAR	28
WIRING THE STUDIO	38



## + BEHIND THE AUDIO 45

While the inner workings of digital audio are fairly complex, the general concepts are pretty simple. This chapter will help give you a basic grounding in digital audio and MIDI.

MIDI EXPLAINED	48
DIGITAL AUDIO	56



## + EXPLORING SOFTWARE 59

DAW software comes in a multitude of packages, but one thing they all have in common is their versatility. Here, I'll explain how to get the most out of your DAW.

DAW BASICS	62
PLUG-INS	66
PLUG-IN INSTRUMENTS	73
DAW VIEWS	78
LOOPS & SAMPLES	82
UNDERSTANDING MIXERS	86



## **+** RECORDING 89

A good recording starts with good preparation. In this section, I'll explain how to get the acoustic environment ready for you to begin recording, while offering tips for recording vocals, guitars and MIDI instruments.

AUDIO	92
MIDI	100
VOCALS	104
GUITAR	108

## **+** TECHNIQUES 113

This chapter will cover some of the essential techniques you need to know when recording and mixing in a home or project studio.

MICS & MIKING	116
MIXING MAGIC	124
ALL ABOUT COMPRESSION	134
EQUALISATION EXPLAINED	138
EXPLORING MASTERING	146
MONITORING BASICS	150

## **+** THE FUTURE 155

Thinking of upgrading your studio, furthering your knowledge, or studying the future of digital music? These last chapters will provide you with essential advice to help you on your way.

DIGITAL SURVIVAL	158
UPGRADING YOUR SYSTEM	160
CAREERS & COURSES	164

## **+** GLOSSARY 173



# HOW TO USE THIS GUIDE

Whether you're a beginner wanting to delve into the world of music technology for the very first time, or you've already got a studio and are looking to further your knowledge and skills, there's plenty here to spur you on in your musical adventures.

**B**efore you get stuck in to this guide, there are some things you should know in order to get the most out of the information contained within its pages.

## Sections

You'll notice from looking at the contents page that this Smart Guide has been split up into six colour-coded sections. Each section contains a selection of chapters relating to specific topics within one subject area (eg. Recording). At the beginning of each set of chapters you'll find a colourful title page with a mini-contents to help you navigate your way through the guide.

## Reference Guides

Along with the usual *SOS* trademark of colourful pictures and clear explanations accompanying each chapter, we've also included several quick reference guides to help with specific subjects, which you can easily flick back between and refer to at your leisure.

## Tip & Info Boxes

Look out for these coloured boxes throughout the Smart Guide. There's an example of each on these pages so you know what to look out for.

## Manufacturer Listings

At the end of most chapters in the guide you'll come across an info box containing details of some of the leading manufacturers of the products mentioned

in that particular chapter. These are usually manufacturers whose products we have tested and reviewed in the pages of *Sound On Sound* and consider to offer appropriately high-quality gear and value for money.

## Education Chapter

At *SOS* we're firm believers in learning, whether through practical application or study, and recognise the







growing importance of education in the audio industry. To this end, we've put together a selection of information to do with all things education. Although some of the advice is pitched at college or degree level, most of the information provided is equally applicable to other levels of study. Whether you're at high school and wondering about the 'next steps',

or already have some experience and are trying to further your career with the aid of training and qualifications, there's something in this section for you!

The first part of the education chapter offers a discussion on audio education covering issues such as reasons for and against doing audio education courses, what kinds of courses are available, what life's like in the music industry, and the debate around education versus experience.

The second part features a list of selected audio institutions in the US, the UK, globally, and online, with their full contact details so that you can find out more. You can also head to [www.soundonsound.com/education](http://www.soundonsound.com/education) to browse

Computers are central to the modern studio, both in a professional and project capacity. Laptops and handheld devices (such as tablet PCs and smart phones) have become increasingly popular, but the technology's not quite good enough to replace your entire studio just yet! You'll still need to grab yourself some gear, learn how everything works together, and then arrange it in an acoustically-treated room. This guide will teach you everything you need to know to get yourself up and running with your own home or project

our online education portal, which we will be developing and expanding in the coming months.

### Glossary

This can be found at the end of the guide. We've given detailed explanations of all the 'jargon' you'll come across in the guide and have written each explanation to be as clear as possible, whilst also giving you lots of information, so that you feel confidently clued-up! There's something for everyone — beginners will find everything easily explained, whilst those with some experience will have enough information to feel 'in the know'.

### Smart Guides Website

As all of our *SOS* monthly readers will know, *Sound On Sound* has a dedicated website which archives all the content published in the mag... and more besides! Alongside this series of Smart Guides,

we've opened a brand-new website — [www.sos-smartguides.com](http://www.sos-smartguides.com) — to act as a portal of information, multimedia content and news for you to get the most out of your purchase.

The online content accompanying this Smart Guide includes a selection of hand-picked resources from the

»

### Tip Boxes



We've peppered plenty of tips throughout this guide, with nuggets of key information to get you recording and producing fast. These are easily identifiable by the coloured boxes with the plus symbol in the corner, just like this one! (We chose the addition symbol 'cos the info in the tips is adding to your knowledge. Clever, eh?)

Ignore these boxes at your peril! Often they'll include ideas and handy hints to help you save your time (and sanity!).



The 'SOS Smart Guides' website — home to all the multimedia and bonus content accompanying the Smart Guides series.

» *Sound On Sound* website to save you time and give you access to the information you need. It's all clearly organised and structured for you, and is a great place to learn even more about home recording. You'll also discover some video tutorials supplied by Berklee Music Online.

Additionally, you can explore the other Smart Guides published by *Sound On Sound*, including the recent title *DAW Power User*, which provides hundreds of tips to get you started with your favourite DAW.

## SOS Forum

The *SOS* website is host to many things, one of which is our extensive forum which is frequented by thousands of visitors each month. There are loads of new discussions cropping up each day, and with a large, established membership, it's a good place to seek advice and meet new friends!

There's a dedicated 'Newbies' forum where new users can post questions and get to know some of the more

### Info Boxes

On your journey through this Smart Guide, you'll come across several info boxes just like this one. They're paler than the tip boxes and don't have the symbol in the corner, but they often provide detailed explanations or further information to compliment the main chapter text.

experienced members, and we've also got specific forums that relate to studios, music business, types of recording and much more!

To get started in the discussions, just

head to [www.soundonsound.com/forum](http://www.soundonsound.com/forum) where you can chat with other musicians and producers and share your home-studio experiences.

## SOS Readers' Ads

The *Sound On Sound* website offers readers the opportunity to post free classified adverts listing their second-hand gear for sale. We list everything from synths to software, instruments to mixing desks, microphones to guitar pedals. Most readers are only looking to get a reasonable second-hand price for their gear, whilst some will happily consider a swap or part exchange. It's free to advertise and to respond so, if you're seeking some extra bits for your home or project studio, check out the Readers' Ads section of the *Sound On Sound* website and grab yourself a bargain (or 10!). There's also a 'wanted' category if you're seeking something specific and can't find what you're looking for in the listings. ■■■

## The SOS Team



If you want to chat to other musicians and recording enthusiasts check out our *Sound On Sound* forums where you can discuss everything audio related

# STUDIO SETUP

CHOOSING A DAW	14
THE COMPUTER	22
GETTING THE GEAR	28
WIRING THE STUDIO	38

A recording studio is a place where you can record music. Along with a computer running DAW software, you'll need equipment such as microphones, speakers and an audio interface to do this. To achieve the same quality offered by a pro studio you'll need to combine the right equipment with an acoustically treated space and expertise. In this section, I'll explore the most important aspects of the studio and offer advice to help you make the right choices.

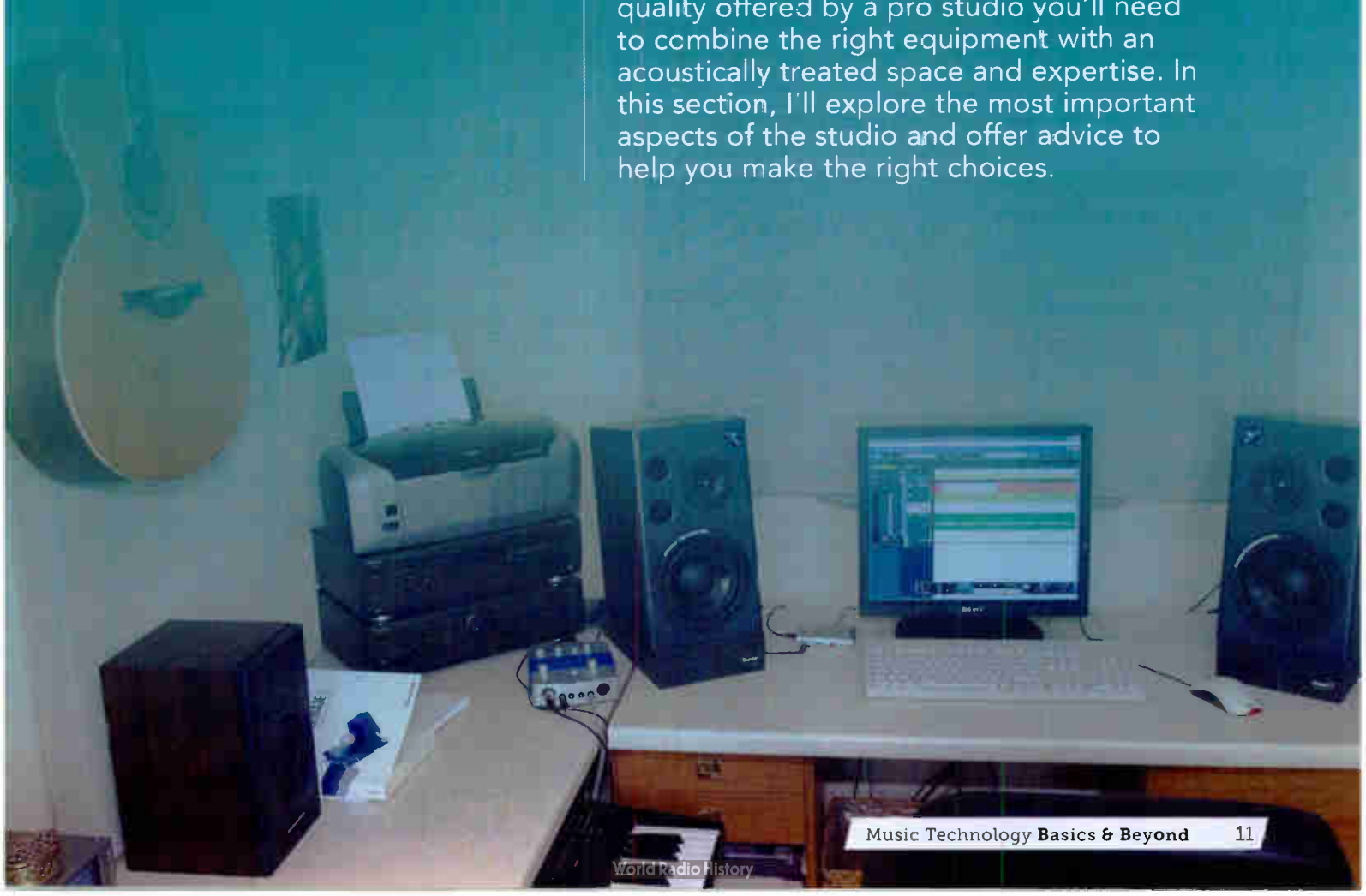



Sweetwater Sound Studio A Control Room

# Spend Your Gear Budget Wisely

## Buying Right the First Time

Even if you have the luxury of a generous gear budget, it makes good sense to spend your money wisely. Here are some tips to help you avoid common gear-buying pitfalls and buy right the first time.

- **Future-proof Your Studio**

That hasty decision made amid the hustle and bustle of a busy retail store is often the one that comes back to bite you. In the process of building your studio — be it a relatively simple DAW, a well-equipped project studio, or a full-blown commercial facility — your setup will grow as your needs change. You'll invariably take a misstep or two; however, the key to minimizing mistakes is to weigh each buying decision carefully in light of future expansion.

- **Specs Don't Tell the Whole Story**

When choosing gear, you need to take into consideration a number of factors besides technical specifications. Ergonomics, features, and your personal workflow preferences all factor into whether a new piece of gear will have a long and productive life in your studio. Fabulous specs notwithstanding, a device you find uncomfortable to work with will steal your time, sabotage your ideas, and ultimately sap your creative energies.

- **Never Skimp on Cables**

Your audio and digital cables carry signals, and, yes, they make a difference. You've spent a bundle on great-sounding gear for your studio, and it may be tempting to save a few bucks on cabling. Once you realize you'd be compromising the performance of all that high-quality equipment, however, skimping out on cables suddenly seems penny-wise, pound-foolish.

[Sweetwater.com/cables](http://Sweetwater.com/cables)



World Radio History

We're the Source for All Your  
**Cable Needs**

Get expert gear advice  
online — 24/7!

Go to  
[Sweetwater.com/buying-guides](http://Sweetwater.com/buying-guides)



### • Get the Big Picture

We've all become enamored with a particular piece of gear, and that's all well and fine — just not when it's to the exclusion of all else in your studio. Remember that your recording setup is a system, and you should take a systems approach when considering additions. Your due diligence should include making sure new equipment will function synergistically with your existing gear. In other words, keep your focus on the big picture.

### • Know Your Real Needs

A singer/songwriter with a vast guitar collection will have different gear needs than a film composer with a studio centered around a keyboard synth workstation. Are you a Mac or a PC user? Will you be running mostly MIDI — or a hundred audio tracks with dozens of plug-ins? The point is that, if you can identify your present and future needs when purchasing gear, you'll be ahead of the game.

### • Don't Blow Your Budget on a Single Piece of Gear

An expensive bit of hardware may sound awesome itself, but perhaps not so great when followed in the signal path by a budget component or two. Makes sense, right? Do your studio a favor: consider your entire system when buying gear.

### • Buy Right — the First Time

The first step is to identify the make-or-break components in your studio. Transducers (mics and speakers) are where the rubber meets the road, converting sound waves into electronic signals — or vice versa. High-quality mics and studio monitors are mission-critical for any size studio, and they'll serve you well for many years to come. Hold off buying if you have to, but make sure you're not purchasing something you'll end up replacing in a year or two — costing you more in the long run.

### • Great Monitors Are a Great Investment

Great studio monitors are an excellent place to start investing in your studio. The essence of a good studio monitor is that your mixes translate to the world beyond your studio. In order for this to happen, your monitors need to tell you the truth about what you're recording. Accurate monitors mirror reality, forcing you to "work for" your mix. Great monitors yield mixes that sound great no matter where you play them!

### • Don't Forget That "Gear" Includes Acoustic Treatment

Have you heard the expression "garbage in, garbage out"? Recorded sound is only as good as the source, and today's highly effective absorption and diffusion materials, bass traps, and isolation tools help you get your studio space sounding as good as it can. Often overlooked, acoustic treatment is one of the best investments you can make in your studio. It pays dividends in the form of better sound — and less work on your part to correct for room deficiencies.

### • Get the Right Tool for the Job

So you've decided to get a compressor for your studio. Will it be used primarily for vocals? Or perhaps you're looking for a more dramatic effect, in which case you may actually want a limiter. Some dynamics processors function as compressor/limiters, and still others have expansion and/or noise-gating capabilities. Confused yet? This is but one example, but it serves to illustrate the importance of deciding how you will use a new piece of gear before you purchase it. Remember, anytime you need expert advice, your Sweetwater Sales Engineer can help you decide on the right tool for the job.



JBL  
LSR4326P

AKG  
C414XLII

MOTU  
UltraLite-mk3 Hybrid

Focusrite  
Saffire Pro 40

Buying quality equipment  
will serve you well in the  
long run.



Auralex acoustic treatment

**We'll help you find the right gear —  
the first time!**

**CALL US TODAY AT  
(800) 222-4700**

**Sweetwater**  
Music Instruments & Pro Audio

# CHOOSING A DAW

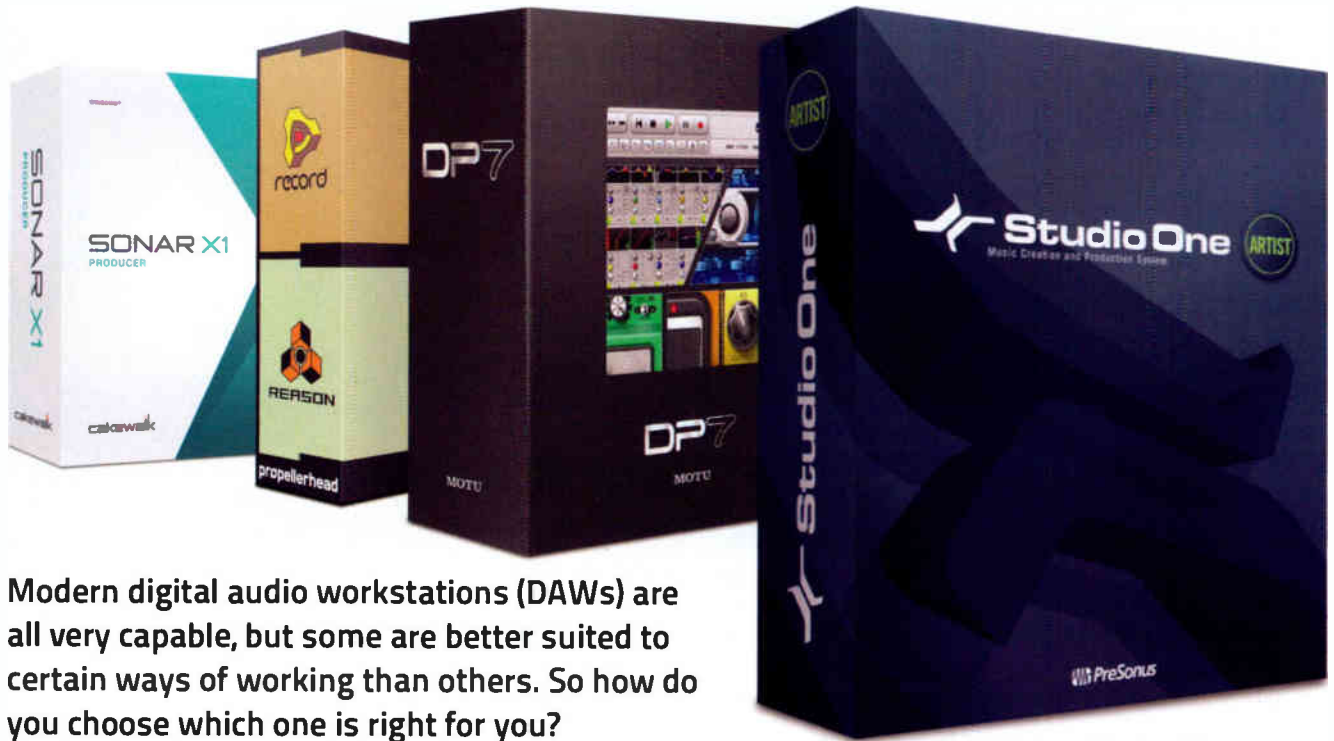

**Modern digital audio workstations (DAWs) are all very capable, but some are better suited to certain ways of working than others. So how do you choose which one is right for you?**

Chances are, you have musician friends who already use computers to record. A good first step is to sit in on a session to see what equipment they use and evaluate whether it would be suitable for your needs. It certainly helps if you use the same music software as other musicians in your social circle as you can get a bit of free help when you need it! Checking respective company websites is another way to gain valuable insight into how the various DAWs compare. You'll find that free instructional videos are available online for many of the leading DAWs, which can be a great help if you've got nobody on hand to offer advice.

As a rule, there are two types of DAW: one that suits traditional musicians who approach music on a linear basis; the other geared towards the DJ/musician who prefers to build music from loops and samples and may not even play an instrument. The more 'traditional' DAWs (which evolved from a conventional tape-recording paradigm) include Apple Logic and GarageBand, Steinberg Cubase and Nuendo, Avid Pro Tools, MOTU Digital Performer, Cakewalk Sonar,

PreSonus Studio One and Propellerhead Record. DAWs designed for loop-based composition include Ableton Live, Sony Acid and Propellerhead Reason. This last one incorporates some impressive software synthesizers and samplers.

For most recording musicians, however, one of the more traditional DAW software packages will best suit the needs of a project studio.

The first thing to explore is what you can expect a DAW to do. Most follow a similar paradigm, but the working environment is far removed from that of tape. A DAW includes everything you might find in a traditional studio, other than the mics and speakers. Certainly, a DAW can be set to operate in a similar way to a multitrack tape machine with the capacity to add overdubs on new tracks and to replace sections that didn't work out first time around, but it goes much further.

DAWs also include a mixer, generally following a similar structure to a traditional hardware mixer, so that you can balance and EQ the various tracks you've recorded to create your final mix.

They can mix music in mono, stereo or even surround sound. DAW mixers can also record and replay fader and other control moves — an essential feature for serious mixing. On a hardware mixer you can move several controls at the same time, but in software you may only have a mouse for control, meaning you can only adjust one thing at a time. There is optional control hardware to get around this but, when mixing with a mouse, you can only optimise the fader moves for one track at a time. The advantage of automation is that you can refine your mix in great detail before recording the project.

## MIDI Tracks

Along with audio tracks, you'll invariably find MIDI tracks available in your DAW. These are for controlling electronic instruments, and as these hold much less data than an audio track, you can usually run a lot of them, even on a relatively low-powered computer. Where computer muscle is necessary, however, is in supporting the software instruments that play back the instrument sounds,

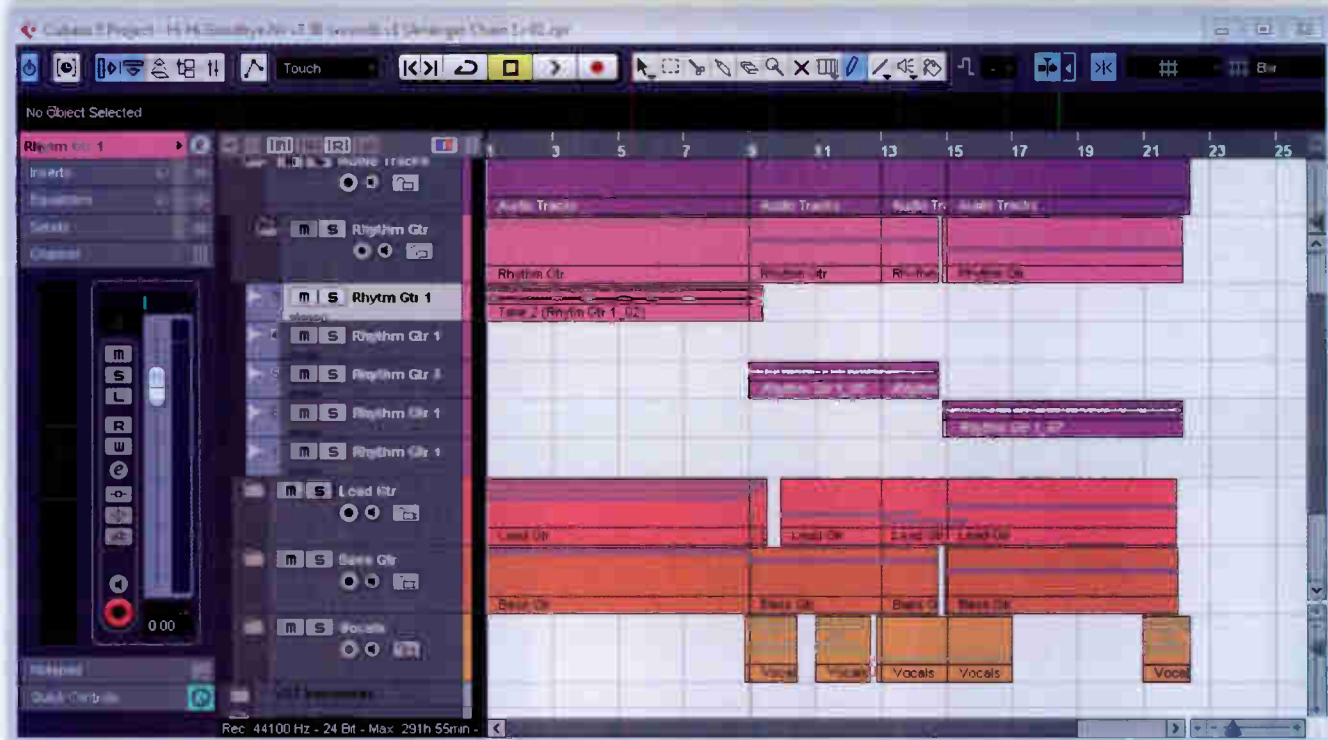
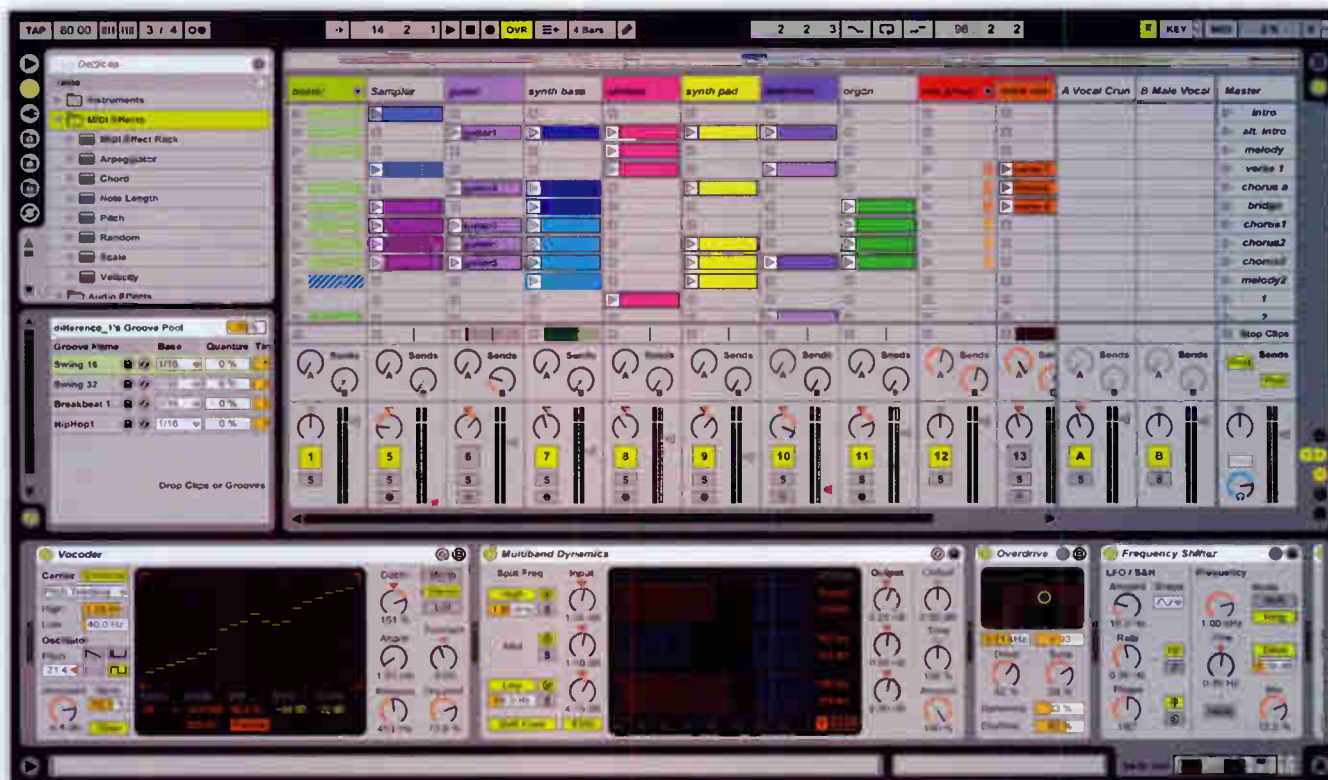

Ableton Live, a loop-based DAW (top) and Steinberg Cubase, a more traditional composition-based DAW (bottom).

although you can also use a MIDI interface connected to your computer to control MIDI-compatible hardware synths, drum machines and samplers. Using external hardware does complicate your setup

slightly, but it relieves your computer of the burden of running software synths and samplers. To put this in perspective, a reasonably modern computer will probably be happy powering more

software instruments than good taste would dictate you use in a mix!

### What's MIDI?

MIDI stands for Musical Instrument Digital Interface. It was developed around 30 years ago to allow musical information (rather than »

» audio) to be sent between compatible devices. In the context of a DAW, this MIDI data is recorded from a musical keyboard (or other MIDI controller) connected to the computer via a MIDI interface or directly via USB, and then when it is replayed it can be routed to a hardware or software musical instrument to recreate the original performance. The beauty of MIDI data is that it can be edited, usually on a very intuitive piano-roll type of screen or presented as a traditional musical score. You do this either to make changes or simply to fix mistakes. With MIDI it is also possible to change sounds after recording, as the MIDI data simply tells the receiving device what to play. Furthermore, as MIDI data is essentially a set of instructions telling the instrument what note to play and when to play it, you can slow down or speed up the track without changing the pitch of the instrument.

If this seems hard to get your head around, think of MIDI as an electronic version of the punched paper roll used in those old-fashioned wind-up toy pianos. If you speed up the rate at which the paper roll feeds through the mechanism by winding the piano

Software mixers are often modelled on their hardware counterparts.

more quickly, the piano plays faster but doesn't change pitch. Similarly, you can think of editing MIDI data as the equivalent of taping over holes representing notes you don't want to keep and punching new holes where you'd like new notes.

If you are too young to know what a toy wind-up piano looks like, then think of MIDI as an electronic equivalent of a musical score. When you hit record, a score is created from whatever you play on the keyboard, and when you come to replay it, the receiving instrument plays back by 'reading' the MIDI score. Editing MIDI data is then the equivalent of a composer deleting unwanted notes and drawing in new ones. Indeed, if you're a good composer but can't play a keyboard, you can write your electronic score entirely on screen and the computer will play it back for you.

MIDI can also be used to control other aspects of an instrument's sound, for example, pitch bend, vibrato and various synthesizer parameters, such as filter sweep. From a DAW user's



## Comping

While tape had to be edited using a razor blade and adhesive tape, you can copy, move or delete any section of a DAW audio track, including copying audio from one track to another. This greatly simplifies the process of 'comping': recording the same performance (eg. lead vocals) several times on different tracks before choosing the best bits of each version and then assembling into a final track.

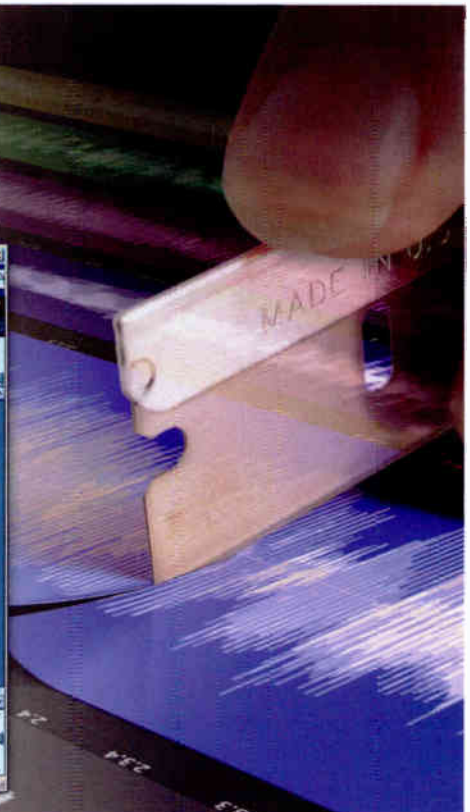
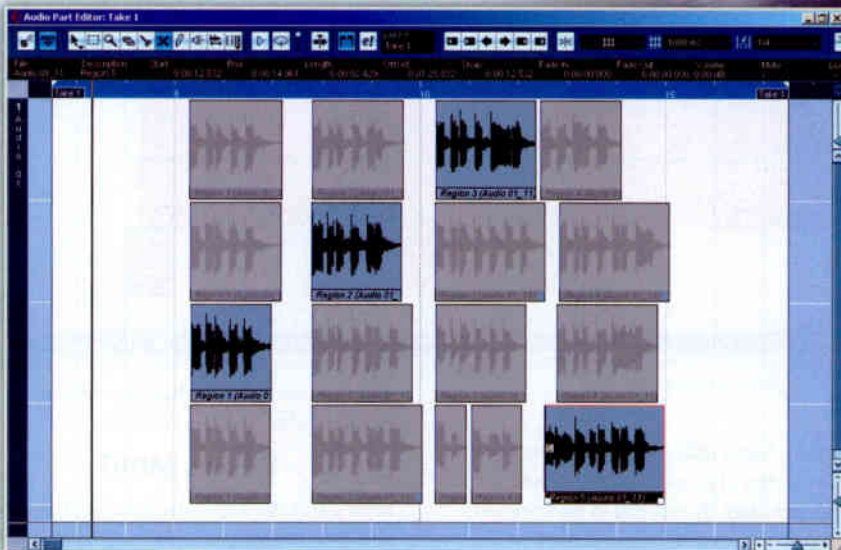



# ALL ABOUT THE MUSIC

## NOTE EXPRESSION 2 COMPING

- Phase-accurate multitrack drum editing
- Lightning-fast multitrack comping
- VST Expression 2 for editing controllers on single-note level\*
- VST Amp Rack virtual guitar tone suite plug-in
- HALion Sonic SE with 900 production-ready sounds



64bit on MAC OS 10.6 and Windows 7

\*Cubase 6 Exclusive



Sascha Dikiciyan | Composer, Producer

Credits: Iron Evolution, Splinter Cell, Quake Series, Prototype, Hellgate: London, Starcraft 2 and many more...

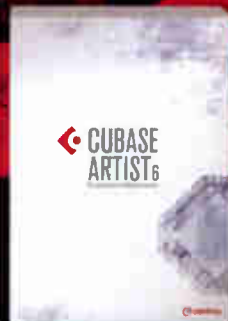

Noah Lifschey | Composer, Songwriter, Producer

Credits: So You Think You Can Dance (FOX), The Squad (A&E), ABC (MTV), Cheri Bomb (Hollywood Records), and many more...



**steinberg**  
Creativity First

"Steinberg, the inventors of VST Technology, have outdone themselves. C6 allows me to explore every potential of my musical ideas without limits. It's a software masterpiece"

"Cubase 6 takes my composing, writing and producing to even higher levels of ease, flexibility and creativity. The new features are essential weapons for my musical madness!"

© 2011 Steinberg, All Rights Reserved.

World Radio History

The three main MIDI editors used in most DAWs: the piano roll, the score and the event list. Notice how each one represents the MIDI notes in a different way.

» perspective it is fairly straightforward and there are many in-depth books and articles on the subject if you wish to explore further. There's also a chapter on the basics of MIDI later in this guide.

## Effects Plug-ins

Rather than buy hardware effects boxes, most DAWs allow you to use plug-in effects to recreate all the usual studio tricks, from chorus and flanging to delay and reverb. Some will come with the DAW, while others will have to be bought as add-ons. Pretty much anything you can buy as hardware is available as a plug-in, as well as some seriously sophisticated processors that have no hardware counterparts. If you're into effects, you'll be like a kid in a sweet shop when you get your DAW up and running!

## Software Instruments

In the plug-in world, there are numerous instruments that can be used in MIDI tracks to play back your MIDI performances. These include emulations of existing synthesizers, drum machines and samplers in which the sounds are based on samples taken from real instruments, such as pianos, drum kits or orchestral elements. There are also some very sophisticated original instruments based on combinations of synthesis, sampling and effects processing that have no hardware counterparts. Depending on their complexity, these may take very little of your computer's CPU power or they may take a lot.

Sampler plug-ins work best when you have enough RAM to hold all the sampled sounds you're using in a project, hence the need to fit your computer with plenty of RAM. If you don't have enough RAM, the plug-ins may have to stream samples from

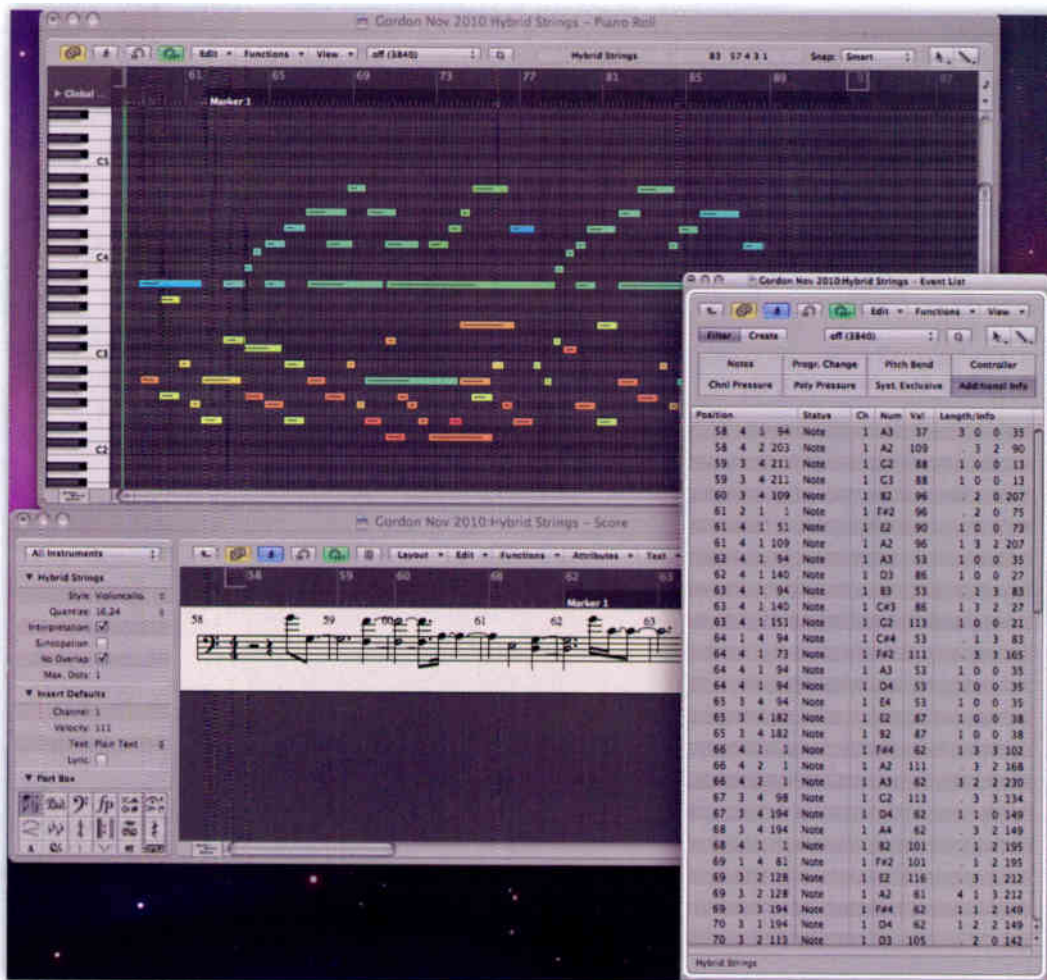

the hard drive, thus reducing the capacity for audio playback when you're running a lot of tracks.

## Choosing Your DAW

Choosing the right DAW at the outset is arguably the most important decision you'll make as far as recording is concerned, as you'll invest a lot of time in developing the skills required for its operation. Despite tempting offers from the various DAW manufacturers, few users relish the idea of changing platforms once they've become familiar with their first DAW. This is one of the dangers of using whatever software comes free with your audio interface, because if it later turns out that something else might suit you better, you'll probably be reluctant to start learning a new DAW all over again.

Before you can make an informed choice, you need to think about how you aim to make music now and how that might change in the future as your skills develop. For example, you might only want to record your acoustic guitar and voice right now,

but perhaps in the future you'd like to add orchestration, which usually means working with MIDI. You may also want to consider using the same DAW as other musicians with whom you are likely to collaborate, as transferring projects between different types of DAW is never entirely straightforward.

Some DAWs are best at handling audio and have a less sophisticated MIDI side, while others concentrate mainly on software instruments and offer less sophistication for straightforward audio recording. Others offer a good balance of the two areas.

**Good general-purpose DAWs include:** Apple's Logic, Steinberg's Cubase and Nuendo, Cakewalk's Sonar, Avid's Pro Tools, MOTU's Digital Performer and Presonus' Studio One.

**DAWs with strong audio-editing capabilities include:**

Avid's Pro Tools, Cokcos' Reaper, Prism Sound's SADiE and Merging Technologies' Pyramix. You'll also find the audio side of Logic, Cubase, Sonar, Magix's

**Samplitude** and **MOTU's Digital Performer** more than adequate for typical recording projects. Having a good MIDI side doesn't necessarily make the software any more expensive, so don't feel bad about not using some of the features on offer. The reality is that most DAW users, myself included, only use a small fraction of what their software can do.

**DAWs that are good for loops and samples include:** Ableton's **Live**, Sony's **Acid Pro**, Propellerhead's **Reason** or even Apple's **GarageBand**. Third-party sample and loop libraries are available for many different genres of music, though it is probably fair to say that loop-based composition is still best suited to the production of dance and urban music. If you want to add your own vocals or other 'live' sounds, make sure that your choice of DAW also has the facility to record audio tracks.

If you're a Mac user and are still undecided, try **GarageBand** as that comes free with new Macs (and has some great loop-based facilities as well). If you decide to move up to **Logic Express** or **Logic Pro** at a later date, you'll be able to import your existing **GarageBand** files and continue working on them. You'll also find the transition to **Logic** less challenging as both programs follow a similar (but not identical) basic paradigm. It's also worth mentioning that some DAW software packages will only be compatible with Mac or PC. For example, **Sonar** is designed to be PC only, while **Logic** will only work on a Mac.

**Expert Advice** +

If you're stuck for which DAW might be best for you, it's worth checking out some of our *Sound On Sound* reviews of each one. Simply go to the **SOS Smart Guides** website, [www.sos-smartguides.com](http://www.sos-smartguides.com), and click on the bookazine cover to explore the portal.



There's a wide variety of processing plug-ins available. Here are just four examples of the kind of thing you might use with your DAW.

Before going further, I should mention the issue of plug-in delay compensation. One limitation to be aware of is that earlier native versions of Pro Tools, such as Pro Tools LE and M-Powered, don't automatically compensate for the small, but significant, delays that are introduced when a signal-processing plug-in is inserted into a track. The professional Pro Tools HD system and native versions from Pro Tools 9 onwards do have plug-in delay compensation, so go for one of these, if at all possible. All the other DAWs I've tried, even Apple's entry-level **GarageBand**, have automatic plug-in delay compensation.

### Help From The Net

Though there are many Internet forums you can peruse to find out what people think of the various DAWs, be aware that there's a lot of misinformation out there too, along with people who'll snipe at even the best systems just because they lack one or two features that only they would use. You'll also find people cursing their DAW for being unstable when the real

problem is their choice of computer, or perhaps an unfortunate choice of additional software that affects the stability of the machine. Try to gain an overall picture of what the various DAWs do well and remember that some users will defend their choices, however obscure, with almost religious fervour!

Many DAWs are available in a time-limited demo format, so if you're still undecided and have some spare time on your hands, you can always download the demos and take them for a spin. You may also find some of the better music stores have the various DAW software set up and running on demo machines for you to try, the advantage there being that staff members may be able to offer guidance if you get stuck.

Though you'll find a lot of 'cracked' software on the Internet, especially for Windows PCs, I'd strongly advise you not to take that route. Not only is it an illegal practice that deprives software houses (some of which are surprisingly small) of legitimate income, it is also fraught



» with risk. Cracked software can be very unstable and often comes packaged with adware and other nasties, all of which will cause you endless frustration. It can be a tempting option but don't do it! If you really think DAW software is too expensive, then look at the 'light' versions of the mainstream programs, which offer most of the key features of their pricier siblings at a much lower price point. There's usually a cost-effective upgrade path for when you do feel the need to move up. Most DAWs cost less than just the cables you'd need to set up an equivalent hardware-based studio!

**Reality Check**

Learning any DAW from scratch is a lengthy process, though it helps to learn the basics first and then explore the more esoteric features as and when you need them. A modern DAW contains a software representation of an extremely sophisticated 'real world' music studio. To use it all effectively, you need to know what all the

Instrument plug-ins cover the whole range of sounds — from drums to piano, orchestral instruments and synths.

components of a traditional studio do. This means you need to read up on mixers, basic digital audio principles, signal processing and effects, and the various synthesis and sampling techniques employed in today's plug-ins. While many plug-ins come with lists of user presets, things like EQ, gating and compression need to be adjusted to each sound source, so read up on those processes first.

Most manufacturers offer some kind of technical support, but some charge by the minute and others seem to be permanently engaged. It's often far better to get to know some existing users and also to join online user groups, where more experienced users are usually happy to share their knowledge. Keep up to date by reading the DAW techniques sections in *Sound On Sound* monthly and online. Also, avoid computer viruses by not using your studio computer online, other than when installing and updating software. Windows users should also use an up-to-date virus-removal program. Keep your original installation



Apple's GarageBand — included for free on most new Macs.

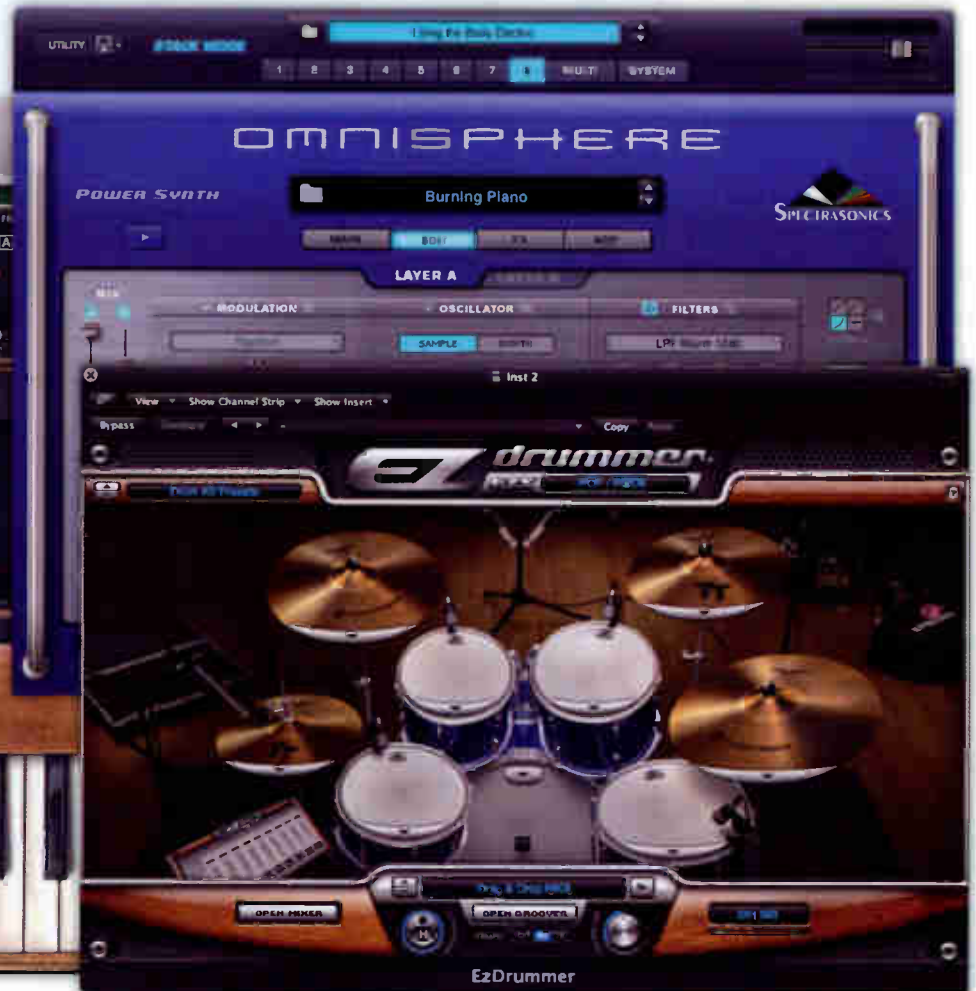

# CHOOSE THE RIGHT DAW

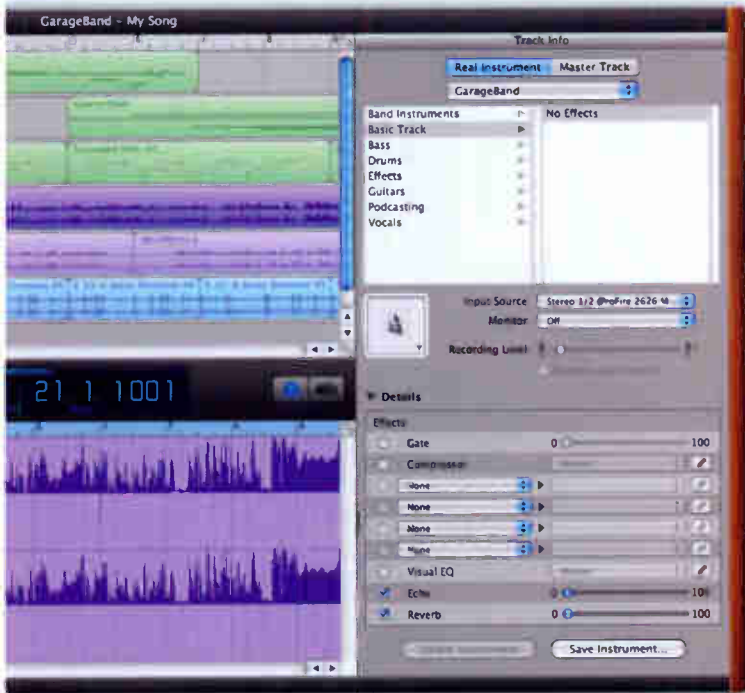

disks and serial numbers in a safe place, as you may need to refer to these when asking for support, and you'll certainly need them if you need to reinstall the software from scratch for any reason.

## Summary

- Think about your musical needs and then choose a DAW package that meets those needs. For example, don't go buying an all-singing-all-dancing loop-manipulation program if what you really want to do is record your band and then make minor edits to polish up the performance. Also, think about other musicians with whom you may collaborate and see if the DAWs they are using would also suit your needs.
- Download demo software to test it for yourself, but avoid cracked software like the plague as it may well corrupt your system, impair performance or allow viruses into your machine — and that's without even mentioning the legal and moral implications.
- Don't dismiss the light versions of the mainstream DAW programs as you may find they still do everything you need at a much lower cost. **///**

## Selected Manufacturers

Ableton <a href="http://www.ableton.com">www.ableton.com</a>	MOTU <a href="http://www.motu.com">www.motu.com</a>
Apple <a href="http://www.apple.com">www.apple.com</a>	Presonus <a href="http://www.presonus.com">www.presonus.com</a>
Avid <a href="http://www.avid.com">www.avid.com</a>	Propellerhead <a href="http://www.propellerheads.se">www.propellerheads.se</a>
Cakewalk <a href="http://www.cakewalk.com">www.cakewalk.com</a>	SADiE <a href="http://www.sadie.com">www.sadie.com</a>
Cockos <a href="http://www.cockos.com">www.cockos.com</a>	Sony <a href="http://www.sonycreativesoftware.com">www.sonycreativesoftware.com</a>
Magix <a href="http://www.samplitude.com">www.samplitude.com</a>	Steinberg <a href="http://www.steinberg.com">www.steinberg.com</a>

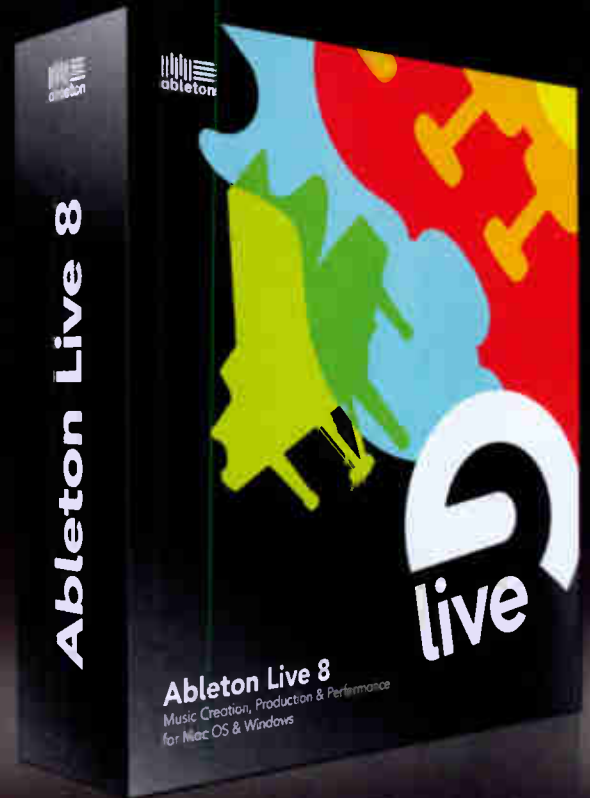

**ableton**

**THE FOUR STEPS  
TO START MAKING MUSIC**

# THE COMPUTER

Choosing the wrong computer for your studio could cause countless problems in the future, from software incompatibilities and fan noise to a slow machine interrupting your creativity. Here's how to get it right first time.

Once you've chosen your DAW, check if it is compatible with Macs or PCs. If it can run on either, you can choose, but otherwise you'll have to buy whichever it was designed for. Also, check the recommended (not minimum!) system requirements of your DAW on the manufacturer's web site, as this will help you choose an appropriate machine. If you feel totally lost, you can always contact a specialist audio computer company, who can build a machine to match your requirements.

Macs and PCs these days use similar processors and other components, which means they're capable of similar levels of

performance. However, Macs in general are more of a known quantity, as they're all made by one company and the components used are more consistent. PCs, on the other hand, are made by many different companies using hundreds of different combinations of components. In fact, even two of the same off-the-shelf model may contain different components.

Macs are significantly more expensive than most general-purpose PCs, but when it comes to comparing them with purpose-built audio PCs you'll find that they're actually about the same price.

Try not to be tempted by the bargain prices, shiny displays and big brand-names

of high-street computer stores. Firstly, most of their staff (even the tech support guys) tend not to be very knowledgeable about the requirements of audio PCs, unless you're lucky enough to find a branch where one of the tech support guys happens to be a home-studio enthusiast! Secondly, you're more likely to run into problems if you buy a general-purpose PC — and the situation may be even worse if you buy a cut-price laptop, because although the spec may look good on paper, they are often put together as a means of using up old parts before they become entirely obsolete.

Most PCs come pre-loaded with one of several versions of the latest Windows



operating system, whereas there's only one version for Mac, which can make things less confusing. In most cases, though, you'll find that any current version of Windows should be fine. In fact, with each iteration of the two operating systems, the two camps seem to be getting closer together, so it really comes down to your personal preference and compatibility with your DAW. If you're determined to have the best of both worlds, though, you can install and run Windows and PC-specific software on Macs using Bootcamp, which allows the computer to switch between the two operating systems. Bear in mind, though, that there are still many more viruses that target Windows, and this still applies even if running it on a Mac.

### Desktop Or Laptop?

These days, most moderately priced laptops can pack a fair punch when it comes to power and versatility. They're also extremely

It's possible to get desktop power on a laptop machine, so the main considerations when choosing between laptop and desktop computers are more to do with portability and value for money.

handy for those of us frequently on the move, visiting other studios and recording venues, as you can get the most of the power of a desktop machine in something a fraction of the size and weight. However, if you do most of your recording in your home studio and don't need to carry your computer around, you'll get more power for your money by choosing a desktop machine.

Another advantage of desktops is in 'future-proofing': they have more space for adding PCI or PCIe cards, hard drives, RAM and so on, and usually have more USB, Firewire or Ethernet ports. It's also possible to increase the capabilities of your laptop, though, so don't panic if this is what you'd prefer to do. Just bear in mind that

»

## Back It Up

Backing up work is vitally important as hard drives do fail and, although they are cheap enough to replace, the data they hold is very valuable to risk losing. Inevitably, the bigger a hard drive the more data you risk losing when it dies! These days there is a multitude of different backup options available. If it's

space you need, external hard drives are often the most cost-effective solution as you can purchase memory in TB (terabyte) multiples for around \$75. Each terabyte is roughly equivalent to 1000 GB. That's enough storage space for nearly 20,000 hours of CD-quality uncompressed audio, or

just shy of 2000 DVDs-worth of information. For those looking for the portability factor, flash drives can be a great option — you can easily cram anywhere from 4-256 GB of data on these, although they tend to be a little more sluggish. Finally, you can use backup media such as writable CDs, DVDs and even Blu-Rays, all of which last better in archive storage than hard drives and flash drives (which require regular use in order to continue functioning properly), but are more susceptible to damage as they scratch easily.

It's a good idea to get into the habit of backing up projects once they are complete, so that you don't risk losing any of your work in the future, but there is another way of getting back your data if you've chosen not to go down the backup media route. You can use a built-in recovery program such as Windows Restore or a software add-on such as Apple's Time Machine to restore your computer software to exactly how it was at a chosen prior date, if and when everything goes horribly wrong.

*You shouldn't trust your computer alone to keep you files safe, so budget for some way to back up your data when buying your computer. Popular backup media includes external hard drives and memory sticks.*



» it can be a more time-consuming and less cost-effective option.

### External Hard Drives

The biggest limitation on the number of audio tracks that can be played or recorded simultaneously is the rate at which data can be sent to and from the hard drive, so it's a good idea to record your audio files to a dedicated hard drive if you want the greatest possible track count. Most modern SATA drives running at 7200rpm or greater will be fine, and you can add an internal drive to a desktop machine, or an external drive to either a laptop or desktop machine.

Personally, I've found from my own experience with my MacBook Pro (an Apple laptop), that there's usually no problem recording to the computer's internal drive as long as you leave plenty of free space and don't try to record a silly number of tracks. A live recording of 16 simultaneous tracks is not a problem, and I know some people who have reported playing back a 70-track mix!

### Processor Speed & RAM

Speed is also important: your computer needs to be fast, but not necessarily the fastest available. If you buy a model that

runs at around 80 percent of the speed of the fastest model, then you'll get a good compromise between performance and value. Also, make sure you get enough RAM. If you intend to use a lot of software instruments based on sampled sounds, you'll need more RAM than if you're just recording and mixing. Some systems can stream sampled sounds from the hard drive to save on RAM, but the harder the drives are working, the fewer tracks you can play back.

Having enough RAM to hold all the samples being used in a song helps optimise the performance of your system. I hesitate to suggest exactly how much computer speed and RAM you should aim for as computer specifications improve dramatically every year in accordance with Moore's Law, which predicts computer speeds and storage capability will double roughly every 18 months. (If you were to read an article I wrote on computer requirements 10 years ago, you'd have a good snigger reading phrases such as: "Ensure your hard drive is at least 1GB and you have at least 64MB of RAM installed".) At the start of 2011, a quad-core Intel

machine running at 2.8GHz and fitted with 4-6 GB of RAM seems pretty high-spec, but give it three or four years and all it will attract is pitying looks. If you choose your computer wisely, though, it should last you around three or four years before it starts to look slow when loaded with newer and more power-hungry software. Of course, you can always take the view that if the software you use already does everything you need then you don't need to upgrade anything and the computer can enjoy a much longer working life. If you choose this route, you're no worse off than if you bought a hardware recorder that couldn't be upgraded.

### Noise

Many home-studio operators record in the same room as their computer, which means that excessive fan and drive whirring will be picked up by the mics and will then be on the recordings. The same noise will also distract you when you're trying to mix, so aim for the quietest machine you can get. High-performance 'gaming' PCs usually





come with high-powered (ie. noisy!) fans to cool their innards, and laptop cooling fans can get very noisy at times. However, modern Macs and dedicated audio PCs tend to be rather quieter.

## Interfaces

Audio interfaces are another matter entirely, and will be covered in some depth later in the book. Some systems utilise a dedicated card inside the computer to connect to an

with Firewire 400 ports use the six-pin format, whereas you'll need to check which type a PC uses. At the time of writing there are two Firewire speeds: Firewire 400 and Firewire 800. You can use an adaptor cable to hook up a Firewire 400 device to a Firewire 800 port, but that port will then only operate at Firewire 400 speeds.

Although many simple stereo USB interfaces are recognised by the computer with no need for dedicated driver

**"If you can already use the computer for word processing or email, then you probably know almost as much as you need to in order to access your DAW software."**

external interface box. Whatever you do, ignore the fact that your computer comes with a 5.1 multimedia soundcard installed: if you use it for music recording, it will probably drive you mad modifying settings to "enhance your gaming experience"!

Most interfaces connect by Firewire or USB. Firewire comes in both four- and six-pin formats, the latter being able to provide power for connected devices that can operate from bus power. Apple Macs

software, interfaces with a greater number of inputs and outputs usually come with specialised driver software. They may also come with mixing and routing software, the purpose of which will be explained in due course. You should always check the manufacturer's website for the latest drivers and firmware, as these may have been updated while the interface has been held in stock by the store.

## Before You Start

It might sound obvious, but if you're running a computer-based audio system, you first need to know your way around the computer! For example, you'll need to know the keyboard and mouse shortcuts for copying, pasting, moving and deleting items, and you'll need to be able to navigate the menu structure of the machine. If you can already use the computer for word processing or email, then you probably know almost as much as you need to in order to access your DAW software, but you'd be amazed how many people buy music computers

It's really important to find the right interface for your needs (which is something we'll look at in the next chapter), as it's one of the only essentials of the home studio.

## Nuttin' But Music

It's important to use your music computer only for music. If it also doubles as the family office, as well as being the house Internet hub and somewhere for the kids to do homework and play games, you'll probably find a bunch of problems when you come to use it for recording. Your music computer is a key part of your studio, not a household appliance, so life will be much easier if you treat it as such. There's a piece of hardware you can buy for around \$200 that'll keep your PC free from problems, reducing the frequency of crashing and the risk of virus infection. It's called an Xbox!

and then expect to be able to use them without even knowing how to open and save files! Sadly, saying, "I'm not technical, I just want to make music!" is not an option when working with DAWs. That's the price you pay for getting so much power for so little outlay. You don't need to be a computer geek, but you do need to be familiar with basic computer procedures, such as installing or updating software, adjusting preferences and settings — particularly for audio — and accessing additional hard drives. In short, whether you've chosen to use an Apple or a Windows machine, you'll still need to know how to drive the thing!

## Computer Tweaks

The latest Mac and Windows operating are pretty good for audio, but you can still do some things to optimise the system performance — largely by ensuring that the computer isn't trying to perform unnecessary tasks in the background and by disabling any energy-saving settings that might slow down the machine. Let's look at some ways you can do this:

- **Disconnect From The Internet**  
While it is extremely desirable to have broadband Internet access from your studio computer for updating, registering and authorising software, for instance, this should be switched on only when you need it. The last thing you need during a vital recording is for the computer to lag because it's trying to download a big software update.
- **Turn Off File Sharing Switch**  
Turn off any file-sharing options to prevent unwanted connections to your computer and, if you have an automatic >>



- » backup system, disable that for the duration of the recording.
- **Disable Spotlight (Mac)** Mac users running Pro Tools should ensure they disable the Spotlight key command as this key command is used by Pro Tools for something else. The current version of Pro Tools helpfully reminds you of this should you ever forget!
- **Optimise For Audio Performance:** If you have the choice to turn off graphics acceleration (which is good for games but a waste of computing power for music) then do so. Turning off those fancy animated icons can also claw back a little performance. Similarly, set the energy-saver panel so that your CPU and drives never sleep when running on mains power, and ensure you've switched the screensaver off. Although not strictly necessary these days, Mac users can also visit the Utilities section (found in Applications) every couple of weeks and select Repair Disk Permission from the Disk

Utility screen. This basically helps everything run that little bit smoother. If your processor has the option of running at a lower clock speed to reduce heating and energy usage then this should be disabled, as it can take a few moments for the CPU to speed up again when it recognises a heavy demand, and this in turn can lead to audio glitches and pops. Laptops often have this kind of feature to extend battery life.

### Good for Music?

Despite the fact that both Mac and PC machines use standardised components, different machines are built with different markets in mind. So you could end up buying a machine that has been optimised for fast graphics in order to appeal to the games market, but will cause glitches and crashes when running audio software. Most high-street computers will work well enough for music recording right out

of the box, but they'll need optimising correctly to give the best performance. Unless you already know a lot about PCs and are prepared to specify exactly what you want — or even build your own — then I'd strongly recommend that you pay the

extra for a machine that offers guaranteed performance with the DAW software of your choice, and that it is reasonably quiet. If you do decide to go for a laptop, seek advice on which models work reliably with your DAW software before making a purchase.

### Hard Drives

While, as I suggested earlier, you can get away with using a laptop with just its internal drive, this may not provide optimal performance. In an ideal world you'd use your internal drive just for programs or applications, one external drive for audio projects, one for your sample library and another for backup. You might even have one more for the automatic backup of just your internal drive.

A hard drive's performance is determined largely by its speed of rotation, which is usually either 5400rpm or 7200rpm. The latter is preferable for working with audio, but many laptops still use cheaper, small-format 5400rpm drives. This is fine for an operating system and running software, but can knock a third or more off your maximum track-playback capability. Whichever speed your hard drive is, it's extremely important that the drive always has at least around 10 percent free space, as data transfer rates get very slow once a drive is full.

To complicate things slightly further, the computer ideally needs to have multiple dedicated connection ports (generally USB 2 for the connection of hard drives, printers, keyboards, mice and smaller audio interfaces). This is another reason to get expert advice when buying, as some computers that appear to have multiple ports actually have these internally connected to the same controller chip, which can cause a data bottleneck. The fact that many audio interfaces also connect via USB just increases the amount of data being passed through these ports. The same is true of Firewire ports, where two or more often share the same controller chip. At the time of writing, most of the larger audio interfaces that are capable of handling eight or more channels connect via Firewire, though we expect the USB 3 or the newer Intel Thunderbolt protocols to take over from Firewire as the 'norm' before long.

You can reduce the data bottleneck by fitting enough RAM so that your sample library disk doesn't need to be accessed during recording or playback, and also

These days lots of popular software products come with licences installed on security dongles, such as the iLok, or proprietary flash drives. It's an inconvenience but, in this age of software piracy, a necessity on the part of the manufacturers in order to try and protect their products.





A dual-screen setup such as this one can be really helpful when you're trying to multitask without compromising screen space.

by disconnecting backup drives while the recording session is in progress. Where possible, don't connect multiple hard drives to a USB hub if they are likely to be accessed at the same time. If you have to use a hub, always try to plug your audio interface directly into a port on the computer to avoid problems.

### Software Protection

It's a sad fact of life that most software companies have to use some form of copy protection to prevent their products being copied and used unlawfully. While a few still trust the user with a simple serial number, most use either an online procedure that authorises the software for use on a specific computer (or sometimes two computers), or they use a hardware 'dongle', such as an iLok, which plugs into a spare USB port or hub.

These hardware dongles are, again, usually authorised online, but they have the advantage that they can be plugged into any computer. This enables you to install the software you need onto multiple computers and then simply plug the dongle into the one you want to use. Dongles tend not to send or receive large amounts of data, so they can usually be connected to a USB hub quite safely. My own system has several dongles poking out of various USB hubs, but most people won't need more than one or two.

### Screens

You'll almost certainly be using a flat display screen of some kind, rather than

the older and more cumbersome glass CRT screen. Flat screens have several advantages, their space and energy-saving facilities being the most obvious. But guitar players will also appreciate the lack of radiated hum, something for which the old CRTs were notorious. They're also not susceptible to the magnetic fields of

the most powerful that you can afford and don't skimp on RAM.

- Use, where possible, separate hard drives for audio projects, sample libraries and backups. Avoid letting your audio drive get too full — otherwise its performance will suffer.
- Don't try to use a general-purpose soundcard for music, because it is unlikely to provide the facilities or sound quality you need.
- Don't use your computer for anything other than music, especially games! Your system will be more stable if it is used only for its intended purpose.
- Ensure your computer has plenty of USB ports: ideally four or more. Expect to have to buy a hub if you need to connect copy protection dongles. Make sure the computer has enough Firewire ports for your needs, and remember that they all have to share the available

---

**"Your music computer is a key part of your studio, not a household appliance, so life will be much easier if you treat it as such."**

---

unshielded speakers.

Most of the mainstream DAWs allow you to have several windows open at the same time, so having a large widescreen monitor, or even a pair of medium-sized ones is an advantage. Modern computers make it simple to set up two (or sometimes more) screens in such a way that items can be dragged from one to the other. When working on a typical DAW it can be useful to have, for example, the main arrange window open on one screen and the mixer window on another. For working on a laptop or other system with a single screen, many DAWs have a system of screensets to enable you to jump between commonly needed screens using simple keystrokes. These work really well, so do use them!

### Summary

- Buy the fastest computer you can afford, and get professional advice on one suitable for music use if you're going for a Windows PC. Most modern Macs will work fine for music, but buy

bandwidth of the port to which they are connected. Try daisy-chaining your audio interface and backup drive, as it is unlikely both will be working flat-out at the same time.

- Check the Tweaks section earlier in this chapter, to save frustration and significantly improve overall computer performance before you load your DAW software. Mac users only need to switch off energy saving, wireless Internet and networking, but PC users may have more adjustments to make, particularly if using earlier versions than Windows 7. The Sound On Sound website at [www.soundonsound.com](http://www.soundonsound.com) as it provides access to many useful articles on the subject
- Once you've done all this, you can think about the extra equipment you might need, such as an audio interface, some speakers and acoustic treatment, a microphone, and — if you wish to use software instruments — a controller keyboard. We'll look at all this next... **■■■**

# GETTING THE GEAR

**So, you've chosen a DAW and a computer to run it on. Now it's time to figure out what other bits of hardware you need to turn your computer into a recording studio.**

**W**hile professional studios still spend big budgets on lots of impressive kit in order to meet the needs of a wide range of clients, you can have most of the same functionality at a fraction of the cost when setting up a home or project studio, by buying equipment tailored to your specific needs.

## **Audio Interface**

The first thing you'll need to buy before you can call your computer and DAW software a 'studio' is a suitable audio

interface. A soundcard that may be perfect for shoot-em-up games or flight simulators is likely to be entirely unsuitable for music recording but, since most retail PCs are geared towards entertainment and not music production, what should you be looking for? Serious audio interfaces are still available in PCI card format, though the majority now connect via USB or Firewire and come either as desktop boxes or rackmount units. You'll also find that some other audio products have audio interfaces built into them, from the simple

stereo-in/stereo-out of a Line 6 Pod amp-modelling processor to the multi-channel inputs and outputs available on a Mackie Onyx Firewire mixer. Some keyboards also feature audio interfacing capabilities, as do USB microphones. If these suit your needs, then they'll serve you well.

Some of the more serious soundcard audio interfaces have the downside that you have to delve inside your computer's machinery to install them and, unless they have an external hardware component, the audio connections tend to be via flying leads, rather than a nice solid box with mic and line input sockets. The fastest and most sophisticated interfaces tend to combine a PCI card with an external hardware box, handling as many as 64





There's a huge range of audio interfaces out there, so consider your needs carefully before you choose one.

channels of simultaneous recording. The main advantage to the PCI card format is that your audio data doesn't have to fight its way through all the other traffic passing through the Firewire or USB ports.

Interfaces that comprise external boxes are the easiest to work with as they connect via a single cable and are supported by easy-to-install driver software. In reality, they're no more difficult to install than a printer. While a high-end system with its own PCI card may offer

### Mind The Meters

Unlike analogue recorders, where it was normal to drive the meters 'into the red', digital audio should never be allowed to clip as there's no safety margin once the meter hits the top. Though you can use your DAW's meters to keep an eye on levels, some audio interfaces also feature some means of level indication, which you may find easier to see from a distance.

better performance when recording and playing back very large numbers of tracks, USB and Firewire interfaces are quite fast enough for normal studio use. It is rare to need to record much more than 16 tracks at a time, even if you want to mic up a full drum kit.

Most audio interfaces aimed at project-studio users have from two to eight sets of inputs, which may be line level, both mic and line level, or a combination of each. They'll also have two or more analogue outputs for feeding your loudspeaker system and, possibly, a separate headphone output. Sometimes, these analogue outputs will come equipped with physical volume knobs, offering a convenient method of adjusting monitor volume.

Multi-channel interfaces may also include one or two sets of Alesis ADAT-format optical connectors for adding further blocks of eight inputs (and sometimes outputs) via an additional

hardware unit. The ADAT optical format is essentially a standard for sending eight channels of audio down a single optical cable. Some interfaces will also include a traditional five-pin DIN MIDI interface for connecting MIDI keyboards and sound modules. (If you're new to MIDI, you can find a chapter on the subject on page 42 of this guide.) The popular M-Audio Profire 2626, for example, offers eight audio channels, which have both mic- and line-level inputs, as well as MIDI in and out and two ADAT expander ports so that you can extend up to a maximum of 24-channel operation. It also features two headphone outlets, each with its own level

### Phantom Power

'Phantom power' refers to using a mic cable to send power from the preamp to a condenser microphone. Most preamps and interfaces offer this, but it only works with XLR cables.



External preamps can range from being multi-channel beasts to compact, single-channel contraptions. Some also offer interface functionality via USB.

- » control, plus a further level control for the main stereo output. Note that the number of channels offered by your interface in no way restricts the number of tracks you can have in a project, just the maximum number of separate sources that you can record at the same time.

### Preamp

The job of the inputs on an audio interface is to bring up the level of the input signal to an optimum level for recording. Microphones produce a relatively low signal and so require a lot of gain. They are usually fed into a three-pin XLR socket via a balanced cable (see the next chapter for more information on balanced and unbalanced connections). Most capacitor

microphones also require 48V phantom power to drive the onboard electronics.

Line inputs from electronic instruments are higher in level than mic signals and so need less gain boost to bring them up to a suitable recording level, while instruments with passive pickups, such as electric guitars and basses, need to plug into a high-impedance input to avoid compromising the signal. Many interfaces include an instrument input (otherwise known as Direct Inject or DI) option where a front-panel switch (or sometimes a software switch) is used to change the jack input from 'Line' to

'Instrument'. The preamp level controls are then adjusted to give a suitable reading on the input-level meters of your DAW software.

If you have a standalone mic preamp, you can plug its line output into the line input of an audio interface and use it that way. If the preamp has a balanced XLR line output, you'll need to buy an adaptor cable to convert it to a balanced jack.

You can also plug the line outputs from a small mixer into the line inputs of an audio interface,

enabling you to use the mixer to provide one or more microphone preamps.

### DI Box

A DI box is a special type of preamp, usually offering a high-input impedance to facilitate use with electric guitars and basses.

The output from the DI box is on a balanced XLR (three-pin connector) that connects directly to the mic input of a mixer, mic preamp or audio interface.



The Radial J48 is a highly regarded active direct injection box.

### Speakers Or Headphones? +

While some people are tempted to mix entirely on headphones, it can be risky. As well as stereo imaging sounding different on headphones and speakers, the bass end of headphones varies according to model and manufacturer and can even depend on how well a particular pair of headphones fits over your ears! Headphones do have one distinct advantage, however, often picking up problems that are easily missed on speakers. For all these reasons, it makes sense to check your mixes on both speakers and headphones, and not rely solely on either.

Most active DI boxes require phantom power for operation, though some can also run from batteries. The term 'active' simply means it contains electronic circuitry that needs powering. There may also be a link jack connected directly to the input so that the signal can be split with the link output feeding, for example, a guitar or bass amp, while the balanced output feeds a recording or PA system.

## Speakers

Hi-fi speakers are usually designed to flatter your music collection, whereas studio speakers and headphones need to be as accurate as possible so that your mix will sound acceptable on other sound systems. Similarly, computer speakers are designed to make games sound exciting, but they rarely approach high fidelity. If your speakers aren't accurate, you'll find yourself making adjustments to your mix to iron out the problems in the speakers. That, in turn, will only make your music sound unbalanced if played elsewhere. For example, if your speakers produce too much low end (bass), you'll probably compensate by reducing the amount of low end in your

mixes. The outcome of this will be that your mixes sound bass-light when played back on more accurate systems. You can either buy passive speakers and team them with a suitable hi-fi amp or you can get active speakers with the amps built in. If you already have a good-quality, reasonably powerful hi-fi amp then, by all means, consider passive monitors, but my preference is for active monitors as

it takes the guesswork out of choosing a suitable amplifier. Usually, there's also some form of driver protection already built in.

It's worth checking reviews to see which monitors deliver accurate sound, but you shouldn't buy anything that is too big for the room you're intending to use for your studio, or you'll just invite bass problems. For a typical domestic room, a pair of two-way speakers with main drivers between five and eight inches in diameter will be fine. You should be aware, though, that both the speaker position and room »

Monitor speakers are an essential bit of kit for your studio, so ensure you get a good-quality pair.



# Subscribe to **SOUND ON SOUND**



12 issues only \$60

SAVE OVER  
**40%**  
on the  
bookstore price

- > More product coverage than any other music magazine
- > In-depth product testing
- > Software and hardware: we know the importance of both
- > The best musician, engineer and produce interviews you'll read anywhere
- > Tutorials and practical 'how to' workshops offering no-nonsense tips and techniques
- > A highly experienced editorial team, second to none in hands-on expertise
- > Since 1985 Sound On Sound has remained consistently at the forefront of developments in technology shaping the music production industry today

[www.soundonsound.com](http://www.soundonsound.com)

**SOUND ON SOUND** Social



[www.twitter.com/sospublications](http://www.twitter.com/sospublications)



[www.facebook.com](http://www.facebook.com) (Sound On Sound)



[www.soundonsound.com/forum](http://www.soundonsound.com/forum)



[www.youtube.com/soundonsoundvideo](http://www.youtube.com/soundonsoundvideo)



# SOUND ON SOUND

subscribers also get FREE access to Sound On Sound online and the digital edition

<http://usdigital.soundonsound.com>

The same great print magazine content but now in an interactive, fully searchable version that you can view in your favourite browser\*

\*requires Flash v9 or higher



# SOS Priority Order Form

## 1 Your Details

Please print clearly using CAPITALS

Name: .....

Address: .....

.....

Tel: .....

Email: .....

## 2 Select Subscription

Please tick the relevant box:

New Subscribers

USA/Canada 12 issues \$60

USA/Canada 24 issues \$99

Renewing Subscribers Please enter your PIN number .....

USA/Canada 12 issues \$49

USA/Canada 24 issues \$89

(All subscriptions include FREE electronic access to soundonsound.com and the digital edition)

## 3 Payment Options

I enclose a Cheque / Postal Order payable to: Sound On Sound Ltd

Please debit my : Visa / Mastercard / Maestro.  
All payments must be in US Dollars.

Credit Card No: .....

Card Valid From: ..... Card Expiry Date: .....

Issue No: ..... Card Security No. (3 or 4 digits) .....

Signed: .....

## Contact details:

Sound On Sound Ltd, Media House,  
Trafalgar Way, Bar Hill, Cambridge  
CB23 8SQ, UK

Tel: +44 (0)1954 789888

Fax: +44 (0)1954 789895

[www soundonsound com/subs](http://www.soundonsound.com/subs)

» acoustics can have a big influence on the accuracy of your system. I'll come back to choosing and setting up your speakers later in this guide.

## Headphones

There are many good-quality headphones around, but the type you need varies according to the purpose for which they will be used. Open or semi-open back headphones are best for mixing as the low end is likely to be more accurate. For monitoring while performing, fully enclosed headphones are better as they allow much less sound to leak out and find its way back into the microphone. You should select your headphones according to what you'll be doing most often, but it's worth getting a pair of each, especially if you're intending to do a lot of mixing and performing. Whatever you decide, make sure you invest in a good-quality set. Decent headphones enable you to hear flaws in your mixes that you might miss when listening over speakers. (They also allow you to continue working late at night without disturbing anyone!)

## Microphones

While you can record almost anything using a live-sound dynamic mic, you won't always get the best possible results. Designed to help the voice project in the upper mid-range, the dynamic mic's flaw lies in its moving-coil mechanism, which isn't too good at capturing higher frequencies. Consequently, things like acoustic guitar recordings may lack sparkle. To capture the entire audio spectrum you need a capacitor microphone. At one time these were simply too expensive for the project-studio owner to consider buying, however, thanks to the increasing size of the project-studio market and a downward pressure on prices brought about by overseas manufacturing, there's now a wide choice of very affordable capacitor microphones available. Check out the chapter entitled 'Mics & Miking' for advice on suitable models.

## Monitor Controller

If, like many studio owners, you choose active speakers, you'll need a physical control to turn the volume up or down. While you may be able to adjust the output from your DAW software, this isn't the best way to control volume and

you could be in for some loud bangs and pops if the software crashes while the speakers are connected. A better option is to use a desktop box with a volume control between the DAW output and the speaker. While there are some products that are simply a volume knob in a box, the majority also include a headphone outlet with its own level control, and switches to allow two or three different sound sources to be selected, such as your DAW, an MP3 player or a CD player, for example. They may also have the option to switch between two or three sets of speakers, the idea being that you might want a cheap and nasty set of

## Adding 'Comfort' Reverb



Singers aren't used to hearing their voice completely 'dry' and hearing reverb while they record often helps them to pitch correctly. Some interfaces allow you to add reverb to the headphone mix, but if you use a mixer as a mic preamp, you can easily hook a hardware reverb up to it.

speakers alongside your main monitors to check your mix will sound good on a small radio.

More sophisticated monitor controllers, such as the Mackie Big Knob, also include



Different mics suit different tasks, so think about what you'll be recording.



The Mackie Big Knob: a monitor controller that also features a talkback function, allowing you to communicate with musicians while recording.

up as you need to create the monitor mixes in your DAW and send each to a separate physical output of your audio interface. This, of course, requires an audio interface with multiple outputs.

### DAW Controllers

Mixing with a mouse can be incredibly challenging, which is why the DAW's ability to record and play back fader moves (mix automation) is a necessity, not a luxury. However, there are third-party hardware control surfaces that give you more traditional hands-on control, all the best ones having motorised faders that follow the on-screen fader movements when automation is being played back. You use these same

a talkback mic and talkback button so that you can interrupt the headphone feed to the musicians to pass on instructions. Talkback is incredibly useful for people who have studio gear in one room (the control room) but have a different room for performers (the live room). If you have this type of setup, you'll also need to budget for a headphone amp to put in the live room so the musicians can hear each other and the output from the DAW. Usually this can be fed from the studio

output of the monitor controller.

Simpler headphone amps designed for foldback will have one input and two or more headphone outlets, each with their own volume control. If you have a small mixer that you use for live work, you can also press that into service as a monitor controller and headphone amp. More sophisticated headphone amps may have separate inputs for each performer so that each can have their own monitor mix. This is a little more complicated to set

faders to record new automation moves or to modify existing ones. While you can operate a DAW using only a mouse and get perfectly good results, many people find that using a control surface improves workflow and makes the whole recording and mixing process more pleasurable. Even if you don't buy one right away, it is something to consider for the future.

The simplest DAW controllers, such as the Frontier Designs Alphatrack, are around the size of a paperback book and



## The 'L' Word

You won't get far into computer recording before you come across the term 'latency'! Because computers multitask, they sort out their tasks into little blocks and then do a bit of each job before moving on to the next. Data buffers are used to store up data in advance so that the flow doesn't stop while the computer is attending to something else, such as accessing a hard drive or redrawing a screen.

When applied to audio, this means that anything you feed into the computer will emerge from it after a short time delay related to the size of the data buffer (usually just a few thousandths of a second) and, while a modern system can run with a very small delay, it is always present to some extent. This is latency and it can be adjusted in your DAW's settings by choosing a larger or smaller data buffer size. A smaller buffer means less delay, but when the computer is working hard it increases the risk of audio glitches if the computer can't keep up.

Latency delay is only a real issue when overdubbing parts at the same time as monitoring your performance. Despite what you record being kept in sync with the tracks you've already recorded, the part you're currently overdubbing will be heard over the speakers or headphones after the delay. This can be very off-putting to a performer trying to sing and play in time. Even a few milliseconds is enough to upset some performers, although the majority of musicians can live with anything under 10 milliseconds.

To get around this problem, some audio interfaces provide what is known as Latency-Free Hardware Monitoring: when recording a new part, your voice or instrument is routed directly to your headphones for monitoring purposes, bypassing the computer altogether. This is a simple and effective solution but makes it more complicated to add 'comfort' reverb (see the box overleaf for more

information) via the DAW's plug-ins at the time of recording to help you sing better — and some singers can't perform without 'reverb in the cans'. To get around this, some of the more exotic interfaces include built-in effects to help musicians feel more comfortable while overdubbing. You'll find a description of adding plug-in reverb to the dry or unprocessed latency-free hardware-monitored signal later in this guide.

You can also set up latency-free monitoring on some mic preamps (such as the SPL Channel One), although you can achieve the same thing using a small mixer instead of a preamp. People generally can't perceive a delay of less than 20 or 30 milliseconds as being a separate echo because the delay simply blends in with the original. A change in tonality may be perceived, however. It's possible with most DAWs to set a buffer size small enough to get the latency down below 10 milliseconds, which is usually sufficient.

“While a high-end system with its own PCI card may offer better performance when recording and playing back very large numbers of simultaneous tracks, USB and Firewire interfaces are quite fast enough for normal studio use.”

» have only one moving fader, which always follows the channel you have selected in the DAW software. They also include a small LCD screen, transport buttons similar to those on a tape recorder and a few other controls to access key features and to move the cursor position in the song. Though this sounds simplistic, these little controllers can make a DAW much easier to use.

You may also find basic DAW controls built into some USB music keyboards, those made by Novation and Edirol being both popular and cost effective. While this type of device seldom features moving faders, they generally provide transport controls and several knobs with LCD screens that can be assigned to the most commonly used DAW functions and can also be used to control plug-ins.

The next step up is a controller with multiple faders so that you can adjust several channel levels at the same time. They may also have rotary controls for adjusting pan, EQ and plug-in settings, as well as Mute and Solo buttons. These feel more like working on a traditional mixer: the Mackie Control and the Euphonix Artist Series controllers are probably the best-known in this category. This type of product generally offers eight channel faders with a bank switch that lets you move onto channels nine to 16, and so on, if you have more tracks in your project than faders on your controller. You can also extend most systems by adding an extra expander unit with more faders.

At the top of the range are digital mixing consoles that can also double as DAW controllers. These are a good choice

for professionals, but not really suitable for project studios.

If you’re using a laptop, one of the compact, single-fader controllers will make your life easier without cluttering up your workspace. Though, if you’re a keyboard player, consider a keyboard with some level of DAW control built-in. If you have a reasonably spacious studio and your budget will stretch to it, consider one of the multi-fader control options mentioned earlier.

### Music Keyboard

Even if you’re not really a keyboard player, some form of music keyboard is useful for tapping in drum rhythms and playing simple melodies. The smaller Novation and Edirol keyboards connect via USB and many models include some level of DAW control. Most of these budget models have simple sprung keys, like an organ, and they come in all sizes from just a couple of octaves up to a full 88-note piano scale. Any model worth having will be velocity sensitive, so that

DAW controllers range from the compact-yet-effective Frontier Designs Alphatrack to Euphonix’s MC Mix. You can even download powerful DAW controller apps for your iPhone or iPad!





The SSL Nucleus controller/interface.

you can produce louder sounds by hitting the keys harder, and will also include physical control levers or wheels for controlling pitch bend and vibrato depth during performance. If you want the feel of a traditional weighted piano keyboard, expect to pay a lot more for it.

While you can use a keyboard synth as a controller keyboard by using its MIDI output, there's a lot to be said for having a compact, lightweight keyboard on the desk where you can reach it while composing on your DAW. The majority of controller keyboards are 'dumb' (they produce no sound on their own), but that's hardly a limitation as most project-studio owners use software instrument plug-ins.

One very practical benefit of using plug-in instruments that you may not have considered is that, when you save a song that you're still working on, all the settings for that project are saved, including all your plug-in settings. That means that if you've tweaked a software synth to create the perfect bass sound, it will be recalled exactly as you set it next time you open that song. You can't always say the same for traditional keyboards, as

you have to save any changes you make to one of the user memories to be able to get them back.

### Shop Smart

- A basic DAW system comprises a computer running suitable DAW software, an audio interface and some means of monitoring the audio output, such as loudspeakers or headphones. To record audio you'll also need a microphone, though you can record electric guitars and bases by plugging directly into the audio interface, providing it has a high-impedance instrument DI option. You'll also need a MIDI or USB controller keyboard to play those virtual instruments, unless you have some alternative type of musical controller.
- The functionality of your DAW can be enhanced with third-party plug-ins.
- There are several pieces of hardware you can add at a later date to upgrade your system, such as a hardware DAW controller, a monitor controller and additional microphones and mic preamplifiers. You don't have to buy everything at once.
- Don't forget to factor in the cost of accessories such as mic and instrument cables, mic stands, speaker stands (unless you plan to put your speakers on the desk) and some kind of desk upon which to set up your studio!
- You may also need to buy some acoustic products, such as sound-absorbing foam to improve your monitoring environment, a 'behind the mic' type of screen to reduce the impact of room reflections on your recordings, a pop shield for your microphone and, perhaps, a shock mount for your microphone. ■■■

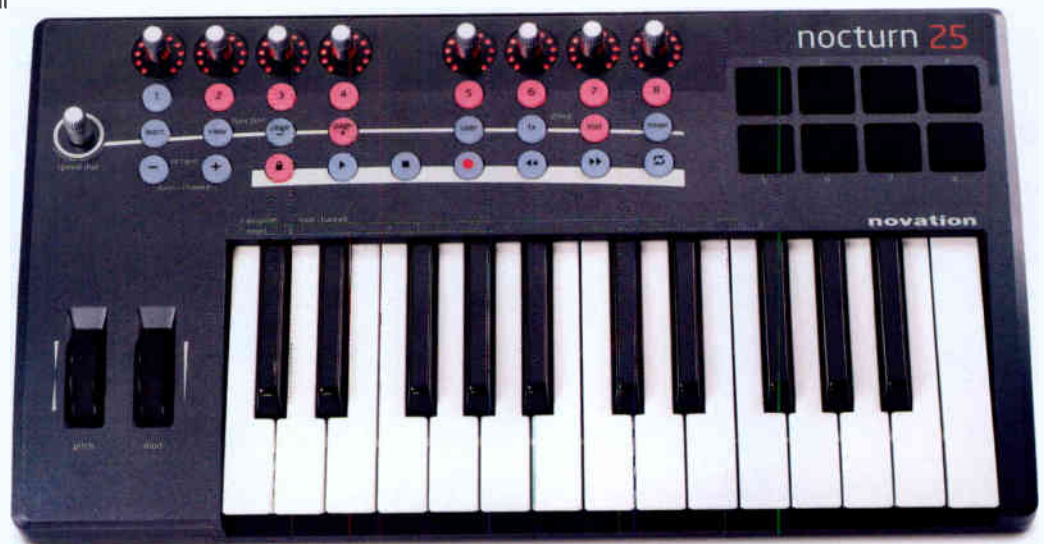

The Novation Nocturn 25 keyboard features controller capability, including drum pads and transport buttons.

# WIRING THE STUDIO

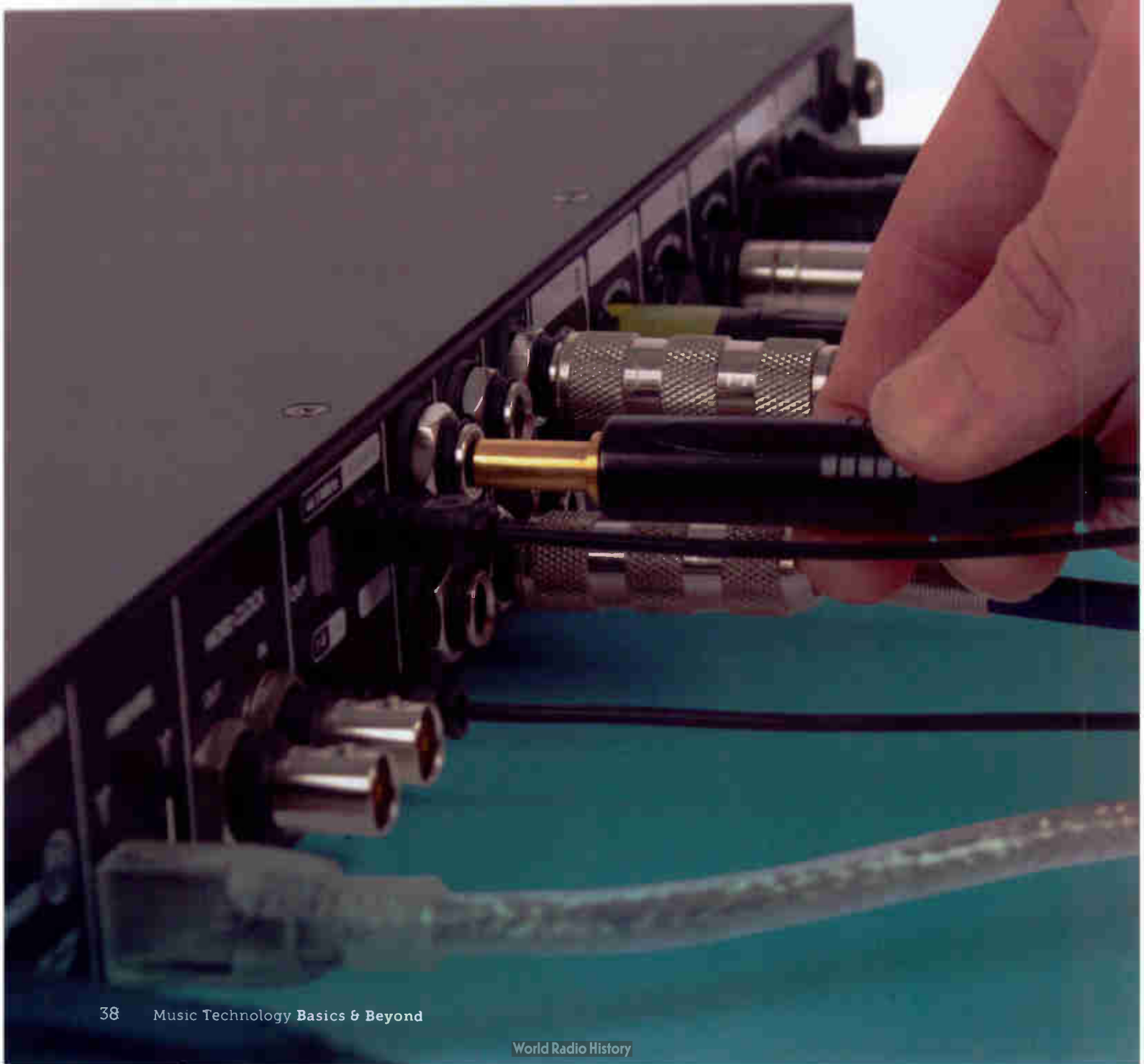

## You've chosen your gear and you're itching to record some music. But before you can get started, you need to know how to connect it all together!

The modern computer-centric studio is considerably less daunting to set up than the traditional 'tape machine and mixer' studios that were common towards the end of last century, but you're still going to need to know how to connect everything together. On the final page of this article, I've provided a diagram that shows a typical setup.

### First Things First: Cables

You can buy virtually all the cables you might need pre-made in a range of standard lengths to suit your studio specification. The down side of these standard lengths is that you'll often find some clutter from excess cables. Nevertheless, you should be able to get a basic desktop studio up and running with just a handful of off-the-shelf cables.

**XLR:** XLR cables are usually fitted with a 'male' 3-pin XLR connector at one end and a female XLR at the other. The male connector is the one with the pins. These

cables comprise two insulated inner conductors surrounded by a conductive screen of woven wire, metal foil or conductive plastic, the general idea being that the screen intercepts electrical interference and drains it away to the electrical ground or earth of the system.

These cables are used for all standard

In addition to connecting microphone equipment, XLR cables are sometimes also required for balanced line-level connections (see the box on balanced and unbalanced connections for more information on this) and for transmitting digital data between equipment that uses the AES3 protocol. The same

**"Balanced wiring is a three-wire system: a screened cable with two cores and a conductive outer sleeve to provide electrostatic protection."**

microphone connections (other than valve mics, which have their own cables to connect them to their power supplies). If you need to plug a microphone into a preamp, mixer or audio interface that has mic inputs, you'll need to buy an XLR cable, as most mics come without them.

type of cable can be used for all three applications.

You'll find XLR cables ranging in price from just a few dollars to well over \$100 per cable, but there's absolutely no need to overspend: as long as you buy cables fitted with decent connectors from a reputable supplier, they should work perfectly well.

**Balanced Jacks:** Balanced line-level signals can also be carried using the type of jack plug used to carry stereo audio in consumer products, such as headphones. These are easily recognisable: they have



XLR cables have three pins, as shown here. The male version has pins extended, whilst the female version has holes to receive the pins. It all depends on the exact gear you have as to which kind of connection you'll see. This audio interface has both male and female connection points, whilst the microphone has only a male connection point.

### Cable Hygiene

- Keep mains cables away from signal cables where possible, especially unbalanced cables such as guitar leads.
- Use balanced leads to connect any equipment that is designed for balanced operation.
- Don't buy the cheapest cables as they are likely to be fitted with equally cheap connectors that will fail more often than decent ones. The ability of the cable to screen interference may also be less impressive if you buy the cheapest. However, there's no need to shell out for the most expensive, exotic studio cables as you'll usually be able to find perfectly decent cables for a reasonable price. Strike a balance between the quality on offer and the funds in your wallet.



Balanced jacks have a tip, ring and sleeve (TRS) whilst unbalanced jacks just have a tip and sleeve (TS). The ring is easily identified by the second band around the metal sheath of the jack, as shown on the topmost of these jacks.

“If you can hear a hum from your monitors then you may be suffering from a problem known as a ground loop.”

that has balanced jack inputs will also work with an unbalanced input via an unbalanced jack cable, although it is advisable to keep the connections short to avoid interference problems.

» a long metal barrel or sleeve connected to a small metal ring between two plastic insulators, with a rounded metal tip that connects to the two inner conductors. Unsurprisingly, these jacks are referred to as TRS (tip, ring, sleeve). For most audio equipment, quarter-inch jacks are used rather than the miniature eighth-of-an-inch variety.

**Unbalanced jacks:** The plugs on unbalanced jack cables can be recognised by their lack of a ring connector between the tip and sleeve. These cables, which have just one conducting core inside the outer screen, are used mainly to connect instruments, such as guitars and electronic keyboards, to the inputs of amplifiers or recording systems. Most equipment

### Balanced/Unbalanced Wiring

Most audio equipment operates internally with ‘unbalanced’ signals. These are transferred between devices using a single-core cable surrounded by an all-encompassing metal or conductive plastic braid called the screen. The signal voltage is passed on the inner core while a zero volt (ground) reference voltage is conveyed by the outer screen. The screen also serves to ‘catch’ any radio frequency interference (RFI) and prevent it from influencing the audio signal.

Where greater protection from electromagnetic interference and freedom

from earth references are required, a ‘balanced’ interface is used. Balanced refers to the way the signal is passed: instead of a single-core cable with a screen, balanced wiring uses a screened cable with two cores. The screen is grounded, as with the unbalanced interface, and the two inner cores carry the same electrical signal as each other where one of the cores (known as ‘cold’) has its signal polarity inverted with respect to the other conductor (known as ‘hot’).

So why this hot/cold arrangement? Any interference making it through the outer

screen will affect the hot and cold signal cores equally as they are in very close proximity to each other. To exploit this, the receiving piece of equipment inverts the cold signal to put it back ‘in phase’ with the hot signal, but in doing so it must also invert the polarity of any interference picked up by the cold conductor. The outcome of this simple but effective strategy is that when the hot signal is recombined with an inverted version of the cold signal, the wanted signal is reinforced but the interference components cancel each other out.

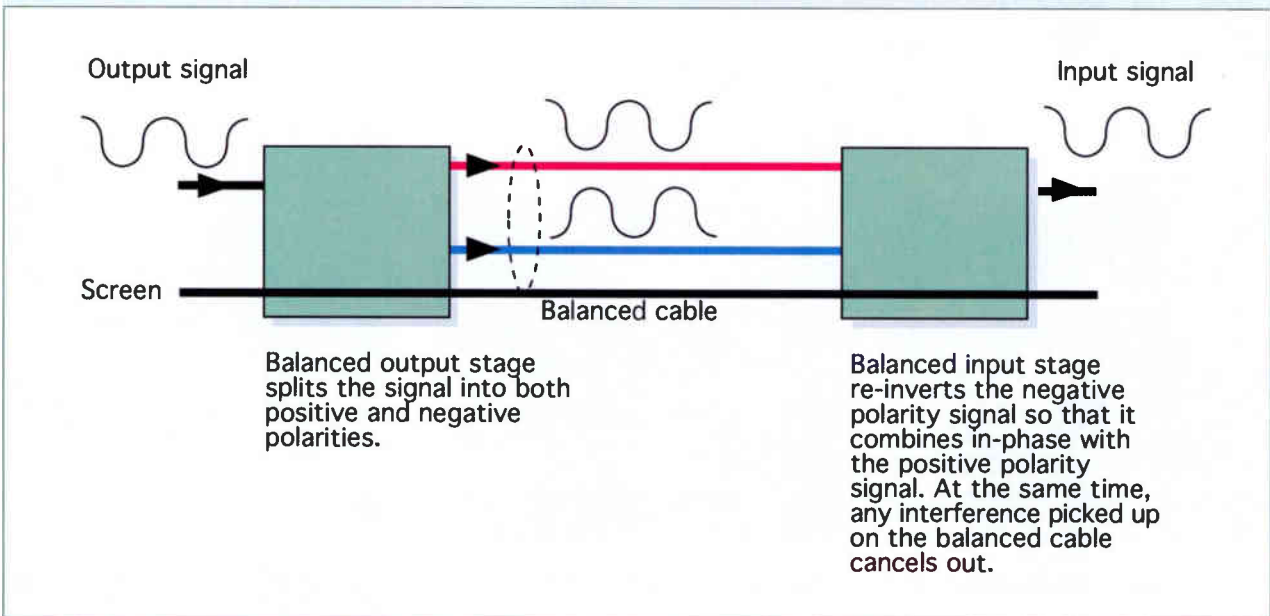

Balanced wiring cancels out interference by splitting an audio signal into positive and negative polarity signals at the output, and then combining the two on input, as shown in this diagram.



## Going To Ground

Having too many grounds in a system can aggravate ground-loop hum, as described in the main text and shown below. However, having no grounds at all is also a recipe for hum, and that's a situation you may find yourself in if all your studio gear runs from external power adaptors. In this category

you'll find things like laptop computers, guitar preamps, stand-alone hard-disk recorders, and so on. You must have at least one grounded item in the system to keep hum at bay, especially when recording electric guitar via a DI preamp which uses an external power supply. A ground wire

connecting one of the metal parts of your audio interface case to the metal case of another item that you know is grounded, such as a hi-fi system or a metal-framed table lamp, should cure the problem. Unless you know what you're doing, get a qualified electrician to do this job for you.

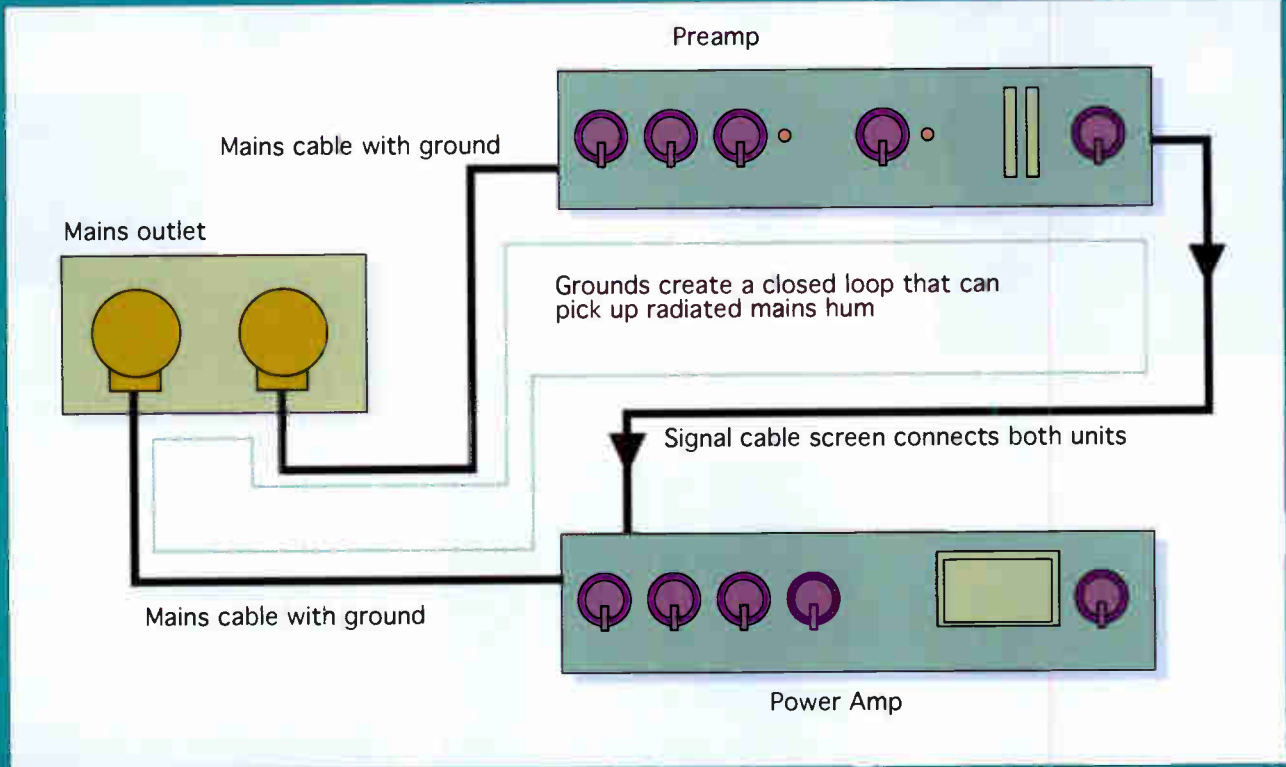

This diagram shows how ground loops arise in a situation with too many grounds: electromagnetic hum from electric components and wiring can be added to the audio signal, causing undesirable sounds.

**IEC leads:** Most mains connections are now via IEC leads, which many musicians insist on calling 'kettle leads', even though they probably won't fit most kettles. These have three conductors to carry the live, neutral and earth connections, and are usually supplied with equipment. Though rare, some equipment uses a two-pin version of this connector without an earth conductor. Three-pin cables also fit and are perfectly safe, but the two-pin IEC cable won't fit onto a piece of equipment with a three-pin connector as there's no hole for the socket's earth pin to fit into.

**Phono connectors:** These are found on many consumer audio products and are always unbalanced. They are simple and reliable, requiring only to be pushed into place, though they can work loose if >>



IEC leads (or 'kettle' leads, as you're most commonly going to hear them described) usually have a female connector on the end, adjoined to the three-pin power socket connector, whilst the equipment they plug in to generally uses male connectors. The IEC lead is one of the most widely used leads across the world because of its versatility. You'll find them powering a huge range of household appliances including kettles, printers, computers and televisions. Let alone audio equipment!



Phono connectors are easily recognisable from their single prominent pin with metal sheath at the base of the pin. They are usually supplied with red or black cables to indicate whether they are positive or negative, and always plug into a female connection point on any audio equipment (similarly coloured, to indicate the appropriate connection).

» repeatedly plugged in and unplugged. Note that the same type of phono connector is often used to connect digital equipment using the S/PDIF protocol, but audio phono cables should not be used as they are not suitable for the very high frequencies involved and may cause corruption of the digital signal. Always buy a dedicated S/PDIF digital phono cable for the job.

**Optical cables:** Used as an alternative to digital phono cables for passing

Optical cables (also known as Toslink cables as they were originally invented by Toshiba) are sometimes used as an inexpensive alternative to coaxial cables (a cable with a copper core insulated with plastic, covered in a copper sheath with a second layer of insulating plastic on the outside). They have only one disadvantage which is their fragility: bending or damaging the cables in any way, no matter how minor, can introduce jitter into the audio signal.

S/PDIF data (stereo), or for connecting using the ADAT protocol carrying up to eight channels of audio along a single cable, these comprise an optical fibre in a protective sheath. They should not be bent or wound into a tight radius as this may damage them and affect their ability to function.

**USB & Firewire:** These cables are commonly used to communicate data between audio interfaces and computers. It is worth using the shortest ones that



Firewire cables are very common in modern computers, and are widely used for multi-channel audio interfaces and other hardware. Of the two common high-speed data-connection formats, it is preferred over USB in the audio world due to its slightly faster speed and ability to maintain high data-transfer rates.



USB connections are one of the most recognisable in the computing world. Found on every single modern laptop and computer as well as a wealth of audio equipment and other hardware, USB is a type of serial bus capable of transferring large amounts of data in relatively short periods of time. This is one of the reasons it has gained so much popularity, but another is its relatively inexpensive manufacturing process.



will do the job. You can find them in any good computer store, and they are usually relatively inexpensive.

Firewire comes with at least three different connector types depending on



## DC Blocking Filters

You'll often find 'DC blocking filters' built into the devices at either end of balanced cables. These allow 48-volt phantom power to be applied to both cable cores without affecting the audio signal running along them. This DC voltage is separated out at the microphone (or active DI box) to power its internal electronics.

For more on phantom power, check out the chapter on microphones and miking in the Techniques section later in the guide, and the Glossary.

the speed of the connection and whether or not it carries power to the connected device, so check the connector you need before you buy.

USB cables can also come with miniature connectors on one end to suit cameras or other portable equipment, but these specialised cables are generally supplied with the original equipment. For general connections, there's only one standard USB cable, commonly available from any computer store.

**Wall warts:** Though not strictly cables, they are part of the spaghetti found behind most home studios as they're used to power everything from laptops



'Wall wart' is the colloquial name for an AC adaptor: they are so-called because they are generally unsightly black boxes that stick obtrusively out of wall-mounted power sockets. They can also be referred to as 'power brick', 'power supply' or 'power adaptor', and are an inexpensive way for manufacturers to provide power to their hardware without investing time and money in developing internal power supplies fitted with cooling fans.



to guitar pedals. I am, of course, talking about power adaptors. It is definitely worth labelling them as soon as you get them; they are often so similar there's no way of telling which piece of gear they actually belong to once they've all been plugged in.

## Cabling Best Practice

You could fill a whole book on studio wiring, and there are plenty of reference articles at [www.soundonsound.com](http://www.soundonsound.com) if you want to go deeper. For now, though, we've got some easy tips that can help keep you out of trouble.

**Power sockets:** Where possible, feed all your recording gear from a single power socket, using distribution blocks to 'fan out' the necessary power feeds from that point. A typical system takes relatively little current, so overloading the socket should not be an issue. This can really help avoid elusive hum problems. Try also not to share a ring main for your studio gear with anything that generates electrical noise, such as fridges, freezers and other machinery.

**Avoiding hum:** If you can hear a hum from your monitors (and I mean a hum, not a buzz!), you may be suffering from a problem known as a 'ground loop' where having pieces of interconnected equipment grounded by two or more different paths (for example, by the signal cable screen and the mains cable ground) can result in mains frequency hum being added to your audio signal. If you were to draw a diagram of the wiring, you'd >>

"It is definitely worth labelling power adaptors as soon as you get them."



A basic wiring tool kit: soldering iron, solder, wire cutters, pliers and screwdrivers.

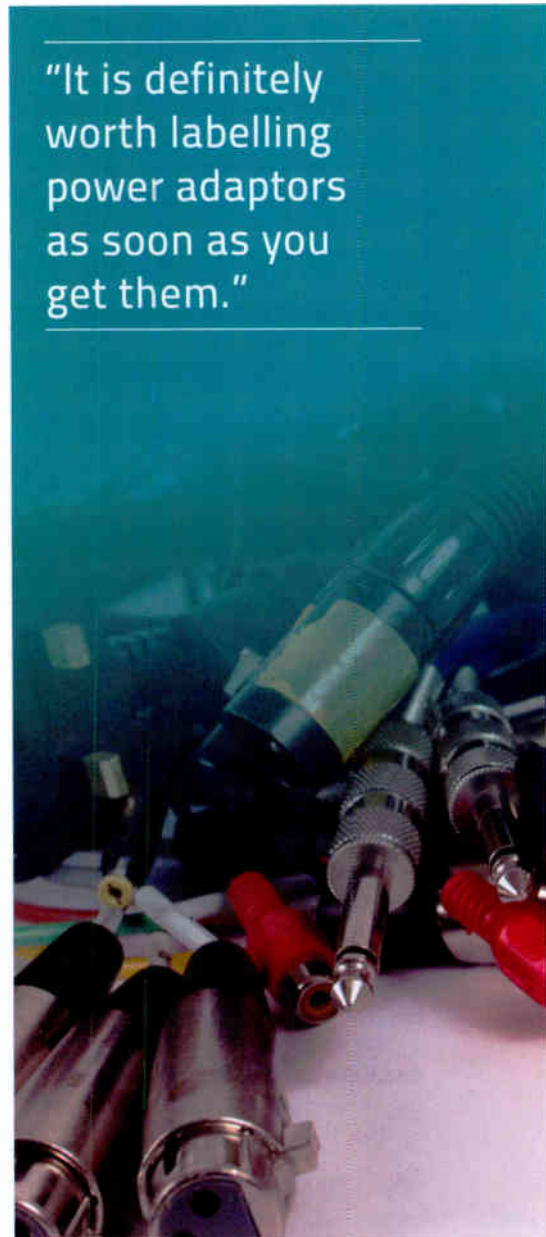

So you've got your gear, learned about wiring and got yourself some cables. But now what do you do with all this stuff? This diagram shows how a typical home studio might look, with suggestions for how to link bits of gear together. As you can see, the computer sits at the heart of the studio, with everything connected to it. Notice how the monitors are not plugged straight into the computer, but rather first through an audio interface and then a monitor controller. Some audio interfaces actually contain their own monitor controller, so this is not always needed. Although the picture shows a desktop computer, this setup would work equally well with a decent laptop computer — most modern laptops are just as powerful as mid-range desktops but offer significant advantages in terms of portability and flexibility.

» see that the mains and signal ground form a closed loop, and it is this loop that picks up electromagnetic hum from transformers and nearby mains wiring.

Well-designed equipment connected via balanced cables rarely suffers from this problem, but if you do find yourself with a ground-loop hum, you can find plenty of resources on tracing and curing the problem on the *Sound On Sound* website. The solution sometimes means resorting to using specially wired signal cables, especially when an unbalanced signal source needs to be fed into something with a balanced input. The wiring diagram for such an unbalanced-to-balanced cable is often shown in the handbook for the equipment in question, as the best wiring method varies from product to product, depending on how the output stage is designed. Though a ground loop can sometimes be cured by disconnecting a mains ground, don't be tempted to do this as there could be adverse safety implications. Fix ground loops by modifying your audio wiring, not your mains wiring.

If you're happy to do a bit of DIY, here's my ground-busting 101: At the sending end, use a balanced connector wired to the cable as usual. At the destination end, fit an unbalanced (TS or Tip/Sleeve) jack plug, and wire the hot core of the cable to the tip, the cold core to the sleeve or body connection of the jack plug and leave the screen disconnected.

**Catch the buzz:** Buzz problems come from having sensitive audio equipment

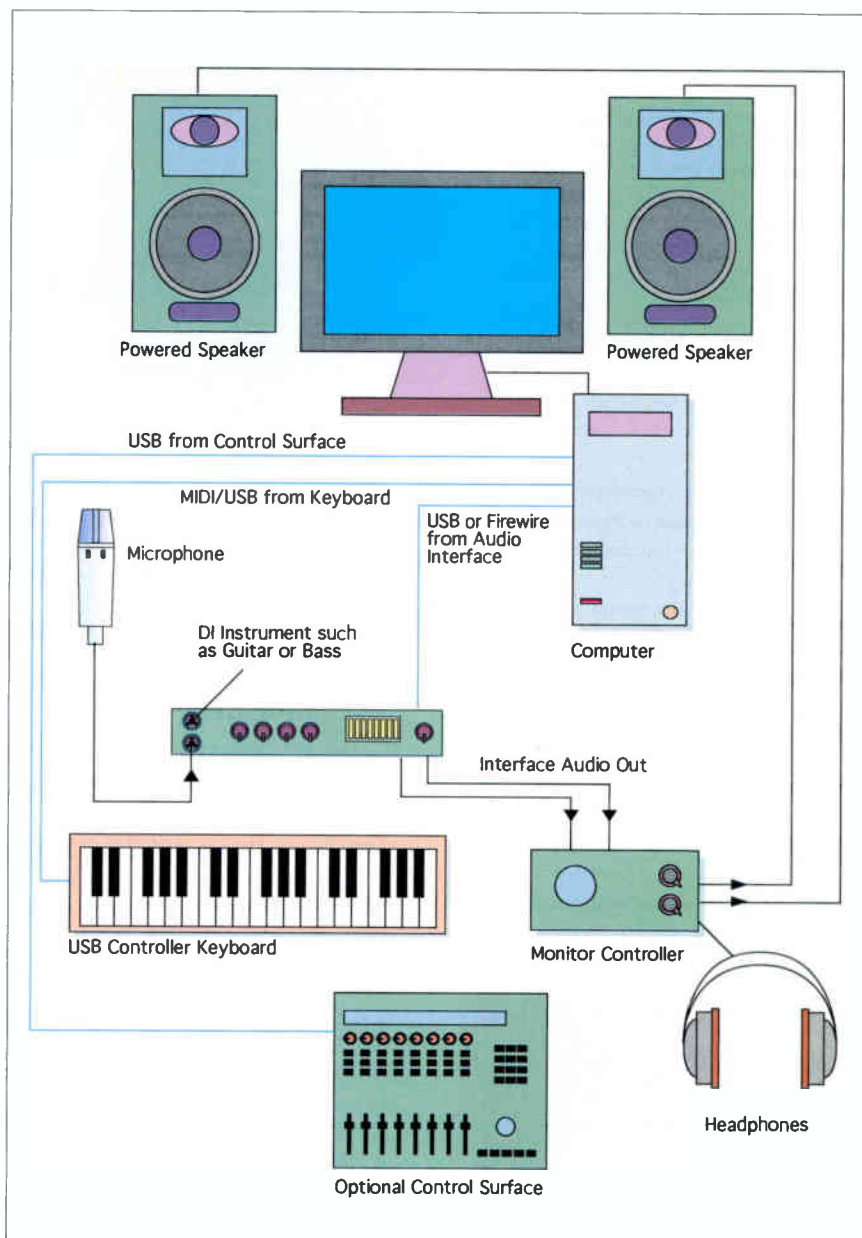

too near to computer hardware or lighting dimmers, and can only be solved by replacing these with low-interference types (or better still, no dimmers at all) and by keeping audio gear away from the source of interference. (If you've ever tried to record an electric guitar while sitting right in front of a computer, you've probably already suffered from buzz!)

**Solder solution:** Though not essential, learning to solder and buying a basic tool kit comprising soldering iron, solder, pliers, wire cutters and an assortment of small screwdrivers can save you a fortune. Knowing how to solder enables you to make cables of exact lengths to fit your

studio gear precisely, and also enables you to repair damaged cables, rather than throw them away to buy new ones. If you don't know how to solder, it's worth checking out YouTube, as there are lots of instructional videos on the subject. ■■■

## Selected Manufacturers

Canford Audio  
[www.canford.co.uk](http://www.canford.co.uk)  
 Hosa  
[www.hosatech.com](http://www.hosatech.com)  
 Sommer Cable  
[www.sommecable.com](http://www.sommecable.com)  
 Studiospares  
[www.studiospares.co.uk](http://www.studiospares.co.uk)

# BEHIND THE AUDIO

**O**n first encountering digital audio in the early '80s, I thought it was more complex than it turned out to be. This was due to writers explaining every little detail. It was like building a car engine before learning to drive! While the inner workings are fairly complex to an average user, the general concept is pretty simple. It's important to get a basic grounding in digital audio and MIDI in order to use both successfully. So, without further ado, let's delve behind the audio!

MIDI EXPLAINED	48
DIGITAL AUDIO	56





# Enhance Your Knowledge of Music Technology

Music technology is a constantly evolving realm. There are more tools available to the recording musician today than ever before. Whether you are a musician with a home studio or an engineer running a project studio, staying on top of current technology and understanding your gear can make or break your musical success.

That is not to say that you must buy a new computer every six months, or that the new mic everyone is talking about will mean instant platinum success. We're talking about developing a working knowledge of the fundamentals of analog and digital audio. Though the specific gear you choose will make a direct impact on both your sound and your workflow, your ability to work productively and efficiently requires an understanding of *why* we choose the tools we do. At Sweetwater, we're committed to making music technology accessible to everybody who has a passion for music. To that end, we're excited to share with you some resources that can greatly enhance your knowledge of all things audio.

## LEARNING THE LINGO

Have you ever started to research an exciting new piece of gear, only to be overwhelmed with jargon that could give a nuclear physicist a headache? Music recording began more as an engineering task than as a creative endeavor, requiring mix engineers to know as much about gain staging and transformers as they did about crafting a great drum sound. If you've ever been confused by terms such as AD/DA, ADAT with SMUX, or OMF, you're not alone. It's important to have a grasp of the tech jargon, as it not only helps you to better understand the gear you're working with but also empowers you to better deal with any technical issue that may arise. Bookmark [Sweetwater.com/expert-center/glossary](http://Sweetwater.com/expert-center/glossary) for our comprehensive Music Technology Glossary, and you'll be talking the talk in no time!



How well do you know what each control on your compressor does? If technical terms become a barrier between you and your creativity, check out our glossary of tech terms at [Sweetwater.com/expert-center/glossary](http://Sweetwater.com/expert-center/glossary).

Once you've caught up on the latest terminology, you can head over to [Sweetwater.com/expert-center/buying-guides](http://Sweetwater.com/expert-center/buying-guides) for our Buying Guides as well as expert advice. There's no fluffy marketing speak here — just solid fundamental information on music technology. You'll find info on how to analyze your room's acoustic properties, the professional way to tune up a PA system, advice on the best ways to record different instruments, and much more. At Sweetwater, we want to share our years of music technology experience with you, to give you the best music-making experience possible.

## TURNING KNOWLEDGE INTO ACTION

Though understanding tech talk is important, and informative guides can point you in the right direction, nothing can top the insight of the industry's greatest names in music recording. Check out [Sweetwater.com/expert-center/videos](http://Sweetwater.com/expert-center/videos) for exclusive interviews and features from the likes of Bruce Swedien, Frank Filipetti, Paul Reed Smith, and other legends. Watch as we put gear through its paces in our own state-of-the-art recording studios. Sweetwater.com brings you the latest information from the most respected names in the industry — because if we didn't, who would?

Enhance your knowledge of music technology with our in-depth product demos and exclusive interviews of world-famous engineers. Check out **Sweetwater.com/expert-center/videos**.

Just as *Sound On Sound* brings you the latest information on all things music technology, Sweetwater's *inSync* daily e-newsletter keeps you current with the top music industry news of the day. Check out the Tech Tip of the Day for info on getting the most out of your gear. Find out about updates for your favorite software, the same day they're released from the manufacturer. With Sweetwater's *inSync*, you'll be in the know. Best of all, *inSync* is an absolutely free resource available to anyone through **Sweetwater.com/inSync!**

Successful musicians and engineers take advantage of every available resource they can get their hands on. Making use of educational resources and learning how the pros work helps you take charge of your projects so that you don't lose time to frustration or intimidation. We encourage you to explore **Sweetwater.com/expert-center**. We have an incredible amount of information available to enrich your music experience — just another part of the Sweetwater Difference!



# EXPERT | Center

Sweetwater's online Expert Center is your one-stop resource for all things pro audio, and we are always adding new content to help inform and enrich your recording experiences. Here, you'll find:

**Gear Reviews:** Hands-on gear reviews written by Sweetwater employees — we use this gear every day.

**Videos:** Exclusive interviews and product demos that take you into the studio with us.

**Buyers Guides:** We share our experiences and insights so that you can buy the right gear for your needs — the first time.

**Glossary:** Fully searchable and easy to navigate — if it has to do with music or audio, you'll find the definition here!

**Tech Tips:** Useful ideas and solutions for the recording musician, to get the most out of your gear.

**Show Reports:** Up-to-the-minute updates of NAMM, AES, GearFest, and more!

**Free Publications:** Stay informed with our free magazines and e-mail newsletters.

**Featured Articles:** In-depth coverage on a variety of pro-audio topics, from using handheld recorders to designing your first PA system.

## Sweetwater.com/sweetcare

### Pro Tools Resource Center

Our Pro Tools Resource Center has the information you need to get (and keep) your Pro Tools system up and running, from product registration to setup to troubleshooting. We include videos, tutorials, tech tips, and current support and compatibility information for your Pro Tools system.

### Knowledge Base

Point your browser to Sweetwater's Knowledge Base, and you'll get instant expert support from almost 20,000 helpful articles! This ever-expanding resource makes it easy to find on-point answers to your questions.

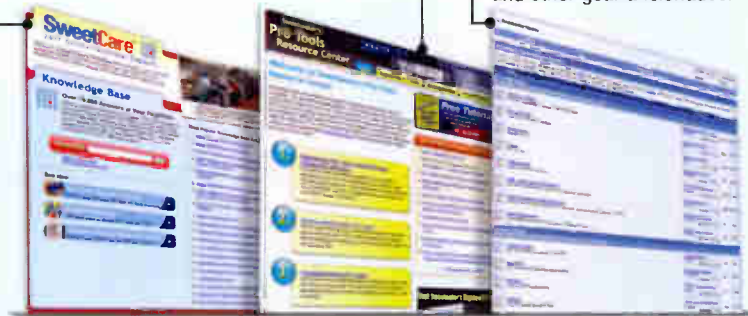

### Gear and Audio Forums

Covering everything from computers to instruments to recording to music industry developments, our gear and audio forums give you dozens of categories to choose from, as well as the opportunity to interact with seasoned pros and other gear aficionados.

**Get expert gear advice plus personalized service!**

**CALL US TODAY AT  
(800) 222-4700**

**Sweetwater**

Music Instruments & Pro Audio

# MIDI EXPLAINED

**The Musical Instrument Digital Interface standard allows the equipment in your studio to communicate, and also opens up a whole world of synthesizer composition and sound manipulation.**

**M**IDI is an incredibly useful studio technology, developed in the early 1980s, that has played a huge part in shaping the modern music studio. It might seem like a complex idea to get your head around when you first get started, but you don't need to know everything about MIDI to use it effectively. You can even understand how MIDI works by comparing it to familiar pieces of home technology that work in a similar way, such as printers and TV channels, which we'll come to later.

Although today's USB controller keyboards don't need a dedicated hardware MIDI 'interface' stage and talk directly to the computer via their USB connections, it can be helpful to go back to how MIDI started, when all MIDI instruments, and other MIDI devices, had to be fitted with 5-pin 'DIN' sockets to handle MIDI data — and, of course, most MIDI devices still are. On a typical

unit, you will see sockets marked MIDI In, MIDI Out and MIDI Thru, though some devices may not have all three. These sockets are connected using standard 5-pin DIN MIDI cables, although only the middle three pins are used. The data travels in only one direction, so for bi-directional communication you need to connect both the MIDI In and MIDI Out of a device. You might also be interested to know that MIDI is a serial protocol, which simply means that pieces of data follow each other down the cable in single file. This precludes any two things happening at exactly the same time, but MIDI is fast enough that when you press down several keys at the same time, the resulting chord sounds as though all the notes start together.

## Take Note

The most commonly used MIDI data refers to note information: which key has

been pressed, how hard it was pressed and for how long it was held down. The keys on an electronic instrument, such as a MIDI keyboard, are actually little more than switches. Whenever a key is pressed on a MIDI synthesizer, a signal known as a Note On message is sent. Releasing a key sends a second message known, unsurprisingly, as a Note Off. The key being pressed is also identified by a unique MIDI number, which defines the pitch of the note being played on the receiving device.

If the master keyboard is touch sensitive, MIDI also sends a message saying how fast or hard you've hit the key. (We tend to use the term 'velocity' rather than 'loudness', as hitting a key harder really means pressing it down more quickly or with greater velocity.) Most synthesizers allow you to do more to a note than simply play it: they usually come equipped with wheels or levers that allow you to bend the pitch of a note or to add vibrato, as well as other sound-altering effects buttons and knobs. MIDI can send this information too.

Simply sending MIDI note information down a MIDI cable so that you can play a remote MIDI module over the other

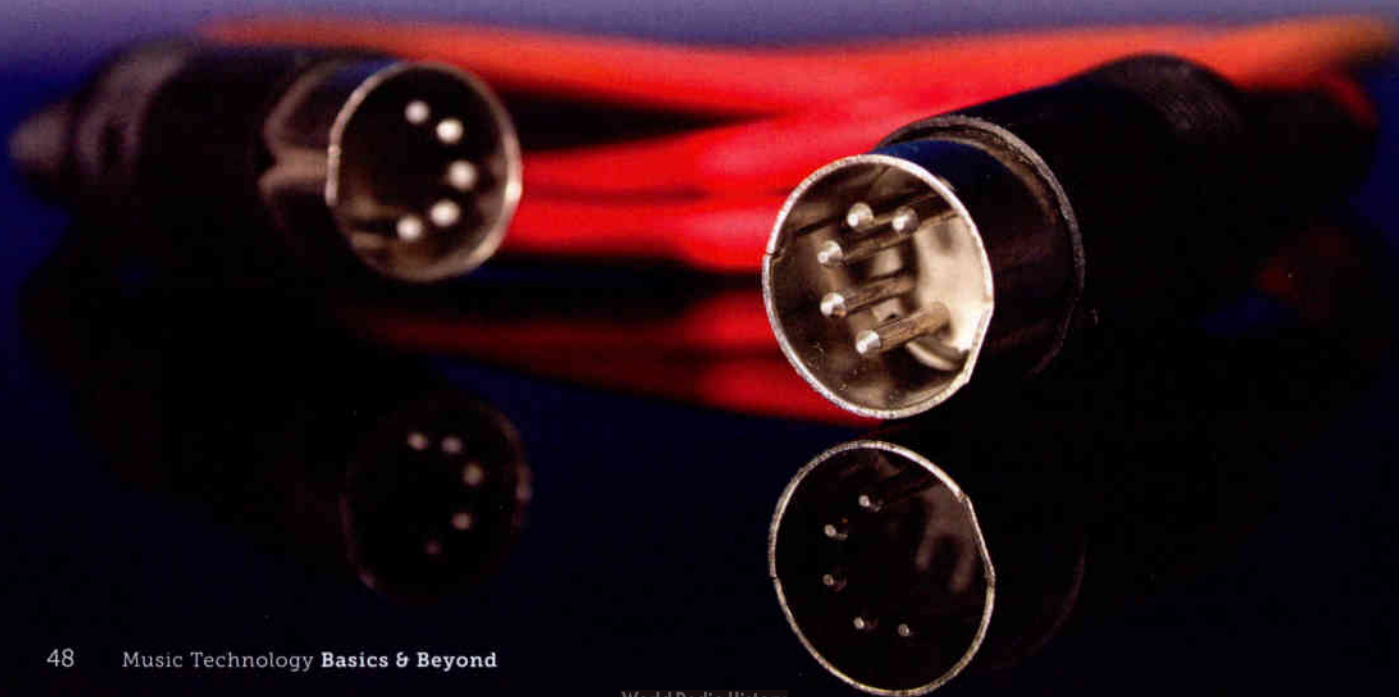



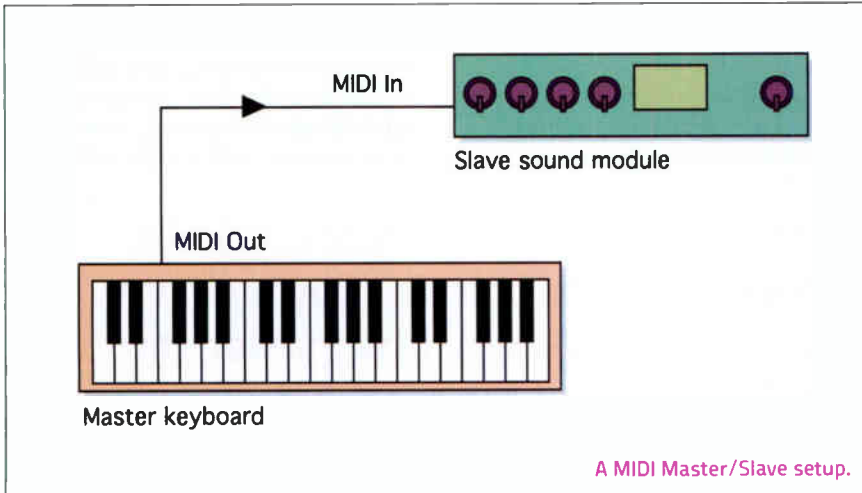

side of the room doesn't, in itself, seem a big deal. Introduce a MIDI sequencer, however, and things get a whole lot more interesting! It then becomes possible to record and play back whole MIDI compositions with multiple parts, which you can record one part at a time.

### Patches & Banks

You can use MIDI as a means of recalling sounds on a sound module, via the MIDI Program Change message, which provides direct access to up to 128 sound patches. When you change the patch on your master keyboard, using its front-panel controls, a MIDI Program Change command is transmitted from the MIDI Out socket to the connected sound module (unless this function has been deliberately switched off).

In order to access more than 128 sound patches, many MIDI instruments provide multiple banks of 128 sounds, and a MIDI Bank Change message is used to switch between banks. There are several non-standard bank change message formats, however, so you may need to consult the manual that came with your module. If you simply record the bank change message from your synth, it will play back in the correct format.

### MIDI Connections

The most basic MIDI connection is where you plug the MIDI Out of the controller keyboard you are physically playing (the master) into the MIDI In socket of the MIDI instrument you wish to control (the slave), as in the diagram above. When you press a note on the master keyboard, the slave instrument will

play — providing both instruments are set to the same MIDI channel.

### MIDI Channels

The idea behind MIDI channels is similar to the idea behind TV channels: you can receive dozens of different TV programme channels even though you only have one aerial or dish. Using a simple MIDI Thru to MIDI In daisy-chain connection between slaves, you can send MIDI signals to multiple devices, with each receiving device set to 'tune in' only to the messages intended for

### There's A Limit!



You can't chain MIDI instruments together indefinitely, because the MIDI signal gets slightly degraded every time it passes through another unit, and eventually the signal becomes unreliable. For example, some of the slaves may start missing notes or, worse still, playing notes and then forgetting to turn them off again! Try to limit MIDI chains to three or four instruments at the most.

it. The secret to making this work is the MIDI channel.

The ability to select which module responds to which messages is clearly an advantage when working with a sequencer, as it enables several different instruments to be connected together, and for each to play only their designated part of the composition. (If you plan to do everything 'inside the box', using software instruments, you may not need to be concerned with the way MIDI hardware is connected, but a bit of background is useful just in case you need to work with MIDI hardware instruments from time to time.) To connect multiple MIDI instruments together, the MIDI Out of the master device needs to be connected to the MIDI In of the first slave, then the MIDI Thru >>

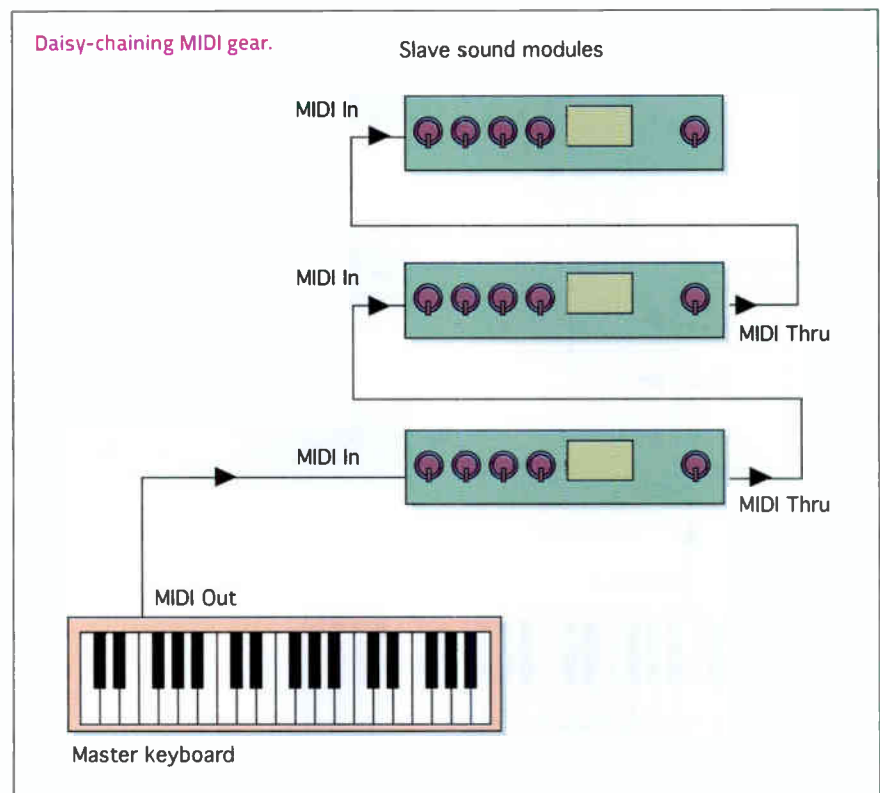

» of the first slave is connected to the MIDI In of the second slave and so on, like the diagram on the previous page.

When connected in this way, all the modules 'see' the same MIDI information at the same time, but the concept of channels means that each piece of connected gear will ignore any MIDI information that is on a channel other than the one it is set to receive. MIDI supports 16 channels, and data is only acted upon when the sending device and the receiving device are set to the same channel. You could, of course, set two or more modules to the same MIDI channel for layering sounds, but in most systems each sound module would be set to a different MIDI channel.

An alternative arrangement for larger systems is to use a MIDI Thru box, which is an active signal splitter, fed from the MIDI Out of the sequencer. The Thru box has several MIDI Thru outputs, and each of these outputs can be connected to a different MIDI slave module, or to a short chain of slave modules — as in the diagram below.

### Multitimbrality & Polyphony

It's probably helpful at this point to explain the term 'multitimbral', which

has its roots in hardware synths and synth modules, but also applies to some more sophisticated plug-in instruments. A hardware MIDI sound module is essentially a MIDI instrument without a keyboard, and most modules can

the electronic limitations of the hardware. If you try to play more simultaneous notes than the maximum polyphony (and this includes any notes that you have released but which are still sustaining), one of the notes already sounding will be cut off.

**"For a basic MIDI connection, plug the MIDI Out of the controller keyboard you are physically playing (the master) into the MIDI In socket of the MIDI instrument you wish to control (the slave)."**

play several different sounds ('timbres') at once, each sound on its own MIDI channel. Such a sound module behaves almost like several different synths (usually up to 16) sharing the same box, and is said to be multitimbral.

We've dealt with how many sounds a synth or sound module can play at once, but what about how many notes it can play? There is a limit to the number of possible simultaneous notes: the maximum polyphony, which is dictated by

In many multitimbral hardware instruments, polyphony is shared between the various parts, so that if, for example, the organ part isn't playing, the marimba part can use more notes before the polyphony limit is reached. Your instrument manuals will tell you about the polyphony limitations of your own instruments.

Software synths rely on the host computer for their power, and the more notes you play at once, the greater the load they place on the computer's central processor. For this reason, it's sometimes possible for the user to set their own maximum polyphony, especially in the case of samplers. This way, you can balance CPU load against the risk of old notes being cut short to make way for new ones.

### Drum Instruments

Drum machines, drum-sound modules and plug-in drum instruments are configured in a similar way to synths but, instead of each key giving you a different pitch of the same sound (as you'd expect from, say, a piano), drum machines and drum instruments are organised so that different drum sounds are triggered from specific MIDI notes. This means that the whole kit can be accessed via different keys on the keyboard. Unlike synth sounds, you can't transpose their pitch by transposing the MIDI data, as you'll just end up triggering the wrong drum sounds!

New drum parts can be recorded from a keyboard just by tapping out a rhythm on the keys, but few people can play a convincing drum part in real time using only a controller keyboard. A better solution is to use a set of MIDI drum pads

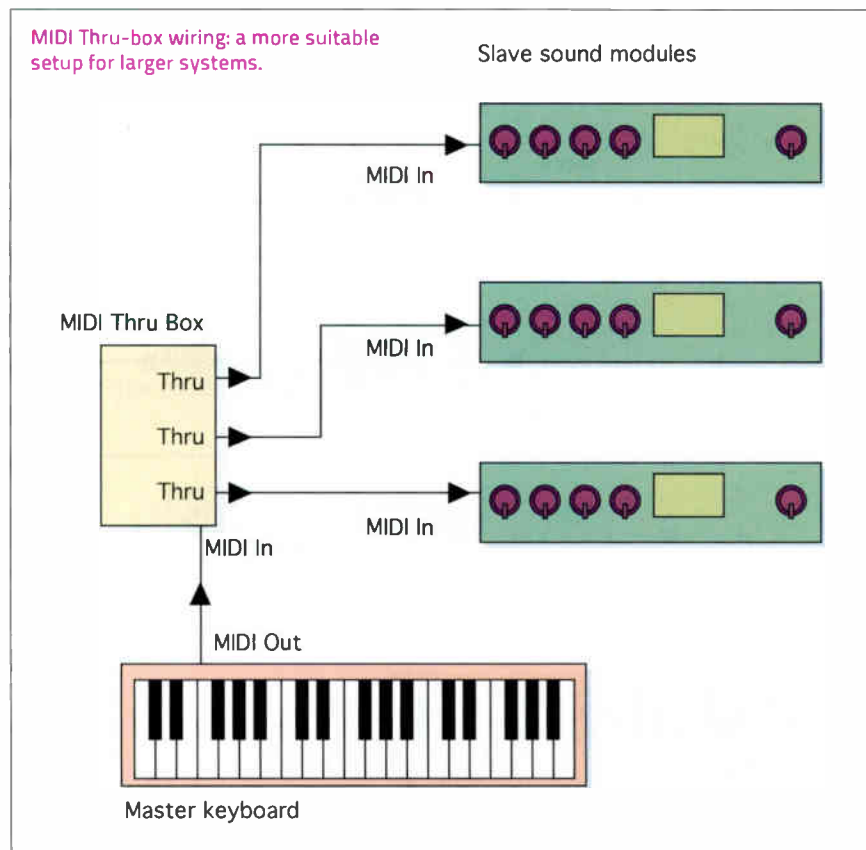



or a MIDI drum kit, as the playing action is more natural.

### MIDI Modes

Most hardware MIDI instruments can be set to work on any of the 16 MIDI channels, or in 'Omni' mode, which allows the unit to respond to all incoming data regardless of channel. Omni is a very useful mode for testing that something works without having to worry about MIDI channels, but in most instances you'll want to use the default 'Poly' mode.

There are further MIDI modes that tell an instrument whether it should play polyphonically or monophonically and,

### MIDI Isn't Audio

It's important to keep in mind that MIDI doesn't transmit sounds directly: it's a system for sending instructions about what is happening on the master keyboard to a sound source or DAW. The principle is much the same as when your computer keyboard sends signals to a word processor program: it sends digital codes to identify the keys, not photographs of the letters themselves.

although polyphonic operation is the most common, mono operation is most useful when playing bass lines or emulating the response of a monophonic analogue synth, where playing a new note cuts off the one previously played. ('Mono' mode is also vital for use with guitar synths, where each string transmits data on its own MIDI channel and needs to be allocated, in effect, its own monophonic synthesizer, to allow each string to send differing amounts of pitch-bend information.) A total of four modes is specified by the MIDI protocol:

#### Mode 1: Omni On/Poly

This mode allows the instrument to play polyphonically but responds to all incoming data on all channels.

#### Mode 2: Omni On/Mono

This mode is rarely supported, as it isn't really necessary, but it does allow you to play monophonic lines without matching the MIDI channels of the master keyboard and instrument.

#### Mode 3: Omni Off/Poly

This mode is the most common

for keyboard players as it allows the instrument to respond to individual MIDI channels and to play polyphonically. It's also the default mode for most applications.

#### Mode 4: Omni Off/Mono

This mode enables a multitimbral synth to behave as several monophonic synths, each on its own MIDI channel. Mode 4 is used mainly when playing mono-style melody or bass lines, or for use with guitar synths.

### MIDI Interfaces

Unless your audio interface includes one or more MIDI ports (and they often do), you'll need to buy and install a MIDI interface in order to use external hardware synths, or to use a MIDI keyboard as a master controller if it doesn't also have a USB connection.

So far I haven't talked about what to do if 16 channels of external hardware synths isn't enough for you, and that's because this issue is also related to MIDI interfaces. While a single MIDI port can only handle up to 16 channels, you can buy MIDI interfaces with multiple MIDI ports, and each one can handle its own set of 16 channels. (Note that you need to check that the interface is supported by the DAW software you plan to use.) The various MIDI ports then show up in your DAW software, so you might, for example, see MIDI ports A through to H listed, with 16 channels available on each.

Before software synths, multi-port interfaces were really important, but now that we have so many great software plug-in synths and USB-equipped master keyboards, you may find you don't need a MIDI interface at all.

### MIDI & Your DAW

Early sequencers handled only MIDI tracks (practical software instruments were still some way off in the future) but, using a single MIDI port connected to a multitimbral synth, you could record and play back up to 16 parts, one on each MIDI channel. A typical modern DAW program contains an advanced form of MIDI sequencer that runs alongside its audio recording tracks and is able to control both hardware and software MIDI instruments.

As with the traditional music composer, sequencer-based work usually starts at the keyboard. Instead of being limited



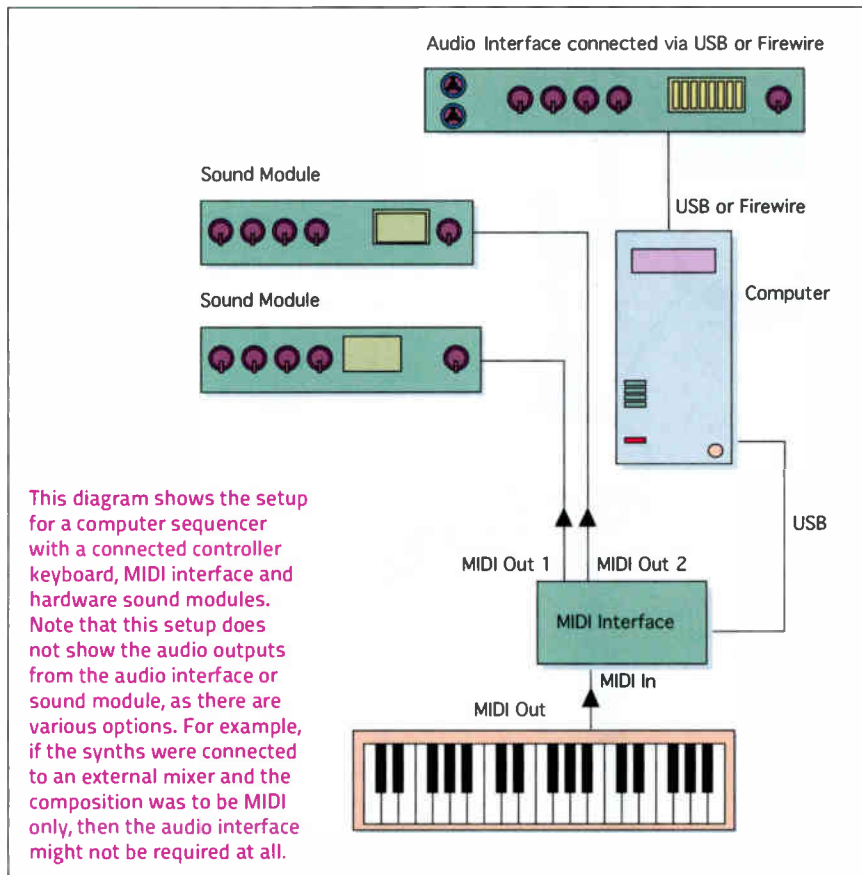

## Remember 'Local Off'!



If you forget to activate 'Local Off' when triggering your keyboard's sound engine from your DAW, you can end up with a MIDI feedback loop, where the data feeds from the DAW back to the keyboard input, then back out to the DAW again, resulting in stuttering playback, or even a complete MIDI log-jam.

resolution of today's computer-based systems is extremely good. Some of the more conventional DAW packages include traditional score-writing facilities which, providing you play to a click track, enable you to print out sheet music for your compositions. It's essential you have some musical literacy because the computer doesn't always interpret what you play in the same way that a musician writing a score by hand would.

## DAW Connections

Typically, a MIDI master keyboard is connected to a DAW either via a MIDI cable and hardware MIDI interface (which may be part of the audio interface, depending on the model) or via a USB cable. When the sequencer is set to record, any notes played on the keyboard are recorded as MIDI data, and a DAW offers multiple tracks into which to record the various musical parts of your composition.

With most DAWs there's no need to change the MIDI channel on the master keyboard as the track data is automatically converted to whatever the channel that track is set to when you're controlling an external MIDI instrument. When you're using software instruments you probably don't have to worry about MIDI channels at all unless they are multi-timbral. However, if you want to set up keyboard splits on the master keyboard (playing bass sounds with the left hand and strings with the right, for example) or if you have a multitimbral software instrument that can receive on multiple MIDI channels, you will need to read the relevant part of the manuals for both the master keyboard and the DAW as some MIDI channel setting changes may be required.

It's also worth mentioning that if you're using a synth keyboard as your controller and you want to play back sounds using that synth, you should select Local Off

» to writing down a score, however, the MIDI composer can record sections of the music into the sequencer, hearing the result via synthesized or sampled sounds. Recording is often done against an electronic metronome or 'click track' set to the desired tempo. The benefit of this is that any subsequent editing that needs

a written score places notes on rigid subdivisions of a musical bar and then leaves the musician playing the part to add 'feel' to the performance. MIDI has a finite timing resolution and hardware synth modules may take a millisecond or two to respond to a MIDI message but, in practice, even old-school hardware-based

**"The ability to quantise data after recording is extremely useful for tidying up imperfect performances, though it can take away the human 'feel' of a performance."**

doing can then be done against a 'bars and beats' grid. To make changes, you simply erase or move the incorrect notes and add new ones.

A sequencer recording is more accurate than the written score because it can play back a part with exactly the same timing and velocity nuances as the original performance. By contrast,

MIDI tends to have more accurate timing than a typical human performer. With hardware (including your master keyboard), the timing of MIDI notes becomes less precise the more notes are being sent at the same time. Using software instruments in a DAW avoids the data bottlenecks that were common in the early days of sequencing, so the timing



Three of the MIDI editing screens of Cubase 6: Piano Roll, Score and Event List.

on the master keyboard and connect the MIDI In of your master synth to your DAW setup's MIDI output, either directly or via one of the outputs of your MIDI Thru box. Selecting Local Off essentially splits your synth so that it behaves like a separate keyboard and sound module with no direct connection between the two. The keyboard then feeds the computer and the computer controls the sound module section. Most synths remember their Local On/Off status when powered down, but I have come across instruments that always revert to Local On when powered up.

### Editing A MIDI Track

A MIDI sequencer is like a word processor — instead of letters, you delete, move or replace musical notes. You can also copy and paste individual notes or entire sections. The data can usually be edited in one of three ways:

1. On a piano-roll style grid, where the notes are represented as blocks positioned according to start time, length and pitch.
2. As a traditional musical score.
3. As a simple list of MIDI data.

I find the grid edit system the easiest but it really comes down to how you prefer to work. As with the earlier MIDI sequencers, you can use the MIDI editing facilities of your DAW to change the pitch, start time, length and velocity of any note you've recorded, as well as adding, moving or deleting notes. You can even build up entire compositions by entering the notes manually. Other options usually include the ability to transpose the MIDI part after recording, and to tighten up the timing by forcing the notes you played to move to the nearest grid line. This is called 'quantising' and will be explained shortly.

You can also reduce the dynamic range of your MIDI data to even out the difference between your louder notes and the softer ones; delay or advance tracks relative to each other; and even reverse sections. As a rule, all these processes are 'non-destructive', ie. the original data stays the same and the DAW computes the necessary changes during playback. This way, you can always revert to your original performance data if you need to. Even where you make permanent changes to the data (so-called 'destructive' edits), you can probably still use the DAW's 'undo' feature to undo the last thing you

did, and it is now common for DAWs to offer multiple steps of 'undo'. If only there were such a feature for real life!

### Quantisation

When you quantise a selection of MIDI notes, the timing is changed so as to push each note to the nearest exact subdivision of a bar. For example, if you select 16 as your quantise value, everything moves so as to line up to the nearest 16th of a bar (otherwise known as a semiquaver or a '16th', to those music theorists amongst us!).

Most modern DAWs include a number of intelligent quantise options, including a percentage quantise feature that allows you to tighten up a performance by as much or as little as you like without making it completely rigid. There's no doubt that the ability to quantise data after recording is extremely useful for tidying up imperfect performances, though if not used with care it can take away the human 'feel' of a performance. Of course, some forms of dance music (many of which would never have existed without quantised note sequencing) demand the rigid feel that quantising produces. For less rigid musical forms, the percentage quantise options lets

»

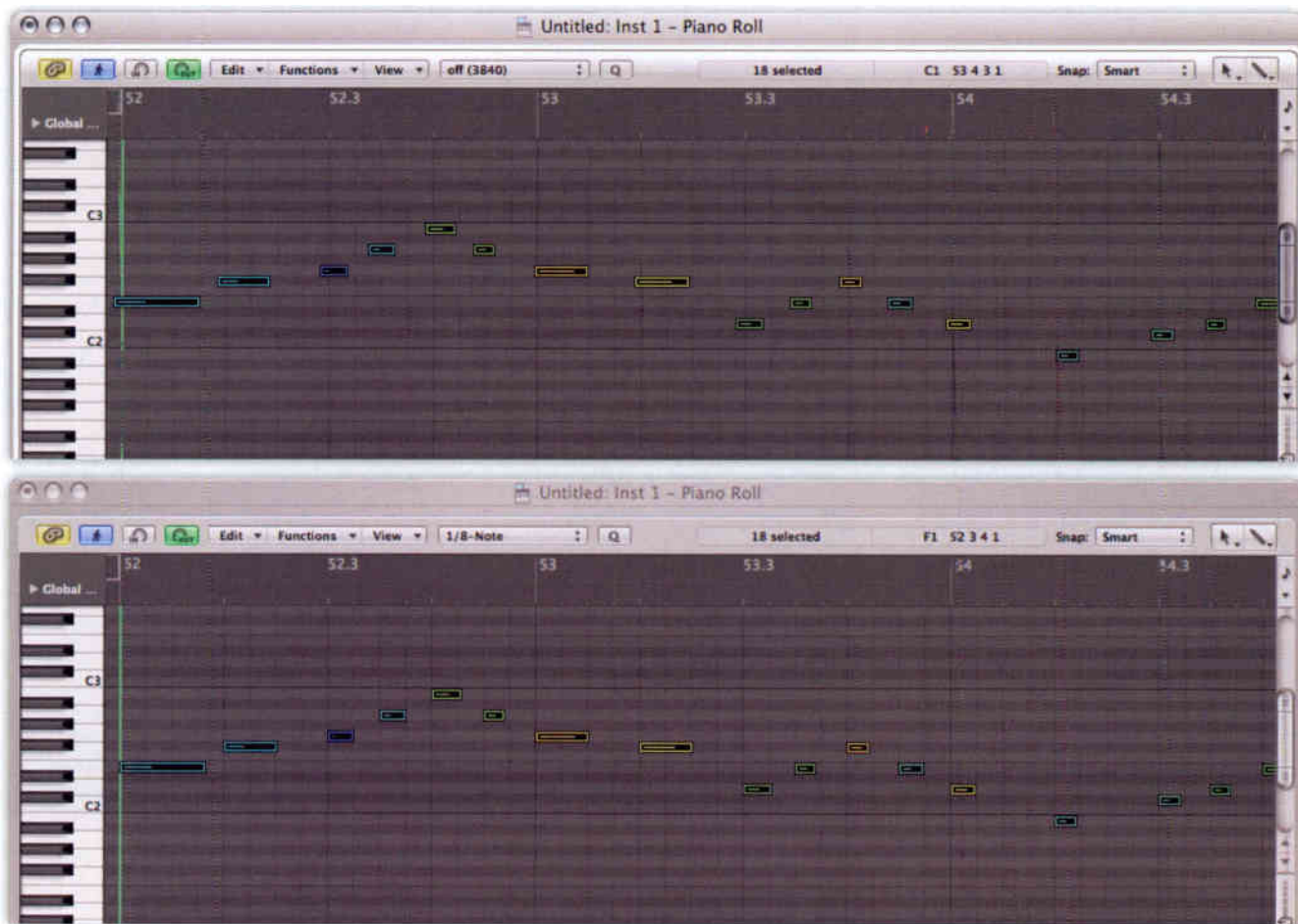

» you reduce the magnitude of human timing nuances without getting rid of them completely.

### Beyond The MIDI Note

A DAW MIDI track can record pretty much any MIDI data you send it, other than MIDI Clock, which is a specific type of MIDI message used for synchronising two or more pieces of MIDI hardware such as

A typical MIDI performance will record note data, pitch bend, vibrato depth, aftertouch (key pressure), if your keyboard sends it, and the messages associated with any other physical controls on the master keyboard that you adjust during performance. That means a typical sequence can include a lot of data, which is another reason I like the grid edit page, as you only see the notes. If you were

Before (above) and after (below) quantisation. Notice how the notes are neatly aligned to the grid in the second screen.

to exclude types of MIDI message that you don't want to record.)

### General MIDI (GM)

A subset of the MIDI standard, created to enable manufacturers to build hardware synthesizers, synth modules and plug-in instruments that exhibit an agreed minimum degree of compatibility, GM sets out rules for patch mapping, drum-note mapping, multitimbrality and polyphony. Its aim is to allow a MIDI sequence recorded using one GM-compatible sound source to be played back on any other without the user having to look for similar sounds or remap drum-note allocations. While GM synths don't sound exactly the same, a piano patch on one machine is located in the same place as a piano on a different brand of machine and so on.

The main benefit of GM, other than also having a basic agreed drum

**“Once you have recorded a MIDI track, it can be played back using any MIDI sound source or software instrument. You don't have to make a decision about the sound until the mix.”**

drum machines or external sequencers. A sequencer transmits all the recorded MIDI information to the receiving synth in exactly the same order and with the same timing as you originally played it, unless you change the playback tempo.

to look at the 'edit' list, a single pitch bend movement would be represented by a string of different MIDI values corresponding to the physical position of the control as you moved it. (Note that you can often set up a filter in your DAW



There's a huge variety of GM sounds available: this selection from Roland's JV-2080 includes intriguing and exotic instrument sounds such as a synth calliope, a shamisen (a Japanese guitar-like instrument), and sound effects for gunshots and goblins, amongst other things!

map supported by different hardware and software manufacturers, is that commercial MIDI files of popular songs will play back correctly if made to the GM standard. There are also some high-quality GM sound sets available as plug-in instruments: useful if you routinely produce backing tracks from commercial MIDI files. Roland were major players in developing GM but have since introduced an enhanced version of General MIDI, which they call GS. Yamaha also developed their own extended GM

system, which they call XG, offering a very similar approach to alternative sounds.

### Summing Up

- MIDI is not audio, it's a set of instructions that tells the receiving device what to do.
- MIDI sends musical information between compatible devices, including pitch and length of individual notes and other aspects of the instruments that lend themselves to electronic control. MIDI can also carry timing

information in the form of MIDI Clock or MIDI Time Code.

- Once you have recorded a MIDI track, it can be played back using any MIDI sound source or software plug-in instrument at your disposal. You don't have to make any final decision about the sound until you come to mix your song.
- MIDI is invaluable to composers who work with sampled or electronically generated sounds, but it also forms a cornerstone of dance music composition, where it can be used to trigger loops, samples, instrument sounds and drum sounds. ■■■

## Some MIDI Synchronisation Background

### MIDI Clock

If you plan to work entirely inside the DAW, using software instruments or external synths and samplers but no drum machines and sequencing devices, you shouldn't have to worry about MIDI Clock, or timecode in general. For hooking up different bits of hardware MIDI kit and trying to get them to run in sync, however, you need a common clock system, rather like a metronome, that all the devices can follow. Normally things like drum machines and DAWs have built-in sequencers running from their own clocks, and the MIDI Out connections also carry this clock information.

These 'electronic metronome' clock pulses are sent at the rate of 96 per quarter note (or 384 pulses per 4/4 bar). You can use MIDI Clock to make two devices run in sync by designating one the master and the other the slave. The master unit is always switched to run from its internal clock, while the slave machine must be switched to 'external clock' mode. For example, you can slave a drum machine to a sequencer so that the drum machine always follows the sequencer. Even when the master machine is not playing, it still sends out MIDI Clocks

at the current tempo, which means that any connected slave device knows exactly what tempo to run at when it receives a Start command. You can have multiple slaves in a system, but only one master.

The MIDI commands for starting and stopping drum machines and sequencers are known as MIDI Real Time messages, and they don't have MIDI channels, as they relate only to overall sync. In addition, virtually all modern instruments and DAWs support a MIDI feature called MIDI Song Position Pointers. These Song Position Pointers are invisible to the user, but the practical outcome is that you can play back a MIDI sequence or song from any point and the two devices will pick up at the correct position and play in sync.

### SMPT E & MTC

Though you may never need it, it doesn't hurt to be aware of SMPT E time code. SMPT E (pronounced Simptee) is a professional time code originating from the film and television industries (SMPT E is an acronym for the Society of Motion Picture and Television Engineers). If you end up working with video, you may need to

delve deeper into SMPT E, which has several 'frame rate' settings to accommodate worldwide TV and film standards. SMPT E code shows elapsed time information subdivided into hours, minutes, seconds and frames of film or TV picture.

The most popular formats are 30fps (frames per second) for US TV, 25fps for European TV and 24fps for film. The format is usually selectable in software and, if you're not doing film or TV work, the local TV frame rate is normally adopted for audio-only purposes. There's also a 30fps 'drop-frame' format for working with NTSC television, which actually runs at a frame rate of 29.97fps, not 30. To delve any deeper into this would only be confusing at this point, so just bear in mind that it's important, when working to video, that both the audio and video components of your project use exactly the same SMPT E format, otherwise timing errors will result.

MTC (or MIDI Time Code) is essentially the MIDI equivalent of SMPT E, and most DAWs can both read and generate it. MTC contains exactly the same timing information as SMPT E, including the choice of frame rates.

# DIGITAL AUDIO

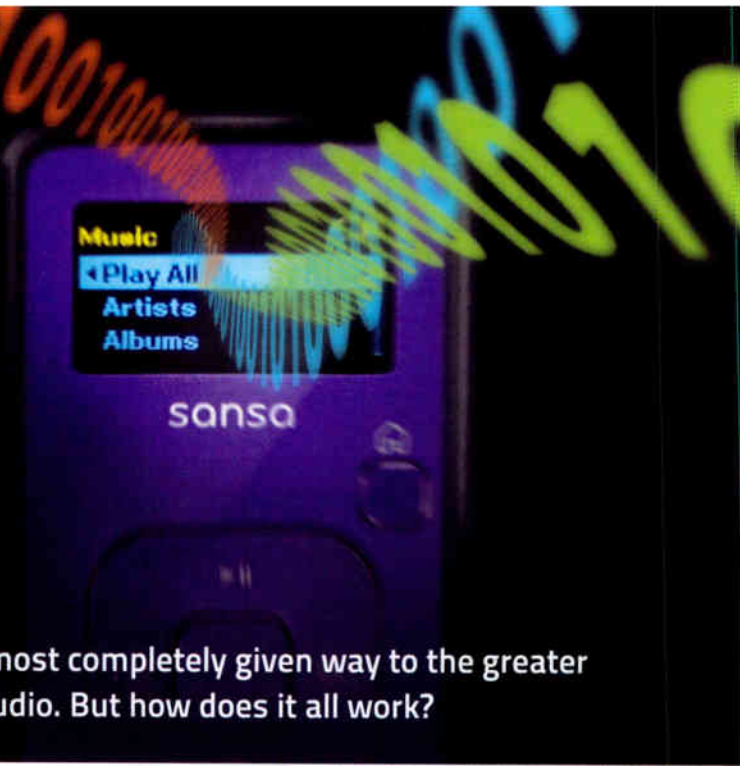

Traditional analogue tape recording has now almost completely given way to the greater accuracy, convenience and reliability of digital audio. But how does it all work?

Even in a supposedly all-digital studio, source signals often start life as analogue outputs from things like microphones or electric guitar pickups. An exception is the digital synthesizer, where the waveforms are created in the digital domain — though most hardware synths do still have analogue outputs. A software plug-in synth, however, sends its output directly to the DAW's mixer entirely in the digital domain.

## The Signal Chain

When you record using a microphone, the analogue signal from the mic will first need to feed into an analogue pre-amplifier, which raises the level of the signal to bring it to the optimum point. (We'll assume for the moment that this pre-amplifier is built into your audio interface, as they often are, but you may be using the preamps in a mixer or from a stand-alone device.) Once inside the interface and pre-amplified, the signal goes to an analogue-to-digital converter (A-D converter), where the continuously varying analogue waveform is converted into binary numbers, becoming digital audio.

You may ask why we even need to go digital, and that's a good question. It's because computers only deal with digital data, and although you can still set up an all-analogue recording studio comprising tape recorders, analogue

mixers and analogue effects, it will cost far more and have far fewer features than its computer-based counterpart. Digital audio also has one huge advantage over analogue: because the audio signal is represented as a string of numbers, any audio recording can be duplicated with no loss of quality simply by copying the numbers — unlike analogue tape, where the sound quality degrades with every copy you make, and with repeated playing. The digital system's ability to make perfect copies is vitally important both when editing digital audio and when backing up copies of your work.

## Sampling

You may have heard the term 'sampling' in the context of capturing small chunks of audio to use in your compositions, but it is also used to describe how analogue audio is digitised. The simple explanation of digital audio is that the height of the analogue waveform is measured many thousands of times each second (see the diagram opposite), and the measured height of each step is converted into a binary number. A piece of analogue audio is thus represented by a long list of binary numbers which, when fed into a digital-to-analogue converter (D-A converter), at the same rate at which they were recorded, recreates the original analogue signal.

That simplified overview describes digital recording and playback, but inside a DAW the list of numbers representing a piece of audio can also be manipulated and processed using mathematical algorithms, to create level changes, equalisation, compression, delay, reverb... and, of course, the mixing of two or more tracks of audio.

The audio data must be fed into the digital-to-analogue converter at the same rate at which it was recorded, in order to recreate the original signal. To achieve this, a digital system must run from a stable electronic clock, which defines the points at which the audio is sampled. Based on work by academics Nyquist and Shannon, it was discovered that to accurately recreate an analogue signal from a stream of samples, the sampling rate had to be more than twice the maximum frequency that was to be sampled. The accepted frequency range for human hearing is 20Hz to 20kHz so, to recreate an audio signal that may contain any frequency within that range, the sampling rate would need to be at least 40kHz. To avoid a type of distortion known as 'aliasing', any frequencies higher than 20kHz (half the sampling frequency) would have to be removed from the analogue audio before conversion, using filters. To compensate for any shortcomings in the filters, the recommended sample rate was increased slightly, giving us the 44.1kHz rate commonly used for CD manufacture (at this rate, the analogue waveform is 'sampled' an incredible 44,100 times per second) and the 48kHz used for video soundtrack work. Higher sample rates are available, but these two are the most commonly used.

It's also possible to apply filtering lower down in the frequency spectrum, to provide digital audio with a lesser 'bandwidth' than 20kHz, which is why there's a 32kHz sample rate that produces FM radio-quality results and relies on the original audio being filtered to remove any signal above 16kHz. However, serious music recording would never normally use sample rates below

### Did You Know...?

The CD's recording time of 74 minutes was originally decided by Sony, who insisted that the whole of Beethoven's Ninth Symphony should fit on one disc.



44.1kHz, as we need to reproduce the full 20kHz upper limit of human hearing.

When the digital audio is converted back to analogue in the D-A converter that feeds your speakers and headphones, further filtering is applied to smooth transitions between the successive sample values. Digital audio is not, as some people would have you believe, a staircase of steps with sharp corners! Similarly, there's no truth in the notion that because the incoming audio is only sampled at intervals, something might happen between samples that gets missed. Providing the sample rate is over twice the maximum frequency of the audio signal entering the converter, every nuance of that signal is recreated as accurately as the sampling 'bit depth' (the accuracy with which we can measure each 'slice' of audio) will allow. To put this in perspective, the amount of distortion added to a signal by analogue tape or valve circuitry may be well over one percent, whereas a digital audio system routinely offers distortion figures of less than one hundredth of that amount.

### High Sample Rates

There are advocates of much higher sample rates — 96kHz, or even 192kHz — as these relax the specifications of the filters required at the sampling stage and can result in cleaner-sounding audio. However, unless you're working with exceptionally good equipment in a good-sounding studio with excellent sound isolation, there's arguably little benefit in doing this. Your hard drive has to store all the numbers that make up an audio file, and the higher the sampling rate,

### Sampling an analogue waveform.

the more disk space will be required for a given length of audio. It is also true that the higher the sample rate, the more CPU power will be required to do any processing on the audio data. Knowing the trade-offs, you can make your own decision as to whether the higher sample rates actually produce better-sounding audio or not.

### Bit Depth

We've introduced the idea of measuring successive 'slices' of the audio signal thousands of times each second, but the other factor relating to how accurately the signal can be reconstructed by the D-A converter is how accurately we measure the height of each slice in the first place. Digital systems only deal in whole numbers, so the waveform measurement is always rounded to the nearest step. In the converters of typical DAW systems, the steps are all the same size. The secret to great accuracy is to measure the sample heights using a system that represents the value closely enough not to introduce significant noise or distortion.

An 8-bit audio signal measures the sample height at only 256 different levels or steps — good enough for the soundtracks of first-generation computer games, despite the sound produced being pretty noisy

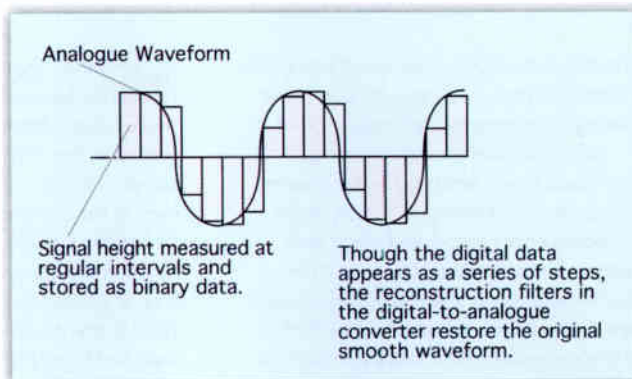

and gritty. The 16-bit system used for CDs provides 65,536 discrete levels, which, as you can imagine, gets us far closer to the original signal. Going up to 24-bit gives us a massive 16,777,216 discrete levels per sample. We define the difference between the lowest level signal a system can reproduce and the highest level it can reproduce as the 'dynamic range'.

As a rule of thumb, the dynamic range of a straightforward digital converter is 6dB for every bit of resolution, so an 8-bit system gives 48dB — which is about as noisy as a cheap tape dictaphone! CD's 16-bit gives a much more impressive 96dB dynamic range. Today's DAWs, however, tend to operate at 24-bit resolution which, even allowing for imperfections in the converters, delivers upwards of 110dB dynamic range, with a theoretical best case of 144dB.

For comparison, the dynamic range of human hearing is around 120dB, measured between the quietest sound we can detect and a sound so loud that it is painful to listen to. Despite the hearing capabilities of human beings and the sound capabilities of >>

## Digital Clocking

Digital audio systems rely on a single, central clock. In the case of a simple DAW setup, this is generated in your audio interface, so you don't need to worry about having to change 'sync' settings. Where additional digital devices need to be connected (such as an expander unit to increase the number of inputs), one unit must be designated the master clock (Internal Clock Mode) and the others slaves (External Clock Mode).

Digital clock is transmitted, with digital

audio, via the S/PDIF two-channel phono or optical connector often found on the back of consumer CD players. S/PDIF is a two-channel digital interfacing standard agreed by Sony and Phillips, and there's also a more professional balanced connection for two-channel digital audio, AES/EBU, that uses XLR connectors. The ADAT optical interface carries eight channels of audio (at a maximum sample rate of 48kHz, though the S/MUX system allows higher sample rates to be split across two ADAT ports), and also

carries an embedded clock.

An alternative clocking system uses word clock, a separate clock signal normally distributed using BNC connectors. Many pieces of digital hardware have word clock In and Out sockets and in larger systems, a master clock unit with multiple word-clock outputs is used to feed all the slaves. The correct digital cable must be used for connecting word clock, to avoid signal degradation, so it's safest to buy ready-made word-clock cables.



The Focusrite Liquid Saffire 56 Firewire audio interface offers several ADAT and S/PDIF digital audio ports, as well as word-clock ports.

» modern technology, most music has a rather narrower dynamic range, with pop music having the narrowest dynamic range of all.

Alongside a wider dynamic range and lower noise, sampling with a greater bit depth also reduces distortion, as the rounding errors introduced when each sample is measured or 'quantised' (the technical name for the measuring process) are smaller. If you want to explore further, there's a mathematical process known as 'dither' that can be used to reduce distortion and increase dynamic range, at the expense of a very slight increase in hiss-like background noise. A brief explanation is given in the glossary.

### Why 24-bit?

If 16-bit is good enough for CDs, why do we need to record at 24-bit resolution?

Unlike analogue recordings, where higher signal levels become progressively more distorted as the tape or circuitry runs out of linear range, digital signals are the least distorted when they are at as high a level as possible, because then the samples are represented by the largest number of steps. If you recorded a signal into a digital system at a very low level, it would be represented by fewer steps, so the percentage distortion would be higher. If you take this idea to its logical extreme, you reach a point where the signal is barely big enough to reach the first measurement level. The signal value would simply bounce back and forth between the values 0 and 1 (effectively reducing your complex analogue signal into a square wave), sounding extremely distorted.

It's also worth mentioning that while analogue distortion can sometimes sound

quite musical, digital distortion caused by the quantisation process is not harmonically related to the original signal and can sound pretty unpleasant, even in very small doses.

Sixteen-bit CDs work so well because the maximum signal level is allowed to peak very close to the maximum possible level (or Digital Full Scale). This means that you get low distortion and low noise. However, when you're recording into a digital system, you must never allow the input signal to exceed the maximum level the converter can measure, as the resulting data would show the same maximum value for the duration of the overload, regardless of the actual shape of the original signal. When converted back to analogue, this would translate to an audio waveform with its loudest peaks 'clipped' flat, and that's not a good sound!

So one important rule is that while analogue tape can be pushed 'into the red', when making digital recordings you should never allow the signal to exceed digital full scale on the level meter. In practice, this means leaving a safety margin sufficient to avoid clipping if a louder-than-expected peak comes along (typically, around 12dB to 15dB). If you were recording at 16-bit resolution and left 12dB headroom, the effective resolution would then only be equivalent to 14 bits. That's still pretty good, but remember that digital systems can only deal in whole numbers.

Whenever you process a signal by mixing it, changing its gain, applying EQ or whatever, some rounding up or down of

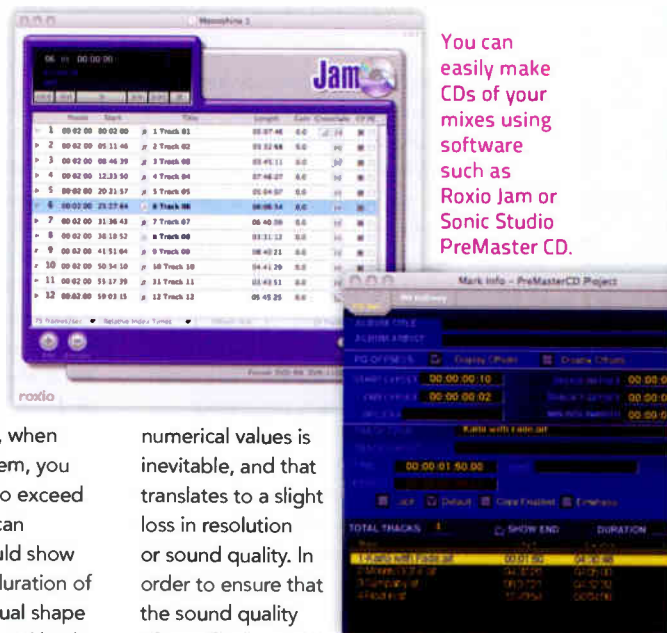

You can easily make CDs of your mixes using software such as Roxio Jam or Sonic Studio PreMaster CD.

numerical values is inevitable, and that translates to a slight loss in resolution or sound quality. In order to ensure that the sound quality of your final project

is equal to or greater than that of a 16-bit CD, simply record, process and mix at 24-bit resolution. Your final 24-bit mix can be converted to 16-bit as the final stage when creating a CD.

### Practicalities

When starting a new project in your DAW, you need to decide which sample rate and bit depth to work at. Most people settle on 44.1kHz and 24-bit, as that's a good compromise between quality and performance. If you decide to work at higher sample rates, be aware that doubling the sample rate halves your maximum track count and the number of plug-ins you can run before the computer runs out of steam.

Before you can make a CD from your DAW mixes, they will need to be converted to 16-bit, 44.1kHz files. Modern DAWs can convert both sample rate and bit depth for you at the point at which you record your final mix. However, if you use a separate CD burning program such as Roxio's Jam or Sonic Studio's Pre-Master CD, you may be able to assemble a playlist of 24-bit, 44.1kHz mixes from your DAW and let the CD-burning program convert them to 16-bit for you prior to burning the disc. (There is a small advantage in doing this, as Jam adds 'dither' to minimise distortion and to maintain the best possible dynamic range when reducing 24-bit files to 16-bit files.) If you want to create MP3 files for the Internet, more serious DAWs handle this for you, and there are also dedicated editing programs that let you edit and master your mixes, as well as preparing a final CD playlist. Popular examples include BIAS Peak and Steinberg's Wavelab. ■■■

## Does Digital Sound 'Cold'?

We hear a lot about the 'warmth' of analogue audio and the cold, clinical nature of digital, but what's the reality? Well, analogue audio devices introduce both amplitude and phase distortions, some of which can sound musically pleasing and some of which present real problems. In fact, the sound of analogue is due to its inaccuracies, but many of us have grown up listening to records made using analogue equipment, so we're used to the sound, which may be why we miss it in some modern recordings.

Digital audio is far more accurate than even the best analogue systems, and it introduces much smaller errors or distortions. It can be copied indefinitely with no loss of quality, and can process

audio in far more sophisticated ways than were ever possible using analogue circuitry. For example, there is no analogue equivalent to a good digital reverb generator. The analogue world had to rely on electro-mechanical devices such as reverb plates, spring reverb, magnetic tape loops, echo rooms and so on. Some of these sounded great, but they were nowhere near as flexible as digital reverb, which can create impossible spaces or capture the reverb characteristics of specific locations.

Some analogue 'flaws' can be musically satisfying, but fortunately, analogue characteristics can be emulated by digital processing. You can also process your mix via analogue hardware by, for example, copying a digital master to analogue tape.

# EXPLORING SOFTWARE

**N**ow you've got gear for your studio and reached a deeper understanding of digital audio and MIDI, it's time to think about actually using some of this to create music! DAW software comes in a multitude of packages, but one thing they all have in common is their versatility. In this section I'll explore how to get the most out of your DAW, from operational 'how to's to tips on using plug-ins, virtual instruments, and loops and samples.

DAW BASICS	62
PLUG-INS	66
PLUG-IN INSTRUMENTS	72
DAW VIEWS	78
LOOPS & SAMPLES	82
UNDERSTANDING MIXERS	86

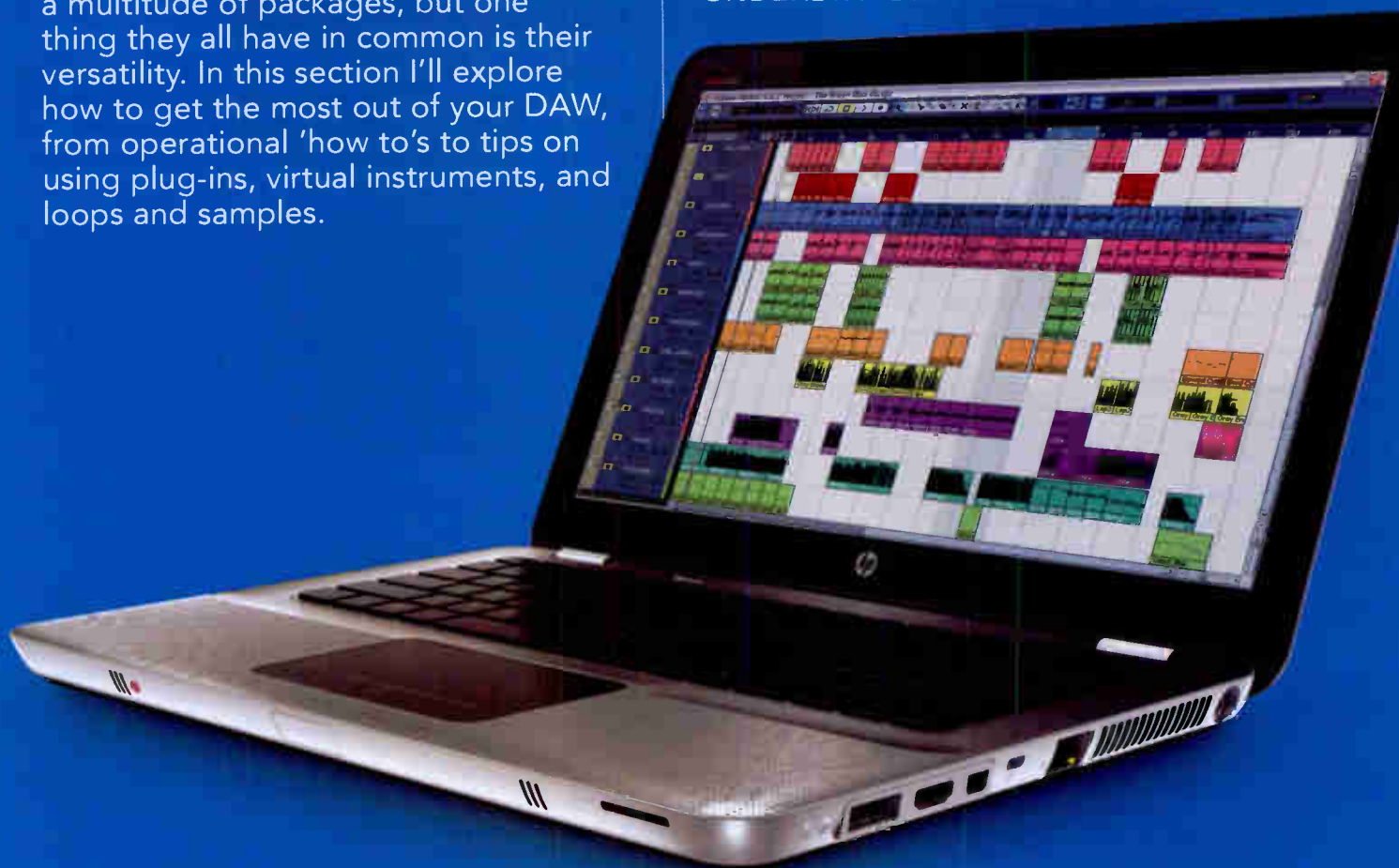



# Is Your Computer Studio Ready?

## Why Aren't All Computers Up to the Task?

Let's face it: the processing power and the efficiency of computers have made them an integral part of working with music and audio. Today's computers can enhance your creative process in many ways, but if your computer is not optimized for audio, it's a headache waiting to happen. Sweetwater builds customized studio computers and designs turnkey systems for some of the biggest names in the industry. We know the needs of the modern recording studio, and we're here to help!

So, what does "optimized for audio" really mean? With the processing power of computers increasing every few months, it may seem as if any Mac or PC computer with a USB port is capable of handling serious audio work — but that's just not the case. Working with digital audio demands a different set of resources than checking your e-mail or browsing the Internet does. Hard drive speed, compatibility with external audio gear, and a streamlined operating system all play a huge role in how efficient and enjoyable your experience will be. At Sweetwater we build our custom Creation Station PCs with industry-standard hardware for peak performance and compatibility with your favorite gear. And by tweaking your operating system to prevent unnecessary strain on your computer's resources, you'll be able to record more tracks and use more effects than you ever could with an off-the-shelf PC.



### Letting Sweetwater Install It, Test It, and Ship It

We take the worry out of getting a new computer system. Our highly trained service team can install all of your new software, register it for you, and even test and optimize your system to make sure it's fully stable and ready for your next session. If you have existing equipment, we can even find and install all of the drivers, so using your new computer will be a seamless transition!

### NUTS 'N' BOLTS

Whether you're working on a Mac or a PC, digital audio is serious work for your computer. Many computers come with a 5400 RPM hard drive, which simply does not spin fast enough to reliably read and write audio in a typical home or project studio. At Sweetwater, we install 7200 RPM Glyph drives in all of our Creation Station audio computers. Consider ordering your new computer workstation with two hard drives: one specifically for recording purposes, and one that holds all of your system software and applications. We've found that this simple consideration when designing your audio computer can make your workflow significantly more effective.

With new gadgets and gizmos becoming available every day, how well your computer interfaces with the rest of your gear is of utmost importance. Though many "stock" computers may seem to have all the right components, audio gear and software can be quite picky about what it works with. The brand of hard drive, the make and model of the FireWire card, and even the type of motherboard you choose can mean the difference between pure creative bliss and

“...it is best to consult with your pro-audio retailer about your specific needs — and to have a computer custom-designed for your studio.”

painful error-message deciphering. And though you can usually find detailed compatibility information in the documentation of each piece of gear you own, it is best to consult your pro-audio retailer about your specific needs — and to have a computer custom-designed for your studio. Sweetwater's computer experts can design a turnkey system specifically for your workflow and your gear. Imagine receiving your brand-new Mac workstation with all of your music software and plug-ins already installed, optimized for performance, and ready for you to take command!

### STREAMLINE YOUR SYSTEM

Optimizing your operating system for audio work is just as important as getting the hardware correct. Every extra bit of processing power you can squeeze out of your CPU means more tracks, higher-quality audio, more effects, etc. By preventing unnecessary programs from launching upon start-up, you'll ensure that CPU power isn't being taken away from your audio tasks. Taking advantage of your computer's auto-backup and auto-maintenance features helps your computer to run optimally, giving you more time to be creative. Although there are many useful tweaks that can be made to a computer to help it become a studio workhorse, it's best to sort all that out right at the start. Whether you choose a Mac workstation or a Creation Station PC running Windows, Sweetwater has the experience and know-how to streamline your operating system so that you're ready for serious audio work, right out of the box.

When purchasing an audio computer, remember that you're investing in a serious tool set that will be the foundation of your creative space! Will you be able to contact a live person if you have questions or concerns about your new system? How long does the warranty last? Will the company you purchased from still be in business next month? These are just a few considerations worth thinking about before you make your investment. You can turn to Sweetwater for personalized service and support — not only at the time of purchase but also over the life of your computer. With the most knowledgeable sales team in the industry as well as an expert tech support team that lives and breathes computer audio, Sweetwater is ready to design your next dream system.

At Sweetwater, we understand the needs of engineers and musicians because we are engineers and musicians. With our expert advice and personalized turnkey systems, you'll know that you're getting the audio computer that's right for you. And with the best personal tech support and the most comprehensive 2-year warranty in the industry, you can be confident that your investment is backed up by the best in the business. Understanding your goals and creating the perfect system to achieve them is just part of what the Sweetwater Difference is all about.



**Get a custom-built computer, made for music!**

**CALL US TODAY AT  
(800) 222-4700**

World Radio History

**We have the perfect music computer for you!**

Go to **Sweetwater.com**



### Support You Can Trust

#### Get Professional Advice and Guidance from Your Sales Engineer



Your Sales Engineer is your main point of contact at Sweetwater. He or she is here to answer your questions, to make sure each piece of gear you're interested in will best serve your ultimate goals, and to ensure that you're always taken care of. Since you work with the same knowledgeable person every time, you don't need to reintroduce yourself or explain your setup all over again.

#### FREE 2-year Warranty



We believe in the products we carry so much that we back them with a 2-year warranty — yours absolutely free. What's more, our in-house service team is authorized to perform warranty repairs for nearly everything we sell. If you ever need basic maintenance or repairs on an amplifier or a speaker, we'll ensure that you receive your gear back quickly, for minimal downtime.

#### FREE Shipping



We add value to your Sweetwater purchase with our fast, free shipping policy. Nearly every item we sell qualifies — including small packages of strings and even heavy guitar amps — and there's no minimum purchase. Plus, our central location in the Midwest ensures that you receive your items quickly, no matter where you are located.

#### 24/7 Online Tech Support



When you're working with music software and hardware, sometimes questions come up. Rather than spend time hunting on the Internet, you can visit our SweetCare® online tech support center at Sweetwater.com/SweetCare. Filled with thousands of helpful articles and tips, we have answers to the most common questions, all in one place.

#### Commitment to Customer Service



We believe in doing the right thing for our customers, every time. It's a belief that extends through every department at Sweetwater — from our courteous and helpful receptionists to our knowledgeable Sales Engineers to our meticulous shipping team, who makes sure your order is correct and packaged safely and securely so that you receive it in perfect condition.

**Sweetwater**

Music Instruments & Pro Audio



# DAW BASICS

**T**he reality is that most of us use little more than perhaps five percent of the capabilities of our DAWs most of the time.

By concentrating on that core five percent, you'll be recording, editing and mixing in no time. To figure out exactly what processes you'll need to learn, it's a good idea to plan a recording session and see the bare minimum you need to do to achieve what you want. You can then take time to explore the other 95 percent as and when you need to learn more.

## Starting A New Project

Stage one, after installing and starting up the software, is to open a new song or project and then check the project settings. Make sure you're recording at the appropriate bit depth and sample rate. For most users, this is 24-bit, 44.1kHz unless you're doing music for video, when the

**When you open the box containing your DAW software and find virtually all the space inside taken up by a 650-page manual, it can seem a little daunting. So, before you panic, let's look at the absolute basics!**

preferred sample rate is usually 48kHz. Select your connected audio interface as the input/output device that your DAW will use. An audio settings window should also allow you to set the audio buffer size. A good compromise setting between overtaxing your DAW and having unacceptably long latency is 128 or 256 samples. When you're creating a project, your DAW might also ask you to specify further details, such as the project tempo, and how many audio or MIDI tracks you'll be needing, though most are

flexible enough to let you change and add things later. A peek in the manual should set you on the right path.

Once you've got your project set up, you will quickly discover that you can select individual tracks simply by clicking on them. But how do you get audio into your tracks? Somewhere, most likely in the Inspector section of the Arrange window, there will be a list of possible input sources for the selected channel. This should show all the physical inputs on your audio interface, so if

## Templates Save Time



It's a great idea to start with customised templates rather than with an empty project, as this eliminates the need to change settings and add tracks each time you boot up your DAW. If this is your first time you're working with your DAW, you may find that the manufacturer has created one or more templates for you, but it's relatively easy to add your own. Just check your manual.

you have an interface with only two inputs, two inputs is all the list will show. If you don't see the right number or choice of inputs, you'll need to visit a setup window such as Cubase's VST Connections dialogue or Pro Tools' I/O Setup page.

If the track is stereo, the inputs you can select will be numbered in adjacent pairs, such as 1/2, 3/4 and 5/6, while mono tracks will show individually numbered inputs. Any



digital I/O will also show up in this list, so if your interface has eight mic/line channels, plus an S/PDIF digital input, the latter might show up as track pair 9/10. Software instrument tracks don't need an audio input, as the software instrument itself is the sound source, though they do need a MIDI input. When you create an instrument track, you'll be presented with a menu of all the plug-in instruments you have installed. Select one, and its graphical editing window will appear. You can usually choose from a preset sound or create your own using the plug-in's own controls. In most cases, a plug-in MIDI instrument will be playable straight away from the keyboard when its track is selected.

## Beginning Recording

Before you start recording audio, you need to set the recording level. The usual procedure is to first arm the track's

Record button. This will then show your input signal on the track's level meter. While playing or singing as loud as you will need to, you then adjust the input gain control on whatever your microphone or instrument is plugged into (usually a mic preamp or mixer channel). Aim for a peak level of between half and two thirds of the way up the meter, so as to leave yourself a safety margin. This is known as 'headroom'. You can then hit Record on the transport control panel and the tracks set to record will start recording immediately. (There's almost always an option to use a count-in first if you prefer.) If you need to play to a click, you can also activate the built-in metronome or click generator. A vertical line, usually known as the 'cursor', indicates the 'now position': the point in the song the DAW is recording and playing back from at any given moment.

Once you've finished recording, you should be able to see your new audio region in the selected track. By moving the cursor back to the start, you should be able to play it back, and marvel as it changes in volume as you drag the channel fader up and down. If there's a 'pan pot' above the fader on your DAW, give that a try too. It's time to experiment a little!

## Manipulating Audio Regions

Consult the manual and find out how to adjust the start and end times of the audio region. This is usually accomplished by dragging handles at the ends of the region, but every DAW has a slightly different approach. You can make a section of recorded audio shorter but you can't extend it beyond its original length. Next, find out how to drag the

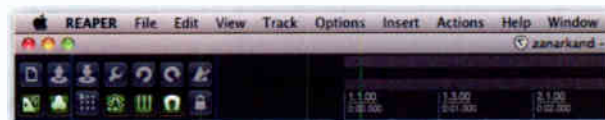

Each DAW has similar functions arranged in not-so-similar ways. Most of the controls you'll need for everyday DAW operation are generally categorised under one of the following menus: audio, track, project, insert, edit and options, for example. You can see this here in a comparison between the menus of Cockos' Reaper and MOTU's Digital Performer.

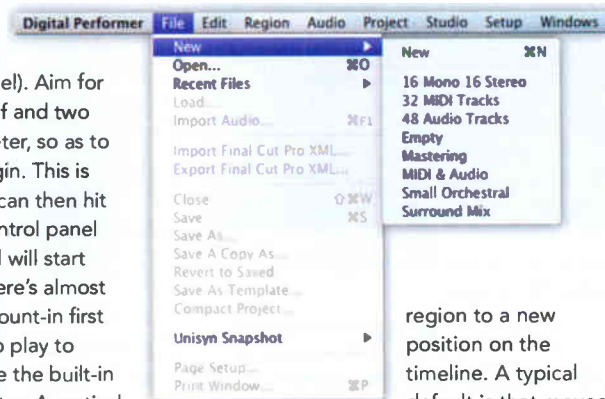

region to a new position on the timeline. A typical default is that moved

audio snaps into position to the nearest beat but, if you want smaller subdivisions or to be able to place the start point anywhere you like, you may have to drag while holding down a combination of some of the computer's function keys.

Find out how to access the editing toolbar in your DAW, and check out what all the tools are for. For instance, many DAWs have 'scissor' tools, which are used to split regions in two. Once you've split a region into two or more parts, each behaves like a separate region that can be dragged, adjusted at the start and end, and moved. You can also copy any of the smaller regions you've created. Also, try dragging a region to a different track.

When you've mastered these moves, you're well on your way to basic audio editing, although finding the best place to make an edit takes a little experience. The smoothest-sounding edits are often the ones where you cut immediately before a new beat or note, or during a pause, >>

## Choosing An Input

Most DAW channel strips give you the option of selecting inputs from a button integrated into the channel strip itself. This example, taken from Apple's Logic, shows how the input is selected, but most DAWs have a similar setup.

Depending on the interface you're using and your DAW setup, you may have access to fewer or more inputs than shown here.

If you want to change your input, it's as simple as a click of a button!

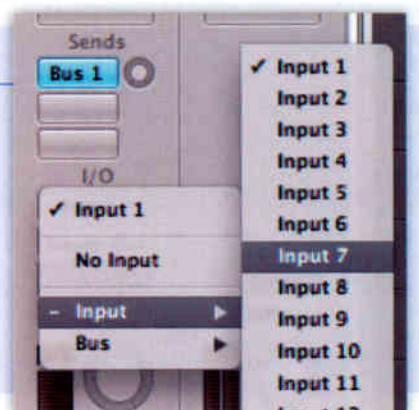

## Safe & Sound



While modern computers running correctly installed software should be pretty stable, crashes do sometimes happen. To avoid loss of data, get into the habit of saving your work after every few steps when recording and editing. If you notice your computer suffering from regular crashes, you may have installed a plug-in that is affecting your DAW's stability. Ensure you read any documentation supplied with your software to check compatibility, and keep your software up to date by checking for and downloading updates.

» which you can see fairly easily in the waveform display.

## MIDI

Next, drop a software instrument plug-in into your MIDI track and ensure that your music keyboard is communicating with the DAW, either via MIDI or USB. Most DAWs have some kind of MIDI activity meter to show you that data is being received. If you're not getting MIDI into the DAW, the manual should point you at the right settings. Turn on the click track, start recording and play a few notes. As with audio, check these play back once you're done recording, then try selecting

## Working With Audio Tracks

Once you've recorded an audio track, you'll end up with something looking a little like this appearing in one of your channels.

In most DAWs you can colour each audio track as shown here. This can be really helpful to visually represent sounds from different instruments, or to indicate audio files being worked on and those with editing complete, or whatever other

categorisation you can think of.

Depending on what tool you have selected, clicking on any part of the audio region will move the cursor to that point in time, enabling you to edit at that position or start playback from there. Clicking and dragging can often be used to highlight a section of the audio track for editing or separating as a region in its own right.



a different instrument or different sound within the same instrument to hear the effect of your melody played back using those alternative sounds.

In the main Arrange page you can copy, split and move MIDI regions, much as you did with audio, but more detailed MIDI editing will usually be done in a separate 'piano roll' edit window (different DAWs give this different names). Familiarise yourself with the actions of moving, lengthening and deleting notes, much as you did with audio regions in the Arrange window. Also, try drawing in some new

ones. If you're not a binary head or music scholar, this is where you'll be doing most of your note editing.

With the piano-roll editor window open, select a bunch of notes by dragging a box around them using the mouse (this works in most DAWs), then select one of the quantise options and see how the notes move to line up with the grid. If you want to quantise the contents of a whole MIDI region or track, you can probably do that from the Inspector part of the Arrange window. Again, the manual (or built-in help) is your friend here. Most are well written and, once you know what you want to do, the relevant section isn't too hard to find.

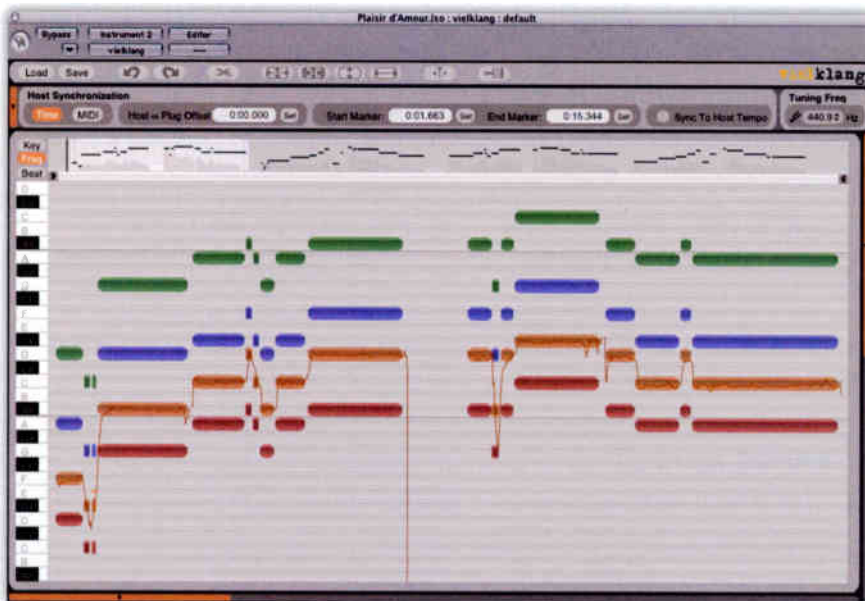

Piano-roll editors all look very similar. The name comes from the perforated piano rolls used with pianolas on which the perforations represent both the pitch (location) and duration (size) of the notes to be played. In a similar way, MIDI piano-roll editors use a visual representation of the piano keys on the left-hand side of the screen over which the grid of notes moves. Notes are shown as rectangular blocks of varying lengths, echoing the perforation system of the old-fashioned piano roll, and are sometimes coloured automatically according to their pitch for easier identification.

## Mixer

Let's assume now that you've recorded a few tracks of audio and maybe a MIDI part or two and you want to mix them to create a song. The faders on the mixer page will let you balance the various tracks while the pan controls shift the sound towards the left or right speaker, as you'd expect. Keep an eye on the levels so that none of the track meters, or the master mix meter hits the red. If your levels are too high, reduce all the channel-fader levels until you're back in the safe zone.

If everything you recorded sounded exactly the way you wanted it to, you could set a balance and just let the track mix itself, but in reality you will probably need to adjust levels to even out discrepancies in the performance and to bring up instruments during solos. To do this effectively you need to learn how to drive the DAW's in-built mix automation. There are two ways to approach this: you can either move faders as your song plays back, and have your DAW record those moves; or



you can simply use the mouse to 'draw' the shapes you want them to follow into 'lanes' below the audio tracks.

The basic automation modes are Off, Write (fader moves are recorded) and Read (fader moves are played back). These modes can be set for individual tracks. There may also be other Write modes, such as Latch, which is particularly useful as, when you let go of a fader, its level 'latches' at the last value you set until you stop recording automation data. Once again, each DAW has its own twists and variations.

Automation capabilities of modern DAWs can be surprisingly sophisticated. Using the automation controls, you can work on each track until the mix balance sounds as you want it to right the way through the song.

### Further Processing Options

A 'real life' mix of a pop song also includes EQ and effects. Your DAW may provide EQ as a standard channel feature or as a plug-in, and some also include dynamics processing, but anything else you need will probably come via the plug-in menu. Processors such as equalisers, gates and compressors are usually inserted directly into a track's 'insert' points, meaning that each plug-in only processes one track, and processes all of the signal on that track. The same goes for a lot of more specialised plug-ins such as distortion effects or pitch-correction processors.

By contrast, there are other effects such as reverberation and delay that work better when added in small amounts to multiple tracks. Try creating an auxiliary, FX or effect track (different DAWs give these different names) with a reverb effect plug-in

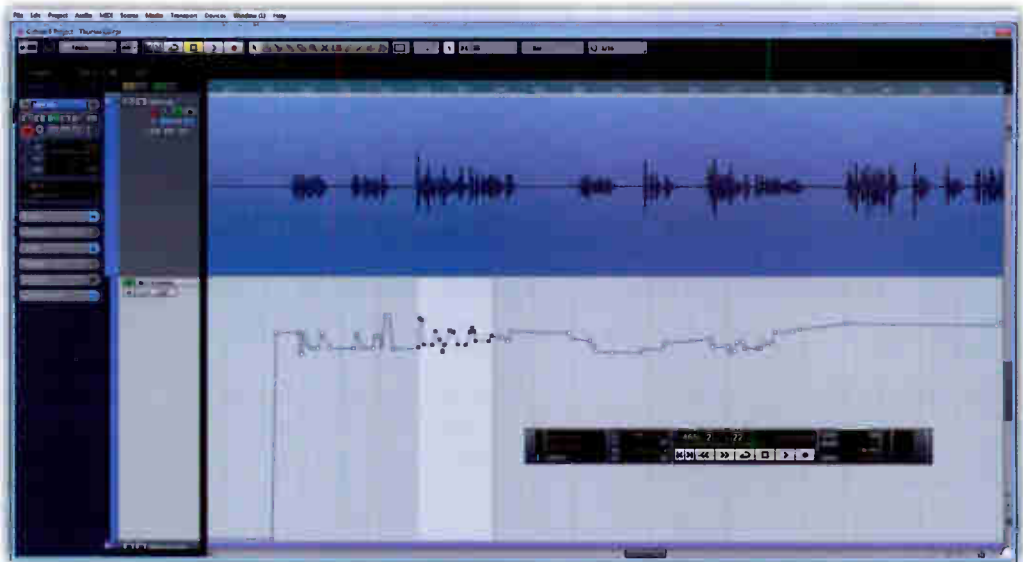

Here's an example of graphical mix automation in Cubase 6. The main audio track is separate from the mix automation settings, which are applied over the audio and do not change the audio itself. Moving any one of the points alters the gain for that particular part of audio. This is useful for fine-tuning gain levels to make specific sections more prominent whilst de-emphasising unwanted sounds such as breaths.

inserted on it. You can then add reverb to all the tracks in various amounts by using the auxiliary sends on those channels. If you feel you need two different reverbs, one long and one short, then set up the second reverb on a second auxiliary send and off you go!

While you can automate most plug-in parameters, it might be as well to leave trying that until you get more familiar with your DAW. Master the basics first!

If you want to affect a whole mix, you can put stereo plug-ins into subgroup buses or into the main stereo mix bus. The *Sound On Sound Mix Rescue* articles provide plenty of insight into using plug-ins effectively, so make use of the *Sound On Sound* web site: it is a fantastic learning resource and all but the most recent content is free to access. You can find it at [www.soundonsound.com](http://www.soundonsound.com).

Once the mix sounds right with all your plug-ins and fader automation working correctly, you can 'bounce' the song to a new stereo audio file. Of course, this is just scratching the surface of what your DAW can do but, as I said at the outset, if you can become familiar with these key elements you can start making and mixing recordings. Everything else can be learned a piece at a time and at your own pace.

### Summary

- A DAW might look complicated, but that's because most of them offer you the software equivalent of a seriously

advanced hardware studio. Fortunately you don't have to learn it all at once. Concentrate on the basics as outlined here, and the learning process should be fairly painless.

- Most DAWs offer similar core features and have evolved towards a similar look and feel in terms of what types of windows are available and how data is displayed, though there are exceptions such as Ableton's Live.
- Despite their similarities, modern DAWs have literally hundreds of features and menu options, which tend to be in different places, depending on which DAW you buy. While knowing what a DAW is likely to be able to do makes learning a new one easier, you can still end up playing a long game of hide and seek to find out how to access the things you know are in there somewhere. ■■■

### Keep Those Manuals!

All DAWs handle setting up software, audio and MIDI instruments differently, so it's worth keeping the manuals to hand for quick reference.



### Level Setting

Track faders turn the level of the sound you hear over the speakers up or down but the actual record level must be set using the gain control on the channel of the audio interface supplying the signal. If the gain is set too high, clipping will occur at the analogue-to-digital stage inside your audio interface and no amount of fiddling with knobs and faders in your DAW will fix it.

# PLUG-INS

DAWs offer a great deal of functionality right out of the box, but it's possible to enhance their performance by adding optional plug-in effects, processors and instruments from third-party suppliers.

A software plug-in, in the context of a DAW, is analogous to an external processor or instrument, such as a reverb unit or a synth, plugged into a conventional mixer. As everything inside your DAW happens in a virtual world, however, you save a fortune on patch cables! You simply choose from a menu showing what plug-ins are available and drop them into the appropriate point in the DAW mixer's signal path.

Most plug-ins are available separately, but some are cheaper if you buy them as part of a bundle comprising several different plug-ins. In some cases, such as with Waves, some plug-ins are only available as part of a bundle. You'll find that you can download time-limited demos for many plug-ins, allowing you to evaluate them before you buy.

Instrument plug-ins generally show up as sound sources, while processors and effects are available for use in the mixer's channel, bus, output insert points or in auxiliary send/return configurations. If you know your way around a basic analogue mixer, you'll have no problem following the signal flow in a typical DAW, but you should still read the manual, as every DAW has a slightly different approach to 'instantiating' plug-ins.

## Plug-in Formats

For a plug-in to work in your DAW, it must be available in a format that your DAW can use. There are four plug-in types in common use:

- RTAS stands for Real Time Audio Suite and was developed

by Digidesign (now Avid) to work with their native ProTools M-Powered and LE software, though some other DAWs can also accept RTAS plug-ins.

- Audio Units is used by Apple Mac programs such as Logic Pro, Studio One and the Mac version of Cubase, though Digital Performer, which is also a Mac program, has its own plug-in format, called MAS.
- VST or 'Virtual Studio Technology' is the most popular plug-in format for

Windows DAWs, though there is also a Mac version of VST that some DAWs can make use of.

- PC-only DirectX plug-ins used to be wildly popular, but are now used far less widely than the other formats.

## Plug-ins That Are Not Plug-ins

Some DAWs, such as Logic, come with a standard set of plug-ins, or at least they look and work like plug-ins, but you won't see them listed in the computer's plug-in folder alongside any of the third-party plug-ins you may have installed. That's because, although they are accessed and deployed in the same way as normal plug-ins, they are actually built into the program itself (hence, not true plug-ins). The same is true of the Instruments in Propellerhead's Reason or the 'plug-ins' in its sister Record. All the instruments, effects and processors are built into the program and, in the case of these two products, can't be expanded using third-party plug-ins. Record users who also have Reason installed can use all of Reason's instruments and other processors inside Record.

## DSP Assistance

The majority of plug-ins are what we call 'native' as, like the DAW software, they run using the power of the host computer's CPU and RAM. However, there are some plug-in platforms that require additional DSP (Digital Signal Processing) to run. This may come in the form of a hardware box connected via Firewire or a card that plugs into a laptop's card slot or desktop computer's PCI bus. It is arguable whether additional DSP is really needed now that computers are so powerful, but if you want to use the plug-ins that run on DSP, you



Most DAWs, such as Logic, pictured here, will happily host plug-ins from other makers.



### Plug-ins & CPU Power

With very few exceptions, you can open as many instances of a plug-in as your CPU's capacity can support. Unlike hardware, you pay for the plug-in once, but unless you run out of CPU power, you can use multiple instances of that plug-in within several different mixer channels and buses at the same time, and each instance can have totally different settings.

have no choice. It is also true that having a hardware component makes it easier for the manufacturer to avoid the plague of software piracy. DSP systems still place some administrative load on the host CPU and may use some system RAM for delay effects, but they carry most of the burden of powering the plug-ins themselves, leaving your CPU with more free capacity to run native plug-ins at the same time. Popular DSP platforms include: Universal Audio's UAD series of processors, TC Electronic's PowerCore, Focusrite's Liquid Mix and SSL's Duende.

### Why Add Plug-ins?

If your DAW already comes with EQ, effects, compressors and a handful of synths and samplers, you may well wonder why you'd ever need to add more. The short answer is that you may not need to, although third-party plug-ins provide a useful alternative to those offered by your DAW, and many offer features that your basic DAW simply doesn't provide. For example, if you want the sound of a specific 'classic' equaliser, such as a Pultec or a Neve, you'd need something like a UAD plug-in from Universal Audio. Universal are a company specialising in

producing extremely accurate emulations of classic studio hardware, including plate reverbs, tape echo devices, equalisers and compressors. They even have a very convincing analogue tape emulator.

The quality of reverbs available in standard DAW packages varies, depending on which DAW you buy. If the reverb included in your DAW isn't up to much, you could splash out on a top-of-the-range Lexicon reverb plug-in, for example. There is also a range of unique products such as Melodyne DNA (tuning software that can retune individual notes even where they appear in the middle of a chord) and SPL's Transient Designer (used to shorten or lengthen drum sounds, as well as adjusting their attack characteristics). While it is your approach to music that will make you unique, it doesn't hurt to use additional plug-ins if it helps make your sound different from what everyone else is doing. Besides, some offer better quality processing than the ones supplied with a typical DAW.

### Inserts

In the world of hardware, you have to buy a stereo processor to process a stereo signal. In DAW-world, it is common for a stereo version of the plug-in to show up automatically in the plug-in list if the audio track or bus into which

it is to be inserted is stereo. Similarly, you see a mono version if the audio track is a mono track. Some plug-ins, such as reverb, can create a stereo output from a mono input, so you may even see the option 'mono-in, stereo-out' available for selection.

The simplest way to deploy an effect or processing plug-in is via a mixer channel insert point. Drop your plug-in there and all the audio passing through the channel will be routed through the plug-in, exactly as though you'd plugged a hardware device into a conventional mixer's insert jack. A DAW mixer can also create subgroups in the same way as a larger analogue console can, where a number of channels are mixed down to a bus channel, which is in turn routed to the main stereo mix.

The benefit of this 'mixer within a mixer' approach using a bus is that all the tracks routed via the bus channel can be adjusted in level using a single fader: the one on the bus channel itself. A practical application is to 'group' all your backing vocals or all the mics for a drum

### Plug-in Types

Not only can you get plug-ins to handle familiar processing such as gating, compression, expansion and EQ, but there are also specialised plug-ins available for reducing background hum and hiss, for correcting out-of-tune vocals and instruments and for adding deliberate distortion. Similarly, all of the familiar chorus, flange, phase, delay and reverb effects are available as plug-ins, but you will also find vocoders, rotary speaker emulations and many weird and wonderful creations that would be impractical to build in the analogue world.

Subgrouping: the individual drum channels (blue) are routed to the drum subgroup (the first yellow channel), which in turn outputs to the stereo mix.



Using send effects in Cubase: the compression and EQ (courtesy of Focurite's Liquid Mix) is used as an insert effect, whereas the reverb is set up as a send effect, and has been panned slightly away from the main vocal (left). Acoustic guitar and vocal parts are able to share the same reverb effect in different amounts (right). Not only does this save on computer resources, but it's a useful way of putting sounds in the same 'space'.

» kit so that the whole set can be controlled by a single fader. You can also insert a single plug-in into the bus insert point to affect all the channels feeding that bus. If you want to EQ the backing vocal mix as a whole, for example, it is both easier and less CPU-hungry to place one EQ plug-in in the bus insert than to put a separate EQ in every backing vocal mic channel insert point. The same is true if you want to compress the overall backing vocal mix: you need only one compressor in the bus insert point.

## Effect Sends

Reverb plug-ins, especially good ones, use a significant amount of CPU power. It makes sense to deploy them wisely, so putting a different reverb on every track in your mix is not the most efficient way to go. You could add reverb to groups, as above, but it is often the case that you only need one or two different reverbs in a mix, in which case using the channel effect sends is far more efficient.

Effect sends are additional level controls that work on the channel signal after it has passed through the channel fader (post-fader) to create separate mixes, somewhat like the bus concept just explained. This is important, because it means that when you turn down the level of a channel, the effect send level falls by the same amount, so the original effect-to-'dry' (un-effected) sound

## A Practical Approach

You can download user manuals for many small mixers from manufacturers' websites. It's a good way to get familiar with the basics of mixer layout and operation before exploring the DAW equivalent.

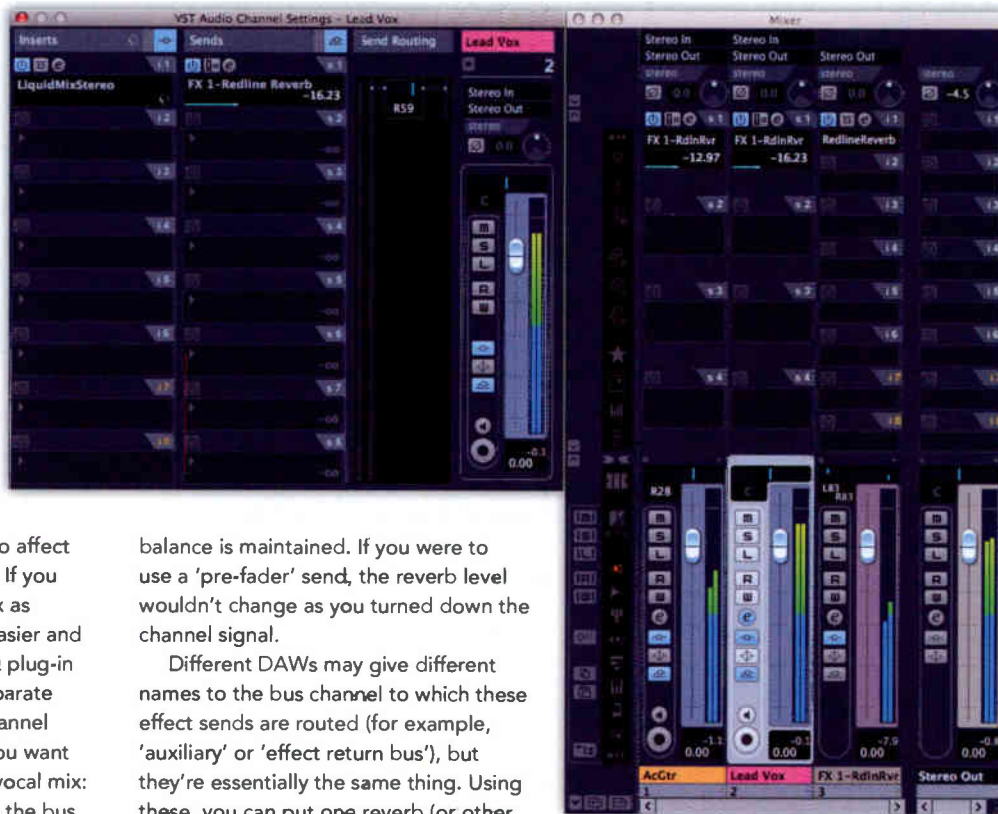

balance is maintained. If you were to use a 'pre-fader' send, the reverb level wouldn't change as you turned down the channel signal.

Different DAWs may give different names to the bus channel to which these effect sends are routed (for example, 'auxiliary' or 'effect return bus'), but they're essentially the same thing. Using these, you can put one reverb (or other effect) plug-in into the effect return bus and then use the channel effect send controls to send any desired amount of signal to the bus hosting the reverb plug-in. The reverb plug-in's mix control should be set to 100 percent effect ('wet') for this to work correctly. Now you can adjust the amount of reverb added to each channel in the mix simply by adjusting the effect send control on the desired channel. If you need two different reverbs, you just set up a second effect send feeding a second effect return bus and insert a different reverb into your new bus. Each channel can now access both of these reverbs with independent amount controls for each. Inserts, buses and auxiliary sends are important, so I'll

be covering them again in the section on mixers later.

## Effects & Processors

I like to differentiate between effects and processors, because the rules as to how each can be deployed within a DAW's mixer differ slightly. As a rule, anything that is designed to process the entire signal (an equaliser or compressor) can be thought of as a 'processor'. An 'effect', on the other hand, usually has a mix control that allows some of the dry signal to be mixed with some of the effected signal, delays and reverb being obvious examples. Typical effects can be used either in DAW insert points or effect send buses. With processors, however, you have to think a little bit more. »



The yellow line on this waveform shows the automation data that has been applied to the audio track. The individual points represent individual automation events, whereas the line is representative of the overall levels of automation. Automation is usually fully customisable, made editable by clicking and dragging on any part of the line or its individual points.



# WAVES AUDIO



## CREATORS OF THE WORLD'S LEADING AUDIO PLUGINS

With over 100 cutting-edge software and hardware processors used in every aspect of audio production, Waves is the leading developer of professional audio signal processing technologies, heard on hit records, major motion pictures, and popular video games the world over.

### Innovation and Excellence

Waves offers an extensive line of off-the-shelf bundles which provide comprehensive selections of the most-used plugins in convenient, affordable configurations. Compatible with all major hosts and formats, Waves plugins are the most popular and widely-used plugins in the industry, found in nearly every recording studio, post production facility, and mastering room worldwide.

Beginning with one of the audio industry's first software plugins—the Q10 Paragraphic Equalizer—Waves established its reputation for technical innovation and sonic excellence. Subsequent plugins like the L1 and L2 Ultramaximizer™ became instant must-haves in studios everywhere, setting the standard for in-the-box dynamics processors. Vocal Rider transformed the world of mixing by simplifying and automating the often tedious task of riding vocal levels. And now, Waves OneKnob plugins makes mixing even faster—and more fun than ever. With OneKnob, mixing engineers and musicians are now able to achieve great sounding results faster and more easily than ever before.

### Artist Signature Series

The Signature Series is Waves' line of application-specific audio processors, created in collaboration with the world's top producers,

engineers, and mixing engineers, like Chris Lord-Alge, Jack Joseph Puig, Eddie Kramer, and Tony Maserati.

Using custom multi-effect processing chains designed by the artists themselves, each and every Signature Series plug-in has been precision-crafted to capture the artist's distinct sound and production style. With dedicated plugins for vocals, guitars, drums, bass, and more, the Signature Series makes it easy for experienced and aspiring audio professionals alike to dial up the sound they're looking for quickly, without interrupting the creative flow. It's like having behind-the-scenes access to the sounds and techniques of the world's leading mixers.

### Modeling

Waves modeled plugins deliver the distinctive sound of the world's most in-demand hardware audio processors—in software. With its SSL 4000 Collection, Waves was one of the first audio companies to venture into the realm of analog modeling, and widely recognized as the first to have 'gotten it right,' offering precision, warmth, and realism that were previously unavailable. Today, Waves modeled audio plugins such as The API Collection, CLA Classic Compressors (CLA-2A, CLA-3A, CLA-76), and JJP Analog Legends (PuigChild 660/670, PuigTec EQP-1A, PuigTec MEQ-5) set the sonic standard to which all others aspire.

Connoisseurs of vintage recording equipment know that no two units of the same make and model sound exactly alike. Tubes, transistors, capacitors, and other components work together to give each piece its own unique personality.

Waves begins the modeling process by acquiring the very best hardware reference units available. Then, with meticulous attention to detail, we analyze every attribute, behavior, and response of the originals. Finally, we replicate their performance in the digital realm, tweaking and adjusting algorithms and parameters to truly capture the distinctive tonal personality of each device. The result is sonic depth, nuance, and detail that make Waves software plugins virtually indistinguishable from the original hardware.

### GRAMMY® Honors

During the 2011 GRAMMY® Week celebration, Waves was presented with a GRAMMY Award for its pioneering work in professional music production software. The award is presented by The Recording Academy® to companies that have made outstanding technical contributions to the recording field. Reaffirming its status as a pro audio industry leader, with this Technical GRAMMY®, Waves joins a prestigious list of previous recipients which includes such well-known names as Apple, Sony/Philips, Shure and Yamaha.

» Processors are designed to process the entire signal. For this reason, you don't generally want to use one as a send effect as then you'd end up mixing the dry signal with the processed signal. Mixing an EQ'd signal with a non-EQ'd signal would, at best, just dilute your EQ settings. The same is true of compression and gating, though there are advanced compression techniques, often referred to as parallel compression, where it is desirable to add a dry signal to its compressed counterpart. This is best left until you've gained more experience working conventionally. You can safely put an equaliser or other processor directly before or after an effect plug-in in the effect return bus, in order to modify its sound, for example, when putting EQ before reverb.

### Plug-in Automation

Most mainstream DAWs allow plug-in controls to be automated in the same way as the DAW's own fader and pan controls. Essentially, you set the track to record automation and then, as the song plays through, you adjust the controls using a mouse, trackpad or external hardware controller. When the track is switched back to reading automation, all your control moves will play back just as you made them. The majority of DAWs include a graphical automation editing view so that you can make changes to the automation data after recording it.

### Editing & Presets

The structure of all mainstream DAWs supports the automatic saving of all current plug-in settings, which are stored along with the rest of the song data whenever you save the song. Furthermore, the majority of plug-ins allow the user to save specific settings for later use in other projects, much in the same way as a synth or hardware effects unit stores user patches. Many also come with a selection of factory settings from which you can choose. While I'm always wary of factory presets for signal processing (especially dynamic processing such as compression),

A selection of amp-modelling plug-ins including IK's AmpliTube, Line 6's Pod Farm and Logic's Amp Designer.

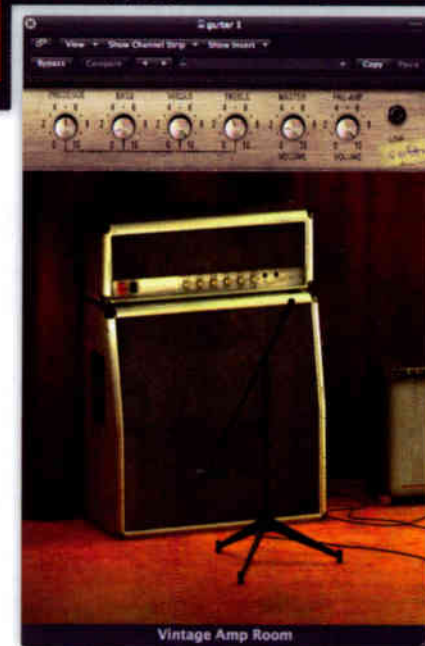

having a large library of factory sounds available for use with software instruments is clearly very attractive.

DAW songs contain the settings for any plug-ins that have been used, but the settings don't save the plug-ins themselves. These usually reside in a separate plug-ins folder elsewhere on the system, and it is likely that their copy-protection system would prevent you creating copies anyway. The practical outcome is that if you open your song on a friend's system running the same DAW software, any plug-ins that you have used, but which they do not also own, will not appear. The only option at this stage, other than your friend buying the missing plug-ins, is to find alternative plug-ins that can do a similar job to the ones that are unavailable.

### Wrappers

Some plug-ins are designed to support only specific plug-in formats. This is frustrating if you'd like to use one in your DAW but find the format incompatible. A possible solution is to use a third-party wrapper program, which essentially makes one format of plug-in appear to the host DAW to be a different format. UK company FXpansion, for example, eased the frustration felt by many Pro Tools users who lusted after certain VST plug-ins by creating a wrapper to allow VST plug-ins to appear as RTAS plug-ins that Pro Tools would recognise. Major software companies don't support these third-party products, as they don't always provide 100 percent compatibility with all plug-ins, but

if you check out the various DAW forums you can find out what works and what doesn't. My own feeling is that wrappers should be used as a last resort, but they're worth a try if you run out of other options and can find no alternative plug-in to do the same job for you.

### Learning Curve

Plug-ins vary in complexity from emulations of a simple two-knob guitar effects pedal to a full-blown synth with hundreds of settings to tweak. Unless you're prepared to use only the factory presets with these more complex plug-ins, be prepared to spend some time reading the manual and experimenting to get the best out of them, even if you only learn enough to make minor adjustments to the factory settings. Also, be aware that any processor plug-in presets that

## Multiple Formats



Non-platform-specific plug-ins come with installers for both Windows and Mac and, unless instructed otherwise, will install all the plug-in formats available for that particular plug-in that are relevant to the computer platform being used. For example, if I install a plug-in to use with Logic (Mac-specific), the Audio Units version that Logic needs is installed, but I also get the Mac VST version and the RTAS version. This can be useful, as there are other audio programs, such as the BIAS Peak stereo editor, that can make use of multiple plug-in formats.

include a threshold control (compressors, gates and expanders) will still require manual adjustment of the threshold setting, as the right setting for this will depend on the nature and level of the input signal.

## Modelling

Modelling is a technique whereby a mathematical model is made that emulated the behaviour of an electronic circuit or mechanical device, enabling it to be recreated in software. There are various technical approaches to modelling, but the aim is to get the virtual-world algorithmic recreation of a device to respond to different input signals in the same way as the real thing.

In the plug-in world, we have modelled recreations of vintage equalisers, compressors, analogue synthesizers, electro-mechanical tape and plate echo/reverb effects and, of course, guitar amplifiers. Some are more accurate than others, but the better ones get very close to the performance of their hardware counterparts. You'll often find that the control

**"Some plug-ins are designed to support specific plug-in formats; frustrating if they're not compatible with your DAW. Third-party wrapper programs can disguise the plug-in with a readable format for your DAW."**

panels of these plug-ins are designed to emulate the look and layout of the original hardware that inspired them.

Guitar amplifiers are particularly interesting, as the algorithmic model has to include the subtle distortions and filtering effects of components such as valves, audio transformers, power supplies and tone controls, plus the electro-mechanical characteristics of the loudspeaker and its cabinet. The majority of guitar-amp modelling programs also include the characteristics and position of the microphone that would be used in the studio to record the real thing, so that the DAW user can make adjustments to fine-tune the sound by, for example, moving the mic further from the speaker or moving it slightly to one side.



# Sonnox ELITE

## The Ultimate Oxford Plug-in Collection

Sonnox takes digital audio processing to a whole new level. The renowned Oxford range of plug-ins offers unparalleled clarity and precision for mixing, broadcast and post production applications. They are the first choice for discerning audio professionals all over the world.

## Seven outstanding plug-ins in a single bundle

Oxford TransMod

Oxford Limiter

Oxford Inflator

Oxford Reverb

Oxford EQ

Oxford Dynamics

Oxford SuprEsser

Educational discount available  
Save 50%



[www.sonnoxplugins.com](http://www.sonnoxplugins.com)

**Oxford  
Plugins**

» A typical guitar-amp modelling plug-in might also include a range of popular effects pedals, again modelled, that can be placed before the amplifier and adjusted in the same way as the real thing. Other plug-ins, such as the Line 6 Pod Farm and NI's Guitar Rig, allow the user to set up two amplifier chains to create more complex sounds.

buffer size you can get away with, so as to minimise latency, though the version of Line 6's Pod Farm designed to work with a Line 6 audio interface includes an ingenious low-latency monitoring mode that still lets you hear all the modelled amps and effects as you play.

Finally, although these plug-ins are designed primarily for use with guitar

**“The majority of plug-ins are what we call ‘native’, using the power of the host computer’s CPU and RAM. However, some require additional DSP (Digital Signal Processing) to run.”**

This approach provides the guitar player with a complete recording signal chain, the only proviso being that the guitar needs to be either plugged into the audio interface via a high-impedance instrument input, if it has one, or into the mic input via a high-impedance active DI box. Plugging directly into the line input will compromise the tone of the guitar to some extent, as the impedance is lower than that of an actual guitar amp.

While all the market-leading modelled guitar processing plug-ins (including Line 6 Pod Farm, Native Instruments' Guitar rig, IK Multimedia AmpliTube, Softube's Vintage Amp Room and Waves Eleven) can produce exceptionally good sounds, they don't all sound the same. This might seem odd, as they all purport to model a similar range of amps and processors, but perhaps the way to look at it is that the same gear recorded in different studios by different engineers would also produce different results. Guitar tone is very subjective, so which sounds best is down to the preference of the individual.

A big advantage of the modelling approach, other than the obvious one of not needing a loud amplifier when you're feeling creative after midnight, is that the guitar sound itself is recorded perfectly cleanly and all the tonal shaping, overdrive and effects come from the plug-in. That means that if you get to the mixing stage and decide your guitar would have sounded better through, say, a Vox amp rather than a Fender Twin, you can change it very easily.

When using modelled guitar amps, it is important to set your DAW to the lowest

and bass, they can be very effective if used for processing keyboards or even vocals. As ever, if something sounds good, it is good.

### Summary

- Plug-ins are additional pieces of software that can be accessed from within your DAW to furnish you with extra signal processors, effects and software instruments. Some DAWs, such as Logic, also come with a set of built-in processors and instruments that behave like plug-ins but are

## Hardware Add-ons



Some guitar modelling software can be used with optional hardware controllers to, for example, switch individual effects on and off during performance or to control wah-wah effects from a pedal.

actually part of the program.

- Your DAW's plug-in format must be supported by the plug-ins you wish to run, though many come with an installer for several different formats and some DAWs can run more than one plug-in format. The common formats are VST, AU, RTAS, Direct X and MOTU's Digital Performer-specific MAS.
- Plug-ins come at every price point, from freeware and shareware up to high-end reverbs that might cost more than your DAW program.
- The amount of CPU overhead varies enormously too, with complex software instruments and high-quality reverbs being the most power-hungry.
- Learn to use the Effects Send system to allow channels to share common plug-ins, such as reverb, conserve CPU power and make your mix easier to handle. Putting a separate reverb plug-in into every channel that needs reverb is very wasteful. ■■■

## Selected Manufacturers

### Avid

[www.avid.com](http://www.avid.com)  
 AudioEase  
[www.audioease.com](http://www.audioease.com)  
 Antares  
[www.antarestech.com](http://www.antarestech.com)  
 BIAS  
[www.bias-inc.com](http://www.bias-inc.com)  
 Cakewalk  
[www.cakewalk.com](http://www.cakewalk.com)  
 Celemony  
[www.celemony.com](http://www.celemony.com)  
 Focusrite  
[www.focusrite.com](http://www.focusrite.com)  
 FXpansion  
[www.fxansion.com](http://www.fxansion.com)  
 IK Multimedia  
[www.ikmultimedia.com](http://www.ikmultimedia.com)  
 Izotope  
[www.izotope.com](http://www.izotope.com)  
 Lexicon  
[www.lexiconpro.com](http://www.lexiconpro.com)  
 Line 6  
[www.line6.com](http://www.line6.com)  
 McDSP  
[www.mcdsp.com](http://www.mcdsp.com)

### MOTU

[www.motu.com](http://www.motu.com)  
 Native Instruments  
[www.nativeinstruments.com](http://www.nativeinstruments.com)  
 PSP  
[www.pspaudioware.com](http://www.pspaudioware.com)  
 SofTube  
[www.softube.com](http://www.softube.com)  
 Slate Digital  
[www.slatedigital.com](http://www.slatedigital.com)  
 Sonnox  
[www.sonnoxplugins.com](http://www.sonnoxplugins.com)  
 Sound Toys  
[www.soundtoys.com](http://www.soundtoys.com)  
 SPL  
[www.spl.info](http://www.spl.info)  
 Steinberg  
[www.steinberg.com](http://www.steinberg.com)  
 SSL  
[www.solid-state-logic.com](http://www.solid-state-logic.com)  
 TC Electronic  
[www.tcelectronic.com](http://www.tcelectronic.com)  
 Universal Audio  
[www.uaudio.com](http://www.uaudio.com)  
 Waves  
[www.waves.com](http://www.waves.com)





# PLUG-IN INSTRUMENTS

Any DAW that accepts plug-in instruments is a playground for creative composers.

These days, you can fill your computer with the kind of synths and other instruments that would cost a small fortune to buy in hardware form. But this is also where you need the most computing power, as some of the more sophisticated instruments can be quite power hungry. Sample-based instruments use a lot of RAM, so an investment in a well-specified computer really pays off.

## Synthesizers

Synthesizers started life as fairly basic analogue devices, whose raw waveforms were shaped into musical sounds by means of filter circuitry and envelope generators. The pitch of the waveforms was controlled from a keyboard and the sound could be modified by adding pitch vibrato, slurring between notes (portamento) and other means. There were also big rack systems whose modules could be interconnected

using patch cords to create even more elaborate sounds, but it could be argued that the basic analogue paradigm was set by the vintage Moog Minimoog, a portable, monophonic instrument.

A simple analogue synth might mix the sounds from two oscillators capable of producing the basic wave-shapes, with a third oscillator to control vibrato, tremolo or other cyclic effects. Though synths varied in what they offered, most started out with oscillators capable of producing sine, square, triangular and rectangular waves, often with the ability to modulate the rectangular wave's 'pulse width' to create a chorus-like effect. 'Envelopes' could be applied to volume to create anything from percussive beeps to slow swells, while the filter frequency could also follow an envelope to produce more interesting sounds. Typical envelope generators have controls for attack

»

"Many plug-in instruments now comprise a sampler with its own dedicated sample set and optimised user interface, which in some cases can be further expanded by buying add-on sample packs."



Moog's Voyager OS hardware synth, above, has preserved the visual aesthetic of its 1970s forebear, the Minimoog. The Minimoog's look and sound is also faithfully modelled by Arturia, in their Minimoog V plug-in instrument.

» (time), decay (time), sustain (level) and release (time). Modern instruments, both hardware and software, may offer further stages, so that more complex envelopes can be created.

Analogue-style synths are still much in demand by those who make dance music, so it comes as no surprise that many of the popular ones have been emulated

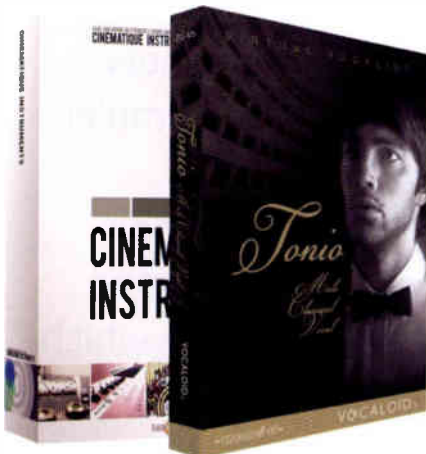

There's a wide variety of plug-in instruments to choose from. From orchestral sounds to drum samples, synths and fantasy instruments... with plug-in instruments, the world is your oyster!

in software. Purists may claim they don't sound exactly like the real thing, but they can come very close indeed. It is fairly common for new features to be added to make the instruments more flexible, the most obvious one being adding more polyphony. Playing one note at a time is great for bass lines and some types of lead solo or melody, but today's player wants to be able to play chords.

Synths have evolved dramatically over the past half century, and new synthesis methods have been developed. Even so, the idea of starting with a basic sound and treating it with envelopes and filters is still at the heart of many instruments.

### Beyond Analogue

Yamaha created a stir in the early 1980s with their DX7 FM (Frequency Modulation)

synthesizer, a digital instrument that used digital oscillators to modulate each others' frequencies to create harmonically rich waveforms reminiscent of bells, electric pianos and plucked strings. Few people could get their heads around the programming aspect of these machines but they came with a set of factory presets that were enough to keep many users happy. Nowadays, FM synthesis is available in plug-in format.

PPG and Korg produced wave sequencing instruments where short sections of digitally stored sound could be changed over time by morphing or fading from one audio sample or waveform to another. Sounds that occur in nature tend to change over time rather than being static so this technology made it possible to produce abstract sounds with

»

# NOT ALL MUSICAL INSTRUMENTS ARE CREATED EQUAL



## That's why we created the new RECEPTOR 2 + line of hardware plug-in players

Virtual instruments and effects have sound quality that is unequalled. But if you want to use them live, well, some ways of running them just don't cut it. If you need an instrument with amazing audio and performance to take your music to the next level, it's time you check out the new RECEPTOR 2 + line of dedicated hardware plug-in players. The RECEPTOR 2 + family gives you more storage capacity and extra processing power to enable your virtual instruments and effects to run with superior performance and stability.

Pros around the world rely on RECEPTOR gig after gig to provide unrivaled sound and feel. But unlike a laptop, RECEPTOR won't smash into a million pieces if dropped, suddenly "go missing" between sets, or overheat in the middle of your performance. RECEPTOR is a better alternative with all metal construction, dedicated rack-mount design and over-designed cooling to get you through those hot summer shows. And now the RECEPTOR 2 + models offer faster performance and greater storage capacity to hold those huge sample libraries... INSIDE the unit where they belong.

Simply put, our new RECEPTOR 2 + line has no equal. Check it out at [museresearch.com](http://museresearch.com) or at your nearest Muse Research dealer.

**MUSE**  
**RESEARCH**  
Virtual Instruments, Real Solutions

### THE NEW RECEPTOR 2 + LINE FEATURES:

- RECEPTOR 2 + : Now with 750GB of hard disk storage in a sleek new black package.
- RECEPTOR 2 PRO + : Now with an even faster 3GHz processor and a 1TB hard drive.
- RECEPTOR 2 PRO MAX + : An astounding 1.5TB drive and the fastest-in-class processor available.
- Legendary 24-bit audio quality does justice to your virtual instruments and effects.
- Amazing "Snapshots" mode lets you select from dozens of instruments and effects instantly.
- Completely self-contained, yet integrates with your Mac or PC to enhance your current system.

» an organic character. Korg's Wavestation is still available as a plug-in that faithfully recreates both the original synth and its patch library. Wave-sequencing has also entered the more general realm of synthesis and crops up in other instruments.

Later-generation synthesizers started out with digitally sampled sounds instead of basic waveforms, and the samples could be taken from analogue synths, orchestral instruments, human voices or anything else that could be coaxed into producing a musical result. The Korg M1 and Roland's D50 were amongst the earliest instruments to popularise this approach but now the hybrid 'sample and synthesis' approach is commonplace.

### A Model Approach

Modelling is used both for emulating existing hardware instruments (usually analogue) and for emulating studio effects and signal processors, but it can also be used to create new instruments by modelling physical processes. For example, Yamaha pioneered a modelling system for creating the sound of wind instruments, both real and imaginary, while Logic's Sculpture synth models the sound of bars of various materials and sizes being struck, bowed or plucked.

Today's plug-in instruments can draw on any of the synthesis methods I've mentioned, and more. Some of the smaller independent companies produce some seriously left-field stuff, so there's something to appeal to everyone



Spectrasonics' Omnisphere.

from the analogue synth traditionalist to the contemporary composer. Those early sample-based synths had only a few MB of sample memory ROM, but today's software leviathans, such as Spectrasonics' Omnisphere, come with many gigabytes of samples.

### Samplers

The line between synthesizers and samplers gets a little blurry these days, as most samplers include volume and filter envelope capability. It's probably fair to say that these instruments tend to be used mainly to play library samples, either as they come or in

a slightly modified form. Most also allow you to record your own samples and there are some excellent bits of software around to help make the process less arduous. If, however, you need an orchestral string section, you're probably going to want to buy the sample library rather than sample it yourself. After all, a piano sample might include up to 128 'velocity layers' for each of its 88 keys, which adds up to over 11,000 individual samples — and that's just for one instrument.

Of course, if you just want to record your dog belching and then play that one sample over a three-octave range, no problem! You can buy sample libraries covering every genre you can think of, including ethnic and rock drums. There's also a huge and ever-evolving selection of urban and dance grooves and loops available. Just make sure the library is compatible with your specific software sampler before you buy.

Many plug-in instruments now comprise a sampler with its own dedicated sample set and optimised user interface, which in some cases can be further expanded by buying add-on sample packs. The reason for this approach is that the controls and user interface can be tailored to the type of library rather than being a generic sampler control panel. For example, drum sample instruments often show graphics of the drum kit in use, where you can click on the various drums to hear their sounds and access menus associated



Korg M1: a popular sampling synthesizer plug-in.



Most plug-in instruments will visually emulate the characteristics of their physical counterparts. This picture of the Native Instruments Vintage Organs library shows drawbars on the right-hand side of the screen, echoing those used on a 'real' organ.

with each drum to load alternative kit pieces. There may also be a mixer section where you can mix samples taken from the close mics, the overhead mics and room mics, just as if you were mixing a real studio session. An organ sample library instrument, by contrast, may have drawbars for mixing the various tones and organ-specific effects, such as a rotary speaker.

### CPU Overload

Even the fastest computer can start to feel overworked if you happen to want to run a lot of processor-intensive instrument plug-ins at the same time, but most DAWs offer a workaround. Some, like Logic, have a 'freeze' option, which essentially turns the finished synth track into a temporary audio file, thus freeing up CPU capacity in exchange for streaming one more audio

track from the hard drive. You can't make changes to the frozen track, but you can unfreeze it and go back to working with the synth again if you need to make further changes. Where there is no freeze function, it's usually still possible to record or export the synth track as an audio file once you are sure everything is correct. More sophisticated instruments, such as drum instruments with different miking controls, may be able to be exported as a bunch of separate audio files, allowing you to change the balance of the various kit components at a later stage.

Alternatively, you could choose to run power-hungry software instruments from a dedicated hardware platform such as the Muse Receptor or the SM Pro V-Machine. Effectively, these are PC processors running a dedicated operating system (OS) that makes them very efficient at this task. ■■■



The Muse Receptor Pro Max — great for running your software instruments externally and freeing up CPU reserves for your DAW.

### Selected Manufacturers

- Arturia  
[www.arturia.com](http://www.arturia.com)
- Best Service  
[www.bestservic.de](http://www.bestservic.de)
- Cakewalk  
[www.cakewalk.com](http://www.cakewalk.com)
- East West  
[www.eastwest.com](http://www.eastwest.com)
- FXpansion  
[www.fxansion.com](http://www.fxansion.com)
- Garritan  
[www.garritan.com](http://www.garritan.com)
- GForce  
[www.gforcesoftware.com](http://www.gforcesoftware.com)
- Ilio  
[www.ilio.com](http://www.ilio.com)
- Image Line  
[www.image-line.com](http://www.image-line.com)
- Korg  
[www.korg.com](http://www.korg.com)
- Native Instruments  
[www.nativeinstruments.com](http://www.nativeinstruments.com)
- Spectrasonics  
[www.spectrasonics.com](http://www.spectrasonics.com)
- Steinberg  
[www.steinberg.com](http://www.steinberg.com)
- Time + Space  
[www.timespace.com](http://www.timespace.com)
- Toontrack  
[www.toontrack.com](http://www.toontrack.com)
- Yamaha  
[www.yamaha.com](http://www.yamaha.com)
- XLN Audio  
[www.xlnaudio.com](http://www.xlnaudio.com)

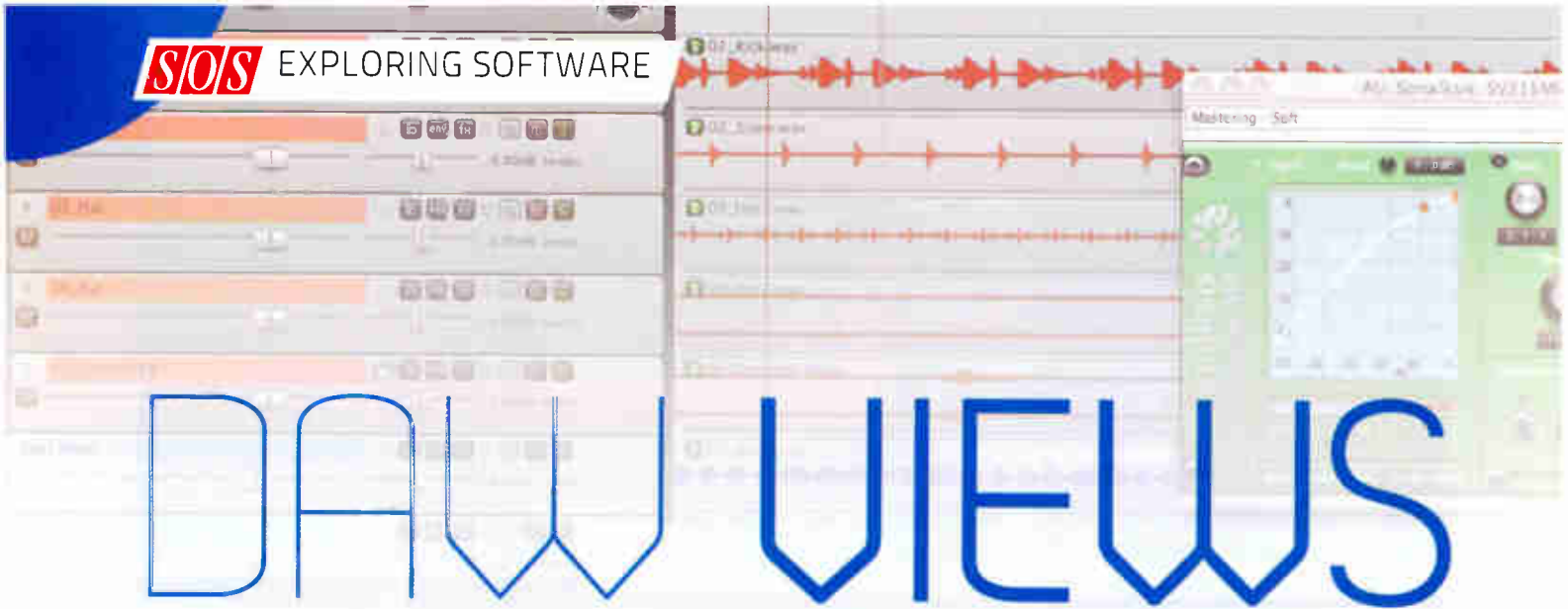

# DAW VIEWS

**The look of your DAW could be anything from simple and functional to a work of art. But what are all those different windows for?**

**B**efore you can even think about getting your head around DAW software, you need to be familiar with the basic operation of your Apple Mac or Windows PC computer. It is also essential to learn how to install new software and drivers, access menus, open, move and resize windows, and create, open and save files. It is also a very good idea to learn the common key commands that tend to be used across different types of software, such as copy, paste, delete, undo and redo. You also need to know how to find the Preferences for programs, as you may well need to make some changes there. You don't need to be a computer expert, but you do need to know your ROM from your RAM and know the difference between CPU speed and hard-drive size.

## GUI

A term you'll come across fairly often when discussing music software is 'GUI', pronounced 'gooey', which simply stands for 'Graphical User Interface'. The GUI is the program designer's way of giving you a visual operating environment for the

### Screensets Save Time

One way to manage the various windows is to make use of the screenset feature that many DAWs provide. Essentially you choose a screen or combination of screens and then use a key command to recall them. Using this system you can set up several frequently used screen views and then flip between them using simple key commands.

software so you don't have to speak to the computer in its own terms (that is, in strings of binary numbers). A typical DAW will have several different window views to allow you to concentrate on the task in hand without the screen being full of everything all the time. Some DAWs, such as Logic, allow you to switch between different views using tabs on the main screen, though you can also open multiple windows at the same time if you want to. Others, such as Pro Tools, try to keep the number of different screens to a minimum so that you essentially flip between the two main views: track recording and mixing. Additional windows open when you adjust a plug-in processor or instrument, so you need to work in an organised way to prevent the screen getting too cluttered, especially if you're working on a laptop computer with limited screen space.

OK, so what windows can we expect to find in a typical DAW? No two DAWs are exactly alike, but the most common views are the 'main' or 'arrange' window (where you can see the various audio and MIDI tracks), the 'mixer' view (where your recordings are mixed and processed), a 'piano-roll' MIDI view (where MIDI data can be edited), a waveform edit view (where you can examine and edit the audio waveform in fine detail), and the list of audio files used within a project.

## Track View

Though some DAWs, such as Ableton Live, adopt a somewhat different visual and operational approach to other mainstream DAWs, the majority have a main page, sometimes called the 'arrange' page,

that is based on the track view first popularised by Steinberg.

You can think of the main or arrange page as the base for your DAW. It may have a different name, depending on the DAW you choose, but I'll stick to 'arrange' for now as it is the page where you arrange your audio and MIDI instrument tracks. Here the tracks are most often represented by horizontal strips, often containing a visual representation of the audio waveform (or MIDI data) with time running from left to right. A cursor or 'current time' line moves along the tracks from left to right as you play or record. The usual convention is to have a timeline 'ruler' running along the top of the screen showing bars and beats, though there may be the option to switch this to minutes and seconds, which is more useful if you're editing a piece of dialogue. Using markers, it is generally possible to set up loop points in the timeline. You can also add automatic punch-in and punch-out points, which put a track into record for a specific section only. This is helpful to replace a 'fudged' vocal phrase, for example. There's also the provision to create multiple location markers to denote various points within a song so that you can jump to them quickly.

## Ableton Live

Ableton's Live adopts a rather different main-screen paradigm, as it was initially developed from the basis of manipulating audio and MIDI loops during live performance. Here, the main screen looks something like a spreadsheet with rows and cells. Audio or MIDI clips are dropped into the cells and can be automatically adapted to the tempo of the project.

Live may also be used to record and edit audio in a more generic DAW-like way, although that is not its main focus.

## Many Tracks Make Light Work

If you have a chunk of audio that you may need later, you can either park it on an existing track past the end of the song parts that you have already assembled, or put it on a muted track until you need it. Even though a DAW can only play back a finite number of tracks at the same time, you can have many more tracks in the project, as long as the unused ones are muted to avoid them taking up computing power.

Typical quantise menus from Pro Tools and Logic. Quantisation is tremendously helpful in aligning audio with the beat.

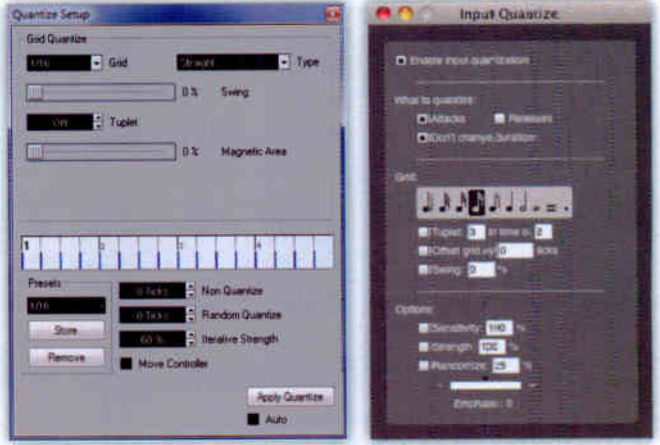

time there until you come to do the mix.

Another popularly adopted paradigm is that a section to the left of the screen is used to view and set track parameters

such as input sources, quantise settings and so on. Steinberg call this the 'Inspector', which is as good a name as any!

Quantisation is important as it allows small timing errors to be corrected. Originally applicable only to MIDI data, quantising forces notes to move to the nearest positions on a time grid, which most DAWs allow you to specify as subdivisions of a musical bar. A typical value might be eighths or 16ths (of a bar) but there are

many other options that allow for both straight 4/4 time and triplets, as well as various 'swing' options and more complex and subtle 'grooves' that incorporate musically satisfying deviations from strict tempo.

Quantisation can rob music of its natural feel, which is why the majority of DAWs now include a percentage-quantise function to allow notes to be pushed closer to the grid but not all the way. For example, a 50-percent quantise value would place the note mid-way between where you played it and the nearest quantise grid division. There will probably be additional options for transposing MIDI events or changing other MIDI settings.

A typical 'inspector' view always relates to the currently selected track. This section may also include a fader or even a complete channel strip relating to the current track, again depending on the DAW. The transport controls usually sit at the top or bottom of the screen where they are easy to access but not in the way of other actions. There will also be key-command equivalents of the transport keys, which make for more ergonomic operation.

### Cut To The Beat

Obviously, editing is simplest if you have recorded everything to the DAW's metronome/click track, as you can make cuts on bar lines. Provided the section you're editing is all at the same tempo (you can insert tempo changes in songs if that's the kind of music you do!), everything will still line up correctly. There may be further tweaking to do so that edits fall between notes rather than in the middle of them, but, even if you must edit mid-note, you can do various tricks, such as crossfading, to help disguise the edit. Even if you've cut the end off a piece of audio, you can still get >>

This arrange window is where you record audio and MIDI parts and where you subsequently edit, copy or move parts as required. Individual audio tracks can be set to record in either mono or stereo, though two physical inputs on your interface will be required to carry a stereo signal. In effect, the arrange window is the area in which you both record and assemble the elements that make up your composition, so you'll spend most of your



Steinberg first popularised the use of an arrange window displaying regions along a timeline, but it's now a standard of most DAWs. Note how similar the view is in Logic and Pro Tools.



The mixer views of different DAWs will allow you to see different things. In Logic's mixer view, shown here, we can see the various different plug-ins used on each track, for example.

» it back by adjusting the end position of the audio region: edits such as cutting regions, changing their length, moving them or copying them are all 'non-destructive'.

The 'copy' command is particularly useful in contemporary music production. This is because it allows you, for example, to use the same chorus vocals for each chorus in a song, or to take a two-bar drum pattern and make it play continuously for 10 minutes!

Where working to a click is not appropriate, it is still perfectly possible to make seamless edits. This takes a little more care as you have to use both the audio waveform displays and your ears to help you align the various parts. Furthermore, the quantise facility will be of no use to you as your bar lines won't match those of the tempo grid. A useful tip for editing multiple-track projects is to use the grouping facility included in most DAWs. It allows multiple tracks to be locked together, so a change to one changes them all. This is a good way to work if you need to add or remove a complete section from a song

**Space Smart** +

When you copy a piece of audio in the arrange window, you're not really making a copy but rather telling the DAW to use the same piece twice. That means that unless you make a deliberate physical copy of a piece of audio for a specific purpose, no additional hard drive space is taken up. However, if you make a destructive change to the audio, such as silencing a section, all the arrange window copies will be affected.

to change its length. Track automation is also available from the arrange window, invariably with a display option to view and edit the automation data.

### Pool, Bin Or Folder?

As you record audio into the arrange window, every track, overdub and alternative take is recorded as a separate audio file. Most DAWs allow these to be accessed individually, and these are all kept, whether or not they are shown in the arrange window, unless you deliberately discard your unused files. You can view the files used in the current project via a dedicated window. In Steinberg's Cubase this is called the 'audio pool', in Apple's Logic it is called the 'audio bin', Sonar has a 'project folder' and in Pro Tools it is a 'region list'. As well as recording audio, most DAWs let you import existing audio files, often simply by dragging them into the audio pool or even directly into the arrange window.

Also, check how to select and delete unused files, as all those unused takes waste space on your hard drive. Be careful, however, not to clean up until the project is done as you might just need one of those trashed files if you make changes to the arrangement.

### Mixer View

Another commonly used window is the 'mixer' view, which is generally set out somewhat like a conventional analogue mixer. You can use the mouse to drag the on-screen faders and knobs to the desired position. Some DAWs show EQ for every channel here, also, while others leave it up to you to call up a channel EQ section if you need it. The tracks recorded in the arrange window correspond to the mixer channels in the mixer window, but, unlike an analogue console, the mixer in your DAW can expand or contract to match the number of tracks used in your project. It is also routine to be

able to add extra buses or auxiliary sends as needed. Many of the functions that can be accessed in the arrange view can also be accessed from the mixer view: in Logic, for example, you can insert plug-ins into tracks from either view. Of course, every DAW will differ in the detail, but some degree of convergence is to be expected.

When you have the mix sounding the way you want it, you can create a mono, stereo (and often surround) mix using a process known as 'bouncing', in which a new file is created that represents your final mix. This may be used to create a track on a CD, or you can make an MP3 version to post on the Internet. Many DAWs can produce MP3s for you at the bouncing stage. If you want to burn an audio CD, your final bounced audio file must be in 16-bit, 44.1kHz stereo interleaved format, unless you use a separate CD-burning program that can change the format for you.

### Edit Views

Also known as the 'waveform view' in some programs, the 'edit' window lets you zoom in on any section of the audio waveform to make permanent, or 'destructive', edits like level changes, fades and so on. Typical applications include removing instrument noises before playing starts or between notes, reducing the level of the singer's breath noises, or even reversing specific sections of audio. If you're worried about making a change that you might later regret, you can make a copy of the original song, including its audio files. If the same piece of audio is used more than once in an arrangement, making a destructive edit will affect all the copies. You can, however, make copies of audio files or regions so that you can edit one without affecting the other.

Different edit views are used for editing MIDI tracks. A typical DAW displays the notes on a 'piano roll' view, or as a simple list of MIDI instructions alongside their time positions, relative to the bars and beats of the song's click tempo. Many also provide a traditional musical score view. However, as DAWs tend to be too literal in their interpretation of what is being played, musical training is usually required to tweak the score if you intend other musicians to be able to play from it.

### Piano Roll

The piano roll is arguably the most intuitive view for MIDI-note editing. The keys of a piano keyboard appear vertically down



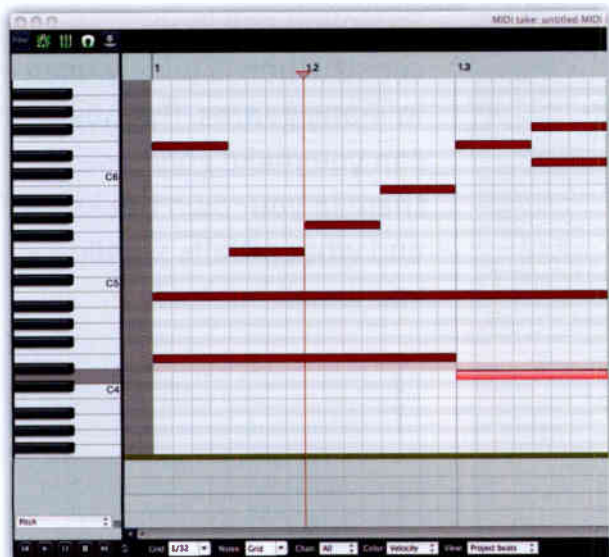

This MIDI Editor from Reaper is fairly typical of those you'll see in most DAWs. Notice how the notes are represented by blocks of colour.

factory and user settings, where applicable, and sometimes an A/B switch for comparing two different sets of panel settings. The majority of DAWs allow plug-in controls to be automated in the same way as the DAW's own mixer controls.

Although the majority of DAWs support one

or more formats of third-party plug-in, Propellerhead's Record uses only its own built-in effects and instruments, unless you also have Reason installed, in which case all of Reason's effects and instruments are also accessible from within Record.

### Other Windows

Even DAWs with only one or two main windows will usually have additional smaller windows, accessed via menus, that enable you to adjust the buffer size, set preferences and define project settings, such as sample rate and bit depth. While most mainstream DAWs offer roughly the same core features and have similar user parameters that need setting up, you'll need to consult the manual for your specific DAW, as every designer seems to conspire to hide their menus in different places!

one side of the screen, time and rhythm is represented by grid divisions running horizontally, and MIDI notes are shown as horizontal bars lining up with the keys and grid. Using standard mouse moves, notes may be dragged to different locations in pitch or time, changed in length and adjusted in velocity. It is commonplace to be able to quantise notes to make them snap to the nearest grid subdivision from this view, though it may also be possible to quantise MIDI data from the arrange view.

### The Toolbar

As with graphics programs, most DAWs utilise a toolbox or toolbar that allows you to select different tools, depending on what you're trying to do. The default is the pointer tool, which is used for selecting things and, in conjunction with the mouse button, for moving items or adjusting controls.

Other common tools include scissors or knife icons for splitting audio tracks into separate regions or for splitting MIDI notes in the piano-roll editor, an eraser for deleting items, a magnifying glass for zooming in, and so on. You may also find specialist tools for creating fades between audio regions in a track, muting regions or MIDI notes and other DAW-specific functions.

### Plug-ins

Plug-ins open in their own windows, which can be dragged to anywhere on the screen. As so many different people create plug-ins, the GUI can be anything from a basic box with sliders to a photo-realistic image of the equipment being emulated. There's usually the ability to load and save

## Neaten Up Your Timing



If your timing isn't good in the first place, the nearest quantise grid line might be even further from your intended note position than you played it, so you may have to reposition some notes manually by dragging in the piano roll editor.

A relatively modern addition to the 'standard' DAW approach is a browser-style window that can access not only the audio files used in the project, but also libraries of audio loops, sample libraries and software instruments. This provides a fast way of locating what you need without having to search through endless files and folders.

Some loop formats, such as Apple Loops, allow you to be drop a loop directly into a project, whereupon the loop tempo automatically changes to match that of the project. As a rule, the further the tempo is changed from that at which the loop was originally created, the less natural it will sound. The loops, again, appear in the browser and can be 'auditioned' from there before loading.

### Video

It's also now commonplace for DAWs to allow you to import video to aid with composing music to picture. This places more load on your CPU, so if you do this kind of work on a regular basis, you should buy the most powerful computer you can afford. A typical DAW has no video-editing facilities, so you'd need to edit the video first, then work on the sound. **///**

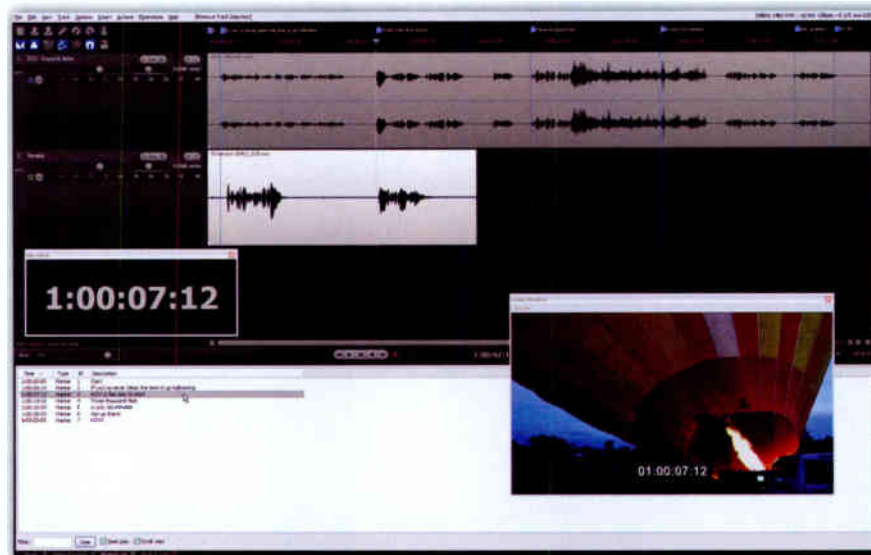

# LOOPS & SAMPLES

ment 1 - pHAATmatik PRO  
Drum Loop1.aif

**Sampling and loop construction is widely used in many genres. But how can you make good use of them in your own tracks, and what pitfalls should you watch out for?**

The term 'loop' is often used to describe a short section of audio or MIDI that's repeated to form the basis of a track. For example, you may repeat a couple of bars of drums to form a backing track, over which you can lay vocal and instrument parts. The loops may be audio or MIDI files, they may be played from a synth or sampler, or you could record them yourself. To use loops quickly and effectively in your tracks, you really need to build up a good loop library, containing a range of material in the genres you're primarily interested in, and to have some means of organising that library, so that you can find what you need without disrupting your creative flow.

## Tempo-matching

Working with loops is all about getting the timing and tempo right. In older DAWs, changing the tempo of an audio loop meant you also had to change its pitch, so it only sounded right if the DAW was running at the same tempo as the loop in question. That was a problem when trying to work with two loops of different tempos! Thankfully, ways have been devised to change a loop's tempo independently of pitch. The broad choice is to 'slice' or to use a time-stretch algorithm. Neither is perfect, as they both create audible side effects that become more noticeable the further you move from the loop's original tempo, particularly when trying to slow the loop down.

## Beat-slicing

Slicing (or 'beat-slicing') became popular with Propellerhead's Recycle software, which enabled the creation of REX audio files, and similar functionality has since become available in most DAWs. The technique involves taking a loop and cutting it apart at the transients to create separate 'slices' (beats or notes), which are played back via MIDI. Each beat is played at the original tempo, but the spaces between the beats are modified. You may hear some artifacts,

## Sample Translation



Samples often contain metadata to provide the host with information like sample rate and loop points. However, samples created for one device may not play back correctly on another. Third-party programs such as Chicken Systems Translator can be used to convert samples between the more popular sampler formats.

but the less you deviate from the original tempo, the fewer artifacts you'll hear.

Spectrasonics' Stylus RMX plug-in instrument is based on this slicing approach but uses sophisticated technology to allow you to take things further. Essentially, individual beats are created with adequately long decay and reverb times, so that when the audio 'slices' are slowed down you don't end up with a tell-tale gap between the beats. Similarly, when the tempo is increased, the samples are given a faster release time to avoid the sound of overlapping hits. Although the user can create their own REX files from existing recordings, the necessary software to create Stylus RMX loops is only available to the developers of approved expansion packs.

## Time-stretching

Time-stretching literally stretches or shrinks an audio loop to make it fit the desired tempo, adding in or removing audio information as necessary. Different time-stretch algorithms work better on different source material. An algorithm that's good for stretching a sustained tone, for example, may cause undesirable doubling or flammings when used on drum sounds. Generally, you'll be presented with options for percussion, and monophonic or polyphonic source material.

Some loop formats, such as Acidised WAVs, include embedded 'metadata' to control the time-stretching process, so that the most appropriate algorithm is used on each loop. Sony's Acid was the first piece of music software to fully embrace loops as a method of composition (it's from this



software that we get the word 'Acidised'), but Apple Loops work in a similar way, as does the time-stretching functionality built into DAWs like Cubase and Pro Tools. Loops that have been treated in this way can be changed in both pitch and tempo (independently of each other) over a usefully large range before the sound quality suffers significantly.

## Loops In Sampling

The word 'loop' also relates to samplers. When you press a key, you'll hear the start of the sampled note, and this is followed by a looped section. When you release the key, you'll either hear the looped section continue under the control of a decay envelope, or will hear the end section of the sampled sound. In the early days of sampling, when memory was very expensive, sample-library designers had to be very clever at creating seamless loops, and their techniques are still useful.

Let's assume you've recorded a flute playing a single note for five seconds, and you import the result into your sampler. The maximum playback time without changing the pitch will be five seconds, but if you loop a section of the note smoothly you can make it last much longer. The secret to smooth looping is to find two points during the section of audio where the shape and level

A REX-sliced drum sample: each beat has been separated into individual 'slices', enabling precise playback and reducing artifacts when adjusting the tempo.

of the waveform is very similar, and then to arrange for this section to be looped as long as a key on the keyboard is held down. To avoid unwanted clicks, make the two points coincide with the same part of the waveform cycle. Also, be careful to choose points that still sound natural if there's vibrato or other modulation present. With care, you can create sounds that appear natural and can sustain indefinitely.

Unfortunately, you can't always find a pair of loop points where the waveform is exactly the same, so you'll often hear a click or thud as the note loops. To address this problem, use a crossfade, so that the end of the loop fades out and the start of the loop fades in at the loop point. (The audio is overlapped during the crossfade.) As a rule, the shorter the crossfade the better, because having two parts audible at the same time can result in an unnatural chorus-like effect.

With so many great sample libraries available, many people don't bother to create their own samples, but it's a great way to get original sounds. If rolling your own samples interests you, look out for specialist programs that make the job easier. For example, if (like me) you use

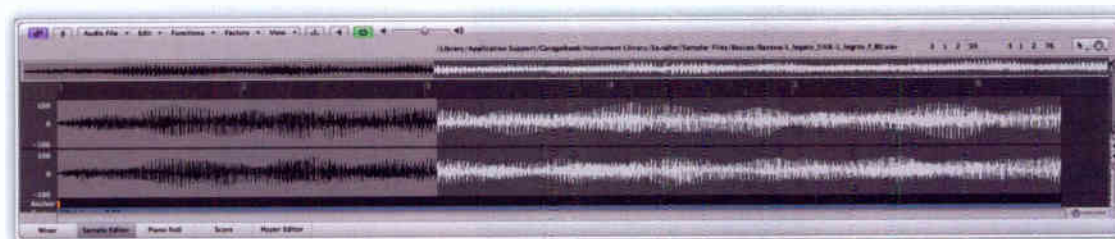

It's important to accurately select the beginning and end of a loop when sampling, to avoid unwanted clicks and pops.

» Apple Logic's EXS24 sampler, check out the sample-editing tools from Redmatica.

## Software Samplers

Although software samplers are often used to play instrument sounds, they can also be used to play back complete loops and audio phrases like guitar riffs or vocal lines, which you may repeat in a song but wouldn't normally expect to loop. Native Instruments' Kontakt is a powerful software sampler, which has all the sound-manipulation abilities of a sophisticated synth combined with comprehensive sampling capabilities.

## Further Pointers

- There's no shortage of loop libraries, the majority of which can be used without paying any further licence fee, but be very careful when creating loops from existing records: any commercial release must be cleared with the sample's copyright holders before you proceed, even if you've only used a single bar of drums.
- Your choice of DAW will be influenced by how much of your music is based on loops. Even the most basic DAW can be pressed into service for loop-based music, but some DAWs, such as Sony's Acid and Ableton's Live include some more advanced loop-based features.
- Samplers are useful when you want to change the sound of an audio loop using, for example, envelope shapers or filters. Using loops directly in a DAW's audio track is more convenient when the loop is to be used 'as is' or when subsequent processing can be achieved via plug-in effects.
- Ableton Live and Sony Acid are the preferred choice of many DJ-style musicians. Ableton Live is particularly powerful in allowing loops to be manipulated during live performance.

Apple Logic's EXS24 (top) and Native Instruments' Kontakt Player (bottom) — two examples of very good samplers to help with your sound manipulation and looping magic!



Its 'spreadsheet' approach to composition is a little unusual in comparison with 'mainstream' DAWs, but it offers a powerful means to layer and synchronise audio loops. There are also several dedicated hardware controllers available for Ableton Live to make live performance a much more tactile experience. ■■■



The Akai APC40 hardware controller for Ableton's Live, which enables you to control your loops and samples through physical controls rather than with a mouse.

## Selected Manufacturers

- Ableton  
[www.ableton.com](http://www.ableton.com)
- Apple  
[www.apple.com](http://www.apple.com)
- Best Service  
[www.bestservice.de](http://www.bestservice.de)
- Big Fish Audio  
[www.bigfishaudio.com](http://www.bigfishaudio.com)
- East West  
[www.eastwestsamples.com](http://www.eastwestsamples.com)
- IK Multimedia  
[www.ikmultimedia.com](http://www.ikmultimedia.com)
- Ilio  
[www.ilio.com](http://www.ilio.com)
- Native Instruments  
[www.nativeinstruments.com](http://www.nativeinstruments.com)
- Propellerhead  
[www.propellerheads.se](http://www.propellerheads.se)
- Sony  
[www.sonycreativesoftware.com](http://www.sonycreativesoftware.com)
- Spectrasonics  
[www.spectrasonics.net](http://www.spectrasonics.net)
- Time + Space  
[www.timespace.com](http://www.timespace.com)

# OMNISPHERE

## 1.5



- Innovative new "Orb"
- Expanded Synthesis
- Tons of New Sounds
- Omni TR - Touch Remote App



SPECTRASONICS

WWW.SPECTRASONICS.NET



iLio

800.747.4546

[www.ilio.com](http://www.ilio.com)

# UNDERSTANDING MIXERS

It may seem daunting, but understanding the basics of how your mixer works is crucial to getting the most from your DAW.

**D**AW mixers usually follow the design of an analogue console fairly closely, so it is worthwhile going over the basic elements if you haven't had much previous experience with mixers.

Mixers comprise several identical 'building blocks', known as channels, plus a master section. The purpose of a channel is to change the level and EQ of the signal fed into it and to provide variable-level feeds both to external effect units and for performer-monitoring purposes. After the EQ section, the channel signal then passes through a channel fader and pan control before being sent onto what is known as the stereo mix bus. This connects all the channel outputs and is where the signals from all the individual channels are combined according to their individual fader settings. The channel 'pan' control dictates how much of the signal is fed to the left mixer bus and how much to the right, enabling sounds to be positioned across the stereo mix.

## Signal Levels

Internally, mixers are designed to work within a particular range of signal levels. Anything fed into the mixer has to be brought up to a level that fits into that range. If the input level is too high, the sound will be

distorted, if too low, the sound will be too quiet and probably also quite hissy. Microphones generate very small electrical signals and need a special type of preamplifier. The mic preamplifier also needs to be able to provide phantom power if it will be used with capacitor microphones or active DI boxes.

Obviously, you can't create a mic preamp in software, so the virtual mixer in your DAW needs to be fed with the correct signal level

from your audio interface. Many audio interfaces have two or more variable-gain mic preamps built-in, but if the inputs are line only, a separate mic preamp will be needed.

## The Mixer Channel

As mixer channels are pretty much repetitions of the same thing, let's consider a very basic four-channel mixer with simple bass and treble equalisation. Most compact hardware mixers have separate input sockets for both the microphone (XLR) and line-input (jack) signals, but usually only one can be used at a time, and the gain-trim control at the top of the channel applies to whichever is in use. The

gain control on the audio interface takes the place of the gain trim for DAW users. Directly after the input gain stage comes the equalisation section, which is not visible on some DAWs unless you add an EQ plug-in to the channel or enable the channel EQ. That's one advantage of hardware: all the knobs and sliders are on show all of the time.

## Inserts

It is common for a mixer channel to have an insert point, usually on a TRS jack socket, that comes directly before the EQ stage. In some of the more sophisticated mixers it can be switched to come pre or post the

## Adjusting Gain

Though a DAW's virtual mixer may include a level control, this comes after the A-D conversion stage in your audio interface. If the input signal is too high and clipping is occurring, you can't fix it by using your DAW's controls. Instead, you have to adjust the gain on the audio interface. The same thing applies if your signal is too low in level: increase the gain on the audio interface, not in the DAW, otherwise you'll lose resolution and you may add more noise than you need to.



A typical view of a mixer channel strip in Pro Tools showing the inserts and sends for each channel.



equaliser. It is important to note that the insert point isn't wired like a stereo jack, even though the connector is the same. The outer screen is ground, as usual, but the two inner cores act as one unbalanced send and one unbalanced return. A special Y lead (stereo jack to two mono jacks) is needed to connect a processor to an insert point, whereupon the signal is routed via the external device before continuing its journey down the channel strip. When nothing is plugged into the insert point, contacts within the socket close and the signal passes through the channel without being diverted to the outside world.

In the DAW mixer, provision is made to insert plug-in processors and effects into insert slots, so there's no need to worry about connectors or cables. Multiple devices can be inserted into the same channel where the signal passes through the devices in the order in which you insert them. Insert points are also available in the buses and main outputs of many mixing consoles, and in all serious DAW mixers.

### Fader, Pan, Mute & Solo

Each channel's output level is controlled by a fader before it passes to the stereo mix bus via the pan control. For ergonomic reasons, the pan control is invariably located above the fader. As far as the signal is concerned, the fader comes before the pan. You may also find a 'channel on' or 'mute' switch, which is self-explanatory, and a 'solo' button. Solo does the opposite of mute: it leaves the solo channel operational, but mutes all the others at the control-room output (this is in the 'master' section of the mixer) allowing signals to be checked in isolation without the need to adjust any faders. Soling a signal does not affect the main mixer output, only the control room output, which is used for feeding the studio speakers and headphones. This enables signals to be isolated and checked during a performance or recording without interrupting the main

In most DAWs, each channel includes a set of controls for that channel, similar to those you'd find on a hardware mixer. They include Mute (M) and Solo (S) buttons as well as pan and gain controls.



**“While a hardware mixer has a fixed number of channels, insert points and auxiliary sends, many DAW mixers adapt to your requirements and grow as you add channels and sends.”**

mixer output. Your DAW mixer is unlikely to have a separate control-room output, so using the solo button during playback will affect the overall stereo mix.

Leaving the pan control set to the centre routes equal amounts of signal to the left and right buses, making the resulting sound appear to originate from mid-way between the speakers. This is sometimes called a phantom image because the sound does not appear to be coming from the direction of the speakers, but rather from between them.

### More Buses!

While on a simple mixer the output from the pan control always feeds the left and right mix buses, a more sophisticated mixer might allow the signal instead to be routed to other stereo mix buses (simply called 'buses'). These buses may be used to feed additional mixer outputs, or they can be routed to feed into the main stereo mix bus. When tape was the dominant format, buses were used as a way of routing different channel signals or combinations of channel signals to specific tape tracks.

An output-level meter monitors the

**If you've ever used a hardware mixer you'll feel right at home using the software mixer in your DAW!**

overall output level of the mixer and this does the same job as the output-level meter in your DAW mixer. As a rule, a DAW will have separate meters for channel levels, bus levels and the main stereo mix level. Software metering uses no additional electronic components, so there's no reason for a DAW to skimp on metering. While an analogue mixer's meter can be considered to be a rough guide to the maximum permissible output level (there's always some headroom left above the 'red!'), a DAW meter should never be

allowed to go into the red as digital systems have no safety margin or headroom left once the meter hits full scale.

### Auxiliary Sends

The previous description skipped over the auxiliary send controls, so let's go back and take a look at them as they are important both on a physical hardware mixer and a DAW's virtual mixer. Auxiliary sends enable us to do things like add effects or to send a separate mix to the performer's headphones. A hardware mixer has a relatively small number of sends, but most DAWs allows multiple sends to be set up with ease. To complicate things further, there are two types of auxiliary send to explore: the pre-fade and the post-fade versions.

### Pre-fade

As its name implies, the pre-fade send is taken from the channel signal before it reaches the fader, so its level isn't affected by the position of the channel fader. Using a pre-fade auxiliary send, the engineer can provide the musician with a monitor mix that is exactly to his or her liking, rather than them having to make do with the main mix in their headphones. The individual auxiliary send controls on the mixer control the mix sent to the corresponding auxiliary output, which in turn can be used to feed a headphone amplifier. If you have multiple pre-fade auxiliary sends, then you can set up multiple monitor mixes to satisfy additional performers.

You can also use auxiliary sends to set up monitor mixes on a DAW, though the number of sends you can use in practice is limited by the number of spare physical audio outputs you have on your audio interface. Two will always be needed for the main mix, so if you have only a two-channel interface, you won't have any free outputs to set up monitor mixes. Then again, you



» can only record one or two people at a time with such an interface, so you can probably set up a temporary main mix to satisfy the performers. To use any remaining free outputs on your audio interface, you simply set up the routing so the DAW's output buses feed them. You can then use cables to hook these outputs up to one or more headphone amplifiers.

### Post-fade

Again, as the name implies, post-fade sends take their signal from after the channel fader. When you turn the channel fader down, the auxiliary send level drops by the same amount. Post-fade sends are used to feed effects that will be shared between two or more mixer channels, reverb being the obvious example. You can use the auxiliary send control to set how much reverb you add to the dry sound passing through the channel. Then, when you turn down the channel fader, the dry sound and added reverb will be affected identically so that their relative balance always remains the same.

Using different post-fade settings on the auxiliary send feeding the reverb unit, different amounts of the same reverb effect can be added to any of the mixer channels. While a hardware mixer has a finite number of post-fade sends and return inputs into which to connect any external hardware effects boxes, your DAW can probably handle more auxiliary sends than you'll ever need. What's more, if you're feeding plug-in effects, no physical audio-interface connections are required, so you can set up multiple send effects with ease, even if you only have a two-channel audio interface.

### Auxiliary Returns

With a hardware mixer, the output of an effects unit may be fed back into the mixer either via spare input channels or via dedicated effects return inputs, which are essentially simplified mixer channels often routed directly into the stereo mix. On some mixers, you get the option to route

them to the foldback mixes instead so the singer can have a bit of 'comfort reverb' in the cans when recording. In a typical DAW, there's a special bus, fed from a corresponding post-fade auxiliary send, into which effects can be inserted and that can, in turn, be routed to any of the DAW's outputs. For normal mixing purposes, the signal would be routed to the main stereo bus via a level fader.

To use a hardware effects unit, such as a reverb device, within your DAW's software mixer, you'll need at least one spare audio-interface output to use as an auxiliary send so that you can feed a signal out to the reverb unit, as well as two spare inputs to use as a stereo auxiliary return (most reverb units can take a mono input and then create a stereo output). The outputs from the reverb unit (again set to 100-percent wet) then feed two spare inputs on your audio interface and these are, in turn, routed to the stereo mix. How you do this depends on the DAW, but most have a system for routing 'live' inputs into the mix. There may be a small delay caused by the A/D conversion in your audio interface. It won't be noticeable with things like reverb and delay, but could cause problems if you were trying more advanced techniques, such as parallel compression, that require sample-accurate timing between the dry and processed sounds. For this reason, stick with plug-in effects where possible to keep life simple!

### Master Section

The master section of a small mixer will include faders for the stereo output, and for any additional buses, plus metering, master level controls for sends and returns, and a 'control room' section, which does much the same job as your DAW's monitor-control box. It may also include talkback so that you can contact performers listening in from the live

This screen shows a typical channel-strip setup from Sonar. Notice the equalisation and processing (compressor) on the channel.



### Wet & Dry

An effects unit or plug-in used in conjunction with a post-fade auxiliary send should be set up so that it produces only the affected sound and none of the original. We call this 100-percent wet, and it is usually adjusted by means of a mix control on the plug-in itself, which should be set to 100-percent wet, zero-percent dry. The dry component of the sound feeds into the mix via the channel fader as usual.

room. A headphone output is also pretty standard. On smaller mixers, the headphone output is identical to the control-room output and may be switchable between the main stereo output, the buses and an external stereo or two-track input. If you need talkback, choose a monitor controller with talkback built in.

When a channel is solo on a hardware mixer, the solo operation affects the control-room speaker and phones output, but not the main mix output. As pointed out earlier, however, the solo button on a DAW mixer channel may well affect the entire stereo mix, so don't use it while mixing down! A typical DAW omits the control-room aspects of a hardware mixer as these are provided on your hardware monitor controller.

### Summary

- DAW mixers use the audio interface as a preamp and output section, and a hardware monitor controller box as a control-room monitoring section, and are very similar to hardware mixers.
- To set up independent headphone mixes in a DAW, you'll need an audio interface with multiple outputs and either several separate headphone amps or one with multiple channels, each with separate inputs and level controls.
- While a hardware mixer has a fixed number of channels, insert points and auxiliary sends, many DAW mixers adapt to your requirements and grow as you add channels and sends.
- Analogue mixers are designed with several dB of headroom above the point at which the meters go into the red, whereas a DAW mixer, being digital, has no headroom at the input or output if the signal levels cause the meters to hit digital full scale. Always leave some headroom to accommodate unexpected peaks. ■■■

### Insert Points

Channel insert points are used where an effect or processor is needed to process the signal of just that channel. Alternatively, you could use a bus insert point to process a mix of signals being sent via that bus. Anything inserted into the main-mix outputs processes the entire mix.



# RECORDING

Once you've chosen your equipment, set up your studio and found your way around the software, you're ready to start recording. A good recording starts with good preparation, and that includes checking that your instruments are working properly and that the acoustic environment you're working in suits the type of music you want to make.

AUDIO	92
MIDI	100
VOCALS	104
GUITAR	108

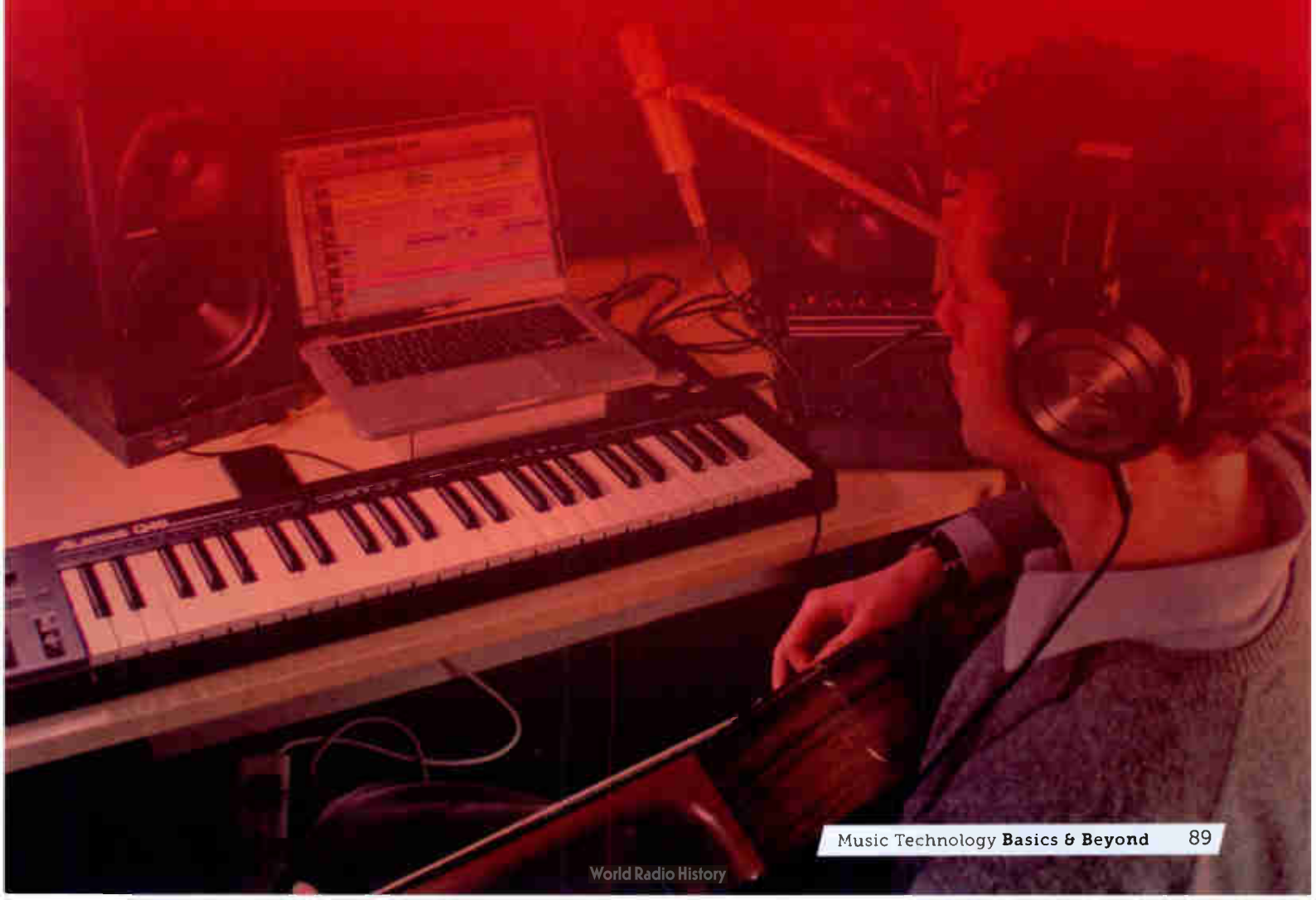

# How Do You Create

## Choosing the Right Recording Gear for the Way You Work

How do you take what's in your head and turn it into sonic reality? Do you want to pick up a guitar or sit down at the piano and hammer out that tune via the shortest-possible path to a recorded result? Or do you prefer to have more recording options at your disposal once you've crafted that initial idea? Maybe you're most comfortable surrounded by multiple instruments and various sound-shaping tools. What works best for you?

SONY  
PCM-M10



iO Dock  
(side view)



Alesis  
iO Dock

### The Direct Route

If your style is of the "most direct route possible" variety, then you'll want an easy-to-use, convenient recording solution. Handheld digital recorders definitely fit the bill here. These ultra-compact devices allow you to record handy MP3s, and many give you better-than-CD-quality sound. Built-in stereo mics provide an excellent stereo "picture," so you may find that your demo is actually good enough to share right off the bat. Add easy computer connectivity, flexible features, and on-the-fly recording capability, and you have a sure-fire recording setup that will enhance your creative process. Now, you can even add high-quality recording capability to your iPad, iPhone, or tablet, thanks to affordable and portable interfaces. Even seasoned studio pros like to keep handheld recording devices on hand; inspiration can strike when you least expect it!

IK Multimedia  
Amplitude iRig



### Capture the Entire Band — Silently!

JamHub TourBus makes a perfect rehearsal and 2-track recording solution for your entire band! This amazing unit allows your band to record straight to handy SD media. Each player gets fully featured, independent monitoring controls, so everybody in the band gets a personalized mix they're comfortable with. Best of all, JamHub TourBus allows for silent rehearsal and recording, so your whole group can work out ideas or rehearse practically anytime!

Find the perfect creative tools!

Go to

**Sweetwater.com**



MacBook Pro-based Pro Tools 9 System



Pro Tools 9

### Studio in a Box

Do you work best immersed in an environment that gives you several creative possibilities? If so, a computer-based recording system may be just your ticket. You can track, edit, play and shape virtual instruments, assemble loops and grooves, perform signal-processing functions, and mix — all “inside the box.” Though digital audio workstations (DAWs) require a learning curve of some degree, the payoff is that you get a complete studio experience on your desktop (or laptop).

Creation Station PC-based SONAR X1 Producer system



SONAR X1



ZOOM R24



BOSS BR-800

### Standalone Multitracking

Imagine that you just put down a great take of that new song, but you're already coming up with harmonies and a second guitar part in your head. Or maybe you need to record the entire band and adjust individual levels later. A standalone digital multitrack recorder makes a perfect solution for both scenarios. You'll appreciate having multiple tracks at hand, not to mention tactile controls, such as faders and knobs. Plus, you won't have to tie yourself to a computer or spend a bundle. There are several very affordable (and portable) standalone recorders available at Sweetwater.

To find the most efficient means of recording, contact our Sales Engineers — today!

CALL US TODAY AT

**(800) 222-4700**

**Sweetwater**

Music Instruments & Pro Audio

World Radio History

# RECORDING AUDIO

There's much more to making a good-quality recording than just hitting the red button. Preparation is key to a smooth recording session, as is knowing how to make the most of your recording environment and software.

When it comes to recording music, preparation is extremely important, and this goes beyond just making sure you have enough cables! Tuning is paramount, as is the actual sound of the voice or instrument. A guitar with rusty strings will never sound good no matter how well played, for example, so preparation starts with instrument maintenance, followed by attention to where you place the microphone.

If the room acoustics are compromising your sound, as is often the case when working at home, you can usually improve the situation by choosing the right microphone and mic position, and by improvising acoustic treatment using household items such as blankets and duvets. You can read up on all this in the chapter on using microphones.

## Preparing Your DAW

It's also worth making sure your computer is ready. Most DAWs work in a project-based way, meaning they create a project folder in which they save all the relevant audio files along with the finished song file. If your DAW doesn't, you'll have to set the file path for your new song so that the audio is saved somewhere logical, otherwise the files could end up almost anywhere on your hard drive. Even the DAW's 'default' folder isn't always the most sensible, so you may still have to tell it where to save audio, unless you agree with the default location. If you have a separate drive for your audio projects, then you should use a file path that reflects this.

It is also worth setting up further folders to organise your projects, either by client or by date. I always try to include the date in the name of any mixes I do, so that I can see at a glance what version is the most recent. A little careful organisation can save a lot of anguish if you later decide to tweak a song.

If you haven't already set up a default project template in your DAW, I'd recommend you do so now, as there's nothing more tedious than setting up a session from scratch every time you start a new song. Having eight audio tracks and eight MIDI tracks is a good starting point, and you can always add more tracks as you need them. Set up the input sources for the audio tracks and place some MIDI instruments or soft-synths in the MIDI tracks, if there are certain ones you tend to use a lot. Most DAWs also let you create 'screen sets' — stored arrangements of the window positions — so you might as well set some of those up while you're at it. If anything comes to mind later, simply update your template and save it. For example, if track one is always used for vocals, then you might as well name it as such and, if your DAW allows you to add cute little icons such as microphones, guitars, drums and so on, why not do that too?

Also decide at this point what bit depth and sample rate you'll be working at. It makes sense to work at 24-bit resolution where possible and, for routine CD production work, a 44.1kHz sample rate is the usual choice. For video work, it's normal to go for a 48kHz sample rate. If you want

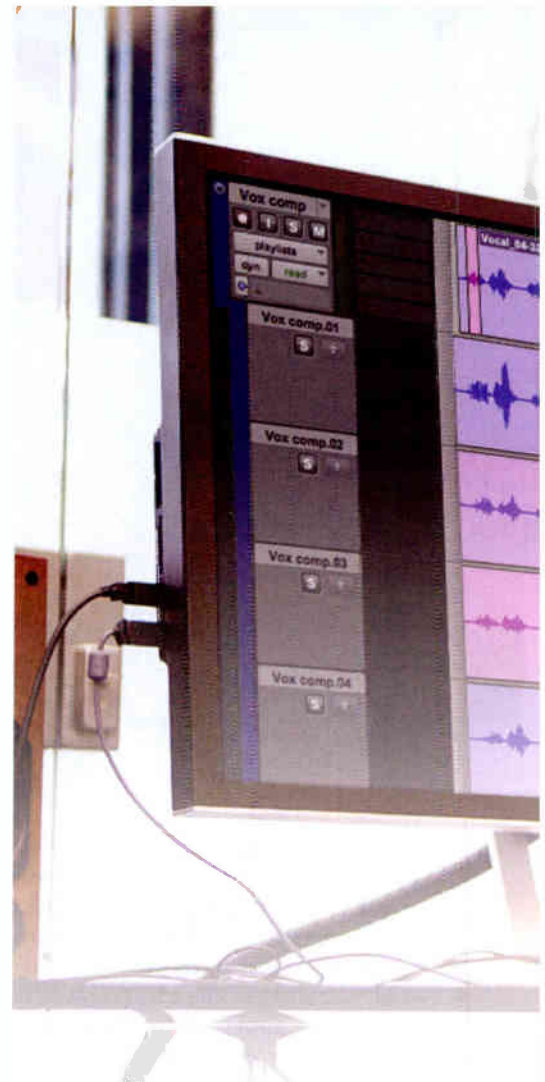

to give higher sample rates a try that's fine, but keep in mind that they'll put twice the strain on your PC: you'll effectively halve your maximum track and plug-in count, and double the amount of space needed for your audio files.

One more consideration is whether to record to a click track, or whether to play without one. The latter makes editing more difficult, and makes it tricky to incorporate loops, but it can add life and feel to many types of music that shouldn't be constrained to a rigid tempo.

Personally, I hate basic clicks, so if I am following the DAW's tempo, I tend to paste in a simple drum loop to use instead.

When recording to a click or loop, your DAW should let you set the amount of 'pre-roll'. This is effectively a count-in that precedes a take or punch-in. One or two bars should give you enough time to get ready for a take.

## Setting Levels

Before you hit record, you'll need to set your input levels on your audio interface or mic preamp. Adjust the front-panel gain knob while the track is in 'record armed' mode (or 'input monitor' mode, if your DAW has it) and the singer or musician is



singing or playing their loudest section. The usual scenario is that the track record button flashes red when the track is in record ready mode, then it lights up solidly once you hit the master Record button on the transport bar.

Often, you'll find that performers get louder as soon as the recording actually starts, but if you set the gain on your interface or preamp so the DAW level meters are reading about halfway up the scale on the loud notes (somewhere between -10dBFS and -18dBFS), you'll leave yourself enough of a safety margin (known as 'headroom'). If the meter clips when you start recording, don't ignore it; stop recording, lower the input gain, and start again. Clipping distortion sounds extremely nasty, and can't be removed once you've recorded it!

Finally, make sure the mic is in the right place and that you aren't suffering from buzzes and crackles due to dodgy cables or connectors.

When you're ready for a take, press record: you'll hear the count-in, and then see the audio track being drawn on the screen. This will help confirm all is well — however, if this is the start of a new recording, you should always play back the audio to check >>

## Keep The Noise Down!



Ensure any ambient noise being picked up by microphones is low enough in level not to be a problem. This could be anything: computer fan noise, outside traffic noise or the sound of household appliances in the next room. Keeping the mics well away from noise sources and using acoustic screens where necessary can really help.

In a typical home studio, getting a signal-to-noise ratio (wanted sound to background sounds) of 50dB is pretty good.

A professional studio with proper sound isolation and silenced air conditioning will achieve much better figures, however.

If the mic is set up in the same room as your DAW and monitoring system, turn the speakers down and monitor using headphones while recording. If you don't do this some of the sound from the speakers will find its way back into the microphone, and you may even end up hearing acoustic feedback.





This is the custom template arrange screen I have for Logic. It's got plenty of space in the top half for several tracks, and then I've got an extensive mixer below for all my channel strips. I take advantage of the colouring function in order to easily tell apart my individual channel strips — most DAWs will have similar customisation features, usually found in one of the various Edit or Options menus.

» that it sounds OK before you continue.

Once a track is done, switch it out of record mode and move on to the next one, checking the input gain settings every time you add a new instrument or voice. If you do make a mistake, the undo button will usually get you out of trouble and, unlike when working on analogue tape, recording over something you've already done doesn't usually erase the previous recording completely!

### Independent Record Monitor Level

Some DAWs, including Logic, allow you to set a user preference for independent monitor levels. This enables you to set one track fader level for playback, and another for recording. As soon as you switch off the record button, the fader will return to the level you set for playback and vice versa. This is very useful, especially if you are using zero-latency hardware monitoring, as it

allows you to reduce or even mute the track you're recording, so that the performer hears only the direct-monitoring source, which will have no latency.

Depending on the DAW, there may also be a global setting to let you kill track monitoring when the track is in record, which is a good option if you routinely use hardware source monitoring. Of course, you can't use source monitoring when playing virtual instrument plug-ins as there's nothing to monitor at source — the sound is created inside the computer so you'll have to enable track monitoring while playing soft-synths.

### Dry Or Wet?

One ongoing source of discussion is whether to process sounds before recording them, or whether to leave all processing to the mix. Technically you can do either. An experienced engineer can usually tell how much processing will be needed in the context of the finished product, but it is very easy to overdo it. If you process before you hit record and it doesn't work out, there's no way back.

For my own recordings I usually make recordings 'dry', which means no added effects or EQ. The only exception is when recording electric guitar or synth sounds that rely on some form of processing for their character (such as overdrive), as removing the processing will affect the way the player reacts to the instrument.

Some engineers add a little compression to vocals via a hardware compressor

when recording, but even an experienced engineer will err on the side of caution. It is easy to add more compression when mixing if you need it, but very difficult to undo the effect of recorded over-compression. Another valid reason for not processing while recording is that it makes patching up mistakes easier if you spot a problem later on in the session. If you have used processing during recording, it can be quite difficult to recreate the exact settings when you come to record replacement phrases. Of course, the final decision on how to work is up to you, but my take on it is to record dry.

### Auto Punch In

Back in the analogue tape days, any replacement sections (mumbled verses, or bodged guitar solos, for example) had to be added by manually 'punching' in and out of record mode at exactly the right place in the track, while the performer sang or played the new part. If you got it wrong there was no undo button, so those of us who had to do it regularly got to be pretty good at it.

Things are much simpler now because virtually all DAWs allow you to set automatic punch-in and punch-out points at the start and end of the problem section, and they also switch the monitoring from 'off-track' to 'live source' and back again during the punch-in. This way you hear the previous recording up to the punch-in point, then hear the live performance as the new part is

»

### Naming Projects

For easy organisation, try naming your project folder with the date at the beginning in yyyy-mm-dd format, followed by the client name or other relevant information. For example, a recording made on the 10th July, 2008 would be represented as: "2008-07-10\_[name].[file extension]". This way, your recordings will be immediately sorted in chronological order.



done ← drop ← drag



awesome.

# Studio One™



download the demo

Tired of having to read a 600-page manual when you really just want to record your song? Then it's time to switch to PreSonus Studio One instead. Studio One works the way musicians work — intuitively.

Pick up what you want, drag & drop it to where you need it, and you're done. Audio tracks, loops, VST & AU plugins, or virtual instruments, it all just works.

They promised us digital audio workstations that would make recording quicker and easier. PreSonus Studio One finally delivers that promise.

[WWW.PRESONUS.COM/DEMO-STUDIOONE](http://www.presonus.com/demo-studioone)

**Drag. Drop. Done.**  
\*The only handbook you need

**PreSonus**

[www.presonus.com](http://www.presonus.com) • Baton Rouge USA

Preamps Mixers Signal Processors Software  
Computer Interfaces Monitoring & Controllers

© 2011 PreSonus Audio Electronics. All rights reserved. Studio One is a trademark of PreSonus Software, Ltd. Other brand names are trademarks of their respective companies.

## Comping Demons



Comping is a tremendously useful skill to learn. By extracting the best bits from individual pieces of audio and melding them together, the idea is to create the best possible audio track — without the hassle of having to do it in one take. Other industries such as the photography industry and the film industry use similar editing techniques to use the ‘best bits’ of source media in order to create a perfect product.

There is one slight snag with the whole process, however. Just as a film editor must look out for continuity errors whilst editing, or an image manipulation specialist must make sure the pictures ‘fit’ together to make the composite, so too you as the audio editor will need to ensure your individual bits of audio link up together properly so that the finished composite audio sounds like one whole. This requires careful and clever editing techniques, and usually comes with practice rather than instruction.

» added. If it goes wrong you can always undo the operation and try again.

The process is simple and doesn’t vary too much between different DAWs; you set the punch-in and out markers, start the track from a few bars before the punch-in, and hit record. Play or sing along until the part that needs replacing when, at the punch-in point, the DAW goes into record and captures the new section of performance. At the end of the section it reverts to playback and the job is done.

### Comping

Comping (short for compiling), is a process routinely used to put together a final vocal or instrumental solo track from a number of separate takes. For example, you might get the singer to record the lead vocal line half a dozen times, then choose all the best phrases for your final version. In the days of tape this was difficult and wasteful of tape tracks. On a modern DAW, however, it is easy and efficient.

Some DAWs have a dedicated comping mode, which allows you to record all the parts on one audio track where they are displayed one under the other as alternate takes. You then use the mouse to select the bits you want to keep from each take. When you’re happy you have the best possible version, the ‘comped’ vocal is saved as a new audio file. If your DAW doesn’t have a comping mode, you can record the various

## How To Comp

Comping is a complex process, so here’s a step-by-step guide to help you.

First, you need to gather the source material that will be used in the comping process. Record several different takes of the same passage and save each recording as a separate track in your DAW.

Once you’ve got your multiple takes, play through each one individually and identify the bits of each one that you’d like

to keep (a really well-sung first verse, for example). You can remove the rest of the audio from each take, so that you preserve only the bits you want to keep.

The final stage is to gather the bits of each take into one track so that you can make a single piece of audio out of the bits you’ve cut. This will turn your audio snippets into a composite (comp). Job done!

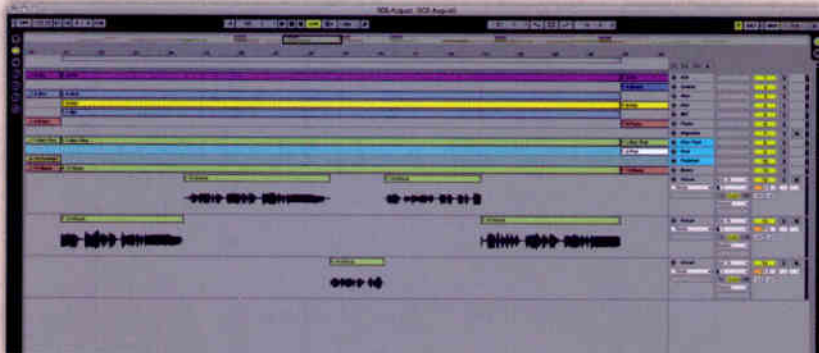

takes on different tracks, slice them into phrases, then keep only the phrases from each that you need. It’s not cheating — everybody does it!

### Destructive Audio Editing

Most editing tasks in your DAW are of the ‘non-destructive’ type: they don’t affect the audio files on your hard disk, they simply tell your DAW which bits of the original audio

files to play, and when.

While you can do a lot of non-destructive editing in your DAW’s arrange window, the destructive capabilities of the waveform editor window (normally accessed by double clicking on a recorded clip) can be very useful for more ‘forensic’ editing. For example, there may be short finger squeaks between guitar notes that can either be silenced or turned down in level, or

»



*PrismSound*

'Portable, versatile and  
unbeatable sound!'  
*Joshua Blair and  
Mark Ronson (Sphere studios)*

## The only interface for the job

**ORPHEUS**  
Professional FireWire  
audio interface



When looking for a high quality I/O solution there is only one choice.

Orpheus provides Prism Sound's world renowned performance, sound quality and state-of-the-art clock technology in a dedicated FireWire unit compatible with both Windows and MAC OS X.

Orpheus features line, microphone and instrument inputs, selectable RIAA Equalization for turntables, a built-in premium-quality monitoring mixer and concurrent ADAT and switchable S/PDIF or AES3 digital I/O plus support for outboard MIDI devices. The Microphone inputs include MS matrix processing and dual headphone outputs are provided each with their own volume control.



**METAlliance™**  
CERTIFIED

Contact us now to arrange *YOUR* Orpheus demo.

sales@prismsound.com    www.prismsound.com  
UK +44 (0)1353 648888    USA +1 973 983 9577

In Logic, as in most DAWs, you can elect to silence a part of your waveform by selecting the area to be silenced, and choosing from a variety of menu options in order to apply the silencing. As always, check your manual as these things do vary from DAW to DAW.

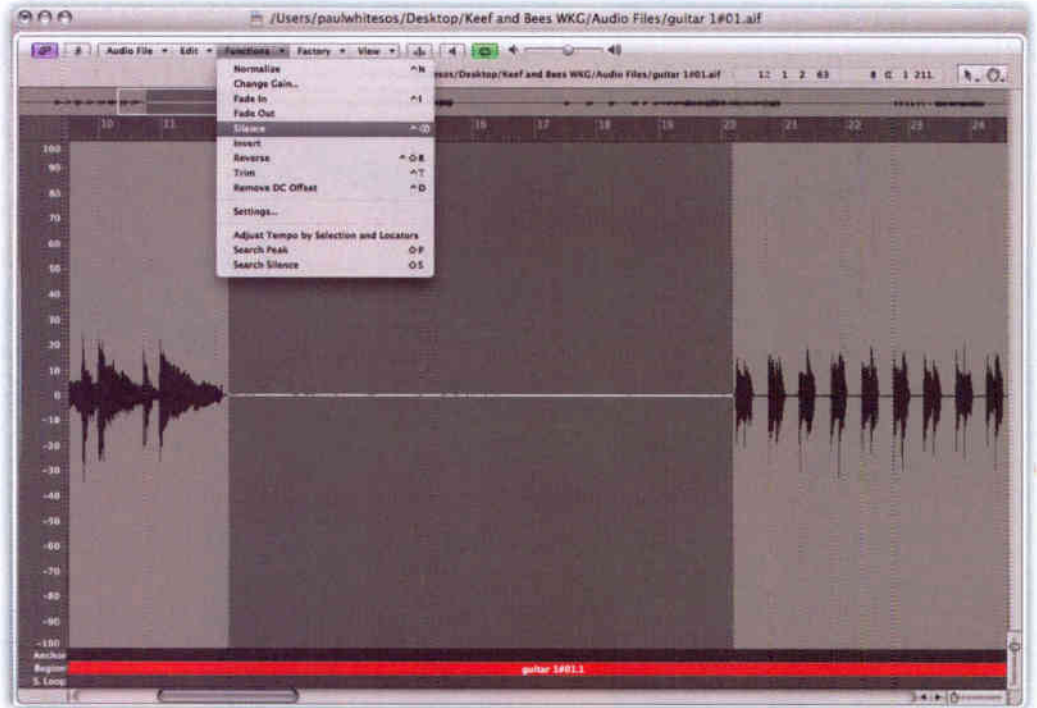

» individual breath sounds on a vocal track that would benefit from being reduced in level. Often turning a noise down by a few decibels, rather than silencing it altogether, makes for a more natural result. As a rule, you can get away with more severe editing if delay or reverb effects are to be added later, as these will help disguise any discontinuities.

If you make an edit in the arrange window rather than in the waveform editor, the DAW normally puts in a default crossfade of a few milliseconds to try to smooth over any discontinuity. For many types of edit, this is the simplest approach. The waveform editor allows you to edit at a much finer resolution (often down to individual sample levels), but bear in mind that anything you do there will be destructive, so read up on waveform editing in your DAW manual before diving in.

## Retaining Perspective

I have seen engineers spend half an hour trying to improve the pitching and timing of a vocal phrase while the singer sits by looking bored. Sometimes it makes sense just to go back to the mic and record the line again. Don't get bogged down thinking you have to be able to fix everything. Sometimes you have to if the singer has just set off on a world tour, but if they are still in

the studio, just get them to do it again.

In short, get the best possible performance you can to start with and then use editing to add the final polish — your recording will sound better for it.

## Freezing

Some plug-in processors or instruments use a disproportionate amount of CPU power, so if you find your computer is struggling to keep up, check out your DAW to see if it offers any 'freeze' options. Many DAWs now allow you to freeze individual tracks (in effect, replacing them with temporary audio files) so that the CPU is no longer running the plug-ins on that track. This works really well, since you can just 'unfreeze' the selected file should you need to make changes to it again. Unfreezing re-engages the plug-ins and discards the temporary file, then you can freeze the track again once you've made the changes.

If you're sure no further changes are needed you can also 'bounce' the part, which means permanently rendering it as

a new audio file. You can then disable the original track and keep it in case you need to revisit it. With DAWs you can always find a way to get back to an earlier stage if you run into trouble.

## Mute & Solo Buttons

The 'mute' and 'solo' buttons found on most DAW tracks are very similar in operation to

## Neat Waveforms

If you need to make a cut in the middle of a waveform, you need to ensure that the waveforms either side of the edit line up correctly when rejoined or you will end up with an audible click. A popular strategy is to make the edit where the waveform crosses through the centre or 'zero crossing' line, but even then the waveform that follows it must continue on smoothly if a click is to be avoided.



Each channel will have two buttons — labelled M for mute and S for solo. Pressing 'M' on a channel will mute just that channel for playback, while pressing 'S' on a channel will leave only that channel audible, muting the rest by default. You can, of course, mute or solo more than one channel at a time. If you want to listen to just two tracks in playback, for example, you can either solo both of them or mute everything else.

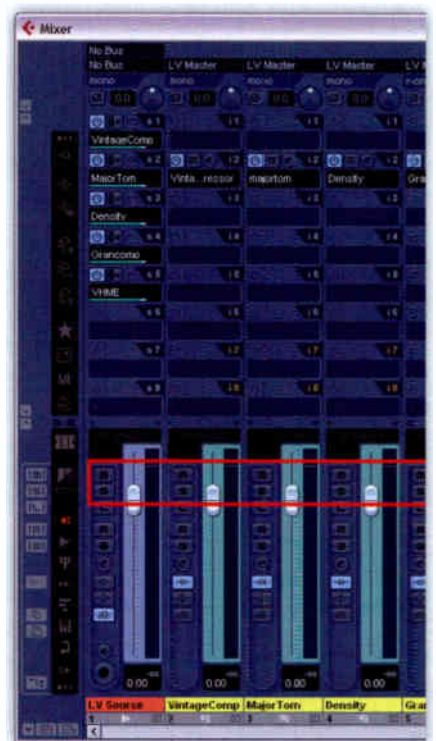

## Keep It Clean!



Unless you deliberately erase an audio file, it remains in the audio file folder, even though it may not be used in the arrange window. Most DAWs offer a means of cleaning up your completed project by deleting any audio files not being used. This saves a lot of hard drive space but don't do it until you're sure that the project really is complete.

those found on a hardware mixer. Solo (S) mutes all the tracks other than those selected as 'solo'. It's a great way of easily listening to tracks in isolation. Mute (M) turns off the output from the muted track, and is useful when you've recorded several alternative versions of a take on different tracks.

DAWs also often include a region mute facility, activated from the toolbox. Rather than mute an entire track, this allows individual regions within a track to be muted. There may also be a solo function that plays only regions within a track that have been selected, rather than everything in the track. Once again, a visit to the manual is essential to find out about your DAW's particular quirks.

### Summary

- Take care to get the best possible sound at source, and avoid clipping during recording.
- Don't immediately try to fix a performance with editing. If it's possible, do another take as this will probably save you time and the end product will sound better.
- Keep all your project files well-organised so that you can see which is the latest version. Also back up everything important as soon as you can after recording.
- Make edits in the arrange window rather than the waveform editor. These can be changed later if necessary, whereas edits done in the waveform editor are usually permanent. **!!!**

### Selected Manufacturers

Alesis <a href="http://www.alesis.com">www.alesis.com</a>	Mackie <a href="http://www.mackie.com">www.mackie.com</a>
Allen & Heath <a href="http://www.allen-heath.com">www.allen-heath.com</a>	MOTU <a href="http://www.motu.com">www.motu.com</a>
Apogee <a href="http://www.apogeedigital.com">www.apogeedigital.com</a>	Peavey <a href="http://www.peavey.com">www.peavey.com</a>
Apple <a href="http://www.apple.com">www.apple.com</a>	Prism <a href="http://www.prismsound.com">www.prismsound.com</a>
Avid <a href="http://www.avid.com">www.avid.com</a>	Presonus <a href="http://www.presonus.com">www.presonus.com</a>
Behringer <a href="http://www.behringer.com">www.behringer.com</a>	RME <a href="http://www.rme-audio.com">www.rme-audio.com</a>
Cakewalk <a href="http://www.cakewalk.com">www.cakewalk.com</a>	Roland <a href="http://www.roland.com">www.roland.com</a>
Echo <a href="http://www.echoaudio.com">www.echoaudio.com</a>	Soundcraft <a href="http://www.soundcraft.com">www.soundcraft.com</a>
Focusrite <a href="http://www.focusrite.com">www.focusrite.com</a>	Steinberg <a href="http://www.steinberg.net">www.steinberg.net</a>
Korg <a href="http://www.korg.com">www.korg.com</a>	Tascam <a href="http://www.tascam.com">www.tascam.com</a>
Lexicon <a href="http://www.lexiconpro.com">www.lexiconpro.com</a>	TC Electronic <a href="http://www.tcelectronic.com">www.tcelectronic.com</a>
Line 6 <a href="http://www.line6.com">www.line6.com</a>	Yamaha <a href="http://www.yamaha.com">www.yamaha.com</a>
M-Audio <a href="http://www.m-audio.com">www.m-audio.com</a>	Zoom <a href="http://www.zoom.co.jp">www.zoom.co.jp</a>

# CHOOSE THE RIGHT INTERFACE



## Scarlett Range

USB 2.0 INTERFACES

## Saffire Range

FIREWIRE & USB INTERFACES



Whatever your budget, **Firewire or USB**, Focusrite interfaces have one singular focus – sound.

# Focusrite®

## THE FOUR STEPS TO START MAKING MUSIC

# RECORDING MIDI

**Recording music as MIDI can be confusing at first, but once you know the basics, you'll discover the vast musical potential that this technology opens up.**

**A**lmost all DAW programs include what's called a 'sequencer'. This gives you the ability to record, edit and play back MIDI data. The MIDI notes can be sent out of your computer to a hardware synthesizer, but these days, it's common for the synthesizer itself to be another software program, running as a 'plug-in' within the DAW.

A physical MIDI connection can transmit up to 16 channels of MIDI data, allowing a sequencer to address more than one instrument via a single cable. With software instruments, there are no such physical limitations, but you will often still need to tell your DAW which MIDI channel a particular track should send its data on. When it comes to recording MIDI, most DAWs are set up by default to accept a MIDI input on any channel ('omni mode'), then convert or 'rechannelise' that data to any desired MIDI channel as required. The clear advantage of this approach is that you don't have to change the controller keyboard's MIDI settings every time you want to record a new MIDI track, though you may well have to ensure that the correct MIDI 'port' is selected so that your DAW knows to expect input from your keyboard rather than, say, a MIDI input on your soundcard.

If you are using a non-multitimbral software instrument plug-in, you probably won't have to worry about MIDI channels on the way out, either:

## Changing Channels



Most controller keyboards transmit on MIDI channel 1 by default, but this can easily be changed. If you've bought a used keyboard, it's worth doing a 'factory reset' to put everything back to its default state. Ensure you back up any custom sound patches worth keeping beforehand.



you can simply route the MIDI track to an instrument, and it will accept MIDI data on any channel. However, if you're using a multitimbral software instrument (one that can play back multiple different sounds simultaneously), or an external, hardware synth, you will need to make

sure your tracks are outputting MIDI on the correct channels.

## Multitimbral & Hardware Synths

When using a multitimbral synth, you'll need to put each part that has its own

**"Most DAWs include a variety of 'quantise' options, which will automatically put your recorded MIDI data into time with the bars and beats grid."**

## MIDI Track Types

Some DAWs have 'instrument tracks' for software synths. These integrate the recorded MIDI data and the synth's audio output on a single DAW track.

synth sound on a different track, and set each to output on the appropriate MIDI channel. Depending on the synthesizer, you might have up to 16 different parts playing back different sounds, all coming from the same device. If working with multitimbral instruments seems initially confusing, stick to one instrument per track until you get the hang of things, then come back and take another look.

When controlling external MIDI synths, you'll need to set the track parameters so that the MIDI playback goes to the required MIDI channel, and on the correct MIDI port if there is more than one. Most DAWs will also allow you to set bank



and patch messages for the track so that the receiving synth knows what patch number to set itself to. If the external synth is a keyboard instrument and you're also using the keyboard to record into your DAW, don't forget to set Local Off on the keyboard, as explained in the chapter on MIDI in the Behind The Audio section (p48).

How do you get the sound from your external synth back into the DAW? That's a good question, and different DAWs handle the process differently. The most logical approach is offered by those DAWs that have auxiliary input tracks taking live audio from an outside source and routing it directly into the DAW's mixer. Fortunately, most DAWs will provide some way to do much the same thing. An attractive alternative (if you're using a lot of external synths, for example)

is to employ a simple analogue mixer to combine the stereo DAW output mix with the outputs from all the individual synths. The output from this mixer can then be recorded back to a new stereo DAW track via inputs on your audio interface to create your final mix.

## The Recording Process

Once all the track parameters are set so you have the desired MIDI source and destination selected, put the track into record ready mode by pressing the arming button. Recording will start when you press the record button. Depending on the DAW, you may not see anything

appear on the screen until you play the first note on the keyboard; as you play, you'll see a horizontal bar appear representing the part you're playing.

MIDI parts can be patched up or replaced in a similar way to audio. Usually, you can choose whether data recorded on top of an existing part replaces that part, or is merged with it. The latter mode is useful for things like drums, where you might record the kicks and snares first, then do the cymbals and hi-hats on a second pass, with the tom fills played on a third pass. Alternatively, you can record the different parts of the drum kit onto different MIDI tracks, then combine them >>

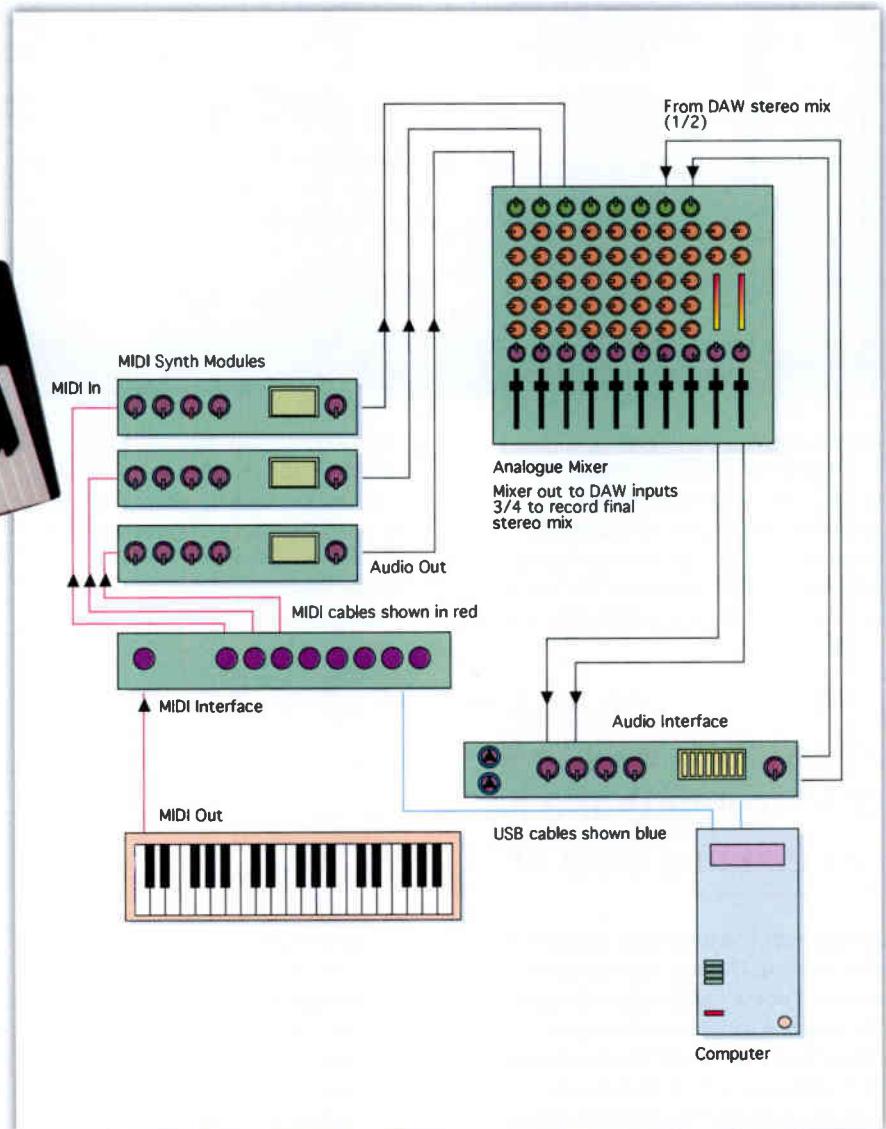

In this scenario, the analogue mixer combines the 'in-the-box' DAW mix with three external synth modules run via MIDI. The mix is monitored from the mixer control room output and may be recorded back to a stereo DAW track or to an external recorder. An alternative is to route all the DAW tracks via outputs 3/4 and to feed the mixer output back into two other free inputs for recording the mix. This will allow monitoring from the audio interface via outputs 1/2.

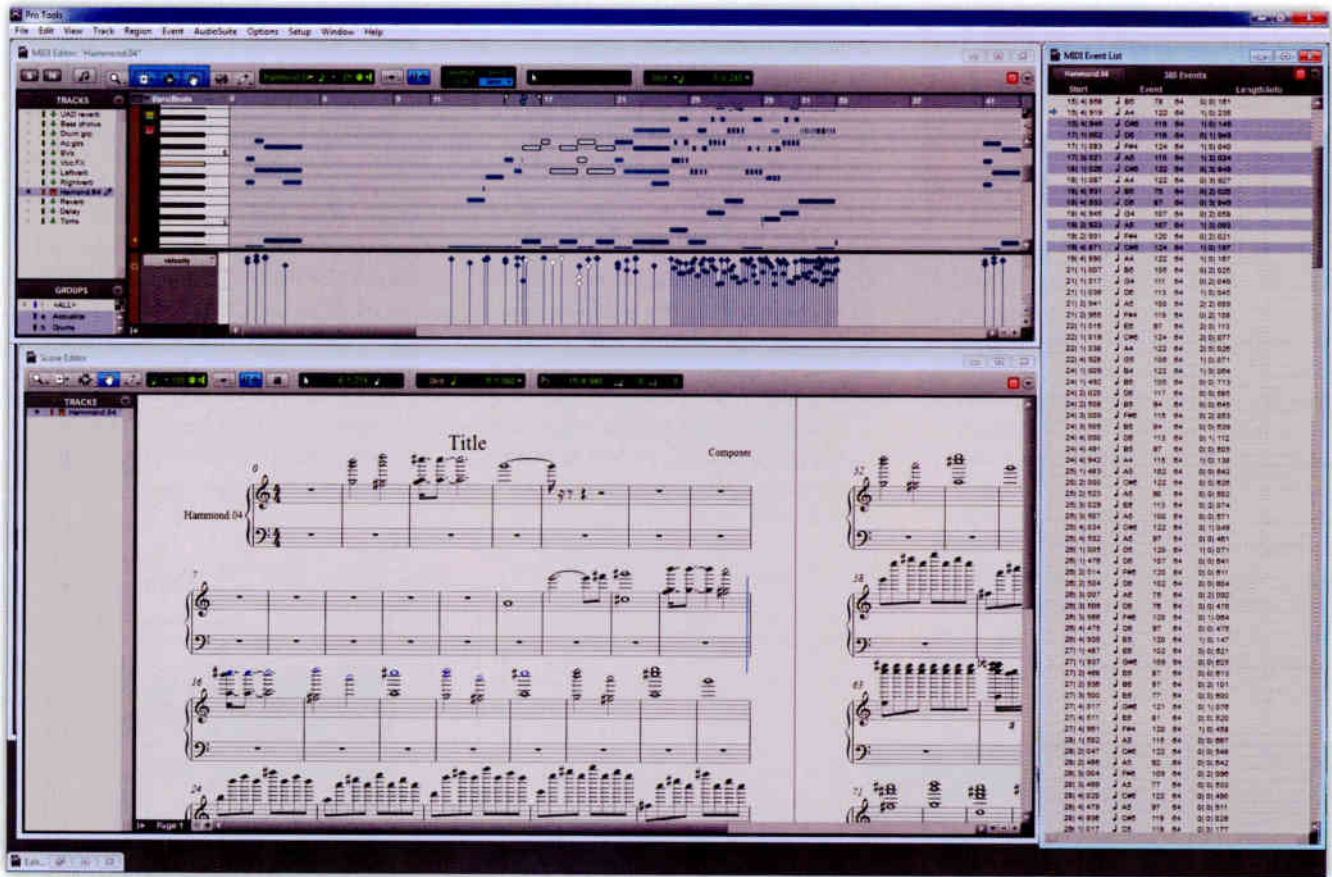

» once everything is completed. Most DAWs include a variety of 'quantise' options, which will automatically put your recorded MIDI data into time with the bars and beats grid. Some DAWs even have the option to allow you to quantise MIDI data as you

relatively slow attack time. Related to quantising is the ability to automatically manipulate the velocity settings of MIDI data, which instruct the synthesizer how loud to play each note. Other things you can do after recording include changing the tempo

Pro Tools MIDI edit views: score (bottom), piano roll (top) and event list (right).

changes. If you're not a great keyboard player, you can always slow down the tempo when you record MIDI parts, then reset it to the correct speed for playback.

MIDI data can also be edited manually, for instance by using the mouse to change the pitch of notes, add new ones or move them to different beats. Many DAWs let you do this directly in the main Arrange page, but most also offer a variety of dedicated editor windows designed specifically for editing MIDI

**"MIDI data can be patched up or replaced in a similar way to audio. Usually, you can choose whether a newly played part replaces the existing data or is added to it."**

record, but I find it far safer to quantise after playing. This way you can always undo it if doesn't work out, and adjust the quantise parameters for a more natural feel. You should also appreciate that rigid quantisation doesn't suit everything, as the musical 'feel' of a real performance often comes from looser timings. Furthermore, instruments such as ensemble string samples may need to be played slightly before the beat in order to feel 'in time', to take account of their

of the song, transposing the MIDI data to a new key or changing the MIDI destination parameters so your track plays back with a different sound or even a completely different MIDI instrument. MIDI tracks can be freely adjusted in tempo, but audio tracks (other than certain types of loop) tend to be rather less malleable. It is safest to make any tempo changes at the MIDI-only stage, then overdub your audio parts when you're happy there'll be no further

**Multiple MIDI** 

Some DAWs will allow you to record several MIDI tracks at the same time, in which case each needs to be set to receive different MIDI channels and/or ports. In Logic, for example, it is important to select all the MIDI tracks that need to be recorded (using the shift + select operation). If you simply put them all into record-ready mode, only the track currently selected will record MIDI data.

# CHOOSE THE RIGHT CONTROLLER

## Size Really Does Matter!

One of the huge benefits of MIDI data is that it takes up very little space compared with audio. This means you can record lots of alternate takes without the risk of eating up excessive hard drive space.

data. The 'piano-roll' editor gives you a useful overview of the recorded MIDI data, but those who are used to more traditional notation might find a 'score' view easier to take in. Many DAWs also offer editing views specifically designed for drums and percussion.

When you're ready for more advanced work, read up on how MIDI can be used to send other messages besides turning notes on and off. MIDI Continuous Controllers can be used to control synth parameters such as filter cutoff frequency and resonance, and can be recorded and edited just as easily as notes, allowing synth filter sweeps and so on to be automated so that they are reproduced precisely every time you play back the track. The controller data can be generated by moving dials on the plug-in window with a mouse, but it can also be recorded from a hardware controller, so if you think you're going to be doing this a lot, consider choosing a master keyboard or separate control surface that also includes some assignable MIDI knobs and faders to make your life easier. And it's not only synths that can be controlled from such a device: MIDI faders can be assigned to mixer faders within your DAW, allowing you to balance the levels of multiple tracks when mixing.

### Summary

- DAWs can record all types of MIDI message so that you can record the effects of other controls such as pitch bend, vibrato depth and even filter settings, as well as pitches of notes.
- With multitimbral synthesizers, both hardware and software, you'll need to make sure that the output of each MIDI track is set to the appropriate channel for that sound within the synth.
- MIDI quantise is a powerful ally, but use it wisely, or you might remove all the humanity from your performance. While some musical genres rely on rigid timing, others need to have room to breathe.
- Multitimbral instruments behave like several instruments in one, each responding on a different MIDI channel. Every DAW has its own way of handling these. **///**

## Selected Manufacturers

Access <a href="http://www.access-music.de">www.access-music.de</a>	M-Audio <a href="http://www.m-audio.com">www.m-audio.com</a>
Akai <a href="http://www.akaipro.com">www.akaipro.com</a>	Moog <a href="http://www.moogmusic.com">www.moogmusic.com</a>
Arturia <a href="http://www.arturia.com">www.arturia.com</a>	Novation <a href="http://www.novationmusic.com">www.novationmusic.com</a>
Clavia <a href="http://www.clavia.se">www.clavia.se</a>	Roland <a href="http://www.roland.com">www.roland.com</a>
Korg <a href="http://www.korg.com">www.korg.com</a>	Yamaha <a href="http://www.yamaha.com">www.yamaha.com</a>



**Click, Touch, Assigned.**  
Novation controllers bridge the gap between you and your music software.



# THE FOUR STEPS TO START MAKING MUSIC

**Getting a good vocal sound is easier than you might think, as long as you follow a few basic rules.**

**Y**ou don't necessarily need expensive mics or preamps to get a good vocal recording: a good singer will still sound good using their live-sound SM58 dynamic mic. Indeed, some rap and rock singers prefer the sound of a dynamic mic to a costly capacitor model.

As touched upon earlier in the guide, it's usually best not to record vocals via any form of processor. This is because it can be impossible to undo an unsuitable setting later, and means you could lose an otherwise perfect take. With 24-bit recording, you don't have to compress up front to maintain headroom as you had to with analogue tape. The exception is that if you have a special piece of outboard gear, there might be no other way to get the same magic than to record through it. Be careful not to overdo the processing and, if you're not entirely sure, split the signal and record an unprocessed version onto another track at the same time.

# RECORDING VOCALS

In the studio, a large-diaphragm capacitor microphone is generally the first choice for vocals. It has the ability to capture high frequencies more accurately than dynamic models and can simultaneously add a flattering weight to the sound. Capacitor mics, other than tube models, do need phantom power to operate, but most mixers and audio interfaces with mic inputs can provide this. Cardioid (unidirectional) mics are a popular choice as they help 'reject' unwanted sound reflections behind them. They're still fairly sensitive at the sides, however, so you can't rely on them to cure all of your room-acoustics problems. Also, any reflections coming from a hard wall behind the singer will bounce right back into the front of the mic where it is most sensitive.

## Acoustics

Room-acoustic problems can have a far more detrimental effect on your recordings than the choice of microphone or preamp.

Also, any compression added to your recording when mixing will bring up the room coloration even more. So, what starts out as a small problem can become quite significant. Having said all that, creating a suitable acoustic for recording vocals is both simple and inexpensive. You don't have to treat the whole room, just the part that the microphone can 'hear'.

The main purpose of acoustic treatment is to stop sound reflections getting into the front and sides of the microphone. If you're using a cardioid model it will be fairly insensitive to the rear anyway. In my experience, the sounds bouncing into the front of the mic over the singer's shoulders present the biggest problem, but you can deal with these simply and cheaply by hanging a heavy polyester-filled duvet behind the singer. If you can hang it in a U or V shape to reach around the sides slightly, so much the better. Don't use feather duvets as all the feathers will sink to one end!



---

**“The vocal sound you get from a combination of a curved screen in front of the singer and a duvet behind is much more natural than you get using a small vocal booth, and the cost is vastly less.”**

---

You can achieve more efficient absorption if you space your duvets away from the wall. Doubling up on the thickness will also help. For temporary hanging, I use a couple of budget T-bar lighting stands and clip the duvet to the crossbars using sprung woodworker's clips. These can then be arranged to form a 'V' shape behind and to either side of the singer. Where the ceiling is low, an absorber above the singer and microphone will also help cut down on reflections. A piece of lightweight acoustic foam works well in this application.

Now we can think about the rear and sides of the mic. Although they are less sensitive to the rear and sides, cardioid

mics often have quite peculiar frequency response plots at these angles, so screening these areas from room reflections helps preserve a more natural sound. You may have seen commercial curved absorbers that fit behind the microphone. These can be very effective in screening the rear and sides of the mic, but need to be used in combination with a duvet or other absorber behind the singer's head for best results.

The vocal sound you get from a combination of a curved screen at the front and a duvet behind the singer is much more natural than you get from using a small vocal booth, and the cost is vastly less. If you can't afford a specialist mic

screen, use another duvet behind and to the sides of the mic, maybe 500mm away.

### Position

Because of the way direct and reflected sound combines in the exact centre of square or rectangular rooms, avoid placing the singers, instruments or microphones in the centre of the room. Also, avoid working very close to walls and corners as the so-called 'boundary' effect caused by surface reflections causes a noticeable bass build-up. Try to arrange things so that your mic is set up as far away as possible from computers and other noise-making sources, and keep the rear of the mic (if it is a cardioid model) facing towards the computer, if possible.

Pop shields should always be used for miking close vocals. An inexpensive mesh or perforated metal screen positioned mid-way between the singer and mic will prevent unwanted pops or thumps whenever loud 'M', 'P' and 'B' sounds are sung. You can improvise your own pop shield using a piece of nylon stocking material stretched over an opened-out wire coat-hanger, but it

»



Unless you're extremely lucky with the acoustics of the room in which you're going to be recording, chances are you'll require some kind of acoustic treatment. Duvets work just as well at absorbing reflections as do commercial products!



Commercially available products, such as this Reflexion Filter, will help to reduce unwanted reflections when placed to the rear of the mic, but work best in conjunction with duvets placed behind the singer.

model to model. Rather than buying one based on its technical specification, try a few and see which one suits your voice best. In many cases you'll find this isn't the most expensive model. Unless the singer has a perfect voice, the mic characteristic needs to oppose the singer's vocal characteristics. For example, someone with a thin or harsh voice might benefit from a warm-sounding mic whereas, someone with a warm voice that lacks definition might pair up well with

» doesn't look as good! The distance between the singer's lips and mic should be around 250mm or maybe a little less depending on the room acoustics and how loudly they sing. Very experienced singers can vary their distance from the microphone to reduce popping and also to exploit the proximity bass boost exhibited by cardioid-pattern mics.

## Mic Choices

Large-diaphragm capacitor mics tend to have a tonal coloration that varies from

## Selected Manufacturers

- AKG  
[www.ake.com](http://www.ake.com)
- Audio-Technica  
[www.audio-technica.com](http://www.audio-technica.com)
- Beyerdynamic  
[www.beyerdynamic.com](http://www.beyerdynamic.com)
- Fostex  
[www.fostexinternational.com](http://www.fostexinternational.com)
- Primacoustic  
[www.primacoustic.com](http://www.primacoustic.com)
- Rode Microphones  
[www.rodemic.com](http://www.rodemic.com)
- Rycote (shockmounts)  
[www.rycote.com](http://www.rycote.com)
- SE Electronics  
[www.seelectronics.com](http://www.seelectronics.com)
- Sennheiser  
[www.sennheiser.com](http://www.sennheiser.com)
- Shure  
[www.shure.com](http://www.shure.com)
- Sony  
[www.sony.com](http://www.sony.com)
- Ultrasone  
[www.ultrasone.com](http://www.ultrasone.com)
- Universal Acoustics  
[www.scvlondon.co.uk](http://www.scvlondon.co.uk)
- Vicoustic  
[www.vicoustic.com](http://www.vicoustic.com)
- Vocalbooth  
[www.vocalbooth.com](http://www.vocalbooth.com)



a bright-sounding microphone. Of course you may need to buy one mic that can work well with a number of different vocalists, in which case try to find one without too much of an obvious character.

## Monitoring

While performing, the vocalist will need to hear any backing that's already on tape, and this is best accomplished via closed-back headphones so the backing track doesn't leak into the vocal mic. If they prefer to work with one phone on and one phone off, make sure that the 'off' phone is snug against the side of their head to prevent sound leakage. Alternatively, you can make up a special phones extension lead where one earphone is disconnected.

It is normal to add a touch of reverb to the vocalist's monitor mix using plug-ins, as this usually makes them feel more comfortable. Always ask what level works best for them. As with recording guitar, turn off all plug-ins that cause excessive delays, and set a buffer size of 128 samples or less if your system will let you. You could also use hardware that allows you to set up direct-source monitoring. It's possible to add monitor reverb to direct-source monitoring by feeding the reverb bus from a pre-fade auxiliary send on the vocal track while turning the main track fader all the way down. This way the singer hears the dry vocal from the hardware mixed with the added reverb from the DAW, and if the reverb suffers a bit of latency delay, it won't be noticeable.

## Summary

- Some simple, improvised acoustic screens can make more difference to the

quality of the end result than the most esoteric mics and preamps.

- Getting the vocalist relaxed is an important part of getting a good vocal performance.
- Pick the mic by how well it suits the singer, not by how impressive its specification looks.
- When you do your initial sound-level check, leave at least 12dB of headroom because the singer will almost certainly turn in a louder performance when the red light goes on. ■■■

Pop shields are fitted directly in front of the microphone, with the singer's mouth approximately 250mm away. Even an improvised DIY job, such as the one shown above, will do the trick!

## Sound Psychology

Sorting out the acoustics and mics is one thing, but getting a good performance from the singer is another. You need to work with the singer to set up the best possible headphone mix.

- Add 'comfort reverb' for the singer.
- Turn off unnecessary lights to reduce distractions.
- Remove unnecessary helpers from the studio to enable concentration.
- Never tell a singer they've done a bad take, it will only damage their confidence!
- Always record everything, even the warm-up, as some of the best moments occur then.
- Record a few takes, then compile a 'best of' version from the best phrases.
- Use 'salvage' software such as pitch correction as a last resort. The less pitch correction that is used, the more natural the end result will sound.

# NT1-A

THE COMPLETE RECORDING SOLUTION

## The world's quietest studio mic!

For over fifteen years this now iconic recording microphone has been relied upon to faithfully capture the sound of artists the world over.

From vocals to guitar, piano to percussion, the NT1-A delivers!

With its signature warmth, extended dynamic range, high SPL capability, and the world's lowest self noise (5dB-A SPL), the NT1-A is now the 'go-to' mic for professional engineers and musicians numbering in their hundreds of thousands.

The NT1-A 'Complete Recording Solution' includes a premium shockmount, an integrated pop filter, a high quality 20' XLR microphone cable, and a dedicated microphone dust cover.

As well as these premium items, a bonus instructional DVD presented by RØDE founder and company president Peter Freedman is also included, offering a range of tips & techniques designed for you to get the most out of your NT1-A system.

If you haven't experienced the NT1-A and why it is now the world's most popular recording microphone it's time to discover what you've been missing.



**RØDE**  
MICROPHONES

[www.rodemic.com](http://www.rodemic.com)

**NT1-A**  
THE COMPLETE RECORDING SOLUTION

**FREE**  
STUDIO GRADE  
POPSHIELD



**FREE**  
SHOCK  
MOUNT



**FREE**  
XLR  
CABLE



**BONUS**  
STUDIO SECRETS  
DVD



# RECORDING GUITAR

Guitar recording can be tricky: you've got to consider the microphone type, its position, and the sound of the instrument, but this guide should help you get started, whether you're recording an acoustic or an electric.

**T**hough apparently similar, acoustic guitars and electric guitars are two very different instruments, and they require their own distinct approaches when it comes to recording them. The electric guitar sound that we've grown used to over several decades, for example, is actually the sound of the instrument plugged into an amplifier, rather than directly into a recorder, so it is normally the sound of the amp that you'll want to capture. When you hear an acoustic guitar on a record, meanwhile, it tends to sound much like being in a room while someone's playing, so the challenge there is to get a fairly natural, 'realistic' sound.

As always, before you think about what mic to use, it's worth making sure your guitar is sounding as good as possible. That means a fresh set of strings, making sure you're in tune, and, when recording electric guitar, getting the amp sounding how you want it.

### To Mic Or Not To Mic?

Many acoustic guitars now come fitted with a piezo bridge pickup and preamp, which can be very convenient, as you can simply plug them straight into your audio interface. However, this rarely sounds as good as actually miking the instrument up, as piezo pickups tend to have an unnaturally hard attack, so they can sound very 'spiky'. While there are modelling acoustic guitar preamps available that can improve the sound, such as the pioneering Fishman Aura, they still don't quite compare to the sound of a properly recorded acoustic. By all means try the pickup if the guitar is part of a pop mix, but for solo performances or exposed parts it's invariably straightforward miking that produces the best results.

### Direct Recording

Electric guitars work best when they are plugged into a high-impedance instrument input — line-level inputs tend not to sound great when fed with pickups. If your audio interface doesn't have one, use a simple active DI box between the guitar and interface.

If you don't have a DI box, you could try using an external hardware pedal before it. The pedal may act as a high-impedance input converter, which will sound better.

'Hard bypass' pedals won't work in this way when switched off, however, but many, including Boss' range of stompboxes, will.



Acoustic guitars tend to sound best when played above a solid, reflective floor, such as wood or ceramic tiles, as the reflections from the floor add life to the sound. If you have to work in a carpeted room, try placing a sheet of MDF or hardboard on the floor beneath the guitar

**Miking an acoustic guitar: a good place to start is 200 to 300 mm from the base of the neck, as shown in this picture.**

mic. These reject more unwanted sound from the sides and rear of the mic. For rooms that sound pretty good, omni-pattern mics often produce the most

---

**"Acoustic guitars sound best when played above a solid, reflective floor, such as wood or ceramic tiles, as the reflections from the floor add life to the sound."**

---

and the mic. You should only need a piece around one metre square. An adjacent reflective wall may also help, but it's worth experimenting with the positioning as every room is different. As a rule, avoid the exact centre of the room, especially if the room is square, but also don't work too close to walls or corners.

When miking an acoustic guitar, remember that the instrument covers a wide frequency range. The best choice is normally a condenser microphone, although other microphones will yield acceptable results. A conventional large-diaphragm vocal mic may give you perfectly good results but, given a choice, a small-diaphragm 'pencil' style mic is usually the best option.

### Mic Position

If the acoustics of the room aren't particularly flattering, use a cardioid-pattern

natural sound and their positioning seems a little less sensitive. If you're lucky enough to have a room with good acoustics, the positioning of the mic becomes much less critical.

An acoustic guitar radiates sound from all over its body, so it is best not to get the mic too close or you'll end up focusing on just one part of the sound. Avoid aiming the mic at the sound hole, as this can produce an excessively boomy result.

A good 'vanilla' starting point is to place the mic around 200-300mm from the guitar, aiming it at the point where the neck joins the body. It is worth donning a pair of headphones and moving the mic around as the performer plays to find the best sound. Hold the mic in your hand while you're finding the best spot, and then fix it to a stand. It's a terrible cliché but you'll know the best sound when you hear it — suddenly everything seems to come into focus, with



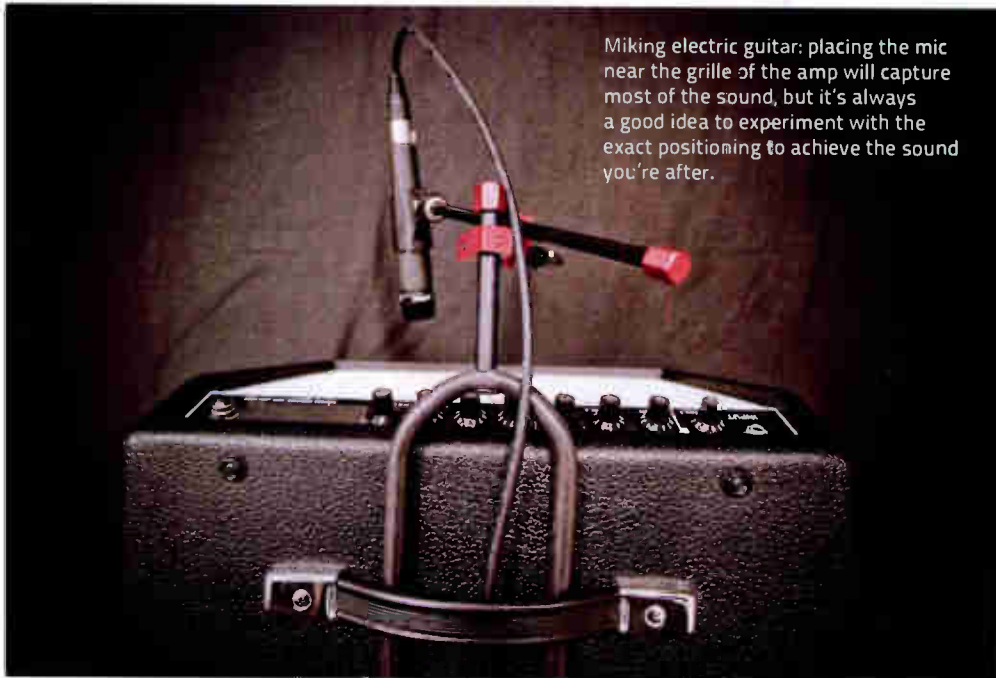

Miking electric guitar: placing the mic near the grille of the amp will capture most of the sound, but it's always a good idea to experiment with the exact positioning to achieve the sound you're after.

is designed to sound as transparent as possible, each guitar amp has its own tonal character, along with subtle and not-so-subtle distortions. The filtering effect of the speaker also affects the sound, removing all the unpleasant upper harmonics created when you use overdrive or distortion.

The traditional method for recording electric guitar is to stick a dynamic mic (often a Shure SM57) close to the speaker grille of the amp, experiment with its position by moving it closer to or further away from the centre of the speaker, and then hit record. As a rule you'll get a more focused sound with strong upper mids near the centre of the cone. Moving towards the edge will create a warmer tonality, and there'll be a different character to the high end. Miking an amp still produces the best results in my opinion, and it is certainly the most satisfying playing experience.

While guitar amps are normally miked up with dynamic mics, it's worth noting that many engineers like to use ribbon mics on electric guitar. Because ribbon mics tend to roll off at the high end, they can produce a smoother tonality than condenser mics.

Every mic produces a different sound when used on electric guitar, so try

» a good balance between the highs and lows.

If you're recording a strummed acoustic guitar as part of a busy mix alongside bass and drums, it's common practice to cut the low end so the guitar doesn't contribute to muddiness in the lower mid-range region. This will be covered in more depth in the chapter on Mixing Techniques.

### Stereo?

These days I invariably record the acoustic guitar with a single mic, as this avoids phase problems. As the guitar is physically quite small, most of the stereo information you hear comes from room reflections, which can often be emulated perfectly adequately using a suitable reverb plug-in, so why not keep it simple?

Stereo recording can work well in some situations, however, so you may wish to give it a try. You can use any of the classic spaced, coincident or M/S stereo mic techniques if you wish, but a lot of engineers just look for two mic positions that give a pleasing sound. One widely used approach is to mic the body (as you would for making a mono

recording), and then to aim a second mic part-way up the neck to capture the brightness of the strings. You don't even have to use the same type of mic for this method. The main problem I find with stereo guitar miking is that if and when the player moves, the stereo image also shifts slightly, adversely affecting the recording.

### Going Electric

If you think the electric guitar is a musical instrument, you're only half right. The guitar itself is only half of the instrument. An amplifier makes up the other half, and is just as important as the instrument when it comes to creating the sound.

Unlike a keyboard or PA amp that



### Reflection Screen

Vocal reflection screens placed behind the mic are quite effective with omni- or even figure-of-eight pattern mics, to reduce the amount of room ambience.



everything you have — even the least likely models can produce pleasing sounds.

Many classic rock albums achieved their big guitar sound through the use of small tube amplifiers (including some of the classic Led Zeppelin albums), so don't

of amplifiers, speakers, pedals and microphones, so that when you play a guitar through one of them the output is much the same as if you'd stuck a mic in front of the real thing. But just as no two studio engineers get quite the same sound from

**“An electric guitar amp is just as important as the instrument when it comes to creating the sound — each amp has its own tonal character and distortion.”**

assume you need a big stack to get a big sound. However, in a home studio it isn't always practical or socially acceptable to mic up even a small guitar amp.

### Model Behaviour

The obvious alternative is to use a modelling preamp, or its software equivalent, as outlined in the chapter on plug-in instruments in the section Exploring Software. If you can get the sound you require from a modelling preamp or plug-in, then all you have to do is set the record levels and go for it.

Modelling creates digital simulations

the same type of amp, each manufacturer's model represents a slightly different view of the truth.

Some players claim that playing through a modelled amplifier feels and sounds very different from playing through a guitar amplifier. It's a valid observation, because the sound is coming from a pair of studio monitors rather than high-powered guitar speakers. You have to bear in mind that what you hear from the speakers is the guitar as it might sound on a typical record, not what the player normally experiences when standing directly in front of a guitar amp, and this can take a little getting used to for some guitarists. Nevertheless, it's still a great way to get a polished, fully produced guitar sound with minimum hassle.

One other benefit of using a modelling plug-in is that you can change the settings after recording. This is because the guitar itself is recorded 'dry' (without processing). If you use a hardware box such as a Pod, however, this isn't possible, as you're recording the model rather than the guitar.

A useful tip when using hardware is to split the guitar signal and record a dry version onto a second track, so that you can use plug-ins on it later and then either add it to the processed track or replace it altogether. Another alternative is to try recording via the hardware unit using a little less distortion than you think you'll ultimately need, and make further tonal changes by processing the recorded part via your amp modelling plug-in. It's easy to add more distortion to a recording, but impossible to take it away if you've overcooked it.

### Features

A typical guitar-amp modelling package will include a choice of amplifier types

## Lost The Stereo?



Effects generated by modelling setups are often stereo, so don't forget to use a stereo track rather than a mono track to get the full effect.

complete with the usual controls found on those amplifiers, plus a selection of speaker cabinets, and a range of stomp-box pedals that can be placed in front of the amplifier just as you would with 'real' pedals. You'll probably also find a few miking options for the speakers, which will include microphone type and position. You may also find a range of studio-style post-processing effects, such as studio equalisers and compressors, so there are plenty of tools for shaping your dream guitar sound in software. Generally, all the controls can be automated from within your DAW to change the sound during a track, so you could use automation to engage pedals during solos and so on, but I personally tend to keep different guitar sounds on different tracks as it makes mixing easier.

Designers try to make the amp models behave as similarly to the originals as possible, although some also offer separate clean and dirty models of the same amp. The actual modelling process varies depending on the designer. Peavey's Revalver, for example, models individual components of the circuitry and then computes their interaction. Other approaches included modelling the amplifier as a series of blocks — such as the preamp stages, the tone stack, the output stage and the combination of speaker cabinet and microphone. Ultimately it doesn't matter what approach the designers take, or how accurate they are for that matter, as long as you find the result musically satisfying.

### Nailing That Tone

Most amp plug-in designers steer clear of legal problems by naming their preset patches in such a way that it's clear what is meant, but they don't actually spell it out for you. For example, if they have a patch set up to emulate the guitar sound from Pink Floyd's 'Comfortably Numb', they might call it something like Comfortably Pink. Other clue-style names might be along the lines of Jimi's Wing, Dire Sultans, Texas Stevie and so on. Of course, you have to use the right type of guitar with the right pickup combination and, most importantly, play like the artist in question to get the result you're looking for. These patches usually

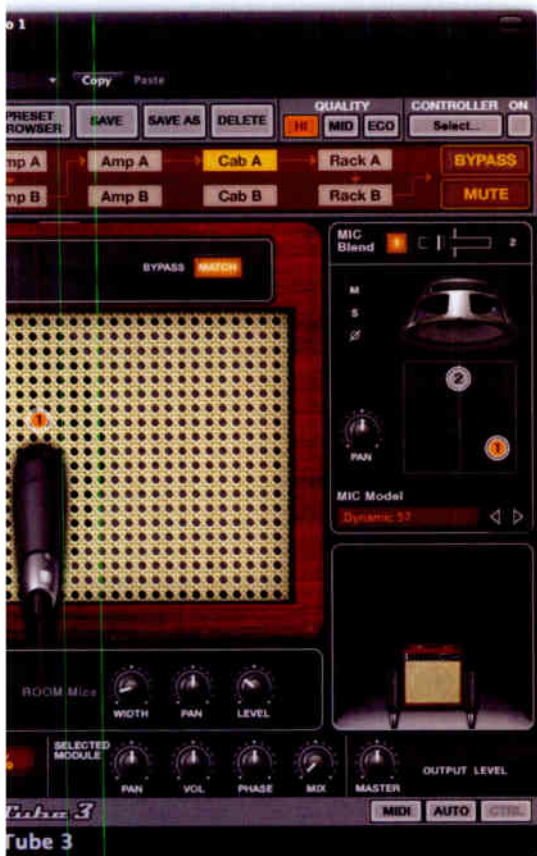

The T-Rex Spin Doctor recording preamp (left) and Amplitube plug-in amp emulator (right).

» need some degree of tweaking to get them sounding close to the original tones, as each guitar sounds different, but they can also be used as a starting point for getting your own unique sound.

## Hiss & Hum

Hiss and hum are inevitable when using high-gain distortion effects. Hum is a particular problem for those instruments fitted with single-coil pickups, such as Fender Stratocasters and Telecasters. Putting a noise gate or plug-in on the guitar track after recording will mute unwanted noise during pauses in the playing, but it is important that any gating is done before adding reverb or delay, otherwise the action of the gate will affect the tail end of the reverb or decay effect. Fortunately, many amp modelling plug-ins include a gate at the correct point in the signal chain.

To keep hum to a minimum, sit far enough away from the amplifier to keep out of range of its power transformer's magnetic field, and then angle the guitar for the least amount of hum. Working close to a computer will also induce noise and buzz into a guitar's circuits, as will some external power supplies, lighting dimmers and fan speed controls.

## Bass Guitar

The options for recording bass guitar are just the same as for electric guitar, except that recording them directly without recourse to modelling is also quite common. This can be via a DI box or from the DI output on the back of the amp.

For many kinds of music, a clean DI with a touch of EQ and compression is all that is needed to beef up the sound, but for rock music a bit of amplifier dirt can help add punch and attitude. You can add mild overdrive and tonal colour using a standard amp-modelling plug-in, although a dedicated bass version may give you more tonal scope. If you do mic a bass amp, choose a mic with a good bass response, as the kinds of dynamic mic normally used for guitar amps often have a deliberate low-end roll-off.

## Further Points

- Guitar amp plug-ins can also be used to coax interesting sounds out of keyboards, drum loops and even vocals so don't be afraid to try a bit of creative abuse. Today's top engineers didn't get where they are by using gear only for the purpose intended!



- Amps and amp simulators are processors, and as such should normally be deployed via channel insert points. However, if you come up with a clever parallel processing effect that means putting it in the effects send and return loop, who am I to tell you that you're wrong? At least putting software plug-ins in the 'wrong' place won't cause an explosion!
- Watch the input gain and also the output level of your plug-ins. Some processing can add a lot of gain. Remember to adjust the output control to keep the signal from hitting the top of the meter.

## Recommended Software

- Native Instruments' Guitar Rig provides a huge range of amp, pedal and effect models along with a very flexible but intuitive routing system. It also allows you to have two amp setups running at the same time. Though it comes with a vast range of presets, it is very easy to set up your own sounds. Its range covers all the standard ground as well as allowing for the creation of exotic, ethereal effects. A combined hardware controller and audio interface is available for live use.
- IK Multimedia's Amplitube is one of the best-respected amp-modelling programs and also has optional live performance controllers. It has a friendly

If buzzing is a problem, try using a noise gate.

GUI and comes in various versions, including one dedicated to Fender amps and one based on the signature sounds of Jimi Hendrix. Some bass amp models are included.

- Line 6 Pod Farm, which replaces GearBox, offers the same functionality as the Pod X3 range of processors and is based around a very simple drag-and-drop interface where components are dragged onto a virtual floor to create custom setups. Some bass amp models are included. The effects section includes some studio EQs, preamps and compressors while an expansion pack can be used to add new models if you don't go for the flagship version right off. The biggest difference between Pod Farm and its rivals is that when used with a compatible Line 6 audio interface, the guitar sounds can be heard with zero latency regardless of your DAW buffer settings. Line 6 also have a strong on-line community for exchanging patches and ideas.
- SoftTube's Vintage Amp Room offers fewer options than most of its competitors and doesn't give you a set of modelled pedals, but the amps it does model are recreated in remarkable detail. ■■■

## Selected Manufacturers

Avid  
[www.avid.com](http://www.avid.com)  
 Behringer  
[www.behringer.com](http://www.behringer.com)  
 Boss  
[www.roland.com](http://www.roland.com)  
 Digitech  
[www.digitech.com](http://www.digitech.com)  
 Fishman  
[www.fishman.com](http://www.fishman.com)  
 IK Multimedia  
[www.ikmultimedia.com](http://www.ikmultimedia.com)  
 Line 6  
[www.line6.com](http://www.line6.com)  
 Magix  
[www.magix.com](http://www.magix.com)  
 Native Instruments  
[www.native-instruments.com](http://www.native-instruments.com)  
 Peavey  
[www.peavey.com](http://www.peavey.com)  
 SoftTube  
[www.softtube.se](http://www.softtube.se)  
 TC Electronic  
[www.tcelectronic.com](http://www.tcelectronic.com)  
 Waves  
[www.waves.com](http://www.waves.com)



# TECHNIQUES

In this section, I'll look at some of the techniques you'll need to know when recording in a home or project studio. Read on to discover how to master miking, excel at equalisation, become proficient with processors, and crack compression.

MICS & MIKING	116
MIXING MAGIC	124
ALL ABOUT COMPRESSION	134
EQUALISATION EXPLAINED	138
EXPLORING MASTERING	146
MONITORING BASICS	150



# Building Your Mic Locker

## 16 Mics Everyone Should Know About

Every day, new customers come to Sweetwater looking for the perfect do-it-all mic. Although there is no one mic that's perfect for every situation, there are several that you can use for many different sources. And you don't have to spend a fortune to build a solid mic locker. Here are some of the most popular and useful microphones available today.

### Shure SM58/SM57

**Two Truly Legendary Dynamic Microphones** — The Shure SM58 and SM57 are two of the most popular and versatile microphones of all time. They're inexpensive and virtually indestructible, and they sound great on just about anything. Adding one or two of each to your mic locker right away is money well spent.

### Sennheiser MD 421 II

**This Dynamic Mic Is Perfect for Toms, Bass Cabinets, and More** — You'll find this mic poised over toms in pro studios everywhere. It fits into the tight space above the toms, but it won't pick up too much bleed from the cymbals. It's also superb at capturing the impact of bass cabinets, the growl of guitar amps, and the resonance of male vocals.

### Audio-Technica AT2035

**An Affordable Large-diaphragm Condenser Mic That's Great for Vocals** — The AT2035 is one of the least expensive large-diaphragm condenser mics that clearly provides the gently flattering quality of large-diaphragm condensers. An impressive 148dB maximum sound-pressure level also makes it a great choice for guitar cabinets.

### Neumann TLM 103

**This Large-diaphragm Condenser Mic Sets the Bar for Smooth Vocals** — The TLM 103 is an exceptional microphone, known for its incredibly low self-noise. It uses the same capsule as Neumann's legendary U 87, which provides delightfully smooth characteristics. This smoothness is great for vocals and guitar cabinets, and for mellowing out cymbals.

### Blue Microphones Spark

**An Amazing Medium-diaphragm FET Condenser Mic with Legendary Blue Style** — The Spark brings genuine FET design to an entry-level price point. But don't let the price fool you; the Spark's ultra-modern FET circuitry gives vocals and acoustic instruments the smooth yet present sound of classic jazz and early rock 'n' roll recordings.

Shure SM58

Neumann TLM 103

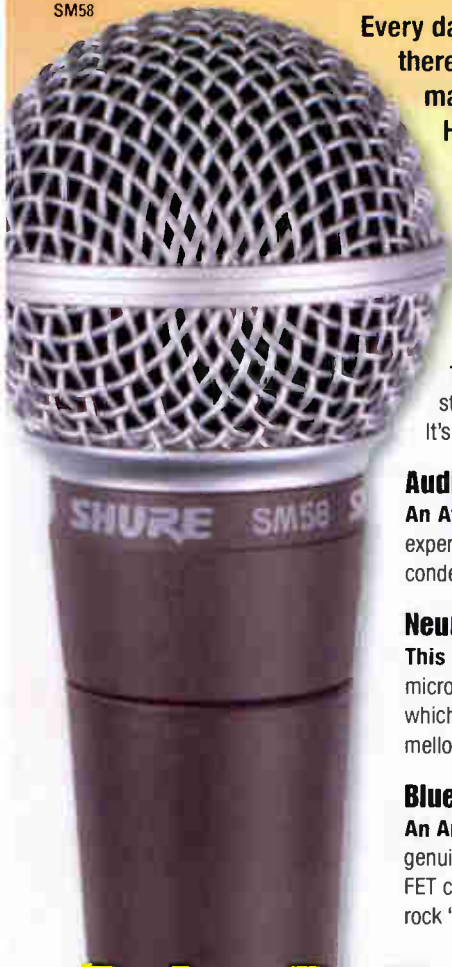

Blue Microphones Spark

## Polar Patterns



### Cardioid

This is the most common polar pattern; it picks up sound only from the front and blocks everything else out. That makes it perfect for isolating individual instruments or vocals. When in doubt, use a cardioid mic.



### Supercardioid

This is a tighter version of the cardioid pattern. It gives you a laser-line isolation in front, blocking out almost all sound from the sides. It's great for drums, as you can isolate a single drum without picking up bleed from the rest of the kit.



### Figure-8

This pattern picks up sound from both the front and the rear of the mic, and nothing at all from the sides. That makes it great for recording two sources at once, such as an acoustic guitar and vocals.



### Omnidirectional

This pattern picks up sound from all directions, making it the perfect pattern for recording room ambience. It also handles low frequencies better than any other pattern, so it's great for kick drums and bass cabinets.

Find your perfect  
microphone online!

Go to  
**Sweetwater.com**



### **Samson C01U**

**A Great-sounding Large-diaphragm Mic with USB Convenience** — The Samson C01U is an excellent mic to have handy, especially if you need to record on the go. All you need is a laptop, a USB cable, and a C01U, and you're set. The C01U even comes bundled with recording software.

### **RØDE NT2-A Studio Solution**

**A Multi-pattern Workhorse Mic That's at Home in Any Studio** — Highpass filters, pad settings, and three selectable polar patterns make the NT2-A a genuine workhorse microphone, good for everything from vocals to violins. Having an NT2-A in your mic locker will ensure that you always have a mic for any occasion.

### **AKG D 112**

**This Dynamic Mic Is the King of the Kick Drum** — The AKG D 112 is one of the most popular kick drum microphones ever made. It captures both the resonant boom of the shell and the click of the beater. It's also an excellent bass-cabinet mic, capturing low-end punch and midrange snap.

### **Audix FP7**

**This Complete Drum Mic Kit Is a Fantastic Value** — Here's an excellent way to get seven great mics for one amazing price. These mics are great for drums, but they're also useful for other instruments. If you're looking for a smart way to build up your mic locker quickly, the FP7 kit is it.

### **Royer R-121**

**This Modern Ribbon Mic Lets You Capture Guitar Amps the Way You Hear Them** — The Royer R-121 ribbon mic "hears" pretty much the way your ears do. So, if you want to capture your guitar tone the way it sounds when you're standing in front of your amp, the R-121 is pretty much the perfect mic for the job. It's also a stellar vocal mic.

### **Mojave Audio MA-200**

**Warm Up Your Vocals with This Incredibly Popular Tube Mic** — The magnificently warm and rich-sounding tone of the MA-200 has made it a popular vocal mic. For a mic that will absolutely flatter vocals across the entire spectrum, this amazing tube microphone is absolutely worth saving up for.

### **Miktek C7**

**If You Want Classically Smooth Vocals, This Large-diaphragm FET Mic Is a Great Choice** — Warm on the bottom yet silky at the top, the Miktek C7 delivers at an attractively affordable price. The C7 also provides you with a range of polar patterns and other settings that give you extra tonal range.

### **Avantone CK-1**

**This Small-diaphragm FET Condenser Is Super for Acoustic Guitar and Wonderful as an Overhead** — The CK-1 takes the same FET smoothness found in mics such as the Spark and the C7, and couples it with the precision of a small-diaphragm mic. That makes it fantastic for acoustic guitars, cymbals, and other harsh-sounding instruments.

### **AEA R84**

**Transparent Tone Makes This Ribbon Mic Incredibly Flexible** — Completely transparent and highly detailed, the AEA R84 delivers vintage ribbon sound. It's based on classic ribbon mic designs and even features the same ribbon material used in the original RCA 44 series microphones.

### **Electro Voice RE20**

**You'll Find This Classic Dynamic Mic in Any Broadcast or Voice-over House** — The RE20 is responsible for the larger-than-life, bass-heavy male broadcast voice that is now the standard of voice-over-style sound. It's also the secret weapon for miking kick drums and bass cabinets in many successful recording houses.

For more information about these and other wonderful microphones everyone should know about, give us a call. Your Sweetwater Sales Engineer will help find the perfect mics for you.

Royer  
R-121

Audio Technica  
AT2035



**Get connected with the mics  
that fit your needs!**

**CALL US TODAY AT  
(800) 222-4700**

**Sweetwater**

Music Instruments & Pro Audio

# MICS & MIKING



**The way you capture your source material will have a huge effect on the success of your recordings, so read on to be sure that you make the right decisions when buying and setting up your microphones.**

**M**icrophones are some of the most essential bits of kit for a project studio. Without them, there would be no way of recording the music you want to make! Given the wide variety of mics available, choosing the right mic for the job is key to making recorded voices and instruments sound good.

There are three main groups of microphones for recording, and each has its own strengths and weaknesses.

## Condenser Mics

Because it is built around an extremely thin, lightweight diaphragm, the

condenser mic has the widest frequency range of all microphone types and is a good choice for natural-sounding acoustic instruments and voices, especially where there's a lot of high-frequency content. Condenser mics can be built to offer any polar pattern or even to be switchable between the various patterns (a polar pattern describes the directions from which a microphone picks up sound). In the home studio, however, the cardioid pattern is the most common choice: this picks up sound mainly in front of the mic, and is less sensitive at the sides and rear.

Aside from a few 'back-electret'

side-address large-diaphragm condenser microphones (ADK A6 and S7), and Charter Oak S600 pencil or stick mic.

condenser mics that can run from batteries, you'll need to provide 48V phantom power to enable condenser mics to operate. Without it there will be no signal whatsoever! The exception to this rule is where the microphone uses valve or tube circuitry, as these come with their own power supplies to provide the higher voltages the valve needs to run.

Don't be tempted to buy cheap microphones from a general-purpose

## Microphone Anatomy

The part of a microphone that picks up the sound is often referred to as the 'capsule'. The part of the capsule that moves in response to sound is called the 'diaphragm'.

electronics shop, as these are seldom in the same league as even the cheapest mics you can buy from a music shop. Also beware of bad-sounding fake microphones sold over the Internet. There are some truly appalling-sounding Shure SM58 copies around that look very much like the real thing.

A good microphone will last a lifetime, so don't skimp in this area by buying attractive-looking junk. As with many things, you get what you pay for. Stick to recognised names or models recommended in *Sound On Sound* reviews and you'll be fine. There are the obvious high-profile European brands such as Neumann, AKG, Sennheiser, Beyerdynamic and Microtech Gefell, but there are many other reputable brands from around the world including, but not restricted to, Shure, Audio-Technica, CAD, Rode, Telefunken, Charter Oak, Blue, Heil, AEA, Royer, MXL, Audix, Studio Projects, sE and Sontronics (to name a few!).

There are two main physical formats for the condenser mic: the thin stick-like 'pencil' models which, in the case of a cardioid version, would be aimed directly at the sound source, and the chunkier large-diaphragm models. The vast majority of these are 'side-address', meaning that you sing or play into one side, not into the end. Large-diaphragm models are popular for use with both vocals and instruments and often have a noticeable and deliberate tonal character that is designed to flatter, while the small-diaphragm pencil models are, as a rule, more accurate and neutral. While there's no reason not to use a small-diaphragm mic for vocals, most engineers choose a large-diaphragm model. Whichever type is chosen,

### Phantom Power Off!



Any serious mixer, mic preamp or audio interface with mic inputs will have phantom power, often switched 'globally' to all of the mic inputs at the same time. This isn't usually a problem as mics that don't need phantom power will not be damaged by it as long as they are balanced (which mics designed for studio use invariably are) and connected using balanced 3-pin XLR cables. However, microphones, and ribbon mics in particular, should not be plugged in or unplugged with the phantom power switched on, as there is still a risk of damaging them.

it is highly recommended that you put a mesh pop screen between the mic and the singer when recording vocals to prevent popping on 'plosive' 'B' and 'P' sounds. The foam 'pop sock' screens that

Unlike condenser mics, however, they can't reach the top of the audio spectrum: most roll off at 16kHz or so. Dynamic models built specifically for instrument use tend to have a smaller basket and



Ribbon microphones, clockwise: Sontronics Delta, Shiny Box 46MX, MXL R77, Audio Technica AT4080 & AT4081.

come with some mics aren't very effective and can also compromise the tone. Check out the Recording Vocals chapter in the Recording section for more specific tips and information on vocal recording.

Before leaving the subject of mic accessories, it is also worth investing in shockmounts for your condenser mics, as these help prevent floor vibrations being carried up the mic stand and into the mic.

### Dynamic Mics

Dynamic moving-coil mics are the type we're all familiar with for live-sound use. Many follow a 'ball-on-a-stick' format, where the wire mesh ball helps reduce popping and protects the capsule. These are rugged, require no phantom power and can usually withstand high sound-pressure levels, making them suitable for recording drums, guitar amps and for close-miking brass instruments.

a more extended low-frequency response, the Shure SM57 being a typical example.

### Ribbon Mics

Finally, the ribbon mic, which is also a type of dynamic microphone, is the most physically fragile of the types mentioned so far. With its low sensitivity, it is also technically the least efficient (you get less output for a given audio input level), and most models are less capable of capturing high frequencies than other types of mic. Given all this, you may ask why anyone bothers to build them. One answer is that they are particularly useful with instruments that can sound harsh when recorded via a condenser mic, such as the violin. Ribbons can also be used to capture a 'vintage' vocal sound, and can sound fabulous on electric guitar amps.

Because of their physical design, where a suspended metal ribbon is open to the »

## Finding The Sweet Spot



To check you have found the best or 'sweet' spot, ask your performer to play continuously, then listen to the mic signal over headphones while moving the mic around the performer. Do this until you've

found the position that sounds the best. When you find the right spot it is almost as though the sound comes into clear focus, so it should be obvious where the sweet spot is located.



make acceptable recordings, although their lack of high-frequency sensitivity may compromise the end result with brighter or more articulate instrument sounds. Dynamic mics are often the preferred choice for close-miking drums and guitar cabinets.

### Mic Position

There are textbook mic positions for most instruments, but these should be regarded only as starting points. Exact positioning will vary between instruments and will also be influenced by the room acoustics and the type of microphone used. For most of this section I've assumed you'll be working with a cardioid mic.

One factor that soon becomes apparent is that the majority of instruments don't produce sound from a single point. What we hear is the result of vibrations coming from the entire body of the instrument. If the mic is too close, you only capture part of the sound. On the other hand, if you put the mic as far away as a typical listener, you'll pick up a lot of reflected room sound, which will make the instrument sound more distant. I have developed a simple compromise technique that works for just about any instrument. We can call this a 'rule of thumb', even though it isn't a rule and doesn't involve thumbs. Simply space the mic away from the instrument by a distance similar to the longest dimension of the instrument. This ensures the mic collects sound from all parts of the instrument facing it while still being reasonably close. You can then use the headphone trick, as described in the box to the left, to find the best place to aim it.

» air on both sides, ribbon mics almost invariably have a figure-of-eight pickup pattern. For this reason, acoustic screens may be necessary to prevent unwanted sound reaching the rear of the mic, which is just as sensitive as the front.

One strength of the figure-of-eight pattern is that it offers almost perfect rejection of any sound approaching from the side of the mic (90 degrees off-axis). This can be exploited by aiming the 'deaf' axis towards other sound sources in the room that you don't want to spill into the mic. Active ribbons also require phantom power, while passive models need to be used with a high-quality, low-noise mic preamp for the best results. Even though modern ribbon models are more rugged than vintage models, you should always handle them with care and never drop them. Before choosing one, it is worth asking the cost of getting a broken ribbon replaced!

### Instrument Recording

To make a good recording of an instrument (or voice), the instrument must sound good in the first place. Not only should the instrument be properly maintained, it can also be beneficial to record it in a sympathetic acoustic environment (drums are an excellent example). After

all, if something already sounds good played in a particular room, it saves you having to try to reshape the sound using further processing. The amount of reverberation that the room contributes to the recording will be affected by the distance of the microphones to the source being recorded. The closer the mic to the instrument, the more direct sound you'll pick up relative to the room ambience. The greater the distance between instrument and mic, the more the room acoustics will contribute to the overall sound.

For most acoustic instruments, condenser mics capture the most natural sound. Dynamic mics can be used to



### Recording Drums

Drums are one of the most difficult things to record in the home studio because you need plenty of height above the kit to place the overhead mics without



### Miking Drums



When miking a drum kit or a collection of percussion instruments you should treat the whole setup as one large instrument, then space the mic accordingly. This applies whether you're using a single mic or a stereo pair. For a standard drum kit, place the mics one or two metres in front of, or above, the kit.



EXPERIENCE MORE .: INSPIRATION .:



New to our family of 20 Series studio condensers, two remarkable large-diaphragm microphones: AT2050 Multi-Pattern Condenser and AT2035 Cardioid Condenser. Look to them for more quality, more clarity, more for your investment. Wherever your music takes you, experience more. [audio-technica.com](http://audio-technica.com)

AT2050 FEATURES	AT2035 FEATURES
<ul style="list-style-type: none"> <li>• Multi-pattern side-address studio condenser</li> <li>• High SPL handling and wide dynamic range</li> <li>• Three switchable polar patterns: omnidirectional, cardioid, figure-eight</li> <li>• Switchable 80 Hz high-pass filter and 10 dB pad</li> </ul>	<ul style="list-style-type: none"> <li>• Side-address cardioid studio condenser</li> <li>• Large diaphragm for smooth, natural sound &amp; low noise</li> <li>• Cardioid polar pattern improves isolation of desired sound source</li> <li>• Switchable 80 Hz high-pass filter and 10 dB pad</li> </ul>



» them also picking up strong ceiling reflections. A ceiling height of two metres above the cymbals should be considered a minimum but, where that isn't possible, you can also suspend acoustic screens above the overhead mics to help reduce the effect of ceiling reflection.

A good drum recording starts with a good-sounding kit, played well in a sympathetic acoustic environment. Where the environment is less than ideal, the best you can do is use screens to reduce the effect of the room as much as possible, before adding a suitable artificial ambience from a reverb unit when mixing. Excessive 'ringing' from the drums can be cured by damping: modern gel pads do a much better job than the old standby of tissue and gaffer tape. If the result is still dire, you can try drum replacement software, which processes the original drum tracks and then uses samples to replace (or layer) the flawed sounds.

In rooms that flatter the kit sound, you can get great results using a single condenser mic placed a metre or two in front of the kit, and adjusting the mic height above the floor to get the best balance of kick drum to the rest of the

kit. However, most engineers opt for a pair of mics so as to capture the kit in stereo. You can further refine this simple technique by moving the mic pair above the drum kit and then adding a third mic for the kick drum to allow more flexibility when mixing. A dynamic model specifically tailored to bass instrument use is recommended (such as the AKG D112), as many dynamic vocal mics have a deliberate roll-off below 200Hz. If the front head of the kick drum has a hole cut into it, try positioning the mic just inside of the shell about 100mm from the shell wall, off to one side. A folded blanket inside the bottom of the shell will provide adequate damping. Where there is no hole, you can try miking either the front or rear head of the kick drum, depending on the sound you want. Using our mic-positioning rule of thumb, start with a mic distance of half the drum's diameter.

### Multi-miking

As the kick and snare are arguably the most important elements of a drum kit, you can extend the miking arrangement further to add a close snare mic. This would typically be a dynamic mic placed

### Mastering Miking

There are other more elaborate stereo-miking techniques, as well as mic setups suitable for making surround recordings, but they are beyond the scope of this guide. If you're interested in learning more, go to [www.soundonsound.com](http://www.soundonsound.com) and have a look at some of the past articles on the subject.

around 50mm from the edge of the drum and about 30 to 50 mm above the head, tilted to aim towards the centre of the drum head. Point the snare mic away from the hi-hat to minimise spill. Some engineers like to use a second mic on the underside of the snare to enable them to add more snare 'snap'. If you decide to do this, you must switch the polarity of the bottom mic 'out of phase' with the top, otherwise the two mic signals will try to cancel each other out, resulting in a very thin sound. If your mic preamp doesn't have a phase-invert switch, record

Complex miking arrangements such as this are not to be attempted by the faint-hearted! It's often easier to start off miking a drum kit as a single instrument.





as normal but then use a phase-inverting plug-in or a destructive edit to invert the polarity of the signal after recording.

To go the whole hog on drum miking, set up separate mics for each tom, positioned as for the snare. Good dynamic mics are ideal for this purpose, although some clip-on drum-mic sets use miniature condenser mics. In a pro studio you'd often find additional stereo pairs set up further from the kit. These room mics can add a great character to the sound, but only in great-sounding rooms, and in most home studios you won't have space to try this.

If the overhead mics aren't picking up enough hi-hat, use a separate condenser mic spaced about half the hi-hat's diameter away from the hi-hat and aimed just below or just above the cymbals so it doesn't get hit by a blast of air every time the hi-hat closes. Whatever way you set up the mics, ensure the drummer isn't likely to hit them! Close-miked drums usually need some EQ to get the sound you want, and you may also need to roll off some low end from the overhead mics to prevent the overall kit sound becoming too boxy.

## Bass & Guitar

The easiest way to record bass guitar is using a DI box or recording preamp, but putting a mic in front of a good bass amp can sound better. Many engineers record both at the same time to hedge their bets. Use a good dynamic or condenser mic 200 to 300 mm from the speaker grille, and move it off to the side slightly if the tone seems too hard.

Electric guitars were covered in some depth in the chapter on guitars in the Recording section, but it is worth reiterating that it's OK to do whatever seems to work for you. You can use absolutely any mic or combination of mics

in any position, though the 'dynamic mic close to the grille' solution usually gets decent results. I also love the sound of ribbon mics on electric guitar, though these often need a little low-cut and upper-mid boost EQ to get them sounding just right.

Acoustic guitars were also covered in the Guitar Recording chapter. In my experience, small-diaphragm condenser mics give the best results in most cases, although you can use your vocal mic if that's all you have. If you have an omni-pattern mic, give it a try: you might find it easier to get a natural sound, although you may need to use acoustic screens behind the mic to keep out room reflections and spill from other sources. As long as you use your ears and keep the mic away from the soundhole, you shouldn't have too much of a problem with acoustic guitar. A hard floor always helps keep the sound lively.

## Keyboards

Keyboards, drum machines and samplers are usually recorded by plugging them directly into the line inputs of your mixer, but miking an amp can sometimes produce a warmer sound. You can also use some guitar-amp overdrive to add energy to the sound. Again, it is a case of 'whatever works'. Mic as you would for electric guitar.

If you're lucky enough to get to record a real Leslie rotary cabinet, work in stereo with one mic at each side of the cabinet facing the speaker grilles. Keep these 250mm or more from the grilles to avoid picking up wind noise from the rotating parts inside.

## Violin

Violins can sound pretty harsh when close-miked, so put the mic 600mm to one metre above the



violin body and start from there. A ribbon mic will give a much smoother sound, but you can also use EQ to tame the top end if you're using a condenser mic. It is also possible to tilt the mic slightly so that it picks up the sound 'off-axis', where it is less responsive to high frequencies. You can try a moving-coil dynamic mic, though I find these can sometimes sound a bit 'honky' on violin.

## Accordion

Because of the movement of the bellows, accordions literally change size as they're being played. Furthermore, different sounds come from the two ends, so you'll need to mic them in stereo. Keep your mics reasonably widely spaced to avoid excessive level changing during performance. Around half a metre out from the sides of the instrument and 300mm or so in front of it usually works well for me. I use condenser mics but you



can also get fine results using moving-coil dynamic mics. Don't pan the two mics too far apart in the mix or you'll end up with the sound of a five-metre wide accordion!

## Wind

Most wind instruments can be successfully recorded by positioning a mic around 300 to 700 mm in front of the instrument, angled so that the mic isn't pointing

»

## Miking Guitars

With acoustic guitars, the majority of sound comes from the body, so measuring the length of the body and using this as a starting point for your mic distance will put you in the right vague area. (A more purist approach would be to acknowledge that some sound also comes from the neck and the strings above it, in which case you'd need to double the mic distance.)



**Miking Unusual Instruments**



The drum-miking rule, though not infallible, is a useful fallback when you're confronted with unusual instruments for which no textbook method exists. You might also like to consider that if the instrument sounds right to the player, then putting a mic or mics close to the player's ears should give good results.

» directly down the bell or mouth of the instrument. Having said that, some sax recordings are made with the mic close to the bell. It gives a different sound but with lots of presence and punch, so try it to see if you prefer it. I've even recorded the digeridoo based on my rule-of-thumb method, but most of the sound does come out of the end of the pipe, so you can afford to get as close as 200mm from the open end without changing the sound too much. Louder wind instruments, such as the sax and trumpet, can be recorded using either condenser or dynamic mics, while flutes seem to sound more airy when recorded with a condenser model. You can also try a ribbon mic if you have one as this will produce a warmer, less aggressive tone that might be more suitable for 'late night' jazz.



**Piano**

Use samples — it's easier! Seriously, though, unless you have a good piano in a good room, samples may work better. However, if you want to give grand piano recording a go, open the lid on its prop, then

put up a couple of mics set at a height of around halfway up the prop and around 1500mm from the piano facing into the open lid. Space them by one metre and then fine-tune the positions for an even balance of bass and treble notes. Condenser mics generally give the best results here, but a good ribbon can also sound very sweet.

Upright pianos can be miked in many ways but I find a spaced pair either side of the player's head gives adequate results. After all, if the piano sounds OK to the player, it is going to sound OK to the

mics. Take off the front panels and open the lid if it improves the sound.

**Stereo Mic Techniques**

For a stereo microphone technique to sound convincing, it must capture sound in a three-dimensional space in a way that our hearing system will believe. The human head is nominally symmetrical, so any stereo-miking arrangement must also be symmetrical. Logic would suggest that using two microphones in place of our own ears would get close to capturing what we need, and this can work using a piece of equipment known as a dummy head (which saves a real person having to sit perfectly still for the entire recording). In practice, this only works properly for headphone listening, where the signals reaching the two ears are completely separate. It doesn't work so well for loudspeaker listening as some of the

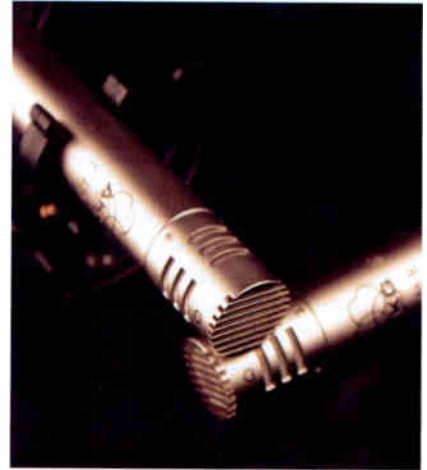

An example of an X-Y mic pair.

(or X-Y pair) where two identical high-quality cardioid or figure-of-eight mics are mounted at approximately 90 degrees to each other and with their

**"A good microphone will last a lifetime, so don't skimp in this area by buying attractive-looking junk. As with many things, you get what you pay for. Stick to recognised names or models recommended in *Sound On Sound* reviews and you'll be fine."**

sound from the left speaker will reach the right ear, and vice versa.

In real life, sound arrives from all directions, but with stereo speakers we only have two point sources to work with. Fortunately, the human hearing system is pretty accommodating when it comes to stereophonic sound, so, even though we can't create the spacial impression of the live event, we can still produce something enjoyable that gives an impression of left/right perspective.

**Coincident (X-Y Pair)**

The simplest stereo-miking setup is the coincident

capsules as close to each other as possible. One mic will tend to pick up sound mainly from one side of the sound stage and the other from the opposite side. Sounds originating from the centre will be picked up equally by both mics. Figure-of-eight mic pairs do the same but will also capture the left and right

sound from the rear of the room, including audience noise and room reverberation.

When played back over stereo speakers all the sound appears to come from

**Miking Pianos**

Pianos can be treated in a similar manner to drums as they are physically large instruments.



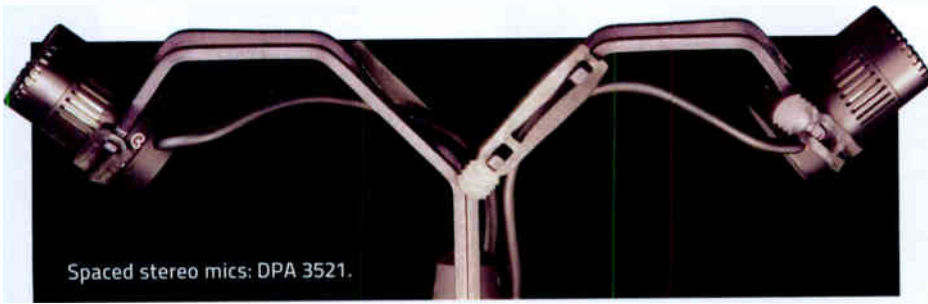

the front, even if it was picked up from the rear of the room. Because the two microphone capsules are very close to each other, sounds always arrive at both mics at the same time, so there are no delay problems to cause phase cancellation when played back in mono.

### Spaced Stereo Mics

Coincident miking is a safe way to work, but you can sometimes create a more dramatic impression of stereo by using spaced mics (sometimes called an A/B pair). Sound originating anywhere other than from the centre will arrive at the

- Use a pop filter for vocal recording, and unless the floor of your studio is solid, using shockmounts to hold the mics is recommended.
- Buy at least one capable condenser microphone. It doesn't need to be expensive, but don't skimp by buying something cheap and nasty either.
- Take time to experiment with all the different mics you have. Don't wait until you have a session to try out new mic techniques.
- Monitor the sound being picked up via enclosed headphones as you physically move the mic around the sound

**"The majority of instruments don't produce sound from a single point. What we hear is the result of vibrations coming from the entire body of the instrument. Mic too close, and you'll only capture part of the sound. Mic too far away and you'll pick up a lot of reflected room sound."**

different mics at different times, so there can be mono-compatibility problems, but the upside is that the stereo effect is more pronounced. You can try this using spaced-cardioid, omni or figure-of-eight microphones and, though the spacing can cause mono-compatibility problems, the result is often still acceptable in mono. You'll need to adjust the distance of the microphones from the performers to get the desired balance of direct and reverberant sound. As a rule, I'd use a mic spacing of around half the width of the ensemble being recorded and seldom less than one metre.

### Summary

- Read up on the textbook miking setups for different instruments, but always fine-tune the mic position to get the best result, as every instrument and room sounds different.

## Pops And Whistles

When you're recording vocals, you'll find that certain sounds can cause particular problems. Some consonants are produced by aggressively stopping the airflow in the mouth when producing the sound. These are plosives, and you'll easily spot them by the tell-tale 'popping' sounds on your vocal recordings. Examples of consonants that produce this effect are P, B, K, G and T. Sounds made when uttering M and N consonants can produce a similar effect, but are made by nasal vibrations; H and W sounds can also cause wind blasts on the mic.

Other consonants that can cause problems are 'sibilants', such as S, T and F, which can sound harsh and exaggerated with some singers and microphones. Special processors called de-essers are designed to tone these down at the mix, but it's better to tackle the problem through mic choice and placement if possible.

source. This will help you find the best mic position and also help you learn what the instrument sounds like from different positions.

- If you don't know how far away to position the mic, measure the length of the part of the instrument that produces sound and use this as the initial mic distance from that part of the instrument. This will ensure you pick up all the sound from the instrument without getting so far away that the room acoustics will dominate. ■■■

## Selected Manufacturers

AKG  
[www.akg.com](http://www.akg.com)  
 Audio-Technica  
[www.audio-technica.com](http://www.audio-technica.com)  
 Audix  
[www.audixusa.com](http://www.audixusa.com)  
 Beyerdynamic  
[www.beyerdynamic.com](http://www.beyerdynamic.com)  
 Blue  
[www.bluemic.com](http://www.bluemic.com)  
 CAD  
[www.cadaudio.com](http://www.cadaudio.com)  
 DPA Microphones  
[www.dpsmicrophones.com](http://www.dpsmicrophones.com)  
 Heil  
[www.heilsound.com](http://www.heilsound.com)  
 M-Audio  
[www.m-audio.com](http://www.m-audio.com)  
 Mojave Audio  
[www.mojaveaudio.com](http://www.mojaveaudio.com)

MXL  
[www.mxlms.com](http://www.mxlms.com)  
 Rode  
[www.rodemic.com](http://www.rodemic.com)  
 Rycote (shockmounts)  
[www.rycote.com](http://www.rycote.com)  
 Samson  
[www.samsontech.com](http://www.samsontech.com)  
 SE Electronics  
[www.seelectronics.com](http://www.seelectronics.com)  
 Schoeps Mikrofone  
[www.schoeps.de](http://www.schoeps.de)  
 Sennheiser & Neumann  
[www.sennheiser.com](http://www.sennheiser.com)  
 Shure  
[www.shure.com](http://www.shure.com)  
 Sontronic  
[www.sontronic.com](http://www.sontronic.com)  
 Studio Projects  
[www.studioprojects.com](http://www.studioprojects.com)



# MIXING MAGIC

**So you've recorded all your tracks — now it's time to think about mixing them...**

In the early days of recording, there was no such thing as mixing: a single microphone would be used to record a complete live performance in one go. As technology developed, it became possible to combine several mics within a single recording, and eventually to record individual instruments to their own tracks on tape. This led to a new phase in the process of making records, where the engineer and producer would play back the tape, using faders to adjust the levels of each instrument and applying effects such as reverb to make the whole thing gel. This process is now a central part of producing music, and skilled mixing is vital to getting the best from your source recordings.

Before you think about adjusting the

levels of your tracks, however, it is normally advantageous to get rid of (or mute) anything that's not needed. This includes alternate takes and passages of supposed silence that may contain background noise, amplifier hum and so on. Long tracks that have audio only at certain locations (such as backing vocals on the chorus), should be split into separate regions so that each region's start and end can be trimmed to eliminate noise. I find that it is also sometimes helpful to fade the ends of regions rather than have any noise stop abruptly. This kind of housekeeping can make a significant improvement to the end result.

Unless you have a lot of experience in mixing, it is very helpful to have some

commercial reference material on hand. Ideally, you should use music of a similar style to what you're working on. This will guide you on how to get a similar balance between instruments and also help in the selection of effects, EQ and other processing. There are few hard and fast rules, but most engineers ensure that low-frequency sounds are panned to the centre of the mix, specifically the kick drum and the bass instrument. As well as sounding well balanced from an artistic perspective, this also has the practical benefit of sharing the high-energy bass sounds between the two speakers. If you pan the bass sounds to one side, then one speaker has to do all the work, which halves the amount of bass power available. Lead vocals are also



routinely positioned in the centre, as you'd expect them to be the centre of attention, and in a live situation, the singer would normally be centre stage.

### Cleaning Up The Lows

Before setting an initial balance, it is often helpful to use low-cut filters to remove unwanted low-frequency content from non-bass parts, as this can significantly clean up the low end of the mix. Simply adjust the frequency control until you hear the low end of the track in question being affected, then back it off slightly so the tonality remains essentially the same. Vocals often include low-frequency breath noises, so adjusting the filter as high as possible

### Evaluate Each Part

Mixes are made difficult by an inappropriate choice of sounds or excessively busy musical arrangements. Question the reasoning behind every part you include, and don't be afraid to take parts out if they are not contributing anything useful. With MIDI parts, experiment with different sounds.

## Spectrum Analysers

If your DAW has a spectrum-analyser plug-in, this can show you what low-frequency energy exists on a track and may help you choose the best filter settings.



This vocal channel EQ shows a low-cut filter working on frequencies below 79Hz, with a spectrum-analyser overlay showing the track's frequency content.

without significantly affecting the vocal tone is usually the best option. With other instruments (pad synths or acoustic guitars, for example) you might want to take out even more low end to help these sounds sit

but this preliminary work will make your track easier to mix and the end result will sound much cleaner. You may end up with some elements sounding quite thin when heard in isolation, but it is how they sound

**"It is usually safest to build your mix starting with the bass and drums, then add in the other parts once you have a solid foundation."**

better in the mix, as the lower mid-range between 150 and 300 Hz can easily get congested, making your mix sound 'muddy'.

The track 'solo' button is very useful for setting up the low-cut filters on the individual tracks. Expect to have to make further adjustments when everything is playing as things have a habit of sounding different in context. Remember that the only tracks that should normally contribute to the bass end (roughly sub-120Hz) are the bass instruments and kick drum. I know you want to get on with the mix,

in the context of the overall mix that matters.

### Building The Mix

I know professional engineers who push up all the faders and then create a mix balance from that point, but that requires a lot of skill. Until you have that level of experience, it is usually safest to build the mix starting with the bass and drums, then add in the other parts once you have a solid foundation. When you have that elusive five minutes, read your DAW

A channel strip showing a pre-fader auxiliary send (going to Bus 1). On that bus, you could insert an effect such as reverb, with the amount of reverb applied being governed by the Bus 1 send level.

» manual to find out how to subgroup tracks via the mixer buses, as this can really help simplify a mix. For example, if your drum kit was recorded using eight microphones, you can route the drum mix via a stereo subgroup so that the overall kit level can be controlled from a single fader, rather than having to adjust all eight individually.

You would first, balance the individual elements of the drum kit using the channel faders, then use the bus fader to balance the entire kit with the rest of the mix. You can also use subgrouping for other groups of tracks that can be usefully controlled as a single item, such as multiple backing vocals or layered keyboard pads.

## Headroom

Just because you can push the track level close to the top of the meter without the signal clipping doesn't mean that you should. In fact, you'll find mixing easier if each track peaks at little more than half way up the meter so you have some spare headroom. The reason for this is that when the tracks are all mixed together, you don't want the combined level at the output to be pushing the meters up into the red. Percussive sounds, such as

## Balance The Band

When working with a band, the chances are that each band member will ask to be made louder. Acquiesce to their requests and you'll quickly run out of headroom. If there's a legitimate reason to make a balance readjustment to a mix that's already close to being OK, try to do it by reducing the level of things that are too loud rather than by turning things up. You can always turn the whole mix up at a later stage.



kick and snare drums, can peak at quite high levels without necessarily sounding particularly loud, so if you start with them set too high you won't have enough headroom left to balance the other elements of the mix. There are plenty of ways to make the final mix sound adequately loud, regardless of how much headroom you leave. At

spring back to their programmed levels as soon as you play the mix.

## Psychoacoustics

Music doesn't always have to be played loud to sound loud. For example, take a heavy metal track, play it back at a very low level and listen to the guitars. They'll

**“Unless you have a lot of experience in mixing, it's very helpful to have some commercial reference material on hand — ideally, music of a similar style to what you're working on.”**

this stage, don't worry about the finished mix sounding as loud as commercial records.

If you find you're running out of headroom, many DAWs allow you to select all the faders and then pull them all down by the same number of dB to regain some headroom without changing the overall balance. Do this before automating any levels as any automated tracks will simply

still sound loud and aggressive because of their dynamics and harmonic texture, not because of their actual level. Adding small amounts of distortion and compression can help make a sound appear louder, even though its peak level remains constant.

Processing also affects the apparent front-to-back perspective of a mix. Bright sounds with little or no reverb sound close

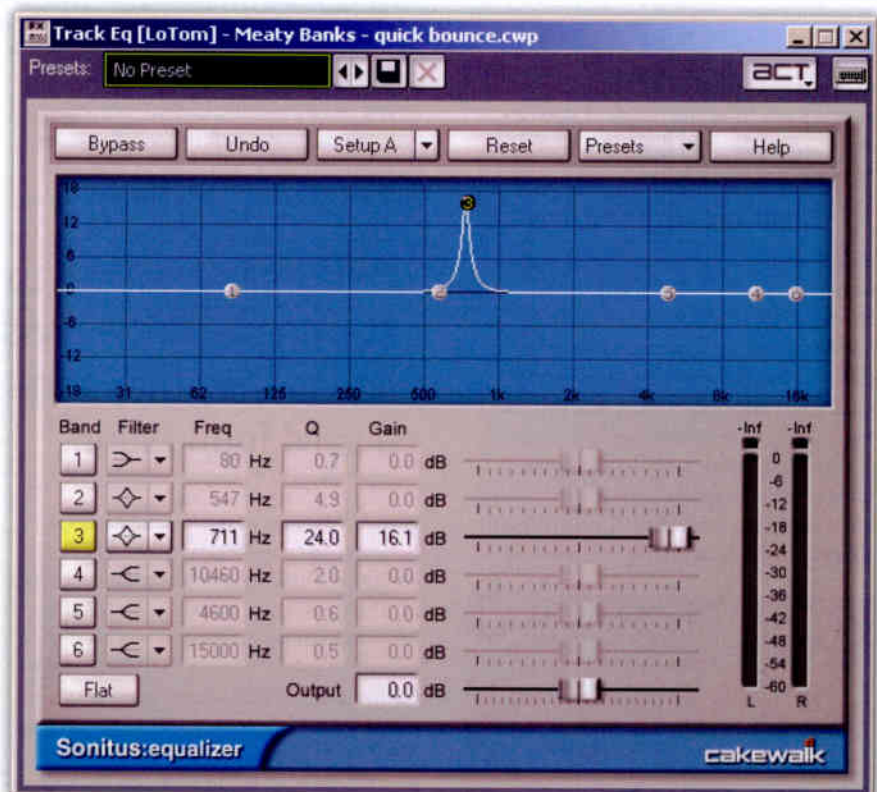

Problem frequencies in a track can easily be identified by using a narrow-band peaking filter. Set the band to boost, and sweep through the spectrum until the offending frequency is at its loudest, and then simply turn that band's gain down.



EQ bracketing can really enhance your recordings. By stripping away unnecessary high and low frequencies, you focus the sound on the mid-range.

to you while adding more reverb and taking out some high end pushes a sound towards the back of the mix. This is a very powerful technique and one that many newcomers to mixing overlook. The temptation is to make every track sound bright and wonderful in isolation, but then when you try to create a mix, you'll find them all fighting it out for a place at the front. Some things are meant to be up front and others are meant to be further into the background, so keep this in mind when mixing. Final EQ settings are usually done with the whole mix playing for this very reason — there's only so much you can do by tweaking sounds in isolation.

## Panning

Bass sounds and vocals should normally be panned centrally, so what should you pan

left and right and by how much? In reality you don't have to pan things far before they appear to be coming almost entirely from one side, so you rarely need to crank the pan controls hard left and right to create a wide illusion of stereo. Also, consider that some plug-in instruments already produce a stereo output so you'll still end up with a sound that has an impression of width, even if you leave them panned centrally. You can use the 'balance' control (the stereo track equivalent of pan) to move the stereo instruments either side of the centre.

Before going further, listen to some of those commercial reference tracks through headphones, as headphones exaggerate panning, making it easier to hear what the engineer has done. The toms and cymbals in a drum kit are often panned to sound the way an audience would hear

## Get Some Perspective

A good tip for judging the mix balance is to stand in the next room with the door open and listen to your mix from there. Many engineers do this as they've discovered that level problems that are not obvious when they're sitting right in front of the speakers stand out like a sore thumb when heard from the next room.

There's a good reason why this tip is so effective: our ears get tired quite quickly. Once you have what you think is the perfect mix, take a break and come back to it a few hours, or even a day, later. Chances

are that you'll hear something you missed first time. Also, don't worry if your track doesn't sound quite as loud and 'in your face' as the commercial reference tracks: those have been 'mastered', where further processing has been applied to make them sound loud and punchy. While professional mastering is always the preferred option for commercial releases, mastering at home is fine for small-scale local releases or putting songs online. See the chapter on Mastering for tips on effective mastering in a home or project studio.

## EQ Cut & Boost

The human hearing system is very sensitive to EQ boost, especially when applied over a narrow frequency range (high Q). If you were to apply EQ cut in the same range, the effect would be much less noticeable. There are several things we can learn from this in order to keep things sounding natural:

- Always try EQ cut before boost.
- Where EQ boost is necessary, try to boost over a wider frequency range (lower Q) and don't boost by more than you have to.
- Be aware that excessive boosting in the 2 to 5 kHz range can make things sound unpleasantly harsh and aggressive.

them, though don't pan them too far from centre or the drum kit will sound as though it is 20 metres wide! You may find that multiple backing vocals are spread both left and right to create a wider sound stage, sometimes with just a little less high- and low-end to help them sit behind the main vocal. Multiple keyboard pad parts are also often panned left and right. Where the mix represents an image of a band on stage, think about where the performers would stand: if there are two electric guitars, these would be balanced either side of centre. Sounds that are added for effect may be panned further out.

There are no solid rules here, but it's a good idea to try to keep a nominally even left/right balance throughout most of the song. You can check this by looking at the output level meters. Also, and this is very important, ensure that the mix still sounds good in mono by hitting the mono button on your monitor controller. While mono listening is less important than it once it was, there are still mono portable radios and TVs. Sometimes you can combine two bass sounds and they'll sound awesome in stereo, but in mono some phase cancellation may take place robbing the sound of its power.

## Equalisation

If every element was recorded perfectly at source, you may need no equalisation other than the low-cut filters mentioned earlier to trim away unwanted low end from non-bass tracks. In real life, however, even a well-recorded track may not have quite the right tonality to sit properly in the mix, so more equalisation is often required. EQ is essentially a fancy name for tone control but, unlike the bass and treble controls on

# SUBJECTIVE AUDIO QUALITIES

'Bite', 'Slap' and 'Sizzle': what does it all mean?

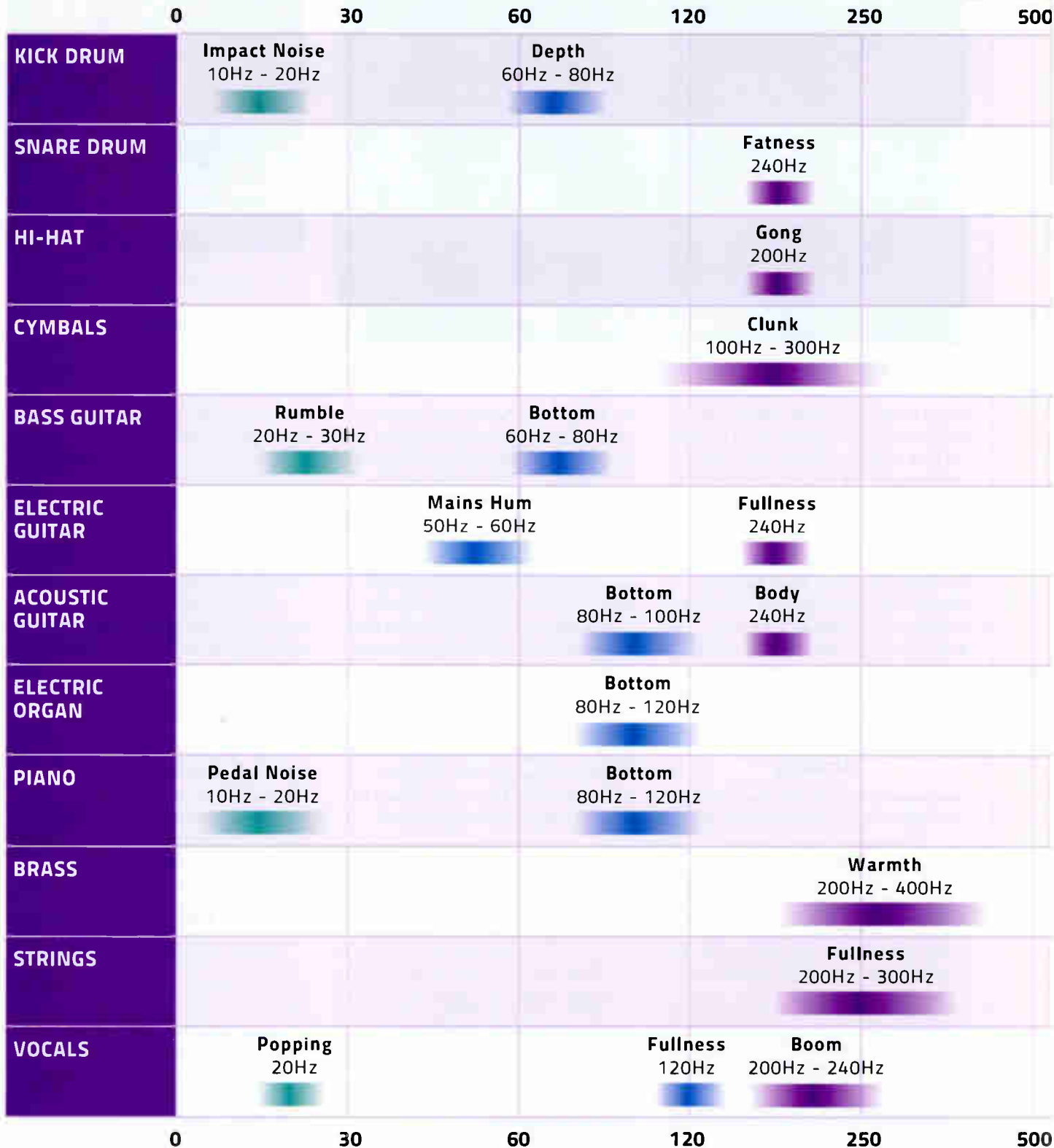





1k

2k

4k

8k

16k

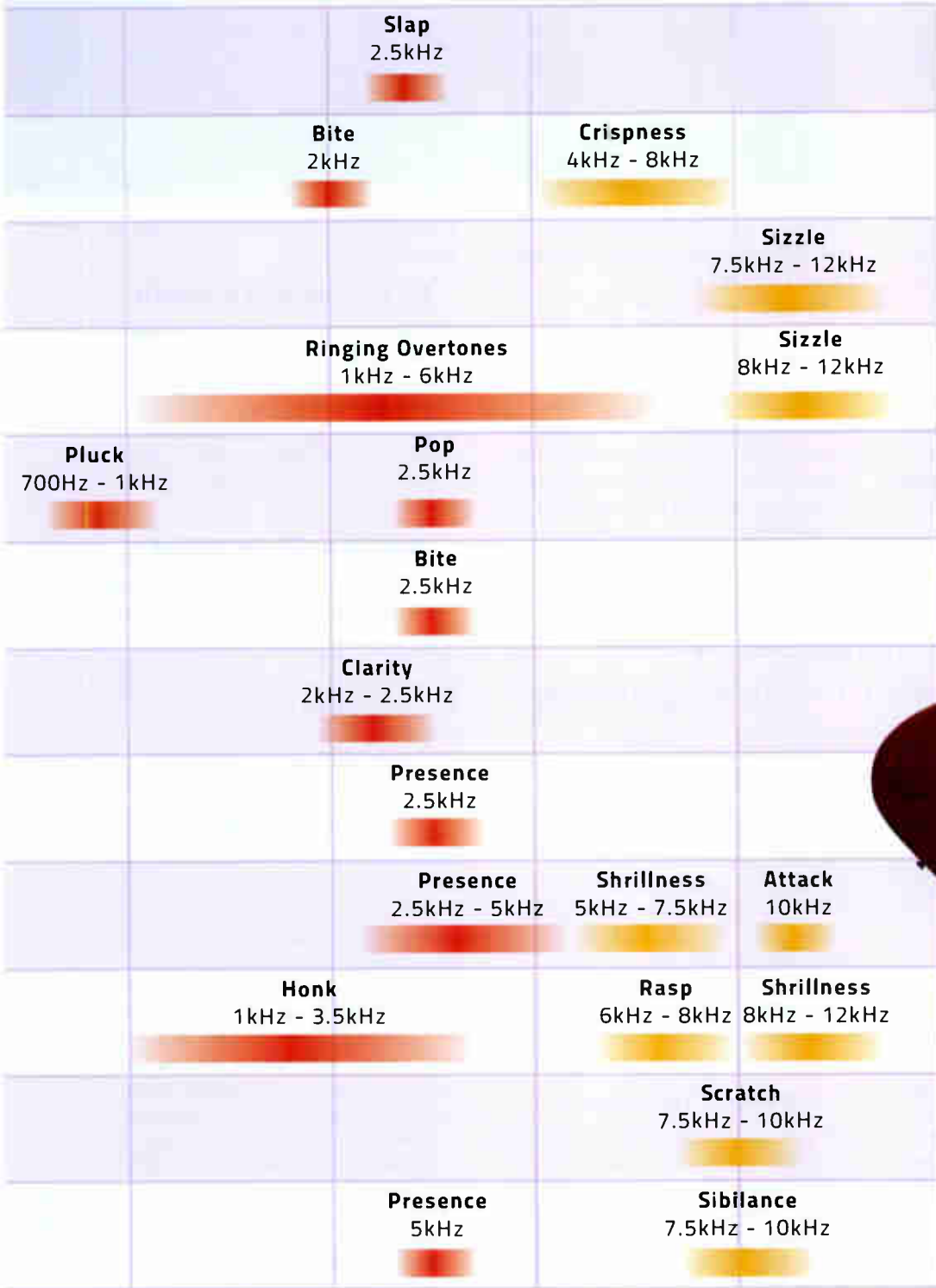

1k

2k

4k

8k

16k

The English language is a wonderful tool in that it usually offers many alternative ways of describing similar things. Alas, that can also make it rather imprecise and confusing, particularly when it comes to describing sound! We might describe a sound as deep, warm, bright, shrill, crisp, forward, or shimmering. They're useful terms because we all know roughly what they mean, but they're not a lot of use when you're trying to narrow down which frequencies to cut or boost.

This grid shows some useful frequencies for sounds produced by different instruments that you might wish to record in your home or project studio. It's by no means exhaustive, but is a useful reference guide as a starting point.





Level automation is key to tweaking vocal tracks. Used correctly, vocal automation can reduce noisy breaths, lessen the gap between extremes of low and high levels, and make the sound more homogenous.

- » the family hi-fi, a typical mixing console or DAW equaliser will have additional controls for adjusting the mid-range. Check out the chapter on Equalisation later in this section for more details on the various EQ types.

The simplest way to pinpoint a frequency that needs cutting or boosting is to use a sweep or parametric equaliser set to maximum boost, then sweep the frequency from low to high and back again until the equaliser picks out the frequency that you feel needs enhancing or suppressing. Once you've found it you can adjust the equaliser to give the desired amount of cut or boost.

## EQ Bracketing

Before getting into such forensic EQ tweaking, consider the technique of EQ 'bracketing' using high- and low-cut filters. We've already covered the benefits of trimming away unnecessary low-frequency components, but some sounds also benefit from trimming away excessive highs as well. Pad keyboard and even electric guitar can sound stronger and warmer with excessive high end removed and, as they'll clash less with other sound in the mix, you may even be able to mix them a bit louder. By using bracketing, the frequency range of many of the contributing parts can be reduced, and this in turn minimises the amount of overlap between elements of the mix,

which helps retain clarity. Make sure you listen to those reference tracks to see how the pros approach this.

It is worth stressing that many amateur recordings have been compromised by being mixed with an overly aggressive high end, often combined with too much boost at the low end. The important part of the audio spectrum, as far as our ears are concerned, is the mid-range. This is why we still hear all the essentials when a song is played on a small radio or telephone, both of which

**"Many amateur recordings have been compromised by being mixed with an overly-aggressive high end, combined with too much boost at the low end."**

have a very limited frequency response. The mid-range can be quite difficult to mix because so many instruments vie for that sonic space alongside the human voice. Restricting the sonic real estate that each sound occupies is one way of making a mix easier to handle. A good musical arrangement is also necessary to avoid sonic conflicts.

## Bass EQ Techniques

Bass guitars can be quite difficult to mix and the temptation is to turn up the bass EQ to make them sound more prominent. This eats up valuable headroom and often serves only to make the bass sound even less distinct. Instead, look to add a subtle boost in the 200 to 500 Hz region, as this is the part of the sound that conveys tonal character, and

it is also the part of the sound you'd hear on a small radio set.

## EQ Techniques For Vocals

If vocals need a lift, first remove unwanted low end. Few vocalists produce anything meaningful below 120Hz. If more projection is needed, use some high-shelving EQ boost above 7kHz so that you add a sense of air to the sound without making it harsh, as might be the case if you were to boost at around 3kHz.

## Kick Drum EQ Techniques

To add more low weight to a kick drum, add a little 90Hz boost. Stop everything getting too muddy by combining this with a little cut in the 150 to 250 Hz region and you'll be surprised how focused the sound becomes. Becoming proficient with EQ takes experience, but your ears soon become attuned to how the different frequency ranges sound.

## On The Level

Before trying for a final balance, I like to use mix automation to even out any excessively low or high spots in the vocal track. Even good singers belt out some sections more than others or move slightly around the mic from time to time. Once you've done what you can using automation, you can then apply compression to make the sound more even and homogenous. Compression also 'stiffens' up the vocal sound making it more solid and assertive, which helps keep it at the front of the mix. Compression is a whole subject in its own right and is often misunderstood, which is why the chapter on Compression is dedicated entirely to that subject.

When fine-tuning your mix, remember that you need to hear a solid foundation. As a rule the vocals should be very clear



and up front. Many an otherwise good mix has been spoiled by not mixing the vocals loud enough.

### Automation

Automation is a useful way to keep your lead vocal at a nominally even level, but it is also an essential part of creating a dynamic mix. For example, you can use automation to bring solo instruments up in level, but you might also use it to drop the level of a keyboard pad or other 'underpinning' musical part during vocal phrases. Even a drop of just 2dB can help clarify a mix. Automation can be recorded either as live fader moves (particularly attractive if you have a physical control surface with motorised faders), or it can be drawn in as graphical level envelopes using the mouse. The latter approach is useful for simple lifts or drops in level, as you can use the audio waveform view as a guide while creating the automation envelope. If you need to 'ride' the fader to create more complex automation, recording the fader moves directly may be the best option. Either way, you can modify the resulting automation envelope later if it doesn't work out the first time.

Most DAWs also make it possible to automate pan positions and plug-in settings, but I'd strongly recommend you gain some experience automating fader levels before you move on to more sophisticated mixing techniques. As a rule, keep your rhythm section reasonably constant in level, otherwise your mix might sound somewhat artificial. And, most importantly, don't forget to switch the track automation back from 'write' to 'read' mode when you've finished, otherwise every time you move the fader you'll record new automation data. Remember that channel fader moves, whether manual or automated, change the



Emulating the mechanical plates used to apply reverb on older recordings, modern reverb plug-ins contain various 'plate' settings that apply different types of reverb and delay to your tracks. Shown here is LexPlate (above) and Space Designer (below).



level of any signal sent via the post-fade sends on that channel, but they don't affect the levels of any pre-fade sends.

### Effects & Processing

The most commonly used effect in mixing is reverb, popular because some form of artificial ambience is needed to compensate

for the relatively dry acoustic environment of typical studios. If you followed my advice on setting up a default song template you may have a reverb already set up 'fed' from an auxiliary send. This means that by using a single reverb plug-in you can add different amounts of that one reverb effect to any or all of your tracks. Delay or echo

»

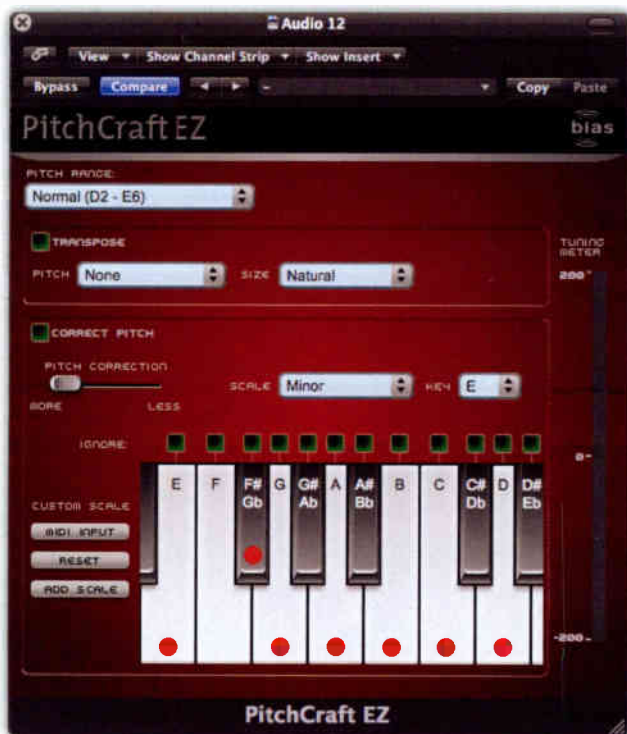

Pitch-correction software allows you to finely tweak your vocal tracks to ensure they are pitch perfect.

» can also be set up on an auxiliary send although, as a general rule, simple delays take up much less computer horsepower than reverb, so you can afford to use them as channel-insert effects if you need to. The exceptions are the delay/echo plug-ins that purport to recreate the sound of particular vintage hardware, as these take more CPU overhead. Commonly used vocal effects may include a combination of delay and reverb.

Delays work well if set to a multiple of the track tempo; many plug-ins allow this to be set from the plug-in window. If they don't, get out your calculator and divide 60 by the bpm you're working at, then multiply that number by 1000 to get the delay in milliseconds. That number will equal one beat, and you can then halve or quarter the result to get faster delays that still stay in time with the track.

Sound On Sound are often asked whether it's OK to use different reverb types on different instruments. In real life, everything would exist in the same acoustic space. In practice, engineers may use three or four different reverbs in a mix. A good starting point is to set up one short and one medium-length reverb on two sends, then blend together to get the effect you need. A short, bright reverb will help make an instrument or voice sound closer to the



listener while a longer reverb usually makes a sound appear further away.

The amount of added reverb has to be judged in the context of the complete mix, and modern mixing tastes tend to err on the side of less rather than more. Many classic recordings were made using a mechanical plate reverb, so try a plate emulation with decay times between 0.8 and two seconds. So-called 'ambience' or 'early reflections' settings are also useful

to create a sense of space without making the reverb sound too obvious. When you have time to experiment, try some of the other reverb settings that recreate specific spaces and appreciate the differences between them.

### Pitch-correction Software

Real-time pitch correction is often done using either an Antares Auto-Tune plug-in or one of the many similar products that

work in much the same way. Essentially, you set up the musical notes used in the performance and then adjust the speed of pitch correction to keep things sounding natural. If you set the correction speed to fast, you end up with the familiar robotic vocoder-like sound heard on so many dance records!

For this type of software to work well, the original vocal needs to be a single voice, reasonably well sung and free of any significant spill. Not only will spill impede the pitch correction process, it will also be shifted in pitch as the vocals are corrected. For this reason, pitch-correction software seldom works in cases where, for example, a singer plays the acoustic guitar at the same time, as some acoustic guitar will always spill into the vocal mic.

For more forensic pitch correction, Celemony's Melodyne is still the one of the market leaders, and it too works best in the absence of spill and with a monophonic source. The user can correct or change the pitch of individual notes, correct pitch droop or even increase or decrease the amount of natural vibrato for individual notes and phrases. The newer and more sophisticated Melodyne DNA also allows the pitch correction of individual notes within polyphonic material, such as specific notes within a guitar or piano chord, but the quality of the result depends very much on the source material.

### Top Mix Tips

- Get the original material right and mixing will be a joy. If the original

material wasn't performed and recorded properly, it can be very frustrating.

- Clean up your tracks first so there are no unwanted noises to surprise you, and filter out any unnecessary low end. It helps to keep reference material on hand so you know what kind of overall effect you're aiming for.
- Leave lots of headroom as it is easy to end up with the output meters hitting the red, and that leads to clipping distortion. Try to balance by turning things down rather than up. Use processing to suggest loudness and power. Don't just rely on volume as your music has to sound good played

back at any level.

- Use automation to make changes during the playback of the mix, but stick to automating just the track volumes until you've gained a little experience. Revisit your mix after resting your ears for a while as your ears can tire quite quickly. If you can monitor at a sensible level, rather than wanting the playback loud all the time, your ears will function all the better for it.
- Be sparing with your use of effects — especially reverb — unless you have an artistically valid reason. Having said that, if you get a great result by breaking all the rules, then break them! **■■■**

**"I lean on Sonnox Plug-Ins"**

**David Isaac**  
Eric Clapton, Marcus Miller,  
Luther Vandross

**Sonnox Oxford Plugins**

[www.sonnoxplugins.com](http://www.sonnoxplugins.com)

### Selected Manufacturers

- Alesis  
[www.alesis.com](http://www.alesis.com)
- Akai  
[www.akai.com](http://www.akai.com)
- Avid  
[www.avid.com](http://www.avid.com)
- Behringer  
[www.behringer.com](http://www.behringer.com)
- Frontier Design  
[www.frontierdesign.com](http://www.frontierdesign.com)
- Korg  
[www.korg.com](http://www.korg.com)
- M-Audio  
[www.m-audio.com](http://www.m-audio.com)
- Mackie  
[www.mackie.com](http://www.mackie.com)
- Steinberg  
[www.steinberg.net](http://www.steinberg.net)

# ALL ABOUT COMPRESSION

**Compression is one of the most useful weapons in the engineer's armoury, but it is often misunderstood. Find out how a compressor works, what all those controls do, and when to use one!**

A compressor is a device that provides automatic gain control, responding to the level of a signal being fed into it. Usually, compressors are used to reduce the 'gap' between the loudest and quietest parts of an audio signal. In real life, our ears can detect sounds as soft as a pin dropping, yet they can also cope with very loud sounds such as taxiing aircraft. The world of recording, however, works with a somewhat more restricted dynamic range, so some sounds have to be electronically 'massaged' to fit. This is particularly important when considering commercial audio, as many 'consumer' audio products (such as the speakers fitted in headphones, car stereos, laptops and mobile phones) are unable to reproduce large dynamic ranges.

Compression is also used for artistic reasons, to control the dynamic range of a piece of audio such as a lead vocal. The majority of singers usually vary their vocal level during a performance, meaning that their vocals might sound too loud in some parts of the song and too quiet in others. We can restore balance manually by adjusting the fader on the vocal channel, or automatically by using a compressor. Because compressors can react almost instantly to changes in volume, the subjective sound of compression is often different from using a fader to control dynamics, and can make the sound seem more present and solid. As a result, compression is often used for its subjective effect on the signal,

rather than simply as a means of level control. Compression can also be used to your advantage on instruments such as acoustic guitar, drums, bass and electric guitar, where it can add punch and sustain to the sound.

## Thresholds, Ratios & Knees

Standard 'hard-knee' compressors use a user-defined level 'threshold' to operate. If the input signal is below the threshold, no compression takes place. As soon as it exceeds it, even by a small margin, compression is applied according to a setting called 'ratio'. The higher the ratio, the more the signal is compressed: a ratio setting of 3:1, for instance, means that an incoming peak 3dB over the threshold will be turned down until it is only 1dB above. A special kind of fast-acting compressor with very high ratio is known as a limiter, and can be useful when it's important that an input signal never exceeds a certain level.

There is a second type of compressor known as 'soft knee', where the gain reduction increases

more progressively as the signal level approaches the threshold. This type of compressor is less obtrusive in use, making it more suitable for compressing complete mixes or for treating instrumental or vocal sounds that need to retain a natural quality. Some models of soft-knee compressor don't have a ratio control at all: they're designed so that the higher the input signal, the higher the ratio. Low-level signals are compressed at very low ratios, while high-level signals are compressed with progressively higher ratios. Again, the result can be very musical and subtle, but may not be ideal for very assertive gain control. Plug-in compressors often generate a graph showing how the

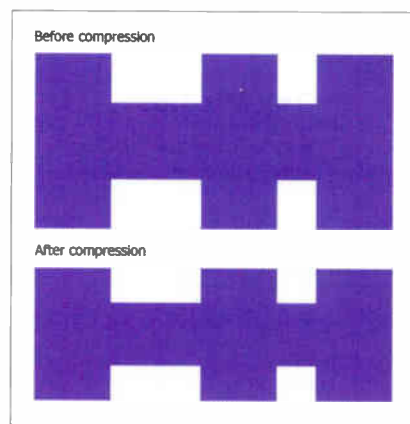

Here you can see the effect of compression used to reduce the gap between the loudest and quietest parts of an audio track. Compare the distances between the high peaks and low peaks in both illustrations.



threshold, knee and ratio settings interact at different input levels.

### Time Constants (Attack & Release)

A compressor's attack control determines how quickly the circuitry reduces the gain once a signal has exceeded the threshold. The faster the attack, the faster the signal level is brought under control, whereas a slower attack time might allow the input signal to overshoot before being brought under control. Allowing the signal to overshoot slightly can emphasise the attack of instruments, such as guitars or drums, thus adding definition.

The release control sets the time the gain takes to return to normal once the input signal has fallen back below the threshold. Short release times can result in audible volume changes, sometimes called 'pumping' — you can hear this effect on many rock songs, where the drum kit cymbal levels change quite drastically whenever another drum is hit. Very short attack and release times can also lead to audible distortion on signals with long wavelengths, such as bass guitar, because the compressor tries to respond to individual waveform cycles rather than the true dynamics of the signal. By contrast, if the release time is too long, the next note along may also be reduced in gain, even if it doesn't exceed the threshold level.

Some programme material has such complex dynamics that a single, fixed release time won't work throughout the track. To address this problem, some compressors have an automatic release mode, which follows the dynamics of the incoming signal and continually adjusts the release time to maintain the most effective control. Auto mode works well on constantly changing signals such as vocals, complex mixes and slap bass guitar. Some compressors have either preset or fully automatic time constants so the user has nothing to adjust.

### Make-up Gain

Because a compressor reduces the maximum level of the signal coming into it, a typical compressor has an output gain control, sometimes called make-up gain, which allows the peak signal level to be brought back up to its original value. Once this is done, you can think of the compressor as having kept the peak levels the same, and having brought up the level of all sounds falling below the threshold.

Note that compressors thus worsen the signal-to-noise ratio of the signal being fed into them, because as you adjust the output level control to bring the compressed signal peaks up to their original levels, the low-level sounds will be brought up by the same amount and, with them, any noise the audio may contain.

### What's A Side-chain?

The part of a compressor that monitors the changing level of the input is known as the 'side-chain' and it, in turn, feeds the part of the circuit that controls the gain. In essence, the side-chain follows the volume envelope of the input signal.

Some compressors let you set the side-chain to either 'peak' or 'RMS sensing'. RMS sensing is a form of averaging that closely relates to the way the human ear perceives loudness, so it's a good choice for getting things to sound subjectively level. However, peaks of very short durations may be averaged out so the compressor won't react to them, and this can be a problem when recording drums, as short hits can pass through with little or no compression. Switching to peak sensing

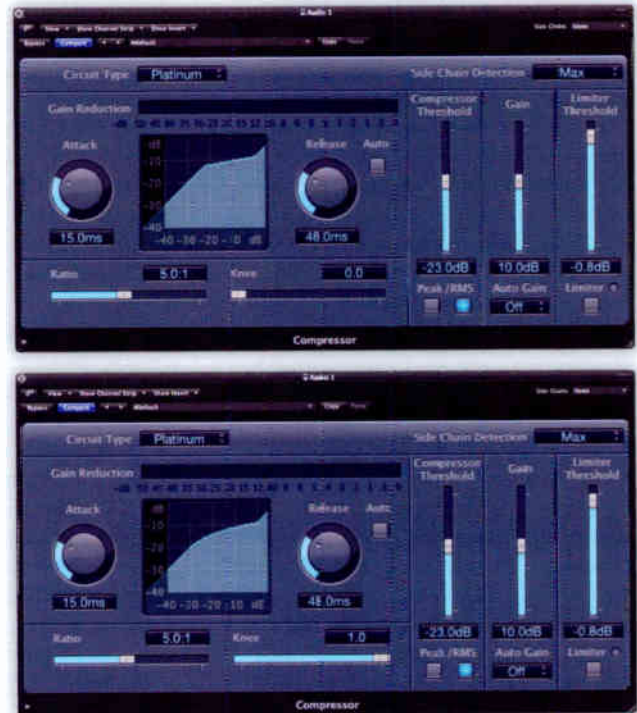

'Hard-knee' (top) and 'soft-knee' (bottom) settings on a plug-in compressor. Notice the difference in the compression curve for each type.

cures this, as the side-chain now looks at peak levels rather than average levels. As a general rule, non-percussive sounds, such as vocals, work well with the RMS setting, while percussive sounds may be treated more appropriately using the peak setting.

Some compressors provide an insert point that allows an additional processor, usually an equaliser, to be placed in the side-chain circuit. By equalising the feed to the side-chain, the compressor can be

## Different Types Of Compressor

Compressors are all designed to do the same basic job, but the technology used to implement compression varies. You'll come across a huge variety of compressors, both as hardware units and plug-ins modelled on their hardware counterparts. It's worthwhile trying out a few to get to know how each one works before deciding on which ones might be best for your individual needs.

If a compressor is a simple gain control, why do people make so much fuss about the sound of certain supposedly 'classic' models? One reason is that different types of gain-control circuitry introduce different kinds of distortion, and small amounts of distortion can be musically flattering. Tube and FET compressors in particular can colour the audio in a musically useful way. VCA (Voltage Controlled Amplifier)

compressors introduce very low levels of distortion and thus have a different sound.

Another reason for sonic differences is that the attack and release curve shapes tend to differ between models. This has an effect on the subjective sound as it modifies the envelopes of individual notes. Also, the ratio of the compressor may not be consistent for different input levels. So-called 'opto' compressors based on lamps and photocells are particularly quirky both in their time constants and their ratios, which lends them a unique quality.

Many of the early compressor designs just happened to sound great because their non-linearities helped flatter certain kinds of sound, so plug-in designers have gone to great lengths to recreate all these little technical imperfections.

» made to respond differently according to the frequency content of the incoming audio. For example, if you were to put a 5kHz boost EQ before the side-chain, then the compressor would respond more strongly to signals with a lot of content in the 5kHz frequency range. This is how simple de-essers work. The side-chain is fed with a signal that is boosted in the frequency band where sibilance occurs. When singers produce a whistly 'S' or 'T' sound, the compressor pulls the gain down to help hide it. Bear in mind that the use of side-chain EQ doesn't change the tone of the audio being fed into the compressor circuit: the EQ only affects what the side-chain responds to.

When you're using a two-channel compressor to compress a stereo signal, it's usual to 'link' the side-chains of the two channels, so that peaks on either the left or the right channels produce the same amount of gain reduction in both. This stops the stereo image from moving from side to side when compression is applied.

It is also possible to feed the side-chain of some compressors from an entirely different source, such as another DAW track. This allows the level of one signal to be pushed down or ducked by another. A common example is often heard on radio programmes: the background music level drops automatically when the DJ speaks. In mixing, you can use it to duck the levels of certain instruments in the presence of vocals, for example.

## Compression & Mixing

OK, so you've now had an introduction to what compressors do and how they do what they do, and you've explored some of the options available to you. But what

about applying what you've just learnt and actually starting to use one?

If you're new to compression, however, it's a good idea to get a feel for what compressors can do by plugging one in to a vocal track and experimenting. Pick a 'vocal' preset, or set up a plug-in with an attack time of around 5ms, a release time of 100ms and a ratio of 3:1. With the vocal track playing, adjust the threshold control while watching the gain reduction meter until you see a gain reduction of 5 or 6 dB on the loudest notes. Next — and this is very important in judging what the compressor is doing — adjust the output gain (or 'make-up' gain), so that the level sounds roughly the same, whether the plug-in is bypassed or not. This stops you falling into the trap of thinking that whatever is loudest must be best.

You should notice that the vocal level stays a little steadier, but you may also find that the voice seems more solid and confident. Try adding more or less compression by adjusting the threshold while watching that gain-reduction meter. The more gain reduction you apply, the more compression you have, and eventually the effect will become very obvious. In most cases you won't want to compress this hard, but some forms of rock music benefit from a bit of deliberate 'gain pumping'.

Now try the same test on a drum track, where the effects of over-compression should be more obvious. Remember that, even if you call up a preset, you still have to adjust the threshold to set the required amount of compression — the person who designed the preset has no idea how loud your instruments were recorded!

## Why Compress?

Many beginners feel the need to compress things because that's what engineers do, right? Well, not always. Compression is used both to even out levels and to make sounds more punchy and 'up front': bass guitar, drums, acoustic guitar and vocals, in particular. Electronic keyboards are less likely to need compression, although clean electric guitar can sometimes benefit. Compression is almost always used on

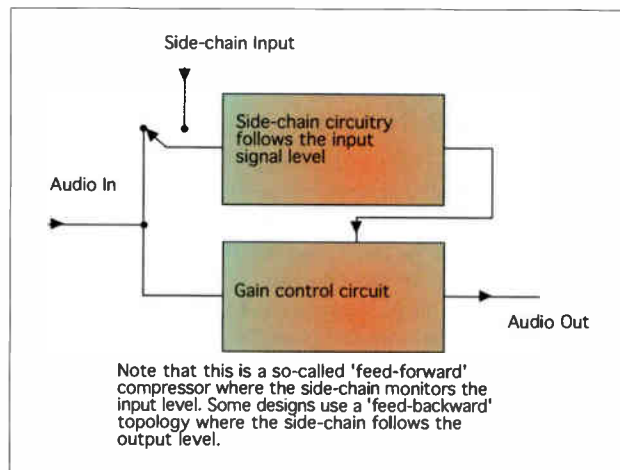

The 'side-chain' is the signal that is fed into the compressor so that it knows how loud the signal is, and how much gain reduction to apply. Normally this is the same as the input, however it is possible to use an external signal for the side-chain, so the compressor 'reads' one signal but applies its compression to another. Compressing a bass using a kick-drum-triggered compressor is a common technique.

pop lead vocals to help them sit solidly at the front of the mix, but bear in mind that a vocal track recorded by someone with good mic technique may need less compression than one recorded by someone whose levels and mic distances are all over the place. The effect we often describe as 'punchiness' happens because a compressor modifies the attack and decay shapes of sounds as well as controlling their overall level. The settings of the attack and release times have a significant effect: fast release times, in particular, tend to make things sound punchier, but extremes can lead to the gain modulation (pumping) becoming too obvious.

The gain-reduction meter is an important visual aid, as it tells you how much compression you're applying. If the meter isn't showing more than 3dB, the compression will be relatively mild and transparent-sounding, while more than 6dB of gain reduction starts to sound quite assertive, and once you get beyond 10dB, you're in heavy compression territory.

As I already mentioned, compression is no different in principle from changing the level with a fader, and there's nothing to stop you applying both compression and mix automation (recorded fader moves) on the same track. Some automation is often required even on a heavily compressed track, for instance to balance it against the rest of the instrumentation, which

## More Compression!

If you'd like to read more about compression, including a more detailed exploration of some basic techniques along with some handy hints you can use in your own audio tracks, check out the 'Compression Made Easy' article by Mike Senior on the SOS web site. You can find it at

[www.soundonsound.com/sos/sep09/articles/compressionmadeeasy.htm](http://www.soundonsound.com/sos/sep09/articles/compressionmadeeasy.htm)

If you've already checked out Mike's article and you're still hungry for more compression advice, take a peek at the section on Techniques on the portal for this Smart Guide at [www.sos-smartguides.com](http://www.sos-smartguides.com)



your compressor can't take account of. Compression plug-ins usually act before the fader on a channel; doing things the other way around will have very different results, as the compressor will be responding both to the signal level and to your automation moves. This can be useful in situations where the vocal recording level varies wildly: evening things up a bit manually before the signal hits the compressor will produce a more natural result.

## Compressing Instruments

There are many ways to apply compression on drum kits, depending on how they were recorded in the first place. Mild compression on the overhead mics can fill out the sound, while the kick and snare may respond better to higher ratios and moderate amounts of gain reduction, to even out the louder peaks without squashing the overall sound too much. If your compressor has the option of peak or RMS side-chain sensing, try 'peak' mode on drums and percussion. You can add weight to a kick drum by compressing it fairly heavily, adjusting the attack time to let the impact of the drum come through strongly. However, you may need to gate the drum sound first to prevent the compressor bringing up the 'ring' of the decaying sound too much.

Bass guitar can sound much stronger with compression, especially if you have a compressor known for its assertive

## Gates

Gates reduce or mute the level of signals that fall below a user threshold, so their controls are much like those of a compressor in reverse. If you set the threshold just above the level of any background noise, the signal level will be reduced or muted during pauses, effectively eliminating the noise. When the wanted signal rises above the threshold the gate opens, but the signal itself will tend to mask any noise unless the level of noise is excessive. Attack and release controls are commonly fitted to prevent the gating effect being too abrupt.

Because compressors can raise noise levels in the signal they're compressing, it may help to gate audio before compressing it, and some compressors have a noise gate built in for this purpose. If none of the compressors you own has this feature, you can simply insert a gate plug-in before the compressor.

These four images show the range of effects different types of compression can have on the attack and release of a snare drum hit. In the first example, the audio has been compressed with a short attack time and a short release time. Combining a fast attack and slow release has produced the second example, which is barely any different in character from the original audio. In the final example, a boost to the attack time boosts the initial level of the attack relative to the sustain. This produces a much more 'punchy' sound that then tails off quickly.

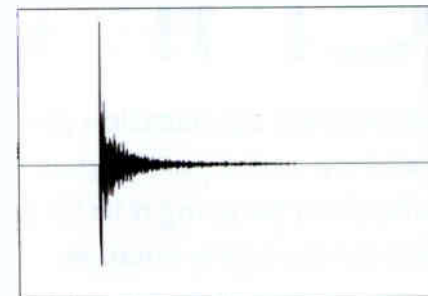
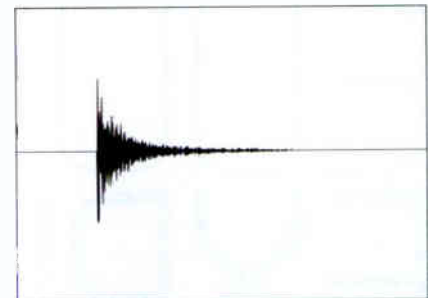
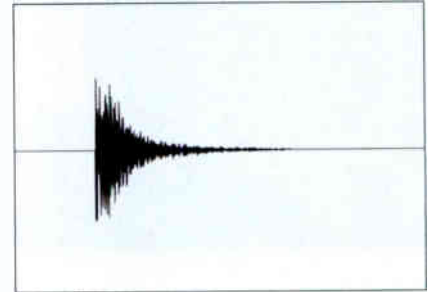
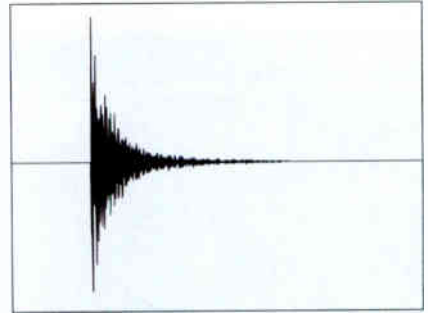

character. However, if there's too much low end in the sound, the compressor will simply push down the overall level, including the mid-range that gives the sound its definition. If you EQ first to reduce any excessive low end, then add compression, you'll stand a much better chance of ending up with a good tonal balance with the required amount of punch. Use heavier compression settings for rock and funk sounds where you want to make the bass sound a bit larger than life, but keep in mind that compression increases the audibility of low-level sounds that you might not want to hear, such as string squeaks and amplifier hiss.

Acoustic guitar sometimes benefits from mild to moderate compression, to add sustain and to tame the transients of picked or strummed notes. Don't overdo it, though, or you'll choke the life out of the sound. Experiment with the attack time to see how it affects the note attacks.

If you have more than one compressor plug-in available, try them all and get a feel for their sonic differences, as you'll usually find that some sound better on some sources than others. You'll find that some control the level very kindly, with few audible 'giveaways', while others sound more like an effect than a way of controlling gain. Don't worry about why they do, just make a mental note so you'll know which one to use next time. And even if you don't want to use presets, you can learn a lot from them by seeing what attack, release and ratio settings they use.

## To Sum Up...

- Compressors reduce the difference between the lowest and highest levels in a piece of audio. With the simplest compressors, signals above the threshold are treated to gain reduction, while those below it pass through without change.
- Compressors not only control the gain of a track but can also make the sound

appear more solid and present, hence the reason so many lead vocal parts are compressed.

- Different types of compressor produce a different sound character depending on their circuitry, which is why there are so many plug-ins modelling classic hardware compressors.
- If you choose to use a preset as your starting point, you'll still need to adjust the threshold control as this determines how much gain reduction will take place. Load a few presets and see what settings they use for different sound sources — it can be very educational. ■■■



# EQUALISATION EXPLAINED

**Whichever equalisation plug-in you use, it's sure to become a core part of your mixing process. However, you shouldn't be using it to fix dodgy source material — using EQ can be highly creative.**

Equalisation (EQ) came about as a means of counteracting or 'equalising' technical shortcomings in an audio system. Today, EQ is more often about being creative and comes in many forms, from the simple treble/bass control to the multi-band, parametric equaliser.

Virtually all analogue equaliser variants are available as DAW plug-ins. Some types of equaliser are also referred to as 'filters', as they essentially filter out a specific range of frequencies.

The limits of human hearing are quoted as being around 50Hz to 20kHz, although the high end diminishes as we get older (especially if we attend

a lot of loud gigs or mixing sessions!). For this reason, most equalisers work up to a little above 20kHz, but may go lower than 50Hz to allow removal of ultra-low frequencies that are beyond our range of hearing but which use up valuable headroom.

## What Does EQ Do?

Equaliser circuits are designed to lift or cut parts of the audio spectrum relative to other parts, so you could think of EQ as a means of frequency-selective volume control. One of the side-effects of EQ is that the circuitry also introduces phase differences between the high- and low-frequency harmonics of a signal, and

this also affects the sound. In the digital domain it is possible to design equalisers that have a so-called linear phase, which gives them a somewhat different sound from analogue 'minimum-phase' equalisers or their plug-in equivalents. If you have access to both types, try each in turn to see if you can hear the difference.

Different models of equaliser sound different, and not just because of the minimum-phase or linear-phase differences just described. It's because equalisers have differently shaped cut or boost curves that may depart from the ideal theoretical curves, and they may also add subtle distortions due to circuitry limitations or the use of audio transformers. Some modelled EQ plug-ins include all the technical imperfections of the original hardware to keep the sound as accurate as possible. I've also noticed that with most well-designed equalisers, a very small adjustment makes a large audible difference, whereas with less-sophisticated



## Twice As Nice



If you've made a deep narrow cut on a single-peaking filter and you're not totally happy with the result, try setting a second peaking filter to simultaneously cut the same frequency. This will effectively double the depth of the cut and can make all the difference when trying to significantly reduce particular frequencies.

It's worth bearing in mind, however, that EQ cut has just as much impact on headroom as EQ boost. This is yet another reason to be cautious, particularly if you've only got access to a budget equaliser, as you may find that two peaking filters produce many more unwanted artifacts than just one, which is, effectively, double the trouble!



Plug-in and native equalisers can look very different, but they perform the same basic functions. Here are three very different examples: Waves REQ 6, UAD Cambridge, and UAD Helios 69.

EQ plug-ins, you may need to add a lot of cut or boost to hear much of a difference.

### Instruments & EQ

It helps when using EQ to know something about the range of frequencies an instrument can produce. Included within this chapter you'll find a reference guide showing the pitch ranges of various common instruments.

At this point, it's worth delving into a little music theory. When producing a note, most musical instruments are actually producing several frequencies simultaneously. There's a fundamental frequency, which is what we humans perceive to be the pitch of the individual note, and then there are usually several harmonics (higher-frequency wavelengths) above this fundamental. The combination of the fundamental and its harmonics is

what produces the 'fullness' to the sound — something that modelled instruments need to imitate so that the instruments they are emulating sound realistic.

On the reference grid, you'll clearly see

below this. However, the high-frequency end is less easy to quantify as most musical sounds include harmonics that extend right to the top of the audio spectrum, even though the level of these harmonics is sometimes very low. That means you need to use your ears to judge how much high end to cut or boost.

The reference guide is very useful

**“Many beginners make the mistake of trying to brighten dull sounds by applying large amounts of treble boost, but all this does is simply enhance the background noise of the track.”**

the fundamentals and harmonics of each instrument indicated.

The low-frequency limit of an instrument tends to be the fundamental frequency of its lowest note and you can afford to filter out any unwanted low-frequency elements that appear

for understanding the frequency ranges of the instruments but, in terms of EQ, it's often not the pitch of notes that is of most interest, rather the tonal changes (or timbres) of the instrument. For example, a kick drum might range from 50Hz up to 8kHz, but within that



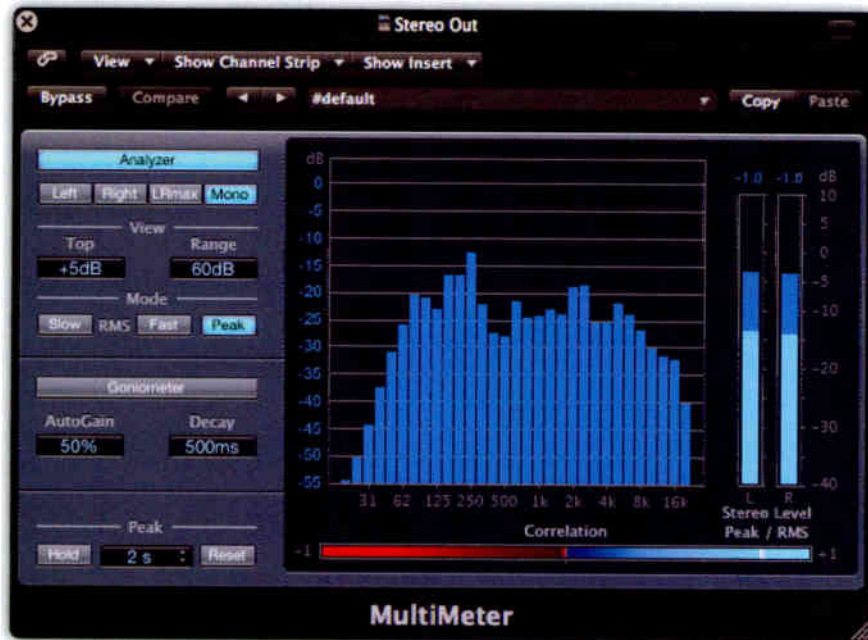

Experimenting by sweeping up and down with a bell EQ will soon tell you where the key elements of a sound reside. If you have access to a spectrum analyser plug-in, this will also help you appreciate the spectral makeup of a sound.

- » range are various types of sounds such as 'punch' and 'thump'. The only limit, really, is your own vocabulary! (These descriptive terms for tonal changes were discussed in the earlier chapter on mixing where you can find the full reference guide showing the frequencies of various instrument tones.)

The best practice here, really, is to

a feel for the effects of the boost in that region. With a little practice, you ought to start getting a feel for the unique characteristics of each sound.

### Applying EQ Boost

Our ears tolerate EQ cut rather better than they do boost. To avoid problems, it's best to go with the rule of aggressively

**"Human ears tolerate EQ cut rather better than they do boost. To avoid problems, it's best to go with the rule of aggressively cutting rogue frequencies and applying any necessary boosts in a broad, modest manner."**

experiment with cutting and boosting in lots of different regions in order to identify the tonal changes yourself. The easiest way of identifying the frequencies corresponding to a particular timbre is to crank up the boost control of a peaking filter, with its Q value set to about three or four, and 'sweep' it through the spectrum, listening as each element of the range is boosted. It can also be useful to stop the peak over a particular area and then switch the EQ in and out to get

cutting rogue frequencies and applying any necessary boosts in a broad, modest manner. Good-quality EQ plug-ins sometimes boost frequencies in a smoother, more natural-sounding way than the simple EQ that comes as standard with your DAW.

However, if you really do need to boost, it's often best to do as little as possible to avoid the resulting changes making the audio sound artificial.

It's also a risk that any EQ settings you

## Fundamentally Missing

Missing fundamentals (or 'phantom' fundamentals) occur when harmonics are generated with no fundamental below. If all the harmonics can be heard, we perceive the fundamental to be there whether it is or not. This is pure psychology: the brain cannot make sense of what it is hearing, so it fills in the gap and calculates the fundamental frequency it should be hearing. The net result is that we believe we are hearing lower frequencies than are actually being replayed by our sound systems.

Psychoacoustic enhancers are often employed to generate these missing fundamentals to give the illusion of bass on small speakers or headphones (such as those on your iPod or laptop). Waves MaxBass is a good example: it allows you to create new harmonics before filtering out the low bass so that the bass sounds in your audio recordings will work on portable devices and consumer speakers.

apply may degrade the audio (especially if you're not using the nicest-sounding equaliser), so make sure the cure is better than the disease! I've said this already, but it's worth repeating, especially if you only have access to budget equalisers: it's better to get the sound right at source and then do less processing than it is to rely on your equaliser to fix the problems for you.

Generally speaking, boosting with EQ should be kept to a few dB if you're after natural-sounding results. Narrow-band cutting can be made much deeper to get the desired result.

### Enhancing Your Audio

Many beginners initially make the mistake of trying to brighten dull sounds by applying large amounts of treble boost. (Now that this has been pointed out to you, hopefully you won't follow in their footsteps!) What this achieves is far from their desired result. In fact, it tends to simply enhance the background noise of the track, which is then blamed on the equaliser itself. It's important to remember that an equaliser can only boost high frequencies where they exist in the first place. A synthetic sound with no top end will not respond well to high-frequency boosting because the high frequency contains mainly noise and interference.

Should you wish to brighten audio that doesn't have enough natural top end

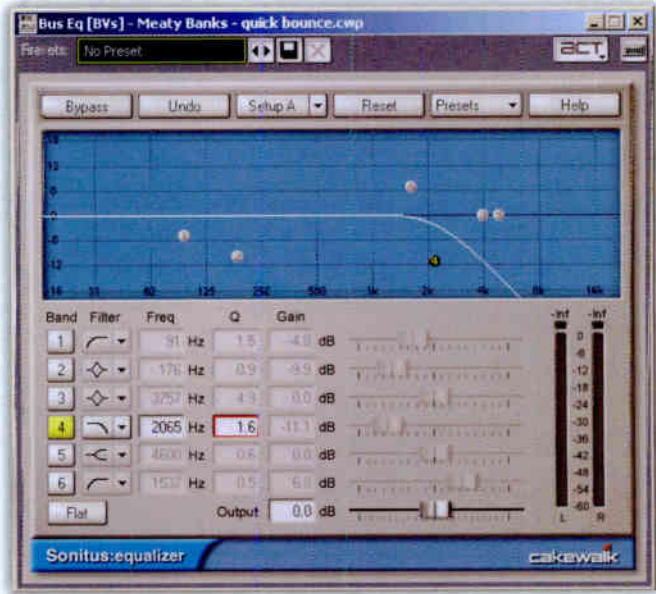

Examples of a low-cut (left) and a high-cut (right) filter from Sonar.

to respond to EQ, it is often preferable to use a psychoacoustic enhancer since it processes the frequencies present in the original signal (through compression, filtering and controlled distortion) to produce extra high-frequency harmonics designed to augment the existing signal. Since these added harmonics are related to the existing audio, the human brain perceives them as 'real', and the result is a much more natural sound.

### Perception Of Distance

EQ can be used in a psychoacoustic manner to manipulate the perception of distance in a mix. Obviously, when close-miking a sound source, the resulting mix will make everything in the sound source seem 'close' to the listener. Placing the mic further away from a sound source, however, will start to affect the listener's perception of distance from various frequencies. Air damps high-frequency sounds more than low-frequency sounds. The net result is that higher frequencies are perceived to sound further away than their low-frequency counterparts, even if they've been produced by the same sound source. You can use this knowledge to bring forward or push back selected parts of your mix. For example, if you want to bring a lead vocal to the front of a mix otherwise dominated by backing vocals, cut the backing vocals a little above 10kHz, and then give the lead vocals more boost above this frequency. This trick

can also work for instrumental parts to emphasise or subdue particular instruments.

### EQ & Mixing

Although your audio should already be sounding pretty good (assuming you've set up a decent recording), EQ can further tweak the tone of each sound being produced (as discussed previously) and also make sure that everything that should be heard can be heard. In this second situation, most improvements can be made simply by cutting away unnecessary parts of the audio spectrum to allow important frequencies to come through.

This can be as simple as using a high-pass or low-pass filter on specific tracks to remove any unwanted noise or hum, or it may require subtle cutting and boosting on every channel. The ease with which this can be done will often depend on how well the track has been arranged.

It is not uncommon to find that you need to take a lot of bottom end out of acoustic guitars or synth-pad parts, for example, otherwise the low end of your mix can get muddy. Usually you can get away with taking quite a lot of low end away from such sounds before they start to sound thin in context, and this can allow important bass instruments and kick drums to come across much more clearly.

Similarly, if you have an instrument that doesn't need to be at the front of the mix, try rolling off a little high end so that it doesn't compete with the sounds that really need to stand out. You could use a shelving equaliser to do this, or a steep low-pass filter if you're after more

surgical removal. This can be particularly successful on rhythm guitar parts, as it focuses the guitar sound and leaves more space for other instruments.

As a general rule of thumb, electric guitars and synthesizers usually cope pretty well with being shaped to fit in with the mix, because they have no inherently 'natural' sound of their own. Even if EQ places heavy emphasis on a particular frequency range, it may not be a problem, as pronounced

### The Smile Curve

No discussion of EQ would be complete without mentioning the 'loudness' or 'smile' curve. Our hearing mechanisms perceive a different frequency balance depending on listening level. As a sound gets louder we hear more low end and more top end, but the mid-range becomes progressively more subdued. It is possible to fool the ears into thinking something is loud and powerful at lower listening levels by creating a deliberate mid-range dip and/or high and low boost using EQ. In fact, this is exactly what the loudness button on a domestic stereo system does.

Pulling down the mid-range slightly can make a mix appear to be less cluttered, because a lot of the information that's clamouring for our attention resides in the mid-range. You often hear a congested, boxy sound if there's too much going on in the 150 to 300 Hz region, while too much energy in the 2 to 4 kHz range can make a mix sound very aggressive. If you're having trouble sitting vocals in a mix, try applying a gentle smile curve to the mix but not to the vocals.

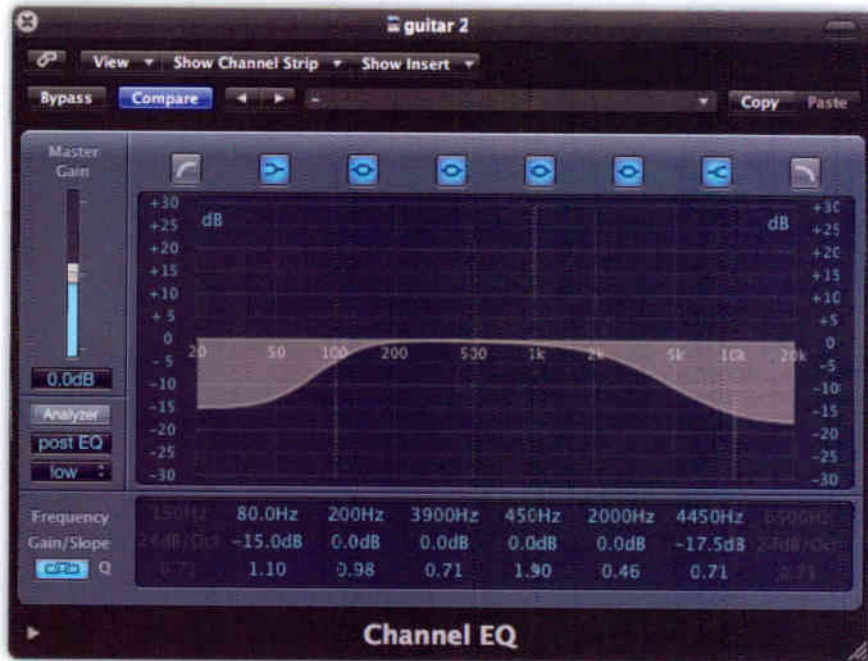

Logic's shelving filter.

» resonances are characteristic of both these families of sounds.

Finally, it's worth mentioning that stereo mixing can confuse matters a little in terms of equalisation during mixdown. This is because panning, like EQ, can create a certain amount of separation between sounds. However, there are still plenty of environments where playback systems work pretty much in mono, and in such cases your mix will lose the benefit of any panning separation and may sound confused. It is for this reason that it's a good idea to check the tonal balance of your track in mono as well as in stereo so that you don't get caught out.

### Cut Filters

The simplest equalisers are the high-cut and low-cut types. A low-cut filter attenuates by a set number of dB per octave below the cut-off frequency, while a high-cut filter attenuates by so many dB per octave above the cut-off frequency. In analogue equalisers, these may be 6, 12 or 16 dB per octave. This type of filter is ideal for removing material above or below the desired frequency range and for bracketing elements within a mix to restrict them to a limited part of the audio spectrum.

### Shelving Filters

A low-pass shelving filter, as its name suggests, passes all frequencies below

its cut-off frequency, but affects all frequencies above its cut-off frequency. Similarly, a high-pass shelving filter passes all frequencies above its cut-off frequency, but affects all frequencies below its cut-off frequency. Unlike the earlier high- and low-cut filters, however, the shelving filter levels out above or below the cut-off frequency so that the amount of attenuation can be controlled fairly precisely. This type of filter can also

### Fit For Purpose

A graphic EQ plug-in designed for a specific purpose, such as for bass guitar, can be arranged so that each filter is set to a crucial part of the spectrum relevant to that instrument. This is more useful than having them equally spaced.

boost as well as cut and is commonly used in hi-fi system's bass and treble controls. The graph looks somewhat like a shelf, hence the name.

### Band-pass Filters

A filter that passes frequencies between two extremes is known as a band-pass filter. A typical mixer's mid-range control is a good example. You may also see it referred to as a bell filter, as a graph of gain against frequency, when boost is applied, has a distinct bell-like shape. This type of equaliser has variable cut and boost, typically around +/- 15dB, and on the better designs it will also be tuneable so you can decide what frequency needs to be cut or boosted. A tuneable band-pass equaliser is known as a sweep equaliser.

### Parametric EQ

A parametric EQ is very similar to the sweep band-pass EQ just described, except that a third control is added

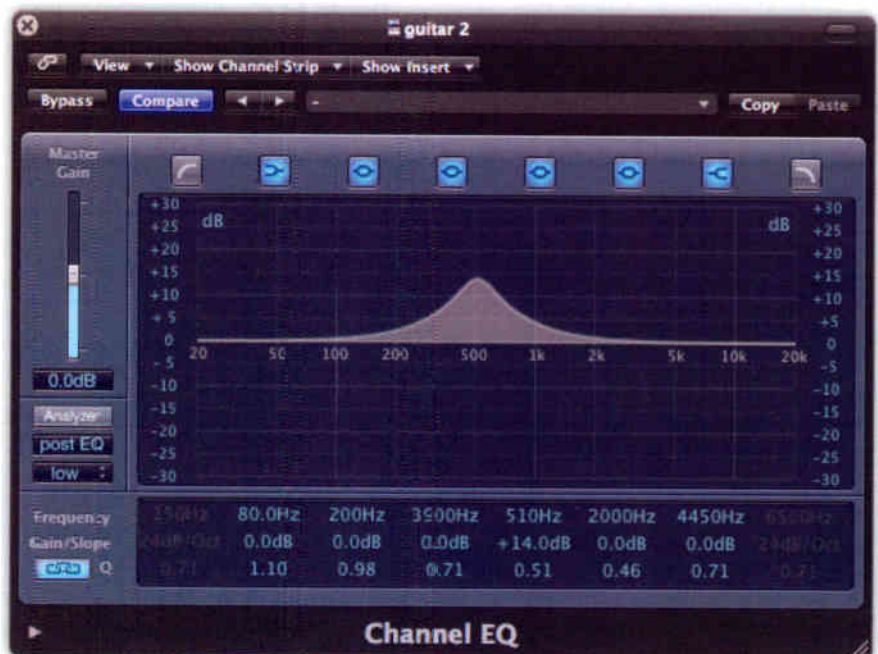

Logic's band-pass filter.

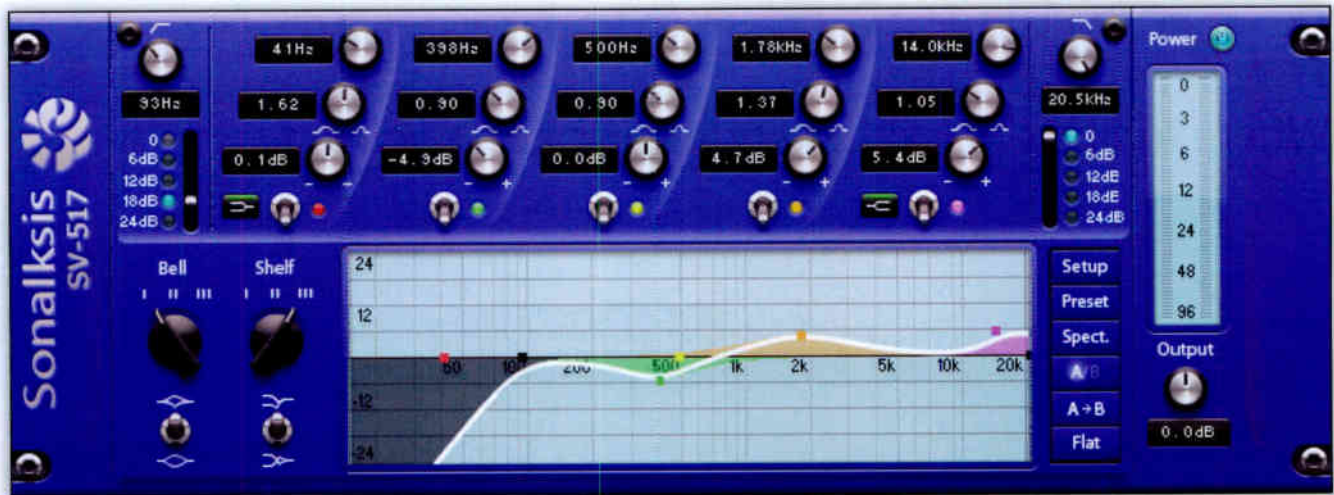

Sonalksis: an example of a parametric EQ. Notice how there are many more fine-tuning settings than on other types of equaliser plug-in.

to allow the width of the filter to be adjusted. If you were to look at the gain/frequency graph with boost applied, you'd see the width of the bell shape change as you adjusted the width control.

The width of a filter is sometimes described as its 'Q' value (Q is an abbreviation of quality). The Q value is the filter frequency divided by the number of Hz the filter affects. In other words, the higher the Q, the narrower the bell. Because the filter response follows a curved bell shape, the filter's bandwidth is measured between the two points on the graph where the signal level is 3dB lower than the peak of the bell.

High Q values are useful for picking out sounds that occupy a very narrow part of the audio spectrum, whereas lower Qs produce a smoother, more musical sound. A typical parametric EQ or DAW plug-in may have two or more filter sections so that several parts of the frequency spectrum can be treated simultaneously.

Parametric EQs can be time consuming to set up properly, but they are the most powerful and most flexible of all the common EQ types. A comprehensive DAW-plug-in

SPL Graphic EQ. Graphic EQs are not widely used in studios, but they're worth exploring along with all the other types so that you understand the full range of what's available and can be selective for your own needs.

equaliser may have several parametric sections flanked by additional high- and low-shelving filters and, often, a pair of high- and low-cut filters with adjustable frequency and slope. That way you get all the main EQ tools in one plug-in. It is commonplace to be able to bypass individual EQ sections when not needed.

### Graphic Equaliser

A graphic equaliser gets its name from the row of faders across its front panel where the shape made up by the faders corresponds to the frequency response of



the equaliser. Each fader (other than the highest and lowest) is, in effect, a fixed-bell equaliser controlling its own narrow section of the audio spectrum, providing boost when the fader is moved up from the centre and cut when moved down. All the filters overlap slightly to maintain a nominally flat frequency response when the faders are set to the same level. The outer faders usually control low- and high-shelving filters.

A typical 30-band graphic equaliser provides independent control over 30 frequency bands spaced one third of an octave apart. Models with fewer bands are easier to adjust, but the area covered by each band is wider, making them less useful for precision tasks. Graphic equalisers have the advantage of being easy to adjust, but they are less flexible than the parametric EQ, which can be tuned exactly to specific frequencies. Graphic equalisers are routinely used in live sound, but less so in the studio. However, plug-in graphic equalisers are available if you'd like to give them a try.

### Summary

- Bring equalisation into play after you've done your best to get the right sound at source.
- Not all equalisers sound the same: some have a noticeably more musical sound than others.
- Solve problems by cutting areas of the spectrum rather than boosting others, as the human ear is far less critical of EQ cut than it is of boost and the result will usually sound more natural.
- Refine EQ settings in the mix after you've EQ'd an instrument in isolation. Context is everything! ■■■

# INSTRUMENT FREQUENCIES

Where to find the fundamental and harmonic ranges

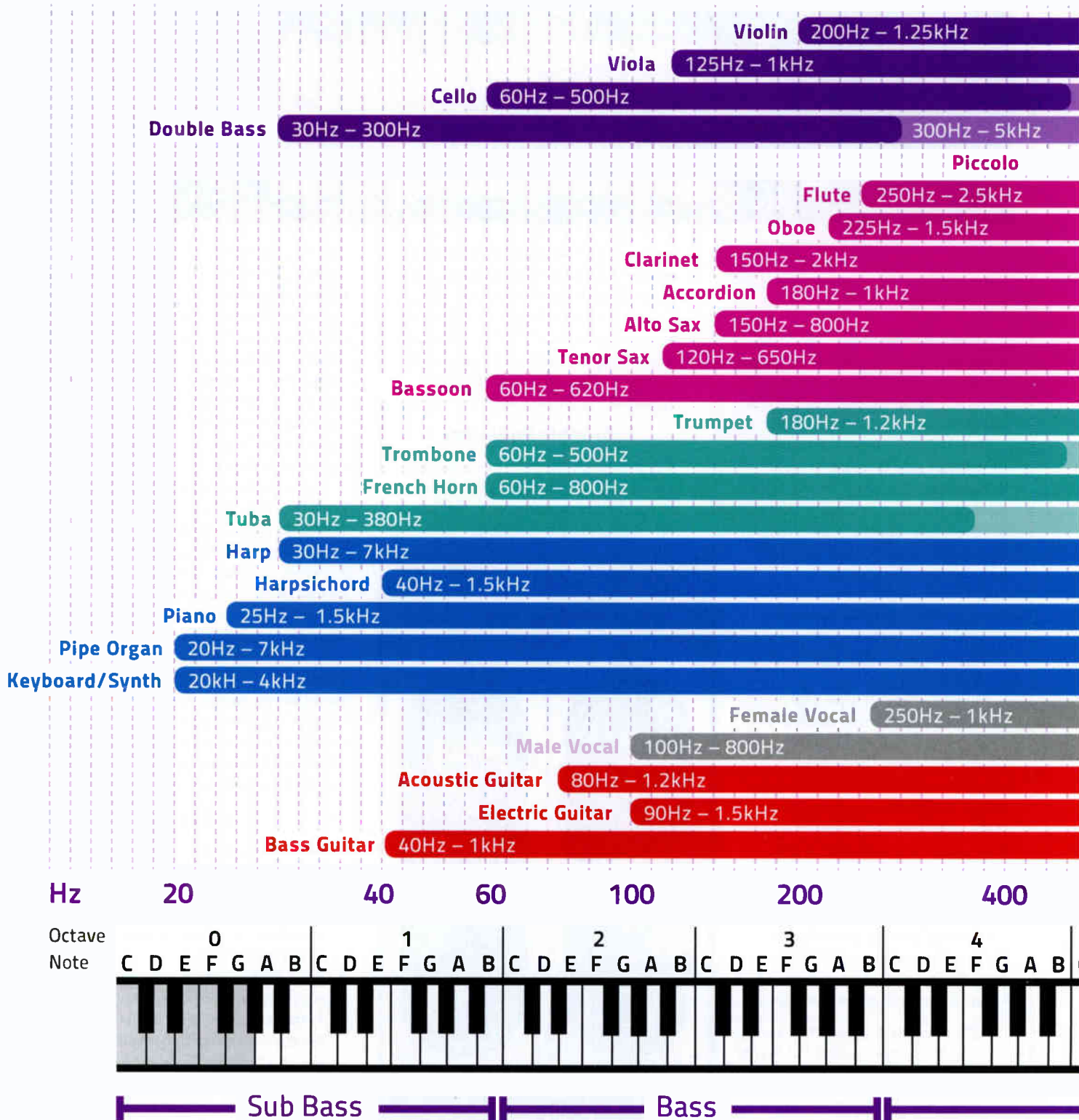



# Key

Fundamentals Range

Harmonics Range

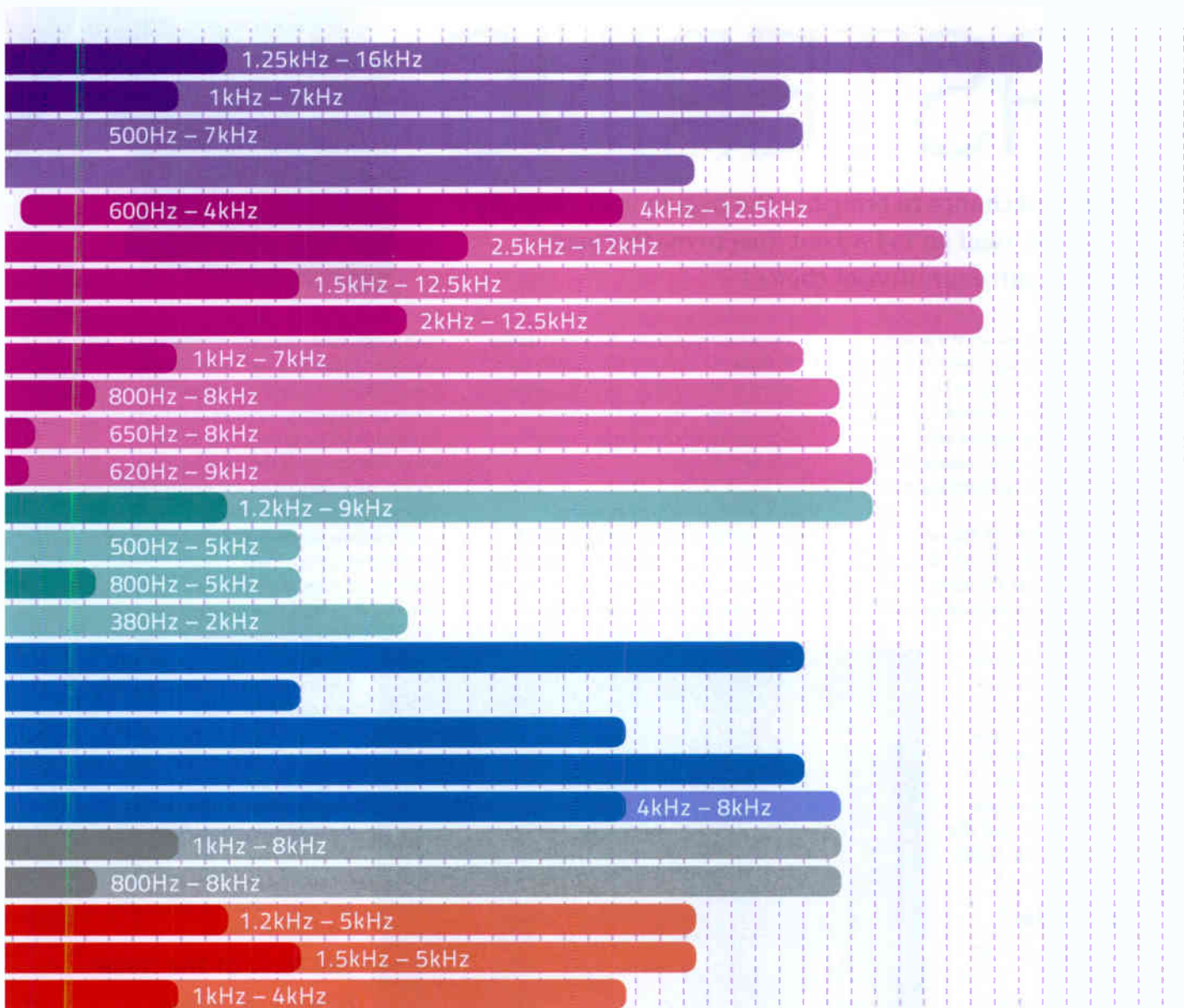

500 1k 2k 4k 6k 10k 16k 20k



Midrange High Mids High Freqs

# EXPLORING MASTERING



This is the final chance to bring out the best in your carefully crafted mix. So, read on to find out how to master your masterpiece with your DAW of choice!

Mastering was originally the process by which audio was treated to make it suitable for cutting to vinyl. Today, it is rather more creative and might be better described as the stage at which the final polish is applied to your mixes so that the various tracks form a professional and consistent-sounding album.

A mastering engineer will also add various technical details to a recording to suit the release format, for example, by adding the PQ Pause and Cue codes to a CD master. Specialist mastering engineers have lots of experience, great monitors and some very sophisticated pieces of equipment, so if you plan a commercial release, it's worth getting the job done professionally. If, however, you plan on doing things yourself (like most of us with a project studio), then this chapter is for you!

## Why Master?

There are several purposes of mastering. These are:

- To correct any tonal defects due to the monitoring system used when mixing.
- To make mixes sound as loud as other commercial material

A typical mastering chain, with a compressor, an EQ and a limiter inserted in series. You can see the compressor is set to a fairly low ratio of 2:1, the EQ is performing gentle boosts rather than any radical tonal adjustments, and the limiter is set to reduce the gain by just a few decibels.

- without compromising the sound quality.
- To make the various tracks on an album sound as though they belong together, even though they may have been recorded at different times or even in different studios.

There's rather more to professional mastering than simply compressing and limiting everything to make it sound as loud as possible, but you can still get excellent results in a home studio providing you

have a reasonably accurate monitoring system and take care over what you are doing. While you may have access to stereo sound-editing software that might be suitable for mastering, most DAWs will enable you to do the same job using good-quality plug-ins, so you may not need to buy any extra equipment.

A few quite simple mastering techniques can be employed to make typically mixed tracks sound more like a commercial release. The most important tool when mastering is the ear of the engineer: it takes just as much skill to decide that nothing needs doing to a track as it does to spot flaws that need correcting. Listen critically to as much commercial music as you can and try to figure out what techniques were used at the mastering stage. Also keep these reference tracks on hand for comparison when you do your own mastering, just as you would when mixing.

## The Tools Of The Trade

Aside from good ears, the most important requirement is an accurate monitoring environment. This should comprise accurate studio monitors with a reasonable bass response set up correctly in a space with adequate acoustic treatment. Computer-style multimedia speakers are not really suitable for any serious musical work and especially not mastering. You should also have a pair of good-quality,



## Mind The Gaps



Try to leave between 0.25 and 0.50 seconds of silence at the start of each track so that CD players don't miss the start of a track when you skip through them. If the mix engineer hasn't left enough silence, you can always paste some in.

open-backed headphones on hand for more 'forensic' listening, as these can show up tiny glitches and editing problems that may be difficult to hear on speakers.

While the pros have lots of specialised tools, you can do your own home mastering if you have access to good-quality equaliser, compressor and limiter plug-ins. These are the basic tools of the trade. If you don't have the budget for anything esoteric, use what your DAW provides but take care to listen out for any audio problems they may introduce.

Tracks that were recorded at different times can sound very different, especially at the bass end, so you may need to use a little overall EQ to even things out. If you have a spectrum analyser plug-in, use it to examine the spectrum of your source track and also the track or tracks you are using as reference material. Any major differences in low-end energy should show up quite clearly. The approach is to apply cut in the areas where certain frequencies are excessively dominant, and modest amounts of boost where they're too weak. It also helps to use a low-cut filter to remove any unwanted sub-bass below 30Hz or so. You may also need to make some minor mid-range tweaks to reduce low-mid boxiness or to add gentle boost in some areas.

If you need to add brightness, use either a high shelving filter or a good parametric EQ set to around 8 to 12 kHz with a wide bandwidth setting. Just a couple of dB of boost can help the track seem clearer and more airy without making the upper mid-range sound harsh, but use any EQ in moderation. Making frequent comparisons between your results and your reference tracks will help prevent you going too far, as it is very easy to overdo the top end.

## Increasing Loudness

The secret to making a track sound loud is not just to normalise the end result, which simply adds digital gain to bring the loudest peak in the audio file up to digital full scale, but rather to use careful dynamic processing applied using a good compressor, followed by a limiter. You'll also find that the subjective result of putting the compressor before or after the EQ is a little different, so see what sounds best to your ears for each song you're working on.

Using compression on a complete stereo mix can add energy because it increases the average level of the sound, and our ears respond more to averages than to peak levels. Some people prefer multi-band compressors for mastering (where the audio is split into two or more audio bands with a separate compressor on each band), but many of the pros swear by the simpler single-band compressor, as described in the earlier chapter in this section on compression. It's probably best to leave multi-band compression until you've mastered all the basics, which is why I've deliberately not covered it here. If you would like to read more on the subject, check out [www.soundonsound.com](http://www.soundonsound.com).

The main difference between processing individual tracks and a complete mix is that, when processing a mix at the mastering stage, you tend to use very low compression ratios, as low as 1.1:1 or 1.2:1, and certainly no higher than 2:1.



# Meet the Award Winning Slate Digital family...



NEW

## Virtual Console Collection

The sound of 4 legendary analog consoles, now available in your DAW.



## FG-X

Virtual Mastering Processor

Computer Music: 10/10  
Music Radar: Plugin Of The Year  
Future Music: Platinum Award  
SOS: Editor's Choice Award  
PAR Excellence Award 2010



**Trigger**  
Advanced Drum Replacer  
Computer Music:  
Editor's Choice Award

Download demos of all the Slate plugins at [www.slatedigital.com](http://www.slatedigital.com)



» If you now adjust the threshold to show a gain reduction of 3 to 6 dB on the signal peaks, you'll be somewhere close, but make the final adjustment by ear. As the dynamics of a song can change at different points during the song, set the release time to 'automatic' and the attack time to between 10 and 20 ms. Fine-tune the attack time so that short, bright sounds, such as hi-hats, get through without being pushed down by the compressor, but set it to be no longer than it needs to be to achieve this. If your compressor also has an auto attack time, then also try that as it might just give better results than a fixed attack time. Because the ratio is so low, you'll find that you need to set a very low threshold level to achieve the amount of gain reduction we're looking for: possibly as low as -35dB. This is perfectly normal, so just keep your eye on the gain reduction meter.

Follow the compressor by a limiter so that the peak output level is at around -1dB. The reason for this extra dB of headroom is that it avoids distortion when converting to MP3, which is a common file format especially for online distribution. You can then increase the limiter input gain so that you get around 3dB of gain reduction on the peaks, such as the loudest drum hit. This combination of gentle compression and peak limiting will make your track sound much louder but without the harshness introduced when engineers use too much processing in the pursuit of loudness. Multi-band limiters are available but, again, are best left alone until you have gained experience.

## Other Mastering Tasks

If the mix engineer hasn't already done it, you'll need to trim the starts of tracks to ensure there's no unwanted sound before the track begins. You may also need to trim the end and, in some cases, apply a gentle fade to the last second or so to allow any residual noise to fade gracefully into

### Making A Master

If you want to have commercial CDs copied from your master, ensure your CD-burning software is capable of making a master that can be copied to produce so-called 'Red Book'-compatible discs for playback on commercial CD players. Such software should also allow you to adjust the start times of individual tracks, and may even allow the creation of crossfades between the tracks.

You can use a program such as Roxio Jam to quickly and easily make your master CDs. With the playlist functionality (shown here), you have control over exactly how your tracks will fit together.

silence. As a rule, don't start your fade until the natural fade of any instruments or reverb is almost complete, otherwise the track might appear to end prematurely.

The mastering engineer also needs to match the relative levels of tracks on an album by ear. If you only use the meters, tracks that are in a quieter style will appear too loud next to the more powerful songs. Listening to the vocal levels often provides a good idea of how well matched songs are, but a lot is purely down to feel.

I like to keep my tracks as 24-bit audio files and then do the final level balance in the software used for CD-burning (for example, Roxio Jam for Apple Mac), as this maintains the best possible audio resolution when the file is finally converted to 16-bit for CD burning. If you have been provided with any mixes done at sample rates other than 44.1kHz, you'll need to sample-rate-convert them to 44.1kHz in your DAW or mastering software before you can make a CD.

After tidying up the starts and ends, you can assemble the tracks in the desired order for the album using the playlist function of the software you choose for CD burning. Most of these programs start with a default track spacing of around two seconds, but you can adjust this by ear if a longer or shorter gap sounds more natural. There's no rule here — you'll know when it sounds right.

Before burning your CD, listen to the finished master all the way through as it plays back from the playlist. Double check for problems using headphones, then burn a test copy and play it back on as many different music systems as possible to make sure it sounds OK on all of them. Also, check you can jump to the start of each track using the CD player's controls, and that no track starts are missed when you do this. Once you're happy, burn another master copy using a good-quality blank CD, making sure it is free from dust. Aerosol cans of clean air are useful for this and most photographic stores sell them. Label the master correctly, play it once to ensure it is



OK then pack it in a paper sleeve or CD box and don't play it again as you may scratch it. You can then have multiple CD-Rs or even commercially pressed CDs made from it.

## Internet Audio

In addition to making a CD master, you may also wish to prepare extracts from your work in a form that can be played over the Internet in MP3 format. MP3s involve data compression, so the smaller the final file size the worse the audio quality. I'd recommend a bit rate of at least 192kbps, and ideally over 200kbps, for the best results. Many DAWs and CD-burning programs include the ability to convert WAV or AIFF audio files to MP3s.

## Summary

- Mastering does not follow a fixed recipe. Each track should be processed according to its needs and, on rare occasions, it may be that no further processing is the best option.
- Successful mastering depends on the ability to hear the recording played back on an accurate monitoring system.
- Some commercial releases end up sounding worse after mastering because the record companies have insisted that it be processed to sound even louder. Don't feel your track has to sound as loud as every other song out there and don't let the quest for loudness compromise your end result. **!!!**

# iMastering

The low cost online mastering service from Metropolis Studios

"The finished result is always AMAZING" - Chris Grabiec

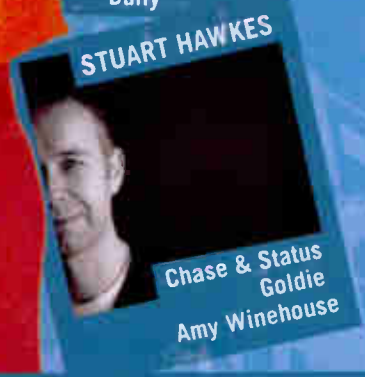
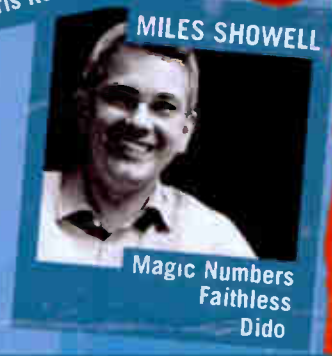
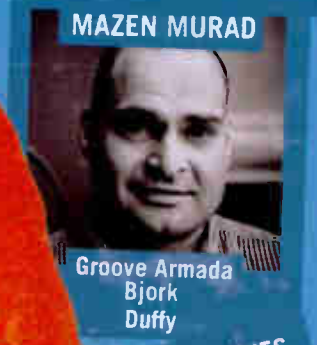
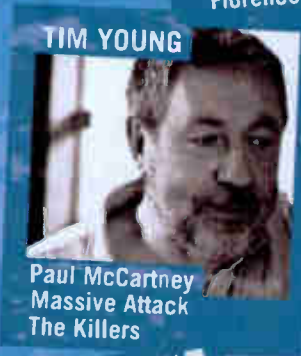
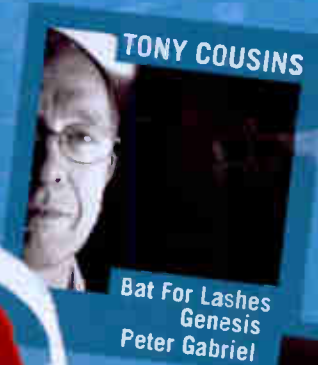
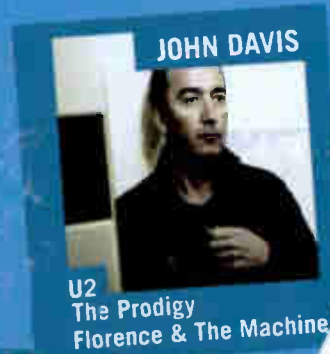

for more information & to order your mastering, visit:

[www.imastering.co.uk](http://www.imastering.co.uk)



The Power House, 70 Chiswick High Road, London, W4 1SY

tel: +44 20 8742 3111 | email: [imaster@metropolis-group.co.uk](mailto:imaster@metropolis-group.co.uk)

# MONITORING BASICS

Accurate monitoring is essential to producing high-quality mixes — but choosing a pair of speakers is only part of the equation...

A theoretically 'perfect' monitor speaker would reproduce the entire audio spectrum with no distortion or coloration but, because of the limitations of both physics and cost, even the best speakers available are built on compromise.

In smaller studios, so-called nearfield monitors have become popular, and even professional studios use them in addition to their main monitors. These are relatively small loudspeakers that can be used close to the listening position, typically around one metre away from the engineer, or even a little closer. This arrangement provides the mix engineer with adequate level and also helps reduce undesirable effects from the acoustics of the room. As the listener is close to the speakers, the ratio of wanted to unwanted sound is higher.

Unlike a hi-fi speaker, which may be designed to flatter the sound, a good studio monitor should sound as accurate as possible, though a smaller nearfield design may not reproduce extremely low frequencies as well as a larger monitor. Some hi-fi speakers are suitable for monitoring but they must be selected for accuracy rather than their ability to flatter the music. I'd recommend you stick to dedicated studio monitors where possible.

While you can't expect to get very deep bass from small speakers, a well-designed nearfield speaker will reproduce bass instruments and kick drums accurately enough to make meaningful mixing decisions. In practice, you probably won't need an overly generous bass extension as, unless the room is acoustically designed to handle it, the results will probably be unpredictable and may mislead you into mixing the bass end either too high or too low.

## Project Studio Monitors

Most monitors designed for home studios are two-way loudspeakers, meaning that they have two drivers: one low-frequency driver and one tweeter. Generally, they will have a bass driver of between five and eight inches in diameter, with larger bass drivers capable of providing more low end.

The designs and materials used when building speaker cabinets can also have a profound effect on their sound. Most nearfield monitors feature air vents, known as 'ports', which provide a more pronounced low end. Un-ported designs (sometimes called 'infinite-baffle' speakers) are slightly less common, though they are generally considered to be more accurate,



Reviewed by *SOS* in May 2010, these Sonodyne SM 50AK active two-way monitors are compact yet powerful, and have a generally well-balanced sound with plenty of mid-range detail and clarity.

even though their bass response can be limited compared with ported designs. Ultimately, it comes down to what sounds right to your ears.

When testing new monitors, you should use commercial material, as your own mixes may be incorrectly balanced because of the limitations of the speakers you originally used when mixing.

## Passive Or Active?

Essentially, the difference between passive and active monitors is that the former require separate amplifiers to drive them, while the latter have amps built in. Passive models may be driven from a suitable hi-fi amplifier, but if you go this route, make sure you have plenty of power in hand. If you don't have enough power, the amp is likely to distort on peaks, such as drum beats. »

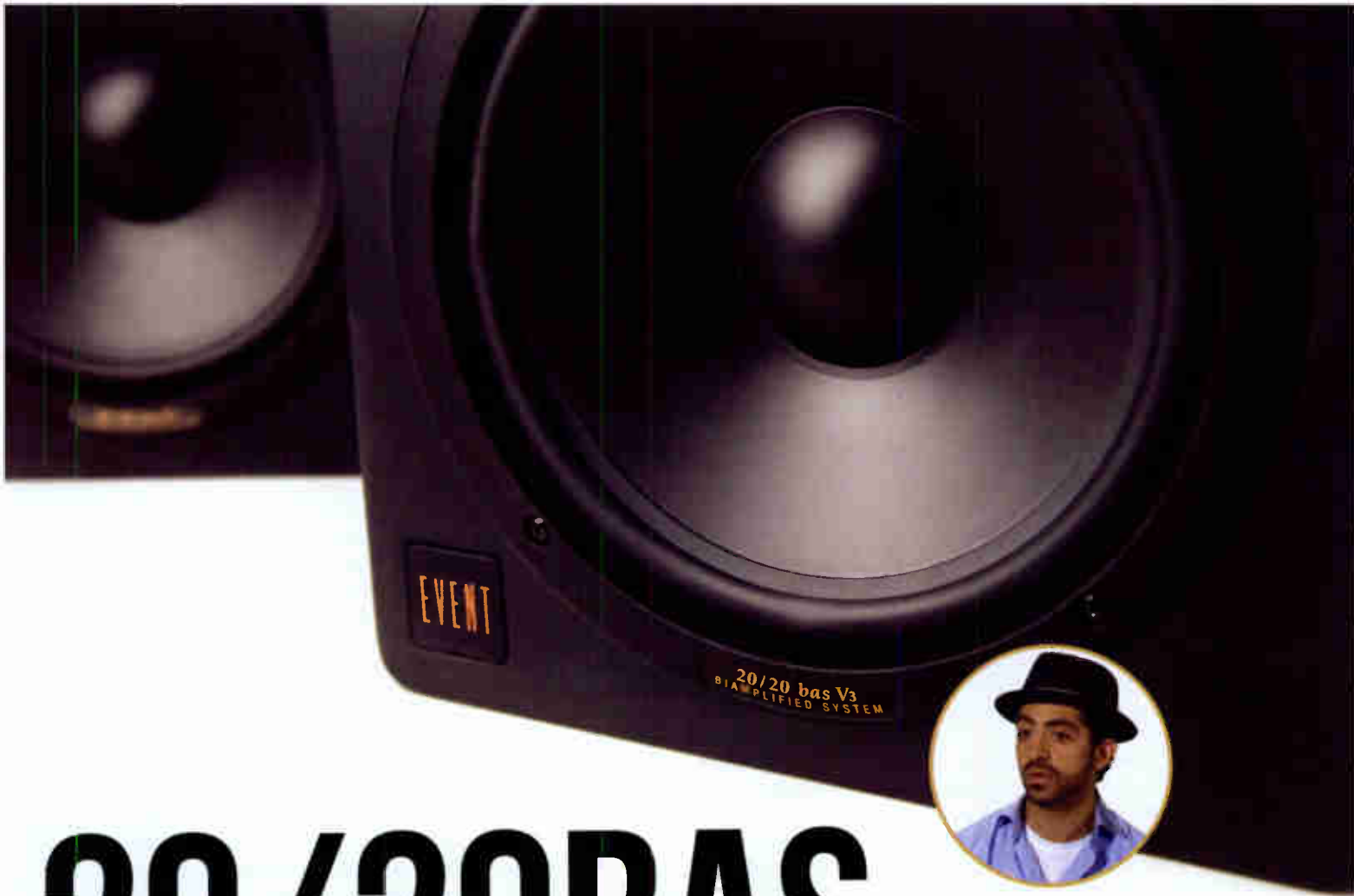

# 20/20BAS

## THE RETURN OF BIG ASS SOUND.

The new 20/20BAS respects the tone and character that made the original 20/20s a standard in studios the world over. Using the original transducer design combined with modern manufacturing practices, and leveraging technology straight from Event's flagship Opal monitor, the 20/20BAS is set to revolutionise the way you hear your mix.

**The time has come to revive the legend.  
Introducing the new 20/20BAS.  
It's ready to take back the crown.**



# EVENT

eventelectronics.com



"The one thing I always liked about the 20/20s was if you can get it sounding good on those speakers it will sound good on a variety of speakers. It'll sound good on the TV, sound good in the car, sound good on headphones."

**- FREDWRECK**  
(SNOOP DOGG, 50 CENT, EMINEM, BRITNEY SPEARS)



"A lot of times monitors will give you an artificial sound that will sound really good in the studio, but doesn't necessarily translate outside. The 20/20s really give you that true sound that will sound good everywhere."

**- MAYER HAWTHORNE**  
ARTIST, PRODUCER, ENGINEER

## Avoid Distortion



As a rule, choose an amplifier capable of delivering a little more power than your speaker rating, so that you won't risk feeding them a distorted signal. Don't, however, run it flat out: not only does amplifier distortion sound bad, it can also wreck your tweeters.

» Around 50 Watts per channel should be considered a realistic minimum, even if you tend to monitor at moderate levels.

It may, however, be more cost-effective to buy a rackmount power amp rather than rely on your hi-fi. For wiring, use heavy-duty cable so that the resistance of the cables is as low as possible (don't use thin cables as the resistance is too high). In my experience, however, expensive and exotic speciality speaker cables make little difference to anything other than your bank balance!

Active monitors all include built-in amplifiers to power the speakers. Most also include some form of electronic protection to prevent the drivers from being pushed too hard, and to shut down the amplifiers if they overheat. As well as being convenient, active monitors take the guesswork out of choosing a suitable amplifier, as the built-in amps have been specifically designed to power those speakers.

Although most active monitors have input gain trim controls, these are not usually designed to be used as general-purpose volume controls and are often positioned on the rear panel where they are difficult to reach. The best solution for working with active monitors is to use a hardware monitor control box. SM Pro Audio make some highly regarded but low-cost models, while some of the more expensive ones may also include a headphone amplifier, and a means of switching between various input sources. Some audio interfaces, such as the Mackie Onyx Blackjack, include a monitor controller, which reduces the amount of wiring needed to set up your studio.

## Subwoofers

Some systems use smaller 'satellite' speakers teamed with a subwoofer to handle the bass end. These can work

Using a subwoofer with your monitors can produce good-quality audio. Be careful to place your speakers correctly though, and don't be tempted to crank up the bass just because you have a bass speaker!

Monitor controllers, such as this one from Presonus one, are really handy bits of kit to use with your studio monitors, giving you more flexibility and control over your volume settings.



well, but you should always follow the instructions for setting the sub level. Users often make the mistake of setting too high. As a rule, the sub should be just loud enough that you miss it when you switch it off, but when it is on you shouldn't really be aware of it.

The position of the sub in the room has a big effect on how even the bass response sounds. A useful tip for finding the best spot is to temporarily place the sub where you normally sit, then play music with a busy bass part over the system. While this is playing, crawl around the front of the room until you find a spot where the bass sounds the most even. That's where you should put the sub. Most times this will be to one side of the centre of the front wall. Don't put subs under enclosed desks as these form a resonant chamber that will make some notes seem way too loud. Additionally, subs should always be placed directly on the floor, not on stands or shelves.

## Speaker Placement

To work correctly, monitors must be set at the correct height and angle so their tweeters are aimed towards the mix engineer's head. Monitor speakers



should also be symmetrically placed within the room where possible. The distance between the speakers should be roughly the same as the engineer's distance from the speakers. Rigid stands are a good option, but if you must stand your monitors on a shelf or desk, one of the commercial isolation pad mounting systems, like those made by Primacoustic or Auralex, is recommended to prevent low-frequency vibrations being transmitted into the desk. Some of these are shaped foam blocks while others include a metal plate on top to add mass and to improve the mechanical decoupling. Though more costly, the latter type work extremely well and the difference can be very noticeable.

Avoid having objects such as computer monitors obscuring any part of the speakers and also avoid having too much flat desk space directly in front of the monitors, as this can bounce sound reflections back to the listener with a detrimental effect on sound quality. In an ideal control room, there should be no monitor speaker reflections from nearby surfaces, and though this is a pretty impossible ideal, there are many ways to improve the situation.

In smaller rectangular rooms, it is essential to have the speakers aimed down the long axis of the room, otherwise the bass response will be very uneven and will

## Headphones



For checking mixes or working on your DAW late at night, good-quality open-backed or semi-open-backed headphones usually give the most natural and speaker-like sound. For tracking, where sound leakage must be avoided, closed-backed phones are the best choice.

Buy decent-quality headphones, as cheaper ones may soon fall apart and may not accommodate the levels demanded by some musicians.



# CHOOSE THE RIGHT MONITORING

Speaker isolation pads work wonderfully to reduce unwanted vibrations rippling through your desk as your speakers rumble away.



change if you alter your listening position even slightly. In most small rooms the speakers end up being quite close to a wall but try to leave at least 200mm of free space behind them, especially if your monitors have bass ports at the rear. Avoid having to sit mid-way between the front and rear walls when mixing.

Small square rooms present a real problem as they result in a quite uneven bass end, meaning that some bass notes sound significantly louder than others. Furthermore, if your mixing position is close to the centre of the room, you may find that all the low end seems to disappear at this point. Cube-shaped rooms are even worse in this respect.

Plasterboard walls, as well as windows and doors, allow some bass to leak out and can improve the evenness of the low end, but solid brick or concrete walls will reflect bass energy back into the room and worsen the problem. Bass trapping — the practice of placing large, sound-absorbing materials in a room — is possible, but it takes up a lot of space and isn't practical in most small domestic rooms.

## Acoustic Treatment

Domestic living rooms and bedrooms tend to absorb quite a lot of sound due to soft furnishings (carpets, curtains and so on), and most of us are comfortable listening to music under these conditions. Consequently, a studio set up in a furnished domestic room can, within limits, provide a workable alternative to a purpose-built studio.

However, sound reflections from walls and other hard surfaces need to be addressed, so it is common practice to hang absorptive panels at either side of the listening position, to prevent sound from the monitors bouncing from the wall and back to the engineer's ears. In rooms with low ceilings, some absorption on the ceiling can also help. Further absorbers behind and between the speakers at head height will reduce secondary reflections from the front wall, which would otherwise interfere with the direct sound from the speakers.

If absorbing panels sound a bit too serious, these can be »

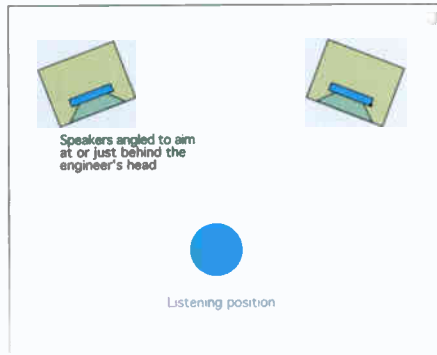

This diagram shows a good monitor setup for a fairly small room. Angle your speakers to direct the sound and try, if possible, to have your speakers pointing down the longest part of the room to even out the bass response as much as possible.



Whether headphones or monitors, KRK are true to your sound – What you hear, is what you get.



# THE FOUR STEPS TO START MAKING MUSIC

If you can see a reflection of the speakers in a mirror held flat against the wall, there will also be sound reflections from this point that need to be dealt with. There will also be a reflection point on the ceiling above the engineering position, and this may also require treatment, especially in rooms with low ceilings.

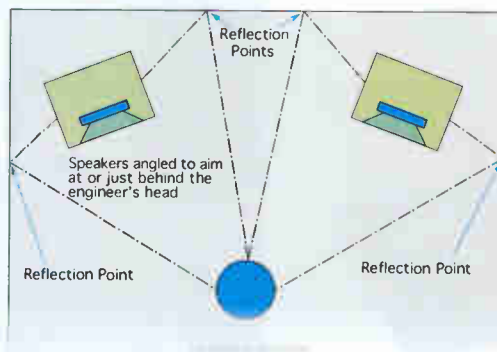

## Smoothing The Bass

To check the evenness of the bass end, play a chromatic scale of pure tone bass notes at the same volume (velocity), and listen for individual notes being louder or softer than the others. A sampler or synth sequenced by your DAW is a good way to do this. You may be able to further improve the low-end evenness by moving your speakers closer to or further from the wall.

» as simple as foam panels hung on the wall like a picture. You can even make your own from medium-density rockwool slab fixed into a wooden frame and covered in porous fabric. A thickness of 50mm or more is recommended, and if you can leave a small air space behind the panel, it will be more effective at lower frequencies. Normally, a panel of this type is effective from around 300Hz upwards, but does little to control bass: the thickness of the absorber has a direct effect on what frequencies it can absorb. You could, if pushed, hang up a few thick duvets to control the low end — it will make a difference. Honestly.

### Mirror Points

To find the best places to hang your absorbers, sit in your mixing chair in your usual position and then get a friend to hold a mirror flat against the walls and other surfaces. If you can see a reflection of the speaker in the mirror, that's where you need to put an absorber. Don't worry too much about floor reflections; hard floors can work perfectly well in control rooms, though carpet is also fine.

To treat reflections from the wall behind you, a simple solution is to use partially-filled shelving or other irregular shapes to scatter the sound. If you must have a flat area of wall behind you, however, just hang another absorbing panel or two.

You can even hang temporary panels over windows when mixing. And when you're not mixing, you might be able to redeploy them as acoustic screens between instruments or to hang behind vocalists.

With the absorbers in place, you should notice that mixes sound tighter, more focussed and have more pronounced stereo imaging.

### Pragmatism

Because no two monitoring systems or rooms sound exactly alike, and because your home studio is unlikely to be fitted with perfect acoustic treatment, it is important to compare your own mixes with commercial music played back over the same system. This way your ears can learn the sound of your system, and they'll help you compensate for any technical shortcomings.

You may see adverts for electronic EQ systems, which try to correct the sound of your room. Although these can work well, they work best when the room has had some acoustic treatment applied. They are not a substitute for correctly placed absorbers. I've never felt the need to use one, but if you think one is right for your

situation by all means take a closer look.

### Summary

- A good monitoring system is a combination of accurate-sounding loudspeakers set up in the right place in an acoustically treated room. The world's best speakers can still sound bad in the wrong room.
- In smaller room, speakers with a 6-inch bass driver are generally adequate. If the speakers have too much bass extension, you may simply exaggerate the room problems.
- Don't aim your speakers across the width of a rectangular room unless it is at least four metres wide, otherwise the bass end will sound inconsistent. In home studios, aiming the speakers down the length of the room is invariably best.
- Use some acoustic absorbers to improve your monitoring environment, even if it's only duvets or blankets.
- You'll find a huge number of monitor speaker reviews on the *Sound On Sound* website ([www.soundonsound.com](http://www.soundonsound.com)) so you can check what is available in your price range before you buy. ■■■

## Speaker Tweaks

Avoid putting your monitor speakers in or close to corners as this has an unpredictable effect on the bass end. You may seem to get more bass by doing this, but it will be uneven. Read the manual that comes with your speakers as that will include advice on positioning for that particular model. If they're active, it will also explain any EQ controls that may be fitted to fine-tune the sound to your liking, and to help compensate for the room characteristics as well as the actual position of the speakers within the room.

## Selected Manufacturers

Acoustic Energy  
[www.acoustic-energy.co.uk](http://www.acoustic-energy.co.uk)  
ADAM  
[www.adam-audio.com](http://www.adam-audio.com)  
Alesis  
[www.alesis.com](http://www.alesis.com)  
AVI  
[www.avihifi.co.uk](http://www.avihifi.co.uk)  
Equator Audio  
[www.equatoraudio.com](http://www.equatoraudio.com)  
Event  
[www.eventelectronics.com](http://www.eventelectronics.com)  
Focal  
[www.focalprofessional.com](http://www.focalprofessional.com)  
Fostex  
[www.fostexinternational.com](http://www.fostexinternational.com)  
Frontier Design  
[www.frontierdesign.com](http://www.frontierdesign.com)

Genelec  
[www.genelec.com](http://www.genelec.com)  
JBL  
[www.jblpro.com](http://www.jblpro.com)  
KRK  
[www.krksys.com](http://www.krksys.com)  
Mackie  
[www.mackie.com](http://www.mackie.com)  
M-Audio  
[www.m-audio.com](http://www.m-audio.com)  
PMC  
[www.pmc-speakers.com](http://www.pmc-speakers.com)  
Presonus  
[www.presonus.com](http://www.presonus.com)  
Prodipe  
[www.prodipe.com](http://www.prodipe.com)  
Quested  
[www.quested.com](http://www.quested.com)

Samson  
[www.samsontech.com](http://www.samsontech.com)  
SE Electronics  
[www.seelectronics.com](http://www.seelectronics.com)  
Silentpeaks  
[www.silentpeaks.com](http://www.silentpeaks.com)  
SM Pro Audio  
[www.smproaudio.com](http://www.smproaudio.com)  
Sonodyne  
[www.sonodyne.com](http://www.sonodyne.com)  
SPL  
[www.spl.info](http://www.spl.info)  
Tannoy  
[www.tannoy.com](http://www.tannoy.com)  
Unity Audio (Rock)  
[www.unityaudio.co.uk](http://www.unityaudio.co.uk)  
Yamaha  
[www.yamaha.com](http://www.yamaha.com)

# THE FUTURE

**E**quipped with all the skills, knowledge and tips to set you on your way, you should be comfortable enough with your home-studio setup to produce high-quality music for a long time. But what about furthering your knowledge, improving your studio and the future of music technology? These last chapters will provide you with some essential advice to help you on your way as you use your new-found music-making skills.

DIGITAL SURVIVAL	158
UPGRADING YOUR SYSTEM	160
CAREERS & COURSES	164



Years of education and real-world experience, 13 weeks of intense training, hours of additional training every week, and an ongoing passion for excellence all add up to make your Sweetwater Sales Engineer your go-to source for music gear. No matter what you need, your knowledgeable Sales Engineer will help find the right gear for you.

# Who's Got Your Back When It Comes to Your Studio?

**At Sweetwater, we hear countless horror stories about good people spending thousands of dollars on the wrong gear, before coming to us. Maybe it's happened to you. The best way to keep your studio running smoothly, is to have a team you can trust ready to back you up.**

## **Option Anxiety Leads to Bad Decisions**

It always starts out the same. You know exactly what you need (let's say, for example, a new preamp), and you know what you want it to do (add warmth to your vocals). Sounds simple enough, right? Unfortunately, most brick-and-mortar stores that sell music gear don't tend to stock a lot of preamps. Logically, this makes the Internet your next stop. There, you discover a zillion preamps that all boast a "warm vintage sound," and you're totally overwhelmed with choices. You can scour the countless forums and blogs, and find hundreds of opinions, but can you really trust them? Who are these people anyway? The anxiety you feel often leads to a terrible buying decision.

Here's where a call to your Sweetwater Sales Engineer can save you a ton of grief. You see, it takes years of real-world experience and education to become a Sweetwater Sales Engineer. Sales Engineers go through 13 weeks of intense training, followed by several hours of additional training every week, just to keep up with all of the latest gear. Of course, Sales Engineers are passionate about music too; they use the gear they love in their own studios and systems, gaining invaluable hands-on experience to go with the knowledge they already have. And they bring all of this expertise to the table the moment you call to ask about whatever preamp you've got your eye on. You simply can't buy advice like that, and at Sweetwater, we can't wait to share it with you for free!

## **Missed Deadlines**

Deadlines are sneaky things. For those of us with professional lives outside of the general hubbub of the music industry, gear-related deadlines can be as innocuous as "I need that new mic by the weekend; otherwise, it's going to be a month before I have the free time to get some recording done," or "I've got a gig Saturday, and it sure would be nice to have that new amp." On the other hand, it's amazing how being the only competent sound guy or gal can quickly elevate you to the role of volunteer engineer for

Get the best gear, service, and resources — from one source!

Go to  
**Sweetwater.com**



your church, school, or other association. Sure, the position is flattering, but you often end up being responsible for getting the gear your organization needs.

The nightmare begins when the order you thought you expedited doesn't show up in time. Automated websites are the source of most shipping evils. For one thing, you have no idea when your order will be processed by the system, let alone how soon it will ship. So the wireless system you need for the Sunday service, which you ordered "in plenty of time" on Tuesday, processes late Thursday, and it doesn't go out for delivery until Monday.

Did you know that free ground shipping may actually get your gear to you faster than 3-day air? It's true, and your reliable Sales Engineer can sort that kind of issue out. Of course, that isn't even an issue at Sweetwater. If the items are in stock, the order you place today will almost certainly go out today, or leave in time for the first shipment tomorrow. That's right, we ship several times a day — an order waiting days to be processed is simply unheard of around here, a fact we pride ourselves on.

### The Technological Disaster

To err is human, to err completely, you need a rack of gear. Compatibility issues can stress out even the most level-headed and experienced engineer. For example, let's say you bought an 8-channel preamp equipped with ADAT optical output so that you can expand your interface, which has an ADAT optical input. You just hook them up with the right cable, and you're good to go. Sounds simple, right? But, what if that's not enough? Unfortunately, most tech support departments pass the buck and make you call the manufacturer for help — not an endeavor for the faint of heart.

What you need is an advocate, such as a member of the Sweetwater support department. Our seasoned support veterans can solve thousands of common technical problems with a single call. Mac, PC, analog, digital... you name it. And when the support team needs to elevate the issue to the manufacturer, they go to work for you, dealing with people they know.

Good gear rarely fails, but when it does, it can really take the wind out of your sails. The ordeal begins when you contact your average service department, whose job is to verify that you didn't just forget to plug it in, and then to send your defective gear to the manufacturer for them to do with it what they please. Realistically, you're looking at about a 90-day turnaround time, if you're lucky.



“Our seasoned support veterans can solve thousands of common technical problems with a single call. Mac, PC, analog, digital... you name it.”

It's a whole different story when Sweetwater is behind you. First, there's the 2-year Total Confidence Coverage™ warranty you get for free with almost anything you buy from us. That gives your gear the kind of coverage most pay-for protection plans fall short of. Behind that 2-year warranty is a service crew like no other, a group of dedicated technicians whose job isn't just to take care of your gear, but to take care of your needs. No matter what, we always take a customer-first approach to dealing with gear-related problems.

### The Team — Your Key to Success

As you can see, the key to success is having the right team behind you, a group of dedicated people who can back you up every time. No matter where you buy your gear, you're paying for the service that company has to offer as well as the commitment they give to customer needs. At Sweetwater, we base our value on the experience and expertise we have to offer. Give us a call to find out more about the Sweetwater Difference.

Why take unnecessary risks? When you buy gear from Sweetwater, the most experienced and competent service and support crew in the industry is standing by, ready to take care of your gear. If there's a problem with your gear, your Sweetwater service representative will work tirelessly to get your gear up and running again.

**Call Sweetwater today for the trusted service you deserve!**

CALL US TODAY AT  
**(800) 222-4700**

**Sweetwater**

Music Instruments & Pro Audio





# DIGITAL SURVIVAL

If you've ever lost important work through an unexpected computer breakdown or something similar, you'll know the value of having good data backups. Let's look at the options.

## Backup Regimes

Backing up to a separate internal or external hard drive is a good way to go, and you can always purge projects of unused files to conserve space if you can be sure you won't need them. However, if you have partitioned your main drive so that you can use one of the partitions purely for audio, don't be tempted to store your backups on a partition of the same drive that holds the original, because if the drive fails, you still lose everything. My personal backup system consists of:

- One drive dedicated to Apple's Time Machine backup system, backing up only my main system drive.
- A second internal drive for audio projects.

**A very wise man once told me that digital data doesn't really exist until it is stored on at least two different systems and ideally in two different locations. For this reason, having a workable backup regime is an absolute essential.**

- A third drive for my sample library.
- A fourth internal drive for backing up audio projects.
- An external USB drive for making further backups of important projects and yet another to keep a backup of my sample library and iTunes songs.

There are also systems that allow you to back up important work online to a remote server which, though this a slow way to back up very large files, can give you added security where the project merits it. After all, a nearby lightning strike could take out your computer and all your local hard drives at a stroke if the computer happens to be plugged into the mains. Scary thought, isn't it?

Systems such as Time Machine that

allow you to restore a system to how it was on a previous date can be life savers when you find that an OS update turns out not to play nicely with your existing software. Be aware that anything you worked on since the date you reset to will also be lost, so make sure you back up any essential new work before getting that DeLorean up to 88 miles per hour and returning to the past!

If you're using external hard drives for backup, be aware that hard drives tend to become less reliable if left unused for long periods, so always power up and check your backup drives every couple of weeks whether you need to access them or not.

Other backup media such as writable discs and USB flash drives can also be useful, though their capacity is still somewhat limited and writable discs can become unreliable after being stored for a few years. If you do use writable CD-ROMs or DVDs, buy reputable brands, label them clearly and store them carefully

---

**"Backing up is an essential part of working in the digital world, not an option or a luxury!"**

---

## It's All In The Name



Always check that any files are saved into the correct project folder, as the chances are you'll have tracks called 'drums' or 'vocals' in many different projects, and finding the right one once it goes astray can be a nightmare. Worse still is the risk of overwriting a wanted file in an existing project. Keep your wits about you and include dates in your filenames wherever possible.

away from light. Also check that the data can be recalled before putting them away, as errors do occur. Even with the best media, assume it won't last more than a decade and copy to new media as it becomes available so you don't get left with media for which players are no longer available (Zip drives anyone?). If you are really paranoid you can make further copies and store them at a friend's house in case yours burns down!

### Future Proofing

The world of computers evolves very rapidly, while third-party software companies come and go, so you may find yourself a few years down the line trying to play a project backup only to find the software instruments you used back then are no longer supported by the operating system of the day. To safeguard yourself, you can bounce separate stereo audio



There's a vast array of storage media on which to back up your digital data. It doesn't really matter which type you choose, as they all have their pros and cons. Go with whatever backup media you find to be good value and the best fit with your existing hardware.

files from all your software instrument tracks and save those as part of your project so that if the MIDI instrument is no longer available you can at least work from the audio track. You may not be able to make changes as you would to a true MIDI track, but it can still be cut and edited in the same way as any other audio part.

### Your Computer Is Not A Computer!

Once a computer enters your studio, it ceases to be a general-purpose family communication, games and business machines and becomes the dedicated

hub of your recording studio. As stressed earlier in the guide, if you want to know that your music computer is equipped only with the stuff you need to record, is reliable and fast, and is free from viruses and other problems, then you absolutely *must* prevent anyone else from using it for any other purpose. Too often I've had people come to me asking for advice with their latest computer problem, only to find out later that the computer is struggling to make sense of the 50+ games installed on it, plus a permanent Internet connection and outdated virus scanner, not to mention their partner's 100GB of office documents all taking up space and power. I cannot stress enough that a music computer should just be for making music. Pay heed to this advice and you'll have fewer problems!

### Summary

- Backing up is an essential part of working in the digital world, not an option or a luxury! Make at least one copy of important data and ideally more. Save to new formats as they become available. Hard drives and other storage media can and do fail, usually when it is least convenient for them to do so.
- Label files in a meaningful way and organise the way in which you store them so that you can find them easily. When resaving files that you have processed using additional software, double check that they are going to be saved in the correct place before you hit the button.
- Just because you're paranoid doesn't mean nobody is following you! **///**



Don't be tempted to use your music computer for anything other than recording — and certainly not gaming or Internet browsing. Also insist that your family doesn't use it as a general-purpose home computer, as unnecessary software and documents could lead to problems and even viruses.

# UPGRADING YOUR SYSTEM

The great thing about a recording system is that it comprises several individual components that can be upgraded when the old ones no longer fulfil your needs.

The less-than-great fact is that as software becomes more sophisticated, it also places greater demands on the computer hardware.

**B**eing realistic, you can expect to need to update your computer every four or five years. This might seem expensive, especially if you're a Mac user and have to buy a completely new machine, but the cost is far less than the depreciation of equipment in the traditional tape-based studios that computer studios replaced. Of course, if you're happy with what your system does, you can leave well alone and just keep using it as it is until the computer rusts! All you have to do is resist updating any of the software once it is all working.

Another thing you can do to extend the life of your computer is to add one of the DSP-assisted plug-in platforms, such as Universal Audio's UAD card or Focusrite's Liquid Mix. These use either internal cards or external hardware to host the company's own plug-ins, and place relatively little load on the computer's CPU. Their plug-ins then show up alongside your usual plug-ins within your DAW. As computers become more powerful, it is arguable whether additional DSP is really necessary, but if you want to use the specific plug-ins that rely on these systems, then there's no option but to buy into the concept.

Another area to consider when upgrading is the audio interface. Does







Here, an RME FireFace 800 audio interface is paired up with a Creamware A16 Ultra expander unit, to provide additional I/O.

your present interface have enough inputs for your current and future needs, or have you outgrown it? If you already have a multi-input interface, or if you have your sights set on a new model, can it be expanded, for example, using ADAT optical ports? If so, it may be worth looking at some of the expansion preamps available, most of which have eight channels with ADAT-format digital outputs that plug into your interface using a single optical cable. Some also include eight channels of ADAT input with corresponding line outputs, so that you can stream more separate channels out of your DAW if you need to. These range from the inexpensive but perfectly serviceable Behringer ADA8000 to more up-market models from companies

### True Cost Of Quality



The ratio of microphone quality to price seems to follow the law of diminishing returns: for half the price of the best mics around you can probably buy one that works almost as well. But while there are some good vocal mic buys at around \$100 or even less, try to budget for something a little better if you can. Some mics can cost as much as the rest of your studio gear added together, so unless you have plenty of spare cash, think hard before buying a high-end mic.



There are many of different makes, models and types of microphone available, covering all price ranges and suitable for a wide variety of purposes. If you're hoping to do a lot of recording of different instruments it's definitely worth investing in more than one kind of mic, so that you can make sure you're always using the one most suited to your recording needs.

such as Focusrite and Presonus. If you plan to record a live band, then 16 physical inputs should be considered a minimum requirement, as the drum mics will probably eat up a whole eight-channel interface on their own.

### Control Surfaces

We've covered the concept of control surfaces elsewhere in the guide, and for many users their tactile approach makes working with a DAW more attractive. The ones with motorised faders work best for me but, now that we have devices such as Apple's iPad, there is also DAW software appearing making use of portable touchscreen technology.

When choosing a control surface you have to think about how you work and which functions would be easier to control from hardware. The simpler controllers focus mainly on the transport section of



» a typical DAW, with maybe one motorised fader for the selected channel, while larger units may provide multiple faders. Then there are USB MIDI keyboards with limited DAW control built in. Only you can weigh up your needs against desk space and budget to come up with the right choice.

### Quality Upgrades

The upgrades discussed so far have been associated with functionality, but you may simply want to improve the quality of your recordings. While buying a more sophisticated audio interface might get you better-quality A-D conversion, it is probably fair to say that the biggest improvements you can make are right at the front end of the recording chain, specifically the microphones you buy and, to a lesser extent, the preamps into which you plug them. Some of the better audio interfaces actually have very capable mic amps that rival those found on mid-priced mixing consoles, but it may still be worth buying one really good external preamp for recording your main vocals and instrument overdubs. Some preamps are designed for pristine accuracy while others impart a deliberate sonic flavour, so check out the reviews at [www.soundonsound.com](http://www.soundonsound.com) before making any decisions.

### Expanding Your Mic Collection

I'm constantly amazed at the sound quality of some of the budget Chinese-sourced microphones on the market, but some brands and models are much better

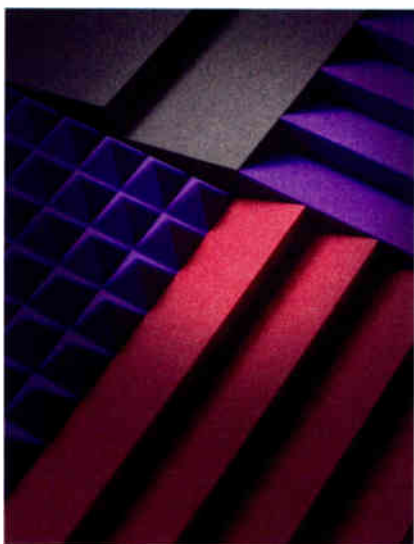

Acoustic foam panels such as these can make a huge difference, and are perhaps one of the cheapest and most effective ways of improving the sound of your studio.

### iDAW

These days, everyone seems to have an iPad, iPhone or other similar i-device, so it was only a matter of time before the ever-expanding App Store began offering products to appeal to music techies.

Whether it's a stand-alone app, or something that integrates with your existing DAW, Apple hit the nail on the head with their slogan: "There's an app for that." There really is!

What makes the apps so great is not only their flexibility, despite their relative simplicity and portability, but also their price. For just a few quid, you can get your hands on a product that offers a range of functionalities similar to existing DAW software. And you can show it off to all your mates when you're on the move!

With the development and success of Apple's series of i-devices, in particular the iPhone and iPad, and the expanding App store, came the inevitable rush of developers producing music-related apps for Apple users to purchase and download. Recognising the demand for such niche products, MOTU developed an iPod/iPhone/iPad controller for DP7 (left). Many indie developers have also tried to break into the scene with more abstract takes on traditional DAWs, such as this iPad music production app called TouchAble (right).

than others. Again, you need to check the reviews to see what is right for your needs and budget. A mic built in the USA or Europe will cost more but, given that microphones have a working life of many decades if cared for, buying a good microphone is never a waste of money. You can never have too many mics! Different models suit different voices or instruments, so you can simply grow your collection as your budget permits.

If you record mainly your own music, it is definitely worth auditioning as many vocal mics as possible to see what suits your voice. Hire them, borrow them or try them in the showroom, but make sure you find some way to hear them before you choose. Sometimes a cheapo model will suit you better than a high-end mic, so try as many mics as you can. On the other hand, if you're working with many different singers, you have the choice of buying one good vocal mic with a fairly neutral character (in the hope that with the aid of a little EQ, it will work pretty well for anything), or buying two or more vocal mics with different characters (one warm

one, and one bright and airy one would be a logical choice).

Where you plan to do a lot of instrument recording, you might consider adding some small-diaphragm condenser mics. It also makes sense to have at least one stereo pair so that you can use them both individually and to make stereo recordings. Cardioid-pattern models are fine for most work, but if you can afford models with interchangeable heads to give you the choice of cardioid or omni working, that will give you more flexibility. Additionally, you'll need some dynamic mics for drums and guitar amps, with a dedicated kick-drum mic to capture those deep lows. While you can buy low-cost drum-mic kits, you do tend to get what you pay for, so don't expect them to sound as good as a better-specified set. If you must settle for an affordable drum mic set, this can be updated later by adding a good kick mic, and maybe some better condenser mics for the overheads.

When you get to the stage where you can afford the odd luxury purchase, consider adding a ribbon mic for recording

electric guitars, bowed strings and other sounds that would benefit from their tonal character. Many of the newer models respond well to EQ, so you can use them anywhere that a smooth-but-warm sound is needed. Ribbon mics used to be expensive and fragile but, although it is still not a good idea to drop one, the modern models seem tougher than their ancestors and are also often much cheaper.

### Accessorize!

It is definitely worth buying high-quality mic stands with metal fittings, as these will last longer than budget models with plastic parts, and should also be more stable because of the extra weight. The last thing you want is for your new vocal mic to hit the floor as the stand topples over! If you record vocals, buy a decent pop filter, and also buy a good shockmount if your mic didn't come with one. Rycote's models are particularly effective and light in weight, so you could do far worse than add a few of those to your upgrade list.

A simple acoustic screen behind the singer and a Reflexion Filter or similar curved screen behind the mic will also make a huge difference (as will an extra duvet or two!).

### Plug-ins

Your DAW may come with many different plug-in types, but will you get a better



Interchangeable-capsule mics provide multiple polar patterns for less than you'd pay for separate mics, and allow you to choose the pattern that best suits the recording

sound if you buy third-party plug-ins? In my experience, the answer isn't always a simple one, though I have found that the better third-party equalisers and compressors generally sound sweeter than the ones in the DAWs I've used. You may also be able to buy a better reverb. While most DAWs include a very capable convolution reverb, some only come with a relatively low-powered synthetic reverb, which could most definitely benefit from an upgrade. Fortunately, many plug-ins are freely available as time-limited demos, so you can try them for yourself before making up your mind.

### Monitoring

Without accurate monitors you can't hope to make accurate mixes, so this is another obvious area in which upgrades can improve your recordings. Choose monitors to suit your room size, and pay attention to the stands or isolation pads you use to mount them, as these also affect the overall sound. Our online reviews at [www.soundonsound.com](http://www.soundonsound.com) will help you find something that fits your budget and your room — but please keep in mind our comments about the acoustic environment in which the speakers are used. If you simply stick good speakers in a rectangular room with bare plaster walls, they're not going to sound good regardless of how much you paid for them. You don't have to make permanent changes to a room to hang up a few acoustic panels: you can improve your room acoustics for a modest

outlay and with minimal disruption, even in a rented flat. Foam panels are light enough to be hung on a single picture nail or a self-adhesive hook, so you don't need to be a DIY whiz to install them.

### Summary

- Upgrade the weakest links in the chain first. Often the room acoustics prevent the rest of the system working at its best so pay attention to this area, even if it only means hanging up a few duvets to dry up the room sound.
- If you can't trust your monitoring system you can't expect to make accurate recordings. Consider the room acoustics and the speakers as being essential parts of the same system, and pay attention to both.
- After room acoustics, microphone choice can make a huge difference and, to a lesser extent, the choice of microphone preamplifier and audio interface. After that you can think about adding plug-ins and maybe a control surface.
- Unless you are 100-percent happy with your system for all present and future needs, expect to need to upgrade your computer every few years, as newer software invariably places higher demands on CPU power, drive capacity and the amount of RAM needed.
- Finally, don't forget to upgrade yourself, by trying the techniques we cover in *Sound On Sound*. Regardless of innovations in studio hardware and software, the most important component is still, and always will be, the engineer. ■■■

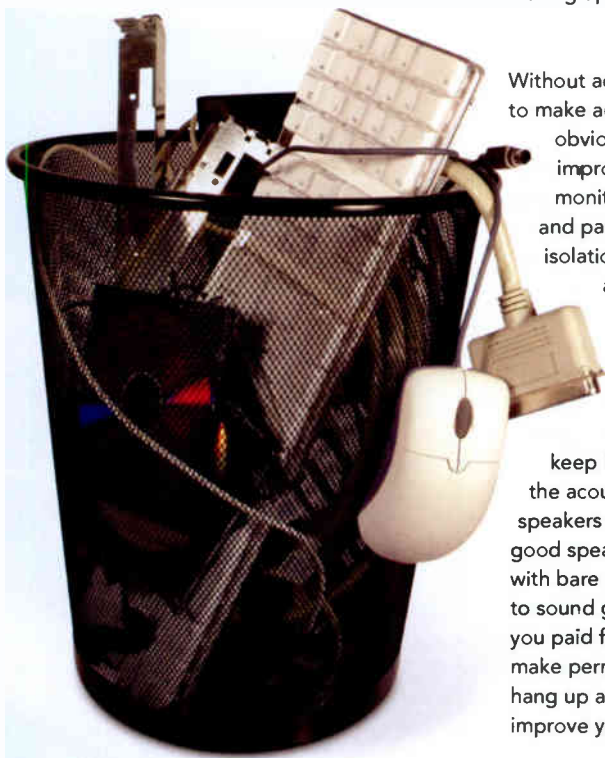

# CAREERS & COURSES

**There are plenty of audio production courses available, but where do you find them and which should you choose?**

**W**hether you're hoping to carve out a career in audio, or are looking to develop your knowledge and skills, this chapter is designed to help you decide if doing a course is the right approach for you. If the answer is 'yes', it will also help you to choose the right course.

You can learn an awful lot about music production from books, magazines (like *SOS*) and online forums, but many people feel there's no substitute for practical, hands-on tuition, and many courses offer exactly this. In this chapter, I'll go through the types of course available at different 'levels', and discuss how to find courses and how they might or might not be right for you.

The advice here applies to the study of audio at any level, not just degree courses. Maybe you're in high school and are considering your next steps; perhaps you're older and want to re-train; or maybe you're already in the process of applying for a degree. At the end of this chapter, there's a directory listing some of the more prominent course providers for you to check out.

## Reality Check

There are several reasons you might be seeking training in audio production, but let's start with the idea that you're training for a career. I'm afraid that

### 'Reading' For A Degree

There's a good reason why they call it 'reading' for a degree! Get hold of your reading list as soon as you can and start devouring the titles listed in it long before you start your course. That way you'll learn a lot and arrive prepared.



this means spelling out an uncomfortable truth: if you're thinking of gaining an 'industry-recognised' qualification that's recognised by 'the industry' then you're in for a shock, and all the more so if you think a 'music technology' diploma or degree will act as a magic passport to a career.

Audio production is a fiercely competitive industry, and music production even more so. In the modern audio industry, almost everyone is self-employed, which means that you're only as good as your recent work (or, more accurately, as good as your clients say you are!). You'll need to compete with lots of audio engineers with impressive CVs and bags of experience, not to mention lesser-known, talented people working for free as they carve out their own reputation.

In short, forging a career in music production is incredibly challenging, and you can't count on making much money any time soon. It's important you're not lulled by course-prospectus marketing into believing that a degree will lead to a job as an engineer — because it probably won't.

If, after reading and digesting all of the above, you still genuinely want to gain a qualification that's recognised by the few remaining large-scale employers in the sector, then you need to be realistic about your chances, and you should read the 'Training For A Career' box in this chapter.

## The Good News!

It's not all doom and gloom! In fact, there's a very positive flipside to all of this. The good news is that if you want to record and mix music — as a career, or as a hobby — then you don't need a qualification, because it's an industry based on talent, hard work and a healthy dollop of luck. For all the talk of recording studio closures,

there is money coming into the recording industry if you know where to look.

When considering a course, the important thing is not simply 'getting qualified', but rather what you can learn, who you can meet, and what opportunities you'll have to develop your skills. If you are considering audio as a career, those skills probably need to include the basics of financial planning, marketing and accounting. Many universities offer modules that cover this sort of thing. I know it's boring, but if you put in the work, you will be glad in the end!

## Types Of Course

Courses aren't all about careers and degrees. What options are there, how do you decide whether they'll meet your needs, and how can you find them? Here's an overview.

### 1. Learning To Use Software

If you're new to music-making with a computer, then it makes sense to get up to speed quickly by taking lessons. Self-starting types can try following a DVD, trawling the web for video tutorials, or reading articles like the regular DAW technique workshops in the monthly *Sound On Sound* magazine. Alternatively, you might learn best from someone else, so you'll get more out of structured courses, or tuition. Some DAW manufacturers, such as Avid, offer their own training

Photo: Karan Mehta, © Leeds Metropolitan University 2010



courses in using their software.

Courses can usually be found in local course directories (such as Floodlight and Hot Courses in the UK). 'Free ads' websites like Gumtree or Craigslist list evening or weekend courses, or one-to-one tuition. Online course providers such as Berklee also offer software-specific tuition, as do many further education colleges. It's also worth asking on the *SOS* Music & Recording Technology forum ([www.soundonsound.com/forum](http://www.soundonsound.com/forum)), as some forum members are happy to provide tuition on an *ad hoc* basis.

## 2. Brushing Up On Your Music Skills

Finding your way around a piece of software is all

very well, but it's no use until you develop general production skills like composing, arranging, recording and mixing. There are plenty of adult and further education courses that'll teach you the basics. Local course directories are a good source of information. Also check college websites for more up-to-date information.

As well as music departments, many colleges will have dedicated adult and community education departments. Some of these offer courses in music and/or music technology at competitive prices, and suit people with day jobs. It might also be worth contacting your council or jobcentre to find out if there are any subsidised course places.

If you're a novice, courses should give you hands-on experience with MIDI keyboards and microphones, teach you some practical basics such as studio wiring, choosing and placing mics, sampling and synthesis, and using a mixing desk (good preparation for using DAWs and EQ).

## Get Stuck In



Don't wait until you're on a course: take every opportunity you can to get some hands-on experience under your belt. The sooner you make your mistakes the sooner you'll learn from them.

Course quality varies according to the staff delivering the training and the facilities available, so it pays to do your research. Ideally, you want the training to take place in a real studio and you want it to be focused on skills, not on specific pieces of software. It's also worth considering the cost of the course. There's nothing to say a cheap course is a bad thing *per se*, but one thing I've noticed is that a course that requires even a modest fee and time commitment generally attracts a more committed type of student. This is important if you're hoping to make the most of your time there or are looking to collaborate with fellow students.

## 3. Remote Learning

An alternative approach, which is becoming increasingly popular in all fields of education, is to enrol »



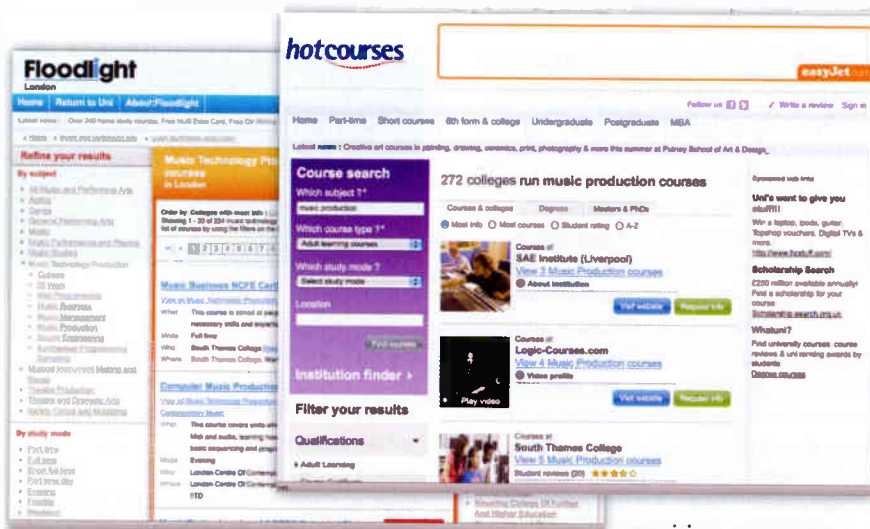

Course directories such as UK-based sites Floodlight (left) and Hot Courses (right) offer lists of appropriate courses.

» with an online course provider. It's easy to dismiss the idea as a bad one, by making the assumption that the lack of human interaction will be a problem. In fact, this option offers some advantages, and is genuinely worth investigating.

Some institutions offer excellent courses where the majority of the support material is delivered online, but real-life, experienced tutors set genuine assignments, mark them and give you constructive feedback. Perhaps the best-known courses are by Berklee ([www.berkleeemusic.com](http://www.berkleeemusic.com)), who offer a broad range of courses for would-be

musicians, composers and producers.

ThinkSpace ([www.thinkspaceonline.com](http://www.thinkspaceonline.com)) also offer training specifically targeted at creating commercial-quality music for the media. There are similar online courses for related disciplines like music and electronic engineering.

At first sight, such courses may not look particularly cheap, given the lower cost involved in online delivery. However,

technology course of some kind.

Before you set your heart on studying for a diploma, or reading for a degree, make sure that it really is what you want. You need to consider that it's a big financial commitment to study for a degree. A typical bachelor's degree lasts for three years, and you'll have to pay fees and living expenses during that time.

One of the benefits of a degree is that it has to meet certain academic requirements. The idea of 'set standards' is great, but there is a flipside. Degrees require a certain amount of academic attainment. They have entry requirements, and you'll be expected to do research and write essays. In short, it won't all be working in the studio.

Another benefit that you need to consider is that the universities that run and/or accredit these courses invest in facilities and further developing the courses. That's got to be good, right? But if your course fees subsidise the university's latest purchase of Neve consoles, it's only useful if you plan to use them in the future. If, however, your

## "The important thing is not simply 'getting qualified' but rather what you can learn."

the costs are usually justified in relation to more traditional courses at the same level. They're just as structured and labour-intensive as most degrees or diplomas, and they're also more flexible than traditional courses — not least in terms of being able to fit your studies around your job, or giving you access to something that is not available in your area. Finally, the same technology that makes these courses deliverable online also means that students are able to collaborate remotely. In fact, an increasing number of people operate online in the music industry. The contacts you develop on online courses can be just as valuable as those made elsewhere.

### 4. Degrees & Diplomas

A number of institutions are dedicated to delivering audio and other media courses. The School of Audio Engineering (SAE) is probably the best-known example worldwide, but there are plenty of others, and music production courses aren't limited to specialist institutions — most universities and colleges offer a music

main interest is composition, synthesis and sound design, or you plan to operate as a mix engineer working largely 'in the box', you should question whether you're going to get good value from that particular course.

As a final thought, I've always felt that three years can be a long time to study for a degree for anyone who already has some experience. It's possible to do the same work in a shorter time period. Some institutions offer 'condensed' two-year degrees, so it's worth researching.

### 5. Postgraduate Courses

A number of institutions also offer postgraduate degrees and even doctorates.

For a master's degree, you'll be expected to have a suitable first degree or equivalent experience. If you have a degree and relevant experience of playing and recording music you should stand a good chance.

But what more does a master's degree offer than a bachelor's degree? Usually, it will offer more access to the studio



## Have Confidence

+

It's not unusual for people to lack confidence in their abilities when they start a course. If that sounds like you, I'm afraid you have to get over it. The more you meet people and collaborate, and the more mistakes you make along the way, the more you'll get out of your course.

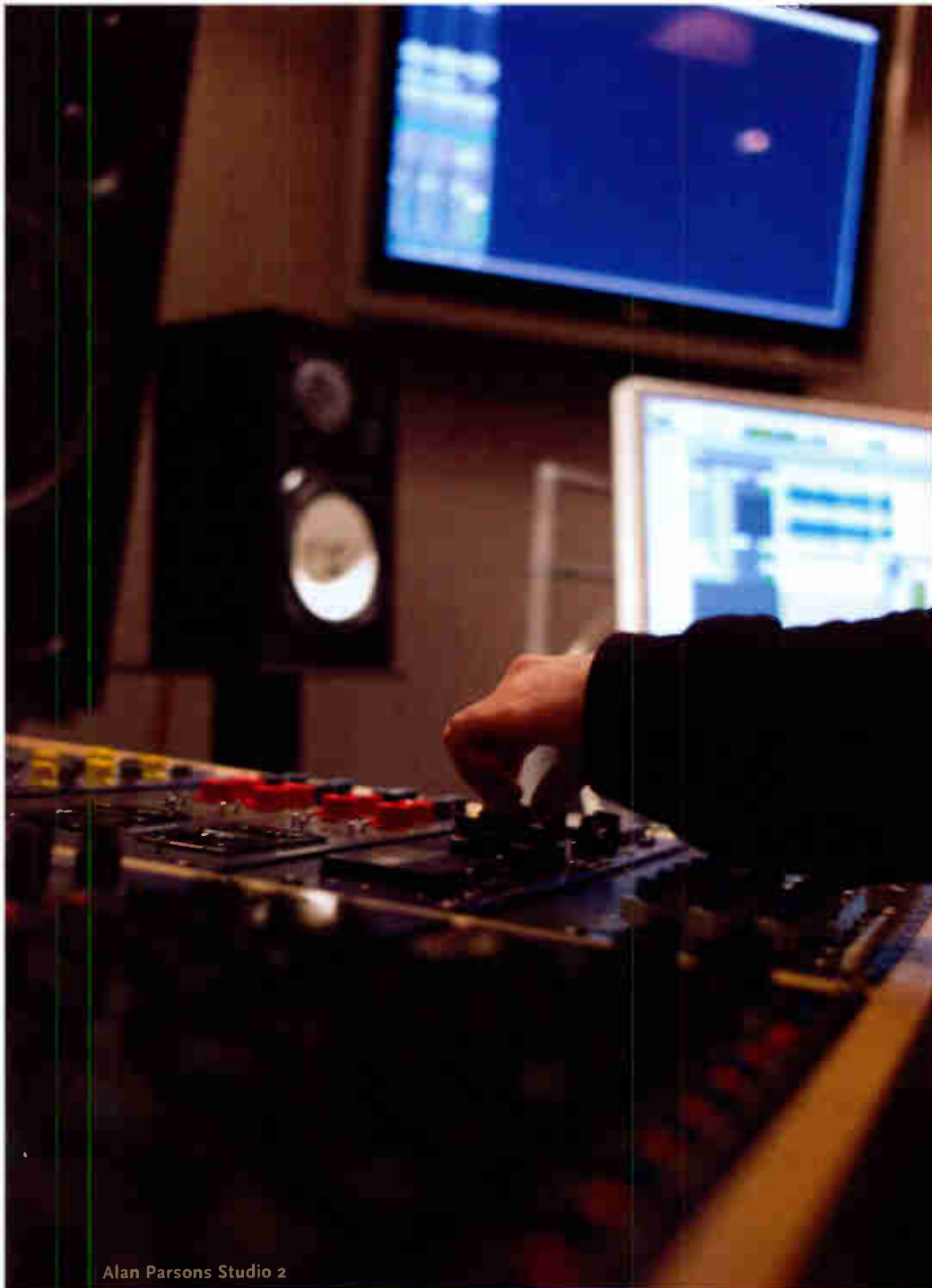

Alan Parsons Studio 2

“Everything you see or hear, every device you hold or app you buy that makes some sort of noise—that’s a potential job.”

—John Scanlon, Program Director, Sound Arts

## Learn more at [expression.edu](http://expression.edu)

The Alan Parsons Studio 2 is one of 40+ rooms devoted to audio at Ex'pression College, including 7 recording studios, 24 audio production suites, and a live music venue.

Offering Bachelor's Degrees in:

- Sound Arts
- Interactive Audio

Learn the principles of audio production, mixing and recording. Earn your Bachelor's Degree in just over 2.5 years.

Accredited by the Accrediting Commission of Career Schools and Colleges (ACCSC).

World Radio History



**ex'pression**  
COLLEGE FOR DIGITAL ARTS

1-877-833-8800 toll free  
6601 Shellmound St.,  
Emeryville, CA 94608

» facilities, it might offer you collaborative opportunities with students at other institutions — some London universities link up with filmmakers and animators from the Royal College of Arts, for example — and, most importantly, the final project should be more stretching. A master's degree is typically a year long (full-time) or two years (part-time). Course fees are high compared with bachelor's degrees, but the shorter duration means you pay less for your living costs!

As far as doctorates are concerned, you'll already have gone through at least a degree, if not a master's degree, before you contemplate doing a doctorate. They are very academic and research-based, and are not just another step up the practical education ladder.

### Question Time

To decide if a course is right for you, think about what you want from it and how you learn best. From there, you'll be able to start considering questions to ask yourself and course providers so that you can narrow down your choices. Here are some example questions to help you focus your mind:

#### **Why do I want to do a course?**

Think hard about what you want to learn. Most courses offer modules in various aspects of production, but they'll often tend to focus on one area. Read course descriptions carefully, and ask tutors for specific details about the content.

Remember that it's not a crime to

Some music technology institutions offer 'workstation' facilities to their students, usually including computers equipped with DAW software, a MIDI controller, and speakers (or headphones). These workstations might be in isolated booths, in an open-plan classroom, or separate from the main teaching spaces.



Photo: Courtesy of SAE Institute

change your mind. A lot of people who start out chasing the 'glamour' of being a music producer find they actually prefer working with audio or music for picture, or radio production. It's important to know what you like, and where your talents lie.

#### **What equipment do I need before I start?**

You'll probably need a decent laptop, a DAW, and a portable hard drive that you can use with the institution's studio and library IT systems. Before you buy a fancy new system, though, remember that some courses will be able to get you educational discounts on a range of equipment, so don't rush into a purchase. On a practical note, it is worth making sure you have a broadband Internet connection if you plan to be working or collaborating online. Also get hold of your reading list long before you start (shop around to get the best prices), and then read the books,

rather than letting them pick up dust on the shelves!

#### **How much money can I invest in a course?**

Some courses are as cheap as chips, and some are very expensive. Even if you're ambitious, it may be a good option to start with some basics on a more affordable course and build on that later, whether that be on another course, on building your home studio, or hiring professional facilities. You might find that the pricier (within reason) the course, the more committed your fellow students are. A few hundred dollars spent on a course rather than a few tens may serve you better.

#### **How much time do I want to devote to my audio education?**

Do you only have a spare evening each week, or perhaps at weekends? Maybe you have a spare few weeks in the summer to do something more intensive, or perhaps you can afford the time and money to go through a full three-year degree? And if you do have plenty of spare time, maybe you'd be better off studying for part of it, and then setting more time aside to practise. This is one for you to decide, but you need to be realistic and decide whether you need a short course, a long and formal course, or something more flexible.

#### **How skilled and experienced am I really?**

Do you know a lot about recording and production already? If you're considering an advanced course, it's a fair bet that you've got some experience. It's a good idea to ensure a course will stretch you, rather than simply reaffirm what you already know.

You need to be honest with yourself: there's no shame in going on a beginners' course if it's what you really need; and

»

## Training For A Career

There are only a few courses worldwide that offer an industry-recognised audio qualification, and they all offer something more tightly defined than 'Music Technology' or 'Music Production'. They tend to be more engineering-orientated as well: it's no coincidence, for example, that the Tonmeister course (regarded as the leading audio course in Europe), has entry requirements including attainment in both music and science disciplines.

There are also more specific qualifications which might be worth considering. You can find courses in acoustics and psychoacoustics, electronics engineering, or software development, for example. These academic qualifications are useful in service, technology and manufacturing industries that support music production.

Alternatively, if the idea of

a science-based qualification puts you off, you could do worse than studying for a degree in 'music'. This is a better preparation for general music production than anything else, as you'll learn a lot more about composition, arrangement and instrumentation, and learn how to work and communicate with musicians. What's more, you'll also meet talented musicians on your course, with whom you can develop relationships that will last many years!

If you manage to secure a place on one of these more prestigious courses, your chances of successfully applying for grants and scholarships may be higher. Institutions such as the AES and individual universities may offer scholarships. Bear in mind that competition for these will be fierce, though. I'll leave you with your library and the Internet to do more research into sources of funding!



# WE'VE GOT THE GEAR. YOU'VE GOT THE POTENTIAL.

**M**  
mcnallysmith  
COLLEGE of MUSIC

## Pro Tools, mixing, and multi-media labs.

Ten on-campus recording studios.  
A world-class faculty covering all  
parts of the music industry.  
All we're missing is *you*.

Imagine a music college that encompasses all aspects  
of the music industry in one place. You can study music  
business, audio recording, music production, live sound,  
composition, or popular music performance with your  
instrument of choice – guitar, bass, drums, keyboard,  
voice, brass, woodwinds and strings.

## A NASM Accredited College:

- Contemporary Music
- Industry Connections
- Ensembles
- Bachelors
- Associates
- Diplomas



Ten On-Campus Recording Studios



Two On-Campus SSL Mixing Boards

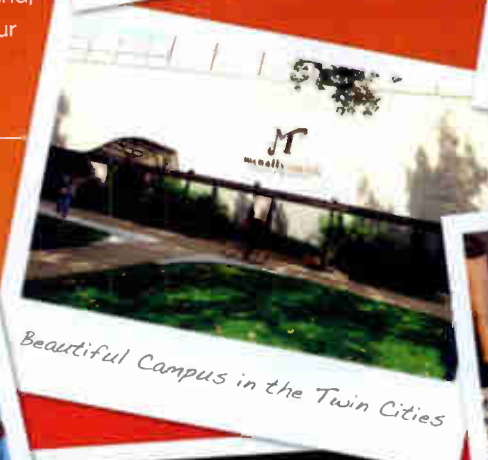

Beautiful Campus in the Twin Cities

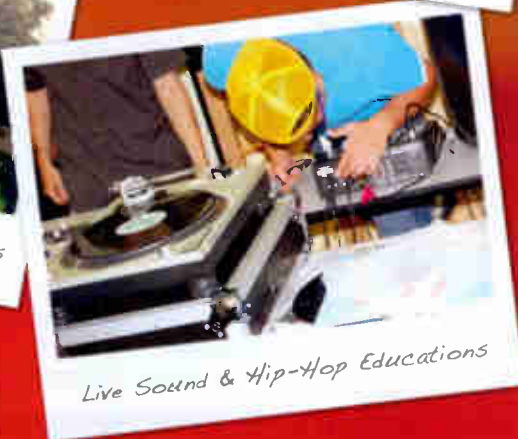

Live Sound & Hip-Hop Educations

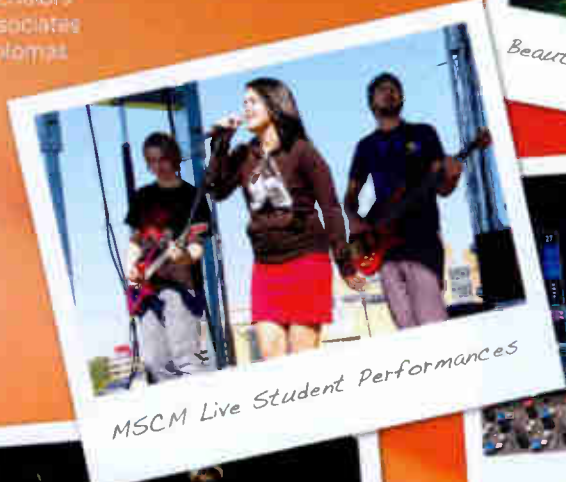

MSCM Live Student Performances



Multiple On-Campus MIDI Labs



Hands-on Music Business Classes

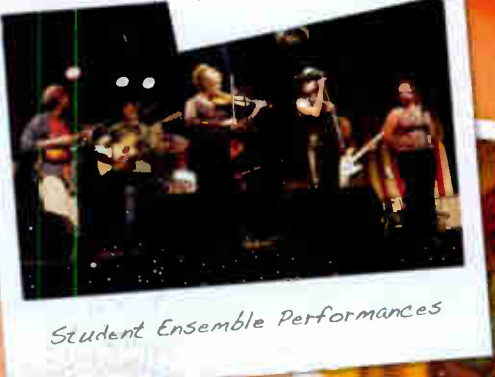

Student Ensemble Performances



MSCM Hip-Hop Diploma Program

## IT'S ALL ABOUT THE MUSIC!



Follow us on Twitter, Facebook, Flickr, YouTube  
& MSCM Blogs, check out [blog.mcnallysmith.edu](http://blog.mcnallysmith.edu)

→ visit [mcnallysmith.edu](http://mcnallysmith.edu)

World Radio History

19 Exchange Street East  
Saint Paul, Minnesota 55101

p: 651.291.0177  
info@mcnallysmith.edu

WWW.MCNALLYSMITH.EDU

» there's no point trying to get on a master's degree course if you don't know the basics.

**How far am I prepared to travel?**

Unless you live in or near a major city, it's likely that you won't have your pick of the best courses. There's certainly more choice in London than Derby, or LA than Smallville or wherever. This might be a factor in deciding whether to opt for an online course or one-to-one tuition.

It's not just the course itself you need to think about. You should also investigate nearby opportunities (extra-curricular activities, collaboration) for gaining experience while on the course to enhance your learning or subsequent career. It might be that there are loads of live venues where you can get some hands-on experience, and scout for good bands with whom to collaborate as a producer, for example. Think not just of the location of an institution in educational terms, but also the potential the local area offers you.

**Do I work better in a classroom or in a real-world situation? Do I prefer group work or one-to-one tuition?**

This question's a no-brainer, really, but you'd be surprised at how many people fail to consider how best they learn. Think about which subjects and projects appealed to you at school and why. It's not

necessarily just the subject matter. Were you working on your own, or with other people? Did you have a lot of direction and support from your teachers? Did you only get the best out of yourself when there were peers to learn from or compete with?

**Am I good at absorbing technical information and theory, or am I better diving in and learning from hands-on experience?**

Bear in mind that most degrees will require

**“Music production courses aren't limited to specialist institutions — most universities and colleges offer a music technology course of some kind.”**

you to demonstrate an academic approach. If that puts you off, maybe you'd be better looking at a different type of training. But if you're strong on the theory and technical, then you need to make a strong effort to do some practical work — it's the best way to make sense of all that information!

**Who teaches on the course?**

You might be dazzled by the names that are referenced on a website, but try to find out how lessons are delivered. Does a course bring in guest lecturers and, if so,

**Try Everything** 

You might think you know what you want to do, but unless you try other things you'll never know. Maybe radio drama production or foley is more up your street than you think!

of what calibre and experience? Are they academics or 'practitioners'? The more people with industry experience that teach, speak, and do Q&A sessions on a course, the better.

**When You're On A Course**

Let's assume it's all gone well and you've made it on to your chosen course. If it's a short course, I'd recommend going to it all and lapping up every bit of information you can.

However, if you're on a degree, here's a bit of controversial advice: you don't need to go to every lecture. This doesn't mean that you can slack off whenever you like. Remember that the piece of paper you get at the end means nowhere near as much as what you learn and what you experience.

In my book, if you miss one or two lectures on a subject you feel confident in to enable you to put time in to a real session, applying your knowledge and learning from your mistakes then it's worthwhile. You could even talk to your tutors about projects forming part of your learning plan — that way they'll see that you're committed and not just bunking, so they'll be more likely to give you help and support when you need it!

**What To Do Now**

You might not want to start your course for a while, or you may be thinking of enrolling very soon. Either way, it's a good idea to start putting out feelers. Most courses have 'cut-off dates' for applications, meaning they will not accept any for the next academic year past a certain date. These are often earlier than you'd think!

Universities and colleges will be more than happy to forward you a copy of their glossy prospectus. More often than not, you can find the information you need online on individual institutions' websites. You could even ask for a tour of the institution's facilities! 



Make sure you take full advantage of the facilities on offer to you. Your institution should give you access to recording studios — either on site or at an external location.



NEXT TERM BEGINS JANUARY 11TH

# LEARN MUSIC PRODUCTION ONLINE WITH BERKLEE

Improve your skills as producer, audio engineer, or live sound professional with Berkleemusic, the online school of Berklee College of Music. Study Berklee's renowned techniques for creating professional-sounding music with the most current software applications available—from anywhere in the world!

## MAKE BETTER MUSIC

With Our Extensive Online Curriculum

- Recording and Producing
- Mixing and Mastering
- Critical Listening
- Live Sound
- Home Studio Production
- Game Audio
- Songwriting for Film & TV
- Orchestration



PRO TOOLS



CONTACT OUR STUDENT ADVISORS TODAY **1-866-BERKLEE** OR **BERKLEEMUSIC.COM**

## Selected Course Directory

### United Kingdom

The **Music Producer's Guild (MPG)** and the **Association of Professional Recording Services (APRS)** run a scheme called **JAMES**, which accredits a number of education courses in the UK. MPG also run the 'Mic To Master' training workshops tour.  
[www.jamesonline.org.uk](http://www.jamesonline.org.uk)  
[www.mpg.org.uk](http://www.mpg.org.uk)

**Alchimea College of Audio Engineering**  
 Offer a range of courses from weekend sessions to full diplomas.  
[www.alchimea.com](http://www.alchimea.com)

**Deep Blue Sound, Plymouth**  
 Offer a range of courses and tuition packages up to degree level. Includes JAMES-accredited courses.  
<http://dbsmusic.co.uk>

**Goldsmiths, University of London**  
 Offer a range of courses up to postgraduate level including electroacoustic music composition. They also offer courses via their PACE (Professional And Community Education) department.  
[www.gold.ac.uk](http://www.gold.ac.uk)

**Leeds College of Music**  
 Offer a range of courses from foundation to postgraduate level in music technology.  
[www.lcm.ac.uk](http://www.lcm.ac.uk)

**Leeds Metropolitan University**  
 Offer a range of courses to degree and postgraduate level. Includes JAMES-accredited courses.  
[www.lmu.ac.uk](http://www.lmu.ac.uk)

**Liverpool Institute for Performing Arts (LIPA)**  
 LIPA offer degrees in sound technology and music, as well a range of courses in the performing arts.  
[www.lipa.ac.uk](http://www.lipa.ac.uk)

**London School of Sound**  
 Intensive, hands-on course with small class sizes in the Britannia Row studios in London.  
[www.londonschoolofsound.co.uk](http://www.londonschoolofsound.co.uk)

**Point Blank**  
 Courses range from summer school to two-year diplomas in subjects including radio production and music business.  
[www.pointblanklondon.com](http://www.pointblanklondon.com)

**School of Audio Engineering (SAE) Institute**  
 SAE have many campuses in the UK, and offer courses up to postgraduate level.  
[www.sae.edu](http://www.sae.edu)

**Thames Valley University**  
 Courses up to postgraduate level.  
[www.tvu.ac.uk](http://www.tvu.ac.uk)

**University of Salford**  
 Courses from foundation to postgraduate level. Includes JAMES-accredited courses.  
[www.smmp.salford.ac.uk](http://www.smmp.salford.ac.uk)

**University of Southampton, Institute of Sound Vibration & Research**  
 A specialist provider: one of the world's leading acoustics research centres.  
[www.isvr.soton.ac.uk](http://www.isvr.soton.ac.uk)

**University of Surrey, Institute of Sound Recording**  
 Offers UK Tonmeister course and others.  
[www.surrey.ac.uk/msr/iosr](http://www.surrey.ac.uk/msr/iosr)

**University of Westminster**  
 Performance, production and music business courses at degree and postgraduate level. Includes JAMES-accredited courses.  
[www.westminster.ac.uk/schools/media/music](http://www.westminster.ac.uk/schools/media/music)

### North America

**SAE Institute**  
 SAE (see UK entry) have several US campuses, including in Nashville.  
[www.sae.edu](http://www.sae.edu)

**Full Sail University**  
 Wide range of courses to degree level in audio and associated sectors (eg. games).  
[www.fullsail.edu](http://www.fullsail.edu)

**Berklee College of Music**  
 Offer summer courses, degree level courses, and online courses for which they're famous.  
[www.berklee.edu](http://www.berklee.edu)

**Conservatory of Recording Arts, Arizona**  
 Cover a range of disciplines, including live sound and career management.  
[www.audiorecordingschool.com](http://www.audiorecordingschool.com)

**Los Angeles Recording School**  
 Courses in audio, film and recording arts.  
[www.recordingcareer.com/home.html](http://www.recordingcareer.com/home.html)

**McNally Smith College of Music, Minnesota**  
 Courses to degree and postgraduate level.  
[www.mcnallysmith.edu](http://www.mcnallysmith.edu)

**New York University (NYU)**  
 Offer a range of courses in music, music technology and music composition.  
[www.nyu.edu](http://www.nyu.edu)

**Pyramid**  
 San Francisco-based courses in audio.  
[www.pyramid.com](http://www.pyramid.com)

**Ex'pression College For Digital Arts**  
 Offer a range of courses to degree level in recording, production and creative arts.  
[www.expression.edu](http://www.expression.edu)

### Worldwide

**SAE Institute**  
 SAE (see UK entry) have campuses in several countries.  
[www.sae.edu](http://www.sae.edu)

**Tonmeister (Germany)**  
 The German Tonmeister is an established qualification, offered at a number of universities in Germany.

**JMC Academy (Australia)**  
 Offer courses in audio up to degree level.  
[www.jmccademy.edu.au](http://www.jmccademy.edu.au)

### Online Course Providers

**Berklee College of Music**  
 Offer a huge range of music, music technology and production courses.  
[www.berkleemusic.com](http://www.berkleemusic.com)

**ThinkSpace**  
 (Formerly 'Music For The Media'). Online courses aimed largely at composition for film, TV and other visual media.  
[www.thinkspaceonline.com](http://www.thinkspaceonline.com)

**SAE Institute**  
 Some online courses offered.  
<http://online.sae.edu/>

**The Open University**  
 The UK's original distance learning university offers a number of music courses.  
[www.open.ac.uk](http://www.open.ac.uk)

**Point Blank Online**  
 Offers a range of online courses from a month to 36 weeks in length.  
[www.pointblankonline.net](http://www.pointblankonline.net)

Check out the education section on the *Sound On Sound* website for further information on institutions offering music technology courses.  
[www.soundonsound.com/education](http://www.soundonsound.com/education)

# GLOSSARY

## **ADAT**

Best known today as a widely used optical digital audio transfer format, 'ADAT Lightpipe' was developed by Alesis for the company's digital eight-track tape machines in the early '90s (Alesis Digital Audio Tape).

ADAT transfers up to eight channels of 24-bit digital audio at base sample rates (44.1 or 48 kHz) via a single fibre-optic cable, physically identical to that used for the Toslink optical S/PDIF stereo interface found on many digital consumer hi-fi devices. The interface incorporates embedded word and bit clocks, and padding zeros are introduced automatically if digital word lengths lower than 24 bits are being transmitted.

## **Amp/Amplifier**

An amplifier is an electrical device that increases the voltage or power of an electrical signal. The amount of amplification can be specified as a multiplication factor (eg. x10) or in decibels (eg. 20dB).

## **Analogue (see also Digital)**

The origin of the term is that the electrical audio signal inside a piece of equipment can be thought of as being 'analogous' to the original acoustic signal. Analogue circuitry uses a continually changing voltage or current to represent the audio signal.

## **Arming (eg. for recording)**

Arming a track or channel on a recording device places it in a condition where it is ready to record audio when the system is placed in record mode. Unarmed tracks won't record audio even if the system is in record mode. When a track is armed, the system monitoring usually auditions the input signal throughout the recording, whereas unarmed tracks usually replay any previously recorded audio.

## **Audio Interface**

A device which acts as the physical bridge between a computer's audio software and the external recording environment. An audio interface usually connects to the computer via PCI, PCIe, Firewire or USB to

pass audio (and sometimes MIDI) data to and from the computer. Audio interfaces are available with a wide variety of different facilities including microphone preamps, DI inputs, analogue line inputs, ADAT or S/PDIF digital inputs, analogue line and digital outputs, headphone outputs, and so on. The smallest audio interfaces provide just a single channel in and two out, while the largest may offer 30 or more each way.

## **Automation (eg. of faders)**

Automation refers to the ability of a system to store and reproduce a set of control parameters in real time. Fader automation is a system involving moving faders (virtual or physical) in which adjustments made by the user are recorded and can be reproduced in exactly the same way at a later time, or modified if necessary. Most modern DAW software allows all fader, mute, routing and plug-in parameters to be automated.

## **Auxiliary Send/Aux Send**

A separate output signal derived from a mixer channel, usually with the option to select a pre- or post-fader source and to adjust the level. Corresponding auxiliary sends from all channels are bussed together before being made available to feed an internal signal processor or external physical output. Auxiliary sends are often used either to feed effects such as reverb, or to create alternative mixes for performers.

## **Balanced/Unbalanced Cables**

Most audio gear operates internally with unbalanced signals sent via single-core screened cables. The signal voltage is passed on the inner core and a 0V (ground) reference is conveyed by the outer screen (an all-encompassing metal or conductive plastic braid). The screen 'catches' radio frequency interference (RFI) and prevents it from influencing the audio signal.

For greater protection from electromagnetic interference and freedom from earth references, a balanced interface is used. 'Balanced' refers to identical impedances to ground from each of two signal-carrying conductors, which are

enclosed in an all-embracing grounded screen. The screen plays no part in passing the audio signal or providing a voltage reference. Instead, the two signal wires provide the reference voltage for each other.

Signals conveyed over the balanced interface may appear as equal half-level voltages with opposite polarities on each signal wire. However, modern systems are increasingly using a single-sided approach, where one wire carries the entire signal voltage and the other a ground reference. An advantage of this is less complicated balanced driver stages. The connection to an unbalanced destination still provides the correct signal level, yet the interference-rejection properties are unaffected. For interface balancing to provide effective interference rejection, both the sending and receiving devices must have balanced output and input stages respectively.

## **Bit Rate**

The number of data bits replayed or transferred in a given period of time (normally one second), normally expressed in terms of kbps (kilobits per second) or Mbps (megabits per second). The bit rate of a standard CD is (2 channels x 16 bits per sample x 44.1 thousand samples per second) = 1411.2kbps. Popular MP3 file-format bit rates range from 128 to 320 kbps, while the Dolby Digital 5.1 surround soundtrack on a DVD-Video disc typically ranges between 384 and 448 kbps.

## **Buffer (computer memory & processing)**

Essentially a short-term data-storage facility used to accommodate variable data read or write periods, temporarily storing data in sequence until it can be processed or transferred by or to some other part of the system.

## **Channel**

A portion of an audio system dedicated to accommodating a single audio signal. Normally used in the context of an audio mixer, where each channel provides a range of facilities to process a single audio signal (gain, EQ, aux sends, fader etc). A hardware >>

» mixer might incorporate 6, 12, 32 or more channels, whereas software mixers are often limited in size only by computer power.

### Click Track

A rhythmic audio signal, often comprising clicks or pops, intended as an audible cue to assist musicians in keeping accurate time during a performance. It is the audible equivalent of visual guides to a painter, and would not normally be heard by the audience.

### Clipping

When an audio signal is allowed to overload the system conveying it, clipping is said to have occurred, and severe distortion results. The 'clipping point' is reached when the audio system can no longer accommodate the signal amplitude — either because an analogue signal voltage nears or exceeds the circuitry's power supply voltage, or because a digital sample amplitude exceeds the quantiser's number range. In both cases, the signal peaks are 'clipped' because the system can't support the peak excursions. In an analogue system, clipping produces strong harmonic distortion artifacts at frequencies above the fundamental. In a digital system those high-frequency harmonics cause aliasing, which results in harmonic distortion where the distortion artifacts reproduce at frequencies below the source fundamental. This is why digital clipping sounds so unlike analogue clipping, and is far more unpleasant and less musical.

### Clocking

The process of controlling the sample rate of one digital device with an external clock signal derived from another device. In a conventional digital system there must be only one master clock device, with everything else 'clocked' or 'slaved' from that master.

### Comping

The process of recording the same performance (eg. a lead vocal) several times on multiple tracks, and choosing the best sections to assemble a 'compilation' performance to be constructed on a final track.

### Compressor

A device (analogue or digital) that is designed to reduce the overall dynamic range of a complex varying audio signal by detecting when that signal exceeds a defined threshold level, and then reducing the amplitude of that portion of signal

according to a defined ratio. The speed of response and recovery can usually also be controlled.

### Converter

A device that transcodes audio signals between the analogue and digital domains. An analogue-to-digital (A-D) converter accepts an analogue signal and converts it to a digital format, while a digital-to-analogue (D-A) converter does the reverse. The sample rate and word length of the digital format are often adjustable, as is the relative amplitude of analogue signal for a given digital level.

### CPU

Central Processing Unit: the number-crunching heart of a computer or other data processor. It may contain one or more processing cores.

### Daisy Chain

An arrangement for sharing a common data signal between multiple devices. A 'daisy chain' is created by connecting either an output or 'thru' port of one device to the input of the next. This configuration is often used for connecting multiple MIDI instruments together: the MIDI Out of the master device is connected to the MIDI In of the first slave, then the MIDI Thru of the first slave is connected to the MIDI In of the second slave, and so on... A similar arrangement is often used to share a master word-clock sample-synchronising signal between digital devices.

### DAW

Digital Audio Workstation: originally applied to any integrated digital production tool, including hardware, this term now more commonly refers only to elaborate software running on a bespoke or generic computer platform, which is designed to replicate the processes involved in recording, replaying, mixing and processing real or virtual audio signals. Many modern DAWs incorporate MIDI sequencing facilities as well as audio manipulation and a range of effects and sound generation.

### Delay

(1) The time between a sound or control signal being generated and it being auditioned or taking effect, measured in seconds or milliseconds. Often referred to as latency in the context of computer audio interfaces. (2) An echo effect, commonly used on vocals and instruments in mixing.

### DI Box

Direct Injection Box: a device that accepts the signal input from a guitar, bass, or keyboard and conditions it to conform to the requirements of a microphone signal at the output. The output is balanced and with a low source impedance, capable of driving long mic cables. There is usually a facility to break the ground continuity between mic cable and source to avoid unwanted ground-loop noises. Both active and passive versions are available, the former requiring power from internal batteries or phantom power via the mic cable. Active DI boxes usually have higher input impedances than passive types, and are generally considered to sound better.

### Digital

#### (see also Analogue)

Digital audio circuitry uses discrete voltages or currents to represent the audio signal at specific moments in time (samples). A properly engineered digital system has infinite resolution, the same as an analogue system, but the audio bandwidth is restricted by the sample rate, and the signal-to-noise ratio (or dynamic range) is restricted by the word length.

### Editing

The process of changing a MIDI or audio performance after it has been recorded, for instance to correct timing problems. Once, audio recordings were edited by chopping up the magnetic tape on which they were recorded; nowadays, all DAWs provide 'non-destructive' editing tools for digital audio.

### Equaliser

#### (see also Filter)

A device which allows the user to equalise, balance or adjust the tonality of a sound source. Equalisers are available in the form of filters, shelf equalisers, parametric equalisers and graphic equalisers — or as a combination of these basic forms.

### Filter

#### (see also Equaliser)

Filters remove unwanted parts of the spectrum above or below a turnover frequency, and the rate of attenuation versus frequency is called the filter's slope. A high-pass (or low-cut) filter removes frequencies below the turnover frequency and usually has a slope of 6, 12 or 18 dB/octave.

### Firewire

A computer interface format based upon the IEEE 1394 standard and named Firewire

by Apple computers (Sony's i.Link format is also the same interface). Firewire is a serial interface used for high-speed isochronous data transfer, including audio and video. Firewire 400 (IEEE 1394-1995 and IEEE 1394a-2000) or S400 interface transfers data at up to 400Mbps and can operate over cables up to 4.5m in length. The standard 'alpha' connector is available in four and six-connector versions, the latter able to provide power (up to 25V and 8W).

The Firewire 800 format (IEEE 1394b-2002) or S800 interface uses a nine-wire 'beta' connector and can convey data at up to 800Mbps.

### **Flash Drive (see also Solid-state Drive)**

A large-capacity solid-state memory configured to work like a conventional hard drive. Used in digital cameras and audio recorders in formats such as SD and CF2 cards, as well as in 'pen drives' or 'USB memory sticks'. Some computers are now available with solid-state flash drives instead of normal internal hard drives.

### **General MIDI (GM)**

A universally agreed subset of the MIDI standard, created to enable manufacturers to build synthesizers, synth modules and plug-in instruments that exhibit an agreed minimum degree of compatibility.

### **Ground Loop & Ground-loop Hum**

A condition created when two or more devices are interconnected in such a way that a loop is created in the ground circuit. This can result in audible hums or buzzes in analogue equipment, or unreliable or glitchy audio in digital equipment. Typically, a ground loop is created when two devices are connected together using one or more screened audio cables, and both units are also plugged into the mains supply using safety ground connections via the plug's earth pin. The loop is from one mains plug, to the first device, through the audio cable screen to the second device, back to the mains supply via the second mains plug, and round to the first device via the building's power wiring. If the two mains socket grounds happen to be at slightly different voltages (which is not unusual), a small current will flow around the ground loop. Although not dangerous, this can result in audible hums or buzzes in poorly designed equipment.

Ground loops can often be prevented by ensuring that the connected audio

equipment is plugged into the same socket or mains distribution board, thus minimising the loop. In extreme cases it may be necessary to disconnect the screen connection at one end of the audio cables or use audio isolating transformers in the signal paths. The mains-plug earth connection must NEVER be disconnected to try to resolve a ground-loop problem, as this will render the equipment potentially LETHAL.

### **GUI**

Graphical User Interface (GUI is often pronounced 'Gooney'): a software designer's way of creating an intuitive visual operating environment controlled by a mouse-driven pointer or similar.

### **Hard Disk Drive (see also Solid-state Drive)**

The conventional means of computer data storage, consisting of one or more metal disks (hard disks) hermetically sealed in an enclosure with integral drive electronics and interfacing. The disks are coated in a magnetic material and spun at high speed (typically 7200rpm or more for audio applications). A series of movable arms carrying miniature magnetic heads is arranged to move closely over the surface of the discs to record (write) and replay (read) data.

### **Headroom**

The available 'safety margin' in audio equipment required to accommodate unexpected loud audio transient signals. It is defined as the region between the nominal operating level (0VU) and the clipping point. High-quality analogue audio mixers or processors will have a nominal operating level of +4dBu and a clipping point of +24dBu, providing 20dB of headroom. Analogue meters don't show the headroom margin at all; in contrast, digital systems normally do — hence the need to restrict signal levels to average -20dBFS when tracking and mixing with digital systems to maintain sensible headroom. Fully post-produced signals no longer require headroom as the peak signal level is known and controlled. For this reason it has become normal to create CDs with zero headroom.

### **Hub**

Normally used in the context of the USB computer data interface. A hub is a device used to expand a single USB port into several, enabling the connection of multiple devices. Particularly useful

where multiple software program-authorisation dongles must be connected to the computer.

### **Impedance**

The 'resistance' or opposition of a medium to a change of state, often in the context of electrical connections or acoustic treatment. Signal sources have an output impedance and destinations have an input impedance. In analogue audio systems the usual arrangement is to source from a very low impedance and feed a destination of a much higher (typically 10 times) impedance. This is called a 'voltage matching' interface. In digital and video systems it is more normal to find 'matched impedance' interfacing where the source, destination and cable all have the same impedance (eg. 75Ω in the case of S/PDIF).

Microphones have a very low output impedance of 150Ω or so, while microphone preamps provide an input impedance of 1500Ω or more. Line inputs typically have an impedance of 10,000Ω and DI boxes may provide an input impedance of as much as 1,000,000Ω to suit the relatively high output impedance of typical guitar pickups.

### **Insert Point**

The provision on a mixing console or 'channel strip' processor of a facility to break into the signal path through the unit to insert an external processor. Budget devices generally use a single connection (usually a TRS jack socket) with unbalanced send and return signals on separate contacts, requiring a splitter or Y-cable to provide separate send (input to the external device) and return (output from external device) connections. High-end units tend to provide separate balanced send and return connections.

### **Latency (see also Delay)**

The time delay experienced between a sound or control signal being generated and it being auditioned or taking effect, measured in (milli)seconds.

### **Limiter**

An automatic gain-control device used to restrict the dynamic range of an audio signal. A limiter is a form of compressor optimised to control brief, high-level transients.

### **Loop**

A small section of audio that is played over and over again, usually from a digital sampler or within a DAW.

»

» **Loudspeaker**  
(see also **Monitor**)

A device used to convert an electrical audio signal into an acoustic sound wave.

**MIDI**

Musical Instrument Digital Interface: a defined interface format that enables electronic musical instruments and computers to communicate instructional data and synchronise timing. MIDI sends musical information between compatible devices, including the pitch, volume and duration of individual notes, along with many other aspects of the instruments that lend themselves to electronic control. It does not carry any actual audio. MIDI can also carry timing information in the form of MIDI Clock or MIDI Time Code for system synchronisation purposes.

**Mixer**

A device used to combine multiple audio signals together, usually under the control of an operator using faders to balance levels. Most mixers also incorporate facilities for equalisation, signal routing to multiple outputs, and monitoring facilities.

**Modelling**

A process of analysing a system and using a different technology to replicate its critical, desired characteristics. For example, a popular but rare vintage signal processor, such as an equaliser, can be analysed and its properties modelled by digital algorithms to allow its emulation within the digital domain.

**Monitor**

A device that provides information to an operator. Used equally commonly in the context of both a computer VDU (visual display unit) — such as an LCD screen — and a high-quality loudspeaker.

**MTC**

MIDI Time Code: a format used for transmitting synchronisation instructions between electronic devices within the MIDI protocol.

**Multitimbrality**

The ability of an electronic musical instrument to generate two or more different sounds simultaneously.

**Optimisation (of computer)**

Configuring a computer in such a way as to maximise its performance for certain tasks. In the context of a machine being used as a DAW, optimisation might involve

disabling sub-programs that access the Internet regularly or intermittently, such as email hosts, automatic program-update checkers and so on. It might also involve structuring the hard drive in a particular way, or the separation of program data to a system drive and audio data to a separate drive to minimise access times and maximise data throughputs.

**Overdubbing**

Recording new material to separate tracks while auditioning and playing in synchronism with previously recorded material.

**Patch**

A specific configuration of sounds or other parameters stored in the memory of a synthesizer or signal processor, and accessed manually or via MIDI commands.

**PCI Card**

Peripheral Component Interconnect: an internal computer bus format used to integrate hardware devices such as soundcards. The PCI Local Bus has superseded earlier internal bus systems such as ISA and VESA, and although still very common on contemporary motherboards has, itself, now been superseded by faster interfaces such as PCI-X and PCI Express.

**Phantom Power**

A means of powering microphones such as capacitor, electrets or dynamics with built-in active impedance converters. Phantom power normally provides 48V (DC) to the microphone as a common-mode signal (both signal wires carry 48V while the cable screen carries the return current). The audio signal from the microphone is carried as a differential signal and the mic preamp ignores common-mode signals so doesn't 'see' the power supply — hence the ghostly name, phantom. This system only works with balanced three-pin mic cables.

Consumer recorders, such as MP3 recorders, are often equipped with a microphone powering system called 'Plug-in Power'. This operates with a much lower voltage (typically 1.5V) and is not compatible with phantom-powered mics at all.

**Pitch Bend**

A means of detuning a signal generator, either manually via a control wheel or under MIDI control. The electronic equivalent of pushing a guitar string sideways when playing.

**Plug-in**

A self-contained software signal processor, such as an equaliser or compressor, which

can be 'inserted' into the notional signal path of a DAW. Plug-ins are available in a myriad of different forms and functions, and produced by the DAW manufacturers or third-party developers. Most plug-ins run natively on the computer's processor, but some require bespoke DSP hardware. The VST format is the most common cross-platform plug-in format, although there are several others.

**Polyphony**

The ability of an instrument to play two or more notes of different pitches at the same time.

**Pop Shield**

A device placed between a sound source and a microphone to trap wind blasts, such as those created by a vocalist's plosives (Bs, Ps and so on), which would otherwise cause loud popping noises as the microphone diaphragm is overdriven. Most are constructed from multiple layers of a fine wire or nylon mesh, although more modern designs tend to use open-cell foam.

**Preamp**

Short for 'pre-amplification': an active gain stage used to raise the signal level of a source to a nominal line level. For example, a microphone preamp.

**Project Studio**

A relatively small recording-studio facility, often with a combined recording space and control room.

**Quantisation**

- (1) In the context of digitising an analogue signal, the process of describing or measuring the amplitude of the analogue signal captured in each sample.
- (2) Automatically moving recorded MIDI notes onto a bars and beats grid to make them play perfectly in time.

**Rackmount**

A standard equipment-sizing format allowing products to be mounted between vertical rails in standardised equipment bays.

**RAM**

Random Access Memory: the default short-term data storage area in a computer, normally measured in gigabytes (GB).

**Reverb**

Short for 'reverberation': the dense collection of echoes that bounce off acoustically reflective surfaces in response to direct sound arriving from a signal source. Reverberation can also be created



artificially using various analogue or, more commonly, digital techniques. Reverberation occurs a short while after the source signal because of the finite time taken for the sound to reach a reflective surface and return, the overall delay being representative of the size of the acoustic environment. The reverberation signal can be broadly defined as having two main components: a group of distinct 'early reflections' followed by a noise-like tail of dense reflections.

### Sample

(1) A defined short piece of audio that can be replayed under MIDI control (such as a Loop). (2) A single discrete time element forming part of a digital audio signal.

### Sample Rate (see also Bit Rate)

The rate at which a digital audio signal is intended to operate, normally denoted either in terms of kilo-samples per second (kS/s) or kilo-Hertz (kHz). The audio bandwidth must be less than half the sample rate, which in high-quality audio systems operates at 44.1 or 48 kHz to provide an audio bandwidth of at least 20kHz.

### Sampler

A device that captures and replays short audio excerpts under MIDI control.

### Sequencer

A device that records and replays MIDI instructions. Original sequencers were hardware devices, but most are now software and are integrated into DAWs.

### Shockmount

A device used to support a microphone in such a way that unwanted external

mechanical vibrations are prevented from reaching the microphone, where they would otherwise generate unwanted low-frequency noise and distortion.

### SMPTÉ Time Code

A means of affording recordings with reliable positional information coded to resemble clock time, originally used to identify individual picture frames in video and film systems.

### Solid-state Drive (see also Hard Disk Drive)

A large-capacity solid-state memory configured to work like a conventional hard disk drive. Some computers are now available with solid-state 'flash' drives instead of normal internal hard disk drives. Also used in digital cameras and audio recorders in formats such as SD and CF2 cards, as well as in 'pen drives' or 'USB memory sticks'.

### Soundcard

A dedicated interface for transferring audio signals in and out of a computer. A soundcard can be installed internally, or connected externally via USB 2 or Firewire, and they are available in a wide range of formats, accommodating multiple analogue or digital audio signals (or both) in and out, as well as MIDI data in and out.

### S/PDIF

Sony/Philips Digital Interface: pronounced either 'S-peedif' or 'Spudif'. A stereo or dual-channel self-clocking digital interfacing standard employed by Sony and Philips in consumer digital hi-fi products. The S/PDIF signal is essentially identical in data format to the professional AES3 interface, and is available as either an unbalanced electrical

interface (using phono connectors and 75Ω coaxial cable), or as an optical interface called Toslink.

### Synthesizer

A device used to create sounds electronically. The original synthesizers were hardware devices and used analogue signal generation and processing techniques, but digital techniques took over and most synthesizers are now software tools.

### USB

Universal Serial Bus: a computer interface standard introduced in 1996 to replace the previous standard serial and parallel ports more commonly used. The original USB 1 interface operated at up to 12Mbps, but this was superseded in 2000 by USB 2, which operates at up to 480Mbps. Most USB interfaces can also provide a 5V power supply to connected devices. USB 3 was launched in 2008 and is claimed to operate at rates up to 5Gbps, but it is only now (2011) starting to appear on hardware.

### XLR

A connector design developed by US manufacturer, Cannon. The original X-series connector was improved with the addition of a latch (Cannon XL) and a more flexible rubber compound surrounding the contacts to improve reliability (Cannon XLR). The connector format is now available in numerous configurations, from many different manufacturers, and with several different pin configurations. Standard balanced audio interfaces — analogue and digital — use three-pin XLRs with the screen on pin 1, the 'hot' signal on pin 2 and the 'cold' signal on pin 3. ■■■

# ADVERTISERS INDEX

Ableton	<a href="http://www.ableton.com">www.ableton.com</a>	tel: (646) 723-4550 .....21	Presonus	<a href="http://www.presonus.com">www.presonus.com</a>	tel: (225) 216-7887 .....95
Avid	<a href="http://www.avid.com">www.avid.com</a>	tel: (626) 633-9050 .....OBC	Prism	<a href="http://www.prismsound.com">www.prismsound.com</a>	tel: +1 973 983 9577 .....97
Audio-Technica	<a href="http://www.audio-technica.com">www.audio-technica.com</a>	.....119	RODE Microphones	<a href="http://www.rodemic.com">www.rodemic.com</a>	tel: (805) 566 7777 .....107
Berklee College of Music	<a href="http://www.berkleemusic.com">www.berkleemusic.com</a>	tel: (617) 747-2146 .....171	Shure	<a href="http://www.shure.com/americas">www.shure.com/americas</a>	.....IFC
Event Electronics	<a href="http://www.eventelectronics.com">www.eventelectronics.com</a>	.....151	Sonnox	<a href="http://www.sonnoxplugins.com">www.sonnoxplugins.com</a>	info@sonnoxplugins.com .....71, 133
Ex'pression College	<a href="http://www.expression.edu">www.expression.edu</a>	tel: +1 877 833 8800 .....167	Spectrasonics (Dist llio)	<a href="http://www.spectrasonics.net">www.spectrasonics.net</a>	tel (800) 747-4546 .....85
Focusrite	<a href="http://www.focusrite.com">www.focusrite.com</a>	tel: (310) 322-5500 .....99	Steinberg North America	<a href="http://www.steinberg.net">www.steinberg.net</a>	tel: (714) 522-9011 .....17
KRK	<a href="http://www.krksys.com">www.krksys.com</a>	.....153	Steven Slate Drums	<a href="http://www.stevenslatedrums.com">www.stevenslatedrums.com</a>	tel: (323) 656-2050 .....147
McNally Smith	<a href="http://www.mcnallysmith.edu">www.mcnallysmith.edu</a>	tel: (651) 291-0177 .....169	Sweetwater Sound	<a href="http://www.sweetwater.com">www.sweetwater.com</a>	tel: (800) 222-4700 .....4-5, 12-13, 46-47, 60-61, 90-91, 114-115, 156-157
Metropolis	<a href="http://www.imastering.co.uk">www.imastering.co.uk</a>	imaster@metropolis-group.co.uk .....149	Universal Audio	<a href="http://www.uaudio.com">www.uaudio.com</a>	tel: (831) 466-3737 .....IBC
Muse Research	<a href="http://www.museresearch.com">www.museresearch.com</a>	tel: (850) 326-5400 .....75	Waves	<a href="http://www.waves.com">www.waves.com</a>	tel: (865) 909-9200 .....69
Novation	<a href="http://www.novationmusic.com">www.novationmusic.com</a>	tel: (310) 322-5500 .....103			

# MUSIC TECHNOLOGY BASICS & BEYOND

## FREE on-line VIDEO TUTORIALS

Visual guides to your favourite recording software  
accessed via our dedicated web site

[www.sos-smartguides.com](http://www.sos-smartguides.com)

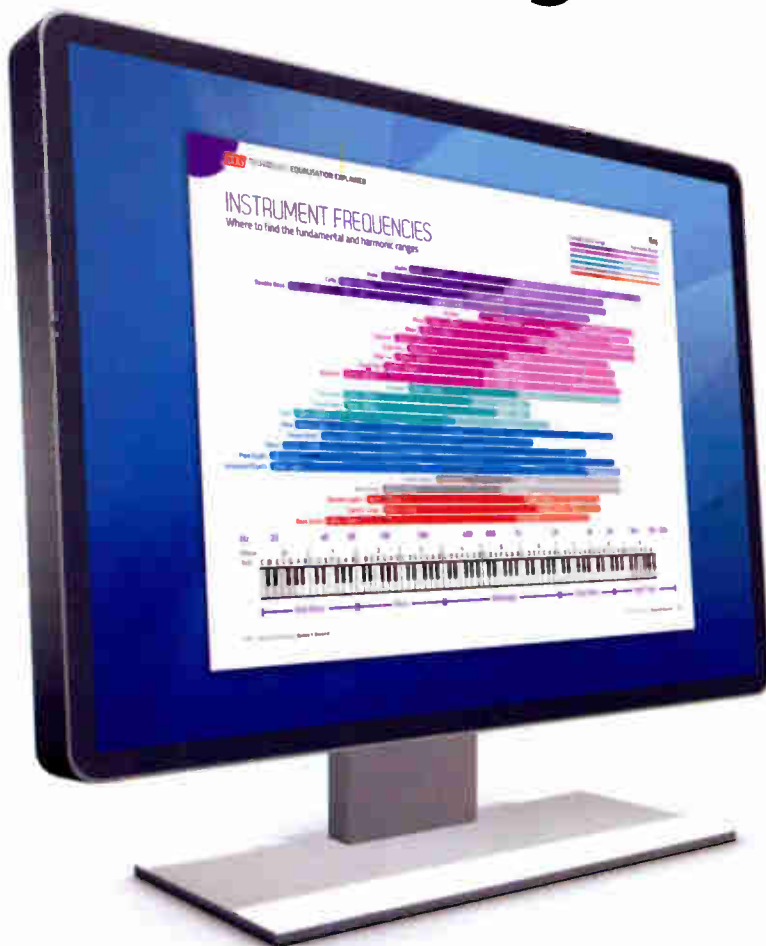

Video Access Code

sosmtbb

Sound On Sound in association with Berkleemusic Online

Berklee  
music

World Radio History



## The warmth of analog. The simplicity of Firewire.



FEATURING POPULAR PLUG-INS FROM THESE PARTNERS:

Roland FAIRCHILD PULTEC

Little Labs SPL TRIDENT

helios Empirical Labs MANLEY

STUDER HARMAN BOSS Neve

Solid State Logic lexicon dbx PROFESSIONAL PRODUCTS

**INTRODUCING UAD-2 SATELLITE.** The UAD-2 Satellite puts the world's finest analog emulation plug-ins within easy reach of select Firewire 800 and 400-equipped Macs, including Intel-based iMacs® and MacBook Pros®. In developing UAD-2 plug-ins, our renowned DSP engineers work with leading hardware manufacturers – using their exact schematics, golden units, and experienced ears – to give your mixes all the warmth and harmonics of classic analog recordings. Visit [www.uaudio.com/satellite](http://www.uaudio.com/satellite) to learn more.

- The world's finest plug-in emulations of classic analog gear
- Simple Firewire 800/400 connection to Intel-based iMacs, MacBook Pros & Mac minis
- Run larger mixes in Pro Tools, Logic Pro, Cubase, Live, Performer and more – without taxing host computer CPU
- Available in both DUO and QUAD processor models



UNIVERSAL AUDIO

World Radio History

© 2011 Universal Audio Inc. All trademarks are recognized as property of their respective owners.

[www.uaudio.com](http://www.uaudio.com)



# Elevate your music.

Avid® creates the gear that empowers you to take your sound to new heights—from award-winning recording hardware and software to best-selling studio monitors, keyboard controllers, and more. Work the way you want. Create and collaborate with the same tools the pros use. And know that you're going to sound incredible. Check out the latest from our Pro Tools®, M-Audio®, and Sibelius® product lines—and hear how Avid can help you elevate your music.

Enter to win a complete studio at [avid.com/elevate](http://avid.com/elevate)

© 2011 Avid Technology, Inc. All rights reserved. Product features, specifications, system requirements, and availability are subject to change without notice. Avid, the Avid logo, M-Audio, the M-Audio logo, Pro Tools, and Sibelius are trademarks or registered trademarks of Avid Technology, Inc. or its subsidiaries in the United States and/or other countries. All other trademarks contained herein are the property of their respective owners.