

RECORD RETAILING
YEARBOOK

1946

4

PILOTONE introduces a revolutionary new idea in records—a **NEW SOURCE OF BUSINESS** for you...



**Deems Taylor, Commentator...Erich Leinsdorf,
Rudolph Ganz and other distinguished Conductors...**

Opening up a new era of musical education and appreciation for your customers. Now the whole family—regardless of musical background—can enjoy good music *immediately!* At the beginning of each selection Deems Taylor briefly tells the listener what he wants to know. Choice symphonies with world-famous conductors leading the Metropolitan Symphony Orchestra. And they're all recorded on miracle **VINYLLITE** that not only means higher tone fidelity and amazing absence of surface noise but is *non-breakable*. Indeed, these are records for the Family—a new fulfillment of musical pleasure!

PILOTONE RECORDS

ALBUM OF 4 TEN-INCH RECORDS

Write for details

PILOT RADIO CORPORATION

37-06—36th Street • Long Island City 1, New York

Pioneers in Frequency Modulation & Television

PILOT RADIO-PHONOGRAPH COMBINATION • PILOT AM-FM RADIOS
PILOT PORTABLE RADIOS • PILOT RADIO TELEVISION RECEIVERS

Statement

The publishers of RECORD RETAILING and of LISTEN, the Guide to Good Music, take great pleasure in presenting the 1946 Yearbook and Directory of Manufacturers and Distributors. The record and radio-phonograph industry has made great strides since the publication of the 1945 Yearbook. Hundreds of new record companies have entered the picture and a great many important developments have taken place in the field of radio-phonograph manufacture. All this bodes well for the record industry. The sale of phonograph records has been mounting steadily. The public has shown a great preference for the phonograph.

Within the pages of this 1946 Yearbook will be found the Record Retailing Institute containing pertinent material for a good store operation: various significant articles on inventory control, a basic problem for the record dealer for successful store operation. The *Sets are on Their Way* section shows the significant development of the radio-phonograph. Mr. Kurt List's article *A Preface to Music*, should prove of value to anyone selling records. Throughout the Yearbook are numerous articles dealing with store operation, promotion, etc.

The Directory section in the back of the book will prove of great value to the dealer in determining where he can buy specific merchandise. The Distributor section will aid the manufacturer in setting up national distribution of his product.

On the whole, the publishers feel this Yearbook will be found to contain a great deal of material for the established concerns in all branches of the industry, and material that will prove helpful to new-comers as well.

Cordially,

Neil F. Harrison

IR **RECORD RETAILING**

yearbook and directory

TABLE OF CONTENTS

Advertisers' Index	4
A Preface To Music	33
Chronological List Of Composers	62
Serious Music—What Next?	66
A Review Of Popular Music	80
World's Smallest Orchestra	81
The Role Of The Independents In Today's Record Picture	92
High Finance Enters The Record Business	98
America's Symphony Orchestras	104
Rumpus-Room Is Solution For Teen-Agers	108
A New Idea For Record Collections	111
Self-Selection Enjoys Continued Popularity	117
Self-Selection, 100 Per Cent	113
3-Dimensional Blueprints Aid Dealers Plan Efficient Store Layouts	115
Self-Selection Plus Trained Sales Clerks Build Sound Business	156
Listening Booths Are Essential To Record Sales	159
Music Is Associated With Gracious Living	169
They're Now Soft On The Words and Sweeter On The Music	171
There's A Growing Market For International Records	174
Pearson's Of Indianapolis	176
"Sales-Closing Room" Featured in Modernized Store	178
Doing Big Things With Smaller Stores	179
No Matter The Area There's Plenty Of Space For Display	180
Deluxe Record Shop In Mexico City	182
Brighten Your Counter	186
The Story Of An Opening	189
All Night Store Proves Basic Operating Rules	192
The Record Shop Built On A \$200 Gamble	196
The Lady Wouldn't Heed Their Advice	198
Easy Come, Easy Go, And Then They Come More Often	200
Emerson Piano House Features Modern Design	201
Paris Letter	209
London Letter	213
Letter From Germany	215
Old Phonographs Stimulate New Business	218
Don't Take Their Needle Needs For Granted	221
Hot Jazz and High Art Are Selling Poles Apart	223
New Emphasis On The Classical Brings Big Returns	226

The Why And How Of A Sheet Music Department	228
Shift Those Casuals To Collectors	232
Children's Records	235
Children's Records Are On The March	236
Children's Record Room	250
Stepping On The Loud Pedal For Records	252
Records Out Of "Step-Child" Class For Good	253
Retailing Records Down Argentine Way	255
Wright's New Store Has Many Model Features	257
The Story Behind An Unusual Record Operation	260
Merchandising Beauty Should Be More Than Skin Deep	266
Books On Music	269
Bookkeeping And Inventory Control	273
Inventory—Basis of Successful Operation	274
Sales Training And Stock Control In The New Record Picture	282
Notebook Inventory Saves Time, Aids Customers	284
A Perpetual Inventory System	285
Victor's Manual On "How To Buy"	289
Preparing For July Inventory And Re-Evaluation of Stock	304
Your July Inventory Tells The Tale	306
Record Retailing Institute	308
Serving Customers In The Store	309
Periodic Mailings to "Sleepers" are Energetic Reminders	323
Importance Of Record Sales Training	325
Do Your Christmas Ordering In August	327
Pushing Hot Jazz	328
Promoting Single Record Sales	329
The Christmas Harvest Is On Your Shelves	331
How Jackets Solve One Dealer's Problems	333
52 Return Visits A Year To Your Store	336
Directory Section	339
Record Companies	340
Record Company Distributors By States	367
Phonograph, Radio, and Radio-Phonograph Distributors	392
Newspapers And Magazine Record Reviewers	421
Accessory Companies	415
The Sets Are On Their Way	449
Record Customers Will Buy Combinations	450
Know Your Facts Before You Sell	452
Facts About Automatic Record Changers	455
Basic Facts of Pickup Design	460
Relating Record And Combination Sales	468
Representative Models of Radio-Phonographs	470

Neil F. Harrison
Editor

Jesse Davidson
Managing Editor

Edward H. Kelly
Associate Editor

Kurt List and
Mark Gilbert
Contributing Editors

Grant P. Donahue
Advertising Manager

Published annually by M. & N. Harrison Inc., Executive and Editorial Offices, 274 Madison Avenue, New York 16, N. Y. Phone LExington 2-7336. Five dollars per copy. Copyright 1946 by M. & N. Harrison Inc.

PRINTED
IN
U.S.A.

index to the advertisers...

A

- Alladin Recordings 15
- Apollo 32
- Pilotone Records . Inside Front Cover

B

- Bibletone 207
- Birwell 212
- Black & White Records 217
- Bonot 16

C

- Cadet 65
- Capitol Records . . . 6, 7, 8, 9, 10, 11
- Chicago Musical Instrument . . . 225
- Collectors Record Shop 337
- Continental Record Co., Inc. 96
- Cosmo Records 100, 101, 102,
103, 194, 195

D

- Deluxe 117
- Disc Company of America 99
- Dulaney 119
- Duotone 14

E

- Electrovox 18

- Emerson 17
- Exclusive 203

F

- Farnsworth 19
- Fidelitone 116
- Fischer, Carl 26
- Freed-Eisemann 97

G

- Garrard 31
- Gem Inside Back Cover
- General Electric 333

H

- Holiday Distributing Co. 370
- Hoffman Radio 122

J

- Jensen 121
- Juke Box Records 21

K

- Keynote 20
- Krich Radisco 377

M

- Magnavox 21

index to the advertisers...

Malverne Distributors 365
Mercury Records 124, 125
Meritone 22
Musitron 288
Musicraft 27, 28, 29, 30
Music Sales Company 384

O

Ohio Appliances 118
Oriole Distributing Corp. 220

P

Peerless 324
Philco Back Cover
Phonola 25
Pilotone 123
Portofonic 23

R

RCA Victor 129
Recoton Needles 335
Rich-Art Enterprises 115
Rhythm Records 391
R. T. A. Distributors 379

S

Schirmer, G. 173

Seeco Records 338
Signature 382
Straus-Frank 386
Stromberg-Carlson 126
Symons, L. H. 141

T

Tone Products 128
Tunis "One Spot" Publishers . . . 120

U

United Albums 127
University Recording 322

V

Verne Records 366
Volunteer Music Sales 387

W

Webster 64
Wileox-Gay 168
Wrightman, Neale 222

Z

Zenith 12, 13

MORE HITS, MORE SALES

WITH

Capitol!

Hits while they're hot, big names while they're news. That's the formula that will bring new Capitol record fans into your store this year. It's the same formula that boosted Capitol to its new high spot among the Big 4 in a brief four years.

New high-speed pressing plants, new regional distribution depots, and an ever-rising list of new talent ... that's how Capitol's expansion is bringing even greater benefits to you.

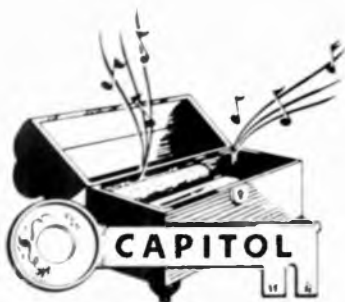

Right at Hollywood's Sunset and Vine—entertainment hub of the world—Capitol brings together the stars your customers like and the music they love to hear. Hollywood's the musical treasure chest, and Capitol holds the key.

A mighty sales-wise trio guides Capitol. Johnny Mercer, Hit-Parader and top-flight song writer ... Buddy DeSylva, motion picture producer and hit tune master ... Glenn Wallichs, expert in recording technique and record merchandising. Mercer, DeSylva and Wallichs *know* talent ... where to find it, what to do with it, how to make it sell.



Capitol RECORDS
FROM HOLLYWOOD

SUNSET AND VINE
HOLLYWOOD 28



New Service, New Speed in Coast-to-Coast **DISC-TRIBUTION**

from Capitol's 21 Branch Depots

• No matter where you are, Capitol's fast-flow distribution network, speeds deliveries of every Capitol hit... only days after pressing. No delay. Factory to you. The branch in your area is company-owned and has *only one important responsibility*—giving you prompt, efficient service on Capitol Records and accessories.

The Capitol representative nearest you knows your business needs—the sectional tastes of your customers, local merchandising problems, and the best local means of expediting delivery. Call Capitol for service and help.

There is a Capitol Branch near you

BRANCHES:

ATLANTA
427 Peachtree St., N.E., Atlanta 3, Georgia

BOSTON
1192 Commonwealth Ave., Boston 34, Mass.

BUFFALO
1066 Main Street, Buffalo 9, New York

CHARLOTTE
614 West Morehead St., Charlotte, N.C.

CHICAGO
1449 S. Michigan Ave., Chicago 5, Illinois

BRANCHES:

CINCINNATI
815 Sycamore Street, Cincinnati 2, O.

CLEVELAND
104 St. Clair Ave., N.W., Cleveland 1, O.

DALLAS
1505 Young Street, Dallas 1, Texas

DETROIT
4456 Cass Ave., Detroit 1, Michigan

KANSAS CITY
1527 McGee Street, Kansas City 8, Mo.



- MINNEAPOLIS
- DETROIT
- CHICAGO
- CLEVELAND
- KANSAS CITY
- ST. LOUIS
- DALLAS
- BUFFALO
- BOSTON
- NEW YORK
- NEWARK, N. J.
- PITTSBURGH
- WASHINGTON, D. C.
- PHILADELPHIA
- CHARLOTTE
- MEMPHIS
- ATLANTA



With 21 years in record wholesaling and retailing, FLOYD BITTAKER, Capitol's national sales manager, *Knows* the merchandising needs of the record dealer. His experience is passed on to you in improved distribution and effective selling aids.



SUNSET AND VINE

BRANCHES:

- LOS ANGELES
318 West 15th Street, Los Angeles 15, Calif.
- MEMPHIS
1088 Union Ave., Memphis 3, Tennessee
- MINNEAPOLIS
21 Hennepin St., Minneapolis 1, Minn.
- NEWARK, N.J.
- NEW YORK
225 West 57th St., New York 19, N.Y.
- PHILADELPHIA
825 Walnut Street, Philadelphia 7, Penna.

BRANCHES:

- PITTSBURGH
1007 Forbes St., Pittsburgh, Penna.
- ST. LOUIS
1407 Pine St., St. Louis 3, Mo.
- SAN FRANCISCO
1355 Bush St., San Francisco 9, Calif.
- SEATTLE
2234 First Ave., Seattle 1, Washington
- WASHINGTON D.C.
930 F Street, N.W. Washington D.C. 14

CAPITOL-IZE on a Great

with a line of Capitol **RECORDS**

When you carry a full line of Capitol record playing accessories, extra profits are right at your fingertips. Needles, albums, recording discs...these are just a few of the ever-growing list...all sure sellers when linked with Capitol's reputation for technical perfection.

Capitol is known as a leader in quality recording... and Capitol accessories are produced by the same outstanding skill and experience that is available only in Hollywood—sound engineering center of the world.

It's a story that makes sense to record-buyers—and dollars for you!



Record

PLAYING ACCESSORIES . . .



SAPPHIRE NEEDLE

Genuine jewel tip allows up to 10,000 tone-perfect plays. Scientifically curved to cushion against jarring and bouncing.

Mirror-polished under the microscope. An entirely new precision design, that assures faithful reproduction of brilliant top treble tones and rich low bases.



PM NEEDLE*

A mirror-smooth self-polishing needle tipped with osmium alloy to minimize friction and extend record life. Gives up to 5,000 plays, all with life-like clarity and tonal range. Cuts distortion and surface noise. Flat upper shank for secure locking.

**Precious Metals*



PRO DISC

Assures home recording that actually meets exacting professional standards. Unbreakable, permanent. Premium grade aluminum base.

Tough, smooth, special formula coating won't warp, chip, crack, or peel. Allows maximum tonal purity with minimum surface noise. In 6½, 8, and 10-inch sizes.



HOME RECORDING DISC

A flexible disc ideal for home recording. Resists peeling, cracking, and softening. Hypoid base with transparent coating assures finer reproduction. Mail anywhere without breaking. Used by the Armed Forces in every climate. In 6½, 8, and 10-inch sizes.



SUNSET AND VINE—HOLLYWOOD 28

It's the NEW **ZENITH** with the **COBRA TONE ARM-**



12

Sales-Making, Money Saving Features

New Cobra Tone Arm
Push-Pull Audio Amplifier
Records Stay New Longer
Only 2 Operating Controls
8-inch Dynamic Speaker
Drip-Proof, Scrape-Proof

80% More Powerful Motor
Short Record Spindle
No Needles To Change
Sturdy Construction
Stout Metal Speaker Grill
Incomparable Tone Quality



Not For Re-Sale To The Public

RECORD DEMONSTRATOR

for Record Dealers Exclusively!

When records *sound* better, they *sell* better—and the new Zenith Record Demonstrator with the Cobra Tone Arm gives tone quality you never thought possible. In fact, the Cobra reproduces records so beautifully that high fidelity FM stations use it for broadcasting. And that's only *one* of its features. The Cobra can be *dropped* on a record—even pressed down and *scraped* across the playing surface without harm!

A tiny filament floats in the record grooves with less than $\frac{1}{8}$ -ounce pressure—needle noise and record wear are reduced to a minimum. Records still sound like new after hundreds of playings. The filament cartridge lasts for thousands of playings, is quickly renewable, yet is locked into the arm so that it cannot be removed by unauthorized persons. Built for dependable day-in-and-day-out service.



\$35

Including Excise Tax
5% Higher in Zone 2

13

For
Additional
Information
Write:
Advertising Dept.,

Zenith Radio Corporation • Chicago 39, Illinois

DUOTONE

THE GREATEST NEEDLE LINE
IN THE WORLD

OTHER WELL-KNOWN DUOTONE PRODUCTS

Miropoint Needles
Transcription Needles
Record Preserver
Duodiscs
Recording Heads
Cactus Needles
Steel Cutting Needles
Sapphire Cutting Needles
Chromium Needles
Coin Machine Needles



DUOTONE

DUOTONE COMPANY
799 Broadway, New York 3, N. Y.



The Duotone Diamond

The world's finest needle for the world's finest phonographs. A jeweler's masterpiece. \$50.00 retail.



The "Star" Sapphire

Completely handmade with a sapphire point. Cherished by record collectors. \$5.00 retail.



The Duotone Ruby

Brilliant achievement of the jeweler's art. A ruby tipped needle that's really new. \$3.50 retail.



The Regent Sapphire

Outstrips competition in any demonstration. Affords the kind of profit margin you like. \$2.00 retail.



The Filter Point

Filters surface noise and reproduces with high fidelity. Plays longer. Package of 35—25¢ retail.



The Durpoint

Fast-moving, high-profit needle with excellent tonal reproduction. Attractively packaged. \$1.00 retail.



The New Lifetone

This superb osmium tip needle surpasses any other needle in its immediate price range. \$1.50 retail.

STARS and HITS Forever!



HELEN
HUMES



KING
COLE

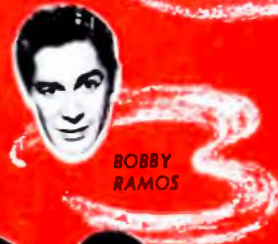

BOBBY
RAMOS



JAY
McSHANN



JOHNNY MOORE'S
THREE BLAZERS



LESTER
YOUNG

Aladdin

RECORDINGS

IN HOLLYWOOD

ALADDIN Distributors

Major Dist. Co., Brooklyn, N. Y.
J. F. Bard, Chicago, Ill.
Crawe Martin, Houston, Texas
Record Sales Co., Birmingham, Ala.
Music Sales Co., Memphis, Tenn.
J. C. Baylan Co., Cleveland, Ohio
Davis Sales Co., Denver, Colo.

Taran Dist. Co., Miami, Fla.
O'Rourke Agencies, Honolulu
Mesner & Mesner, Hollywood, Calif.
Pan-American Record Distributing, Detroit, Mich.
Blue Banner Music Co., Dallas, Texas.
Commercial Music Co., St. Louis, Mo.
Independent Record Sales, Los Angeles, Cal.

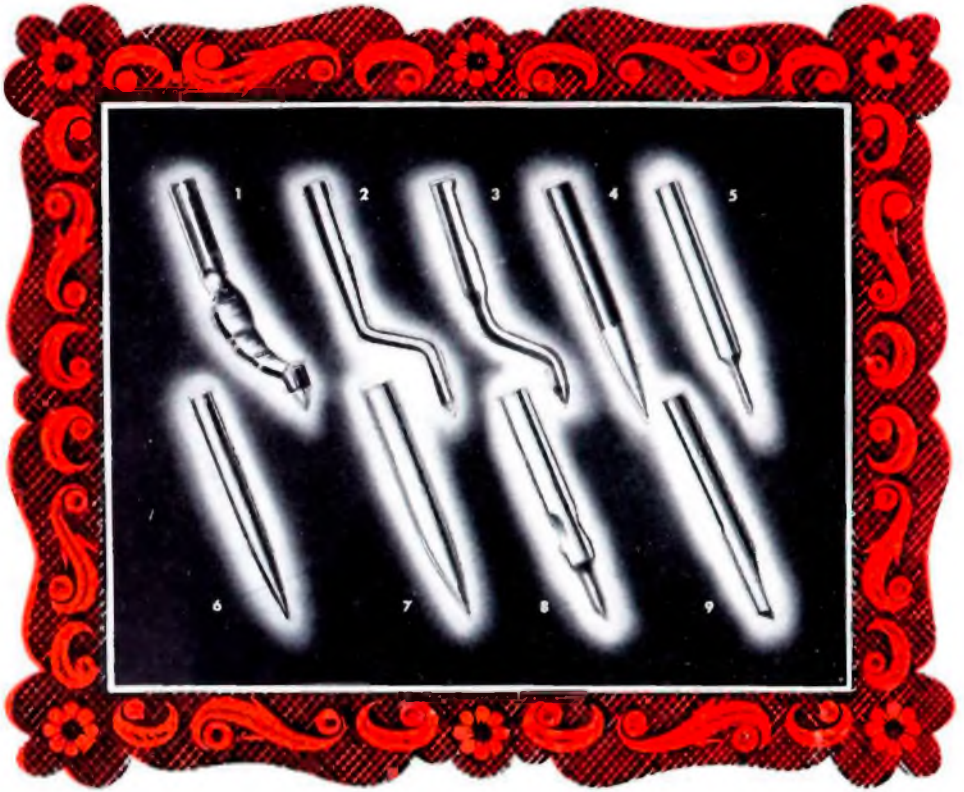

Bonot

... presents

YOUR NEEDLE - PROFIT PICTURE AT A GLANCE!

1. Rubaiyat, 2. Silver Sapphire, 3. Silver Meteor, 4. Chrometip, 5. Electrapoint,
6. Broadcaster, 7. Microtip, 8. Itranium Coin Machine Needle, 9. Cutting Needle

There are BONOT distributors everywhere—write,
wire or phone for name of one nearest you.

BONOT COMPANY • MANHATTAN PACIFIC BLDG. • STAMFORD, CONN.

* 4-Point Quality

Better 1-STYLE 2-TONE 3-PERFORMANCE 4-VALUE

BY THE *Specialists* IN SMALL RADIO



Your
"Indispensable
Line"

*Emerson
Radio
and Phonoradio*

17

New, outstanding Phonoradios — Recorders — Portables — Compacts — Pocket Receivers—with BETTER Style, Tone, Performance and Value—that's the Emerson Radio set-up for 1946-47.

Widespread advertising and sales promotion combine with constructive merchandising policies to make this your "INDISPENSABLE LINE."

Ask your Emerson Radio distributor

EMERSON RADIO & PHONOGRAPH CORP. • NEW YORK 11

World's Largest Maker of Small Radio



Sensational

**...in high fidelity reproduction
...in trade acceptance!**

THE WALCO "400" SERIES PLAYBACK NEEDLES



**Volume sales... greater profits...
are in the palm of your hand!**

There's a reason why more leading manufacturers entrust the performance of their instruments to WALCO. Great names in record players depend on a great name in needles... for tonal fidelity... smoothness... and longer service! That's why your trade depends on WALCO... the phono needle that is standard equipment with the "big leaguers" — MAGNAVOX, GENERAL ELECTRIC, PACKARD-BELL, ADMIRAL, MOTOROLA,

SEARS (SILVERTON), SCOTT, PHILCO, HALICRAFTERS, HOFFMAN, etc. And manufacturer acceptance of WALCO needles is only one of many hard-hitting sales features that reduce dealer effort... stimulate sales demand... get repeat sales month after month. Backed by consistent, intensified national advertising you are "in" with WALCO! Stock or re-order today. Address inquiries to Electrovox Co., Inc., 51 Fulton St., Newark 2, N. J.

WALCO "400"
FLOATING JEWEL \$250



NOW IN THESE BEAUTIFUL, NEW PLASTIC CONTAINERS

WALCO "400"
RUBY JEWEL \$200



WALCO

WALCO "400"
PRECIOUS METAL \$150



A black and white illustration of a hand wearing a white kid glove, holding a vinyl record. The record is tilted, showing its surface and the center label. The hand is positioned as if presenting the record. A torn-edge paper tag is attached to the top of the record.

*They Get the
"Kid Glove" Treatment*

from the new
FARNSWORTH
record changer!

It has an almost human touch—so gently, carefully and dependably does the new Farnsworth automatic record changer handle records. Suspended at three separate points, records are held at the edges only — no chipping or marring of surface grooves.

"Trouble-free" is more than a catchword when applied to this new Farnsworth record changer. Even a child can operate it.

To this mechanical perfection, add a climatic tested crystal pick-up, a precious-metal stylus and the superb quality of Farnsworth tonal reproduction — and you can see why Farnsworth design and engineering "know how" reduces costly service problems and pays off in customer good will. Farnsworth Television & Radio Corporation, Fort Wayne 1, Indiana.

19

FARNSWORTH TELEVISION • RADIO
PHONOGRAPH - RADIO

Farnsworth Television & Radio Receivers and Transmitters • Aircraft Radio Equipment • Farnsworth Television Tubes • Halstead Mobile Communications and Traffic Control Systems for Rail and Highway • the Farnsworth Phonograph-Radio • The Capehart • The Panamuse by Capehart

Keynote sets the record pace!



distinctive music

Folk music, hot jazz, classical, international selections . . . each a masterpiece . . . each indicative of the best in musical expression!

outstanding artists

Paul Robeson, Tom Glazer, Josh White, Richard Dyer Bennett . . . America's jazz immortals . . . Bill Harris, Lester Young, Cozy Cole, Teddy Wilson, Red Norvo . . . International ensembles of Russia, Spain, China . . .



quality reproduction

Carefully supervised from "biscuit" to finished product to afford the utmost in brilliant reproduction and lasting enjoyment.

20

a name to remember . . . a name to sell!

Keynote

records inc.

522 Fifth Avenue, New York

1469 Vine Street, Hollywood, Calif.



Magnavox
... found only in the
finest stores

Non-competitive and profit-protecting, the Magnavox franchise assures fine stores everywhere good profits and ample markets. Therefore, as a Magnavox dealer you are able

to offer prospective customers the best in service—the finest in radio-phonographs. Magnavox tone quality and performance are established as the highest standard in radio. Every model is a masterpiece of furniture design and craftsmanship. Today Magnavox is the most widely imitated instrument on the market—the most desired of all radio-phonograph franchises. The Magnavox Company, Fort Wayne 4, Indiana.

The Symbol of Quality in Radio
— since 1915

Magnavox
RADIO PHONOGRAPH

IN PHONOGRAPH NEEDLES

THERE'S A DIFFERENCE
WORTH KNOWING!



Of fine, highly polished Swedish steel, MERITONE needles are *turned* on Swiss screw machines specially designed for this purpose . . . not *ground* like ordinary needles - which explains why their perfectly rounded and uniform points reproduce sound so brilliantly, why each plays 12 or more records with maximum fidelity, minimum surface noise, record wear and tear. You feature the best when you feature *Meritone!*
Retail: 10 for 10¢ - 25 for 25¢.

*Meritone Needles Are Nationally Advertised In
Leading Magazines, Sunday Newspaper Supplements*

Meritone

AMERICA'S GREATEST PHONOGRAPH NEEDLE VALUE



INTERNATIONAL MERIT PRODUCTS CORPORATION
254 West 54th Street, New York 19, N. Y.



A GREAT NEW NAME IN PORTABLE PHONOGRAPHS!



PLEGGED to bring you the
finest in record reproduction
... both acoustical and
amplified.

MODEL NO. 2

- FINEST TONAL QUALITY YET ACHIEVED IN AN ACOUSTICAL PHONOGRAPH
- PLAYS 10" AND 12" RECORDS WITH LID CLOSED, ELIMINATING ALL SURFACE NOISE
- TRULY DISTINCTIVE IN DESIGN
- PATENTED REMOVABLE ALBUM IN LID AFFORDS GREATEST POSSIBLE PROTECTION TO RECORDS
- EXCLUSIVE COVERINGS, HANDSOME AND DURABLE
- AVAILABLE WITH MATCHING RECORD CARRYING CASES, LEADING TO DOUBLE SALES

Full Particulars Upon Request

PORTOFONIC MANUFACTURING CORP.

NEW YORK 13, N. Y.

HIT RECORDS!

NATIONALLY

FAMOUS

LABELS

**JUKE
●
BOX**

STERLING
●

TOP BANDS!

TOP VOCALISTS!

24

DISTRIBUTORS IN PRINCIPAL CITIES . . . or
JUKE BOX RECORD CO., INC. New York 19, N. Y.

For the complete line of
portable phonographs . . .
get a line on



Phonola

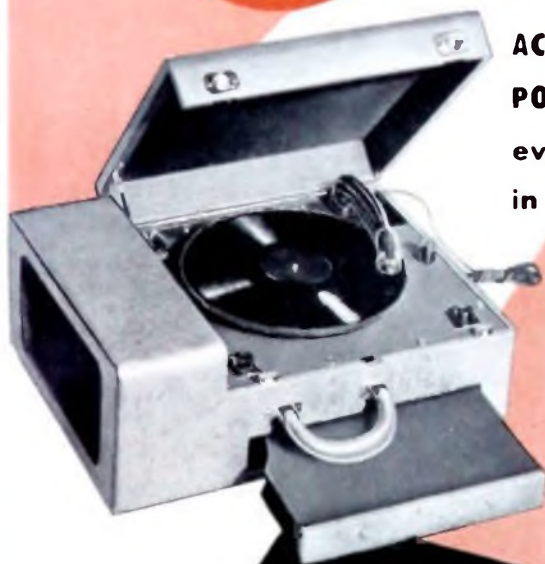

**ACOUSTIC AND ELECTRONIC
PORTABLE PHONOGRAPHS of
every popular description,
in every popular price line!**

Exclusive distributors every where.
For your distributor contact our
nearest Sales Office:

Eastern and Export Sales Office
17 E. 42nd St. • New York 17, N.Y. 6-2079

Midwestern and Western Sales Office
224 S. Michigan Ave. • Chicago 4, ILL. 1880

Factory and Engineering Laboratory
Rochester, Minnesota

WATERS CONLEY COMPANY
ROCHESTER, MINNESOTA

As Usual

THE DEALER COMES FIRST

AT CARL FISCHER

Our ONE STOP-ONE DAY JOBBING SERVICE offers

- Immense wholesale stock
- Immediate service
- Best prices

Now that the restrictions on the use of paper have been removed, we are again able to supply a comprehensive assortment of standard classical music in two famous editions.

THE CARL FISCHER LIBRARY EDITION

A modern and authoritative edition of standard classics. More than 1,000 separate volumes of studies and selected works for Piano, Violin, Voice, Wind and Bow instruments and various ensembles. Here, in a very moderate price range, are the foremost musical classics and studies in technique edited by outstanding musicians. They are clearly printed and handsomely bound with attractive title pages.

THE CARL FISCHER SUPERIOR EDITION

More than 3,000 titles from the finest music of all time for Piano, Violin, Voice, Flute, Clarinet, Saxophone, Cornet and Trombone. A carefully selected list of best-selling numbers edited and revised by musicians pre-eminent in their fields. The Superior edition is the perfect edition for teacher and student. It is attractively printed on fine, durable stock with individually designed title pages.

ORDER THE

CARL FISCHER LIBRARY EDITION for Collections and Studies
CARL FISCHER SUPERIOR EDITION for the Best in Sheet Music
AT A LIBERAL TRADE DISCOUNT.

CARL FISCHER, INC.

62 Cooper Square, New York 3, N. Y.

Boston • Chicago • Dallas • Los Angeles



THESE ARE THE
Musiccraft DISTRIBUTORS
 FROM *Coast to Coast*

Call on the one in your territory for information and help. You'll find every distributor anxious to assist you in every way possible.

ATLANTA, GA.

Southland Distributors Co.
 441 Edgewood Avenue, S. E.
Distributors for Georgia

BALTIMORE, MARYLAND

Barnett Distributing Co., Inc.
 8 West 20th Street
*Distributors for State of Maryland,
 Washington, D. C. Trading Area,
 Franklin and Adams Counties in
 Pennsylvania*

BOSTON, MASS.

Massachusetts Music Distributors Co.
 619 Washington Street
*Distributors for Eastern Massachu-
 setts and Rhode Island*

BUFFALO, N. Y.

Niagara Midland Co., Inc.
 881 Main Street
Distributors for Western New York

CHARLOTTE, N. C.

Williams & Shelton Co., Inc.
 Charlotte 1, N. C.
*Distributors for States of North Car-
 olina and South Carolina*

CHICAGO, ILL.

James H. Martin
 1407 Diversey Boulevard
*Distributors for Northern Illinois,
 Northern Indiana, Southern
 Counties of Wisconsin*

CLEVELAND, OHIO

Allied Music Sales
 740 Superior N. W.
Distributors for State of Ohio

DENVER, COLO.

Associated Distributors Co.
 1823 California Street
*Distributors for Colorado, Northern
 Counties of New Mexico*

DETROIT, MICH.

Allied Music Sales
 3112 Woodward Avenue
Distributors for Michigan

EL PASO, TEXAS

Diehl and Lehman
 1409 Texas Street
*Distributors for New Mexico (except
 northern counties) and Western
 Texas*

HARTFORD, CONN.

State Music Distributors Co.
 1156 Main Street
*Distributors for State of Connecticut
 and Western Massachusetts*

HAVANA, CUBA

Taran Distributing Inc.
 Havana
Distributors for Cuba

AN OPEN LETTER TO



RECORD DEALERS

There has been a good deal of exciting talk in the trade in recent months about the progress of Musiccraft Records, much of it being generously extravagant and unfounded. We would like to check off with you some of the facts—and ignore the fiction.

- ✓ It is true that we have new top management, new financial and technical resources!
- ✓ It is true that we now operate our own three fully integrated plants!
- ✓ It is true that we are supporting Musiccraft Records with an extensive consumer advertising program!
- ✓ It is true that many internationally known artists now record for the Musiccraft label!
- ✓ It is true that Musiccraft has revised its sales policies to conform with those of the acknowledged leaders in the industry.
- ✓ It is true that Musiccraft's classical catalog—matched by only two other companies—is being and will continue to be enlarged!

In short, we are determined to make secure for Musiccraft a top place in the phonograph record industry. We have the resources, the facilities and the imagination—plus the will to do it! We are not making any promises—we are just asking that from now on you keep your eyes on Musiccraft!

Peter Hilton
President



Musiccraft Records Inc.
40 West 46th Street, New York City



GEORGIE AULD



PHIL BRITO



MILTON CROSS



DAVE DENNY



FONTAINE SISTERS



HARRY GIBSON
The Hipster



DIZZY GILLESPIE



WALTER GROSS



E. HOGAN



KITTY KALLEN



JOE MARSALA



GORDON MacRAE



PHIL MOORE



E. SHAW



PILELY SHEPARD



SLAM STEWART



MEL TOPME & THE MELTONES



ORRIN TUCKER



MIGUELITO VALDEE



SARAH VAUGHAN



TEDDY WALTERS



FRANCES WAYNE



TEDDY WILSON



Musicraft DISTRIBUTORS

(Continued)

HONOLULU, T. H.

Robert E. Ricker, Ltd.
2138-2140 Kalakua Ave.
Distributors for Hawaiian Islands

JACKSONVILLE, FLORIDA

Taran Distributing Inc.
90 Riverside Avenue
Distributors for Northern Florida

KANSAS CITY, MO.

Frederick Lee Co. of Kansas City
304 West 10th Street
Distributors for States of Iowa, Nebraska, Kansas and Oklahoma

LOS ANGELES, CALIF.

Herbert H. Horn, 2401 So. Hill St.
Distributors for Southern California and Yuma County Arizona

MEMPHIS, TENN.

Stratton Warren Hardware Co.
Carolina Avenue & Florida Street
Distributors for Memphis, Tennessee, Trading Area

MINNEAPOLIS, MINN.

Frederick Lee Inc.
325 Second Avenue, South
Distributors for Central and Northern Wisconsin, States of Minnesota, North Dakota, South Dakota

MIAMI, FLORIDA

Taran Distributing Inc.
170 N.W. 23rd Street
Distributors for Southern Florida

MONTREAL, CANADA

Sni-Dar Radioelectric Ltd.
455 Craig Street, West
Distributors for Canada

NEW YORK, N. Y.

Musicraft Distributors Inc.
665 Fifth Avenue
Distributors for New York City, Long Island, Westchester County and Northern New Jersey

PHILADELPHIA, PA.

Kayler Co., 1639-41 Vine Street
Distributors for Eastern Pennsylvania, Southern New Jersey, Delaware

SALT LAKE CITY, UTAH

S. R. Ross, 1212 South State Street
Distributors for State of Utah

SAN FRANCISCO, CALIF.

Coast Wholesale Music Co.
536 Mission Street
Distributors for Central and Northern California

SEATTLE, WASH.

Herb E. Zobrist
2125 Westlake Avenue
Distributors for States of Washington, Oregon and Northern Idaho

ST. LOUIS, MO.

St. Louis Music Supply Co.
4400 Delmar Boulevard
Distributors for States of Missouri and Southern Illinois



**MOST FAMOUS NAME
IN RECORD CHANGERS AMONG
DISCRIMINATING MUSIC LOVERS**

GARRARD

**AUTOMATIC RECORD CHANGER
COSTS A BIT MORE
BECAUSE IT'S THE FINEST**



GARRARD SALES CORP.

401 Broadway, New York 13



32

APOLLO RECORDS DISTRIBUTING CO.

NATIONAL DISTRIBUTORS FOR *Hub Records*

NEW YORK	DETROIT	LOS ANGELES	ATLANTA	BALTIMORE	NEW ORLEANS
415 10th Avenue	100.02 E. Alameda St.	2705 W. Pico Blvd.	367 Edgewood Ave., S. E.	2015 Maryland Ave.	418 Gravier St.
New York 10, N. Y.	Detroit 26, Mich	Los Angeles 4, Calif	Atlanta, Ga	Baltimore 18, Md.	New Orleans, La

a preface to music

This article deals with the background of music, its forms and composers. Designed to aid the dealer in any discussions with his customers and to prepare him for being a guide to the intelligent client, the article explains musical terminology in non-technical language.



BY KURT LIST

When you live in a house and you like living in it, you are not much bothered by the question of who built it, what material it is made of and how old it is, unless you want to sell your property. Yet when you listen to music or are in some way connected with it, your natural curiosity will be aroused and you will ask yourself all sorts of questions. First of all, you will be baffled by the many strange words which you may have heard repeatedly, but which have never made much sense to you. There is a lot of talk about symphonies, and if you live in Boston you know that Symphony Hall is the place where the Boston Orchestra gives its concerts. Yet, you still don't know what a symphony actually is. If you go any deeper into the subject, as for instance when you have some connection with records of serious music, you will find such terms as "chaconne," "fugue," "suite" and many others which you never hear in any other connection. Chances are that you are at first surprised, then eager, to find out

what it is all about, only to arrive finally at the conclusion that all the books explaining the fugue to you do so by using a great deal of other technical terms such as counterpoint, themes, etc., which again defy all understanding. By that time you are completely defeated and think it is just as well to give the whole thing up. You find that you can enjoy a piece of music entitled "Passacaglia" even if you

Kurt List, who is shown above broadcasting a talk on American music to Europe for the State Department, is the editor of *Listen* and music critic for *Record Retailing*. He writes regularly on musical subjects for various national magazines, including *Atlantic Monthly*, *Glamour*, *New Republic* and *Commentary*. His latest composition has had six successful performances in New York, California and Virginia during the past two months. At present Mr. List is writing a book on music, scheduled for publication in 1947 by Reynal & Hitchcock.

have not the faintest idea what a *passacaglia* is. Or if you are a timid soul you are so frightened by all these high sounding terms which sound so forbidding that you don't even bother to listen to the music although you might be quite aware of what you may be missing. At any rate, to learn something about music without taking a course in composition seems to be an insurmountable task.

To get back to our erstwhile house. You live in it and you don't bother about its background. So why not do the same about music? But is it really true that you don't know anything at all about your house? You certainly know where it is located. You know whether it is a small house or a skyscraper, whether it has this color or that, whether you pay rent or taxes for it, and so on. You are never quite aware of this knowledge because it is so much part of your life, such an accepted fact that you don't give it another thought.

It is different with music. Although the tones and the sound may be part and parcel of our background, the details of its making are not. Thus we often stand bewildered at what seems to us an impenetrable mystery although we know that many musicians, often of rather questionable intelligence, have mastered the mumbo-jumbo of music.

The following brief notes are written for the express purpose of giving the average music lover an idea of what these terms are all about. In outlining a few high points—and brevity was of the essence if we were not to fall into a learned compendium of music history—I have viewed music as the layman might view it, emphasizing certain types of composition that are not necessarily the most important ones in the course of music's history, but are extremely important to the layman because of his preferences and the frequent performances of these works in the concert halls and the opera houses.

ORCHESTRAL MUSIC

Chances are that you like any music played by an orchestra better than that which is played by a solo instrument or

a small combination of several instruments. One of the chief rules in music is: the form of a composition and its whole make-up are largely determined by the performers. That is to say, an orchestral work will follow different rules than a song or a string quartet. Among all the orchestral compositions the symphony is best known. Now the word symphony in itself does not denote anything else but a work that is made up of several movements, mostly completely separated parts like chapters in a book which follow a certain preconceived design. It is self-evident that the symphony underwent several changes in the course of its development, but basically it follows the same design whether written by Mozart, Brahms or Tchaikovsky.

Before I go into explaining what the different movements of the symphony look like, I shall have to discuss two terms that will creep into our discussion again and again. These are homophonic and polyphonic. There is no reason to be scared of these rather strange sounding words. In a minute you will see how simple they actually are.

Polyphonic music, or polyphony, makes up the bulk of the music that was composed during the middle ages up to the 18th century. It is mainly intended for choral music, that is to say, such compositions as are performed by male and female singers who sing in separate groups which combine into one whole group at the final performance. Each group, whether it is made up of tenors, basses, contraltos or sopranos, sings the same melody. The four or five or six melodies, as the case may be, when put together, are the polyphonic work. The important fact in this music is that the melody of each group is as important as that of the next one. There is no supremacy of one melody over another, and the melodies complement each other in a skillfully contrived way which is called counterpoint. Thus polyphonic, or as it is sometimes also called, contrapuntal music is music that derives its existence from the democratic interplay of various voices.

Sometimes polyphonic music is performed by instrumental groups. Then the procedure is very similar to that of the choral composition. Only in this case several instruments form one group as against another group of different instruments. If we had basses, tenors, contraltos and sopranos as independent choral groups before, we may now have bass fiddles in place of the basses, cellos in place of the tenors, violas in place of the contraltos, and violins in place of the sopranos. Instrumental polyphonic music, used much more seldom than choral music, is just another variant of vocal polyphonic music. The principle of the interplay of various groups, however, remains the same.

Homophonic music is different. There one melody has supremacy and the other instruments or voices perform an accompaniment that is designed to give a background to the one, supreme melody. This style is also often called the harmonic style because the accompanying instruments form a harmony, that is they play notes which are the support of the main melody and important as such but not important as independent tones.

Now if you want to see a practical difference between the two styles all you need remember is this: in polyphonic music you can take each part and whistle it separately and it will give you some sort of a melodic line. But you can never whistle the whole work because you would be forced to leave out the other melodies that are performed simultaneously and are also essential to an adequate effect. In homophonic music you can always whistle the melody and thus can give a rather faithful, though sketchy, impression of the whole work. If you know a few musical works it is quite clear what I mean. Take, for instance, the homophonic "Piano Concerto" by Tchaikovsky and try to whistle it. You will have no trouble with it, and everybody will know what you are trying to whistle.

But take a fugue by Bach and you will be stumped right at the beginning. Because there are so many parts that belong



ORLANDUS LASSUS, 16th century composer, is a master of polyphonic music.

to this composition you cannot relate the work to anybody by whistling just one of the many melodies. Or better still: everybody is acquainted with a "round" like "Row, row, row your boat." Now if you have two people one will sing the words until he arrives at the words "merrily, merrily." At that time the other fellow will come in and sing from the beginning "Row, row, row your boat" while the other continues singing "Merrily, merrily, merrily, merrily, life is but a dream." Now this is really a fine example of polyphonic music. You see, if the one singer sang alone he would be performing homophonic music. But if the other singer comes in the music is polyphonic and no one man could ever perform it adequately alone.

Let me give you a graphic picture of the polyphonic example:



PETER ILYITSCH TCHAIKOVSKY is probably the most popular composer in the *fin de siècle's* homophonic style.

(alone)

Singer 1: "Row, row, row your boat
gently down the stream,"

(together)

Singer 1: "merrily, merrily, merrily.

Singer 2: "row, row, row your

A fine example of homophonic music is easy to find since most of the music with which we are chiefly acquainted is written in this style. Just think of the "Ave Maria," the "Star Spangled Banner," the "Yankee Doodle" and so forth. There is always one top melody which is the fundamental factor in the music plus some accompaniment. The melody does not always have to be high up, although this is the most usual practice. Sometimes you will find it also in the bass with the accompaniment higher but it never loses its importance no matter where it is.

Now we can go back to the symphony. The symphony is the best example of homophonic writing. Its entire style is dominated by a melody which is heard in various different guises and played by different instruments. But the melody remains the essence of the symphony, and

that probably explains its great success among musicians and laymen alike.

Of course, a symphony is only one type of homophonic music. Just what makes a symphony a symphony?

THE SYMPHONY

As we have said before, the symphony consists of several chapters, called movements, and most of the earlier works have four of them. When I talk of earlier works I refer, of course, to the symphonies of the three great composers who have made symphonic writing an essential part of Western music: Haydn, Mozart and Beethoven. They are called the Viennese classics, although none of them was born in Vienna. But they all lived in Vienna at the height of their careers and they wrote symphonies in their purest, most beautiful form. Later symphonists, such as Schubert, Mendelssohn, Brahms, Tchaikovsky, Mahler and Sibelius, were also essentially symphonic composers and their works show slight variants from the classics, although none of them was enough to give their compositions a new name.

The principle of symphonic writing is simple. The composer invents several melodies called the themes, arranges them in order of their importance, and has the orchestra play them first in their original, and then in some disguised form. The disguised form employs various changes, such as extensions or shortenings of the original themes, slight alterations in the melody or in the timing of it, some variants in regard to the instruments, and a new application of the harmonies, that is to say the underlying accompaniment. To present a theme in its various shapes is called to evolve it and an evolution can take place in numerous fashions. Some composers take minute parts of the themes, often called motifs, repeat them by breaking up the original theme, and endowing them with a great many curlicues. Others just take the ending of a theme, repeat it, turn it around, and practically make a new melody out of it. Whatever any composer may do, his attempt to form a theme or parts of it in

such a manner that it will look different, yet can be recognized as somewhat related to the original theme, is what is called the evolution of the theme.

As stated before, the symphony is presented in four, rarely in five different movements. As a rule the movements are divided as follows:

- (1) Sonata form. (2) Slow movement.
- (3) Scherzo or dance form. (4) Rondo form.

SONATA FORM

The sonata form must not be mistaken for the word "sonata" which usually connotes a separate type of composition for one or several solo instruments. This type will be discussed later. The symphonic sonata form is a form that falls into three distinctly different sections: the exposition, the development, and the recapitulation. These three sections go over into each other without any distinct markings, and it is sometimes not quite easy to determine where one ends and the other begins. The exposition serves to acquaint the listener with the melodies that are going to be used throughout the movement. Sometimes it is preceded by a slow introduction which serves to establish a general, mostly solemn mood (see the recording of Haydn's "Symphony 98," Victor DM-1025). The general tempo of the exposition is usually fast, regardless of the tempo of the introduction. With Mozart and Haydn it is mostly serene or stormy; with Beethoven, dramatic.

At first the most important melody is played, the main theme. Then it is evolved and leads into some transitory passage which serves to take you into the next important melody, the secondary theme. The secondary theme usually contrasts the main theme; if the former is heroic, then it is lyric, and vice versa. The secondary theme again is evolved, played through several times either to lead back to some variant of the main theme or to lead directly into the codetta, a short ending of the exposition which usually employs some minute segments of the main theme and turns it into all kinds of sectional variants. So far nothing has happened except that the listener has

become acquainted with the principal melodies of the work. (Some works even have a tertiary theme. This, however, is seldom.)

At this moment the development begins. The development as a rule uses the main theme and turns it into all kinds of different shapes, sometimes shortened, sometimes transferred to a higher or lower region. In other words, the development serves the purpose of running the theme through all possible paces and of employing all its possibilities.

Most composers only use the main theme for this purpose but others also employ the secondary theme to the same end. It is only rarely that a symphony introduces a new melody into the development, but it happens sometimes (see the recording of the first movement of Beethoven's "Eroica," Columbia M-285). Once the development is finished the recapitulation begins.

The recapitulation is actually nothing but the repetition of the exposition, changed in some ways and often extended, but never varying in its principles from the first section. When the imitation of the exposition has reached its close, the

WOLFGANG AMADEUS MOZART, proficient in every type, represents the acme of the purest form of symphonic writing.



coda follows. Coda is an Italian word meaning tail, or in a wider sense the end. The coda finishes the entire movement by using the main theme again and by leading it unmistakably to its end, as marked by some firm statements usually in a loud sonority, but sometimes, as in the case of Tchaikovsky's "Sixth Symphony" (Victor DM-553) with a very soft passage, yet clearly indicating that the end of the movement is reached.

THE SLOW MOVEMENT

Here we have then the sonata form, one compact movement representing the first chapter of the symphony. The second movement is, as a rule, slow although even here there are exceptions. Thus Beethoven's "Ninth Symphony" (Columbia M-227) exchanges the usual fast third for the slow second movement so that we have a scherzo as the second and a slow movement as the third chapter. We, however, will stick to the rule and consider the second movement a slow one.

The slow movements can have all sorts of forms. Most usual are the three-part "Lied" form and the variation form. The word "Lied" is German and means song. Like a strophic song of three verses it has three parts. The first part states a simple theme and its evolution and repetition; the second part evolves the theme some more, at times even in the manner of the development which we have discussed in the first movement, and leads us back to the third part, which restates the original theme, and like a recapitulation, only somewhat shortened, picks up the first part again. As always it is followed by a coda, incorporating the slow theme.

If the slow movement is a variation movement then the matter looks different. First a lengthy theme is stated. Then in separate sections, which imitate exactly the original structure of the thematic statement, the theme appears somewhat altered. Each of these sections is called a variation and there are sometimes as many as twelve. Don't be worried that

this may get too monotonous. The variations are of such a quality that they make the theme appear each time in a new and interesting light. The main difference between a variation and a development is the fact that in a development the theme can be shortened, extended, stood upon its head, just be reminiscenced about, lead into further implications derived from several of its notes, etc., while the variation clearly follows the outline of the theme even imitating its original number of bars and never cutting loose from it. The variation is the highest art of composition and masters such as Beethoven, have reached an absolute apex in employing it.

Naturally there are also other formal possibilities for the slow movement, such as two contrasting sections pitted against each other as in the slow movement of Beethoven's "Ninth Symphony" or a three part "Lied" form in which two themes appear in the first part. But such forms are comparatively rare.

THE SCHERZO

The third movement is usually a scherzo or a minuet. The difference is mostly that of tempo and mood, the scherzo being fast and furious, the minuet more stately and strictly indoor music. The scherzo consists of three main parts, the scherzo, the trio, and a restatement of the scherzo again. The scherzo proper—and it is all quite confusing, because the first and the last parts of the movement are called scherzo, while the whole movement again is called a scherzo—is a three part "Lied" form, only this time faster and gayer, in a $\frac{3}{4}$ beat, just like a very fast waltz. After this comes the trio, which has completely new melodies, contrast with the scherzo proper through its mildness and greater melodiousness. The trio is again a very short three part "Lied" form which leads back into the original scherzo. After this is repeated it is followed again by the inevitable coda which finishes the movement.



LUDWIG VAN BEETHOVEN used the sonata form for his symphonies in a clear, unequivocal, almost pedantic manner.

THE RONDO

As a fourth movement we are safe to accept the rondo, which is the typical fourth movement. The rondo changes in its forms more than all other movements. Basically, it consists of several independent sections which have their own melodies, and which are in contrast to each other. One or two sections have the preponderance over others and are repeated several times. As a rule the rondo ends with the same section with which it began. Let us take a large rondo for an example. First you have section 1,



ROBERT SCHUMANN, eminent romanticist, clung to the classical form despite the effusiveness and disintegration of his era.

followed by section 2, then section 1 might be repeated only to lead over into section 3. At this point the rondo returns to section 1, again followed by section 2 which now leads into section 4, only to close with a restatement of section 1. In this form we see that section 1 is really the leader, being at the beginning and the end of the movement and experiencing a four time repetition. In second place is section 2, which is repeated twice, and then follow sections 3 and 4 as two minor equals. It is quite clear that the melodies of sections 1 and 2 will attract your attention to a much greater degree than those of sections 3 and 4.



HECTOR BERLIOZ, most important of all French symphonists, evolved the romantic type of symphony with complete success.

This finishes our schematic outline of the symphony, a work that is always performed by a large orchestra made up of various groupings of instruments which will be a subject of further discussion. If you want to listen to a typical example of a symphony turn your attention to the recording of Beethoven's "Fifth" (Victor DM-640). Here you have a sonata form in the first movement (the exposition follows immediately after the so-called victory motif has sounded twice as introduction). The second movement is a variation form, the third a typical scherzo and the fourth a rondo. Note how strongly the symphony is dominated by the idea of

a three part symmetry. The sonata form consists of three sections—exposition, development, recapitulation; the “Lied” form has three parts; and the scherzo has the three parts twice—once as scherzo proper, a three part “Lied” form, and once as a whole movement, divided into scherzo, trio, scherzo. Even the variation form and the rondo are often divided into groups in such a manner that you can clearly discern their three part structure.

It seems that the symphony adheres to the classic ideal of symmetry: the clear statements at the opposite ends, with the climax (development in the sonata form, and trio in the scherzo form) in the middle. At any rate, music seems to have a tendency always to return in its melody to the very beginning of its departure as can be witnessed best in the three part form where a movement always ends with tones reminiscent of its start. In this manner, the symphony is the incarnation of music’s purest and highest ideals, which are hard to attain for the composer, yet most revealing and fascinating for the listener.

THE CONCERTO

The orchestral symphony is the most important and purest representation of the previously outlined forms. This, however, does not mean that other types of composition have not adopted or borrowed extensively from the symphonic form. An almost exact replica is the concerto as written by such masters as Mozart, Haydn, Beethoven, Brahms, Tchaikovsky and Rachmaninoff.

The concerto is a composition which features a solo instrument, most commonly the piano or the violin, which carries the main melodies over an accompanying background of the orchestra. An additional device is the featured contrast between passages played by the solo instrument and the answers by the orchestra. In order to allow the solo instrument a free display of all its musical and technical potentialities and to give the virtuoso the opportunity to show off his technical prowess, the melodies are

usually conceived in an extremely elegant, extensive and more technically than musically exciting manner. This is the chief difference between the concerto and the symphony. Even the greatest concertos have never quite gotten away from this brilliance and they stand the biggest chance of arousing wide public enthusiasm, an enthusiasm which is further kindled by the great attraction of the contrasting sounds between two sonorous bodies: that of the solo instrument and that of the orchestra.

Since the concerto follows closely the symphony in form, it consists of the same types of movements although these are slightly modified. Thus the first movement is usually a very extended sonata form in which the exposition is first played by the orchestra and then repeated by the solo instrument which is accompanied by the orchestra. After this repetition follows the development. Then the movement goes on in the usual way until it reaches the final section. At this point the orchestra pauses and allows the solo instrument to carry on alone in a general, rather loosely knit fantasy over the chief melodies of the movement in a form which is full of technical brilliance and very little influenced by formal considerations. As a matter of fact, this part used to be the highpoint in every virtuoso’s performance and composers such as Mozart and Beethoven never bothered to compose this solo section, known as cadenza, themselves but left it to the fantasy and free improvisation of each virtuoso who happened to perform the concerto.

Since the first movement is of such larger scope than that of a symphony, composers usually desisted from writing a slow introduction to it. And more often than not they also gave up writing four movements, leaving the scherzo movement out entirely. Thus the average concerto consists of three movements, sonata form, slow movement and final movement, usually a rondo. The latter two movements are formally very much like the corresponding movements of an orchestral symphony. Brahms, however, often felt called upon to imitate the sym-

phony completely and his "Piano Concerto in B flat" contains all four symphonic movements (see Victor recording DM-470).

I have said before that the concerto was mostly written for either the piano or the violin as solo instrument. Naturally, occasionally concertos were also written for other instruments. Thus we have oboe concertos, flute concertos, harpsichord concertos, and many others. Then there were composers who wrote concertos for two or more instruments as solo instruments. Well known are the Bach "Double Concerto" for two solo violins (see Victor recording 7732/3) and the six "Brandenburg Concertos" by Bach (Columbia M-249/50) where different instrumental groups take over the solo part in each concerto. The Handel "Concerto Grosso" (Nos. 1 and 5 in Victor DM-808) is an example of a composition which features a large instrumental group as contrasting part (like a solo instrument) against the whole orchestra. And in our days composers have appropriated the name *Concerto* for works that have very little in common with the original connotation of the term. Thus Bela Bartok has written a "Concerto for Orchestra" in which no solo part by either one or more instruments as pitted against the orchestra is discernible at all.

THE TONE POEM

The purity of the symphony was not preserved forever. The romantic movement of the 19th century, an increasing preoccupation with literary themes and the desire to cut loose from any shackles that may be imposed upon the composer by the comparatively strict requirements of the symphonic form, led to the evolution, or as some have called it the degeneration, of the symphony into the tone poem. The tone poem is usually written in a free form which allows the composer to follow a literary program, any plot or story of his choosing. Thus its form is guided more by the step by step development of the underlying drama's evolution than by any considerations that center around the evolution of

themes as we have seen it in the symphony. And, of course, the direct imitation of sounds of nature, like the bleating of sheep in Strauss' "Don Quixote," or the crying of the infant in the same composer's "Symphonia Domestica," becomes an integral part of the tone poem.

The first feeble attempts at tone poems had been made as early as the late 17th century when the composer Johann Kuhnau wrote "Biblical Histories" for the clavier, a predecessor of the piano, of which one bears the following subtitles: "Hiskia's lament over the announced death and his deep prayers," "His confidence in the Lord," "The joy of the recovered patient," "He reminisces over the past hard luck," "He forgets about it." This reads almost like the headings of Strauss' "Death and Transfiguration," a work written two hundred years later. Even Beethoven, absolute master of the symphony, tried at times to approach the tone poem. In his "Sixth Symphony," which he called the "Pastoral Symphony" (Victor DM-417) he departs from the usual four movement setting by inserting a movement which is a strict imitation of the noises created by a furious thunderstorm.

But those earlier examples remain isolated. It is not until Richard Strauss and Debussy enter the scene that the tone poem reaches its fullest height. Strauss, trained in the classical tradition, often prefers to fit his tone poems into the classical mold. Although the work follows clearly a literary program it is more often than not presented in the outer form of a conventional structure. Thus we see his "Till Eulenspiegel" (Victor DV-1) as a rondo and his "Don Quixote" (Columbia M-506) as a theme and variations. Debussy, who has no concrete program with a plot and a lot of dramatic things happening, was satisfied to paint scenes of nature (see his "La Mer" Victor DM-613). Thus his form is quite free, and what is more important, he works mostly in colors, using the orchestral instruments as his palette without employing any melodies that are strictly definable in the classical sense of the



RICHARD STRAUSS, master of the tone poem, symphony's coup de grace.

symphony. His works are homophonic, yet if you try to whistle any of his orchestral works you will probably not be able to shape any musical idea through the efforts of your whistle. You see that music has now reached a stage where the one-time differentiation between homophony and polyphony does not make much sense any more. A new quality, that of tone color, has entered the picture, and modern music has driven this new concept to the limit.

The modern tone poem is a work which, in order to be understood fully, must communicate at least its title, but preferably even its entire program, to the listener.

OVERTURES

We now go back to a form of orchestral composition that is much older than the tone poem and even the symphony. Originally the "Overture" was written as a prelude to an opera, using either the chief themes of the stage work in order to acquaint the listener with the future dramatic plot, or introducing entirely new themes never to be used in the opera in order to effect a certain mood in which

the listener should become acquainted with the intricacies of the drama. Because so many overtures have been written with such great skill they later were accepted as independent compositions which had a decisive place in the concert repertory.

Earlier overtures, as those by Lully, were three part forms, with the first part repeated as last part, while the middle part represented an entirely new and mostly contrasting section. Later overtures, for instance those by Mozart, used also other forms, such as the sonata form. Thus many overtures are actually nothing but the first movement of a symphony that uses some melodies of the opera for its themes.

Finally we have the type of opera overture that, not unlike the tone poem, arranges the opera's characteristic themes in a medley fashion, giving the listener a bird's eye-view of what he can expect later once the opera is under way. Into this category fall most of Verdi's overtures and all of the overtures to the light operas of Gilbert and Sullivan.

Sometimes an overture was written as prelude to a spoken drama. Again it followed similar principles. Beethoven's "Egmont" overture (Victor 7291), written to the play by Goethe of the same name, is one of the most famous dramatic preludes.

Another type of overture is the concert overture which is actually nothing but a tone poem written in a more conservative form. Again all kinds of imitations of natural sounds are admissible and a general program determines the progress of the music. Tchaikovsky's "1812 Overture" (Columbia MX-205) is a typical concert overture.

THE SUITE

The classical suite was the actual predecessor of the symphony. A suite was usually a series of dance movements, anything from three to six or eight would do, which were related to each other only vaguely, but never through a similarity in melodies. While all previously dis-

cussed musical forms were clearly homophonic the style of the suite is not easily determined. Very frequently it combines both the homophonic and polyphonic style quite successfully. In its tendency it clearly represents an attempt of orchestral music to free itself from the ancient polyphony and to strive towards the modern form of symphonic homophony.

The individual dance movements of the suite can include practically all dances in use at the time when it was composed. Thus we see in the older suites the employment of dances whose names are not even familiar to us. There are the allemande, courante, sarabande, gigue, gavotte, musette, minuet, and many more. It is safe to say that most of these dance forms consist of three parts, in a manner similar to the "Lied" form which we have discussed previously. A special case of the suite is the "Divertimento" which was a suite used as music for the supper festivities of the 18th century aristocracy.

The more modern type of classical suite includes, of course, more modern forms of the dance, such as waltzes, marches, polkas, mazurkas, and polonaises, forms which vary in their structure greatly but which do not defy immediate acceptance on the part of the listener because of their appealing melodies and their lack of any profounder musical problems. This type of suite is definitely homophonic and was in use simultaneously with the symphony which it outlived for quite a period of years.

Another type of suite is an innovation of the nineteenth century. At that time arrangements of compositions became very popular and many composers took excerpts from their ballets, operas and even symphonies and combined them into loosely knit together movements which they called suites. The form of these suites depends largely upon the form of the original composition from which they are taken. Sometimes they are but occasional makeshifts designed for specific occasions, and sometimes they are valid musical compositions. Practically all of Stravinsky's ballet suites, for example, have survived in this form so far and



IGOR STRAVINSKY, best known for his ballet music, managed to salvage his stage works in the more objective suite form.

stand more of a chance of being preserved for posterity as suites than in their original ballet versions.

With symphony, concerto, tone poem, overture and suite we have exhausted the chief forms of orchestra music as it is presented today in the regular concert repertory. Needless to say, there are also other forms, some of which we shall encounter in our discussion of other types of music. Most of these, when used for orchestra, are merely transcriptions; some of them are actually borrowed for orchestra from another field of music; and quite a few are just momentary figments of certain composers, valid as compositions, nevertheless impossible to classify for their isolated appearance. Most orchestral music is a comparatively recent event in the history of music, but it is without doubt the bulk of our daily musical fare.

THE INSTRUMENTS OF THE ORCHESTRA

Now that we have talked a great deal about orchestral music we might as well ask ourselves the vital question: "What is the orchestra?" Of course, everybody

knows what an orchestra is. You have possibly seen it in Carnegie Hall, or at the NBC studios or even at some small cafe. There are always a great many musicians sitting around, sometimes more and at other times not quite so many, who play their instruments. At certain times some of them pause while the others go on playing, and at other times everybody blows, bows or beats like mad.

Essentially what you have read in the above paragraph is exactly what the orchestra is: a conglomeration of instruments that are used simultaneously, in separate groups or as a whole, and in a make-up that varies with each composition or rather with each period of music. Quite obviously, not the whole orchestra plays all the time. That would be rather boring and would defeat its one purpose: contrasting color. The orchestra is really designed to lend new interest to the same melody which can be repeated in its exact form several times, yet still be interesting because it is played by different orchestral instruments or groups of instruments. If you know Ravel's "Bolero" (Victor DM-352) you will recall that one and the same melody is played over and over again, and although this melody only lasts a few seconds the whole composition (always repeating the same melody) lasts about eleven minutes. This sounds rather boring, but actually it is a most fascinating *tour de force* because the composer, understanding this, has the melody played by different orchestral groups each time it is repeated. The "Bolero" is an extreme case but it illustrates well the principles of orchestration, that is to say the way of allotting music to the different instruments. Basically, all orchestrations follow this one principle, namely to provide contrasts by distributing different sections of music among different instruments.

The instruments are not treated as solo instruments. With an average modern symphony orchestra of about 80 players you would get quite a turmoil if each player would play some different solo part. Rather the composer combines them into different groups which play against or with each other. Theoretically, it is left

entirely to the composer which instruments he likes to combine into any one group. But since each instrument is somewhat limited technically in its sonority he will have to choose those for one group which blend well. The classics had it easy in this respect. Their orchestra was small and their groups were predetermined by tradition and the coherence of acoustically related instruments. But the modern orchestra is much more complex, contains so many more instruments—quite a few have only been invented in the 19th century—that the composer has to be very careful in his choice of groups.

For our purposes it will be best to follow the classical grouping and to register all new instruments in those groups into which they would fall according to their acoustical characteristics.

The four basic groups of orchestral instruments are the woodwinds, brass, strings and percussion instruments. The woodwinds play a comparatively small role in the classical symphony. Mozart, for instance, uses clarinets only rarely and the variants of each family of the woodwinds are hardly ever used. Mostly the woodwinds serve to enforce the string instruments and to add some color to them. But the romantics use the woodwinds in a more independent fashion and modern composers have discovered that their sonority is not only sweet and lyrical, what it seemed to be mostly for the classics, but that it can be quite wild and ferocious if exploited in the upper ranges:

The lyricist among the woodwinds is the flute whose sweetness of tone is rather touching. The flute has an even tone which is not too flexible and it is paired especially well with the violin. On records with poor fidelities it even sounds very often like the violin. Another member of the flute family is the piccolo, which is higher than the flute and often doubles its tones in an upper register. If played in a very high range it sounds rather shrill and gives the impression of some hysterical tones. Orchestras use from one to five flutes. (For exact sound of individual instruments listen to Columbia's album of "Instruments of the Orchestra" X-250.)

The next family is that of the oboe. The oboe is usually described as a pastoral instrument. In its upper regions it sounds nasal and can be employed to satirize certain emotions in a grotesque manner. But in its usual range it is solemn and, if played well, of a strange and expressive beauty. There are several ancient versions of the oboe, such as the oboe d'amore, but they have disappeared from the orchestra for all practical purposes. The English horn, however, which is neither English nor a horn, is still an important and sought after member among the oboes. Lower than the oboe proper it serves to emphasize the solemn appeal of the former. Slightly less movable in regard to swiftness it is the pastoral instrument *par excellence*. You can often find two oboes and one English horn in the orchestra.

The clarinet family is an important asset to the modern score. With a tremendously wide range whose tone character changes in each register (section of several notes), it is a most expressive instrument, being at once lyrical, wild, heroic and grotesque. It comes in all kinds of forms, from the low bass clarinet which can give you the most somber effects, to the high e-flat clarinet, whose penetrating sound is most conducive to the sharp expressiveness of bands. Being so useful, it is employed extensively and in numbers that go as high as 8 individual clarinets.

The saxophone family is considered an appendage to the clarinet family and an important standby of modern woodwinds, although saxophones are not made of wood. However, they are blown in a fashion similar to the clarinet technique, while their fingering approximates that of the oboe. They too have a tremendous range that is further expanded through the various variants of the family which is manufactured from the high soprano saxophone down to the deep bass saxophone. Their big disadvantage is a rather rigid, unexpressive tone that lacks any intrinsic beauty. A comparative newcomer to the woodwinds (the saxophone was invented around the middle of the 19th

century) it is not used extensively in the symphony orchestra. Its main employ is in popular and jazz music, and in band work. However, such composers as Berlioz and Richard Strauss have made repeated use of its penetrating tone qualities.

The comedian among the woodwinds is the bassoon which sounds extremely grotesque in the upper registers. However, in its middle and lower range it has a certain tonal profundity which makes it the highly estimated lower support of all the woodwinds. The bassoon comes in two variants: the bassoon proper, and its lower relative the contrabassoon. The latter is used but rarely in the classical orchestra but is a frequent guest in modern times. The bassoon usually appears in pairs.

MAURICE RAVEL'S "Bolero" is an object lesson for the usage of instruments.



All the woodwinds have two qualities in common, that of pastoral expressiveness and the potentiality to caricature. As one compact group they can be used to perform chorales in the style of Bach or grotesque marches in the style of Prokofieff. Having all the possibilities between these two extremes they are a valuable and frequently employed device for the composer who could never quite get along without some of them no matter in what period he lived.

You may be surprised to hear that the organ (pipe organ) is also considered a woodwind because its tone production is similar to that of the woodwinds. The organ is rarely employed in the orchestra. Only when a composer wants to create a very compact tonal or sacred effect, such as in a religious or operatic composition, does he take recourse to the organ.

The brass instruments are essentially festive instruments. Whenever we hear a brass instrument we are reminded of some occasion like a procession, a fanfare or some other event that signals something out of the ordinary to us. The classic composers used mostly the French horn and the trumpet, seldom the trombone and were not acquainted with the tuba.

The French horn with its wide range, warm tone and comparative flexibility resembles strongly the woodwinds. As a matter of fact its sonority is so closely related to them that it is often used as an intensification of their expressive tones. Furthermore, it has at its disposal a certain grotesque and clumsy tone especially when muted through the player's hand held into the bell mouth from which the sound emanates. This enhances the resemblance even more. Some composers use as many as 12 French horns.

The trumpet is a clear and loud instrument that is well suited for heroic and marchlike themes, or to signal danger or any important dramatic event. Some composers, like Mahler, have used the trumpet to indicate the approach of the last judgment and others, like Verdi, to accentuate rhythms. As an accompanying instrument it adds vigor to musical

sections and in its highest ranges it is clear and of amazingly cool beauty. The cornet, used very seldom in the orchestra, is a trumpet variant that differs little from the original. When used with a metal mute the trumpet can sound either sweetly balladesque or grotesque to the point where it actually imitates a caricature version of the human voice. Orchestras usually use from two to four trumpets.

The trombone, which comes in higher versions under the names of alto and tenor trombone and in lower versions such as the trombone proper and the rarely used bass-trombone, is a full and festive instrument. It lends definite body and profundity to the brasses and it is the mainstay of any sacred music. The classics use it but rarely, and then only to signify festive occasions such as Mozart in his "Magic Flute" when the priests are characterized by trombone sounds. Being both stately and flexible in its tonal expression the trombone is a colorful instrument of the modern orchestra. As such it is used in numbers from two to four.

The tuba is an instrument that is unknown to the classics but from Richard Wagner, who used it as a characterizing instrument, on it has become a frequent visitor in the modern symphony orchestra. Being low, dull sounding and slow moving it lends special character to such figures as giants, but it also caricatures anything clumsy very well. Several tubas together can give quite a solemn sound and their usage as the groundwork for a woodwind group is quite solid. Due to the heaviness of their tone one bass tuba usually suffices, but the higher tenor tubas come in pairs of two and four.

Bands also use the susaphone, a variant of the tuba, but symphony orchestras keep away from its rather heavy, unwieldy sound.

The string instruments are the mainstay of the classical orchestra. They carry the melody and the greatest part of the accompaniment and the woodwind groups often double with them only for the purpose of additional color while the brasses

are used in order to outline the harmonic implements of the accompaniment. Thus we see that each group has a different function. But the string instruments lose their importance somewhat in the modern orchestra because all wind instruments assume greater individual responsibility, and it is not uncommon to hear the strings as the harmonic background to a brass or woodwind choral in a modern work.

It is not difficult to see why the strings are so popular with the classical composers. They have a wide range, are extremely flexible, can be bowed, plucked or beaten with a bow, and can even play two or three notes at the same time, a feat of which any wind instrument is incapable. Their tone quality can change from harshness to extreme sweetness and they can hold their tones much longer than the wind instruments which are handicapped by the breath of the player.

The string instruments, as used in the classical orchestra, follow all the same principles. Their differences are mainly those of tonal height. Thus the lowest of them, the bass fiddle, is actually nothing but a very low violin, while the others are higher variants of the same instruments. Beginning at the highest point the string instruments are, in going down order: the violin (and the orchestra uses two groups of them in order to get more simultaneous melodies in), the viola, the violoncello and the bass fiddle. Most modern orchestras use as many as over forty strings, with the higher groups considerably stronger represented than the lower ones.

A more modern string instrument is the harp, whose sweetness adds a great deal of color to any orchestration although it is not very usable for solo effects unless one wants strange, eerie or celestial sounds. The piano is also a string instrument which is quite often employed in the modern orchestra. As an orchestra instrument it is largely used for percussive effects. Its tone has not too many possibilities but since as many tones can be played at the same time as the performer has fingers, it can often imitate the whole orchestra gamut and

is almost an instrument equivalent to the rest of the orchestral organization. Its percussive effects are not too loud but due to a sonority that differs greatly from that of any other instrument quite startling and effective. String instruments like lute, guitar and mandolin are rarely used in orchestras and do not have to be discussed here.

The final group of orchestra instruments is that of the percussion instruments. Here one must differentiate between those which have definite pitch, that is to say can play the exact tones prescribed by the composer, and those that have no pitch, in other words only play one general sound that reminds the listener more of a pleasant noise than a melodic tone.

Among the percussion instruments with definite pitch are the tympani or kettle drums which have a hollow, rather low sound. They are used to mark the beatings of the march or to indicate certain accentuations in the score. It is noteworthy that each kettle drum can only play one definite tone, and requires additional tuning if it has to change its pitch.

Another percussion instrument of definite pitch is the celesta, which sounds bell-like and has a piano keyboard, the glockenspiel, several high and small bells, the big chimes that range from a profound deep sonority to high clarity, the xylophone, which is made up of wood-blocks and reminds one of chinese music, and the vibraphone, whose halting sound quivers through the employ of electrical machinery.

Percussion instruments of indefinite pitch are the big bass drum, with a deep and hollow, sometimes quite shocking, sound, reminiscent of thunder; the snare drum, used for the rattling rhythm in marches and if beaten regularly and continuously an excellent medium to indicate tension; the triangle, a metal instrument with a high sudden brassy sound; the gong, a deep and solemn instrument; the cymbals, which produce the loud and sudden crashes of two metal plates; and the tambourin and castagnettes, preferably used for Latin rhythms and quite noisy if employed continuously. There



CHRISTOPH WILLIBALD GLUCK'S orchestra was less concerned with color and frills, more with musical substance.

are many more percussion instruments which are used occasionally, but none of them represents a definite part of the symphony orchestra.

Classical composers used percussion rather sparingly, because their music was devoid of the rhythmic and coloristic suspense and surprises of which they alone are capable. But the modern orchestra considers them a substantial part of its inventory, and they add a great deal of fascination, ranging from the electrifying shock effect of a Prokofieff march to the hollow and sombre mood of a Berlioz in their sonority.

We have seen then that the orchestra undergoes quite a transformation in its development. This transformation is mainly one of emphasis, which shifts from the strings to the wind instruments. New instruments are added but no new group has come into existence since the classical period. The wind instruments have gained independence since the time when they were only supporters of the all powerful strings, and the percussion instruments seem to come into their own more and more. Orchestral color really reached its climax under Debussy and the latest trend points again toward a greater color economy in the sense of the classical composers although the days of the string supremacy seem to be over for good.

INSTRUMENTAL MUSIC

It may seem quite arbitrary to separate orchestra and instrumental music into two distinct categories especially when we shall find out that the forms of the latter resemble so closely those of the former. After all, in the last analysis the orchestra itself is nothing but one large, compact instrument which, not unlike the organ, can change its tone colors, yet presents itself to the listener as one, supercolossal instrument.

On the other hand, instrumental music, that is to say such music which is played by one or several instruments, naturally requires a thinner texture and has a few features that are different from orchestra music although the borderline is sometimes not quite clear. Take, for instance, the suite or the divertimento which is often played just by a few instruments and you will see that it comes much closer to instrumental than orchestra music.

In instrumental music we have two definite types: music which is written for the solo instrument, sometimes with piano accompaniment, and music written for a group of several instruments, also frequently referred to as chamber music. The chief difference between this music and orchestra music lies in the fact that here each instrument plays its own part while in the orchestra certain types of instruments, such as the violins for ex-



ARNOLD SCHOENBERG, best known modernist, has returned in his orchestrations to the economic style of music.

ample, play the same melody all the way through. This latter kind of playing is called playing in unison, and it almost never appears in instrumental music.

Music for the solo instrument has been written for practically every instrument. In earlier times pieces for lutes were very fashionable, but for our purposes it is enough to be acquainted with the music that still represents the bulk of contemporary concert repertory. Here we have at first the various instrumental pieces from the time of Bach and Handel. This period is often referred to as baroque, a name which is borrowed from the vocabulary of the then prevailing architecture. Among the compositions of this period we find many for organ solo. The organ is the outstanding instrument for polyphonic music, and we shall get acquainted with the polyphonic forms as played by the organ when we discuss vocal music, because vocal music gave polyphony its most genuine impetus. But because the instrumental texture is thin and each instrument has to carry an individual melodic load, we find a strong polyphonic influence in all instrumental music, even in that written at a time when the homophonic style was almost exclusively prevalent for orchestra and stage works.

Besides the organ, baroque composers chose the violin and cello as solo instruments, or in combinations with the harp-



RICHARD WAGNER'S heroic operas are full of the most splendid orchestra sound.



CLAUDE DEBUSSY uses the modern orchestra in the same deliberate manner as the late impressionist painter his palette.

sichord, the most prominent forerunner of our modern piano. And, of course, there was always a great deal of keyboard music as composed by the pre-Bach and the baroque composers.

In the classical period the violin-piano combination and the cello-piano combination was most popular, as witnessed by the many violin and cello sonatas written by Beethoven. And here we meet for the first time a new term—sonata. We had discussed the sonata form before, but then it was only a name indicating the structure of the symphony's first movement. Now we see that the word sonata signifies an entirely new composition. Actually, the sonata is a work consisting of several movements written for one or two solo instruments. These movements correspond in their form closely to those of the symphony, although they are smaller in their scope and often much more tightly knit. In general, however, it is safe to say that the sonata is formally the symphony written for solo instruments. And, of course, ever since the classics piano solo music has occupied a great deal of the composers' creative thinking. The piano used the sonata quite extensively. But the piano also inspired new forms which were essentially derived from the three part form of the "Lied." Romantic composers such as Chopin and Schumann, wrote a great



JOHANN SEBASTIAN BACH'S name is always associated with the typical contrapuntal forms, such as fugue and canon.

deal of these three part forms for the piano, and according to individual texture and atmosphere, called them preludes, etudes, nocturnes, and so on.

Among the chamber music the string quartet occupies a most important place. Usually written in the same form as the sonata or symphony, it is the most polyphonic of all group music. Often the suite form is also employed for this type of music, and, of course, there are many other combinations of instruments that can play chamber music, such as the wind quartet, the mixed string and wind ensemble, and so forth. The forms are almost always the same, derived either from the sonata or the suite. The 20th century has seen a closer rapprochement between the chamber group and the orchestra when some composers wrote chamber symphonies, that were built in the manner of symphonies, yet no two instruments played in unison. Theoretically there is no limit to the number of instruments for which chamber music can be written. But for all practical purposes you will not find more than nine

instruments with the possible exception of the chamber symphony, in which each of the principal orchestra instruments is represented as solo part. But most popular, in addition to the string quartet, have remained the piano trio (violin, cello, piano), the string trio (violin, viola, cello) and the quintet which appears in many variants such as two violins, two violas, cello, or string quartet (two violins, viola, cello) and piano, or two violins, viola, cello and bass fiddle.

VOCAL FORMS

Vocal music has been the backbone of Western music. Although it is now relegated to a secondary position by the orchestra it has given the most vital impulse to almost all polyphonic forms, which were at first generated by vocal music but later taken over by instrumental groups and the orchestra. Thus we must discuss the polyphonic form principles in the abstract, that is to say simply as forms, while we shall be aware continuously that they have been employed by almost any group of performers, such as singers, instrumentalists, orchestras, and have even found entrance into some sections of the symphony (see the last movement of Mozart's "Jupiter Symphony" Columbia M-565).

THE CANON

The canon symbolizes the most intricate, but also the most genuine of all polyphonic forms. It is what is popularly known as a "round" and we have discussed it before. Let us recapitulate briefly how it works. Instrument A plays a melody; after several, let us say two, measures instrument B comes in and plays the same melody while A continues; then after several measures again instrument C comes in and begins with the original melody while A and B continue their melodies. This can be continued indefinitely, but it is naturally limited by the receptive capacity of our ear. The principle is quite clear. Each instrument imitates a preceding one or several preceding ones at a distance. Let us say the melody played consists of the measures 1, 2, 3, 4, 5, 6, etc. Then the

thing looks graphically like this:

Instrument A: 1, 2, 3, 4, 5, 6, etc.

Instrument B: silent, 1, 2, 3, 4, 5, 6, etc.

Instrument C: silent—1, 2, 3, 4, 5, 6, and etc. Thus what we have is: measures 1 and 2 are played alone at first, then together with measures 3 and 4 and finally at the same time as two more instruments play simultaneously measures 3 and 4, and 5 and 6 respectively.

This principle of imitation can be one independent form or it can be injected into any larger form for a few measures. In the latter case it is called a canonic imitation.

THE FUGUE

The principle of the fugue, or of its earlier, smaller predecessor the *ricercare*, is that of imitation. The fugue theme, a definite preconceived melody, is first played by one instrument, then taken up by a second one, finally by a third and fourth one, etc. while the other instruments go on playing. However, they don't play the same melodies after having finished the theme as happened in the canon but they go on to different and new melodies, which vary in each instrument. After each instrument has played the theme once the first section is closed. Then follows an interlude leading over into the second section which repeats in some varied manner the principles of the first section. There are sometimes as many as four or five sections, all based on the same principles and all connected with interludes. The last section is usually a so-called *stretta* in which the fugue theme is played in canonic imitation, that is to say the second and third instruments start playing the theme before the first instrument is quite finished with it.

There are two, three and more part fugues according to how many singers or instruments execute independent melodies. In a two part fugue the theme appears twice in each section, three times in a three part fugue, four times in a four part fugue, etc. There are also other types of fugues such as the double fugue which has two contrasting themes, the triple fugue with three contrasting

themes, etc. Needless to say that the number of parts and themes is restricted again by the capacity of the human ear which can absorb just so much and not more. For a fine example of a fugue listen to Bach's "Organ Fugue in C minor" (Columbia 70087-D).

THE PASSACAGLIA AND THE CHACONNE

These two forms are so similar to each other that it is not necessary to distinguish them especially. As a matter of fact, most theoreticians are in doubt whether there is any definite distinction between them. The form principle is simple. A theme of several measures is continuously repeated throughout the whole composition by one instrument, or as in the organ by one part of the instrument, very often the bass. At the same time the other instruments, or the other registers of the organ, play different melodies simultaneously with the theme. These melodies change in the manner of variations every time the theme recurs (see Bach-Busoni "Chaconne Violin Partita No. 2," Columbia X-91).

THE TOCCATA

Toccatas originally only meant a composition for a keyboard instrument. Later on, by accepting strongly the mechanical characteristics of the keyboard instrument, it became a musical form which was characterized by the continuous rhythmic flow of fast notes. Its most outstanding feature is its virtuoso character, giving ample room for the performer to show off his technical prowess, and a rather free, unconventional character which defies any formal schematization. Composers of the 19th century have often used the name *toccatas* to indicate any composition that did not fit into any traditional or conservative formal scheme (see Bach's "Toccatas and Fugue in D minor," Victor 18058).

THE CHORAL PRELUDE

The choral prelude originated at the church service when the organist used to improvise on the organ before the com-

munity singing in order to get the worshippers into the right mood. For this purpose he used snatches of the choral melody which was to be sung later by the community. Thus the form of the choral prelude is largely determined by the choral which it uses as its basis. The melody of the choral is divided into separate sections. Each of these sections is accompanied by other instruments that play variants of the choral melody simultaneously with it, ornamenting it and enlarging its scope in a manner that is reminiscent of free and fanciful improvisation. All sections are connected with each other by short interludes. The choral prelude is actually a very elaborate fantasy in strict form over a given choral melody. (See Bach's Prelude on "Eine feste Burg," Columbia 11758-D.)

THE MOTETTE AND THE MADRIGAL

Both these forms are strictly vocal compositions, the motette mostly to a sacred text while the madrigal uses secular poetry for its lyrical basis. The two forms have undergone so many changes

FRANZ LISZT'S attempts at symphonic resurrection also led him into the field of the mass and the oratorio.

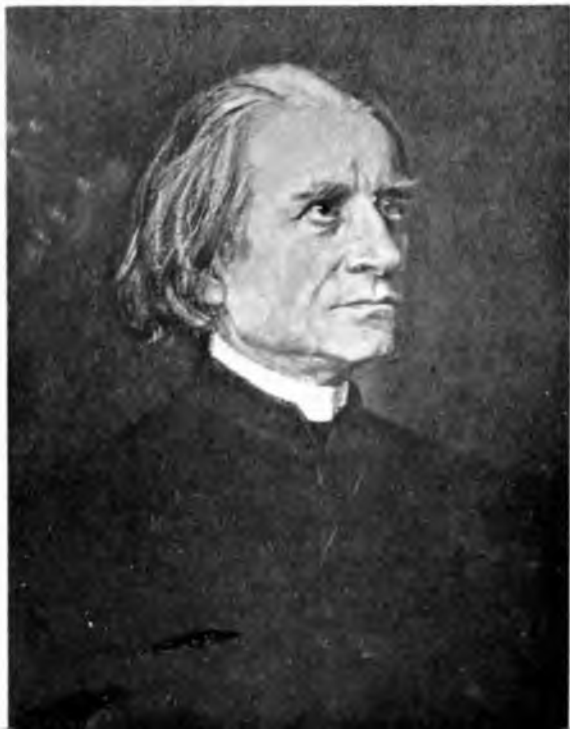

during the course of history that no one definition could do justice to them. Their form is mostly governed by the poetry they use as text. They are definitely polyphonic in their style. The later motette consists of several independent sections that follow each other without interruption. These sections are all taken from the well known polyphonic forms. Thus a motette may look like this: Section one: chorale. Section two: a set of vocal imitations in the manner of the canon but not canons proper. Section three: a canon proper. Section four: variant of the erstwhile chorale. Section five: chorale prelude over the melody of the erstwhile chorale. Section six: free introduction and double-fugue.

THE CANTATA

In its further development the motette finally leads into the cantata which, if sacred, takes a biblical incident or idea and elaborates it dramatically. The cantata is an opera in miniature although it is not staged scenically. But the discussions of the soloists, the exhortations of the chorus and the dramatic impact are so clearly exciting and dramatic that there can be no doubt as to the immediate effectiveness and the emotional interest they contain. In regard to form, the cantata is not restricted in any sense, but it makes ample use of the various polyphonic forms in its different sections (see Bach's "Cantata No. 78," Victor DM-1045).

LARGE CHORAL WORKS

Among the large choral works the oratorio is most important. It is a tremendously enlarged cantata, lasting sometimes as long as four hours, and uses all the dramatic devices which were apparent in a smaller way in the cantata. In its development it has moved from the extremely polyphonic oratorios of Bach and Handel (Handel's "Messiah," Columbia 271) to the more homophonic conception that approaches opera considerably in the oratorios of Haydn and some lesser church composers.

Another important choral composition is the mass which again follows in its

styles the prevalent styles of the periods in which it has been composed. Its forms are combinations of the prevalent musical forms and those prescribed by the liturgical service and the sacred text. (Beethoven's "Missa Solemnis," Victor DM-758.)

From the above we see rather clearly that the realm of choral music is the church. But, of course, there have been quite a few secular oratorios too, such as Haydn's "The Seasons" or Schumann's "Paridies and Peri." In addition, quite a few symphonic composers have worked the last movements of their symphonies into choral movements to secular texts. (Last movement of Beethoven's "Ninth Symphony," Columbia MM-227.)

STAGE WORKS

From the oratorio there is only one step to the opera. Actually many theoreticians consider the madrigal a forerunner of early opera. In a sense opera actually belongs more in the orchestral category because the bulk of the well-known operatic output from Mozart to Strauss and Puccini is based upon a prevalent homophony, with the singer doing the most important job against an instrumental background.

Opera has undergone many changes in its development but two different types are clearly discernible: that of the "number" opera and that of the music drama. The number opera, written by such composers as Gluck, Mozart, Rossini, Verdi and Puccini, consists of separate musical items in which a soloist or several singers perform a musically closed form which is a unit in itself. These "numbers" are connected by recitatives, dramatic recitations accompanied by the harpsichord in the case of Mozart, or by the orchestra in the case of Verdi. Sometimes the recitatives are neglected and a spoken dialogue connects the individual numbers as in Mozart's "Magic Flute." The numbers follow closely well known forms, most of all the three part "Lied" form.

The music drama is constructed in the opposite way. The whole drama is set to



FREDERIC CHOPIN, although never interested in the ballet, has furnished a great deal of music later used for this purpose.

music throughout and the music follows the plot rather faithfully. There are motifs which characterize personalities, moods, events, etc. and these determine the form. The orchestra has a much more important place here because it is the essential factor that describes the dramatic plot. There are no recitatives in the traditional sense and hardly any arias or musically self-sufficient scenes. Richard Wagner was the real instigator of this operatic form and he was followed in his principles by many German composers such as Richard Strauss and his contemporaries. For a difference in approaches between the two types it is best to compare the recording of Mozart's "Don Giovanni" (Victor M 423/4/5) with that of Wagner's third act from the "Meistersinger" (Victor DM-537).

Another very popular stage work is the ballet. It goes without saying that it does not fall into the category of vocal music. But since it is so closely related in its formal principles to the opera it might as well find a place here. The ballet is practically the orchestral version

of the "number" opera. Its numbers are various dances that are often connected by orchestral recitatives which are loosely knit orchestral paraphrases and dramatic outcries. Music lovers are less acquainted with the ballet as a compact stage work—as a rule when seen on the stage the music plays second fiddle to the dancers—but rather with the suites and excerpts taken from the complete ballet scores which we have discussed under the heading of "suite."

Modern ballets have turned away more or less from the idea of the "number" ballet and are approaching more and more the dramatic concept of Wagner's music drama.

THE SONG

Singing is almost as old as man. In our Western civilization the early Christians sang sacred songs, known as the collection of Gregorian and Ambrosian Chants. Later on the troubadors sang their highly personalized love songs and folk music was largely made up of numerous songs, that vary in form and texture according to each ethnic group, yet are always clearly discernible and easily understood as songs.

It is not difficult to see that songs have determined many of our musical forms. Only recall that one very important form of orchestral music is called "Lied" form (Lied being the German word for song). Then again, the song is largely influenced by the words the vocalist sings. Thus, poetry has had a tremendous and direct influence upon music. The song is almost always strophic, that is to say it is divided into different sections which are related to each other and of which one or the other section may even be repeated in the course of the song. Thus we arrive at a form of the song which is divided into several parts, two, three or more, with some of the parts repeated in the middle, at the end or wherever tradition may have required it.

Yet, although the song has been so influential in the evolution of all music it is only in the late 18th century that the composition which we know today as

art song comes into being. Previously there had been folksongs, minnesongs, songs by the Meistersingers, the German Protestant song and many more. They all were strophic repetitions of poetic stanzas set to music. (The choral, incidentally, was such a song performed by four voices and represents one of the essential bridges from polyphony to homophony.) But the new art song, started by Mozart and led to its height first by Schubert and Schumann and later on by Hugo Wolf and Richard Strauss, was much more a symphonic poem in miniature than a mere strophic song in the traditional sense. This art song, in its outer form still determined by the sectionalized structure of the underlying poem, can be lyric, dramatic, narrative or explosive, descriptive of a mood or a landscape or involved in emotions as any larger form. Its style is a variant of homophony with the singer still carrying the supreme melody; but the accompanying piano does not serve exclusively to fill in the missing harmonies. It has a life of its own, sometimes aiding the singer in his expressions, sometimes furnishing the atmospheric background or the entire setting of the scene, and very often lending its own, personalized characterization to the song.

The art song has become a substantial part of the repertory of great singers and of home music. It is to opera what the piano sonata is to symphony. In its condensed form, with appealing lyrics and an enticing melodic line, it is the type of music that finds most understanding with the musical novice.

With the song we have exhausted the variants of musical form. It will serve well to remember that the secret of artistic success does not lie in the stubborn following of preconceived ideas and patterns but in the capability of each composer to transcend the formal blueprint stage and to endow each and every one of his works not only with his own flavor but also with his own, private conception of design. Consequently, our enumeration and definition of musical forms can be at best only an approximation to musical

reality. A good definition is the best known common denominator of all existent forms; but you may not find the exact outlines given above in each symphony or song. With that in mind you will have a faint idea of each composer's aim. The rest you can only get through listening. Now, as always, the old principle still stands: music should be heard and not read about.

THE GREAT MUSICAL EPOCHS AND THEIR PRINCIPAL COMPOSERS

The origin of Western music lies far back in ancient times. The background of our music stems from all kinds of foreign countries and strange times which were cultural highspots while Western and Northern Europe were still barren lands. The first composition which we can really call our own as an immediate point of departure for Western music is the singing of the early Christians. Many of their songs have been collected, for instance in the collection known as the "Gregorian Chants." While these were the basis of music's further development they are by no means the only great music written before the times of Bach, although what we hear in the concert hall may often give this impression.

If we are to treat this period rather summarily it is not because its music lacks the beauty or importance of later compositions. But unfortunately, the expression of this music is so removed from our contemporary feeling and understanding that very little interest is found in music lovers for any of the pre-Bach periods, unless they happen to be professional musicians. What went on between the Gregorian chants and the Bach period, a time span that covers roughly twelve hundred years, was more variegated and fascinating than the music development afterwards. Yet, it is a time span whose music we have neglected and are probably going to neglect for a long time to come.

To mention its landmarks briefly: the Catholic Church, which had been the only sponsor of music in the early days, soon

found a competitor in the courts and the aristocracy which were equally interested in music. In addition, folk music gained increasing importance. The struggle between secular and sacred music lasted through all this time. Yet for many years sacred music was still most important. The three Netherland schools with such composers as Dunstable and Dufay in the first, Ockeghem in the second and Obrecht in the third period mark a definite highspot in sacred polyphony. Their work was overshadowed only by Josquin des Prés who summed up all the conflicting results of his predecessors in a most magnificent way.

The Renaissance, of course, introduced new forms in music just as sweepingly and violently as it had done in the other arts. Among many types of lesser importance the opera was born at the beginning of the 17th century. If des Prés was the synthesis of the pre-Renaissance period, so Claudio Monteverdi became the giant of the Renaissance days.

In the meantime the protestant movements of Germany had gained a tremendous momentum and they developed a music that was at once simpler and more introspective than the earlier polyphony. Of course, sacred music was continued in Italy at the same high standard throughout the 16th century when such men as Palestrina and Vittoria wrote their great church works. Yet, there are many conflicting styles in this period—on the one side the desperate clinging to polyphony in the church style, on the other the homophony introduced and furthered by the opera and finally culminating in the fashionable "thoroughbass period" of the rococo when homophony was reduced to its structural essentials.

Gradually, however, we see a shift of the important musical scene towards the North where such masters as the German Heinrich Schuetz write some of the most profound Protestant music. This profundity plus rapprochement between homophonic and polyphonic styles is the chief characteristic of the baroque period of which Bach and Handel are the undisputed masters.



FRANZ SCHUBERT is the one composer who represents a strong connecting link between late classicism and romanticism.

BACH AND HANDEL

Both Bach and Handel were true representatives of their era. But Bach, who had been born in Germany and had never left the country, was much more provincial than Handel. When he was employed at the court of Weimar, he wrote instrumental music and when he finally got his position as organist in Leipzig he wrote church music exclusively. Bach was a musician who wrote whatever the opportunity bade him. Yet his emotions were so deep, his whole existence so artistic that whatever he wrote bore not only the mark of the great composer but also that of the deeply sensitive, introspective, devout believer.

Handel was a man of the world. He had left Germany, the country of his birth, at an early age and settled in England where he had his ups and downs which were as far apart as extreme poverty and highest recognition by the king. His music, although beautiful and of perfect symmetry in its structure, has many more superficial aspects than that of Bach. If the old struggle between secular and sacred music would still have been continued then Bach could very well have represented the one side with Handel as antagonist in the mundane field. But

those times were long gone, and it is only in the feeling of the two composers that we recognize these differences, certainly not in the types of works they did. True, Handel wrote numerous operas, and Bach wrote none. But Bach wrote many secular cantatas in addition to his purely instrumental music which has little to do with the church service. On the other hand, Handel wrote a great many sacred oratorios, true in a more colorful and gay fashion than Bach, but sacred music it remained. Thus the two composers together sum up the spirit of the age splendidly: pietism with the as yet hardly visible portents of the rococo's carefreeness.

THE VIENNESE CLASSICS

The period between Bach and Haydn was one of beginning innovations. Whatever there had been of polyphony in Bach, and this was a great deal in the attempt to unite both poly- and homophonic styles, gradually disappeared and the so-called classics of Mannheim created the predecessor of the symphony together with some of Bach's sons. The one towering composer of this period, Gluck, had devoted his life to opera, a field which he rescued from the triteness and shallowness of some of his predecessors in France.

A new era had begun. The ideas that led eventually to the French Revolution find their ways into the salons and certainly into the heads of composers. Operas are written to modern texts; the orchestra becomes an integral part of concert life; new types of compositions are created; the art song begins to come into its own. This is the time when the three Viennese classics, Haydn, Mozart and Beethoven appear on the scene. Haydn, twenty-four years Mozart's and by thirty-eight years Beethoven's senior, was by no means the most timid of the three. On the contrary, his music is most incisive in that it establishes the new orchestral style beyond the rather timid attempts of the Mannheim classics who still wrote very much along the lines of the dance suite. It is exaggerated to call Papa Haydn the one

and only creator of the symphony. But if any one man could have created this form it would have been Haydn. Even as it were, his evolution of the symphonic form was a decisive influence towards the definite establishment of this music.

During his long life, which was eventually crowned with success and veneration by all his contemporaries, Haydn stayed always close to Vienna. With never tiring industry he wrote his greatest works, which encompass all possible forms of music.

It has often been pointed out that no other composers were as prolific and universal as the Viennese classics. And this holds certainly true of Mozart who, when he died at the age of 36, had left to posterity some of the greatest symphonies (e.g., "Jupiter," "Haffner"), operas (e.g., "Don Giovanni," "The Marriage of Figaro," "Magic Flute"), chamber music, keyboard music, church music (e.g., "Requiem"), in short, his output cannot be evaluated with the narrow scale of human considerations. Mozart, although more conservative in his formal aspects than Haydn, was the greater revolutionary spirit in all other fields of thought, a fact probably conditioned by his materially miserable life. He is one of the few truly great and the apex of his period.

With Beethoven we meet the modern composer for the first time. While Haydn and Mozart were still partially dependent upon the financial support of the aristocracy, Beethoven addressed himself already to an additional and new public, the up and coming richer merchants, students and professionals. A revolutionary even in his outward appearance, the German-born composer was the sensation of Vienna in which he spent the greatest part of his life. His revolutionary approach was not only restricted to his personal life. Writing his early works as a true pupil of Haydn, he soon freed himself from this style. Expanding his forms and injecting a very individualized and personal feeling into them, he is the strongest romantic among the classics, and the later romantics have taken his music as a point of departure. His sym-

phonies certainly are the greatest romantic masterpieces, while his string quartets are the absolute height of quartet writing in any period so far.

ROMANTICISM

The 19th century is the century of romanticism, that is to say an art movement which evolves its style and pattern from the personal experience of the artist and which defies this experience to an unprecedented degree. Franz Schubert, contemporary of Beethoven, was the first great composer to translate consistently his personal feelings into music in a more intimate fashion. While Schubert, a tragic figure in 19th century Vienna which virtually let him starve to death, still wrote the large symphonic forms somewhat in the style of the classics, he became completely original in the creation of a miniature, namely the art song. That does not mean that his symphonies are not equally great and original. But in the art song the form was entirely his.

The miniature form remained one of the chief forms of romanticism. The later triumvirate of romantics, Chopin, Schumann and Mendelssohn, used it extensively although each of them went his own way: Chopin that of the virtuoso

GIUSEPPE VERDI and his operas are Italy's substitute for the emotional romantic movement and its mystic heroism.





ANTON BRUCKNER, strongly influenced by Wagner, was late romanticism's strongest gift to the slowly dying symphony.

preoccupied with the piano; Mendelssohn that of the dreamer who wishes to recreate the great oratorio style of the baroque; and Schumann that of the classicist who, in a desperate attempt to use his lyrical faculties for the symphony, tries to become the most immediate successor of Schubert.

But there was also another art form that was typical of romanticism, namely the music drama. Carl Maria von Weber was the first composer to employ some of its technique which reached its height in Richard Wagner, the one great operatic composer whose talent and temperament overshadowed so many of his sometimes even better contemporaries. Wagner was a fighter, in words and in deeds. Not only did he take part in the 1848 revolution in Dresden, but he also attacked everything in music that stood for principles which were not his own. His great counterpart in the operatic field was Verdi who followed more the Italian traditional conception of opera; his great adversary in the symphonic field was

Brahms, whose romantic symphonies tried to establish the classical symphonic structure once more without necessarily giving up the personalized melodies and harmonies of romanticism.

The antagonism, with Wagner having Bruckner as symphonist and Wolf as song composer for his direct followers, took on some rather ugly forms, but historically they were eventually ironed out by such composers as Mahler and Richard Strauss who represented somewhat of a synthesis between the two romantic styles.

ROMANTIC SIDELINES

Of course, no music development actually ever happens as smoothly as it can be read in a book. While the above outlined tendencies came to a climax in Central Europe other countries created their own romantic movements. Thus Russian composers, at first violently national in a reaction against the West, became later some of the flagbearers of romanticism. We see Russia's music develop from the first break with the West in Glinka to the excitedly national composers Moussorgsky, Balakieff, Borodin, to end finally with such typical romanticies as Rimsky-Korsakoff and Tchaikovsky.

In France the romantic movement took on different aspects. Partly influenced by Russia some French composers broke loose from the academic tradition and the romantic heritage as handed over to a younger generation first by Berlioz, then by D'Indy, Cesar Franck and others. These young Frenchmen conceived romanticism not so much as the personal expression of one's private problems, but rather as personal impression which the outside world had made on the composers. Thus the descriptive movement of impressionism, clearly romantic yet quite different from its German edition, took its start and found its most perfect creator in Debussy. Simultaneously, a certain fresh and new approach in reaction to the pompousness of Wagner and Meyerbeer gained foothold in this music whose humor is often undeniable. Thus the new musical France started out as

the heir to gaiety and tone painting.

Germany, France and Russia remain the musically most important countries during the 19th century. Italy only follows its old course of opera, its climax is the "verismo" which chooses without much taste from whatever style direction it finds acceptable. Thus we find many Wagnerisms in Leoncavallo's operas, while Puccini, doubtless the greatest master of "verismo," collects preferably from Debussy.

In Bohemia we find a pattern resembling that of Russia, namely the resurgence of a consciously national movement. The more provincial, but musically more gifted, Smetana and his younger and more popular colleague, Antonin Dvorak, are the most significant representatives of this epoch.

The 19th century, despite its comparative decline in musicianship, has produced more music played today in the concert hall than any other century. What new roads will emerge from this music nobody can know. But the 20th century has given an indication of the reactions of many composers which are as variegated as the epoch in which they live.

TODAY

Basically, all music written in this century is the direct outgrowth of some former school, be it immediately preceding or centuries removed from it. We have seen the national school of composers as the mainstay of Russian 19th century music. This school lasts into our day, not only in Russia with Prokofieff and Shostakovitch, but also in countries that are comparative newcomers to the stream of music. Thus America has many national composers who have made quite a name for themselves, as for instance Aaron Copland, Roy Harris, etc. Other countries follow suit. Hungary has Bela Bartok, Czechoslovakia, Jaromir Weinberger and Finland, Sibelius, with Bartok being the most interesting and advanced composer of the three.

Influenced not only by the ideas of romanticism but actually by its style are many of the so-called academic composers, such as Deems Taylor and Howard



JOHANNES BRAHMS is the last of the great composers who dreamed of a renaissance of the symphony in classic terms.

Hanson in America, Florent Schmitt in France, Max Schillings in Germany, Serge Rachmaninoff of Russia and so on. But men like Stravinsky have consciously gone back to pre-Gluck sources in order to revitalize music. They turn away from romanticism by being no less romantic than Mendelssohn when he wanted to bring the baroque oratorio to life again. This trend, called neo-classicism, has found numerous adherents in addition to Stravinsky, but especially Italian composers such as Casella and Malipiero, did their best work in this style.

Only two romantic schools have found direct followers who continued and expanded the ideas of their predecessors. One is the school of impressionism which so influenced all French composers that at least one work of each French composer is in the impressionist style. But the greatest impressionists after Debussy remain Ravel and de Falla, while others such as Honegger and Milhaud adhered

more to the humorous, satirical side of the French esthetic movement.

The other school is that of the Brahms-Wagner synthesis which found its continuation in the expressionists of whom Arnold Schoenberg is most important. Other expressionists, although often deviating from Schoenberg's ideas are Alban Berg, the Austrian, and the American, Roger Sessions.

If we look at music today it seems like a confused knot that cannot be disentangled. But let us not forget, that while everything looks clear and precise at a distance the contemporaries of Bach probably did not know any better which way music would turn. And although we may be in the dark about the future there is enough in the past and present to make us want to enjoy it while waiting what future times may bring.

SUGGESTED READING LIST

If you want to enlarge your knowledge about music, musicians and specific works, the following books are recommended. They are selected with consideration for the layman who does not possess any technical knowledge.

About Musical Forms: Aaron Copland: "What to Listen for in Music," Whit-tlesy House.

About Music History: (concise) Alfred Einstein: "A Short History of Music," Alfred A. Knopf.

——— (extensive) Paul H. Lang: "Music in Western Civilization," W. W. Norton & Co.

About Composers: A. L. Bacharach, ed.: "Lives of the Great Composers," E. P. Dutton & Co.

In each of these books you will find further reading material.

SUGGESTED RECORDINGS:

Key: (V) indicates Victor, (C) indicates Columbia.

ORCHESTRA MUSIC

Haydn: Symphony No. 98. Arturo Toscanini and the NBC Symphony. (V) DM-1025.

Beethoven: Symphony No. 3 (Eroica). Felix Weingartner and the Vienna

Philharmonic. (C) M-285.

Franck: Symphony in D minor. Sir Thomas Beecham and the London Philharmonic. (C) M-479.

Tchaikowsky: Symphony No. 6 (Pathe-tique). Wilhelm Furtwangler and the Berlin Philharmonic. (V) DM-553.

Mahler: Symphony No. 9. Bruno Walter and the Vienna Philharmonic. (V) DM-726.

CONCERTOS

Bach: Double Concerto for Two Violins and Orchestra. Yehudi Menuhin and Georges Enesco with orchestra under Pierre Monteux. (V) DM-932.

Mozart: Concerto for Violin and Orches-tra No. 4, K. 218. Joseph Szigeti and the London Philharmonic under Sir Thomas Beecham. (C) M-224.

Beethoven: Piano Concerto No. 4. Artur Schnabel and the Chicago Symphony under Frederick Stock. (V) DM-930.

Schumann: Concerto in A Minor for Piano and Orchestra. Claudio Arrau and the Detroit Symphony under Karl Krueger. (V) DM-1009.

Brahms: Double Concerto for Violin and Cello. Jascha Heifetz and Emanuel Feuermann with the Philadelphia Or-chestra under Eugene Ormandy. (V) DM-815.

TONE POEMS

Liszt: Tottentanz (Dance of Death). Edward Kilenyi and the Orchestre Symphonique de Paris under Meyro-witz. (C) X-122.

Strauss: Til Eulenspiegel's Merry Pranks. Serge Koussevitzky and the Boston Symphony. (V) DV-1.

Debussy: La Mer. Serge Koussevitzky and the Boston Symphony. (V) DM-613.

OVERTURES

Mozart: Overture to the Magic Flute. Arturo Toscanini and the British Broadcasting Company Orchestra. (V) No. 15190.

Beethoven: Fidelio Overture. Felix Weingartner and the London Phil-harmonic. (C) 69545-D.

Verdi: Overture to La Forza del Destino.

Arturo Toscanini and the NBC Symphony. (V) No. 11-9010.

Rossini: Rossini Overtures. Arturo Toscanini and the NBC Symphony. (V) DV-2.

Tchaikowsky: 1812 Overture. Artur Rodzinski and the Cleveland Orchestra. (C) X-205.

SUITES

Bach: Suites 1-4. Adolph Busch Players. (V) DM-332 and DM-339.

Gluck: Ballet Suite arranged by Felix Mottl. Arthur Fiedler and the Boston "Pops." (V) DM-787.

Tchaikowsky: Nutcracker Suite. Frederick Stock and the Chicago Symphony. (C) M-395.

Stravinsky: Petrouchka. Igor Stravinsky and the New York Philharmonic. (C) X-177.

INSTRUMENTAL MUSIC

Bach: Goldberg Variations. Wanda Landowska, harpsichord. (V) DM-1022.

Beethoven: Sonata No. 9 (Kreutzer) for Violin and Piano. Adolph Busch and Rudolf Serkin. (C) M-496.

Haydn: Quartet in G Major. Budapest String Quartet. (V) DM-869.

Brahms: Quintet in B Minor. Adolph Busch and the Busch Quartet with Reginald Kell, Clarinetist. (V) DM-491.

Hindemith: Trio for Strings No. 2. Hindemith Trio. (C) M-209.

CONTRAPUNTAL MUSIC

Bach: Organ Fugue in C Minor. Edouard Commette (organist). (C) 70087-D.

Bach: Chaconne in D Minor—Unaccompanied Violin Partita No. 2. Ernst Wolff (pianist). (C) X-91.

Bach: Toccata and Fugue in D Minor. E. Power Biggs (organist). (C) 18058.

Bach: Cantata No. 78. Lucius Metz (tenor), Mack Harrell (bass). Bach Choir of Bethlehem, and Orchestra under Ifor Jones. (V) DM-1045.

LARGE CHORAL WORKS

Verdi: Requiem Mass. Maria Caniglia,

(soprano), Ebe Stignani (mezzo-soprano), Benjamins Gigli (tenor), Ezio Pinza (bass), and the Rome Royal Opera and Chorus under Tullio Serafin. (V) DM-734.

Handel: The Messiah. Labette (soprano), Brunskill (contralto), Eisdell (tenor), Williams (bass), BBC Chorus and the London Philharmonic under Sir Thomas Beecham. (C) M-271.

Beethoven: Missa Solemnis. Harvard Glee Club, Radcliffe Choral Society, Jeanette Vreeland (soprano) Anna Kaskas (contralto), John Priebe (tenor). Norman Cordon (bass), with the Boston Symphony under Serge Koussevitzky. (V) DM-758 and DM-759.

STAGE WORKS

Mozart: Don Giovanni. Glyndebourne Festival Opera Company under Fritz Busch. (V) DM-423, DM-424, and DM-425.

Verdi: Aida. Artists. Chorus and Orchestra of La Scala Opera Company, Milan. (V) DM-54.

Wagner: Die Meistersinger—Act III. Margarete Teschemacher and Lene Jung (sopranos), Torsten Ralf and Martin Kremer (tenors). Eugen Fuchs, Sven Nilsson, Arno Schellenberg and Hans Nissen (basses). and the Choir of the Dresden State Opera with the Saxon State Orchestra under Karl Bohm. (V) DM-537 and DM-538.

Strauss: Der Rosenkavalier. Lotte Lehmann. Anne Nicholsky and Elisabeth Schumann (sopranos). Maria Olizewska and Bella Paalen (contraltos). Herman Gallos and William Wernigk (tenors), Victor Madin (baritone), Karl Ettl and Richard Mayr (basses). with the Vienna Philharmonic under Robert Heger. (V) DM-196.

SONGS

Schubert: Die Winterreise. Lotte Lehmann (soprano) with Paul Ulanowsky (pianist). (V) M-692.

Schumann: Dichterliebe. Lotte Lehmann (soprano) with Bruno Walter (pianist). (C) M-486.

CHRONOLOGICAL LIST OF COMPOSERS

14th CENTURY

DUNSTABLE, JOHN (1370?-1453)

15th CENTURY

BINCHOIS, GILLES (1400?-1460)
OKEGHEM, JEAN (1430?-1495)
DES PRES, JOSQUIN (1450-1521)
WILLAERT, ADRIAN (1480?-1562)

16th CENTURY

AICHHINGER, GREGOR (1564-1628)
ANERIO, FELICE (1560-1614)
ARCADELT, JACOB (1514-1575)
BYRD, WILLIAM (1542-1623)
CALVISIUS, SETHUS (1546-1615)
GESUALDO, CARLO (1560-1613)
JANNEQUIN, CLEMENT (16th Century)
LASSUS, ORLANDUS (1532-1594)
MAUDUIT, JACQUES (1557-1627)
MORLEY, THOMAS (1557-1603)
PALESTRINA, GIOVANNI (1515-1594)
TALLYS, THOMAS (1510-1585)
VITTORIA, TOMMASO (1540-1611)
WILBE, JOHN (1574-1638)

17th CENTURY

CACCINI, GUILIO (1546-1615)
CALDARA, ANTONIO (1678-1763)
CARISSIMI, GIACOMO (1604-1674)
CESTI, MARC ANTONIO (1620-1669)
FRESCOBALDI, GIROLAMO (1583-1644)
GIBBONS, ORLANDO (1583-1625)
LOTTI, ANTONIO (1667-1704)
LULLY, JEAN-BAPTISTE (1633-1687)
MONTEVERDI, CLAUDIO (1567-1643)
MOURET, JEAN JOSEPH (1682-1738)
PERI, JACOPO (1561-after 1609)
PRAETORIUS, MICHAEL (1571-1621)
PURCELL, HENRY (1658-1696)
SCARLATTI, ALESSANDRO (1659-1725)
SCHUETZ, HEINRICH (1585-1672)
VIVALDI, ANTONIO (c. 1675-1743)

18th CENTURY

BACH, JOHANN CHRISTIAN (1735-1782)
BACH, JOHANN SEBASTIAN (1685-1750)
BACH, K. PH. E. (1714-1788)

BOCCHERINI, LUIGI (1743-1805)
DAQUIN, CLAUDE (1694-1772)
GLUCK, CHRISTOPH W. (1714-1787)
HANDEL, GEORG FRIEDRICH (1685-1759)
HAYDN, FRANZ JOSEPH (1732-1809)
LECLAIR, JEAN-MARIE (1697-1764)
MARCELLO, BENEDETTO (1696-1739)
MOZART, WOLFGANG AMADEUS
(1756-1791)
PARADIES, PIETRO DOMENICO (1710-1792)
RAMEAU, JEAN PHILIPPE (1683-1764)
SACCHINI, ANTONIO GASPARA (1734-1788)
SCARLATTI, DOMENICO (1685-1757)

19th CENTURY

ALBENIZ, DON ISAAC (1861-1909)
APENSKY, ANTON (1861-1906)
AUBER, DANIEL (1782-1871)
BALAKH'W, MILI (1837-1910)
BEETHOVEN, LUDWIG VAN (1770-1827)
BELLINI, VINCENZO (1801-1835)
BERLIOZ, HECTOR (1803-1869)
BIZET, GEORGES (1838-1875)
BORODIN, ALEXANDER (1834-1887)
BRAHMS, JOHANNES (1833-1897)
BRUCH, MAX (1838-1920)
BRUCKNER, ANTON (1824-1696)
CHABRIER, EMMANUEL (1841-1894)
CHARPENTIER, GUSTAVE (1860-
CHAUSSON, ERNEST (1855-1899)
CHERUBINI, LUIGI (1760-1842)
CHOPIN, FREDERIC FRANCOIS (1809-1848)
CUI, CESAR (1835-1918)
DEBUSSY, CLAUDE (1862-1918)
DELIBES, LEO (1836-1891)
DELIUS, FREDERICK (1863-1935)
DONIZETTI, GAETANO (1797-1848)
DUKAS, PAUL (1865-1935)
DUPARC, HENRI (1848-1933)
DVORAK, ANTON (1841-1904)
ELGAR, EDWARD (1857-1935)
FAURE, GABRIEL (1845-1924)
FLOTOW, FRIEDRICH (1812-1883)
FOSTER, STEPHEN (1826-1864)
FRANCK, CESAR (1822-1890)
FRANZ, ROBERT (1815-1892)
GIORDANO, UMBERTO (1863-
GLAZOUNOW, ALEXANDER (1865-

GLINKA, MICHAEL IVANOVICH (1804-1857)
 GODARD, BENJAMIN (1849-1895)
 GOLDMARK, KARL (1830-1915)
 GOUDON, CHARLES FRANCOIS (1818-1893)
 GRANADOS, ENRIQUE (1867-1916)
 GRETCHANINOFF, ALEXANDER (1804-1881)
 GRIEG, EDVARD HAGERUP (1843-1907)
 HERBERT, VICTOR (1859-1924)
 HUMMEL, JOHANN (1778-1837)
 HUMPERDINCK, ENGELBERT (1854-1921)
 D'INDY, VINCENT (1851-1931)
 IPPOLITOW-IVANOW, MICHAEL (1859-1931)
 LA LO, EDOUARD (1823-1892)
 LEONCAVALLO, RUGGIERO (1858-1919)
 LIADOW, ANATOL (1855-1914)
 LISZT, FRANZ (1811-1886)
 MACDOWELL, EDWARD (1861-1908)
 MAHLER, GUSTAV (1860-1911)
 MASAGNI, PIETRO (1863-1946)
 MASSENET, JULES (1812-1912)
 MENDELSSOHN, FELIX (1809-1847)
 MEYERBEER, GIACOMO (1791-1864)
 MOSCZKOWSKI, MORITZ (1854-1925)
 MOUSSORGSKY, MODESTE (1839-1881)
 NEVIN, ETHELBERT (1862-1901)
 OFFENBACH, JACQUES (1819-1880)
 PAGANINI, NICCOLO (1784-1840)
 PIERNE, GABRIEL (1863-1937)
 PONCHIELLI, AMILCARE (1834-1886)
 PUCCINI, GIACOMO (1858-1924)
 RACHMANINOFF, SERGEI (1873-1943)
 REGER, MAX (1873-1916)
 RIMSKY-KORSAKOFF, N. (1844-1908)
 ROSSINI, GIOACCHINO (1792-1868)
 RUBINSTEIN, ANTON (1830-1894)
 SAINT-SAENS, CAMILLE (1835-1921)
 SARASATE, PABLO DE (1844-1908)
 SATIE, ERIK (1866-1925)
 SCHUBERT, FRANZ PETER (1797-1828)
 SCHUMANN, ROBERT (1810-1856)
 SCRIBAN, ALEXANDER (1872-1915)
 SIBELIUS, JAN (1865-1957)
 SMETANA, FRIEDRICH (1824-1884)
 SPOHR, LOUIS (1784-1859)
 STRAUSS, JOHANN (1825-1899)
 STRAUSS, RICHARD (1864-1949)
 SULLIVAN, SIR ARTHUR (1841-1900)
 VON SUPPE, FRANZ (1819-1895)
 TSCHAIKOWSKY, PETER ILICH (1840-1893)
 THOMAS, AMBROISE (1811-1896)
 VERDI, GIUSEPPE (1813-1900)
 VIEUXTEMPS, HENRI (1820-1881)
 WAGNER, RICHARD (1813-1883)

VON WEBER, CARL MARIA (1786-1826)
 WIENIAWSKI, HENRI (1835-1880)
 WOLF, HUGO (1860-1903)

20th CENTURY

BARBER, SAMUEL (1911-1981)
 BARTOK, BELA (1881-1945)
 BAX, ARNOLD (1883-1969)
 BERG, ALBAN (1885-1935)
 BLOCH, ERNST (1880-1959)
 BRIDGE, FRANK (1879-1941)
 CADMAN, CHARLES WAKEFIELD (1881-1959)
 CARPENTER, JOHN ALDEN (1876-1959)
 CASTELNUOVO-TEDESCO, MARIO (1895-1972)
 COATES, ERIC (1886-1959)
 COPLAND, AARON (1900-1990)
 DOHNANYI, ERNST VON (1877-1946)
 DUBENSKY, ARCADY (1890-1982)
 ENESCO, GEORGES (1881-1955)
 GERSHWIN, GEORGE (1898-1937)
 GLIERE, REINHOLD (1874-1955)
 GRAINGER, PERCY (1882-1961)
 GRIFFES, CHARLES (1884-1920)
 GRUNBERG, LOUIS (1883-1961)
 GUION, DAVID (1895-1972)
 HANSON, HOWARD (1896-1981)
 HARRIS, ROY (1898-1991)
 HOLST, GUSTAV VON (1874-1935)
 HONEGGER, ARTHUR (1892-1955)
 IVES, CHARLES (1874-1954)
 JANSSEN, WERNER (1900-1981)
 KODALY, ZOLTAN (1882-1967)
 KREISLER, FRITZ (1875-1926)
 MALIPIERO, G. FRANCESCO (1882-1972)
 McDONALD, HARL (1889-1972)
 MILHAUD, DARIUS (1892-1974)
 PROKOFIEFF, SERGE (1891-1973)
 QUILTER, ROGER (1877-1959)
 RAVEL, MAURICE (1875-1937)
 RESPIGHI, OTTORINO (1879-1936)
 SCHONBERG, ARNOLD (1874-1951)
 SESSIONS, ROGER (1896-1985)
 SOWERBY, LEO (1895-1972)
 STRAWINSKY, IGOR (1882-1972)
 SZOSTAKOWICZ, DMITRI (1906-1975)
 TAYLOR, DEEMS (1885-1972)
 TURINA, JOAQUIN (1882-1969)
 VILLA-LOBOS, HECTOR (1886-1959)
 WEBERN, ANTON VON (1883-1985)
 WEINBERGER, JAROMIR (1896-1981)
 WOLF-FERRARI, ERMANN0 (1876-1948)
 ZEMACHSON, ARNOLD (1892-1972)

The

choice of music lovers . . .

WEBSTER

Automatic Record Changers

Selected by makers of the finest radio-phonograph combinations for use in their instruments . . . chosen by consumers as replacement units or for attachment to their present radio sets . . . Webster Automatic Record Changers give brilliant performance and outstanding fidelity of reproduction. Several models are offered . . . in chassis form, or with base.

64

MODEL
56



WEBSTER



CHICAGO

5610 BLOOMINGDALE AVENUE

CHICAGO 39, ILLINOIS

• 32 YEARS OF CONTINUOUS SUCCESSFUL MANUFACTURE •

CADET

1947

THE
INDEPENDENT

TO

WATCH IN



TOP TUNES
TOP TALENT

Recorded with
Unsurpassed Fidelity

79¢

RETAIL PRICE
Federal Tax Included
Standard Trade Terms
& Discounts Apply

CADET

• RECORDED IN HOLLYWOOD •

Produced by JACK RILEY
CADET RECORD COMPANY
P O Box 307
HOLLYWOOD 28, CALIFORNIA
Telephone HI-1308

Distribution through Direct Factory Branches Now Being Opened Coast-to-Coast

GET IN STEP WITH **CADET** FOR THE MARCH TO BETTER BUSINESS!

serious music— what next?

In the following article, Mr. List discusses the contribution of recordings to the musical scene, the large body of music that is, as yet, unrecorded, and the future of records.

BY KURT LIST

The serious music which forms the backbone of our Western music was written over a period of more than a thousand years. Within this period thousands of works have been composed, many of which are now lost and many more, although valuable, are completely unknown or have to be unearthed by musicologists for public performance. Some of these works are significant only for historical reasons; others are significant as beautiful works. Nevertheless, only a very small percentage of all these works is ever performed publicly. The regular symphony orchestras, opera houses, and the

chamber music associations and choral groups devote their energy mainly to that music which has been composed since Bach and Handel, roughly a period of about two hundred out of the thousand years of Western music. Within this period there are composers who wrote scores of deep beauty, yet are completely forgotten today. Who remembers even the names of such one time famous musicians as Stamitz, Monn and Dittersdorf?

Of those composers whose names and works have remained alive in the repertory only a few compositions are regular-



VLADIMIR
GOLSCHMANN'S
*glamorous conductor
personality has been a
substantial factor in
the sale of Indianapolis
Symphony records.*

ly performed. How many of Mozart's numerous symphonies can you recall having heard in the concert hall? How many symphonies of Haydn's one hundred and four are played publicly? Of Verdi's thirty operas hardly a dozen are performed at the Met. Of Wagner's thirteen operas only about half are performed regularly not to mention the significant operas of Gluck, Mozart, Weber, Strauss and others.

Yet when we compare what has been recorded to what is being performed in live performances, the scales incline definitely and very strongly in favor of the recorded performance. It is almost commonplace today to say that people who do not live in metropolitan areas get their serious music exclusively by way of records. But the people who live near New York, Chicago or San Francisco get a great deal of serious music also only through records even if they attend concerts regularly. After all, where can one hear all the "Piano Sonatas" of Beethoven, the major "String Quartets" of Mozart, some of the "Cantatas" by Bach, etc. in one season? The works that could be mentioned are legion. This, of course, does not mean that every important work ever composed is recorded; but it means that the number of recorded works is greater and more varied than the number of works in the regular concert repertory.

This holds true with one possible exception, that of contemporary music. But even here we see a tendency to remedy the situation on the part of the record companies which, during the last year, have embarked on a rather ambitious program of recording the best known works of today's musical literature.

Doubtless, the record companies are faced with one serious problem in the future. If all major works of the concert repertory are already recorded, and some in duplicate or triplicate, then what are the companies to record in the future? The obvious answer is: works that are not in the concert repertory. But there is a catch to this. Rarely heard and unknown works find only a limited market. People want to possess the recordings of



KURT APPELBAUM, outstanding pianist of the younger generation, will record all of Beethoven's piano sonatas for Musicraft.

those works which they have heard previously on the radio or at concert performances. Usually they prefer two different performances of one and the same work to one performance of an unknown work. Naturally, the market can always stand a certain number of rare works, works which can easily become collector's items, but the possibilities are limited. Thus the natural tendency is, and will remain, to re-record the old standbys in new performances.

The serious and die-hard collectors who are already in the possession of the standard works naturally frown upon such practices. I have a letter in my possession, written by a prominent music manager who wishes to remain unnamed, in which he writes: "It occurred to me that we are badly in need of an article from your hands on the eternal duplications of solo works. Of course, you know many more than I do, but while so many essentials are missing or unavailable we still find two Max Bruch 'Concertos' (G minor) in the Columbia catalog (Campoli and Milstein); two 'Rhapso-



SYLVIA MARLOWE is another star whose unusual playing of the harpsichord enhances the value of the independent company for which she records.

dies in Blue' (Levant, Templeton, on Columbia) [and, I may add, a San Roma version on Victory—K.L.] two Bach double concertos (Szigeti—Flesch and Busch—Magnes) [and again, Menuhin—Enesco—K.L.], two Mendelssohn 'Concertos' (Szigeti and Milstein)—and you could not doubt go on. Why no Glazounow 'Concerto,' or Chausson 'Poeme,' no Saint-Saens 'Concerto for Violin or Cello,' no Mozart 'A Major Violin Concerto,' no MacDowell 'Piano Concerto,' nothing of Vaughan Williams for violin in the Columbia catalog? Is it because of a complicated interlocking system of utilizing a special performance in order to record next day and save on the rehearsal? This means that the repertory and sales departments, the symphony conductor and the manager, and sometimes the executive board and the soloist must by some miracle want the same work by the same artist, at the same place, and at same time (not to speak of the ambulant recording equipment which must be available on just *that date!*)"

Of course, the gentleman is perfectly right from a mere esthetic and cultural viewpoint, although even here I must make certain reservations. First of all, not all of the recordings mentioned in the letter are available at present. If they are, there is a question of whether a ten-year old recording measures up technically to the newly discovered and applied techniques that yield a much higher fidelity. However, this does not

mean that all old recordings should be cut out of the catalog. On the contrary, some of them possess great value in the style and playing of artists who may now be dead or past their prime. What would we not give today for recordings of Paganini's or Liszt's playing! And future generations may feel the same way about Schnabel or Szigeti, although by then the recording techniques may be so far advanced that a high fidelity recording of today will seem to them as inadequate as the early Caruso recordings seem to us today. Even more than that, it is important to hear different interpretations of the same work, that is, interpretations which throw a new light upon it. Of course, this is not always the case with duplications many of which are, for this purpose, worthless. But wherever it is the case, it is almost imperative that another artist be heard as well as the one who did the original recording. Furthermore, our young artists who are now coming into their own should be given a chance at showing their musicianship in standard works that have been reserved previously for interpretation by the gods of an almost forgotten era.

Another reason for re-recording may come up for musicological reasons. Recently, in a discussion with Joseph Szigeti, the well-known violinist pointed out to me that all Beethoven "Violin Concerto" recordings, including his own were wrong in following the score of the publisher Breitkopf. In this edition several

passages were noted down wrongly, that is, not in the way Beethoven had them in the original manuscript. Szigeti, who was made aware of this through the recent researches of the conductor Klemperer, rectified the mistakes in his latest concert performances. But the mistakes are made permanent in the previous recordings. Consequently, a new recording of this work seems imperative.

These things happen all the time. Research proves that a great many of our past performance practices and actual readings are based upon mistakes; thus a new reading is called for that should be incorporated in a new recording.

But aside from these points our correspondent is certainly wrong from the merchandising point of view. The works he mentions should certainly be recorded but they can only be recorded in addition to the standard works. Otherwise, sales would drop considerably and the entire industry, which after all is governed by commercial rules, would collapse very soon. Consequently, it is up to the record companies to find the middle road between recording the standard works and those that are neglected in the concert repertory.

I dwell in such detail on this point be-

cause it will be crucial in the next few years. As a matter of fact, as it stands now, it seems to be the key to the future recorded music. The formula is pat and simple: a great number of new artists, who will gradually record all the standard works; a smaller number of rarely heard works thrown in mainly for cultural reasons; a certain amount of contemporary music, mainly that which has already found public recognition through live performances; and a very modest measure of experimental recording.

Another reservation that must be made to our correspondent's letter concerns availability. Naturally, during the war years, with production facilities seriously curtailed, many recordings became unavailable, although they remained listed in the catalog. The companies are at present trying to repress as many of their catalogued items as possible. It is hard to say what is available at a certain date because the production situation is constantly fluctuating. Eventually, everything now listed in the present catalogs will be on the market. How long it will take is hard to foretell, but the policy of all the major companies is certainly to restore the catalogs completely.

The problem of "cut-outs" is not less

The BUDAPEST STRING QUARTET has been one of the chief reasons for the wide appeal chamber music has had in recent years throughout the country.



involved. "Cut-outs" are those recordings which are definitely deleted from the catalog and which will not be reinstated. It is a "mystery wrapped in an enigma" for the outsider to ascertain why the companies decide that certain, sometimes very worthwhile, or at least historically interesting, recordings should be cut-outs while others hardly deserve a repressing. Sales considerations partly influence the executives in their decisions but if one considers that a cut-out item becomes a "collector's item" and as such commands a price which is often five or eight times as high as the original, one wonders whether this record, if available in quantity, would not command at least a modest market. At any rate, if a certain work becomes a "cut-out," its recording in a new version is imperative.

In a quick glance at the repertory recorded so far, we discover the following trends: all music before Bach and Handel is largely neglected, with such composers as Palestrina, Lassus, and des Près almost non-existent in the catalog. However, the earliest example of Western

music, the Gregorian Chants, are fairly well represented, partly in recordings of the major companies, and partly in recordings of such specialized companies as the Gregorian Institute of America. The market for these discs is not so limited as one might assume at first. Serious collectors and devout Catholics, plus church institutions, are always eager to get them.

The contemporaries of Bach and Handel are also neglected to a great extent. Once in a while you may find an album by Scarlatti or another contemporary, but by and large such albums are rare.

Bach, of course, is copiously represented on records, but not with anything approaching completeness. Of his several hundred cantatas only about twenty are on discs; a very small percentage of the choral preludes for organ is recorded; of the passions only that according to St. Matthew is available complete; and similar situations exist in regard to all different types of Bach's many-faceted output. Recording companies would find in this composer much that could give them material for extending their repertory. The recent tremendous success of Wanda Landowska's rendition of the "Goldberg Variations" proves the great merchandising potentialities of Bach's music.

Handel is represented with even fewer works in comparison to his output than his great contemporary. His oratorios and operas are missing in complete editions and the repertory could well stand some more recordings of his chamber works.

If we come to the so-called Viennese classics we find a much better representation of their music on records. Take Mozart, for instance. Naturally, it would be asking too much to have all of his more than eight hundred works recorded (some of them are hardly worth the trouble), but with four operas complete on discs ("Magic Flute," "Marriage of Fi-

HELEN TRAUBEL'S Wagnerian performances replace some of the older "cut-out" discs of European operatic stars.



garo," "Cosi fan tutte," and "Don Giovanni"), thirteen of his symphonies, and a host of concertos, operatic excerpts and chamber music scores on records. the collector can get an adequate picture of his creative efforts. As far as the string quartets go, the repertory is not very complete, but if all the recorded items were available they should suffice to satisfy the demand.

Haydn is less lucky. His quartets especially have been neglected, being recorded in a very hard to get Society edition at present, with the exception of about half a dozen separate albums. Neither are his oratorios represented in any complete edition, and even the excerpts are spotty. The recent discovery of some additional Haydn symphonies should have led to an extension of his symphonic recordings, an extension which, unfortunately, did not take place. As to church music, neither he nor Mozart have as many representative works on discs as would be desirable.

The works of Haydn and Mozart are at least recorded to the extent that the collector can get an adequate idea of their work, and often a better one than is available in the concert repertory. But the contemporaries of the two masters are largely unknown to the public and have a very slim representation on records. Their works should prove to be an inexhaustible source for those companies that want to reach the collector's market with more than the standard works.

Beethoven again comes in for a fairly complete representation. Beethoven is essentially a symphonic composer, and his symphonies and chamberworks are his most important outputs. They are recorded in abundance, some, like the "Fifth Symphony," in as many as nine versions, with a Koussevitzky rendition already in the Victor vault to await release in the future. The piano sonatas, available only on expensive imported records, are to be recorded by Kurt Appelbaum on Musicraft in the near future.

The one Beethoven work which is still waiting to be recorded and which is cer-



WANDA LANDOWSKA and YEHUDI MENUHIN team up in an unusual series of harpsichord-violin recordings which will give chamber music a new boost.

tainly important enough to be in the collector's home is the opera "Fidelio," of which so far only excerpts have come to the market.

Again, lesser contemporaries are missing from the catalogs. The best known of them is Rossini, whose overtures are well recorded but whose complete operas have not found their way into the record repertory with the exception of the "Barber of Seville." Another significant composer of that time may be Mercadante, whose slightly superficial and Italianate church music has found more favor with the European public than with that of this hemisphere.

Schubert is a different case. His most popular works are available not only in their original versions but also in numerous transcriptions. (Just remember the "Serenade," "Ave Maria" the F Minor "Moment Musical" etc.) But only a small percentage of his entire song-output is on discs with the church music



ROBERT MERRILL, most recently discovered American baritone, is equally at home in the popular and operatic repertory.

and operas lacking, although neither of these categories of his works seem important enough to warrant extensive recording. But some of his chamber music could certainly stand resurrection, and it would be important to have all of his piano sonatas made available again.

His symphonies, with the exception of the first one, are all available, although the sixth appeared only several months ago on Victor records for the first time.

The climax of the romantic movement is preserved in near completeness. Schumann and Chopin are present with more than just their important works, but few of them are available at present. Similarly, Mendelssohn has a great many works recorded, but some of his piano music and the oratorios would warrant a more detailed attention.

Of the Russian composers, Tchaikovsky is treated by far the best. His standard works are being recorded over and over again ("Swan Lake," "Nutcracker Suite," the "First Piano Concerto") and his lesser known compositions are fairly well represented. Rimsky-Korsakoff has numerous recordings of his most popular works, and the others hardly warrant any

special attention today. But Moussorgsky, who is well represented with his opera "Boris Godounov," does not fare too well with his important songs, which are very significant and could command a larger market (if issued in a comprehensive album) than the record companies seem to believe.

It is hardly possible within this limited space to go into details about every composer of the nineteenth century. By and large two tendencies can be noted which, though seemingly contradictory, have

72

ALLAN JONES' balladeering of semi-classical and popular music has enjoyed undiminished success through many years.



PATRICE MUNSEL, youngest Met star, is a pleasant addition to Victor's repertoire of highly successful operatic singles.



proved to be complementary. One is the duplication of the standard works, like, for instance, the famous "D Minor Symphony" by Cesar Franck. The other is the desire to explore the neglected major works of such composers as Berlioz and Mahler, whose symphonic works are gradually entering the catalog as is witnessed by the recent Victor recording of Berlioz's "Harold in Italy" and the Columbia recording of Mahler's "Fourth Symphony." Both composers are important enough to warrant such enterprises as is also proved in the sales figures of these albums. One can only hope

that complete recordings of Berlioz's "Damnation of Faust" (already recorded in France) and Mahler's "Third," "Fifth," "Sixth," and "Seventh" Symphonies and some of his songs, will appear soon.

Two German composers are neglected without any apparent reason. Collectors have been asking repeatedly for the numerous exquisite songs of Hugo Wolf and for the symphonies of Anton Bruckner. Only twenty-seven songs of Wolf have ever been recorded of which only two or three are available at present, while Bruckner's symphonies, of which numbers four, five, seven and nine have appeared under domestic labels, are out of print at present.

The French impressionists, Debussy and Ravel, on the other hand, are represented with an adequate number of works. However, their forerunner and aesthetic god, Eric Satie, has not found much favor with the record companies although his music may be perfectly suited to recording purposes. Later impressionists such as de Falla and Ibert have their chief compositions recorded



LAURITZ MELCHIOR'S perennial popularity has increased a thousand fold since he appeared in the movies where he sings both serious and semi-popular music.

and their availability is only a matter of production facilities.

As to opera, Verdi is probably the luckiest. There are numerous operatic excerpts of his works, (and operatic sions: "Aida," "Falstaff," "Otello," "Recently assumed sales proportions that almost rival the success of the early Caruso renditions); but also many of his operas can be heard in complete versions: "Aida," "Falstaff," "Otello," "Rigoletto," etc. But Wagner has only the third act of Meister-singer recorded completely, while the "Walkuere" was only recently completed in its three acts through the new Columbia third act release. All other operas are either available in nearly complete versions such as "Tannhaeuser," or in numerous excerpts. True enough, a complete Wagner opera on records would not sell too well at once due to the high price necessary to cover production costs; but on a long range

program such works as a complete "Tristan and Isolde," or a complete "Meistersinger," should prove to be good sellers. Outside of these two works, however, there is no need to record Wagner in any more detail than is given through the numerous, often very exhaustive, excerpts now available.

Puccini, the third in the operatic triumvirate of popular composers, is represented with "Bohème," "Madame Butterfly," and "Tosca," which are recorded complete and with numerous arias, duets, and ensemble scenes waxed repeatedly. Other composers of the Italian and French school have a great many excerpts on records but Tchaikovsky's "Pique Dame" is sadly waiting for a complete rendition, an enterprise surely warranted in view of the tremendous popularity of the composer and the excellence of the work.

So far, music has had a better fate on

The PHILADELPHIA ORCHESTRA'S symphonic recordings belong to the best seller class in the serious category. Eugene Ormandy conducts.





JOSEPH SZIGETI, is known not only for his fine musicianship but also for his thoughtfulness and serious application to the most intricate problems of music. Here he is shown making a recording under the conductorship of the composer.

records than in the concert hall, despite the fact that some important works are missing from the catalog. But when we come to contemporary music the situation seems to be reversed to some extent. Naturally, the traditional contemporary composers who have reached great popularity, such as Sibelius and Rachmaninoff, have no complaints. Their works have been recorded in abundance, and are being re-recorded repeatedly. Neither can some of the more radical moderns argue that contemporary music is not well represented. Stravinsky's works are copiously recorded and so are those of Prokofieff and Shostakovich. But the radical composers of Central Europe, the more modern composers of the United States, and some of the important younger musicians of France are neglected. Only recently have the two major companies decided to go in for an ambitious program of contemporary music which already has resulted in the recording of works by Copland, Barber, Thomson and others. Eventually, however, it will

prove to be important to record not only those contemporary works that have already met with popular approval, but also those which are respected, but not yet universally known. Here the companies could perform a singular service, and, incidentally, one that would pay not as immediate best selling material, but eventually when the compositions had experienced more and more concert performances, as the present trend already indicates. I have in mind the works of Bartok, (some of which were recorded several years back, yet have never been released), Schoenberg, Ives, Sessions and others.

But as said before, the crux of the present situation is not so much the lack of material which is recorded, but rather the question of availability, a problem that can and will only be solved if our economy returns to normal.

As far as the recording artists are concerned the situation looks quite different. It must not be forgotten that at least half of all classical records are sold mainly



SERGE KOUSSEVITZKY and the **BOSTON SYMPHONY** represent an all time high in serious music making. Probably the best orchestra in the world, it has done more to spread the gospel of symphonic music than any other organization. Their discs are best sellers.

by virtue of the artist's and not the composition's appeal. This holds especially true of discs that feature semi-classical music, vocal compositions, and "war horses." And it is also true of most duplications. Thus the artist plays a big role both for the public and the dealer, and especially with the narrowing down of possible new repertory he gains added importance.

The trend has changed here during the past decade. While in the early days of recordings only the top singers had any appeal, an appeal that outlasted far the zeniths of their careers and which is still demonstrated by the high prices such collector's items as discs of Scotti and Caruso command nowadays, the public has come to understand that not only the top artists, but also the substantial and good musicians have their values. This development was partly due to the

spreading out of recorded music from the single operatic aria to the complete recordings of symphonies and chamber music. And the preference for young American artists over some of the faded stars of yesterday is also salutary and owes its existence to a growing awareness of national cultural values and the necessity to add a new kind of glamour to recent releases. For no matter how great the demand for old discs and reissues may be, each new release creates new interest provided that it has an angle which makes it appealing. Thus each new release is of utmost importance to the dealer.

As to the artists themselves, we notice that the public develops as much love for large orchestral organizations as for individual stars. Of course, whether preference is given to a conductor over an orchestra, or vice versa, depends on

the individual case. Stokowski, who has not been at the helm of a permanent organization for several years, appeals solely on the strength of his individuality. Whether he conducts the Hollywood Bowl Symphony or the New York City Symphony does not matter so long as he conducts. In the case of the New York Philharmonic and the Philadelphia Orchestras, it is probably safe to say that the organizations hold as much appeal as their respective conductors, Rodzinski and Ormandy. In the case of Bruno Walter and Koussevitzky, the appeal lies probably more in the conductor, although the Boston Symphony has established a reputation of its own separate from that of its leader.

As it stands now, the major American symphony orchestras are all under contract to the large companies. There are the Boston, NBC, San Francisco, Cincinnati, Chicago, St. Louis, Minneapolis and Indianapolis orchestras (to name only a few) which record for Victor. The New York Philharmonic, Philadelphia, Cleveland and others are under contract to Columbia. The Los Angeles records now for Decca. These contracts, of course, take care also of our leading conductors, who are usually the permanent directors of the respective orchestras. Thus we see men like Koussevitzky, Mitropoulos, Ormandy, Monteux, Defauw

Golsmann and others busily engaged in making records. Other prominent conductors not permanently attached to any orchestra, such as Bruno Walter and Stokowski, usually appear as guest leaders and receive their substantial share in being recorded.

As far as the foreign orchestras are concerned the war has effected considerable changes. The European orchestras, and especially those of Germany, which previously under Furtwaengler, now banned as a Nazi, and the late Felix Weingartner were one of the greatest attractions of the repertory, are hardly in a state today to deserve a representation on discs. This again enhances the value of our native organizations, although the demand for their older issues is still great and will probably continue to be so. With the decline of continental orchestras, increased attention has been focused upon British orchestras. Above all, Sir Thomas Beecham has had great success with the American public, a success which interestingly enough was not duplicated in his personal appearance tours here although it continued on discs. Sir Thomas, whose recordings are available on both Victor and Columbia labels, will make his future recordings with a British orchestra for Victor.

Victor has also instigated a trend to sign the less prominent American organi-

"SHOWBOAT" by JEROME KERN is not only a successful Broadway production but also a most appealing record album. Columbia has enlisted the original cast of the 1946 production for the waxing.



zations with its new contract with the Dallas Symphony under Antal Dorati. This trend, incidentally, will increase the more the smaller companies attempt to enter the serious symphonic field.

As far as chamber music is concerned there is also an increase noticeable ever since the stigma has been taken off this type of music. Previously, many learned experts have in their writings and lecturing actually scared away the public from chamber music by continuously harping on its difficulties. The increasing fame of individual chamber organizations, like the Budapest Quartet, and of individual players, has made chamber music today an integral part of the repertory.

The big advance in chamber music came with the new policy of accenting the artist and presenting the albums in a colorful, much advertised display. Thus it was not surprising that even such a seldom heard work as the "Goldberg Variations" by Bach could command a wider market than the very successful first post-ban release of Berlioz's "Harold in Italy." And this despite the fact that not only was the work rather intricate, but also that it was played on a very unusual and little known instrument, the harpsichord.

In line with the policy of accenting the artist, Victor features photographs of its outstanding musicians in its LIFE ads, and both Victor and Columbia go in for chamber recordings that are based more upon the fame of the individual musician than upon the reputation of a chamber organization. Thus smaller combination works, like violin-piano, cello-piano, violin-viola sonatas, seem to stand a better chance than string quartets or larger combination works. Both Victor and Columbia have already released such works as Beethoven violin and cello sonatas, Bach violin-harpsichord sonatas, etc., and the trend moves definitely in this direction. However, each company will retain one larger group for works of bigger scope. Thus Victor will feature a string ensemble of the Boston Symphony under Koussevitzky as a

chamber group, and its first release (Bach's "Brandenburg Concertos Nos. 3 and 1") has already reached the market. Columbia has under contract the one organization that cannot be surpassed in the chamber field, the Budapest String Quartet.

With the emphasis on the artists goes hand in hand an emphasis upon the soloist in concertos. Thus we shall see an increase in this field too, although the public has always been very partial to concertos.

It goes without saying that this same trend also contributes to the growth of interest in singers, although none of the new artists commands quite the same response as the Italian stars of the Met of about forty years ago. But the amazing quality of young American singers has found many friends not only for the Met and the vocal network programs, but also for the innumerable, mostly very good, operatic singles and albums and some of the vocal renditions in the lighter vein. The movies, with their new policy of half serious, half entertaining musicals, have contributed to the growth of interest, and we should not be surprised to see such young artists as Patrice Munsel and Robert Merrill occupy a place right next to Helen Traubel and Lauritz Melchior.

Interest in opera, whether in excerpts or complete, is always strong, and now the successes of the various ballets have brought about an increased interest in ballet music as well. A great deal of this music has been in existence before, but was never pointed up as ballet music. Recently, however, almost all music that serves as background to the ballet has been advertised as such. For instance, Schoenberg's "Verklaerte Nacht," existing in a rendition under this title, was recorded in a new version and brought out as "Pillar of Fire," the name of the ballet to which it served as accompaniment. Such practices prove to be well received by the public which is much more likely to accept the music on the basis of the association with the ballet than as an absolute work.

There is hardly any need to go into all the details of semi-classical recordings. They, of course, are of great appeal and can be divided into several categories. First of all, there are the direct and genuine recordings of semi-classical music such as Herbert, Friml, Johann Strauss, etc. In this category there may be vocal renditions, such as comprehensive discings of shows. Decca has done a great deal of excellent work in recording the original casts of such shows as "Song of Norway," "On the Town," "Carousel," etc. and Columbia has followed suit with several recordings of similar shows either with the company's own artists or with the original Broadway cast, such as "Showboat" by Jerome Kern. And Victor has also done a certain amount of show recordings, mainly featuring the individual star, instead of the compact show, e.g. Allan Jones in an album of "Cole Porter Songs," Lauritz Melchior in the songs of his movie, "Thrill of a Romance."

Another way of presenting this music is in the symphonic arrangement of which André Kostelanetz seems to be the undisputed master. At least he, at the helm of his own organization or leading the Robin Hood Dell Orchestra or accompanying his wife Lily Pons, has acquired a very large reputation.

Then, of course, there are the numerous transcriptions of classical music, presented in a lush and exciting semi-classical way, and the numerous movie scores which have come into prominence ever since the British-made picture "Suicide Squadron" scored a big hit with the original composition "Warsaw Concerto" by Richard Addinsell. It is difficult, and probably irrelevant, to determine where serious music ends and popular music begins in all these recordings. The fact remains that the recorded repertory is extremely diversified, and aims to reach both the serious collector and the occasional or rather, not-too-occasional, but musically unbiased, customer.

With Victor and Columbia firmly entrenched in the classical field, Decca

doing only a minute amount of serious recording, and the rest of the large companies concentrating upon popular music, any newcomer may find it easy or difficult to record serious music, depending on the course he takes. Obviously he cannot compete with the large outfits. On the other hand, he can supplement their catalogs by recording those works which have not found entrance into the big league catalogs and by signing those artists who, though not of national repute at present, are excellent and seem to have a great future.

Musicraft has given one example. By signing pianists Jacques Abrams and Kurt Appelbaum, and assigning to the latter the recording of all the Beethoven Piano Sonatas, and by having harpsichordist Sylvia Marlowe make several recordings of pre-Bach music, the company will definitely fill a gap in the catalogs without having to compete with the excellent qualities of Victor and Columbia recordings directly. Another smaller outfit, the Symphony Record Company, has signed an unknown, but qualitatively very good symphony orchestra, the Santa Monica Civic Symphony, which records seldom-heard works of very well known composers, such as the "Second Symphony" by Tchaikovsky. And Disc specializes in the importation of masters from other countries, especially Soviet Russia. In this manner the smaller companies can perform a definite service by rounding out the general repertory, giving a chance to lesser known or foreign organizations and enlarging the general musical picture.

There is no doubt that the interest in music, which sky-rocketed in the past few years, will remain on the same level, might even increase and will probably improve largely in taste once all the older recordings are made available again. Even if we are conservative and say that the interest will remain the same during the next few years, it cannot be denied that music has become an important part of American life. And records have certainly contributed more than their share to this development.



Miniature orchestra makes attractive display for window of Monroe Record Shop. Tiny musicians are made from odds and ends.

world's smallest orchestra

80

Claimed to be one of the world's most remarkable orchestras, the symphony orchestra of the Monroe Record Shop in Rochester, New York, is certainly the smallest. Made of pipe-cleaners, cardboard and buttons, the small figures are the work of Leo J. Goldman, manager of the record shop, and have proved to be of great customer interest in the short time they have been used for display.

Inspired by the matchless Thorne collection of miniature rooms and furniture and aided by his family and friends, Mr. Goldman has produced a full symphony orchestra, complete to the piccolo player. Despite the odds and ends out of which the men are made, the orchestra is remarkably life-like. Each has his own chair and music stand. The general effect is that the

onlooker has come upon a full orchestra in mid-performance, but is looking through the wrong end of a telescope.

Bringing the project closer to life, Mr. Goldman's family donated their own hair to give the musicians an added touch of authenticity. A friend gave a few strands of red hair to make a red-haired musician or two.

The orchestra has its own stage, complete with curtains. There's a podium for the conductor and the larger instruments such as the piano and tympani are there, too, true to life in reduced fashion.

The Goldman orchestra is on display at the Monroe Record Shop, where it makes an excellent attention catcher for any display of symphonic records. Mr. Goldman's hobby thus provided him with a lot of fun and a business asset.

a review of popular music

A general summing up of the booming field of popular and folk music and a few prophecies based on past performances are featured in this informative article.

BY MARK GILBERT

The season 1945-46, anxiously expected by manufacturers, dealers and jukebox operators alike, was an exciting period for the disinterested observer. Those who had expected immediate and revolutionary changes in the record business with the ending of the war were sorely disappointed. The prophets of doom, who had warned of a sudden slump in the market as soon as civilian reconversion began, did not see their prophecies fulfilled. Neither did those soothsayers who had predicted a sudden hocuspocus that would clear all production bottlenecks overnight find too much satisfaction. The truth was that record production advanced, the market expanded, many new companies entered the field, and public interest was maintained on an increasing level.

Thus the season was full of signs and portents for the future, yet was not a period of change in itself. The indications, however, promised a great deal of excitement in the future. First of all, the expansion of the field, conditioned by the many new small independents, promised practically a total coverage of the popular field on records. Even as it stands today, with record companies hitting the hundred mark, there is hardly a popular singer or band who hasn't got a contract. If the predicted two hundred companies should be a reality by the end of next year, they may be faced with a serious shortage of artists. It remains to be seen whether the amusement field, outside of records, will develop enough good entertainers to furnish the new record demands, provided that the

BING CROSBY symbolizes the height of popular success any single artist can ever reach.





GENE KRUPA leads one of those good bands which, without ever reaching the top, has delivered numerous fine performances.

demands for live entertainment will keep in step with those for discs. Obviously, a band or a singer can't live just by their recordings alone. And if they do not find a satisfactory field in nightclubs, radio or on the screen, it is doubtful whether they'll go in for entertaining only on the basis of discs.

Another question is whether the popular market will absorb the six hundred million predicted discs. And even more important is the problem of music. Tin Pan Alley can turn out a tremendous number of songs each year, but the last year has already shown that the number of real hits is constant and not in proportion to the total output. The increase of written music has shortened the life of the big hit, but it has not produced substantially better songs or a greater number of top tunes.

Naturally, there is always room for duplicate performances of tunes. The endless speculations of what sells a song—arrangement, tune or performer—never lead very far. It is safest to assume that a combination of the three does the trick. Certain people will go only for the performer, no matter what he plays. Only a few insist upon a special song

without giving a hoot who plays it. And the public is hardly aware of arrangements—that is, aware of them consciously. But the past has proved that certain bands or singers become identified with one song (not necessarily their theme song). This happens for only two reasons: the quality of the tune and the arrangement. Cole Porter's "Begin the Beguine" became a hit when it was several years old. Then Artie Shaw picked it up, and there it was—a great sensation. "Beguine," of course, sold in all kinds of versions, the Andrews Sisters making probably the biggest success with it. But Artie Shaw remained identified with it, and the tune made his band as much as the band had made the tune. Examples like that could be counted by the hundreds, from Louis Jordan's rendition "Is You Is," which swept this small combo into national focus, to Hampton's "Boogie," which has not been surpassed in any other rendition.

This situation has one very grave consequence for the lesser known combinations. They have to find a tune which becomes theirs, if they are to stay in the race. Sometimes an arrangement with great originality will do; but the music is still the thing. The present situation is hardly indicative of this development. Every band, from big to small, famous to unknown, plays the same tune in arrangements that vary from excellent to poor. And they all sell. But the poor ones only sell because there is still a shortage of materials which limits the production of top band records. Once this problem is solved it seems doubtful that a poor XYZ rendition of "Love in Spring" will be able to compete seriously with a good rendition by Tommy Dorsey, or will even sell at all.

There are two fields in which this thing does not quite hold true: hot jazz and folk music. Hot jazz records usually sell for the individual star performance of a solo entertainer or a small combination. It doesn't matter what he plays, as long as he plays it in his inimitable style. But the hot jazz field is limited to zealous collectors, with only an occa-

sional disc sold to the average "pop" buyer. Folk music, on the other hand, depends upon the song not less strongly than the pop field, but the simplicity of the music and lyrics and their definite clichés require less of an effort on the part of the song writer, and we have seen folk tune composers and lyricists turn out as many as sixty tunes in two days with a heavy percentage of hit material among them.

Another noteworthy phenomenon of the great record boom is the shortened life span of hits. It is extremely seldom that a hit occupies the number one spot on the best seller list for four weeks. Usually there is a week by week change. Interestingly enough, sheet music sales

and juke box favorites do not necessarily coincide with record sales. And the longevity of the performer's fame depends upon many things completely beyond the control of the record manufacturer and dealer.

The small companies may have a terrific star on their hands, yet because of failure to promote him properly or to have him promoted adequately outside the field of recordings, he does not go so far as he might. After all, the record seldom sells for itself, but rather because of some entertainment event which has made a star or a song famous in the public's eye. For instance, Musicraft has what we consider a first class crooner in Gordon MacRae. He has done quite

ARTIE SHAW, here shown in a glamorized version in a moving picture, has made so many come bucks in so many original ways that he has held the limelight almost constantly.





FREDDY MARTIN, *once famous for making Tchaikovsky and Grieg famous, now records sweet and refined salon dance music.*

a few platters for this company, and all of them have been well received by the reviewers. Yet the public is still largely unaware of Mr. MacRae, and unless he gets a movie contract or is pushed into the national spotlight by some other world-shaking event, chances are that record sales will not match his qualities.

One result of the dearth of songs and performers is the return of the popular "oldie", the hit song of yesteryear which is still good, and which very often shows up the poor quality of present day hits. Another is the entry into the recording field of musicians whose quality would hardly have warranted their being made eternal on shellac several years back. With that also goes a certain type of song that is poor in its musical, and frequently questionable in its lyric, taste. Chances are that these songs and performers will disappear as fast as they mushroomed during the elephantine days of post-war prosperity and shortages.

"Oldies" will probably always remain on the market to a certain degree, if for no other than nostalgic reasons. But in general, it is safe to assume that the popular field will continue to be characterized by a tremendous and rapid turnover. The popular hit of today is the white elephant of tomorrow, and the dealer will have to use all his skill, sensitivity to momentary trends, and salesmanship to keep those platters moving.

But if it is important to take the short life of each hit into consideration, one need not worry too much about the popularity of the individual entertainers. The public may grow weary of a song in a short time, but it remains faithful to a performer once it has singled him out as its favorite. Neither are the expert reviewers fickle in their selection of top performers. "Esquire's" annual choice of an all-American Jazz band, one of the most indicative compilations of popu-

larity and quality in the eyes of hot jazz reviewers, has named the same top performers as favorites for several seasons in a row. Cootie Williams (trumpet) made the grade twice, Coleman Hawkins (saxophone) three times, Benny Goodman (clarinet) three times, Duke Ellington (arranger and orchestra) twice, Louis Armstrong (vocal) twice, and Mildred Bailey (female vocal) twice.

As to general popularity, the big name bands and the popular vocalists still hold the center of the stage. In both fields a few former stars have just returned from the services. Although their performances lack the polish they had before the war, they will doubtless make a faultless comeback once they have had the chance to acclimatize themselves to civilian life. It was a special pleasure to welcome the bands of Bob Crosby and Glenn Miller, the latter unfortunately without its leader, who died in an airplane crash while embarking on a tour of the continent. Jack Leonard, interrupted in what then seemed to be a brilliant and ascending career, is back as heart-throb crooner and his recent releases prove that he will continue just where he left off several years ago. And quite a few more returning veterans are to be expected in the coming season. There is Larry Clinton of "Dinsy Doodle" fame, and Claude Thornhill, who had really only come into his own just before he enlisted in the Navy.

The big name bands are legion, with Woody Herman, Benny Goodman, Tommy Dorsey, Harry James still in the top brackets. But the bands which never quite made the top, yet are still in excellent shape got also their well-deserved breaks, and found for the first time a wide opportunity beyond their previous fields that were usually limited by the inflated popularity of the headliners. Les Brown and Gene Krupa, Vaughn Monroe and Charlie Spivak are excellent examples of this trend, although we could easily add scores of names that well deserve to be in this category.

As to song styles, it was still either sweet and low-down, or hot and fast,

with the latter coming up strong. But the increase of novelty numbers like "I'm a Big Girl Now" and "One-zy, Two-zy" gave salon-type bands like Freddy Martin's and Sammy Kaye's plenty of opportunity to renew their popularity. And speaking of Freddy Martin, we noticed that the fad of jazzing the classics has died away to some extent. This is mainly due to the new movie trend of rendering appealing classical melodies in their original form or in a manner which fits more into the semi-classical Kostelanetz-Rose-Gould treatment which has proved to have successful appeal.

The salon orchestra has also received its boosts. René Musette, specializing in international discs but also delivering some extremely smooth melodies in the salon department, and the always dependable André Kostelanetz, have certainly had their field days in the past season and are most likely to continue to do so.

Somewhere in this category are also

MARK WARNOW'S *lush orchestrations borrow material from both the popular and the classical field. Not having waxed anything for a long while, he is now making a big come back on Sonora discs.*





BETTY HUTTON, best known for her movie activities, is also a remarkable songstress. Her viracious singing is quite special.

the Latin rhythm discs which range from smoothly sweet to torrid and terrific. Carmen Cavallaro, for instance, still a top favorite, is in most of his performances more the sweet type, while Cugat and some of the lesser known outfits can change their style at the drop of a sombrero from mere atmosphere to rhythmical excitement. In this department several of the smaller companies have been much luckier than they have been with the bands which, if good and known, are usually tied up with the big names. The smaller Latin combinations, however, sounded good on many records the labels of which were still unknown only a year ago. And their popularity goes on undiminished, promising a bumper crop for the coming season.

The crooners are another perennial mainstay that has brought in cold cash for the dealers. The trend is now to divert attention from one exclusive crooner to an array of vocalists who can all hold their own. This tendency has worked well with both the public and dealer, especially since there are some outstanding names in the field.

Leader, of course, is always Bing

Crosby. But "Der Bingle," whose qualities as a balladeer plus home-spun humorist are hardly to be topped, has found strong competition in some of the more lyrically-inclined baritones. It is safe to say by now that the Sinatra rage, flaring up so suddenly and impetuously two years ago, was not just a sudden fad. Frankie boy has held his own pretty well during the past three years, despite his championing of the cause of liberalism—which has made him probably more friends than enemies.

But coming up also are several others who, after plodding along for several years, made the top grade. Andy Russell and Dick Haymes enhance their record appeal mainly by way of the movies. The movies try hard to groom Dick to be the future Crosby although he hardly approximates the "Bingle" histrionically. With the only average success of the "voice," Hollywood is still waiting for a reasonable Crosby substitute. As far as discs are concerned, Perry Como seems to be the fellow to come close to Bing's success.

Even without the aid of the movies such crooners as Perry Como and the recently discharged Jack Leonard have advanced comparatively fast. Jackie, of

DINAH SHORE, *Basin Street* alumna, is America's best known discuse. Her smooth and blues vocalizing is still sensational.



course, has his biggest success yet to come, but it will not wait long if you consider his smooth singing style and his exceptional looks.

Female vocalists have held great attraction for the public, although they have never quite reached the popularity of the boys. This may point up one aspect of popular music—that the girls are more interested in singing than the male audience. Furthermore, recent tendencies, as borne out by a number of surveys, seem to indicate that the public shows a decided preference for sweet music, whether sung or played. Hot music is largely patronized by men. Thus all angles of investigation seem to give the female customer the lead as far as popular music is concerned, a fact which deserves to be kept in mind.

Among the female vocal stars Dinah Shore has received a terrific build-up since she changed her contract from Victor to Columbia. Dinah's discs may have been a trifle disappointing at first on the new label, but her recent output justifies again the assumption that she will stay in the limelight of popular singers for quite a while.

ANDY RUSSELL is one of many young crooners who vie for Crosby's laurels. Andy's nice voice and personality may easily push him even beyond present heights.



GINNY SIMMS, who once sang with Kay Kyser's band, has also proven her talents as a soloist, although lately she was rather unfortunate in the choice of material.

None of the other gals has quite been able to match Dinah's popularity. Ella Mae Morse and Peggy Lee have given some dependable performances without adding anything startling to the repertory. Ginny Simms, idol of only two years ago, has decidedly fallen off although Ginny's singing is still good and sentimental. Her decline is decidedly due to the choice of tunes which were far from outstanding. This is a thing with which most female balladeers have to struggle. Most of the sweet ballads are written today for men of the Sinatra type, and cannot easily be adapted to the female style, especially on account of the lyrics that usually worship a girl. Thus many female singers have concentrated on the humorous, novelty-type or boogie-woogie ballad. Here Betty Hutton, of movie fame, has done a more than outstanding job, especially in those discs that featured the music from her movie "Stork Club." Betty is most likely to remain an attraction for the next season, although the public has not taken to her in the same enthusiastic way as this writer.

A name definitely to be watched is Pearl Bailey, who jumped into sudden



BARRY WOOD, one-time star of the *Hit Parade*, has a smooth voice and a pleasing personality which makes him the target of many autograph hunters and fans.



BURL IVES is probably the best known among the American folk singers. His "Wayfaring Stranger" album has found friends among all types of music lovers.

recognition through the Johnny Mercer-Harold Arlen show "St. Louis Woman." Pearl Bailey, whose specialty is sophisticated blues singing, may not reach the popularity of any male crooner—this obviously requires the rendition of singable, sentimental ballads. But as a diseuse of songs of the cabaret type, she has hardly her equal today, especially since her name-sake, Mildred Bailey, has been disappointing on her last few discs, which, of course, may only be temporary.

The trend goes definitely towards the Pearl Bailey type of singing in the female department, and a few recent discoveries bear out this fact. Among the most publicized and important is Stella Brooks, who suddenly sees herself as one of the major singing stars. At any rate, the general emphasis among singers will still be upon the men, with the girls doing a reliable, but not too close second.

There is also a tendency to employ big operatic stars in the rendition of pop or at least semi-classical songs. This is not always too successful because it is neither the real thing for the pop fan nor is it appealing to the serious music lover.

But one must not forget that there is a wide stratum of musically neutral listeners who enjoy this sort of thing, and it is for them that such discs as Lauritz Melchior's movie songs or Rise Stevens' "Jerome Kern Songs" hold the strongest attraction.

As we said before, the hot jazz business is hot always in quantity, often in quality, and not quite so hot in public response. The small combinations are still only for a very limited public, people who frequent out-of-the-way nightclubs or really and truly enraged fans. It is one of the characteristics of the hot jazz fan that he will swear by one and only one style, often even by only one band. Obviously, he does not constitute a very rewarding public although he will be all-out in enthusiasm.

The small companies do their best in cashing in on those combinations which they picked up while they were still unknowns, yet in the course of time have reached national reputation. But unless the small independent has such a combo tied to his company for an appreciably long time, he is not going to profit greatly



XAVIER CUGAT may not be the most original interpreter of Latin-American rhythms, but his performances have reached the greatest popularity for their danceable qualities.



DANNY O'NEIL, Irish tenor, sings smooth melodies, whether they be modern ballads or the "Eastside, Westside" type. He is shown autographing his Al Smith Album.

from them. No sooner has a combination reached a certain reputation than it is picked up by one of the major companies and becomes a successful seller for the biggies.

Both Victor and Capitol have done splendidly with the recorded "Hot Jazz Series", historically arranged, during the past year. Columbia had cashed in on the hot jazz vogue even earlier. Now Victor has picked up Bunk Johnson, ace trumpeter, and has featured him extensively. There is no doubt that these combinations have appeal. Whether they will continue to do so, and whether they will do so in quantities unheard of in the past and on completely unknown labels, is a different matter.

Those bands that border in their hot jazz playing on the commercial side, in other words, those who not only feature improvisations but a recognizable tune itself, always fare best. Louis Jordan and his Tympani Five, a small combo which adheres to such a practice, has done extremely well, as has also the Cozy Cole Trio. Larger bands, or the derivatives of them, such as Duke Ellington and the Benny Goodman Trio, Sextet

and what-have-you, are also prominent. But here the question arises whether the real and true hot jazz experts would accept them as the real thing. No matter what their judgment might be, the fact remains that they find more favor with the public than the obscure smaller combinations.

Individual soloists, however, are doing quite well, almost as well as the big hot jazz bands. (Ellington's contract, for instance, has changed hands from Victor to Musicraft, an indication that the big Victor company does not consider him a sufficiently big drawing card for its elephantine outputs, although he will doubtless do very well with the new company.) Among soloists who have made the grade in a wider measure are Johnny Guarnieri and Maurice Rocco and, of course, such old standbys as Art Tatum and Pete Johnson.

There are some people who think that hot jazz is the only true expression of American music. That may be the case. However, as far as the dealer is concerned the hot jazz appeal is limited, and while it may roar skyhigh in the sophisticated neighborhoods of big towns, it

dwindles away rapidly in the small town shops.

A species of unlimited appeal is the music which features salon, cocktail lounge, international folk and Latin American music. Designed partly as mood, partly as dance music, it does not attract the collector but yields its profits as the single disc picked up for various occasions, such as parties or for the enhancement of the individual library. Latin-American music especially appears in all guises from boleros to rumbas and tangos, and is always good for one additional record. Naturally, outfits like those of Enrique Madriguera and Xavier Cugat are almost always sure-fire. But for people who just want to dance and be gay to the strains of a Spanish-tinged tune, the name of the band matters little. Consequently, chances are that completely unknown organizations will sell a great deal provided that they have snappy rhythms and adequate arrangements.

Among the international folk records there has been a tremendous upsurge as well. More and more we have become interested in the music of all lands and it seems that no one nation is limited to specific neighborhoods. Swedish records have sold in Texas and Russian discs in the state of Washington.

As to our own native folk music, we must differentiate between two types; that which is genuine and that which is slickly commercialized and often dressed up as a dance tune. The first category is recorded comparatively rarely, with appeal mostly to so-called "highbrows." Even here there are arguments going on constantly as to who is authentic and who is not. The balladeers have carried off the palm with such singers as Josh White, Burl Ives, Richard Dyer-Bennett leading. Every year there appear new authorities and performers. Among the latter Susan Reed seems to be a gradually-arriving star with a small and attractive voice and a quaint zither accompaniment.

But in the category of slightly commercialized tunes, there is appeal which is hardly equalled by any other popular record. Cowboy songs of, for instance, Gene Autry, not only remind one frequently of the slow ballad of the Sinatra type, but they also approach the Voice's records in their popular appeal. As a matter of fact, it is often difficult in some of the crooners, such as Bing Crosby, to decide whether he is singing a ballad or a cowboy song.

There are numerous small combinations that perform both vocally and instrumentally, in a style that, utilizing the cowboy type of song, speeds it up and



BUNK JOHNSON has not with success at a late age, but then to a great degree. His New Orleans trumpet is especially loved by dancers.

DUKE ELLINGTON, who can play "hot" and commercial, has weathered the severe scrutiny of *Esquire* magazine's experts repeatedly by carrying away the top award in the class of orchestras and arrangers.



makes it rhythmically acceptable for dancing. Outfits like those of Roy Acuff and the Smoky Mountain Boys are half-way between hillbilly music and dance type. More on the satirical side are the Korn Koblbers and certain discs of Spike Jones. But no matter what it is, this music is always received with great enthusiasm both in the West and East.

American music has found entrance into the pop field also over another way. It is American music tailor-made and extremely successful. We are talking about the music of the various Broadway musicals which, in the past few years, again have come to the fore with even greater success than at the time of the great Ziegfeld. Show music proved to be extremely successful, consequently it appeared on discs in various forms; first of all as the hit song which could be picked up by either a band or a singer, in any arrangement from hot to sweet, simple or lush. But then there are also the numerous albums which try to recreate the show by giving a condensed musical version of it. It was Decca which started this approach with great success, utilizing the original cast of the show whenever possible. The audience is delighted with this. First of all, they like the show and like to have its music on records. Then they want to remember the performance they have seen, or if they live in regions which are not fortunate enough to be favored with Broadway productions, at least they want to get a glimpse of what goes on in New York. Thus we have on discs almost any of the successful shows, sometimes with prominent actors, sometimes only with those who were starred in the show and who are not necessarily big names. But big names don't play such a great role in this case. If the liveliness of the show is preserved, that is all that counts. And there are many successful recordings,

ranging from "Song of Norway" and "Up in Central Park" to "On the Town" and "Carousel."

A similar development can be noticed with movie music which has been utilized either as hit song, or in albums which feature even background music such as in the case of "Spellbound."

And, of course, there are the numerous orchestras of the symphony-salon type, like Kostelanetz's, Al Goodman's, and Mark Warnow's, which pick up all of this music, and a great deal of transcribed classical works, and present them in a lush style of large scope. It is noteworthy that all show, movie and semi-classical music appeals mostly to the neutral collector, the one whose mind is not definitely made up on whether he should go in for one type of music or another. Thus the symphony-salon type of music is often the easiest means with which to approach a new customer.

This seems to sum up the field of popular music pretty generally. No doubt, what has been good in the past will also prove to be good in the future, and whatever new experiments may come about will, in one way or another, bear the stamp of past success. True, the field is unpredictable; but it is a safe guess that no major changes will affect the public taste in the season to come.

the role of the independents in today's record picture

The editor of RECORD RETAILING examines the problems for the dealer and manufacturer of the many new independent record companies that have sprung up during and since the war.

BY NEIL F. HARRISON

The influx of so many new record companies to the field of popular music has put a great many additional records into the market. Quite understandably, some of these companies, inspired by an expanding market (until the present seasonal slump) are seeking a permanent niche in the popular field. Some, it would appear, are being influenced by a false sense of security in assuming that a boom is coming when the radio-phonograph manufacturers get into full production and millions of new combinations are sold. In this assumption they are only partially correct.

There will be a boom, no doubt, in all fields of recorded music, and from all indications it will surpass anything enjoyed at any period of the industry's history. But it does not necessarily follow that all phases of the boom will be open to everyone. Even in the most prosperous times, concerns that do not know the fundamentals of their own business go bankrupt. Mismanagement, lack of knowledge of the market, lack of knowledge of distribution, etc., can bankrupt a company whether it makes shoes, underwear, furniture or records, even in prosperous times.

Powerful forces that were held back

by limitations on labor and materials during the war period are now free to unleash a flood of records, classical, popular, hillbilly, race and other kinds.

All Records Sold

Until quite recently it was true that any and every popular record easily achieved wide sales. Just as long as a record company could produce records, the retailer could sell them. During the war years, the magical sales appeal of a particular record label disappeared, just as it had in every other line of merchandise. Can you even remember now the names of some of the little-known brands of cigarettes that sold well during the shortage? During the war years, people were not concerned with the make of a refrigerator as long as they could get their hands on one. The same sales phenomenon occurred in radios, washing machines, electric irons—and records. A great many record manufacturers were like the fly that stood on the axle of the chariot as it raced along and said, "Look at the dust I'm raising!" The buying public cared little if the color of the label was pink, yellow or blue, and it did not care if the recording was by a nondescript like Joe Doakes or a name like Tommy Dorsey, or whether the

vocalist was Fizzie Tish or Dinah Shore. During those lush days, the record dealer said to the manufacturer, "You make them and we'll sell them." Accordingly, the small and independent record firm found little or no sales resistance to disposing of everything and anything it could make, and that held true for the distributor, retailer and the ultimate buyer. The independent record manufacturer made headway in a field which would not give him a hearing before the war. He saw his salesmen welcomed with open arms, distributors carried his favor, his label was displayed on the counter — why, he even got a prominent place in the window trim. He had arrived, so it seemed. But the nub of the question is: Has he?

Competition Keener

While we hold no brief for any particular recording company, large or small, we fail to see a place for the small independent firms on the basis of permanence and institutionalism in the coming period unless they follow tested marketing and merchandising methods. No longer will the juke box operator come in with a fist-full of greenbacks and pay spot cash for hundreds and thousands of records. Those days are over. Now, the independent record manufacturer must sit down seriously and consider the questions of product, distribution, the record retailer, displays, etc. Most certainly, the public will continue to buy phonograph records, and more and more of them. But this is of cardinal importance—they will not buy on the basis of scarcity. Discrimination will be a major conditioning factor in all record purchases.

We must not lose sight of the fact that the independent companies of today will find the competition keener and sharper tomorrow and the day after. Victor, Columbia, Capitol and Decca are stepping up their production considerably. They all intend to fight for the market, and this requires that the independent record manufacturer sit down and give serious consideration to what he

intends to do and how he intends to do it.

Already, motion picture companies view popular recordings as an excellent field for the exploitation of their products. Metro-Goldwyn-Mayer expects to release its first records by January 1st of 1947, and there are persistent rumors that other motion picture concerns will enter the field. At one time, it was thought that the radio stations would enter the field, but to date there have been no indications of this. WOR with its record label has turned out to be an unimportant factor to date, but there are rumors that they intend to push their label (WOR) seriously in the future. Recently, book publishers and advertising agency executives have been looking upon the record field with a great deal of interest. Mr. H. Paul Warwick of Warwick and Legler is entering the field with Audience Records.

On the surface, such heavy competition may be viewed by many as significant portents of prosperity for all. On the other hand, such a scramble for a potentially rich market may very well result in confusion. Regardless of how high a level of sales records will reach, the fact remains that there is only so much cream in any bottle of good milk.

Production Important

It may well be borne in mind that before the war there were approximately 100 different record labels, of which hardly a baker's dozen were able to survive the war. Now, from latest reports, there are approximately 210 listed recording companies. In fact, Musicians Local 47 of the American Federation of Labor has licensed 20 new firms to make recordings in Los Angeles in one month. How many will be able to survive when new and even greater problems present themselves is indeed a moot question; but the answers can hardly be numerous. Just as the ability to produce during war time was an all-important factor, production will be an increasingly important matter which the independents will have to face in the future. In a highly competitive market with possible

shifts in the retail price, the pressings will have to be obtained quickly at the lowest possible price. Unless the independent can control his production facilities, chances of survival are mighty small, unless he makes something for which time is not a factor.

With production reaching normal levels for the major concerns, the independent cannot afford to wait in line until his order is filled. Under these conditions it is difficult to compete in the open market. Even today, when an independent firm strikes a hit record, it cannot take advantage of the sales value of the recording for two reasons, the lack of production and lack of adequate distribution. We are at the moment thinking of "Cement Mixer." If a major company had "Cement Mixer" with Slim Gaillard, it would have sold a million copies of it.

Distribution Major Factor

Still another major problem facing the independent record company is distribution of its product. During the war, the distributor, whose many lines had been frozen because of priorities, was more than glad to handle any line of phonograph records. Some of them even handled crossword puzzles, kitchen stools and toys. In fact, they were glad to be able to get any line to keep them in business.

Where an independent record firm is unable to offer the distributor quantity, which is the only basis upon which the record distributor can survive, the interest in a record label can never hope to survive. Where the record firm plans on setting up its own distributing branches, the cost of such distribution is prohibitive unless the company is able to produce in adequate quantities. This has been the case with ARA, which was compelled to shelve its idea of having its own branch offices and turn over its distribution to independent distributors. Those without proper distribution can hardly hope to attract the attention of the retailer.

It is our firm opinion that distribution

is one of the cardinal questions in the record business. Emerson's famous remark that if you build a better mousetrap, people will beat a path to your door, may hold for the mousetrap industry, but from where we sit, it doesn't seem to hold for the record industry.

Ninety per cent of all record companies have poor and spotty distribution and unless they correct this situation, they cannot hope to survive. Most of the independents do not know the market, and they do not know the key states that sell records. They do not know the percentage of sales in these states. They do not know which states need one distributor and which states need three distributors. They do not know where the concentration of phonographs is (after all, you can't sell a record unless a person has a phonograph). They have no adequate dealer lists. They do not know how many dealers there are in each territory and consequently cannot check whether their distributors are covering the territory properly. In other words, they make a product and then they sit down and hope that by some miracle it will sell.

In the same light, there is the matter of promotion. The willingness and ability of the major recording companies to promote both the label and the recording artists has been well demonstrated in the past. The independent firms cannot hope to approximate the advertising, promotion and exploitation programs of the major companies. From all indications, these expenditures on the part of the major firms will be far greater and more generous in the days ahead.

This will unquestionably create a great demand for records, upon which the independent record manufacturer, who cannot afford consumer campaigns, can trade.

Another problem that the independent

manufacturer will have to give serious consideration to its possible lowering of prices somewhere along the line. Although there have been rumors that some of the majors might increase the price of their records, the general policy of the major companies has been to sell as many popular records as possible at the lowest possible price, so that they can reach the great mass of people.

While it is certainly true that the sales of popular records will continue to soar to unprecedented levels, it must be borne in mind that the retailer will be restricted in the number of record labels his store will be able to absorb. At the present time, there are approximately 210 record companies in existence, and new ones are being created at the rate of about 10 a month. Only utter confusion and a storeroom packed with records gathering dust will result for a retailer who takes all the record labels offered him in the field of popular music.

As a result, the retailer, as the ultimate consumer, will have to be most discriminating in the popular records purchased. He can hardly hope to handle 100 labels, or even 60, or even 40. The retailer will have to think more than twice before burdening his store and stock.

However, that does not necessarily mean all independent firms will have to go out of business. As a matter of fact, the independent firm can enjoy a healthy share of the record business, but not until it is prepared to seek for itself a proper place in the record picture.

The major record companies, as past experience has shown, are not prepared and are not in a position to give specialized treatment to all musical tastes. One need only listen to the radio to ap-

preciate the diversity of musical taste in the popular field. It is only where the independent record manufacturer endeavors to embrace the entire field of popular music that he encounters a forceful competition that makes survival both hazardous and problematical.

We can picture a record market in which one label specializes in boogie-woogie music; another is devoted to hill-billy music; another reaches out in the race field; another concerns itself with folk songs; some specialize in party records; several others feature the music of various national groups; some are devoted to pure hot jazz; and a great many others specialize in children's records, sacred music, and so on and so on.

True, the sales field for such specialized recordings is restricted, but the fact remains that there are considerable markets for specialized recordings to meet the special musical tastes of our vast and diverse public. It is a field in which speed of production and vast national distribution does not figure as prominently as in the all-embracing field of popular music. Nor does the price of the record figure so much. Moreover, there is nothing to stop the independent company from further cultivating and expanding the field favoring the particular brand of music with which it might become identified.

In the next issue of RECORD RETAILING, we will take up in detail: distribution; the importance of the record sales clerk; the disc jockey; the exaggerated importance of the juke box (which uses only 15% of all popular records sold as against the 85% sold by the dealer. Of course, all albums and classical singles are sold by dealers); and the independent and the dealer.

NOT UNBREAKABLE...

Unbroken!



That's the Record of
CONTINENTAL

UNBROKEN!

100% exchange privilege
dealers.

UNBROKEN!

Run of 200 consecutive jobs
logs on every side—200 nick
for your 50s!

UNBROKEN!

String of top taxes—top ex-
ists, top sellers, and of course
top quality—1,000,000 a month
worth!

UNBROKEN service to our dealers since 1919

That's our Record

CONTINENTAL'S RECORD

and we're standing on it!

CONTINENTAL RECORD COMPANY, INC.
265 WEST 54th STREET • NEW YORK, 19, N. Y.



Freed-Eisemann

We take pride in the exclusive production of the finer type of radio-phonograph with FM. This expert specialization, and a traditional leadership in quality radio, have earned recognition for the Freed-Eisemann as *one of the world's great radio-phonographs*—famous for extraordinary performance, magnificent musical tone and authoritative cabinet design.

Distribution of the new Freed-Eisemann line will be on a selective basis, to quality stores noted for their prestige and finer clientele. Your inquiry is invited concerning the direct-to-dealer Freed-Eisemann franchise.



Freed Radio Corporation, 200 Hudson Street, New York 13, N. Y.

97

Freed-Eisemann

ONE OF THE WORLD'S GREAT RADIO-PHONOGRAPHS

high finance enters the record business

A new and important development is taking place in the record industry. Wall Street money to the tune of many millions of dollars is being invested in record companies. The results for the record business promise to be almost revolutionary.

Until only a few years ago the industry grew chiefly through the development of independent companies which achieved a volume of business that was by no means small. The Victor Company, doing at that time more than half of the industry's total business, grossed fifty million dollars in 1920 and 1921; in 1929 record sales by all companies reached about 65 million dollars. After a slump caused by competition from radio, neglect by the record companies and the general business depression, the industry started a steady return to high volume sales which has continued at an accelerating pace until today. The figures are impressive: From a record production of only ten million in 1932, the record companies increased their output to 33 million in 1938, 75 million in 1940, 127 million in 1942, 148 million in 1944, and 156 million last year. The spurt in production—and sales—in the last four years has been achieved despite severely hampering war-time shortages and other difficulties. The most carefully determined opinions today indicate that sales will literally skyrocket when production difficulties are overcome and new phonographs make their appearance.

Wall Street has carefully observed this growth, has noted the volume of sales, and has begun to act. Convinced that the industry is capable of a high and stable volume of activity on a considerably larger scale than at present, Wall Street bankers and investment houses are investing millions of dollars into existing companies to enable them to compete successfully with RCA Victor and Columbia. Decca Records was the first company to feel the effect of infusion with Wall Street dollars, and the results have been an impressive jump in sales and Decca's present important position among the top recording companies. Within the past year Capitol has grown mightily as a result of big financing, and with its recent purchase of the Scranton Record Company plant has consolidated its position as one of the Big Four. Other big deals, involving mergers of existing companies and flotation of stock issues, are being negotiated now.

The chief result for the record dealer will be to increase the stability and potentialities of his business. No longer can the record department be confined to a corner of the music merchant's store and regarded as a minor part of his business. Records and phonographs are now the biggest part of the music business, but they will only be so for the dealer who realizes this fact and acts upon it.

The immediate results of this new development are being felt already. New

record companies are being formed and new plants are being built across the country. Greatly increased sums are being spent for advertising particularly in consumer publications. Hitherto nationwide advertising was carried out only by Victor and Columbia; now Decca is advertising nationally, and soon other companies will follow suit. The effect in the form of increased demand for records will grow steadily. Capitol Records has broken new ground by advertising in such magazines as Seventeen, thus going aggressively after the important and lucrative teenage business. Competition has never been stronger in the record business; the effects can only be healthy for the dealer.

Significant, too, is the purchase of Muscraft by Jefferson-Travis Company, which, though it manufactures sound-on-tape recording equipment, is sufficiently confident of the future of the

record to invest money in it. The development of the plastic non-breakable record will undoubtedly strengthen the record business and open up new markets. Research is already well advanced on a cheaper source of plastic for records. It is pretty certain that the shellac record will be replaced by plastic within a few years, perhaps even before many months have passed.

All these developments augur well for the industry and for the dealer connected with it. The knowledge that conservative Wall Street money is being invested in records will give the dealer the assurance of stability he needs to plan and carry out expansion of his business. He can be reasonably confident that records are going to be an even bigger business than they are now, and that they will have the financial assets to weather all but the severest economic storms that may lie ahead.

*Progress
with*

TOP TALENT



HIGH FIDELITY RECORDING

Mary Lou Williams
John Kirby
Meade Lux Lewis
Sidney Bechet
Josh White
Woody Guthrie
Lead Belly
Dyer Bennet
Lord Invader
Erno Balogh
Elie Siegmeister
Prokofieff

**TOMORROW'S HEADLINERS TODAY!
TOMORROW'S REPERTORY TODAY!**

*Authentic Folk Music--Jazz
Rare Classics--Children's Songs*

DISC COMPANY OF AMERICA
117 WEST 46th STREET • NEW YORK 19 N.Y.

Alpha-Latin American records . . . Official representatives for
French American Cultural Exchange and for U.S.S.R. in U.S.A.



WE'VE GOT THE BIGGEST

**We're Distributors for Cosmo Records!
EXCLUSIVELY!**

From the banks of The Mississippi to the shores of the Pacific, look to us for those COSMO clicks. We've got the "exclusive" on the hits that are sweeping the country . . . top tunes, recorded by outstanding artists in that grand 'n' glorious COSMO way. Come And Get 'Em!



THERE ARE

Cosmo

 **BLUE BONNET MUSIC CO.**
3235 Ross Ave.
Dallas, Texas

**DISTRIBUTORS
THROUGHOUT
THE WORLD!**

HITS THIS SIDE OF THE RIVER! . . .



DAVIS SALES CO.
1010 17th St.
Denver, Col.

M. S. WOLF DIST. CO.
427 S. W. 13th Ave.
Portland, Oregon

FREDERICK LEE CO.
325 Second Ave. South
Minneapolis, Minn.

M. S. WOLF DIST. CO.
1348 Venice Blvd.
Los Angeles, Calif.

M. S. WOLF DIST. CO.
2313 3rd Ave.
Seattle, Wash.

FREDERICK LEE CO.
304 W. 10th St.
Kansas City, Mo.

M. S. WOLF DIST. CO.
1175 Folsom St.
San Francisco, Calif.

ROBERTS NICHOLSON CO.
1201 Commerce St.
Houston, Texas

..... IN THE EAST ... LOOK TO US



*Cosmo
distributors
cover
the world!*

- **ALLIED MUSIC SALES CO.**
3112 Woodward Ave.
Detroit, Michigan
- **ALLIED MUSIC SALES CO.**
2610 E. 9th St.
Cleveland, Ohio
- **ALLIED MUSIC SALES CO.**
314 Monroe St.
Toledo, Ohio
- **AMERICAN COIN-A-MATIC**
1435-37 5th Ave.
Pittsburgh, Pa.
- **APPLIANCE DIST. CO.**
106 S. Gallatin
Jackson, Miss.
- **A. CONNORS DIST. CO.**
265 E. North St.
Buffalo, New York
- **COSMO RECORDS, INC.**
745 5th Ave.
New York City
- **M. S. DIST. CO., INC.**
1429 N. Clark St.
Chicago, Ill.

OR

Cosmo

RECORDS!



Exclusive — that's what we are — and mighty proud to be the sole distributors of those hit COSMO records in the east. From the Mississippi to the Atlantic look to us for those sensational tunes recorded in the COSMO manner by America's top artists!

• **MUSIC MANAGEMENT, INC.**
2823 The Plaza
Charlotte, North Carolina

• **RUNYON SALES CO.**
595 10th Ave.
New York City

• **SCOTT-CROSSE CO.**
1423 Spring Garden St.
Philadelphia, Pa.

• **TARAN DIST. CO.**
102 Cain St. N.W.
Atlanta, Ga.

• **TARAN DIST. CO.**
90 Riverside Ave.
Jacksonville, Fla.

• **TARAN DIST. CO.**
170 N.W. 23rd St.
Miami, Fla.

■ **THE CARTER CORP.**
1139 Tremont St.
Boston, Mass.

■ **THE ORIOLE CORP.**
512 Pennsylvania Ave.
Baltimore, Md.

america's symphony orchestras

The following two lists show the proportion of orchestras now under contract to record companies and those without contracts.

BY RICHARD LEWIS

The growth of music in America has not ended with the expansion of the record field and radio. On the contrary, the increased mechanical reproduction of music has given impetus to the development of numerous new musical organizations which have done their substantial share in arousing more interest in music.

Thus it is not surprising that this country, which only fifty years ago had a total of about one dozen symphony orchestras, now possesses nearly two hundred orchestral organizations which in most instances do some splendid work. Among them there are at least seventy-two of such high standing that their work should be known beyond the small local sphere of their activities. Of these seventy-two orchestras only twenty-two are at present under contract to record companies. These twenty-two orchestras are the top organizations in the country, some of them the top orchestras in the whole world. That their recordings sell, and sell especially because their conductors are first rate, is a matter of course.

What about the small orchestras, then, which have, so far, not found a permanent place in the recording field? Doubtless, with the increase of small independent record companies these orchestras will, sooner or later, receive their chance at recording dates. There seem to be no difficulties for newcomers to find adequate orchestral organizations to record. The question of what music to record may be more difficult, because most of the symphonic repertory exists already

in countless, often very excellent, versions, so that an addition of the same work by an orchestra which does not command top quality, may not be of great interest to the record collecting public.

The decision will rest with those executives who select the recorded repertory. Their opinion will decide whether the record market can stand any more orchestral recordings by organizations that, so far, have been innocents in the field. Without doubt there are a number of organizations whose past work proves that they have something definitely new to add to the musical scene. Among the fifty orchestras which are not under contract to any recording company, there are a few which have avoided the beaten track of regular symphonic music.

For instance, two New York organizations, the New York Little Symphony and the Saitenberg Little Symphony, have specialized in rare music, featuring either preclassical or modern works for the chamber orchestra. Others, like the Columbus Philharmonic Orchestra, have specialized in music appreciation for children with practical demonstrations of instruments, musical segments, etc. This might be another clue to future recordings.

Some of the smaller organizations can also boast of conductors who have reached a certain measure of national reputation. For instance, Saul Caston, known for his activities with the Philadelphia Orchestra, is now conductor of the Denver Symphony; Reginald Stewart,

of NBC fame, is with the Baltimore Symphony; Efrem Kurtz, once heard on Columbia recordings, now heads the Kansas City Philharmonic, which is not under contract; Izler Solomon, well-known as conductor, is in Columbus; and Leon Barzin, who possesses national renown, conducts the National Orchestral Association.

Some of the smaller orchestras have gained reputations for themselves through

their broadcasting activities over several of the networks. In other words, there is no reason why one or more of these organizations, such as the New Orleans Orchestra or any of those already mentioned, should not find its place among recording orchestras under contract either to one of the larger record companies, or, more probably, to one of the smaller independents.

The following orchestras are listed by name, address, permanent conductor, and recording company.

RECORDING ORCHESTRAS

Boston Symphony Orchestra

Symphony Hall, Boston 15, Mass.
Serge Koussevitzky
RCA-Victor

Boston Sinfonietta

Symphony Hall, Boston 15, Mass.
Arthur Fiedler
RCA-Victor

Chicago Symphony Orchestra

220 S. Michigan Ave., Chicago 4, Ill.
Désiré Defauw
RCA-Victor

Cincinnati Symphony Orchestra

1106 First National Bank Bldg., Cincinnati 2, Ohio
Eugene Goossens
RCA-Victor

Cleveland Orchestra

11001 Euclid Ave., Cleveland, Ohio
George Szell
Columbia

Dallas Symphony Orchestra

1321 Kirby Bldg., Dallas, Texas
Antal Dorati
RCA-Victor

Detroit Symphony Orchestra

350 Madison Ave., Detroit, Mich.
Karl Krueger
RCA-Victor

Indianapolis Symphony Orchestra

Murat Theater, Indianapolis 4, Ind.
Kabian Sevitzyk
RCA-Victor

Philharmonic Orchestra of Los Angeles

Philharmonic Auditorium, 427 W. Fifth St., Los Angeles 13, Cal.
Alfred Wallenstein
Decca

Janssen Symphony of Los Angeles

Paramount Studios, 5151 Marathon, Hollywood 38, Cal.
Werner Janssen
RCA-Victor

Minneapolis Symphony Orchestra

110 Northrop Auditorium, Minneapolis 11, Minn.
Dimitri Mitropoulos
Columbia

Philharmonic Symphony Society of New York

113 W. 57 St., New York 19, N. Y.
Artur Rodzinski
Columbia

NBC Symphony Orchestra

Rockefeller Center, New York, N. Y.
Arturo Toscanini
RCA-Victor

New York City Symphony

City Center, 130 W. 56 St., New York, N. Y.
Leonard Bernstein
RCA-Victor

Busch Little Symphony

113 W. 57 St., New York, N. Y.
Adolf Busch
Columbia

Philadelphia Orchestra
1910 Girard Trust Co. Bldg., Philadel-
phia 2, Pa.

Eugene Ormandy
Columbia

Pittsburgh Symphony Orchestra
1305 Farmers Bank Bldg., Pittsburgh 22,
Pa.

Fritz Reiner
Columbia

Rochester Philharmonic Orchestra
26 Gibbs St., Rochester, N. Y.

Guy Fraser Harrison
RCA-Victor

St. Louis Symphony Orchestra
1607 Arcade Bldg., St. Louis 1, Mo.

Vladimir Golschmann
RCA-Victor

San Francisco Symphony Orchestra
War Memorial Opera House, San Fran-
cisco 2, Cal.

Pierre Monteux
RCA-Victor

Santa Monica Symphony Orchestra
608 Santa Monica Blvd., Santa Monica,
Cal.

Jacques Rachmilovich
ARA

National Symphony Orchestra
1113 Woodward Bldg., Washington 5,
D. C.

Hans Kindler
RCA-Victor

NON-RECORDING ORCHESTRAS

Altoona Civic Symphony
914 28th Ave., Altoona, Pa.
Russell Gerhart

Austin Symphony Orchestra
City Hall, Austin, Texas

H. J. Buytendorp

***Baltimore Symphony Orchestra**
1112 Fidelity Bldg., Baltimore 1, Md.
Reginald Stewart

***Buffalo Philharmonic Orchestra¹**
Kleinhans Music Hall, The Circle,
Buffalo 1, N. Y.

William Steinberg

Cedar Rapids Symphony Orchestra
331 14th St., S. E., Cedar Rapids, Iowa
Joseph H. Kitchen

Charleston Symphony Orchestra
305 Chamber of Commerce Bldg.,
Charleston, W. Va.

Antonio Modarelli

Charlotte Symphony Orchestra
East Third St., Charlotte, N. C.

Guy Hutchins

**Colorado Springs Symphony Orchestra
Association**

118 E. Washington, Colorado Springs,
Colo.

Frederick Boothroyd

Southern Symphony Orchestra
13 Arcade, Columbia, S. C.
Carl Bamberger

***Columbus Philharmonic Orchestra**
114 E. Broad St., Columbus, Ohio
Izler Solomon

Tri-City Symphony Orchestra
2915 Middle Road, Davenport, Iowa
Oscar W. Anderson

Dayton Philharmonic Orchestra
Hotel Biltmore, Dayton, Ohio
Paul Katz

***Denver Symphony Orchestra**
1302 Williams St., Denver, Colo.
Saul Caston

***Duluth Symphony Orchestra**
712 Alworth Bldg., Duluth, Minn.
Tauno Hannikainen

El Paso Symphony Orchestra
Hilton Hotel, El Paso, Texas
H. Arthur Brown

Evansville Philharmonic Orchestra
Evansville College, Evansville, Ind.
George Dasch

***Fort Wayne Philharmonic Orchestra**
209 W. Berry St., Fort Wayne, Ind.
Hans Schwieger

*Indicates specially high artistic standing of orchestra and conductor.

¹ At presstime we are informed that the Buffalo Orchestra under Mr. Steinberg has been signed by Musicraft.

***Grand Rapids Symphony Orchestra**
224 Scribner Ave., N.W., Grand Rapids,
Mich.

Nicolai Malko

Harrisburg Symphony Orchestra
310 Patriot-News Bldg., Harrisburg, Pa.
George King Raudenbush

Houston Symphony Orchestra
Houston Symphony Society, City Audi-
torium, Houston 4, Texas

Ernst Hoffmann

Huntington Symphony Orchestra
1712 Crestmont Drive, Huntington, W. Va.
Raymon A. Schoewe

Jersey City Symphony Orchestra
Jersey City, N. J.

J. Randolph Jones

Kalamazoo Symphony Society
113 Allen Blvd., Kalamazoo, Mich.
Herman Felber

***Kansas City Philharmonic Orchestra**
918 Scarritt Bldg., Kansas City 6, Mo.
Efrem Kurtz

Louisville Philharmonic Orchestra
313 W. Walnut, Louisville 2, Ky.
Robert Whitney

Miami Symphony Orchestra
University of Miami, Miami, Fla.
Modeste Alloo

Milwaukee Symphony Orchestra
622 N. Water St., Milwaukee, Wis.
Julius Ehrlich

New Haven Symphony Orchestra
39 Church St., New Haven, Conn.
David Stanley Smith

New Orleans Symphony Orchestra
605 Canal St., New Orleans, La.
Massimo Freccia

American Youth Orchestra
302 Convent Ave., New York, N. Y.
Dean Dixon

New York Little Symphony
New York, N. Y.

Joseph Barone

***National Orchestral Association**
119 W. 57 St., New York 19, N. Y.
Leon Barzin

***Saidenberg Little Symphony**
119 W. 57th St., New York, N. Y.
Daniel Saidenberg

***New Jersey Symphony Orchestra**
4 Central Ave., Orange, N. J.
Frieder Weissman

Oklahoma Symphony Orchestra
Municipal Auditorium, Oklahoma City 2,
Okla.

Victor Alessandro

Vermont State Symphony Orchestra
Center St., Rutland, Vt.
Alan Carter

Saginaw Civic Symphony
1918 Newton Ave., Saginaw, Mich.
William A. Boos

***St. Louis Little Symphony**
6926 Delmar Blvd., St. Louis, Mo.
Stanley Chapple

Utah State Symphony Orchestra
19 W. South Temple St., Salt Lake City 1,
Utah

Hans L. Heniot

***Symphony Society of San Antonio**
209 Travis Bldg., San Antonio, Texas
Max Reiter

Scranton Philharmonic Orchestra
Chamber of Commerce Bldg., Scranton,
Pa.

Frieder Weissman

Seattle Symphony Orchestra
620 Seaboard Bldg., Seattle 1, Wash.
Carl Bricken

The Springfield Symphony
Springfield Orchestra Association, 49
Chestnut St., Springfield 5, Mass.

Alexander Leslie

Tacoma Philharmonic Orchestra
Tacoma, Wash.
Eugene Linden

Tuscaloosa Symphony Orchestra
University of Alabama, Tuscaloosa, Ala.
Ottokar Cadek

Utica Civic Orchestra
Utica, N. Y.

Edgar J. Alderwick

Waco Symphony Orchestra
510 Austin Ave., Waco, Texas
Max Reiter

U. S. Navy Symphony
Washington, D. C.
Lt. Charles Brendler

Wheeling Symphony Orchestra
2227 Chapline St., Wheeling, W. Va.
Antonio Modarelli

Youngstown Symphony Orchestra
Youngstown Symphony Society, Youngs-
town, Ohio

Michael Ficocelli, Carmine Ficocelli

rumpus-room is solution for teen-agers

Here's how an alert Mid-West dealer kept the bobby-sox element happy, yet out of their elder's way, all by smart use of excess basement space.

BY GRIER LOWRY

What can be done with turbulent teenagers who clutter up record shops, occupy listening booths for interminable periods and in general get in the hair of dealers, clerks and the staid adult clientele? How can the slick chicks and the loud lads be gotten out of the way of their elders and yet kept happy so that the important teen-age patronage will not be lost?

A unique solution to this problem that has perplexed many a dealer and at the same time is an effective use of what is ordinarily waste space has been evolved at Barnard's, Kansas City, Missouri. To the satisfaction alike of the younger set and more sedate grown-ups, a "Rumpus Room" has been installed in the basement of the two year old firm's new shop for the sole convenience of the bobby-soxers. Here, the kids may cavort to their hearts' and lungs' content and yet give vent to their exhaustive emotions without distracting older patrons.

With keen cognizance of the problem of what to do with the young fry, dealer Elliot Barnard declares. "It is a recognized fact among merchants that

any business with an appeal to juveniles has a problem in keeping this age group from taking over the entire store. There is no complete solution for teen-age-itus, but installation of a room for their exclusive use has proved our most constructive move."

A by-line in the weekly Barnard advertisements in the Kansas City Star reads "A program of fun to sell." That ideal is actuated for the adolescents in the "Rumpus Room." Apportioned 300 square feet in the basement, the room can handle twenty-five young people without strain or pain to customers upstairs who want quiet. Attended by a record clerk chosen for her ability to talk the bobby-sox language, the room is equipped with a record cabinet, a Coca-Cola machine and benches for the inevitable lounge lizards, junior grade. It's a smart looking room, with high school pennants adorning the walls. There's plenty of appeal to the kids in its appearance, which is just as brisk and refreshing as those for whom it was designed. As the lads and lasses would say, it's super, but super.

"By including the 'Rumpus Room'

in the drafts of the new store, I was looking to the future," says Mr. Barnard. "Parents of these boys and girls are our customers of the present, but the youngsters themselves are our customers of the future. Their good will is an essential in the development of our business."

Not only does the "Rumpus Room" settle the teen-age problem for Barnard's, but it also brings in a very satisfactory added revenue to the firm from the increased juvenile traffic. The room is open during the regular store hours, but the peak of its popularity is naturally reached on weekends.

Barnard's, however, has more than one good idea on how to use a basement to fullest advantage. Adjoining the "Rumpus Room" is a clubroom that can accommodate 100 people. This clubroom is designed primarily for the convenience of the buyers of photographic supplies, a sideline carried by the store. But Mr. Barnard plans to use it for lectures and chalk-talks for the ever-increasing number of record cultists who want to hear more about music from leading authorities. The clubroom is tasteful, informal and comfortable. Between it and the lectures, Barnard's has another powerful appeal to draw potential customers to the store.

Rounding off the basement into an excellently coordinated sales establishment for patrons of all ages are two sales demonstration rooms, furnished in the best of taste with fireplaces, rugs, books, pictures and all the accouterments of an attractive living room in an above-average American home. In these appropriate surroundings, Barnard's demonstrates its line of expensive radio-phonograph combinations, in a sales setting that gives prospective buyers a fine, homelike atmosphere in which to make their selections.

The firm is well-situated to catch the expensive trade. It is located on the Country Club Plaza, in a neighborhood where Kansas City's well-to-do citizens live. A great potential market for the

very best phonographic equipment exists in the district and the alert Mr. Barnard is ready to utilize the market to the utmost.

The main floor of the store is a nice blending of the artistic with the efficient. 85 by 45 feet, the main store boasts eleven listening booths with built-in players and upholstered seats. Outside each booth is a record display that is constantly changed to spotlight the latest favorites, both classical and popular. Behind the fixtures, there is stock space for 3,000 albums and 6,000 singles. Self-selection is encouraged by a 30-foot record display which is set off by a number of smaller displays. Barnard's, however, prefers to give its customers personalized attention, since so many of them approach music from a studious viewpoint and want alert, informed service from the staff.

Backing up the services that Barnard's offers is a widespread advertising campaign that sells the store in newspapers and other publications, in institutions, and ties in artists' local appearances with records in stock. Full page advertisements in the program of concerts by the Kansas City Philharmonic Orchestra focus attention on recordings of symphonic or solo numbers heard in the concerts. Soon to appear is a pictorial brochure emphasizing Barnard's most attractive features and specially treating the basement combination of "Rumpus Room," radio-phonograph sales demonstration rooms and the clubroom. This ten-page brochure will go as direct mail to the twelve thousand names on the mailing list of J. C. Nichols, realtor who developed the Country Club district.

Unusual in the Middle West is a record mart with the good taste, efficiency and the unique basement installations of Barnard's. The combination should augment the growth of a firm that has grown steadily since its inception.

And its growth will not be hampered by the cut-ups and capers of the bobby-soxers. The "Rumpus Room" will take care of that.



Photos show how Barnard's in Kansas City utilizes waste space in basement. Above, Rumpus-Room.



Clubroom in Barnard's basement, capacity 100, draws crowds to lectures on music by leading authorities.

a new idea for record collections

B. Altman's in New York had Christmas promotion of record library which suggested this treatment for the average dealer.

The record department of B. Altman, one of New York City's larger department stores, had a Christmas surprise for New York's record buying public that netted the store a great deal of publicity in the local and national press and initiated what may prove of value to dealers all over the country.

Altman's prepared a two shelf record cabinet, priced at \$24.00 and containing forty-two albums which, more or less, were designed to represent a comprehensive record collection. The general idea was not so much to sell the whole package which retailed at \$197.20, cabinet plus albums, but rather to incite an interest in the public for the start of a record collection and to boost unit sales. The cabinet was displayed as a floor model and the inquiries about it were numerous, actually out of proportion to the sales of the actual unit which, however, was quite successful in itself.

The inquiries were the most valuable asset, because they attracted many new customers who left their addresses at the store and who, even if they did not

purchase anything at the moment, constitute, as the management feels, valuable contacts for the future. These contacts can be exploited through mailing pieces, phone calls and other possible follow-ups.

The Altman management believes that two factors are important in the presentation of the unit: first, the public has to be given the impression that the selection of albums has been prepared by people of musical authority and that it constitutes a representative and popularly known cross-section of the best in music. Second, substitutions must be possible, and if the customer so desires, he can acquire less than the suggested total of forty-two albums.

The selections, made according to the above two viewpoints, had to be somewhat modified since not all records, that may have been desirable for the unit, were available. Thus the selection was divided between popular (mainly Decca show albums) and classical records. Among the classical albums there were mostly the popular classical orchestral works, such as Tchaikovsky's "1812

Overture," Saint-Saëns' "Carnival of the Animals," Franck's "D Minor Symphony" and Tchaikovsky's "Mozartiana."

There were also some lesser known symphonic works which held their main appeal simply by the fact that the composers enjoyed great popularity. In this category fell Rachmaninoff's "Second Symphony" among other works. The concerto always finds many adherents. Consequently, Altman's selected some of the best and most appealing works of this type. There we find Tchaikovsky's famous "Piano Concerto," and Mendelssohn's "Violin Concerto" as the most representative works. In the chamber music department the solo instrument was preferred over combinations, thus killing two birds with one stone in doing right by the general category, yet at the same time featuring an instrument that is always well liked. Here the choice was Beethoven's "Appassionata" as played on the piano by Artur Schnabel. Operatic music was represented by a less popular work, but because this recording had found a great deal of favor with the critics and was actually one of the best of its kind it stood to reason that it would appeal even to a less sophisticated crowd. This album was Alexander Kipnis' rendition of excerpts from Moussorgsky's "Boris Godounoff."

As stated before, the popular department was heavily represented and here we find a good balance between show and movie music, popular classics and symphonic arrangements. Thus we see in the first category such albums as the music from "Up In Central Park," "Merry Widow," "On the Town" and the Bing Crosby movie "Going My Way." In the second department we find Andre Kostelanetz's rendition of "Music by George Gershwin" and in the third the symphonic scenario from Jerome Kern's "Showboat."

There was also a certain measure of folk music represented by an album of "Songs" sung by Josh White.

Returning to the classics we found only a few less known items altogether.



Ad announcing the Altman library which brought better than expected results.

The least known classical work was Brahms' "Variations on a Theme by Haydn" in the two-piano version. As the management explains, the selection did not appeal to the sophisticated clientele, but the idea proved of interest even to the lover of serious and more involved music.

From these experiences of Altman's it seems clear that the propaganda for a complete unit of recorded music is of advantage to the dealer because it stimulates interest in collections. Doubtless, the unit attracts great attention and will do so more in the smaller communities where the selections may easily become a subject for discussion among the music-conscious public. However, the difficulty lies in the right selection and in this respect Altman's choice was not ideal, although it must be granted that it was impeded by the lack of sufficient stock.

First of all, it seems that a too heavy

mixture of popular and classical music falls flat because it does not appeal to the buyer in either category. As far as regular collectors are concerned, these two departments are still strongly separated. But even in the eyes of the general public a collection that comprises both Broadway shows and symphonic music loses somewhat in value and musical authoritative-ness.

Since the idea is too good to go to waste, the staff of RECORD RETAILING has compiled a list, mainly aimed at the consumer interested in good music, that will initiate him into the art of collecting records sensibly and with a view to the best possible comprehensive-ness. Needless to say, the items in this list can be substituted by other items more available at present, or more to the taste of the consumer or dealer. But the present list may serve as a definite model. To use it as such, it will be wise to examine the principles that guided its compilation.

There are three lists altogether. The first one is basic; the second, intended to be sold as a unit and as an addendum to the first, aims at the further extension of musical appreciation; the third list, added to the first two, will comprise almost all of important music. The units can be sold under the following slogans. List I "for the novice collector as start and basis for future expansion." It will retail at \$100. List II, which when added to List I, retails at \$150, "first steps of expansion," and List III, including the first two and retailing at \$200, "the comprehensive home library of recorded music."

The classical items selected represent a salutary mixture of popular classics, whose titles will attract the customer and which should be played up for the beginner, and of more unknown classics which will introduce new or rarely heard music to the novice. All important periods of music are represented through their most outstanding composers, although the stress is laid upon symphonic music in the first place and operatic music to a smaller

degree. Other categories, such as chamber and choral music, are included as well.

Each composer is represented with not more than one work. The purpose of these principles is obvious. Aside from the fact that they are the only ones giving the listener a comprehensive bird's-eye view of music and, consequently, the best possible material for appreciation, they will result in the following merchandising advantages. On the basis of the selection's variety, the collector will later be able to decide which category of music he prefers and what composer he would like to see better represented in his library. He may not like one or another of the items on the list, but then there will be so many other discs which may delight him, that he will use them as a point of departure for future purchases. Thus the groundwork is laid for a steady potential customer.

As stated before, in selling or advertising the units stress should be laid upon the best known items and especially those in the orchestra field, since their titles are familiar and the compositions are well liked. Advertise the Beethoven "Fifth Symphony," the Dvorak "New World Symphony," the Gershwin "Rhapsody in Blue," the Grieg "Peer Gynt Suite," the Mendelssohn "Violin Concerto," the Johann Strauss "Waltzes" and the Tchaikovsky "Nutteracker Suite" from List I. In List II you may point out the Franck "D Minor Symphony," the Offenbach "Gaité Parisienne," the Puccini "Bohème" and the "Wagner Concert." But since this list is aimed at the more advanced collector it may be advantageous to highlight the lesser known items, such as the Handel "Concerto Grosso," the Sibelius "Symphony No. 7," etc. The latter approach can definitely be used in List III which stresses contemporary and some lesser known classical works.

Following is the detailed list. The abbreviations V and C refer to Victor and Columbia records, respectively.

A SUGGESTED LIBRARY FOR COLLECTORS

LIST I

<i>Bach</i> : Brandenburg Concertos, Vol. 1. (C) M-250	\$ 8.50
<i>Beethoven</i> : Symphony No. 5. (C) M-198	4.50
<i>Bizet</i> : Carmen Suite. (V) DM-1002	4.50
<i>Brahms</i> : Violin Sonata No. 1. (V) DM-987	4.50
<i>Chopin</i> : Mazurkas, Vol. 1. (V) M-626	5.50
<i>Debussy</i> : Two Nocturnes. (C) X-247	2.50
<i>Donizetti</i> : Daughter of the Regiment. Excerpts. (C) X-206	2.50
<i>Dvorak</i> : New World Symphony. (V) DM-169	5.50
<i>Gershwin</i> : Rhapsody in Blue. (V) SP-3	2.00
<i>Gluck</i> : Ballet Suite. (V) DM-787	2.50
<i>Grieg</i> : Peer Gynt Suite No. 1. (C) X-180	2.50
<i>Herbert</i> : Medley. (C) M-415	4.50
<i>Mendelssohn</i> : Violin Concerto. (V) DM-531	4.00
<i>Mozart</i> : Quintet K. 516. (C) M-526	4.50
<i>Prokofieff</i> : Classical Symphony. (V) 7196/7	2.00
<i>Rachmaninoff</i> : Piano Concerto No. 2. (V) DM-666	4.50
<i>Rimsky-Korsakov</i> : Scheherazade. (V) DM-920	5.50
<i>Rossini</i> : Overtures. (V) DV-2	8.50
<i>Shubert</i> : Selected Songs. (C) M-89	8.50
<i>Shostakovich</i> : Symphony No. 1. (V) DM-192	5.00
<i>Johann Strauss</i> : Waltzes, Vol. 1. (C) M-364	4.50
<i>Tchaikovsky</i> : Nutcracker Suite. (V) DM-1020	3.50

\$100.00

LIST II

LIST I	\$100.00
<i>Berlioz</i> : Harold in Italy. (V) DM-989	5.50
<i>Franck</i> : D-Minor Symphony. (C) M-179	5.50
<i>Gabrieli</i> : Processional and Ceremonial Music. (V) DM-928	4.50
<i>Handel</i> : Concerto Grosso No. 6. (C) X-154	2.50
<i>Haydn</i> : Symphony No. 98. (V) DM-1025	4.50
<i>Moussorgsky</i> : Boris Godounoff. Excerpts. (V) DM-100	5.50
<i>Offenbach</i> : Gaité Parisienne. (C) X-115	2.50
<i>Puccini</i> : Heart of "La Bohème." (V) DM-980	5.75
<i>Ravel</i> : Daphnis and Chloe Suite No. 2. (V) SP-1	2.25
<i>Sibelius</i> : Symphony No. 7. (C) M-524	3.50
<i>Stravinsky</i> : Petrouchka. (C) M-109	3.50
<i>Wagner</i> : A Wagner Concert. (C) M-519	4.50

\$150.00

LIST III

LIST I AND II	\$150.00
<i>Copland</i> : El Salón Mexico. (V) DM-546	2.50
<i>Mahler</i> : Lied von der Erde. (C) M-300	7.50
<i>Monteverdi</i> : Madrigals. (V) DM-196	5.50
<i>Schoenberg</i> : Transfigured Night. (V) DM-1005	4.50
<i>Schumann</i> : Dichterliebe. (C) M-186	4.00
<i>Richard Strauss</i> : Till Eulenspiegel. (V) DV-1	4.50
<i>Verdi</i> : Aida. (C) OP-3	19.00
<i>Villa-Lobos</i> : Serestas. (C) X-219	2.50

\$200.00

RICH-ART ENTERPRISES, INC.

— Announces —

Three new lines of living, virile records



1—Richtone: Classic and Standard
"Music of the Muses"
 To Retail for \$1.10 Tax included

2—Rich-Art: Popular Recordings
"The Ultimate in Art—Every Mood in Music"

3—Rich Records: Western and Hillbillie
"Songs of the Wide Horizons"

4—Race Tunes:
"Jive, Tears, or Laughter—Melodies of a Melodic Race"

To Retail for 79c. Tax inc.



"Every Song a Hit"

Write 2638 South Gladys Avenue

Garvey, California

For Distribution and Release Lists

Fidelitone

1st

in sales and first in dealer cooperation
 NATIONAL MAGAZINE ADVERTISING • CO-OPERATIVE
 NEWSPAPER ADVERTISING • POINT-OF-SALE MATERIAL
 AND COUNTER DISPLAYS • WINDOW SPECTACULARS



SEE PACKAGE
BELOW



\$1.50

Fidelitone MASTER

provides all these: (1) Floating point construction. (2) Horizontal and vertical shock absorption. (3) Permium† metals tip (four times more costly than gold) assures maximum needle life. (4) Finest reproduction. (5) Increased kindness to records. (6) Filtered record-scratch. (7) Patented self-locking insertion design.

Fidelitone DE LUXE

With the Permetal® Tip. Gives smooth, scratch-free reproduction. Months of satisfactory service . . . Floating point construction kind to records . . . Patented self-locking design. The best needle a dollar can buy.



\$1.00



50c

Fidelitone

FLOATING POINT

worth more than the price. Its Floating point construction filters record scratch, and its precious-metals tip assures up to 1000 or more perfect plays with kindness to records.

Fidelitone

DE LUXE RECORDING STYLUS

professional stylus of true Fidelitone quality for home recording. The platinum metals (Permium†) tip is accurately shaped and precision-ground to scientific specifications. The finest stylus available for home recordings.



\$1.50



†REG. U. S. PAT. OFF.
 Each FIDELITONE MASTER comes packaged in a useful record brush.

PERMO Incorporated

6415 Ravenswood Ave., Chicago 26

The original and world's largest manufacturer of longlife phonograph needles

VICTOR RECORDS *Distributor*

*Ohio, Northern Kentucky and Southeastern
Indiana*

Also distributor for:

Bluebird Records
Pfanstiehl Needles
Rubaiyat Needles
Peerless Albums
Gem Needles
Permo Needles
Fidelitone Needles
Lyric Racks
Recoton Needles
Recording Discs
Victor Needles
Victor Albums

118

Ohio Appliances, Inc. Sixth & Court Sts., Cincinnati, Ohio

Ohio Appliances, Inc. 243 N. Fourth St., Columbus, Ohio



*DISTRIBUTORS IN STATE OF OKLAHOMA and
TEXAS PANHANDLE*

RCA Victor Records
Record Accessories
RCA Victor Radio and Television
RCA Victor Victrolas
Coleman Floor Furnace
Coleman Hot Water Heater
Grand Gas Ranges
Black Stone Home Laundry Equipment
Carrier Air Conditioning
Vornadofans
Elgin Steel Kitchens
Furniture

DULANEY'S

MANUFACTURERS • DISTRIBUTORS

834 N. W. SECOND, OKLAHOMA CITY 2, OKLAHOMA



Self Selling Record System



SELF SELLING the "ONE-SPOT" way, is a companion service to the "ONE-SPOT" Record Finder. These features and other "ONE-SPOT" services have been standard equipment in the record trade for the past six years. For full description of all "ONE-SPOT" speed systems send coupon.

**SEND COUPON TODAY
FOR COMPLETE INFORMATION!**

Without obligation send information on all "ONE-SPOT" services.

Name _____

Address _____

City _____ Zone _____ State _____

TUNNIS....
"ONE-SPOT" PUBLISHERS
OAK PARK, ILL.

Announcing JENSEN'S 1946 SALES DISPLAY



Available also is the Jensen 12-unit display of Concert Phonograph Needles—the most popular \$1 needle ever offered to the music world.

This is the colorful, sales-inviting display of twelve Jensen Genuine Sapphire Needles beautifully packaged in gold foil trays. "Must be seen to be appreciated" is an age-old truism that describes this up-to-the-minute selling aid. It's a fitting complement to the increasingly popular Royal Jewel Needle at \$2.50. Get in touch with your distributor and see for yourself. Display and needles available for prompt shipment.

Jensen INDUSTRIES, INC.
329 S. Wood St., Chicago 12, Ill.

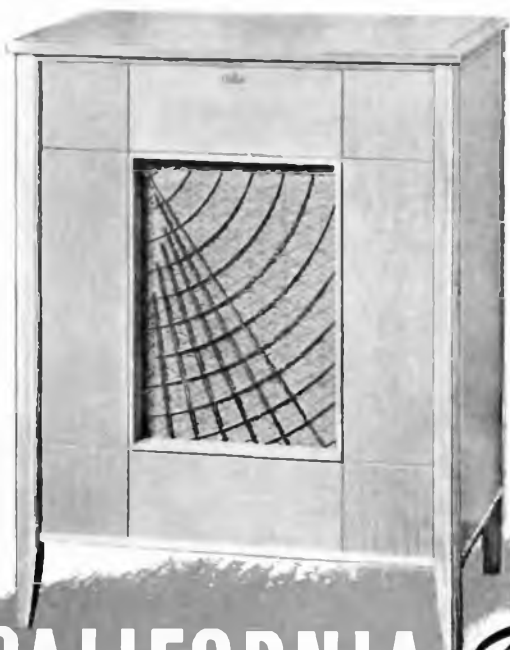

Beauty
... in a **CALIFORNIA** *Setting*

Hoffman SHASTA MODEL A 500, radio-phonograph — true California styling offering listening pleasure on both broadcast programs and records.

It took the western spirit of pioneering, and its love of leisure living, to create the West's own favorite, the new Hoffman Radio.

Each smart compact table model, each luxurious console radio-phonograph, reflects this western charm and originality by imaginative styling, the finest of woods and the

latest in plastics.

In HoffmanRadio there's more than meets the eye: Built-in craftsmanship . . . New standards of listening enjoyment . . . True life reproduction of your favorite recordings.

Know why Hoffman radios are style leaders — why western music lovers prefer a Hoffman.

122

Hoffman  **Radio**

The SOUND Buy

LOS ANGELES, CALIFORNIA



PILOTONE

non-breakable

RECORDS

At last! The postwar recording perfection your customers have been waiting for! The sensational new PILOTONE RECORDS, another "first" by Pilot Radio, manufacturers of fine radios, who produced non-breakable records during the war exclusively for the Armed Forces. For incredible high fidelity, amazing absence of surface noise and *permanent* satisfaction, these new PILOTONE RECORDS can't be beat. You can feature them, *sure* of sales and *sure* of performance, because they're a Pilot Radio product, engineered with seasoned skill to bring a new treat in listening pleasure. For information, write



SIT ON THEM



DROP THEM



STACK THEM

123

PILOT



RADIO

Long Island City 1, N. Y.

Pioneers in Frequency Modulation and Television

The Living Symbol of a Great Name in Music



WATCH FOR THE
LITTLE MERCURY MAN
"THE LIVING TRADEMARK"
JUST A LITTLE FELLOW
3 FEET 7 INCHES TALL
BUT WHAT A PERSONALITY!
NOW TOURING THE COUNTRY.

•
ARRANGE FOR HIS APPEARANCE
WITH YOUR MERCURY DISTRIBUTOR



MERCURY

IF IT'S NEW IN RECORD MERCHANDISING MERCURY WILL HAVE IT FIRST!

THE GREATEST DEALER AID IN THE RECORD FIELD

MODERN! DIFFERENT!

EXCLUSIVE WITH MERCURY ONLY

Now all Mercury Records are packaged in the beautiful autographed picture envelopes with life story on the back. Each envelope a different color.

**DISPLAYED IN THE MERCURY RACK
YOU WILL HAVE A FAST MOVING
SELF SERVICE UNIT THAT WILL
MEAN BIGGER PROFITS TO YOU!**



**THESE
FAMOUS NAMES
MAKE MUSIC
MEAN SALES
FOR YOU**



Tony Martin - Buddy Rich - Tito Guizar - Frank Parker - Connie Haines - Eileen Barton - Dixie Helle - Vincent Lopez
Chuck Porter - Jack Palance - Red Nichols - Harry Belafonte - Jayne Wallen - Buddy Morrow - Tiny Hill - Francis & Hershell
Rex Allen - Bill Samuels - Eddie Vinson - Romy Gosz - Jay McShane and many others.

ALBUMS

Jack Carson - John Garfield - Frank Parker - Loyal Gamon - Dixie Helle - Johnny Finnapple - Peter Lorre and Maturity
Miniature Playhouse Series for Children.

**Mercury has established a reputation for IMMEDIATE DELIVERY.
WHY OVERSTOCK? BUY WHAT YOU NEED WHEN YOU NEED IT!**

RECORDS



126

*For exquisite reproduction of records and in reception of
broadcasts, there is nothing finer than a Stromberg-Carlson.*

STROMBERG-CARLSON

ROCHESTER 3, NEW YORK



EXHIBIT SOUND PHOTOGRAPHY TELEVISION & SOUND EQUIPMENT AND INDUSTRIAL
SYSTEMS TELEPHONE SWITCHBOARDS AND INTERCOMMUNICATION SYSTEMS



Unrivalled for beauty and serviceability



In the manufacture of United Phonograph Record Albums there never has been a compromise with quality and beauty. When materials are again available our two enlarged modern factories in New York and Ohio will be proud to serve you.

United Albums

ALBUM COMPANY, INC., 233 SPRING STREET, NEW YORK, NEW YORK



Merry-Go-Sound

PHONOGRAPHS AND RECORDS FOR CHILDREN

The Merry-Go-Sound electronic child's phonograph is no toy—it's a high-fidelity electrically amplified record player, superior in tone quality to more expensive adult phonographs. It will play 7", 10" or 12" records—nursery rhymes, dance music or symphonies with concert hall clarity. The turntable revolves in carousel fashion, giving animation to the fanciful storyland characters astride horses. The colorful "carousel" is scratch-proof and washable. Merry-Go-Sound Records are different! Embodying radio technique, each album is a complete educational story with music and sound effects.

6 KIDDI-KLASSIC ALBUMS

128

RUMPELSTILTSKIN—TP 1
A musical fantasy with song and sound effects—2 records.

SEVEN AT A BLOW—TP 2
Set to music and enacted by the Merry-Go-Sound Players—2 records.

MOTHER GOOSE PARTY—TP 3
A "must" for all toddlers—starring Dick Brown—2 records.

ADVENTURES OF TOM THUMB—TP 5
Children love this story. Set to music, dramatically enacted—2 records.

CHILDREN'S OPRY HOUSE—TP 6
Imaginative portrayals in music. Educational—2 records.

AESOP'S FABLES—TP 7
Stories with morals, set to music. Character builders—2 records.

TONE PRODUCTS CORPORATION OF AMERICA
351 FOURTH AVENUE
NEW YORK 10, N. Y.



BANESE



ANDERSON



ARRAU



BAMPTON

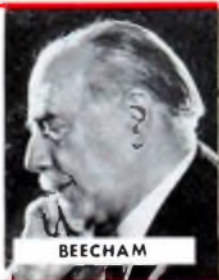

BEECHAM

You get the greatest **PRESTIGE**



BRNSTEIN



BIGGS



BRAILOWSKY



CORDON



CROOKS

when you tie up with



DEFAUW
Symphony Orch.



DORATI
Dallas Symphony Orch.

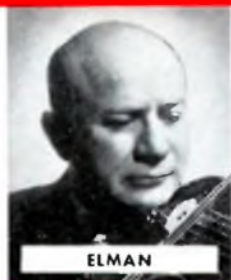

ELMAN

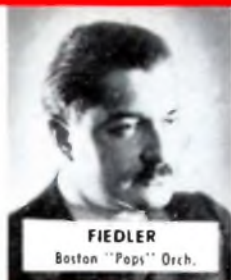

FIEDLER
Boston "Pops" Orch.



FOX

the World's Greatest Artists...



DOSSENS
Symphony Orch.



GORIN

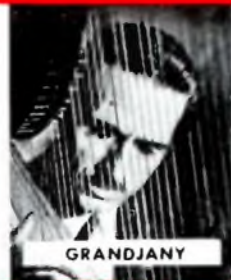

GRANDJANY



HARSHAW



HEIFETZ



WARREN



HENRY "RED" ALLEN



LOUIS ARMSTRONG



DESI ARNAZ



TEX BENEKE

And, of course, everyone



AL GOODMAN



ERSKINE HAWKINS



J. C. HIGGINBOTHAM



LENA HORNE



BETTY HUTTON

the World's Greatest Artists



BETTY RHODES



DAVID ROSE



CHARLIE SPIVAK



WHITTEMORE & LOWE



HENRI RENE



RCA VICTOR



ELTON BRITT



BUCHANAN BROS.



CECIL CAMPBELL



CLAUDE CASEY



HARMONIZERS QUARTET



OLL & SATISFIERS



RUSS CASE



PERRY COMO



JOHNNY DESMOND



TOMMY DORSEY

knows that



MIKE JONES



SAMMY KAYE



WAYNE KING



FREDDY MARTIN



VAUGHN MONROE

are on



META KELLER



STEPHANO LOMBARDI

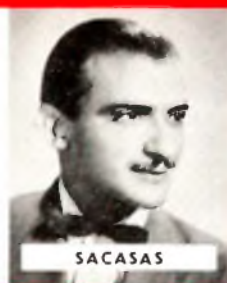

SACASAS

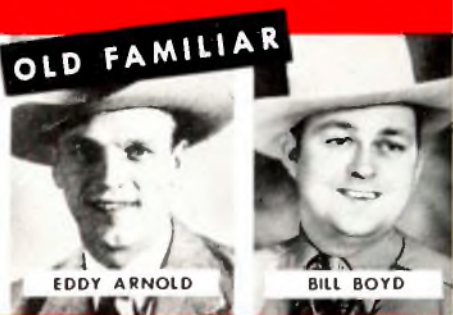

OLD FAMILIAR

EDDY ARNOLD

BILL BOYD

RECORDS



HOW TO TIE UP!



MIKE MANNERS



MORRIS BROS



NETTLES BROS



TEXAS JIM ROBERTSON



ROY ROGERS

RCA VICTOR DISTRIBUTORS

DALLAS REGION (Continued)

Oklahoma City, Okla. . . . Dulaney Distributing Co. 834 N. W. 2nd Street Phone 3-9461

San Antonio, Tex. . . . Straus-Frank Co. 301 South Flores Street Phone Fannin 0101

LOS ANGELES REGION

Billings, Mont., Northwestern Auto Supply Co. 5th & Broadway Phone 3146

Los Angeles, Cal. . . . Leo J. Meyberg Co., Inc. 2027 So. Figueroa Street Phone Prospect 6011

Portland, Ore. . . . Harper-Meggee, Inc. 1506 N. W. Irving Street Phone Atwater 1133

Salt Lake City, Utah . . . The Salt Lake Hardware Co. 105 North 3rd West Phone 3-5771

San Francisco, Cal. . . . Leo J. Meyberg Co., Inc. 70 Tenth Street Phone Umerhill 1212

Seattle, Wash. . . . Harper-Meggee, Inc. 960 Republican St. Phone Elliott 8092

NEW YORK REGION

Albany, N. Y. . . . R. T. A. Distributors, Inc. 36 Broadway-Menands Phone Albany 5-0616

Baltimore, Md. . . . D & H Distributing Co., Inc. 31-37 Lee Street Phone Saratoga 4506

Buffalo, N. Y. . . . Bickford Brothers Co. 1209 Broadway Phone Humboldt 7738

Cambridge, Mass. . . . The Eastern Company 620 Memorial Drive Phone Trowbridge 4720

East Hartford, Conn. . . . Radio & Appliance Distributors, Inc. 643 Connecticut Boulevard Phone Hartford 8-4121

Harrisburg, Pa., D & H Distributing Co., Inc. 311 South Cameron Street Phone 7327

Newark, N. J. . . . Krich-Radisco, Inc. 422 Elizabeth Ave. Phone Bigelow 8-3000

New York, N. Y. . . . Bruno-New York, Inc. 460 West 34th Street Phone Medallion 3-5716

Philadelphia, Pa. . . . Raymond Rosen & Co. 32nd & Walnut Streets Phone Baring 2-2600

Portland, Me. . . . Cressey & Allen 35 Commercial Street Phone 3-4982

Providence, R. I. . . . Eddy & Company, Inc. 43 Hospital Street Phone Gaspee 2015-2046

Syracuse, N. Y., Morris Distributing Co., Inc. 412 S. Clinton St. Phone 3-7912

Washington, D. C., Southern Wholesalers, Inc. 1519 L St., N. W. Phone District 3422

CANADIAN REGION

Calgary . . . RCA Victor Company Ltd. 523 8th Avenue, West

Halifax . . . RCA Victor Company Ltd. 99 Brunswick Street

Montreal . . . RCA Victor Company Ltd. 1050 Lacasse Street

Toronto . . . RCA Victor Company Ltd. 1040 Yonge Street

Vancouver . . . RCA Victor Company Ltd. 1206 Homer Street

Winnipeg . . . RCA Victor Company Ltd. 168 Market Street

Ottawa . . . RCA Victor Company Ltd. 18 Rideau Street



Low self-selection racks by The Gorton Company, Elmira, N. Y., do not obstruct a view of the counter.

self-selection enjoys continued popularity

Self-selection, originally a wartime expedient born of shortages of merchandise and sales help, enters the first post-war year with its reputation established as the biggest new wrinkle in display. Reports coming in from all over the country indicate that dealers old and new are converting to it in whole or in part, having found, in almost every case, that it makes for a brighter, more eye-appealing store and bigger sales. Opinion on this score is so unanimous that there can be no doubt that self-selection is here to stay.

While it is apparent that self-selection

War-time expedient, accepted by dealer and customer alike, is now recognized as best way to boost sales.

does not permit any real reduction in sales personnel, it is of great assistance to the new clerk, who would otherwise have to familiarize himself with all the peculiarities involved in storing merchandise in a record store, besides gaining a working knowledge of the music he is trying to sell. Moreover, it has been found that the customer can be of assistance to him while he is still learning when records are displayed within easy reach.

Self-selection has made it possible for many dealers to sell items which very often brought no response at all when

advertised in a conventional manner. The temptation to browse through an album of Mozart lying within easy reach is great, even for the teen-age whose primary interest lies in the popular field. Customers entering the store to make only one purchase are much easier to sell when the stock is laid out in such a manner that inspection is easy, and latent appetites may very often be whetted to the point of making additional purchases. There is a psychological advantage in holding an attractive album in one's hand that no amount of sales promotion conducted over a counter can equal.

The attraction perhaps is greatest for the traditional browser. The person walking into a store with the settled intention of making a purchase can only be improved on, but the large potential mass of buyers who are often kept from approaching a clerk because of indecision or shyness are suddenly transformed into a large market. The princi-

ple is very simple, but effective: simply permit this large number of prospects to walk around and examine to its heart's content. Nothing is lost by this, but the desire to own favorite pieces of music is immediately awakened, and a market which would otherwise come alive only in fits and starts, is easily made into regular customers.

Despite some occasional hedging by a few dealers, self-selection displays continue to enjoy tremendous popularity. The theory is that in many cases lovers of the classics, who enjoy strolling about in understocked stores which have plenty of available room, will object when that space is no longer available, forcing the retailer to go back to more conventional displays. Whatever the outcome of this theory the present trend to SS displays continues, and, if anything, appears to be stronger than ever.

Displays are generally broken down into two main categories, popular and classic. Popular displays usually feature

Plenty of SS is evident in this newly-opened record section of Rich's Department Store, Atlanta, Ga.





The Record Shop, Kansas City, Mo., uses self-service album racks labeled to aid customers in making selections.

The Cochran Music Company, Kansas City, pays particular attention to single record displays in racks and on the counter.





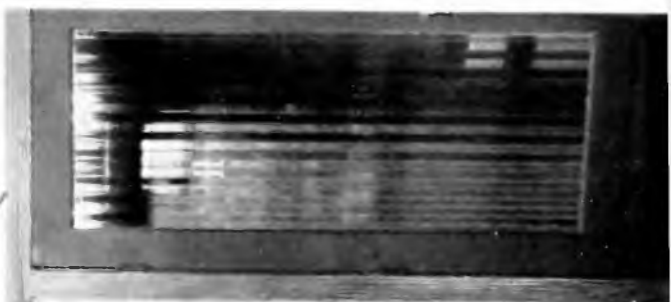

SP Intimate atmosphere and personalized service are featured by Miss Helen Gunnis' Record Shop, Milwaukee.



THE CHILDREN'S CORNER

Attractive display in the children's Corner of Rich's Department Store, Atlanta, popular with adults as well as with the younger generation.

SP Victory Radio and Records shop, Chicago, makes good use of flat space between two doors.

current hit tunes, often emphasizing Hit Parade selections; ballads and swing tunes are often separated, as are the better known artists and orchestras. Displays also take advantage of current crazes and buying sprees like that started by the movie *Rhapsody in Blue*. Further classification results in counters containing Latin American numbers, piano, and vocal specialties, etc.

The classics are divided into many classification, individual counters often being used for symphonies, concertos, opera, sonatas, overtures, organ music, piano music, etc. Within each classification numbers are listed alphabetically by composer. Here, then a customer is provided with a library which makes it possible for him to find whatever he is looking for without any trouble, and examine it on the spot.

Single records are carried under separate classification. A leading artist's

name is displayed prominently, often with a listing of additional titles available. A separate counter containing ten current best sellers is usually set aside and placed in a prominent position, carrying a heading to the effect that all items on the counter are in the best seller group.

Perhaps one of the best reasons advanced for self-selection's appeal to dealers is the relatively small expense involved in installing the system. Nothing elaborate is needed to give the display on the floor. Necessary counters may very often be obtained cheap from local furniture dealers who specialize in that sort of material, and if that isn't possible, any good carpenter can put together an excellent counter from a rough blueprint. Painting is a minor consideration, for the eye-appeal rests with the merchandise display, and not with the stand itself.

Clever display rack of The Record Shop, Chicago, is used to advance single record sales.





Spacious interior and self service racks which line store are shown in this interior photo of Music Shop in Puyallup, Washington.

self-selection, 100 per cent

143

With a policy of 100 per cent self-selection, the Music Shop, owned and operated by Conley Stone, recently opened in Puyallup, Washington. The store, which offers a complete line of records, sheet music and record accessories, stresses self-selection with wall racks for albums and table displays for single records. Customers are allowed to browse as they would in a library.

Record accessories are featured in low counters which provide attractive displays through glass tops and sides.

Mr. Stone has equipped his store with scientific lighting, a balcony to be used for the display of musical instruments, and air-conditioned listening booths, in which are installed the latest types of record players.

The self-service album racks which line the walls of the entire store are shown in accompanying photographs. Tables where the customer may select individual records are in the center of the floor. Complete freedom is allowed patrons in making their choices.



Above, Conley Stone, left, and staff discuss Norsky album with M. E. Littlejohn, Columbia distributor, right.

Lighting gives the attractive effect to this corner below.



3-dimensional blueprints aid dealers plan efficient store layouts

The following pages illustrate model floor plans, showing how to make optimum use of your space, whether it's 300 or 3,000 square feet. With the use of these accurate scale models of all record shop equipment, the dealer can see how his store will look before he builds.

Every dealer has probably wished at one time or another for an architect like Frank Lloyd Wright to come along and offer to design a store layout for him. The expense of hiring Mr. Wright, however, has been spared him by RCA Victor. This company has come up with a series of three-dimensional blueprints designed to aid the dealer plan a more efficient store layout. Cardboard scale models of all the fixtures of a record store were made, and the dimensions of a particular store were ruled off on a piece of paper. The models were then shifted about on the paper until the best layout was worked out. Using this system the dealer could visualize the way the completed store would look. In the following ten pages will be found typical layouts intended to meet specific dealer floor layout problems.

Having proved by research that prospective record buyers like to browse, Victor has placed the emphasis on self-selection in these plans. All types of self-selection racks have been combined with the conventional counters and booths so as to utilize to the maximum every inch of floor space and yet present a pleasing picture that will keep the customer coming back again and again.

It was several years ago that Victor executives, studying the self-selection question, decided to apply the principles that had been so successful in other lines—food, books, china, etc.—to the record business. The discovery that record buyers were leaving stores with less than they had intended to buy, but that self-selection had doubled food sales provided impetus for the research. A test department selling only albums and classical single records was set up in 2,000 square feet of space in a store, while the store's conventional record department continued regular selling methods. Self-selection scored an immediate success. More records were bought in the test department than in the regular one, and sales of classical singles rose to near-equality with album sales—a new phenomenon in the business. It was further proved that sales personnel could handle approximately three times as great a volume of sales. In other words, the customers liked it, and the dealer found it a more effective and economical way of selling records.

Victor has applied its findings to the problem of attractive but efficient store layout and determined how the dealer can best capitalize on them in these blueprints.

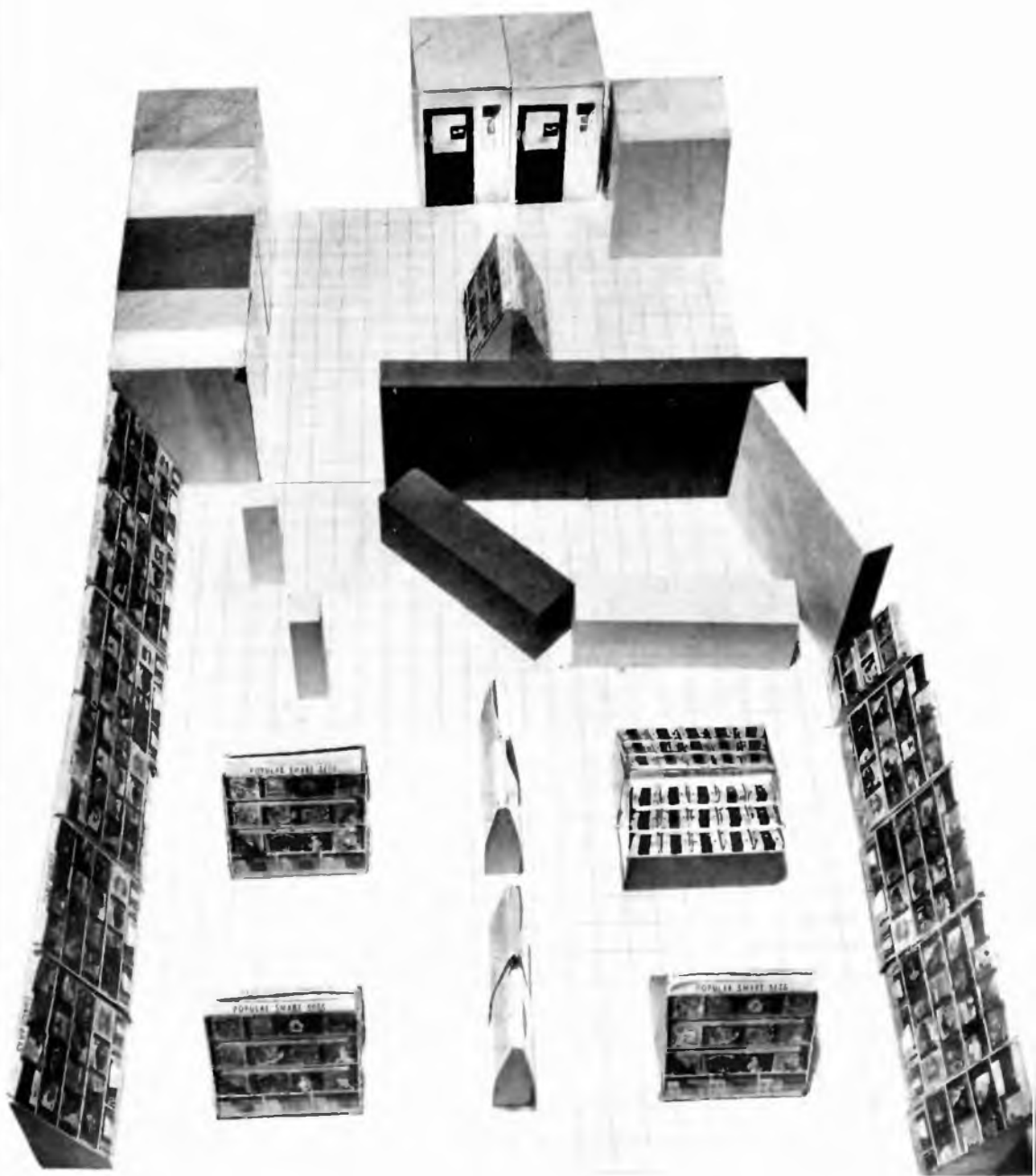

An ideal arrangement for the dealer whose record shop's dimensions approximate 10 feet by 60 feet.

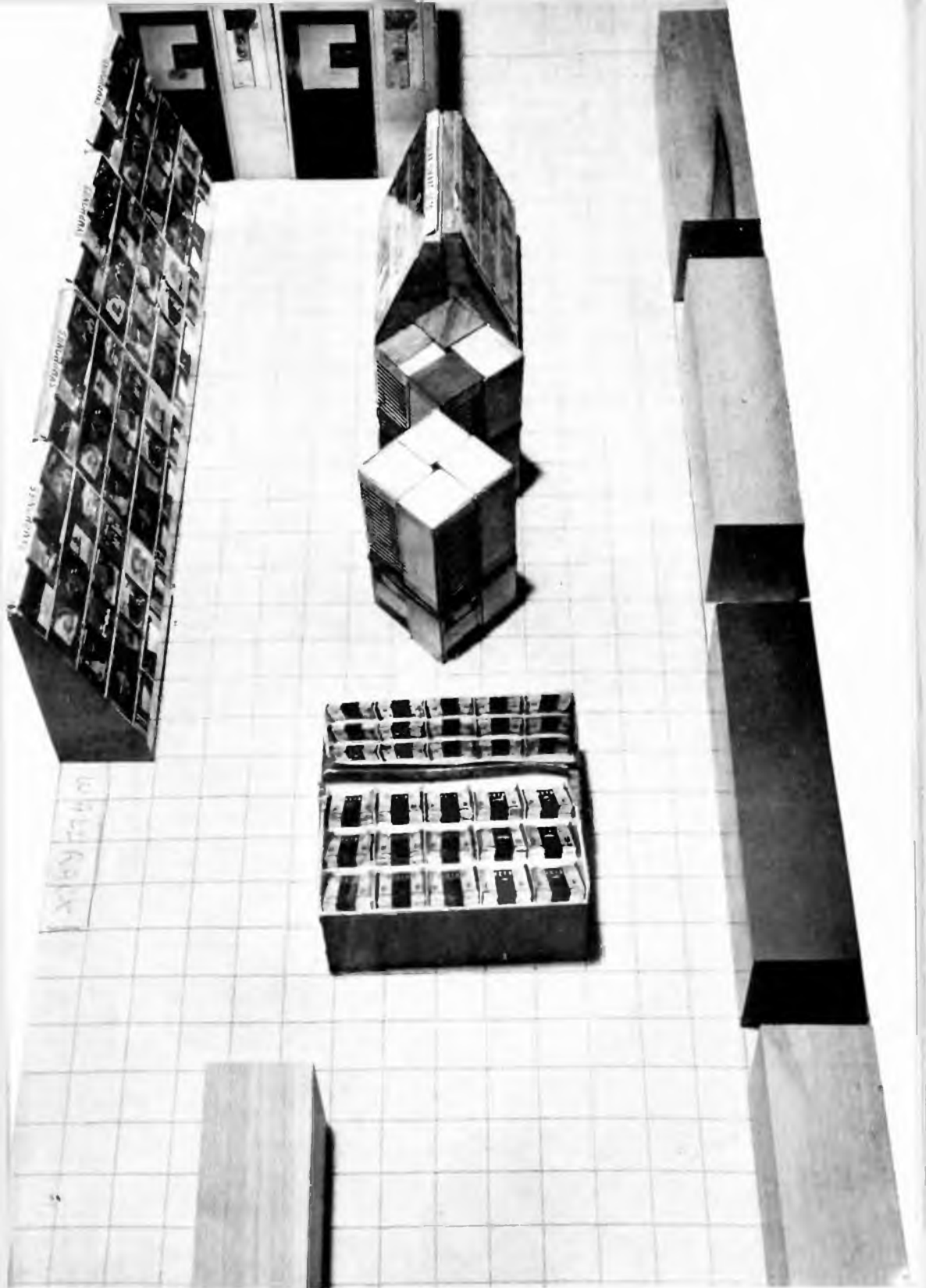

A neat arrangement of floor and wall racks and "Best Sellers" can be worked out of this roomy record department. Floor space is approximately 900 square feet.

A medium-size, compact, layout design suitable for a neighborhood store. Dimensions approximately 55 feet by 50 feet.

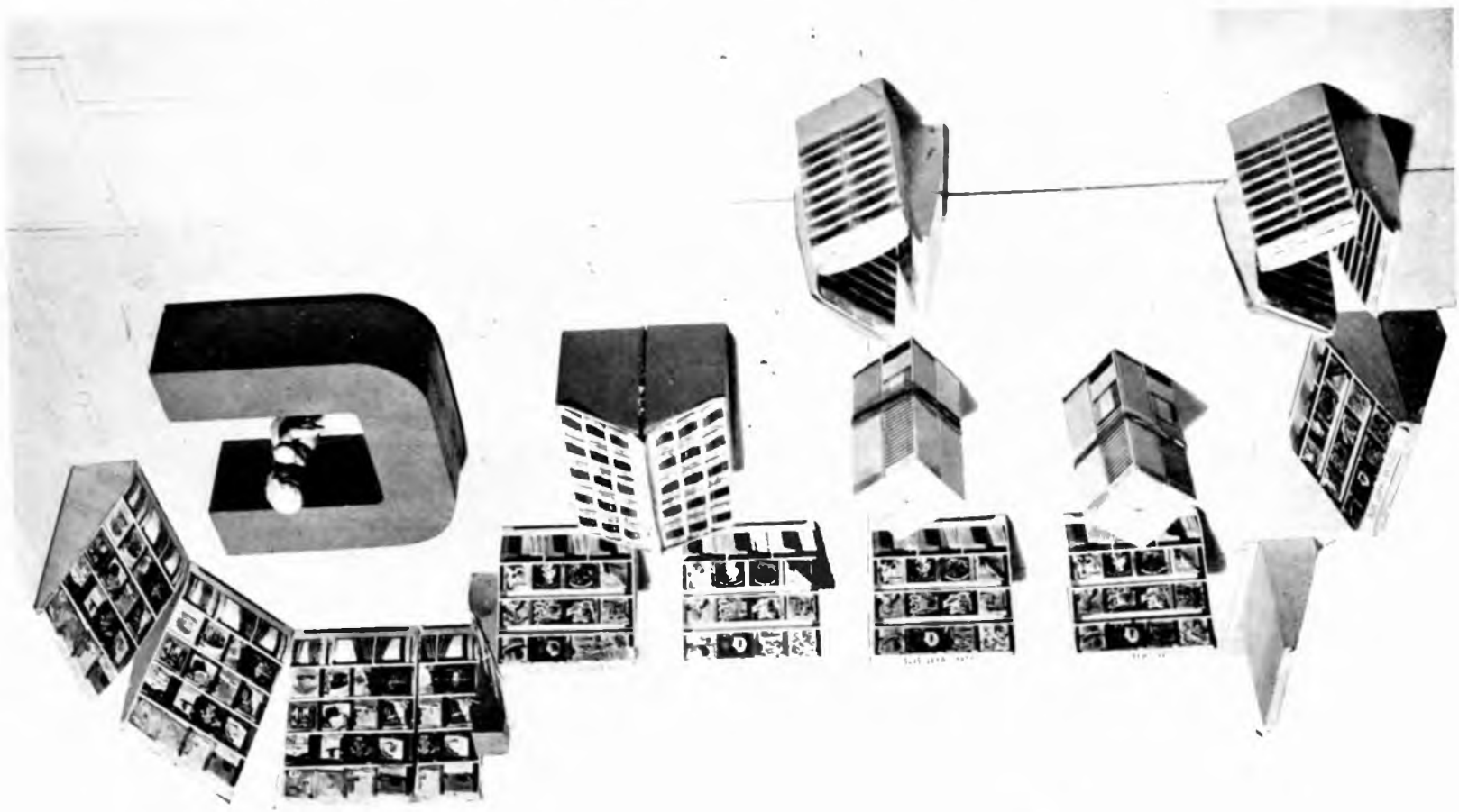

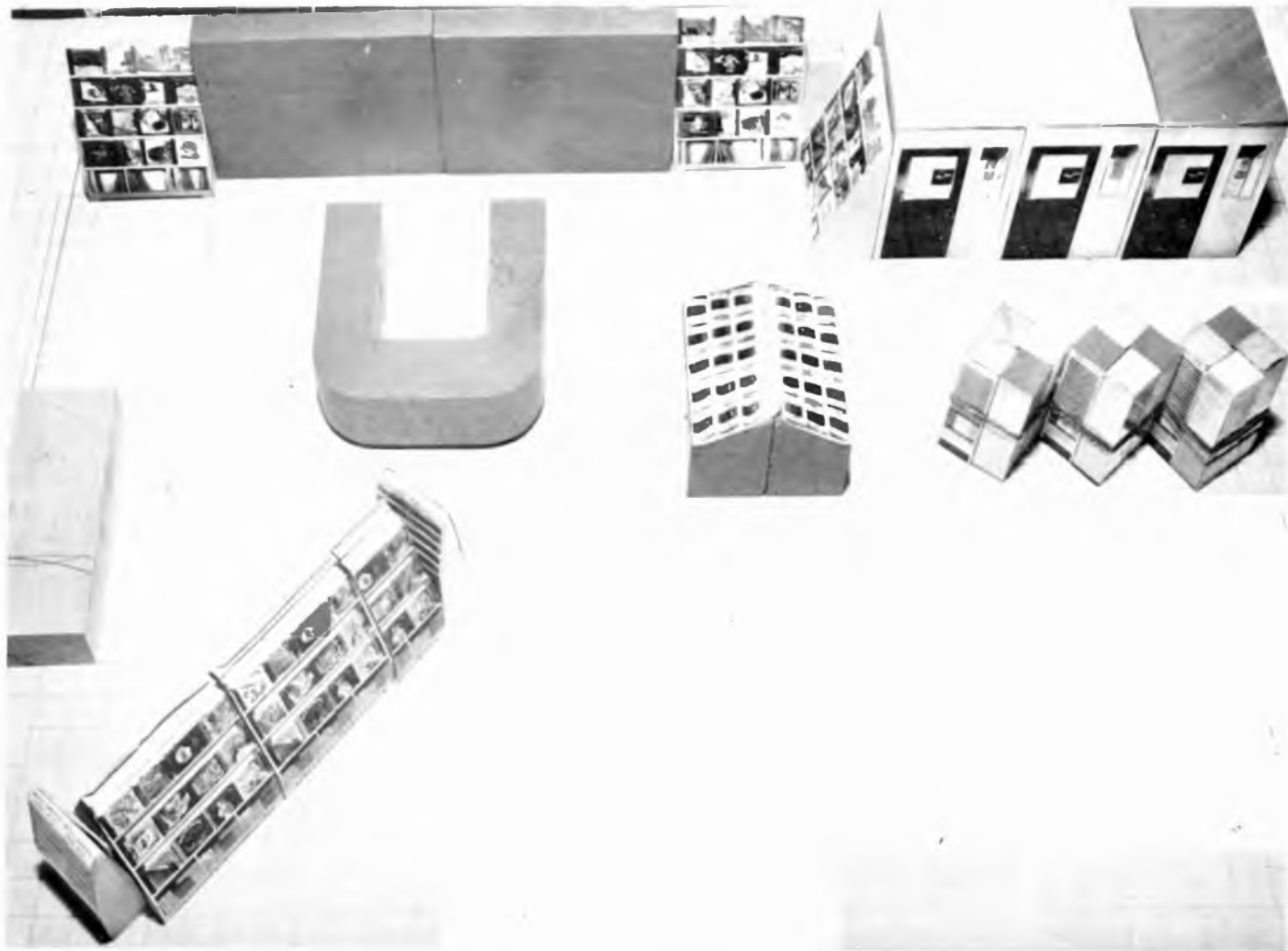

Unit planned to include existing built-in stock racks and booths on side. Floor space approximately 580 square feet.



Possible treatment of a central stairway and island posts is shown in this arrangement of display racks around such obstructions. Layout takes up 300 feet of floor space.

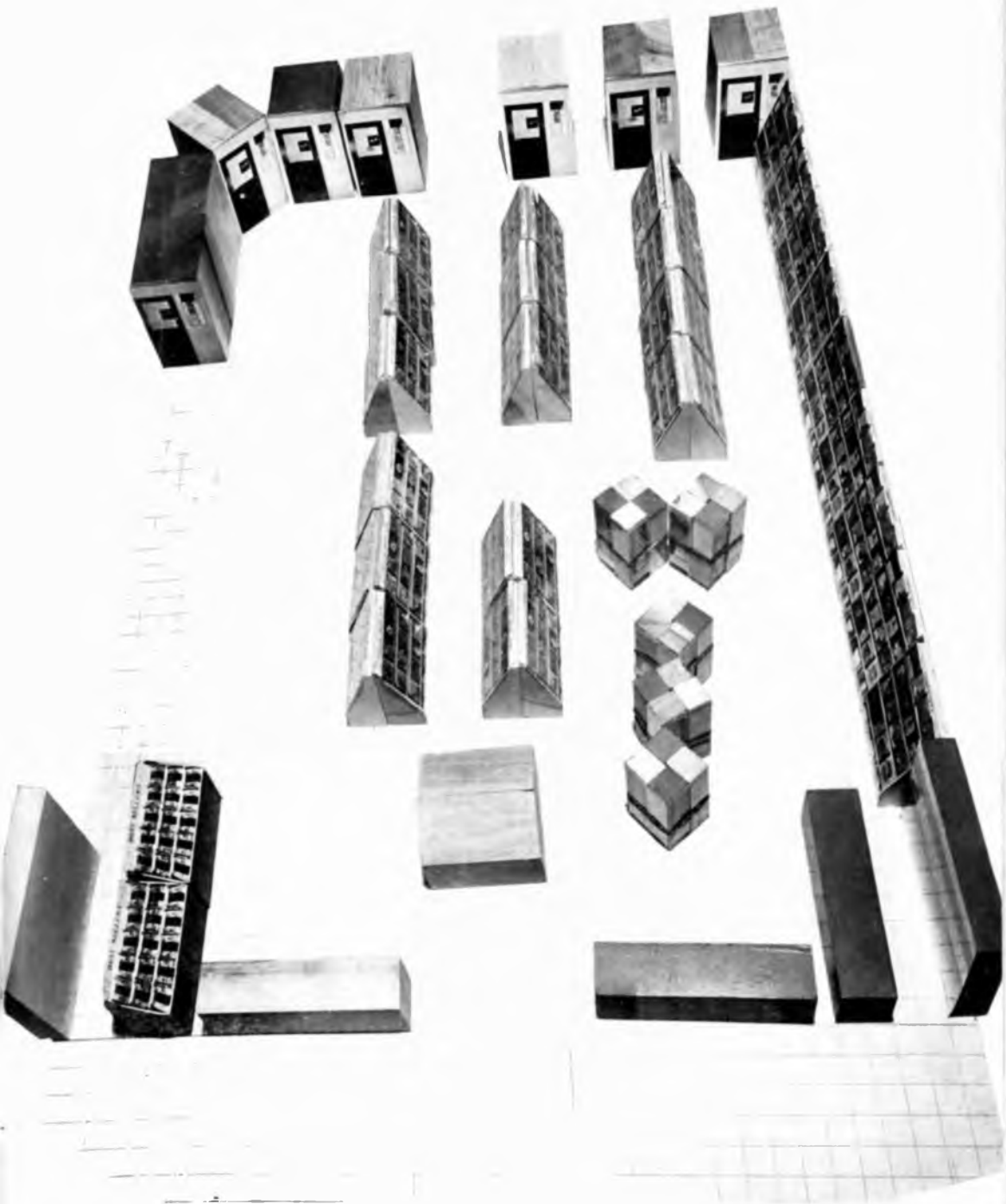

A window 6 feet deep is allowed for on the left side of the above layout. This large department covers 2160 square feet of floor space.

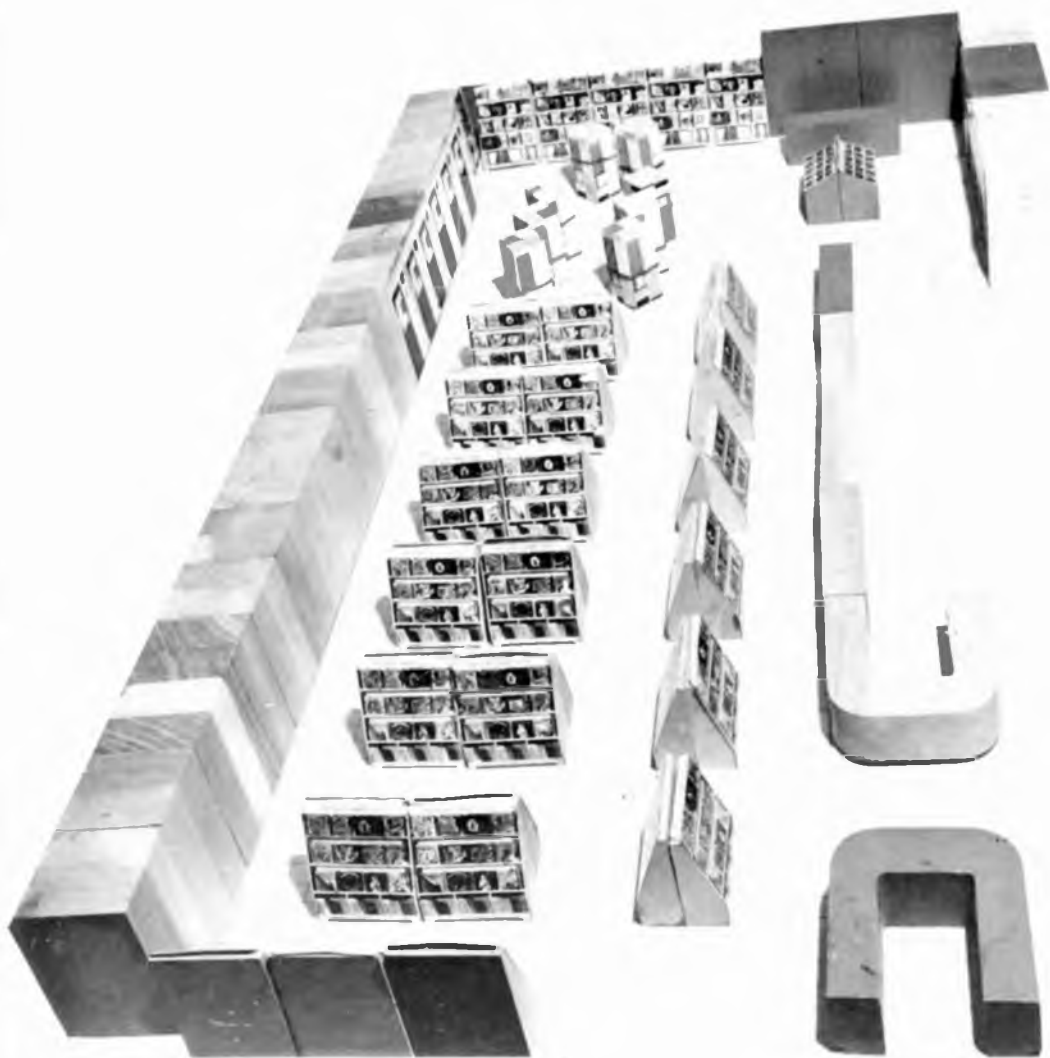

Plenty of listening booths constitute an attractive feature in this large record department. Note "Best Sellers" counter near entrance for impulse sales. Floor space is 2812 square feet.

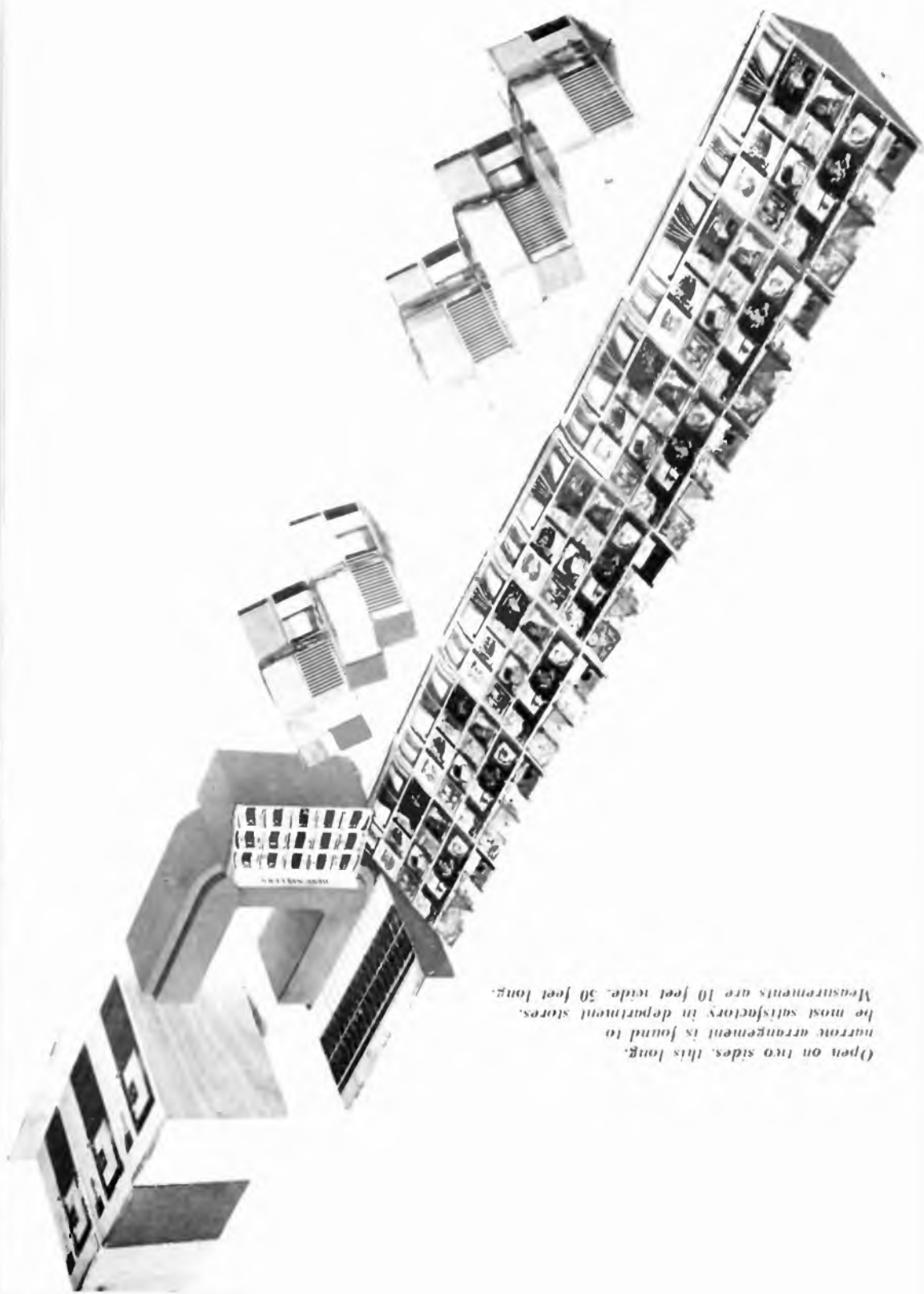

(Open on two sides, this long, narrow arrangement is found to be most satisfactory in department stores. Measurements are 10 feet wide, 50 feet long.

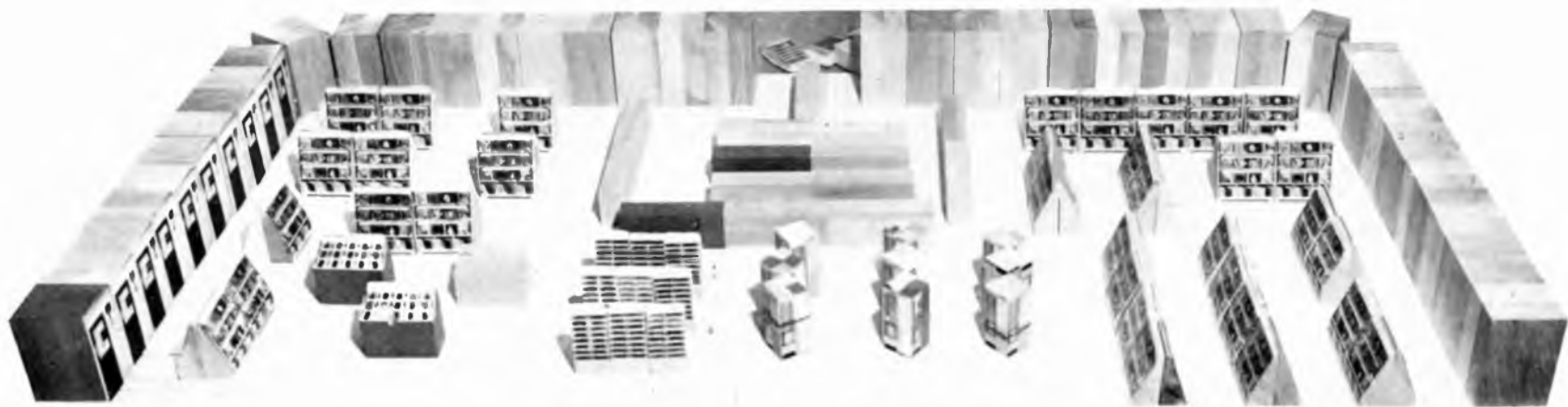

Unusual is the word for this 4001 square foot record department. Counters are located near store entrance while the rest of the department is devoted entirely to self-selection.



Close-up of a corner in the Music Center, San Francisco, Calif., shows a well-arranged store. By enabling the dealer to visualize what his store will look like before he builds, the foregoing 3-dimensional blueprints help him to achieve the maximum in efficient use of floor space.

self-selection plus trained sales clerks build sound business

Lee Thagard Music Company has built a sound business on the foundations of well-known merchandise, trained sales clerks, and reliable service.

BY GRIER LOWRY

Few firms among Oklahoma's music merchandising stores have displayed the year-around business building capacity of the Lee Thagard Music Company. This Oklahoma City store has regularly chalked up solid profits from records, sheet music and musical instruments in appealing surroundings.

It was as an exclusive radio and appliance store that the company made its bow on the Oklahoma City business scene, but in 1929 Lee Thagard, president, adopted a line of instruments, records and sheet music. In 1941 the company leased a building in downtown Oklahoma City which was ideally suited to be a music store. A steel building, with doors spacious enough to admit a piano without removing the legs, the structure has bleached mahogany fixtures with streamlined design. Records are stocked directly behind the band instrument department.

Record sales constitute a very handsome portion of the good profits marked up by the store; currently, the record department is functioning at a \$20,000 a year pace. Indicating the potent effect of modern surroundings on sales is the fact that sheet music sales since the move to the new quarters have increased 100 percent, and are, at present, grossing \$10,000 a year.

Roger Abbott, secretary of the company, and T. J. Woodmancee, vice-president, emphasize that store officials have never yearned to operate a large store; rather, it has been the inclination of these key men to keep sales at a moderate pace and service at a high level.

Frances Scott, record department manager, eyes the future confidently. When combinations and record players reach the store in sufficient number, there is going to be a completely new set of record shoppers on which the staff can



Thousands of records are within easy reach of the sales girls.

ply their sales art. There is a prospect list for combinations and players nearly "a mile long," but they aren't taking deposits anymore. It was a firm policy to accept deposits until refunds started mounting, because people were buying merchandise anywhere they could.

"At least two-thirds of the people on our prospect list," predicts Miss Scott, "will buy their combinations from us."

The record department basks in the reflected glory of the store's service department. A completely equipped radio repair service performed at peak efficiency during the war when there was a letdown by competitors. Although radio repair in homes was abandoned, the firm initiated a pick-up service on radios, which included picking the radio up and delivering it. Few firms were offering this service in the city. Apparently insignificant, this service developed an abundance of good-will among patrons, is one reason why the prospect list for

combinations is long, and Frances Scott can prophesy a rosy sales outlook.

"It is an apathetic record department," she says, "that cannot nail as regular customers for records two out of three of those patrons who buy combinations and players from their store. From the beginning, when they purchase a combination or player, is the time to tab their taste in music and cater to it."

She and her assistant are taste-tabbers par excellence, have the ability to "type" a person, musically, after a few moments discussion.

The Thagard Music Company has one of the most proficient sales staffs in the state, thanks to the fairness with which officials treat the salesmen. Employment of sales personnel is kept at a minimum in order that the members will realize a comfortable living from their efforts. Extra sales help is not employed to sell merchandise in season, and all of the sales staff has approval to sell appliance

lines. Well-rounded salesmen, who can talk equally well about radio combinations and refrigerators, are the most efficient in the minds of Thagard Music Company officials.

Record sales have benefitted materially from the diligent efforts of the office personnel of the company to maintain an up-to-date mailing list. The store regularly dispatches pamphlets describing current releases, and in the opinion of T. J. Woodmansee, "this type of advertising is tops for pushing records." A periodical culling of the mailing list keeps it in good shape, and the record sales personnel cooperates by tactfully securing names and addresses of new customers and obtaining changes of address of old patrons.

Cooperative advertising with national manufacturers of merchandise handled at the store is another preferential form of promotion by store officials, and both the classified and display advertising

columns are used in sustaining this aggressive advertising program.

A completely glassed-in front, even including the doors, converts virtually the entire handsome interior of this company into a display, and the four record booths, including one large-sized booth, and three of medium size, can be easily viewed by passers-by.

"We like this arrangement very much," said Mr. Woodmansee, "except for the fact that you don't merely arrange a window display—you really arrange your entire floor."

Good will is no idle expression to T. J. Thagard and associates. Probably more than anything else it is the quality on which the business has been nurtured. A respect for the term has made the Thagard management avoid off-brand merchandise despite emergency conditions. The officials would rather patiently await the delivery of nationally-known dependable products that will not undermine the store's prestige.

Sheet music sales at The Lee Thagard Music Company, Oklahoma City, increased 100 per cent after the store was remodeled.



listening booths are essential to record sales

New record dealers and those already in the business will find this article of great interest when considering the listening booth.

With new materials and equipment gradually becoming available, both new and old dealers will be thinking of furnishing listening booths. During the period of war-created shortages, customers became unwillingly accustomed to booths that needed painting and to phonographs that were only capable of emitting croaks; but with new equipment slowly seeping out of the factories, they will not put up with defective reproducing machines much longer. If the dealer is slow in putting his listening booths in top mechanical condition, he will be running the risk of losing customers to more alert competitors. In any case, new conditions in record selling make it advisable for the wide-awake dealers to reconsider carefully the function of the listening booth before he goes ahead with remodeling or rebuilding.

The record business has expanded so rapidly that most record departments are crowded for space. While it is desirable to have booths always available for listening, a compromise with this ideal is necessary in most cases. The most practical solution is to make a real effort to

realize the ideal with customers for classical records, and to depend on counter turntables for demonstration of popular records. Dealers who have difficulty in supplying booth facilities to classical customers during busy hours—or even at less busy periods—find it wise to urge customers for popular records to play them on counter turntables, though booths may be available. In this way they avoid friction with these customers who, if they became accustomed to using booths, would see no reason why classical customers should be given preference when the booths were busy.

In planning the layout of a record department, it is advisable, if at all possible, that the booths be so arranged that they all can be seen by the sales clerks from behind the counter. Of course, this isn't always possible, but it helps the sales clerk keep his eye on his customers without leaving his post. If booths are adjacent to the record counter, it is an excellent idea to have glass windows opening into the booths. This makes it possible for the sales people not only to observe when the customer has

finished playing the records he has selected, but also to talk with the customer and hand in additional records for auditioning with a minimum of time and steps.

Some dealers have booth wiring so installed that illumination and phonograph operate from one switch. This arrangement makes it easy for clerks to know when a machine has been left on. Otherwise, players are sometimes left running for a long time after booths have been

vacated. In summer, the same switch turns on the fan with which each booth is equipped.

A setup that is increasingly coming into use is the centrally controlled auditioning of records. Turntables are placed in the showcases, or on or under the record counter, in front of the record racks. Operating by sales people only, these turntables are used to play records for all who wish to hear them. They can be heard in the main room or in one

This listening corner, one of six in Dynamic's uptown New York store, needs little description but fulfills all the requirements of the accompanying article notably the comfortable seat, room for handling records, high quality machine.





At Barnard's, Kansas City, Mo., twelve of these booths have attractive interiors in pastel colors matching leather benches. Two rooms at rear are larger and are reserved for classical customers.

of the booths, as desired, through amplifiers wired to the turntables. This arrangement gives the sales people complete control of both customers and records.

In addition, it takes care of many problems connected with the auditioning of records. It eliminates damaged and stolen records, and misuse of the booths by those who may come into the store only for entertainment and may lounge around playing records. It eliminates too, the cost of maintenance of machines in the booths, and discourages crowds of young people who may have nothing in mind but hearing the latest swing band or songs—and possibly learning the tunes and words. It also eliminates the complaints resulting from the sale of records that have been played in the booths, possibly several times and carelessly. It assures that if the records are played be-

fore being sold, they are always in careful and experienced hands.

It is the quickest way to serve customers. decisions are made more quickly, and there is no loafing in booths. Dealers employing this arrangement state that it meets with no objections from the customer. Most of them seem to like it and to regard it as more convenient for them than having to take the records into a booth and play them themselves. Further, thoughtful customers feel responsible for the records, and are greatly upset if any damage is done to them.

Below are listed the features that are characteristic of a good booth:

1. Good natural ventilation. An electric fan in summer if store is not air-conditioned.
2. Good light.
3. A phonograph in perfect working condition, and fresh needles.

Modern and simple, these striking booths of Rich's, Atlanta, Georgia, have bench big enough for two, smoking stand, air-conditioning, and an easily operated phonograph.

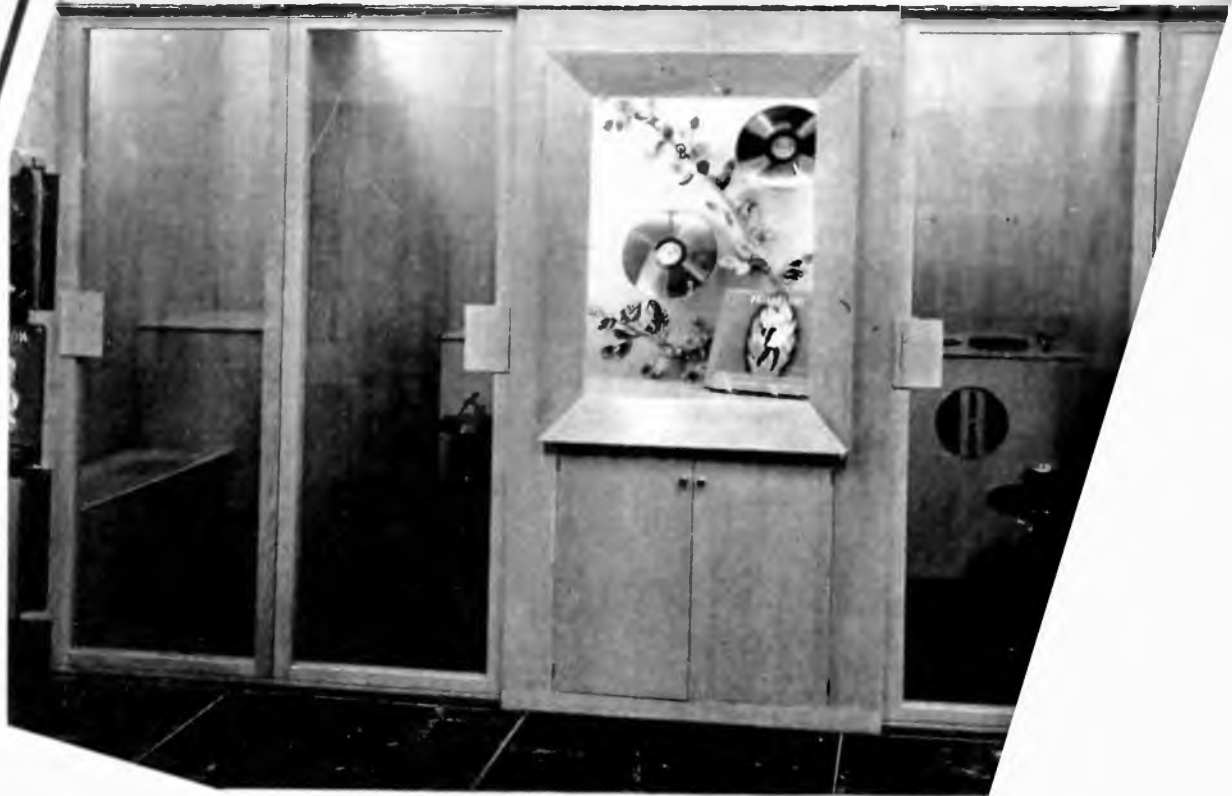



Listening booths in knotty pine are roomy and attractive. Note hangers inside and signs on door saving "Classical Only." They are part of Ray Goodman's, Spokane, Wash.

Listening booth of The Record Shop, Kansas City, Mo., is a good example of one that allows sales people to keep in close contact with the customer. Large windows like this, beside separating booths, also line fronts.





Setup becoming increasingly popular is this earphone apparatus of Claire's Record Bar, Los Angeles. Clerk behind counter plays record, and sales are speeded, especially those of the younger set

Another Chicago store, Lyon & Healy, (left) has eight of these booths now in service, and eight more will be opened soon. Clerks can watch over potential buyers, and air-conditioning thermostat on wall will keep them comfortable.

Multi-booth arrangement of Lyon & Healy's downtown record store is shown here. In addition to the many booths, head-set stations are available for the popular buyers.



4. Two chairs, or a bench to seat two people. Record customers frequently shop in pairs.

5. Shelf space sufficient to hold an open album. Two files for records, one for rejects, one for purchases.

6. Minimum wall echo, maximum insulation against outside noise. Sound bounces off smooth wood or metal walls. Unless walls and ceilings are of some

sound-deadening material, they should be covered with a textile.

7. A window door through which the clerk can see what the customer is doing and glass windows giving access to the booth if they are adjacent to the counter.

Walls of booths are good places for promotional material, but it is important that such material be arranged with an eye to good appearance. Leaflets and throwaways should be neatly kept in

Spacious booth at Holland's, Chicago, allows plenty of customer comfort as well as much wall space for up-to-date hangers, one of the requirements laid down for the model booth.



holders, and not allowed to be scattered untidily about. Replace soiled or tattered hangers on the walls, and keep them up to date! We have seen booths even in first class stores where the hangers were not months, but years old! There is little point in advertising stock that is out of print or unavailable when you have a store full of current releases that you want to sell.

It is important to emphasize that now it is more essential than ever that the phonograph equipment in your booth be of good quality. The new high fidelity records sound good even on machines of limited range, but the full extent of their superiority over the old recordings is apparent only on a good phonograph. There is not much sense in extolling the realism of the new releases if they do not sound better to customers in your booths.

Probably the majority of the new record customers you acquire during the coming year or so will be the owners of new console radio-phonographs and will be accustomed to the fuller, richer tone of such machines. The records you want to sell will not be heard to advantage on a small old, creaking phonograph. Consider the installation of good reproducing equipment an invest-

ment that will pay off in increased sales. Such equipment need not be expensive; even relatively cheap pickups and amplifiers have good tone if they are played through good-sized speakers properly mounted on baffles.

Ventilation is an important point. A customer who wants to listen to all of Beethoven's Third or Ninth Symphonies, Schubert's C Major, any of Mahler's or Bruckner's symphonic works, Berlioz's Symphonic Fantastique, Tchaikovski's "Manfred," Rachmaninoff's Second Symphony—or any other such long work that requires forty minutes or more for playing in full—cannot listen in comfort if the booth is too hot or if the air becomes stale. Irritated by his discomfort, the customer is all too likely to say, "I don't think I want that now," when he came into the store in a receptive frame of mind, ready to buy if he found something he liked. This may sound exaggerated to dealers accustomed to wartime conditions, but remember that stiffer competition and a buyer's market are not far off. Dealers interested in expanding their business are going to be eager to study the customer's wishes and comfort rather more than during the seller's market that existed in the war period.



Plenty of space, easily seen by sales people, is offered by these booths of the Boston Music House, Boston, Mass.

THEIR PROFITS CONVINCING YOU

Recordio Discs and Recordioint Needles
SATISFY THE PUBLIC

Recordio Discs during the entirety of their long lives reproduce with magical fidelity. Mirror-finished with an exclusive Wilcox-Gay preparation, the gleam of their ebony or colored surfaces pleases the eye as their magical fidelity pleases the ear.

The new Aluminum Base RECORDIO DISCS.
Popular Diameters of 10, 8, 6½ inches.

Fiber Base RECORDIO DISCS. Handy Diameters of 8 and 6½ inches.

Recordioint Cutting Needles cut with a shiny, quiet groove on any disc. They solve every cutting need. RECORDIOPOINT Playback Needles . . . sapphire-tipped, platinum-tipped, or precious metal tipped . . . lead in distinguished performance wherever records are played.

Recordio is the radio-phonograph-recorder winning all America to home recording. It is made by Wilcox-Gay, manufacturers of the first successful home recorder.



RECORDING INSTRUMENTS FOR HOME,
COMMERCIAL, AND PROFESSIONAL USE

Recordio

T.M. REG. U.S. PAT. OFF.

The World's Finest Home Recording Instrument

Recordio Discs and Recordioint Needles

Manufactured by

139-24

WILCOX-GAY CORPORATION • CHARLOTTE, MICHIGAN

music is associated here with gracious living

Combining beauty of architecture and historic atmosphere with modern methods of merchandising and promotion gives this record store a most unusual appeal.

BY R. L. BROWN

Owner, Brown's Record Shop, Covington, La.

Combining the old in architecture and much of the atmosphere with the new in merchandising and promotion, I am trying to keep our music store modern in every operational detail, and I am thoroughly sold on the idea of self-selection and the attractive display of albums. I have over five hundred records, each a different one, on display in my self-selection racks. Each record is placed on the rack in a green stock envelope and carries a label in the upper right hand corner, giving the title of both sides of the record, orchestra, make of record and number. The racks are so constructed as to hold one record in each slot, thereby—with the use of heavy stock envelopes—keeping our breakage practically nil.

In every town and city, at one time or another, the old landmarks die and spots of interest are sacrificed to the steady march of progress. This is necessary to the growth and development of a town, but we feel gratified that one of

Covington's landmarks, the Hammond House, on Main Street, old both in years and in tradition, has not been sacrificed, but rather by the recent remodeling, has been made more attractive, losing none of its charm in its restoration.

Covington is situated in the heart of the Alleghamies, half-way between Washington and Cincinnati, on the main line of the C. & O. R. R., thirty miles from White Sulphur, W. Va., world famous summer resort now a government hospital, and twenty miles from Hot Springs, Va. Covington was rated in a recent Federal survey as one of the leading shopping centers of Virginia. It has three major industries: the West Virginia Pulp and Paper Co. (the world's largest self-contained paper plant, employing about 2,000); the Industrial Rayon plant (employing over 1,200), and the Covington Weaving Co.

On March 10, 1943, we opened the Music Shop in one room of the old Hammond House (the parlor) and on Sep-

New self-selection racks in a setting of old rough-hewn logs provide a striking combination at Brown's. The shop exterior is shown at the bottom of the page.



tember 1 enlarged the business to include the other three rooms on the first floor (namely the sitting-room, dining room and the kitchen) remodelling them into one room with attractive arches dividing the shop into three distinct departments: popular, hillbilly and race records in one; classical records and al-

bums in another; and sheet music in the third.

With the remodelling the interior of the house is even more interesting, as the removal of the paper and plaster brought to light the beauty of the old hewn logs, hidden for years, and the great open fireplaces. Everything possible has been



done to restore these rooms to their former comfort and beauty.

The house was built by William Scott soon after he and his wife moved to Covington in 1822 and was later inherited by Mrs. Hammond, whose husband, Dr. George Hammond, was killed in the Civil War.

An interesting incident in connection with the house was told me by one of the direct descendant of the Scotts, a Mrs. Howard Revercomb. During the war, on Averill's raid through Covington, Mrs. Revercomb's mother was nursing her sister who was ill, when the house was taken over by the Union soldiers.

The officer in charge asked permission to warm his feet, and sat before the fire in what was then known as the "parlor." This officer, in appreciation of the courtesy he had received, provided a military escort for Miss Scott, who wished to communicate with friends "across the fields" (approximately four blocks).

When leaving, he left supplies for the family—coffee that had not been enjoyed in months, and, as a special treat, a bag of salt. The only salt available had been taken from the old smoke house and boiled down for use by the Confederates. This was such a luxury that people from miles around came to beg a handful, which was not denied them, as long as it lasted.

The house now is an ideal setting for a Music Shop and is, we feel, one of the most attractive spots in Covington. At the present time the offices and studios of Covington's only radio station, WKEY, Blue Network affiliate, occupy the second story of this building and the first floor is occupied by Brown's Music Shop.

The splendid lights shining through the clear glass of the windows, give a fairy-like effect that attracts those passing by, and a visit inside, where the stock is attractively displayed, sustains, I think, the feeling that one has been "suddenly transported with Alice into Wonderland."

they're now soft on words and sweeter on the music

There's lots in the unusual name that this ex-disc jockey chose for his venture into the realm of retail merchandising of matters cultural, but even the original conception has undergone radical changes, as the growing demand for recorded music has necessitated a number of changes in policy and a great deal of expansion in space, staff and facilities devoted to records. The post-war prospects, too, are being carefully considered.

For several years prior to 1939, Mallory Chamberlin, native of Memphis, graduate of Yale and then co-owner, time salesman, announcer and janitor of station WNBR, had been watching the progress of records. His programs, outside of sports and civic events,

on the sweeter music



From bank to books to Brahms and boogie—that's quite a transition—but it has been made in this Memphis edifice.

172

were mostly of disc music and he was getting more and more requests to play this and that by certain recording artists.

By August of 1939, he had made up his mind to go into the book and record business, making books his major line and carrying records as a promising auxiliary. He disposed of his radio interests, and "Words and Music by

Mallory Chamberlin" was born across from the North Main Street corner of Court Square in Memphis.

A small stock of records was carried for the first year, but by September of 1940, the stock had more than doubled itself and occupied twice as much space. By 1942 more than half of the store was devoted to records. Single classical

and popular records were separated from the albums and installed in the opposite side of the store. (See photo next page.)

Now, Mallory Chamberlin discovered, recorded music was his major line and books his auxiliary. He was also handling radio-combinations and phonographs. By early 1914, he was running out of room for his records even though he had no more books and had no machines to sell. He believed he had a firm foothold in the record business and looked about for a new home for "Words and Music."

Mr. Chamberlin found that he could buy a two-and-a-half story investment banking building, plus basement, that had been built 30 years ago by a prominent citizen of Memphis somewhat as his own business monument. Mr. Chamberlin knew he could not change his store front or re-decorate as he would like to, due to war-time restrictions, so he moved into his new home and installed self-selection fixtures made of the fully adequate materials that were available. He kept the floors, walls and high ceilings as the bank had left them, converting most of the balcony into eight listening booths.

The second floor, which is reached by a separate stairway leading up from the small lobby just inside the big bronze main entrance door, will in time be used for the display of several well-known lines of combinations and phonographs. An elevator will be installed as soon as it is put to this use. In the meantime it is rented as a clubroom. The basement, too, has a separate outside entrance and it is there the devotees can find the latest in race and hillbilly records.

Self-selection is a new form of an old story at "Words and Music" and as for promotion, Mallory Chamberlin has always had enough of the showman in his make-up to let the public in on anything that he thought they should know about, and in a big way too.

★ ★ ★ ★ ★ ★

Stock the quality line your quality customers select

SCHIRMER'S LIBRARY OF RECORDED MUSIC ★ ★

Best-Sellers Include

- ★ **HAROLD BAUER AT THE PIANO**
Playing music by Mendelssohn, Debussy, Handel, Bach, Schumann, Chopin, Brahms, Schubert, Scarlatti and Couperin
Album No. 1-5 records \$5.00
- ★ **MUSIC OF BALI**
Recorded by Colin McPhee and Benjamin Britten. Two Pianos, and Georges Barrère. Flute
Album No. 17-3 records 2.50
- ★ **JOHN ALDEN CARPENTER**
String Quartet in A Minor. Gordon String Quartet
Album No. 4-4 records 5.00
- ★ **GABRIEL FAURÉ**
Quintet for Piano and Strings in D Minor. Opus 89. Emma Boynet (Piano) with the Gordon String Quartet
Album No. 9-4 records 6.00
- ★ **CHARLES MARTIN LOEFFLER**
String Quintet (in one movement). Gordon String Quartet with Kay Rickert (3rd Violin)
Album No. 13-2 records 3.50
- ★ **SERGEI RACHMANINOFF**
Eleven songs sung by Nina Koshetz
Album No. 16-4 records 4.50
- ★ **EFREM ZIMBALIST**
String Quartet and Little March (William Kroll). Gordon String Quartet
Album No. 6-4 records 3.50

Also "Songs by Nina Koshetz", "Rudolf Friml in Person" and compositions by Dana Suesse. In the popular field: recordings by Sheila Barrett, Carol Bruce, Caspar Reardon, Lanny Ross, Diosa Costello, Jimmy Carroll, Billie Hayward and Cliff Arden

Write today for a complete list of Schirmer's Library of Recorded Music

SCHIRMER'S

3 EAST 43rd STREET NEW YORK 17, N. Y.

★ ★ ★ ★ ★ ★

there's a growing market for international records

BY DOROTHY HAMEL

*Manager, Record Department,
Breuner's, Oakland, Calif.*

International records, are in the air! With the war over, the boys coming back and the UN spanning the oceans, this growing market bears watching.

Our experience at Breuner's shows that it does not take any extra courage to fill racks with records whose labels may not mean anything to you and your sales force in the beginning. But observation, tact and trial and error have shown the vast possibilities of a line which we started to replace—the holes of which made by cut-outs, limited shipments and plain lack of records. Record shipments of any kind being worth a celebration, Internationals filled the gap for us, brought a flock of new customers and an increase in volume. And this is how it is done:

First, you go to your local city library and study the statistics of your "foreign-stock" fellow citizens. Contact leading personalities of organizations such as lodges, clubs and folk-dance groups. This will allow you an estimate of the stock-volume to begin with.

Next see your record distributors and discuss your plans with them. In most cases they will be willing to stock Internationals for you, especially from now on. List the available records and begin with instrumentals only in the beginning.

Third, see your potential customers with your list and ask their advice. Every club woman will be happy to let you know which songs and which arrangements are desirable and which are not. Don't risk dead ducks, since they are very dead when it comes to foreign labels.

Then take a deep breath and order!

Emphasize well-known basic recordings; let variety be up to the future. Spread the good news, wherever you go, wherever your sales-help goes. Over the lunch counters, in the beauty shops, in shoe-repair parlors . . . there are people from the "old country" everywhere, and their young ones like to buy Internationals as gifts for every occasion. If you can advertise by newspaper, mail or radio, so much the better. This is up to your budget, while the grapevine would be up to your ingenuity. (And not less powerful.)

Now, all you have to do is to wait for your first shipment. Don't shrink from the task of labeling and racking the "foreigners." Let me tell you about the "color-scheme" that I thought up for my helpers, when we were looking forward to the addition of about ten foreign nations' recordings. This area has about that many minorities settled within the city and along the valley. The mere idea of coping with labels and customers; the probable confusion with stock-work (who was supposed to do that?); the store obviously turned into a Babel; and "just wait, until the adventure simmers down to a dozen cartons with unsalable discs!"

Well, our first shipment arrived, and we segregated the different nations. Then we put them down on a list with every country represented by a color-scheme closely associated with flags and political events. Thus blue-yellow stood for the Swedish Polkas and Hambos, red for Russian Polkas and Lesginkas, orange-green for Mexican dances, white and red



Breuner's system of keeping track of International records is shown by these envelope markings and a page from the store catalog. Left, corner of envelope shows that it is Swedish Hambo. Tabs are blue and yellow to indicate nationality and type of song. At right, the same colors are used on tabs in catalog.

for Swiss Yodlers and Landlers, black for Greek Hespapikos, and so on down the line. Gummed labels from the five-and-ten signaled the master-folder at the side and also on the stock-label. We marked them just like any other record and emphasized the kind of dance or song in the foreign language.

After the records were in their place, we began to play them, and having traveled in Europe quite a lot and being entirely familiar with folk-music, it did not take me long to get the girls excited about many of the new recordings. While getting acquainted we started our own typed catalogues on the same color system, so that a customer, not knowing anything but the word "Swedish record," was waited on without delay or embarrassing stammering on the part of the sales help. Color: blue-yellow . . . open the catalogue, give the customer pad and

pencil and presto! by jotting down the number, anyone was able to find it.

It did not take long until our foreign section was in full swing. Everyone could easily wait on Armenians, Greeks, Turks and we even had several Arabians.

There were some cases where there was no linguistic bridge between customer and salesperson but we usually understood each other, we made new friends and some Old World customers brought their children in to tell us what these songs and dances meant.

We found that the more you get into this field, the more you enjoy it. But it must be entered without prejudice to production, customers and nationalities.

If you have an open mind and enough imagination to create this new line within your business, stock up with International records.



Artist's drawing of the front of Pearson's new Indianapolis store now being built.

pearson's of indianapolis

The following letter was so complete that the editors were prompted to reproduce it without editorial treatment, to give readers an authoritative insight into this store's operation.

GENTLEMEN:

We have unquestionably the largest and most complete stock of records in Indiana. We feature classical records and direct most of our advertising to their sale. However, under the able direction of the assistant manager, Mrs. Maude Cummings, we have built up a tremendous popular business. In three months we have almost doubled our sales of popular records.

Promotion

176 Our advertising budget is ample. Most of our promotion is through direct mail and LISTEN is the backbone of it all. In addition we have full page ads in the various musical programs such as the Indianapolis Symphony featuring symphonic and artists records, Ensemble Music Society featuring Chamber Music records, English's Theatre featuring show music and light classical records, etc. We also run a large ad at least once a week in the local press. Most of the newspaper advertising is on popular records but once a month we have a tie-in ad with some organization. In January we ad-

vertised the Ensemble Music Society and in February we advertised a course on Russia given by the Extension Division of Indiana University. The University is bringing the film "Alexander Nevsky" here and one of their talks on Russian music will be held in our Piano Salon featuring the music from the film. This ties in with the Columbia recording of "Alexander Nevsky."

We have a fine working arrangement with the local FM station WABW and get several "plugs" per day in exchange for records. A weekly feature of the station is their "Chamber Music Hour" which is entirely records from our library and the station gives us a courtesy plug on this program. In the plug they tell the audience about LISTEN and ask for subscriptions. The response has been surprising.

Another of our local stations, WIBC, has a very popular afternoon program called "Easy Does It." This features Easy Quinn, who uses records. It is surprising what he can do in the way of promotion. He has been personally responsible for making "Tired" by Pearl Bailey and "Guitar Boogie" by the

Rambler Trio the two biggest selling records in Indianapolis. The afternoon we were fortunate enough to get 200 of Pearl Bailey's "Tired" we called him and he announced it on his program—we sold out in three hours.

Before the war a local society, Music Appreciation League, Inc., met in Pearson's. Ernst Heberlein, the present manager of Pearson's Record Library, was the League's president. This same group will be reorganized perhaps under another name in the immediate future. At present its membership is being contacted through LISTEN, its official magazine.

We also make a monthly mailing of Victor's "In the Groove" and "Record Review," and Columbia's new successor to "Coda." A mimeographed sheet called the "Bulletin" is inserted in each copy of LISTEN mailed to keep customers in close touch with events in Pearson's Record Library.

Mailing lists are obtained through cooperative efforts with various local musical organizations.

Future Plans

Plans for the future are not dreams but actually set up and approved by the management with work going ahead.

A beautifully remodelled store with a new modern front and new style windows are part of the plans. The Record Library will have definite windows assigned to it for permanent record displays. There will be no "sharing" of windows as each music department will have its own windows.

The present store, which took on a line of furniture during the war years rather than recondition old pianos, will be changed into a 100% music operation to be known as Pearson Music Company instead of Pearson Company, Inc. The name "Pearson" has stood for reliability in musical merchandise in Indiana since 1873.

The Record Library now occupying the mezzanine floor will be moved to the first floor and will occupy practically all of its 80 x 200 feet.



Ernst Heberlein, manager of Pearson's Record Library and author of the accompanying letter.

New design sound-proof booths with air-conditioning will be installed.

A semi-self-service department will be set up. It is our contention that 100% self-service is worse than no self-service. Intelligent, trained sales personnel contacting each customer with intelligent suggestions will "plus" each sale.

The Record Library will be separate but near the sales-rooms for Radios and Combinations. Combination sales will be "plussed" with records.

The Record Library will be divided into "popular" and "classical" sections with separate sections of booths for each type. Thus no chamber music buyer will be bothered by Boogie Woogie and Perry Como will not be interrupted by Stravinsky.

Most important of all will be trained personnel.

If feasible, it is intended to have a "record hour" during the lunch period and play records audible throughout the store.

Our policy will be to help promote any worthwhile musical effort in Indianapolis realizing that any musical effort ends up in the sale of more records.

"sales-closing room" featured in modernized store

The Alamo Piano Company of San Antonio, Texas, which believes in making buying easy for its highly diversified customers, recently completed expanding and modernizing its store.

Unusual features of the store are the "sales-closing room," where salespeople may have quiet talks and demonstrations with prospective buyers; three private rooms, more than booths, where customers may play records (and which have been instrumental in upping record sales 100 percent); six glassed-in basement studios where music teachers are urged to instruct pupils and pupils are urged to practice; piano adjacent to the sheet music department always available for trying out songs; space, blocked off and furnished like a living room, for the display of pianos.

Another item which contributes to making this music store of Alfredo Flores one of the largest and most modern in the Southwest, is that the building has

been faced with construction glass in two-tone, the base a light tan while the borders and trim are in ox-blood.

A window 30 feet in length and extending from floor to ceiling on the north side, gives a clear, unobstructed view of the interior at the same time providing a spot for displaying new and late merchandise.

On a ledge along one side and one end of the sales room a series of 14 shadow boxes have been arranged for displays of individual items, such as radio sets, band instruments, etc.

A service department is immediately adjacent to the studios which has been equipped with the latest tools and equipment, and manned by experienced men. These men recently completed construction of a piano which was designed and made in their workshop.

Two glassed-in bulletin boards have been provided, one on the inside of the column at the corner entrance, and the other on the west side of the building.

Alamo store where buying is made easy.





Indirect lighting here highlights album, sheet music and accessory displays to an unusually effective degree.

doing big things with the smaller stores

179

Interesting variations in album display methods, effective combinations of direct and indirect lighting, and a special section and display facilities for accessories are operational items that have been

given close and careful attention in the new Music Box at Newark, N. J.

When the Music Box moved recently to a new location, careful attention was given in the planning to the questions of

arrangement and lighting, with the belief in mind that a bright, well-ordered store automatically draws the customer and potential customer inside.

In addition to selection of colors calculated to give better light reflection, J. H. Seader, who was responsible for much of the planning, insisted on plenty of direct overhead lighting. Then, for the purpose of dramatizing certain displays, such as those of pop and standard albums, accessories and sheet music, additional indirect panel lighting was installed. One example of this is to be noted in the illustration which shows the wall-recessed album rack. Another is to be found, in the other picture, in the large accessory cabinet shown at the rear of the shop.

Combining a self-selection and counter service operation, the new Music Box provides a colorful array of picture albums to greet the customer as he enters. This is achieved both through the self-selection display racks and by special display slots on the behind-the-counter single record and album shelves.

Speedy self-selection is the method for merchandising many of the single records as well as the sets, and Mr. Seader reports, use of the Victor single record counter merchandiser has accounted for innumerable plus sales of familiar Red Seal records.

Stock is conveniently stored on handy shelves running at right angles to the counter, and the use of decorative albums at the front of each such section serves as purchase-reminders for undecided buyers, the Music Box staff finds. Full-color artist and album blow-ups also heighten the eye-appeal of the Music Box, they feel.

An interesting line of record accessories is offered by this attractive record center. Combining neatness, attractiveness and modern layout with far-sighted stocking and merchandising policies, the Music Box proves a lot can be done in comparatively little space if there is careful attention to layout and lighting, along with good selection of staff and stock and the right kind of promotion and selling.

no matter the there's plenty of space for

Making wide use of all of its facilities for the showing of merchandise, Morrell's of Niagara Falls, N. Y., offers "finger-tip" self-selection in albums, singles, sheet music and accessories. Plenty of guide markers on racks and counters, and a lot of listening posts and booths have helped materially to give this energetic operation a big boost in business and an even brighter outlook.

Morrell's Music House at Niagara Falls, N. Y., has only one regret — they haven't as yet figured a way to use their ceiling space for display. But, as is indicated in the accompanying photograph, they use just about every other available inch of space, and since moving into their new store and giving all possible emphasis to display—of albums, single records, sheet music and record and other accessories—their record sales have increased 75 per cent.

The new Morrell location, at 2023 Main Street, Niagara Falls, is a more central location than was the old one, but they feel this to be a minor factor in the big increase in

area display

business. Display and "finger-tip" self-selection arrangement of all stock are unquestionably major factors. And the Morrell Music House can truly remind the customer that its merchandise is literally at his finger-tips.

For one thing, the store is compact. But more important still, the manage-

ment feels, is the attention given to arrangement and to clear labelling of all the major self-selection racks. Through close attention to arrangement and to guide marking it is thus possible to display a mass of merchandise—without creating confusion or the appearance of cramming too much into a limited space.

Another factor to which the Morrell management attributes the very substantial increase in business is the fact that, as with its merchandise, its facilities for demonstrating that merchandise are practically at the customer's finger-tips. Firm believers in the value of providing listening facilities in abundance, Morrell's has installed seven listening posts (mostly for the pop record buyers) and several listening booths. So it is that even the busiest or the most uncertain customer is pretty sure to find what he wants, and in a hurry if that's the way he wants to, through the new "finger-tip" service offered by Morrell's Music House.

This is the way Morrell's uses just about every inch for display. Note sheet music racks—one tucked between record racks, the other atop the counter.



deluxe record shop in mexico city

"Madero 10" is perhaps the most luxurious record store in the world. Designed to cater to the wealthy international set that lives in the Mexican capital, it is as richly decorated as a dressmaker's salon, and has every facility to promote the sale of American and foreign records and radio-phonographs.

Pictured below is one of the listening rooms of "Madero 10." On the opposite page is a general view of the main display room, where cabinet consoles and albums are on view.



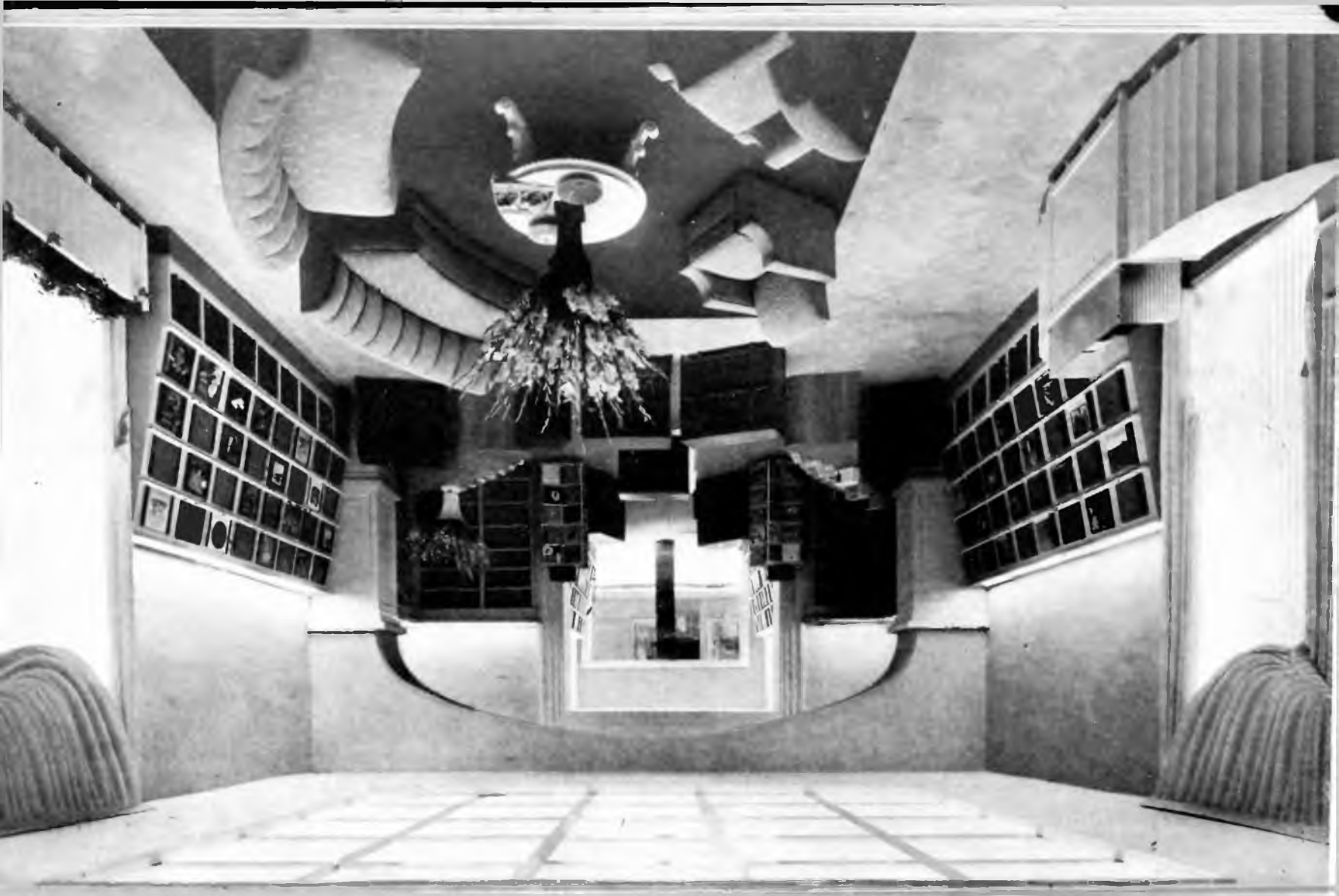

*A view from the lobby of
"Madero 10" through to the main
display room for albums and instruments.*





Against the walls of the main room are capacious racks for self-selection display of albums.



Another view of the main room shows single record display tables, record cabinets and listening rooms.



Despite the luxury of its appointments, "Madero 10" is a modern store that believes in displaying its merchandise.

Neat appearance of Shackleton's Piano Company Shop, Louisville, Ky., invariably attracts customers.



Record Department of Sibley, Linsey & Curr, Rochester, N. Y., presents pleasing over-all appearance.

186

brighten your counter

Clean, neat, illustrated counters, blending well with self-selection displays, represent the ultimate in music store arrangements. Emphasis is placed on eye-appeal and signs which are read easily and quickly.

Good display involves the use of a great deal of merchandise, laid out profusely on the counter, and yet does not give an impression of crowding. Everything is within easy reach of customer and sales clerk alike. Every attempt is made to avoid sloppy counters cluttered with discarded records.

Picture of well known artists and orchestra leaders are often used as illustrations, both on the counter itself and on the wall above the display. An effective tie-in is achieved by placing the latest recordings made by these artists under their pictures.

Phonograph accessories, such as needles and cleaning brushes, are often placed on the counter as a reminder to the purchaser. Such objects are usually placed in corners or near the sales register, where they will be seen, but will not be in anybody's way.



Effective arrangement of long, narrow store space achieved by The Columbia Music and Appliance Store, Rochester.



Gramophone Shop, Wilkes Barre, Pa., features combined album-single record wall racks.

Victory Radio & Records store, Chicago, allows space for single record display at point of sale.



the story of an opening

The opening of Alvina Aigner's new music shop on upper Michigan Avenue, Chicago, accomplished a three-fold mission: it was not only a gala social affair but it made many new friends for the store and a strong and favorable impression on the many people of the record industry who attended.

At the opening, the gay new shop was crowded with distributors, dealers, musicians, and friends who had come to wish Miss Aigner well in her new venture. It was a gay occasion with champagne being served by a smiling colored boy and soft music playing in the background. Intriguing to the guests were the many autographed photos of record artists on the walls and the unusual lucite and glass display fixtures which held new albums and records in the wall cases. Not least of the attractions was the interior of the store which, as the accompanying pictures show, is the latest word in striking fixtures and layout.

The new record shop has a color scheme which is international in scope—a warm Italian gray for the walls and ceilings, a French blue carpet over all the floors, and soft, full Chinese red drapes which hang from the ceiling to the floor to form a background for the smartly lighted window. The lighting is shielded by squares of frosted glass with etched designs and the mandarin red is carried out in a color scheme within the shop in the covering of the comfortable stools and benches in the booths as well as the painted tops of the record tables.

Another effective feature of Aigner's is the especially high counters, 40 inches high, with clear glass tops, displaying single records, albums, needles, and other

accessories, laid within a shallow display space about two inches deep beneath the glass. Miss Aigner changes these displays frequently, and whenever a customer is selecting his records, these colorful items beneath the glass top counter also occupy his attention.

Of special interest is the large front window which is equipped with several spot lights and in which the display is always concentrated on one artist or one album. These displays are changed about three times a week. Miss Aigner finds that the displays attract much attention, especially with the spotlighting of large photographs of recording artists as a center, and that the special albums and records by those artists have an increased sale during and directly following the displays.

"The mailing list of any music business is one of its most vital assets" says Miss Aigner, "and we intend to have a





Above is a striking, modern corner of the new Aigner store showing self-service racks, pictures of artists and flowers from her hosts of friends.

190

special mailing piece which will be sent out each month to keep our customers informed as to new recordings and to tell them record news. It is my hope that those who come here will find this shop a pleasant place to browse and one where lovers of fine music will feel at home. While our decoration is simple, it has been chosen with a deliberate thought in mind to have colors which are warm and friendly in appearance and not garish or discordant. With the return of radios and radio phonographs we will have a special radio salon in which we will display and demonstrate the finest in radio-phonograph equipment. We have tried to think of every

means to be of service and to have a shop which it will be a pleasure to visit."

As for the "school-days set," there are actual blackboards hanging in the record booths. Says Miss Aigner, "If our customers just can't resist that impulse to doodle, then they are perfectly free to do so on our little blackboards. We like to have the young people enjoy themselves and popular music sales to this group have been substantial. As a matter of fact, we already feel that our old friends and the many new ones we have made are most responsive to our endeavors to make this a really effective center of music."



Miss Aigner, fourth from left, and her staff at the opening; below, striking use of wall space with pictures and single display.

all night store proves basic operating rules

The Broadway Music Shop of New York is showing that an all-night store in the heart of a big city is not much different from the average one on Main Street

A 7x25 foot shop which stays open twenty hours a day in the heart of New York City is proving that the same basic rules of operation apply in a fast-moving city as in the smaller, more leisurely communities. This is particularly true of courteous salesmanship, a trained staff, up-to-the-minute inventory and careful attention to customer demand.

The Broadway Music Shop, owned and operated by Joe David, is small in size but more than makes up for this by its volume of business, most of which is late at night or early in the morning. Open from nine a. m. to five a. m. the store draws tourists, night workers, theater patrons, nightclub entertainers, professional musicians and song writers. The volume from this trade is demonstrated by the fact that sales of two or three hundred dollars an hour are not uncommon between three and five a. m.

A large stock of records is kept on hand for this varied patronage, and Mr. David finds that his best sales feature is his perpetual inventory system which provides his staff with information on every record in stock, where to find it and, at the same time, allows a quick turnover. It is particularly valuable because of the lack of space in shops where storage is divided between the upstairs itself and three basement store rooms.

The basis of the system is a master

inventory book listing every record in the \$50,000 stock. Records and albums are stored vertically on shelves and arranged numerically by numbers and sections according to firm labels. The master book is corrected by a daily turnover sheet which reports each day's deliveries and whether the new records are stored upstairs or down. A replenish chart is kept at the cash register and marked as the upstairs stock runs low, replacements being brought from the basement. This system is designed for speed and allows the stock in the store to be renewed automatically from the storerooms.

For sales purposes, two cross inventory notebooks are kept, one popular, one classical, in which artists and orchestras are listed alphabetically, with every recording entered that they have made for any company. By this arrangement, whenever a request is made for a record with which the salesman is not familiar, instead of the customary thumbing through catalogs, he looks it up in the artists' notebook, finds the list number and gets it from the shelf. If it is out of stock, he will know from the notebook, which is kept up-to-date. Thus a simple paper operation saves much useless searching through shelves. Further, the artists' notebook is a good sales point, for a customer glancing at it will frequently see under the name of his favorite artist, a number he had not thought of buying or the existence

of which he did not know and another sale is made on the spot.

The importance of a comprehensive inventory adaptable to a rapid turn-over is equalled at the Broadway Music Shop by the value of a trained staff which knows how to get along with many types of customers and know music. "We are located at the cross-roads of the world," says Mr. David, "and have a changing clientele which offers every conceivable problem to a salesman. So, we apply a certain amount of psychology in our customer dealings. Basically, our policy is to treat all customers with respect and to give them advice on what to buy only if they want it. In that way, we hope to keep the customers coming in and coming back." No pressure is ever applied. Mr. David believes that pressure may drive a potential customer away, but courtesy never. Special attention is given to such problems as the fear of many visitors that all New Yorkers are out to fleece them. Part of the courtesy lies in gifts such as record brushes to customers who make large purchases.

"Courtesy and know-how is an essential in building up any record operation," declares Mr. David. He cites, as an example of how he got a steady customer, the story of a well-dressed man who came in the store late one night and said quietly that he would not leave the shop until he got a number of which he did not know the name and was unable to hum the melody.

"He was perfectly sober, so I reasoned that he was doing this on a bet, and did not know much about music. I found out that he had heard the piece on a network classical hour that night. From there on it was simple. I called the program department at the net work and from the program of that broadcast deduced that the number most likely to be remembered was Bach's Air for the G-String. Without saying anything to the customer, I got the Bach tune and put it on a turntable, then as the first strains filled the

shop, I said to him 'Did your song sound anything like this?'

"The well-dressed man threw his hands in the air with a look of amazement. 'That's my tune,' he said. 'You must be a genius!'"

It was perhaps not genius, but it was a good guess and Mr. David gained a customer who has been coming back ever since.

Night sales cover the whole field of music. Visitors to New York in general favor the semi-classics, with foreigners, particularly sailors, partial to anything by Bing Crosby. Patrons from the theaters, the night clubs and the dance halls ask for popular tunes. The three to five a.m. musician crowd wants hot jazz, with requests for artists, not numbers, and musicians of the caliber of Coleman Hawkins, Don Byas and Les Young leading the requests. A surprising number of the horn and reed boys want classics, particularly Ravel, Stravinsky and Debussy, from whose works they derive ideas for jazz.

Sales follow the usual trends, showing that Tin Pan Alley is just another Main Street at heart. Popular tunes sell according to the current Hit Parade to such an extent that the week's top ten songs are prominently posted. Jazz sells by the artist and sales depend on what jazzman is the moment's favorite son. Jazz does not age as quickly as the pop tunes, but then, neither does it sell in such quantities even on Broadway. Semi-classics sell better than the classics, but there is always a strong demand for the masters.

The big four labels, Victor, Columbia, Decca and Capitol, all do well at the Broadway Music Shop. Savoy is carried as a Broadway exclusive for the shop and it leads in hot jazz roles, with ARA in the Spanish field and Asch in the folk department in the top ranks. Since the shop caters to a clientele with every possible taste, Mr. David makes it a policy to carry as many labels as he can reasonably hope to sell.

WE NEVER PUT IT ON



HAL McINTYRE



TONY PASTOR



BOBBY BYRNE



LARRY CLINTON



FRAN WARREN



"TUBBY the TUBA"



VICTOR JORY



PAT KIRKWOOD



KAYE CONNOR



KEN CARSON



THE TWO TONES
Benjie and George



SHERMAN HAYES

RUBY HILL and The JOE MOONEY Quartette
ARE SOME OF COSMO'S NEWEST SURE-FIRE RECORDING ARTISTS!
More and more top recording artists are getting on the Cosmo Bandwagon!

RECORD 'TIL WE'RE SURE!

- ✓ It must be the Hit of the day!
- ✓ It must be the Smash of Tomorrow!
- ✓ It must be recorded by Top Artists!
- ✓ It must be Full-toned, Smooth, Melody-perfect!

**EVERY COSMO RELEASE
AN INVITATION TO PLEASURE**

osmo

the record shop built on a \$200 gamble

This dealer had a little day-dream, and now it's getting better all the time—so much so, in fact, that it's becoming even more a robust reality each day.

From side line to main line. That's the story of records and the Price Music and Radio Store in Towson, Md.

Four years ago the owner of a radio sales and service business decided, with some hesitation, to add a line of records to his merchandise, since there was no record outlet in Towson, a town of about 15,000. He cautiously invested \$200 in records and \$20 in needles, and thought he had probably supplied Towson with

its record needs for a year. How mistaken Mr. Price's doubts were is proved by the fact that today, just four years later, his record business is in a new, larger, improved location, and represents a \$20,000 investment.

From the first day his record department was opened, Mr. Price found that all kinds of people were interested in all kinds of records. Three colleges, two high schools and usual quota of grade

Four years ago a record nook, now a shop that is complete, even to a kiddie section (shown in the photo on the other page), the new Price store is a model of beauty and efficiency.



schools furnished youthful customers for the popular records. Then followed the parents and their friends, some in search of similar music, others seeking records and albums of the standard numbers and the classics.

In no time at all the little record nook at 13 Shealy avenue was too small. It was remodeled to provide more space and better display, but as time went on it was still inadequate. It did allow, however, for expansion from the original three brands to eleven different record labels. When war-time exigencies halted radio manufacture, Mr. Price turned solely to records, accessories and sheet music as the solution to his problem and, as he says, "they came through handsomely."

The new Price record shop, located at 514 York Road, is 79 feet from front door to rear wall, 13 feet wide at the entrance and 26 feet wide in the main section of the store. Leaning toward a semi-self selection arrangement, the store devotes one long wall to open display of albums. Many singles are also arranged in a help-yourself manner, and well-lighted classification signs identify each type of merchandise. One colorful corner is devoted to an attractive Kiddie department, which has already met with enthusiastic response from the youngsters

and with delight from their parents and friends.

Solid walnut fixtures and soft lighting contribute to the salon air at Price's. Against the rear wall the design is that of a large organ, with a protruding semi-circular effect providing a high spot for current advertising or display material. This unit contains the sound system, an expensive reproducing device which gives the best possible tone to all recordings played in the store. A sound-proof booth is also at the disposal of the classical record patrons.

Display material is used tastefully to add brightness and interest to interior decoration. Colored blow-ups of artists and record displays are placed where they will gain just the desired effect, and lively window displays on either side of the entrance serve to put the prospective record customer in just the right musical mood.

Mr. Price's own enterprise, ingenuity and good management are to be credited with the amazing success of his record venture. But he reports enthusiastically, "I am proud of the Record Shop and of the way records have kept me in a thriving business when my regular line dropped out of the picture. And I may even adopt the slogan of 'A Record Is My Best Friend'." he adds.



the lady wouldn't heed their advice

The growing trend toward home-like and intimate record store interiors is exemplified in the new Helen Gunnis Music Shop of Milwaukee. Beautifully appointed, with easy chairs and period benches placed around casually, the interior of the new store can be seen through an open-front show window. Open display of records encourages browsing, while sound-proof booths are effectively equipped with red leather benches to afford customers maximum listening comfort.

Nine years after opening a small corner in a music store, with a limited but choice stock of record albums and discs, Miss Gunnis' success carried her business into this handsome and spacious

music salon on Broadway, opposite the Milwaukee Athletic Club.

"The move has evidently been all to the good, as business has just been marvelous, and we are running 'way ahead of last year.'" Miss Gunnis reports, "If we could just get half the records we order, it would be wonderful."

Helen Gunnis has been identified with the record business for the past 25 years. In fact, some of her good friends believe she placed the first needle in the first phonograph in Milwaukee. She believed in the influence of recorded music from the very beginning, and progressed steadily in the success of a life-long career in this business of selling music. One of the most popular personalities in



This is just an attractive bit of what has happened since "the record lady who knows her stuff" disregarded the warnings of the viewers-with-alarm.



A new record salon set for business, and a mezzanine awaiting lines of radio-phonograph combinations.

the record business in the Middle West. she has developed an enthusiastic clientele—because she knows music, the classics as well as the lighter trend. This knowledge has instilled confidence in the purchasers, which brings them back to the “record lady who knows her stuff.”

After having managed several of the larger departments in Milwaukee music stores until 1936, Miss Gunnis decided to open her own shop. Almost everyone discouraged her, due to the popularity of radio, and “depression blues”—and folks with less vision were certain that the radio would replace phonographs and recorded music. However, the lady with vision felt that radio would only be a medium to increase the interest in recorded music, because a much greater public would become familiar with better music, and they would desire to own it. Her constant slogan is, “They will want the music they want when they want it.”

Helen Gunnis was right; her shop has become the rendezvous for music-lovers, and she serves them in an intimate and charming atmosphere of melody. Her

broad acquaintance with the concert and opera lovers gives her shop the personal touch. The many sound-proof booths are beautifully appointed with red leather benches, offering the buyer comfort while making a selection. The mezzanine floor consists of three large sound-proof rooms, just waiting for the post-war shipments of instruments to fill them.

Miss Gunnis' shop was one of the first, if not the first, to carry the self-selection system of displaying the great recorded works on shelves so the title could be read, making it possible for the buyers to browse before the well-stocked shelves to their hearts' content.

Associated as a partner with Miss Helen Gunnis, is her sister, Miss Estelle Gunnis, finance manager and treasurer. Additional well-trained personnel at the new shop now look forward to the broadened interest in phonograph-combinations. Magnavox and RCA Victor combinations will be featured, along with a vastly enlarged line of records and accessories.

easy come, easy go, and then they come more often

Here's a store that always remembers its principal commodity is entertainment, and one of the rules is to make record shopping fun for those who look upon it that way.

BY AGNES HARRIS

Manager, Record Shop, Robertson's, South Bend, Ind.

200

The record shop at Robertson's of South Bend (Northern Indiana's largest department store) has proved by substantial sales increases each year since it was established in 1937 that customers really appreciate and respond to orderly arrangement, courtesy, comfort and musically-trained personnel. The shop has recently been enlarged 60 per cent and equipped with this thought in mind, and the customer response was immediate and has been in every way exceedingly gratifying.

The newly remodeled Robertson record department is fixtured throughout in grayed walnut with walls of soft green. Ash trays, book ends, etc., lend a touch of orange, thus providing a restful and cheerful atmosphere. Spacious air-conditioned listening booths

and comfortable chairs give a "honey" atmosphere that is conducive to enjoyable listening.

Prompt attention to the shopper has been achieved through the efficient arrangement of stock. Counter "One-Spot" files, classified under *titles, bands and types* take care of over 100 popular selections in a minimum of space. Back-of-the-counter double filing cabinets and under-the-counter files take care of hundreds of both classical and popular selections.

Album displays include complete stocks numerically arranged on the bottom shelves of the new modern fixtures. The top shelves are used for the colorful cover displays. The Robertson Record Shop, including four booths, has floor space of 1,500 square feet. The



Section of the new record department at Robertson's.
Note counter accessory display and effective signs above the panel.

album display takes care of 140 sets with room on the shelf for five or six albums of each number. Most customers like to browse among the albums—and usually end up buying one or more, due to the attractive open displays.

Robertson's uses the tops of record cases back of the counter for display of new album releases and storage album samples. The front counter has a glass case for needles, and the side counter has shelves below counter-level facing the customers, for holding carrying cases, racks, record logs and other accessories.

One of the booths is unusually large (6' x 9') with a large window, a good player, easy chairs, and is sound-proof—as are the others—a joy to classical

music lovers. Knowing that it is impossible to listen to symphonic music and judge a recording in small space with minimum volume, Robertson's gives them adequate room for satisfactory listening pleasure. A series of framed pictures from the Capehart collection, depicting great music, adds to the atmosphere and attractiveness of the listening booths.

Both from the description and illustration, it is easy to see that a good share of our stock is visible to the public. Whenever the customer stops to look, the sales person approaches with a cheerful nod and an interesting remark about the merchandise. Robertson's work on the principle that they are selling entertainment and want to make record shopping fun for anybody



much time is saved. The sample (shown with this article) of our perpetual album loose-leaf inventory sheet, we think, answers this need. It's self-explanatory.

Between performances recently at a local theatre, Stan Kenton, well-known orchestra leader, devoted a visit at the Robertson Record Shop to autographing his latest recording for an enthusiastic group of fans. This was our first attempt to feature personal artist appearances. It was a success, as the picture indicates, and we shall make similar arrangements as often as possible. Other means of advertising include regular newspaper advertisements on the amusement page of the local paper. In addition, we have found our store radio programs a fine asset to business. Each morning four records are used, and we get a line after the second recording, "Our music is recorded and features popular favorites available in Robertson's Record Shop, fifth floor." It is sort of a Martin Block "Listening Booth" for our customers, you see. We

also include in our radio advertising, several spots weekly following symphony programs, and feature on these spots recordings of the classical music just heard.

Several reasons can account for our marvelous increase in business—days that double and triple last year's business—i.e., our new efficient layout, friendly service, increased advertising, trained personnel. And the last could have a paragraph by itself.

It is generally agreed that anybody can sell records that can read—you know, finding the thing the customer asks for. But a good job in music selling takes quick thinking and means being a librarian, a linguist, a salesman, and having a musical education, too. The fun in salesmanship comes in the plus sales—and who can suggest the added item properly without a musical background? In short, we see that our business is a pleasure to the customer, and, important to us, we get much pleasure through managing a successful business.

emerson piano house features modern design

Imagination in choosing lights, colors, and fixtures succeeds in transforming an old building into an appealing store.

BY FREDERICK THOMAS

204

Scenic decoration and the most modern, attractive lighting and wall treatment are some of the outstanding features which make the new \$21,500 Emerson Piano House in Decatur, Illinois, a forerunner of things to come for the modernized music and record shop. Through the use of Dillon process wall paper, Marbalia impressionistic paper for columns, and original contemporary and period scenes on the walls, the store attains a high level as a "symphony of color and design."

W. Curtis Busher, who with two other men purchased the store from John Wanamaker's of Philadelphia twenty-five years ago and later acquired sole ownership, began his plans for the store modernization long before it was actually started last October. Realizing that he was entering a new retailing era with keener competition which would reach

out for many miles with modern methods of travel, Mr. Busher set out to do everything possible to make the store more attractive with much attention to atmosphere and setting for the type of merchandise to be displayed.

On the main floor, the excessive height of the ceiling has been reduced by the use of dark teal blue and special new fluorescent lights with diffusing glass bottom shading tubes to cast all reflection down rather than toward the ceiling, thus properly centering attention on the merchandise. Eight hooded ceiling spotlights with special louvers also help accentuate certain displays, and several spotlights are connected with the window lighting to illuminate parts of the floor after the store is closed for the night. Absence of backing in the windows make it easy for the customer to see the displayed merchandise and to

feel an invitation to come inside the store.

The display center on the left side of the front of the store is covered with "Countryside," an original provincial contemporary drawing, a wallpaper of charm and distinction. This paper has been received with much enthusiasm among national decorators because of its quaint originality. There are four centers or "stations" with this background, which are separated by modernistic walls with circular motif in swedish red. This paper gives a colorful kitchen wallpaper background for refrigerators, ranges, and washing machines, where only one model of each product will be displayed.

On showing interest in any one product, the customer is taken to a large display, where sales help is available. To the right of this display the salesman of the organization have been given special consideration. Sales desks, made on the job, with a nineteen-inch opening underneath, and with three small drawers, adjoin one another in a series. By the use of these desks valuable space is conserved and the salesmen are in no way handicapped. Black marble DiLon is placed on the presswood top of the desks and covered with clear plate glass, giving the appearance of a real marble top desk. These sales desks are made in sections of three, each thirty inches high and twenty-four inches deep, placed near the front of the store, from which the salesmen may arise to serve customers.

On the right-hand side of the store is another display of pianos and radios, with grey bleached walnut DiLon as a beautiful and harmonious background, where again one of each of the products is displayed. If interest is shown, the prospect is taken back to an individual sales room, spacious in size, where a complete line is on display of the particular make in which the customer is interested.

The names of various products sold by the Emerson Piano House are silhouetted in cut-out modern wooden letters, painted white, against a grey background in a border arrangement, with an opening 85" in length and 10½" high, which carries around the main floor over all the demonstration rooms, with eight-foot fluorescent lights behind each. This display was also designed by Mr. Busher, to give proper shading effect, so they could be read clearly from any angle. It is a striking way of advertising your products; the letters being mounted on special strips can be changed, if desired.

The service department at the back of the store has been brightened by blue grey walls, mahogany service desk and counters, and the most modern equipment. It is purposely made neat and attractive, as it is considered one of the most important things to be sold in a specialty store. Also appearance of a service shop is felt to be very important. All service men are furnished with special uniforms, with the store name on each hat and blouse. "We service our sales" is a store slogan.

The record department space had always been very limited on the main floor. As there was no upper floor, it was decided to move the record department to the basement. The business in records has been doubled since making the change, and the anticipation of an ever-growing and steadily increasing return from the record department has been made the answer to the question, "Will the customer go downstairs to buy record and appliances?"

The customer walks down a silver billiard cue-type bannistered stairway, facing a green Marbalia wall. Upon arriving in the basement, he is met with a variety of color — lime, yellow, wedge-wood blue, swedish red and grey. A

canopy was installed covering unsightly steam pipes around three walls. On the front of the canopy are cut-out wooden letters in empire green, mounted on a panel, which reflects the light back of the letters, also giving a brightening effect directly on the merchandise with the use of continuous fluorescent lights. The background underneath the wall canopy is made of presswood, curved to give the effect of distance.

The record department was carefully drawn to scale by Mr. Busher, including all fixtures.

There are eight sound-proof 4' x 6' listening rooms, equipped with a special switch on each door, so when the door is closed behind a customer, both light and phonograph are automatically turned on. This eliminates customer's playing records without light, or leaving a booth with the phonograph in operation. The booths are sound-proofed with celotex mounted on 1 x 2's. They are lined on each side with celotex, with rock wool in between. A ventilator is installed in each ceiling, connected to a large 17" fan at the back of the store. The walls of the listening rooms are painted cocoa brown to eliminate the possibility of the younger set writing on the walls. Painting the walls destroys some of the sound-proofing qualities but makes for a better appearance. Three rooms are reserved for playing of classical recordings with keys for these rooms obtainable at the desk. Especially good machines are installed in these rooms.

In the center of the floor are installed two unique record racks for individual records, with 80 bins, each holding 20 records, making a total of 1,600 records on display. Storage space below holds a like number. The title board with 10 numbers and titles is at the back, extending 14½" above the rack, which is 3½' tall at back, and 8' long. Below,

the bins are numbered from 1 to 10, corresponding to the title strips above. This arrangement saves the time of a record girl, and the young folks especially like to look over the title and make their selections. It not only sells new records, but the older records also move faster. The record department also has a double classical rack, with 50 bins on each side for 12" and 10" records, with record capacity of 15 each, designed along the same line. It is 63" long by 35½" wide. These self-service single record racks, designed by Mr. Busher, have had sensational acceptance.

The modernistic sales counter is sloped inward at the bottom and has a glass top, which allows display of record accessories under the glass. Behind the counters are racks for surplus stock. A three-tier small appliance table adjoins the counter, awaiting this type of merchandise.

Album racks of 5 shelves each are along the entire 37' east wall, making a striking display. Three double 4-shelf album racks adjoin the self-service single record racks. Title strips above racks describe the type of albums below.

Victor, Columbia, Decca and Capitol are silhouetted in wooden cut-out letters above the 8 record listening rooms.

The transformation of the store into a virtual fairyland of color and harmony has been well worth all the effort expended. It is stimulating to work in such attractive surroundings, which will pay dividends in increased sales and confidence of buyers of musical merchandise and appliances.

Dealers from several states have already visited the Emerson Piano House, and anyone contemplating remodeling is cordially invited to see this new home.

Bibletone
Records
are endorsed by
THE AMERICAN BIBLE SOCIETY
and
THE FEDERAL COUNCIL OF CHURCHES
OF CHRIST IN AMERICA



Enjoy the comfort and inspiration of

SACRED MUSIC

in your own home

on **BIBLETONE RECORDS**

Ask to hear them today!

EXCLUSIVELY DEVOTED TO PRODUCING THE **FINEST** IN RELIGIOUS RECORDINGS

DISTRIBUTORS for....

EXCLUSIVE RECORDS

American Coin-A-Matic
1437 Fifth Avenue
Pittsburgh, Pennsylvania

Becker Novelty Company
97 Dwight Street
Springfield, Massachusetts

C & C Distributing Company
714 Fourth Street
Seattle, Washington

Commercial Music, Inc.
827 E. 12th Street
Kansas City, Missouri

Commercial Music Company
510 N. Sarah Street
St. Louis, Missouri

Hales-Mullaly Company
1-7 North East Sixth Street
Oklahoma City, Oklahoma

J. D. Hurst
219 Cannon Blvd.
Kannapolis, N. C.

M. B. Krupp Distributors
506 N. Kansas Street
El Paso, Texas

Lion Distributing Company
726 S. Fourth Street
Louisville, Kentucky

Music Sales Company
680 Union Avenue
Memphis, Tennessee

Music Sales Company
303 N. Peter Street
New Orleans, Louisiana

Pan-American Record Distributor
11721 Linwood Avenue
Detroit, Michigan

Record Sales, Inc.
2117 Third Avenue, N.
Birmingham, Alabama

Runyon Sales Company
593 Tenth Avenue
New York, New York

Standard Music Distributors
1913 Leeland
Houston, Texas

M. S. Distributors
1429 Clark Street
Chicago, Illinois

David Rosen
855 N. Broad Street
Philadelphia, Pennsylvania

Exclusive Record Distributing, Inc.
1418 W. 24th Street
Los Angeles, Calif.



Paris Letter

BY ANDRE JOLIVET

Amidst the calamities which besieged them the French have turned towards music. This great movement of curiosity for all musical matters has engulfed all social strata which have literally hurled themselves towards the consoling harmonies in a feast of sound that dispenses pure joy. Among the classics Beethoven and Bach have been the great catalysts of this movement of enthusiasm, and among the modernists Ravel and Debussy have reached the multitudes which had ignored them previously.

One of the most fruitful manifestations of this attraction towards music was the founding of the "Jeunessees musicals" ("Young Musicians"). This organization, brought to life by M. Rene Nicoly in Paris, has spread rapidly to all towns of France. Under Nicoly's guidance forty thousand students were advised in the choice of concerts, educated in aesthetics, initiated into the

masterworks and instructed to form choirs and orchestras.

Simultaneously, the publication of numerous collections of ancient French songs offered to all young people a varied repertory which permitted them to sing really "French" with a pleasure that defied vulgarity. During the same period the folk songs were enriched secretly by numerous melodies of the Resistance Movement. Many of these are very beautiful.

Finally, a musical examination was added to the baccalaureate tests, (B.A.) for young girls. This is the first step towards the integration of music into a truly humanistic culture.

Another sign of the masses' enthusiasm for the higher forms of music has been the success of the organ recitals at the Palais de Chaillot in Paris. Never before could one have hoped to fill this hall, which has a capacity of three thousand, through organ concerts. The recitals were given by the most eminent representatives of the French organ school at extremely low admission. Among the virtuosi were Andre Marchal, Oliver Messiaen, Jean Langlais, Andre Fleuris, J. J. Grunenwald and Henrietta Roget.

Circulation of records, quality of recording and the value and importance of the works imprinted on wax are probably the factors which indicate best that liveliness of renewed affection which the French people have had for music in the past years.

Just think what a miracle it is under the occupation to have the enterprising spirit to record the principal French

André Jolivet, composer, conductor and musical director of the Comédie-Française, Paris, has attracted public attention in the past years through his ballet "Guignol et Pandore" which was given with great success at the Opera in Paris, and with his "Five Ritual Dances" for orchestra which have unleashed the most clamorous manifestations ever to be heard since the first memorable performance of Stravinsky's "Rites of Spring."

works like Debussy's "Pelleas et Melisande," "The Damnation of Faust" and the "Requiem" by Berlioz. To say that these recordings have been done with the maximum of care is an understatement; they have been made with love.

Among symphonic recordings we mention only the most significant discs, recorded with the most successful technique. Still, the list is long. Above all, there are Debussy's "La mer," Ravel's "La Valse" and "Nuit" (Night) by Gustave Samazeuieh, performed by the Orchestre de la Societé des Concerts du Conservatoire under the direction of Charles Munch. The same artists recorded the "Concerto for the Left Hand" by Ravel, with Jacques Fevrier at the piano, the "Serenade Concertante" for violin and orchestra by Marcel Delannoy and the "Concerto in C" for violin and orchestra by Jean Hubeau, the latter two works with Henry Marckel as soloist. The "Ballad for Orchestra" by Maurice Jaubert, killed in action June 1940, and the "Sinfonietta" for string orchestra by Albert Roussel belong in the same category.

Ravel's "Bolero" as conducted by Jean Giardino and Henri Sauguet's "Concerto for Piano and Orchestra" with Goutaut-Biron as soloist and under the direction of Roger Désormière deserve special mention. Naturally, Honegger occupies an important place in the catalog with his "Jeanne au bucher," the "Danse des Morts" (Dance of the Dead) and his "Symphony for Strings."

Before passing over to chamber music we must mention the important recordings of operatic excerpts such as: Verdi's "Othello," Chabrier's "L'Etoile," Delannoy's "Genevra" and Donizetti's "Don Pasquale."

In the field of chamber music we welcome above all the founding of the quartet Gabriel Bouillon which will record Debussy, Ravel and d'Indy. The Trio B.B.N. (Benvenuti, piano, Benedetti, violin, and Navarra, cello) spent its care on the recordings of Schubert and Beethoven trios. The instrumental quintet of Pierre Jamet (harp, flute,

violin, viola and cello) comes to our attention with the recordings of Gabriel Pierné's "Voyage au pays du tendre" (Voyage to the Land of Love) and Ravel's "Introduction et Allegro." Furthermore there are recordings of Schubert and Cesar Franck quintets by the quartet Bouillon with Lucette Descaves at the piano.

Returning to contemporary music we notice the remarkable "Danceries" for violin and piano by Claude Delvincourt, the director of the Conservatoire National de Paris, performed by Janine Andrade and the composer, and the songs of Debussy, Poulenc and Faure, rendered by Pierre Bernac and Francois Poulenc.

Nothing is missing in this catalog, not even the traces of efforts to bring to our days the ancient music of France which is done partly by the group "Ars rediviva" with its recording of the violin concerto in F major by J. M. Leclair, and partly by Jacques Chailley and his "Psallette de Notre-Dame," who perform works by Dufay, Guillaume de Machaut and Perotin, the great master of the Notre-Dame school of Paris (12th to 14th century).

Actually, the record industry is completely paralyzed by the lack of basic material and ingredients. But without being indiscreet we can predict that the contemporary works of chief interest await only more favorable circumstances in order to enrich the present already extensive hour list.

Returning to the discussion of musical activities it is interesting to note that in this atmosphere, so favorable to music, it was also possible to organize a tour through the provinces of Honegger's "Jeanne au bucher," (St. Joan at the Stake) written to a text by Paul Claudel. The initiative in this matter was taken by a young conductor Hubert d'Auriol, only twenty-five years of age. This made it possible to have Honegger's principal work played forty times also in those towns and country places which had previously been aloof of all contemporary music.

And while speaking of Arthur Honegger we must at once state that he, among all living composers, met with the greatest triumphs during the past five years. This success was climaxed in a celebration in July 1942, consisting of a series of festivals in honor of his fiftieth birthday. In answer to those who may marvel at the fact that Honegger's fiftieth birthday was celebrated while those of Debussy, Ravel or Faure were neglected, one can state that Honegger for several generations now has been the only musician in France who has conquered both the great public and the elite. The Honegger festival produced excellent performances of the "Roi David" ("King David"), of "Jeanne au bucher," of numerous chamber works and the premiere of the "String Symphony." In the latter work one can find a musical expression which is extremely faithful to and suggestive of the painful and troubled period during which it was written.

On a similar plan of grandeur filled with anguish are two other significant French works which were written approximately at the same time: "Incantation pour le mort d'un jeune Spartiate" (Incantation at the Death of a Young Spartan) by Pierre Capdevielle, and "Le Psaume des captifs" (The Psalm of the Captive) by Jean Martinon. The latter work was composed in German captivity and netted its author the prize of the city of Paris in 1943.

Among the aesthetic tendencies clearly opposed to the above works one must note the success of the two prodigies of the French school: "L'Apocalypse selon St. Jean" (The Apocalypse According to St. John) by Jean Françaix and the "Concerto in C" for violin by Jean Hubeau. Both works display freshness and appealing facility.

It is impossible to indicate all the interesting works which are created during this period. But we cannot fail to emphasize the place which Oliver Messiaen at present residing with Tony

Aubin, the most remarkable of Paul Dukas' pupils, has occupied right in the front row during the last years.

Ever since he had founded the group "Jeune France" (The Young France) in 1936 together with Yves Baudrier, Daniel-Lesur and Andre Jolivet,—a group which Honegger has hailed as a successor to the famous "Six"—Oliver Messiaen has proved his significance in these principal works: "Le combat de la mort et de la vie" (Struggle of death and Life) for organ, the quartet for "La fin du Temps" (The End of Time), "Les visions d'Amen" (The Visions of Amen) for two pianos, and above all the "Trois petites liturgies" (Three Small Liturgies) for women's chorus, piano, celesta, "ondes Martenot" (an electrical instrument), percussion and string orchestra. In the theoretical field Messiaen has written a "Treatise on Musical Language," where he expounds his rhythmic and model innovations and which has attracted numerous pupils.

While there were numerous new creations in the field of symphonic and chamber music, this did not hold true of the operatic realm. Aside from two works imposed by the occupying forces, the "Palestrina" by Pfitzner and the "Peer Gynt" by Werner Egk, French opera has only been augmented by one work likely to live, the "Antigone" by Honegger. This is a work of great power admirably strengthened by the staging of the author of the libretto, Jean Cocteau. On the other hand, on the stage of the same opera house, the ballet has experienced a renaissance full of vitality which has offered the chance to admire, in addition to the revivals of the "Bolero," the "Deux Pigeons" (The Two Pigeons), "Istar," and "Amour Sorcier" (Enchanted Love), the summits of Serge Lifar's creations: "Le chevalier et la Demoiselle" (The Lady and the Knight) by Philippe Gaubert, "Le Jour" (The Day) by Maurice Jaubert, "Les Animaux Modeles" (The Model Animals) by François Poulenc and "Guignol et Pandore" by Andre Jolivet.

The Opéra Comique was more fortunate with the revival of Chabrier's "L'Etoile" (The Star), the "Carmosine" by Henry Février and above all with "Ginevra" by Marcel Delannoy, the "Rossignol de Saint Malo" (The Nightingale of Saint Malo) by Paul Le Flem and the "Le Gageure imprevue" (The Unexpected Wager) by Henri Gauguier. These last three works do not only deserve to remain on the repertory of the Opera-Comique, but should also be presented abroad.

Finally it would be unjust to pass over in silence a very felicitous initiative of the secrétariat général of the Beaux-Arts and the Association Française de l'Action Artistique. These two government organizations have had the fortuitous idea of participating in the distribution of contemporary French music abroad. Circumstances permitting, they will send records to our Embassies and

to the music societies of the entire world. Although the catalog is very eclectic, it still does not comprise all living French composers. Among the numerous works we find most engaging the "Cinq portraits de jeunes filles" (Five Portraits of Young Girls) for piano by Françaix, the "Offrandes oubliées" (The Forgotten Offerteries), a remarkable symphonic poem by Messiaen, "Intermède" for string orchestra by Maurice Paubert, "Sonata" for two flutes by Charles Koechlin, "Prelude and Finale" for piano by Tony Aubin, "Introduction, Theme and Variations" for instrumental quartet by Jehan Alain, who died on the field of honor in June 1940, "Prelude Chorégraphique" by Claude Delvincourt, "Chanson du Galérien" (Song of the Galley-Slave) and "Chanson du Matelot" (Song of the Sailor) by Delannoy, and the "Overture for an Imaginary Opera" by Jean Rivier.

PAN-AMERICAN RECORDS

Always Tops In Music

*Recognized specialists in Latin American—Rumbas & Samba—
Hawaiian—Native Songs & String Symphonic Jazz by Cliff Lang
Ballads by John Laurenz*

Distributors located

Atlanta
Boston
Denver
Chicago
Seattle
San Francisco
Reno
Salt Lake City
Oklahoma City
Louisville
Minneapolis

Des Moines
Omaha
Detroit
Buffalo
Milwaukee
Dallas
San Antonio
Fort Worth
New Orleans
Memphis

St. Louis
Indianapolis
Cleveland
New York City
Newark
Philadelphia
Charlotte
Jacksonville
Miami
Richmond
Pittsburgh

Manufactured by

BIRWELL CORPORATION

6618 Santa Monica Boulevard
Hollywood 38, Calif.

London Letter

The noted British music critic, W. R. Anderson, of the staff of the "Gramophone Magazine" and of the "London Musical Times," reports on musical conditions in war-torn England. Excerpts from his letter, which appeared in LASTEN, are reprinted on these pages.

A book could be written on musical developments in war-time England. Indeed, pamphlets, books and articles are not lacking. There is one on the National Gallery chamber concerts started by Myra Hess; there is a pamphlet on the work of the London Philharmonic Orchestra (to which, joyfully for us, Beecham returned in 1944); there is a history of Queen's Hall, by Robert Elkin—Queen's, home of our beloved "Proms," whose 50th birthday Sir Henry Wood just lived to see, though the hall had been destroyed by a fire-bomb some years before.

It is against this background of fire, fury and weariness that you must please try to imagine our war-time music, in a land where close upon 147,000 civilians have been killed or injured by the enemy; a shabby, frayed-cuff people, spending £66,000,000 every day; whose rations have been short, often poor; where endless hours formerly given to recreation have been used in growing food, in Fire Guard and Home Guard work, and in long business days, because of shortage of staffs; where six years of distress have whitened many a head and enfeebled many a body; and, however some of these griefs have been shared by you, our allies, we venture to emphasize that no one who has not lived through them here can have more than a very remote idea of their wearing effect.

Orchestras too, have worked overtime, almost to exhaustion. There has been an enormous increase in concerts. The Halle, of Manchester (now conducted by Barbirolli), will by this date have given 265 concerts in eleven months, travelling widely. The strain has told. In two months the orchestra had to pay out, from its sickness-benefit scheme, nearly 100 pounds to its members. The chief orchestras, coming together, have asked a higher fee for outside broadcasts than that up to now paid by the BBC—£400, with in rare cases a rise to £500. As I write, they have asked for arbitration. But we have no Petrillo!

During the war years in England shellac has been very short; no gramophones or other instruments of music have been allowed to be made. Some months we had but half a dozen or so recorded items, this including every department of serious music. The thinnest of all has been operatic song. I name a few records issued here, that seem worth noting either by reason of the recording or the playing; or, sometimes, by the value of the music. In the case of these records being repressed in the United States I have given the American trademark and label. Naturally, there have been very heavy deletions from the catalogues and some of the records named here may soon be un-

obtainable in England. The compilation of the following list was done in collaboration with my colleague Alec Robertson of the *Gramophone* magazine. (The list comprises recordings released between 1940 and spring 1945.)

Most of the good orchestral recordings made in England have been made available in the United States. Here are a few outstanding ones:

Weber: Clarinet Concerto (Kell and orchestra under Goehr). Columbia 69869-D.

Vaughan Williams: Fantasia on a Theme by Tallis (BBC orchestra under Boult). Victor DM-769.

Mozart: Don Giovanni Overture (London Philharmonic under Beecham). Columbia 70365-D.

Mozart: Prague Symphony (London Philharmonic under Beecham). Columbia M-509.

Mozart: E-flat Symphony (London Philharmonic under Beecham). Columbia M-456.

Brahms: Second Symphony (London Symphony under Weingartner). Columbia M-493.

Dvorak: First Symphony (Czech Philharmonic under Talich). Victor DM-874.

Haydn: Drum Roll Symphony (Halle Orchestra under Heward). Columbia M-547.

Among the orchestral records not obtainable in the United States were a Concertino by Pergolesi (Decca), the Third Symphony by Bax (His Master's Voice), the Violin Concerto by Delius (Columbia), the Second Symphony by Elgar (His Master's Voice) and the Piano Concerto by Bliss (His Master's Voice).

Practically none of the chamber music recorded here has been reissued in the States. Among our outstanding recordings were those done by the Philharmonia Quartet, playing Mozart's Quartet K. 498, Beethoven's op. 59, No. 1, and Schubert's "Death and the Maiden." (All under the Columbia label.) The Busch Quartet recorded Schubert's op. 168 for His Master's

Voice and there were a few sonatas by Brahms and Faure.

Among piano literature we find Liszt's two concert etudes (Columbia), Medtner's piano sonata (His Master's Voice), two Mozart sonatas (Columbia), Beethoven's "Diabelli Variations" (Columbia) and Chopin's Etudes (His Master's Voice). The outstanding soloists were Benno Moiseivitch, Eileen Joyce and Solomon (his fame is so great that even the dictionary does not list his first name).

In the vocal field Victor has made obtainable our Maggie Teyte album with Gerald Moore at the piano—of Berlioz, Duparc and Debussy songs (Victor M-895) to collectors in the United States. Among the recordings not available in the States are some songs by Mozart, Grieg and Chausson, and two albums of Scot Folksongs and Polish Mountain songs (both His Master's Voice). The most outstanding choral-recordings are Walton's "Belshazzar's Feast" (Huddersfield Choral Society and Liverpool Orchestra under the composer), available in the U. S. under the Victor label DM-974, a Mass by Byrd (Decca) and the Michelangelo Sonnets by Britten (His Master's Voice).

That seems about to conclude the list. I do not pretend, of course, to have named all the worth-while records. A great many records offered here have been made in the United States. Those which were obviously of American origin I have omitted.

The big record companies here are His Master's Voice, Columbia and Decca. Parlophone appears to have dropped, during the war, the issue of serious music.

I imagine this picture will give you a segment of what we had to put up with during the war (not to speak of the food situation). I burn to get back to America: so much to do, see, learn: and we are weary, and I am fast greying: I doubt if American friends would recognize the bright young man they saw off in 1939.

—W. R. ANDERSON

Letter from Germany

BY JEROME PASTENE

With the end of the war in Europe, American record-collectors and critics who were on the spot in Germany quite naturally turned to their leading interest and began to track down all available information on the activity of German recording companies since the outbreak of the European war. A little more fortunate than most I was able to make inquiries in all the major communities of Southern Germany from Frankfurt east to Salzburg and from Nurnberg south to Lake Constance. I found everywhere utterly depleted stocks, the result of the complete breakdown of Germany's commercial transportation system many months ago, with virtually nothing of interest available. Then, too, it seems that what little was not sold was destroyed in the complete devastation of Germany's large cities. It has been possible, however, to locate monthly release bulletins of the major recording companies, and from these, there is a great deal of information to be gleaned.

Recording in Germany apparently came to an end sometime in 1943 (the latest lists I have been able to locate end in 1942), but between the beginning of the war and that date a number of extremely interesting recordings came into the lists, headed by an excellent Electrola recording of the Bach "Passion According to St. Matthew" (Tiana Lem-

nitz, Friedl Beckman, Karl Erb, Gerhard Huech, Siegfried Schulze, St. Thomas Choir and Gewandhaus Orchestra, conducted by Guenther Ramin). This is an excellent performance which has been given a rich recording in which choral parts stand out with unusual clarity; it easily replaces the old Polydor set directed by Bruno Kittel. No less interesting are the recent re-recordings made by Richard Strauss of his own compositions: "Don Quixote" (Bavarian State Orchestra; for Siemens-Special), "Athens Symphony" (Bavarian State Orchestra; Electrola), "Ein Heldenleben" (Bavarian State Orch.; Gramophone), Waltzes from Act III of "Rosenkavalier" (Bavarian State Orchestra; Gramophone), and the "Festival Music" for the 2600th Anniversary of the Japanese Empire (Bavarian State Opera Orchestra; Gramophone).

The wartime Electrola bulletins list a number of attractive recordings. These releases include another Beethoven "Emperor Concerto" (Edwin Fischer, Boehm-Saxon State Orchestra), what is apparently the first recording of the Schubert "Symphony No. 3 in D Major" (Oswald Kabasta-Munich Philharmonic), Dvorak "Polonaise in E Flat" (Talich-Czech Philharmonic), Smetana's Overture to "Libussa" (same artist), Schubert's "Erlkonig" and "Auf dem Wasser zu Singen" (Frieda Leider), Bach "Brandenburg Concerto No. 2" (Edwin Fischer & Chamber Orchestra), Mozart "Piano Concerto in D, K. 537" (Bachaus, Fritz Zaun-Berlin State Orchestra), and above all, the Beethoven "Symphony No. 9 in D Minor" (Margarete Teschemacher, Elisabeth Hoengen, Torsten Ralf, Josef Hartman, Saxon State Chorus and Orchestra, cond. Karl Boehm). I have

215

Cpl. Jerome Pastene, who has been a contributor to leading American music magazines prior to his activities in military service, is now with the American Army of Occupation in Europe. His account of musical events in Germany is first hand and authoritative.

made considerable efforts to locate at least a few of the records of this recording, but without success. American collectors who lament the inadequacy of recording of the Weingartner set and the inadequacy of performance of the Stokowski set will share my eager curiosity in this recording, of which I have heard considerable praise from some people in Germany, and which remains until we are given the long-promised Toscanini performance, the only recent recording of the majestic work. (*Editor's Note:* In the meantime the adequate Ormandy version has been released in the U. S. on Columbia discs.)

German Columbia lists some plums in the Brahms "Violin Concerto" (Wolfgang Schneiderhan, Boehm-Saxon State), Bach's "Italian Concerto" (Gieseking), Schumann's "Kinderszenen" (Gieseking), and the Schumann "Piano Concerto in A Minor" (Gieseking, Boehm-Prussian State Orchestra). The Schumann-Gieseking records are said to be outstanding.

Guila Bustabo, young Italian-American violinist who was in Europe during the war years, concertizing and recording extensively, appears on Columbia lists in two major recordings: the Paganini "Violin Concerto No. 1" and the Sibelius "Violin Concerto in D Minor," both with Fritz Zaun-Berlin State Orchestra. In Frankfurt recently, Miss Bustabo told me that the latter recording was made at the express request of Jean Sibelius, who praised her interpretation for its complete understanding of his wishes. Those who know the superlative Heifetz performance, which the Finnish master must have heard, will reasonably conclude that what prompted Sibelius to ask Bustabo to make this recording was perhaps the fact that Heifetz, under Nazi proscriptions, was *verboten* in Germany and all Nazi-dominated countries.

Miss Bustabo also told me that she recently signed a contract to record a number of sides with English Columbia, to be done in either British or French studios as the occasion permits, and hopes at that time to record the new

Wolf-Ferrari "Violin Concerto," which was written expressly for her (and with her collaboration), and to which she holds exclusive rights until 1948.

The little-known Imperial Kristall label (with surfaces tending to be unsatisfactory and with recording techniques sometimes thin in reproduction) offers the Haydn "Symphony No. 104" which, understandably, is not subtitled *London* here (Hans Weisbach-Vienna Philharmonic). Other issues for this company, excepting some scattered recordings by Max Schoenherr and a Viennese radio orchestra, are extremely light and inconsequential.

The German Gramophone Company, which uses the motto *Die Stimme seines Herrn* (His Master's Voice) and employs the famous listening dog device, but which has no affiliation with Victor or HMV, features what may be a remarkable performance of the Brahms "Piano Concerto No. 2" (Elly Ney, Max Fiedler-Berlin Philharmonic) and which is listed in the October 1941 supplement, and the Mozart "Requiem" (Tilla Briem, Gertrud Freimuth, Walter Ludwig, Fred Drissen, Bruno Kittel Choir and Berlin Philharmonic, conductor Bruno Kittel).

I have been fortunate enough to hear a few of these wartime recordings, which maintained an excellent standard of quality. Readers may notice that I have omitted mention here of Telefunken issues: I have been unable to locate either wartime lists or issues for this label. All the record shops which I discovered are quite sold out and claim to have been for about two years. Production having obviously ceased, small stocks, apparently of scattered issues still remaining in distributor's warehouses, are infiltrating into the shops in limited quantities. I am further told that the master-records have been discovered intact in the factories, and it is not impossible that, in return for past royalties long overdue, the American, British and French record companies may take possession of certain of these and issue them in their respective catalogs.

The Fastest Rising Star on the Horizon

BLACK
and
WHITE
Recordings



DISTRIBUTORS
IN
PRINCIPAL
CITIES

BLACK & WHITE RECORDING CO., INC.
4910 Santa Monica Blvd. Los Angeles 27, Calif.

old phonographs stimulate new business

This Syracuse, N. Y., record dealer finds that his customers and potential customers get a tremendous kick out of seeing and hearing "those new-fangled talking machines that are going to destroy real music."





Here are some of the more "modern" Clark collection pieces

Clark Music Co. of Syracuse, N. Y. is commencing a new type of sales activity in connection with their record department. They have gathered together a sizable collection of phonographs and gramophones dating back to the inception of recording. Every conceivable type is represented in this group, together with recorded discs of the voices of great statesmen of the past. Clark's plans to sell such discs to museums and schools.

In connection with this department, Clark's intends to build up a "Bureau of Missing Recordings." It will feature hard-to-obtain releases of 10, 20 or more years ago. It is making a determined effort to accumulate from community attics and cellars platters of the past—the more ancient the better.

In the post-war period Clark's will boast its own "collector's corner" where individuals who desire a mountain ballad of 1922 vintage or a rare album of

The real old-timers are here, under the watchful eye of "Nipper."



a decade ago, can be accommodated. In this section Clark's is building up a display of record catalogs of bygone eras. From time to time it will attempt to secure specimens of newspaper and other display advertising used by recording manufacturers in the early years of the industry.

Clark's is of the opinion that this type of merchandising will attract many casual patrons to the record section and, in addition, will cement relationships with accomplished musicians who are in the mood for expensive and extensive classical platter purchases. For good measure, Clark's intends to gather together record releases from European and South American sources.

Clark's has found that many highly danceable tunes are issued by London orchestras which American record collectors would be happy to have available. For great good measure this record merchandiser will present a number of recorded versions of famous speeches in European history, offering the voices

of Churchill, Chamberlain, Hitler and Mussolini and Stalin, to mention but a few.

The store feels that the value of this unique program is incalculable, for the collections of old machines and of old or unusual discs not only serves as a constant stimulant for regular customers' interest, it also serves to attract many new customers and potential customers. Most important, perhaps, of those in the latter category are the school children whose interest can be directed toward the store because of the musical and historical interest in the museum pieces and in the collection of unusual records—particularly those of the voices of notables of the current scene and of public figures now taking their place as a part of the hectic 20th Century's history.

The advantages that are to be thus gained in interest and good will—from collectors, educators, parents and pupils—will, naturally, open the way for still further interesting and profitable display and selling.

EXCLUSIVE DISTRIBUTORS

in

MARYLAND, WASHINGTON,
VIRGINIA and NORTH CAROLINA

FOR



THE ORIOLE CORP.

RECORDS AND ACCESSORIES

512 Pennsylvania Avenue

Baltimore 1, Maryland

The Largest Independent Distributor of Records in the South

don't take their needle needs for granted

Mary McGivern found that, despite the best of intentions, she was overlooking the plus possibilities in accessories — so she immediately proceeded to do something about it.

Out of sight is out of mind—and merchandise out of mind means money out of the dealer's pocket. That is what Mary McGivern discovered about her needle sales.

Mary McGivern runs a friendly little neighborhood record shop on Chicago's North Side. The bulk of her sales are to people of the neighborhood, who, in the course of months, become personal acquaintances and friends. The atmosphere of the store is like that of a

book shop where a limited coterie come to browse and gossip about their favorite authors and artists.

But after all, Miss McGivern likes to eat, and she *must* pay the rent, so she does not ignore the business side of her venture. When she first opened her shop—and at that time most of her customers were strangers to her—she made a point of keeping her long-life needles prominently on display, and didn't forget to ask "How about



The sales person as well as the customer is helped by having a handy reminder in a spot that neither can very well overlook. Here Miss McGivern is making "plus profit" change for that bill in the customer's hand.

needles?" as she started to wrap up the customers' purchases.

But gradually, as the customers became her friends and conversations tended to become more personal and less commercial, the needles began to get shoved into the background or under the counter. Mary forgot to say: "How about needles?" And needle sales fell off.

A few months back, Mary was checking over her books and noticed how badly needle sales had dropped off. She remembered how readily they had sold in the first months of her venture and decided to see if they couldn't be built up again. She was a little hesitant about it though. It is comparatively easy to promote that little "plus" sale when you are operating on a business basis. But after the majority of your customers have become personal friends, you may feel a bit hesitant about "needling them" for additional sales, she points out, but needle profits are

worth trying for, so she gave it a try.

The results were amazing, she adds. One month after placing the display cards within easy view and reach—and, of course, getting back into the habit of saying: "How about needles?" her needle sales had increased thirty per cent. That was even better than she had done in her earlier efforts. And what is more, instead of her friends being annoyed by this touch of good merchandising, they appreciated it. Some remarked, "Oh yes, I've been meaning for weeks to ask you about needles." Others came back later with comments on how much better their records sounded with the needle which she had recommended.

It hardly seems necessary to point out the moral—but certainly if a little neighborhood shop catering to limited clientele can boost needle sales so much with so little effort, then shops with larger potentials should be able to do at least as well.



brings you

"SONGS THAT SATISFY BY ARTISTS YOU WILL ENJOY"

THE GLOOMCHASERS

THE PRAIRIE PIRATES

THE BOB PERKINS TRIO

HOLLYWOOD LEGION BAND

BERNIE FERMAN, etc.

ALBUMS - RECORDS - SHEET MUSIC

HOLLYWOOD — NEALE WRIGHTMAN PUBLISHERS — Bx. 2645

hot jazz and high art are selling poles apart

It takes a good salesperson to sell the customer all those choice items upon which he gazes so fondly—particularly in a colorful album display—probably the most effective use of floor space which contains self-selection album display equipment especially designed to attract the eye.

Pros and cons of self-selection vs personalized selling have been many, but time has shown that there are merits in both, and each augments the other. Your customer, like a bird dog, stands and points to the game he is after when he wanders into your department or your store and pauses before a self-selection rack.

These racks, to attain their maximum efficiency, should be used for *classified* groups of merchandise. The tops of most of these album racks have slots into which long cards, lettered to indicate the type of music to be found on that rack, can be inserted. Grouping record merchandise in this fashion makes self-selective selling very easy and profitable. For instance, you can arrange an album rack of overtures, one of musical comedy albums, another of light classical works, and so on. These albums can be changed frequently, according to merchandise available, and in the case of certain items which are headlined for advertising, an entire rack can be devoted to the display of that album alone. This mass display of a single item featuring a brilliant cover

design, has heavy sales appeal. At the bottom of these racks is storage space which is sufficient to contain a stock of all the albums displayed on the racks. This space will help you to solve your record storage problem.

There are numerous forms of single record self-selection racks wherein single records may be displayed in a vertical position or a slant type rack which can be constructed to be used for wall or column display. There are also single record racks which display the records in a horizontal position with space in each slot for six records. A large space for album storage is at the bottom of these racks as well. These self-selection racks can be used in groups or singly. Another effective method of merchandising single popular records is with the use of glass partitions to divide the surface of an ordinary sales table, each division just large enough and deep enough to hold one box of records or 25 singles. With this method an entire table of recent "pops" can be exposed for self-selection; or there can be a variety of standard popular numbers that are perennial best-sellers. There are infinite variations on the self-selection theme.

From the practical point of view it has been found that the use of single record self-selection display racks will bring a substantial amount of breakage, and there is no evading the problem which incorrect replacement of records

by the customer will bring to the sales-people. Single record racks, as well as album racks, must be reviewed and re-organized each morning before the customer traffic begins or there will be chaos. With constant attention however, it is not too great a task and one-half hour each morning should mean all racks sorted and in order.

While these wooden racks and scientifically designed slots are man-made and must be classified by human intelligence to meet the needs or desires of other human beings, remember that there is no mechanical sales device or display set-up which can replace the intelligence and personality of a human being. Presiding over all these fine mechanical devices for sales is the record sales manager or the dealer, and in the last analysis, it is personal plus-selling which makes the customer actually buy more.

The use of standard files of single records to which only the record salesperson will have access, plus self-selection racks which have been found to be most effective for the store, will provide the maximum sales efficiency for the department, as well as the maximum eye-appeal for the customer.

Hot jazz and high art do not mix. The trend is more and more to the separation of popular and classical record merchandise. The customer who buys fine music requires fine machines to hear those records reproduced, and adequately large booths to make listening a pleasure. Here is the *sensational* volume trade, and it is well to segregate this business in location and in treatment from the popular records. There is no need to install large expensive listening booths for the young fry or popular trade. They know what they want and a short session at a "listening post" at which they can stand with a three-sided partition and play their records on a turntable which is placed at a convenient height, will serve them admirably.

For popular record demonstration many record operators have found

most effective the counter-type of turntable inset into the counter with a specially muffled counter-cloth covering for the speaker. This makes it possible for the salesperson to play records upon request at the counter, and yet to conduct business with other customers without an excess of volume from the record being played. This counter-type of record player can be heard by only the two or three customers directly above the machine. Chain stores are finding this equipment effective for lowering sound disturbances to other departments.

If space is limited, it is suggested you at least sound-proof all booths—to prevent the jive hounds from annoying the Beethoven listener. If you have a little space to work with, make attractive booths for listening to popular music on one side of the department or shop, and dignified listening booths for classical trade on the other side. Post-war air-conditioning in the store and record booths will insure customer comfort and increased sales.

A young, peppy salesperson with a knowledge of what is the latest in hit tunes can serve the high school and college-age customers, and you yourself or your record sales manager can meet the needs and do suggestive selling for the substantial classical record buyer.

If you have only one salesperson, or if you yourself serve most of the customers, try to group your popular stock files and self-selection racks in one location, and classical records and self-selection racks in another so that your customer for serious music will be at least a few feet away from where bedlam reigns.

Personal service by trained record sales personnel and self-service equipment, plus adequate listening facilities add up to the basis of a successful retail record business; and in the tremendous competition ahead, it is the smart dealer who will "help himself" to a slice of success!

L. G.



THE NEW *Plastic* JACK AND JILL RECORDS

Here at last—ideal children's recordings—Jack and Jill Plastic Records. These 7" records have unusual tonal quality and durability and can be played on any type of machine. The series of six recordings contains many old favorite nursery rhymes with modern musical backgrounds. Each record is packaged in an attractive 4-color folder with play value of its own.

Write us for the name of your nearest distributor

- Of Vinylite Plastic
- Will not warp
- Non-breakable
- Superb tone quality
- Unique package design
- 39 cents retail

225



CHICAGO MUSICAL INSTRUMENT CO.

39 EAST ADAMS STREET
CHICAGO 3, ILLINOIS

new emphasis on the classical brings big returns

Enterprising record dealers who are anxious to enjoy the profits of a thriving university trade have found that merchandising and promotion policies such as those developed by the Campus Camera and Record Shop of Minneapolis generally pay big dividends.

Located at 1327 S. E. 4th Street in the small business section serving the University of Minnesota, the Campus Record Shop is only twenty minutes by street-car from the metropolitan areas

of St. Paul and Minneapolis. The Minneapolis Symphony Orchestra is housed at the university, and two wide-awake high schools flourish nearby—which means that the Campus Record Shop's clientele varies from the exacting musician or enthusiastic classical record collector to the boisterous bobby-soxer.

A year ago the Campus Record Shop was just another record store. Then, when post-war plans were being discussed on every side, systematic studies

The Campus Record Shop increased its volume nearly 300 per cent in this new store where album display received special attention.



This is Campus Record's new "efficiency corner," complete with a needle display unit, catalogs, reference manuals, a special listening post and other sales aids.



were made of the record market in this community. Sales counsel meetings conducted by the F. C. Hayer Co., Victor distributor in Minneapolis, were a stimulus. From the shop's many good customers connected with the University of Minnesota came helpful advice on various problems, such as commercial design, advertising and merchandising. The findings from these meetings, discussions and studies were encouraging—encouraging enough so that actual layouts, selling devices, color and space schemes were blueprinted.

The modern, efficient record store which has resulted is a model of some of the latest ideas in record store furnishings. Fixtures are of Luau wood, bleached and lacquered with wearing surfaces and accents in Swedish red. Counter tops are a blue linoleum, walls are soft green and the floor a pattern of browns. Roomy listening booths are completely soundproofed.

The accompanying pictures tell only part of the story; cash register totals tell the real tale, for already the aver-

age monthly sales of phonograph records have been raised almost 300 per cent!

One investigation in particular is worth describing. The old store sold popular records over classical to a ratio of about 90 to 10. Studies revealed a double-headed possibility: the number of popular records sold could be increased enormously, but this market had a far greater potentiality in classical records. Within three months after moving into the new quarters, the ratio was 40 to 60—60 per cent of the greatly increased volume now in classical records!

The Campus Record Shop has, even with these interesting figures, merely started on its successful trek to bigger and better business, it is felt. As soon as the post-war "go" signal is given, an addition to the present space will be made; existing floor schemes will be shifted according to a pre-arranged plan, and fixtures already designed will be built and installed. The shop has proved that university business pays!

the why and how of a sheet music department

A sheet music department is a natural addition to a record and phonograph store. Easily installed at small expense, it means bigger sales, and brings in a new group of customers.

BY ARTHUR A. HAUSER

Vice-President and Sales Manager, Carl Fischer, Inc.

Adding a sheet music department to an already-established record store should mean more customers and larger profits for the dealer who wishes to look ahead.

A brief consideration of the great potential advantages of carrying both lines of merchandise and the relatively small effort involved in achieving the combination should convince the dealer that the idea merits some careful thought.

Sheet music and records are fundamentally partners in the same business. They are the chief merchandising agents of that phase of America's huge entertainment industry that concerns itself with music. Few will deny that any force that works for greater interest in and enjoyment of music in this country works for the greater benefit of all in the music industry.

Practically speaking, the dealer should discover that the inauguration of a sheet music department will attract more customers to his store, bring them back more often, help move his higher-priced stock and result in increased sales of his original line of recordings.

If this sounds like a tall order, consider for a moment the fact that sheet music will bring a new group of customers—new, that is, to the record dealer.

They are, however, among the oldest customers in the business; the people who make their own music. They will buy records where they can buy sheet music and other musical items. And it is highly probable that they will buy their radios, pianos, phonographs and appliances where they do most of their trading in music.

These customers are regular, repeat customers, whether their interest is in the hit tunes of the week or in scales and arpeggios for woodwinds. And they are good customers for records in either the classical or the popular field.

There is, of course, no logical basis for viewing records and sheet music as competitors for the music trade. Rather, they supplement each other. For the customer who can use both live and recorded music, the combination of printed music and recordings offers fuller musical satisfaction. He may use one medium in concert with another; for example, a study score for greater appreciation of a classical symphony, or an E. Robert Schmitz recording to improve his interpretation of a Debussy Prelude. The younger set, too, may like to pound out the latest ballads with a boogie bass, but that doesn't take the place of a Sinatra recording.

A sheet music department will gain the trade of the youngster learning painfully to master the clarinet, before he has acquired much interest in the "hot platter." The boy's needs are simple: music and methods, reeds and maybe a new clarinet. He may not be a frequent customer, but he is making his first contact with a music store. And a pleasant early association can be very profitable in the future for both dealer and customer.

The store with a sheet music department can also make a strong bid for the local school trade. Here the prospect of volume business in such items as choral music, band and orchestra scores and kindred music is attractive both for itself and for the good will it establishes in the community. Stocking music for the church choir and organist will help to establish the store as a local music center.

People who make their own music form a sizeable group of customers. More men and women are now earning their living as musicians than ever before. Recent figures indicate a total of approximately eight million people in this country who play the piano. These people as well as those owning other instruments are all potential customers for sheet music.

With this growing group of musicians, amateur and professional, added to his record customers, the dealer is well on his way to attracting all possible customers for music in his community. But what of the costs involved in adding a sheet music department?

Taking the matter of investment first, I should like to emphasize that a sheet music department need not call for a large initial outlay by the dealer. In the next article in this series I plan to set forth the details of stocking sheet music on a small scale for as little as \$100. This would include a balanced selection of hit tunes, standard popular and classical numbers and assorted albums.

Other factors of expense too, may be reduced to a minimum with some fore-

thought and careful planning. The merchandising essentials are already at hand for the record dealer who can adapt his habits of thought and operation to new ideas. His sales force is equipped with the vital knowledge of music and of the people who buy it. This trained help also has the advantage of being able to tie in the two lines of merchandise. They know many of the customers, their tastes and interests, and they have had experience in handling stock which may be applied with some slight modification to the new merchandise.

It will be necessary, of course, to set aside some vital space for the new sheet music department. In music merchandising, adequate display is important for a satisfactory return. But sheet music is a fine self-service item when displayed where the customer can see it and examine it. A fair allotment of space may even eliminate the need for additional sales people.

Of course, the *bulk* of stock in sheet music is hardly comparable to that of records. And special display arrangements may serve both types of stock. Advertising and publicity activity can be directed, with little if any increase in space and cost, to service both departments. There will be occasions when specific items in either field will be pushed, but the opportunities of combining records and sheet music are numerous.

Tie-ins with local events, with the personal appearance of musical personalities, with the engagement of a musical film at the local motion picture theatre, or with a community concert, may be arranged to sell both records and sheet music. Attractive title pages in color make fine decorative elements at no cost to the retailer. A display of the current hit parade tunes will move both types of stock.

And there is no conflict here. Few customers would consider records and sheet music as alternate purchases. They are individual forms of musical expression answering specific musical needs. The dealer who carries both can make

his shop the center of musical activity in his community.

The foundation for a successful sheet music department is within the reach of the progressive record dealer. Once established it will provide him with a steady flow of customer traffic. It will increase the scope of his potential trade. It will tap new groups of customers for higher-priced merchandise. And it will provide him with a fair profit in his own right when properly administered.

It's time now to get down to "brass tacks." The proposition sounds reasonable in the abstract, but how about the specifics? Just how low is a *moderate* cost?

The last question cannot, of course, be answered flatly, since requirements would vary from dealer to dealer and from community to community. The smallest outlay might prove the least economical for the dealer who desires to serve a large body of music customers well. But for the small enterprise in the small community the answer as it pertains to stock could be: "As low as \$100."

This modest sum would be an initial outlay to cover a varied selection of popular and standard music. Such a group, chosen by experts in the field of music merchandising, is available as a "package" or "unit" to save the dealer time and money. The numbers are a well-balanced group of top hit parade tunes—a "must" for the sheet music dealer in any location—light popular favorites that are perennial best-sellers wherever people play and sing, standard piano solos, and an assortment of albums to meet varying needs. Every number in the unit is backed up by sales records in music stores throughout the country and each one is a best seller in its own field.

The dealer who buys by the package saves himself the headache of poring over stock lists in a field where he is not completely at home and secures the advantage of volume price. A carefully selected unit enables him to determine the business he might expect at the outset on the basis of the experience of

thousands of successful music dealers all over the country. It keeps him up to date with the latest hits. And, once in operation, it offers him the best gauge for calculating the needs of his own customers and for re-ordering with confidence.

For many dealers of course, this would not be sufficient stock. One unit may not cover adequately the fields in which the greatest volume of business might be expected. This problem might be solved by purchasing an additional unit or two, giving a wider selection of popular titles, and offering music and methods for standard band and orchestra units, accordion, harmonica or ukelele. If there is an active school music department in his community, the dealer will undoubtedly need a good stock of educational music, contest numbers and similar materials. But the same young school musicians will demand the latest popular tunes. They will want their jive along with Bach, Beethoven and Brahms. A double order of up-to-the-minute hit tunes would be a good investment.

The dealer who is already in the music business with records, radios and phonographs has a decided advantage in possessing some knowledge of the music-buying potentialities of his community. He is in a position to estimate with a fair degree of accuracy the amount of sheet music he might sell. He can then order the unit or units which best meet that estimate. In this way his sheet music department should pay its own way right from the start.

The matter of local competition poses some additional questions which the individual dealer must answer for himself. He may not consider himself in a position to stock everything in sheet music at the outset—popular and classical music, educational items, folios, methods and albums. But he will want to assure himself that he is able to fulfill the desires of his regular trade and attract some new customers as well. He should not permit his customers to go regularly to his competitors for a part of their musical purchases.

Obviously the dealer need have no fear of going into competition with himself. Sales of sheet music will be *in addition* to record sales, and equally important they will frequently be made to *additional* customers.

Once the dealer has determined his stock requirements, he and his sales force should start familiarizing themselves with the names of the new numbers. This will not be too difficult a task for people working in music, but it will prove a great time-saver and help to gain the confidence of new customers. The staff should become acquainted, too, with the reference catalogs issued by music publishers and jobbers and the services they offer to keep the dealer up-to-date on all types of music. Current popular songs, for example, are guaranteed for a limited period. The dealer will want to be continually alert to the expiration dates of these guarantees. He will want to know about new music and possibilities for seasonal "on approval" shipments, (Christmas and Easter).

A sheet music dealer may also find it helpful to keep his own catalog, listing specific requests of particular customers. Music and methods that have been found to satisfy a special need may be the means of making another sale if the dealer keeps such information on hand. This is as true for music carried regularly in stock as for the more unusual item that must be ordered from the publisher or jobber.

Another listing that is invaluable to the dealer is an accurate record of purchases and sales by which a dealer may ascertain immediately how many copies are on hand and how fast they move from his shelves. Such a record can be kept simply and efficiently on the stock wrapper. An empty wrapper then serves as a re-order notice, with all pertinent information for easy reference.

I am not suggesting that music should or could be sold "under wraps." The improvement that adequate display can make in his sales. He will find this even more true in sheet music. Customers record dealer is already aware of the

like to browse around in music much as they do in books. And they feel freer to do so when they are not holding up a salesman.

One display copy of each popular item might be arranged in a music rack, a handy display piece for the floor, counter or showcase. Racks may be built to order or purchased for a modest cost in a variety of sizes and materials. Small movable racks can be placed on counters or pedestals in the center of the store to draw the customer's attention to special merchandise. Larger ones may be lined against the wall or banked back-to-back in the center of the store. These racks can be attractive pieces of furniture as well as silent salesmen.

A progressive dealer will tie-in his sheet music displays with events of musical interest in his community. The artist, teacher or amateur is always interested in knowing what leading performers are playing and singing. For such promotions some music publishers will ship a supply of music on special terms. Similar arrangements may also be made for music of a seasonal character and limited timeliness.

The dealer who keeps abreast of musical events does more than sell the specific music or records advertised. By taking an interest in the musical life of his community he can help to make his store a center of musical activities and information. He might arrange to handle tickets for local musical attractions and even help to organize glee clubs and bands in schools or industrial plants. And he should, of course, keep in close touch with the activities of music teachers and music clubs.

By knowing what is going on in music in his neighborhood and in the country and being able to discuss it, the music dealer will build good will and good customers. By stocking records and sheet music, methods and radios, he will be well on the way toward meeting all their musical requirements.

Thus the addition of a sheet music department as a form of advertising and as a means of added profits may prove to be a music dealer's best investment.

shift those casuals to collectors

BY ARTHUR A. HAUSER

Vice-President and Sales Manager, Carl Fischer, Inc.

It is not necessary for anyone to prove to record retailers that Americans are musical. If they were not, there would not be so many record retailers. So let us start from the premise that since Americans are musical, there is a big market for music in many forms.

Some people are passive music patrons and others are active ones. Many of the passive variety are completely satisfied to listen to music in any quantity that does not cause them effort to obtain it. They are the ones who like push-button radios—they occasionally buy a record. It is fortunate, though that the large group constitutes a good percentage of record buyers. It is this group that is anxious to learn more about music. Just listening to the same record over and over is not satisfying to them. They want to broaden their musical experience; they want to know something about musical instruments, about forms, about arrangements.

Comparisons between two renditions of the same composition bring a keener perception of intrinsic values in musical form, themes, and phraseology. Interpretation in music becomes more than just a word used by critics. The listener begins to develop a sense of musical values, which may not be those

of the trained musician, but at least they are a guide to the amateur who purchases records. The record retailer benefits from the growing taste for music, no matter whether the taste runs to popular or to serious music.

The record companies have long realized that the desire of the average person for more insight into the pleasures obtainable through music is a valuable stimulus to the sale of records. This instinct can be fostered or not; with just a little help from the record dealer many people have been led over from the passive into the active class. Pamphlets and books on what is popularly called "Music Appreciation" have been published by the record companies and sold by the hundreds of thousands. Music history is fascinating; biographies of composers and artists make delightful reading; stories of the operas and symphonies bring the listener into greater intimacy with the music.

Radio programs featuring good music as entertainment were formerly considered by the chains as part of their required "public service." Today most of these programs are sponsored by far-seeing business men who realize that public taste for good music has devel-

oped greatly and that people actually want it. So I say again that Americans are musical, only now I add that Americans, more than they were a decade or so ago, are hungry to know more about music.

Just as there are passive and active music lovers, there are passive and active business men. The difference between them is that the passive music lover misses what could be a great cultural part of his life while the passive business man misses the profits from extra sales that are begging to be made. The record retailer must be active—he must look for ways and means to develop the desire of most people to know more about music; he must lead them to active participation in making music. Any effort along these lines is bound to help him sell more records.

Among all other presentations of musical merchandise, the sheet music department is high in value. That greater musical knowledge creates more business is well known to everyone connected with the business of music, whether it be through selling radios, records, pianos, musical instruments, or tickets to concerts. The advantages of sheet music retailing, however, have not always been understood by record retailers. Many music merchants are of the opinion that a sheet music department involves a complicated system of keeping stock, ordering music, etc. All these longitudes about sheet music are pure imagination. Anyone who knows how to keep a record stock will have no difficulty in handling sheet music. The idea of displaying popular music folders and outstanding works of a serious nature, whenever it is timely to do so, is similar to the same policy in connection with records. The merchandising of sheet music, therefore, ties in admirably with the record retailing business.

We know that record buyers are anxious to know more about the music on a record. A sheet music department carrying printed copies of the recorded music can present to every purchaser of

let's say, the Tchaikowsky *Piano Concerto*, the printed copy at a reasonable price — much less than the cost of the records themselves. If, for instance, the record purchaser wishes to be able to play the outstanding themes from the Tchaikowsky *B Minor Piano Concerto*, your sheet music department can sell him the printed edition of selected themes from the work, either in the original form or in simplified form.

If your sheet music department carries books on the various symphonies, every purchaser of the Beethoven *Fifth Symphony*, or the Shostakovitch *Sixth*, or the Brahms *First*, etc., will be delighted to know that he can purchase a book which tells him not only about the symphony which he is purchasing on records, but about a great many other important symphonies. As a record retailer you will want your customer to know something about other symphonies because the more he knows about them the more likely he is to buy additional records of symphonies.

Space does not permit us to go into any more of the numerous ways in which a sheet music department stimulates sale to record buyers. Let us say, however, that the ideal library for a music lover is one which contains the record, the printed music (whether it be a full conductor score, an opera score, or an instrumental solo, etc.), and a book describing the music. Libraries of this kind are really worthwhile and the record dealer should make every effort to increase his record sales through an interest in the other two music branches.

We have seen how a record department can create sheet music sales. Let us now examine a sheet music department and see how it in turn can create record sales. There are many professional musicians, students, teachers, and amateurs who are constantly purchasing sheet music. They enter the sheet music store on the average of once a week. If they have never been record buyers to any degree, it is easy to see

how the sheet music salesperson can suggest that his customer listen to the recording of the music he is buying. In the school field many of the band, orchestra, and choral conductors would be delighted to build a personal library of records of the masterworks so that when his school organization performs them he will be thoroughly familiar with the various interpretations of these works: the tempi, nuances, climaxes, different tonal effects, etc. Even if the conductor or teacher is thoroughly familiar with the composition in question, his students can always benefit by hearing a rendition of the work by an outstanding organization. By recognizing the fact that educators are potentially large buyers of records, a sheet music salesperson can create very good additional sales for the record department.

It seems to me that any record retailer looking for additional merchandise to sell would not overlook the psychological effect of adding kindred lines to records than lines such as electrical equipment, which have no bearing on music. The sale of an electric iron does nothing to build a desire for a well rounded library of good records. The sale of a piece of printed music or a book on music, however, holds the customer's interest in music so that with the proper encouragement from the retailer he will become a valued record purchaser.

234

During the past few years, when merchandise of various kinds has been difficult to obtain, many record retailers have experimented with sheet music. It is gratifying to report here that one of them not only has continued his sheet music department but has increased its size. This is irrefutable proof that a sheet music department is a money maker for the record retailer. Most of the dealers referred to began with units of popular and standard numbers and folios. They built display racks according to a diagram that appeared in a booklet entitled "Making Money in Music" (published by Carl Fischer,

Inc.). Other dealers purchased display racks exhibiting their first music units. As they added the second and subsequent units they built shelves and shelf-boxes for storing their stocks. The aforementioned booklet, "Making Money in Music," gives detailed and workable descriptions of the routine of running a sheet music department.

Many stores were turning to steel letter files made to the proper dimensions for housing their sheet music and folios. These metal files take up about one-third of the floor space required for the ordinary shelf-folio shelving. Because of war needs metal files have been unavailable, but recently the outlook for new supplies of these files has improved and they may be available in the near future. No record retailer, however, should delay the acquisition of a sheet music department pending the appearance of the steel files. He can use one or more of the racks which are now available at reasonable cost, and can begin with sheet music units of \$100 or more (net wholesale price) which greatly simplifies the choosing of the proper stock. Unit I contains small quantities of the twenty outstanding popular tunes (from the Hit Parade), an assortment of standard songs ("O Promise Me," "Gypsy Love Song," etc.), and an assortment of collections (community song books, piano solo albums, cowboy songs, etc.). Unit II contains a wider variety of items covered by the classifications in Unit I. The experience obtained through the sale of music in the first two units is a distinct guide to the dealer in further developing his stock according to the demands in his territory.

The theory of self-service, which has been publicized in connection with the sale of records, also applies to the sheet music department. The display of popular and standard sheet music and folios creates self-service sheet music sales. For additional information concerning a sheet music stock—units one and two, and prices of racks—inquire of the Information Service of RECORD RETAILING.

children's records

some suggestions for
departments and display
arrangements in an
often-neglected field



children's records are on the march

The fast and superdimensionally growing new market of children's recordings is analyzed in this article by Mr. Lewis and the most important recordings are discussed according to their educational, entertainment and sales values.

BY RICHARD LEWIS

It is only in the past two years that the record industry has discovered the children's market as one of the most profitable fields, provided that the recordings are done with a certain amount of care and knowledge of the problems involved. Previously the general assumption was that the small child is a complete idiot, that anything—and therefore

nothing is good enough for him and that a child is a child whether he is three or eleven years old. Since then much has changed. The radio networks were the first ones to demonstrate that the child makes the most impressionable and vivid audience. The comic books proved that, once he can read, he will read with greater zest and perseverance



than the adult. Unfortunately, they also proved that he will be less discriminatory than the adult if he is fed exclusively on a diet of inferior material. In other words, the child seems to be the best market for trash.

However, it was never proved that the child will not be as attentive, or even more so, to good material as to trash, simply because he was never brought into contact with good material. Advertising agencies and radio executives are professional misanthropes; by believing the worst about their audience, they believe they reach the widest possible public. Parents and educators, however, know differently. They know that the small child is receptive to the good nursery rhyme, that he is delighted by a Brahms or Mozart "Lullaby" and that even the "Jack Armstrong" age is not so closed to the better things in culture as is commonly assumed.

The record companies, somewhat more committed to cultural advance than other commercial agencies, at first thought it wise to stay away from the children's market. Gradually, however, they entered the field, at first shyly with a few baby stories and nursery rhymes, then after the success of such works as "Peter and the Wolf," with more conviction and ambition.

Of course, it is preposterous to say that children will go only for the best material. After all, children are only grown people with less footage. Thus the children's market will include a great deal of what is called the semi-classical stuff in the adult world right next to the more valuable material.

But the matter is not quite so simple as all that. The problems with which the producers of children's records are faced are much more intricate than those involved in the production of, say, the "Goldberg Variations." All you need

in the latter case is a good performer, a good engineer, and production facilities. In the case of children's records you need that and one thing more: the man, or rather the group of men, who will know exactly what will appeal to the child and at the same time will give him something that imbues in him certain absolute values by which our society lives. These values may be cultural, such as introducing the child to music; or they may be social, like evoking a feeling of tolerance and charity toward his fellow man; or they may be practical, such as teaching him to count or to read, etc. In other words, the children's record must be both entertaining and educational. It must be entertaining without neglecting to teach the child something valuable, and it must teach without boring him. The difficulties are great, indeed, if we consider that a child's attention cannot be held for any length of time, and that children are rather suspicious of any attempts to smuggle wisdom into fun.

The first and most decisive step forward was made when we came to recognize that children of different age groups respond differently to the same material. What is exciting adventure for eleven-year-old Johnny may be completely incomprehensible to six-year-old Christine, and music that may be fascinating for a three-year-old infant can be tediously disgusting to an eight-year-old boy who is interested in the construction of airplanes. Thus gradation became one of the uppermost requirements in the making of children's discs.

Then we gradually gained the conviction that the sophisticated children's story and the wise treatment which appeals so much to the adult does not necessarily appeal to the little tots. We all know from experience what delightful stories there are in "Alice in Wonderland" and "Winnie the Pooh." As a





Milton Cross's clear enunciation is a definite asset to the narration of the plot.

matter of fact, most of us read and re-read these stories at a much later date and discover new and hidden charms which we had failed to discover when we were children. But the child, as a rule, is rather indifferent to these charms. Thus both "Alice" and "Winnie" are much more appreciated by children when presented in a simplified, straightforward way without sophisticated trimmings.

Finally, we learned that in the substance of the material we wanted to teach the child there was much which could readily be converted into an appealing story. Thus Prokofiev's "Peter and the Wolf" was written and became a howling success.

This proved to be of decisive importance. For what "Peter" accomplished, not only in profits for the companies and the dealers, but also for the parent and the child, was invaluable. Not only was the child fascinated by the story itself—and my guess is that the fascination would have been greater had there been less cruelty and suspense in

the treatment—but he also learned something very valuable, namely, the distinction of orchestral instruments.

(I cannot quite agree with some of progressive education's critics who claim that the child who previously did not know anything about the French Horn now believes it to be a wolf. But I must admit that such dangers are inherent in the Prokofiev treatment and that it will be up to the educators to devise means which, by keeping the Russian composer's basic idea, avoid this potential danger.)

Once we came to see that the substance of teaching material yielded readily the necessary dramatic setting for the educational purpose, the trend changed radically. From the simple narrative about animals, flowers and fairies, our recordings changed during the past two years to such valuable items as "Black Sambo's Jungle Band" and "Tubby the Tuba," which, in attractive fashion, exposed the child to the instruments of the orchestra, much as "Peter and the Wolf" had, but, in the case of "Tubby," in a much integrated and intelligent, if musically less inspired way. Then there also came into being the various "Music Master Series," which give a detailed and, for the child, comprehensible account of the lives of the great composers with an additional featuring of the music. The portents are that this trend will increase and that more recordings of this type will come on the market. Records certainly will then play a substantial function in making the child aware of music and in awakening his interest at an early age.

This seems important for both the record companies and the dealer not only from the cultural, but from a long range merchandising viewpoint as well. It must not be forgotten that the early years are the most impressionable ones in the life of man. If we are able to arouse interest in music in the infant we can be fairly sure that he will grow up to be a consistent and often discriminating music lover. The good music-

educational record sold today may bring in a steady customer ten years later.

But while we have made consistent progress in these matters, we cannot feel quite so smug about other details in the recording of children's discs. First of all, there is the question of the narrator. True enough, there, too, definite improvements have been made, but still only too often do we encounter the story teller who very sweetly, but at the same time also very condescendingly, speaks to the children in a manner that would not even appeal to a low-grade moron. I don't know why it is popularly assumed that children have to be spoken to like almost deaf and stubborn mules, with strong emphasis, slowly, and with an enunciation that hits you like a ton of bricks. Every time a child hears "And noohw, my deah littaal cheeldren," he knows perfectly well that the whole thing is phony. However, it would be unfair to say that we have only announcers of this calibre among us. Men like Paul Wing, or recordings that feature well known actors like Gene Kelly, have demonstrated quite clearly that the child, like the adult, can and should be spoken to with clear, but unexaggerated enunciation and in a manner that emulates an intelligent, conversational tone.

Another point where children's records go amiss frequently is in the recording technique. While a great deal of care is spent on the preparation of the script and the acting, somehow the recording is neglected simply because we assume that the child is not a discriminating listener. No record company would dare to present a Toscanini recording in the same technical condition as it often does children's records. The Toscanini fan would simply refuse to buy the record, but the child, actually not given much of a choice, will be equally affected by a bad recording. In other words, he will either receive a distorted picture of music that may stay with him all his life and undo the good the educational substance of the recording has effected, or he may lose interest in the music altogether and concentrate

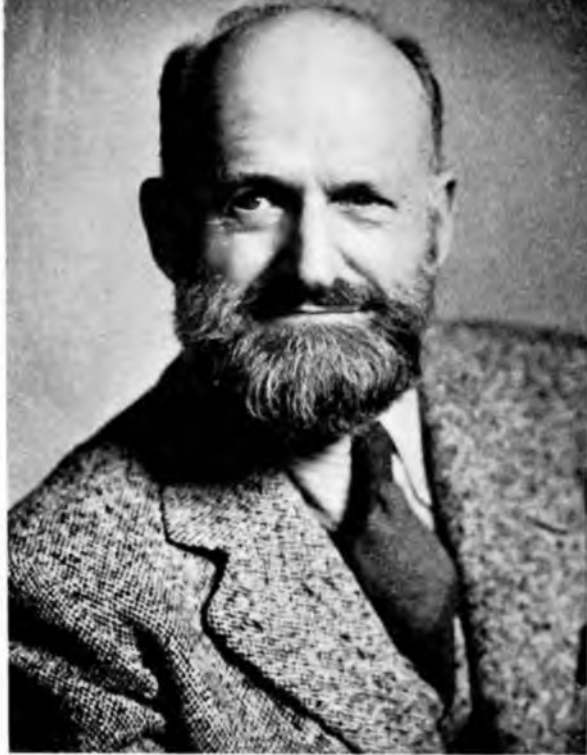

Paul Wing's declamation is simple and straightforward, especially in "Little Black Sambo's Jungle Band."

entirely on the story, simply because the spoken word comes over better in even the worst technical recording.

The same, of course, goes for the performance of the music which very often lags behind the excellent quality of the story about the composer. The child may not be conscious of a poor or good performance, but he will react differently to different performance qualities. Again the best story about a composer will only remain a story about the man if the music is done badly, and after all, our purpose in educating children to music will be only half fulfilled if we teach them all about the man without making them hear his music.

However, it must be said that the last years have seen definite improvements on all these counts and that the record companies are gradually becoming aware of the necessity of giving only the best to the child.

The picture is not so rosy in one respect, which is completely neglected,

that of music proper. Very few musical selections have been presented as such to children, and parents and educators are reduced to books that will single out standard musical selections for different age groups. Here the companies could do real pioneer work, by culling from the great repertory of musical history those works that will interest the child of a special age group and by presenting such a selection in an attractively designed album cover with an illustrated story about the composer and the work, written in terms of the child. There have been such attempts, but they have remained singular, again because they were not done according to regular plans or on the basis of the experience of conscientious music educators.

Nevertheless, there is a wealth of decent children's discs on the market at present, and the following lines represent an attempt to describe their merits and what they will do for the child so that the dealer may offer competent advice to parents who are interested in purchasing the right album for their youngster.

The following descriptive list is arranged alphabetically according to record companies.

ARA: The company is just entering this specific field. The first album was made by Parkyakarkus and is called "Parky's First Reader." We haven't heard it yet, but the title is almost self-explanatory if you know the wholesome and appealing humor of the comedian. Further albums in preparation are two items of stories done by Martha Blair Fox and an album by Smiley Burnette of Western music. The Fox albums are generally educational, while the Burnette discs will introduce the child to some native American music.

ARROW: The authors of "Tubby the Tuba" have again written a delightful miniature called "Jack and Homer," all about a little boy, a horse, a princess and a giant. The story is more or less on the fairy tale side, but the music is

so charmingly done and the narration and presentation so skillful that neither entertainment nor musical value can be doubted. A further release is the "Story of Ferdinand" with a musical score by Herbert Haufrecht.

BEL-TONE: There is an impressive number of albums and one single record which should all make the grade. They are all stories for the younger set and are done with charm and taste. Jump Jump, the tiny sprite no bigger than your thumb, is an appealing character which appears in three albums titled respectively, "The Little Lost Star," "Sleepy Slim, the Tired Lion" (exceptionally cute) and "The Ugly Duckling." Another album features the dramatized story of "King Thrushbeard" from Grimm's fairy tales which is excitingly presented. Finally two more Grimm stories are combined into one album. They are "The Fisherman and the Flounder" and "The Elves and the Shoemaker," and are quite thrilling. The single record features "The Princess and the Pea," which is labelled as another Grimm tale. If this reviewer, however, recalls correctly, it is by Anderson which does not diminish its attraction by any means.

BIBLETONE: "Adventures in Bibleland" is a series for which about fifty albums are planned. The one "David and Goliath" and "Daniel in the Lion's Den" is just out, and it is fascinatingly enacted with all the trimmings of realism, such as the lion's roar, in order to hold the child's interest, which it doubtless will do. Bound into the album is a booklet, album-size, which is nicely illustrated and has the whole story. Not the least attraction of the nice album is this packaging job.

CAPITOL: Most charming of the three albums is the one in which the diminutive movie star, Margaret O'Brien, tells "Stories for Children" consisting of "The Town Musicians" and "Three Billy Goats Gruff." Sound effects and a tasteful musical accompaniment round out the picture. The Great Gildersleeve's "Stories for Children" is also good

entertainment. The album contains "Rumpelstiltskin," "Jack and the Beanstalk" and "Puss in Boots." On the musical side is the album "Children's Songs and Stories," told and sung by Cowboy Tex Ritter in a simple and direct manner. The collection includes a great deal of traditional Americana, such as "Billy the Kid," "The Pony Express," "Texas Rangers" and "Night Herding Song." All three albums are produced with great care and a minute attention to the clarity of the protagonists' diction.

Capitol has recently announced a series of additional children's albums. There is "Bozo the Clown," a trip through the circus under the guidance of Bozo with numerous color illustrations and an educational instruction to start a picture book. A second Gullerstein album is to follow in which the comedian will deal with the stories of "Hansel and Gretel" and "The Brave Little Tailor." In an album "Rusty in Orchestraville" the various musical instruments are made to talk by the aid of Sonovox, an electrical amplified device, used previously in movies. Story centers around the meeting of Rusty, a little boy with the instruments of the symphony orchestra. And Margaret O'Brien tells the story of "Goldilocks and the Three Bears" to the background of sound effects and music in the fourth album of the new releases.

CORIT Jimmy Scribner, of radio's "Johnson Family" tells the story of "Uncle Nappy" third on the list of the six stories recommended by the National Radio Council for juvenile entertainment, in a series of albums. The first one of the releases is "Uncle Nappy and the Bouncing Oil."

COLUMBIA: As is to be expected, the output is plentiful and very meritorious. A great deal of care goes into these records and the drawings of the covers and packaging, mostly in hard cover albums, are most attractive. On the whole, Columbia offers less reading material and concentrates largely upon the recorded effect. Of great importance

are the various Vernon Crane stories, interesting and simply told by Crane against a backdrop of sound effects. To name a few: "Edward, the Dignified Monkey," "Hermann, the Littlest Locomotive," "Mike, the Tough Little Tugboat," and "Cherub, the Chuck." The nursery rhymes are in good hands as well. They are done by Betty Martin, who does the singing and talking, while Yvonne Rayoll performs nicely on several discs under the general heading of "Music Fairy Stories," which range from "The Little Fir Tree" to "The Night Before Christmas." Of larger and more monumental scope, often so big that they occasionally may be above the heads of smaller children, are Basil Rathbone's dramatic and exciting presentations of "Robin Hood" and "The Night Before Christmas." Most of these productions are little concerned with specific musical education; instead, they aim at the child's world of imaginative thinking. A combination of both these worlds can be found to some extent in the various recordings of movie actor Gene Kelly, of which the one we heard, "The King Who Couldn't Dance," comes with an extremely attractive booklet that tells the story and shows many illustrations. There is a great deal of music, expressly written for these recordings by contemporary Americans, which furnishes the orchestral background to Mr. Kelly's narration. Other recordings repeat old favorites which children never tire of hearing, such as "Little Black Sambo" in the narrative of Don Lyon, and "Let's Pretend," which includes the stories of "Cinderella," "Puss in Boots" and "Jack and the Beanstalk." The narration is by Uncle Bill Adams.

Columbia is busy re-pressing all of its previous very attractive records. Among those not mentioned before are "Sugar Cookie Flats," a nice story for the younger set, "A Christmas Fantasy" re-pressed especially for the holidays and done by the Columbia Children's Story Group, Basil Rathbone's narrative of "Peter and the Wolf" with Stokowski's All American Orchestra, the same actor's

version of Scrooge in Dickens' "Christmas Carol," Stevenson's exciting "Treasure Island," and Humperdinck's charming opera "Hansel and Gretel" with the newest Hollywood discovery Jane Powell.

New releases include Nelson Eddy's humorous account of "The Whale Who Wanted to Sing at the Met" from the Disney movie "Make Mine Music," a definite asset to the Columbia children's list.

Gene Kelly has two new four-side albums in which he narrates the stories of "The Little Red Hen" and "Peter Rabbit" in his charming and enchanting manner. Great care has gone into the preparation of this album. The narration is carefully planned, the music by Herbert Haufrecht is simple, yet imaginative,

and the level of the orchestral accompaniment, executed with precision and fine musicianship under the competent leadership of Paul Affelder, by far surpasses what usually babbles behind the scene of stories for children.

COSMO: This company has practically made history with its excellent music-educational "Tubby the Tuba," which is about the best recording in existence, giving children a real feeling for orchestral colors and instruments. At present another album is in preparation which deals with a little boy who runs away to the circus because he is tired of practising his piano. At the circus he is introduced to all the acrobats, animals, etc. Finally he is convinced that the circus bandleader is the most

Gene Kelly, ably supported by numerous animated characters, sings, narrates and dances the story of the "King Who Couldn't Dance" just as vividly on discs as he did in his picture "Anchors Aweigh."



important person in the circus, which makes him go back to piano playing. The musical moral of the story is obvious, and I have related it in such detail to show that certain musical ends can be accomplished not only by directly demonstrating music, but also by implying it morally and dramatically in a narrative. Needless to say that there is plenty of orchestral music as accompaniment.

DECCA: An array of big movie stars presents dramatic versions of the best children themes, often in such grandiose and ambitious proportions that one wonders whether they are not rather aimed at adults. This makes up the bulk of Decca's children field. There are Frederic March in Oscar Wilde's fairy tale of the "Selfish Giant;" Loretta Young, sweet and natural in the "Littlest Angel;" Edna Best reciting "Cinderella;" Walter Huston, quite convincing even as far as children are concerned in his rendition of "Rip Van Winkle;" Charles Laughton, with a big cast and a monumental production, as Captain Ahab in a shortened and concise version of Herman Melville's "Moby Dick;" and Ginger Rogers, not quite putting over the humor and grotesquery of Lewis

Carroll's immortal "Alice in Wonderland." All these albums usually have large and well directed casts in support of the stars, and specially written musical scores that also contain impressive sound effects. The enclosed booklets are more about the actors and composers than about the stories, which proves that Decca is guided rather by the routine of its usual production policy than by thoughts about children's psychology. However, if these discs catch on with the children they will certainly arouse in them an interest in worthwhile literature and in themes that form the background of the tales of Western civilization.

A better plan for children are the "Pinocchio" album using the familiar tunes from the Disney movie and Frank Luther's excellent rendition of the important, educational and appealing "Songs of Safety" by Irving Caesar. Frank Luther, equally versatile and excellent in prose and song, also does an extremely nice job in delivering twenty-four songs of the Mother Goose type with orchestra accompaniment in an attractive album entitled "Children's Corner." But the most attractive item on the Decca list—and possibly among the ten best children's albums—is Luther's narration of the story of "Rolito," a little Mexican boy. This story is not only good fun, but with its nice music and the exchange of English and Spanish words it will serve to arouse interest in our South-American neighbor and is an excellent introduction to the study of the Spanish language. The smooth organ accompaniment is provided by Jesse Crawford.

Prokofiev's "Peter and the Wolf" is also nicely told by Mr. Luther whose instrumental aide is the Decca Symphony Orchestra under the experienced baton of Alexander Smallens. Finally there is an exciting dramatic album in which James Hilton's "Lost Horizon," the famous story of Shangri-la, is thrillingly told by Ronald Colman and a support-

Frank Luther recites Irving Caesar's fascinating "Songs of Safety" with conviction.



ing cast. Sound effects and an illuminating score by Victor Young heighten the total effect and will make the album an impressive event in the life of children above ten years of age.

A most excellent album featuring Oscar Wilde's fairy tale of the "Happy Prince" has just been released. The story is not altered and the dialogue is presented in dramatic form. Orson Welles does the narration clearly and pointedly and Bing Crosby is an appealing prince. The Musical score, simple and effective, is by Bernard Herrmann and the conductor of the well recorded album is Victor Young.

DE LUXE: Jean Hersholt is about to do an album called "Jean Hersholt's Favorite Fairy Tales." His "A Child's Garden of Manners," all about good behavior in the kindergarten age, is already on the market.

DISC: In this company's best children's release, the poet Alfred Kreyenbourg and the composer Elie Siegmeister have pooled talents and produced a nice collection of songs with poetic content and feeling. We found the album "Funnybone Alley" extremely appealing and one of the rare cases of a work that will delight the audience of both old and young.

The same company has also embarked upon an ambitious enterprise consisting of a series of albums called "Songs to Grow On." The first two albums in this series, which is supervised by Beatrice Landeck from the staff of New York University's School of Education, are "Nursery Days," with American balladeer Woody Guthrie presenting a great deal of American songs, and "School Days" in which such songs as "Trot, Trot, Trot" and "Coming Round the Mountain" are sung by Charity Bailey.

GRAPHIC: This is the first company to release a combination of books and children's albums. The series is called "phono-books" and its first four titles are



Basil Rathbone is one of the numerous movie stars who have given their talents to kiddie discs.

"What Makes Rain?", "Why Are Bees So Busy?", "Who Was Aesop?" and "Why Do I Have To Go To Sleep?"

The basis of this series is the book which is written by movie and radio authors and which ties in many problems of the younger child. The record then serves as the climax to enhance and attract to the content of the book.

KEYNOTE: This company has one album which deals with the political fundamentals of America and is obviously designed to influence the child in the direction of tolerance and social living-together. Lee J. Cobb is the narrator on the discs, called "Yank and Christopher Columbus." The idea is most commendable. Whether this moralizing with a sledge-hammer will cut any ice with the kids remains to be seen. If it does, its effect upon the children's social conscience should, indeed, be great.

LITTLE FOLKS FAVORITES: Two stories are attractively told in an album called "Story Time." The narrators are

Betty Jaynes and Bill Roberts, and the stories are well known: "Puss in Boots" and "The Fairies and the Dandelions." Most appealing are the colorful album cover and the background music.

MERCURY: John Garfield, the movie actor, tells the story of a black and a white rabbit in the album "Herman Ermine in Rabbit Town." The symbolic inferences are clear and the records serve well to instill racial tolerance in children. The clear narration is underlined by a nice musical score by Alec Wilder.

Movie actor Jack Carson does an original musical story which is called "Willie and Hannibal in Mouseland." There are quite a number of songs in it.

Irene Wicker gives a musical picture in an album called "The Singing Lady's Christmas Stories" and Two-Ton Baker, The Music Maker deals with a similar subject in "Christmas Party." Two-Ton Baker also has an album of "Nursery Rhyme Time" and Irene Wicker sings the ABC's with special sound effects in a separate album.

The very successful "Singing Lady" has added another album to her already quite impressive series of recorded musical stories. This one is called "Goldilocks and the Three Bears," is well known and presented with a piano accompaniment.

"Captain Bill Meets Feary O'Leary" is an album packed with adventure and thrills.

MONARCH: An album called "Falla" deals dramatically and often amusingly with President Roosevelt's dog and his adventures. There is music and singing in it, all well executed and charmingly written, and some subtle implications of the late President's political philosophy. Children from five to eight will enjoy the album which has been prepared under Roosevelt's personal advice given to the authors several weeks before he died.

MUSETTE: This company specializes in children's recordings, a fact which is quite obvious from the packaging of the recordings, especially designed for

the youngsters. Among the releases are "Musicomics," and the "Jack and Jill" series, appealing stories and songs, and the music-educational series of the "Great Little Music Masters" dealing with the life and works of such composers as Handel and Mozart. The story is good, but the musical presentation does not always measure up to the excellence which one should rightfully demand for children who are to be initiated into the mysteries of music.

MUSICRAFT: The output falls basically into two categories, those of recitation or singing of familiar stories or poems, and those of music-educational value. The first category comes under the heading of "Red Robin Series" and features Earl Rogers in several items, some of which also entice the child to execute physically the stories narrated by the artist. The individual records are: "Mother Goose," "Happy Time Tunes," "Hansel and Gretel" (a rather short and superficial condensation of Humperdinck's children's opera), "Songs and Singing Games," "Songs of America" and the rather skimpily done "Robin Hood."

In the music-educational series one finds Milton Cross telling the stories of "Peter and the Wolf" by Prokofiev, Dukas' "Sorcerer's Apprentice," and Tchaikovsky's "Nutcracker Suite." Along similar lines is the story of the "Three Bears" in which each character is treated to a musical motif much in the manner of "Peter and the Wolf" only with a chamber ensemble instead of an orchestra. The singing of Mordy Bauman, baritone, is added to the narration. A second album based upon the same principle features the tales of "The Little Red Hen" and "Chicken Licken."

RAINBOW RECORDS: Jules and Ruth Werner, two whizzes about what kids like, have written and directed two albums which are chockfull of excellent material and are nicely presented. One is called "Sweetie Swings a Tale" and is about an organ grinder and his little monkey. There is plenty of opportunity

for singing, melodies from old nursery tunes and new attractive lyrics. The other album is "Polly, the Personality Parrot" and is for slightly older kids. Chief character, of course, is a parrot which makes for numerous nice and humorous situations. The performance is clear in both cases and should prove attractive for children.

SACRED RECORDS: There are two albums in a series of bible stories told by the "Bible Storyman." In the first album there are two stories, that of "Noah and the Ark" and "Lot's Wife." The stories are told with sound effects as accompaniment and are produced by Rev. Earle Williams. The second album features a single record containing the story of "Samson and the Lion," again a narration against the background of sound effects. An item for older children might be the album of the "Young People's Church of the Air Quartet" which features seven hymns in the manner in which they are presented by the same group on the radio.

SONORA: There are mostly stories and songs in this company's output, such as "All Around the Christmas Tree," "Happy Little Songs," "Playland" and "Land O' Songs," the latter two with the narration of Uncle Don, the children's radio favorite. Taken from Storyland Theatre is "Tick-Tock-Tale," all about clocks and watches, with a dramatic cast, a narrator and a musical score by Paul Creston. In the musical department, Eddy Brown's string ensemble offers a selection of well known and appealing "Lullabies."

For Christmas this company is releasing an album of "Christmas Carols" sung by the Sonora Choristers, and containing such items of long standing as "Adeste Fidelis," "Silent Night" and "God Rest You Merry Gentlemen." All told there are twelve carols in the album. Finally there is the "Song Stories Album" in which "Cinderella," "Jack and the Beanstalk" and "Hansel and Gretel" are featured. The stories are done by two kids

and the background is provided by a supporting cast and by the Lyn Duddy Swing Choir.

STINSON: This company releases a single disc packaged in a folder with pictures and musical notations which has been produced by the American Society for Russian Relief Incorporated. It is called "Songs of Young Russia" and features some Russian folksongs sung by American children.

STORY BOOK: The strong appeal of the various discs lies in a special packaging. The six and a half-inch records are made of cardboard upon which are painted the figures that play the chief roles in the recorded story. Several records come in one attractive box which again has a cover with illustrations. This is mainly for very small children. The disadvantages of this kind of packaging are obvious; the quality of the recording is not very good and the center hole is very small so that it may not fit on an ordinary phonograph. Parents, therefore, should be advised to use specially designed children's phonographs for these sets. The stories presented are the usual standbys, "The Boiling Pot," "The Tortoise and the Hare," "Wolf, Wolf," etc.- The whole set is called "Story Book Records" and will certainly delight small children.

TONE PRODUCTS CORPORATION: Ted Cott, musical anecdotist and well known radio announcer, directs the production of three well liked stories which are mostly sung to a nice musical accompaniment. The stories are "Mother Goose Party," "Rumpelstiltskin" and "Seven at a Blow."

VICTOR: Much care and expenditure have gone into the production of children's records with a heavy emphasis upon stories for smaller children, but also with quite a considerable amount of direct music, usually taken from the masters of the regular classical releases and packaged in the typical Victor way. This consists of the insertion of one or two records into a cardboard envelope

which is designed in colors and features pictures and stories appropriate for the age group for which the disc is intended.

Popular among the discs for lower age groups are the "Songs of the Zoo," "Rock-a-bye Parade," "Nursery Rhymes," sung by Uncle Mac and a very appealing children's chorus, and a more or less devotional fantasy "What is God Like," which is backed up by the "Song of Growing Things." Directly related to the real or imaginary world of the child is Gudrun Thorne-Thomsen's fine story of "The Three Billy Goats Gruff" with "Answer Three Questions" on the reverse side, and "When the Husband Kept House." The excellent Paul Wing, probably the best among story tellers for children, has two very commendable records, "The Little Engine That Could" and "The Five Hundred Hats of Bartholomew Cubbins." The latter disc leads right into the fantasy realm of the child, who also will find a great deal of satisfaction in a "Rumpelstiltskin" recording. A more elaborate presentation of fairyland can be found in a package of three records featuring songs and sound effects from Walt Disney's "Snow White and the Seven Dwarfs" and in a similar package entitled "The Christmas Adventure of Billy and Betty." Another important Christmas recording is Milton Cross's account of Clement Moore's "The Night Before Christmas" with a great deal of musical background. And Charles Dickens' "Christmas Carol" in the production of Ernest Chappell with music, carol singing and a clear and fascinating dramatic presentation is as fine an album as any parent may desire.

"Little Black Sambo" has long been a story favorite, especially when told as nicely as by Helen Bannerman, but Paul Wing's story of "Little Black Sambo's Jungle Band," something of a sequel to the first disc, opens the doors to the music appreciation discs. In this field Victor concentrates more on direct music than on stories that interpret the composition. A nice introduction, with text, to Americana is the "One String Fiddle," but such items as Stokowski's rendition

of the "Stars and Stripes Forever" and the "El Capitan March," Goossens' "Peer Gynt Suite," Fiedler's "William Tell Overture," Stokowski's album of the charming Saint-Saens' "Carnival of the Animals," Fiedler's excerpts from the "Coppelia Ballet" and his renditions of Brahms' "Hungarian Dances Nos. 5 and 6" and John Charles Thomas' singing of "Home on the Range" and "Take Me Back" demonstrate that good music finds its way to the children's ears and hearts if presented in a package expressly designed for their level. Less welcome is an abridged version of the first movement of Beethoven's "Fifth Symphony" and Schubert's "Unfinished" because this kind of "excerpting" seems arbitrary and destroys all potentialities of the child's sensitivity for the symphonic structure.

How earnestly Victor goes in for the promotion of music appreciation among the young can be seen from a recent announcement. This states that the company releases a series of three albums called "The Children's Treasury Of Music." The albums are well balanced in their selection giving music its due not only through the presentation of traditional music but also through the inclusion of some contemporary compositions. The music is selected according to difficulties in comprehension, that is the emphasis is rather on simpler pieces. The performances are all outstanding with such veteran performers as Ormandy, Stokowski, Koussevitzky and Toscanini raising the baton, and pianist Alexander Brailovsky and violinist Jascha Heifetz playing their respective instruments. (The records are taken from previous masters of Red Seal releases.)

Intelligently enough the three albums are arranged for different age groups. Album I is addressed to children between three and six years of age and features music that is easily comprehensible. There are the "Polka and Fugue" from Weinberger's opera "Schwanda," "The Skaters' Waltz," Liszt's "Hungarian

for singing, melodies from old nursery tunes and new attractive lyrics. The other album is "Polly, the Personality Parrot" and is for slightly older kids. Chief character, of course, is a parrot which makes for numerous nice and humorous situations. The performance is clear in both cases and should prove attractive for children.

SACRED RECORDS: There are two albums in a series of bible stories told by the "Bible Storyman." In the first album there are two stories, that of "Noah and the Ark" and "Lot's Wife." The stories are told with sound effects as accompaniment and are produced by Rev. Earle Williams. The second album features a single record containing the story of "Samson and the Lion," again a narration against the background of sound effects. An item for older children might be the album of the "Young People's Church of the Air Quartet" which features seven hymns in the manner in which they are presented by the same group on the radio.

SONORA: There are mostly stories and songs in this company's output, such as "All Around the Christmas Tree," "Happy Little Songs," "Playland" and "Land O' Songs," the latter two with the narration of Uncle Don, the children's radio favorite. Taken from Storyland Theatre is "Tick-Tock-Tale," all about clocks and watches, with a dramatic cast, a narrator and a musical score by Paul Creston. In the musical department, Eddy Brown's string ensemble offers a selection of well known and appealing "Lullabies."

For Christmas this company is releasing an album of "Christmas Carols" sung by the Sonora Choristers, and containing such items of long standing as "Adeste Fidelis," "Silent Night" and "God Rest You Merry Gentlemen." All told there are twelve carols in the album. Finally there is the "Song Stories Album" in which "Cinderella," "Jack and the Beanstalk" and "Hansel and Gretel" are featured. The stories are done by two kids

and the background is provided by a supporting cast and by the Lyn Duddy Swing Choir.

STINSON: This company releases a single disc packaged in a folder with pictures and musical notations which has been produced by the American Society for Russian Relief Incorporated. It is called "Songs of Young Russia" and features some Russian folksongs sung by American children.

STORY BOOK: The strong appeal of the various discs lies in a special packaging. The six and a half-inch records are made of cardboard upon which are painted the figures that play the chief roles in the recorded story. Several records come in one attractive box which again has a cover with illustrations. This is mainly for very small children. The disadvantages of this kind of packaging are obvious; the quality of the recording is not very good and the center hole is very small so that it may not fit on an ordinary phonograph. Parents, therefore, should be advised to use specially designed children's phonographs for these sets. The stories presented are the usual standbys, "The Boiling Pot," "The Tortoise and the Hare," "Wolf, Wolf," etc. The whole set is called "Story Book Records" and will certainly delight small children.

TONE PRODUCTS CORPORATION: Ted Cott, musical anecdotist and well known radio announcer, directs the production of three well liked stories which are mostly sung to a nice musical accompaniment. The stories are "Mother Goose Party," "Rumpelstiltskin" and "Seven at a Blow."

VICTOR: Much care and expenditure have gone into the production of children's records with a heavy emphasis upon stories for smaller children, but also with quite a considerable amount of direct music, usually taken from the masters of the regular classical releases and packaged in the typical Victor way. This consists of the insertion of one or two records into a cardboard envelope

which is designed in colors and features pictures and stories appropriate for the age group for which the disc is intended.

Popular among the discs for lower age groups are the "Songs of the Zoo," "Rock-a-bye Parade," "Nursery Rhymes," sung by Uncle Mac and a very appealing children's chorus, and a more or less devotional fantasy "What is God Like," which is backed up by the "Song of Growing Things." Directly related to the real or imaginary world of the child is Gudrun Thorne-Thomsen's fine story of "The Three Billy Goats Gruff" with "Answer Three Questions" on the reverse side, and "When the Husband Kept House." The excellent Paul Wing, probably the best among story tellers for children, has two very commendable records, "The Little Engine That Could" and "The Five Hundred Hats of Bartholomew Cubbins." The latter disc leads right into the fantasy realm of the child, who also will find a great deal of satisfaction in a "Rumpelstiltskin" recording. A more elaborate presentation of fairyland can be found in a package of three records featuring songs and sound effects from Walt Disney's "Snow White and the Seven Dwarfs" and in a similar package entitled "The Christmas Adventure of Billy and Betty." Another important Christmas recording is Milton Cross's account of Clement Moore's "The Night Before Christmas" with a great deal of musical background. And Charles Dickens' "Christmas Carol" in the production of Ernest Chappell with music, carol singing and a clear and fascinating dramatic presentation is as fine an album as any parent may desire.

"Little Black Sambo" has long been a story favorite, especially when told as nicely as by Helen Bannerman, but Paul Wing's story of "Little Black Sambo's Jungle Band," something of a sequel to the first disc, opens the doors to the music appreciation discs. In this field Victor concentrates more on direct music than on stories that interpret the composition. A nice introduction, with text, to Americana is the "One String Fiddle," but such items as Stokowski's rendition

of the "Stars and Stripes Forever" and the "El Capitan March," Goossens' "Peer Gynt Suite," Fiedler's "William Tell Overture," Stokowski's album of the charming Saint-Saens' "Carnival of the Animals," Fiedler's excerpts from the "Coppelia Ballet" and his renditions of Brahms' "Hungarian Dances Nos. 5 and 6" and John Charles Thomas' singing of "Home on the Range" and "Take Me Back" demonstrate that good music finds its way to the children's ears and hearts if presented in a package expressly designed for their level. Less welcome is an abridged version of the first movement of Beethoven's "Fifth Symphony" and Schubert's "Unfinished" because this kind of "excerpting" seems arbitrary and destroys all potentialities of the child's sensitivity for the symphonic structure.

How earnestly Victor goes in for the promotion of music appreciation among the young can be seen from a recent announcement. This states that the company releases a series of three albums called "The Children's Treasury Of Music." The albums are well balanced in their selection giving music its due not only through the presentation of traditional music but also through the inclusion of some contemporary compositions. The music is selected according to difficulties in comprehension, that is the emphasis is rather on simpler pieces. The performances are all outstanding with such veteran performers as Ormandy, Stokowski, Koussevitzky and Toscanini raising the baton, and pianist Alexander Brailowsky and violinist Jascha Heifetz playing their respective instruments. (The records are taken from previous masters of Red Seal releases.)

Intelligently enough the three albums are arranged for different age groups. Album I is addressed to children between three and six years of age and features music that is easily comprehensible. There are the "Polka and Fugue" from Weinberger's opera "Schwanda," "The Skaters' Waltz," Liszt's "Hungarian

Rhapsody No. 2," Offenbach's "Barcarolle" and Schubert's "Moment Musical."

The second album aims for the higher age group of from six to nine. There we find the overture to Rossini's opera "The Barber Of Seville," parts of Wagner's "Rheingold," Carpenter's "Adventures in a Perambulator," the "Rakoczy March" and the overture to the "Nutcracker Suite."

The final album features music that is comparatively complicated but still within the easy grasp of youngsters from nine to twelve years old. In addition to Stravinsky's excerpts from "Petrouchka" we find here the prelude to Wagner's "Lohengrin" and to Verdi's "Traviata." Bach's "D-Minor Toccata and Fugue" in the orchestral transcription of Stokowski, and the third movement from the Beethoven "Violin Concerto."

Victor designed and selected the records with the advice of George Marek, music editor of the *Good Housekeeping Magazine* who was assisted by a children's music committee which included such famous personalities as Howard Hanson and Sigmund Spaeth in addition to several educators. A special feature of the albums are the covers which are of a highly practical nature being manufactured of a sturdy and washable material which can hardly be ruined by the hands of the youngsters.

As an original musical-dramatic story we recommend highly the "Robin Hood" album dressed up nicely as "light opera" with appealing music and charmingly performed by the Junior Programs Opera Company. And, of course, there is the devastatingly humorous album of Walt Disney's "Dumbo" with some of the music taken directly from the soundtrack of the movie and as vivid and plastic on records as it was on the screen.

Several new recordings are in production now and should be on the market by the time you read this. We have not heard them as yet so all we can do is report their titles and vaguely their contents. The authors of "Tubby the Tuba"

have written another appreciation item called "Pec Wee The Piccolo" which will be narrated by Paul Wing accompanied by an orchestra under Russ Case. The famous "Peter and the Wolf," this time done up in the manner of Walt Disney's "Make Mine Music," will come to life with the help of Sterling Holmway.

The remainder are story records again. Paul Wing will continue his series in "Little Black Sambo and the Twins" and will also appear as narrator in a new musical story called "Edgar, the Unsuccessful Elf." Miss Thorne-Thomson has a few stories such as "The Pancake" and "The Farmer's Bride." Winnie the Pooh pops up once more in Robert Shaw's "In Which a House is Built at Pooh Corner" and Dame May Whitty will tell us all about "Rapunzel" to musical accompaniment. "Hello, I'm Adeline" is a new song story and "Erbert's 'Appy Birthday," a caricature dog adventure story, rounds out the picture for this season.

Helen E. Myers' set "Let's Play" all about airplanes, fire engines, trains and telephones is now re-issued and should find many enthusiasts. "Hello, I'm Adeline" is a new release for the very young with good music presented by Ellen Merrill, the Tune Twisters and Henri Rene and his versatile orchestra. The music is in the continental style and the songs should make quite a hit with the kiddies.

VOGUE: A novelty record of considerable merit should attract exceptional attention. Made of non-breakable material, the disc is painted in color with the chief scenes and characters of the stories featured on the platter. The stories themselves are nicely and clearly told against a musical background. Thus the child will be interested not only in what is in the grooves but also what is on the outside of the disc. A whole series of these records is going to be released. We heard the two first ones, "The Boy Who Cried Wolf" and "The Trial of the Bumble Bee" and found them highly valuable.

VOX: The Music Master Series is one

of the most commendable enterprises yet undertaken. Jose Ferrer tells the life story of a composer in intelligent terms written for the youngsters, and the orchestra plays some of the shorter selections of the composer. So far only the first two albums dealing with Mozart and Schubert, respectively, have been released, and prove to be of high value. Further releases are in the offing.

WINANT PRODUCTIONS: First in a series of similar albums, the company presents "It's Fun To Eat." Directed pointedly at the individual listening child it combines good fun with an educational moral. The difficult tasks of mealtime are made pleasant for both mother and child through the character, Goodee, who stands as the mediator between the child and the concretized world of food. The dramatic stories are excellently produced and of exceptional clarity. The album has been endorsed by Angelo Patri, Johanna Lindlof, Harvey Zorbach, professor of sociology at New York University, and it finds equally enthusiastic endorsement with this reviewer. The next album in line, to be released shortly, is "It's Fun

To Behave" which will deal with particular phases of the child's behavior problems.

Late Arrivals

ADVENTURE RECORD CO.: Shortly before going to press we received two albums from this company. One of them features "The Adventures of the Gingerbread Boy" and the other "The Adventures of Pinocchio." On both albums Uncle Henry figures as narrator. He is the same uncle Henry who conducts a successful kiddie program over radio station WNEW. The musical background is by Irving Ross and the stories are presented in an exciting and attractive manner with "Little Black Sambo" thrown in as a special feature character in the "Gingerbread Boy."

FUNNYFACE RECORDS: "How To Draw 1000 Funny Faces" is a novel idea in children's records. The ten-inch record, which comes with numerous instruction charts teaches children how to draw cartoons. It is both entertaining and highly instructive and can be recommended from every point of view.





Youngsters go for the new Victor Children's Record Wagon.

children's record room

Grouping of children's records in their own gaily decorated room proves sound merchandising plan by encouraging impulse buying.

The Children's Room recently opened at Schirmer's Record Shop is the result of a sound merchandising plan. For Miss Filomena D. Rush, manager of the Record Shop, located on the second floor of the Schirmer building in New York City, believes that the concentration of juvenile records in one spot boosts sales by encouraging impulse buying and providing a comfortable corner for browsers. And, of course, the room, which has rapidly achieved popularity with both young folks and their elders, proves a haven for children visiting the Record Shop.

The first of its kind in New York the Children's Room is a particularly pleasant place in which to listen to children's

records while delighting one's eyes with the room's two large murals by Jack Sheridan. These charming paintings depict Walt Disney scenes and figures from outstanding children's records including Snow White and the Seven Dwarfs, Peter and the Wolf, Little Black Sambo, Pinocchio, Dumbo, The Pied Piper, Alice in Wonderland and Treasure Island.

Although children's records are usually purchased by adults, the Children's Room draws many young enthusiasts. For example, Miss Rush recently spent an afternoon in the Children's Room aiding a child with noticeably defective aural perception. The boy, who had been sent over by his physician, listened eagerly as she played one record after

another. Slowly, painstakingly, his mother and Miss Rush noted his responses to sound. Both child and parent were visibly delighted with the results, according to Miss Rush.

This incident is just one small instance of the "Schirmer Service" stressed at the Record Shop. And it is service that pays off in sales: the boy's mother left the shop with an armful of albums.

In addition, Schirmer's program of service to customers has always included expert aid and guidance for collectors interested in forming record libraries, and special assistance for school teachers desirous of building music appreciation programs.

Miss Rush is especially proud of the Record Shop's fifteen comfortable listening booths. She lays great stress on comfort for she believes that a comfortable customer is a satisfied customer who will come back again and again.

Besides its large selection of the usual popular and classical recordings, Schirmer's Record Show is now negotiating for distribution rights to foreign records, and expects in a very short time to be able to supply its customers with a great variety of them. What's more, many new titles are being planned for Schirmer's own record series, "The Schirmer Library of Recorded Music."

The Record Shop, which proudly fills mail orders from all over the world, also emphasizes the profitability of tie-in sales for sheet music (available in the Sheet Music Department on the first floor) and popular recordings.

"In short," Miss Rush says, "the Children's Room is just one part of our program of doing everything imaginable to keep our customers happy. Why, when records have been unobtainable anywhere, I have even sold some from my own collection."

Miss Rush, manager of Schirmer's Record Shop, in a corner of the new Children's Record Room.



stepping on the loud pedal for records

The Purucker Piano House this spring reopened its doors to the public: the new location is North Central Avenue, in the central shopping district of downtown Medford, Oregon, after having been closed for two years, due to war-time shortages of all types of musical merchandise.

Mr. and Mrs. Purucker, owners and managers, are well known in southern Oregon. They formerly operated and owned the Baldwin Piano Shoppe for thirteen years. It is their plan to offer the public all the facilities of one of the most complete music stores on the Pacific Coast.

The interior of this new store is spacious and convenient and is designed to conform to the new self-selection plan of merchandising. The building, 50 x 100 feet, is divided in the center to separate the departments. At the front, just to the rear of the front display windows, is an impressive arch, which connects the small goods section with the piano department.

The piano display room is the more formal of the two departments and it is here that complete line of pianos and electric organs will be shown. The color scheme is cream, aqua and buff. An attractively placed stage occupies the rear of this room. On each side of this stage large 16 x 15 feet aqua drapes are hung, for decoration and acoustics. To break the center wall space a 5 x 9 foot mirror is installed on each wall,

with a 9 x 17 foot aqua rug beneath each. Armstrong block tile has been used for the floors throughout, with a cream and buff design.

The other half of the building is for records, accessories, sheet music, accordions, band instruments and small goods. Two insulated, air-conditioned, sound-proof record listening booths have been provided for the convenience of the public in making their record selections.

These booths have been so designed that the doors must be closed before the turntables and air-conditioning systems will operate.

All of the service counters in the store, the covering on the floor of the display windows in the small goods section, as well as the turntable shelves in the record listening booths are covered with a wine shade carpet. This facilitates the handling of sheet music, reduces record breakage and makes the handling of fine instruments more satisfactory.

The four front display windows have a total of 75 lineal feet of glass, giving a visibility of the interior from all angles for window shoppers.

On opening day there was a large crowd of visitors to the various musical departments and an interesting program was presented during the afternoon and evening, with free recordings being made and presented to all of the participants.

records out of "step-child" class for good



This West Coast record shop has taken records out from behind appliances and they will never go back there.

BY MISS BOBBY HUGHES

Manager record department, H. L. Miller Co., Pasadena, Calif.

Acting on the belief that records never again will be relegated to the status of sideline to refrigerators, washing machines and such, the H. L. Miller Co., electrical sales and service dealers of Pasadena, Calif., have doubled the size of the record department in their new store. In direct proportion to the increased room, Miller's expects a doubled sales volume in records and record accessories.

In the new and enlarged department we have not only carried over the most satisfactory display equipment from the old store but have also made many necessary and profitable additions. Instead of the old solid wood type counter used formerly, the record department now boasts an all-glass show case in which attractive displays are arranged. This adds to the general tone of the record section and allows emphasis on particular albums or discs which we might wish to feature. It also makes

for more effective use of advertising material provided by manufacturers.

In our former store the self-selection racks proved so effective that the present extended record sales department is emphasizing this method of display particularly for albums. We use the moveable circular racks mainly for popular and light classical albums, while the opera and symphonic type of album is arranged on a more stationary form of self-selection shelf.

One particular advantage now enjoyed through the addition of more space is the arrangement of coordinating interior displays of record cabinets, carrying cases, empty albums, etc. Miller's expects to expand these showings of merchandise to include all types of electrical reproducing machines as well as home recording equipment.

With twice as much display and sales room, it is obvious that more playing booths were a necessity. Instead of the

two booths formerly available we now have four. Mainly because of the shortage of reproducers, Miller's is limited for the time being to four playing rooms. While this has relieved some of the customer waiting that was experienced in the old store where only two rooms were fitted for listening, we still are not able to care for everyone during the busy times of the day. When more machines are obtainable it appears certain that we will find it desirable to expand our listening quarters even further.

Prospective customers of the H. L. Miller Co. find the benches and chairs provided in the listening rooms are as comfortable in the new installation as

formerly, and that surroundings are equally, if not more, pleasant. This factor does make a difference in building up an established clientele, particularly among collectors who are mainly interested in albums or groups of discs that require some time for making selections. We found this to be true in the past and have carried it on as a vital part of our present record merchandising plan.

As conditions return to normal, the record department of the H. L. Miller Co. will be complete in every detail. It will continue to be a main section of the store and will never again become a "poor relation" of the regular appliances line.

With twice as much display and sales space there is now room for displays like these at H. L. Miller's.



retailing records down argentine way

Buenos Aires' Casa Iriberri is a modern store with a complete stock of foreign and domestic records and a record operation resembling that of its northern cousins.

A stock of records seldom equalled by any record store in this country is carried by the Casa Iriberri, leading record shop of Buenos Aires, Argentina. Drawing on both native and foreign sources of supply, Casa Iriberri imports records from American Victor and its English affiliate, HMV; American and English Columbia; Parlophone, and (though reduced to a trickle during the war) German Telefunken and Polydor.

Founded twenty years ago by Mr. Iriberri and Mr. Bellocq, the Casa Iriberri sells radios and pianos in addition to records, but the discs are the biggest part of the business. Of the dozen important record shops in the Argentine capital, the Casa Iriberri is the only one that sells more classical records than popular. It also acts as a distributor to some of the more than 100 small dealers who sell electrical appliances, refrigerators, etc., in addition to records. The store keeps in contact with its customers by means of a mailing system, and between that and direct selling in the store, it sells about 40,000 records a year out of 100,000 kept constantly in stock. And to round cut his varied activities, Mr. Iriberri runs a concert bureau!

From 3½ to 4 million records are produced in Argentina or imported into the country every year. Domestic discs cost about four or five pesos apiece (\$1.00-\$1.25), while the imports range from five to seven pesos (\$1.25-\$1.75).

There are a few Argentinian recording artists, and their records, chiefly of popular music, sell well. Naturally, tangos and jazz are the greatest favorites. For their native dance, the tango, the Argentinians prefer native artists, but Xavier Cugat's performances are well liked. Other popular American recording artists are Duke Ellington, Bing Crosby, Frank Sinatra and Harry James.

The serious music lover in Argentina shows a decided preference for the German classical masters, moderns like Debussy, and the Russian romanticists. American film biographies of Chopin and Gershwin have created a demand for their recorded works. About 600 of the Kostelanetz albums of Gershwin have been sold at the Casa Iriberri alone.

Tschaikowsky, as represented by his Nutcracker Suite and other ballet music, is as popular in Argentina as in this country. Ballet music in general has become very popular. The virtuoso compositions of Franz Liszt are general favorites. Like their North American music-loving brethren, the Argentinians prefer orchestral music to any other kind. Toscanini is especially popular in the city where he made his first notable success, and Koussevitzky also has a great reputation. Rubinstein is a favorite pianist, and the other Artur's (Schnabel) recordings of Mozart, Beethoven and Brahms are in demand.

Among the violinists, Heifetz and Menuhin stand pre-eminent. The Budapest Quartet has long been known for the superlative chamber music organization it is. Italian singers lead in popularity, but all singers are given a generous hearing. The Casa Iriberry makes a point of keeping a large stock of Caruso records on hand at all times.

Serious collectors are interested in modern music and buy various performances to compare them. Aaron Copland and Morton Gould are two American moderns who are well-known in Argentina. Folk music from the Indian and Spanish is not neglected.

Serving these varied tastes is the "Encyclopedic Catalog of Records" published by the Casa Iriberry, a 600-page volume that would make the Argentine collector the envy of his North American cousin. Listed in its pages is just about every performance of every important work of music recorded in the last dozen and more years in the United States and Europe. Many of the important sets and single records cut out of the American catalogs during the war or unavailable because of wartime shortages are listed in mouth-watering

profusion in the "Encyclopedic Catalog." Though German records have, of course, been hard to get, and though no American records have been imported since the beginning of the war, English pressings of both English and American masters have been kept regularly in stock.

Apparently because of the size of his stock, Mr. Iriberry is able to list many American discs that disappeared from the shelves of dealers in this country early in the war. Such collector's items as the Cortot-Thibaud-Casals performances of the Beethoven, Brahms and Schubert Trios; the Vienna Opera Rosenkavalier; Rubinstein's Chopin; and other rarities are listed—in both manual and automatic sequence! Twenty-two pressings of Bach's "Air for the G String" are available. Some of these are duplicates because the collector has his choice of Victor, HMV, or English Columbia surfaces. Bach listings occupy 20 pages in the catalog; Beethoven, over 18. Mozart tops them all with 21 pages, while Wagner has 17. All in all, a collection unrivalled in the southern hemisphere.

Picture of a well-stocked, well-arranged record store in Buenos Aires. Indirect lighting illumines some of Casa Iriberry's 100,000 records.





Popular music is displayed downstairs, classical on the balcony. Here is shown listening booth section where each booth contains ten hits of the day.

wright's new store has many model features

BY GRIER LOWRY

A streamlined store for customers in a hurry is the latest addition to the chain of ten Gary Wright stores in smaller Kansas-Missouri cities. Opened in January in a 26-story office building in downtown Kansas City, the new store caters to a clientele which has no time for leisurely shopping.

Sharing space with photography supplies, records take up two-thirds of the shop's floor space of 2700 square feet. Every wall is covered with the more than 250 albums, most with decorated covers, which are constantly on display. Fluorescent lighting overhead and strip lighting on each album draw in custom-

ers from the street and highlight the bright colors on the album covers.

The merchandise has been arranged to speed up selling. Counters and concealed merchandise have been eliminated so that every record and album in stock is instantly available for customer inspection. Nine attractive salesgirls cover the whole store to wait on customers. There's a cash-and-wrap counter to which salesgirls escort customers after making a sale, where two more girls complete the transaction by ringing up the sale and wrapping the purchases. Sales efficiency is increased by having one stock girl whose sole job is to replace merchandise.

Popular music, which draws most of the clients, occupies the first floor of the new store; classical music is installed on the balcony. Twelve listening booths accommodate the "pop" listeners, and each is lined with ten selected hits of the day. The balcony has three booths.

Popular discs are filed numerically according to recording artist. Spotlit tunes of the day occupy a specially-designed display. The display of records along the staircase wall is ingeniously devised to lure the browsing customers upstairs to look over the wide stock of classical records. At the foot of the stairs are albums of music from top musical shows, both stage and screen, of the

day. A current display features the sparkling tunes from "Carousel." As the customer ascends the stairs, he sees Gershwin albums, and is enticed to the top by the bright covers of Strauss waltz albums.

Symphonies, and ballet, chamber, and sacred music are displayed separately on the balcony. Within each category, arrangement is alphabetical. One listening booth is devoted exclusively to opera and operettas, one to lieder, the third to drama and the spoken word.

George Shearer, record sales manager of the Wright Stores, is responsible for the streamlined sales technique that is producing good results. In addition to

This sales demonstration room at Wright's is lined with albums but main purpose is to sell radio-phonograph consoles such as one in background.



the usual newspaper advertising, the store uses a 15-minute radio show on KCMO with a coveted spot just before Teen-Town Jamboree. Record favorites of the day are the staple of the show, but Shearer attempts to unearth at least one too-little-known record item for each program. He usually succeeds.

A monthly mailing piece, a review of records, is divided into three parts: material calling attention to latest releases of serious music; comment aimed at arousing interest in neglected recordings; and reviews of popular music. Four per cent of sales receipts go into advertising.

Making a strong bid for the dollars of radio and combination customers, the store has a specially-designed display devoted to small radios and a sales demonstration room on the balcony where customers relax in comfortable chairs and observe the performance of the various sets.

"Sales girls are charged with sales of records, small radios, and portable combinations, but eventually a man will assume the role of console combination salesman. Capable feminine help sells small radios and phonograph merchan-

dise effectively, but is not so efficient on console combination selling as a man," says Mr. Shearer.

The new store has been made a training agency for the record girls who serve in the Wright stores in the outlying Missouri and Kansas towns. Before entering the Wright organization, record sales assistants in the nine other stores undergo a thorough schooling in record sales technique by actually serving in the Kansas City downtown shop. Tyros absorb instruction and get actual selling experience for two weeks under George Shearer before they sell in the smaller stores.

Stock replacements for the new store come from the headquarters store, located on the fringe of downtown Kansas City, which makes possible a 24-hour replacement service on record stock.

To accommodate workers who can't come in during the day, Wright's is open evenings until 8:30. Two shifts of sales girls cover the floor from 9:00 until closing time, one working until 5:30, the other coming in at noon and staying until 8:30. Thus the new Wright's has both shifts on hand for the two busiest times of the day, the lunch hour and from 4:30 until 6:00.



How even the space adjoining the staircase is utilized at Wright's is shown in this photo. A new high in accessibility to merchandise has been reached and record albums are arranged so as to entice customers on up to the classical department on the balcony.

the story behind an unusual record operation

Tremendous interest has surrounded opening of New York's beautiful new Dynamic Record Salon. Here, for the first time, is the story of the merchandising, promotional, and operational philosophy behind this striking establishment, together with a preview of some unusual things to come in the display and selling of radio-phonographs, television and other instruments for home entertainment.

260

Jack Winer went to the dictionary for a brief explanation of a word that's on most everybody's lips—and about the exact meaning of which almost everybody is pleasantly vague. He looked up the word *electronics* and came away from Webster's with a concise definition; with the makings of an effective slogan—and with the germ of an idea that has already expanded to an amazing extent.

Electronics, the dictionary states, is "the phenomenon of electricity in motion." Jack Winer, to fashion his slogan, merely added, *as applied to music*. And that covers recorded music, radio, FM and a sizable portion of what is likely to come with television.

Dynamic Electronics-New York, Inc. has opened its beautiful new record

salon on 57th street; will open another along Park Avenue, New York, late in the summer, and is preparing for intensive—and in some ways, revolutionary methods of displaying and selling instruments.

What makes this record establishment such a wide subject of interest is not merely the physical set-up. It's true, of course, that many are interested in that particular phase—as exemplified in the open view, adjustable depth show window (with its "floating" album and other traffic-stopping displays), extensive but soft lighting, effective use of glass within the store, "library" arrangement of albums, and the tiny but multiple-capacity booths. But going beyond the physical set-up, the visitor to Dynamic finds other things to intrigue

the observer who is concerned with merchandising the promotion.

It is of these things—stock arrangement, two-to-one backing of the sales staff, four-way inventory controls, language and children's record specialization, staff training, and self-suggestion and "de-mystification" selling—that Jack Winer talked with us the other day. And he spoke, too, of his organization's plans for displaying, advertising, and selling radio-phonograph, FM, television and other instruments, through simplified but dramatized comparison displays, careful attention to settings, amplification rather than conversion of customers' tastes and so on.

The 57th street Dynamic store now occupies the first floor and basement, and remodelling of the second floor is under way, to provide for the instruments and for a television theatre and recording studio. In designing the main floor, or record salon, special attention was given to color selection, wide use of glass, arrangement of racks, shelving and placing of furniture. There was definite purpose behind each selection.

"We felt it highly important in the handling of records to create the impression of efficiency—without an air of hustle and bustle that would destroy all attempts at an atmosphere in keeping with the browsing through and selections of good music." Mr. Winer explains.

This they felt they could best achieve by judicious use of glass, background colors, furniture selection and placement, and by arrangement of stock, display material and listening facilities. Use of glass—in doors and for display racks and counters—tends to foster the impression of cleanliness and wholesomeness. It acts too, Mr. Winer adds, to keep the staff constantly alert, especially to the need for orderliness, since the lack of obstructions give them the feeling of being part of one huge showcase.



An example of Dynamic's "high visibility" display fixture set-up

The background color effect (a light blue-green) and an abundance of soft lighting, both direct and indirect, are calculated to complement the album and other displays; and, more important still, to eliminate eye-strain and create a restful atmosphere for the staff and customers. Trim and fixtures are of a darker blending of the blues and greens, and furniture is, for the most part, white. The main floor is approximately 30 feet wide by 100 feet deep.

In arrangement of album stock and in cross indexing and arrangement of singles, Dynamic has adopted some of the most efficient and unobtrusive features of library or large book store operations. In the main album library there are more than 4,000 sets, arranged so that only the narrow backbones are showing. In addition to this arrangement, there are more than 450 sets on display in open racks or wall brackets that show the cover jackets to their full advantage.

Browsing and self-selection (or self-suggestion, as Dynamic prefers to term it) is facilitated for the customer, and



These 4½ x 6-foot listening booths can hold three listeners comfortably and without crowding.

262

inventory control is simplified for the staff, through the arrangement of the album library in two general sections. Approximately one-third of the sets are arranged numerically, and the other two-thirds are placed on the shelves alphabetically by composers and by general types of music. All of the sets carried by the store are kept in both the numerical and the alphabetical groupings. Because Dynamic has found that relatively few people select by number, only one, or at most two copies of a set are put in the numerical section. In the alphabetical grouping there may be anywhere from one to a half dozen copies of a set, depending on its status as a current best-seller, war-horse, or collectors' item.

Seals are broken and wrappings removed from all albums before they are

placed on the shelves—and there's a double purpose in this. Dynamic insists that all sets be opened before they are taken by the customer. As far as the album library is concerned, that is for appearance sake, since it is felt that wrappings add nothing to attractiveness of the albums, particularly when torn or marked. The store encourages the customer to accept open sets from the floor stock, but if a fussy one insists, he or she gets a set from the reserve stock. However, in such cases the seal is broken and the set inspected and initialed (in the customer's presence). This serves as a protective check for the store, and also serves to impress the customer as to Dynamic's reasons for giving out opened sets.

One of the first operational principles to which Dynamic holds steadfastly is



Here is where Dynamic simplifies much of its inventory operation, through a dual system of stock arrangement.

that each number of the sales staff should be backed up by two people behind the scenes. And the thought prompting this operational formula is interesting. In the first place, this behind the scenes support makes it easy for customer or clerk to find desired albums or singles, because the latter is freed of the burden of acting as stock clerk, messenger or runner.

"We feel that although the customer may appear to be shopping in a leisurely fashion, or may be devoting a lot of time to browsing, upon reaching or nearing a decision, he or she becomes

Capitol's songstress Jo Stafford, and Jack Meltzer, record manager, look over some display photographs.



somewhat impatient," Mr. Winer explains. "And at that point it's not sound merchandising or selling to have the salesperson wander off in search of stock."

Secondly, Dynamic feels that simplification of stock control through its arrangement speeds up the operation all along the line. True, the store has a staff of 18 to do the job, but a number of these folks are there now in preparation for the future—when some will be shifted to the Park Avenue store, and when others will work into the instrument selling and recording departments.

Dramatize the product and de-mystify the customer. That sums up the sales policy of the Dynamic Record Salon in New York's swank 57th Street shopping area. The policy is already in use there in the sale of records and whatever instruments happen to be available, but it is for the anticipated post-war radio, radio-phonograph, FM and television set boom that Dynamic's "double D" sales program is being primed. So before continuing where we left off in the opening article of this series (in which Dynamic's present physical layout and its arrangements and sales methods for

records were outlined) let's see what is behind this "dramatize and de-mystify" thinking.

Jack Winer, president of Dynamic, is firmly convinced that the way to sell major appliances, particularly such items as combinations, FM or television sets, will be to show the customer *what* he's getting, why it's better, how it works and what it's going to look like in his home. To do all this—and to do it within the "dramatize and de-mystify" policy—Mr. Winer and his sales staff are evolving a number of interesting display, promotion and sales plans. Here are a few of the Dynamic highlights for the post-war selling of sets:

1. Records will continue to be featured on the main floor—at the 57th Street salon, at another to be opened soon on Park Avenue and at others that may be opened later. (Dynamic feels they will continue to be a No. 1 traffic builder.)

2. A combination radio salon, television theater and recording studio (this latter also viewed as an excellent traffic stimulator) will be opened on the second floor.

3. Sets and other major items will be displayed on the first floor and in the main floor show windows only to tell that they are carried. All demonstration and sales activities on these items will be undertaken away from the main floor.

4. The radio salon will be split off into a number of sections or rooms. These will be of various periods and types, so that the customer can see rather than having to imagine just how one or another set would fit in his home. It is planned to arrange these sections or rooms so that they will appear to be a series of show windows along an arcade.

5. Television will be demonstrated in miniature theaters, approximately 15' x 20',—and here is where we begin to see what Dynamic means by the "double D" sales policy. Television sets will be demonstrated on a rotating stand, so

that the customer, the while he is comfortably seated, can compare the performance and appearance of the various sets being demonstrated.

6. Graphic demonstration techniques are also planned for FM. One such "de-mystification" example is the planned use of a pictorial display that will simulate a storm scene, in which the effect of lightning as static in ordinary reception and the absence of effect in FM reception will be demonstrated in a simple but convincing manner.

In addition to the foregoing methods, Dynamic is planning a number of other demonstrations of a scientific or semi-scientific but simple nature that will tend to remove the hocus-pocus element from set selling. Modifications or adaptations of some of these techniques will be used in window displays too, as traffic-stoppers or attention-getters.

For the record selling phase of the business, Dynamic plans to expand along lines already in effect. The plan for selling albums through a combination of "self-suggestion" and attended service (discussed in detail in the opening article) will be followed in much the same pattern as has been developed since the new 57th Street salon was opened a few months ago. For the selling of singles, Dynamic plans to stick rather closely to the attended service plan.

Under this plan, which is now in effect at 57th Street, there is no self-selection of singles. If a customer wants some time to browse before being served by a member of the sales force he or she may go through the album library, or if the interest of the moment is in singles, a complete card index is available. In this cross indexing system all singles are listed according to types (viz. waltzes); composers (Strauss); conductor or artist (Stokowski, Budapest Quartet); as classics, semi-classics or popular, and as symphonic, chamber music, opera, operetta, band, choral, solo vocal or instrumental, etc.

Dynamic is beginning and plans to

expand emphasis on special categories of recordings, such as foreign language sets, children's records, educational discs and so on. An example of the specialty treatment for which they are strong is that being devoted to children's records. One booth in the 57th Street store is set aside for trying out children's sets or singles. An appropriate decorative theme is followed; the walls are lined with suggestions for the youngsters, and a special rack is being installed for album displays right in the booth.

Another of the six booths installed to date at the 57th Street store is set aside largely for use by customers interested in foreign language discs. An angle Dynamic has found that attracts favor in this connection is to have language kits in this booth. They plan, too, to have a number of the staff members trained in one or another language, so

as to be better able not only to serve the customer interested in learning another language, but also to serve more efficiently those unfamiliar or hesitant about their English.

At first glance this unusual New York store seems to be setting some almost-impossible goals for itself. Because of the ultra-modern and efficient arrangement, it is attracting wide-spread interest throughout the industry and in allied fields, but actually, with the kind of intelligent planning that is already being translated into actual promotion, display and sales operations carried on to logical conclusions, Jack Winer's program brings to mind that little motto some enthusiastic Army engineer tacked up in his office one day a little while after we went into the war:

"The difficult we do immediately—the impossible may take a little longer."

A view of the 57th Street Salon. Fixtures are by the Bitter Construction Co. of New York.





before



These pictures show an attractive department, but one somewhat lost in the surrounding sections. Contrast it with the remodelled record unit on the other page.

**merchandising beauty
should be
more than skin deep**

after

Here arrangement and subtle lighting create an effect that sets the section off and seems to foster the musical impression to an unusually high degree.



Blend is highly desirable, in cigarettes and camouflage—but in displaying merchandise it's something to be handled with extreme care.

Glance at the two sets of pictures on these pages. The first impression in each case is likely to be pleasant. Each group seems to represent a well-planned, carefully arranged, neat and tastefully furnished record department.

But now study the contrasting sets of photos closely. In the first instance the

department seems to be just a part—albeit an attractive part—of one huge floor; which is just exactly what it is. In the second set, however, a musical ensemble effect is achieved which, despite the fact that this department too is part of the same big area, makes the record section stand out like some precious jewel in a luxurious setting.

The seemingly magical effect that has been achieved, largely through unusually fine treatments in arrangement and

lighting, took place recently at the big Sears Roebuck store in Chicago, and the *before* and *after* pictures which accompany this article, are all from the same store. And if, as the Chinese philosopher said, "one picture is worth a thousand words," here are a handful of pictures that should be worth a whole five-foot shelf of volumes to anyone interested in better merchandising through better interior arrangement.

By comparison with most of the accepted standards of layout, there is little room for criticism of the department shown in the *before* set of pictures. It is only when it is held up to comparison with the remodelled department represented in the *after* series that the seemingly minor weakness become glaringly evident. Then what would ordinarily pass as an attractive, spacious record department becomes just another part of a big and busy store.

But look again at the new arrangement. Here is a set-up that literally seems to sing. From the gay and colorful album covers on the many open-display racks to the litling sign over the main

counter there is an atmosphere at once musically stimulating and restful.

Within the highly-effective whole there are a number of individual touches that spell better merchandising without marring or intruding upon the overall effect. Note, as an example, the subdued but attention-compelling lighting over the single records along the front of the main counter, and the glass-enclosed listening stations located at regular intervals on the same counter.

The album racks, one of which is pictured on this page, are an effective combination of attractiveness and efficiency, with their unobstrusive signs indicating general musical category, specific type of recordings and prices; with their protective glass flanges at each side, and with the neat storage cubby-holes at the ends.

In all, after a visit to the store or careful study of the pictures, it is easy to understand why Sears' management is highly pleased with the creation of a setting that has added new merchandise appeal to its record department and new sparkle to the whole store.



Utility (note the sections for storage) and attractiveness are effectively combined in this album rack.

books on music

The list of books printed below comprises all those volumes that are likely to be of interest to the regular record customer. Experience has taught that those people interested in records usually want to know more about the music, performers, conditions of recordings, history of music, etc. To keep a line of books on hand will facilitate matters for the sales clerk and will also bring some additional revenue.

We have divided our books into three categories: the "A" list, which has the most universal appeal; the "B" list, which caters mainly to those who are already familiar with the fundamentals of music; and the "C" list, which comprises books that are of interest only to the more serious amateur or student of music.

In the first category there are mainly those books which deal with the making of records, their selection in regard to building a library, the evaluation of performances and the lighter side of music as told in many anecdotes.

The "B" list contains several important books on music appreciation, biographies of the best-known composers and some light reading on the musical scene.

In the "C" list there are those books which deal in a more intricate manner with certain phases of music which are of special interest to the initiated music lover.

These books contain a great many technical terms as a rule and every customer should be informed that he needs some kind of musical background in order to understand them.

List A—Books for the uninitiated music-lover.

Barbour, H. B., and Freeman, W. S.—*How to Teach Children to Know Music*. Barnes, New York. \$2.50. A selection of records, arranged progressively according to age, aimed at giving the child the proper musical background as he grows up.

Cott, Ted—*Victor Book of Musical Fun*. Simon and Schuster, New York. \$1.50. Musical games, quizzes and some hilarious anecdotes about musicians.

Ewen, David—*Listen to the Mocking Words*. Arco, New York. \$2. Some more anecdotes, some new and some of earlier vintage.

Ewen, David—*Men of Popular Music*. Arco, New York. \$2.75. Biographies of Tin Pan Alley's greats, e. g., Rodgers, Kern, Berlin, Porter.

Ewen, David—*Music for the Millions*. Arco, New York. \$5. A thorough account of the great musical masterpieces and what the authorities have to say about them, with extensive discography.

Gaisberg, F. W.—*The Music Goes Round*. Macmillan, New York. \$3. A fascinating narrative of recording history by one of its top engineers. With many personal experiences in the course of recording from Caruso to Bruno Walter.

- Graf, Max—*Legend of a Musical City*. Philosophical Library, New York. \$3. The Viennese music critic tells of his city's musical past.
- Graham, Shirley—*Paul Robeson, Citizen of the World*. Julian Messner, New York. \$2.50. Biography of the versatile Negro singer and actor.
- Gramophone Shop Encyclopedia of Recorded Music*. Simon and Schuster, New York. \$5. Rather complete discography of all classical recordings, European and American.
- Haggin, B. H.—*Music for the Man Who Enjoys Hamlet*. Knopf, New York. \$2.75. Serious music appreciation rather on the heavy side, with close references to records.
- Haggin, B. H.—*Music on Records*. Knopf, New York. \$2. A solid selection of discs for the serious novice, and some good pointers for starting a library.
- Hall, David—*The Record Book*. Barnes, New York. \$4.95. Well-written and rather complete survey of recorded serious music with some pertinent explanations of styles and periods.
- Howe, M. A. De Wolfe—*Tale of Tanglewood*. Vanguard, New York. \$2. Story of the American counterpart of Salzburg where Serge Koussevitzky and the Boston Symphony hold forth.
- Hughbanks, Leroy—*Talking Wax*. Hobson Book Press, New York. \$2.50. A simply written expose of the technical side of the recording industry and its historical development.
- Kolodin, Irving—*A Guide to Recorded Music*. Doubleday, Doran, New York. \$3.50. Discussion of most individual classical recordings and their performances.
- Miller, Paul—*Esquire's Jazz Book*. Barnes, New York. \$2. The annual book on hot jazz, its development, trends and the musicians who make it.
- Nestyev, Israel—*Sergei Prokofiev*. Knopf, New York. \$3. Soviet-inspired biography of one of Russia's most important contemporary composers.
- Norman, Gertrud and Schrifte, Miriam L.; editors—*Letters of Composers*. Knopf, New York. \$5. Collection of significant letters of outstanding composers of the last four centuries.
- O'Connell, Charles—*Victor Book of the Opera*. Simon and Schuster, New York. \$2. A not quite up-to-date account of operatic recordings and of the plots of the operas with Victor discography.
- O'Connell, Charles—*Victor Book of the Symphony*. Simon and Schuster, New York. \$3.50. Mainly Victor discography of symphonic masterpieces with some attempt at analysis.
- Panassie, Hughes—*The Real Jazz*. Barnes, New York. \$2.50. An authoritative book on this music and its musicians.
- Sargeant, Winthrop—*Jazz: Hot and Hybrid*. Arrow Editions, New York. Best analysis of jazz on the market so far. Often somewhat technical.
- Smith, C. E., Ransey, F., Jr., Russell, W., Rogers, C. P.—*Jazz Record Book*. Barnes, New York. \$3.50. Incomplete, but excellent, jazz discography of outstanding records in the field with some penetrating remarks and articles.
- Spaeth, Sigmund—*At Home With Music*. Doubleday, Doran, New York. \$3.50. An easy music appreciation and introduction to music. Some discographical material.
- Ulanov, Barry—*Duke Ellington*. Creative Age Press, New York. \$3. A biography of one of the most significant jazz musicians.

Walter, Bruno—*Theme and Variations*. Knopf, New York. \$5. Autobiography of one of our foremost conductors containing the author's many experiences in Germany and throughout the world.

List B—Books for people already familiar with music fundamentals.

Abraham, Gerald—*Eight Soviet Composers*. Oxford University Press, New York. \$1.50. Intelligent discussion of outstanding Russian contemporaries but often rather involved.

Antheil, George—*Bad Boy of Music*. Doubleday, Doran, New York. \$3. Amusing anecdotes and story of the composer's life.

Barne, Kitty—*Listening to the Orchestra*. Bobbs-Merrill, New York. \$2.75. Excellent introduction for laymen to the orchestra.

Bauer, M., and Peyser, E.—*Music Through the Ages*. Putnam, New York. \$5. An easily understandable music history.

Buchanan, Fannie R.—*How Man Made Music*. Follett Publishing Co., Chicago, Ill. \$2. Well presented, this is mainly for adolescents.

Caruso, Dorothy—*Enrico Caruso, His Life and Death*. Simon and Schuster, New York. \$2.75. Interesting biography of the singer by his wife. Complete discography.

Copland, Aaron—*Our New Music*. McGraw-Hill, New York. \$2.50. An intelligent introduction for the layman.

Darnton, Christian—*You and Music*. Pelican Books, New York. \$0.25. A very handy and meritorious music appreciation.

Einstein, Alfred—*Mozart*. Oxford University Press, New York. Magnificent, but not easily understandable biography.

Erskine, John—*What Is Music*. Lippincott, Philadelphia, Pa. \$2.75. Simple music appreciation.

Howard, John T.—*Our American Music*. Crowell, New York. \$5. Discussion of American composers and their music.

Johnson, Harriet—*Your Career in Music*. Dutton, New York. \$3. Mainly for those who want to become professionals. Practical angle.

Lakond, Wladimir; editor—*The Diaries of Tchaikovsky*. Norton, New York. \$5. The life of the Russian master from 1873 until 1891 (including his stay in the United States) as revealed in his own journals.

Mahler, Alma—*Gustav Mahler*. Viking, New York. \$5. Biography of the composer by his wife with an appendix containing letters to and from Mahler.

Safranek, Milos—*Bohuslav Martinu, the Man and His Music*. Knopf, New York. \$3. Biography of Czech contemporary composer.

Schauffler, R. H.—*Florestan, the Life and Work of Robert Schumann*. Henry Holt, New York. \$3.75. Well written and interesting biography.

Selden-Goth, G.—*Mendelssohn's Letters*. Pantheon Books, New York. \$4.50. Excellent, and often fascinating, selection of letters.

Spaeth, Sigmund—*Read 'em and Weep*. Arco, New York. \$3. Anecdotes and reminiscences of the lighter side of music.

Stringham, E. J.—*Listening to Music Creatively*. Prentice-Hall, New York. \$5. Rather pretentious music appreciation book.

Thomson, Virgil—*The Musical Scene*. Knopf, New York. \$3. Collection of five years of criticism by the *New York Herald Tribune's* first stringer.

Walter, Bruno—*Gustav Mahler*. Grey-stone Press, New York. Discussion of the composer's life and his music.

Welch, Roy D.—*The Appreciation of Music*. Harper, New York. \$3. Music appreciation with many musical examples.

List C—Books of a more technical nature for the initiated music-lover.

Apel, Willi—*Harvard Dictionary of Music*. Harvard University Press, Cambridge, Mass. \$6. Excellent dictionary of musical terms and subjects. No biographies.

David, Hans T.—*Bach's Musical Offering*. G. Schirmer, New York. \$3. Musical, technical analysis.

David, Hans T., and Mendel, Arthur—*The Bach Reader*. Norton, New York. \$6. Bach's life in documents plus his biography by Forkel.

Dorian, Frederick—*The History of Music in Performance*. Norton, New York. \$4. Fascinating account of the development of musical performance practices.

Geiringer, Karl—*Musical Instruments*. Oxford University Press, New York. \$4. Good, but very technical, discussion of instruments and their histories.

Graf, Max—*Composer and Critic*. Norton, New York. \$3.75. Account of critics' attitude to great composers of the past.

Le Massena, C. E.—*Galli-Curci's Life of Song*. The Paebur Co., New York.

\$3.75. Biography of the great Italian singer.

Moore, Gerald—*The Unashamed Accompanist*. Macmillan, New York. \$1.50. Music from the accompanist's viewpoint.

Palmer, Winthrop—*Theatrical Dancing in America*. Bernard Ackerman, New York. \$3. A concise history of the subject, limited to this country.

Rosenwald, Hans—*Handbook of Music History*. Lee Stern Press, Chicago. Ill. \$1. Questions and answers encompassing all periods of music.

Runes, Dagobert D., and Schrickel, Harry G.—*Encyclopedia of the Arts*. Philosophical Library, New York. \$10. Mainly on all the arts, but some important articles on musical subjects as well.

Salazar, Adolfo—*Music in Our Time*. Norton, New York. \$5. Exposition of the sources of contemporary music and its relationship to the social and artistic scene of today. Technical.

Slonimsky, Nicolas—*Music of Latin America*. Crowell, New York. \$3.50. A detailed account of Latin-American composers and their music. Mainly for reference.

Tovey, Donald F.—*Beethoven*. Oxford University Press, New York. \$3. More analytical than biographical, it is an outstanding contribution to the literature on the German master.

Tovey, Donald F.—*Essays in Musical Analysis*. Oxford University Press, London, England. \$4. Lucid articles of technical nature on musical subjects.

Tovey, Donald F.—*Musical Articles from the Encyclopedia Britannica*. Oxford University Press, London, England. \$4. Another collection of similar scope, but on different subjects.

**bookkeeping
and
inventory control**



inventory— basis of successful operation

The various types of record operations can be broken down, roughly, into approximately these categories:

1. *The class-A dealer* is the one who specializes in musical merchandise of all types with a strong emphasis on musical instruments, radios and radio-phonographs, record and musical accessories, and a complete stock of all available classical, semi-classical, popular, and rare recordings. The bulk of these dealers have continued in business—particularly in the phonograph-record business—throughout the war years. Most of them are thoroughly experienced by now in the successful merchandising of phonograph-records and record accessories, and know their value in relation to the radio merchandise which they will soon have.

2. *The class-B dealer* has handled phonograph records throughout the war during the absence of other musical and radio merchandise. These dealers are the independent radio-appliance dealers of pre-war years who handled no musical stock other than phonograph records as well as the retail department store and chain store record operations which have also carried radio and appliance merchandise to a large or small degree and who will return to that policy.

These stores now carry, and will con-

tinue to carry only a moderate selection of the most familiar classics, the best-loved semi-classics, and as many popular records as they can get. The stores, independent and chain, that plan to install a record stock of this nature are many—and in the minds of the bulk of the radio-record buyers now in charge of these departments, phonograph records have little more than a “nuisance value.” As a consequence, present record departments are in line for relocation and diminished size in order to make room for the return of the “big-ticket” items of radios and appliances.

On the surface, this re-adjustment of the relative importance of phonograph records in relation to radios, and a lessening of importance to records which many radio men feel are “the tail to the radio dog”—may seem a justified change. However, we must say again that all dealers must remember that records make the repeat sales in the radio-phonograph field and it is the sale of the second and third radio and radio-phonograph that will lengthen the life of any record-radio operation.

3. *The class-C record dealer* operates at the lowest point of sales efficiency of the record retailing picture. These dealers are the cheaper chain-stores and small local appliance and

radio dealers or radio service men who have stocked records during the war years as a traffic-bringer, or who are about to stock records for the same purpose or because there seems to be a boom ahead in the phonograph record sales field.

These dealers cater to the popular record field and consequently stock only the available hit tunes. These hit tunes may include a popularized classic such as the theme from the Tchaikowsky piano concerto, as played by a dance band, or in some cases the actual concerto itself during the peak of its demand. These record operations are usually not given much space and are operated rather like a record bar where quick turn-over is the watch-word. They do not build a record business or even make a very competent job of bringing in traffic unless they happen to be situated in a very advantageous location.

Too often these class-C record bars and departments are incompetently handled and represent only an additional item in the store's inventory. Where there is no centralized buying, the mass of unsold and badly chosen discs will continue to grow and materially lessen the profit of the record operation. In this type of operation also, can be found many of the lesser-known labels which capitalize on the popularity of a tune by its title but which does not have the necessary artists to make the record salable.

4. *Class-D* record operations have just begun to spring up since the end of the war. These are the records which will appear in self-service racks throughout the country in drug stores, railroad stations, theatre lobbies and newsstands, and which will be priced—or underpriced—to sell and sell quickly. The bulk of the present day record pressing outfits which are actually pressing or preparing to press an infinite number of records under an equally infinite number of labels, will be the principle source of this type of record operation. Here is where the highest mortality in the record business will

be found, both in the manufacture, and the distribution, as well as the retail operation itself. This type of record manufacture and record retailing operation has a definite possibility of quick return for a hasty investment if those who manufacture the records know the record business, can get the necessary artists, and can play the hit tune field successfully.

It is conservatively estimated by the major companies, that the steadily growing and already abnormal phonograph record demand by the public cannot be satisfied even with peak production by all record companies in the field. The factor of the power of selection by the public must be taken strongly into consideration in relation to what will sell and what will not in any branch of the recording field, and inasmuch as public demand already requires more in every field than the record manufacturers can now produce with the raw materials at hand, it is obvious that with the influx of millions of radio-phonographs and record players to the consumer market, that this demand will swell beyond the hope of any production schedule.

The public will choose familiar artists first, rather than the unknown, and the hit tunes of the day will not sell necessarily because twenty different labels or two hundred different labels can carry that title. Playing records to win is a much longer shot than horse racing and much more perilous. The dealer who stocks the unknown record labels may or may not be backing a stable of winners. He can only find out the hard way, i.e., by the public's choice. The dealer that franchises from the better known record manufacturers can only hope that he puts his dollars into the right titles and on the right artists on those records. The percentage of possible failures in selecting records by nationally known companies and artists and a full crop of hit tunes, well orchestrated, is a great deal smaller than that same potential of failure when

the choice must come from lesser known labels and obscure talent.

Whether you get the return of your dollar from your phonograph stock lies entirely in your choice of inventory and your skill at selling but your real interest should lie in the realization that phonograph records that are well chosen and skillfully merchandised, as well as promoted and advertised, are the key to thousands of dollars of repeat radio and radio-phonograph sales. Almost anyone can buy records from somewhere—but the inventory that comprises his phonograph-record operation will spell success or failure for more than just sales. Phonograph records are high on your customer-preference list today—but if you have the right tunes with the wrong artists, or vice-versa, or an inadequate stock, or indifferent sales people—no amount of dollar-investment will save you from failure. Inventory takes analysis and know-how and skillful selling. Your distributor and your buyer must provide the first two and you and your sales staff must know what you are selling and how to sell it.

May we suggest that you review this rough break-down into four classes of the many possible types of record-radio dealers and try to identify yourself in one of them. Then talk to your nearest major record distributors to get the benefit of their many years of experience in distributing records to retail dealers. These men can help you to estimate the investment necessary for your type of inventory, analyze your present or your expected record sales set-up and see how your chances stack up before you actually put your money on the record retailing race horse.

With the taking of the annual or the semi-annual inventory in any record operation, the dealer has completed only one part of a dual function. He already has taken a dollar inventory in January to estimate the amount of investment actually on hand and to compare it with the previous six months, inventory figure by which he can estimate

the percentage of profit or loss under which he is operating. But this procedure represents only one-half of the inventory picture. The follow-up of the dollar and cents inventory should be an itemized inventory by label and number of every record and record album now in the dealer's stock. This will give the record dealer his first comprehensive picture of what actually comprises his stock and he will find it very enlightening to tally the numbers of records of which he has multiples. By this we mean that while the dealer's stock may include some thirty-five hundred record titles, more or less, even this wide selection may not be indicative of a successful record business.

First, the dealer must estimate, by review of the actual stock on hand, whether he is carrying a complete basic stock, the backbone of any record operation, or whether his selection of titles includes many obsolete, obscure, undesirable, or little known recordings that fill up the shelves, but which do not sell under ordinary circumstances. An estimate of what is a basic record stock for his store can be made by taking into consideration these factors:

- (1) Size of city or town in which he is located.
- (2) Location of nearest record stores or record departments.
- (3) His own location in relation to the business section of the town.
- (4) Size of the store and position within the store of the record department.
- (5) Type of clientele.
- (6) Average dollar sales per customer.
- (7) Size of dollar inventory in relation to dollar sales.
- (8) Number of times turnover per year of record stock.
- (9) Actual amount of obsolescent stock, slow moving items or "dogs" now in stock and not returnable.

The established six-month return privilege to the distributor from the dealer is 5% of that period's purchases in wholesale dollar value. Dead stock or

slow stock over and above this amount remains the dealer's responsibility, and its existence can be attributed to only two sources, i.e., the record buyer and/or the point of sale. In the nature of preventive medicine for the illness of over-stock of any kind, we would suggest that every record buyer make an analysis of three things:

- (1) The clientele to whom he is selling records.
- (2) The record inventory most suited to this clientele.
- (3) A maximum and minimum estimate, item by item, of every record or album in the basic inventory, on a weekly or monthly basis of actual estimated sales.

If the dealer knows, for instance, that in his store he can sell four copies of the "Nutcracker Suite" per week at the maximum, he knows he should never have less than half that amount on hand. His estimate of the maximum and minimum, then, for the most popular recording of the "Nutcracker Suite," will be four and two. When he finds there are only two of these albums on hand, then he will automatically reorder, etc.

It is well known that for the past four years and up to the present moment to some degree, it has been necessary to order three to six months supply of all basic record items, whether singles or albums, because of the system of rotated pressings which has been in effect. Due to the shortage of material and labor it became necessary for the major recording companies to select a skeleton list of basic records to press, plus a very few new releases. These pressings have been made in quantity at intervals of three to six months. This has made it necessary for the distributor to urge the dealer to buy quantities of records sufficient to last from one pressing period to another. In their enthusiasm to sell, and in the dealer's anxiety to be well protected, there has been much over-selling and over-buying of items not necessarily suited to the dealer's needs. By evaluating his own type of stock and his own clientele,

the dealer can avoid the mistake of over-buying items which he will find hard to move.

To facilitate the sale of over-stock and slow moving items the dealer must make every effort to install and to utilize the latest type of display ideas and equipment, both in his store and in the store windows. There have been many types of self-selection display racks and holders developed for counter and floor use. These displays incorporate the exposure of the maximum amount of merchandise, carefully titled, in the minimum amount of space. One counter rack of this nature contains about sixty pockets for the vertical display of single records, with a place for a typed title to be slipped in above the record slot. When the customers stand at the counter for service, they automatically thumb over these records and sell themselves anywhere from one to ten out-of-print, old or obsolete records for which they would never have thought to ask the sales person.

Customers love to discover things for themselves and if they can find a record or an old song, which they have always liked and never forgotten, and which is no longer issued, they feel that they have made a personal discovery and will search further for such items. One title calls another to mind and where the customer has come in to buy one record or one album, he will stay to spend additional dollars in his own particular hunt for record gold.

Other types of single record display racks are made to fit against unsightly posts and in that way make unproductive areas in the dealer's store yield some revenue. An old table can be put to use by squaring off the top with glass partitions and inserting about twenty-five varied records in each bin. Here again the customer makes his own personal discoveries and feels that your store is a gold mine of desirable items which cannot be found elsewhere. Your record "dogs" will have acquired dignity.

It has been established beyond a

shadow of a doubt that floor display racks for record albums more than pay their way. The recording companies feel the value of these racks to the extent that they are now producing almost no albums with plain covers. Every album comes out with a colorful design which sells the product visually before the records are heard. These album display racks also contain storage space at the bottom in which can be placed the multiple stock for each item on the rack. Some very successful record shops have wall bins in which groups of from ten to twenty-five records are placed in each bin, either horizontally or vertically. These records are not filed in numerical sequence, and some times they are not even filed by label, but the whole bin contains the recordings of one artist, one band, etc., and the record collector can look for records by an artist or an orchestra regardless of when or where they were recorded. This method of stocking will bring to light much out-dated material that would otherwise never move.

It is obvious then, that the second half—or the follow up of the inventory procedure may well be the most vital one. If you have stock that matches your clientele and which is in correct dollar-wise proportion to the potential volume of sales in your store, then you should have a healthy record operation. It takes more than money to buy records—it takes a “know-how” to both buy records and to merchandise them.

278

Find out what your slow or unsalable stock is at the present moment, bring it to light and place it in self-selection racks where the public can get hold of it. Then when these slow moving items have become dollars once more, buy only what you know you can sell in your store to your particular clientele. When the next inventory period rolls around, it should see you with a cleaner record stock that contains a maximum of effective record merchandise and a minimum of “dogs.”

1. The class A dealer who specializes in all types of musical merchandise, including sheet music, musical instruments, radios and radio-phonographs, records, and record accessories. Most of these dealers have continued in business—particularly in the phonograph record business—throughout the war years. Most of them are thoroughly experienced by now in the successful merchandising of phonograph records and accessories, and know their value in relation to the radio merchandise which they will soon have.

2. The class B dealer has handled phonograph records during the war while other musical merchandise and radios have been missing. These dealers are the independent radio-appliance dealers of pre-war years who handled no musical stock other than records, as well as the retail department store and chain store record operations which have also carried radio and appliance merchandise to a large or small degree, and who will return to that policy.

These stores now carry, and will continue to carry, only a moderate selection of the most familiar classics, the best-loved semi-classics, and as many popular records as they can get.

3. The class C record dealer, comprising chain stores, small appliance or radio dealers, or radio service men who may or may not have stocked records before.

4. The class D record operations which are just beginning to operate. These represent the self-service record business which is beginning to show itself in the drug stores, railway stations, theater lobbies and newsstands.

Each class of these retail record operations is based upon a definite merchandising program, with a certain outlay involved in space, stock and display equipment. Much of the success of your record business will lie in your selection of location, not only of the store itself but in the placing of the

record department within your store's area. What every potential record dealer must remember is that phonograph records are a tremendous traffic item and that, with the release each week of new phonograph records by the major recording companies, it is possible for the skillful merchandiser to bring his record customers back into his store 52 times a year. There is no other retail item with the potential customer return value of phonograph records.

Class A:

If you are now operating or are planning to open a Class A music and record store, you would do well to allow a generous amount of floor space on your main floor for a retail record set-up. If you are already in the record business, try to look at your present equipment with new eyes and judge its efficiency and appearance. Are your counters modern in construction, of a comfortable height for the customer, and are they equipped with inset glass (well lighted) cases for the display of accessories which will bring you plus sales? Have you enough ten-inch and twelve-inch record bins located within easy reach of the record sales clerks so that all labels may be accommodated and classified in full without the necessity of miscellaneous stacking of records under the counter in odd boxes or back on a reserve shelf where they may be forgotten? Have you provided fully for the storage and classification of surplus stock of albums and singles? Dealers are finding it more expedient to build reserve bins directly in back of the bins for counter use so that the record sales help can have immediate and undelayed access to reserve record stock.

Good lighting everywhere is an absolute must for a modern record shop as both the clerk and the customer must be able to read record titles on albums and on labels, as well as a large amount

of supplements and reading material which is available on the counters of all accurate record shops. Shielded or indirect lighting and tubular lighting are the most effective means to light actual record stock and the record shop itself.

In the music house, it is particularly desirable to separate the popular and the classical record sections. This can be accomplished in a small shop by placing popular records at one end of the counter and classical record merchandise at the other end of the counter. Whenever it can be avoided, there should be no open playing of the record on the counter unless the volume control has been set very low. The hot jazz fan will not care for race records and the classical customer will be seriously bothered by a blaring record machine playing popular music.

Record listening booths do not need so much to be large as to be well planned. Place your record booths in such a way that the popular and the classical record fans will not be next to each other unless you can afford to install entirely soundproof booths. Otherwise, on the popular end of your shop or record counter, you can install a type of listening booth which will take care of the listening needs of your popular customer but which will not be so spacious and comfortable that he will linger far beyond the normal listening time in order to complete his selection. Many music houses are furnishing their popular listening booths only with a waist high shelf which contains an inset record player and which leaves a space on which to set records, and a padded bench built against the wall and facing the speaker.

As much as possible the actual record playing machine is not exposed for handling or investigation and the functional turntable and tone arm are of the simplest design. Because of the scarcity of radio equipment during the war and up to now, many dealers have found that the young people who frequent the

popular record booths will remove the needle and in many cases the actual crystal pickup itself from the tone arm. To combat the loss of needles, dealers have found it expedient to replace the ordinary turn screw that holds the needle with a shortened set screw which must be inserted or removed by a tiny screw-driver. As for the crystal pickup it is necessary to see that these are screwed in tightly and that a constant watch is kept on the record listeners through the glass doors and windows of the record booths. This difficulty will be eliminated when there is a return of a normal flow of radio material to the retail market.

The booths for classical customers should be constructed with a definite idea of providing fine reproduction and comfortable listening space and equipment. These customers represent the bulk of the dollar sales for all Class A record dealers and at least 40 per cent of the record sales for Class B dealers. There should be soft indirect lighting in both types of record booths and it is well to have the classical listening booths sufficiently large so that the listener may sit a small distance from the loud speaker and be able to listen to the reproduction of a full symphony orchestra without feeling drowned by sound. It goes without saying that every record dealer should have the finest reproducing equipment in all his classical listening booths. Fine equipment and comfortable surroundings will encourage a return of the best type of clientele.

Class B:

In the case of small dealers or of record operations in department stores, there is not as much space available and the bulk of the record sales usually lies in the popular field. Being adjacent to other types of merchandise such as appliances or radios or ordinary department store merchandise such as lamps, furniture, books, etc., it is neces-

sary that the record department be planned on the basis of economizing in floor space and using the most efficient type of fixtures.

The Class B store usually carries a representative classical and light classical stock and a full line of pops, westerns, etc. This dealer will not need as much space for album stock or album display and his record displays will be planned to feature pop record albums and pop singles rather than twelve inch classical stock or twelve inch albums. Once again, lighted display type counters do the best job; particularly in the case of department and chain stores, where the noise will cause added confusion it is well for the management to install an inset type of counter record player. The record player itself is operated by the sales clerk at the request of the customer and the loud speaker may be placed facing upwards and inset into the counter. The mouth of the loud speaker is hidden beneath a beige cloth covering which muffles the sound to some degree and which makes it possible for only one or two people directly over the speaker to hear.

Listening booths in this type of operation are usually compact and made only for brief listening purposes. It is wise to have at least one good sized and well equipped classical listening room which is kept for the sole use of classical listening customers. Wherever space is extremely limited, three-sided listening posts can be installed which are like telephone booths that have no top nor front and which shield the sound on three sides from the rest of the store. Customers may stand at these listening posts at a chest high shelf which will hold records and an inset player. These have been found very satisfactory for quick listening to pop records. In all cases it is suggested that the management adjust the volume controls so that the customers may not annoy others by overloud playing.

Class C:

Radio service shops, and other operations which have not previously handled records and who are handling records as an accommodation for their radio customers will not have the space or money to invest in a layout such as that of a Class B store. These record inventories will probably be limited to the lightest light classical field—such as Viennese waltzes and to pop records and specialty records such as race, hill-billy, hot jazz. Their inventory will be relatively smaller and will take less space and their counter space is necessarily limited. If you are one of these dealers, it might be well for you to consider installing a record bar which will contain a display case for accessories and will hold reserve stock on the inside counter side. Record bins can be built against the wall directly in back of this which will hold the bulk of the stock and a counter record player or players would be a good investment. Two or three pop listening booths and or a listening post or two will take care of the bulk of Class C record customers.

Class D:

Drug store, theater lobby and railroad station record buying, a field which some new manufacturers have been considering for the future, will be pretty much of a self-service operation and the records must be packaged ready for sale and sold from self-selection type racks and display equipment in most cases. To do this successfully, a cheap, non-breakable record must be developed before the system can be put into effect and, of course, this type of selling will deal only with popular records.

It is essential to all dealers, A, B and C, that they estimate their available floor space and plan for its most efficient use in relation to album display equipment and single record self-

selection racks. There are vertical record self-selection racks for counters which hold a maximum amount of records in a minimum amount of space and which make excellent places to move slow stock. Every dealer is familiar with the pyramid type of album display rack which has storage space in the bottom shelf. Placed back to back, these racks make excellent merchandising islands in your record department and provide colorful display.

Window displays which are frequently changed are a necessity for the alert dealer and window space must be reserved in every type of operation for a constant reminder display of record merchandise. By simply requesting them in many cases, it is possible to secure, without charge from record manufacturers, numerous dealer-helps and displays which will help you to increase sales in your record departments. Use must be made of every colorful display piece, picture or release listings which come to your shop. These are your means if telling your customers what you have in stock.

As in every phase of the retail business, you must choose your location carefully, select your stock well and do a promoting and advertising job in order to get happy results. Poor equipment, poor lighting, bad machines, inadequate stock and unchanged window displays may add your name to the dealer mortality list which has already begun in the retail record business. Phonograph records sell phonograph combinations. When you sell one, you sell the other but when you sell records you're in the show business and you have to treat it with imagination and showmanship. Your windows will bring your customers in and your equipment and displays will bring them back.

L. G.

sales training and stock control in the new record picture

Miss Tubbs, who has written this comprehensive story on training of sales personnel and stock control, is supervisor of the record departments for the Barker Bros. stores in California. She has taught public school music, studied music at Lake Erie College and the Institute of Musical Art in New York and was formerly assistant record buyer for Halle Bros., Cleveland, Ohio.

BY MARGARET E. TUBBS

Supervisor, Record Departments, Barker Bros.

Much money, time, and effort is spent by retailers in the record business trying to increase the volume of sales. In many cases two most obvious factors are overlooked. The first is the training of sales personnel, and the second is the development and conscientious up-keep of a perpetual system of stock control.

Before a manager makes the effort to train a sales person, he should be sure he has selected the right person for the job. Much thought and consideration should be given to this before the actual hiring. Many employers are willing to take a chance on the first applicant when a position is open. The attitude is, "If the person doesn't work out—so what? We'll get another one." Considering the time and effort it takes to gain the necessary knowledge and working speed for selling records on a money-making scale, this shows great lack of foresight and poor business judgment on the employer's part.

Past experience has taught me that

wasting time with people who don't have the potential requirements for record selling is an extravagance which most retailers cannot afford. In selecting a person to sell records the first requisite is personality and animation. The personality in this case has nothing to do with glamor; it does include a neat, attractive appearance, a pleasant smile, and a clear, confident speaking voice. Intelligence, memory, alertness, a sympathetic attitude toward customer problems, and patience are necessary, coupled with the willingness to cooperate and the desire to learn. The ideal applicant has a knowledge of both classical and popular music as well as sales personality. If I had to choose between musical knowledge and sales personality, however, I would choose the latter. I have found that many times the girl with selling ability, because of her pleasing manner and untiring efforts, outsells the learned person who hasn't these qualities. It's true that sales personality can be de-

veloped, but the fundamental ability must be there and the employer must be quick to spot it during an interview.

After an employer has carefully decided to hire a person, he should see that he or she is given an opportunity to "learn the ropes" before being planked bewilderingly behind a counter. Many of us—even though we feel we had a fairly wide knowledge of all types of music—will never forget our first few weeks struggling to satisfy the requests made by our first customers. If an experienced person is assigned to train the newcomer and help her, it will pay dividends later on. An inexperienced person behind the counter is a menace to future business, since the customer loses confidence in the department. The use of catalogues, and time to study them, should be allowed. Makes of records, serial numbers, prices, filing systems, and the use of "quick-aids" should be explained. Each accessory or item in stock to be sold should be shown and selling points clearly pointed out. Sales demonstrations by the experienced should be planned and the newcomer given a chance to ask questions. Then she should be given an opportunity to practise selling, with sympathetic and helpful criticism of her efforts.

We are realizing more than ever before the necessity of suggestive selling. These suggestions must come easily and naturally in order to make a sale. Prepared lists of related merchandise are helpful in bringing forth quick suggestions. During the war, girls became artists in selling suggested merchandise to keep the customer from walking out without a package when they were unable to supply the demands. The retailers who have been able to exist during these past few years should realize that is one reason they are still in business today.

When we have done all we can do in training our sales force to sell merchandise, we must look into the operation of the business to see that we have done everything possible to get the merchandise on our shelves sold. This brings up the second important factor in in-

creased record sales—an accurate and complete stock control system. We all realize that a quick turnover of our money means more net profits. Intelligent buying is the basis upon which we should work. If a buyer hasn't a record of when his stock came in, the quantity, how fast it sold and how much was re-ordered, he can't order intelligently in the future. Record buying is a gamble and every bit of knowledge we can possibly acquire means that we will strike that much closer to being right in our future buying. There are always "hits" which we cannot foresee, but our "bread and butter" comes from the standard items which sell year in and year out. These, under normal conditions, should never be out of stock. At the same time, we should not be overstocked. Some basis for anticipation of the amount of stock to safely cover a period of selling time should be established. A complete record of what has gone on in the past is the best guide to what to anticipate for the future. An accurate and controlled system of inventory and stock control seems to me to give the greatest assurance of getting our best turnover on the money invested in the business.

In conclusion let me say that the selling of records has become a profession. Radio has brought music to the masses. People are being educated by having an opportunity to listen and become familiar with all types of music and therefore are developing a desire for music of their own choosing in their own homes. It means that record retailers must be alive to everything new, besides having a knowledge of everything old in music. The customer expects the sales person of today to have an extensive knowledge of her job and to be worthy of the confidence placed in her. We can never reach the saturation point in record knowledge.

We are all planning on big business in the next few years. Competition is keener than ever. It is my belief that the manager who is willing to study the business and go deeply into working out its problems will be the successful one in the period we're just entering.

notebook inventory saves time, aids customers

BY HELEN BRANSON

Margery Garner, manager of the record section in the L. C. Taylor Appliance Company of Pasadena, California, has worked out a rather unique perpetual inventory which is not only useful to her in dispensing records to her customers, but is a valuable merchandising aid appreciated by the customers themselves.

For popular recordings, Miss Garner has two identical loose leaf notebooks. In these she lists, according to artist or orchestra, all popular recordings in stock at a particular time. Entries are made whenever a shipment comes in, and numbers are crossed off as the purple marking envelopes indicate the last disk of a particular number is being sold.

Classical records are listed in a similar manner in a larger loose leaf binder. Here there is one section cataloguing the classical stock according to orchestra and artist, as well as composer.

A card file indexes every record and album in stock according to name.

The uses of these various filing systems are many. One of the most important is the convenience to the customer. Miss Garner says, "These days when nobody knows what any firm has on hand, customers are more than glad to have opportunity to peruse listing of what we have in stock. They find our notebooks very convenient. Our department per-

sonnel formerly wasted much time in looking through catalogues for various items. Now we have only to check in our notebooks or card index and we know in a few seconds whether an item is in or out of stock. This is particularly handy when customers call us by telephone or when a new person comes into our sales force."

The record section at L. C. Taylor's is arranged to appeal to customers of all musical tastes. Three small playing rooms with one added machine in the front section of the sales room give accommodations for handling a considerable number of customers at a time. A waist high counter with stools make notebook checking or waiting for service a pleasurable rest for the customers. Shelves, which later will be used for display of small radio-phonographs, now contain displays of albums. Flat, self-service pyramid type of display racks may be installed later when the shelves now in use are no longer available.

Classical albums are arranged on self-service cabinet type shelves according to composers. "Our convenient arrangement of merchandise together with our perpetual inventory listings enables us to give our record customers much quicker service than would otherwise be possible with our limited personnel," Miss Garner declares.

a perpetual inventory system

Story of an efficient and successful system which keeps sales moving and is in wide use in West Coast record shops.

BY ERNEST BEALL



Have you ever known a record salesman who hasn't advised inventory control of one kind or another? Practically every one of them has his own idea of the most efficient system; but if you've ever given some of them a try-out, you have found that practically every one is more trouble than it is worth.

If you buy badly, you either have money tied up in dead inventory, or you miss sales because you did not buy enough, soon enough. When, on the other hand, you know the turnover of every record in your stock, you can detect a sleeper before it becomes a dead dodo

and dispose of it in one of several ways available to you. (Try promoting it; if that fails, you can use your return privilege—but use that only as a last resort.) Keep a record of every set and single so that not only you, but also your future employees can benefit from your experience—happy or unhappy, as the case may be.

The perpetual inventory system recommended to all dealers in northern California by the H. R. Basford Company has been proved to be a successful and efficient answer to the question, "How will I keep track of the albums I sell?"

In the first place, as a courtesy to your customers, every album should have the price clearly marked on it; it saves the customer the nuisance of waiting while the price is looked up. But make your price marker really work for you. Be sure that it has on it the manufacturer's name, or label, and the set number. You might even include on it the name of the composer or the type of music, the title of the album, and the artist. Writing this information on price markers is the best training for salespeople in learning the stock.

The best way to attach this marker

Ernest Beall. West Coast record salesman got into the record business as a collector. When Columbia Broadcasting System took over Columbia Recordings, Ernest Beall took a job as a shipping clerk, then opened his own record store. He later became librarian and program arranger for station KYA in San Francisco, now heads salesmen for H. R. Basford, San Francisco.

to an opened album is to clip it to the lower right hand corner of the first record pocket. Why there? Because then the first record can be removed without disturbing your marker and without the chance of the clip scratching the record. On sets still in their factory wrappers, you can attach the marker with a gummed sticker at each end so that it will not be pulled off when you shuffle stock to make room for other sets. Don't use Scotch tape for the job because you'll want to remove the sticker easily when you open or sell a set.

It is important that every album in your stock be marked, whether it be on display, under the counter, or in your overstock room. From these cards (which are removed from the albums at the time of sale) you post your sales to your inventory control cards.

The inventory card should have on it columns to indicate date of order of each record or album, date received, date sold, and balance on hand. You should be able to tell how many copies of each you have on hand at any time even though they may be in several places.

To begin such a control system, first post your complete inventory on hand. We have found it useful to make all inventory entries in blue pencils and all order entries in red. As your receipts and sales are posted, keep your balance on hand up-to-date. When the balance gets down to the minimum quantity kept in stock at all times (this figure can be written at the top of the card for easy reference), it is time to reorder. In this way you give yourself time to order more fast-moving items before you run out of them completely. In posting sales to your inventory cards, stand each card on end on which you need to reorder. When you write up your order, all numbers will then automatic-

ally be in numerical sequence. As each order is filled completely, underline that entry so that you can tell at a glance that you do not have any more of that item on order with your distributor.

As an aid to all dealers in our territory, the H. R. Basford Company has had printed inventory cards for every album in the Columbia catalog up to January, 1946, with full information about each one: name of composer (or type of music), title, artist, number and size of records in the album, and price. An asterisk (*) after the label indicates that the set has a picture cover.

Ruled on both sides, the inventory cards are in numerical sequence with printed divider cards separating the different series. The complete set, in a covered file box with adjustable stop, is offered to dealers at cost. Additional ruled inventory cards without printed heading for use with new releases can also be had.

Ninety percent of our dealers are either using this system now or are putting it into effect soon. Such a response makes us feel that the time and effort used in making it available was well spent.

After all, the function of the H. R. Basford Company, like that of any distributor anywhere in the nation, is to buy and sell records. When we help our dealers to sell more records, they buy more records. We want them to buy the right records, and those are, of course, the ones that sell.

The system that I have outlined in this article has worked so well for the dealers to whom we have introduced it, and has been so successful for us, that I recommend it strongly and without hesitation to other dealers and distributors who are having trouble with that old bugaboo, inventory. A smooth-running system saves a lot of headaches.

On the opposite page are reproductions of the cards which are the heart of the perpetual inventory system developed by Ernest Beall of the H. R. Basford Company of San Francisco. All order entries are in red as indicated; remainder of inventory is in blue.

COLUMBIA* *Personality* Beatrice Kaye—vocal
 NAUGHTY NINETIES No. 2

C-36 (8) Red

4-10" 2.50

date	ord.	rec.	sold	bal.	date	ord.	rec.	sold	bal.
1-1-46				0					
1-5	15	Red							
1-10		10		10					
1-14			5	5					
1-18		5		10					
1-21			6	4					
1-21	20	Red							
1-23		20		24					
1-28			7	17					

LABEL _____ NUMBER _____
 COMPOSER _____
 TITLE _____
 ARTIST _____
 PRICE _____

COLUMBIA* *Beethoven* Soloists/Westminister Choir: Ormandy—Philadelphia
 SYMPHONY NO. 9 IN D MINOR, Op. 125 "Choral" MM-591 (6) Red 8-12" 8.50

date	ord.	rec.	sold	bal.	date	ord.	rec.	sold	bal.
1-1-46			1	3	1-1-46			2	10
1-21			1	2	1-7-46			2	8
1-28			1	1	1-14-46				6
1-28	1	Red			1-14-46	10	Red		11
2-3					1-18-46		5		8
					1-21-46		5		13
					1-23-46			3	10
					1-28				

MUSITRON

THE COMPLETE LINE OF PORTABLE PHONOGRAPHS



SRC-2 Four-tube automatic Record Changer with 6 1/2 p.m. Speaker. Sturdy constructed case, covered with simulated alligator leather.



PICCOLO MODEL No. 102. Hand wound. Features MUSITRON'S own Dual-Spring Motor that plays 2 complete 12 inch records on both sides. Sturdy, true-tone instrument.

Insure customer "buy-appeal" with these smartly designed and true-tone fidelity MUSITRON pace-setters. They're hard to resist because each important element: amplifier, motor, speaker, pick-up controls and case, is scientifically created and perfectly balanced. Highest quality workmanship, materials and finish blended into every MUSITRON.

MODEL PX-1 4 tube highly perfected 6 1/2 Watt Push-Pull A. C. Amplifier with 6 p.m. Speaker. Controls outside of case permit tuning with lid closed.



PICCOLO MODEL No. 101. 3 tube amplifier with superior tone quality. Superbly designed case of luxurious leather-like material. Features saddle stitch top. Patent Pending.



PICCOLO MODEL No. 103. 3 tube amplifier operating on either AC-DC and battery current with dual spring hand wound motor. Excellent unit for outdoor and home use.



Note to Dealers: Appointments at EXHIBIT 2000-2001, 1938-1939, 1940-1941, 1942-1943, 1944-1945, 1946-1947, 1948-1949, 1950-1951, 1952-1953, 1954-1955, 1956-1957, 1958-1959, 1960-1961, 1962-1963, 1964-1965, 1966-1967, 1968-1969, 1970-1971, 1972-1973, 1974-1975, 1976-1977, 1978-1979, 1980-1981, 1982-1983, 1984-1985, 1986-1987, 1988-1989, 1990-1991, 1992-1993, 1994-1995, 1996-1997, 1998-1999, 2000-2001, 2002-2003, 2004-2005, 2006-2007, 2008-2009, 2010-2011, 2012-2013, 2014-2015, 2016-2017, 2018-2019, 2020-2021, 2022-2023, 2024-2025, 2026-2027, 2028-2029, 2030-2031, 2032-2033, 2034-2035, 2036-2037, 2038-2039, 2040-2041, 2042-2043, 2044-2045, 2046-2047, 2048-2049, 2050-2051, 2052-2053, 2054-2055, 2056-2057, 2058-2059, 2060-2061, 2062-2063, 2064-2065, 2066-2067, 2068-2069, 2070-2071, 2072-2073, 2074-2075, 2076-2077, 2078-2079, 2080-2081, 2082-2083, 2084-2085, 2086-2087, 2088-2089, 2090-2091, 2092-2093, 2094-2095, 2096-2097, 2098-2099, 2100-2101, 2102-2103, 2104-2105, 2106-2107, 2108-2109, 2110-2111, 2112-2113, 2114-2115, 2116-2117, 2118-2119, 2120-2121, 2122-2123, 2124-2125, 2126-2127, 2128-2129, 2130-2131, 2132-2133, 2134-2135, 2136-2137, 2138-2139, 2140-2141, 2142-2143, 2144-2145, 2146-2147, 2148-2149, 2150-2151, 2152-2153, 2154-2155, 2156-2157, 2158-2159, 2160-2161, 2162-2163, 2164-2165, 2166-2167, 2168-2169, 2170-2171, 2172-2173, 2174-2175, 2176-2177, 2178-2179, 2180-2181, 2182-2183, 2184-2185, 2186-2187, 2188-2189, 2190-2191, 2192-2193, 2194-2195, 2196-2197, 2198-2199, 2200-2201, 2202-2203, 2204-2205, 2206-2207, 2208-2209, 2210-2211, 2212-2213, 2214-2215, 2216-2217, 2218-2219, 2220-2221, 2222-2223, 2224-2225, 2226-2227, 2228-2229, 2230-2231, 2232-2233, 2234-2235, 2236-2237, 2238-2239, 2240-2241, 2242-2243, 2244-2245, 2246-2247, 2248-2249, 2250-2251, 2252-2253, 2254-2255, 2256-2257, 2258-2259, 2260-2261, 2262-2263, 2264-2265, 2266-2267, 2268-2269, 2270-2271, 2272-2273, 2274-2275, 2276-2277, 2278-2279, 2280-2281, 2282-2283, 2284-2285, 2286-2287, 2288-2289, 2290-2291, 2292-2293, 2294-2295, 2296-2297, 2298-2299, 2300-2301, 2302-2303, 2304-2305, 2306-2307, 2308-2309, 2310-2311, 2312-2313, 2314-2315, 2316-2317, 2318-2319, 2320-2321, 2322-2323, 2324-2325, 2326-2327, 2328-2329, 2330-2331, 2332-2333, 2334-2335, 2336-2337, 2338-2339, 2340-2341, 2342-2343, 2344-2345, 2346-2347, 2348-2349, 2350-2351, 2352-2353, 2354-2355, 2356-2357, 2358-2359, 2360-2361, 2362-2363, 2364-2365, 2366-2367, 2368-2369, 2370-2371, 2372-2373, 2374-2375, 2376-2377, 2378-2379, 2380-2381, 2382-2383, 2384-2385, 2386-2387, 2388-2389, 2390-2391, 2392-2393, 2394-2395, 2396-2397, 2398-2399, 2400-2401, 2402-2403, 2404-2405, 2406-2407, 2408-2409, 2410-2411, 2412-2413, 2414-2415, 2416-2417, 2418-2419, 2420-2421, 2422-2423, 2424-2425, 2426-2427, 2428-2429, 2430-2431, 2432-2433, 2434-2435, 2436-2437, 2438-2439, 2440-2441, 2442-2443, 2444-2445, 2446-2447, 2448-2449, 2450-2451, 2452-2453, 2454-2455, 2456-2457, 2458-2459, 2460-2461, 2462-2463, 2464-2465, 2466-2467, 2468-2469, 2470-2471, 2472-2473, 2474-2475, 2476-2477, 2478-2479, 2480-2481, 2482-2483, 2484-2485, 2486-2487, 2488-2489, 2490-2491, 2492-2493, 2494-2495, 2496-2497, 2498-2499, 2500-2501, 2502-2503, 2504-2505, 2506-2507, 2508-2509, 2510-2511, 2512-2513, 2514-2515, 2516-2517, 2518-2519, 2520-2521, 2522-2523, 2524-2525, 2526-2527, 2528-2529, 2530-2531, 2532-2533, 2534-2535, 2536-2537, 2538-2539, 2540-2541, 2542-2543, 2544-2545, 2546-2547, 2548-2549, 2550-2551, 2552-2553, 2554-2555, 2556-2557, 2558-2559, 2560-2561, 2562-2563, 2564-2565, 2566-2567, 2568-2569, 2570-2571, 2572-2573, 2574-2575, 2576-2577, 2578-2579, 2580-2581, 2582-2583, 2584-2585, 2586-2587, 2588-2589, 2590-2591, 2592-2593, 2594-2595, 2596-2597, 2598-2599, 2600-2601, 2602-2603, 2604-2605, 2606-2607, 2608-2609, 2610-2611, 2612-2613, 2614-2615, 2616-2617, 2618-2619, 2620-2621, 2622-2623, 2624-2625, 2626-2627, 2628-2629, 2630-2631, 2632-2633, 2634-2635, 2636-2637, 2638-2639, 2640-2641, 2642-2643, 2644-2645, 2646-2647, 2648-2649, 2650-2651, 2652-2653, 2654-2655, 2656-2657, 2658-2659, 2660-2661, 2662-2663, 2664-2665, 2666-2667, 2668-2669, 2670-2671, 2672-2673, 2674-2675, 2676-2677, 2678-2679, 2680-2681, 2682-2683, 2684-2685, 2686-2687, 2688-2689, 2690-2691, 2692-2693, 2694-2695, 2696-2697, 2698-2699, 2700-2701, 2702-2703, 2704-2705, 2706-2707, 2708-2709, 2710-2711, 2712-2713, 2714-2715, 2716-2717, 2718-2719, 2720-2721, 2722-2723, 2724-2725, 2726-2727, 2728-2729, 2730-2731, 2732-2733, 2734-2735, 2736-2737, 2738-2739, 2740-2741, 2742-2743, 2744-2745, 2746-2747, 2748-2749, 2750-2751, 2752-2753, 2754-2755, 2756-2757, 2758-2759, 2760-2761, 2762-2763, 2764-2765, 2766-2767, 2768-2769, 2770-2771, 2772-2773, 2774-2775, 2776-2777, 2778-2779, 2780-2781, 2782-2783, 2784-2785, 2786-2787, 2788-2789, 2790-2791, 2792-2793, 2794-2795, 2796-2797, 2798-2799, 2800-2801, 2802-2803, 2804-2805, 2806-2807, 2808-2809, 2810-2811, 2812-2813, 2814-2815, 2816-2817, 2818-2819, 2820-2821, 2822-2823, 2824-2825, 2826-2827, 2828-2829, 2830-2831, 2832-2833, 2834-2835, 2836-2837, 2838-2839, 2840-2841, 2842-2843, 2844-2845, 2846-2847, 2848-2849, 2850-2851, 2852-2853, 2854-2855, 2856-2857, 2858-2859, 2860-2861, 2862-2863, 2864-2865, 2866-2867, 2868-2869, 2870-2871, 2872-2873, 2874-2875, 2876-2877, 2878-2879, 2880-2881, 2882-2883, 2884-2885, 2886-2887, 2888-2889, 2890-2891, 2892-2893, 2894-2895, 2896-2897, 2898-2899, 2900-2901, 2902-2903, 2904-2905, 2906-2907, 2908-2909, 2910-2911, 2912-2913, 2914-2915, 2916-2917, 2918-2919, 2920-2921, 2922-2923, 2924-2925, 2926-2927, 2928-2929, 2930-2931, 2932-2933, 2934-2935, 2936-2937, 2938-2939, 2940-2941, 2942-2943, 2944-2945, 2946-2947, 2948-2949, 2950-2951, 2952-2953, 2954-2955, 2956-2957, 2958-2959, 2960-2961, 2962-2963, 2964-2965, 2966-2967, 2968-2969, 2970-2971, 2972-2973, 2974-2975, 2976-2977, 2978-2979, 2980-2981, 2982-2983, 2984-2985, 2986-2987, 2988-2989, 2990-2991, 2992-2993, 2994-2995, 2996-2997, 2998-2999, 3000-3001, 3002-3003, 3004-3005, 3006-3007, 3008-3009, 3010-3011, 3012-3013, 3014-3015, 3016-3017, 3018-3019, 3020-3021, 3022-3023, 3024-3025, 3026-3027, 3028-3029, 3030-3031, 3032-3033, 3034-3035, 3036-3037, 3038-3039, 3040-3041, 3042-3043, 3044-3045, 3046-3047, 3048-3049, 3050-3051, 3052-3053, 3054-3055, 3056-3057, 3058-3059, 3060-3061, 3062-3063, 3064-3065, 3066-3067, 3068-3069, 3070-3071, 3072-3073, 3074-3075, 3076-3077, 3078-3079, 3080-3081, 3082-3083, 3084-3085, 3086-3087, 3088-3089, 3090-3091, 3092-3093, 3094-3095, 3096-3097, 3098-3099, 3100-3101, 3102-3103, 3104-3105, 3106-3107, 3108-3109, 3110-3111, 3112-3113, 3114-3115, 3116-3117, 3118-3119, 3120-3121, 3122-3123, 3124-3125, 3126-3127, 3128-3129, 3130-3131, 3132-3133, 3134-3135, 3136-3137, 3138-3139, 3140-3141, 3142-3143, 3144-3145, 3146-3147, 3148-3149, 3150-3151, 3152-3153, 3154-3155, 3156-3157, 3158-3159, 3160-3161, 3162-3163, 3164-3165, 3166-3167, 3168-3169, 3170-3171, 3172-3173, 3174-3175, 3176-3177, 3178-3179, 3180-3181, 3182-3183, 3184-3185, 3186-3187, 3188-3189, 3190-3191, 3192-3193, 3194-3195, 3196-3197, 3198-3199, 3200-3201, 3202-3203, 3204-3205, 3206-3207, 3208-3209, 3210-3211, 3212-3213, 3214-3215, 3216-3217, 3218-3219, 3220-3221, 3222-3223, 3224-3225, 3226-3227, 3228-3229, 3230-3231, 3232-3233, 3234-3235, 3236-3237, 3238-3239, 3240-3241, 3242-3243, 3244-3245, 3246-3247, 3248-3249, 3250-3251, 3252-3253, 3254-3255, 3256-3257, 3258-3259, 3260-3261, 3262-3263, 3264-3265, 3266-3267, 3268-3269, 3270-3271, 3272-3273, 3274-3275, 3276-3277, 3278-3279, 3280-3281, 3282-3283, 3284-3285, 3286-3287, 3288-3289, 3290-3291, 3292-3293, 3294-3295, 3296-3297, 3298-3299, 3300-3301, 3302-3303, 3304-3305, 3306-3307, 3308-3309, 3310-3311, 3312-3313, 3314-3315, 3316-3317, 3318-3319, 3320-3321, 3322-3323, 3324-3325, 3326-3327, 3328-3329, 3330-3331, 3332-3333, 3334-3335, 3336-3337, 3338-3339, 3340-3341, 3342-3343, 3344-3345, 3346-3347, 3348-3349, 3350-3351, 3352-3353, 3354-3355, 3356-3357, 3358-3359, 3360-3361, 3362-3363, 3364-3365, 3366-3367, 3368-3369, 3370-3371, 3372-3373, 3374-3375, 3376-3377, 3378-3379, 3380-3381, 3382-3383, 3384-3385, 3386-3387, 3388-3389, 3390-3391, 3392-3393, 3394-3395, 3396-3397, 3398-3399, 3400-3401, 3402-3403, 3404-3405, 3406-3407, 3408-3409, 3410-3411, 3412-3413, 3414-3415, 3416-3417, 3418-3419, 3420-3421, 3422-3423, 3424-3425, 3426-3427, 3428-3429, 3430-3431, 3432-3433, 3434-3435, 3436-3437, 3438-3439, 3440-3441, 3442-3443, 3444-3445, 3446-3447, 3448-3449, 3450-3451, 3452-3453, 3454-3455, 3456-3457, 3458-3459, 3460-3461, 3462-3463, 3464-3465, 3466-3467, 3468-3469, 3470-3471, 3472-3473, 3474-3475, 3476-3477, 3478-3479, 3480-3481, 3482-3483, 3484-3485, 3486-3487, 3488-3489, 3490-3491, 3492-3493, 3494-3495, 3496-3497, 3498-3499, 3500-3501, 3502-3503, 3504-3505, 3506-3507, 3508-3509, 3510-3511, 3512-3513, 3514-3515, 3516-3517, 3518-3519, 3520-3521, 3522-3523, 3524-3525, 3526-3527, 3528-3529, 3530-3531, 3532-3533, 3534-3535, 3536-3537, 3538-3539, 3540-3541, 3542-3543, 3544-3545, 3546-3547, 3548-3549, 3550-3551, 3552-3553, 3554-3555, 3556-3557, 3558-3559, 3560-3561, 3562-3563, 3564-3565, 3566-3567, 3568-3569, 3570-3571, 3572-3573, 3574-3575, 3576-3577, 3578-3579, 3580-3581, 3582-3583, 3584-3585, 3586-3587, 3588-3589, 3590-3591, 3592-3593, 3594-3595, 3596-3597, 3598-3599, 3600-3601, 3602-3603, 3604-3605, 3606-3607, 3608-3609, 3610-3611, 3612-3613, 3614-3615, 3616-3617, 3618-3619, 3620-3621, 3622-3623, 3624-3625, 3626-3627, 3628-3629, 3630-3631, 3632-3633, 3634-3635, 3636-3637, 3638-3639, 3640-3641, 3642-3643, 3644-3645, 3646-3647, 3648-3649, 3650-3651, 3652-3653, 3654-3655, 3656-3657, 3658-3659, 3660-3661, 3662-3663, 3664-3665, 3666-3667, 3668-3669, 3670-3671, 3672-3673, 3674-3675, 3676-3677, 3678-3679, 3680-3681, 3682-3683, 3684-3685, 3686-3687, 3688-3689, 3690-3691, 3692-3693, 3694-3695, 3696-3697, 3698-3699, 3700-3701, 3702-3703, 3704-3705, 3706-3707, 3708-3709, 3710-3711, 3712-3713, 3714-3715, 3716-3717, 3718-3719, 3720-3721, 3722-3723, 3724-3725, 3726-3727, 3728-3729, 3730-3731, 3732-3733, 3734-3735, 3736-3737, 3738-3739, 3740-3741, 3742-3743, 3744-3745, 3746-3747, 3748-3749, 3750-3751, 3752-3753, 3754-3755, 3756-3757, 3758-3759, 3760-3761, 3762-3763, 3764-3765, 3766-3767, 3768-3769, 3770-3771, 3772-3773, 3774-3775, 3776-3777, 3778-3779, 3780-3781, 3782-3783, 3784-3785, 3786-3787, 3788-3789, 3790-3791, 3792-3793, 3794-3795, 3796-3797, 3798-3799, 3800-3801, 3802-3803, 3804-3805, 3806-3807, 3808-3809, 3810-3811, 3812-3813, 3814-3815, 3816-3817, 3818-3819, 3820-3821, 3822-3823, 3824-3825, 3826-3827, 3828-3829, 3830-3831, 3832-3833, 3834-3835, 3836-3837, 3838-3839, 3840-3841, 3842-3843, 3844-3845, 3846-3847, 3848-3849, 3850-3851, 3852-3853, 3854-3855, 3856-3857, 3858-3859, 3860-3861, 3862-3863, 3864-3865, 3866-3867, 3868-3869, 3870-3871, 3872-3873, 3874-3875, 3876-3877, 3878-3879, 3880-3881, 3882-3883, 3884-3885, 3886-3887, 3888-3889, 3890-3891, 3892-3893, 3894-3895, 3896-3897, 3898-3899, 3900-3901, 3902-3903, 3904-3905, 3906-3907, 3908-3909, 3910-3911, 3912-3913, 3914-3915, 3916-3917, 3918-3919, 3920-3921, 3922-3923, 3924-3925, 3926-3927, 3928-3929, 3930-3931, 3932-3933, 3934-3935, 3936-3937, 3938-3939, 3940-3941, 3942-3943, 3944-3945, 3946-3947, 3948-3949, 3950-3951, 3952-3953, 3954-3955, 3956-3957, 3958-3959, 3960-3961, 3962-3963, 3964-3965, 3966-3967, 3968-3969, 3970-3971, 3972-3973, 3974-3975, 3976-3977, 3978-3979, 3980-3981, 3982-3983, 3984-3985, 3986-3987, 3988-3989, 3990-3991, 3992-3993, 3994-3995, 3996-3997, 3998-3999, 4000-4001, 4002-4003, 4004-4005, 4006-40

victor's manual on "how to buy"

RCA Victor presents this system of inventory and stock control which should be studied carefully by every dealer in the record business.

Every dealer who has sweated over his inventory knows the vital importance of a workable, efficient system of control. Aware of this problem, RCA Victor set a research staff to work to discover such a system. The results are graphically presented in the following pages, which are adapted from Victor's new manual, "How To Buy."

To emphasize the importance of this inventory control system, RCA Victor made it the star attraction at its presentation at the recent National Association of Music Merchants Trade Show in Chicago, where it was studied with great interest by the dealers present.

Any system of buying and inventory control that is to be useful to all the nation's record dealers must be simple and uncomplicated. Victor believes that the system it has worked out is simple enough to be mastered by the average clerk, who can thus take off the shoulders of the dealer himself much of the

burden of keeping tabs on the number of records in stock.

The system must be flexible enough to take care of both popular records, which are extremely short-lived merchandise that must be watched literally daily, and classical records and albums, most of which have a selling life extending over a period of years. Victor's system provides for both types of record merchandise.

The twin dangers of overstocking some items and running short on others, familiar headaches of every record department, are provided against by an ingenious use of green stock envelopes. Victor's research indicates that this is one of the simplest and most efficient ways of enabling the dealer to keep always in stock a predetermined number of regular selling items and to gauge the number of copies of a popular hit that he can sell during its brief life.

Your Biggest Problem
In the Operation of a Record Department

HOW TO BUY

**SO YOU HAVE
THE RIGHT MERCHANDISE
IN THE RIGHT QUANTITIES
AT THE RIGHT TIME**

TO MAKE A PROFIT

you need turnover . . .
up to six turns a year.

TO GET SIX TURNS

you need merchandise . . .
the right merchandise in the proper quantities,
at the right time.

290

TO HAVE THE MERCHANDISE

you must buy properly . . .
you must have a system of buying.

*The following is a suggested way of organizing your own
system of buying . . .*

IN THREE CLASSIFICATIONS



I. ALBUM SETS

This includes not only Red Seal Albums but Show pieces, popular "Smart Sets," and Children's merchandise in special packages.

2. STANDARD SINGLES

This includes Red Seal 10" and 12" singles, 12" Black Label singles, and also a great many of the 10" Black Label records you sell in your store.

For example: Tommy Dorsey's SONG OF INDIA is a "standard" 10" record . . . as standard as any Red Seal. You have consistent demand for it.



3. "HIT PARADE" NUMBERS

291

This would include all new releases of Popular Dance records which go to a peak of popularity, then drop off and become totally unsalable.

Some of these numbers, after a first flare of popularity, become consistent sellers and must thereafter be considered in the second classification . . . Standard singles.

Each of These Classifications

Needs Its Own System of Buying—

GRANTED YOU WANT SIX TURNS A YEAR . . .

*How many of a given album must you
have on hand to supply demand?*

First you must establish the 'going rate' on each album number. This you can determine by watching sales on a new album for six months.

1 Early every morning your order girl enters the sales of the previous day on the inventory card and shows balance on hand. After this system has been in force for six months you calculate the average sale per month. That's your 'going rate' on this album.



2 You will note at the lowest right corner of this card there is a space for MAXIMUM AND MINIMUM. Your going rate per month is your MINIMUM. A 3-month supply is your MAXIMUM. As the girl makes her daily entries for sold albums on this card she notices when the quantity is down to a month's supply, the MINIMUM.

293



3 Then she immediately orders a 2-months supply, which gives you a 3-month supply, the MAXIMUM. Thus, on the average, you are working on a 2-month supply . . . or six turns a year.

USE THE "ALBUM MARKER" SYSTEM

for keeping tab on album sales



These "markers" are made in two sizes, for 10" and 12" albums. They are made about a half inch taller than an album so that, when inserted in albums, they stick out above, making the price visible to the customer.

Each "marker" carries the selling price, album number, name of manufacturer, and rack number. It serves two purposes:



1 When an album has been sold off a self-selection rack the marker is a flag, a reminder, to the sales girl to take a duplicate album out of stock and put it on display at once. The rack number on the marker tells her quickly where the album goes.

2 During the day, as sales are made, the markers are accumulated in a drawer near the cash register. Each morning your order girl checks these markers and makes her entries on the inventory cards.



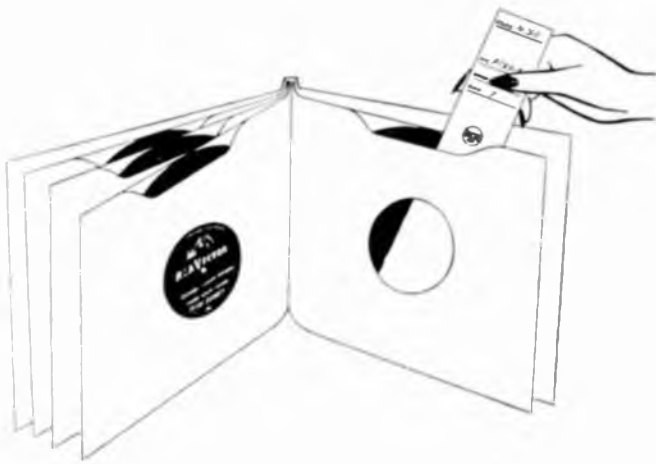

THESE MARKERS should be placed in the last pocket of each album. Few customers play an album through to the last record before purchasing. The marker in the last pocket runs less risk of getting lost.

Care must be exercised not to wrap the marker with the album . . . it's important for this system of inventory keeping to toss each marker promptly into the designated drawer when the sale is made . . . and check them off on the inventory card each morning.

Every album on display on your floor, wrapped or unwrapped, should have a marker.

Cut a slit in wrapped albums and slide the marker into position.

- ★ On an average, the whole job of checking **MARKERS** against **INVENTORY CARDS**, making entries, and writing up a list of albums to order, is a half hour job for a good order girl. This system of perpetual inventory gives you the most efficient control with the least loss of time.

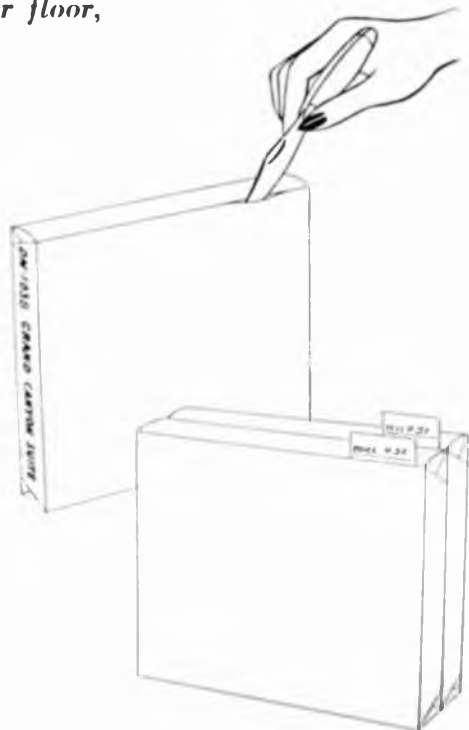

THIS SYSTEM, just described, has been used by many record dealers. It has one weakness . . . Either your stock girl must constantly check stock or you'll frequently be out of your best selling standards. The last record, in the green envelope, gets sold before you order a new quantity.

HERE IS A WAY TO OVERCOME THIS WEAKNESS IN THE SYSTEM:

- 1 The green stock envelope, with its white tab, is your key. Train your sales people to file all stock of selection **to right of green envelope**.
- 2 You've determined your **MINIMUM** on each standard single. Suppose, for example, this minimum for one selection is five sales per month. When your stock gets down to five you order ten more, to a total of 15.
- 3 Here's the trick: Put the **fifth** record to the right of the green stock envelope **IN A PURPLE ENVELOPE**.
- 4 Write the record number on this purple envelope. **SALES PEOPLE ARE INSTRUCTED TO SELL UP TO THIS PURPLE ENVELOPE.**

Your sales people should always sell from the extreme right. When the record in the purple envelope is reached **THAT'S YOUR FLAG**. It means you've reached your minimum. It's time to reorder a 2-month supply of that number.

- 5 When the record in the purple envelope is sold, the clerk puts it in a standard factory envelope for the customer and **TOSSES THE PURPLE ENVELOPE IN THE INVENTORY DRAWER** with the album markers.

- 6 The following morning the order clerk picks it up, consults the green stock envelope, and reorders according to the maximum noted on the tab.

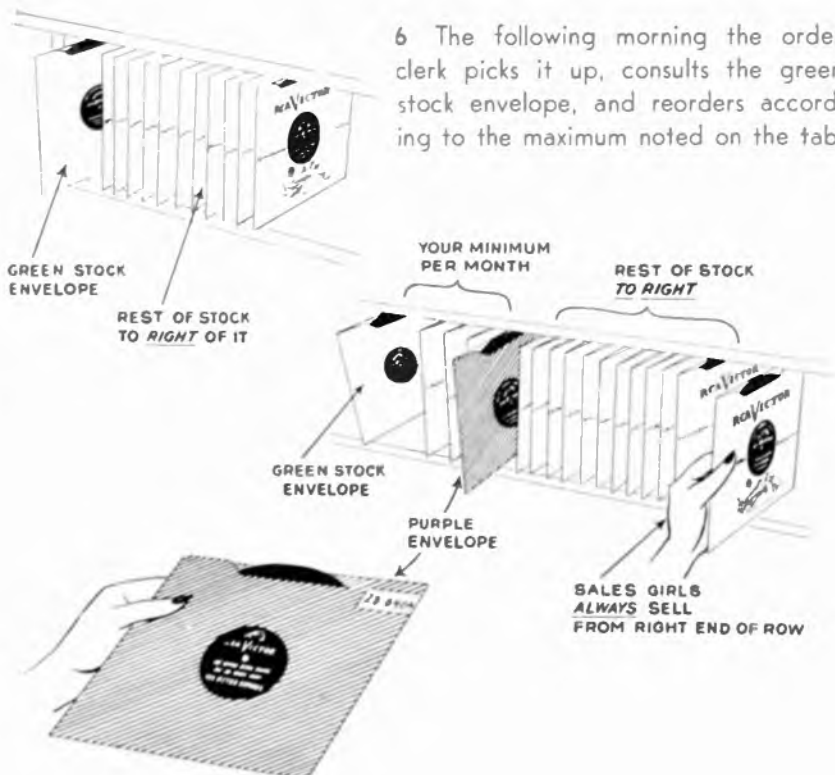

VERY OFTEN

a good selling number should be in your self-selection rack as well as back in the wall rack. Your stock is divided. How do you know when you are down to minimum on that number? Here's a suggestion:

THE STOCK IN THE DISPLAY FIXTURE SHOULD BE A PART OF YOUR MINIMUM STOCK. HERE'S HOW IT WORKS:

1 Suppose you want to put two of a selection on display—YOU TAKE TWO RECORDS FROM BETWEEN THE GREEN ENVELOPE

AND THE PURPLE ENVELOPE. You take them out of the factory envelopes and put them into sturdy green envelopes for the display rack.

2 Stickers are provided for these green envelopes listing record number, manufacturer's name, rack number and selling price. Spaces on this sticker should be properly filled in, and sticker pasted to upper right-hand corner of green stock envelope.

3 As the selection is sold from the display rack the green envelope is refilled immediately from the wall rack (always taking records farthest to the right) and put back on the proper rack. Your minimum stock of any given standard single is the two on display plus the number between the green and purple envelopes in the wall rack.

You reorder the moment the wall rack is depleted as far as the purple envelope.
YOU CAN'T MISS!

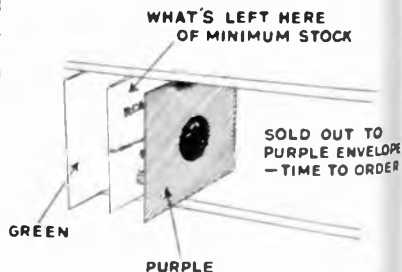

IN SOME CASES

your maximum stock of a Standard Single is ONE RECORD. This record should be housed in a green stock envelope, properly identified on the tab. When the record is sold the green envelope goes into the Inventory Drawer with the purple envelopes and markers collected there. It's your flag to re-order.

IN THOSE CASES

where you want to put your entire stock of a selection in open display KEEP THE EMPTY GREEN STOCK ENVELOPE IN THE WALL RACK. Then when you sell one from the display fixture, and go to the wall rack to refill the fixture envelope, you'll be reminded that you have no additional stock on that item.

Time to reorder.

MANY DEALERS

prefer to put all standard records on open display fixtures into green display envelopes. It is more orderly, more inviting, looks more businesslike, and the heavier green envelopes reduce breakage. Then when a sale is made, the record is slipped back into a factory envelope for the customer to take away.



299

★ Fast selling "Hit Parade" records should be left in factory envelopes for quick handling.

A SYSTEM FOR BUYING "HIT PARADE" NUMBERS

GENERALLY, all popular records go through much the same sales curve. They go rapidly to a sales peak, then diminish gradually until they are no longer salable.

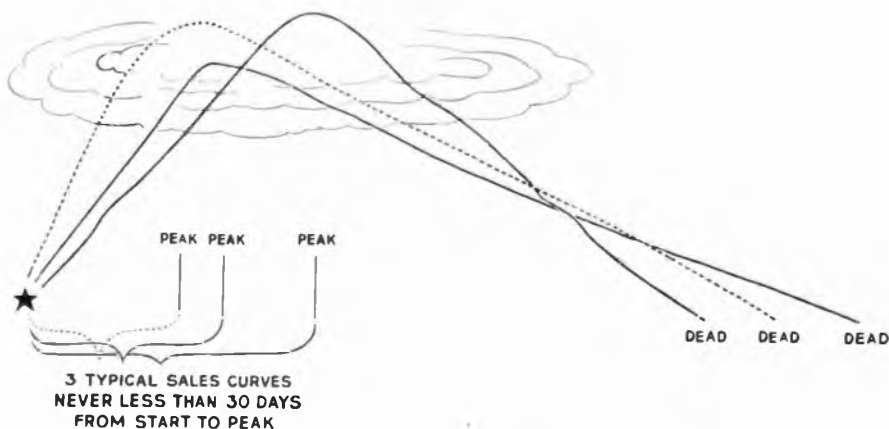

Some tunes rise to their peak sale in a matter of weeks. Others may take months. This much is sure . . . THE PEAK IS NEVER REACHED IN LESS THAN 30 DAYS. It always takes longer than that.

300 This being true YOUR STANDING ORDER for any new record should be the average first 30 day sale of that particular artist. This will give you enough stock to introduce the record in your market. If the record turns out to be a riot you have time to reorder and meet the demand. If the record turns out to be a dud you are certain of moving the minimum stock you have received.

ANOTHER FACT,

AND THIS IS A GOOD ONE:

THE DEMAND FOR A NEW POPULAR RECORD
AFTER IT HITS ITS PEAK WILL EQUAL THE
DEMAND FOR IT WHILE IT WAS CLIMBING.

In other words, you can sell as many of a given popular record **AFTER** it reaches its peak of sales as you did from the time it began to the time it reached its peak.

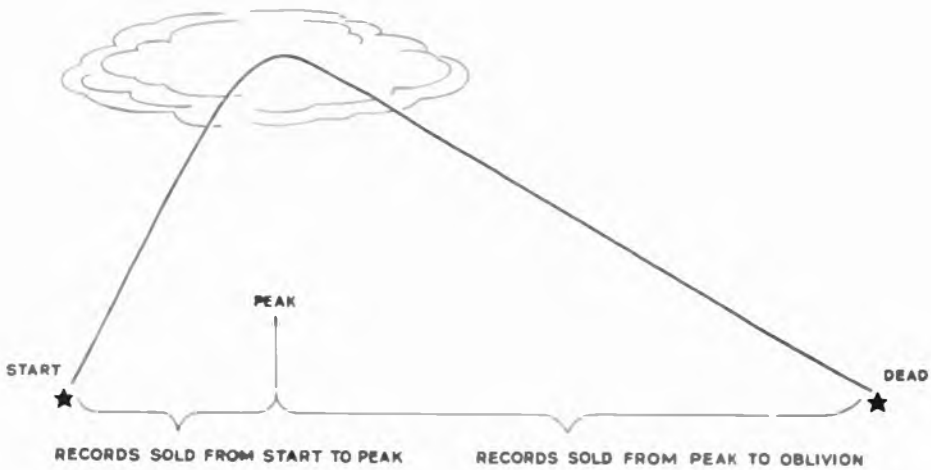

SO: While popularity of a record is on the increase, you should always have as many records on hand or on order as you have sold. Then when the peak is reached . . . without buying more . . . you will have enough records in stock to fill the demand for the rest of the life of the number.

301

IF YOU CHECK THIS SALES CURVE and order accordingly you will not be out of stock when the record is **most** in demand and you will not be stuck with unsalable merchandise when the record is dead.

*You will sell as many records after
the peak as you sold reaching the peak*

THE IMPORTANT THING IS TO KNOW THE POINT WHEN A RECORD REACHES ITS PEAK OF POPULARITY IN YOUR STORE



YOUR WHOLE ORDERING
PROCEDURE IS BASED
ON THAT POINT

HERE'S A WAY OF
FINDING THAT POINT:

1 An 8 x 5 Hit Parade Inventory Card is created for each new popular release.

2 Every Monday morning your order clerk takes a physical inventory of each popular record. This inventory is entered on the card.

At most your order clerk will be taking inventory on 30 titles. In most stores this Monday morning count is a half-hour job or less.

Inventory Card

DATE	ON HAND	DATE	REORDER	DATE	INVENTORY	SALES	DATE	INVENTORY	SALES
5/14	500	5/6	500	5/17	390	110			
				6/19	208	192			

302

3 By subtracting the count from the balance on hand the previous week you can keep a check on how many are sold week after week.

4 The secret is to keep ordering on demand titles. Always have on hand or on order as many records as have been sold to that date.

5 Watch it! When weekly sales show a decline for a week or two

YOU KNOW THE ITEM HAS PASSED ITS PEAK

IF, WHEN THE RECORD PASSES PEAK

and your stock on hand and on order is the equal of the number you've already sold, you have enough to ride the record to its finish.

Inventory Cards are finally filed by artist, and twice a year you check them over to determine the average first 30 day demand for each artist. You revise your standing orders accordingly.

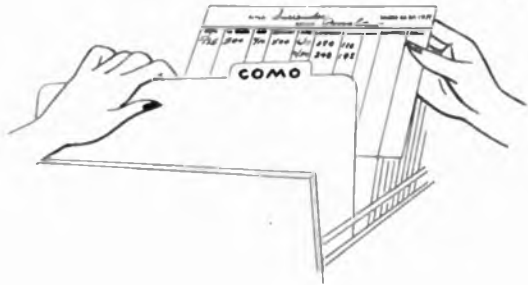

THIS SYSTEM may not always work accurately. Holidays, weather conditions and business conditions will alter the sale of records. Sometimes there is a lull in sales, then a new spurt of popularity on some tune. You'll need to watch each one individually.

303

The element of good business judgment cannot be eliminated but this system of buying popular merchandise will serve you well.

*YOU CAN TRAIN your least experienced girl to be your buyer. Using these formulae and with some supervision, she will do the job. This allows your most expert record sales girl to spend her time with your customers instead of your books.

That's the way it should be!

preparing for july inventory and re-evaluation of stock

During the summer months, when people spend a lot of time outdoors, business is likely to fall off unless the dealer plans for this period by pushing seasonal music fare and by promotion aimed at appealing to hot weather tastes.

304

July is the time of year when every dealer begins to plan for the inventory and a re-evaluation of his stock. In the period between June and the end of August there is a drop in sales activity due to the appeal of the outdoors, and the fact that people would rather go out for amusement than stay at home. Because there are still no portable record players on the market, it is obvious that the record buying public will still have to play their platters at home. If you are a new dealer, just take this normal curve of sales activity into consideration and plan accordingly. There are several ways that you can combat the drop in sales—by ingenious promotion within your store, and by using your mailing list for customer contact with interesting and intriguing ideas for summer music as expressed in clever mailing pieces.

Plan to revise your display's very def-

initely. Put out before the public some of the lighter material in both albums and singles, and where you have self-service racks with classification headings, plan a whole new set of classifications, and put up fresh signs on top of these racks. One very important thing to remember about records is that entertainment always has to have a new twist to it and you must change your racks and your displays frequently. Plan to change the location of the fresh classifications as well as changing the grouping itself so that the customer will be surprised and interested when he comes into your shop seeking musical merchandise.

Summer is an excellent time to plan and to push accessory displays and sales. Use every dealer help that is sent to you by the manufacturers, and give their goods the utmost chance to sell themselves. If it is feasible, give your sales force some incentive to push certain

items which you would like to move. For instance, one week make it a rule that the sales person must ask every record customer if he knows about record brushes and how they keep the surfaces of records clean and the grooves free from dust so that they get not only better playing but actually lengthen the life of the record—or with each sale see to it that they say, "What type of needle are you using? Can we suggest a new one?"

During all the process of presenting fresher material on racks and to the customer, and changing displays of accessories, etc., you are paving the way for the coming July inventory. You will find items in your stock which were forgotten but which are still extremely salable, and you also find, alas—unless you are a great exception—that there is some merchandise which will get lost in the shuffle, or which you over-ordered and could not sell. This will give you some idea of what your inventory problem will be in relation to returns to the distributors. It is the inventory which tells you dollar-wise what you have on hand, and music-wise what you have to sell.

SECTION II

Record inventory can be taken in two ways, by dollar volume with a breakdown in price units or, by item (title, label, price). A dollar and cents inventory of record stock can be taken very quickly because records have only a few price classifications at the present time—35c., 50c., 75c., \$1.00, \$1.50 plus tax. Since the advent of the newer independent record manufacturers, the pricing of ten-inch records has begun to vary from the long established 35c. and 50c. in the popular field. There are now 75c., \$1.00, and \$1.50 popular records. In the field of classics and light classics, the major record manufacturers have pretty well confined the price to 75c., and \$1.00 for the ten-inch records, and 75c., \$1.00 and \$2.00 (the new vinylite records). The placement on the record shelves of your record stock automatic-

ally groups the price classifications according to label and size. The dollar and cents inventory of stock on hand as compared to the figures of sales during the past six months and in comparison to the amount of records bought during that period of time, will give you ample indication of whether you are getting sufficient stock turnover for healthy record operation.

Popular records have an immense and frequent turnover, and it is not possible to estimate a definite figure of popular record turnover without taking into consideration the type of store, its location, clientele, amount of stock, etc. It is safe to say, however, that popular stock should never remain in the store long, as replacement should be constant. Classical and light classical record stock should be, of course, only those which you anticipate will have a constant demand in their field as standard classics and well-loved favorites. It is safe to say that a well-planned classical and light-classical record stock can have a complete turn-over at least two or three times a year, and with expert management and selling this turn-over can be increased to four or more. This depends upon your buying as much as your selling.

SECTION III—Stock Control

In order to be successful, every record operation which has as its basis a complete classical and light-classical library of the major record labels should have a planned inventory, which includes a maximum and a minimum for each item to be ordered. This inventory should be planned entirely in relation to that particular store and its clientele.

An ordering system which includes a control by maximum and minimum, operates in this fashion:—First, the dealer or the record buyer reviews with the distributor what items in that distributor's record catalog will be most suitable for the dealer's store. These records are listed both numerically and according to artist. It is upon this list that the dealer bases his future ordering.

your july inventory tells the tale

Most major record manufacturers and distributors extend a 5% semi-annual return privilege to all of their franchised dealers based on the number of records purchased by the dealer during the preceding six months. Because breakage must be taken into consideration within this same 5%, it is not too large a figure. On the contrary, almost all record dealers find that records received broken in transit and those records which are damaged or broken thru handling or demonstration in the stores will often account for much of the 5% possible return. Therefore if the dealer finds too many "dogs" on the shelf at the time of renewing his stock, it will be his unhappy dilemma to choose between returning the broken records for which he has legitimate return privilege, or returning the unsold or poorly bought records which are on the shelves due to mis-management.

Once again the dealer is faced with the results of his own and/or his sales-force's inexperience or lack of judgment in buying and inexperience or lack of training or enthusiasm in selling. As we have said in previous articles, phonograph records are definitely specialized merchandise that might well be called "intangible tangibles." It is the intangible quality of the phonograph record which renders it so difficult to choose correctly from a market of many possible preferences *the* record of a particular title or by a particular artist which will sell. Most tricky of all is the decision which must be made regarding the quantity to be ordered of each record. Phonograph records are sold as a

general rule in boxes of 25; if a dealer makes five poor selections in an order, it means that 125 records minimum have come to roost on his shelves—and he will find them at the regular period of stock review and inventory. Too many bad guesses puts him out of business.

Therefore it is necessary for every record operation to be supervised and under the constant care of a record sales person who has been trained in the business both of buying and selling record merchandise and the related merchandise in this field. By their decisions these record sales managers and buyers determine the success or failure of retail record operations. Unfortunately, there are only too few trained record sales-people in the field today.

Remember that at this time of year, the principal activities in most communities are school graduations, weddings, and plans for vacations. This means that thoughts are definitely turned away from the previous interest in musical entertainment in the home. The best strategy that any record dealer can use to combat this seasonal slump in record sales is to review his stock carefully and plan advertising, promotion, and display of light classics in single records and albums. Begin to lay special stress on popular music which is most desirable during the summer months. The stock inventory has a dual function: the dealer is not only able to bring to light much desirable record material for this period of the year—(many records which have lain unnoticed during the spring months)—but he is also able to evaluate his record stock in relation to turn-over value, and

whether or not he will wish to retain it after the period of inventory.

We will assume that the June review of record stock on hand has been made by the dealer or the sales manager who purchased these records during the past six months. Because it has been necessary to buy in quantity, due to the uncertain record pressing situation, no doubt many dealers have more unsold stock in single records on hand than they are aware of. Have your sales people pulled out their single record boxes in which 25 records came originally, from the many places in which they are now stacked, intentionally or unintentionally?

Happy the dealer who finds additional supply of standard records that can always be sold, but heavy the heart that finds multiples of 50, 75, or 100 in the accumulated boxes behind the counter, below the regular shelves, or back in the store room. These are records which must be taken into account to make the difference between operating with a profit or operating at a loss. It is possible that some distributors will be able to accept and resell some of the unmoved merchandise which you find hoarded in your shop. It is also possible that arrangement can be made with the distributors to return some of this merchandise, over and above the regular 5%, if it is immediately salable to another dealer. However, if it is immediately salable, why can't you sell it yourself?

Your July inventory will give you some picture of whether or not the many records which crowd your shelves are there because you have done a poor job. Let us hope that your inventory will show that you have found it necessary to replace again and again a well chosen record stock which has had a constant turnover. Trained buying and selling; regular checkup on stock, plus selling of every type of item in your record department; adequate self-selection display equipment for albums and singles; and the common ingredient of cheerful courtesy will make your record operation a success. And your July inventory will show it.

The following are some of the questions that the alert dealer must ask himself at the time of inventory:

1. What amount in dollars and cents, of the records I have bought in the past six months, do I find remaining on my shelves at the end of this period?

2. What portion of these records is salable?

3. Do I have enough single record display racks, displays, self-selection bins, etc.

4. Who has been doing the record buying? And at what conclusions do you arrive upon evaluating this record stock which is on hand as the result of this buying?

5. Are you guided too much by over-enthusiastic salesmen who tend to "load" you with each month's new releases whether your store can handle that much merchandise or not?

6. Do you use all of the dealer helps available from the major record manufacturers to sell these fresh releases?

7. Have you an active mailing list on which you can make weekly contact with your record customers and bring them into the store more frequently?

8. Do you have counter record lists from which your customers may choose any one of the new releases regardless of label? These cross list not only new releases but old standards as well, and very often bring to mind records for which customers might ask, and which you might otherwise not sell.

9. Do you train, or do you have someone who trains, the record sales force to know what is considered the standard popular record library, or the standard light classical or classical library in records?

10. Do you ever "shop" your own store to find out how customers are treated and whether or not additional suggestions are made when the customer asks for one record?

11. Is your store well lighted, equipped with adequate listening booths with good machines, well ventilated, and with record literature and pictures of record artists everywhere?

L. G.

record retailing institute

a series of articles

by the staff of record retailing
and outside authorities on specific
phases of successful record
merchandising

serving customers in the store

This article is designed to assist the dealer in serving his customers, new and old, in a manner that builds sales, wins their good will and brings them back regularly.

Sales ideas and suggestions are based on actual experience to successful record dealers everywhere. The methods are *now being used*. They are tested and tried. They will work for you because they are already getting results for other dealers.

Speaking of the record business, one enthusiastic young salesman said:

"Selling records requires skill, knowledge and understanding of human nature. You've got to deal with every kind of customer. You've got to know music all the way from Boogie Woogie to Beethoven. And you've got to know human nature because you are selling, not black discs, but music—fun, entertainment, pleasure, enjoyment. It's not a job—it's a career."

He's right; but let's see why.

1. *A record sale is an "emotional" sale.*

The human element enters into every sale of records. You can't "talk people into" liking certain music. You must understand their personal tastes, viewpoint, and interests and go along with them.

2. *The record business is a "repeat" business.*

A record department lives on its repeat business. "One-time" sales aren't profitable. Your success depends on customers coming back, again and again and again. They must be *satisfied* with the service. They must be *pleased* with you. They must look to you as an "authority" on their kind of music.

3. *The record business influences other store business.*

When customers come into a store regularly and often, they are attracted to other departments. A good record department builds trade for the entire store.

Follow the suggestions in this article for handling your customers and building up your record sales. Your entire store will benefit from a better record department.

DON'T CONFUSE SALESMANSHIP AND HIGH PRESSURE

Let's get one thing straight right here at the very beginning. The man who says, "I never try to *sell* my customers because I don't believe in high pressure" has the wrong idea of salesmanship.

Good salesmanship is *never* high pressure. In such an essentially "repeat" business as the record business no one could be a worse salesman than the one who nags his customers into buying.

GET THE RIGHT SLANT ON YOUR CUSTOMER

Before you can help a customer intelligently you've got to know his interests and tastes. That's very important. There's no quicker way to antagonize a record customer than to ignore his preferences.

But don't jump to conclusions. If a customer asks, "What's popular right now?" don't assume too quickly that he wants dance records. Just because someone asks for a Heifetz, don't assume he is solely interested in violin music. Just because a customer buys dance records, don't take for granted he is interested in nothing else.

Instead, just ask one simple question: "What sort of music do you like?"

Do this casually and informally. But let the customer see that you are asking because you are *interested* and *want to be of service*.

Then, *listen to what the customer tells you*. Really listen. Remember, you are laying the groundwork for all your future contact with him. What he tells you—in words or by his manner—will be worth money to you.

Once you know what the customer likes you have "sales ammunition." You can tell *what* to suggest and *how* best to please him. More than that, your conversation—even a short one—should have brought you together. It gets the sale off on a good footing. He should know you are sincerely interested and he will unconsciously feel he is going to get good service.

GET THE SALE OFF TO A GOOD START

"Always greet the customer *promptly*."

Recognize the presence of every customer as soon as he enters your department, regardless of how busy you may be with other customers. Look up, smile pleasantly and say, "I'll be with you in a minute." Then get to him as soon as you can.

Give the customer interested, concentrated attention while he is telling you what he wants. If he asks for a particular record by name or number, pull it out promptly from stock.

Hand the record to the customer. Put it in his hands. Let him read the label, feel it, touch it, look at it.

If the customer doesn't know what he wants, make a quick first selection after consulting with him about his preferences, and give him a record to look at while you are searching for others.

Always utilize the time the customer takes in examining the first record to find other records. By the time he has finished, you are ready to hand him several more with a short comment, "We also have these new records by Toscanini." Or, "Here are some other recent Toscanini recordings."

310

By doing this you make the additional records an integral part of the sale. The customer doesn't think of them as "extras."

Suggest he listen to the additional records. (Unless he indicates that he wants to hear it, you can assume he doesn't want to listen to the one he asked for.)

But be sure to put the emphasis on *listening*, not on *buying*.

DON'T SAY:

"Here are some other Toscanini records you may like to *buy*."

DO SAY:

"Here are some other Toscanini records you may like to *hear*."

If he accepts your suggestion and goes into the booth with the records, you have laid the groundwork for additional sales within the first five minutes.

HOW TO HANDLE CUSTOMERS IN THE BOOTHS

Your attitude towards customers should be that of a host or hostess to a guest. One saleswoman expressed the idea this way:

"I always think of myself as a hostess. If I am entertaining a guest in my home, I don't send them into an unfamiliar room alone to take off their wraps. I go with them, turn on the light, see they have everything they need and ask them to call me if they need anything. Then, if I am busy with other guests, I excuse myself and leave them alone—carefully watching for the moment when they join us in the living room."

Always conduct a new customer into the booth. The booth is less formal than the counter so this is your opportunity to draw out the customer, set him at his ease, and put the sale on a friendly, personal basis. Naturally, you should not waste time but you should capitalize this opportunity to get acquainted and build up confidence.

When entering the booth with the customer, observe the following rules:

1. Make sure the instrument is in good working order and that the needle is new.
2. Make sure the customer is comfortable, provided with a chair, has cleared shelf space on which to handle the records, and a good light.
3. Make sure the customer understands how to operate the machine.
4. If the customer is trying an album, place the first record on the machine and indicate the second record to the customer.
5. Start the record, close the lid of the instrument and shut the door of the booth, saying as you leave, "I'll be right here at the counter if you need me. Ask for more records if you'd like to hear something else while you're here."

CAPITALIZE THE CUSTOMER'S VISIT TO THE BOOTH

If you are busy, leave the customer alone in the booth.

But if you are *not* busy, cash in on this chance to get better acquainted with a new customer, or to introduce additional records.

Do it this way:

—As soon as a record is finished—never open the door while a piece is playing—open the door and say, "How do you like it?" or something similar. If the customer is enthusiastic, assume the sale of that record. If he doesn't like it, find out *why*. His comments will give you further clues to his likes and dislikes.

—Lay down the records you have brought in with you and say, "While you are here you may care to listen to these, too. I think you'll find them particularly interesting."

Even if you are busy with other customers, keep an eye on the booth where you have a customer. Notice when he leaves the booth and cash in on the pleasure he has had. Look up and smile. If you are busy, indicate you will be with him in a minute. If you can speak at once, by all means do so, even if it means leaving another customer alone for a second. Ask him, "How did you like it?"

If he says he liked the records, assume that the sale is made. Take the records from him and start wrapping them. If he didn't like them, find out why, and suggest other records.

This may seem like a minor point but it frequently is important. Sometimes a customer returns from a booth, pleased and thrilled by the music he has heard. What happens? The sales person is busy and ignores him, or takes his money and wraps his records with a mumbled, "Thank you, come again." The customer feels let down. His pleasure is gone. All the good work the sales person has done at the start of the sale is lost.

Don't forget your customer when you have sent him to a booth. Keep on giving him service as long as he remains in the store.

WHEN TO SUGGEST ADDITIONAL ITEMS

You have three good opportunities to suggest additional items, although you won't use all three of them on one customer on any particular visit:

1. *When the customer comes to the record counter.*
Suggested records at this stage of the sale should always be "closely related" to the one requested by the customer.
2. *When the customer is in the booth.*
When you cannot think of "related" records when the customer comes in, dig some out as quickly as possible and take them into the booth. Suggest that he listens to them, "while you are here."
3. *When the customer is completing the purchase of records.*
If you have done a good job in suggesting additional records at points 1 or 2, naturally you won't do it here. However, if you didn't have a chance to do it earlier, do it now. The end of the record sale is always the best time to suggest accessories.

While these three points in the sale are obviously good places to make suggestions, your customer *at any time* may give you clues which point the way to additional sales. Be on the alert. Take advantage of such opportunities no matter *when* they occur.

ADDITIONAL RECORDS ON TIME PAYMENTS

One of the commonest reasons for customers limiting their orders for records is that they feel that they have spent enough for the time being. Many dealers are selling records on time payments when the volume of sales to an individual justifies this and the soundness of the customer's credit is established. Obviously, now that the popularity of record libraries has made single purchases of records and albums amounting to \$25.00 more and more a common occurrence, the question of convenience in paying must often arise. Many a customer who could well afford to place a substantial order is restrained by the thought of immediate convenience. Realizing this, dealers are more and more meeting the situation and increasing their record sales by arranging for payments on time.

When the customer has proved worthy of the credit, lists of records and albums can be prepared with a view to appeal to the tastes and musical preferences of the customers, and submitted for consideration on the basis of an easy payment plan. Even if the list is not sold, direct selling effort has been made and the customer has been stimulated and will probably buy at least part of the records suggested, or perhaps all at a later date, and the sales person has a definite quota to aim for with the particular customer.

312

WHAT ADDITIONAL RECORDS TO SUGGEST

Suggesting additional records requires skill, experience and sound musical knowledge. But here are a few rules that will help you:

1. *Suggest "closely related" records first.*
Another Tommy Dorsey; another Toscanini; another Lily Pons, and so forth.
2. *Suggest "associated lines."*
Another "name" band; another symphony by the same composer; another operatic selection; another type of popular vocal music and so forth.
3. *Suggest records featuring the customer's major interest.*
A wider selection of popular records; symphonies by other composers; operas by other composers; instrumental selections by other composers; other vocal music and so forth.

4. Suggest the "well-rounded record library."

Broaden your customers' field of interest as you get to know them better. Encourage them to develop a well-rounded library. Thus, the symphony collector branches out into opera; the popular customer starts collecting classical music, etc.

Naturally, you are not going to suggest all these to a customer at one time. With many of your regular customers, who return week after week, you frequently will not want to suggest extra records. But do it "every so often." Start with 1 and 2 and work down the list. Aim to build up the customer's library over a period of weeks and months.

PRACTICE WORKING OUT "ENSEMBLE" GROUPINGS

Teach your customers to use the catalog. Show them how to find other records by the same artist or composer.

Use your imagination and creative ability. If you have a "regular" customer who likes French opera, list all the records you have that will interest her. If you know someone devoted to piano concertos, make a list of those. Use these lists when those customers come in and help them build a fine library.

BUILD UP YOUR ALBUM SALES

Here's a good rule to follow in promoting the sale of albums:

Always show your customers an album instead of a single record when they request a record contained in an album.

Know your albums so thoroughly that you can do this *immediately* when the customer asks for a record. Lay the foundation for a larger sale the first minute of your contact with the customer. Do it like this:

"The record you asked for is in this Sibelius album. You might like to hear some of the other selections?"

OR

"That record is in this album. Since you like Bach, you'll enjoy hearing the whole collection while you're here."

If the record requested by the customer is not contained in an album, you can still introduce an album of related music:

"Here is the record you asked for and while you're here you might enjoy listening to the selections in this album. There are a number of other organ pieces as fine as the one you have chosen."

It is often as easy to sell an album as a single record. One sales person said:

"Not only do I make a larger unit of sale but I find that by showing my customers the advantages of buying album sets instead of single records, I am educating them to buy all their records in sets. After a while, they take this larger unit of sale for granted and take no more time to decide on an album than they formerly took to purchase one record."

Try this. Educate your customers to think of albums instead of single records. Show them the added pleasure of listening to an entire symphony, or a complete group of selections on one particular subject.

Encourage your customers to develop the "collector spirit." People love to "collect" things. Encourage your customers to become collectors of records. They will soon boast about it to their friends; be eager to add new things to their library; and become a lucrative source of business for you.

Capitalize the decorative appeal of albums. Say, "These albums are as beautifully bound as fine books. They not only keep your records in good condition and well

organized, but they also add a rich decorative note to your home—something you will be proud to display on your shelves.”

ALBUMS ARE ONE OF YOUR BEST MEANS OF DEVELOPING STEADY, SATISFIED CUSTOMERS WHO WILL RETURN TO YOU AGAIN AND AGAIN. DO NOT NEGLECT THEM.

HOW TO SELL MORE ACCESSORIES

Introduce accessories after the sale of records is completed. While you are wrapping the records—before ringing up the sale and making change—remind the customer of the accessories which will increase his enjoyment of the music and add to her pleasure in her record library.

You have four major types of accessories to suggest:

1. *Articles needed to play the records with maximum satisfaction.*

Needles: You are doing your customers a helpful, thoughtful service when you remind them of needles. Many successful stores make it “standard practice” to suggest needles after *every* record sale. It’s a small sale but it aggregates a sizable amount over a period of time. More important, it builds customer good will. Don’t limit yourself to the cheaper needles. Show customers the advantage of better needles and longer wearing needles. *Record brushes:* Educate your customers to take care of their records. Show them how. Supply them with the equipment needed. This is a real service to customers as well as extra sales for you.

2. *Articles needed to store the records in the customer’s home.*

Storage albums, record envelopes, etc. Find out what facilities your customer has for keeping her collection. “How do you keep your records—in albums, on shelves, or do you have a cabinet?” If she has shelf space, she needs albums. Make her appreciate the need for caring for her records properly—just as she takes care of her fine china or sterling silver. Point out that there is less breakage when albums are used. Point out that with albums, records may be stacked vertically to prevent warping and other injury and for ease of access.

Always make sure the customer has *enough* storage equipment. As she collects more records, see that she gets more equipment.

3. *Articles designed to increase the customer’s knowledge of music.*

Suggest books on music; magazines; subscriptions to musical publications and so on. But don’t create the impression that you want to “educate” the customer. Adopt the attitude of being so interested in his musical preferences that you want to give her special service. In distributing the catalogs, point out their advantages as reference books, also. Keep posted on new books about music and talk about them. Have them available or on display. It will repay you many times over in increased interest in records.

4. *New or additional instruments.*

Be alert for opportunities to sell the customer extra or better instruments. Don’t take the attitude, “I don’t sell instruments so it’s nothing to me if he needs a new one. I’d rather he spent the money on records.” This is shortsighted. If a customer buys a turntable for the game room, a small phonograph for the nursery, or a portable for the summer cottage, you can sell him more records. Again, *the better the customer’s machine the more he will use it and the more records he will buy.*

Keep your eyes and ears open for “signals” that the customer is a prospect for a better or an extra radio-phonograph. Typical signals are:

"It sounds better on your machine than on the one at home."

"The children turn the living room into a dance hall. I wish we had a turntable for the game room."

"It annoys my husband when we play the baby's nursery rhymes in the living room."

"We can't use records at the cottage because we haven't a portable phonograph."

STARTING OFF THE CUSTOMER WITH A NEW INSTRUMENT

Each day, more people are discovering the new phonographs and combinations—people who haven't listened to records since the days of Alma Gluck and "Casey at the Bat." It is your responsibility—because it is good business if for no other reason—to see that these new discoverers are not disappointed.

Whether they find that pleasure which their new instrument can and should bring to them is largely up to you. What you do will largely determine whether the new owner will discard his "novelty" for another "game" in a few months or turn into a music lover and record collector whose pleasure in his instrument mounts from year to year and whose record library grows faster and faster as his enthusiasm increases.

WHICH KIND OF CUSTOMERS DO YOU MAKE OUT OF THE PEOPLE WHO ARE TURNED OVER TO YOU BY THE INSTRUMENT SALESMAN?

RULES FOR HANDLING THE NEW INSTRUMENT OWNER

Here are four rules that will help you in handling the new instrument owner:

1. *Draw out the new interests and tastes before showing records.*

Refer back to the section called "Get the Right Slant on Your Customer." The suggestions made there about regular customers apply with particular force to the new owner.

2. *Make him feel at ease.*

Naturally, you wouldn't consciously high-hat a customer. But be mighty careful not to do or say anything that will permit a customer to suspect you of it. Don't talk over his head about composers or music he's never heard of. He knows *some* music—even if it's only Home Sweet Home—or he wouldn't have bought a phonograph. Find out his musical level by starting low and working up. Your main job at this stage is to gain his confidence and make him feel at ease in your record department.

3. *If you give advice, be sure it is good.*

Don't suggest your own personal favorites unless your tastes are conservative. Until you know your customer, avoid "queer" things or "modern" music. Play safe at first. Beethoven is "safer" than Stravinsky; and unless you are sure of your ground, Victor Herbert is better than either. Remember that the customer's attitude toward his new instrument and towards your store depends on his getting an initial selection which is pleasing to him and his family. Use your catalogues freely in helping him make a selection which will give him pleasure and lay the groundwork for the future.

4. *Give maximum good service to the new customer.*

Remember, you must make the customer like his machine, like his records, like your store and like you. You want him to become a regular customer and a record collector. That means top-notch, interested, sincere, courteous service. Be particularly careful to avoid clerical errors, mistakes in his order, delay, misunderstandings or other problems. Do everything you can to make the new customer feel that your store is the ideal store in which to buy records.

When the new customer returns, continue giving this good service. Specifically:

- Don't fail to recognize him and call him by name whenever he comes into the store.
- Don't fail to ask him how he is enjoying his new instrument and the first records you sold him.
- Don't fail to remember what the "next step" in building up his collection should be.
- Don't fail to give him as sincerely interested and enthusiastic service as you did the first time—even though he now is buying only one record at a time instead of ten.

NEVER FORGET THAT YOUR BUSINESS IS A "REPEAT" BUSINESS. EVERY SALES CONTACT SHOULD BE HANDLED IN A WAY THAT WILL BRING THE CUSTOMER BACK.

HOW TO HANDLE DIFFICULTIES AND AWKWARD SITUATIONS

Don't worry over awkward situations and difficulties. They *will* happen occasionally and they are annoying. But such happenings often give you your best opportunity to build up customer good will and establish a reputation for good service.

Suppose, for instance, the customer asks for something not in stock. Suggest, and try to awaken the customer's interest in, other recordings of a similar nature. Frequently, you'll make the sale. If not, however, promptly place an order for the desired record. When it comes in, notify the customer and arrange for delivery. The customer will be pleased at the "special attention."

Or suppose the customer has a complaint. Listen to his troubles. Be sympathetic and understanding. Avoid argument and do all you can to help him. When you handle things this way he becomes a more loyal customer, *because of the complaint and the way you handled it.*

Difficulties give you one of your *best* opportunities to establish yourself on a firm footing with customers and to win their lasting gratitude and good will.

Here are a few Do's and Don'ts on how to handle awkward situations and difficulties:

DONT

Don't argue. No matter who wins the argument, you lose a customer.

Don't lose your poise, self-control or temper.

316 Don't contradict a customer or give the impression that you don't see his side of it.

Don't magnify the customer's objection by talking about it too much.

DO

Be sure you understand the customer's grievance before you start action. Find out the real trouble. Get him talking and listen carefully.

Keep your poise and pleasant, courteous manner with the customer at all times. Use the "Yes—but" method. "Yes, I can see how you got that impression, but—" "Yes, I appreciate your viewpoint, but as a matter of fact—"

Answer an objection clearly but briefly; then swing back to constructive selling.

Think back over your relations with the stores where you do your buying. How do you feel towards those where some difficulty came up which was handled to your satisfaction? Because they gave you good service, under unusual circumstances, you are even more loyal to those stores than you were before. Isn't that so? *Your* customers will feel the same way towards *your* store.

WHEN THE STORE IS CROWDED

Frequently it seems that just when you are busiest, more customers come in demanding attention. Yet such busy periods can be handled so smoothly that

each customer will feel that he or she is getting prompt, courteous service. To do that, keep your head; divide your attention among several people at once; be strictly impartial.

Here are some pointers that dealers and sales people find effective:

- Greet each customer *as soon as you see him*, if you are busy. Then he won't feel unnoticed or neglected.
- If a customer asks for a specific record by name or number, *assume* he knows it and doesn't want to try it. Take it from stock, put it in an envelope, pull out some additional records along related lines and invite the customer to listen to *them* "while you are here." This not only sells many extra records but cuts booth "listening" time on things which the customer has already decided to buy.
- Hand the hesitant customer a catalog, or supplement or booklet which lists a number of records along his line of interest. *Find the right place for him* and let him study the catalog himself. This leaves you free to wait on someone else in the meantime. When you are free of your other customer—or can snatch a few seconds—return to the one studying the catalog and say, "Have you found some you like?"
- Ask regular customers if they will go to the booth alone, saying, with a friendly smile, "Booth four is empty. You can manage it yourself, can't you?"
- When customers are waiting for a booth, give them something to do: "While you're waiting maybe you'd like to look at this new album that just came in." Or: "this new copy of the Review."
- You can keep several customers happy at once by giving each something to handle, to look at, or to read. Call attention to your open-counter pile of records. Get them thumbing through releases. Invite them to examine the titles of the shelf of albums. Call attention to your newest hangers or the Hit Parade placard or other material listing new records.
- Keep smiling. Be pleasant, self-controlled, businesslike. Take customers in the right order. Even though customer Number 3 is very wealthy and buys freely, customer Number 2 is next and should be taken in turn. Don't play favorites. People are used to waiting their turn, but they bitterly resent being done out of it. Be scrupulously impartial when your counter is crowded with customers.

PLEASING THE "VERY-MUSICAL" CUSTOMER

By "very-musical" we mean either the classical customer or the popular customer who knows, or thinks he knows, a great deal about his particular type of music. An "authority" on hot music is very like the expert on sonatas—they both know what they want and want what they want. Both are easily antagonized. Both are profitable customers—if handled correctly.

It's bad to argue with *any* customer, but particularly so with this customer. Sink your own likes and dislikes entirely. Be guided by his tastes and preferences at all times. If he expresses opinions, listen respectfully. Defer to his special knowledge:

"I don't need to tell you that this is one of the hottest numbers this month."

"As soon as this came in, I knew you'd be interested because you're so well-informed on chamber music."

A "very-musical" customer may be interested in one specialty alone but many of them have a broad range of interests and you can sell them many types of records.

If you handle such customers tactfully and competently, they will buy all their records—as well as their other musical needs—from you.

One thoughtful record sales girl had this to say of the professional people and real music lovers who come into her department:

“Every musical customer helps me learn something about my business. A church organist has taught me a great deal about organ music . . . the jitterbugs are my best source of information on hot music . . . the members of the park band have helped me know the different instruments. Now I can remind my customers that such-and-such a record has a good trombone or horn solo in it. I have an elderly customer who is crazy about Italian opera. I’ve learned from him how to talk more intelligently about that. After a musical customer has been in, I look things up at night. Then, next time he comes back, I can talk a little more intelligently about his interests.”

This sales girl is doing more than improving her own education—she is selling more records. Why? Largely because of the way she handles her “very-musical” customers. She lets *them* tell *her* things about the records she sells them.

WIN THE CONFIDENCE OF THE HESITANT CUSTOMER

A skillful sales person will “educate” her customers to better music. But she doesn’t do this in any “schoolteacherish” manner. If she did, her customers wouldn’t come back. She does it tactfully, indirectly, and by suggestion.

This is particularly necessary with the hesitant customer. The hesitancy often arises from a very human weakness—timidity about pronunciation of unfamiliar or foreign words.

Follow these proved methods in handling such customers:

1. *Avoid foreign terms or unfamiliar words.*

Just because words like Scheherazade are part of your daily life, don’t assume that they are familiar to the customer. Whenever you have to use an unfamiliar word, let the customer see it in writing. Show him how to look up pronunciation in the catalog, so he becomes more confident in this regard.

2. *Avoid showing off your superior knowledge of musical terms.*

Don’t talk over the head of a customer with a limited musical knowledge. Your personal satisfaction in demonstrating that you are well-informed won’t balance the lost customer who is afraid to come back for fear of being “high-hatted.”

3. *Stick to well-known names and titles until the customer feels more at ease.*

Introduce unfamiliar composers and artists gradually. Start with names and tunes he recognizes. People prefer music they have heard before.

4. *Encourage the customer to select things from the catalog.*

Get the customer to select and listen to records of music new to him. Even if he doesn’t buy them immediately, this will build up his appreciation of music.

5. *Suggest outstanding programs he can listen to.*

“Toscanini is giving an all-Sibelius program on the air this Saturday night. You know—the great Finnish composer. I’d be interested to know what you think of it.” “They’re going to play Beethoven’s Fifth Symphony at Municipal Park tonight. Drop around with your girl friend and tell me what you think of it.”

Once you make friends with the hesitant customer, he will trust you and come to you for help. Take a little time to encourage and develop such customers. They will be firm friends and excellent customers.

POPULAR RECORD CUSTOMERS

So far we have been talking chiefly about classical customers, although the same basic selling methods apply to all kinds.

The popular customer, also, may be someone who is positive he knows all there is to know about his kind of music. If a customer doesn't want advice, by all means defer to his judgment—whether he's devoted to Duke Ellington or Koussevitzky. Make only indirect suggestions and limit them strictly to the field in which he is interested. Let *him* take the leadership.

But among popular customers, as well as among classical, there are many people who don't know what they want. These customers welcome intelligent advice and help. You are giving good service when you help them make a good selection.

With the popular customer, as with the classical, *find out what he wants.*

When the customer says:

"What's new?"

You should:

Make sure that you know the *kind* of music he likes. Then suggest some of your popular new releases of that particular type.

When the customer says:

"I want some dance records for a party."

You should:

Find out the tastes of the dancers—rhumbas, waltzes, fox trots, jitterbug, etc. Suggest music which is good to *dance* to (rather than merely good to *listen* to) with the emphasis on dancing quality rather than "newness." The best dance records of the type they like may be two or three months old.

When the customer says:

"I want a half dozen new records for a gift."

You should:

Find out whom the gift is for: age, sex, and tastes. Will they use the records for dancing, or just listen to them? Are they for "background" music for a bridge party; for a weekend "hostess" gift; for kids away at school? Once you know the tastes and habits of the person to receive the gift, you can select records that will be sure to please.

Sometimes, record sales people who are real music lovers themselves, make the mistake of belittling popular customers, although their business is just as profitable as that done in Red Seal records. Others cater to the popular customer, give them the kind of music they want and—*without appearing to run a school*—gradually enlarge their customers' tastes to include better music. Eventually, their popular customers become Red Seal fans.

It can be done and *is* being done. But don't attempt it if you have a "reformer's" attitude. It requires tact, a thorough knowledge of music and an ability to judge people. There are no "rules" for "trading-up" a customer's musical tastes; it is highly individual and very personal.

But here are some suggestions:

With customers who like sweet music:

With customers who don't "understand" opera but want to learn:

To a blues fan or torch singer fan:

Start "trading-them-up" with the Strauss waltzes and Liszt and similar composers.

Start them on Gilbert and Sullivan.

Suggest fine old melodies by famous singers.

With a hot-jazz enthusiast in the high school orchestra:

Open his eyes to great orchestral music: Bolero or Blue Danube.

Never let a customer suspect you are "educating" him. Observe his tastes and suggest something else casually. "Since you like songs, you'll enjoy this Habanera from Carmen. Just listen to Gladys Swarthout a minute . . ."

TURN YOUR JITTERBUGS INTO PERMANENT CUSTOMERS

Most dealers say:

"We like kids. We get along all right with them in our homes and we don't have any trouble with them in the store. Besides, it's good business to cater to kids. They spend their allowances on dance records now. When they go to college they'll start buying albums. Later, they are going to be established citizens in our community and our business will depend on them. If we're sympathetic now when they're just beginning to be conscious of music, they'll stick with us when their tastes improve."

That's sound. People who talk about the jitterbug "problem" frequently do not have the right attitude towards it. Remember, the parents of the jitterbugs are also your customers. If the young people complain that your store is antagonistic, the parents will resent it. On the other hand, if you are popular with young people, you'll get their present and future business and also win the good will of their parents.

Moreover, you *will* win the approval of most parents in your community by making an effort to trade-up your jitterbugs to better music.

You *can* develop your "youngster market," if you handle it intelligently. Here are a few practical tips:

- Have turntables for the kids, so they can play records themselves while you are busy with other customers.
- Cater to their market by making new releases, hangers, the Victor, Bluebird, and Hit Parade placards easily available, so they can find their favorites with a minimum demand on your time.
- Post a few tactfully worded "rules for jitterbugs," courteously asking them to respect the desire for quiet of those in the booths, requiring that all records be wrapped before leaving the store (to prevent slipping them under jackets, or an extra one in an envelope); and suggesting care in handling records. They will respect you the more for maintaining order and will cooperate when they discover you are sincerely sympathetic to their interests. If any real disciplining is called for, it should of course be handled by the dealer himself, whose authority is recognized and respected.

320

SELL THE WHOLE FAMILY

Borrow a leaf from department store gift departments. After the sale of a gift is completed, the sales girl asks the customer, "Whom else do you have on your list?"

Adapt this idea—particularly around Christmas time—to the selling of records. After you know your customer and have won his confidence, ask: "*Whom else in your family listens to music?*" and follow that up with, "*What kind of music do they like?*" Then you've got something on which to base specific and suitable suggestions.

Go through the whole family this way. Point out that you have Victor records for the nursery, for the dance crowd, for the grandmother who loves church music. Suggest that the maid will be less homesick if she can hear some of her native folk songs in her own language. Point out the need of popular music for entertaining

purposes. Suggest records for his wife to play the next time the club meets at the house. Remind him of songs for special occasions; patriotic songs; humorous songs; novelties; songs which will start the whole crowd singing the night they have the wiener roast . . . all on Victor and Bluebird Records.

You'll do this almost automatically if you'll *think of your customers in terms of families*—not as individuals. Each member of the family has different tastes, special favorites. See that the family record library caters to all of them. When a customer comes in, be more than a sales person; be a family friend, giving them music, entertainment, fun. You can say, "I have a new Spalding you're going to like, Mr. Black and Mrs. Black will be interested in this new Flagstad album. And, by the way, Bill asked us to remind him next time we got in some new Dinah Shore records."

When you can talk like that to your customers, you're going to sell families, not just individuals.

BRING YOUR CUSTOMERS BACK

Every time you wait on a customer, ask yourself this question: "Am I giving the kind of service that will bring him back to my store?" Bringing them back is not difficult. Just follow the suggestions in this manual and give them the kind of service we've been talking about.

Go one step farther; *plant the idea in the customer's mind that he is going to come back*. Throw out suggestions which convey the idea indirectly:

"Some day when you have time, you'll want to listen to this straight through."

"I'll be on the lookout for good rhumbas and have some ready for you next time you come in."

"It's a good idea to get the hang of this catalog; then when you come in again you can look things up yourself."

"You'll eventually want the whole opera, probably. Maybe you can get another next time you come in."

"When you come in next time, just ask for me—I'm Miss Smith—and I'll be glad to help you."

"I suppose you'll be in again soon? We'll have some new Tibbett releases that you'll want to hear."

"The interesting thing about records, Mrs. Jones, is that we always have something new. Drop in any time you're shopping in the neighborhood. I'll always have some new songs for you to listen to."

"Naturally, you want to keep posted on the latest dance records. Stop in next week and we'll have some new ones for you."

Such comments are the good host saying, "Come again soon; we'll be glad to see you."

One more point—when the customer does come back—*remember him!* Call him by name, if possible. If not, at least give him a smile of recognition. Say, "*Glad to see you again. Are you enjoying those new records?*" A cordial reception on the return visit encourages the customer to come back a *third time*. Soon it becomes a habit.

BUILD FOR THE FUTURE

One of the most engrossing things about the record business is that you never stop learning. The more you know, the more you *want* to know. Always new, always different, it is one of the most fascinating professions in the world.

There is no cut-and-dried formula for success in any business—and the record

business is no exception. We do know, from actual experience, however, that the following guide posts will help:

1. *Maintain a "listening ear."*

Play records in your spare time. And while busy at your counter, listen "in the back of your mind" to the records being played in the booths. Learn to recognize music by its theme or melody. A good "musical memory" can be developed.

2. *Be sincere, enthusiastic and energetic.*

These three—sincerity, enthusiasm and energy—are the outstanding traits of a successful record "sales personality." Develop them until they are the dominating traits of your character during business hours.

3. *Develop a real desire to give good service.*

A sales person who thinks of his customer instead of himself—who tries to please—who sincerely wishes to help—is bound, sooner or later, to win the rich rewards of larger orders and steady customers.

Remember the words of the salesman quoted at the beginning of this chapter. "Selling records is not a job; it's a career." If you consistently and persistently follow these three guide posts, you'll make it so. Success to you!

RETAIL DEALERS

By Mail Order

Direct — AT

Distributors

Price — 37½c.

Retail price 75c.

plus tax

Write today for

Latest Releases



University Recording Company
HOLLYWOOD 28, CALIFORNIA

periodic mailings to “sleepers” are energetic reminders

This unsolicited dealer story from International Records Agency, Richmond Hill, New York, shows how a mailing list can be made to work efficiently.

To the average record dealer, who relies chiefly upon passing traffic, newspaper copy, and those customers who attach themselves to his establishment, the use of a mailing list is a subordinate activity.

The mailing list is important, however, to the success of any dealer whose service goes beyond the scope of ordinary neighborhood trade. It is the very life of a

concern like ours, which, in times of peace, concentrates upon gathering together from all quarters of the earth, unusual records of particular merit and making them available to record collectors of discernment everywhere.

It is obvious that in any such business the mailing list assumes formidable proportions and that, aside from imposing a tremendous physical burden upon the

This graph shows how Albert J. Franck of International circularizes his dormant list. Light shaded portion is active list; dark blocks indicate alphabetical portion that is given a shot every seventh mailing.

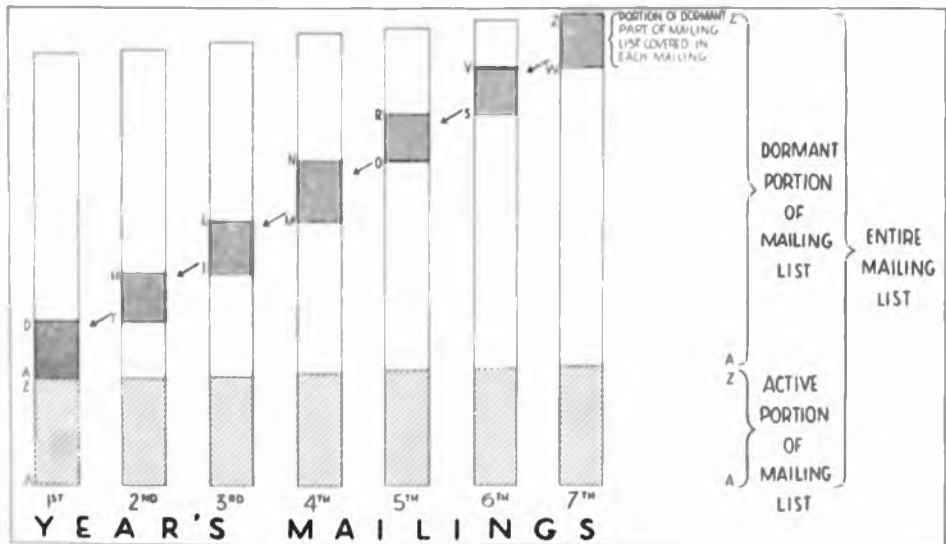

organization, it can become costly and relatively unrewarding unless it is planned with care and understanding. This is of utmost importance when the mailings consist of the dealer's own publication, manufacturer's supplements or other organs of publicity.

A well-conceived house organ or mailing piece usually includes, in each issue, something likely to appeal to every type of trade to which a particular dealer caters. Experience shows that if three consecutive mailings fail to elicit business or some other adequate evidence of vital interest from a new name, that name may just as well be transferred from the file of active and new clients to the "dormant" file.

To circularize the "dormant" file is an extravagance. On the other hand, to discard it is to eliminate a possible source of revenue. Experience seems to support

the belief that many of these "sleepers" need only an energetic reminder to produce renewed interest. We manage this by circularizing roughly one-seventh of our "dormant" list at each regular mailing of our house organ. Thus, on the eighth mailing, the first seventh of the "dormant" list would be reached a second time. It is only when no responses ensue upon the second mailing to names in the "dormant" list that those names go into the "moribund" file. Once there, they are all but forgotten, save for random tests of a dozen names or so every few years.

The diagram opposite illustrates our mailing processes. The idea has worked well for us. We commend it to the consideration of other dealers as a saver of time, material and money.

ALBERT J. FRANCK

The

PEERLESS ALBUM COMPANY



SERVING THE PHONOGRAPH INDUSTRY SINCE 1919

324

Protecto-Flap

THE ALBUM THAT REALLY PROTECTS YOUR RECORDS

Throughout the years Peerless Albums and Racks have been expressly designed to meet consumer demand.

Contact your Distributor

PEERLESS ALBUM COMPANY

352—4th AVENUE, NEW YORK 10, N. Y.

Los Angeles Factory—5523 East Slauson Avenue

importance of record sales training

SEPTEMBER marks the beginning of the busiest season in retail merchandising. With the return of students to schools and colleges and the resumption of normal family living and shopping following the vacation period, the retail record and radio dealer should feel a definite increase in sales. This is only the first indication of the heaviest sales period of the year. Therefore during the month of September, if you have not already instituted sales training classes of some nature for your record sales clerks, it will be to your benefit to begin them now.

Unfortunately there are not very many record sales managers or record buyers who are in a position to establish and to give record sales training courses. Perhaps some of these people do not feel that they are interested in teaching or that they are competent to do it, but it is of the utmost importance to every retail record operation that your record sales people have some guidance before the actual sales rush begins. It is my suggestion that you, yourself, the dealer, and your record sales manager, sit down together to discuss how you think your record sales service can be improved in your particular store.

No doubt you have one full-time, and one or two part-time record sales clerks in addition to yourself. What happens when you or your record sales manager find it necessary to be away from the store or the record department for a period of time? Does your sales help

know the answers required in the selling of records? Probably one of the most eye-opening tests of this that you can make is to give your record sales help an unexpected sales quiz early some morning. (And will you know the answers yourself?)

1—What is the price range of phonograph records?

2—How many labels do you carry in stock?

3—What is a numerical catalog?

4—How do you use this catalog?

5—What is the back-order system and how is it used?

6—What is the meaning of "five percent return" and when it is employed?

7—What do you do when you do not have the record or album requested by the customer?

8—What is meant by "related sales" in the record field?

9—What percentage of classical records as compared to popular records are you selling in this shop? Do you think that you can increase the percentage of classical record sales?

10—Do you read the sales literature sent to you by the two major classical record manufacturers? Do you use the information contained in this literature to inform your customers of new releases and to increase sales?

11—How do you find most popular records are sold—by title or by artist?

12—How do you find most classical records are sold—by title or by composer?

13—Do you use the Victor and Columbia classical record catalogs for reference or do you prefer to use a counter record-guide?

14—Do you keep a customer file of your clientele and is this file broken down into classifications of musical preferences?

15—Do you direct sales promotion over the counter, by telephone, by direct mail, and by local advertising?

16—Do you have your single record stock placed advantageously on your shelves so that the records most in demand are the nearest at hand and the popular and classical merchandise separate?

17—When you sell a record to your customer do you suggest other records?

18—How do you determine what to suggest?

19—Do you try to increase every record sale dollarwise by suggesting and promoting the sale of phonograph needles, carrying cases, record cabinets, etc?

20. During the period of shortage in production of radios, do you keep a memo of the name and address of every customer who requests a radio or radio-phonograph whether you have it or not?

21—Do you tie-in the sale of records with every combination sold?

These are only a few of the many and varied questions which you can ask yourself and your record sales clerks at the beginning of this extremely busy season. Successful record dealers can tell you that records require not only personalized selling but a thorough knowledge of the record merchandise before it can be sold. New releases must be listened to—at least in part—in order for your record sales clerks or for you to do an intelligent and competent job of classical record sales. In the "pops" field the weekly listing of the Hit Parade should be a prominent feature of your record department as well as a corresponding list of as many standard favorites that are available. Your packaging should be done in record envelopes which are imprinted with your store's name and address and some

special color or design which will make people know at once that this is merchandise from your store. In this way you make every customer who carries a record package your personal silent salesman. There is no better advertising.

A close check must be kept from now on on all broken record merchandise which is received so that it may be tabulated and stored for return against your five percent return privilege. If this breakage grows too high, you must contact your distributor and find out whether it is lack of proper packaging or rough handling that is causing the difficulty. Fresh advertising material must be kept in all of the display containers on your counter and this material must be kept up to date. It is not only irritating to the customer, but an indication of indifference on the part of the record sales manager if the pamphlets and advertising material which the public finds are even two months old.

These suggestions should lead you on to your own investigation of what your record sales people actually know about the record merchandise they are handling. It should also stimulate you to establishing certain principles and policies of salesmanship within your store which will increase your sales and make your entire record sales force more efficient.

You should also give serious consideration to the idea of incentive pay to clerks in order to attract intelligent and efficient personnel and to stimulate them to make as many sales as possible. Three successful forms of incentive pay are a small percentage on gross sales, a specific sum on each album sold above a certain price, and a combination of both.

Record shop owners should bear in mind that the average clerk is as interested in making money as they are. Incentive pay has proved its value in terms of increased sales in other fields of merchandising; there is no reason why it cannot do the same for records.

L. G.

do your christmas ordering in august

The most important group of orders of the year is made during the latter part of summer and in the early fall, when record merchandise is ordered for the Christmas season. During the months of July and August and early in September, the major record companies sent out lists of those records and albums which they expect to produce in quantity for the Christmas season, and it is during this one period of the year that the alert dealer plans to meet this Christmas volume of trade by these pre-season orders.

It became necessary during the war for all record companies to plan months ahead on their recording and pressing schedules. These plans were made into lists which were, and still are, shown to the dealer on a monthly or quarterly basis in order to permit him to do planned buying which will cover time ahead. There have been cases in which dealers have felt that the distributors have been using them as sub-distributors, in requiring them to order three months in advance, especially in the case of albums.

While the quarterly orders may bring in a fairly large amount of merchandise and thus consequently tie up a considerable sum of money for dealers, it must be borne in mind that, if this ordering has been well planned—and in direct ratio to the needs of the dealer—that the merchandise should be sold within that quarterly period. It is only in the case of poor judgment in choosing titles and over-ordering, that the dealer finds himself with a large inventory of

many multiples of unsold sets and singles.

It is particularly necessary during August and early September that the dealer sit down with his record sales manager or record buyer and plan these Christmas orders. This again demonstrates the necessity for competent trained record personnel.

One of the most important phases of the Christmas order is the ordering of children's records. There has always been a good market for such records, both narrative and music, but during recent years the interest in them has increased enormously, and the record companies have found themselves hard put to provide merchandise in sufficient quantity. As this article is being written, I have at hand a list of children's records and albums which is headed, "Only 152 Shopping Days Left Before Christmas." This is July as I write this and those dealers who fail to give immediate attention to this submitted list of Christmas merchandise for children are going to be sorely disappointed when that season arrives.

Have your record manager make up a list of albums which are "musts" for your particular clientele, then check your inventory for the number of those albums on hand, and check your back-order boxes to see how many of these are on order and how old those orders are. Following this, you can estimate how many of the albums you think you can sell each week between now and Christmas. Add this number up and you will have some idea of the quantity of

albums, or records which you must order to cover the period ahead.

During the month of August, record sales usually reach their lowest point of the year and it is only with specially planned advertising, displays and movie tie-ins that the dealer can build the summer sales quota. Advertise and display only the lightest type of summer music, such as light classical waltz albums, overtures, musical comedy favorites, etc., and plan displays in the window and in the store which will suggest summer enjoyment of recorded music at home. A group of summer porch furniture featuring a table top radio and record player with records prominently

displayed on the table and in a carrying case would make a nice window display or floor grouping. If your store is limited in space, it is only necessary to have one piece of summer furniture.

Clever displays can be made with a spray of artificial flowers, or a pair of canoe paddles, a portable record player and some records, with a banner across the window reading, "In the Good Old Summer Time." Ingenuity counts more than an expensive outlay. However, you can be thankful for the comparative quiet of August which gives you an opportunity to order and plan for the busy, profitable months ahead.

pushing hot jazz

Dealers are all aware that interest in hot jazz, the most authentic American music, has grown to such an extent in the last few years that the big record companies have recognized it by re-issuing jazz classics by the great instrumentalists (like Armstrong, Goodman, Hampton, Beiderbecke, etc.). Early last year RECORD RETAILING suggested a well-rounded campaign by which dealers could take advantage of this new interest to push the re-issues and make a handsome profit. If you missed the original article, or if you would like to check the success of your campaign with RR's suggestions, here are the main points summarized:

1—Make full use of your display facilities, in your show window and within your store. Use promotional material supplied by the record companies. Play the discs constantly.

2—Prepare an over-the-counter talk that is sincere, well informed, and pleasant. Stress the historical beginnings of jazz, and the educational value of a library of it—something the customer should be proud to own. Prove to the neophyte, young or old, that jazz is not the exclusive possession of the "hep cats." Remember one of the beauties of jazz is its ability to arouse discussion and criticism.

3—Make a post card mailing to your Hot Jazz customers. The gross on one

album is \$1.60, appreciably more than the gross on a standard four-pocket popular album. One album sale on 50 cards will still mean a good profit.

4—Push the many good jazz books available. You make an immediate profit on them, and they make new and steady customers for you.

5—Canvass schools and colleges; advertise where students will see your ads. Contact the superintendent of schools and sell him these new educational records for inclusion in the musical curriculum. Hard to do, but it has been done—in New York and Philadelphia. At the very least, you've met the superintendent and smoothed the way for future sales.

6—Take stock of your storage albumse and prepare a package deal of six Hot Jazz Classics albums, any other preselected albums, and a selection of single records in the storage albums. Put books, albums, single records in a cabinet and sell the whole works—on the installment plan if necessary (through your local personal credit house).

Above all, look on the whole promotion as the first big push into a comparatively undeveloped market—the market for those who want to build a hot jazz library and don't know how to start. This is educational and institutional selling which will pay off in future repeat sales.

promoting single record sales

In this article the author discusses the possibilities of increasing sales of single classical discs through the use of self-selection displays.

In previous articles we discussed at some length the various types of record display and record merchandising racks which are available to the enterprising dealer. The merchandising of single records or groups of records not in albums requires more effort than merely placing the records on a table top or in one of these record racks. Ingenuity must be used in grouping the records for sale and increasing your customer self-service record purchases by the planned placing of related records in the various racks and holders.

Any record store is very much like a library of books in the manner in which it is approached by the customer. Just as in a library, there are thousands of titles, or at least hundreds of titles, which are classified by artist (the author), title, and serial number. As in a library, the serial numbers are for the use of the librarian; the record dealer keeps a representative stock of each number on his shelves in numerical order so that they may be found easily by the record sales clerk (the librarian) in charge.

On open display racks, much like the open shelves of any public library, are stacked the single records and the albums available to the customers. It is obvious that the customer has little or no interest in, or knowledge of, the

numbers on the records, but is interested solely in the title of the record or the name of the artist. Therefore, the dealer must plan to put out his self-selection merchandise in either or both of two possible types of display—(1) the records can be grouped according to the artist who performs them, or (2) they can be grouped according to the name of the selection, irrespective of the artist. General record experience has indicated a preference for *artist* classification; in the popular field, in particular, as well as in many instances in the field of classical literature, the customer looks for recordings by certain artists or conductors or composers rather than seeking the composition itself and then choosing the performer he prefers.

Dealers new to the record business may find great difficulty in displaying and promoting single classical records. These classical records represent a larger volume of dollar sales, if properly handled, than the 53c popular record, and learning the technique of presenting them is a prerequisite to selling them successfully. They can be grouped in the following three ways: (1) by artist, (2) by title, (3) by musical classification. For instance, it is possible to delight a John Charles Thomas fan by grouping his records in one rack

or one bin or on one section of a shelf. The customer will hunt for the record he originally had in mind, and in hunting will very often find several others which will be added to his selection for final purchase. This method of self-selection invariably increases the sale of what might have been only one record by a particular artist to several records. The customer is happy, the dealer is happy, and the cash register shows a happy increase.

The second method of grouping singles is by title. There is a certain advantage in this method of self-selection display, because many times the inexperienced record dealer has bought a title on a label which is not well-known and by an artist who is equally obscure. To the dealer's sorrow it soon becomes apparent that he is accumulating slow-moving merchandise, or "dogs." One way of moving this merchandise is to group it by title rather than by artists. As the customer goes through the record stock in self-selection bins or on the self-selection table, he will be intrigued by old and familiar titles or by new ones, and will pick over them and select certain records on the strength of titles alone. A record customer loves to discover what he considers rare items. If he is looking for an old or obscure title and finally succeeds in finding it, he will not quibble very much over the artist or performance. There are fewer sales made by this type of selection, however, than by the method of artist selection. An example of how classical titles can and will sell is the famous "Music Appreciation" series which was issued with only the title of the music itself on the record and no indication of the performing artists. These records were extremely well promoted and the public flocked to buy them because they were desirable musical selections.

The third way to display records for self-selection is in racks or bins or on tables where the records are grouped according to musical classification. This type of grouping gives the dealer the

advantage of using both the other methods of classifying their self-selection singles—i.e., when he has a rack of polkas, marches, waltzes, piano concertos, symphonies, overtures, etc., the dealer can choose at will from his entire record stock without regard to artist or even title. In this instance the customer is after a certain type of music rather than any particular artist or selection, and a lot of miscellaneous record merchandise can be displayed and sold under a general heading of this nature.

One most important factor to keep in mind is that a constant check must be kept of stock on hand, and a new supply of records of all classifications and groupings must be ordered daily, or at least semi-weekly. Place a series of clever box ads in your local paper advertising first one classification of music and then another, with headings such as "A Whole Table of Polkas—We Invite You to Browse in the Self-Selection Department of Our Record Shop."

Many of your dollars are tied up in a vast stock of single records with which you are hardly acquainted. Make a practice of checking over at least one section of single records on your shelves, each day to weed out the older and less known numbers which are turning to dead stock on the shelf behind your counter, but which will turn into dollars in the till if you put them out where your customers can get at them. In many cases, the record customer will sell himself more records from self-selection racks—WHERE THE RECORD STOCK HAS BEEN CAREFULLY CLASSIFIED BY ARTIST, TITLE, OR MUSICAL CLASSIFICATION—than he might have been sold by an inexperienced or indifferent record clerk who did not bother to look for related merchandise beyond the customer's first request.

Actually, the function of self-selection is to make it possible for the customer to sell himself more merchandise. If you are overlooking this tremendous selling angle, it is a costly oversight.

—L. G.

the christmas harvest is on your shelves

This is a late time in any record dealer's life—even in a normal season—to still have the problems and planning of Christmas buying and Christmas merchandising of records and accessories yet to do. However, there is one redeeming feature in the lean delivery days ahead for the record and accessory dealer. Your watch word this year is definitely "The Christmas Harvest Is on Your Shelves" and every resourceful dealer, buyer, record-sales manager will give immediate attention to a complete review of every record that is now in stock.

What are these records that you have on your shelves? Why are they still on your shelves? And what is their potential market-value for your trade and in your location? You will probably find that you have a gold-mine of forgotten items lying dormant—classical and semi-classical records that have great appeal when they are properly displayed and promoted, and many standard items now unobtainable but which have a constant sale value. This is the Christmas season when you must exercise every bit of ingenuity that you have in sales promotion, display, advertising, and general salesmanship. For instance, have you a lot of singles which could be grouped into a classification such as Ballet Music, Music for Evenings at Home, Favorite Melodies, Memories in Song, Operettas, etc.?

Look through every label in your stock—for all of the Student Prince music that you can find and put it together in one rack headed "Songs You Love from the Student Prince." Very often it becomes a habit for the record sales person to identify certain productions, operas, symphonies, etc., with particular recordings on certain labels, without further thought for the many dollars invested in additional inventory in other labels by other artists of selections from these same musical scores. As a consequence, it is very easy for the sales person, when out of that particular label's recording, to say that you are out of stock in that particular selection. A careful review of the many duplications on your shelves, will give added sales impetus and reduce stock.

The alert dealer will find that these days of lean delivery ahead on the classical inventory are really a blessing in disguise. Here is a golden opportunity for the enterprising dealer to reduce his inventory and to increase his sales with records that he forgot he had. Certainly everyone is familiar with Tschaiikowsky's Nutcracker Suite, 4th and 5th symphonies, ballet music, the piano concerto—but how long has it been since you have reviewed the many Tschaiikowsky selections on single records that you have in your shelves, such as *None But the Lonely Heart*, *Romeo and Juliet Fantasy*, *Waltz from Eugene Onegin*,

The Pilgrim's Song, March Slav, etc. . . ? Not only will you open new musical worlds to your customer, but you will ring the cash register a great many more times than you had expected to, as well as gaining a reputation for skillful merchandising.

Now is the time to review every record of Christmas music that is in your stock left over from last year. Plan to build a special window display rack or floor rack which will house these Christmas records in the most colorful fashion that you can devise. Make it your plan this year to merchandise every Christmas record—single or album—that you have in stock so that by the time Christmas Eve arrives you will be as clean as the proverbial whistle, with no carry-over to burden your inventory the following year.

Have you or your record buyer placed the maximum orders for your Christmas needs in the field of hymns, choral music, chimes, organ, and the larger oratorios and monumental masterworks that are a "must" for Christmas demand? Have you talked with your distributor about what he will and will not have available this year in actual Christmas music, and what adjustments have been made from the current catalog to cover the Christmas field—even in a small way?

What about the needle, accessory, and record-cabinet business? Are you completely covered in these fields with adequate orders for the tremendous plus-business that is ahead during the holiday season? One of your best plus-items should be the sale of permanent needles (in all forms) to your record customers. Make a needle sale with every record sale, and watch your profits grow!

Are you prepared for the heavy demand for record-cabinets, large and small, in which to house the millions of records which will be sold to Mr. and Mrs. America? This is a separate field which should be treated with the greatest consideration, as it represents sales

in the larger-ticket class, and during the holiday season the sale of a number of record-cabinets per day will step up your sales figure enormously. Directly related to these sales can be the record storage albums which every record collector needs to house his single records. Are you adequately stocked with 10 and 12 inch albums in a complete price range to meet every pocketbook? It is well to order in sufficient quantities so that you may be able to assure the customer that he can return for more albums of the same kind following the Christmas season—or be sure to have arrangements made with your album manufacturers or distributors to have a subsequent supply.

A new and tremendously popular field that is opening up, especially since the war, is the use of the home-recording disc for off-the-air recordings, and messages from home to those away, or for permanent recordings of the baby's laughter and first words, the voices of grandparents, and all other forms of recordings for personal usage. Here again you can tie in with the sale of cutting needles and play-back needles. The home recording disc sales field and that of the needles for its use, has hardly been tapped—but with the availability of thousands of home-recording machines, here again is an opportunity to plus the sales in your record and radio store.

This holiday season is the overture to the exciting, dangerous, and highly competitive year ahead in the record and radio field. Are you making the most of what merchandise you have on hand? Will you reap every dollar of the investment which you have made during these pre-season days? And, are you alert to the challenge which will take every ounce of your time, your energy, and above all your ingenuity in salesmanship, in the record field? Dare to do the unusual. Plan an outstanding sales campaign for items of real appeal in your locality, and you can make the most of the supply which is on your shelves.

L. G.

how jackets solve one dealer's problems

This Syracuse, N. Y. store uses record envelopes for simplification of inventory, elimination of breakage — and to help the customer to help himself to classical or popular singles.

Onondaga Music Co. of Syracuse, N. Y., plans to offer self-service of a little different nature in the post-war period. On the basis of an experiment now being conducted, they intend to set aside a number of display racks, each rack being devoted to a particular type of

recording—the classics, juke box delights, marches, instrumentals, etc. Each section will contain *all* available recordings belonging to that designated type. Within the rack no actual records will be found. Instead, there will be empty record-containers, each one with a



All that the (Onondaga customer has to do is pick out the jacket, pass it to one of the girls and choose a comfortable chair. This system, combined with mass arrangement of albums (other page), → tends to emphasize impressions of size and variety of the record stock carried

pasted-on slip bearing the name of the selection and the recording artist and a key number.

The plan is now being tried out with a limited number of singles, both pop and classical, and the Onondaga management feels it has a number of advantages. In the past when they displayed actual records on their shelves they were troubled with breakage and theft. In addition it was difficult for patrons to search for a particular platter and they often hesitated to ask the clerk in charge if the desired number was available.

Under the new system, the customer picks out all the envelope containers for the discs in which he or she is particularly interested and takes them to the counter clerk. The clerk assigns the customer to a listening booth, and the desired recordings are piped in via

a loud speaker imbedded in the chamber walls. The patron has to make no phonographic adjustments whatsoever, but can lean back and listen in solid comfort.

Located behind the sales counter are record racks containing actual discs corresponding by section to the display racks on the actual sales floor. Also located behind the counter are a number of demonstration phonographs. The clerk simply puts the desired record on and presses the appropriate button which shoots the recording into the appropriate booth.

After the war a two-way "talk-a-
phone" will be installed in each chamber so that the listener may converse directly with the clerk and request that a certain number be played the second time, or that a new platter be put on. Thus it will not be necessary for the



purchaser to leave his or her comfortable quarters until final decision has been reached on the platters to be purchased.

Onondaga displays a cartoon of the week—dealing with records—at its counter. Many of these cartoons show customers trying out platters and never purchasing any . . . high school youngsters using a record store as a hang-out, etc. This retailer finds that such cartoon works hammer home desirable messages to the public.

Onondaga asks all customers to fill out a card giving their name, address and the types of records they're most interested in. Then each week the patron receives a phone call advising him or her of new discs along their favorite lines. The call ends with a

"May we reserve these numbers for you?" More often than not the answer is yes.

This method of calling customers personally at least once every seven days has several decided advantages, the store has found. It's harder for the customer to say no over the phone than to toss a letter advising him of recent record releases in the basket. And Onondaga invariably asks "Any of your friends or relatives having a birthday or anniversary this week—if so, let us recommend suitable recordings as a desirable and easy-on-the-budget gift." It's a rare instance when such tactics do not pay off in the form of a direct sale of substantial proportions within a day or two of the phone inquiry. And, often too, another friend is made.



AMERICA'S FINEST PHONEEDLES

Streamlined Long-Life Needles

World-famous Steel Needles

Superchrome Phoneedles • Steel Cutting Needles

Sapphire Cutting Needles • Home Recording Discs

THERE'S A RECOTON NEEDLE FOR EVERY PURPOSE

52 return visits a year to your store

Phonograph records — 600,000,000 of them per year! These are now the *conservative* figures given to us by the record manufacturers for production during the first year following V-J Day, when American production of civilian good will have reached the greatest peak in its history. Competition for the consumer dollar will be the greatest ever known, and survival will be only for the fittest.

Radio manufacturers anticipate that the bulk of their production will be in combination radio-phonographs and each one of these combinations, large and small, must be serviced with records.

Today there are over 70 record labels on the market, and more are appearing weekly. Everyone wants to be on the gravy train—manufacturers, distributors, and dealers—but due to the very nature of the product that they are handling, i.e., phonograph records, there is bound to be a high mortality rate, especially in the retail field.

Today it is still the seller's market, but tomorrow, with the release of goods, it will become the buyer's market, and it is the smart dealer that knows his own potential, record-wise, in that market.

New franchises are being issued daily to dealers new in the record merchandising field. Plans for greater expansion and modernization in record retailing are being announced by both individual outlets and chain stores alike. Where there are radios there will be records in the shop or department of every enterprising dealer. Phonograph records are highly specialized merchandise and

are not comparable to anything else being sold on the retail market. The record dealer is selling entertainment, and it requires and will continue to require skilled merchandising and trained personnel to do suggestive selling in the field of entertainment for these record operations.

The salesgirl must classify the customer, his preferences and his desires by his initial request—and follow up with suggestive selling of related merchandise in that part of the music field. With the extreme variety of entertainment now available and with what will be available in greater scope, it will require very alert, experienced record sales personnel to buy the best records and to sell the most. While the customer will show silently, from his position at the self-selection album racks, what his personal preference in music is, it takes the record salesperson to develop that customer's sales interest to the greatest extent and to plus-sell him—not only in records, but in other related merchandise.

Record sales competition will be on all sides, in every form of record merchandise and through every media of advertising available. There will be no limit to either quantity or quality of records and every radio-phonograph dealer in the country, every chain or individual department store that carries radios, all mail order houses, five and dime store chains, drug stores and tire chains, as well as specialty stores or music houses will carry records of some kind to service those combinations. The importance of the phonograph record is already being taken into consideration

by the radio manufacturers to the extent that two of the major radio manufacturers have begun pressing records with their own labels, so that they may serve their dealers post-war, with both radios and records.

Are the record dealers prepared with the merchandise "know-how" necessary for successful record retailing? In subsequent articles we will discuss the details of these basic record retailing problems: 1. Location and traffic potential. 2. Fixtures, types of record machines, lighting and display fixtures. 3. Competent record sales personnel. 4. Basic inventory (suited to your needs). 5. Planned plus-business in accessories, sheet music, record cabinets, musical instruments, et cetera. 6. Promotion and advertising.

In the last analysis the success of any record operation lies in the hands of

the person at the "point of sale." Whether you have your money invested in salable record stock that forms a sound basic inventory most suited to your needs, and whether there is adroit buying of current popular merchandise wisely chosen, and in the correct quantities for your needs, will lie in your record manager's hands. Only with trained record personnel can the record dealer of today and tomorrow, selling in a highly competitive market, hope to maintain an effective and profitable record operation. That means an operation which is neither over-stocked nor under-stocked for your customers' daily demands.

With new record releases each week the record store or department has the most powerful repeat-sale potential in the retail market . . . a potential of 52 consumer return trips per year to the store!

C.R.S. HISTORICAL RECORDS

Exclusive Editions

Re-issues and re-recordings of rare vocal operatic, theatrical, and speech records. Offering a special appeal to your private collectors of out of print and unusual recordings. Exclusive territory open. We do not sell retail. 100% return privilege. High profit. Label known world over.

COLLECTORS RECORD SHOP

325 Seventh Avenue

New York 19, N. Y.

CI 6-9280

SEECO RECORDS, INC.

*The Biggest Name
in LATIN AMERICAN Recordings*

1393 FIFTH AVE., NEW YORK 29, NEW YORK

Grew from an Acorn in **1944**

to an Oak Tree in **1946**

and Branching out **FAST**

thanks to your sincere patronage.



SIDNEY SIEGEL
President

"Seeco Records continues and will continue as in the past, to present to you the Finest Names in Latin American Recordings, such as CHUCHO MARTINEZ GIL, TRIO SERVANDO DIAZ, BOBBY CAPO, DANIEL SANTOS, JOHNNY RODRIGUEZ, MARTA DOMINGUEZ, LAURITA Y RAY, POLITO GALINDEZ, NORO MORALES, TRIO LOS PANCHOS, CELSO VEGA, GUILLERMO PORTABALES, MIGUELITO VALDES, GRUPO MARCANO, CONJUNTO MATAMOROS, CHANO POZO and many other famous Latin American SEECO recording artists."

"You have my personal assurance that you can count on SEECO to serve you—only with the finest."

1393 FIFTH AVE., NEW YORK 29, NEW YORK
2519 West 7th STREET, LOS ANGELES 5, CALIFORNIA
FREDERICK LEE CO., 325 2nd Ave., So., MINNEAPOLIS, MINN.



directory section

listing latest available

data on record, accessory and

set manufacturers, artists,

publishers and distributors

record companies

340

A list of all
existing record companies,
their officials, plus
their distributors.



RECORD COMPANIES

The following record companies are those which were in existence at the time the RECORD RETAILING YEARBOOK went to press. If information about any other record company is desired, please write the Record Retailing Information Service, 274 Madison Avenue, New York 16, N. Y.

A-I Records of America

16 East 43rd St., New York 17, N. Y.

Proprietor and sales manager:

Eugene A. Panzone

Trade Name—A-I Records.

Retail Price—10-in. record, 79c.

Serial Numbers—1001-1006, etc.

Own distributors.

Ace Record Co.

1619 Broadway, New York 19, N. Y.

Aladdin Recordings, Inc.

427 West Fifth St., Los Angeles 13, Calif.

Partners: Leo and Edward Mesner

Distributors

J. F. Bard, 414 S. Franklin St., Chicago, Ill.
Commercial Music Co., 510 N. Sarah St., St. Louis, Mo.

Major Distributing Co., 106 DeKalb Ave., Brooklyn 1, N. Y.

Mid-West Distributing Co., 2218 Vine St., Kansas City, Mo.

Millner Record Sales, 6529 Bartner Ave., St. Louis, Mo.

Music Sales Co., 680 Union Ave., Memphis, Tenn.

Music Sales Co., 303 N. Peter St., New Orleans, La.

Record Sales Co., Inc., 2117 Third Ave. N., Birmingham, Ala.

Alco Recording Co.

3913 Sunset Blvd., Hollywood 46, Calif.

Lee Alden

8910 Holly Place, Hollywood 16, Calif.

Alert Record Distributing Corp.

1303 Fulton St., Brooklyn 16, N. Y.

President and sales manager:

Theodore Gottlieb

Secretary and treasurer: Melvin Herman

Trade Name—Alert.

Retail Price—79c.

Serial Numbers—200, 201, 400, 401.

Distributors

General Dist. Co., 4109 Norfolk Ave., Baltimore, Md.

Roanoke Vending Machine Co., 13 S. Jefferson St., Roanoke, Va.

Globe Dist. Co., 1623 N. California Ave., Chicago, Ill.

W. M. Amann Dist. Co., 115 Olive St., Shreveport, La.

All Star Artist Bureau

500 N. Western Ave., Los Angeles 4, Calif.

Alpha Record Co.

501 Madison Ave., New York 22, N. Y.

President: Aldert Van der Molen

Sales manager and secretary: Louis Nurko

Treasurer: Jacob Rudd

Products Manufactured—Latin-American
Vinylite Records.

Trade Name—Alpha Records.

Alvin Record Co.

230 E. Ohio St., Chicago 11, Ill.

President: Paul Bennett

Ambassador Record Co.

3100 Wilshire Blvd., Los Angeles 5, Calif.

American Music Records

647 Means Ave., Pittsburgh 2, Pa.

Sales manager: William Russell

Trade Name—AM.

Retail Prices—10-in. record, \$1; 12-in.
Vinylite record, \$1.75.

Serial Numbers—500 series (10-in.), 200 series (12-in.).

American Records (Goody Dist. Co.)

853 Ninth Ave., New York 19, N. Y.

Angelus Recordings

6404 Hollywood Blvd., Hollywood, Calif.

Apollo Records, Inc.

615 Tenth Ave., New York 19, N. Y.

President: Herman Siegal

Sales manager: Frank J. Marks

Secretary: Samuel Schneider

Treasurer: Ike Berman

Trade Name—Apollo Records.

Retail Price—75c. and \$1.

Serial Numbers—100 series (folk and spiritual), 300 series (blues), 700 series (jazz).

Distributor—Apollo Records Dist. Co.

367 Edgewood Ave. S. E., Atlanta, Ga.

2015 Maryland Ave., Baltimore 18, Md.

1450 Broadway, Detroit 26, Mich.

2705 W. Pico Blvd., Los Angeles 6, Calif.

615 Tenth Ave., New York 19, N. Y.

ARA, Inc.

5655 Wilshire Blvd., Los Angeles 36,
Calif.

President: Mark D. Leff

Sales manager and vice-president:

Shelby York

Secretary: Morton Garbus and

Herman Taylor

Treasurer: Jay C. Leff

Retail Price—Single records, 75c.; al-
bums (4 records), \$3.75.

Arrow Enterprises

515 Madison Ave., New York, N. Y.

Arts Recording Co.

29 W. 57th St., New York, N. Y.

Asch Recording Studios (Disc Co. of America)

117 W. 46th St., New York, N. Y.

President: M. Asch

Trade Name—Disc Co. of America.

Retail Price—10-in. Red dot, 75c.; 10-in.
Blue dot, \$1; 10-in. Yellow dot, \$1.25;
12-in. Red dot, \$1; 12-in. Blue dot,
\$1.50; 12-in. Vinylite Yellow dot,
\$2.25.

Serial Numbers—3000-7000.

Distributors

Interstate Music Suppliers, 236 W. 55th St.,
New York, N. Y.

Pacific Allied Products, 1311 W. Seventh St.,
Los Angeles, Calif.

Sni Dor Radio Electric, Ltd., 455 Craig St.,
W., Montreal, Canada.

Household Dist. Co., 1233 N. W. 12th St.
Portland, Ore.

Mid West Music, 1002 S. Michigan Ave.,
Chicago, Ill.

Associate Studios

6560 Hollywood Blvd., Los Angeles 28,
Calif.

Atlas Records & Dist. Co.

5901 Lindenhurst Ave., Los Angeles 7,
Calif.

President: Robert Scherman

Atom Record Co.

6253 Hollywood Blvd., Los Angeles 28,
Calif.

Atomic Record Co., Inc.

5634 Santa Monica Blvd., Hollywood 38,
Calif.

President: Lyle Griffin

Sales manager: Chester Haskin

Treasurer: J. W. Blue

Trade Name—Atomic Records.

Retail Price—79c.

Serial Numbers—A-201, A-202, A-209,
A-210, A-215, A-216, A-220, A-221,
A-225, A-226.

Distributors

Atomic Record Co.
K & M Service

Audience Records, Inc.

230 Park Ave., New York 17, N. Y.

Audio Pictures, Inc.

951 N. La Ciegenga, Los Angeles 46, Calif.

Avalon Record Co.

117 W. 48th St., New York 19, N. Y.

President and sales manager:

Raymond A. Sterling

Secretary-treasurer: Edith Sterling

Trade Name—Avalon Records.

Retail Price—75c.

Serial Numbers—A 1001, A 1003.

Distributor

Continental Record Dist. Co., 265 W. 54th
St., New York, N. Y.

Sol Babitz Records

1661 Waterloo St., Los Angeles 26, Calif.

Bakelite Corp.

30 E. 42nd St., New York 17, N. Y.

Sales manager: Gil Shaw

Products Manufactured—Preforms for rec-
ords and resins for preforms.

Trade Name—Vinylite.

Bar Music Co.

4071 S. Budlong St., Los Angeles 37,
Calif.

B & B Recordings

2615 Canyon Drive, Los Angeles 28, Calif.

Beacon Record Co.

331 W. 51st St., New York 19, N. Y.

Beasley, Mebane Studios

1930 N. Vine St., Hollywood 28, Calif.

Toni Beaulieu

3316 San Marino, Apt. 309, Los Angeles
6, Calif.

Bee Bee Record Co.

1538 N. Cahuenga Blvd., Los Angeles 28,
Calif.

Bell Records

1658 Broadway, New York 19, N. Y.

President and sales manager:

Benny Bell Samberg

Products Manufactured—10-in. shellac
phonograph records.

Trade Name—Bell Records.

Retail Price—Bell (Blue Ribbon Series),
79c.; "Bell" Novelty Records (Dollar
Edition), 98c.

Serial Numbers—523-A&B, 327-A&B, 221-
A&B, 332-A&B.

Bel-Tone Recording Corp.

8624 Sunset Blvd., Los Angeles 46, Calif.

President and sales manager:

H. R. C. Elwell

Secretary: Regina G. Cook

Treasurer: Robert S. Cook

Trade Name—Bel-Tone.

List Price—75c.

Serial Numbers—E-0257—E-0268, 2001,
2002, 7001, 7002, 751—758, 269.

Distributors

Apollo Record Dist. Co., 367 Edgewood Ave.
S. E., Atlanta, Ga.

Economy Supply Co., 2015 Maryland Ave.,
Baltimore, Md.

Associated Record Dist., 3612 W. Chicago
Ave., Chicago, Ill.

Dobbs of Dallas, 2821 Live Oak St., Dallas,
Texas

Apollo Record Dist. Co., 100 E. Atwater,
Detroit, Mich.

Trilon Record Dist. Co., 1317 W. Seventh
St., Los Angeles, Calif.

Music Sales Co., 680 Union Ave., Memphis,
Tenn.

Music Sales Co., 303 N. Peters St., New
Orleans, La.

Apollo Record Dist. Co., 615 Tenth Ave.,
New York, N. Y.

Trilon Record Dist. Co., 3123 San Pablo
Ave., Oakland, Calif.

S. R. Ross, 1212 South State St., Salt Lake
City, Utah

Commercial Music Co., 510 N. Sarah St.,
St. Louis, Mo.

Berger Enterprises

8111 Santa Monica Blvd., Los Angeles
46, Calif.

The Bert-Co Press

4864-66-68 Santa Monica Blvd., Los An-
geles 27, Calif.

Sales manager: B. P. Couturier

Products Manufactured—Phonograph rec-
ords and transcription labels.

Beta Records

5027 S. Figueroa St., Los Angeles 37,
Calif.

Bibletone

354 Fourth Ave., New York 10, N. Y.

President: Arthur L. Becker

Sales manager: Roger L. Becker

Trade Name—Bibletone.

Distributors

Allied Music Sales, 3112 Woodward Ave.,
Detroit, Mich.

All State Dist., 45 Clinton St., Newark, N. J.

Appliance Dist., 1910-12 Washington St., St.
Louis, Mo.

Associated Dist. Co., Tabor Bldg., Denver,
Colo.

Barth Feinberg, 17-19 Union Square W., New
York, N. Y.

Crowe Martin Dist. Co., 1201 Chenevert St.,
Houston, Texas

Dobbs of Dallas, 2821 Live Oak St., Dallas,
Texas

Diehle & Lehman, 1409-11 Texas St., El
Paso, Texas

Interstate Music Suppliers, 236 W. 55th St.,
New York, N. Y.

R. H. Kyle, 1354 Hansford St., Charleston,
W. Va.

Music Dist. Co., 1408 W. Ninth St., Cleve-
land, Ohio

Pacific Allied Prod., 812 W. Eighth St., Los
Angeles 14, Calif.

Ryan Radio & Electric Co., 1808 Grand Ave.,
Kansas City, Mo.

Yancey Co., Inc., 340 Peachtree St., N. W.
Atlanta, Ga.

Mountain Dist., Inc., 32 Exchange Place,
Salt Lake City, Utah

Herb E. Zobrist, 2125 Westlake Ave., Seattle,
Wash.

Birch Records

63 E. 56th St., New York 22, N. Y.

President: Robert Birch

Trade Name

Birch

Black & White Recording Co.

4910 Santa Monica Blvd., Los Angeles 27,
Calif.

President: Paul Reiner

Secretary-treasurer: Sam Mademan

Trade Name—Black & White

Retail Price—75c., \$1, \$1.50.

Serial Numbers—BW1-BW 178, BW
10000-BW 10005, BW 2000-BW 2008.

Distributors

W. E. Harvey Co., 1312 Ontario St., Cleve-
land 13, Ohio

Frederick Lee Co., 304 W. 10th St., Kansas
City, Mo.

Acme Dist. Co., 2535 Elm St., Dallas, Texas
Anthony Foster & Sons, 306 Church St.,
Toronto, Can.

Legum Dist. Co., 108-112 Light St., Balti-
more, Md.

Frank Gerry & Co., Ltd., 379 Talbot St.,
London, Ontario, Can.

Electric App., Ltd., 622 Craig St., Montreal,
Quebec, Can.

Radio Laboratories, 308 Laurier Ave., W.,
Ottawa, Ontario, Can.

LeRoy H. Bennett Co., 1355 Market St.,
San Francisco 3, Calif.

Love Electric Co., 325 Westlake Ave., N.,
Seattle 9, Wash.

Stewart Dist. Co., 34 Richards St., Salt Lake
City 1, Utah

Stuart Sales Co., 414 S. Amherst, Albuquerque, N. M.
 Wilford Bros., 1169 S. Broadway, Los Angeles 15, Calif.
 Wilford Bros., 1902 Kettner Blvd., San Diego, Calif.
 Colorado Springs Supply Co., 15-31 W. Cucharas, Colorado Springs, Colo.
 Midwest Monitor Corp., 540 N. Lake Shore Drive, Chicago 11, Ill.
 Monitor Co. of Ga., 976 W. Peachtree St., N.W., Atlanta, Ga.
 Monitor Dist. Co., P. O. Box 38, Providence, R. I.
 Monitor Home App. of S. Car., 1323 Lady St., Columbia, S. Car.
 Monitor of Indiana, 1121 N. Meridian St., Indianapolis 4, Ind.
 Monitor Sales, Inc., 110 E. 42nd St., New York 17, N. Y.
 C. A. Markley Electric Co., 314 Chestnut St., Harrisburg, Pa.
 Gill-Brand Products Co., 477 Congress St., Portland, Me.
 Monitor App. Co., Inc., 1432-36 Main St., Buffalo, N. Y.
 Frederick Lee, 325 Second Ave. S., Minneapolis, Minn.
 Tom P. McDermott, Inc., 1100 S. Boston, Tulsa 5, Okla.

Bliss Records

1518 N. Ave. 45, Los Angeles 41, Calif.

Blue Note Records

767 Lexington Ave., New York 21, N. Y.
 President and treasurer: Alfred W. Lion
 Sales manager: Francis Wolfe
 Secretary: Lorraine Lion
Trade Name—Blue Note.
Retail Price—10-in. records, \$1; 12-in. records, \$1.50.
Serial Numbers—1 and up (12-in.); 501 and up (10-in.)

Blue Star Records

2211 Cottage Grove Ave., Des Moines 9, Iowa
 President: Jerry Smith

Bost Records Co.

29 W. 57 St., New York 19, N. Y.
 President: Rudolf R. Steiner
 Secretary: John Babb Jr.
 Treasurer: Irving Gromet
Products Manufactured—Phonograph records and transcriptions.
Trade Name—Bost.
Retail Price—10-in. records, \$1; 12-in. records, \$1.50.

Distributors

Interstate Music Suppliers Co., 236 W. 55th St., New York, N. Y.
 J. F. Bard & Co., Chicago, Ill.
 Century Dist. Co., Los Angeles, Calif.
 Music Dist. Co., Detroit, Mich.

Jose Bribiesca

114 W. First St., Los Angeles 12, Calif.

Bronze Record Co.

623 East Vernon Ave., Los Angeles 11, Calif.

President: Leroy E. Hurte

Broadcast Recorders, Inc.

1538 N. Caluenga Blvd., Los Angeles 28, Calif.

Bullet Record Co.

Nashville, Tenn.

Campus Christian Recording Corp.

1226 E. Eighth St., Los Angeles, Calif.

Distributors

Music Distributing Co., 1408 W. Ninth St., Cleveland 13, Ohio.
 Pennsylvania Record Supply, Inc., 1221 Arch St., Philadelphia 7, Pa.
 Volunteer Music Sales Co., 1710 Portland Ave., Nashville, Tenn.
 Eastern Music Sales, Inc., 10 W. 46th St., New York 19, N. Y.
 Associated Record Distributing Co., 3612 W. Chicago Ave., Chicago 51, Ill.

C & F Radio Prod.

6365 Selma Ave., Los Angeles 23, Calif.

Cal's Music Store

1650 W. Washington Blvd., Los Angeles 7, Calif.

Cadet Records

P. O. Box 307, Los Angeles 28, Calif.

Capitol Records, Inc.

Sunset and Vine Sts., Hollywood 28, Calif.
 President: John Mercer
 Vice-president and general manager: C. E. Walllich
 Sales manager: Floyd Bittaker
 Treasurer: William H. Fowler

Products Manufactured—Phonograph records, phonographs, home recording discs, pro-disc, needles, storage albums.

Trade Names—Capitol phonograph records, Capitol Phonograph, Capitol (Sapphire) Needle, Capitol P.M. Needle, Pro-Disc, aluminum base.

Retail Price—Records—50c.; Pro-Discs—6½ in., 30c.; 8 in., 50c.; 10 in., 75c.; fibroid home recording discs—6½ in., 15c.; 8 in., 25c.; 10 in., 35c.

Distributor—Capitol

127 Peachtree St., N.E., Atlanta 3, Ga.
 1134 Commonwealth Ave., Boston 31, Mass.
 1066 Main St., Buffalo 9, New York.
 1449 S. Michigan Blvd., Chicago 5, Ill.
 104 St. Clair Ave. N.W., Cleveland 13, Ohio
 1505 Young St., Dallas, Texas
 1156 Cass Ave., Detroit 1, Mich.

318 W. 15th St., Los Angeles 15, Calif.
1527 McGee St., Kansas City 8, Mo.
1088 Union Ave., Memphis 3, Tenn.
225 W. 57th St., New York 19, N. Y.
825 Walnut St., Philadelphia 7, Pa.
1355 Bush St., San Francisco 9, Calif.
1107 Pine St., St. Louis 3, Mo.
2234 First Ave., Seattle 1, Wash.
930 F St., N. W., Washington, D. C.
815 Sycamore St., Cincinnati, Ohio
21 E. Hennepin Ave., Minneapolis, Minn.
81 Lock St., Newark, N. J.
611 W. Morehead St., Charlotte, N. C.

Cardinal Co.

6000 Sunset Blvd., Hollywood 28, Calif.

Carey Music Publishing Co.

P. O. Box 281, Asbury Park, N. J.

President: Thomas J. Carey

Sales manager: R. F. Kaiser

Treasurer: Leta Bender

Trade Names—Kayo, Gay Toons, Skatin' Toons.

Retail Price—75c.

Serial Numbers—111 D.S., 115 D.S., 125 D.S., 128 D.S., 135 D.S., 136 D.S.

Distributors

B. L. Frankhouser, Kayo Recording Co., 416 Hamilton St., Allentown, Pa.

R. L. Kaiser Co., 1224 Madison St., Milwaukee, Wis.

Irving Siegal Music Co., 1543 Box, Miami, Fla.

Dorothy Anderson, 601 Robert St., New Orleans, La.

Phyllis Battleson, Canby, Ore.

Grace Valentine, P. O. Box 85, Watsonville, Calif.

Harriet Jane Sams, 1624 N. Dakota Ave., Sioux Falls, S. Dak.

Catherine Carey, P. O. Box 819, Eureka, Calif.

Nell Seely, 333 E. Ash St., Lebanon, Ore.

Frieda F. Ayre, 5000 Crystal St., Chicago, Ill.

M. M. Cole Co., 823 S. Wabash Ave., Chicago, Ill.

Joe McDaniel Music Co., P. O. Box 1105, New Bern, N. C.

Rainbow Melodies Inc., 1564 Broadway, New York, N. Y.

Leta S. Bender, P. O. Box 413, Friend, Nebr.

Belle Schrag, 1771 La Grange St., Toledo, Ohio

Grace Shumaker, 1521 Franklin St., Lafayette, Ind.

Kelly Music Publications, 19 Pennell St., Franklin, Pa.

Joe A. Saracini, 5009 A Delmar Blvd., St. Louis 8, Mo.

Victor J. Pilisotta, General Delivery P. O., Los Angeles, Calif.

Harry S. Reynolds, 232 W. 97th St., Los Angeles, Cal.

Skatin' Toons, P. O. Box 264, Malverne, N. Y.

Caribbean Record Co.

437 N. Westmoreland, Los Angeles 4, Calif.

Cavalcade Music Corp.

1674 Broadway, New York 19, N. Y.

Carlee Art Record Co.

608 Santa Monica Blvd., Santa Monica, Calif.

Cartoon Records, Inc.

Room 113, 6331 Hollywood Blvd., Los Angeles 28, Calif.

Jack Cascales

608½ N. Sweetzer, Los Angeles 36, Calif.

Chicago Recording Studios Co.

64 E. Jackson Blvd., Chicago, Ill.

President: R. W. Kittinger

Products Manufactured—Commercial phonorecords (under any trade name), electrical transcriptions for radio.

Chief Records Corp.

74 Riverside Drive, New York 21, N. Y.

President: Jerome H. Kanner

Sales manager: Frank Stanton

Secretary: Josh Meyer

Treasurer: Maxwell Frank

Products Manufactured—Commercial Phonograph Records.

Trade Name—Chief.

Retail Price—75c.

Serial Numbers—6300.

Cincinnati Records

521 W. Sixth St., Cincinnati, Ohio

Circle Records

6120 Santa Monica Blvd., Hollywood 38, Calif.

Classic Record Co.

7 W. 46th St., New York 19, N. Y.

Co-Art Record Co.

1403 S. Fairfax Ave., Los Angeles, Calif.

Trade Name—Co-Art.

Retail Price—10-in. record, 75c.; 12-in. record, \$1.

Distributors

Co-Art Dist. Co., 3763 Wilshire Blvd., Los Angeles 5, Calif.

Mr. Walter R. Velaney, 1154 Nostrand Ave., Brooklyn 25, N. Y.

Coast Record Mfg. Co.

2534 W. Pico Blvd., Los Angeles 15, Calif.

President: Charles E. Washburn

Sales and advertising manager: W. M. Abel

Secretary: Gladys Washburn

Coda Record Co.

1291 Sixth Ave., New York 19, N. Y.
 Sales manager: Edesio Ocando Soto
 Secretary: Gabriel Oller
Trade Name—Coda.
Retail Price—\$1.
Serial Numbers—5000.
 Direct distribution.

Collector's Items, Inc.

119 E. 57th St., New York, N. Y.

Collectors Record Shop

825 Seventh Ave., New York 19, N. Y.
 Sales manager: Jack L. Caidin
Trade Name—C R S.
Retail Price—10-in. record, \$2; 12-in. record, \$2.25.
Distributor—Jack L. Caidin.

Columbia Recording Co.

1473 Barnum Ave., Bridgeport 8, Conn.
 President: Edward Wallerstein
 Sales manager: Paul E. Southard
 Secretary: Kenneth E. Raine
 Treasurer: W. G. Wilkins
Trade Names—Columbia, Okeh, Columbia Masterworks.
Retail Prices—35c., 50c., \$1.
Serial Numbers—6000, 35000.

Distributors

Artophone Corp., 4200 Forest Park Blvd., St. Louis 8, Mo.
 H. R. Basford Co., 425 Second St., San Francisco 7, Calif.
 Bennett Radio Co., Inc., 211 N. Fourth St., Columbus, Ohio
 Cain & Bultman, Inc., 505 W. Adams St., Jacksonville P. O. 4429, Fla.
 Charleston Electrical Supply Co., 914 Kanawha St., Charleston 29, W. Va.
 Columbia Wholesalers, Inc. of New England, 584 Commonwealth Ave., Boston 15, Mass.
 Benjamin T. Crump Co., Inc., 1310-34 E. Franklin St., Richmond 13, Va.
 Crumppacker-Covington Co., Hamilton & Canal Sts., Houston 2, Texas
 Electric Appliance Dist. of Ky. Inc., 1601 S. First St., Louisville, Ky.
 Farrar-Brown Co., 492-498 Forest Ave., Portland 5, Me.
 Federal Dist Co., 1717 Walnut St., Kansas City 8, Mo.
 Flint Dist. Co., 316 W. Second St., Salt Lake City 11, Utah
 Ludwig Hommel & Co., 600-620 Second Ave., Pittsburgh 19, Pa.
 Hopkins Equipment Co., Inc., 418 W. Peachtree St., N.W., Atlanta 3, Ga.
 Latham & Co., Inc., 1010 Broad St., Newark 2, N. J.
 Mathias & Co., 113 S. Mesa, El Paso, Texas
 Mathias & Co., 305 S. Second Ave., Phoenix, Ariz.
 Miller-Jackson Co., 111-115 E. California Ave., Okla. City 2, Okla.

Motor Parts Co., 145-157 S. Cameron St., Harrisburg, Pa.
 Omaha Appliance Co., 18th at St. Mary's St., Omaha 2, Nebr.
 Motor Parts Co., 1229 N. Broad St., Philadelphia 22, Pa.
 Onondaga Supply Co., 351-357 East Onondaga St., Syracuse 1, N. Y.
 Philco Dist., Inc., Detroit Division, 1627 W. Fort St., Detroit 16, Mich.
 Philco Dist., Inc., Toledo Division, 1034 Grand Ave., Toledo, Ohio
 Radio Specialty Co., 829 N. Broadway, Milwaukee 2, Wisc.
 Rodefeld Co., 612-614 N. Capital Ave., Indianapolis 4, Ind.
 Roskin Bros., Inc., 351 Central Ave., Albany 4, N. Y.
 Roycraft Co., 1625 Hennepin Ave., Minneapolis 3, Minn.
 Roycraft-Iowa Co., 1326 Walnut St., Des Moines 9, Iowa
 Sampson Co., 3201 S. Michigan Ave., Chicago 16, Ill.
 Simons Dist. Co., 17 Lyman St., Providence 3, R. I.
 Southern Bearings & Parts Co., Inc., 315 N. College St., Charlotte 1, N. C.
 Southern Equipment Co., 210 W. Commerce St., San Antonio 6, Texas
 Southwestern Co., Inc., 1719 N. Harwood St., Dallas, Texas
 Stern & Co., 210 Chapel St., Hartford 1, Conn.
 Strong, Carlisle & Hammond Co., 1392 W. Third St., Cleveland 13, Ohio
 Sunset Electric Co., P. O. Box 3148, Seattle 14, Wash.
 Sunset Electric Co., N. W. Tenth Ave. & Glisan St., Portland 9, Ore.
 Sweeney Electrical Co., 1601 23rd St., Denver 17, Colo.
 Ray Thomas Co., 1601 S. Hope St., Los Angeles 15, Calif.
 Times Appliance Co., 353 Fourth Ave., New York 10, N. Y.
 Tri-State Dist. Corp., 328 E. 8th St., Cincinnati 2, Ohio
 Walther Bros. Co., 714-20 Howard Ave., New Orleans 13, La.
 Watts-Newsome Co., 1724 First Ave. N, Birmingham 3, Ala.
 Western Mdse. Dist., Inc., 68 W. Huron St., Buffalo 2, N. Y.
 Woodson & Bozeman, Inc., 482 Union Ave., Memphis 1, Tenn.
 Zamoiski Co., 110 S. Paca St., Baltimore 1, Md.

Command Radio Prod.

6000 Sunset Blvd., Los Angeles 28, Calif.

Commodore Record Co., Inc.

415 Lexington Ave., New York 17, N. Y.
 President: Milton Gabler

Sales manager and secretary: Jack Crystal
Treasurer: Julius Gabler

Trade Names—Commodore, Jazz Information.

Retail Price—10-in. records, \$1.05; 12-in. records, \$1.57.

Serial Numbers—500 series (10-in.), 1500 series (12-in.).

Concert Hall Society

250 W. 57th St., New York, N. Y.

Consolidated Record Distributors, Inc.

500 N. Western Ave., Los Angeles 4, Calif.

President: Richard A. Nelson

Executive vice-president: Harry Fox

Trade Names—4-Star Records, Gilt-Edge Records.

Retail Price—79c. (4-Star), \$1.05 (Gilt-Edge).

Distributors

J. C. Boylan Co., 224 Rose Bldg., Cleveland, Ohio

Williams & Shelton, 420 S. Tryon, Charlotte, N. Car.

Taran Dist., Inc., 2820 N. W. Seventh Ave., Miami, Fla.

Taran Dist., Inc., 90 Riverside Ave., Jacksonville, Fla.

Commercial Music Co., 510 N. Sarah St., St. Louis, Mo.

C & C Dist. Co., 714 Fourth Ave., Seattle, Wash.

American Coin-A-Matic Machine Corp., 1437 Fifth Ave., Pittsburgh, Pa.

David Rosen, 855 N. Broad, Philadelphia, Pa.
Record Sales Co., Inc., 2117 Third Ave. N., Birmingham, Ala.

Music Sales Co., 303 N. Peters St., New Orleans, La.

Music Sales Co., 680 Union Ave., Memphis, Tenn.

The Record Distributors, 1220 Grand Ave., Des Moines, Iowa

G & S Dist. Co., 243 W. Kellogg Blvd., St. Paul, Minn.

R. A. Howe & Co., Honolulu Mdse. Mart, Honolulu, Hawaii

King Record Co., 437 Elizabeth Ave., Newark, N. J.

Associated Record Dist. Co., 3612 W. Chicago Ave., Chicago, Ill.

Consolidated Records, Inc.

1600 Broadway, New York 19, N. Y.

Constellation Record Co.

11561 Ventura Blvd., Hollywood, Calif.

Continental Radio Prod.

6381 Hollywood Blvd., Hollywood 28, Calif.

Continental Record Company, Inc.

265 W. 54th St., New York 19, N. Y.

President: Donald H. Gabor

Sales manager: Emery Rozsa

Trade Name—Continental.

Retail Price—50c. (Red Label), 75c. (Black Label), \$1 (Green Label).

Serial Numbers—C-1, C-200, C-300-C-500, C-700, C-1000, C-1100, C-2000-C-6000, C-10,000, MR-1, H-1, WE-1.

Distributors

Goody Dist. Corp., 853 Ninth Ave., New York, N. Y.

Oriole Dist. Co., 512 Pennsylvania Ave., Baltimore 1, Md.

J. C. Boylan Co., 224 Rose Bldg., Cleveland, Ohio

J. F. Bard, 414 S. Franklin St., Chicago, Ill.

Monarch Sales Co., 210 N. 22nd St., Birmingham, Ala.

William B. Allen Supply Co., 916-918 N. Claiborne Ave., New Orleans 16, La.

Sni-Dor Radio Electric Ltd., 455 Craig St. W., Montreal, Que.

Coronet Records

40 W. 46th St., New York 19, N. Y.

Cosmopolitan Records, Inc.

745 Fifth Ave., New York 22, N. Y.

President: Harry W. Bank

Sales manager: Eddie Heller

Vice-president: Howard E. Stark

Trade Name—Cosmo Records.

Retail Price—75c.

Serial Numbers—400, J. S. 900, SS 700, 8500, DMR 100.

Distributors

Allied Music Sales Co., 3112 Woodward Ave., Detroit, Mich.

Scott-Crosse Co., 1423 Spring Garden St., Philadelphia, Pa.

Stephenson Film Co., 814 Gray Ave., Houston, Texas

Alberta News Ltd., 620 Eighth Ave., Calgary, Alberta, Canada

Allied Music Sales Co., 2610 E. Ninth St., Cleveland 15, Ohio

Allied Music Sales Co., 314 Monroe St., Toledo, Ohio

American Coin-A-Matic, 1435 Fifth Ave., Pittsburgh, Pa.

Appliance Dist., 106 S. Gallatin St., Jackson, Miss.

Blue Bonnet Music, 3235 Cross Ave., Dallas, Texas

A. Connors Dist. Co., 2173 Bailey Ave., Buffalo, N. Y.

M. S. Wolf Dist. Co., 2313 Third Ave., Seattle, Wash.
 M. S. Wolf Dist. Co., 1175 Folsom St., San Francisco, Calif.
 M. S. Wolf Dist. Co., 1305 Kellner Blvd., San Diego, Calif.
 M. S. Wolf Dist. Co., 427 S. W. 13 Ave., Portland, Ore.
 M. S. Wolf Dist. Co., 1318 Venice Blvd., Los Angeles 6, Calif.
 Frederick Lee Co., 301 W. Tenth St., Kansas City, Mo.
 Frederick Lee Co., 325 Second Ave., S., Minneapolis, Minn.
 Taran Dist., Inc., 90 Riverside Ave., Jacksonville, Fla.
 Taran Dist., Inc., 170 N. W. 23 St., Miami, Fla.
 Taran Dist., Inc., 102 Cain St., N. W., Atlanta, Ga.
 M & S Dist. Co., 1429 No. Clark St., Chicago, Ill.
 Oriole Corp., 512 Pennsylvania Ave., Baltimore, Md.
 Philippine Educational Co., Inc., 1101 Castillejos, Manila, Philippines
 Roberts-Nicholson, 1201 Commerce St., Houston, Texas
 Runyon Sales Co., 595 Tenth Ave., New York, N. Y.
 Capital Sales Co., 366 Shaw St., Toronto, Canada.

Howard M. Courtney

1425 E. Nadeau, Los Angeles 1, Calif.

Crest Recordings

8641 W. Third St., Los Angeles 36, Calif.

Crescent Records

6420 Santa Monica Blvd., Hollywood 38, Calif.

Owner: Marili Morden.

Trade Name—Crescent.

Retail Price—\$1.

Distributor

Jazz Distribution, 6420 Santa Monica Blvd., Hollywood 38, Calif.

Crestwood Publications

1585 Broadway, New York 19, N. Y.

Crosby Record Co.

109 Cottage Ave., Porterville, Calif.

Crown Records, Inc.

107 W. 52nd St., New York 19, N. Y.

President: Meyer Rabson

Secretary: M. R. Weinberg

Treasurer: Jack Steiner

Trade Name—Crown.

Retail Price—\$1.

Serial Numbers—10A, 100A.

Crystal Record Studio

2356 Dorris Pl., Los Angeles 31, Calif.

Joe Davis Record Co.

331 W. 51st St., New York, N. Y.

Owner: Joe Davis.

Decca Records, Inc.

50 W. 57th St., New York, N. Y.

President: Jack Kapp

Executive vice-president: F. F. Stevens Jr.

Secretary: Milton Diamond

Treasurer: Milton Rackmil

DeLuxe Record Co., Inc.

Linden, N. J.

President: David H. Braun

Sales manager: Jules Braun

Trade Name—DeLuxe.

Retail Price—75c., \$1.

Serial Numbers—1000-2000, 3000-5000.

Distributors

All State Dist., 45 Clinton St., Newark 2, N. J.

J. F. Bard, 414 S. Franklin St., Chicago, Ill.

Coinmatic Dist., 2712 W. Pico Blvd., Los Angeles 6, Calif.

Colonial Record Service, Box 42, Richmond, Va.

D-H Record Co.

120 Pritchard, Fullerton, Calif.

Davidson & Cascales

5232 Maymont Drive, Los Angeles 43, Calif.

Leader Sales & Dist., 4116 Live Oak St., Dallas, Texas

Malverne Dist., 1303 Fulton St., Brooklyn, N. Y.

Joseph Molien, 327 Washington St., Buffalo, N. Y.

Music Dist. Co., 1408 W. Ninth St., Cleveland, Ohio

Oriole Dist., 512 Pennsylvania Ave., Baltimore, Md.

David Rosen, 855 N. Broad St., Philadelphia 23, Pa.

Dial Records

5946 Hollywood Blvd., Hollywood 28, Calif.

President: Ross Russell

Sales manager and treasurer: Marvin Freeman

Trade Name—Dial.

Retail Price—\$1.

Serial Numbers—1000 series.

Distributor

Turntable, 1132 Tamarind Ave., Hollywood, Calif.

Diamond Record Co.

1650 Broadway, New York, N. Y.

Diamond Recordings

11819 Calvert St., N. Hollywood, Calif.

Dix Records

1510 Broadway, New York 19, N. Y.
 President: Dick Gilbert

Doris Record Co.

2356 Dorris Pl., Los Angeles, 31, Calif.

Duke Record Co.

769 Rockaway Ave., Brooklyn, N. Y.
 General manager: Nick Ross

Eagle Records

1069 Market St., San Francisco, Calif.

Eccles Disc Recording Corp.

6233 Hollywood Blvd., Hollywood 28,
 Calif.

Charles Eckert Co.

4880 Santa Monica Blvd., Los Angeles
 27, Calif.

Trade Name

Cocktail Hour Records

Distributor

Harris Mfg. Co., Los Angeles, Calif.

Electro Recording & Bdcstg.

308-310 N. Verdugo, Glendale 6, Calif.

Electro-Vox

5546 Melrose Ave., Los Angeles 38, Calif.

Elke Recordings Enterprises

6253 Hollywood Blvd., Hollywood 28,
 Calif.

Embassy Record Co.

1697 Broadway, New York 19, N. Y.
 President and sales manager: David Roth
 Secretary-treasurer: Stanley Roth

Trade Name—Embassy.

Retail Price—79c.

Serial Number—124A, 124B.

Frances A. Emig

809 N. Orange Grove, Los Angeles 16,
 California

President: John Facchino
 General manager: Charles B. Mish, Jr.
 Treasurer: Everett Fallis

Encore Record Co.

918 S. Flower St., Los Angeles 15, Calif.
Trade Name—Encore.

Enterprise Records, Inc.

8107-11 Santa Monica Blvd., Hollywood
 46, Calif.

Gus Evans

303 E. 35th St., Los Angeles 11, Calif.

E R A Recordings Co.

P. O. Box 948, Hollywood 28, Calif.

Eslava Recording Corp.

321 Gertrude Ave., Los Angeles 33, Calif.

Empire Record Corp.

825 Seventh Ave., New York 19, N. Y.
 President and sales manager: Jack L. Caidin
 Secretary: David Rubin

*Products Manufactured—Shellac phono-
 graph records for outside labels.*

Empire Recording Studios

1114 Madison Ave., Redwood City, Calif.

Excelsior Record Co.

3661 S. Gramercy Place, Los Angeles 7,
 Calif.

President and general manager: Otis Rene
 Secretary-treasurer: Margaret C. Rene

Exclusive Records

6272 Sunset Blvd., Hollywood 28, Calif.

President: Leon Rene
 General manager: Ben Ellison

Trade Name—Exclusive.

Retail Price—\$1.

Serial Numbers—201-221.

Distributors

Jack Gutshall, 1870 W. Washington Blvd.,
 Los Angeles, Calif.

Commercial Music, 510 N. Sarah, St. Louis,
 Mo.

American Coin-A-Matic, 1437 Fifth Ave.,
 Pittsburgh, Pa.

Standard Music Dist., 1913 Leeland, Houston,
 Texas

Music Sales, 303 N. Peters St., New Orleans,
 La.

Record-Sales Co., 2117 Third Ave. N., Bir-
 mingham, Ala.

C & C Dist. Co., 714 Fourth Ave., Seattle,
 Wash.

Lion Dist. Co., 726 S. Fourth St., Louisville,
 Ky.

Melody Sales Co., 316 Sixth St., San Fran-
 cisco, Calif.

Music Sales, 680 Union Ave., Memphis, Tenn.

Runyon Sales Co., 593 Tenth Ave., New
 York 18, N. Y.

Becker Novelty Co., 97 Dwight St., Spring-
 field, Mass.

Hales-Mullaly, 1-7 N. E. Sixth St., Oklahoma
 City, Okla.

Pan-American Record Dist., 11721 Glenwood
 Ave., Detroit 6, Mich.

David Rosen, 855 N. Broad St., Philadelphia,
 Pa.

Commercial Music, Inc., 827 E. 12th St.,
 Kansas City, Mo.

J. D. Hurst 219 Cannon Blvd., Kannapolis,
 N. C.

M. B. Krupp Dist., 506 N. Kansas St., El
 Paso, Texas.

Fabrico De Discos Peerless, S. de R. L.

Calzado Mariano Escobedo 225, Mexico City, Mexico
President and treasurer: Eduardo Baptista
Secretary: Louis R. Baptista
Trade Names—Discos Peerless, Discos Fenix.

Retail Price—\$1.
Serial Numbers—1550-2310 and on (Peerless), 4001-4081 and on (Fenix).

Distributor
Eduardo Baptista Y Cia., Venustiano Carranza 13, Mexico City, Mexico

Famous Records, Inc.

116 Market St., Newark 2, N. J.
President: Thomas P. Chakiris
Retail Price—50c., 75c., \$1.
Serial Numbers—1000, 5000, 7000.

Distributor
Goody Dist., 853 Ninth Ave., New York, N. Y.

Fargo Records

1011½ Washington Blvd., Venice, Calif.
President and secretary: Del Rey Hughes
Sales manager: Everett Hughes
Treasurer: Billy Hughes
Trade Names—Fargo, Range, Rafa.
Retail Price—75c. (Fargo, Range), \$1 (Rafa).
Serial Numbers—1110-1113.

Distributors
Coinmatic Dist., 2712 Pico Blvd., Los Angeles, Calif.
Music Sales, New Orleans, La.
Dobbs of Dallas, Dallas, Texas.

Favorite Record Co.

P. O. Box 3123, Hollywood 28, Calif.

Feature Records

1440 Broadway, New York 18, N. Y.

Robert T. Fell

6112 Malabar, Huntington Park, Calif.

F & M Recording Co.

1012½ N. Palm Ave., Los Angeles 46, Calif.

Four Star Record Co.

500 N. Western Ave., Hollywood, Calif.

Fran-tone

2004 Holly Drive, Hollywood, Calif.

Gala Record Co.

350 Fifth Ave., New York, N. Y.

Gem Records

2504 W. 6th St., Los Angeles 5, Calif.

General Records Co. (Div. Consolidated Records, Inc.)

1600 Broadway, New York 19, N. Y.

President: Hazard E. Reeves

Manager: Daniel A. Wolfert

Trade Names—Acompo, Gamut, General, Timely, Topical Tempos (skating records).

Retail Price—Majority 10-in. records, 75c.; majority 12-in. records, \$1.

GI Record Co.

1674 Broadway, New York, N. Y.

Giltedge Records

411 N. Western Ave., Los Angeles 4, Calif.

Globe Record Co., Inc.

1270 Ave. of the Americas, New York 20, N. Y.

President and treasurer: William Morris
Executive vice-president: Arnold S. Hecht
Secretary: Ruth Morris White

Dist. of recordings of U.S.S.R. and other United Nations.

Globe Record Co.

4714-16 S. Hoover, Los Angeles 37, Calif.

President: E. L. Hearn Jr.

Sales manager: Chas. O. Wyatt

Trade Name—Globe.

Retail Price—75c.

Distributors

Crowe-Martin Dist. Co., 1201 Whenevert St., Houston, Texas

Monarch Sales Co., 210 N. 22nd St., Birmingham, Ala.

Music Dist. Co., 1108 W. Ninth St., Cleveland, Ohio

Commercial Music Co., 510 N. Sarah St., St. Louis, Mo.

Hermitage Music Co., 423 Broad St., Nashville, Tenn.

W. M. Amann Dist. Co., 115 Olive St., Shreveport, La.

M. B. Krupp Dist., 506 N. Kansas St., El Paso, Texas

G N E

503 Ceres Ave., Los Angeles 13, Calif.

Goody Record Corp.

853 Ninth Ave., New York 19, N. Y.

President: Sam Gutowitz

Sales manager: William L. Simon

Trade Name—Goody.

Retail Price—75c.

Serial Numbers—3000-3004.

Distributors

Goody Dist. Co., 853 Ninth Ave., New York 19, N. Y.

Oriole Dist. Corp., 512 Pennsylvania Ave., Baltimore, Md.

Gotham Records

853 Ninth Ave., New York 19, N. Y.

Graphic Educational Products, Inc.

1108 Lillian Way, Hollywood, Calif.

Gregorian Institute of America

2130 Jefferson Ave., Toledo 2, Ohio
President and sales manager:
Clifford A. Bennett
Secretary: Esther Roeser
Treasurer: C. M. Murphy

Products Manufactured—Records of Catholic Church Music and Gregorian Chant.

Trade Name—Gregorian Institute of America.

Retail Price—Gregorian Chant Kyriale—10 albums (46 10-in. records), \$60; Preface and Pater Noster (chants—1 album (3 10-in. records) \$5; Catholic Hymns—1 album (4 10-in. records) \$5.

Direct distribution.

Guitarist Records

1105 W. Seventh St., Los Angeles 14, Calif.

Gulf Record Co., Inc.

3014 Telephone Road, Houston, Texas

Hamilton Platter Co.

4257 McKinley Ave., Los Angeles 11, Calif.

Hamptone Records

1127½ E. 10th St., Los Angeles 21, Calif.

Distributors

Ebony Dist. Co., 307 Lenox Ave., New York, N. Y.

Del Ray Radio Co., 2640 St. Antoine St., Detroit, Mich.

Hargail Records

130 W. 56th St., New York 19, N. Y.

President: Harold Newman

Trade Name—Hargail, H. N. Society

Distributors

Hargail Records

J. F. Bard, Chicago, Ill.

Harmonia Records

1328 Broadway, New York, N. Y.

Harwall Music Publishers

1752 N. Vine St., Hollywood 28, Calif.

Dave Hendricks

1333 57th St., Los Angeles 11, Calif.

Haven Records

716 Rockaway Ave., Brooklyn, N. Y.

Hi-Dee-Ho Record Co.

6805 S. Hoover St., Los Angeles 44, Calif.

Historical Recordings Co.

505 Fifth Ave., New York 17, N. Y.

President: T. F. Hanlon

Sales manager: Robert Lieberman

Trade Name—Historical

Retail Price—12-in. unbreakable record, \$2; album of 4 12-in. records, \$8.50.

Serial Numbers—100 (albums), 1000 (records).

Direct distribution.

Hit Records

7 W. 46th St., New York, N. Y.

Holiday Dist. Co.

137 N. Western Ave., Los Angeles 4, Calif.

President and sales manager: Lewis R. Chudd

Secretary: K. Martinez

Treasurer: Max Feirtag

Trade Names

Discos Imperiales

Imperial

Gold Seal

Retail Price—75c.

Hollywood International Records

985 Menlo Ave., Los Angeles 6, Calif.

General manager: Ben Ellison

Hollywood Records Corp.

750 N. La Cienga, Los Angeles 46, Calif.

H. R. S. Records, Inc.

303 Fifth Ave., New York 16, N. Y.

President: Lee Smith

Sales manager: Jack L. Caidin

Secretary: Steven Smith

Treasurer: Heywood Hale Brown

Trade Name—H. R. S.

Retail Price—10-in. records, \$1.05; 12-in. records, \$1.55.

Serial Numbers—1000 (10-in.), 2000 (12-in.).

Distributor

Jack L. Caidin, 825 Seventh Ave., New York 19, N. Y.

Immortal Records

Prince Edward Hotel, Long Beach, New York

Independent Record Prod.

6425 Hollywood Blvd., Hollywood 28, Calif.

Imperial Records

137 N. Western Ave., Los Angeles 4, Calif.

Distributor

Holiday Dist. Co., 137 N. Western Ave., Los Angeles 4, Calif.

Indigo Records

1506 N. Sierra Bonita, Hollywood 46, Calif.

International Artists, Inc.

1512 No. Gordon St., Hollywood, Calif.

International Record Co.

27-19 Jackson Ave., Long Island City 1, N. Y.

President: William B. Feldstein

Trade Name

International

International Records Agency
P. O. Box 171, Richmond Hill 18, N. Y.
Owner: Albert J. Franck
Importers and exporters of records.
Trade Name—Iragen Records.
Retail Price—\$1.50.

Jamboree Records, Inc.
1650 Broadway, New York 19, N. Y.
President: L. Miller
Sales manager: Morty Kline
Secretary: Sonia Becker
Treasurer: Ruth Royce
Trade Name—Jamboree.
Retail Price—\$1.05.
Serial Numbers—900-907.

Distributors
Music Dist., 1408 W. Ninth St., Cleveland, Ohio
Melody Record Supply, 314 W. 52nd St., New York 19, N. Y.
All State Dist. Co., 45 Clinton St., Newark, N. J.
Zobrist Co., 2125 Westlake Ave., Seattle, Wash.

Jay-Dar Recording Co.
54 W. Randolph St., Chicago 1, Ill.

Jazz Man Records
6420 Santa Monica Blvd., Hollywood 38, Calif.
Owner: David Stuart
Trade Name—Jazz Man.
Retail Price—\$1.

Jewel Record Co.
1514-1520 Crossroads of the World, Hollywood 28, Calif.
President: Ben Pollack
Sales manager: Ed Dougal
General manager and comptroller: Joseph J. Chernus
Trade Names—Jewel Record Co., Metro Record Co., 20th Century Record Co.
Retail Price—75c., \$1.05 (Goldnote series).
Serial Numbers—J-1000—, S-3000—, G-4000—, R-5000—, T-7000—, E-8000—, G. G.N. 10,000, D-1.

Jubilee Records
1832 Seventh St. N. W., Washington D. C.

Juke Box Record Co., Inc.
7 W. 46th St., New York 21, N. Y.
President and treasurer: Al Midaleinan
Sales manager: B. O. Siegal
Secretary: A. N. Rupe
Trade Name—Juke Box.
Retail Price—\$1.
Serial Numbers—UR 100 series, JB 500 series.

Junkin Machine Co.
8825 S. Crocker St., Los Angeles 3, Calif.

Jupiter Publishing Co.
808 S. Vermont Ave., Los Angeles 5, Calif.

KFI Rec. Div.
141 N. Vermont Ave., Los Angeles 4, Calif.

K & L Record Co.
314 N. Berendo St., Los Angeles 4, Calif.

K and M Recorders
1028 N. Western Ave., Los Angeles 27, Calif.

K & M Service
1913 W. Pico Blvd., Los Angeles 6, Calif.

KMTR Radio Corp.
1000 Caluenga Blvd., Hollywood 38, Calif.

K. S. L. Recording Co.
489 Fifth Ave., Suite 500, New York 17, N. Y.

Sales manager: Karl Lorenz
Secretary-treasurer: Selma Frank-Lorenz
Products Manufactured—"On the spot" business-film recordings; educational-film recordings; documentary recordings of business, social and personal events.
Trade Name—K-S-L High-Fidelity Recordings of Distinction.
Retail Price—According to special estimate.
Serial Numbers—WM 348-599, OM 101; 599.

Keynote Recordings, Inc.
522 Fifth Ave., New York 18, N. Y.
President: Eric Bernay
Trade Name—Keynote.
Retail Price—10-in. records, 75c.; 12-in. records, \$1.

King Jazz, Inc.
140 W. 42nd St., New York 18, N. Y.
President and sales manager: Milton Mezzrow
Vice-president: John van Beuren
Secretary-treasurer: Harry M. Houck
Trade Name—King Jazz.
Retail Price—10-in. records, \$1; 12-in. records, \$1.50.
Serial Numbers—K.J. 140-145.
Distributor—King Jazz Inc.

King Record Co.
1510 Brewster, Cincinnati 7, Ohio
President: Sydney Nathan
Sales manager: Al Miller
Secretary-treasurer: Sam Nathan
Trade Name—King, Queen.
Retail Price—75c.
Serial Numbers—500 series (King), 4100 series (Queen).

Kismet Record Co.

227 E. 14th St., New York 3, N. Y.
Products Manufactured—Folk dances, Oriental and Russian records.
Trade Name—Kismet.
Retail Price—79c. (folk dance and Russian), \$1.05 (Oriental).

Distributor

Favorite Mfg. Co., 105 E. 12th St., New York, N. Y.

Lamplighter Records

R.F.D. 1, Pacific Palisades, Calif.

Lariat Records

308-310 N. Verdugo Road, Glendale 6, Calif.

Liberty Music Shops, Inc.

150 Madison Ave., New York 22, N. Y.

President: Arthur Hill

General manager: Frederick A. Kolmetz

Secretary-treasurer: Benjamin Kaye

Products Manufactured—Radios, radio-phonograph combinations, records.

Trade Names—Libertyphones (radio and combination), Liberty (records).

Liberty Record Co.

1269 Tujunga, N. Hollywood, Calif.

Linguaphone Institute

30 Rockefeller Plaza, New York 20, N. Y.

President: Max Sherover

Sales manager: Carl M. Remy

Products Manufactured—Recorded language and speech courses.

Trade Name—Linguaphone.

Retail Price—\$50—29 languages.

Lion Records

799 Seventh Ave., New York 19, N. Y.

Little Folks Favorites

918 S. Flower St., Los Angeles, Calif.

Lockie Music Exchange

950 S. Broadway, Los Angeles 15, Calif.

Lorelei Recording Co.

43-10 53rd St., Woodside, L. I., New York.

President and sales manager: Henry P. Backs

Secretary: Doris Mulvaney

Treasurer: Dolly Backs

Products Manufactured—Foreign language recordings.

Trade Name—Lorelei.

O. P. MacGregor

729 S. Western Ave., Los Angeles 5, Calif.

Maestro Music

2511 Maybery St., Los Angeles 26, Calif.

Distributor

Pacific Music Sales, 1515 N. Vine St., Hollywood 28, Calif.

Magic Recording Co.

6370 Franklin Ave., Los Angeles 28, Calif.

Majestic Records, Inc.

St. Charles, Ill.

Trade Name—Majestic.

Retail Price—50c., 75c.

Serial Numbers—1000, 5000, 7000, 8000.

Distributors

Reins-Freeman Dist., 201 Jay St., Albany 6, N. Y.

Amarillo Hdwe. Co., 600 Grant St., Amarillo, Texas

Crawford & Thompson, 291 Ivy St., N.E., Atlanta 3, Ga.

J. B. Mitchell Co., 117 Market Place, Baltimore 2, Md.

Birmingham Electric Battery Co., Ave. B & 23rd St. S., Birmingham, Ala.

Major Appliance Corp., 11 Deerfield St., Boston 15, Mass.

Mutual Appliance Dist., 122 Clinton St., Buffalo 3, N. Y.

Main Appliance Co., 31 Main St., Camden, Me.

Southern Appliances, Inc., 517 E. Trade St., Charlotte 2, N. C.

Allied Appliance Dist. of Chattanooga, Inc., c/o Allied Appliance Dist. of Knoxville, Inc., 923 Central Ave., N., Knoxville, Tenn.

Chicago-Majestic, Inc., 515 N. LaSalle St., Chicago 10, Ill.

Kelley-Mason, Inc., 49 Central Ave., Cincinnati 2, Ohio

Elliott & Evans, Inc., 1800 Prospect Ave., Cleveland 3, Ohio

Thompson & Hamilton, Inc., 211 N. Fourth St., Columbus, Ohio

Lone Star Wholesalers, Inc., 10th Floor, 2nd Unit, Santa Fe Bldg., Dallas, Texas

Gem City Appliances, Inc., 129 Ludlow St., Dayton, Ohio

The Parker Co., 1520 Wazee St., Denver 2, Colo.

Sidles Co., 912 Locust St., Des Moines 9, Iowa

LaSalle Electric & Mill Supply Co., 6911 E. Lafayette, Detroit 7, Mich.

Allied Appliance Dist. of Evansville, Inc., c/o Bomar Mfg. Co., 1114 Bardstown Road, Louisville 4, Ky.

State Dist. Co., 30-32 Ionia St., N.W., Grand Rapids, Mich.

Bohman-Warne, Inc., 35 W. Franklin St., Hagerstown, Md.

Electrical Equipment, Inc., 1680 Ingeborg St., Houston 3, Texas

Modern Dist., Inc., 1540 Fourth Ave., Huntington, W. Va.

Kiefer-Stewart Co., 122 S. Senate, Indianapolis 9, Ind.

Mississippi Appliance Co., 800 S. State St., Jackson 110, Miss.

Maco Appliance Dist., 416 Admiral Blvd., Kansas City 6, Mo.

Allied Appliance Dist. of Knoxville, Inc., 923 Central Ave., N., Knoxville, Tenn.
 George C. Stafford & Sons, 406 Main St., Laconia, N. H.
 555, Inc., Second & Broadway, Little Rock, Ark.
 Roach-Driver Co., 1701 S. Grand Ave., Los Angeles 15, Calif.
 Bonar Mfg. Co., 1114 Bardstown Road, Louisville, Ky.
 The Soo-Marquette Hdw. Co., 319-321 Division St., Marquette, Mich.
 Allied Appliance Dist. of Memphis, Inc., 1090 Union Ave., Memphis 3, Tenn.
 Shelley Dist. Co., 3015 Grand Ave., Miami 33, Fla.
 Moe Bros. Milwaukee Co., 319 E. Clybourn St., Milwaukee 2, Wisc.
 Northwest Dist. Co., 1012 LaSalle Ave., Minneapolis 2, Minn.
 Automotive Supply Co., Mitchell, S. Dak.
 United Electric Service, 905 Louisville Ave., Monroe, La.
 Allied Appliance Dist. of Nashville, Inc., 216 Tenth Ave., S., Nashville 4, Tenn.
 Igoe Bros., Inc., Ave. A & Poinier St., Newark, N. J.
 Mory Sales Corp., 156 Brewery St., New Haven 11, Conn.
 United Dist., Inc., 539 Carondelet St., New Orleans 12, La.
 Colen-Gruhn Co., Inc., 387 Fourth Ave., New York, N. Y.
 Hales-Mullaly Co., 1 N. E. Sixth St., Okla. City 4, Okla.
 Sidles Co., 502 S. 19th St., Omaha, Nebr.
 J. J. Pocock, Inc., 1920 Chestnut St., Philadelphia 3, Pa.
 Electrical Equipment Co. of Arizona, 124 N. Central Ave., Phoenix, Ariz.
 J. E. Miller Co., 206 Kirby Bldg., 80 26th St., Pittsburgh 22, Pa.
 A. H. Marshall Co., Inc., Plattsburg, New York.
 F. B. Connelly Co. of Oregon, 1233 N. W. 12th Ave., Portland, Ore.
 Eagle Sales Corp., 49 Westminster St., Providence, R. I.
 The Wallahan Co., 1815 West St. Joe St., Rapid City, S. Dak.
 Dowdy Electric Co., Roanoke, Va.
 Harmon Automotive Corp., 16 Charlotte St., Rochester 4, N. Y.
 Tri-City Radio Supply Co., 1919 Fourth Ave., Rock Island, Ill.
 Glenn Earl, Inc., 353 West 2nd South St., Salt Lake City 1, Utah
 McCormack and Co., 450 Ninth St., San Francisco 3, Calif.
 F. B. Connelly Co., 1015 Republican St., Seattle 9, Wash.
 Femco Dist. Co., 1603 Prairie Ave., South Bend 14, Ind.
 Prudential Dist., Inc., 151 Stevens St., Spokane 8, Wash.

B. H. Spinney Co., 62 Hampden St., Springfield, Mass.
 Recordit Dist. Co., 3028 Locust St., St. Louis 1, Mo.
 B. H. Spinney Co., 1133 West Genesee, Syracuse, N. Y.
 Gerlinger Equipment Co., 1001 Adams St., Toledo, Ohio
 Mehen Dist. Co., 2480 Sixteenth St., N. W., Washington 9, D. C.
 Home Appliance Co., 149 North Rock Island, Wichita, Kan.
 Monarch Radio & Appliance Co., 211 W. Market St., San Antonio 5, Texas
 R. A. Howe & Co., 816 Fort St., P. O. Box 3371, Honolulu 1, Hawaii

Manor Record Co.

162 Prince St., Newark 3, N. J.
 President: Irving Berman
Trade Name—Manor.
Retail Price—79c., \$1.05, \$1.58.

Distributors

Regis Record Co., 162 Prince St., Newark, N. J.
 Record Dealers Supply Co., 40 W. 46th St., New York 19, N. Y.
 Colonial Record Service, P. O. Box 42, Richmond, Va.
 Oriole Dist. Co., 512 Pennsylvania Ave., Baltimore, Md.
 David Rosen, 855 N. Broad St., Philadelphia, Pa.
 Friedman Amusement Co., 441 Edgewood Ave., S. E., Atlanta, Ga.
 William B. Allen Supply Co., 916 N. Claiborne Ave., New Orleans, La.
 Melody Record Supply, 314 W. 52nd St., New York 19, N. Y.
 Charlie Record Dist., 311 Riverside Ave., Jacksonville, Fla.

Master Recorders

6926 Melrose Ave., Los Angeles 38, Calif.

Mastertone Record Co.

6513 Hollywood Blvd., Hollywood 28, Calif.

Matla Records

127 Washington Ave. N., Minneapolis, Minn.

Don McDiarmid

1969 Makiki St., Honolulu, T. H.

Medlee Recordings

127 W. Fifth St., Los Angeles 13, Calif.

Mello-Strain Records, Ltd.

1658 Broadway, New York 19, N. Y.
 President: Al Bandini

Melodisc Recording Co.

6625 Sunset Blvd., Hollywood 28, Calif.
 President: Daniel O'Brien

Sales manager: Bob Goodman
Products Manufactured—Phonograph records, raw material and biscuits.
Trade Name—Melodisc.
Retail Price—79c. (1000 series), \$1.05 (100 series).

Distributors

J. F. Bard, 414 S. Franklin, Chicago, Ill.
The C. & C. Dist. Co., 714 Fourth Ave., Seattle, Wash.
Colonial Record Service, Box 42, Richmond, Va.
Crowe-Martin Dist. Co., 1201 Chenevert St., Houston, Texas
Goody Dist. Co., 853 Ninth Ave., New York, N. Y.
Hermitage Music Co., 423 Broad St., Nashville, Tenn.
Household Dist. Co., 1233 N. W. 12th Ave., Portland, Ore.
M. B. Krupp, 506 North Kansas St., El Paso, Texas
Monarch Sales Co., 210 N. 22nd St., Birmingham, Ala.
Music Sales Co., 680 Union Ave., Memphis, Tenn.
Music Sales Co., 303 N. Peters St., New Orleans, La.
Trilon Record Co., 3123 San Pablo, Oakland, Calif.
Melodisc Sales Co., 6625 Sunset Blvd., Hollywood, Calif.

Melody Moderne, Inc.

6233 Hollywood Blvd., Hollywood 28, Calif.

President: Lee Ryer

Sales manager: G. W. Russell

Secretary: J. W. O'Neill

Treasurer: Noel M. Ryer

Products Manufactured—Records, sheet music and orchestrations.

Trade Name—Memo Records.

Retail Price—79c.

Serial Numbers—1001-1003, 3001, 3002, 5001-5004, 7001-7005.

Distributor

K & M Service, 1913 W. Pico Blvd., Los Angeles 6, Calif.

Melrose Record Co., Inc.

601 E. 19th St., Brooklyn 26, N. Y.

President: Melvin Rose

Trade Name—Melrose.

Retail Price—75c.

Serial Numbers—1400 series.

Distributor

I. R. Gwirtz Dist.

Memory's Garden Record Co.

11430 Decente Drive, N. Hollywood, Calif.

Mercury Recordings

232 E. Erie St., Chicago 11, Ill.

President: Irving C. Green

Mills Music Inc.

6425 Hollywood Blvd., Hollywood 28, Calif.

Roy Milton Co.

3138 1/2 Sixth Ave., Los Angeles 16, Calif.

Mirror Record Corp.

1133 Broadway, New York 10, N. Y.

President and treasurer: P. K. Trantwein

Sales manager: Arthur Heine

Secretary: G. L. Damato

Products Manufactured—Blank discs for recordings, recording accessories.

Trade Name—Mirror.

Mirror Recording Co.

810 S. Rollin St., S. Pasadena, Calif.

1585 Broadway, New York, N. Y.

Modern Music Record Co.

678 1/2 S. Vermont Ave., Los Angeles 5, Calif.

President: Jules Bihari

Sales manager: Joe Bihari

Production manager: Saul Bihari

Trade Name—Modern Music.

Retail Price—\$1.

Distributors

Modern Music Dist. Co., 678 1/2 S. Vermont Ave., Los Angeles 5, Calif.

Jack Gutshall Dist. Co., 1870 W. Washington Blvd., Los Angeles 7, Calif.

Commercial Music Co., 510 N. Sarah St., St. Louis, Mo.

Music Sales Co., 680 Union, Memphis, Tenn.
David Rosen, 855 N. Broad St., Philadelphia, Pa.

Record Sales Co., Inc., 2117 Third Ave., Birmingham, Ala.

Runyon Sales Co., 593 Tenth Ave., New York 18, N. Y.

Standard Music Dist., 1913 Leeland Ave., Houston, Texas.

Becker Novelty Co., 97 Dwight St., Springfield 3, Mass.

C & C Dist. Co., 714 Fourth Ave., Seattle, Wash.

M. B. Krupp, 506 N. Kansas St., El Paso, Texas.

Taran Dist. Co., Inc., 170 N.W. 23rd St., Miami, Fla.

Hales-Mullaly Co., 1-7 N.E. Sixth St., Oklahoma City, Okla.

Lion Dist. Co., 726 S. Fourth St., Louisville, Ky.

Taran Dist. Co., Inc., 90 Riverside Ave., Jacksonville, Fla.

Davis Sales Co., 1010 Seventeenth St., Denver, Colo.

American Coin-A-Matic, 1437 Fifth Ave., Pittsburgh, Pa.

Melody Sales Co., 316 Sixth St., San Francisco, Calif.

Musette Publ., Inc.

113 W. 57th St., New York 19, N. Y.
 President and treasurer: Arthur Zinkin
 Secretary: A. P. Wollheim
Products Manufactured—Books that live,
 they talk, they sing.
Trade Names—Musette, Musicomics.
Retail Prices—29c. (Jack and Jill series),
 59c. (Musicomics), \$1.50 (2-record al-
 bum of miniature classics), \$2.50
 (Freedom's Plow-album and folio).

Distributors

Chicago Musical Instrument Co., 30 E.
 Adams St., Chicago 3, Ill.
 Continental Music Co., 630 S. Wabash St.,
 Chicago 5, Ill.

Music For Society Record Co.

1585 Broadway, New York, N. Y.

Musicraft Corp.

40 W. 46th St., New York 19, N. Y.
 President and sales manager: Paul Puner
 Secretary: Frank Baron
 Treasurer: Justin Harris
Trade Names—Musicraft, Red Robin.
Retail Price—10-in. records, 50c. and 75c.;
 12-in. records, \$1.
Serial Numbers—15000 series, 200-300
 series.

Distributors

Allied Music Sales, 3112 Woodward Ave.,
 Detroit, Mich.
 Associated Dist. Co., 1823 California St.,
 Denver, Colo.
 Coast Wholesale Music Co., 536 Mission St.,
 San Francisco, Calif.
 Kayler Co., 1639-41 Vine St., Philadelphia 3,
 Pa.
 James H. Martin, 1407 Diversey Blvd., Chi-
 cago, Ill.
 Massachusetts Music Dist. Co., 1269-71 Tre-
 mont St., Roxbury, Mass.
 Allied Music Sales Co., 314 Monroe St.,
 Toledo, Ohio
 Barnett Dist. Co., Inc., 8 W. 20th St., Balti-
 more 18, Md.
 Dale Dist. Co., 40 E. 32nd St., New York,
 N. Y.
 Dale New Jersey Inc., 79 Locke St., Newark,
 N. J.
 Diehl & Lehman App. Dist., 1409 Texas St.,
 El Paso, Texas
 Herbert Horn Co., 2401 S. Hill St., Los
 Angeles, Calif.
 Lighting Fixture & Electric Supply Co., 307
 Tchoupitoulas St., New Orleans, La.
 Pittsburgh Prod. Co., 500 Fontella St., Pitts-
 burgh 12, Pa.
 Record Releasing Corp., 1317 N. Broadway,
 Oklahoma City, Okla.
 Record Releasing Corp., 911 Camp St., Dal-
 las, Texas
 Robert E. Ricker, Ltd., 2138-40 Kalakua St.,
 Honolulu, T. H.

Royal Dist. Co., 2211 Commerce St., Houston,
 Texas
 Sni-Dor Radioelectric, Ltd., 155 Craig St.,
 W., Montreal, Can.
 Taran Dist. Co., 102 Cain St. N.W., Atlanta,
 Ga.
 Taran Dist. Co., 90 Riverside Ave., Jack-son-
 ville, Fla.
 Taran Dist. Co., 170 N. W. 23rd St., Miami
 37, Fla.
 Vogel, Birch & Co., 22nd St. & Central Ave.,
 Ashland, Ky.
 Williams & Shelton Co., Inc., 420 S. Tryon
 St., Charlotte, N. C.
 Frederick Lee Co. of Kansas City, 301 W.
 10th St., Kansas City, Mo.
 Frederick Lee, Inc., 325 Second Ave., S.,
 Minneapolis, Minn.
 Niagara Midland Co., Inc., 881 Main St.,
 Buffalo, N. Y.
 St. Louis Music Supply Co., 4100 Delmar
 Blvd., St. Louis, Mo.
 State Music Dist. Co., 1156 Main St., Hart-
 ford, Conn.
 Stratton Warren Hdwe. Co., Carolina Ave. &
 Florida, Memphis, Tenn.
 S. R. Ross, 1212 S. State St., Salt Lake City,
 Utah
 Herb E. Zobrist, 2125 Westlake Ave., Seattle,
 Wash.
 Musicraft Record Dist. of New York, Inc.,
 665 Fifth Ave., New York, N. Y.
 Allied Music Sales, 2610 E. Ninth St., Cleve-
 land, Ohio

Music You Enjoy, Inc.

420 Lexington Ave., New York 17, N. Y.
 President and sales manager: J. H. Alderton
 Secretary: D. J. Randall
 Treasurer: D. O. Slauson

Products Manufactured—7-in. children's
 phonograph records.

Trade Names—Pied Piper, Listen Look
 Picture Books, S Melodyland Record
 Book.

Distributor

Barth-Feinberg, Inc., 17 Union Square W.,
 New York, N. Y.

National Recording & Film Corp.

20 North Wacker Drive, Chicago 6, Ill.
 President: Richard Bradley
 Secretary-treasurer: Ben Tunick
Products Manufactured—Instantaneous
 and transcription recordings, projec-
 tion and movie jobs, etc.

National Records Co., Inc.

1811 Broadway, New York 23, N. Y.
 President: A. M. Cary
 Secretary: B. G. Kornheiser
 Vice-president and treasurer: A. B. Green
Trade Name—National
Retail Price—79c. (4000, 5000, 7000
 series), \$1.05 (6000, 8000, 9000).
Serial Numbers—4000-9000.

Distributors

National Disc Sales Co., 1811 Broadway, New York 23, N. Y.

Midwest Music Co., 1002 Michigan Ave. S., Chicago, Ill.

Neeko Records

1913 Pico Blvd., Los Angeles 15, Calif.

New Bourbon Records

Box 2964, Hollywood 28, Calif.

Normjini Enterprises

1617 Donaldson St., Los Angeles 26, Calif.
505 Fifth Ave., New York, N. Y.

Notable Records

8577 Wonderland Ave., Los Angeles 46, Calif.

Orpheus Record & Transcription Co.

1585 Broadway, New York 19, N. Y.

President: R. C. Douglas

Pan American Record Co.

619 Antonia Ave., Los Angeles 31, Calif.

Trade Name—Pan American.

Retail Price—79c., \$1.05.

Distributors

J. F. Bard, 414 S. Franklin St., Chicago 7, Ill.

M. B. Krupp, 506 N. Kansas St., El Paso, Texas

William M. Amann, 115 Olive St., Shreveport, La.

George L. Bard, 4 Colonial Road, Bronxville, N. Y.

Paraclete Music Disc

Foxon East Haven, Conn.

Proprietor: S. A. Evreinow

Products Manufactured—Publish music on records—piano and chamber music specialty.

Trade Names—Paraclete Music Disc, PMD, Paraclete.

Retail Price—10-in. records \$1.10.

Paragon Records

834½ N. Poinsettia Place, Hollywood 46, Calif.

Paramount Records

6037 Hollywood Blvd., Hollywood 28, Calif.

Paramount Recording Corp.

505 Fifth Ave., New York 17, N. Y.

President and secretary: Gus Peter Statiras

Sales manager: Peter Statiras

Treasurer: George C. Acrivides

Trade Name—Paramount.

Retail Price—\$1.

Serial Number—500 series.

Pearl Records

809 Madison Ave., Covington, Ky.

Peerless Records

1511 W. Pico Blvd., Los Angeles 15, Calif.

President: Paul Mayer

General sales manager: William Abel

Trinidad Pelaez

408 N. Main St., Los Angeles 12, Calif.

Perfection Recorders

535½ N. Sycamore Ave., Los Angeles 36, Calif.

Phoenix Records

1201½ E. 50th St., Los Angeles 11, Calif.

Phono Record Co.

220 Fifth Ave., New York, N. Y.

Phototone Record Co.

9417 Parmalee Ave., Los Angeles 2, Calif.

Pick-Up Records

Room 1008, 1600 Broadway, New York 19, N. Y.

Partners: Les Schriber, Walter F. Gustafson

Trade Name—Pick-Up.

Retail Price—75c.

Pioneer Radio Prod.

8736 Sunset Blvd., Los Angeles 46, Calif.

Pioneer Record Co.

1051 E. 55th St., Maywood, Calif.

Piper Records

730 N. Naomi, Burbank, Calif.

Planet Recording Co.

834½ N. Poinsettia Place, Hollywood 46, Calif.

Popular Recording Co.

846 N. Ardmore Ave., Hollywood 27, Calif.

Premier Radio Enterprises, Inc.

3033 Locust St., St. Louis 3, Mo.

President: H. S. Somson

Vice-presidents: Wilson Dalzell, Dave Ward

Secretary-treasurer: J. M. Yawitz

Preview & Coinop Records

4215 S. Vermont Ave., Los Angeles 37, Calif.

W. E. Prior

1644 Cherokee, Hollywood 28, Calif.

Process Record Co.

19 Pennell St., Franklin, Pa.
President: Norman Kelly
Sales manager: Charles F. House
Secretary-treasurer: John B. Whitney
Trade Name—Process.
Retail Price—75c., \$1.
Serial Numbers—501 up, 1001 up.
Distributor—Process Records
19 Pennell St., Franklin, Pa.
1502 S. 49th St., Omaha 6, Nebr.
831 W. 53rd St., Los Angeles 37, Calif.

RCA Victor Division of Radio Corp. of America

Camden, N. J.
Sales manager: M. Seklemian
Products Manufactured—Records, radios,
radio-phonograph, record changers,
auto radios.
Trade Names—Victrola, Red Seal, Blue-
bird, The Golden Throat.
Distributors
The Yancey Co., Inc., 340 W. Peachtree St.,
N.W., Atlanta 3, Ga.
R. P. McDavid & Co., Inc., 1630 Second
Ave., N., Birmingham 5, Ala.
Southern Radio Corp., 1201 West Morehead
St., Charlotte 1, N. C.
Major Appliances, Inc., 474 Riverside Ave.,
Jacksonville 4, Fla.
C. M. McClung & Co., 501-9 W. Jackson
Ave., Knoxville 7, Tenn.
Wyatt-Cornick, Inc., Grace at 14th St., Rich-
mond 16, Va.
RCA Victor Dist. Corp., 445 N. Lake Shore
Drive, Chicago 11, Ill.
Hendrie & Bolthoff Mfg. & Supply Co., P. O.
Box 5110, Terminal Station, Denver 17,
Colo.
G. W. Onthank Co., 11 & Cherry Sts., Des
Moines 9, Iowa
Associated Dist., 211 S. Illinois St., Indian-
apolis 4, Ind.
RCA Victor Dist. Corp., 1422-24 Grand Ave.,
Kansas City 6, Mo.
Taylor Electric Co., 112 N. Broadway, Mil-
waukee 2, Wis.
F. C. Hayer Co., 300 Washington Ave., N.,
Minneapolis 1, Minn.
Klaus Radio & Electric Co., 707 Main St.,
Peoria 2, Ill.
Interstate Supply Co., 26 S. Tenth St., St.
Louis 2, Mo.
Ohio Appliances, Inc., Daylight Bldg., E.
Sixth & Court Sts., Cincinnati 2, Ohio
Cleveland Radioelectric, Inc., 2905 Chester
Ave., Cleveland 14, Ohio
Ohio Appliances, Inc., 243 N. Fourth St.,
Columbus 15, Ohio
RCA Victor Dist. Corp., 1930 E. Jefferson
Ave., Detroit 7, Mich.
Van Zandt Supply Co., 1123 Fourth Ave.,
Huntington 11, W. Va.
Ewald Dist. Co., 1538 S. Brook St., Louis-

ville 8, Ky.
Hamburg Bros., 305 Penn Ave., Pittsburgh
22, Pa.
Adleta Co., 1900 Cedar Springs, Dallas 1,
Texas
Midland Specialty Co., 427 W. San Antonio
St., El Paso, Texas
Straus-Frank Co., 4000 Leland St., Houston
1, Texas
McGregor's, Inc., 1071 Union Ave., Memphis
3, Tenn.
Electrical Supply Co., 201 Magazine St., New
Orleans 8, La.
Dulancy Dist. Co., 834 N. W. Second St.,
Okla. City 2, Okla.
Straus-Frank Co., 301 South Flores St., San
Antonio 6, Texas
Northwestern Auto Supply Co., Inc., 420
N. Broadway, Billings, Mont.
Leo J. Meyberg Co., Inc., 2027 S. Figueroa
St., Los Angeles 7, Calif.
Harper-Meggee, Inc., N. W. 15th & Irving
Sts., Portland 9, Ore.
The Salt Lake Hdwe. Co., 105 N. Third
West—Box 510, Salt Lake City 9, Utah.
Leo J. Meyberg Co., Inc., 70 Tenth St., San
Francisco 1, Calif.
Harper-Meggee, Inc., 960 Republican St.,
Seattle 9, Wash.
R. T. A. Dist., Inc., 36 Broadway Menands,
Albany, N. Y.
D & H Dist. Co., 31-37 E. Lee St., Baltimore
2, Md.
Bickford of Buffalo, 1209 Broadway, Buffalo
12, N. Y.
The Eastern Co., 620 Memorial Drive, Cam-
bridge 39, Mass.
Radio & Appliance Dist., Inc., 673 Connecti-
cut Blvd., East Hartford, Conn.
D & H Dist. Co., 311 S. Cameron St., Harris-
burg, Pa.
Krich-Radisco, Inc., 422-432 Elizabeth Ave.,
Newark 8, N. J.
Bruno-New York, Inc., 460 W. 34th St., New
York 1, N. Y.
Raymond Rosen & Co., 32nd & Walnut Sts.,
Philadelphia 4, Pa.
Cressey & Allen, 35 Commercial St., Portland
6, Me.
Eddy & Co., Inc., 23 Broad St., Providence 3,
R. I.
Bickford Bros. Co., 28 S. Union St., Roches-
ter, N. Y.
Morris Dist. Co., 201-212 W. Jefferson St.,
Syracuse 2, N. Y.
Southern Wholesalers, Inc., 1519 "I" St.,
N.W., Washington, D. C.

Radionic Recording Co.

5525 Sunset Blvd., Hollywood 28, Calif.

Radio Recorders

7000 Santa Monica Blvd., Los Angeles 38,
Calif.

Record Productions, Inc.

500 N. Western Ave., Los Angeles, Calif.

Regal Records

1506 N. Sierra Bonita Ave., Hollywood
46, Calif.

Regis Record Co.

162 Prince St., Newark 3, N. J.

President: Irving Berman
Treasurer: Mildred Berman

Republic Prod., Inc.

4024 Radford Ave., N. Hollywood, Calif.

Rex Records

715 Fifth Ave., New York, N. Y.

Rhapsody Records

1752 N. Vine St., Hollywood, Calif.

Rhythm Recordings

1317 Grove St., San Francisco, Calif.

President: David Rosenbaum
Trade Name—Rhythm.
Retail Price—\$1.

Rhythm Records Co.

4990 Melrose Ave., Hollywood 27, Calif.

President: Neely Plumb
General manager: Hal V. Hughes
Secretary: Flora June Plumb

Products Manufactured—Phonograph records: rhythm-section accompaniments to standard numbers.

Trade Name—Rhythm.

Retail Price—10-in. records, \$1.50; album of 3 records, \$5.

Serial Numbers—101-104 (singles), 105-107 (album).

Distributors

General Music Corp., 1105 W. Seventh St., Los Angeles 14, Calif.

Ernest Deffner, 461 Eighth Ave., New York 1, N. Y.

Fortune Dist. Co., 4990 Melrose Ave., Hollywood 27, Calif.

R. Cram & Co., 1595 Broadway, New York 19, N. Y.

Pacific Jobbers Co., 553 S. Western Ave., Los Angeles 5, Calif.

Grossman Music Co., 210 Prospect Ave., Cleveland, Ohio.

Frederick Gretsch Mfg. Co., 218 S. Wabash Ave., Chicago 4, Ill.

Charles Parker Music Co., 916 Capitol Ave., Houston, Texas.

Southern Music Co., 830 E. Houston, San Antonio 6, Texas.

Thomas Music Supply Co., 34 E. Elizabeth St., Detroit 1, Mich.

H. & A. Selmer, Elkhart, Ind.

Richart Enterprises

2638 S. Gladys Ave., Garvey, Calif.

President: Arthur C. Rich
Sales manager: E. F. Tarr
Secretary-Treasurer: Clyde Rich

Products Manufactured—Phonograph records

and biscuits, records.

Trade Names—Rich Publications, Richart Milling Co., Richart Record Co., Rich-tone Record Co., Rich Record Co.

Retail Price—75c., \$1, \$1.50.

Distributors**Richart Enterprises**

Basin Dist. Co., Vernal, Utah

Basin Dist. Co., 4932 Poplar St., Murray, Utah

Riggs and Jeffreys, Inc.

73 Winthrop St., Newark 4, N. J.

President and sales manager: W. P. Riggs
Secretary-treasurer: J. T. Jeffreys

Products Manufactured—Records, phonographs, amplifying systems for churches, public address sets.

Trade Name—Election Bell.

Retail Price—\$4.10 (Chime recordings), \$3 (Chime pressings).

Rodeo Records

1511 W. Pico Blvd., Los Angeles 15, Calif.

President: Paul Mayer

General sales manager: William Abel

Roger Record Co.

416 S. Robertson Blvd., Los Angeles 36, Calif.

Roy Records

1619 Broadway, New York 19, N. Y.

Royal Record Co.

8407 Santa Monica Blvd., Hollywood 46, Calif.

Rumpus Record Co.

6021 Will Rogers St., Los Angeles 45, Calif.

Russian Music Co.

121 Lexington Ave., New York 16, N. Y.

S.W.L. Co.

10966 Fairbanks Way, Culver City, Calif.

San Antonio Records, Inc.

9162 Sunset Blvd., Hollywood 46, Calif.

President: Hermon S. Hatch

Sales manager and secretary: J. A. Bradley
Treasurer: George Stuart

Trade Name—San Antonio.

Retail Price—75c.

Serial Numbers—100 series.

Distributors

American Coin-A-Matic Machine Co., 1437 Fifth Ave., Pittsburgh, Pa.

Birmingham Vending Co., 2117 Third Ave., N., Birmingham, Ala.

Lion Dist. Co., 726 S. Fourth St., Louisville, Ky.

Oriole Dist. Co., 512 Pennsylvania St., Baltimore, Md.

Standard Music Dist. Co., 1913 Leeland St., Houston, Texas.
 Pan American Record Dist. Co., 11721 Linwood Ave., Detroit, Mich.
 Runyon Sales Co., 123 W. Runyon St., Newark, N. J.
 C & C Dist. Co., 714 Fourth Ave., Seattle, Wash.
 Commercial Music, 510 N. Sarah St., St. Louis, Mo.
 Music Sales, 680 Union St., Memphis, Tenn.
 Music Sales, 303 N. Peters St., New Orleans, La.
 Premier Automatic Music Co., 813 Ritner St., Philadelphia, Pa.
 Jack Gutshall Dist. Co., 1870 W. Washington, Los Angeles, Calif.
 Runyon Sales Co., 595 Tenth Ave., New York, N. Y.

Sarco Records

6107 Sunset, Hollywood, Calif.

Carl H. Saunders

1101 S. Oak Knoll, Pasadena, Calif.

Savoy Record Co.

58 Market St., Newark, N. J.

President: Herman Lubinsky

Trade Names—Savoy, King, Solomon.

Retail Price—75c. and \$1 (single records), \$3.75 (albums).

Serial Numbers—500, 600, 1000, 3000, 5500, 8000.

Distributors

Century Dist. Co., 921 E. Pico Blvd., Los Angeles, Calif.

Garden State Dist. Co., 201 Warren St., Newark, N. J.

Hawaii Music Co., 1184 Fort St., Honolulu, Hawaii

Music Suppliers of New England, Inc., 561 Warren St., Roxbury, Mass.

Scott-Crosse Co., 1123 Spring Garden St., Philadelphia, Pa.

Southland Dist. Co., 111 Edgewood Ave. S. E., Atlanta, Ga.

Sterling Record Co., 3600 Forbes St., Pittsburgh, Pa.

Scandinavian Music House

625 Lexington Ave., New York 22, N. Y.

President: Edwin Jarl

Trade Names—Scandinavia, Cordion.

Retail Price—79c.

Distributors

J. F. Bard, 414 S. Franklin St., Chicago, Ill.

Murray M. Kirschbaum, Fifth St. & Hennepin Ave., Minneapolis, Minn.

G. Schirmer, Inc.

3 E. 43rd St., New York 17, N. Y.

President and treasurer: Gustave Schirmer

Secretary: H. Fitzpatrick

Trade Name—G. Schirmer Library of Recorded Music.

Distributors

G. Schirmer Music-Wilshire, 5732 Wilshire Blvd., Los Angeles, Calif.

G. Schirmer Music, 700 W. Seventh St., Los Angeles, Calif.

G. Schirmer, Inc., c/o Humphreys', 130 Pine Ave., Long Beach, Calif.

G. Schirmer Music Co., The Arcade, Cleveland, Ohio

Boston Music Co., 116 Boylston St., Boston, Mass.

Willis Music Co., 124 E. Fourth St., Cincinnati, Ohio

Albert A. Schulman

7265 Melrose Ave., Los Angeles 46, Calif.

S. D. Records

1225 N. LaSalle St., Chicago 10, Ill.

President: John Steiner

Trade Name—S. D. Records.

James U. Seat

6711 Parmalee Ave., Los Angeles 1, Calif.

Seeco Records, Inc.

2519 W. Seventh St., Los Angeles 5, Calif.

President: Sidney Siegel

Sepia Records, Inc.

8407 Santa Monica Blvd., Hollywood 46, Calif.

President: Sam Green

Sales manager and treasurer: H. S. Hatch

Secretary: Joe Greene

Trade Names—Gem, Coronet, G & G.

Retail Price—75c. (Coronet, G & G), \$1 (Gem).

Serial Numbers—1-500 (Gem), 1000-2000 (Coronet), 1000-6000 (G & G).

Distributors

American Coin-A-Matic Machine Co., 1437 Fifth Ave., Pittsburgh, Pa.

Birmingham Vending Co., 2117 Third Ave., N., Birmingham, Ala.

Lion Dist. Co., 726 S. Fourth St., Louisville, Ky.

Oriole Dist. Co., 512 Pennsylvania St., Baltimore, Md.

Standard Music Dist. Co., 1913 Leeland St., Houston, Texas

Pan American Record Dist. Co., 11721 Linwood Ave., Detroit, Mich.

Runyon Sales Co., 123 W. Runyon St., Newark, N. J.

C & C Dist. Co., 714 Fourth Ave., Seattle, Wash.

Commercial Music, 510 N. Sarah St., St. Louis, Mo.

Music Sales, 680 Union St., Memphis, Tenn.

Music Sales, 303 N. Peters St., New Orleans, La.

Premier Automatic Music Co., 813 Ritner St., Philadelphia, Pa.

Jack Gutshall Dist. Co., 1870 W. Washington, Los Angeles, Calif.

Runyon Sales Co., 539 Tenth Ave., New York, N. Y.

Session Record Shop

125 N. Wells St., Chicago 6, Ill.
President: William P. Featheringill
Vice-president: David W. Bell
Secretary-treasurer: Evelyn Featheringill

Seva Record Corp.

46 E. 49th St., New York 17, N. Y.
President and sales manager: J. Kupitsky
Retail Price—50c., 75c., \$1.
Serial Numbers—A-1, K.S. 303, K.M. 1,
C S. 100, M.S. 201, B-1, G.M. 501,
W.G. 601, M.G. 800, J.M. 700A.
Own distributors.

Signature Recording Corp.

601 W. 26th St., New York 1, N. Y.
President: Robert Thiele
Sales manager: Roy Hagelin
Secretary: A. Taccetta
Treasurer: Joseph M. Messina
Trade Name—Signature.
Retail Price—75c., \$1, \$1.50.
Serial Numbers—15000, 28000, 90000.
Distributor
General Electric Supply Corp., 291 John St.,
Bridgeport, Conn.

Silver Spur Records

3907 Lankershim Blvd., N. Hollywood,
Calif.

S & L

10966 Fairbanks Way, Culver City, Calif.

Simmel-Meservey

9538 Brighton Way, Beverly Hills, Calif.

Murray Singer Records

1674 Broadway, New York 19, N. Y.
President: Murray Singer

Skating Rhythms Record Co.

P. O. Box 1838, Santa Ana, Calif.

Skatin' Toons Record Co.

Box 261, Malvern, N. Y.

Sonart Record Corp.

251 W. 42nd St., New York 18, N. Y.
President and treasurer: John Marsich
Sales manager: Ben Goodman
Secretary: John Marsich, Jr.
Trade Name—Sonart.
Retail Price—75c., \$1.
Serial Numbers—100, 200, 400, 500.

Sonora Products, Inc.

325 N. Hoyne Ave., Chicago 11, Ill.
President: Edward L. Harris
Sales manager: Milton Benjamin
Trade Name—Sonora.
Retail Price—53c. (single record), \$2.09

(3-record album), \$2.62 (4-record
album).

Distributors

Appliance Dist. Co., 1910-12 Washington
Ave., St. Louis 3, Mo.
Associated Dist. Co., 1823 California St.,
Denver, Colo.
George D. Barbey Co., 132 Walnut St., Read-
ing, Pa.
Barth-Feinberg, Inc., 17 Union Square W.,
New York 3, N. Y.
Beller Electric Co., 301-303 Plane St., New-
ark 2, N. J.
Bison Electrical Co., Inc., 1135 Main St.,
Buffalo, N. Y.
Brilliant Music Co., 1606 Cass Ave., Detroit
1, Mich.
Cannon Dist. Co., 198 E. Bay St., Charleston,
S. C.
Chemcity Radio & Electric, 1225 E. Wash-
ington St., Charleston 27, W. Va.
George K. Ching Co., 208 Hawaiian Trust
Bldg., Honolulu, Hawaii
Clark Supply Co., 245 E. Keefe Ave., Mil-
waukee, Wis.
Davis Supply Co., 415 S. Eighth St., Boise,
Idaho
W. B. Davis Electric Supply, 661 Jefferson
Ave., Memphis, Tenn.
Diehl & Lehman Appl. Dist., 1409-11 Texas
St., El Paso, Texas
Electronics Co., 306 Market St., Shreveport
21, La.
Electronic Sales Co., 81 Wallace St., New
Haven, Conn.
Franklin Electric Co., 529 Arch St., Phila-
delphia 6, Pa.
Goldberg Co., Inc., 5 N. 13th St., Richmond
19, Va.
Goldberg Co., Inc., 125 Third St., S. E.,
Roanoke, Va.
J. W. Graham & Co., 707-11 Sprague Ave.,
Spokane 6, Wash.
Grossman Music Co., 210 Prospect Ave.,
Cleveland, Ohio
The Lagoe Co., 1007 Locust St., Des Moines-
9, Iowa
Leitz Carpet Corp., 312-320 Third St., Min-
neapolis, Minn.
Charles S. Martin Dist. Co., 254 Peachtree
St. N.E., Atlanta 3, Ga.
McDavid Supply Co., 1620 Second Ave., N.,
Birmingham, Ala.
Millhender Dist., Inc., 619 Atlantic Ave., Bos-
ton 10, Mass.
Millhender Dist., Inc., 387 Charles St., Provi-
dence, R. I.
Monroe Hdwe. Co., 701 Magazine St., New
Orleans, La.
Nelson & Co., 1000 S. Linwood Ave., Balti-
more 24, Md.
H. C. Noll Co., 2226 Harney St., Omaha 2,
Nebr.
North Coast Electric Co., 625 N. W. Everett
St., Portland 9, Ore.

Pacific Music Supply, 1024 S. Santee St.,
Los Angeles, Calif.
Radio Maintenance Supply, 17 Central St.,
Worcester 8, Mass.
Rapid Sales Co., 63 Hudson Ave., Albany 1,
N. Y.
S. R. Ross, 1212 S. State St., Salt Lake
City, Utah
Ryan Radio & Electric Co., 1808 Grand Ave.,
Kansas City, Mo.
S & S Dist., 800 S. Adams St., Peoria, Ill.
J. M. Sahlein, Music, 718 Mission St., San
Francisco 3, Calif.
L. H. Smith, Inc., 8 Eighth St., Pittsburgh
22, Pa.
Southern Music Co., 830 E. Houston St., San
Antonio 6, Texas
Standard Paper Co., 50 Vine St., Columbus,
Ohio
George Steele & Co., 126 W. Broadway, Butte,
Mont.
The Sutcliffe Co., 225 S. Fourth St., Louis-
ville, Ky.
Targ & Dinner, 425 S. Wabash Ave., Chicago
2, Ill.
Texas Farm Supply Co., 316 Louisiana St.,
Houston 2, Texas
Thurow Dist. Inc., 806 Main St., Jacksonville,
Fla.
Thurow Dist. Inc., 120 S. W. Eighth Ave.,
Miami, Fla.
Thurow Dist. Inc., 115-117 S. Franklin St.,
Tampa, Fla.
Williams & Shelton Co., Inc., 422 S. Tryon,
Charlotte, N. C.
Herb E. Zobrist, 2125 Westlake Ave., Seattle
1, Wash.

Sounds Workshop

445 S. La Cienega Blvd., Los Angeles 36,
Calif.

Sorority Fraternity Record Co.

12 W. 117th St., New York 26, N. Y.
President: Norridge B. Mayhams
Sales manager: Jessie Winley
Secretary-treasurer: Julia Betty Mayhams
Trade Names—Co-Ed, Co-Ed Collegiate
Records.
Retail Price—79c., \$1.
Serial Numbers—102, 108, 110, 210, 212.
Distribution direct.

Southern Record Corp.

307 Lenox Ave., New York 27, N. Y.

Specialty Records, Inc.

2719 W. Seventh St., Los Angeles 5, Calif.

Spin Records

74 Riverside Drive, New York 24, N. Y.
Sales manager: Jerry Kanner
Trade Name—Spin.
Retail Price—75c.

Serial Numbers—845, 847, 848.

Distributor

James H. Martin, Chicago, Ill.

Spotlight Records, Inc.

6064 Hollywood Boulevard, Hollywood 28,
Calif.

President: C. E. Hastings, Jr.

Sales manager: E. La Voie

Secretary: Haydn Broughton

Treasurer: E. White

Products Manufactured—10-in. and 12-in.
shellac and vinylite records.

Trade Name—Spotlight.

Retail Price—51c. (blue label), 75c.
(red label).

Serial Numbers—2001 and up.

Distributors

List furnished upon request to company.

Standard Phono Co.

163 W. 23 St., New York 11, N. Y.

Proprietor: Tetos Demetriades

Sales manager: Alexander Bard

Standard Radio

6104 Hollywood Blvd., Hollywood 28,
Calif.

Standard Record Co.

50-18 Vernon Blvd., Long Island City,
N. Y.

Stan-Lee Records

1697 Broadway, New York 19, N. Y.

La Marr's "Star Records"

212 Spring Arcade, Los Angeles, Calif.

President: Baline La Marr

Sales manager: Gerry Bransford

Trade Name—La Marr's "Star Records"

Retail Price—40c.

Distributors

Globe Record Dist.

Appalla Record Dist.

K & M Record Dist.

"Star Records"

Starlight Records

3180 Lindo Ave., Hollywood 28, Calif.

Starlight Music Co.

P. O. Drawer 1110, Pasadena, Calif.

Starr Record Co.

P.O. Box 1073, San Antonio 6, Texas

Sterling Records, Inc.

7 W. 46 St., New York 21, N. Y.

President and treasurer: Al Middleman
Sales manager and secretary: Art Rupe

Trade Name—Sterling.

Retail Price—75c.

Serial Numbers—100 series (race, jazz,
sepia), 7000 series (pop tunes).

Stinson Trading Co.

27 Union Square W., New York 3, N. Y.

Stork Records

576 Fifth Ave., New York, N. Y.

Story Book Record Co., Inc.

200 Fifth Ave., New York 10, N. Y.

President: George Saigh

Sales manager and treasurer:

Ben Portugal

Secretary—David H. Faber

Products Manufactured—Children's unbreakable plastic records.*Trade Name*—Story Book Records.*Retail Price*—\$1.19 (album of 4 records).*Distributor*

Barth Feinberg, 17-19 Union Square W., New York, N. Y.

Studio & Artists Records

6107 Sunset Blvd., Hollywood 28, Calif.

Sunset Radio Center

6000 Sunset Blvd., Hollywood 28, Calif.

Sunset Recording Co.

10527 Felton Ave., Inglewood, Calif.

President and sales manager: E. H. Laguna

Secretary-treasurer: Beryl Ridges

Trade Name—Sunset.*Retail Price*—75c. (75 series), \$1 (100 series).*Serial Numbers*—75 series, 100 series.*Distributors*

Interstate Music Suppliers, 236 W. 55 St., New York, N. Y.

Independent Music Suppliers, 1543 N. Sedwick, (Chicago, Ill.)

Pacific Allied Products, 812 W. Eighth St., Los Angeles, Calif.

Sunshine Productions and Artists Agency

1480 W. Jefferson Ave., Los Angeles 37, Calif.

President: B. F. Spikes

Sales manager: Ray Rovin

Trade Name—Sunshine Record Co.*Retail Price*—7c.*Serial Numbers*—105-108, 1501, 1502*Distributors*

K & M Dist., Los Angeles, Calif.

W. M. Amann Dist. Co., Shreveport, La.

Cliff Wilson Dist. Co., Tulsa, Okla.

Campa Dist. Co., Memphis, Tenn.

S. Coast Amusement Co., Houston, Texas

Cardinal Sales, Louisville, Ky.

Super Discs

610 Fifth Ave., New York, N. Y.

Super Entertainment

Box 629, Hollywood 28, Calif.

Superior Recording Co.

1712 Glendale Blvd., Los Angeles 26, Calif.

Swan Recording Co., Inc.

1600 Broadway, New York, N. Y.

President: Les Schriber

Secretary: Walter F. Gustafson

Treasurer: Eric Becker

Trade Name—Swan.*Retail Price*—75c.*Serial Numbers*—7500 up.**Swank Records**

1674 Broadway, New York 19, N. Y.

President: Murray Singer

Secretary-treasurer: C. Reese

Trade Name—Swank.*Retail Price*—75c., \$1.*Serial Numbers*—501-509.

Direct distribution.

Symphony Record Co.

220 W. Fifth St., Los Angeles 13, Calif.

Tech-Art Recordings

8812 6th Ave., Inglewood, Calif.

Tele-Tone Records

6110 Santa Monica Blvd., Los Angeles 28, Calif.

Teleways Radio Prod., Inc.

5746 Sunset Blvd., Los Angeles 28, Calif.

Tempo Record Co.

1526 Cahuenga Blvd., Hollywood 28, Calif.

President: Irving Fogel

Sales manager and treasurer: William H. Holmes, Jr.

Secretary: Charles Holmes

Products Manufactured—Records, Tempo Transcription Library Service, Rest Assured Album.*Trade Name*—Tempo.*Retail Price*—\$1 (records), \$7.50 each (transcriptions), \$7.50 (Rest Assured album).*Serial Numbers*—TR 700-TR 926 (records), 101-107 (transcriptions), Series A (Rest Assured Album).*Distributors*

Gem Phono Dist., Inc., 7 W. 46th St., New York, N. Y.

Seattle Radio Supply, 2117 Second Ave., Seattle 1, Wash.

Louis Graf, 1526 Cahuenga Blvd., Los Angeles 28, Calif.

Top Records, Inc.

1671 Broadway, New York 19, N. Y.

President: Dick Kuhn

Secretary-treasurer: Charles P. Shaw

Trade Name—Top.

Retail Price—75c.

Distributors

E. Herman Dist. Co., 608 S. Dearborn St., Chicago 5, Ill.

David Rosen, 855 N. Broad St., Philadelphia 23, Pa.

The Turntable

P. O. Box 622, Hollywood Station, Hollywood 28, Calif.

Partners: Edward A. Kocher, Clive S. Acker

Secretary: Richard Cox

Treasurer: Harry Guy Armour

Products Manufactured—Records, radio-phonographs.

Trade Names—Jump, Target, Corax records and radio-phonographs.

Retail Price—10-in. record, 75c. (Corax and Target); 12-in. record, \$1 (Corax and Target); 10-in. record \$1 (Jump); 12-in. record, \$1.50 (Jump).

Twentieth Century Records

1032 Sycamore Ave., Hollywood, Calif.

Union Records

119 W. 46 St., New York 19, N. Y.

Sales manager and secretary: Julia Stuart

Products Manufactured—Vinylite records.

Trade Name—Union.

Retail Price—12-in. record, \$2.25.

Serial Numbers—U 201 and up.

Distributors

Interstate Music, 236 W. 55th St., New York, N. Y.

Pacific Allied Prod., 812 W. Eighth St., Los Angeles, Calif.

United Record Co.

2304 W. Seventh St., Los Angeles 5, Calif.

Sales manager: Benjamin O. Seigel

Universal Broadcasting Co.

6757 Hollywood Blvd., Los Angeles 28, Calif.

Universal Radio Prod.

2851-53 Beverly Blvd., Los Angeles 3, Calif.

Universal Recording Co., Inc.

117 W. 46th St., New York, N. Y.

University Recording Co.

Box 2892, Hollywood 28, Calif.

President: Jimmie Richards

Sales manager: Max Fiertaug

Secretary-treasurer: Neli Richards

Trade Name—University.

Retail Price—75c.

Serial Numbers—K 505-K 515.

Distributor

Holiday Dist. Co., 137 N. Western Ave., Los Angeles, Calif.

Urban Record Co.

1506 N. Sierra Bonita, Hollywood 46, Calif.

President: Braheem Urban

Sales manager: Vincent Ross

Secretary: Norman Edwards

Treasurer: Thomas Urban

Trade Name—Urban, Sierra.

Retail Price—33c.

Serial Numbers—101 and up.

Thomas J. Valentino, Inc.

1600 Broadway, New York 19, N. Y.

President and treasurer:

Thomas J. Valentino

Sales manager and secretary: E. Topping

Products Manufactured—Major sound effect records, transcriptions, processing and pressings, vinylite or shellac records.

Trade Name—Major Sound Effect Records.

Vanguard Records

1211 N. Orange Grove, Los Angeles 46, Calif.

Variety Records

746 N. La Cienega Blvd., Los Angeles 46, Calif.

Venus Records, Inc.

1801 N. Pepper St., Burbank, Calif.

Verne Recording Corp. of America

1724 Madison Ave., New York 29, N. Y.

President: Luis Cuevas

Sales manager: Robert Velez

Treasurer: Esperanza Cuevas

Trade Name—Verne.

Retail Price—\$1.

Serial Numbers—V-0001.

Distributor

Verne Dist. Co., 1724 Madison Ave., New York, N. Y.

Victory Records—Div. Zoeller Music Co. Pubs.

P. O. Box 684, Beverly Hills, Calif.

Owner: Lou E. Zoeller

Trade Name—Victory.

Retail Price—79c.

Serial Numbers—121, 125.

Vogue Recordings, Inc.

Div. Sav-Way Ind.

Box 117 Harper Station, Detroit 13, Mich.

Vox Productions

236 W. 55th St., New York 19, N. Y.

Jimmy Wakeley Recordings
1651 Cosmo St., Hollywood 28, Calif.

Wallace Record Co.
154 E. Erie St., Chicago 11, Ill.

Charles E. Washburn
1511 W. Pico Blvd., Los Angeles 15, Calif.

George Weber
2356 Dorris Place, Los Angeles 31, Calif.

Western Recording Co.
12555 Rye St., Box 213, N. Hollywood,
Calif.

Westernair Records
Box 213, N. Hollywood, Calif.

White's Radio & Record Shop
1221 1/2 Avalon, Los Angeles 11, Calif.

Wilshire Records
Apt. 8, 133 S. Crescent Drive, Beverly
Hills, Calif.

Winant Prod.
300 W. 13rd St., New York 18, N. Y.

World Broadcasting Co.
5305 Melrose Ave., Hollywood 38, Calif.

World Record Co.
8913 Sunset Blvd., Los Angeles 16, Calif.

Worldwide Records
7030 Sunset Blvd., Hollywood 28, Calif.

Neale Wrightman Publishers
P. O. Box 2645, Hollywood, Calif.
President: Neale Wrightman
Secretary: L. M. Wrightman
Products Manufactured—Albums, records,
sheet music, folios, band and orches-
tra music.
Trade Name—Wrightman.
Retail Price—10-in. record, 75c; 12-in.
record, \$1.

W & W Record Shop & Dist.
623 E. Vernon Ave., Los Angeles 11, Calif.

You Sing The Lead Record Co.
9032 Burton Way, Beverly Hills, Calif.

Zora Record Co.
2711 E. Division Ave., Detroit 12, Mich.

MALVERNE DISTRIBUTORS

Distributors in Metropolitan New York,
Westchester, Suffolk and Nassau Counties for

MERCURY RECORDS • DE LUXE RECORDS

BENNY BELL RECORDS

AERO POINT NEEDLES • ACTON NEEDLES

RECOBIN CARRYING CASES

REGINA HASSOCK RECORD HOLDERS

Radios • Electrical Appliances • Phonographs • Accessories

• • ● • •
**MALVERNE
DISTRIBUTORS**

FOR FAST SERVICE CALL STerling 3-7333—7305

293 FLATBUSH AVENUE
Brooklyn 17, New York

150 NASSAU STREET
New York 7, N. Y.



The 'Voice of the Americas'



Latin American Music
is
Our Baby

366

The life, color and rhythm of Latin Music on "VERNE" Records.

DEALERS SOLICITED

VERNE DISTRIBUTING COMPANY

1724 MADISON AVENUE

NEW YORK 29, N. Y.

record company distributors by states

On the following pages are
the various record companies and
their distributors by states
plus all the record labels
they carry.



record company distributors by states

The following sources represent the latest compilation of record distributors gathered up to the time this volume went to press. If information about any other record company is desired, please write the Record Retailing Information Service, 274 Madison Avenue, New York 16, New York.

KEY TO LABEL CODES

A—A 1	COM—Commodore	H—Hargail	RE—Regis
AC—Ace	CON—Continental	HA—Harmonia	RH—Rhythm
ACO—Acompa	COR—Cordion	HI—Historical	RI—Richart
ALA—Aladdin	COS—Cosmo	HRS—HRS	RO—Rodeo
ALP—Alpha	CR—Crescent	I—Iragen	SAN—San Antonio
ALV—Alvin	CRN—Crown	J—Jamboree	SA—Savoy
AN—Angelus	CRS—CRS	JZ—Jazz Man	SC—Scandinavia
AP—Apollo	D—Decca	JE—Jewel	SCH—Schirmer
AR—Ara	DL—De Luxe	JK—Juke Box	SD—S.D.
AT—Atlas	DC—Disc	JU—Jump	SE—Seeco
ATM—Atomic	DX—Dix	KO—Kayo	SEP—Sepia
AV—Avalon	DK—Duke	K—Keynote	SES—Session
B—Bell	EMB—Embassy	KI—King	SEV—Seva
BT—Bel-Tone	EMP—Empire	KJ—King Jazz	SI—Signature
BE—Beta	EN—Encore	KIS—Kismet	SO—Sonart
BI—Bibletone	EX—Excelsior	L—Liberty	SON—Sonora
BW—Black & White	E—Exclusive	LFF—Little Folks	SP—Spin
BLB—Bluebird	F—Famous	Favorites	SPO—Spotlight
BLN—Blue Note	FA—Fargo	MAE—Maestro	ST—Standard
BLS—Blue Star	FE—Feature	MJ—Majestic	STN—Stan Les
BST—Bost	FS—4-Star	MA—Manor	STA—Star
BR—Bronze	G—Gala	ME—Mello Strain	STE—Sterling
BRN—Brunswick	GA—Gamut	MEL—Melod'ic	STI—Stinson
BU—Bullet	GM—Gem	MM—Melody Moderne	STO—Story Book
CC—Campus Christian	GG—G&G	MRS—Melrose	SU—Sunset
C—Capitol	GEN—General	MEM—Memo	SUN—Sunshine
CL—Climax	GI—Gilt-Edge	MER—Mercury	SUP—Super Disc
CA—Co-Art	GL—Globe	MOM—Modern Music	SW—Swan
CST—Coast	GO—Goody	MU—Musette	SWA—Swank
COD—Coda	GIA—Gregorian Inst.	MUS—Musicraft	T—Tempo
COE—Co-Ed	of America	MYE—Music You Enjoy	TI—Timely
CO—Columbia	GU—Guild	N—National	TO—Top
		OK—Okch	U—Union
		O—Orpheus	UHC—United Hot
		PA—Pan American	Clubs of America
		PAR—Paraclete	UN—University
		PE—Peerless	UR—Urban
		PR—Premier	V—Verne
		PRE—Preview	VI—Victory
		PRO—Process	VO—Vogue
		Q—Queen	W—Westernair
		R—Range	WE—White Eagle
		RCA—RCA-Victor	WR—Wrightman

ALABAMA

Birmingham

Birmingham Electric Battery Co.
(MJ), Ave. B and 23rd St., S.
Birmingham Vending (SAN, SEP)
2117 Third Ave., N.
Decca Distributing Corp. (BRN, D)
1616 Third Ave., N.
R. P. McDavid Supply Co. (BLB,
RCA, SON), 1630 Second Ave., N.
Monarch Sales Co. (CON, GL,
MEL), 210 N. 22nd St.
Record Sales Co., Inc. (ALA, E, ES,
GL, MOM), 2117 Third Ave., N.
Watts-Newsome Co. (CO, OK)
1721 First Ave., N.

Mobile

George Amusement Co. (WR)
P. O. Box 415

ARIZONA

Phoenix

Electrical Equipment Co. of Ariz.
(MJ), 124 N. Central Ave.
Albert Mathias & Co. (CO, OK)
305 S. Second Ave.

ARKANSAS

Little Rock

555, Inc. (MJ)
Second and Broadway

CALIFORNIA

Beverly Hills

Victory Records (VI)
Box 684

Eureka

Catherine Carey (KO)
P. O. Box 819

Hollywood

Angelus Recording Co. (AN)
6404 Hollywood Blvd.
Atomic Record Co. (ATM)
5634 Santa Monica Blvd.
Fortune Dist. Co. (RH)
1990 Melrose Ave.
Jazz Distribution (CR, JZ)
6420 Santa Monica Blvd.
Jewel (JE)
1514-20 Crossroads of the World
Melodi-c Records (MEL)
6625 Sunset Blvd.
Pacific Music Sales (MAE)
1515 N. Vine St.

Spotlight Records (SPO)
6064 Hollywood Blvd.
Standard Phono Co. (ST)
1549 Vine St.
The Turntable (SES)
1132 Tamarind Ave.
Urban Record Co. (UR)
1506 N. Sierra Bonita

Long Beach

G. Schirmer Inc. (SCH)
130 Pine Ave.

Los Angeles

Ace Distributing Co. (CST, PE)
1511 W. Pico Blvd.
Apollo Records Distributing Co.
(AP), 2705 W. Pico Blvd.
Beta Records (BE)
5027 S. Figueroa St.
Capitol Records Distributing Co. of
Calif. (C), 318 W. 15 St.
Century Distributing Co. (BST, SA,
SAN), 921 E. Pico Blvd.
Co-Art Distributing Co. (CA)
3763 Wilshire Blvd.
Coinmatic Distributors (COE, DL,
EMP, FA, N, PRO, R)
2712 W. Pico Blvd.
Decca Distributing Corp. (BRN, D)
1865 Cordova St.
Encore Records (EN)
918 S. Flower St.
Flash Record Studio (BR)
988 E. Vernon Ave.
Fox Associates (SE)
2519 W. Seventh St.
General Music Corp. (RH)
1105 W. Seventh St.
Giltedge Records (GI)
500 North Western Ave.
Louis Graf (T)
1526 Caluenga Blvd.
Jack Gutshall Distributing Co.
(ALA, E, EX, JK, MOM, PRE,
SAN, SEP)
1870 W. Washington Blvd.
Holiday Distributing Co. (UN)
137 S. Western Ave.
Herbert Horn Co. (MUS)
2401 S. Hill St.
K & M Service (MEM, MM, STA,
SUN), 1913 W. Pico Blvd.
Little Folks Favorites (LFF)
918 S. Flower St.

DISCOS IMPERIALES

PRESENTS

The greatest line of Latin American records in America. Terrific personalities such as:

ALTEÑITA Y FIERRO
LOS MADRUGADORES
HERMANAS PADILLA
HERMANAS GOMEZ
FERNANDO ROSAS
ARTURO VAZQUEZ
LOS MORENOS
LOS CRUDOS

ORCHESTRAS CONDUCTED BY

MANUEL S. ACUÑA
JOSE RODRIQUEZ
AL TOFT

IMPERIAL RECORDS

PRESENTS

Authentic music for folk dancing, played by Al Toft and his orchestra, and approved by the Folk Dance Federation of California.

COMING

CHILDREN'S RECORDS AND ALBUMS

DISTRIBUTED NATIONALLY

HOLIDAY DISTRIBUTING COMPANY

137 North Western Avenue
Los Angeles 4, Calif.

Leo J. Meyberg Co. (BLB, RCA)
2027 S. Figueroa St.
Modern Music Distributing Co.
(MOM), 678½ S. Vermont Ave.
Music Distributing Co. (AT,
GG, GI.), 2504 W. Sixth St.
Pacific Allied Products Co. (BI, DC,
STI, SU, U, WR)
812 W. Eighth St.
Pacific Jobbers Co. (RH)
553 S. Western Ave.
Pacific Music Supply (SON)
1024 S. Santee St.
Victor J. Pilisotta (KO)
General Delivery P. O.
Process Records (PRO)
831 W. 53 St.
Harry S. Reynolds (KO)
232 W. 97 St.
Roach-Driver Co. (MJ)
1701 S. Grand Ave.
Rodeo Records (RO)
1511 W. Pico Blvd.
G. Schirmer Music (SCH)
700 W. Seventh St.
G. Schirmer Music Wilshire (SCH)
5732 Wilshire Blvd.
Sterling Record Distributors (STE)
3110 Trinity St.
Ray Thomas Co. (CO, OK)
1601 S. Hope St.
Trilon Record Distributing Co. (BT)
1317 W. Seventh St.
Wilford Bros. (BW)
1169 S. Broadway
M. S. Wolf Dist. Co. (COS)
1348 Venice Blvd.

North Hollywood

Western Recording Co. (W)
12355 Rye St., Box 243

Oakland

Trilon Record Distributing Co. (BT,
MEL), 3123 San Pablo Ave.
E. C. Winger Co. (COS)
1450 Harrison Ave.

San Diego

Wilford Bros. (BW)
1902 Kettner Blvd.
M. S. Wolf Dist. Co. (COS)
1305 Kellner Blvd.

San Francisco

H. R. Basford Co. (CO, OK)
425 Second St.

LeRoy H. Bennett Co. (BW)
1357 Market St.
Capitol Records Distributing Co. of
Calif. (C), 1355 Bush St.
Coast Wholesale Music Co. (MUS)
536 Mission St.
Decca Distributing Corp. (BRN, D)
525 Sixth St.
McCormack & Co. (MJ)
450 Ninth St.
Melody Sales Co. (E, MOM)
316 Sixth St.
Leo J. Meyberg Co. (BLB, RCA)
70 Tenth St.
J. M. Sahlein Music (SON)
718 Mission St.
M. S. Wolf Dist. Co. (COS)
1175 Folsom St.

South Pasadena

The Turntable (JU)
610 Rollin St.

Watsonville

Grace Valentine (KO)
Watsonville

COLORADO

Colorado Springs

Colorado Springs Supply Co. (BW)
15-31 W. Cucharas

Denver

Associated Distributing Co. (MUS,
SON), 1823 California St.
Associated Music Co. (BI, COS)
Tabor Bldg.
Davis Sales Co. (MOM)
1010 17th St.
Decca Distributing Corp. (BRN, D)
1708 16th St.
Hendrie & Bolthoff Mfg. & Sup. Co.
(BLB, RCA)
P. O. Box 5110, Terminal Station
Modern Music Co. (ALV)
Denver
The Parker Co. (MJ)
1520 Wazee St.
B. K. Sweeney Electrical Co. (CO,
OK), 1601 23rd St.

CONNECTICUT

Bridgeport

G. E. Supply Corp. (SI)
291 John St.

East Hartford

Radio & Appliance Distributing
(BLB, RCA), 673 Connecticut Blvd.

East Haven

Paraclete Music Disc (PAR)
Foxon

Hartford

State Music Distributing Co. (MUS)
1156 Main St.
Stern & Co. (CO, OK)
210 Chapel St.

New Haven

Electronic Sales Co. (SON)
81 Wallace St.
Mory Sales Corp. (MJ)
156 Brewery St.

DISTRICT OF COLUMBIA

ARA, Inc. (AR)
1708 G St.
Barnet-Hooker Distributing Co.
(COS), 1120 Vermont Ave. N. W.
Capitol Records Distributing Co. (C)
930 F St., N.W., Atlantic Bldg.
Decca Distributing Corp. (BRN, D)
52 O St., N.W.
Mehen Distributing Co. (MJ)
2180 16th St. N.W.
Southern Wholesalers (BLB, RCA)
1519 L St., N.W.

FLORIDA**Jacksonville**

Cain & Bultman (CO, OK)
505 W. Adams St.
Charlie Record Distributing (MA)
311 Riverside Ave.
Decca Distributing Corp. (BRN, D)
202 Riverside Ave.
Major Appliances (BLB, G, RCA)
174 Riverside Ave.
Taran Distributing (COS, FS, GI,
MOM, MUS)
90 Riverside Ave.
Thurrow Distributing (SON)
806 Main St.

Miami

Irving Seigal Music Co. (KO)
Box 1513
Shelley's Distributing Co. (MJ)
3015 Grand Ave.
Taran Distributing (COS, FS, GI,
MOM, MUS)
170 N.W. 23rd St.
Thurrow Distributing (SON)
120 S. W. Eighth Ave.

Tampa

Thurrow Distributing (SON)
115-17 S. Franklin St.

GEORGIA**Atlanta**

Apollo Record Distributing Co. (AP,
BT), 367 Edgewood Ave., S. E.
ARA, Inc. (AR)
1050 Ponce de Leon, N. E.
Barnet-Hooker Distributing Co.
(COS), 102 Cain St.
Capitol Records Distributing Co. of
Ga. (C), 127 Peachtree St., N. E.
Crawford & Thompson (MJ)
291 Ivy St., N.E.
Decca Distributing Co. (BRN, D)
72 Central Ave., S. W.
Friedman Amusement Co. (MA,
MUS), 411 Edgewood Ave., S. E.
Hopkins Equipment Co. (CO, OK)
118 W. Peachtree St., N. W.
Charles S. Martin Distributing Co.
(SON), 251 Peachtree St., N. E.
Monitor Co. of Ga. (BW)
976 W. Peachtree St., N.W.
Southland Distributing Co. (SA)
111 Edgewood Ave., S. E.
Taran Dist., Inc. (COS, MUS)
102 Cain St., N.W.
The Yancey Co. (BL, BLB, RCA)
310 W. Peachtree St., N. W.

IDAHO**Boise**

Davis Supply Co. (SON)
115 S. Eighth St.

ILLINOIS**Chicago**

ARA, Inc. (AR)
164 N. Wacker Drive
Associated Record Distributing (BT,
CC, FS, GI), 3612 W. Chicago Ave.
Frieda F. Ayres (KO)
5000 Crystal St.
J. F. Bard (ALA, BST, CON, DL, IL,
MEL, PA, SC, ST)
111 S. Franklin St.
Capitol Records Distributing Co. of
Ill. (C), 1419 S. Michigan Blvd.
Chicago-Majestic, Inc. (MJ)
515 N. La Salle St.

Chicago Musical Instrument Co.
(MU), 30 E. Adams St.
M. M. Cole Co. (KO)
823 S. Wabash Ave.
Continental Music Co. (MU)
630 S. Wabash Ave.
Decca Distributing Corp., (BRN, D)
1509 S. Michigan Ave.
Decca Distributing Corp. (BRN, D)
22 W. Hubbard St.
Frederick Gretsch Mfg. Co. (RII)
218 S. Wabash Ave.
E. Herman Distributing Co. (TO)
608 S. Dearborn St.
Independent Music Suppliers (DC,
SU), 1513 N. Sedwick Ave.
M & S Dist. Co. (COS)
1129 N. Clark St.
Martin & Morris Music Studio (BR)
1315 S. Indiana Ave.
James H. Martin Co. (MUS,
SP), 1107 W. Diversy Parkway
Mercury Recordings (MER)
232 E. Erie St.
Midwest Monitor Corp. (BW)
510 N. Lake Shore Drive
Mid-West Music Co. (DC, N)
1002 Michigan Ave. S.
Modern Record Co. (WR)
7463 S. Chicago Ave.
Music Distributing Co. (AT, GG,
GL, GM), 1002 S. Michigan Ave.
Pan-American Record Distributors
(PA), 411 S. Franklin St.
RCA-Victor Distributing Corp.
(BLB, RCA)
415 N. Lake Shore Drive
The Sampson Co. (CO, OK)
3201 S. Michigan Ave.
S. D. Records (SD)
1225 N. La Salle St.
Sterling Record Distributors (STE)
610 N. State St.
Targ & Dinner (SON)
125 S. Wabash Ave.

Peoria
Klaus Radio & Electric Co. (BLB,
RCA), 707 Main St.
S & S Distributing (SON)
800 S. Adams St.

Rock Island
Tri-City Radio Supply Co. (MJ)
1919 Fourth Ave.

INDIANA

Elkhart

H. & A. Selmer

Indianapolis

Associated Distributors (BLB,
RCA), 211 S. Illinois St.
Kiefer-Stewart Co. (MJ)
122 S. Senate
Monitor of Indiana (BW)
1121 N. Meridian St.
Rodefeld Co. (CO, OK)
612-14 N. Capitol Ave.

Lafayette

Grace Shumaker (KO)
1521 Franklin St.

South Bend

FEMCO Distributing Co. (MJ)
1603 Prairie Ave.

IOWA

Des Moines

Blue Star Record Co. (BLS)
2211 Cottage Grove Ave.
The Lagoe Co. (SON)
1007 Locust St.
G. W. Onthank Co. (BLB, RCA)
11th and Cherry Sts.
The Record Distributors (FS, GI)
1220 Grand Ave.
Roycraft-Iowa Co. (CO, OK)
1326 Walnut St.
Siddles Co. (MJ)
912 Locust St.

KANSAS

Wichita

Home Appliance Co. (MJ)
117 Rock Island, N.

KENTUCKY

Ashland

Vogel, Birch & Co. (MUS)
22nd St. & Central Ave.

Louisville

Bomar Mfg. Co. (MJ)
1114 Bardstown Road
Cardinal Sales (SUN)
Louisville
Electrical Appliance Distributors of
Ky. (CO, OK), 1601 S. First St.
Ewald Distributing Co. (BLB, RCA)
1538 S. Brook St.
The Lion Distributing Co. (E, MOM,
San, SEP), 726 S. Fourth St.

The Sutcliffe Co. (SON)
225 S. Fourth St.

LOUISIANA

Monroe

United Electrical Service (MJ)
905 Louisville Ave.

New Orleans

William B. Allen Supply Co. (CON,
MA), 916-18 N. Claiborne Ave.*

Dorothy Anderson (KO)
601 Robert St.

Decca Distributing Corp. (BRN, D)
517 Canal St.

Electrical Supply Co. (BLB, RCA)
Lighting Fixture & Electric Supply
Co. (MUS), 307 Tchoupitoulas St.
201 Magazine St.

Monroe Hdwe. Co. (SON)

701 Magazine St.

Music Sales Co. (ALA, BT, E, FA,
FS, GI, MEL, R, SAN, SEP)

303 N. Peters St.

United Distributors (MJ)

539 Carondelet St.

Walther Bros. Co. (CO, OK)

714-20 Howard Ave.

Shreveport

W. M. Amann Distributing Co. (GL,
PA, SUN), 115 Olive St.

Electronics Co. (SON)

306 Market St.

MAINE

Camden

Main Appliance Sales Co. (MJ)
31 Main St.

Portland

Cressey & Allen (BLB, RCA)
35 Commercial St.

Farrar-Brown Co. (CO, OK)

192-98 Forest Ave.

Gill-Brand Prod. Co. (BW)

177 Congress St.

MARYLAND

Baltimore

Apollo Record Distributing Co.
(AP), 2015 Maryland Ave.

Barnett Dist. Co. (MUS)

8 W. 20th St.

D & H Distributing Co. (BLB,
RCA), 31-37 E. Lee St.

Economy Supply Co. (BT)

2015 Maryland Ave.

Legum Distributing Co. (BW, COS)
108-112 Light St.

J. B. Mitchell Co. (MJ)

117 Market Place

Nelson & Co. (SE, SON, STI)

1000 S. Linwood Ave.

Oriole Distributing Co. (CON, COS,
DL, GO, MA, SAN, SEP, WE)

512 Pennsylvania Ave.

Joseph M. Zamoiski Co. (CO-OK)

110 S. Paca St.

Hagerstown

Bohman-Warne, Inc. (MJ)

35 W. Franklin St.

MASSACHUSETTS

Boston

ARA, Inc. (AR)

265 Huntington Ave.

Boston Music Co. (SCH)

116 Boylston St.

Capitol Records Distributing Co.
(C), 1134 Commonwealth Ave.

Columbia Wholesalers of New Eng-
land (CO, OK)

584 Commonwealth Ave.

Decca Distributing Corp. (BRN, D)

110 Cunningham St.

Major Appliance Corp. (MJ)

11 Deerfield St.

Massachusetts Music Distributing
Co. (MUS), 619 Washington St.

Milhender Distributing (SON)

619 Atlantic Ave.

Cambridge

The Eastern Co. (BLB, RCA)

620 Memorial Drive

Roxbury

Massachusetts Music Dist. Co.
(MUS), 1269-71 Tremont St.

Music Suppliers of New England
(SA), 561 Warren St.

Springfield

Becker Novelty Co. (E, MOM)

97 Dwight St.

B. H. Spinney Co. (MJ)

62 Hampden St.

Worcester

Radio Maintenance Supply (SON)

17 Central St.

MICHIGAN

Detroit

Allied Music Sales Co. (BI, COS, MU S. N. STI), 3112 Woodward Ave.
Apollo Record Distributing Co. (AP), 1450 Broadway
Apollo Record Distributing Co. (BT), 100 E. Atwater
Brilliant Music Co. (SON)
4606 Cass Ave.
Capitol Records Distributing Co. (C), 4456 Cass Ave.
Decca Distributing Corp. (BRN, D)
23 Erskine St.
La Salle Electric & Mill Supply Co. (MJ), 6911 E. Lafayette
Music Distributing Co. (BST)
Detroit

Pan American Record Distributing Co. (E. SAN, SEP)
11721 Linwood Ave.
Philo Distributors (CO, OK)
1627 W. Fort St.
RCA-Victor Distributing Corp. (BLB, RCA)
1930 E. Jefferson Ave.
Thomas Music Supply Co. (RH)
34 E. Elizabeth St.
Vogue Recordings (VO)
Book Bldg.

Grand Rapids

State Distributing Co. (MJ)
30-32 Ionia St., N. W.

Marquette

The Soo-Marquette Hdwe. Co. (MJ)
319-21 Division St.

MINNESOTA

Minneapolis

Automatic Sales Co. (AV)
56 E. Hennepin Ave.
Capitol Record Distributing Co. (C)
21 E. Hennepin Ave.
Decca Distributing Corp. (BRN, D)
17-19 E. Hennepin Ave.
F. C. Hayer Co. (BLB, RCA)
300 Washington Ave. N.
Murrey M. Kirschbaum (COR, SC)
Fifth St. & Hennepin Ave.
Frederick Lee (BW, COS, MUS)
325 Second Ave. S.

Leitz Carpet Corp. (SON)
312-20 Third St.
Northwest Distributing Co. (MJ)
1012 La Salle Ave.
The Roycraft Co. (CO, OK)
1625 Hennepin Ave.

St. Paul

G & S Distributing Co. (FS, GI)
243 W. Kellogg Blvd.

MISSISSIPPI

Jackson

Appliance Dist. (COS)
106 S. Gallatin St.
Mississippi Appliance Co. (MJ)
800 S. State St.

MISSOURI

Kansas City

Capitol Records Distributing (C)
1527 McGee St.
Commercial Music, Inc. (E)
827 E. 12th St.
Decca Distributing Corp. (BRN, D)
3614 Main St.
Federal Distributing Co. (CO, OK)
1717 Walnut St.
Frederick Lee Co. of Kansas City (BW, COS, MUS), 304 W. 10 St.
Maco Appliance Distributors (MJ)
416 Admiral Blvd.
Mid-West Distributing Co. (ALA)
2218 Vine St.
RCA-Victor Distributing Corp. (BLB, RCA), 1422-24 Grand Ave.
Ryan Radio & Electric Co. (BI, SON), 1808 Grand Ave.

St. Louis

Appliance Distributors (BI, SON)
1910-12 Washington St.
Artophone Corp. (CO, OK)
4200 Forest Park Blvd.
Capitol Records Distributing Co. (C), 1407 Pine St.
Commercial Music Co. (ALA, BT, E. FS, GI, GL, MOM, SAN, SEP)
510 N. Sarah St.
Decca Distributing Corp. (BRN, D)
1916 Washington Ave.
Interstate Supply Co. (BLB, RCA)
26 S. Tenth St.

Millner Record Sales (ALA)
6529 Bartner Ave.
The Recordit Co. (MJ)
3028 Locust St.
St. Louis Music Supply Co. (MUS)
4400 Delmar Blvd.
Joe A. Saracini (KO)
5009A Delmar Blvd.

MONTANA

Billings

Northwestern Auto Supply Co.
(BLB, RCA), 420 N. Broadway

Butte

George Steele & Co. (SON)
126 W. Broadway

NEBRASKA

Friend

Leta S. Bender (KO)
P. O. Box 443

Omaha

H. C. Noll Co. (SON)
2226 Harney St.
Omaha Appliance Co. (CO, OK)
18th at St. Mary's Ave.
Process Record Co. (PRO)
1502 S. 19 St.
Sidles Co. (MJ)
502 S. 19 St.

NEW HAMPSHIRE

Laconia

George C. Stafford & Sons (MJ)
106 Main St.

NEW JERSEY

Newark

All-State Distributors (BL, DL, J)
45 Clinton St.
Beller Electric Co. (SON)
301-303 Plane St.
Capitol Records Dist. Co. (C)
81 Locke St.
Dale New Jersey Inc. (MUS)
79 Locke St.
Decca Distributing Corp. (BRN, D)
49 Edison Place

Garden State Distributing Co. (COS
SA), 201 Warren St.
Igoe Bros. (MJ)
Ave. A & Poinier St.
King Record Co. (FS, GI)
437 Elizabeth St.
Krich-Radisco (BLB, RCA)
422-32 Elizabeth St.
E. B. Latham & Co. (CO, OK)
1010 Broad St.
Regis Record Co. (MA, RE)
162 Prince St.
Runyon Sales Co. (SAN, SEP)
123 W. Runyon St.

NEW MEXICO

Albuquerque

Stuart Sales Co. (BW)
414 S. Amherst

NEW YORK

Albany

Rapid Sales Co. (SON)
63 Hudson Ave.
Reines-Freeman Distributors (MJ)
201 Jay St.
Roskin Bros. (CO, OK)
351 Central Ave.
R. T. A. Distributing (BLB, RCA)
36 Broadway—Menands

Bronxville

George L. Bard (PA)
4 Colonial Road

Buffalo

Bickford of Buffalo (BLB, RCA)
1209 Broadway
Bison Electrical Co. (SON)
1135 Main St.
Capitol Record Distributing Co. (C)
1066 Main St.
A. Connors Dist. Co. (COS)
2173 Bailey Ave.
Decca Distributing Corp. (BRN, D)
1233 Main St.
Joseph Molien (DL)
327 Washington St.
Monitor App. Co. (BW)
1432-36 Main St.
Mutual Appliance Distributors
(MJ), 122 Clinton St.

KRICH-RADISCO Inc.

"One of America's Great Distributors"

422-32 Elizabeth Avenue

Newark 8, N. J.



*"The World's Greatest Artists Are
On Victor Records"*

GO ALL THE WAY WITH RCA
RADIO :: TELEVISION :: RADIO PHONOGRAPHS

EXCLUSIVE DISTRIBUTORS FOR
BENDIX AUTOMATIC HOME LAUNDRY—NORGE HOME APPLIANCES
EUREKA—AMERICAN KITCHENS—KNAPP-MONARCH—NEW HOME
SETH THOMAS—WESTCLOX—COMFORTAIR

Niagara Midland Co. (MUS)
881 Main St.
Western Merchandise Distributors
(CO, OK), 68 W. Huron St.

Brooklyn

Decca Distributing Corp. (BRN, D)
662 Pacific St.
Duke Music Corp. (DK)
769 Rockaway Ave.
Major Distributing Co. (ALA)
106 De Kalb Ave.
Malverne Distributors (DL)
1303 Fulton St.
Melrose Record Co. (MRS)
601 E. 19 St.
Walter Velancy (CA)
1154 Nostrand Ave.
Malverne Skatin' Toons (KO)
P. O. Box 264

New York

A-1 Records of America (A)
16 E. 43 St.
Alpha Records (ALP)
501 Madison Ave.
American Steel Export Co. (SE)
347 Madison Ave.
Apollo Records Distributing Co.
(AP, BT, COS), 615 Tenth Ave.
ARA, Inc. (AR)
313 W. 57 St.
Barth Feinberg (BI, MYE, SON,
STI, STO), 17 Union Square W.
Bell Records (B)
1658 Broadway
Blue Note Records (BLN, CL)
767 Lexington Ave.
Bruno—New York, Inc. (BLB,
RCA), 460 W. 34 St.
Jack L. Caidin (CRS, HRS)
825 Seventh Ave.
Capitol Records Distributing Co.
(C), 225 W. 57 St.
Coda Record Co. (COD)
1291 Sixth Ave.
Colen-Gruhn Co. (MJ)
387 Fourth Ave.
Commodore Record Co. (COM,
UHC), 415 Lexington Ave.
Continental Distributing Co. (AV)
265 W. 51 St.
R. Cram & Co. (RH)
1595 Broadway

378

Crown Records (CRN)
107 W. 52 St.
Dale Dist. Co. (MUS)
40 E. 32 St.
Decca Distributing Corp. (BRN, D)
619 W. 51 St.
Ernest Deffner (RH)
461 Eighth Ave.
Dix Records (DX)
1510 Broadway
Eastern Record Sales (MA)
40 W. 46 St.
Embassy Record Co. (EMB)
1697 Broadway
Favorite Mfg. Co. (KIS)
105 E. 12 St.
Gem-Phono Distributing (T)
7 W. 46 St.
General Records Div. of Consoli-
dated Records (AGO, GA, GEN, TI)
1600 Broadway
Goody's Record Distributing Co.
(CON, E. F. GO, MEL, WE)
853 Ninth Ave.
Guild Records, Inc. (GU)
665 Fifth Ave.
Hargail Records (H)
130 W. 56 St.
Harmonia Distributing & Publ. Co.
(HA), 1328 Broadway
Historical Recording (HI)
505 Fifth Ave.
Interstate Music Suppliers Co. (BI,
BST, DC, N, STI, SU, U)
236 W. 55 St.
Keynote Recordings (K)
522 Fifth Ave., Suite 303
King Jazz (KJ)
140 W. 42 St.
Liberty Music Shops (L)
450 Madison Ave.
Mello-Strain (ME)
1658 Broadway
Melody Record Supply Co. (AV, BL,
DL, J, MA), 314 W. 52 St.
Modern Music Sales Co. (JE, N, SP,
TO), Tenth Ave. and 45 St.
Musicraft Record Distributing of
N. Y. (MUS), 665 Fifth Ave.
Monitor Sales, Inc. (BW)
110 E. 42 St.
National Disc Sales (N)
1841 Broadway

Orpheus Record & Transcription Co.
(O), 1585 Broadway
Rainbow Melodies, Inc. (KO)
1564 Broadway
Record Dealers' Supply (CC, MA)
40 West 46 St.
Runyon Sales Co. (COS, E, MOM,
SAN, SEP)
595 Tenth Ave.
Seva Record Corp. (SEA)
45 E. 49 St.
Signature Recording Corp. (SI)
601 W. 26 St.
Sonart Records (SO)
251 W. 42 St.
Sorority-Fraternity Record & Re-
cording Club of America (CO)
Station I, Box 46
Sterling Record Distributors (STE)
7 W. 46 St.
Super Discs (SUP)
610 Fifth Ave.
Swan Records (SW)
1600 Broadway
Swank Records (SWA)
1674 Broadway
Times Appliance Co. (CO, OK)
353 Fourth Ave.
Verne Distributing Co. (V)
1724 Madison Ave.
WOR Recording Studios (FE)
1440 Broadway

Plattsburg

A. H. Marshall Co. (MJ)
Plattsburg

Richmond Hill

Iragen Records (I)
P. O. Box 171

Rochester

Bickford Bros. Co. (BLB, RCA)
28 S. Union St.
Harmon Automotive Corp. (MJ)
16 Charlotte St.

Syracuse

Morris Distributing Co. (BLB,
RCA), 201-212 W. Jefferson St.
Onondaga Supply Co. (CO, OK)
351-357 E. Onondaga St.
B. H. Spinney Co. (MJ)
1133 W. Genesee

NORTH CAROLINA

Charlotte

Capitol Record Distributing Co. (C)
611 W. Morehead St.
Decca Distributing Corp. (BRN, D)
213 W. Palmer St.
Southern Appliances, Inc. (MJ)
517 E. Trade St.
Southern Bearings & Parts Co. (CO,
OK), 315 N. College St.
Southern Radio Corp. (BLB, RCA)
1201 W. Morehead St.
Williams & Shelton (FS, GI, MUS,
SON), 420 S. Tryon

Kannapolis

J. D. Hurst (E), 219 Cannon Blvd.

New Bern

Joe McDaniel Music Co. (KO)
P. O. Box 1105

OHIO

Cincinnati

Capitol Record Distributing Co. (C)
815 Sycamore St.
Decca Distributing Corp. (BRN, D)
105 E. Third St.
Kelley-Mason, Inc. (MJ)
49 Central Ave.
King Record Co. (KI, Q)
1540 Brewster
Ohio Appliances, Inc. (BLB, RCA)
Daylight Bldg., E. Sixth and Court
Sts.
Tri-State Distributing Corp. (CO,
OK), 328 E. Eighth St.
Willis Music Co. (SCH)
124 E. Fourth St.

Cleveland

Allied Music Sales (COS, MUS)
2610 E. Ninth St.
J. C. Boylan Co. (CON, FS, GI)
221 Rose Bldg.
Capitol Records Distributing Co. of
Ill. (C), 104 St. Clair Ave. N. W.
Cleveland Radioelectric Inc. (BLB,
RCA), 2905 Chester Ave.
Decca Distributing Corp. (BRN, D)
716 W. Superior Ave.
Elliott & Evans, Inc. (MJ)
4800 Prospect Ave.
Grossman Music Co. (RII, SON)
210 Prospect Ave.

W.E. Harvey Co. (BW)
1312 Ontario St.
Music Distributing Co. (AT, BL,
CC, CMT, DL, GG, GL, J, JK,
CC, N, ST1), 1108 W. Ninth St.
G. Schirmer Music Co. (SCH)
The Arcade
Strong, Carlisle & Hammond Co.
(CO, OK), 1392 W. Third St.

Columbus

Bennett Radio Co. (CO, OK)
211 N. Fourth St.
Ohio Appliances, Inc. (BLB, RCA)
243 N. Fourth St.
Standard Paper Co. (SON)
50 Vine St.
Thompson & Hamilton (MJ)
211 N. Fourth St.

Dayton

Gem City Appliances (MJ)
129 Ludlow St.

Toledo

Allied Music Sales (COS, MUS)
314 Monroe St.
Gerlinger Equipment Co. (MJ)
1001 Adams St.
Gregorian Institute of America
(GIA), 2130 Jefferson Ave.
Phileo Distributors (CO, OK)
1034 Grand Ave.
Belle Schrag (KO)
1771 La Grange St.

OKLAHOMA

Oklahoma City

Decca Distributing Corp. (BRN, D)
710 N. W. Second St.
Dulaney Distributing Co. (BLB,
RCA), 834 N. W. Second St.
Hales-Mullaly Co. (E, MJ, MOM)
1-7 N. E. Sixth St.
Miller-Jackson Co. (CO, OK)
111-115 E. California Ave.
Record Releasing Corp. (MUS)
1317 N. Broadway

Tulsa

Tom P. McDermott, Inc. (BW)
1400 S. Boston
Cliff Wilson Distributing Co. (SUN)
Tulsa

OREGON

Canby

Phyllis Battleson (KO)
Canby

Lebanon

Nell Seely (KO)
333 E. Ash St.

Portland

F. B. Connelly Co. (MJ)
1233 N. W. 12th St.
Harper-Meggee, Inc. (BLB, G,
RCA), N. W. 15th & Irving
Household Distributing Co. (DC,
MEL), 1233 N. W. 12th St.
North Coast Electric Co. (SON)
625 N. W. Everett St.
Sunset Electric Co. (CO, OK)
N. W. 10th & Glisan Sts.
Western Distributing Co. (ALV)
Portland
M. S. Wolf Dist. Co. (COS)
127 S.W. 43th Ave.

PENNSYLVANIA

Allentown

Kayo Record Co. (KO)
416 Hamilton St.

Franklin

Kelly Music Publishers (KO)
19 Pennell St.
Process Records (PRO)
19 Pennell St.

Harrisburg

D & H Distributing Co. (BLB, RCA)
311 S. Cameron St.
C. A. Markley Electric Co. (BW)
314 Chestnut St.
Motor Parts Co. (CO, OK)
145-157 S. Cameron St.

Philadelphia

Capitol Records Distributing Co.,
Inc. (C), 825 Walnut St.
Decca Distributing Corp. (BRN, D)
731 Arch St.
Franklin Electric Co. (SON)
529 Arch St.
Kayler Co. (MUS)
1639-41 Vine St.



this ... **distributing power**

+ this ... **quality record**



X **our unlimited production**

= *Proof that Signature*

MEANS BUSINESS

Signature is now a leader in the record field because of our recognized ability to pick tomorrow's song hits interpreted by a list of exclusive artists including Ray Bloch, Skinnay Ennis, Monica Lewis and Harry Cool. All this is backed by our own modern and capacious plant geared to quantity production of quality records.

Bob Thiele

PRESIDENT

Signature

records
DISTRIBUTED BY

**GENERAL ELECTRIC
SUPPLY CORPORATION**

IN 112 CITIES COAST TO COAST

you get immediate service for fast turnover

Concentrate on these record department profit makers. Nationally distributed by GESCO. Our quick delivery service means bigger sales on less investment for you.

Signature RECORDS

"Platter spinners" go for every new Signature release. So will your customers. If it's a Signature record you can count on fine technical recording, less surface noise and longer life.

DUOTONE

NEEDLES—Cash registers ring merrily for dealers with the full Duotone line of needles and record accessories. Superlative quality that means satisfied customers and prestige for you. 25¢ to \$50 retail.

Meritone

NEEDLES—Precision turned of Swedish steel, high fidelity Meritone needles play 12 or more records each. Bring you business that repeats over and over. 10¢ and 25¢ packages.



DISTRIBUTED BY

**GENERAL  ELECTRIC
SUPPLY CORPORATION**

GENERAL OFFICES BRIDGEPORT, CONN.

WHOLESALE

• PHONOGRAPH •

MUSIC SALES COMPANY

RECORDS • NEEDLES • LIGHT BULBS • RECORD PLAYERS & SUPPLIES

CARRYING THE FOLLOWING LABELS:

ALADDIN

ATLAS

BEL TONE

BULLET

COAST

EXCLUSIVE

FARGO

FOUR STAR

JUKE BOX

LIBERTY

MELODISC

MODERN

NATIONAL

PACIFIC

SAN ANTONIO

STERLING

384

MUSIC SALES COMPANY

680 UNION AVE.

Memphis 3, Tenn.

E. H. Newell, Mgr.

303 N. PETERS ST.

New Orleans, Louisiana

E. C. Roberson, Mgr.

Motor Parts Co. (CO, OK)
1229 N. Broad St.
Pennsylvania Record Supply, Inc.,
(ALP, CC), 1224 Arch St.
J. J. Pocock, Inc. (MJ)
1920 Chestnut St.
Premier Automatic Music Co. (E,
SAN, SEP), 813 Ritner
David Rosen (DL, E, FS, GI, MA,
MOM, TO), 855 N. Broad St.
Raymond Rosen & Co. (BLB, RCA)
32nd & Walnut Sts.
Scott-Crosse Co. (COS, SA)
1123 Spring Garden St.
H. Royer Smith Co. (G)
10th & Walnut Sts.

Pittsburgh

American Coin-A-Matic Machine
Corp. (COS, E, FS, GI, MOM, SAN,
SEP), 1137 Fifth Ave.
ARA, Inc. (AR)
925 Pennsylvania Ave.
Decca Distributing Corp. (BRN, D)
925 Liberty Ave.
Hamburg Brothers (BLB, RCA)
305 Penn Ave.
Ludwig Hommel & Co. (CO, OK)
600-620 Second Ave.
J. E. Miller Co. (MJ)
206 Kirby Bldg., 80 26th St.
Pittsburgh Prod. Co. (MUS)
500 Fontella St.
L. H. Smith Inc. (SON)
8 Eighth St.
Sterling Record Co. (SA, STE)
3600 Forbes St.

Reading

George D. Barbey Co. (SON)
432 Walnut St.

RHODE ISLAND

Providence

Eagle Sales Corp. (MJ)
49 Westminister St.
Eddy & Co., Inc. (BLB, RCA)
23 Broad St.
Milhender Distributing, Inc. (SON)
387 Charles St.

Monitor Dist. Co. (BW)
P. O. Box 38
Simons Distributing Co. (CO, OK)
17 Lyman St.

SOUTH CAROLINA

Charleston

Cannon Distributing Co. (SON)
198 E. Bay St.

Columbia

Monitor Home App. of S. Car. (BW)
1323 Lady St.

SOUTH DAKOTA

Mitchell

Automotive Supply Co. (MJ)
Mitchell

Rapid City

The Wallahan Co. (MJ)
1815 W. St. Joe St.

Sioux Falls

Harriet Jane Sams (KO)
1624 N. Dakota Ave.

TENNESSEE

Knoxville

Allied Appliance Distributors of
Knoxville (MJ),
923 Central Ave. N.
C. M. McClung & Co. (BI, BLB,
RCA), 501-9 W. Jackson Ave.

Memphis

Allied Appliance Distributors of
Memphis, Inc. (MJ)
1090 Union Ave.
Canipe Distributing Co. (SUN)
Memphis
Capitol Record Distributing Co. (C)
1088 Union Ave.
W. B. Davis Electrical Supply
(SON), 661 Jefferson Ave.
Decca Distributing Corp. (BRN, D)
632 Madison Ave.
McGregor's, Inc. (BLB, RCA)
1071 Union Ave.

DISTRIBUTOR IN SOUTHEASTERN TEXAS



Also distributor for

RCA Victor Radios and Victrolas
Lyric Record Holders
Rubaiyat Needles
Pfanstiehl Needles
Peerless Albums and Racks
Lyric Carrying Cases
Fidelitone Needles
Duotone Needles
Presto Recording Blanks

386

Straus-Frank Co 4000 Leeland St., P. O. Box 358, Houston 1, Texas



**BULLET RECORDS EXCLUSIVELY MORE GRAND OLE OPRY
STARS THAN ANY OTHER COMPANY IN AMERICA**

GRAND OLE OPRY SERIES

I WORSHIP YOU

IF I HAD MY LIFE TO LIVE OVER

CLYDE MOODY

No. 608

Swing Billie Nickel Grabber

79¢

*Other Grand Ole Opry
Stars on BULLET records*

The Alabama Boys
Chester Atkins
Owen Bradley
Milton Estes
Bradley Kincaid
Pete Pyle
Jimmy Selph
Jack Shaak
Texas Troubadours
Zeb Turner
Turner Bros.
Yark Bros.

I'M LOOKIN' FER A FELLER

JEALOUS HEARTED ME

MINNIE PEARL

Star of NBC Prince Albert Show

No. 613

Really lookin' fer a feller

79¢

THAT CHEAP LOOK IN YOUR EYE

YOU WERE THE CAUSE OF IT ALL

FRANKIE "PEE WEE" KING

And His Goldenwest Cowboys

No. 614

Bouncy with a Hillbilly Beat

79¢

FAMOUS QUARTETS

Baxter Quartet
John Daniel Quartet
Stamps-Baxter Mixed
Quartet

OTHER GREAT STARS

Fard Rush
Tammy Scott
Sheb Wooley

SEPIA SERIES

WHO STOLE MY OLD SHOES

BETTER LEAVE THAT LIAR ALONE

FAIRFIELD FOUR

No. 253

Southern Negro Singin' At Its Best

79¢

OTHER SEPIA STARS

Cecil Gant
Wynonie Harris
Trumpeteers
Fairfield Four

VOLUNTEER MUSIC SALES CO.

1710 PORTLAND AVE.

NASHVILLE 4,

TENNESSEE

National Distributors For Bullet Records

Music Sales Co. (ALA, BT, E, FS,
GL, MEL, MOM, SAN, SEP)
680 Union Ave.
Stratton Warren Hardware Co.
(MUS), Carolina & Florida Aves.
Woodson & Bozeman, Inc. (CO,
OK), 482 Union Ave.

Nashville

Allied Appliance Distributors of
Nashville (MJ)
216 Tenth Ave.
Heritage Music Co. (GL, MEL)
423 Broad St.
Volunteer Music Sales Co. (BU)
1710 Portland Ave.

TEXAS

Amarillo

Amarillo Hardware Co. (MJ)
600 Grant St.

Austin

Rawlett Distributing Co. (COS)
1010 Congress Ave.

Brownwood

Central Supply Co. (WR)
614 Citizens Bank Bldg.

Dallas

Acme Dist. Co. (BW)
2535 Elm St.
Adleta Co. (BLB, G, RCA)
1900 Cedar Springs
ARA, Inc. (AR)
911 Camp St.
Blue Bonnet Music (COS)
3235 Cross Ave.
Capitol Records Distributing Co.,
Inc. (C), 1505 Young St.
Decca Distributing Corp. (BRN, D)
508 Park Ave.
Dobbs of Dallas (BI, BT, FA, R)
2821 Live Oak St.
Leader Sales & Distributing (DI.)
4116 Live Oak St.
Lone Star Wholesalers, Inc. (MJ)
Santa Fe Bldg., 10th Floor, 2nd Unit

Record Releasing Corp. (MUS)
911 Camp St.
Southwestern Music Corp. (CO,
OK), 19 N. Harwood St.

El Paso

Diehle & Lehman (BL, MU, S, SON)
1109-11 Texas St.
M. B. Krupp Distributors (E, GL,
MEL, MOM, PA), 506 N. Kansas St.
Albert Mathias & Co. (CO, OK)
113 S. Mesa
Midland Specialty Co. (BLB, RCA)
427 W. San Antonio St.

Houston

Crowe-Martin Distributing Co. (BL,
GL, MEL), 1201 Chenevert St.
Crumpacker-Covington Co.
(CO, OK), Hamilton & Canal St.
Decca Distributing Corp. (BRN, D)
1212 Franklin Ave.
Electrical Equipment, Inc. (MJ)
1680 Ingeborg St.
Roberts-Nicholson (COS)
1201 Commerce St.
Charles Parker Music Co. (RH)
916 Capitol Ave.
Royal Dist. Co. (MUS)
2211 Commerce St.
S. Coast Amusement Co. (SUN)
Houston
Standard Music Distributors (E,
MOM, SAN, SEP), 1913 Leland
Stephenson Film Co. (COS)
814 Gray St.
Straus-Frank Co. (BLB, RCA)
4000 Leland St.
Texas Farm Supply Co. (SON)
316 Louisiana St.

San Antonio

Decca Distributing Corp. (BRN, D)
512 Fifth St.
Monarch Radio & Appliance Co.
(MJ), 211 W. Market St.
Southern Equipment Co. (CO, OK)
210 W. Commerce St.
Southern Music Co. (RH, SON)
830 E. Houston St.
Straus-Frank Co. (BLB, RCA)
301 S. Flores St.

UTAH

Murray

Basin Distributing Co. (RI)
4932 Poplar St.

Salt Lake City

Glenn Earl, Inc. (MJ)
353 W. Second St.
Flint Distributing Co. (CO, OK)
316 W. Second South St.
Mountain Distributing, Inc. (BI)
32 Exchange Place
S. R. Ross Distributors (BT, MUS,
SON, WE)
1212 S. State St.
The Salt Lake Hardware Co. (BLB,
RCA), 105 N. Third West Street,
Box 510
Stewart Dist. Co. (BW)
34 Richards St.

Vernal

Basin Distributing Co. (RI)
Vernal

VIRGINIA

Richmond

Colonial Record Service (DL, MA,
MEL), Box 42
Benjamin T. Crump Co. (CO, OK)
1310-34 E. Franklin St.
Decca Distributing Corp. (BRN, D)
Fifth & Cary Sts.
Goldberg Co., Inc. (SON)
5 N. 13th St.
Wyatt-Cornick, Inc. (BLB, RCA)
Grace At 14th St.

Roanoke

Dowdy Electric Co. (MJ)
Roanoke
Goldberg Co., Inc. (SON)
425 Third St. S. E.

WASHINGTON

Seattle

Capitol Record Distributing Co. (C)
2234 First Ave.

C & C Distributing Co. (E, FS, GI,
MEL, MOM, SAN, SEP), 714 Fourth
Ave.

F. B. Connelly Co. (MJ)
1015 Republican St.
Decca Distributing Corp. (BRN, D)
3131 Western Ave.
Harper-Meggee, Inc. (BLB, G,
RCA), 960 Republican St.
Love Electric Co. (BW)
325 Westlake Ave. N.
Seattle Radio Supply (T)
2117 Second Ave.
Sunset Electric Co. (CO, OK)
P. O. Box 3148
M. S. Wolf Dist. Co. (COS)
2313 Third Ave.
Herb E. Zobrist Co. (BI, COS, J,
MUS, SON, STI)
2125 Westlake Ave.

Spokane

J. W. Graham & Co. (SON)
707-11 Sprague Ave.
Prudential Distributors, Inc. (MJ)
151 Stevens St.

WEST VIRGINIA

Charleston

Charleston Electrical Supply Co.
(CO, OK), 914 Kanawha St.
Chemcity Radio & Electric (SON)
1225 E. Washington St.
R. H. Kyle (BI)
1354 Hansford St.

Huntington

Modern Distributing, Inc. (MJ)
1540 Fourth Ave.
Van Zandt Supply Co. (BLB, RCA)
1123 Fourth Ave.

WISCONSIN

Milwaukee

Clark Supply Co. (SON)
245 E. Keefe Ave.
Decca Distributing Corp. (BRN, D)
511 E. Clybourn St.
R. L. Kaiser Co. (KO)
1224 Madison Ave.
Moe Brothers Milwaukee Co. (MJ)
319 E. Clybourn St.

Radio Specialty Co. (CO, OK)
829 N. Broadway
Taylor Electric Co. (BLB, RCA)
112 N. Broadway

CANADA

Calgary

Alberta News Ltd. (COS)
620 Eighth Ave.

London

Frank Gerry & Co. Ltd. (BW)
379 Talbot St.

Montreal

Electric App. Ltd. (BW)
622 Craig St.
Sni-Dor Radio Electric. Ltd. (CON,
COR. DC. MUS, SC, STI. WE)
455 Craig St., W.

Ottawa

Radio Laboratories (BW)
308 Laurier Ave. W.

Toronto

Capitol Sales Co. (COS)
366 Shaw St.
Anthony Foster & Sons (BW)
306 Church St.

HAWAII

Honolulu

George K. Ching Co. (SON)
208 Hawaiian Trust Bldg.
Hawaii Music Co. (SA)
1184 Fort St.
R. A. Howe & Co. (FS, GI, MJ)
Honolulu Mdse. Mart. 816 Fort St.
Robert E. Ricker, Ltd. (MUS)
2138-40 Kalakua St.

PHILIPPINE ISLANDS

Manila

Philippine Educational Co., Inc.
(COS), 1104 Castillejos



RHYTHM RECORDS

"The Records That Never Get Old"

These little guys are well-known to thousands of record-buying readers of *Down Beat*, *Metro-nome*, *Clef*, and *Hollywood Note*.

They symbolize not just another label, but a series of accompaniment records cut by such name-band rhythm-section men as Nick Fatool, drums; Stan Wrightsman, piano; George Van Eps, guitar; and Artie Shapiro, bass. Amateur and professional musicians play with RHYTHM RECORDS — this unique feature has made RHYTHM RECORDS one of the fastest sellers on the counter.

If you are not yet capitalizing on RHYTHM RECORDS, call your distributor or write direct.

CURRENT RELEASES

Title	Reverse
R101 Exactly Like You	Out of Nowhere
R102 Embraceable You	Honeysuckle Rose
R103 Blue Skies	Ain't Misbehavin'
R104 Moonglow	Oh, Lady Be Good
R108 I'm Confessin' That I Love You	I Found A New Baby
R109 These Foolish Things	I Never Knew
R110 Rhythm Blues (Slow)	Rhythm Blues (Jump)



**RHYTHM
RECORDS**
4990-Y Melrose Avenue
Hollywood 27, California

phonograph, radio, and radio-phonograph

listing latest available data
on instrument manufacturers,
their executives,
distributors and etc.



RADIO, RADIO - PHONOGRAPH COMPANIES

The Admiral Corp.

3800 Cortland St., Chicago 47, Ill.

President: Ross D. Siragusa

Sales manager: W. C. Johnson

Secretary: Ken D. Turner

Treasurer: L. C. Park

Products Manufactured

Record players, radio-phonographs, radios, accessories, Dual-Temp and conventional refrigerators, home freezers, electric ranges

Trade Names

Admiral, Dual-Temp Refrigerators

Distributors

Tri-State Distributors, Inc., Colonie & Montgomery Sts., Central Warehouse Bldg., Albany 4, N. Y.

Sun City Dist., Benton Warehouse Bldg., 110 East New York, Albuquerque, N. M.
Edwards Supply Co., 1607 Avenue "G," Lubbock, Texas.

Peaslee-Gaulbert Corp., 434 Marietta St., N.W., Atlanta 3, Ga.

Baltimore Gas Light Co., 111 East Lombard St., Baltimore 2, Md.

Long-Lewis Hardware Co., Fifth Ave. at Ninth St., Birmingham 2, Ala.

Bluefield Hardware Co., 400 Bluefield Ave., Box 389, Bluefield, W. Va.

Fay-San Dist., Inc., 1669 Main St., Buffalo 8, N. Y.

Northwest Supply Co., 1110 East Front St., P. O. Box 368, Butte, Mont.

United Dist., Inc., 281 Vassar St., Cambridge 39, Mass.

R. H. Kyle & Co., 1353 Hansford St., Charleston 30, W. Va.

McClain Dist. Co., 1213 Morehead St., Charlotte 1, N. Car.

Appliance Dist., Inc., 444 Lake Shore Drive, Chicago 11, Ill.

The Bimel Co., 2600 Colerain Ave., Cincinnati 2, Ohio.

The Kane Co., 2621 East Ninth St., Cleveland 15, Ohio.

The Kane Co., 168 East Long St., Columbus, Ohio.

The Bimel Co., 100 South St. Clair, Dayton, Ohio.

Peaslee-Gaulbert Corp., 2700 Canton St., Dallas 1, Texas.

Graybar Electric Co., Inc., 1501 Eighteenth St., Denver 2, Colo.

Luthe Hdw. Co., 100-114 Court Ave., Des Moines 5, Iowa.

Brennan Appliance Dist., 5245 Grand River Ave., Detroit 8, Mich.

Morley Bros., 5943 Second Blvd., Detroit 2, Mich.

The Home Supply Co., 976 Main St., Dubuque, Iowa.

Sun City Dist., 1601 Magoffin Ave., P. O. Box 232, El Paso, Texas.

Delta Hardware Co., 400-414 Ludington St., Escanaba, Mich.

Small and Scholowsky Co., Pennsylvania and Market Sts., Evansville 10, Ind.

Kiefer Sales Co., 211½ North Broadway, Fargo, N. Dak.

Morley Bros., 25 Ottawa, S.W., Grand Rapids, Mich.

Havre Jobbing Co., 245 First St., Havre, Mont.

Richards and Conover Hdw. Co., Fifth and Wyandotte Sts., P. O. Box 889, Kansas City 10, Mo.

House-Hanson Hdw. Co., 759 Western Ave., Knoxville 7, Tenn.

Auto Parts Service, 125 North Third St., LaCrosse, Wisc.

Graybar Electric Co., Inc., P. O. Box 1227, Little Rock, Ark.

Royal Distributing Co., 2211 Commerce St., Houston 3, Texas.

Griffith Dist. Corp., 537 North Capitol Ave., Indianapolis 4, Ind.

Orgill Brothers and Co., Jackson, Miss.

Peaslee-Gaulbert Corp., 2301 Main St., Jacksonville 6, Fla.

Herbert H. Horn, 2401 South Hill St., Los Angeles 7, Calif.

Peaslee-Gaulbert Corp., 226 North Fifteenth St., Louisville 3, Ky.

Orgill Bros. & Co., Inc., 32-48 West Calhoun, Memphis 2, Tenn.

Peaslee-Gaulbert Corp., 152 North East Eleventh St., Miami 27, Fla.

Shadbolt & Boyd Co., 413 North Second St., Milwaukee 1, Wisc.

W. R. Beamish Co., 1612 Harmon Pl., Minneapolis 3, Minn.

Monroe Hdw. Co., 204 North Third St., Monroe, La.

Graybar Electric Co., Inc., 315 Eighth Ave., Nashville 2, Tenn.

Dale-Connecticut, Inc., 238-240 Whalley Ave., New Haven, Conn.

Stratton Baldwin Co., Inc., 700 Tchoupitoulas, New Orleans 13, La.

Ad Aorisma, Inc., 89 Broad St., New York 4, N. Y.

Dale Dist. Co., Inc., 40 East 32nd St., New York 16, N. Y.

Allied Dist. Corp., 933 West 21st St., Norfolk 8, Va.

Richards & Conover Hdw. Co., 1 East Grand St., Oklahoma City, Okla.

Paxton and Gallagher Co., 9th and Jones Sts., Omaha, Nebr.

Appliance Merchandisers Co., 800 South Adams St., Peoria 2, Ill.

Peirce-Phelps, Inc., 437 North Fifth St., Philadelphia 23, Penn.

Black and Ryan, P. O. Box 2234, Phoenix, Ariz.
 Keps Electric Co., 808 Penn Ave., Pittsburgh 22, Penn.
 Appliance Dist., Inc., 33 Commercial St., Portland 3, Me.
 Lou Johnson Co., 422 N. W. 8th Ave., Portland 9, Ore.
 R. U. Lynch, Inc., 9 Federal St., Providence, R. I.
 A. R. Tiller, Inc., 1800-02 West Broad St., Richmond 20, Va.
 Fay-San Dist., Inc., 95 North St., Rochester, N. Y.
 Morley Bros., 129 N. Washington Ave., Saginaw, Mich.
 Graybar Electric Co., Inc., 2642 Washington Ave., St. Louis 3, Mo.
 Appliance Wholesalers, 307 South 4th East St., Salt Lake City 2, Utah.
 South Texas Appliance Corp., 1201 East Houston St., San Antonio 2, Texas.
 Kaemper-Barrett, 216 South Van Ness Ave., San Francisco 3, Calif.
 McKay Appliance Co., 515 Westlake Ave. N., Seattle 9, Wash.
 L. C. Lippert Co., 221 S. First Ave., Sioux Falls, S. Dak.
 McKay Appliance Co., 123 S. Madison St., Spokane, Wash.
 Mascon Dist., Inc., 214 Birnie Ave., Springfield 7, Mass.
 City Electric Co., Inc., 514 West Genesee St., Syracuse 4, N. Y.
 Peaslee-Gaulbert Corp., Florida Ave., and Platt St., Tampa 1, Fla.
 The Kane Co., 909 Jefferson, Toledo, Ohio.
 United Distributors, Inc., 2015 W. Virginia Ave., N.E., Washington, D. C.
 R. B. Wall Co., 56 East Union St., Wilkes Barre, Penn.

Air King Products, Inc.

1523-29 63rd St., Brooklyn 19, N. Y.
 President: J. P. Lieberman
 Sales manager: Eugene Lucas
 Secretary-treasurer: D. H. Cogan
Products Manufactured
 Table model radios, radio-phonographs, F.M. and television
Trade Name
 Air King

Allied Radio Corp.

833 W. Jackson Blvd., Chicago 7, Ill.
 President: A. D. Davis
 Sales manager: Walter F. Marsh
 Assistant secretary-treasurer: A. E. Davis
Products Manufactured
 Radios, table models, consoles, and portables; sound amplifiers; intercommunications units
Trade Names
 Knight, Lincoln

Andrea Radio Corp.

43-20 34th St., Long Island City, N. Y.
 President: F. A. D. Andrea
 Sales manager: F. V. Goodman
 Secretary: H. J. Heindel
 Director of purchases: R. F. Reinitz
Products Manufactured
 Radios, players, combination radio-phonographs, television receivers, table and console television sets, combination radio television sets
Trade Name
 Andrea

Ansley Radio Corp.

41 St. Joes Ave., Trenton 9, N. J.
 President: Arthur C. Ansley
 Sales manager: Frederick Collins
 Assistant secretary: Harriet Westin
 Treasurer: Anne K. Ansley
Products Manufactured
 Radio-phonographs, electronic piano, built-in wall installations
Trade Names
 Dynaphone, Dynatone, Paneltone

Audar, Inc.

Walnut & Maple Sts., Argos, Ind.
 President: John S. Meck
 Sales manager: Eugene W. Applebaum
 Secretary-treasurer: Russell G. Eggo
Products Manufactured
 Portable record players, automatic record players, musical instrument amplifiers, public address systems, amateur transmitters
Trade Name
 Audar

Audio Industries

1001 Green St., Michigan City, Ind.
 President: Paul W. Dolembro
 Sales manager: Harry Byrne
Products Manufactured
 Phonographs
Trade Name
 Ultratone
Distributors
 Jules Alexandre, Inc., 619-621 Walnut St., Harrisburg, Pa.
 Appliance Dist., Inc., 421 East Market St., Indianapolis 4, Ind.
 Henry O. Berman Co., 12 East Lombard St., Baltimore 2, Md.
 Bowers Wholesale Corp., 1605 Granby St., Norfolk 10, Va.
 Colfax Co., Inc., 802 South Main St., South Bend 18, Ind.
 Crowe-Martin Dist. Co., 1201 Chenevert St., Houston 3, Texas.
 Empire State Dist., 448 North Pearl St., Albany 4, N. Y.
 J. Geo. Fischer & Sons, Inc., 1019 East Genesee Ave., Saginaw, Mich.

E. Stanley Freeman, Inc., 80 Federal St., Boston 10, Mass.
 Gambill Dist. Co., 117-119 Ninth Ave., N., Nashville 3, Tenn.
 General Utilities Corp., 647 West Virginia St., Milwaukee 4, Wisc.
 General Utilities Dists., Inc., 540 North Lake Shore Drive, Chicago 11, Ill.
 Gross Dist., Inc., 570 Lexington Ave., New York 22, N. Y.
 Grossman Music Co., 210 Prospect Ave., Cleveland 15, Ohio.
 Gulf Appliance Dists. Inc., 206 South Franklin St., Tampa 2, Fla.
 H. D. Taylor Co., 99 to 117 Oak St., Buffalo 5, N. Y.
 Williams & Shelton Co., Inc., Charlotte 1, N. Car.
 Edward F. Hale Co., 925 Harrison St., San Francisco 7, Calif.
 Harmon Automotive Corp., 16 Charlotte St., Rochester 4, N. Y.
 H. & S. Dist. Co., 812 North Broad St., Philadelphia 30, Pa.
 Megert Music Co., 415 North Main, Borger, Texas.
 Morley Bros., 5943 Second Blvd., Detroit 2, Mich.
 Morris Dist. Co., Inc., 616 Mulberry St., Scranton 10, Pa.
 Pacific Allied Products Co., 812 West Eighth St., Los Angeles 14, Calif.
 Padgett Dist. Co., 409 Bullington St., Dallas, Texas.
 Republic Dist. Co., 159 Orange St., Providence 3, R. I.
 S. R. Ross, 1212 South State St., Salt Lake City 4, Utah.
 St. Louis Music Supply Co., 4400 Delmar Blvd., St. Louis 8, Mo.
 Southern Radio Supply Co., 405-07 South Roman St., New Orleans 19, La.
 Stratton-Warren Hdwe. Co., Carolina Ave. & Florida St., Memphis 2, Tenn.
 I. and M. Sufrin, 1207 Muriel St., Pittsburgh 3, Pa.
 Superior Dist. Co., 2307 Pennway, Kansas City 8, Mo.
 Tri-State Supply Co., 1148 Market St., Chattanooga 2, Tenn.
 Rodney Young Co., 228 West 7th St., Cincinnati 2, Ohio.

Automatic Radiomanufacturing Co.
 122 Brookline Ave., Boston, Mass.

Aviola Radio Corp.

Sky Harbor Airport, Phoenix, Ariz.
 President: J. J. Ross
 Sales manager: W. Keene Jackson
 Secretary: Riney Salmon
 Treasurer: C. N. Inman

Products Manufactured

Automatic record changers, record players, phono combinations, table and floor sets, portables, recordiolas

Trade Name

Aviola

Retail Price

\$24.50—\$69.95, \$69.95—\$350.

Bell Sound Systems, Inc.

1183 Essex Ave., Columbus 3, Ohio.
 President and treasurer: F. W. Bell
 Sales manager: Harry E. Harris
 Secretary: R. J. Quinn
Products Manufactured
 Phono public address system, record players, record-o-phone

Belmont Radio Corp.

5921 W. Dickens Ave., Chicago 39, Ill.
 Executive vice-president: Harold Mattes
 Sales manager and vice-president: Charles Hofman
 Vice-president: William Dunn
Products Manufactured
 AM and FM home receivers-combinations, consoles, table models; television receivers; complete sound systems, aircraft transmitters and receivers

Bendix Radio (Division of Bendix Aviation Corp.)

Baltimore 4, Md.
 General manager: W. P. Hilliard
 General radio and television manager:
 L. C. Truesdell
Products Manufactured
 Table and console radios and radio-phonographs
Trade Name
 Bendix

Distributors

Acme Co., 218 McCrea St., Indianapolis 4, Ind.
 Albany Hardware & Iron Co., Broadway at Arch St., Albany 1, N. Y.
 Alford's, 413-15 N. Second St., Albuquerque, N. M.
 Allied Appliance Co., 111 Berkeley St., Boston 16, Mass.
 American Sales & Dist., Inc., 33 N. Grubb St., Columbus 15, Ohio.
 American Sales & Distributors, Inc., 400 Linden Ave., Dayton 3, Ohio.
 D. K. Baxter and Co., 806 Pierce St., Sioux City 7, Iowa.
 Biehl's, Inc., 500 S. Centre St., Pottsville, Pa.
 Bomar Appliance Co., Inc., 520 Western Ave., Knoxville 30, Tenn.
 Bond-Rider-Jackson Co., 1210 Wilson St., Charleston 27, W. Va.
 Brown-Camp Hdwe. Co., First & Elm Sts., Des Moines 6, Iowa.
 The Buckeye Appliance Co., 944 Phillips Ave., Toledo 12, Ohio.
 Car Parts Depot, 716 Texas St., El Paso, Texas.

Cleveland Dist. Co., 2323 E. 67th St., Cleveland 4, Ohio.
 Coastal Equipment Co., 2306 Texas Ave., Houston 3, Texas.
 Crest Corp., 301 S. Vandeventer Ave., St. Louis 10, Mo.
 D'Elia Electric Co., 1330 Fairfield Ave., Bridgeport 5, Conn.
 Edlec Distributors, Inc., 65 Main St., Springfield 5, Mass.
 Enterprise Wholesale, Inc., 600-602 Central St., Kansas City 6, Mo.
 Florida Radio & Appliance Corp., 2320 Liberty St., Jacksonville 6, Fla.
 Florida Radio & Appliance Corp., N. W. 5th St. at 1st Ave., Miami 7, Fla.
 Florida Radio & Appliance Corp., P. O. Box 301, Tampa, Fla.
 General Utilities Corp., 647 W. Virginia St., Milwaukee, Wisc.
 The A. B. Gray Co., 2002 S. Calhoun St., Fort Wayne 6, Ind.
 Graybar Electric Co., Inc., 1529-31 First Ave., N.W., Birmingham 3, Ala.
 Graybar Electric Co., Inc., 163 Georgia St., Buffalo 1, N. Y.
 Graybar Electric Co., Inc., 1222 Carter St., Chattanooga 2, Tenn.
 Graybar Electric Co., Inc., 201 Santa Fe Ave., Los Angeles 12, Calif.
 Graybar Electric Co., Inc., 434 W. Madison St., Phoenix, Ariz.
 Graybar Electric Co., Inc., 186 N. Water St., Rochester 4, N. Y.
 Graybar Electric Co., Inc., 245 S. First West St., Salt Lake City 13, Utah.
 Graybar Electric Co., Inc., 9th & Howard Sts., San Francisco 3, Calif.
 Gunn Dist. Co., Inc., 310 E. Third St., Little Rock, Ark.
 Household Dist. Co., 1233 N. W. 12th Ave., Portland 9, Ore.
 Inter State Appliance Co., 630 Spring St., Shreveport 80, La.
 Jensen-Byrd Co., 320 Riverside Ave., Spokane 8, Wash.
 Edward Joy Co., 133-35 Market St., Syracuse 2, N. Y.
 K. K. Co., 806 South 16th St., Omaha 2, Nebr.
 Kelley-How-Thomson Co., 309-19 S. Fifth Ave., West, Duluth 1, Minn.
 Kentucky Appliance Corp., 605 West Main St., Louisville 2, Ky.
 E. B. Latham Co., 1010 Broad St., Newark 2, N. J.
 Lehr Dist., Inc., 16 West 61st St., New York 23, N. Y.
 Lighting Fixture & Electric Supply Co., Inc., 307 Tchoupitoulas St., New Orleans 2, La.
 Loyal Dist., 815 East Second St., Wichita 2, Kan.
 McDaid's Electrical Supply Co., 112 Market St., Charleston 8, S. C.
 Mid-Atlantic Appliance Dist., 205 Burton Bldg., 928 Fifth St., N.W., Washington 1, D. C.

Mid-Atlantic Appliance Dist., 213 West Fayette St., Baltimore 2, Md.
 Miller-Jackson Co., 111-19 E. California Ave., Oklahoma City 2, Okla.
 Moore-McCord, Ltd., 693 Peachtree St., N.E., Atlanta, Ga.
 Nelson Hdwe. Co., 17 Campbell Ave., S.E., Roanoke 11, Va.
 Newburgh Dist. Co., 37-39 S. Lander St., Newburgh, N. Y.
 Peninsular Dist. Co., 3116 East Jefferson St., Detroit 7, Mich.
 Philadelphia Electronics, Inc., 2013 Walnut St., Philadelphia 3, Pa.
 Pittsburgh Products Co., 500 Fontella St. at Reedsdale, Pittsburgh 12, Pa.
 Radio & Appliance Corp., 1 Cummins Station, Nashville 3, Tenn.
 Republic Dist. Co., 159 Orange St., Providence 3, R. I.
 The Sampson Co., 3201 S. Michigan Ave., Chicago 16, Ill.
 Schwabacher Hdwe. Co., First & Jackson Sts., Seattle 14, Wash.
 Southern Bearings and Parts Co., 315 N. College St., Charlotte 1, N. C.
 Stratton-Warren Hdwe. Co., Carolina Avenue & Florida St., Memphis 2, Tenn.
 Texas Wholesalers, 2211 Commerce St., Dallas 1, Texas.
 Thiele-Winslow Co., 5th Floor Transit Tower, San Antonio 5, Texas.
 R. F. Trant, Inc., 912-14 West 21st St., Norfolk 10, Va.
 Van Deren Hardware Co., Inc., Merino and Water Sts., Lexington 31, Ky.
 Western Appliance Corp., 1147 Broadway, Denver 3, Colo.
 Williams & Martin Corp., Terminal Warehouse, 49 Central Ave., Cincinnati 2, Ohio.

Biltmore Radio Corp.

15 Ave. A, New York, N. Y.

President: H. Schreiber
 Sales manager and treasurer: W. Berry
 Secretary: F. Esternaux

Products Manufactured

Phonographs, radio and television receivers

Trade Names

Biltmore, Phono. Radio.

Boetsch Bros.

221 E. 144th St., New York 51, N. Y.

Partners: George and Fred Boetsch

Products Manufactured

Portable phonographs

Trade Name

Birch

Distributor

Louis E. Dorfman Co., 521 Fifth Ave., New York 17, N. Y.

The Brush Development Co.

3405 Perkins Ave., Cleveland 14, Ohio

President: A. L. Williams

Sales manager: Blair Foulds

Products Manufactured

Magnetic recording equipment, industrial equipment, Piezo electric products

Trade Name

Soundmirror

Retail Prices

\$150, \$350, \$314.50

Distributors

C. E. Anderson, Rockefeller Bldg., Cleveland, Ohio.

I. Walter Berggren, 2007 S. Michigan Ave., Chicago, Ill.

Burlingame Assoc. Ltd., 11 Park Place, New York, N. Y.

Disc M. Lee Co., 2626 Second Ave., Seattle 9, Wash.

Gerald B. Miller Co., 1051 N. Havenhurst Dr., Hollywood, Calif.

Ray Perron & Co., 131 Clarendon St., Boston 16, Mass.

R. M. Richardson, 5215 Third Ave., S., Minneapolis 9, Minn.

J. Y. Schoonmaker, 2320 Griffin St., Dallas, Texas.

Morris F. Taylor Co., Silver Springs, Md.

P. D. Foxwilliger, 27 W. 85 St., Kansas City 5, Mo.

Concert Master Radio & Television Co.

1800 Winnemac Ave., Chicago, Ill.

Concord Radio Corp.

901 W. Jackson Blvd., Chicago 7, Ill.

President: S. J. Novick

Sales manager: H. R. Levinger

Products Manufactured

Radios, phono-radios, amplifiers

Trade Names

Concord, Lafayette

Continental Electronic Ltd.

81 Pine St., New York 5, N. Y.

President and sales manager: Ralph S. Mork

Secretary-treasurer: Allen A. Sylvan

Products Manufactured

Portable record players and radio-phonographs

Trade Name

Skyweight

Retail Price

\$36.75

The Crosley Corp.

Arlington St., Cincinnati, Ohio.

President: Powel Crosley, Jr.

Sales manager: J. H. Rasmussen

Advertising manager: S. C. Mahan

Delco Radio Division

(General Motors Corp.)

1146 Home Ave., Kokomo, Ind.

General manager: B. W. Cooper

Sales manager: K. T. Milne

Comptroller: R. I. Showalter

Products Manufactured

Automobile radios, home radios

Trade Names

Automobile radios—Cadillac, Buick, Oldsmobile, Pontiac, Chevrolet, Delco; home radios—Delco

Models

Home radios, table models, table model combination, consoles, console combinations

Distribution through General Motors and United Motors Service.

DeWald Radio Mfg. Corp.

110 Lafayette St., New York 3, N. Y.

President and treasurer: David Wald

Sales manager and secretary: I. N. Weiss

Products Manufactured

Portable table models and console radio receivers

Trade Name

DeWald

Dynavox Corp.

684 Sixth Ave., New York, N. Y.

F. E. Dine and Co., Inc.

2221 Warwick Ave., Santa Monica, Calif.

President: F. E. Dine

Secretary-treasurer: W. E. Patton

Products Manufactured

Variable condensers, tubular paper condensers, radio transmitters and receivers

Trade Names

Hoyt Radio Supply—HRS, McMullen Products

Eastern Electronics Corp.

41 Chestnut St., New Haven 11, Conn.

President: A. G. Annis

Sales manager: R. S. Bruneau

Secretary-treasurer: J. J. Sullivan

Products Manufactured

Radio and electronic test equipment, precision wire wound resistors, phonograph

motor units, rotary selector switches, home radio receiving sets, portable phono

record players, portable phonograph-radio combinations

Trade Names

Korect-Ohm (resistors), Ampliphone (portable phonograph player)

Eckstein Radio & Television Co.

914-16-18 La Salle Ave., Minneapolis 2, Minn.

President: E. A. Eckstein

Sales manager and secretary-treasurer:

E. R. Bostrom

Products Manufactured

Home radios, Karadio

Trade Names

Karadio, L'Tatro, Eckco

Models

Karadio 3-band Communication Receiver

Model RCN

Electromatic Mfg. Corp.

88 University Place, New York 3, N. Y.

President: Edward Ehrlich

Sales manager: Leonard C. Welling

Products Manufactured

Radio receivers, phonographs, automatic phonographs and combinations

Trade Name

Electromatic

Electronic Assembly Co.

9 Belvidere St., Boston 15, Mass.

President: E. M. Carbury

Sales manager: G. W. Thelin

Products Manufactured

Portable electric phonograph players, single and automatic mechanisms

Trade Name

Tel-Rad Products

Electronic Corp. of America

45 W. 18th St., New York 11, N. Y.

President: S. J. Novick

Sales manager: Jack Geartner

Products Manufactured

ECA Radios, musical typewriters

Trade Names

ECA, Typatune

Models

Radio-phonographs, table models, consoles, phonographs

Electronic Devices Co.

601 W. 26th St., New York 1, N. Y.

Sales manager: Paul O. Schonwit

Products Manufactured

Radios, phonographs and combinations, DC to AC phonograph invertors, noise eliminators

Trade Name

20th Century

Emerson Radio and Phonograph Corp.

111 Eighth Ave., New York 11, N. Y.

President: Benjamin Abrams

Home Products Division Manager:

P. G. Gillig

Secretary-treasurer: Max Abrams

Products Manufactured

Radio receivers, phonographs and combinations, television, tubes and parts, electronic hearing aids

Trade Name

Emerson

Models

AC, DC pocket radios, 3-way portable radios and self-powered pocket radios, AC and AC-DC consoles, AM and FM receivers

Espey Mfg. Co., Inc.

528 E. 72nd St., New York 21, N. Y.

President: Nathan Pinsley

Sales manager: Michael Ross

Manufacturer of radios and phonographs under private label.

Fada Radio and Electric Co., Inc.

30-20 Thomson Ave., Long Island City 1, N. Y.

President: Jack M. Marks

Advertising manager: Herman N. Lubet

Assistant secretary: J. Nathan Marks

Secretary-treasurer: David I. Marks

Products Manufactured

Radios, phonographs and combinations, home recorders, FM and television sets

Trade Name

Fada

Models

Table, floor, and portable radios; table and portable phonographs and combinations

Farnsworth Television and Radio Corp.

3702 E. Pontiac, Ft. Wayne 1, Ind.

President: E. A. Nicholas

Sales manager: E. H. McCarthy

Secretary: E. M. Martin

Treasurer: J. P. Rogers

Products Manufactured

Radio and television receivers and transmitters, television tubes, phonograph-radio

Trade Names

Farnsworth, Capehart, Panamuse

Distributors

American Dist., Inc., 76 Franklin St., P. O. Box 1834, New Haven 11, Conn.

Bargelt Supply, 1131-35 S.W. Washington St., Portland 5, Ore.

Bigelow & Dowse Co., Appliance Division, 652 Beacon St., Boston 15, Mass.

Paul Blackwell Co., 2016 Richardson Ave., Dallas 1, Texas.

The Burden-Bryant Co., 126 Liberty St., Springfield 3, Mass.

Harry W. Cameron, Inc., 1021 Chestnut St., Chattanooga 2, Tenn.

F. O. Carpenter & Son, 207 N. Fourth St., Columbus 15, Ohio.

Charleston Electrical Supply Co., 914 Kanawha Blvd., Charleston 29, W. Va.

Cloud Bros., 110 E. Western Ave., South Bend 11, Ind.

Consolidated Gas & Equipment Co., 220 W. Sixth, Plainview, Texas.

P. F. Crenshaw, Jr. Co., 32 W. Iowa Ave., P. O. Box 2124, DeSoto Station, Memphis 2, Tenn.

Cross & Rogers, 801-7 E. Markham St., Commercial Bldg., Suite 25, Little Rock, Ark.

Crouch Appliance Co., 608 Texas St., El Paso, Texas.

B. T. Crump Co., Inc., 1310-34 E. Franklin St., Richmond 13, Va.

Frank Edwards Co., Inc., 1414 Van Ness Ave., San Francisco 9, Calif.

Electric Constructors, Inc., 2023 North Fourth Ave., Birmingham, Ala.
 The Emery-Waterhouse Co., 145 Middle St., Portland 6, Me.
 Fargo Glass & Paint Co., 648 N. P. Ave., Fargo, N. Dak.
 Farnsworth Television & Radio Corp., Suite 535-B, The American Furniture Mart, 666 Lake Shore Drive, Chicago 11, Ill.
 Foster Supply Co., 1081 Main St., Buffalo 8, N. Y.
 F. Garnich & Sons Hdwe. Co., 400 12 Seventh Ave., W., Ashland, Wis.
 General Heating Products Co., 3353 University Ave., S. E., Minneapolis 11, Minn.
 J. S. George Supply Co., 112-14 North St., Burlington, Vt.
 Graybar Electric Co., Inc., 1644 Baltimore Ave., Kansas City 8, Mo.
 Graybar Electric Co., Inc., 1120 Capitol Ave., Omaha 2, Nebr.
 Graybar Electric Co., Inc., 124 N. Rock Island Ave., Wichita 1, Kan.
 Graybar Electric Co., Inc., 37 Water St., Pittsburgh 22, Pa.
 Harper & McIntire Co., Commercial St., Ottumwa, Iowa.
 Harper & McIntire Co., Cedar Rapids, Iowa.
 Horrocks-Ibbotson Co., 51 Genesee St., Utica 2, N. Y.
 Independent Dist., Inc., 12 Campau Ave., N. W., Grand Rapids, Mich.
 Interstate Electric Co., 643 Magazine St. at Girod St., New Orleans 7, La.
 Jackson Dist. Co., 48 Richard St., Salt Lake City 1, Utah.
 Kentworth Corp., 726-30 W. Main St., Louisville 2, Ky.
 L. & K. Electric Co., 72 State St., Binghamton, N. Y.
 Lappin Electric Co., 1022 N. Fifth St., Milwaukee 3, Wisc.
 LeValley, McLeod, KinKaid Co., Inc., 126-140 Van Guvsling Ave., Schenectady 1, N. Y.
 Lincoln Sales Corp., 1307 St. Paul St., Baltimore 2, Md.
 A. Y. McDonald Mfg. Co., 110 Fourth St., Sioux City, Iowa.
 A. Y. McDonald Mfg. Co., 415 N. Phillips Ave., Sioux Falls, S. Dak.
 D. W. May Corp., 250 Fulton St., New York 7, N. Y.
 Midland Electric Co., 2125 Superior Ave., Cleveland 14, Ohio.
 Muntz & Lea Co., 618 W. Jefferson St., Rockford, Ill.
 National Mill Supply Co., 207 E. Columbia St., Fort Wayne 2, Ind.
 Neyhart's, Inc., 145 W. Third St., Williamsport 3, Pa.
 Northwest Appliance Dist., 1926 Smith Tower, Seattle 4, Wash.
 Northwest Appliance Dist., 412 Radio Central Bldg., Spokane 8, Wash.
 Packard Manufacturing Corp., Electronic Dist. Div., 2900 Columbia Ave., Indianapolis 7, Ind.
 Palmetto Electric Supply Co., 1850 Laurel St., P. O. Box 329, Columbia, S. Car.
 Paul-Jeffrey Co., 350 W. Fayette St., Syracuse 2, N. Y.
 Providence Electric Co., Inc., 110-14 Empire St., Providence 3, R. I.
 Rapid Wholesale & Dist. Co., Rapid City, S. Dak.
 Raybro Electric Supplies, Inc., 812-14 Twiggs St., Tampa 1, Fla.
 Raybro Electric Supplies, Inc., Jacksonville, Fla.
 Raybro Electric Supplies, Inc., Miami, Fla.
 Republic Supply Corp., 424 W. Jefferson Ave., Detroit 26, Mich.
 Rice & Miller Co., 28 Broad St., Bangor, Me.
 The Sacks Electrical Supply Co., 605 S. Main St., Akron 11, Ohio.
 W. T. Shackelford Co., 393 Peachtree St., N.E., Atlanta 3, Ga.
 Shepler & Lowes Radio & Appliance Co., Div. Nu-Tred Tire Co., 823 Main St., Peoria 2, Ill.
 Sherman-Swenson & Assoc., 2436 E. Eighth St., Los Angeles 21, Calif.
 Standard Dist. Co., 119 S. St. Mary's St., San Antonio 6, Texas.
 Standard Equipment Co., 125 N. First St., Phoenix, Ariz.
 Stanley Dist. Co., 3912 W. Pine Blvd., St. Louis 8, Mo.
 Sterling Appliance Co., Inc., 135 W. Second St., Reno, Nev.
 Straus-Bodenheimer Co., 1510-12 Preston Ave., Houston 2, Texas.
 Superior Dist. Co., 917 N. Robinson, Oklahoma City 3, Okla.
 B. K. Sweeney Electrical Co., 1601 Twenty-third St., Denver 17, Colo.
 Taylor Dist. Co., 2716 Montana Ave., Billings, Mont.
 Trilling & Montague, 2401 Walnut St., Philadelphia 3, Pa.
 Tri-State Appliance Dist., 1015 State St., Erie 2, Pa.
 Turners, Inc., 308 S. Campbell Ave., Springfield, Mo.
 Twin States Dist. Co., 515-17 W. Palmer St., Charlotte 2, N. Car.
 The Wadding, Kinnan & Marvin Co., 332-34 Summit St., P. O. Box 1677 Central Station, Toledo 3, Ohio.
 Washington Wholesalers, 1733 Fourteenth St., N.W., Washington 9, D. C.
 West Central Dist., 1 Mt. Hope Ave., Rochester 7, N. Y.
 Williams & Co., 615 Taylor St., Amarillo, Texas.
 The York Supply Co., 2624 Colerain Ave., Cincinnati 14, Ohio.
 The York Supply Co., 531 E. Third St., Dayton 2, Ohio.

Freed Radio Corp.

200 Hudson St., New York 13, N. Y.
President: Max Adelberg
Vice-president and general manager:
Arthur Freed
Secretary-treasurer: Melvin Zalkin
Products Manufactured
High fidelity radio phonographs
Trade Name
Freed-Eisemann
Models
Combinations in period furniture
Retail Prices
\$350-\$1,000

Galvin Mfg. Corp.

1545 Augusta Blvd., Chicago 51, Ill.
President: Paul V. Galvin
Sales manager: William Kelley
Secretary: Charles E. Green
Treasurer: George MacDonald
Products Manufactured
FM and AM home radios, auto radios,
automatic combinations, portable radios,
television sets, communication equipment
Trade Name
Motorola
Distributors
Ashman Dist. Co., 807 Granby St., Norfolk
10, Va.
Auto Service Co., 1916 Fourth Ave., S., Bir-
mingham 3, Ala.
Battery & Starter Co., Inc., 2505 Main St.,
Buffalo 14, N. Y.
Big Boys Auto Parts Co., 123-129 South Sec-
ond St., Sunbury, Pa.
Boyd Dist. Co., 20 West 13th Ave., Denver 4,
Colo.
Bryant & Trimble, Inc., 406 Broad St., Chat-
tanooga, Tenn.
Bryant & Trimble, Inc., 103 W. Jackson Ave.,
Knoxville, Tenn.
Porter Burgess Co., 815 North Pearl St.,
Dallas 1, Texas.
Appleway Supply Co., Dishman, Wash.
C & H Supply Co., 1316 S. W. Washington
St., Portland 5, Ore.
Carolina Appliance Co., P. O. Box 967,
Charlotte 1, N. Car.
Christian-Sheidler Co., Adams & 20th Sts.,
Toledo, Ohio.
Currey's, 17th & West End Ave., Nashville 3,
Tenn.
Davis Radio Co., 498 North Fresno St.,
Fresno 3, Calif.
Dibert Radio Dist. Co., 1802 11th Ave.,
Altoona, Pa.
Disco Dist. Co., 2843 Washington Blvd., St.
Louis 3, Mo.
Duke's Radio Co., 111 West Fourth St.,
Sioux City 6, Iowa.
Dunckelman-Pace Co., 1417 Louisiana Ave.,
Shreveport, La.
Edwards Harris Co., 258 Peachtree St., N.E.,
Atlanta 3, Ga.
Electro-Pliance Dist., Inc., 2458 W. Lisbon
Ave., Milwaukee 5, Wisc.

Falls City Supply Co., 315 Roland Ave.,
Louisville 3, Ky.
Fargo Paper Co., 26-28 Eighth St., N., Fargo,
N. Dak.
I. Feldman Co., 186 Broadway, Providence 3,
R. I.
Forster Dist. Co., 1122 Harmon Place, Min-
neapolis 3, Minn.
Fort Worth Battery Co., 615 Lamar St., Fort
Worth, Texas.
Gary Tire & Supply Co., 400 W. Fifth St.,
Gary, Ind.
Freck Radio & Supply Co., 38 Biltmore Ave.,
Asheville, N. Car.
Gifford-Brown, Inc., 1216-18 Grand Ave.,
Des Moines, Iowa.
Gifford-Brown, Inc., 106 First St., S.W.,
Cedar Rapids, Iowa.
Goldner Dist. Co., 46-50 North 5th St., Phila-
delphia 6, Pa.
Graff Motor Supply Co., 122-24 West Seventh
St., Sioux Falls, S. Dak.
C. G. Hadicke Co., 85 So. Van Ness Ave.,
San Francisco 3, Calif.
Industries Sales Corp., 2927 Jackson Ave.,
New Orleans, La.
Home Appliance Dist. of Ark., 600 West 7th
St., Little Rock, Ark.
Hudson Valley Asbestos Corp., 170 Central
Ave., Albany, N. Y.
Ingram Dist. Co., 4490 Cass Ave., Detroit 1,
Mich.
Jones-Cornett Electric Co., Welch, W. Va.
Kearns, Inc., Harrisburg & Atlantic Aves.,
Atlantic City, N. J.
Kemp Equipment Co., 57 Mt. Hope Ave.,
Rochester 7, N. Y.
Kierulff & Co., 820 W. Olympia Blvd., Los
Angeles 15, Calif.
Krisch-Delavan Co., 801 Main Ave., San An-
tonio 2, Texas.
Lee Dist. Co., 1126 North Blvd., Richmond
20, Va.
Lockie & Glenn, 2110 Gilbert Ave., Cincin-
nati 6, Ohio.
Logren Dist. Co., 1202 Fourth Ave., Moline,
Ill.
The M & M Co., 5200 Prospect Ave., Clevel-
land 3, Ohio.
The M & M Co., 214 E. Gay St., Columbus,
Ohio.
McDonald Auto Supply Co., 2nd & Polk Sts.,
Amarillo, Texas.
McGrew Dist., Inc., 1312 East Douglas Ave.,
Wichita 7, Kan.
Wm. Mee Co., 120 E. Grand Ave., Oklahoma
City, Okla.
Metro Dist., Inc., 884 Commonwealth Ave.,
Boston 15, Mass.
Mills-Morris Co., 171 S. Dudley St., Mem-
phis 1, Tenn.
Mitchell Products Co., 492 W. Water St.,
Santa Fe, N. M.
Moore Bros. Co., 3401 Milam St., Houston,
Texas.
Moore Equipment Co., 226 W. Third St.,
Dayton 2, Ohio.

Moto Radio Dist. Co., 5732 Baum Blvd., Pittsburgh 6, Pa.
 Motor Radio Co., Inc., 2440 Charlotte St., Kansas City 8, Mo.
 Motorola-Chicago Co., 1330 West Washington Blvd., Chicago 7, Ill.
 Motorola Dist. Co., 620 Eastlake Ave., Seattle 9, Wash.
 Motorola-New York, Inc., 33 West 60th St., New York 23, N. Y.
 Motorola-New Jersey, Inc., 177 Central Ave., Newark 4, N. J.
 Mueller & Selby Co., 2615 Farnam St., Omaha 2, Nebr.
 Nelson Radio & Supply Co., 263 St. Louis St., Mobile, Ala.
 Nevada Dist., Inc., P. O. Box 1047, Reno, Nev.
 Oakes Battery & Electric Co., 423 Texas St., El Paso, Texas.
 Offenbauer Co., 227 W. Washtenaw St., Lansing, Mich.
 Lee Pasley, 20 N. 33rd St., Billings, Mont.
 Post & Lester Co., 10 Chestnut St., Hartford 5, Conn.
 Radio Dist. Co., Monroe & Carroll Sts., South Bend, Ind.
 Radio Dist. Co., 1013 N. Capitol Ave., Indianapolis 4, Ind.
 Radio Sales Co., 816 E. Genesee Ave., Saginaw, Mich.
 Radio Service Laboratory, 1191 Elm St., Manchester, N. H.
 Radio Service Laboratory, 45 Haymarket Sq., Bangor, Me.
 Radio Service Laboratory, 45A Free St., Portland 3, Me.
 Radio Specialties Co., 401 W. Jackson St., Phoenix, Ariz.
 Republic Dist. Co., 72-74 N. Division Ave., Grand Rapids, Mich.
 S. R. Ross, 1212 S. State St., Salt Lake City 4, Utah.
 Seltzer Co., 604 Fulton St., Peoria 2, Ill.
 Simon Dist. Corp., 615 Pennsylvania Ave., N.W., Washington 4, D. C.
 Specialty Sales Co., 116 W. Chestnut St., Lancaster, Pa.
 Strickland Dist. Co., 615 Jefferson St., Paducah, Ky.
 Thurow Dist., Inc., 115-117 S. Franklin St., Tampa 1, Fla.
 Thurow Dist., Inc., 518-520 W. Flagler St., Miami, Fla.
 Thurow Dist., Inc., 209 N. Olive St., West Palm Beach, Fla.
 Thurow Dist., Inc., 131 S. Court St., Orlando, Fla.
 Thurow Dist., Inc., 806 Main St., Jacksonville, Fla.
 Thurow Dist., Inc., 213 E. Tennessee Ave., Tallahassee, Fla.
 Tire Sales & Service Co., 401 Hillsboro St., Raleigh, N. Car.

Wall Dist. Co., 211 Pearl St., Fort Wayne 2, Ind.
 Western Auto Supply Co., 1100 S. Grand Ave., Los Angeles 54, Calif.
 Western Virginia Sales Co., P. O. Box 1506, Roanoke, Va.
 Mr. A. H. Wherry, Jr., Chester, S. Car.
 Wilson Radio Dist., Co., 1116 Central Ave., Charleston 4, W. Va.

Garnet Radio Corp.

69 Glenwood Place, E. Orange, N. J.
 President and sales manager: Lester G. Flynt
 Secretary: H. T. Tudor
 Treasurer: Arthur L. Ungerleider
Products Manufactured
 Home receiving radios
Trade Name
 Garnet
 Models
 Table

Garod Electronics Corp.

70 Washington St., Brooklyn 1, N. Y.
 President: M. W. Weintraub
 Sales manager: Louis Silver
 Treasurer: B. S. Trott
 Assistant to the president: M. Raphael
Products Manufactured
 Home radios, phonograph combinations, portable radios, record players
Trade Name
 Garod

Distributors

Airflow Products Co., 1421 N. Penn Ave., Wilkes Barre, Pa.
 Allied Electric Supply Co., 928 Penn Ave., Pittsburgh 22, Pa.
 Leonard Ashbach Co., 152-54 W. Huron St., Chicago 10, Ill.
 Associated Dist. Corp., N. E. Corner Charles & Lombard Sts., Baltimore 1, Md.
 George W. Bauer & Son, 2145 Highland Ave., Utica, N. Y.
 C. C. Brown Co., 26 Ninth St., San Francisco, Calif.
 Capital Bedding Co., Inc., 14th & Howard Sts., Harrisburg, Pa.
 Chambers Radio Supply Co., 1104 Broadway, Cincinnati 10, Ohio.
 Chapman Drug Co., 516-518 State St., Knoxville 10, Tenn.
 Clembro Appliance Corp., W. Eighth St. at Chestnut, Chattanooga, Tenn.
 Eastern Electric Co., 315-324 Twelfth St., Lynchburg, Va.
 Electric Products Corp., 148 Second Ave. N., Nashville, Tenn.
 The Furbay-Sommer Co., 115 Schroyer Ave., Canton 2, Ohio.
 Gilbert Bros., Inc., 826 S. W. Second Ave., Portland 4, Ore.
 Golden Appliance Co., 1761-67 E. 18th St., Cleveland 14, Ohio.

The Jake Hayutin & Sons Co., 1126 Larimer St., Denver 2, Colo.
 Huntington Paper & Supply Co., 841-843 Second Ave., Huntington 12, W. Va.
 Incandescent Supply Co., 814 Fulton St., Fresno, Calif.
 Incandescent Supply Co., 825-833 E. Third St., Los Angeles 13, Calif.
 K Stores Co., 1310 Boylston St., Boston, Mass.
 Lifetime Sound Equipment Co., 911-913 Jefferson Ave., Toledo, Ohio.
 Maga Dist., Ltd., 614-18 New St. (P.O. Box 1173), Macon, Ga.
 Mill Dist., Inc., 422 S. Tryon St., Charlotte, N. Car.
 Missouri Furniture Assoc., Twelfth and Walnut Sts., St. Louis 2, Mo.
 Monarch Sales Co., 210 N. 22nd St., Birmingham 3, Ala.
 Morley Bros., 5943 Second Blvd., Detroit, Mich.
 Morley Bros., Saginaw, Mich.
 McGowin-Lyons Hdwe. & Supply Co., 113 N. Water St., Mobile 7, Ala.
 National Radio Dist., Ltd., Congress Bldg., Miami, Fla.
 Paramount Dist., Inc., 42 Hampden St., Springfield 3, Mass.
 Radio Tube Merchandising Co., 508 Clifford St., Flint 3, Mich.
 Gil Schaefer Dist., 101 Weston St., S.E., Grand Rapids 2, Mich.
 Southern Electric Co., 14 East Johnson St., Staunton, Va.
 Stern and Co., 210 Chapel St., Hartford, Conn.
 Tede & Etchingham, 234 W. Bonneville, Pocatello, Idaho.
 Tel Ra Appliance Co., 252 Asylum St., Hartford, Conn.
 Tel Ra Appliance Co., 16-18 N. Fifth St., Philadelphia 6, Pa.
 Tel Ra Appliance Co., 122-130 W. Exchange St., Providence, R. I.
 Universal Products Co., 621 Botetourt St. (P. O. Box 323), Norfolk 7, Va.
 W. & K. Wholesale Dist., 1308-10 Main St., Fort Worth, Texas.
 Wilson Dist. Co., 1740 Taylor St., Columbia 59, S. Car.
 Herb E. Zobrist Co., 2125 Westlake Ave., Seattle 1, Wash.

Garrard Sales Corp.

315 Broadway, New York 7, N. Y.
 President: William Carduner
 Sales manager: Leonard Carduner
Products Manufactured
 Automatic record changers, record players, phono motors, pick-ups
Trade Name
 Garrard
Models
 Deluxe automatic record changer

Geib, Inc.

1751 N. Central Pk. Ave., Chicago 47, Ill.
 President: Nic. V. Geib
 Sales manager: N. J. Geib
 Secretary: A. C. Geib
Products Manufactured
 Portable phonographs
Models
 Spring wound, electric
Retail Price
 \$27.13.
Distributors
 Eastern Electronic Sales, 136 Liberty St., New York, N. Y.
 Goodman Bros., P. O. Box 24, Portsmouth, Va.

General Electric Co.

1 River Rd., Schenectady 5, N. Y.
 President: Charles E. Wilson
 Secretary: William W. Trench
 Treasurer: J. W. Lewis
Products Manufactured
 Standard radio receivers, FM radio receivers, television receivers, combination radio-phonographs

General Television and Radio Corp.

2701-17 Lehmann Court, Chicago 14, Ill.
 President: F. R. Marlier
 Sales manager: John E. Rogers
Products Manufactured
 Radios
Trade Name
 General Television and Radio
Models
 Table models, phonograph combinations, amplifier phonograph

Distributors

Andrews & Medema, Inc., 406 S. Columbia St., South Bend 4, Ind.
 Associated Dist. Co., 308-316 Ivy St., N.E., Atlanta 1, Ga.
 The Barron Co., Inc., 318-320 S. 12th St., Omaha 2, Neb.
 Earl W. Bentley Operating Co., 516-518 N. Broadway, Oklahoma City, Okla.
 D. Coad Co., 1125 Locust St., St. Louis 1, Mo.
 Dietz Dist. Co., 309 N. Chicago St., Joliet, Ill.
 W. M. Dunbar Co., Inc., 2318 First Ave., Birmingham 3, Ala.
 Flora Dist. Co., 1822 Adams St., Toledo 2, Ohio.
 Electronic Dist. Co., 3162-64 N. Elston Ave., Chicago 18, Ill.
 The Ferguson Co., Tenth and Broadway, Paducah, Ky.
 5 5 5, Inc., Second to Third on Broadway, Little Rock, Ark.
 Horola Corp., 1020 N. Third St., Milwaukee 3, Wisc.
 Inboden Radio Dist. Co., 218 S. Highland Ave., Pittsburgh 6, Pa.

Irving Dist. Co., 1418 Michigan Ave., Detroit 16, Mich.
 Lang and Newell Co., 235-36 Insurance Exchange Bldg., Des Moines 9, Iowa.
 Leuck Radio Supply, 243 South 11th St., Lincoln 8, Nebr.
 Major Dist. Co., 49 Central Ave., Room 601, Cincinnati 2, Ohio.
 Moore Dist. Co., 2342 N. Illinois St., Indianapolis 8, Ind.
 J. D. Nowlin and Sons Co., 1095 Union Ave., Memphis 4, Tenn.
 Radio Parts Co., 234 S. Second St. at E. Genesee Ave., Saginaw, Mich.
 Radio Supply Co., 1219 E. Douglas, Wichita 7, Kan.
 Ramsey-Bennett Co., 430 Huren Road, Cleveland 15, Ohio.
 Ray-De-O Dist., 514 Iowa St., Sioux City 12, Iowa.
 Arthur Rixon & Son, 209 W. Washington St., Greenville, S. Car.
 S. & S. Radio Supply, 721 S. Detroit, Tulsa 3, Okla.
 Shedlov-Jarvis, Inc., 717 - 3rd Ave. S., Minneapolis 2, Minn.
 The Soo-Marquette Hdwe. Co., Marquette, Mich.
 Tire Supply Co., 1604-06 Oak St., Kansas City 8, Mo.
 Todd & Co., 945 King Ave., Columbus 8, Ohio.

Gilfillan Bros., Inc.

1815 Venice Blvd., Los Angeles 6, Calif.
 President: S. W. Gilfillan
 Sales manager: A. Jennings Brown
 Secretary-treasurer: I. Kemp
Products Manufactured
 Radios, phonograph combinations, television
Trade Name
 Gilfillan
Distributors
 Herb E. Zobrist Co., Seattle, Wash.
 Pacific Wholesale Co., San Francisco, Calif.
 Central Appliance Co., Portland, Ore.
 Billings Wholesale Radio, Fresno, Calif.
 Zions Cooperative Mercantile Inst., Salt Lake City, Utah
 Reynold Plath, Great Falls, Mont.

Globe Electronics Inc.

225 W. 17th St., New York 11, N. Y.
 President: Robert Siegel
 Vice-president: Milton Dolgins
 Secretary-treasurer: Oscar Dolgins
Products Manufactured
 Radios, automatic amplified phonographs, manual amplified phonographs, combinations
Trade Name
 Globe
Models
 Table model radios in catalin and wood cabinets, portable and table model phonographs, table model combination

The Hallicrafters Co. (Echophone Div.)

2611 Indiana Ave., Chicago 16, Ill.
 Vice-president and general manager:
 L. L. Kelsey
 Sales manager: Paul Eckstein
Products Manufactured
 Broadcast receivers, AM/FM receivers, console receivers, table model receivers, radio-phonograph combination consoles and table models, portable receivers, television receivers
Hamilton Radio Corp.
 510 Avenue of the Americas, New York 11, N. Y.

President and treasurer: A. A. Juviler
 Sales manager: J. F. Crossin
 Secretary: P. L. Schoenen
Products Manufactured
 Radio receiving sets, radio-phonographs, electric phonographs
Trade Names
 Olympic, Tru-base
Retail Price
 \$23.50-\$119.95.

Hoffman Radio Corp.

3761 S. Hill St., Los Angeles 7, Calif.
 President: H. Leslie Hoffman
 Sales manager: R. J. McNeely
 Secretary-treasurer: R. A. Yarcho
Products Manufactured
 Radios, phonographs, home recording equipment
Trade Names
 Hoffman, Mitchell-Hughes
Models
 Radios in walnut, ivory, mahogany, and blonde finish
Retail Price
 \$23.55-\$128.95.

Distributors
 Radio Products Sales Co., 1237 - 16th St., Denver 2, Colo.
 Martin Dist. Co., Inc., 2618 Tulare St., Fresno, Calif.
 Radio Parts of Arizona, 36 W. Madison St., Phoenix, Ariz.
 Stubbs Electric Co., 33 N. W. Park Ave., Portland 9, Ore.
 E. M. Kemp Co., 1115 R St., Sacramento 14, Calif.
 Western Radio & Elec. Co., 1415 India St., San Diego, Calif.
 Tom Doyle, 202 W. Santa Clara, San Jose, Calif.
 Radio Supply Co., 45 E. Fourth S. St., Salt Lake City 1, Utah.
 Love Electric Co., 325 Westlake Ave. N., Seattle 9, Wash.
 Hoffman Sales Corp., 1355 Market St., San Francisco 3, Calif.
 Hoffman Sales Corp., 3761 S. Hill St., Los Angeles 7, Calif.
 Exportadora, Inc., 354 S. Spring St., Los Angeles 13, Calif.

Tommy Kearns, 1067 Alakea St., Honolulu, T. H.

Hollywood Radio Transcriptions, Inc.
2919 S. Norton Ave., Los Angeles 16, Calif.

President and sales manager: W. A. Watson
Secretary: L. M. Watson
Treasurer: W. S. Watson

Products Manufactured

Radio transcriptions

Trade Names

Hollywood Radio Transcriptions, Inc.,
Modern Charm Institute of Hollywood

Howard Radio Co.

1735 Belmont Ave., Chicago 13, Ill.

President: Joseph F. Riley

General sales manager: J. M. Muniz

Secretary-treasurer: George I. Turnquist

Products Manufactured

Radios, radio-phonograph combinations

Trade Name

Howard

Distributors

Aberdeen Supply Co., Aberdeen, S. Dak.

All-State Dist., Inc., 45 Clinton St., Newark 2, N. J.

Appliance Wholesalers, Inc., 1749 W. Lafayette Blvd., Detroit 16, Mich.

Arizona Hdwe. Co., 1st & Jackson Sts., Phoenix, Ariz.

Bakers Service Co., Malone, N. Y.

Bowers Wholesale Corp., 1605 Granby St., Norfolk 10, Va.

Brooks-Huff Tire Co., Reisterstown Rd. & Garrison Ave., Baltimore 15, Md.

Broome Electric Co., 1003 Harrison, Amarillo, Texas.

J. N. Cazan Co., Western Mdse. Mart. 1355 Market St., San Francisco 3, Calif.

Central Electrical Sales Corp., 430 W. Juneau Ave., Milwaukee 3, Wisc.

Chapman Drug Co., Knoxville 10, Tenn.

Charleston Hdwe. Co., 1121 Smith St., Charleston 31, W. Va.

Chattanooga Paper & Woodenware Co., 201 W. Main St., Chattanooga, Tenn.

B. Davis, 22-26 S. Third Ave., Mt. Vernon, N. Y.

The DeWitt Co., 2219 - 19th St., Lubbock, Texas.

Dixico Wholesale Dist., 101 21st St., S., Birmingham, Ala.

Electric Supply Sales Co., 230 Andrews St., Rochester 4, N. Y.

Electronic Engineering Service, 119 S. 9th St., Boise, Idaho.

Ellicott Electric Corp., Ellicott at Huron Sts., Buffalo 3, N. Y.

Empire Supply Co., 209 North P Ave., Fargo, N. Dak.

Engleby Auto Supply Co., 339 Luck Ave., S.W., Roanoke, Va.

G. & S. Dist. Co., 213 W. Kellogg Blvd., St. Paul 2, Minn.

Gate City Furniture Dist., 529-49 Stewart Ave., S.W., Atlanta 3, Ga.

General Utilities Dist., 510 N. Lake Shore Drive, Chicago 11, Ill.

Gill-Brand Products, Inc., 177 Congress St., Portland, Me.

Grossman Music Co., 210 Prospect Ave., Cleveland 15, Ohio.

Gulf Appliance Dist., Inc., 210 So. Franklin St., Tampa 2, Fla.

Halifax Dist. Co., 418 S. Salina St., Syracuse 2, N. Y.

Harris-Patrick Elec. Sup. Co., 179 Second Ave., N., Nashville, Tenn.

E. G. Hendrix Co., 729 So. Flores St., San Antonio 6, Texas.

C. A. Herlong, Greenville, S. Car.

The Louis M. Herman Co., 885 Boylston St., Boston 16, Mass.

Howard Radio Dist. Co., 10792 Ashton Ave., W. Los Angeles 24, Calif.

The Indiana Tinware Co., 112-18 So. Pennsylvania St., Indianapolis 4, Ind.

Kansas City Auto Supply Co., 1818 McGee Trafficway, Kansas City 8, Mo.

Kent Wholesale Dist., 209 S. Division, Grand Rapids 7, Mich.

Keps Electric Co., 636 Grant St., Pittsburgh 19, Pa.

Lafayette Electric Corp., 48 E. 21st St., New York 10, N. Y.

Luethi & Welch, Inc., 225-229 N. Fourth St., Columbus 15, Ohio.

Major Appliance Co., 130 N. Patterson Blvd., Dayton 1, Ohio.

Middlesex Bag & Paper Co., 10 Cooley Ave., Middletown, Conn.

Midwest Dist. Co., 602 W. Kearsley St., Flint, Mich.

Milben Dist., Inc., 71 W. Washington St., Hagerstown, Md.

Mitchell Products, 159 Water St., Santa Fe, N. M.

Monroe Furniture Co., 132 N. Second St., Monroe, La.

North Pacific Supply Co., 519 Central Bldg., Seattle 4, Wash.

Pioneer Dist. Co., 508 Hillsboro St., Raleigh, N. Car.

H. Poll Electric Co., 14-16 St. Clair St., Toledo 4, Ohio.

Quanrud, Brink & Reibold, Inc., Bismarck, N. Dak.

Radio Products Sales Co., 1237 Sixteenth St., Denver 2, Colo.

Radio Supply Co., 45 E. 4th S. St., Salt Lake City 1, Utah.

The Reed Co., P. O. Box 1787—Fannin at Main, Beaumont, Texas.

Robinson Wholesale Co., 216 Second Ave., Des Moines 9, Iowa.

W. A. Roosevelt Co., 220 N. Front St., La Crosse, Wisc.

S. & S. Auto Parts, 410 E. Superior St., Duluth 2, Minn.

Smith-Rankin Dist. Corp., 333 W. Main St., Louisville 2, Ky.

Sommers-Brown, Union at Third, Memphis 3, Tenn.

Southern Electric Co., 11 E. Johnson St., Staunton, Va.
 Southern Radio Supply Co., 405-07 S. Roman St., New Orleans 19, La.
 Spin-Roy, 31 Hillman, Springfield, Mass.
 Taylor, Lowenstein & Co., Mobile 8, Ala.
 Teague Hardware Co., Montgomery, Ala.
 Terry-Durin Co., 409 - 7th Ave., S.E., Cedar Rapids, Iowa.
 Trenton Radio, 300 Grant Ave., Morgantown, W. Va.
 Truc's Dist. Co., 717 N. Hamilton St., Spokane 11, Wash.
 Edward K. Tryon Co., 815 Arch St., Philadelphia 5, Pa.
 Twin States Electric Co., 81-83 S. Main St., White River Junction, Vt.
 United Radio Supply Co., 203 S. W. Ninth Ave., Portland 5, Ore.
 Wm. Van Domelen Co., 218 Ogden Ave., Menominee, Mich.
 Warren Electric Co., 7th & Nebraska Sts., Sioux City, Iowa.
 Waugh & Robertson Dist. Co., 27 East Grand Ave., Oklahoma City 2, Okla.
 Wholesale Appliance Co., 201 Rock St., Little Rock, Ark.
 Witte Hdw., Co., 704 No. Third St., St. Louis 2, Mo.
 Wolf & Klar Wholesale Supply Co., 1308 Main St., Fort Worth, Texas.
 Wholesale Radio Labs, 711 W. Broadway, Council Bluffs, Iowa.
 The Rodney Young Co., 228 W. 7th, Cincinnati, Ohio.

Industrial Electronic Corp.

505 Court St., Brooklyn 31, N. Y.
 President: M. H. Avram
 Sales manager: Harry Goldman
 Secretary-treasurer: Harold Greenwald
Products Manufactured
 Home radio receivers, phonograph-radio combinations
Trade Name
 Simplon
Retail Price
 \$29.70.
Distributor
 Simplon Radio Sales Corp., 505 Court St., Brooklyn 31, N. Y.

International Detrola Corp. (Radio Division)

Beard at Chatfield, Detroit 9, Mich.
 President: C. Russell Feldmann
 Sales manager: Harley R. Wall
 Secretary: H. E. Hamilton
 Treasurer: R. J. Nixon
Products Manufactured
 Radios, combinations, record changers, automatic phonographs
Trade Names
 Detrola, Utah Radio, Private Brands

Jackson Industries, Inc.

1708 S. State St., Chicago 16, Ill.
 President, sales manager, and treasurer:
 David Krechman
 Secretary: Goldie Krechman
Products Manufactured
 Electric phonographs, radio cabinets, portable cases, replacement cabinets, baffles, etc.
Trade Name
 Jackson

Jameson Electronics Laboratory Co., Inc.

115 Cooper Lane, Dayton 9, Ohio.
 President and treasurer: Russel D. Jameson
 Sales manager: Jack J. Greger
 Secretary: Mildred Jameson
Products Manufactured
 Table model receivers, communication and navigation transmitter crystals, frequency monitor
Trade Name
 Jelco

Jefferson-Travis Corp.

245 E. 23rd St., New York 10, N. Y.
 President: Irving M. Felt
 Sales manager: Walter Hustis
 Secretary: Frank Baron
 Treasurer: Justin C. Harris
Products Manufactured
 Two way radio communication, marine receivers, Fonda recording machine
Trade Names
 J.T. Fonda Recorder

Distributors

Pat Patterson, Allan Bldg., Dallas, Texas.
 Art Cerf & Co., 741 Broad St., Newark, N. J.
 Wood & Anderson Co., 915 Olive St., St. Louis, Mo.
 Marbank Sales Co., 672 S. Lafayette Place, Los Angeles, Calif.
 Don H. Burcham, 917 S. W. Oak St., Portland, Ore.
 Emmett N. Hughes, 1709 W. Eighth St., Los Angeles 14, Calif.
 Gail Halliday, 1526 Ivy St., Denver, Colo.
 Edward F. Liddle, 18925 Grand River Ave., Detroit, Mich.
 Hollingsworth & Still, Norris Bldg., Atlanta, Ga.
 The Heimann Co., 1215 Harmon Place, Minneapolis, Minn.
 Reynolds & Harris Co., 126 State St., Boston, Mass.

Josephson Mfg. Co.

103 W. 14th St., New York, N. Y.

Keith Radio Products

Orleans, Indiana

Kingston Radio Co., Inc.

1415 N. Webster, Kokomo, Ind.
 President: J. P. Johnson
 Sales manager: H. S. Masquette

Secretary-treasurer: C. Shewmon

Products Manufactured

Home radio receivers

LaMagna Mfg. Co., Inc.

51 Clinton Place, E. Rutherford, N. J.

President: Nicholas LaMagna

Sales manager: Arthur Ackerman

Secretary: Emil LaMagna

Treasurer: Vincent LaMagna

Products Manufactured

Radios, radio components, radio stampings, automobile antennae

Trade Names

LaMagna Mfg. Co., Inc., Lamco Products, Inc.

Lavoie Laboratories

Matawan-Freehold Rd., Morganville, N. J.

Sales manager: H. Melnick

Products Manufactured

UIF Precision Frequency Meter, Harmonic Frequency Generator, frequency standards, receivers, transmitters, antennas and mounts, phonographs and radios

Trade Name

Lavoie

Lear, Inc.

110 Ionia Ave., Grand Rapids, Mich.

President: William P. Lear

Sales manager: Nate Hast

Secretary-treasurer: Ralph Raemer

Products Manufactured

Radio-phonograph combinations, record player

Trade Name

Lear Radio

Models

Tablemodels, consoles, portable combinations, television, FM

Retail Price

\$19.95—\$500.

Distributors

Adams Co., 1210 Farnam St., Omaha, Nebr.
Appliance Dist., P. O. Box 1682, Jackson, Miss.

Approved Appliance Co., 77 W. New Jersey St., Indianapolis, Ind.

W. S. Bain Co., Coshocton, Ohio.

Billups Wholesale Supply, 500 N. Carrollton Ave., New Orleans, La.

H. G. Bogart Co., 1714 Toledo Trust Bldg., Toledo, Ohio.

Brown & Halfpenny, 2101 So. Ervey St., Dallas, Texas.

Central Sales, 540 Ansborough Ave., Waterloo, Iowa.

Chambers Radio Supply, 1104 Broadway, Cincinnati, Ohio.

Dalco Appliance Co., 1355 Market St., San Francisco, Calif.

Eastern Distributing Co., 1422 Dallius St., Albany, N. Y.

Electrical Wholesalers, 159 Trinity Ave. S.W., Atlanta, Ga.

Fey & Krause, Inc., 1635 South Figueroa St., Los Angeles, Calif.

First Colony Dist., 107 East Martin St., Raleigh, N. C.

Foreman Dist. Co., 824 S. W. 1st Ave., Portland, Ore.

Forston Dist. Co., 629 East Grand, Oklahoma City 2, Okla.

Gen'l Radio & Electronics, 287 So. Main St., Wilkes-Barre, Pa.

Graybar Elec. Co., 242 S. 2nd St., Memphis, Tenn.

Gulf States Dist. Co., 2215 Third Ave. N., Birmingham, Ala.

H. & W. Dist. Co., 812 North Broad St., Philadelphia, Pa.

Hunt-Marquardt, Inc., 664 Commonwealth Ave., Boston, Mass.

Nelson and Small, 68-78 Union St., Portland 3, Me.

Parker-Montana Co., 2401 Minnesota Ave., Billings, Mont.

Pan-Electronics Labs., 511 E. Morehead, Charlotte, N. C.

Radio Sound Corp., 922 Park Ave., Baltimore, Md.

Rayvern Supply Co., 912 E. Washington St., Springfield, Ill.

Sherman Sales Co., 614 St. Clair Ave., Cleveland, Ohio.

Southern Supply Co., 1711 Marshall St., Shreveport, La.

Southwestern Sales, 226 W. Market St., San Antonio, Texas.

Stusser Elec. Co., 601-611 Fourth Ave., Seattle, Wash.

James-Stevens Co., 600 N. Washington, Albany, Ga.

Jay Gere Corp., 501 Butternut St., Syracuse, N. Y.

M. D. Larkin Co., 115 E. 3rd St., Dayton, Ohio.

Learadio Dist. of Western Mich., 14 Burton St. S.E., Grand Rapids, Mich.

E. B. Latham Co., 250 Fourth Ave. at 20, New York City, N. Y.

Learadio of Houston, 1517 Milam St., Houston 2, Texas.

Learadio Sales of New Jersey, 263 Central Ave., East Orange, N. J.

Mountain States Dist., Salt Lake City, Utah.

Midwest Furniture Dist., 1920 Lyndale Ave. S., Minneapolis, Minn.

Sloan & Gesas, Riverside Drive, N. Hollywood, Calif.

Jess J. Gesas, Honolulu, T. H.

Superior Equipment Sales Co., 16941 Hamilton Ave., Detroit 3, Mich.

Universal Furniture Co., 1419 W. Pennsylvania, Evansville, Ind.

Wholesale Furn. Co., 2921 Olive St., St. Louis, Mo.

Wood Distributing Co., Eldorado, Ark.

Zook Tire Co., 431 W. Colfax, Denver, Colo.

Zook Tire Co., Grand at Fifth, Pueblo, Colo.

Standard Elec. Supply Co., Milwaukee, Wisc.

Lincoln Electronics Corp.

653 Eleventh Ave., New York 19, N. Y.

President: Robert E. Kayatt

Sales manager and treasurer: Ezra G. Leavitt

Secretary: Kathleen V. Daly

*Products Manufactured*Portable electric and battery phonographs,
transcription devices, sound systems*Trade Names*

Lincoln, Port-O-Fone

Lewyt Corp.

60 Broadway, Brooklyn, N. Y.

Magnavox Co.

2131 Bueter Rd., Fort Wayne 4, Ind.

President and treasurer: R. A. O'Connor

Assistant sales manager: O. A. Fiebig

Secretary: G. M. Unzaro

Products Manufactured

Radio-phonographs

Trade Name

Magnavox

Majestic Radio, Inc.

29 W. 57th St., New York 19, N. Y.

President: James J. Walker

Sales manager: Parker H. Erickson

Secretary: Curtis Franklin

Treasurer: Guy Lemmon

*Distributors*Reines-Freeman Dist., 201 Jay St., Albany
6, N. Y.Amarillo Hardware Co., 600 Grant St., Ama-
rillo, Texas.Crawford & Thompson, 291 Ivy St., Atlanta
3, Ga.J. B. Mitchell Co., 117 Market Pl., Baltimore
2, Md.Birmingham Electric Battery Co., Avenue B
& 23rd St., S., Birmingham 3, Ala.Major Appliance Corp., 11 Deerfield St.,
Boston 15, Mass.Mutual Appliance Dist., 122 Clinton St.,
Buffalo 3, N. Y.Maine Appliance Sales Co., 31 Main St.,
Camden, Maine.Southern Appliances, Inc., 517 E. Trade St.,
Charlotte 2, N. Car.Allied Appliance Dist. of Chattanooga, Inc.,
c/o Allied Appliance Dist., 923 Central
Ave., N., Knoxville 17, Tenn.Chicago-Majestic, Inc., 545 N. LaSalle St.,
Chicago 10, Ill.Kelley-Mason, Inc., 49 Central Ave., Cin-
cinnati 2, Ohio.Elliott & Evans, Inc., 4800 Prospect Ave.,
Cleveland 3, Ohio.Thompson & Hamilton, Inc., 211 N. Fourth
St., Columbus 15, Ohio.Lone Star Wholesalers, Inc., 10th Floor, 2nd
Unit, Santa Fe Bldg., Dallas, Texas.Gem City Appliances, Inc., Attn: Robert S.
Bradford, 129 S. Ludlow St., Dayton 2,
Ohio.The Parker Co., Attn: E. W. Dickson, 1520
Wazee St., Denver 2, Colo.Sidles Co., 912 Locust St., Des Moines 9,
Iowa.LaSalle Electric & Mill Supply Co., 6911 E.
Lafayette, Detroit 7, Mich.Allied Appliance Dist. of Evansville, Inc.,
c/o Bomar Mfg. Co., 1114 Bardstown Rd.,
Louisville 4, Ky.State Distributing Co., 30-32 Ionia St., N.W.,
Grand Rapids, Mich.Bohman-Warnc, Inc., 35 W. Franklin St.,
Hagerstown, Md.Electrical Equipment, Inc., 1680 Ingelborg St.,
Houston 3, Texas.Modern Distributors, Inc., 1540 Fourth Ave.,
Huntington 1, W. Va.Kiefer-Stewart Co., 122 S. Senate, Indianap-
olis 9, Ind.Mississippi Appliance Co., 800 S. State St.,
Jackson 110, Miss.Major Appliances, Inc., 474 Riverside Ave.,
Jacksonville 4, Fla.Maco Appliance Dist., Inc., 1815 Baltimore,
Kansas City, Mo.Allied Appliance Dist. of Knoxville, Inc., 923
Central Ave., N., Knoxville 17, Tenn.George C. Stafford & Sons, 406 Main St.,
Laconia, N. H.555, Inc., Second & Broadway, Little Rock,
Ark.Roach-Driver Co., 1701 S. Grand Ave., Los
Angeles 15, Calif.Bomar Mfg. Co., 1114 Bardstown Rd., Louis-
ville 4, Ky.The Soo-Marquette Hardware Co., 319-321
Division St., Marquette, Mich.Allied Appliance Dist. of Memphis, Inc.,
1090 Union Ave., Memphis 3, Tenn.Shelley Dist. Co., 3015 Grand Ave., Miami
33, Fla.Moe Brothers Milwaukee Co., 319 E. Cly-
bourn St., Milwaukee 2, Wisc.Northwest Dist. Co., 1012 LaSalle Ave.,
Minneapolis 2, Minn.

Automotive Supply Co., Mitchell, S. Dak.

United Electric Service, 905 Louisville Ave.,
Monroe, La.Allied Appliance Dist. of Nashville, Inc.,
216 Tenth Ave., S., Nashville 4, Tenn.Igoe Brothers, Inc., 35 Halsey, Newark 5,
N. J.Mory Sales Corp., 152 Brewery St., New
Haven 11, Conn.United Distributors, Inc., 539 Carondelet St.,
New Orleans 12, La.Colen-Gruhn Co., Inc., 387 Fourth Ave., New
York 16, N. Y.Hales-Mullaly Co., 1 N.E. 6th St., Oklahoma
City 4, Okla.

Sidles Co., 502 S. 19th St., Omaha, Nebr.

J. J. Pocock, Inc., 1920 Chestnut St., Phila-
delphia 3, Pa.Electrical Equipment Co. of Ariz., 424 N.
Central Ave., Phoenix, Ariz.J. E. Miller Co., 206 Kirby Bldg., 80 26th
St., Pittsburgh 22, Pa.

A. H. Marshall Co., Inc., Plattsburg, N. Y.

F. B. Connelly Co. of Ore., 1233 N.W. 12th Ave., Portland, Ore.
 Eagle Sales Corp., 49 Westminster St., Providence, R. I.
 The Wallahan Co., 1815 W. St. Joe St., Rapid City, S. Dak.
 Dowdy Electric Co., Inc., 32 Church Ave., W., Roanoke, Va.
 Harmon Automotive Corp., 16 Charlotte St., Rochester 4, N. Y.
 Tri-City Radio Supply Co., 1919 Fourth Ave., Rock Island, Ill.
 Glenn Earl, Inc., 353 W. 2nd S. St., Salt Lake City 1, Utah.
 Monarch Radio & Appliance Co., 211 W. Market St., San Antonio 5, Texas.
 McCormack and Co., Attn: D. F. McCormack, 450 Ninth St., San Francisco 3, Calif.
 F. B. Connelly Co., 1015 Republican St., Seattle 9, Wash.
 Femco Distributing Co., 1603 Prairie Ave., South Bend 14, Ind.
 Prudential Distributors, Inc., S. 151 Stevens St., Spokane 8, Wash.
 B. H. Spinney Co., 62 Hampden St., Springfield, Mass.
 Recordit Dist. Co., 3028 Locust St., St. Louis 1, Mo.
 B. H. Spinney Co., 1133 W. Genesee, Syracuse, N. Y.
 Major Appliances, Inc., 209 S. Franklin St., Tampa 1, Fla.
 Gerlinger Equipment Co., 1001 Adams St., Toledo 2, Ohio.
 Mehen Dist. Co., 2480 16th St., N.W., Washington 9, D. C.
 Home Appliance Co., 149 N. Rock Island, Wichita 2, Kan.
 R. A. Howe & Co., 816 Fort St., P. O. Box 3371, Honolulu 1, Hawaii.
 Motor Equipment Co., 100-123 E. Marquette St., Albuquerque, N. M.

Marco Industries Co.

215-A S. Beverly Drive, Beverly Hills, Calif.

President: Vincent A. Marco

Products Manufactured

Radios, ironing cords

Trade Names

Marcola, Com-Bac

Models

Table model, console, radio and record changer

Mason Radio Products, Inc.

80 Prince St., Kingston, N. Y.

President: Samuel D. Mason

Sales manager: M. L. Silver

Secretary: Milton Haas

Treasurer: Louis Mason

Products Manufactured

Radio receivers, record-changer combinations, special electronic equipment

Trade Name

Mason

Retail Price

\$23.45-\$32.95.

Distributor

Mason Radio Sales Corp., 50 E. 12nd St., New York, N. Y.

Meissner Mfg. Div. of Maguire Ind., Inc.

936 N. Michigan Ave., Chicago 11, Ill.

President: Russell Maguire

Sales manager: O. F. Jester

Secretary: C. Beeson Neal

Treasurer: John C. Bossert

Products Manufactured

Radios, radio-phonographs, test equipment, railroad radios, record changers, home recorders, component parts

Trade Names

Maguire, Meissner, Brewster, Thordarson, Radiart

Midwest Radio Corp.

909 Broadway, Cincinnati 2, Ohio.

President and treasurer: A. G. Hoffman

Vice-president and secretary: E. F. Hoffman

Products Manufactured

Home radio receivers, aviation receivers and transmitters

Trade Name

Midwest

Models

Table, console, phonograph combinations

Minerva Corp. of America

238 William St., New York 7, N. Y.

President: Sidney Berens

Sales manager: H. B. Esterly

Secretary-treasurer: Herman Weissberger

Products Manufactured

FM & AM radios, television, pocket type super miniature transmitters, table models, consoles, combinations

Trade Name

Minerva

Music Master Mfg. Co.

69 W. Washington St., Chicago 2, Ill.

Products Manufactured

Phonographs, recording equipment, phonograph needles, record demonstrators

Trade Name

Music Master

Musitron Co.

223 W. Erie St., Chicago 10, Ill.

General manager: Leo Frankel

Sales manager: Gerald H. Rissman

Products Manufactured

Portable electric and handwound phonographs, transcription playback units and sound equipment

Trade Name

Musitron

Retail Price

\$56-\$150.

Noblitt Sparks Industries, Inc.

Columbus, Ind.

President: Glenn W. Thompson

Sales manager: Gordon T. Ritter

Secretary: Dee Lenfesty

Treasurer: Yandall C. Cline

Products Manufactured

Home radios, electric irons, electric home heaters, car heaters

Trade Name

Arvin
Models

Table models, table combinations, floor combinations, consoles, portables, battery sets

Distributors

Standard Electric Co., 37 W. Lawrence St., Pontiac, Mich.
Joseph Woodwell Co., 201 Wood, Pittsburgh, Pa.
Valley Equipment Co., 1401 Washington St., E., Charleston, W. Va.
Bertram Motor Supply Co., 811 Jefferson St., Boise, Idaho.
Tom Killian, 1236 Broadway, Denver, Colo.
Marshall-Wells Co., S. Lake Ave., P. O. Box 39, Duluth, Minn.
Marshall-Wells Co., Billings, Mont.
Marshall-Wells Co., 1420 N. W. Lovejoy, Portland 8, Ore.
Booneville Western Inc., 32 Richards St., Salt Lake City, Utah.
Marshall-Wells Co., 157 S. Howard St., Spokane, Wash.
Hackner Tire Warehouse, Appliance Div., 521 W. 2nd St., Davenport, Iowa.
Radio Trade Supply Corp., 1224 Grand Ave., Des Moines 9, Iowa.
Basham Appliance Co., 218 N. Main St., Wichita, Kan.
Ryan Interstate Dist., 1800 Grand Ave., Kansas City, Mo.
The Kormsmeier Co., 412 S. 9th St., Lincoln 1, Nebr.
The Ryan Supply Co., 508-514 E. Pascagoula St., Box 1668, Jackson 113, Miss.
Allen Brown Co., 56 N. 3rd St., Memphis, Tenn.
Shelby-Skipwith, Inc., 972 Union Ave., Memphis, Tenn.
Peden Iron & Steel Co., Box 1891, Houston 1, Texas.
Purse & Co., 601 Elm, Dallas 2, Texas.
Purse & Co., 425 W. Houston, San Antonio 5, Texas.
Standard Equipment Co., 125 N. 1st St., Phoenix, Ariz.
Stephens Wholesale Co., 7 N. 7th Ave., Phoenix, Ariz.
Gough Industries Inc., 3255 5th Ave., San Diego 3, Calif.
Lester Dist. Co., 1800 16th St., Sacramento, Calif.
Radio Specialties Co., 1956 S. Figueroa, Los Angeles 7, Calif.
State Electric Supply, 241 10th St., Oakland, Calif.
Hayes & Hopson, 20 S. Spruce St., Asheville, N. Car.
C. D. Franke & Co., Inc., 912 Lady St., Columbia, S. Car.
C. D. Franke & Co., Charleston, S. Car.

Bates Radio & Supply Co., 7 S. Main St., Greenville, S. Car.
Arvin-Salmanson Co. of Baltimore, 2126 Edmondson Ave., Baltimore 1, Md.
Arvin-Salmanson Co. of New England, 700 Beacon St., Boston 15, Mass.
Arvin Dist. of Eastern N. Y., 63 Hudson Ave., Albany, N. Y.
Arvin Salmanson Co., 1107 Broadway, New York, N. Y.
Everybody's Supply Corp., 810 Arch St., Philadelphia, Pa.
B. T. Crump Co., Inc., 1314 E. Franklin St., Richmond 13, Va.
Furste's Auto Supply, 1622 Broadway, Mattoon, Ill.
Kiefer Electrical Supply Co., 318-20 S. Washington, Peoria 2, Ill.
Schacht Tuck Co., 907 E. State, Rockford, Ill.
Lynn Stewart Co., 150 N. Wacker Drive, Chicago 6, Ill.
Colfax Co., 802 S. Main St., South Bend 18, Ind.
The Gibson Co., 433 N. Capitol, Indianapolis 6, Ind.
Appliance Dist. Inc., 115 S. 7th St., Louisville, Ky.
Brown Supply Co., 2800 Pine St., St. Louis, Mo.
Industries Dist. Inc., 1305 Marshall St., Shreveport, La.
Modern Appliance & Supply, 4300 Washington Ave., New Orleans, La.
Dunkerley Dist. Co., 913 W. Adams St., Jacksonville, Fla.
Morley Radio Co., 944-946 Main St., Sarasota, Fla.
Southern Furniture Sales, 418 Gay, Knoxville, Tenn.
Auto Bearings & Parts, 1227 Broad St., Nashville, Tenn.
Alexander-Seewald Co., 410 W. Peachtree, N. W., Atlanta 3, Ga.
A. S. Hatcher Co., 598 Third St., Macon, Ga.
Gulf States Dist., 2212 3rd Ave. N., Birmingham, Ala.
Group Parts Inc., 440 E. Genesee, Syracuse, N. Y.
Kemp Equipment Co., 39-47 Mt. Hope Ave., Rochester 7, N. Y.
Southern Tier Electric Supply, Cor. Water & Henry Sts., Binghamton, N. Y.
B & B Electric Co., 1015-1017 Broadway, Cincinnati 2, Ohio.
Irving Leon Co., 214 National Terminals Bldg., Cleveland 13, Ohio.
The McCleery-Carpenter Electric Co., 301 N. 3rd St., Columbus, Ohio.

World Radio & Appliance Co., 1020 Madison Ave., Toledo 2, Ohio.
 Automobile Equipment Co., 623 E. Congress, Detroit 26, Mich.
 Fitzpatrick Electric Supply, 144 Irwin Ave., Muskegon, Mich.
 C. E. Hamlin Co., 225 N. Jackson, Jackson, Mich.
 Madison Electric Co., 282 E. Milwaukee, Detroit 2, Mich.
 Standard Electric Co., 219 Tuscola, Saginaw, Mich.

Operadio Mfg. Co.

St. Charles, Ill.
 President: J. M. Stone
 Sales manager: F. D. Wilson
 Treasurer: R. T. Anderson

Products Manufactured

Intercommunication systems, amplifiers, school sound systems, loudspeakers, public address systems

Trade Names

Operadio, Soundcaster, Flexifone, Explainette

Pacific Electronics

1011-1013 First Ave., Spokane, Wash.
 Partners: A. C. Nash and W. Johnson

Products Manufactured

Home receivers and phonographs

Trade Name

Peco

Packard-Bell Co.

3443 Wilshire Blvd., Los Angeles 5, Calif.

President: H. A. Bell
 Sales manager: Frank E. Ware
 Secretary-treasurer: Lowell R. Day

Products Manufactured

Table model radios and phonograph-radio combinations, portable combinations, console combinations

Trade Name

Packard-Bell, PhonOcord

Distributors

E. K. Rogers Co., 2313 Fifth Ave., Seattle, Wash.
 N. Earl Davison Co., 6365 Lake Ave. S.W., Tacoma 9, Wash.
 Walter H. Switzer, 3918 E. Hartson, Spokane 15, Wash.
 Packard-Bell Oregon Co., 414 S.W. 1st Ave., Portland, Ore.
 Gordon O. Leonard, 964 Norway St., Salem, Ore.
 Norris C. Teakle, 516 So. E. St., Santa Rosa, Calif.
 Adams Dist. Co., 454 E. Santa Clara St., San Jose, Calif.
 A. Donald Macaulay, 401 San Antonio Way, Sacramento, Calif.

K. W. Curtiss Co., 3661 Grove St., Oakland 9, Calif.
 J. H. Fletcher Co., 351 9th St., San Francisco 3, Calif.
 Dick Schattinger, P. O. Box 1983, Fresno, Calif.
 Clyde Wallichs Co., 12437 Ventura Blvd., N. Hollywood, Calif.
 Frank A. Nelson Co., 4107 Chestnut, Riverside, Calif.
 The Lowell Wood Co., 416 W. Beech St., San Diego 1, Calif.
 W. S. Taylor, 2751 Fashion Ave., Long Beach, Calif.
 Fred G. Serafield, 3413 Wilshire Blvd., Los Angeles 5, Calif.
 Cloyd Marshall, 3443 Wilshire Blvd., Los Angeles 5, Calif.
 G. S. Quinlan, 3113 Wilshire Blvd., Los Angeles 5, Calif.
 Chas. R. Bowen, 3443 Wilshire Blvd., Los Angeles 5, Calif.
 E. L. Silberstein, 3443 Wilshire Blvd., Los Angeles 5, Calif.
 H. H. Rhodes, 3443 Wilshire Blvd., Los Angeles 5, Calif.
 Ray E. Thomas, 3443 Wilshire Blvd., Los Angeles 5, Calif.
 Bruce White, 3443 Wilshire Blvd., Los Angeles 5, Calif.
 Ralph Ott, 3413 Wilshire Blvd., Los Angeles 5, Calif.

Pan American Electric Co., Inc.

132 Front St., New York 5, N. Y.
 President and treasurer: I. F. Biosca
 Sales manager: R. Petrino
 Secretary: J. Zkanoncz

Products Manufactured

Radio receivers, television receivers, speech amplifiers, electronic testing equipment

Philco Products Inc.

C & Tioga Sts., Philadelphia 31, Pa.
Trade Name
 Philco

Distributor—Philco Products, Inc.

3701 N. Broad St., Philadelphia, Pa.
 31 Milk St., Boston, Mass.
 948 B. of L. E. Bldg., 1365 Ontario St., Cleveland 14, Ohio.
 666 Lake Shore Drive, Chicago, Ill.
 Suite 509, Chamber of Commerce Bldg., Indianapolis, Ind.
 502 Plymouth Bldg., Hennepin & 6th Sts., Minneapolis 2, Minn.
 Pickwick Bldg., 903 McGee St., Kansas City, Mo.
 601-602 Southland Life Bldg., Dallas 1, Texas.
 1501 Rhodes Haverly Bldg., Atlanta, Ga.
 647 Russ Building, San Francisco, Calif.
 114-120 E. 23rd St., New York 10, N. Y.

Pilot Radio Corp.

37-06 Thirty-sixth St., Long Island City
1, N. Y.

President: Isidor Goldberg
Sales manager: Allen D. McGehee
Secretary: Isidor W. Wyckoff

Products Manufactured

Radios, combinations, television receivers,
non-breakable records

Trade Names

Pilot Radio, Pilotone (records)

Models

Portable and table radios

Plaza Mfg. Co., Inc.

869 Broadway, New York 3, N. Y.

President: H. Germain
Secretary: G. Cheadle

Products Manufactured

Portable phonographs, electric amplified
and hand wind Acoustic, phonograph
needles, juvenile records

Trade Names

Pal (phonographs), Supertone and Wall-
kane (phonograph needles)

Portofonic Mfg. Corp.

54 Franklin St., New York 13, N. Y.

President: Benjamin Josephson
Sales manager and treasurer:
Joseph Wexelbaum

Secretary: Arthur Josephson

Products Manufactured

Portable phonographs, record cases, ac-
cessories

Trade Name

Portofonic

Distributors

Everybody's Supply Corp., 810 Arch St.,
Philadelphia, Pa.

All-State Dist., 45 Clinton St., Newark, N. J.
Sanborn Music Co., 740 Superior Ave.,
Cleveland, Ohio.

Recordit Co., 3028 Locust St., St. Louis, Mo.
All American Dist., Montreal, Quebec,
Canada.

Precise Developments Co., Inc.

1100 W. Washington, Chicago 7, Ill.

President: F. M. Lund
Sales manager: H. M. Pushker

Products Manufactured

Record changers

Trade Name

Precise

Pro Electronics Co.

401 Flatbush Ave. Ext., Brooklyn, N. Y.
See: Tac Industries

Radio Corp. of America

Camden, N. J.

Sales manager: H. Baker

Radio Development & Research Corp.

26 Cornelson Ave., Jersey City 4, N. J.

President: S. Irving Weiss
Sales manager: I. B. Meltzer
Secretary-treasurer: Francis Weiss

Products Manufactured

Broadcast receivers, aircraft and marine
two-way radio equipment, magnetic re-
cording machines

Trade Names

Magictone, Chronovox

Models

Broadcast receivers—table, phono-radio,
consoles

Radio & Television, Inc.

211 Madison Ave., New York 16, N. Y.

President and sales manager:

H. L. Weisburgh

Secretary: A. O. Englander

Treasurer: Raymond Kahn

Products Manufactured

Radios, television

Trade Names

Brunswick, Brunswick Radio Panatropé

Models

Table models, consoles in period furni-
ture

Ray-Dyne Mfg. Corp.

111 W. 21th St., New York 11, N. Y.

President: Ralph Count
Sales manager and treasurer: Irving Price

Products Manufactured

Phonographs, wired radio-record changers

Trade Name

Ray-Dyne

Models

Portable automatic phonographs, portable
hand-wound phonographs

Ray Energy Radio & Television Corp. of America

32 W. 22nd St., New York 10, N. Y.

President and sales manager: A. A. Harman
Secretary-treasurer: S. M. Ansell

Products Manufactured

Radios, combinations

Trade Name

Ray Energy

Record-O-Vox, Inc.

721 N. Martel Ave., Hollywood 46, Calif.

President: S. Solat

Products Manufactured

Radio-phonograph combinations, phono-
graphs, television receivers, cabinets

Trade Names

Symphony, Music King

Regal Electronics Corp.

20 W. 20th St., New York 11, N. Y.
 President and treasurer: W. Spiegel
 Sales manager and secretary: A. Spiegel

Products Manufactured

Radios, phonographs, combinations, amplifiers

Trade Names

Tokfone, Ultradyne, Regal

Remler Co., Ltd.

2101 Bryant St., San Francisco 10, Calif.
 President: E. G. Danielson
 Sales engineer: H. L. Parker
 Secretary: William Jardine

Products Manufactured

Home radio receivers, combinations, inter-communication equipment, marine loudspeaker systems

Trade Name

Remler

Rexon Inc.

295 Fifth Ave., New York 16, N. Y.
 President: Jacques Schwalbe
 Sales manager and secretary: John Fisher

Products Manufactured

Phonographs, record changers, cabinets

Trade Name

Thorens

Scientific Development Corp.

614 W. 49th St., New York 19, N. Y.
 President and sales manager:

Maurice Schatt

Secretary: Morris Sorokin

Treasurer: Eugene Silber

Products Manufactured

Radios, electronic devices, antennas, viewers and photographic equipment, R. F. coils

Trade Name

Edy

Scientific Radio Products Co.

738½ W. Broadway, Council Bluffs, Iowa.
 President: E. M. Shideler

Products Manufactured

Quartz crystals for aircraft, marine, amateur, and commercial use

Trade Name

Scientific Radio Products Co.

Scott Radio Laboratories, Inc.

4511 N. Ravenswood Ave., Chicago, Ill.
 President: H. S. Darr

Vice-president: E. J. Halter

Products Manufactured

Radio-phonographs

Trade Name

Scott

Searle Aero Industries, Inc.

101 Highway & Placentia, Orange, Calif.
 President: Marshall O. Searle
 Controller: Roy Nikkila

Products Manufactured

Home radios, radio components, conduit assemblies, electrical assemblies

Trade Names

Clipper, Martian, Amerflex

Sentinel Radio Corp.

2020 Ridge Ave., Evanston, Ill.
 President and treasurer: E. Alschuler
 Sales manager: E. G. May
 Secretary: C. L. Stout

Products Manufactured

Radio receiving sets, radio-phonograph combinations

Trade Name

Sentinel

Setchell Carlson, Inc.

2233 University Ave., St. Paul 4, Minn.
 President: B. T. Setchell
 Sales manager: Don L. Johnson
 Secretary-treasurer: Don C. Carlson

Products Manufactured

Home radio receivers, audio amplifier-

Trade Name

Radio DorAfone

Sheridan Electronics Corp.

2850 S. Michigan Ave., Chicago 16, Ill.
 President: John J. Sheridan
 Sales manager: Robert Shellow
 Secretary: L. Schlifkin

Products Manufactured

Electrical appliances, radios, electric phonographs, combinations

Trade Name

Vogue

Distributors

Allied Dist. Co., 915 N. San Jacinto, Houston, Texas.

Allied Music Sales Co., 3112 Woodward Ave., Detroit, Mich.

Associated Furniture Dist., 2105 Grand, Kansas City, Mo.

Airlow Products Co., Union St. at Pennsylvania Ave., Wilkes-Barre, Pa.

Associated Radio Dist., 271 7th St., San Francisco, Calif.

Bristols Wholesale Radio, Fergus Falls, Minn.

Ri Chrome Bulb Co., 103 S. 3rd St., La Crosse, Wisc.

Beknap Hdw. & Mfg. Co., 111 E. Main St., Louisville, Ky.

Blue White Products Inc., 712 S. Olive St., Los Angeles 14, Calif.

Cardinal Dist. Inc., 3319 Lindell Blvd., St. Louis, Mo.

Clinton Radio & Appliances Corp., 12 Elizabeth Ave., Newark, N. J.

H. L. Dalis, Inc., 17 Union Sq., New York, N. Y.

Dallas Electric Supply Co., 1800 Magnolia St., Dallas, Texas.

DeMambro Radio Supply Co., 1111 Commonwealth Ave., Boston, Mass.

Dynamic Electronics, 37 W. 57th St., New York, N. Y.
 Eastern Wholesalers Inc., 31 S. Eutaw St., Baltimore 1, Md.
 Electric Motors Co., 219 1st St. S. W., Cedar Rapids, Iowa.
 Electra-Pliance Co., 116 W. Michigan St., Duluth, Minn.
 K. L. Frank Co., 134 E. 10th St., Erie, Pa.
 Ft. Orange Radio Dist. Co., 356 Broadway, Albany, N. Y.
 George Gerber Co., 121 W. Exchange, Providence, R. I.
 Globe Electric, 307 1st Ave. S., Seattle, Wash.
 Globe Supply Co., 209 Whitehall St., Atlanta, Ga.
 John W. Graham & Co., 707 Sprague Ave., Spokane, Wash.
 E. G. Hendrix Co., 321 S. Flores St., San Antonio, Texas.
 Johnson Electric Supply Co., 43 S. 3rd St., Minneapolis, Minn.
 Slap and Lasky, 2530 N. Broad St., Philadelphia, Pa.
 Moto Radio Dist. Co., 5732 Baum Blvd., Pittsburgh, Pa.
 Midwest Commodity Co., Ltd., 1405 Harney St., Omaha 2, Nebr.
 National Radio Dist., Congress Bldg., Miami, Fla.
 Penn Appliance Dist., 126 S. 2nd St., Harrisburg, Pa.
 Peerless Electric Co., 509 Westlake Ave. N., Seattle, Wash.
 Radio Products Sales, 238 W. 15th St., Los Angeles 15, Calif.
 Radonics, 5040 Easton Ave., St. Louis, Mo.
 Ray-De-O Ray Mfg. Co., 514 Iowa St., Sioux City, Iowa.
 Rainier Supply Co., 1728 Pacific Ave., Tacoma, Wash.
 Reese Electric Supply Co., 530 Washington St., Johnstown, Pa.
 Richmond Sales Co., 507 Westlake Ave. N., Seattle, Wash.
 Ralph Pill Electric Supply Co., 349 Central Ave., Dover, N. H.
 Sheridan Dist. Co., 624 S. Michigan Ave., Chicago, Ill.
 Sound Service, 11th & Quaker, Tulsa, Okla.
 Southern Sales Co., Oklahoma City, Okla.
 The Schuster Electric Co., 321 Sycamore St., Cincinnati, Ohio.
 Vogue Dist. Co., Postal Station Bldg., Indianapolis, Ind.
 Whites Auto Stores, Wichita Falls, Texas.
 Wilson Radio Dist., 1116 Central Ave., Charleston, W. Va.
 V. A. Williams, 601 Montana St., El Paso, Texas.
 Wholesale Appliance Co., 201 Rock St., Little Rock, Ark.
 M. W. Zimmerman, 957 Main St., Springfield, Mass.

Sonora Radio & Television Corp.

325 N. Hoyne Ave., Chicago 12, Ill.

President: Joseph Gerl

Sales manager: Edward Harris

Secretary: Jess Raban

Products Manufactured

Radios, combinations, portable radios, television receivers, wire recorders

Trade Name

Sonora

Distributors

Appliance Distributor Co., 1910-12 Washington Ave., St. Louis 3, Mo.
 Arizona Wholesale Supply Co., 505 W. Madison St., P. O. Box 2379, Phoenix, Ariz.
 Auto-Rad Supply Co., Inc., Central Parkway at Sycamore, Cincinnati, Ohio.
 Geo. D. Harbey Co., 432 Walnut St., Reading, Pa.
 Barth-Feinberg, Inc., 17-19 Union Square, West, New York 3, N. Y.
 Beller Electric Co., 301-3 Plane St., Newark 5, N. J.
 Billmeyer's, 240-8 S. Arthur Ave., Pocatello, Idaho.
 Bison Electrical Co., Inc., 1135 Main St., Buffalo 3, N. Y.
 Boetticher & Kellogg Co., 15 Fulton Ave., Evansville, Ind.
 Cannon Distributing Co., 198 E. Bay St., P. O. Box 294, Charleston, S. Car.
 Chemcity Radio & Electric Co., 1225 E. Washington St., Charleston 27, W. Va.
 Geo. K. Ching, 706 Fort St., P. O. Box 1453, Honolulu 6, Hawaii.
 Clark Supply Co., 233-45 E. Keefe Ave., Milwaukee, Wis.
 A. Ray Curtis Co., 2205 Highland Drive, Salt Lake City 5, Utah.
 Dakota Hardware Co., Fargo, No. Dak.
 W. B. Davis Elec. Supply Co., 655-61 Jefferson Ave., Memphis, Tenn.
 Davis Supply Co., P. O. Box 1757, Boise, Idaho.
 Diehl & Lehman Appliance Co., 1409-11 Texas St., El Paso, Texas.
 Electra Distributing Co., 1914 West End Ave., Nashville, Tenn.
 Electric Appliances, Inc., 120 W. North St., Indianapolis 4, Ind.
 The Electronics Co., 305 Market St., Shreveport, La.
 The Electronic Sales Co., 84 Wallace St., New Haven, Conn.
 Florence Elec. Supply Co., Inc., 11 De Russey St., Binghamton, N. Y.
 M. L. Foster Co., 103 N.W. 23rd St., Oklahoma City, Okla.
 Franklin Electric Co., 529-31 Arch St., Philadelphia 6, Pa.
 Goldberg Company, Inc., 5 North 13th St., Richmond 19, Va.
 Goldberg Co., Inc., 425 Third St. S.E., Roanoke 11, Va.
 John W. Graham & Co., 707-11 Sprague Ave., Spokane 6, Wash.

- Graybar Electric Co., Inc., 55 W. Canfield at Woodward, Detroit, Mich.
- Graybar Electric Co., Inc., 120 E. Third St., Flint 1, Mich.
- Graybar Electric Co., Inc., 125 E. Shiawassee St., Lansing 2, Mich.
- Graybar Electric Co., Inc., 221 Patton Ave., Asheville, No. Car.
- Graybar Electric Co., Inc., 120 West Morehead St., Charlotte, No. Car.
- Graybar Electric Co., Inc., 303 Duke St., Durham, No. Car.
- Graybar Electric Co., Inc., Greenville, No. Car.
- Graybar Electric Co., Inc., 321 Brookstown Ave., Winston-Salem, No. Car.
- Graybar Electric Co., Inc., 255 James St., Akron, Ohio.
- Graybar Electric Co., Inc., 1010 Rockwell St., Cleveland, Ohio.
- Graybar Electric Co., Inc., 1700 Canton St., Toledo, Ohio.
- Jno. E. Graybill & Co., Inc., 135-7 E. Philadelphia St., York, Pa.
- Higginbotham-Pearlstone Hwde. Co., P. O. Box 5205, Dallas 2, Texas.
- Home Mfg. & Sales Co., Piqua, Ohio.
- Johnson Hardware Co., Clarksburg, W. Va.
- The Lagoe Co., 1007 Locust St., Des Moines, Iowa.
- Leitz Carpet Corp., 312 Third St., N., Minneapolis, Minn.
- McDavid Supply Co., 2104 First Ave., N., Birmingham 3, Ala.
- Maine Industries Co., 15 Columbia St., Bangor, Maine.
- Manufacturers' Sales Co., 201 Landreth Bldg., Muskegon, Mich.
- Chas. S. Martin Dist. Co., 254-256 Peachtree St., N.E., Atlanta, Ga.
- Masline Radio & Elec. Equip. Co., 193-196 Clinton Ave., N., Rochester 4, N. Y.
- Wm. Mee Co., Amarillo, Texas.
- Millhender Dist., Inc., 619 Atlantic Ave., Boston 10, Mass.
- Millhender Dist., Inc., 387 Charles St., Providence, R. I.
- Monroe Hardware Co., Inc., 701 Magazine St., P. O. Box 1605, New Orleans, La.
- Morey Mercantile Co., P. O. Box 5150, Terminal Annex, Denver 17, Colo.
- Nelson & Co., Inc., 1000 S. Linwood Ave., Baltimore 24, Md.
- French Nestor Co., Union Terminal Warehouse Bldg., 700 E. Union St., Jacksonville, Fla.
- H. C. Noll Co., 2226 Harney St., Omaha, Nebr.
- North Coast Electric Co., 625 N.W. Everett St., Portland 9, Ore.
- North Coast Electric Co., 171 Jackson St., Seattle 4, Wash.
- Pacific Music Supply Co., 1021 S. Santee St., Los Angeles, Calif.
- G. M. Popkey Co., Main & Ninth Sts., Marinette, Wisc.
- Radio Maintenance Supply Co., 17 Central St., Worcester, Mass.
- Rapid Sales Co., 63 Hudson Ave., Albany 1, N. Y.
- Russell & Co., Inc., 200 W. Washington Ave., North Little Rock, Ark.
- Ryan Radio & Electric Co., 1808-10 Grand Ave., Kansas City 8, Mo.
- Ryan Supply Co., 216 S. State St., Jackson, Miss.
- S. & S. Dist., 800 S. Adams St., Federal Warehouse, Peoria, Ill.
- Schwalb-Lapkin Co., 1190 Bryant St., San Francisco 3, Calif.
- The Chas. B. Scott Co., 119 Franklin Ave., Scranton, Pa.
- L. H. Smith, Inc., 8 Eighth St., Pittsburgh 22, Pa.
- Southern Music Co., 830 E. Houston St., San Antonio, Texas.
- Springfield Radio Co., 405 Dwight St., Springfield 3, Mass.
- Standard Paper Co., 50 Vine St., Columbus, Ohio.
- Geo. Steele & Co., 126 W. Broadway, Butte, Mont.
- The Sutcliffe Co., 225 S. Fourth St., Louisville, Ky.
- Texas Farm Supply Co., 316 Louisiana St., Houston 2, Texas.
- Nelson R. Thomas Agency, Inc., 615 Nineteenth St., Bakersfield, Calif.
- Nelson Thomas Agency, Inc., 344 E. First St., Los Angeles, Calif.
- Nelson R. Thomas Agency, Inc., 3255 Fifth Ave., San Diego, Calif.
- Nelson Thomas Agency, Inc., 1355 Market St., San Francisco 3, Calif.
- Valley Appliances, Inc., 220 Dale Ave., Knoxville 16, Tenn.
- Vermont Electric Supply Co., 143-5 West St., Rutland, Vt.
- Walker-Jimieson, Inc., 311 S. Western Ave., Chicago 12, Ill.

Sparks-Withington Co.

Jackson, Mich.
 President: Harry G. Sparks
 Sales manager: E. C. Bonia
 Secretary: D. L. Johnson
 Treasurer: H. M. Johnston

Products Manufactured
 Radio receiving sets, combinations
Trade Name
 Sparton
Models
 Table models, consoles

Stewart-Warner Corp.

1826 Diversey Parkway, Chicago 14, Ill.
 President: J. S. Knowlson

Sales manager: F. E. Masters
Secretary: A. R. Benson
Treasurer: F. P. Kirch

Products Manufactured
Radios, radio-phonographs
Trade Name
Stewart-Warner
Retail Price
\$28.14-\$178.25.

Distributors

Fort Orange Radio Dist. Co., Inc., 356 Broadway, Albany, N. Y.
Charles Ilfield Co., Albuquerque, N. M.
Mottier Electric Co., 916 11th St., Altoona, Pa.
Cowan-Boze Co., 224 Nelson St., S.W., Atlanta, Ga.
Butler Bros., Baltimore & Liberty Sts., Baltimore, Md.
Coffin & Wimple, 108 Hammond St., Bangor, Me.
Northrup Supply Corp., 168 Water St., Binghamton, N. Y.
Cruse-Crawford Dist. Co., 2130 Third Ave., S., Birmingham, Ala.
Afton-Lemp Electric Co., 415 S. Ninth St., Boise, Idaho.
DeMambro Dist., 1111 Commonwealth Ave., Boston, Mass.
John Henrich Co., Inc., 422 William St., Buffalo, N. Y.
Hagar Hardware & Paint Co., 164 St. Paul St., Burlington, Vt.
The Treasure State Gas & Electric Co., Metals Bank Bldg., Butte, Mont.
Home Appliances Co., P. O. Box 336, Charleston, S. Car.
Shaw Distributing Co., 205 W. First St., Charlotte, N. Car.
Johnson Tire Co., Broad at Eleventh St., Chattanooga, Tenn.
Thomas H. Maginniss Co., 1326 S. Michigan Ave., Chicago, Ill.
Harry Knodel Dist. Co., 1002 Gilbert Ave., Cincinnati, Ohio.
J. C. Boylan Co., 224 Rose Bldg., Cleveland, Ohio.
Edwin Flato Co., P. O. Box 1781, Corpus-Christi, Texas.
Butler Bros., Young and Ervay Sts., Dallas, Texas.
Graybar Electric Co., Inc., 206 E. Fifth St., Davenport, Iowa.
Standard Radio & Electronic Products Co., 135 E. Second St., Dayton, Ohio.
Ralph Olsen Sales Co., 30 W. 13th Ave., Denver, Colo.
Graybar Electric Co., 112 Eleventh St., Des Moines, Iowa.
Specialties Dist. Co., 525 E. Jefferson Ave., Detroit, Mich.
Diener Appliances, 623 Main St., Dubuque, Iowa.
Great Lakes Auto Parts and Machine Works, 302 E. Superior St., Duluth, Minn.

Reliable Radio, Inc., 30-32 W. Eleventh St., Erie, Pa.
SM Supply Co., Eau Claire, Wisc.
Silkworth Dist. Co., 1659 N. Saginaw St., Flint, Mich.
Shirley & Onstad, 104½ Broadway, Fargo, N. Dak.
Wise Radio Supply Co., 914 Towson Ave., Fort Smith, Ark.
Kinney Bros., 1717 Van Ness Ave., Fresno, Calif.
Zittrin Dist. Co., 121 E. Main St., Fort Wayne, Ind.
Graybar Electric Co., 432 Monroe Ave. N.W., Grand Rapids, Mich.
The Treasure State Gas and Electric Co., 15th St. North and Smelter Rd., Great Falls, Mont.
Wood, Alexander and Co., 565 Asylum St., Hartford, Conn.
Edwin Flato Co., P. O. Box 1185, Houston, Texas.
Enmons-Hawkins Co., Huntington, W. Va.
Central Rubber and Supply Co., 120 S. Meridian, Indianapolis, Ind.
Lovejoy Co., P. O. Box 1948, Ocean at Ashley Sts., Jacksonville, Fla.
Fitzgerald and Co., 110 W. 18th St., Kansas City, Mo.
Bright Dist. Co., 529 State St., Knoxville, Tenn.
Lewiston Maytag Co., 157 Lisbon St., Lewiston, Me.
Suttle Equipment Co., Lawrenceville, Ill.
Connerly Radio Dist., 208 W. Fourth St., Little Rock, Ark.
John W. Walter, 37-08 Northern Blvd., Long Island City, N. Y.
Kinney Bros., 275 North Ave. 19, Los Angeles, Calif.
Stratton and Terstegge Co., Main at 15th, Louisville, Ky.
Southern Minnesota Supply Co., Mankato, Minn.
Woodson-Bozeman, 482 Union Ave., Memphis, Tenn.
J. M. Keely Sales Co., 400 S. W. Second Ave., Miami, Fla.
State Dist. Co., 3500 W. Pierce St., Milwaukee, Wisc.
Minnesota Electric Supply Co., 801 Plymouth Bldg., Minneapolis, Minn.
Shirley and Onstad, 15 W. Central, Minot, N. Dak.
W. W. Acuff Co., 3021 West End Ave., Nashville, Tenn.
Clinton Radio and Appliance Corp., 12-16 Elizabeth Ave., Newark, N. J.
Williams Wholesale Dist., 35 S. Fourth St., Newark, Ohio.
C. T. Patterson Co., Inc., 800 S. Peters St., New Orleans, La.
Appliance Dist., Inc., 51 Lawton St., New Rochelle, N. Y.
Kunkel Auto Supply Co., 507 N. Jeffers St., North Platte, Nebr.

Stewart-Warner Products Co., 23 North-western, Oklahoma City, Okla.
 Motor Parts Co., 2017 Harney St., Omaha, Nebr.
 Michael Hardware Co., 203 Broadway, Paducah, Ky.
 Graybar Electric Co., 212 S. State St., Peoria, Ill.
 Philadelphia Dist., 234 N. Eleventh St., Philadelphia, Pa.
 Arizona Mercantile Co., P. O. Box 3907, Phoenix, Ariz.
 I. & M. Sufrin, 1207 Muriel St., Pittsburgh, Pa.
 Graybar Electric Co., Park and Flanders St., Portland, Ore.
 The Hibbs Hdwe. Co., Fifth St. near Chilli-cothe, Portsmouth, Ohio.
 Tracy and Co., Inc., 80 W. Exchange St., Providence, R. I.
 Blackwood's, Inc., 404 Hillsboro St., Raleigh, N. Car.
 Hills Gas and Appliance Co., Rapid City, S. Dak.
 Consolidated Sales Co., 308 N. Laurel St., Richmond, Va.
 Cornell-Priddy, Inc., 425 E. Campbell Ave., Roanoke, Va.
 Southern Minn. Supply Co., Rochester, Minn.
 National Sales Co., 365 North St., Rochester, N. Y.
 Butler Bros., 18th and Olive Sts., St. Louis, Mo.
 Vance Electric Supply, 1063 S. State St., Salt Lake City, Utah.
 Edwin Flato Co., P. O. Box 1676, San Antonio, Texas.
 Edward F. Hale Co., 925 Harrison St., San Francisco, Calif.
 Graybar Electric Co., King and Occidental Sts., Seattle, Wash.
 Rudning-Robertson Co., 267 Boyce-Greeley Bldg., Sioux Falls, S. Dak.
 Graybar Electric Co., 152 S. Post St., Spokane, Wash.
 Harry Cooper Supply Co., 223 E. Water St., Springfield, Mo.
 Gershoff Electric Supply Corp., 220 W. 83rd St., New York, N. Y.
 Graybar Electric Co., Inc., 1214 A St., Tacoma, Wash.
 Stewart-Warner Products Co., 1234 S. Detroit, Tulsa, Okla.
 Miller Electric Co., 11 Hopper St., Utica, N. Y.
 Ott Heiskell Co., 86 - 19th St., Wheeling, W. Va.
 Wichita Building Material Co., 414 S. Commerce St., Wichita, Kan.
 White Auto Stores, 1507 Lamar St., Wichita Falls, Texas.
 Kile-Jacobs & Co., 132 N. Washington St., Wilkes Barre, Pa.
 Minnesota Electric Supply Co., Willmar, Minn.
 Motter Electric Co., 131 N. George St., York, Pa.

Silkworth's, 4 E. Michigan Ave., Ypsilanti, Mich.

Stromberg-Carlson Co.

100 Carlson Road, Rochester 3, N. Y.
 President: Ray H. Manson
 Sales manager: C. J. Hunt
 Secretary: E. C. Roworth
 Treasurer: W. W. Hetzel

Products Manufactured

Radio, telephone and sound equipment products

Trade Name

Stromberg-Carlson

Models

Table models, portables, farm sets, table combinations, consoles, radio-phonograph combinations, FM, television and wire recorders

Retail Price

\$27.50-\$500.

Distributors

Branch offices:

564 W. Adams St., Chicago, Ill.
 2152 W. Washington Blvd., Los Angeles, Calif.
 211-219 Geary Ave., Toronto, Canada.
 325 Ninth St., San Francisco 3, Calif.
 Clark & Jones, 112 S. 20th St., Birmingham 3, Ala.
 Motor Supply Co., 315-321 North Central Ave., Phoenix, Ariz.
 Boren Bicycle Co., 812 Main St., Little Rock, Ark.
 Robert F. Clark Co., 3062 Blake St., Denver, Colo.
 Domestic Refrigeration Co., 134 N. W. Third Ave., Miami, Fla.
 Byars-Forgy, Inc., 105 E. Twiggs St., Tampa, Fla.
 Schiffer Dist. Co., Suite 201-5 Glenn Bldg., Atlanta, Ga.
 Electrical Dist., Ltd., 1216 Kapiolani Blvd., P. O. Box 228, Honolulu 10, Hawaii.
 Appliance Dist., Inc., 421 E. Market St., Indianapolis 4, Ind.
 Midwest-Timmermann Co., 114 Western Ave., Davenport, Iowa.
 Midwest-Timmermann Co., 812 Tuttle St., Des Moines, Iowa.
 Jenkins Wholesale Div., 400 South Emporia, Wichita, Kan.
 Vogel, Birch & Co., Central Ave. at 22nd St., Ashland, Ky.
 Graybar Electric Co. Inc., 624-628 South 6th St., Louisville 2, Ky.
 Modern Appliance & Supply Co., 4300 Washington Ave., New Orleans 19, La.
 Farrar-Brown Co., 494 Forest Ave., Portland 5, Me.
 Henry O. Berman Co., 12 E. Lombard St., Baltimore, Md.
 Adams-Erickson, Inc., 938 Park Square Bldg., Boston, Mass.
 Radio Dist. Co., 966 Cherry St., S. E., Grand Rapids 6, Mich.

Graybar Electric Co., Inc., 320 W. 1st St., Duluth, Minn.
 Graybar Electric Co., Inc., 824 S. 4th St., Minneapolis 15, Minn.
 Graybar Electric Co., Inc., 464 Robert St., St. Paul, Minn.
 Jenkins Wholesale Div., 1217 Walnut St., Kansas City 13, Mo.
 Jenkins Wholesale Div., 4824 Washington Blvd., St. Louis 8, Mo.
 Island Supply Co., 1221 W. Oklahoma Ave., P. O. Box 804, Grand Island, Nebr.
 Auto Electric Service Co., 1214 Elm St., Manchester, N. H.
 H. D. Taylor Co., 99 to 117 Oak St., Buffalo 5, N. Y.
 Barker, Rose & Kimball, Inc., Elmira, N. Y.
 Gross Dist., Inc., 570 Lexington Ave., New York 22, N. Y.
 Baldwin Hall Co., 309 E. Water St., Syracuse 1, N. Y.
 H. A. McRae & Co. Inc., 137 River St., Troy, N. Y.
 Chapman & Wilhelm Co., P. O. Box 1194, Liberty Life Bldg., Charlotte, N. Car.
 Tepfer Appliance Co. Inc., 19 Central Ave., Cincinnati 2, Ohio.
 J. J. Skinner & Co., 6523 Euclid Ave., Cleveland 3, Ohio.
 The Callander-Lane Co., 81 N. 3rd St., Columbus 15, Ohio.
 Jenkins Wholesale Div., 29 East Reno St., Oklahoma City, Okla.
 Huletz Electric Co., 1132 N. W. Glisan, Portland 9, Ore.
 Bell-Clark & Co., 14th & Gordon Sts., Allentown, Pa.
 Elliott-Lewis Elec'l. Co. Inc., 1011-21 Race St., Philadelphia 7, Pa.
 Ludwig Hommel & Co., 600 Second Ave., Pittsburgh, Pa.
 The Careva Co., 545-61 E. Princess St., York, Pa.
 John J. Moore Co., 49 Westminster St., Providence 3, R. I.
 Tri-State Supply Co., 1148 Market St., Chattanooga, Tenn.
 Roden Electric Supply Co., 808 N. Central Ave., Knoxville, Tenn.
 Adair Appliance Co., 664 Union Ave., Memphis 3, Tenn.
 Better Home Products, Inc., 6 Cummins Station, Nashville 3, Tenn.
 Central Supply Co., 209 Fisk Ave., Brownwood, Texas.
 Padgett Dist. Co., 409 Bullington St., Dallas, Texas.
 Houston Radio Supply Co., 910 Calhoun, Houston 2, Texas.
 General Appliance Co., 217 South Flores St., San Antonio, Texas.
 Standard Supply Co., Box 1231, Salt Lake City, Utah.
 Graybar Electric Co. Inc., 6th & Cary Sts., Richmond 19, Va.
 Huletz Electric Co., Broadway & Pike, Seattle 22, Wash.

Spokane Paper & Stationery Co., 152 S. Jefferson St., Spokane 8, Wash.
 Roth Appliance Dist., Inc., 647 W. Virginia St., Milwaukee 4, Wisc.

Sylvania Electric Products, Inc.

500 Fifth Ave., New York 18, N. Y.
 President: W. E. Poor
 Sales manager: C. W. Shaw
 Secretary: John S. Learoyd
 Treasurer: M. F. Balcom
Products Manufactured
 Radio tubes, panel lamps, electronic devices, fluorescent lamps and fixtures, photographic equipment, cathode ray tubes, wiring devices, electric light bulbs
Trade Name
 Sylvania

Symphonic Radio & Electronic Corp.

292-298 Main St., Cambridge 42, Mass.
 President and sales manager: M. H. Cogan
 Secretary: H. Zaff
 Treasurer: James Speranza
Products Manufactured
 Radios, phonographs
Trade Name
 Symphonic

Tac Industries Inc.

44 DeKalb Ave., Brooklyn, N. Y.
 President: Bernard V. Friedman
 Secretary-treasurer: A. K. Friedman
Products Manufactured
 Radios, phonographs, combinations, toys
Trade Names
 Airtec (radios), Tac (toys)
Price
 \$25.95-\$89.50.

Tech-Master Products Co.

123 Prince St., New York 12, N. Y.
 President: L. Lazoff
Products Manufactured
 Radio and electronic equipment
Trade Name
 Tech-Master
Models

Table, portable, manual phonograph, automatic record changer phonograph

Teletone Radio Corp.

609 W. 51st St., New York 19, N. Y.
 President: S. W. Gross
 Sales manager: John S. Mills
Products Manufactured
 Table radios, radio-phonograph combinations
Trade Name
 Teletone

Telicon Corp.

851 Madison Ave., New York 21, N. Y.
 President: S. Sagall

Vice-president: S. Surrey
Secretary: Colin C. Ives
Products Manufactured
AM and FM radio and television receivers, "Intra-Video" system
Models
Table and console

Templetone Radio Mfg. Corp.

100 Garfield Ave., New London, Conn.
President: Oscar Dane
Sales manager: S. A. Kelsey
Secretary: I. Friedman
Vice-president and treasurer: Eli Dane

Products Manufactured

Home radios

Trade Name

Temple

Distributors

Alabama-Florida Dist. Co., 601-06 N. 9th St., Birmingham 4, Ala.

Hassco, Inc., 1745 Wazee St., Denver 1, Colo.

Hartford Stove Co., 60 Morgan St., Hartford, Conn.

Eastern Wholesalers, Inc., Bond Building, 14th & New York Ave., N.W., Washington, D. C.

Seaboard Dist. Co., 1408 N. W. 7th Ave., Miami, Fla.

The A. G. Rhodes Co., Rhodes Center, Atlanta 1, Ga.

H. U. Mann Co., 540 Lake Shore Drive, Chicago 11, Ill.

Ridge Motor & Mach. Co., 163-71 Iowa St., Dubuque, Iowa.

Sioux Electrical Appliance Co., 421-26 Warnock Bldg., Sioux City 15, Iowa.

Eastern Wholesalers, Inc., 34 S. Eutaw St., Baltimore 1, Md.

Littlefield-Greene, Inc., 778 Commonwealth Ave., Boston 15, Mass.

Maurice-Roberts, Inc., 1212 N. Main St., Ann Arbor, Mich.

Associated Industries, Inc., 2287 E. Jefferson Ave., Detroit 7, Mich.

Goyer Supply Co., Greenville, Miss.

Roehr Dist. Co., 2720-28 Locust St., St. Louis, Mo.

Appliance Dist., Inc., 912-44 North 24th St., Omaha 2, Nebr.

Northern Air Conditioning Corp., 21-23 Central Ave., Newark 2, N. J.

Alfred Dist. Co., 29-31 Green St., Albany 7, N. Y.

W. A. Case & Son Mfg. Co., 1 Lewis St., Binghamton 25F, N. Y.

Weed & Co., 95 Swan St., Buffalo 5, N. Y.

Templetone, New York, 15 Maiden Lane, New York, N. Y.

Weed & Co., 15 Exchange St., Rochester 4, N. Y.

W. A. Case & Son Mfg. Co., 115 No. Geddes St., Syracuse, N. Y.

Electrical Wholesalers, 17 E. Martin St., Raleigh, N. Car.

Schuster Electric Co., 321 Sycamore St., Cincinnati, Ohio.

K & F Dist. Co., 1300 W. 3rd St., Cleveland 13, Ohio.

Martin Clark Radio, 301 N. Broadway, Ada, Okla.

Penn Appliance Dist., 126 S. 2nd St., Harrisburg, Pa.

Slap & Lasky, 2530 No. Broad St., Philadelphia 32, Pa.

Hi Major, 109 Third Ave., Pittsburgh, Pa.

J. J. Weis Sales Co., Inc., 106-08 Cedar Ave., Scranton 5, Pa.

Radio & Appliance Sales Co., 382 Weybosset St., Providence, R. I.

Ass. Dist. Co. of S. Car., Box No. 25, Columbia, S. Car.

The Aladdin Co., 505 E. Eighth St., Sioux Falls, S. Dak.

Southern Dist., 962 N. Broadway, Knoxville, Tenn.

Bird's & Co., 148 Depot St., Greenville, Tenn.

Mack Lewis, 161 N. Main St., Memphis, Tenn.

Texas Motor Co., 904 So. E. Washington, Brownsville, Texas.

Norman-Young, Inc., 1016 McKinney, Dallas 2, Texas.

Electrical & Mechanical Supply Co., Inc., 708-16 N. Piedras St., El Paso, Texas.

W. W. Slaughter Co., 1009 Florence St., Fort Worth, Texas.

Allen Sales Co., 624 M & M Bldg., Houston 2, Texas.

The Peck Co., St. Johnsbury, Vt.

Ridge-Madison Co., 826 E. Washington St., Madison, Wis.

Tone Products Corp. of America

351 Fourth Ave., New York 10, N. Y.

President and treasurer: Lee Geier

Secretary and sales manager:

Howard A. Jacobs

Products Manufactured

Merry Go Sound electric amplified children's phonographs and records

Trade Name

Merry-Go-Sound

Trav-Ler Karenola Radio & Television Corp.

571 W. Jackson Blvd., Chicago 6, Ill.

President: Joe Friedman

Sales manager: A. F. Faherty

Products Manufactured

Radio receivers, electric phonographs, combinations, radio components, cabinets

Trade Name

Trav-Ler

Distributors

Lynn Stewart Co., 150 N. Wacker Drive, Chicago, Ill.

Florence Dist. Co., 4827 S. E. Division St.,
Portland, Ore.
Park Radio Service, 130 Cedar St., New
York, N. Y.
Gilbert Dist. Co., Suite 325, Bankers Trust
Bldg., Indianapolis, Ind.
Traveler Radio Sales Co., 571 W. Jackson
Blvd., Chicago, Ill.
Traveler Radio Sales Co., 394 Arcade Bldg.,
St. Louis, Mo.
Traveler Radio Sales Co., 402 Sweetland Bldg.,
Cleveland, Ohio.
Traveler Radio Sales Co., 1301 Clark Bldg.,
Pittsburgh, Pa.
Traveler Radio Sales Co., 7310 Woodward,
Detroit, Mich.

United States Television Mfg. Corp.

3 W. 61st St., New York, N. Y.
President: Hamilton Hoge
Sales manager and secretary:
Francis H. Hoge, Jr.
Treasurer: John Hoge

Products Manufactured

Radio and television receivers, television
receiver parts and test equipment

Trade Names

UST, U. S. Television, Madison

Models

Table, combinations, consoles, FM, AM
and television

Retail Price

\$32-\$950.

Distributors

Home Appliance & Equipment Corp., 10 N.
Second Ave., Phoenix, Ariz.
Pacific Appliance Co., 2767 Mission St., San
Francisco, Calif.
M. Goldman & Co., Inc., 1481 Seaview Ave.,
Bridgeport, Conn.
Consolidated Sales Co., 1496 H St., N.E.,
Washington, D. C.
Southeastern Dist., 625 West Bay St., Jack-
sonville, Fla.
Lowe Electric Co., Macon, Ga.
Federal Household Industries, Space 624,
American Furniture Mart, Chicago, Ill.
Bullerdick Appliance Co., 821 N. Illinois St.,
Indianapolis, Ind.
Acme Radio Supply Co., 632 Quincy St.,
Topeka, Kan.
Wm. B. Allen Supply Co., 916 N. Claiborne
Ave., New Orleans, La.
Hall & Knight Hardware Co., Lewiston, Me.
Cooper Electric Supply Co., 1027 Washington
St., Boston, Mass.
Aire Flo Products Co., 8313 Mack Ave.,
Detroit, Mich.
Cumings Bros., 901 South Saginaw St., Flint,
Mich.
Ohio Battery & Ignition Co., 831 Market Ave.,
North, Canton, Ohio.
Walter E. Schott Investment Co., 2346 Gilbert
Ave., Cincinnati, Ohio.

American National Corp., 5300 Harvard
Ave., Cleveland, Ohio.
M. D. Larkin Co., 115 East 3rd St., Dayton,
Ohio.
Chester R. Crane Co., 1030 Summit St., To-
ledo, Ohio.
C. Y. Schelly & Bro., Inc., 32-36 North 7th
St., Allentown, Pa.
Morris Appliance Co., 15-21 North Prince
St., Lancaster, Pa.
Lindley Electric Supply Co., 4910-12 N. Fair-
hill St., Philadelphia, Pa.
Radio Parts Co., 929 Liberty Ave., Pitts-
burgh, Pa.
Ricol Co., 606 Field St., Dallas, Texas.
Ricol Co., 1114 Jennings Ave., Fort Worth,
Texas.
Dixie Supply Co., 916B M & M Building,
Houston, Texas.
Southwest Appliance Co., 316 West Com-
merce St., San Antonio, Texas.
Wichita Hardware Co., 1010 Scott Ave., Wi-
chita Falls, Texas.
Bean Electric Co., 1014 First Ave., Seattle,
Wash.
Emmons-Hawkins Hardware Co., Hunting-
ton, W. Va.
Diverso Products Co., 610 N. Water St., Mil-
waukee, Wis.

Univox Co.

83 Murray St., New York 7, N. Y.
President: A. L. Rubenstein
Sales manager: Joseph Silver
Secretary: Shirley Sawitz

Products Manufactured

Phonographs, transformers, amplifiers

Models

Single players and automatics

Distributor

Firman Leather Goods Co., 18-50 Walker St.,
New York, N. Y.

Viewtone Television & Radio Co.

203 E. 18th St., New York 3, N. Y.
President: Irving Kane
Sales manager: Joseph H. Moss, Jr.
Secretary: Louis Kane
Treasurer: Herbert H. Flamm

Products Manufactured

Television, radios, phonographs

Vlectrical Engineering Co.

828-830 N. Highland Ave., Los Angeles
38, Calif.
President: Charles Zingle
Sales manager: Wes G. Ternouth
Treasurer: I. Dubin

Products Manufactured

Radios

Trade Name

Calbest

Models

Combinations, table, console

Warwick Mfg. Corp.

1610 Harrison St., Chicago 41, Ill.

President: John S. Holmes

Sales manager: Reau Kemp

Secretary: Fred Holmes

Products Manufactured

Radios

Trade Name

Clarion

Distributors

James W. Clary Co., 2024 Fourth Ave., N., Birmingham, Ala.

Harris Supply Co., Mobile, Ala.

Nolin-McLinnis Inc., 205 Commerce St., Montgomery, Ala.

Tarr McComb & Ware, Kingman, Ariz.

Southwest Wholesale Radio & Appliances, 122 S. Third St., Phoenix, Ariz.

Boren Co., 810 Main St., Little Rock, Ark.

Radio Products Sales, 238 W. 15th St., Los Angeles, Calif.

E. C. Wenger Co., 1450 Harrison St., Oakland, Calif.

The Robert F. Clark Co., 31st & Blake, Denver, Colo.

Associated Dist., Inc., 343-345 Trumbull St., Hartford 3, Conn.

Associated Dist., Inc., 50 Green St., New Haven, Conn.

Artercraft Electric Supply Co., 103 W. Fourth St., Wilmington, Del.

May Hdw. Co., 1051 31st St., N.W., Washington, D. C.

Kinkade Radio Supply Co., 1323 Franklin St., Tampa, Fla.

Kinkade Radio Supply Co., 1402-04 Laura St., Jacksonville, Fla.

Dixie Radio Dist., 14 S.W. First Ave., Miami, Fla.

Marston & Quina, Inc., Pensacola, Fla.

Electric Sales & Service Co., 209 Walton St. N.W., Atlanta, Ga.

Electric Sales & Service Co., 11 West Bay St., Savannah, Ga.

Waken & Whipple Inc., 66 W. Ohio St., Chicago, Ill.

Tri-City Appliance Co., c/o Rogers Maytag, 1413 - 5th Ave., Moline, Ill.

Capitol Wholesalers Inc., 132 S. Pennsylvania, Indianapolis, Ind.

Commercial Sound & Radio Co., 528 N. Colfax, South Bend, Ind.

Union Supply Co., Fourth & Washington, Burlington, Iowa.

Herring Wissler Co., 1212 Locust St., Des Moines, Iowa.

Irvin Kahn & Son, 525 W. Main St., Louisville, Ky.

Monroe Automobile & Supply Co., Washington & Walnut, Monroe, La.

Monroe Automobile & Supply Co., 501 Elysian Field Ave., New Orleans, La.

Farrar-Brown Co., 492 Forest Ave., Portland, Me.

Shepherd Electric Co., Inc., 13-15 E. Lombard St., Baltimore, Md.

United Dist., 136 N. Mechanic St., Cumberland, Md.

John Dunn, Inc., 87 High St., Boston, Mass.

John Dunn, Inc., 782 River Ave., Providence 8, R. I.

Walker Electrical Supply Co., 15 Union St., Worcester, Mass.

Midwest Home Appliance Dist., 4105 Cass Ave., Detroit, Mich.

Radio Electronic Supply Co., 113 S. Division, Grand Rapids, Mich.

William Van Domelen Co., Menominee, Mich.

The S & M Co., 13th & Hennepin, Minneapolis, Minn.

Townsend Paper Co., Roach & Pascagoula, Jackson, Miss.

Jenkins Wholesale Div., 1217 Walnut St., Kansas City, Mo.

Jenkins Wholesale Div., 4824 Washington Ave., St. Louis, Mo.

Jenkins Wholesale Div., 27 E. Reno, Oklahoma City, Okla.

Jenkins Wholesale Div., 400 S. Emporia, Wichita, Kan.

Enterprise Electric Co., 1103 Farnam St., Omaha, Nebr.

Enterprise Electric Co., 324 S. 9th St., Lincoln, Nebr.

Appliance Wholesalers, 271 Halsey St., Newark, N. J.

Electric Supply Co., 513 N. Second St., Albuquerque, N. M.

Electric Supply Co., Box 1731, El Paso, Texas.

H. I. Sackett Electric Co., Div. of W. A. Case & Son Mfg. Co., 173 Elm St., Buffalo, N. Y.

Warren-Connelly Co., Inc., 253 W. 6th St., New York, N. Y.

Golub Corp., 140 Erie Blvd., Schenectady, N. Y.

Genesee Supply Co., 405 Washington St., Utica, N. Y.

L. W. Driscoll Inc., 226 S. Myers, Charlotte, N. Car.

The Johnson Electric Supply Co., 329 Main St., Cincinnati, Ohio.

Western Reserve Dist., 504 Hanna Bldg., Cleveland, Ohio.

Loeb Electric Co., 242 N. Third St., Columbus, Ohio.

Warren Radio Co., 1320 Madison Ave., Toledo, Ohio.

Warren Radio Co., 139 S. Elizabeth, Lima, Ohio.

Warren Radio Co., 720 S. Clinton, Fort Wayne, Ind.

Hoffman Sales & Dist. Co., 15 S. Ave., Rochester 4, N. Y.

Stull Bros., Wyoming Ave. at Union, Kingston, Pa.

Rumsey Electric Co., 1007 Arch St., Philadelphia, Pa.

M. V. Mansfield Co., 937 Liberty Ave., Pittsburgh, Pa.

Radio Dist. Co., 140 S. Second St., Harrisburgh, Pa.

Radio Laboratories, 215 King St., Charleston, S. Car.
 Graves Electric Supply Co., 122 River St., Greenville, S. Car.
 J. F. Blackford Co., 1300 Broad St., Chattanooga, Tenn.
 Holston Appliance Co., 101 Broadway, Johnson City, Tenn.
 Wayne Spinks Co., 1658 Union Ave., Memphis, Tenn.
 Wayne Spinks Co., 521 Eighth Ave., S., Nashville, Tenn.
 Meletio Electric Supply Co., Young & Preston, Dallas, Texas.
 Jefferson Dist. Co., 1001 Pearl St., Beaumont, Texas.
 Jefferson Dist. Co., 915 San Jacinto St., Houston, Texas.
 Rowles Sales Co., 101 W. Pecan St., San Antonio, Texas.
 Associated Dealers Supply Co., 61 W. Fayette Ave., Salt Lake City, Utah.
 Twin State Electric Supply Co., 81 S. Main, White River Junction, Vt.
 Tower-Binford Electric & Mfg. Co., Fourth & Carv., Richmond, Va.
 Standard Sales Co., West 1219 First Ave., Spokane 8, Wash.
 Pugh Furniture Co., 1320 Wilson St., Charleston, W. Va.
 Seattle Radio Supply Inc., 2117 Second Ave., Seattle, Wash.
 Seattle Radio Supply Inc., c/o Rudy Wilhelm Whse. Co., 1233 N.W. 12th Ave., Portland, Ore.
 Seattle Radio Supply, Inc., c/o Cater Transfer & Storage Co., S. 121 Madison St., Spokane, Wash.
 State Dist. Co., 3500 West Pierce, Milwaukee, Wisc.

Waters Conley Co.

Rochester, Minn.

President: Glen M. Waters

Service manager: Wayne Davis

Secretary: H. M. Sanders

Products Manufactured

Acoustic and electronic portable phonographs and parts

Trade Names

Phonola, Melodier

Distributors

Cain & Bultman, Inc., 505 W. Adams St., Jacksonville 1, Fla.

Chapin-Owen Co., Inc., 205-213 St. Paul St., Rochester, N. Y.

Charleston Electrical Supply Co., 914 Kanawha Blvd., Charleston 29, W. Va.

Columbia Wholesalers, Inc., 584 Commonwealth Ave., Boston, Mass.

B. T. Crump Co., Inc., 1310-1334 E. Franklin St., Richmond, Va.

Farrar-Brown Co., 492-498 Forest Ave., Portland 5, Me.

Ludwig Hommel & Co., 600-620 Second Ave., Pittsburgh, Pa.

E. B. Latham & Co., 1010 Broad St., Newark, N. J.
 Motor Parts Co., 1229 N. Broad St., Philadelphia, Pa.
 Onondaga Supply Co., 351 E. Onondaga St., Syracuse, N. Y.
 Roskin Bros., Inc., 351 Central Ave., Albany 5, N. Y.
 Roskin Dist., Inc., 48 Winthrop St., Hartford 5, Conn.
 Roskin Bros. Inc., 23-27 W. Main St., Middletown, N. Y.
 Simons Dist. Co., 17 Lyman St., Providence, R. I.
 Southern Bearings & Parts Co., 315 N. College St., Charlotte, N. Car.
 Times Appliance Co., Inc., 353 Fourth Ave., New York 10, N. Y.
 Western Merchandise Dist., Inc., 68 West Huron St., Buffalo 2, N. Y.
 The Yancey Co., Inc., 340 W. Peachtree St. N.W., Atlanta, Ga.
 Jos. M. Zamojski Co., 110 South Paca St., Baltimore 1, Md.
 The Artophone Corp., 4200 Forest Park Blvd., Saint Louis 8, Mo.
 H. R. Basford Co., 425 - 2nd St., San Francisco, Calif.
 Bennett Radio Co., Inc., 39 E. Chestnut St., Columbus 15, Ohio.
 Crumpacker-Covington Co., 34 N. Hamilton St., Houston 2, Texas.
 Electric Appliance Dist. of Ky., 1601 S. First St., Louisville, Ky.
 Federal Dist. Co., 1717 Walnut St., Kansas City 8, Mo.
 Flint Dist. Co., 316 W. 2nd South St., Salt Lake City 11, Utah.
 Albert Mathias and Co., 113 South Mesa, El Paso, Texas.
 Albert Mathias and Co., 305 South Second Ave., Phoenix, Ariz.
 Miller-Jackson Co., Inc., 111-119 E. California Ave., Oklahoma City 2, Okla.
 Modern Dist. Co., 1415 Walnut St., Cincinnati 10, Ohio.
 Omaha Appliance Co., 18th & St. Mary's Ave., Omaha 2, Nebr.
 Philco Dist., Inc., 1627 W. Fort St., Detroit 16, Mich.
 Philco Dist., Inc., 1034 Grand Ave., Toledo, Ohio.
 Radio Specialty Co., 829 North Broadway, Milwaukee 2, Wisc.
 Rodelfeld Co., 614 N. Capitol Ave., Indianapolis 4, Ind.
 The Roycraft-Iowa Co., 1326 Walnut St., Des Moines 9, Iowa.
 The Roycraft Co., 1625 Hennepin Ave., Minneapolis 3, Minn.
 The Sampson Co., 3201 S. Michigan Ave., Chicago 16, Ill.
 Southern Equipment Co., 210-212 W. Commerce St., San Antonio 5, Texas.
 The Southwestern Co., Inc., 1719 North Harwood St., Dallas 1, Texas.

Strong, Carlisle & Hammond Co., 1394 W. Third St., Cleveland 13, Ohio.
 Sunset Electric Co., 509 N.W. 10th Ave., Portland 9, Ore.
 Sunset Electric Co., 300 Westlake Ave. N., Seattle 14, Wash.
 The B. K. Sweeney Electrical Co., 1601 - 23rd St., Denver 17, Colo.
 Ray Thomas Co., 1601 South Hope St., Los Angeles 15, Calif.
 Walther Bros. Co., 714-20 Howard Ave., New Orleans 13, La.
 Watts-Newsome Co., 1724 First Ave., N., Birmingham 3, Ala.
 Woodson & Bozeman, Inc., 482 Union Ave., Memphis 1, Tenn.

Wells-Gardner & Co.

2701 N. Kildare Ave., Chicago 39, Ill.
 President: G. M. Gardner
 Sales manager: H. A. Johanson
 Secretary: W. V. Bennett
 Treasurer: Frank Dillbahrner

Products Manufactured

All types of radio receiving sets

Westinghouse Electric Corp.

Home Radio Div., Sunbury, Pa.
 President: G. A. Price
 Sales manager: Edgar G. Herrmann
 Secretary and assistant treasurer:
 C. W. Pomeroy
 Vice-president and treasurer: L. H. Lund

Products Manufactured

Home radio receivers

Trade Name

Westinghouse

Distributors

Wesco, 454 N. Pearl St., Albany 4, N. Y.
 Wesco, 98 Water St., Augusta, Me.
 Wesco, 175 Broad St., Bangor, Me.
 Wesco, 87 Chenango St., Binghamton 60F, N. Y.
 Wesco, 88 Pearl St., Boston 10, Mass.
 Buffalo Electric Co., Inc., 75 W. Mohawk St., Buffalo 2, N. Y.
 Wesco, 208 Flynn Ave., Burlington, Vt.
 Wesco, 49 Liberty St., Newark 5, N. J.
 Wesco, 240 Cedar St., P. O. Box 1830, New Haven 8, Conn.
 Wesco, 150 Varick St., New York 13, N. Y.
 Times Appliance Co., Inc., 353 Fourth Ave., New York 10, N. Y.
 Wesco, 66 Ship St., Providence 1, R. I.
 Wesco, 1018 University Ave., Rochester 7, N. Y.
 Wesco, 46 Hampden St., Springfield 3, Mass.
 Wesco, 961 W. Genesee St., Syracuse 4, N. Y.
 Wesco, 414 S. Broad St., Trenton 10, N. J.
 Kempf Bros., 227 Genesee St., Utica, N. Y.
 Wesco, 17 Mulberry St., Worcester 4, Mass.
 Penn Electrical Engineering Co., 517-19 Ash St., Scranton, Pa.
 Wesco, 1216 K St., N.W., Washington 5, D. C.

Wesco, 318 W. 11th St., Williamsport 1, Pa.
 Wesco, 216 E. 2nd St., Wilmington 99, Del.
 Wesco, 113 S. George St., York, Pa.
 Wesco, 1299 Northside Drive, N.W., Atlanta 2, Ga.
 Wesco, 210 E. 6th St., Charlotte 1, N. C.
 Wesco, 915 Lady St., Columbia (A), S. C.
 Wesco, 226 Pendleton St., Greenville, S. C.
 Wesco, 37 S. Hogan St., Jacksonville 3, Fla.
 Wesco, 739 Hamilton St., Allentown, Pa.
 Wesco, 40 S. Calvert St., Baltimore 2, Md.
 Superior-Sterling Co., 200 Bluefield Ave., Bluefield, W. Va.
 Service Appliance Co., Moore & Scott Sts., Bristol, Va.
 Thomas, Field & Co., Charleston 27, W. Va.
 Wesco, 2600 Hampton Blvd., Norfolk 1, Va.
 Wesco, 141 N. 11th St., Philadelphia 7, Pa.
 Wesco, 4th & Elm Sts., Reading, Pa.
 Wesco, 301 S. 5th St., Richmond 19, Va.
 Wesco, 726 First St., S.E., Roanoke 4, Va.
 Southern Furniture Sales Co., 418 Gay St., Knoxville, Tenn.
 Wesco, 11 N. E. 6th St., Miami 4, Fla.
 J. I. Perry Co., 305 Broadway, Nashville, Tenn.
 Wesco, 420 S. Peters St., New Orleans 12, La.
 Wesco, 319 W. Martin St., Raleigh, N. C.
 Wesco, 417 Ellamae St., Tampa 1, Fla.
 The Mook Electric Supply Co., 422 S. Broadway, Akron, Ohio.
 The Mook Electric Supply Co., 502 Cleveland Ave., N.W., Canton, Ohio.
 Wesco, 2329 Gilbert Ave., Cincinnati 6, Ohio.
 Wesco, 575 Sixth Ave., Pittsburgh 19, Pa.
 Wesco, 6545 Carnegie Ave., Cleveland 3, Ohio.
 Wesco, 266 N. Fourth St., Columbus 16, Ohio.
 Wesco, 226 W. Fifth St., Dayton, Ohio.
 Wesco, 517 Harper Ave., Detroit 2, Mich.
 Wesco, 1013 State St., Erie 2, Pa.
 Wesco, 201 N. W. First St., Evansville 8, Ind.
 Wesco, 511 Monroe Ave., N.W., Grand Rapids 2, Mich.
 Tafel Electric & Supply Co., 329 W. Main St., Louisville 2, Ky.
 Danforth Co., 5820 Centre Ave., Pittsburgh, Pa.
 Wesco, 1920 N. 13th St., Toledo 2, Ohio.
 Wesco, 1117 Main St., Wheeling, W. Va.
 The Mook Electric Supply Co., Wick & Rayon Ave., Youngstown, Ohio.
 Wesco, 113 N. May St., Chicago 7, Ill.
 Wesco, 402 E. 4th St., Davenport, Iowa.
 Wesco, 1400 Walnut St., Des Moines 8, Iowa.
 Wesco, 308 W. Michigan St., Duluth 2, Minn.
 Wesco, 612 S. Harrison St., Fort Wayne 2, Ind.
 Wesco, 619 Main St., Green Bay, Wisc.
 Wesco, 137 S. Pennsylvania St., Indianapolis 9, Ind.
 Wesco, North End Mesquite St., Corpus Christ. Texas.

Wesco, 1022 E. Washington Ave., Madison 3, Wisc.
 Wesco, 546 N. Broadway, Milwaukee 2, Wisc.
 Wesco, 515 S. 7th St., Minneapolis 15, Minn.
 Wesco, 117 N. 13th St., Omaha 2, Nebr.
 Wesco, 412 S. Washington St., Peoria 2, Ill.
 Wesco, 253 E. 4th St., St. Paul 1, Minn.
 Wesco, 1005 Dace St., Sioux City 4, Iowa.
 McCaffery Co., 216 Wayne St., South Bend, Ind.
 Wesco, 300 W. Third St., Waterloo, Iowa.
 Wesco, 99 Taylor St., Amarillo, Texas.
 Wesco, 405 N. Griffin St., Dallas 2, Texas.
 Zork Hardware Co., 305 N. El Paso St., El Paso, Texas.
 Wesco, 210 Jones St., Fort Worth 1, Texas.
 Wesco, 1903 Ruiz St., Houston 1, Texas.
 Continental Electric Co., 1517 Oak St., Kansas City 8, Mo.
 Fones Bros. Hdwe. Co., Second & Rock Sts., Little Rock, Ark.
 Wesco, 366 Madison Ave., Memphis 1, Tenn.
 Wesco, 850 N. W. 2nd St., Oklahoma City 2, Okla.
 Wesco, 1211 E. Houston St., San Antonio 2, Texas.
 Wesco, 50 E. Broadway, Butte, Mont.
 Wesco, 1011 Spruce St., St. Louis 2, Mo.
 Wesco, 307 E. Brady St., Tulsa 3, Okla.
 Wesco, 233 S. St. Francis Ave., Wichita 2, Kan.
 Wesco, 905 E. 2nd St., Los Angeles 51, Calif.
 Wesco, 711 E. 8th St., Oakland 6, Calif.
 Wesco, 315 W. Jackson St., Phoenix, Ariz.
 Wesco, 719 Kay St., Room 413, Sacramento 11, Calif.
 Wesco, 235 W. S. Temple St., Salt Lake City 11, Utah.

Wesco, 260 Fifth St., San Francisco 1, Calif.
 Wesco, 152 S. Monroe St., Spokane 1, Wash.
 Wesco, 134 N. W. 8th Ave., Portland 9, Ore.
 Wesco, 1051 First Ave., S., Seattle 4, Wash.
 Wesco, 239 State St., Watertown, N. Y.
 Radio and Appliance Dist. Co., 1634 - 18th St., Denver 2, Colo.
 Wesco, 1930 Pacific Ave., Tacoma 2, Wash.
 Hawaiian Electric Co., 235 King St., Honolulu, T. H.

Wilcox-Gay Corp.

605 W. Seminary St., Charlotte, Mich.
 President and treasurer: Chester Wilcox
 Sales manager: Warren L. Hasemeier
 Secretary: Baynon Skinner

Products Manufactured

Recording instruments

Trade Names

Recordio, Recordiopoint Needles

Zenith Radio Corp.

6001 W. Dickens Ave., Chicago 39, Ill.
 President: E. F. McDonald, Jr.
 Sales manager: H. C. Bonfig
 Secretary: R. D. Burnet
 Treasurer: Hugh Robertson

Products Manufactured

Household radios, auto radios, portable radios, battery radios, radionic hearing aids

Trade Name

Zenith

Retail Price

\$19.95-\$295

newspapers and magazine record reviewers

On the following pages are
listed the various magazines and
newspapers that review
classical and popular
records.

newspaper and magazine record reviewers

C—Classical

P—Popular

ALABAMA

BIRMINGHAM NEWS-AGE HERALD

Miss Lilly Mae Caldwell
Terrace Court Apts.
S 20th & Highland Avenue,
Birmingham, Alabama

ARIZONA

ARIZONA DAILY STAR

Record Turntable—News Room
Tucson, Arizona

ARKANSAS

ARKANSAS GAZETTE

Mr. Joseph Rosenberg
115 E. Fifteenth Street,
Little Rock, Arkansas

CALIFORNIA

EXAMINER

Mr. F. H. McMahon
550 Cumberland Road,
Glendale, California

LOS ANGELES NEWS

Mr. Bruno David Usher
2529 Olive Avenue,
La Crescenta, California

SAN DIEGO UNION

Mr. Bill Adair
San Diego, California

SAN FRANCISCO CALL BULLETIN

Mrs. Marie H. Davidson
860 Howard Street,
San Francisco, California

SAN FRANCISCO NEWS

Miss Marjorie Fisher
Alexander Hamilton Hotel,
San Francisco, California

Mr. Gerald Ray
612 Mission Street,
San Francisco, California

L. A. HERALD EXPRESS

Miss Alma Gowdy
5721 Briarcliff Road,
Los Angeles, California

LOS ANGELES TIMES

Miss Isabel Morse Jones
5386 Village Green,
Baldwin Hills,
Los Angeles, California

SAN FRANCISCO CHRONICLE

Mr. Alfred Frankenstein
Mr. E. E. Huthsing
5th & Mission Streets,
San Francisco, California

SAN FRANCISCO EXAMINER

Mr. Alexander Fried
3rd & Market Streets,
San Francisco, California

COIN MACHINE REVIEW

1113 Venice Blvd.,
Los Angeles, California

CONNECTICUT

POST

Mr. W. R. Clark, Jr.
67 Lynnbrook Road,
Bridgeport, Conn.

THE COURANT

Mr. T. H. Parker C
Hartford, Conn.

WATERBURY SUNDAY REPUBLICAN

Miss Mollie Cullen P
Waterbury, Conn.

HARTFORD TIMES

Mr. Carl E. Lindstrom P
33 Filley Street, C
Windsor, Conn.

TOWN & COUNTRY

Mr. Alec Templeton C
Round Hill Road,
Greenwich, Conn.

BRIDGEPORT HERALD

Mr. Leo Miller P
17 Park Hill Avenue, C
Norwalk, Conn.

ASSOCIATED PRESS

Mr. John Selby C
Box 344,
Westport, Conn.

DISTRICT OF COLUMBIA**DAILY NEWS**

Mr. John T. O'Rourke C
Washington, D. C.

426

LIBRARY OF CONGRESS

Mr. Carl Engel C
Chief of Division of Music
Washington, D. C.

EVENING STAR

Miss Alice Myersman C
Washington, D. C.

THE WASHINGTON STAR

Mr. John W. Stepp, P
Mr. Robert Humphreys C
2012 O Street, N. W.,
Washington, D. C.

FLORIDA**MIAMI DAILY NEWS**

Mr. Frank Mallants P
Gibson Hotel C
N. E. Second Avenue at 6th,
Miami, Florida

TAMPA TRIBUNE

Mr. Harry E. Schaden P
811 S. Orleans Avenue, C
Tampa, Florida

ST. PETERSBURG TIMES

Mr. T. C. Harris C
St. Petersburg, Florida P

GEORGIA**CONSTITUTION**

Miss Marguerite Batholomew C
Paul Jones P
Mr. Lee Fuhrman
Atlanta, Georgia

ATLANTA JOURNAL

Mr. Ernest Rogers P
600 Collier Road, N. W., C
Atlanta, Georgia

ATLANTA ADVERTISER, SOUTHERN ISRAELITE, NORTH SIDE PRESS

Mr. Eldin Burton C
164 Fourth Street, N. E.,
Atlanta, Georgia

AUGUSTA CHRONICLE

Mr. Berry Fleming C
2242 Pickens Road,
Augusta, Georgia

ATLANTA POST

Mr. Robert D. England C
227 Third Avenue,
Decatur, Georgia

ILLINOIS**HAMMOND INDIAN TIMES**

Mr. Paul K. Damai P
14 Highland Street,
Calumet City, Illinois

CHICAGO HERALD AMERICAN

Mr. Weley Hartzell
912 N. Central Park Avenue
Chicago, Illinois

P

CHICAGO SUN

Mr. Felix Borowski
36 East Bellevue Place,
Chicago, Illinois

C

CHICAGO DAILY NEWS

Mr. E. J. Bulliet
Chicago, Illinois

P
C**COIN MACHINE JOURNAL**

Mr. Harvey Carr
328 South Jefferson Street,
Chicago, Illinois

P

TRIBUNE

Miss Claudia Cassidy
50 East Walton Place,
2nd Floor East,
Chicago, Illinois

C

TRIBUNE, SUNDAY DEPT.

Mr. William Davidson
Chicago, Illinois

P

ASSOCIATED NEGRO PRESS

Mr. Frank Marshall Davis
3507 South Parkway,
Chicago, Illinois

P

SEARS ROEBUCK

The Record Reviewers
804 Glencoe Avenue,
Highland Park, Illinois

P
C**TIMES**

Mr. Remi Gassman
5650 Kenwood,
Chicago, Illinois

C

PEORIA, JOURNAL

Mr. H. G. Dewees
Eureka, Illinois

P

LYON & HEALY RECORD NEWS

Mr. Richard Weddell
610 North Washington St.,
Hinsdale, Illinois

P
C**PEORIA STAR COMPANY**

Mr. Charles E. Barnum
Peoria, Illinois

P

INDIANA**JOURNAL GAZETTE**

Mr. Park Williams
3502 North Washington Road,
Fort Wayne, Indiana

P
C**NEWS-SENTINEL**

Mr. Edgar E. Ferrey
Mr. Walter A. Hansen
2 Concordia College Place,
East Drive,
Fort Wayne, Indiana

P
C**THE INDIANAPOLIS TIMES**

Mr. Richard Lewis
Indianapolis, Indiana

P
C**STAR**

Mr. Corbin Patrick
2727 N. Pennsylvania Avenue,
Indianapolis, Indiana

P
C**THE UNION**

Mr. Earl R. Thorbahn
230 East Ohio Street,
Indianapolis, Indiana

P
C**NEWS**

Mr. Walter Whitworth
Hotel Lincoln,
Indianapolis, Indiana

C

TRIBUNE

Mr. Robert Walton
South Bend, Indiana

P
C**IOWA****GAZETTE**

Miss Nadine Subatnik
Cedar Rapids, Iowa

P
C**GLOBE-GAZETTE**

Mr. Roger Rosenblum
Station KGLO
Mason City, Iowa

P
C**DEMOCRAT & LEADER**

Miss Ina Wickham
Davenport, Iowa

C

KANSAS**CAPITAL**

Mr. E. D. Keilman
2029 Collins Avenue,
Topeka, Kansas

P
C

BEACON

Mr. Earle Davis
918 North Yale,
Wichita, Kansas

P
C

STATE JOURNAL

Mr. John Randolph Tye
Topeka, Kansas

P
C

LOUISIANA**OUR NEWS**

2415 Valence Street,
New Orleans, Louisiana

P
C

MARYLAND**BALTIMORE AMERICAN**

Mr. John Phillips Cranwell
1622 Park Avenue,
Baltimore, Maryland

C

THE EVENING SUN

Baltimore, Maryland

C

MASSACHUSETTS**BOSTON POST**

Mr. Warren Storey Smith
28 Crescent Road,
Belmont, Mass.

P
C

THE BOSTON GLOBE

Mr. Cyrus Durgin
P.O. Box 189,
Boston, Mass.

P
C

SPRINGFIELD UNION

Mr. Vin Breglio
136 Rimmon Avenue,
Chicopee, Mass.

P

MORNING UNION

Mr. Willard M. Clark
187 Florida Street,
Springfield, Mass.

C

BOSTON SUNDAY ADVERTISER

Mr. Walter Howey
5 Winthrop Square,
Boston, Mass.

P
C

HERALD

Miss Elinor Hughes
Mr. Rudolph Elie, Jr.
80 Mason Street,

P
C

CHRISTIAN SC. MON.

Leslie A. Sloper
73 Bayley Street,
Westwood, Mass.

P
C

TELEGRAM

Mr. Ray LaRocque
15 Ellsmere Street,
Worcester, Mass.

P
C

NEWS

Mrs. Rosemary Donoghue
465 Summer Avenue,
Springfield, Mass.

P
C

REPUBLICAN

Mr. Victor Prah
70 West Alvard Street,
Springfield, Mass.

C
P

MICHIGAN**THE DETROIT NEWS**

Mr. Cecil Betron
Detroit, Mich.

P
C

DETROIT TIMES

Mr. Chas. Gentry
Detroit, Mich.

P

DETROIT FREE PRESS

Mr. bo D. Gallagher
Detroit, Mich.

P
C

THE HERALD

Miss Markuerite S. Kerns
Grand Rapids, Mich.

C

MINNESOTA**NEWS TRIBUNE**

Miss Margaret Morris
Mr. J. R. Van Horn
2909 East Superior Street,
Duluth, Minnesota

P
C

PIONEER PRESS

Miss Frances Boardman
235 Summit Avenue,
St. Paul, Minnesota

C

STAR JOURNAL

Mr. John K. Sherman
Mr. Robt E. Murphy
2503 West Franklin Avenue,
Minneapolis, Minnesota

P
C

MISSOURI

STAR

Mr. C. H. Thompson
449 West 67th Terrace,
Kansas City, Missouri

C

Mr. R. J. Hoyland
7336 Grand Avenue,
Kansas City, Missouri

P

GLOBE DEMOCRAT

Mr. Harry R. Burke
St. Louis, Missouri

C

POST-DISPATCH

Mr. Thomas B. Sherman
5267 Pershing Avenue,
St. Louis, Missouri

C

NEBRASKA

OMAHA DAILY TRIBUNE

Mr. Carl J. Peter
Omaha, Nebraska

C

WORLD-HERALD

Mr. Martin W. Bush
Jake Bachman
Omaha, Nebraska

C

NEW JERSEY

EVENING NEWS

Mr. R. C. Bush
841 Kearney Avenue,
Arlington, New Jersey

P

C

NEWARK STAR LEDGER

Mr. Maurice Bland
217 Halsey Street,
Newark, New Jersey

P

C

INTERNATIONAL MUSICIAN

Mr. Dick Wolfe
Miss Jan Hart
39 Division Street,
Newark, New Jersey

C

Mr. Henry C. Beck
909 Washington Avenue,
Palmyra, New Jersey

C

COURIER

Mr. James O'Neill
8359 Maple Avenue,
Merchantville, New Jersey

P

CONSUMERS' RESEARCH

Mr. Walter Gruening
56 Claremont Road,
Palisade, New Jersey

C

NEWARK CALL

Miss Marguerite Krahenbull
N. W. Ayer & Son, Inc.
30 Rockefeller Plaza,
New York City

C

NEW YORK

TIMES UNION

Mr. Edgar S. Van Olinda
11 South Lake Avenue,
Albany, New York

C

NEW YORK WORLD TELEGRAM

Mr. Robert C. Bagar
Mr. Louis Biancolli
2110 Tiebout Avenue,
New York, New York

P

C

BROOKLYN EAGLE

Mr. Miles Kastendieck
Brooklyn, New York

C

P

COURIER-EXPRESS

Mrs. Isabelle Workman Evans
Buffalo, New York

C

NEWS

Mr. A. H. Kirchhofer
Buffalo, New York

P

RICHMOND NEWS-LEADER

Mr. Paul Affolder
210 West 101st Street,
New York, New York

C

KING FEATURES

Mr. Eugene Leuchtman
9 East 54th Street, Apt. F,
New York, New York

C

NEWSWEEK

Miss Emily Coleman
152 West 42nd Street,
New York, New York

P

C

NEW YORK TIMES

Mr. Howard Taubman
229 W. 43rd Street,
New York, New York

P

C

**UNION PAPERS &
JOURNAL AMERICAN**

Mr. Richard A. Yaffe P
Mr. Laurence White C
New York, New York

AMERICAN MUSIC LOVER

Mr. Peter Hugh Reed P
115 Reed Avenue,
Pelham Manor, New York

DEMOCRAT & CHRONICLE

Mr. Norman Nairn P
Rochester, New York C

HERALD TRIBUNE

Mr. Jerome D. Bohm P
Mr. Virgil Thompson C
200 West 57th Street,
New York, New York

LOOK MAGAZINE

Mr. Sam Rowland P
511 Fifth Avenue. C
New York, New York

NATION

Mr. B. H. Haggin P
116 Seaman Avenue C
New York, New York

NEW YORK SUN

Mr. Irving Kolodin C
Mrs. Alfred D. Charles P
12 East 10th Street,
New York, N. Y.

Mr. Michael Levine P
2415 RKO Bldg.,
1270 Sixth Avenue
New York, New York

GOOD HOUSEKEEPING MAGAZINE

Mr. George R. Marek C
20 West 84th Street,
New York, New York

NEW YORK DAILY NEWS

220 East 42nd Street, C
New York, New York

METRONOME

Mr. Barry Ulanov P
26 West 58th Street,
New York, New York

Mr. George Simon
254 West 4th Street,
New York, New York

THE NEW YORKER

Mr. Robert A. Simon C
25 West 43rd Street,
New York, New York

TIME MAGAZINE

Mr. Herbert Kubly C
9 Rockefeller Plaza, P
New York, New York

UNITED PRESS

Mr. Louis F. Keemle C
39-33 47th Street,
Sunnyside, L. I.
New York

THE POST-STANDARD

Mrs. Thala Tabor Schenck C
Syracuse, New York

HOUSE & GARDEN

420 Lexington Avenue, P
New York, New York C

RECORD RETAILING

Mr. Kurt List P
274 Madison Avenue. C
New York, New York

HERALD JOURNAL

Mrs. E. H. Van Wormer P
Herald Place, C
Syracuse, New York

LISTEN MAGAZINE

Mr. Kurt List C
274 Madison Avenue, P
New York, New York

NORTH CAROLINA**ASHEVILLE ADVERTISER****FARMERS FEDERATION NEWS**

Mr. Bob Brown P
20 Vandalia Avenue. C
Asheville, North Carolina

GREENSBORO NEWS CO.

Mr. Fritz Raley Simmons C
Greensboro, North Carolina

CHARLOTTE OBSERVER

Miss Adelaide C. Butler
114 North 16th,
Wilmington, North Carolina

P
C

HERALD SUN

Mr. Robert Frances Simmons
Durham, North Carolina

P
C

NEWS & OBSERVER

Mr. A. J. McKevlin
Raleigh, North Carolina

P
C

HIGH POINT ENTERPRISE

Miss Virginia Frank
901 Garrick Avenue,
High Point, North Carolina

C
P

OHIO**BEACON-JOURNAL**

Mr. Oscar Smith
173 North Portage Path,
Akron, Ohio

P
C

POST

Mr. Frank Aston
Cincinnati, Ohio

C

CINCINNATI TIMES STAR

Miss Helen Detzel
Howard Hess
Cincinnati, Ohio

P
C

THE COLUMBUS CITIZEN

Mr. William S. Cunningham
Columbus, Ohio

C
P

DISPATCH

Mr. Paul Horung
Mr. Samuel T. Wilson
1507 Wyandotte Road,
Grandview,
Columbus, Ohio

P
C

THE CINCINNATI POST

Mr. R. Williams
Post Square,
Cincinnati, Ohio

P

THE NEWS

Mr. Elmore Bacon
Mr. Ben Wickham, Jr.
1801 Superior Avenue,
Cleveland, Ohio

C
P

PLAIN DEALER

Mr. Stewart Matter
3280 Kenmore Road,
Shaker Heights,
Cleveland, Ohio

P
C

CLEVELAND PRESS

Mr. Milton Widder
3011 Somerton Road,
Cleveland Heights, Ohio

C

Mr. T. S. Howard
1256 Delta Avenue,
Cincinnati 8, Ohio

STAR

Mr. Joe R. Mills
63 East Lynn Street,
Columbus, Ohio

P

JOURNAL HERALD

Miss Merab Eberle
30 Lexington Avenue,
Dayton, Ohio

C

DAYTON DAILY NEWS

Miss Betty A. Dietz
Dayton, Ohio

C
P

MARIETTA NEWS BUREAU

Mr. Larry M. Smith
507½ Third Street,
Marietta, Ohio

P

VINDICATOR

Mr. L. R. Boals
3030 Hillman Street,
Youngstown, Ohio

P
C

OKLAHOMA**OKLAHOMAN**

Miss Marguerite Macklin
Mr. Clyde Neibarger
920 N. W. 22nd Street,
Oklahoma City, Oklahoma

P
C

THE TULSA WORLD

Russel A. Gideon
Tulsa, Oklahoma

P
C

OREGON**OREGONIAN JOURNAL**

Mr. H. B. Grondahl
223 North Jessup Street,
Portland, Oregon

P
C

PENNSYLVANIA

CALL-CHRONICLE

John Y. Kohl P
Francis Weishampel C
Allentown, Pa.

Mr. Joseph A. Barone C
700 Montgomery Avenue,
Bryn Mawr, Pa.

Mr. Kenneth J. Carlow P
1317 West 9th Street, C
Erie, Pa.

COURIER

Mr. Jos. G. Lowengard C
229 Forster Street,
Harrisburg, Pa.

MAGAZINE DIGEST

Miss Sara Colton P
907 Manning Street, C
Philadelphia, Pa.

PHILADELPHIA RECORD

Edwin Schloss C
Mr. George M. Lilley P
Broad & Wood Streets,
Philadelphia, Pa.

THE BILLBOARD

Mr. Maurice H. Orodener C
6004 North 13th Street, P
Philadelphia, Pa.

PHILADELPHIA INQUIRER

Linton Martin P
Philadelphia, Pa. C

PITTSBURGH SUN-TELEGRAPH

Mr. LeRoy E. Wolfe P
2016 Walnut Street, C
Philadelphia, Pa.

PITTSBURGH PRESS

Mr. Ralph Lervando P
Pittsburgh, Pa. C

POST-GAZETTE

Mr. D. S. Steinfir C
1463 Beechwood Blvd.,
Pittsburgh, Pa.

RHODE ISLAND

PROVIDENCE JOURNAL

George Y. Loveridge P
845 Elmwood Avenue, C
Providence, Rhode Island

SOUTH CAROLINA

J. Albert Fracht P
172 Rutledge Avenue, C
Charleston, South Carolina

THE STATE

Mr. Murray deQ. Bonnoitt P
Columbia, South Carolina C

TENNESSEE

TIMES

Mr. J. R. Reithmeyer
Chattanooga

THE KNOXVILLE JOURNAL

Mr. W. F. Watson P
Knoxville, Tennessee C

COMMERCIAL APPEAL

Mr. Mike McGee P
Memphis, Tennessee C

FREE PRESS

Mr. Ralph Sanders C
311 North Tacoa Avenue,
Chattanooga, Tennessee

NEWS-SENTINEL

Mr. Frank Williams's P
1618 Laurel Avenue, C
Knoxville, Tennessee

BANNER

Mr. Milton Randolph P
Nashville, Tennessee C

TEXAS

AMERICAN-STATESMAN

Miss Marcia Townsley P
Austin, Texas C

BROWNWOOD BULLETIN

Mr. Curtiss Petrey P
1319 Avenue A, C
Brownwood, Texas

DALLAS MORNING NEWS

Mr. Victor Davis P
 Mr. John Rosenfeld C
 Dallas, Texas
 Miss Ida Belle Hicks
 2508 Sixth Avenue,
 Fort Worth, Texas

THE DALLAS TIMES HERALD

Mr. James Lovell P
 Dallas, Texas C

PRESS

Mr. Jack Gordon P
 Fort Worth, Texas C

STAR TELEGRAM

Mr. Clyde Whitlock C
 1100 West Cannon Avenue,
 Fort Worth, Texas

THE PRESS

Mr. W. L. Vennell P
 Houston, Texas C

THE HOUSTON POST

Mr. Hubert Roussel P
 Houston, Texas C

SAN ANTONIO EXPRESS

Mr. John E. Secrist P
 San Antonio, Texas C

LIGHT

Mr. Renwicke E. Cary P
 843 Hammond Avenue,
 San Antonio, Texas C

WICHITA DAILY TIMES

Mr. Wm. Donnell P
 Wichita Falls, Texas

UTAH**SALT LAKE CITY TRIBUNE**

Miss Grace Grether P
 Tribune-Telegram Building, C
 Salt Lake City, Utah

DESERT NEWS AND OGDEN

Mr. Conrad Harrison P
 1063 East Fourth South, C
 Salt Lake City, Utah

VIRGINIA**NORFOLK LEDGER DISPATCH**

Mr. Charles H. Hoofnagle P
 Norfolk, Virginia C

VIRGINIAN-PILOT

Mr. Warner Twyford P
 Norfolk, Virginia C

TIMES DISPATCH

Mr. Norman B. Rowe P
 2614 Powhatan Street,
 Richmond, Virginia

Mr. Fredson T. Bowers - C
 Collonade Club
 University, Virginia

WASHINGTON**STAR**

Mr. V. B. Westphal P
 Seattle, Washington C

POST-INTELLIGENCER

Miss Suzanne Martin C
 6th & Pine Streets,
 Seattle, Washington

SEATTLE TIMES

Mr. Richard Hays P
 Seattle, Washington C

NEWS-TRIBUNE

Miss Katherine Hunt P
 3706 North 33rd Street, C
 Tacoma, Washington

WEST VIRGINIA**DAILY MAIL**

Charleston, W. Va. C

THE GAZETTE

Mr. Bayard F. Ennis P
 Charleston, W. Va. C

THE CLARKSBURG TELEGRAM

Mr. Frank Carpenter P
 Clarksburg, W. Va. C

HUNTINGTON PUBLISHING CO.

Mr. James R. Haworth P
Huntington, W. Va. C

NEWS

Mr. Richard Suter C
327½ Ninth Street,
Parkersburg, W. Va.

NEWS REGISTER

Mr. Robert Permar C
Box 471
Wheeling, W. Va.

WISCONSIN

Miss Mary McDonald Welles
Lannon, Wisconsin C

WISCONSIN STATE JOURNAL.

Mr. Wm. L. Doudna P
115 South Carroll Street, C
Madison, Wisconsin

CAPITAL TIMES

Mr. Harry Sheer P
311 Norris Court, C
Madison, Wisconsin

JOURNAL.

Mr. Richard S. Davis P
4901 North Lake Drive, C
Milwaukee, Wisconsin

SENTINEL

Mr. E. P. Halline C
Mr. Buck Herzog P
1913 North Summit Avenue,
Milwaukee, Wisconsin

accessory companies



NEEDLE & ACCESSORY COMPANIES
(Including Companies Offering Services To Dealers)
SERVICES

H. W. Acton Co. Inc.

370 Seventh Ave., New York 1, N. Y.
(Products manufactured by W. H. Bagshaw Co., Lowell, Mass.)

President: H. W. Acton
Sales manager: H. A. Bengueyfield
Trade Names: Brilliantone, Actone Transcription Needles, 100% Shadowgraphed.
Type of Needles: Cutting Styli, special brands for manufacturers, semi-permanent needles, needles for special purposes.

The Bonot Company

114 Manhattan Street, Stamford, Conn.

President: Edwin B. Murphy
Vice-Pres.: C. E. Murphy
Sec.:Treas.: F. P. Hardy
Trade Names: Rubaiyat, Silver Sapphire, Electropoint, Broadcaster, Silver Meteor, Musicrome.
Type of Needles: Playback (ruby, sapphire, osmium, chrome plate, 100% shadowgraphed, steel); Recording (sapphire, precious metal, steel)
List Prices: 10c. to \$7.50
Export Manager: Jesse French III

Duotone Company, Inc.

799 Broadway, New York 3, New York

President: Stephen Nester
Secretary and Treasurer: V. Daniels
Sales Manager: William A. Boeger, Jr.
Trade Names: Duo Chrome, Duodisc, Duomatic, Duotone, Duropoint, Filter Point, Lifetone, Miro Point, Regent, Star Sapphire, Van-Eps, Diamond, Ruby.
Types of Needles: Playback and recording.

List Prices: 10c. to \$50.00
Other Products: Recording discs, record preserver, pre-recording fluid, hardening fluid.

The Eldeen Company

610 W. National Avenue, Milwaukee 4, Wisconsin

Officials: Harold G. Olsen and Anton M. Olsen, partners.
Trade Names: Classic Point, 50c. list price; Merit Point, \$1.00 list price; Phono Point, \$1.00 list price.
Type of Needles: Long Life phonograph needles.

Electrovox Company, Inc.

31 Fulton Street, Newark 2, N. J.
President: H. Lowell Walcutt

Secretary: R. G. Walcutt
Chief Engineer: Roy Dally

Trade Name: Walco "400"
Types of Needles: Floating Jewel Sapphire, Ruby Jewel, Precious Metal.

Flexograph, Inc.

Hamilton Building, Ripon, Wisconsin
Vice-President: H. F. Diedrich
Treasurer: G. W. Lambert
Secretary and Sales Manager: Henry K. Miller

Types of Needles: Luxuratone Century Model needle—list price \$1.50; also the \$1.00 permanent point needle.
Other Products: Record carrying cases and cabinets.

Gem Phono Manufacturing, Inc.

33 West 16th Street, New York, N. Y.
President: Jack H. Bergman
Vice-President: Robert E. Parr
Trade Name: Gem needles and Gem portable phonographs

Type of Needles: Gem sapphire and Gem ruby needles.

General Phonograph Manufacturing Company, Inc.

Elyria, Ohio
President: Allan W. Fritzsche
General Manager: John M. Dean, Jr.
Secretary and Treasurer: Carl F. Russell
Assistant Secretary and Treasurer: Ralph S. Hahn

Type of Merchandise Manufactured: Phonograph needles; Textile pins; Ice picks and all pointed goods.

International Merit Products Corporation

251 West 54th Street, New York 19, N. Y.
Chairman of the Board: Ernest T. Laubscher
President: Julius Mueller
Vice-President: Anna Mueller
Treasurer: Ernest Koller
Ass. Treasurer: Pierre Ruedin
Secretary: Harvey McCoy
General Manager Edward M. Bieber

Trade Name: Meritone.
Type of Needles: Playback and Cutting.
Other Products: Precision small screws and turned parts.

NEEDLE & ACCESSORY COMPANIES (Including Companies Offering Services To Dealers) SERVICES

Permo, Incorporated

6115 N. Ravenswood Ave., Chicago 26, Ill.
Vice-Pres. and General Sales Manager: E. C. Steffen-

Type of Needles: Long Life Phonograph Needles

List Prices:

Fidelitone Supreme Floating Point \$2.50
Fidelitone Master Floating Point 1.50
Fidelitone DeLuxe Floating Point 1.00
Fidelitone Floating Point .50
Fidelitone DeLuxe Recording Stylus 1.50
Fidelitone DeLuxe Micro-Matched Points (set of Stylus and Playback needle) 2.50

Pfanstiehl Chemical Company

101 Lakeview Avenue, Waukegan, Ill.
President and Treasurer: Henry B. Babson
Vice-President and Secretary: T. W. Merritt
General Manager: Owen O'Neil
Assistant Secretary: James A. Babson

Types of Needles: Home phonograph, coin machine, resistance pick-up.

List Prices: 50c. to \$1.50

Other Products: Vibrodamp (plastic damping material)

Distribution: In most instances Pfanstiehl needles are carried by Columbia and RCA Victor distributors, who are listed in the Record Companies section.

Putnam Needle Company

Springdale, Connecticut
General Manager: Fairchild Brown
Trade Name: Goldentone.

Types of Needles: All types of steel, brass plated, chromium plated, 100% shadow-graphed transcription, semi-permanent and coin machine phonograph needles; steel and alloy cutting needles.

List Prices: 10c. package to \$1.50 each.

Recoton Corporation

212 Fifth Avenue, New York, N. Y.
Vice-President: Herbert H. Borchardt
Trade Names: Automatic, Concerto, Superior, Supertone, Primus, Rubypoint, Supra and Symphonic.

Type of Needles: Playback and recording.

List Prices: 10c. to \$7.50

Other Products: Recording Discs

H. & A. Selmer, Inc.

Elkhart, Indiana
General Sales Manager: Jack Feddersen
Trade Names: Duo-Tone, Audar, Peter Grey Inc., Recordisc, Electro-Voice Mikos.
Type of Needle: ToneX Sapphire needle
Other Products: ToneX Recording Blanks, and Air-O Record case.

United Loose Leaf Co.

233 Spring Street, New York, N. Y.
President: Frank Trinkhoff
Secretary-Treasurer: Benjamin B. Freifeld
Sales Manager: Manuel A. Freiberg
Manufacturers of Phonograph Record Albums

Wall Kane Needle Mfg. Co.

869 Broadway, New York 3, N. Y.
President: H. Germain
Type of Needles: Steel Phonograph Needles, Brass Plated 10 Play Needles.

The Indie Index

1523 N. Hudson Street, Hollywood, Cal.
Owned and operated by: Henry Stone and Bill Darnell

Service: For \$20.00 a year the retail dealer receives: Major Index, Indie Index, Major Hit Sheet, Indie Hit Sheet, and Kiddie Index of children's records and albums.

Recordaid, Inc.

P.O. Box 5765, Olney, Philadelphia 20, Pa.
President: Alex A. Gettlin
Vice-President & Treasurer: Harry B. Gettlin
Secretary: David R. Gettlin

Service: Publishers of Consolidated Record Catalogues and other Record Dealers aids—Subscription, \$20.00 per year.

The Recordplate Company

30 North Raymond Ave., Pasadena, Cal.
President and Sales Manager: O. Morey Smith

Trade Name: Recordplates

Service: Phonograph record indexing

NEEDLE & ACCESSORY COMPANIES
(Including Companies Offering Services To Dealers)
SERVICES

labels, album labels and visible index books for home collections. Visible index books for retailer indexing, cataloguing, inventory and sales follow-up.

List Price: Record Index Book for the home complete with alphabetical Index and 150 indexing sheets \$2.95. Same with 100 Recordplates and set of Album Alphabets \$1.65.

Tunnis "One-Spot" Publishers

Oak Park, Illinois—Chicago address is 4124 Madison Street, Chicago 24, Ill.
Manager: John F. Tunnis

Service: Speedy filing, finding and selling systems for record departments. The One-Spot Record Finder, "Magic," "Disc-Hits," "Box Score," "Price Guide," "Self-Sell," etc.

A. Bitter Construction Co.

721 East 133rd Street, New York 54, N.Y.
President: A. Bitter
Products Manufactured: Record and album racks, record booths.

Garrard Sales Corporation

315 Broadway, New York 7, N. Y.
President: William Carduner
Advertising & Promotion Manager: Leonard Carduner
Sales Manager: Lee Bunting
They manufacture: The RC 60 record changer, listing at \$115.50; 201-A two-speed transcription motor, listing at \$99.00; and the V single record assembly, listing at \$55.00. Also manufacture cabinets and carrying cases for use with the above.

the sets are on the way



presenting
record retailing's series
of new phonographs, radios
and radio-phonograph
combinations

record customers will buy combinations



BY HAROLD LEVIN

Manager, Center Music Stores, Inc.

This progressive New York music retailer expects much of its future radio-phonograph business to come from present-day record customers.

It is our belief that the record and radio-phonograph industries are entering the most productive sales era that the record, radio dealer in America has ever experienced.

440

During the years of the war, the Center Music stores expanded their record business to over twice its original size and we feel this expansion is only the beginning. We have added display racks, additional shelves for singles and albums, displays for record storage, albums, carrying cases, needles and accessories and have enjoyed a rewarding four years of record and accessory business. It is our feeling that records and radio-phonographs go hand in hand and, to further this idea, we are about to modernize and extend our record section to make it even more complete.

Every alert dealer knows that his record customer will be his radio-phonograph customer as soon as the new models are released for sale and without reducing any part of the present record space. Center Music Company will carry a few lines of price-protected radio merchandise.

We are also prepared to meet the enormous radio-phonograph business with an increased supply of records, accessories and window displays, as well as inside displays of all this merchandise. We feel that this naturally leads to the association in the customer's mind of the Center Music Shop with all of the customer's needs for radio-phonographs, radios and records.

It is our intention to emphasize our present highly successful department

of children's records and to have a special kiddies' display at all times. The clientele of our stores is necessarily a transient and varied one, due to its location in the heart of New York City and Rockefeller Center. We have young people, old people, children, jitterbugs, service men and women as our customers. This wide variety of tastes is equivalent to the demands of a small store on Main Street, an exclusive specialty store in any large city or the radio, or record department in a department store in its demands upon our resources and ingenuity. With the return of larger record production and distribution, we hope to reduce our record inventory and work on a smaller basic stock. This will enable us to

follow the public demands more closely and to keep our stock up-to-date, particularly in the record field.

I feel that one of our most valuable assets is the large, active mailing list of record customers and radio repair customers which we have compiled and which is being added to daily. This mailing list makes our promotions successful and keeps our customers informed on any new merchandise in the record and radio field. We feel that every one of our record and radio customers is a potential buyer of post-war radios and radio-phonographs from our store. In turn, these same customers will come back constantly to Center Music Store for records. These frequent visits make our customers our friends.

REC-ALBUM

Registered. Patent pending.

*A Better Album
For The Trade*

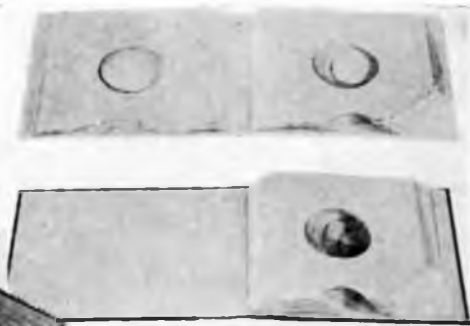
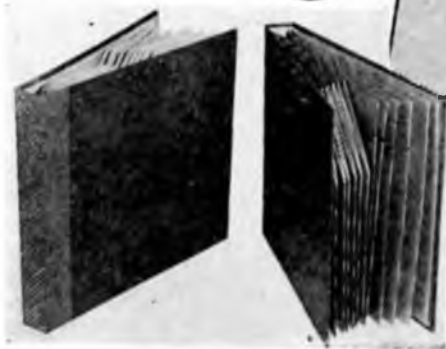

Storage and package type. New non-rip binding. Envelope of heavy craft stock, lays flat with edges recessed. Inverted safety tip prevents record from falling out. Glamorized in beautiful tu-tone standard colors and pastels. Gold stampel backs. Million production capacity.

*Inquiries & Correspondence Invited
Jobbers Being Appointed*

345 Hudson St., N. Y. 14, N. Y.

L. H. Symons Associates

know your facts before you sell

An article concerning technical innovations in the record and phonograph industry written by an expert in the field and designed to give the dealer an honest understanding of basic design and the advantages and value of new improvements.

BY R. S. LANIER

Can you make clear to your customer what a "radionic" pickup is, and how its principle of operation differs from that of other types of pickups? What actually floats in a "floating jewel tone?" How plentiful is the power in a "plenti-power" design, and what actual advantages of this feature should you sell?

The average radio-phonograph dealer, hopeful of great post-war opportunities in his business, probably regards the bewildering techni-sloganeese that is springing up in phonograph advertising as just another of the difficulties connected with his business, something he will get along with as best he can. But the difficulty is deeper than just the over-bright color used by the advertising copy writers. The phonograph, as one of the principal products of the now mighty electronics industry, is about to enter the most active period in its business history.

This means that when the cream of the post-war demand has been skimmed off, competition between firms will encourage the introduction of many new technical features, some the re-dressing of old ideas, but many representing radical changes from past practice. New ideas

and techniques are available in abundance in every branch of electronics. There is a plentiful supply of experienced engineering personnel.

This promised crowding of the field with highly competitive, enthusiastically advertised products, many of them of radically new design and untested value, will create obvious difficulties for the retail dealer, even though that business will be very profitable for him in the "right" products for a long time to come. What can the dealer do to get himself ready for this coming flood of new ideas in phonograph equipment?

One thing that the progressive dealer will want, if he does not have it already, is a basic understanding of the various techniques of recording and reproducing sound. In addition, he will certainly need an authoritative description of new equipment as it appears on the market, giving in simple, non-technical language the important facts about new and unfamiliar technical developments. To meet these very evident needs, RECORD RETAILING INSTITUTE is presenting a series of articles, which will cover both types of information. The general sec-

tions of the articles will constitute a complete review of the basic facts of phonograph technique, in the layman's language, for the dealer who wants to provide himself with a general background of technical knowledge. In addition each article will include a current review of new types of equipment as they appear on the market, telling what the new technical features are, how they differ from equipment formerly used, what the manufacturer intended to accomplish with any particular new feature. The subject of the general section of each article will be related to the specific features covered in the current review, but the material will be so arranged that the reader can use either section separately.

Simple, accurate technical information will be valuable to the dealer, not only to help clarify his own ideas about new equipment, but also to lay the basis for a sound dealer-customer relationship. There will be a great opportunity for the dealer to strengthen and stabilize his business in the future with intelligent use of "technical guidance." There are already on the market enough new things to thoroughly confuse the customer who wants to buy a genuine "post-war" phonograph. The rival claims of film, wire, tape and disc recordings; new record changers; new pickups described in radically new terms; scores of super-needles; new record materials; all these combine to bewilder the customer who wants to replace his ailing pre-war outfit. The customer's confusion is bound to become greater when the phonograph industry gets into real volume.

There is another aspect of the public state of mind, one which is loaded with danger for the dealer. The public expects marvels. After all, the modern phonograph is a branch of "electronics," that magical thing that can bounce a wave off the moon or listen to the whispers of insects. Advertising copy writers are certainly not going to interrupt their chorus of praises to give the buyer a simple explanation of what he will actually get for his money. The fact is, however, that in spite of many new things on the market, at this writing the major-

ity of the products available are pretty much the same technically as they were before the war. The full flood of technical innovations and improvements is a season or two away.

The dealer must therefore use his salesmanship intelligently with respect to the products available at this moment. Satisfaction of the simple "replacement demand" is going to keep the dealer busier than he has ever been before for a season or two, and it will not be necessary to convince the customer that he is getting some new marvel of science with every machine that crosses the dealer's counter. By avoiding the overselling of the product he now has, the dealer will also avoid the flare-back that comes later when the customer discovers that his faith in "electronics" has been traded on to sell a product very much like what he had before.

For the dealer who makes intelligent use of his technical information, there is a very positive and profitable side to the public's hope and bewilderment. The buyer's feeling of helplessness in the face of so many conflicting choices and dazzling claims will make him gravitate toward some source of technical guidance. What is more natural than for the dealer to be this source of guidance? The dealer must participate in the buyer's choices in any case, and the dealer stands to gain the most by the buyer's making satisfactory choices, choices that will keep him coming back for more of the same. The logic of this situation appears so strong that the phonograph dealer in the coming period will to some extent, whether he likes it or not, be forced into this role of technical advisor. When the abnormal, deferred demand for phonograph equipment has been satisfied and a normal competitive market returns, the dealer who has established himself as a reliable guide to new equipment will have a positive hold on his customers.

Will it be difficult for the dealer without a background of technical training to use technical information in this way? Certainly not, the dealer has a

full-time function of his own to perform and has neither the time nor the need to become a technician or engineer. The material in the coming series will be simple and straightforward, avoiding all non-understandable technical phraseology and concentrating on the basic facts that the dealer needs to know. Most phonograph dealers already have enough technical background to orient themselves toward new developments, but it is likely that they have not used their technical knowledge as a stabilizing factor in their business—the commercial situation has not required this to any extent.

An important angle that should not be overlooked in this connection is that the use of facts makes a most effective selling technique. When you have said that an outfit has a "glorious tone," the customer can make very little progress toward a definite desire for that particular instrument—every outfit on the market from now on will have a "glorious tone." But if you can describe very briefly, in simple language, the design and technical features of a machine, you have laid the groundwork for a sale. The customer is then able to visualize a number of definite things that he will get if he buys that particular machine. The review sections of the coming articles will supply accurate information as to the technical features of the new machines, in brief, simple form that should appeal to both the dealer and his customer.

444

However, in describing technical features the dealer will do well to emphasize actual results to be expected. In the future it will not be possible for long use of misleading technical jargon to dazzle the customer and arouse a spurious enthusiasm for equipment not adequate to the customer's requirements. The abundance of new devices and competitive makes will influence the public demand for equipment that measures up reasonably well to the advance promises made for it.

Right at the start, one question should be taken up that is very much in the minds of the manufacturer, the dealer, and the public—will new recording

methods such as wire and tape make the disc record obsolete?

It is possible, of course, that some time in the future the obsolescence of the disc record will become a fact. However, this event will arrive slowly and in full sight of everybody. It must be preceded by a series of large-scale, readily apparent changes in the commercial, technical and artistic set-up of the entire industry. No such major upheaval in the industry is in sight. The reasons for the continuation of disc recording are not just the commercial and technical inertia of the industry, either. The disc has a wide gap of technical superiority, for the recording of music, over other methods that have been developed. Wire recording seems to have a great psychological appeal for many people, who believe, among other things, that it would be much more convenient than the disc.

Although the quality of disc recording is now far ahead of that on wire or tape, it is certain that the latter methods will be steadily improved and will become increasingly effective. Already it is obvious that wire or tape recording is the best method for certain purposes. A later article will describe the operation of wire and tape instruments, and explain the various uses to which they can advantageously be put. For the dealer who understands what the disc can do and what wire can do, the newer methods cease to be any threat to his business. He can sell them alongside of his disc machines and records, making a net addition to his business and keeping himself in a good position to profit from any future improvements in the new methods.

The coming technical articles will concentrate on such time-and-money-saving guidance for the dealer. The articles will also take up the basic elements of a phonograph system in sequence, starting with the pickup and proceeding through to the loudspeaker. After that many of the more specialized aspects, such as home recording devices and new record materials, will be taken up. We believe that every reader of RECORD RETAILING will find the series of value and interest.

facts about automatic record changers

A well-known expert gives the dealer the information he needs to know about phonographs to answer the customers' questions.

BY R. S. LANIER

Are you ready for the "automatic period" of the phonograph? One of the outstanding facts about the post war phonograph is the development of a large number of new and improved record changers, with a price range such that nearly every phonograph, in the future, will have automatic changing. The record changer will become one of the principal "features" that the dealer will have to sell to every customer looking for a postwar phonograph. This article will discuss in a general way the various operating features that create satisfaction in using a changer, and will describe general methods of sorting out the reliable changers from the fly-by-nights that appear on the market.

The dealer is under heavy attack from two directions on changers. The manufacturers will push new types of changers, with plenty of advertising razzle-dazzle, as important new features of their post-war product. The buyer, for his part, is thoroughly alerted and on the lookout for something new and wonderful in changers. The changer is thus a natural "hot-point" of both manufacturer pressure and buyer interest.

The buyer is coming with a lively hope, but in many cases he will have his fingers crossed. That part of the phonograph-owning public which had experience with record changers in the dozen or so years

before the war, is convinced that too many changers are out of order a good part of the time, that most of them are damaging to the records, and that there is a good possibility that long-running wire or tape recording will make the record-changer obsolete anyway. The dealer has two good facts with which to demonstrate that the automatic record changer will be just about indispensable to the music lover:

1—As pointed out in previous articles of this series, the phonograph industry is committed to large-scale exploitation of disc recording for an indefinite period, several years at least, so that practically all of the music desired by the phonograph owner will be on disc records.

2—The better changers now coming on the market are greatly improved over the pre-war average, and offer a satisfactory solution to the problem of uninterrupted playing time with disc records, without damage to the records and with good serviceability.

As to the fundamental inconvenience of disc records, the public has a number of misconceptions, which will be discussed further on. Given the two facts stated above, the dealer's main problem in connection with changers comes down to this: How can he separate the record-smasher and repairman's horrors from the reliable changers, in the flood of new

models on the market? For it is plain that a certain number of the too-quickly designed and produced changers will turn out to be duds and dangerous for the dealer to sponsor.

One quick way to get an idea of the quality of a changer is to set it in operation and concentrate on the two main actions, the manipulation of the pickup and the handling of the records. Start off, for instance, by watching the motions of the pickup arm through a fair number of changes, without diverting attention to the records for the time being. Ten or twelve changes, or cycles, of this will make clear what actually happens to the pickup arm on that particular changer.

Nearly every type of changer must do approximately the same thing with the pickup. It is lowered into the first groove at the beginning of the record, lifted off the record when the music has been played, moved back out of the way while the record is being changed, and then brought back and dropped into the first groove of the new record. Thus the following rules of good pickup behavior apply to almost any type of changer under inspection:

1—Ideally, the pickup should move to a position as nearly as possible directly over the first groove, and then drop gently straight down into the groove. Because of the variation in records, complete accuracy of action at this point is impossible, and many changers put the pickup down on the edge of the record and slide it gently into the groove. Definitely faulty action would be represented by excessive "side-swiping" action which causes the pickup to jump grooves or scratch holes in the record, dropping far out on the edge of the record and never getting into the first groove, dropping inside the first groove far enough to skip part of the music and hitting the record with a whack that digs a hole.

2—After the pickup is on the record and playing, the arm should be free to move both horizontally and vertically, so that there is no drag on the record.

3—The arm should remain free of drag until the record has been completely played.

4—At the end of the record, the pickup should lift straight up, without any side motion until it is clear of the record surface, to avoid the obvious damage to both record and pickup that would result by scraping over the record surface.

5—A common fault of some cheaply-designed changers is lifting the pickup off the record before the end of the music is reached. The majority of changers today are not guilty on this count.

6—The arm should move well out beyond the turntable while the record is being changed. This may seem elementary, but a number of changers in the past, if slightly out of adjustment, dropped the record on the moving pickup arm or got entangled with it in some way.

If the arm performs reliably according to the above rules for ten or twelve cycles, the critical eye should be turned on the record-handling cycle. Pickup manipulation is pretty well standardized, but record cycles have been as varied as the human imagination could make them. Everything from a pancake-flip to a deck-of-cards reshuffling has been used at one time or another to get phonograph records on and off the turntable.

Before watching the record handling of a typical present-day changer, it should be interesting to consider some of these past methods. The automatic record changer, of course, is not a new feature: it goes back almost to the beginnings of the recording of sound. When electrical reproduction was coming in, about 1927-1928, changers for home use had been developed that were very elaborate indeed, so much so that they were strictly "de luxe" accessories, taking up as much room and costing about the same as a medium-sized juke box.

In spite of their being luxury items, however, many of the early changers worked badly. Record-handling cycles were often of a fundamentally difficult character mechanically. For instance, one widely used system started with the records in a pile next to the turntable, and moved them one at a time over the turntable, dropping them onto the spindle. This action required a precision lifting

and dropping mechanism which easily got out of adjustment, dropping records on the floor, in back of the cabinet—anywhere but on the spindle. There was a "magazine" type with a metal frame holding a number of records, which, during the cycle, moved over the turntable and slid one record into position. The records were broken in two if they stuck half-way out of the slot while the magazine moved back out of position.

A very popular system was the one starting with a full pile of records on the turntable, and using robot fingers of one kind or another to lift them off one by one, as they were played. It was not considered good taste for the customer to ask what the mechanical fingers did with the records after getting them off the turntable. The writer remembers with amusement a visit to a phonograph dealer some twelve years ago, to watch a changer of this last type. By a series of inadequately concealed diversions, the dealer avoided putting any of his own stock of records on the changer for a demonstration. It was obvious that he had reason to fear an accidental reduction in his inventory.

The transition to the simpler and better record handling of today has been accomplished by a good deal of painful experimentation. Several leading phonograph manufacturers have each used five, six, or even more types of record handling, and nearly every manufacturer of some years standing has abandoned the one he started with. This must have been very upsetting to the average executive in the industry, but it has been valuable for the phonograph-owning public. It has been established that, as of this writing, well-designed changers of the drop type have the most reliable record-handling cycle yet developed. The industry itself is endorsing this view by concentrating almost entirely on drop-changers, both in the new changers appearing and in those continued from pre-war designs.

This does not mean that every drop changer is a good machine, because some of the worst changers on the market will be of this type. It does mean that the

general discussion of the record-handling cycle can be confined, for the present, to the drop type of changer, and cover ninety-nine percent of the changers now being marketed. Machines with other types of record-handling are so few that they will be considered in the reviews of specific outfits that will appear near the end of this series of articles.

Now to watch the record-handling of the drop-changer. A full stack of records, preferably of different ages and manufacture, etc., should be put on the spindle. The great advantage of the drop-changer is, of course, that it does not move the records around from place to place: they merely slide down the spindle into playing position. Here are the most common faults of poorly designed drop-changers:

1—The post type, with the records resting on selector blades that turn to drop one record in the change cycle, is often choosy as to the thickness of the records. If the records are much thicker or thinner than the separation between the selector blades, they are apt to get caught between the blades, jamming the whole mechanism.

2—The pusher-type of drop-changer, with the records resting on a shelf in the spindle, from which the bottom record is pushed by an arm at the side of the turntable, is apt to drop two records at a time, especially if the records are thin or the center holes somewhat enlarged.

3—The post type, unless carefully adjusted, will sometimes drop the record at one post and not at the other, leaving it dangling in a position that often results in breakage.

4—Dropping the record on the moving pickup arm occurs in changers in which the cycle timing is not properly worked out.

5—The records should not be held in a position that subjects them to mechanical strain over any period of time. Records warp easily. Even the weight of the records themselves will cause warping if they are left stacked on the changer for a day or two.

6—The general mechanical refinement of the changer is pretty well indicated

by the lack of clatter, grinding, etc., during the change cycle.

7—Naturally it is better for the records themselves not to clatter and bang their way down to the turntable, striking projections in the spindle or at the side as they go down. The ideal drop is accompanied only by the “-wish” of the air cushion that lets the records down easily to the turntable.

If the changer gets the records down to the turntable one at a time through ten or a dozen cycles, without any of the listed difficulties, or any other readily apparent faults, the dealer can then begin to worry about its lasting qualities. It was their tendency to get out of adjustment that caused so many of the early changers to lose public approval. It is usually not the complete breakdown that is so irritating with the weak-kneed type of changer, but such out-of-adjustment tricks as stopping at the end of each record, or snatching the needle off the record in the middle of the music, or shutting off the motor just as the pickup reaches the first groove. Any owner of a temperamental changer can make up his own list of pet tricks of this kind and get rid of some of his accumulated exasperation in doing it.

How to get a line on the staying ability of a new changer? A radio manufacturer of the writer's acquaintance has three different changers in the homes of record-owning friends, all of whom have children. He believes that several weeks of this service will bring out any hidden weaknesses. Most phonograph dealers should find it possible to arrange, in their own shops, some such running test to cover a substantial period of service. The record booths would certainly make the test drastic enough. It might be a good advertising stunt to have a changer running continuously, during the business day, in the shop window. It would make an impressive sales argument to be told that a changer had run every business day, from nine to five, for three weeks, and still was rolling along. Naturally, somebody has to crawl into the window every 40 minutes or so to reload it, but

that's a disadvantage which seems definitely worth the trouble.

Changers that have basically sound operating design and reasonably good serviceability will still differ greatly in adaptability, convenience and refinement. This is to a great extent a matter of cost, but sometimes an inexpensive changer will be found that is more intelligently designed than the higher-cost types. Here are some points to watch for in scoring a changer on its convenience and ease in use:

1—The automatic trip which starts the change cycle when the pickup reaches the end of the record should work with all types of record groove arrangements. Many automatic trip mechanisms require some particular type of eccentric or run-in groove to operate properly.

2—The changer should stop automatically when the last record has been played. This is not a necessity, as pointed out below, but it is a great convenience.

3—Manual as well as automatic operation is convenient.

4—A great convenience is a device that resets the changer at the beginning of the cycle, when it is turned off before all the records have been played.

5—It should be easy to get the records on and off. Some changers in the past required a Chinese-puzzle type of ingenuity to load and unload records.

6—The operating controls should be simple and not so stiff in operation that it is a chore to start and stop the changer.

7—The records should be held securely in the proper position for non-jamming operation.

8—The changer should be reasonably secure against being thrown out of adjustment if the pickup arm or some other moving part is touched while it is cycling. Many older changers were extremely delicate and easily thrown off balance by interference.

9—An even-running motor is a great joy. A motor that “wows” badly, will, of course, make a changer completely unuseable. More on this below.

10—If interchangeable needles are

used, it should be easy to get them in and out of the pickup.

Some or all of these conveniences can be dispensed with if cost is a very strong consideration. For instance, the lack of an automatic stop at the end of the last record usually means that the owner must learn to jump up and turn the changer off at just the right part of the cycle so that it will be in the "beginning" position when next used. In general, lack of refinements such as those listed means that the owner must carefully learn the changer's habits and adapt himself to them, rather than having the changer adapt itself readily to his convenience.

The amount of quality that a user needs in a motor depends very much on the type of music he will play. Most of the rim-drive motors used on inexpensive changers will be adequate for jazz or other fast music. But a motor that sounds all right with jazz can raise the listener's hair and turn his stomach over with very slow violin or piano music. The way to test for such serious "wow" is to put on a record with very slow, sustained notes, and listen for any up-and-down, over-the-waves effects.

The dealer with a line of changers or changer-equipped phonograph outfits that has passed the dealer's own serviceability and operating tests, more or less along the lines of those outlined in this article, will have accumulated, in performing the tests, any number of powerful selling arguments. But there will probably be some people who, because of the hulla-baloo about the "electronic age" and especially about wire recording, will persist in regarding automatic changing of disc records as an inconvenient and obsolete system, even though it is going to be widely used in the coming years.

Such people should be asked to analyze their listening habits honestly, to determine whether or not they really want a manufacturer-selected program that goes on uninterruptedly for an hour or more.

The jazz addict would find this intolerable. The average jazz piece is 3 to 4 minutes long, and selective listening to

jazz requires a system of interchangeable units of that length. As everyone knows, the jazz fan enjoys "style" comparisons and specially selected programs, arranged from his own or his friends' collections of treasured 10-inchers. A dozen selected "hot" records on the drop changer seems like the perfect answer to the needs of the jazz fan.

The same reasoning applies to any kind of relatively short composition, whether it is a song by Hugo Wolf, a set of nursery rhymes for the children, or a satire by Danny Kaye. A one-package "program" of short pieces running an hour or more would nullify the free selectivity that is one of the principal reasons for owning phonograph records. In the writer's experience, the record fan with a collection of serious music and some like-minded friends on hand is only a little less frequent, in his trips from the record shelf to the turntable, than the jazz devotee. This "sampling of the shelf" is one of the pleasures that goes with listening to the phonograph and demonstrates how well adapted the disc record is to the enjoyment of many types of music.

With respect to the longer symphonies, choral works, etc., running up to an hour in length, the drop changer does a satisfactory job, requiring at the most one interruption in the middle of the music to restack the records. However, if the music lover wants, for example, three of his favorite symphonies played absolutely without interruption while he does household chores or stretches in a corner in an hours-long state of suspended animation, the changers now available will not make the grade. Most lovers of serious music probably want something like this from time to time, and one hope for it is that there will be records commercially available that play 10 minutes or more to each side. This is the old "long-playing" idea that failed badly in the "early thirties" for technical reasons, but is certainly feasible now. Such records, combined with present changers, should give the maximum usable program length.

basic facts of pickup design

An article of interest to all present and prospective owners of phonographs by an expert in the subject. If you are planning to buy a new phonograph, Mr. Lanier gives you the information you need to choose intelligently among the many different kinds of pickups that are now, or soon will be, available.

BY R. S. LANIER

The phonograph buyer is going to be very much concerned with new types of pickups as soon as post-war production gets into full swing. The pickup and needle together determine the performance of a phonograph in so many important ways that they can make or break it—a “wrong” needle alone will ruin the tone quality of a fine phonograph. Not only tone quality, but the seriousness of record wear depends on the design of the

needle and the parts that move with it inside the pickup. From the engineer's point of view a phonograph pickup is a complicated and difficult problem in design, and in the past many of the standard pickups have fallen short of the ideal in a number of ways.

Every pickup for use with disc records must have a needle, a small pointed member that rides in the groove of the record and is vibrated by it. It may be

450

The crystal in a crystal pickup has the inherent capacity to convert the mechanical vibrations conveyed by the needle from the record groove into electrical potential that can be fed into the amplifier and loudspeaker of the phonograph. The pickup and cartridges shown below and on top of opposite page illustrate three types of crystal pickups. This kind of pickup is cheaper to make than others, requires less power for amplification, and has good tone.



the long-familiar steel needle, or a sliver of cactus, or a tiny tube of aluminum with a sapphire in the tip—the manufacturers may call it a “stylus” or a “floating jewel” or something else—it may be interchangeable or built into the pickup—but in any case it must be there to make frictional contact with the record groove and respond to the waves in the groove.

Some people believe that certain widely advertised pickups operate without any contact with the record, using a beam of light or some magical means to pick the music out of the groove. It can be stated flatly that no such pickup will be developed, because the method of putting the music—more technically, the “modulation”—onto the record requires a direct mechanical contact between pickup and record.

However, although the pickup manufacturers cannot eliminate the needle, they can make it smaller and lighter, give it a better-shaped, smoother, and longer wearing point, and reduce the pressure with which it is applied to the record. The new pickups are definitely improved in these respects. The pressure on the needle should be as low as possible consistent with the needle's not jumping out of the groove on heavy passages or warped records; that is, the needle must have enough weight on it to make it stay in contact with the groove at every instant. Microscopic “hopping” of the needle up out of the groove, which may be completely invisible to the eye, will nevertheless increase record wear materially and cause very serious distortion of the music.

The weight on the needle can be reduced to a low value if the whole moving system in the pickup is designed with this in mind. The older types of heavy pickups are *not* designed to operate with light pressures and they will only produce distortion and record wear if a counterweight is placed on the back of the arm to reduce the weight on the needle.

Early types of magnetic pickups required five to six ounces of pressure on



the needle to track properly, that is, to keep the needle in constant contact with the groove. By 1940, the standard commercial pickup—a crystal type—operated with two ounces or less of pressure. The new post-war pickups are designed for even lighter pressures of an ounce or less. The very expensive moving-coil type of pickup, used in broadcast stations and special installations, has for a number of years used very small needle pressures, as low as a few grams.

The needle by itself affects tone quality and record wear. The point must be perfectly smooth and round and must fit the groove reasonably well. With interchangeable needles, this is achieved by having the record grind the needle down to fit. With semi-permanent needles like the popular sapphire, it is important to make sure that the point is perfect, as a chipped, cracked, or badly-shaped point is a killer on records and produces scratch and distortion.

By making the needle flexible in the middle, various tonal effects can be achieved. The principle of the needles that “filter out” scratch is simply that the high frequencies bend the needle, without moving the parts connected to the top of the needle. This gives a quieter, more mellow tone, but one lacking in the high overtones of the music. Other needles bend in such a way that a narrow band of high frequencies is emphasized strongly. The technician says that such needles have a strong “peak” in the highs. This matter of needle bending is technically complicated, but the phonograph user can handle it effectively by using his ear. If the tone quality on a certain machine is too soft and lacks sharpness for the listener's

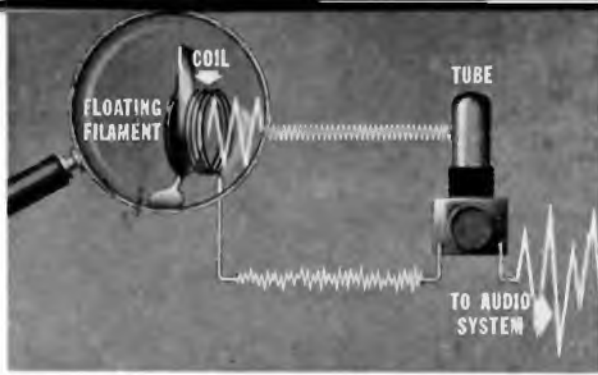

"Radionic" pickup: Vibrations in vane attached to needle produce change in action of adjacent coil, which causes transmitting tube in amplifier to which it is connected to produce the electrical impulses.

taste, it is possible that a filter-type needle is the cause. On the other hand, if the tone is too sharp and edgy, with distortion in the high frequencies, a "peaking" needle can be the cause.

A most important pickup characteristic that vitally affects both record wear and tone quality is the resistance of the needle system to sideways motion, known technically as the "needle impedance." This can be understood if we remember that the needle and parts connected with it do not move completely freely in the pickup, but are "springy": it takes some pressure to push them to one side. In addition to the "springback" of the needle system, there is the weight of the needle itself, which strongly resists being vibrated rapidly by the groove. This is not the pressure on the needle from the weight of the pickup arm, but the actual weight of the needle and parts associated with it, as if they were removed entirely from the pickup. A phonograph needle may seem like a very small object with negligible weight, but when it must be pushed from side to side as rapidly as 5000 times or more each second, the inertia becomes a large force working

against the record groove. An idea of the effect may be gained by imagining that a block of metal weighing 100 pounds is suspended from the ceiling on a rope, and that it must be vibrated from side to side as rapidly as possible with a hand on each end.

The spring in the needle system, plus the weight of the needle and other moving parts, combine to form needle impedance, which should be reduced to the lowest possible value for low record wear and realism of tone quality. A simple way of saying this is that the needle should resist as little as possible being pushed sideways by the groove. Low needle impedance is one of the most important advantages that an improved pickup can have.

The quick way to get an approximate idea of the needle impedance of a pickup lies in the fact that low pressure on the needle requires low needle impedance to go with it, if the pickup is to track properly. That is why pickups, like some of the post-war types, that are designed to operate with less than an ounce of pressure, are definitely improved over

452

The "radionic" design, light and compact in construction, is ideal for use in automatic record changers like the post-war model above.



The magnetic pickup works on the same principle as a generator: a wire is moved in the vicinity of a magnet, creating a current of electricity in wire.



former types: the needle impedance must be fairly low.

The needle and mechanical parts that vibrate with it can be considered the first basic element in any phonograph pickup. The second basic element is a device for transforming the mechanical motion of the needle into corresponding electrical impulses.

What have these electrical impulses coming out of a pickup to do with the music as originally recorded? Starting with the original sound, say a middle C, there is a back-and-forth motion of the air which repeats itself 256 times each second. On the revolving record, this is represented by a wavy groove, with the microscopic waves in the groove so spaced that 256 of them pass any given point in a second. The needle, following the twists in the groove, moves from side to side 256 times a second; and the electrical energy in the pickup rises and falls 256 times each second.

Thus, while a sound in the air, a groove on a plastic record, a vibrating needle and the rising and falling of electricity are all entirely different things, they have one characteristic in common—the motions they make all take place at 256 times each second. It is a purely mathematical relationship, one which can be applied to the better understanding of any part of a sound reproducing system.

There are literally dozens of ways in which mechanical motion can be transformed into electrical pulsation, and several of the new pickups differ from older types in that they use transformation methods formerly unknown in

any phonograph pickup. Before the war only two methods of turning the needle motion into electricity were generally used, the magnetic and the crystal. The principal exception was the famous photo-electric pickup developed by Philco. The basic principles of these three types will be described.

The magnetic pickup works on the same principle as the generators used in a power plant: a wire is moved in the vicinity of a magnet, creating a current of electricity in the wire; or the magnet can be moved with the wire stationary, to give the same effect. The first pickups used on electrical phonographs, the older "moving iron" magnetic types, had a stationary coil of wire, a magnet, and a flat piece of iron, the "armature," attached to the needle. When the needle vibrated, the armature moved with it, in effect shifting the magnet with respect to the coil, and creating electrical impulses in the coil.

The "moving coil" type of pickup construction, in which the magnet is stationary and a tiny coil is attached to the needle so that it vibrates with it, is used in the finest pickups made today. Such pickups are found in broadcast stations and in special custom-built installations, but they are usually far too expensive for standard home phonograph use.

The crystal pickup, which became general about 1937 and had just about eliminated the magnetic type on home phonographs by 1941, owes its popularity to three main factors. First, it is much cheaper to build than a magnetic type of comparable quality. Second, it

gives a greater quantity of electricity, with lower pressure on the needle, than does a moving-iron pickup. This is important to the manufacturer because it reduces the cost of the amplifier in the phonograph; and it also appeals to the buying public because it offers a reduction in record wear.

The third factor in the popularity of the crystal is its characteristic tone quality, which has been found to appeal to a large section of the public. It is unquestionable that a great many people, when they speak of a "glorious tone," mean a great fullness in the mid-bass range. The crystal pickup, when used on commercial records of the present type, can easily be arranged to give such a tone quality.

The principal of operation of the crystal pickup is very simple. The back-and-forth motion of the needle twists a thin slab of mineral, usually a Rochelle salt crystal, which is attached to the needle at one end and fastened into the pickup head at the other end. Any bending of crystal substances of this type produces an electric potential in the crystal which corresponds to the amount of bending, and which can be fed into the amplifier and loudspeaker of the phonograph. The outfits announced for post-war sale indicate that the crystal pickup will continue to be very widely used.

Philco's "beam of light" pickup used the photocell, familiar as the sensitive element in beam-of-light door openers, etc., as the means of converting the needle motion into electrical motion. The light is used between the vibrating "stylus"-type needle and the photocell, and not to pick the music out of the groove, as many people supposed. The needle has attached to it a tiny mirror, which reflects the light from a bulb in the pickup head onto the photocell. When the needle moves, turning the mirror rapidly from side to side, the light beam sweeps across the photocell, which produces electrical impulses corresponding to the motion of the light beam.

Post-war pickups use several new conversion methods. Here are the basic operating principles of some of them:

Frequency Modulation (FM) Pickup:

In this system the phonograph has in it, as a part of the amplifier, a very tiny FM transmitter. The pickup includes two small plates very close together, one of them attached to the needle. The two plates are electrically connected into the circuits of the FM transmitter, or "oscillator." When the needle moves, vibrating one plate next to the other, the oscillator sends into the phonograph amplifier and loudspeaker electrical impulses that correspond to the motion of the needle. This type of pickup is also known as a "condenser" pickup, because the two plates form an electrical "condenser," one of the most common elements used in radio circuits.

"Radionic" Pickup:

This pickup is similar to the one just described, in that the amplifier includes a small transmitter, or oscillator, which in this case operates on "AM" principles. In the pickup a round, flat vane is attached to the top of the needle, and a small coil of wire is placed next to the vane. The coil is electrically connected to the oscillator. When the vane vibrates with the needle, it produces a change in the action of the coil, and the oscillator produces corresponding electrical impulses.

Strain-Gauge Pickup:

This pickup gets its name from an instrument used in industry to measure the bending of steel beams, etc. In "strain testing" a small piece of special wire is stretched between two points on the surface of an object. If a current of electricity is sent through the wire, it will register the smallest changes in the amount of stretching of the wire. In the pickup, the wire is stretched across in the front of the pickup head, and the needle is connected to the middle of it through a lever system. When the needle moves, the wire is stretched alternately one way, then the other, in time with the needle motion. The electrical current

in the wire varies to follow the motion of the needle.

The examples given should demonstrate how confusing the subject of pickup design, and especially the relative merits of different designs, is going to be. There are an almost unlimited number of ways of building a phonograph pickup, and it seems that many of them are going to be tried by firms seeking to maintain or create a favorable market, in what promises to be the most competitive period in phonograph history. Obviously a manufacturer develops a pickup not only to improve performance, but also to supply his advertising department with an exclusive feature on which to hang a sales campaign.

The phonograph fan seeking a new outfit can avoid getting bogged down under the complications of the new pickups if he remembers that every pickup has the two elements that have been discussed: a vibrating needle which is in

contact with the record, and a device for transforming the needle vibration into electrical impulses. Furthermore, there is no "wonder" method of building a pickup which will automatically produce a super-instrument. The quality of the pickup depends on how well it is built; no pickup can be any better than the care which went into its construction.

Every pickup, no matter how complicated, must start with a vibrating needle and must in the end produce exactly the same electrical impulses as any other pickup, from a given record. The way to judge a pickup, therefore, is by the overall electrical result, rather than by the cleverness of some feature of the construction. Although the phonograph user probably has no ready means of testing the electrical performance of a pickup, he can classify it quite accurately from the manufacturer's specifications and by careful listening. Here is a set of basic mechanical and electrical

Keyed components of a pickup assembly. 37—Pick-up arm assembly, complete with crystal cartridge, lead, all cushions, guide bracket and cam assembly, but less phono needle. 38—Same as 37 except less crystal cartridge, cushions and pick-up lead. 39—Arm, pick-up. 40—Pick-up shaft and cam assembly. 41—Pin, pick-up arm hinges pick-up to cam. 14—Clip, cartridge retainer. 34—Pad, cartridge (small). 30—Needle. 10—Cartridge, crystal. 42—Pin, cartridge locating (rubber). 35—Pad cartridge (large). 16—Cushion, pick-up arm. 15—Clip, retainer. 57—Rod, pick-up (for elevating pick-up). 68—Screw, steel (lateral adj. lock screw). 93—Washer. "C" spring (lateral adj. screw retainer). 73—Screw, adjustment (lateral adj.). 8—Cable and pin terminals assembly.

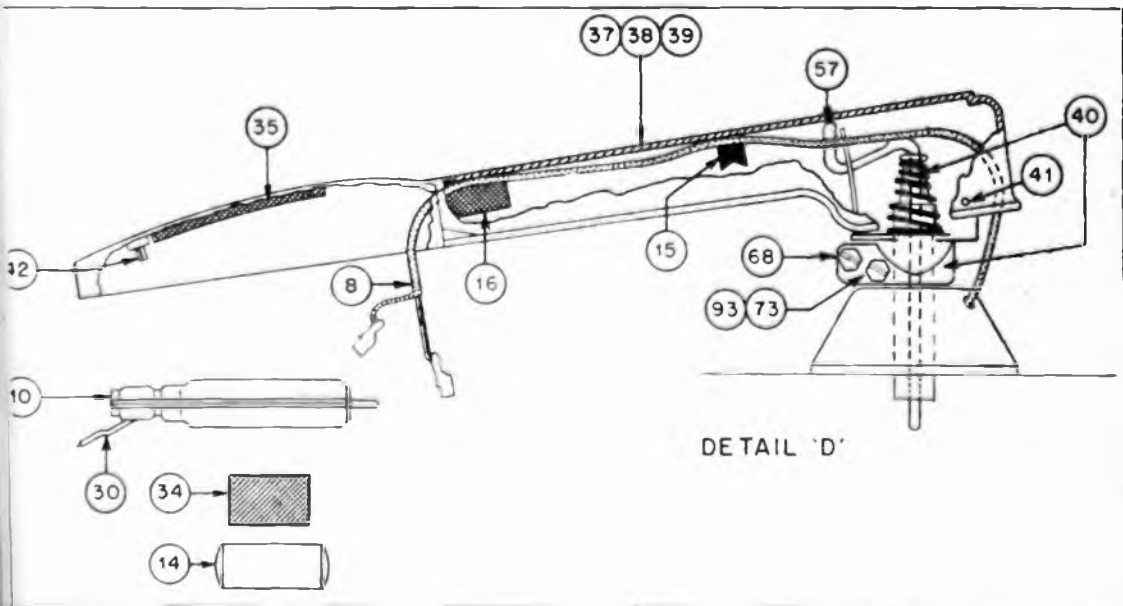

specifications that apply to any pickup, with a discussion of each in terms of actual listening results:

Needle Pressure: As discussed above, it is desirable that a pickup be designed to operate with an ounce or less of pressure on the needle, as this indicates that the needle impedance is fairly low. Several of the new standard pickups meet this requirement. Because of the importance of needle pressure in the operation of the pickup, the operating pressure of a new pickup should always be ascertained.

Frequency Response: No subject is more fervently discussed in phonographic circles than the frequency response of the various pickups available. Plenty of high-fidelity "experts" are eager to explain why one instrument or another is the only decent one to be had because of some marvelous quality in its frequency response. The question of a desirable frequency response is technically complicated and is full of pitfalls for any person except the engineer who has had experience in testing pickups in the laboratory. However, the ear is a really excellent instrument—and one not used by many of the amateur "experts"—for indicating the frequency characteristics of a pickup. With an understanding of the simple, fundamental facts of the subject, the phonograph buyer can use his ear to get a very good idea of the general frequency response of a new pickup.

456

Theoretically, a pickup should reproduce all the notes that can be heard by the ear, that is, it should operate over the whole tonal range from about 15 cycles per second—a note about four octaves below middle C on the piano—up to the extreme overtones at 15,000 cycles. However, such a wide-range pickup is difficult and expensive to build and there are many reasons why a manufacturer wishes to cut the range of a pickup.

In the first place, the records made today do not contain tones in the very highest range, and a pickup sensitive

above the top frequency on the record merely gets more scratch and noise, without improving the music. The buying public has reacted strongly against such pickups. Secondly, tests have shown that most people find that music sounds fairly good if 4,000 cycles is the top frequency, that it sounds quite good with a 6,500 cycle top, and that it sounds practically perfect with a 9,000 cycle top.

Thirdly, if the high frequencies are cut down, any distortion present in the record, or that might be produced by the needle or pickup itself, is greatly reduced, "cleaning up" the reproduction. Under many conditions which are common today, a pickup with quite "poor" high frequency response gives very much better, clearer tone than one of better design in this respect. Of course, as other aspects of phonograph tone quality are improved, especially as scratch and distortion from all causes are brought down to very low values, the extreme high overtones that are not useable now will become important, and it will be possible to approach the ultimate ideal in realism.

The many people who prefer the soft, mellow quality will choose by ear a pickup that does not reproduce extreme high frequencies. On the other hand, persons with wide knowledge of music, especially those trained in playing an instrument, are likely to want the added "realism" and sharpness that the extreme high tone gives.

Let's see how this works out in two hypothetical cases, as applied to two pickups, one with about the minimum and the other with the maximum range of frequency response useable with present-day commercial records. The actual figures on the range covered in each case have been obtained from the manufacturer or other reliable source of information. Such figures must be used with a certain amount of caution, as different manufacturers are apt to interpret the tests of their pickups in somewhat different ways, but the figures are good general indications of what to expect.

Here is how the figures tie up with actual "ear testing":

Pickup A—(For the person who wants mellow tone). Frequency Response, 100 to 4,000 cycles. The mid-bass will probably be strong and full, but very low notes will not be reproduced or may tend to sound alike, merging into a boomy sound without definite pitch. Tone is soft and nearly all records will play without scratch or distortion of the high notes.

Pickup B—(Wide Range type). Frequency response, 40 to 9,000 cycles. Bass probably sounds less "heavy" than with pickup A, but has a more definite quality in the 2 octaves below middle C. Tone is very sharp and very high notes may have a slight edgy quality. All the instruments sound "truer" and more realistic; the high notes of violin and flute, for instance, are clearly differentiated; a kettle-drum note has a very sharp "struck" quality as well as a "boom"; the bowing of the string instruments has its characteristic "pull." Although from one point of view Pickup B is a much better instrument than Pickup A, remember that many records may not be playable on Pickup B with any pleasure at all to the listener, but they may sound quite pleasing on Pickup A. This applies especially to old, worn, or badly warped records, or those with extremely loud high notes near the center of the record.

A particular set of records should be used for testing all new pickups. These records should have some passages for (1) bass tuba or double-bass in which the customer can hear the bass climbing down note after note without merging into a boomy roar; (2) some spectacular tympani work, including snare drums, triangles and other percussion instruments. The unexpected sharpness of percussion sound is a very convincing demonstration of "high-fidelity" response.

The above descriptions apply, of course,

to the effect of the whole phonograph, including the amplifier and loudspeaker, and not just the pickup alone. However, in most cases the pickup quality determines that of the whole instrument; no phonograph can be substantially better than its pickup. The part the amplifier and loudspeaker play will be discussed in the following articles.

Distortion: Distortion has been mentioned as being on the records or arising from the needle or pickup. Electrical distortion, which is unfortunately present in many pickups, exists when the electrical pulses coming out of the pickup are not precisely "in time" with the needle vibration. Only an engineer with a well-equipped laboratory can actually measure distortion, but its effects are apparent to the ear. If the records and needle are known to be good, and the volume is turned down rather low, any remaining distortion such as muddling on heavy bass passages or unpleasant harshness of the high notes is probably pickup distortion.

One of the most important superiorities of the fine pickup is the low level of distortion that can be achieved in a carefully made instrument. Low distortion plus wide-range of frequency response produces the ultimate in realism of tone, together with a pleasing "easiness" and clearness; there is no harshness or other unpleasant quality to the tone.

Very inexpensive pickups are bound to produce rather large amounts of distortion. Such pickups are most often found on the less expensive record players, and are used with small radios that do not pass frequencies above 3,500 or 4,000 cycles, so that the high-frequency "harshness" may not be present; but there is a strong tendency of small, light pickups to "go to pieces" on heavy bass passages. This is a clear case of cost-vs.-quality.

relating record and combination sales

In this article, the author tells how to sell records to the combination customer in order to keep him coming back for more.

One of the happiest thoughts that the record and radio-phonograph dealer can have today is the one that tells him that records are, to radios and radio-phonographs, what razor blades are to razors—they make the large sales figures which we are all looking for. It is a fairly simple job to sell records to the purchaser of a new radio-phonograph, but are you selling as many records at the time of that first bulk sale as you should?

One of the major chains of music houses in the middle west has an arrangement whereby every radio-phonograph sale has a required record sale which the radio salesman must make. To this end, the music store has developed a series of record combinations containing both single records and albums and ranging in price from \$25.00 for the group to \$200.00. This has proven extraordinarily successful in both increasing combination sales and in making the customer happy.

The average person who is buying a radio this year and next, after the absence of radios from the market for over four years, has indicated from answers to surveys that seven choices out of ten will be for a radio-phonograph combination. It is with this in mind that every progressive radio dealer, whether he has handled records before

or not, has already stocked or is planning to stock phonograph records in his radio store.

You can plan to assemble a library of music for the average radio-phonograph buyer which will contain popular and light classical selections and a few well-known classical albums. Give your customer an opportunity to choose a certain dollar amount of popular records in addition to the albums which you have selected as part of the combination. Give him the same privilege for light classics and classics. A customer will always think in terms of a round figure if guided by a skilled salesperson. Set up your own thinking in some concrete form such as, this radio-phonograph combination costs so much plus a certain dollar amount of records. This can be presented to the customer in a package. Place the console radio that you have in mind, or the table-top radio, beside or on top of a record album cabinet containing a complete and varied selection of records, and tie those sales in together with a sign which says: "Phonograph-radio, so much; cabinet complete with records, so much; total—complete entertainment for your home, so much."

Records have the happy faculty of bringing your original customer back into your store on almost weekly visits

for new record merchandise. On one of those visits you can probably sell him the secondary radio or combination set for his rumpus room, his kitchen, or his bedroom. When this happens, don't forget once again, records have been the bait that brought him back for the second and perhaps the third sale. Make your permanent record customers constantly conscious of new merchandise by frequent mailings of news about records. Every record customer that comes in is a potential radio-phonograph customer—get his name and address—put him on the mailing list. You not only establish yourself as an accommodating and alert dealer, but when they think of radios or records, those people will think of you.

We will assume that you have furnished your store with as modern and complete equipment for display purposes as is possible and that fixtures for both single records and albums are carefully placed for the best effect. Is your sales force trained to suggest other records and record accessories for plus sales with every inquiry for a single record or album? Is at least one of your windows devoted solely to records and radio-phonographs? Are you using all the dealer-helps which are sent to you by the phonograph record companies in order to keep new titles and new artists before the eyes of the public?

Effective advertising in local newspapers need not be excessively expensive. A small box ad with clever copy placed in the same position daily will remind your record customers, and all others who buy records, of your store and of your imaginative selling. Make it a plan to highlight not only new releases but certain types of music or certain well-known artists when they are in your community, with window displays, and ads in papers. If you plan a promotion well ahead, your distributors will be glad to cooperate in an advertising program and in helping you to build displays, etc. Every enterprising dealer who succeeds in moving goods is of great interest to a distributor. You can get all kinds of coopera-

tion if you make an effort first. Try it.

In stores where Class A merchandise is sold almost exclusively, it is an excellent plan to have a fine machine loaded with excellent music which is of a soothing rather than a disturbing nature, playing constantly in the background. After all, you are selling music and the means of listening to it, and when your customer enters your store, he should become instantly aware of this. Keeping the customer record-minded is a comparatively simple business. Your distributors keep you record-minded by constant direct-mail and dealer-helps. Pass on this information and material to your customer.

The way to increase sales is to go after them. The way to make people buy things is to make them want them.

Selling records is a form of selling entertainment and as such is a form of the show business. The show business is full of imagination and color and exciting exploitation of material. All these tools are at your hand if you will use them, if you intend to increase your dollar sales volume in a way to make you one of the successful dealers in radio-phonographs and records, in your community, you will have to use every one of these devices mentioned. In the long run however, any advertising which you do will be successful only because you have done it repeatedly. The reason that your windows will be watched is because you have changed them constantly, and the reason that people will come into your store rather than someone else's is because they know that you are record-minded all of the time. If there is something new, you not only have it but you tell them about it as well.

You're in the advertising business, as well as the retail radio and record business! A lot of people are going to sell radios and records—but if you want to be the man who sells the most and stays the longest, you'll have to make your community conscious of you and your store every week in every possible way.

L. G.

**representative
models of
radio-phonographs**



admiral

Admiral, which has been doing one of the outstanding jobs of preparing for the post-war set boom through consumer advertising and dealer aids (such as its Flex-o-Plan for store modernization) is getting ready with an extensive line of radios, combinations and television sets, all of which they expect to have ready for the market in quantity and very shortly.

Admiral officials look over one of their new television models.



ansley

The Salem, the Normandy and the very modern Skyline are among the many attractive Ansley offerings. Models such as the Salem are in their line of "Period Dynaphones," and those that are design companions to the Skyline are known as "Modern Dynaphones."

All are radio-phonographs, with automatic record changers

The Salem is in the American Colonial style and is made in pine mellow brown finish.



arvin

Promising top-flight promotion to help push its "Top-Flight" line of combinations and radios, Arvin is already pre-selling for "upstairs, downstairs, all through the house—outdoors, too."

Said to be the finest Arvin built is this ten-tube, 3-band including FM, super-heterodyne console. In grained walnut.



capitol

Capitol's three-way portable Model U-24 features both electrical and mechanical hand wound motor, amplifier operating on either alternating or direct current or battery; permanent Alnico No. 5 magnetic type speaker. Plays three ten-inch records with one winding.



Model T-13 is table-top designed phonograph 16" x 14" x 8" of solid walnut panel construction. Constant speed motor. Plays 10—12" records with lid closed. Electronic pick-up is designed to minimize surface noise.

capitol

Model D-17 is dealer's demonstrator free of complicated gadgets, tamper proof and built for constant use. Bass boost feature enables listener to hear deepest tones when machine is operated at minimum volume. Designed to accommodate special equipment for remote transmission in auditoriums. Solid walnut construction contributes to acoustical clarity.



crosley

Crosley holds its place among the top radio and phonograph makers by incorporating such features as the "Floating Jewel Tone System," Seeburg "Single-Control" record changers, modernistic cabinets, master tone control and automatic record stop after the last record.

Console combination features Seeburg "Single-Control" record changer, automatic sensitivity, "Floating-Jewel Tone."



466

A new De Wald table model combination radio-phonograph, with fully automatic changer.

The De Wald "Connoisseur," a radio-phonograph combination with fully automatic record changer will be one of the major items in the old New York radio manufacturing concern's line of table, portable and console sets. Features of the "Connoisseur," in addition to the automatic changer, include self starting phono-motor, lightweight pickup, walnut cabinet with special wood inlays, and an electro-dynamic speaker and tone modulator

emerson



*One of many Emerson post-war portables
is this attractive "carrying case" set.*

*Complete with photograph, including automatic
changer, this Emerson set
presents many interesting possibilities.*





466

A new De Wald table model combination radio-phonograph, with fully automatic changer.

The De Wald "Connoisseur," a radio-phonograph combination with fully automatic record changer will be one of the major items in the old New York radio manufacturing concern's line of table, portable and console sets. Features of the "Connoisseur," in addition to the automatic changer, include self starting phono-motor, lightweight pickup, walnut cabinet with special wood inlays, and an electro-dynamic speaker and tone modulator



emerson

One of the many Emerson post-war portables is this attractive "carrying case" set.

Complete with phonograph, including automatic changer, this new Emerson set presents many interesting possibilities.





466

A new De Wald table model combination radio-phonograph, with fully automatic changer.

The De Wald "Connoisseur," a radio-phonograph combination with fully automatic record changer will be one of the major items in the old New York radio manufacturing concern's line of table, portable and console sets. Features of the "Connoisseur," in addition to the automatic changer, include self starting phono-motor, lightweight pickup, walnut cabinet with special wood inlays, and an electro-dynamic speaker and tone modulator



emerson

One of the many Emerson post-war portables is this attractive "carrying case" set.

Complete with phonograph, including automatic changer, this new Emerson set presents many interesting possibilities.



farnsworth

With 17 years of experience in building quality record changers and circuits, Farnsworth Television and Radio Corporation presents its 1946 line of portables, table models, and consoles. The portables feature a wire-wound loop Bilt-In-Tenna in the door of the receiver providing directional pickup when the receiver is rotated to the point of best reception from any individual broadcasting station. Console combinations have de luxe 3-point suspension record changers.



Farnsworth's 8-tube combination has phono-compensated circuit for quality record reproduction, 3-point suspension record changer, drift-corrected tuning.



Six-tube combination has 3-point suspension changer, light weight tone arm with sealed crystal pickup and permanent stylus, moving dial with illuminated lucite pointer.

farnsworth

The Farnsworth line covers portables, table models, consoles in many cabinet combinations but the company feels that its 17 years' experience in building quality record changers and circuits puts it in an advantageous position for coming combination sales.

EK-264 in walnut has 6 tubes, 3-point suspension record changer, lightweight arm, sealed crystal pickup and permanent needle.



freed-eisemann



Handsome styling and finish of the Sheraton model radio-phonograph symbolize the policy of the Freed-Eisemann Radio Corp., which has always been to substitute superior craftsmanship and artistry for mass production.

garrard

The new Garrard Model RC60 Record Changer is a radically improved design, incorporating all the scientific developments and technical knowledge acquired during the past five years. Outstanding feature is a "Mixer" changer which will play intermixed record sizes without adjustment.



The Garrard Automatic Record Changer has a governor-controlled, speed-regulated motor. It plays 10- and 12-inch records, and features an exclusive non-slip spindle, and trouble-free motor. Another feature is the choice of pick-up ranges, which will satisfy music connoisseurs who demand true wide-range reproduction, as well as customers who prefer the mellow tones of the lower frequency range.

gilfillan

The Gilfillan line of radio-phonograph combinations is striking because of its attention to modern design in cabinet exteriors, record changers, recording devices and circuits. As shown below, the ultra-deluxe Adam has pullout drawer, front tuning, light simply-styled cabinet.

13-tube Adam has automatic record changer, recorder, FM-AM receiver.



hoffman

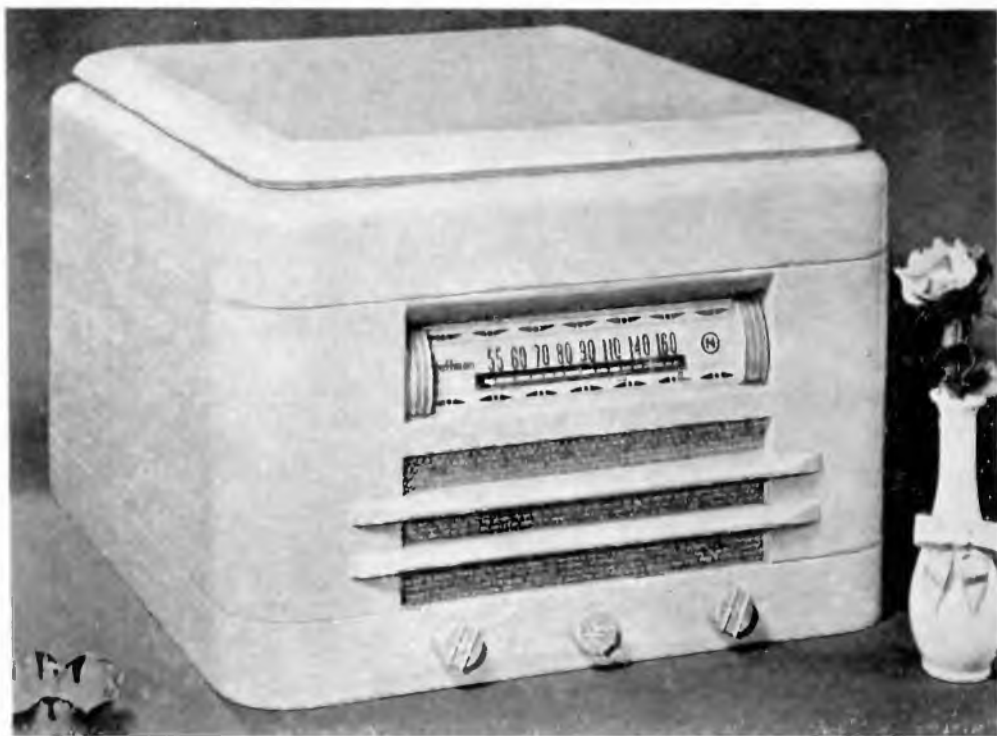

The "Avalon" table model is modernly styled compact radio-phonograph combination with improved automatic record changer. Plays 12-10" or 10-12" records utilizing feather-light crystal pickup and permanent sapphire needle. Radio has 6 tubes (including rectifier). Built-in loop antenna. Comes in mahogany, walnut or blond finish.

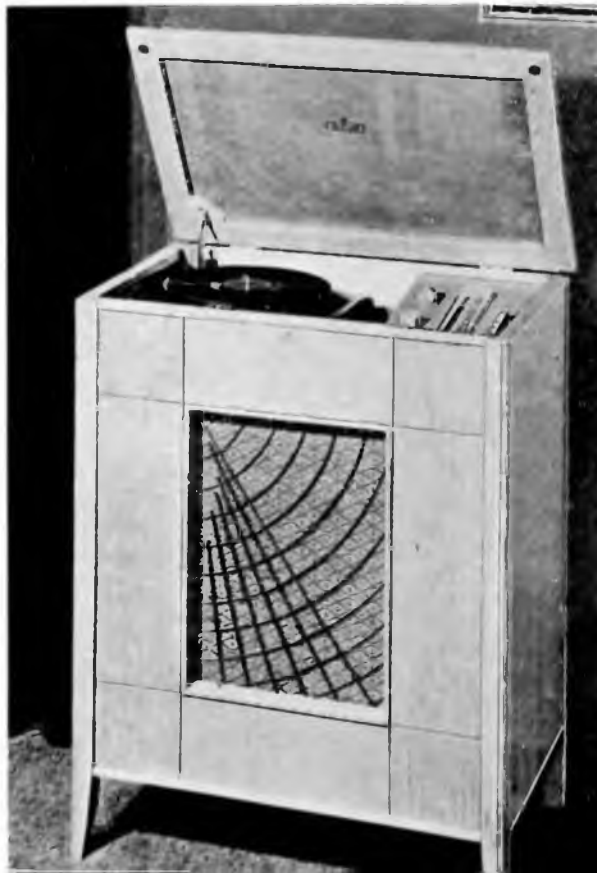

The "Shasta" radio-phonograph console combination embodies styling for modern home or apartment. Includes radio facilities as described in above model including 3-gang variable condenser with tuned radio frequency amplification and new 10" speaker. Styled in mahogany, walnut and blond finishes.

lear



This 5-tube, AC-DC set with automatic volume control is available in mahogany or ivory. 14-tube console has FM-AM, record-changer, Lear wire-recorder, push-button control.



magnavox

Continuing with its most popular market-tested models, the Magnavox combinations and radios combine simplicity of style and high engineering standards to bring to the dealer a line that embodies many fine points. Finishes are clear and transparent in mahogany, walnut and oak; record changers are simpler with fewer moving parts; radios incorporate a "frequency response balance" which is said to compensate for some of the deficiencies of AM reception.



Magnavox Chairside has radio and phonograph controls within easy reach; 9-tube receiver; 6-station push-button tuning

magnavox



This console has transparent finish featured by Magnavox; FM receiver is optional.

Built-in loop antenna is included in combinations like this although outside or attic one is urged for best performance.



meck



The "Palm Springs" is a leather-encased portable type of phonograph designed for Meck by Barnes & Reinecke.



Large deluxe console combination (Louis J. Wronke design) as record changer that flips discs over.

meissner

Meissner has put great emphasis on tonal reproduction in its new line of combinations. The multiple speaker system incorporated into these new sets features a "woofer" or 15-inch main speaker for bass tones, a pair of high frequency units for upper limits. Other important features are the eight-key tone control, automatic record changer for two hours of playing, FM and super short wave.

The "Century" is simple and modern with lucite pulls on ivory leather panels.



meissner

The Meissner Sheraton cabinet is classical and houses radio-phonograph combination.



motorola

Experience gained during the war is proving invaluable to Galvin in designing and building new Motorolas with a new patented record changer and a pickup that gives super-accurate record reproduction.

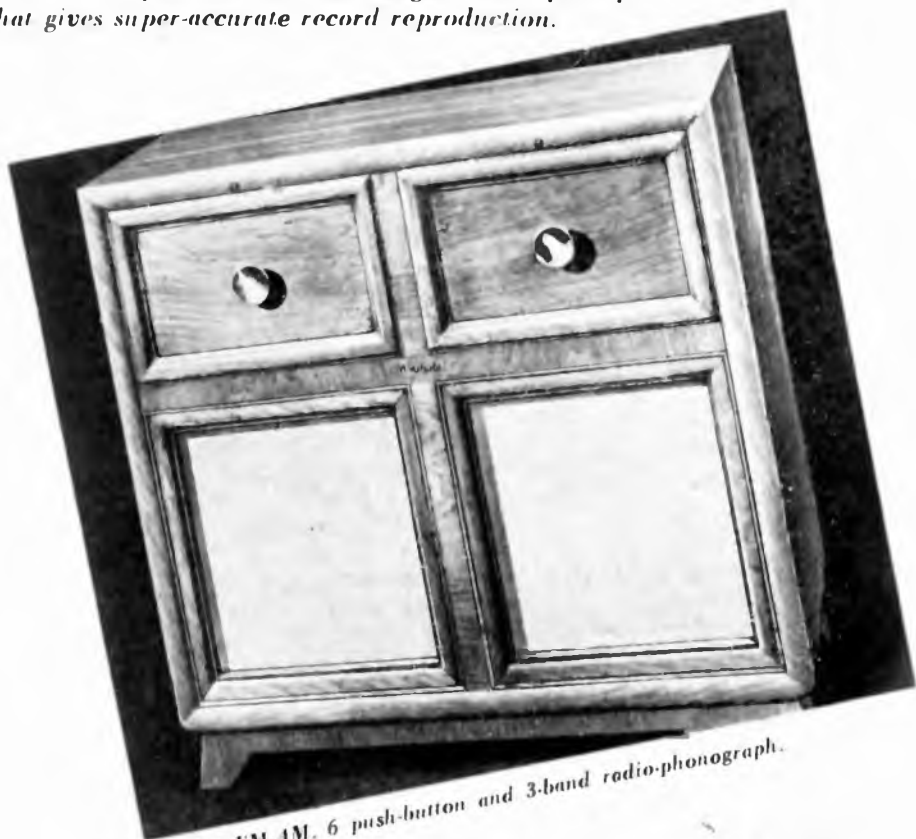

An FM-AM, 6 push-button and 3-band radio-phonograph.



Wireless record changer plays through any radio without wires or other attachments.

musitron

Widely known to servicemen with whom it was used for instruction and entertainment, the Musitron portable phonograph is now being offered to the public in several models. They are specially designed to achieve high fidelity tone and performance hitherto unknown in such small instruments.

Newly-developed Astatic pickup, 6½" speaker, 1-tube amplifier, and outside controls are features of the model "PX."



A lightweight (19 lbs.), high fidelity portable, the Musitron "Piccolo" has a 3-tube amplifier, a 6-inch speaker, and plays even 12-inch records with the lid closed.

philco



Really new is this automatic Philco record player which only requires that the record be put in slot as shown. Takes ten or twelve inch records; has permanent needle, built-in antenna, five tubes.

482

Philco has made news in the radio and phonograph industry. Recently it announced plans for the future which encompass several entirely new features; its post-war line will carry 43 radios and radio-phonographs; it will manufacture four million sets in 1946, twice as many as ever before; it has spent seven million dollars on reconversion; it is introducing a new FM circuit said to eliminate all noise and simplify tuning. The sets themselves are new in many ways such as the record slot table model shown below in which the process of playing a record is completely mechanical except for putting the record in the slot, something a four-year-old child can do.

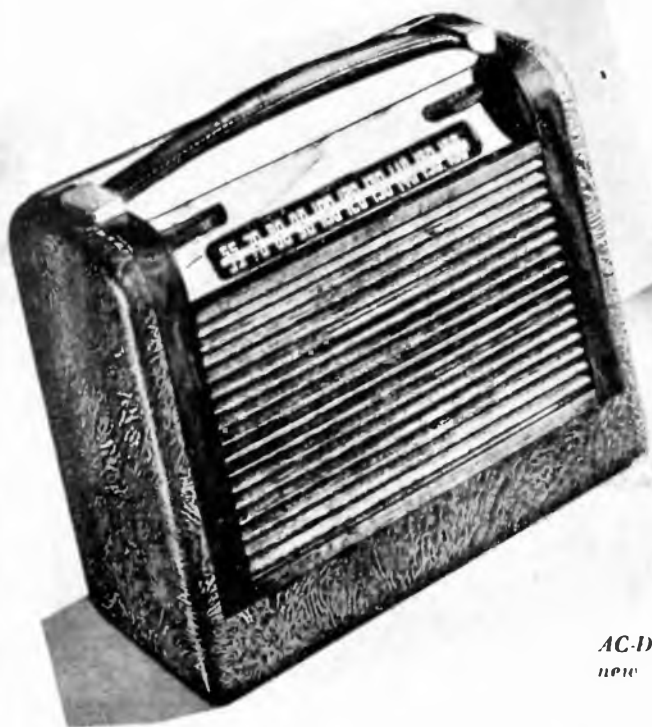

philco

*AC-DC battery model with
new super-het circuit.*

*One of six custom-built Philco models, this automatic radio-phonograph
has 11-tubes, FM-AM circuits, new motor tuning device.*



philco

Always one of the leaders, Philco offers an extensive line of all types of radios this year. Featured improvements are an advanced FM circuit that "actually ignores noise," two newly developed record changers; and the dynamic reproducer, a tone arm copied from the expensive, high fidelity type used in broadcasting studios.



Philco's Sheraton. 14-tube console featuring the new advanced FM system, high fidelity tone control, two dynamic speakers, and feather-weight tone arm with permanent jewel needle.

philco



The Chippendale, Philco's finest model, has 14 tubes and three balanced dynamic speakers, plus every new feature.

The same chassis available in the Sheraton is incorporated in English Regency cabinet, which has AM and FM American and Foreign short-wave.



phonola

*Model S-8, a
Deluxe Phonola with
easily wound spring motor,
is 17"x13"x7".*



*Phonola model S-90 has
padded top, snap flush
leather handle, cast
throw-back tone arm,
automatic stop,
luggage-type covering.*

486

Waters Conley's Phonolas, both spring-driven acoustic as shown here and amplified models, are now being made. They will be distributed nationally and exported to most parts of the world to which end, the company's plant has been doubled in size. The machines are more modern, have molded tone chambers, striking color harmony, improved volume and fidelity.

rca victor



Here is Victor's new Pocket Personal,
a miniature set in strong plastic case.

Victor's Model 58F is the lowest-priced combination set in its "kick-off" line.



recordio

Wilcox-Gay, makers of Recordio instruments for the home, professional and commercial use, is selling a line of recording and reproducing units that are modern, efficient and adaptable to all recording needs. The sets come in blond, cordovan and regular mahogany as well as metals and plastics.

This combination in classical mahogany design; has recording and phonograph devices under lid.

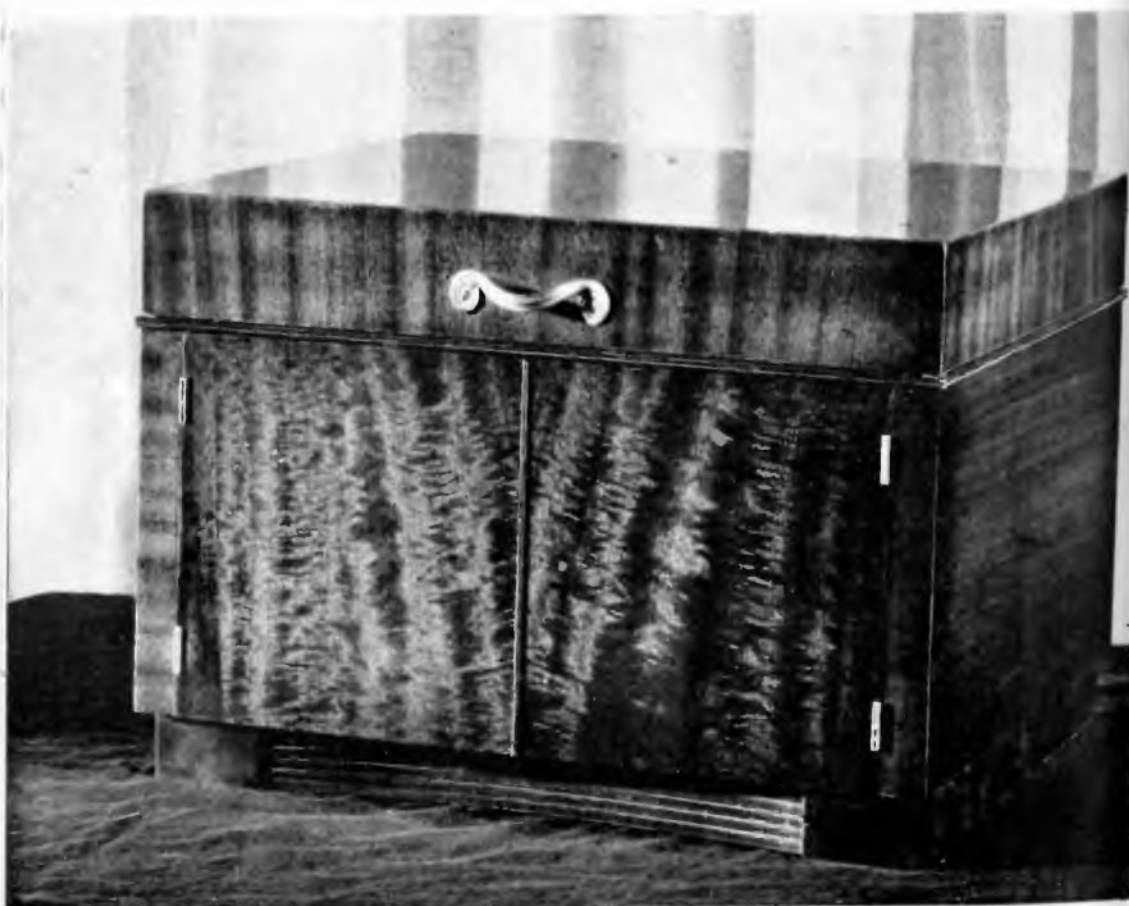



recordio

Bleached blond model has radio, phonograph, PA connection and microphone.

Portable dual speed recorder has no radio but has device for recording radio programs.



sentinel

Featuring both popular-priced sets and quality combinations for those who will spend a little more to get a lot more. Sentinel is ready with models like these; which are specifically designed for the jobs they are meant to do.

With automatic record changer, this combination features 6-tube AC radio, Walnut veneer cabinet, will hold 12 ten-inch or 10 twelve-inch records.



sonora

*A pretty girl—and something pretty nice in new radio-phonographs.
The set's by Sonora and it promises
to be one of the leaders in the company's line.*



sparton

The Sparton line of radios and radio-phonographs now is in production, and in many dealers' hands. The line features cabinet designs by Magda Ranney, FM-AM, automatic record changers, and a single record player table model combination.



Console of Sparton features radio-phonograph with automatic player, FM-AM, short-wave.

Sheraton style console has automatic record changer, FM-AM.



sparton



Bureau-type set of Sparton is another radio-phonograph combination.

Blond, modern combination has sleek lines, FM-AM and automatic phonograph.



stewart warner



A cleanly-designed 6-tube, single band, AC table model combination with temper-proof record changer and permanent needle.



Stewart Warner's first postwar line counts 14 radios and combinations, from an AC-DC portable with self-charging batteries to a 7-tube console combination with automatic shut-off and low-friction alloy permanent needle good for 5,000 sides. Two models are 18th century-styled commodes housing 6-tube radios and equipped with phonograph jacks for use with external record player.

The same model with lid raised shows ease of access to automatic record changer

stewart warner



Pride of the SW line is this 7-tube, 2-band AC console combination with tamper-proof changer and low friction alloy permanent needle.



The mahogany Hepplewhite-styled Pembroke drop leaf table contains a 6-tube, 2-band AC radio which has both standard broadcast and 9-12 megacycle range.

stromberg-carlson

Radio-phonograph table and console models head the wide variety of Stromberg-Carlson models soon to make their appearance on the market. Two of the sets shown on these pages have record-playing equipment as well as facilities for one or more type of radio reception. Designs vary from period or traditional to ultra modern

496



This 6-tube superheterodyne table combination in mahogany cabinet has an automatic record changer and push-button selection.



stromberg-carlson

Here is an interesting example of the contemporary design in a small "personal" radio.

Among sets to appear early next year is this large radio-phonograph console.

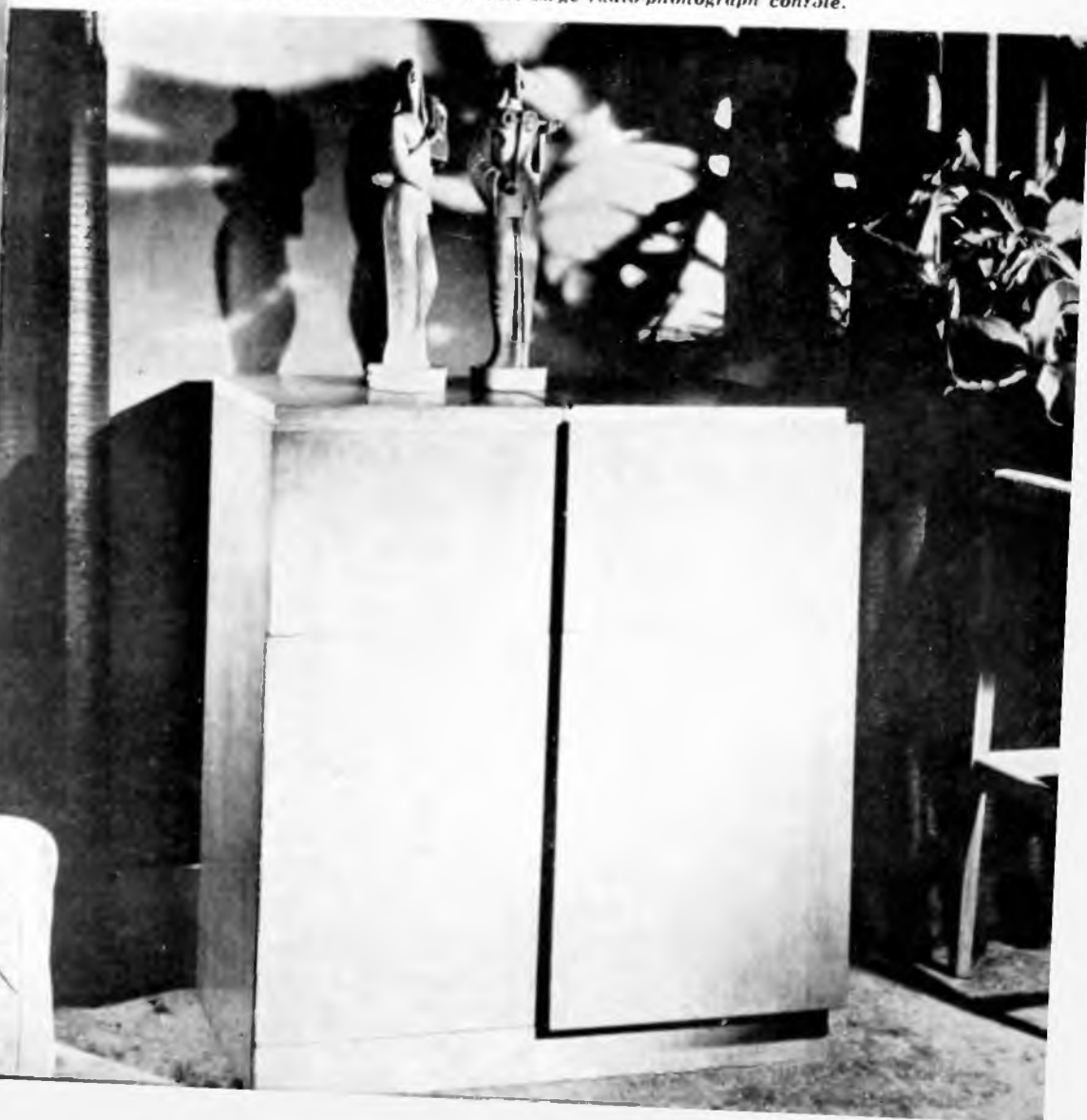

tone

After fourteen months of research, experimentation and field tests, Tone Products Corp., specialists in musical merchandise for children, has announced that this Merry-Go-Sound is now ready for the market. Resembling a carousel, the electrically amplified children's phonograph has plastic surface, is scratch-proof and washable, has single control for on-off and volume. Tone Products has also made recordings for children to go with the Merry-Go-Sound including such numbers as "Rumpelstiltskin" and "Old MacDonald Had a Farm."

In this new Merry-Go-Sound, organ pipes cover speaker, single control and stout construction make it a durable machine.





Above is TA-6, automatic player 15"x15"x10"; below smart portable electric model with record compartment.

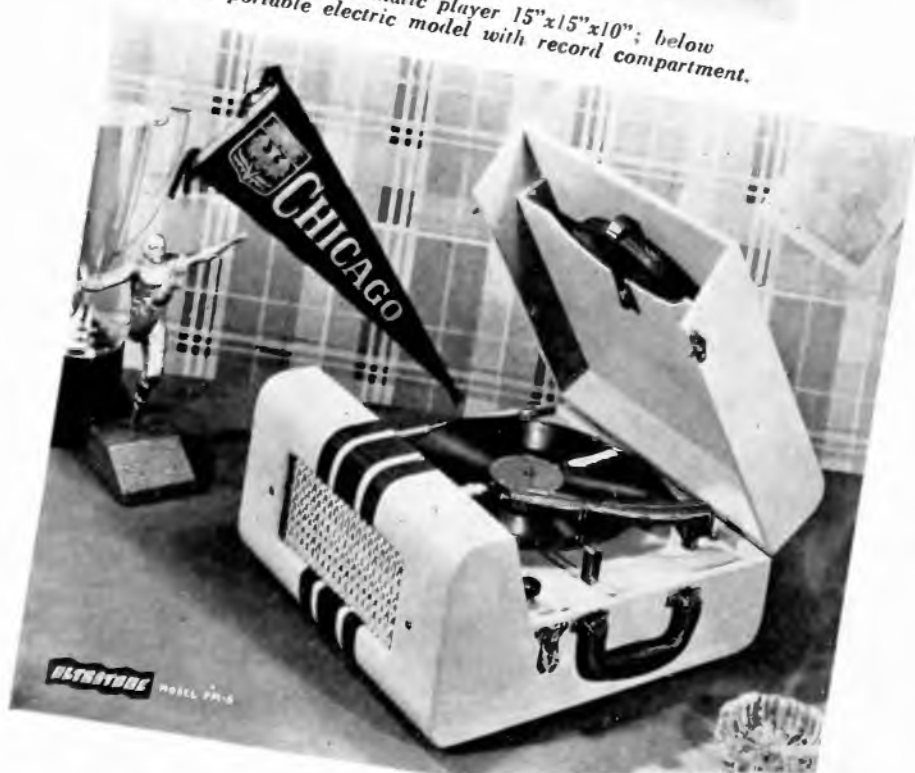

westinghouse

Westinghouse has begun shipments of its post-war sets which will include nine distinctive radio and radio-phonograph models ranging from a 6-tube table radio to a 14-tube combination. One new feature is a built-in switch connection whereby all but the lowest priced models will pick up independent record players, television or FM sets or wire recorder units.



This period, seven-tube combination has automatic record changer. grain mahogany 18th century design.

Front section of this Duo Receiver can be taken out for use independent of the record player.



westinghouse



*This console has Westinghouse "Plenti-power" circuit
as well as handsome period styling.*

*Six-by-six-by-nine carry-about model comes in pastel green and
gold or gold and ivory and has handle which folds into back recess.*



zenith

26 advance models, "brand new, clear through," are offered by Zenith at prices ranging from \$19.95 to \$295. Most notable of Zenith's new features is the Cobra tone arm for phonographs. Outstanding buying-appeal: it is both harm-proof and child-proof to the extent that it can be bounced on or scraped across a record without damage either to itself or to the record. With pickup weight of only $\frac{2}{3}$ of an ounce, it greatly increases disc life. The complete line includes table models, consoles, portables, radio-phonographs, and farm battery sets.

One of Zenith's finest consoles boasts the Cobra tone arm, AM and FM reception,



special promotions

capitalizing on movie

tie-ins, personal appearances

concerts and other

special musical events

playing all the personal appearance angles

Two Columbia pop artists have been making personal appearances, new friends and better record customers through a series of distributor-arranged trips to key cities in the West and Mid-West. In each case the distributors worked closely with their dealers to get full publicity and good-will value from the appearances.

When Frankie Carle appeared at the Norman Naval Base in Oklahoma City, Miller-Jackson Co., Columbia distributor in the area, put on a promotion known as "Frankie Carle Day."

On that day every record dealer in Oklahoma City devoted window space to a large display built around a streamer which read, "Frankie Carle featured on

Columbia Records." During the promotion, Carle signed records and albums. He also played several piano solos at Larsen's Music Shop.

Carle was also spotlighted by the Omaha Appliance Co. in a full week's promotion. The promotion included two highly publicized personal appearances, one at Schmoller-Mueller Piano Co. and the other at Montgomery Ward. Approximately 1,000 Carle enthusiasts attended the two appearances, at which Frankie autographed records and albums.

In addition to these two publicized appearances, Carle visited Lyon & Healy, the Brandies Store, and the Ed Patton Music Co., all Omaha dealers. He was entertained at a luncheon by Paul



Jacobus, owner of Omaha Appliance. Special window display, counter cards and newspaper ads backed the promotion.

When Les Brown brought his band to the Tune Town Ballroom, St. Louis was waiting for him. Promotion of his Columbia records had begun a week before he arrived, and did not end until his engagement at Tune Town was over. A giant sign, 10' tall and 5' wide, placed in the Tune Town lobby, announced that Brown was coming to town. Featuring a giant Columbia record, it plugged Brown's latest discs, *Sleigh Ride in July* and *Twilight Time*.

Going all-out for Columbia, the ballroom plugged the records of its pop artists in a three-minute nightly announcement from the dance floor. They also distributed 5,000 special dance programs which carried Columbia record plugs on every page. Supplied by Artophone, they were used by those at the ballroom to secure autographs of Brown and his band members.

Newspapers also co-operated with Artophone in making this promotion a success. Both the St. Louis *Post-Dispatch* and *Globe Democrat* featured articles on Brown in their Sunday editions. Radio stations pitched in too. Brown appeared on three local stations

in feature broadcasts. In addition to these shows, he made transcriptions with Rush Hughes for use on Hughes' syndicated radio programs in Tulsa, Oklahoma City, Detroit, Kansas City and Toledo. A direct wire from Tune Town was used to air 30-minute broadcasts from the ballroom each Tuesday and Thursday during the engagement.

Brown's personal appearance at Stix, Baer & Fuller, St. Louis department store, arranged before the band came to town, was publicized well in advance. Using direct mail in the form of special articles placed in "Sub-Deb Smatterings" and "The Flying Horse," both published by the store; newspaper ads, large signs in five different merchandise departments of Stix, Baer & Fuller, and a large window display brought over 800 fans to the record shop. And Brown, with Doris Day and "Butch" Stone, the band's featured vocalists, signed records until the supply of discs was exhausted.

To continue the extensive promotion, Brown visited each major record shop in downtown St. Louis, meeting sales personnel and autographing records and photographs. A personal note from Brown to each dealer he had met was later sent, thanking them for their co-operation.

An Oklahoma City welcome for Frankie Carle.





When good (music) fellows and girls get together. Included in this group are: 1. Guy Fraser Harrison, director, Rochester Philharmonic Orchestra; 2. Neil Gallagher, Sibley, Lindsay & Curr Co.; 3. Mayor Samuel B. Dicker; 4. Paul Wolk, Bickford Bros. Co.; 5. C. E. Corcoran, Bickford Bros. Co.; 6. David Kessler, Eastman Theater; 7. Lafayette Blanchard, Gannett Newspapers; 8. Mrs. Hawley Ward, Rochester music patron, and 9. Sigmund Romberg.

blueprint for a successful personal appearance

506

Uow well one RCA distributor—Bickford Brothers of Rochester, N. Y.—cooperated with record dealers in the area to capitalize on the personal appearance of a performer is evidenced by the volume sales of Sigmund Romberg records and albums in Rochester when he performed there recently at a concert of his melodies. Both the Romberg albums and the albums of "Up in Central Park" were sell-outs.

The campaign this distributor put on

upped the sales of "Up in Central Park" albums by several hundred . . . 50 per cent more than might otherwise have been considered a potential. The company believes that still more records could have been sold, had they been available.

Bickford Brothers supplied their dealers with promotional material, and suggested ways of tying-in with the personal appearance. Active cooperation by almost all of the dealers in the



Among attractive windows for Romberg visit was this one by McCurdy & Co. of Rochester, N. Y.

area, and the efforts of several department stores in creating specially dressed windows and newspaper advertisements for the occasion were considered primary reasons for the success of the campaign.

Sibley, Lindsay and Curr arranged for Sigmund Romberg to be present at an informal session in the store before the concert. Top store executives were on hand to greet the composer, introduce him to the audience and conduct a personal interview. A capacity crowd filled the record department as Sigmund Romberg chatted with customers and autographed his albums and records for purchasers. An announcement in the store window for a week previous, additional signs placed strategically throughout the store, and 3-column newspaper advertisements had been responsible for whipping up interest in the event.

McCurdy & Co. devoted a full window to albums of "Up in Central Park." Effective use was made of a mannequin, a framed photograph of Sigmund Rom-

berg and publicity shots of Jeanette MacDonald, who sings the lyrics in Victor's album. Records and sets flanked the photographs on all sides.

Bickford Brothers worked closely with the dealers in every instance, supplying them with display material and helping them to plan events. Dealers were encouraged to promote the personal appearance itself, as well as the sale of records. Sibley, Lindsay & Curr not only played up the concert in its ads, but gave it prominent mention in its daily radio program. Enthusiasm for the concert was stirred up by advance notices by the theatre where the concert was held, announcements by dealers for days previous to Sigmund Romberg's visit, and a cocktail party arranged by Bickford Brothers, at which Mr. Romberg could meet with dealers and members of the press. Several stories and items in the Rochester papers resulted.

Follow-up advertisements snared the sales of those who had enjoyed the concert and wished a permanent memento for their record libraries.



Eugene Ormandy's visit to the May Company in Los Angeles kept him busy autographing records.

personal appearance

Popular music fans welcomed Hal McIntyre in recent visit to Mt. Vernon, N. Y., Record 5





Large audience crowded the record shop in San Antonio when Tex Ritter, Capitol cowboy artist, autographed his recordings.

RCA Victor soprano Gladys Swarthout had a busy day at Willis' Music Store in Cincinnati.



promotion on small budget can bring results

The small dealer who is not in the middle of the shopping district can bring customers to his back street location with a small, intelligently planned advertising and promotion campaign as demonstrated by this story of Sol Silver, Evansville, Ind., dealer.

With many dealers, it is hard to tell just what does bring people into their store. Sol Silver, Evansville, Indiana dealer, is fortunate in this respect, for his location makes it a certainty that it is the advertising and promotion efforts which have kept his business on the upgrade. He had no intention of heading for the tall timber and a hard-to-find location when he went into business, but a previous venture, which had no need for the "high rent district," found his store placed three blocks from the main business artery of this midwestern town of more than 100,000 people. So he took up the weapons of smart promotion and aggressive advertising. Over a period of four years, he has attracted many customers away from better-located competitors to a tune that sounds good when played on his own cash register.

His fight for business, which started as a battle against a rather poor location, has given advertising on a modest budget a chance to prove its real value to any dealer regardless of current volume. Many smaller retailers have argued for years against planned advertising and sales promotion campaigns because they have felt that their slender purses would not stand the strain for the benefit produced. They have stuck by this argument for it is often hard to prove definite results from a short campaign. In this

instance, due to his isolated location, Mr. Silver is able to put his finger on the reason for his steadily growing volume. He can say definitely that it hasn't been caused by a big "drop-in" business of people anxious for a new sonata, Sinatra, or radio.

For a little background, the firm started in business as the Silver Novelty Company and its stock-in-trade was coin-operated machines, principally juke boxes. Here location was relatively unimportant, the only requirement being low overhead and enough room to service equipment.

In the passing time, Mr. Silver saw the opportunity which was offered by the growing demand for records for home consumption, and he opened a record shop in the front end of his store.

"Soon after I started this new venture," Mr. Silver said, "I saw that the public was not beating a path to my door because they didn't know where I was. Since Evansville had a one-street business district, a location on Main Street was at a premium. So for the time being I had to look for a different way to entice customers three block down a side street. Advertising then and now is my answer, and it really works."

This is something of a modest understatement on Mr. Silver's part, for that advertising and promotion effort has

caused him to enlarge his record department, take on a full line of appliances, and institute modern merchandising techniques, as well as remodel the store on several different occasions so that his clerks could handle growing crowds.

In fact, the juke box business has been gradually shoved out the back door to a new spot, and the owner himself has to be satisfied now with a very tiny office in place of his former rather spacious personal quarters.

His new appliance line at the present time includes the full Philco, Admiral, R.C.A., and Emerson lines, as well as the Bendix radio. The location bugaboo will have to be met and settled soon for, with the return of enough merchandise to properly stock his store, more floor space will be absolutely essential. Mr. Silver plans to lay the same merchandising stress on appliances, but with his ever booming record business, the radio and combination radio-phonograph will necessarily occupy the spotlight.

How was all this accomplished? You just don't change overnight from a juke box and coin machine operator to an expanding appliance and record dealer by wishful thinking. Although he has a limited budget, Mr. Silver has adopted an across-the-board technique which includes all available media for his advertising program. In the field of publications, he uses two daily newspapers, as well as school publications of all five city high schools.

"This school paper media," Mr. Silver says, "should not be overlooked. I have found that by actively advertising for high school students I have not only brought the jitterbug business my way, but those kids have a way of influencing their parents, and they bring them in for adult types of records as well as appliances. Then, too, garnering the youngsters is training a generation of future customers whose purchases today of 75¢ swing sellers will in a few years turn into \$75 radios or other appliances."

In the daily papers, Silver uses a more elaborate type of tie-in ad which has produced a good volume of business. As far as records are concerned, his daily



This young girl is representative of the 16 to 20-year-old bobby-sox group which yearly adds many million record sales to America's dealers. She is on the threshold of becoming an adult customer and is one to whom Mr. Silver is directing much of his efforts.

paper advertising tries to tie in with the showing of musical films, stage appearances by name bands, concerts by guest artists, and promotion of the numbers played by the city's Philharmonic orchestra. Tie-ins of this kind recently won Silver national recognition for his promotion of "Rhapsody in Blue."

He isn't content, however, to stop with newspaper ads, but makes every effort to get name band leaders appearing locally to make personal appearances in his store to autograph records. More than twenty such appearances have been made in the last two years.

For the first several years he was in the business, Silver limited himself to newspaper campaigning, but when he was finally convinced as to the possibilities of radio, he went into it in a big way that has netted large returns. His activities along this line have included not only the standard spot announcement campaign of the average small re-

tailer, but he now sponsors his own quarter-hour show over the city's WFOA, entitled "On Record Row" with Lucille. In planning the program, Mr. Silver tried for a combination of transcribed music which would co-ordinate the tie-ins used in his newspaper advertising, and would at the same time appeal to all kinds of music lovers.

For talent, he went beyond the staff of the local station to get a radio-trained young lady with a selling personality. In addition to her regular radio show, Lucille makes personal appearances in the store to build her listening audience. During the year "On Record Row" has been on the air, the gross business has substantially increased.

Besides the music, Lucille has a carefully prepared script which gives interesting human interest background on the composer or orchestra which is featured on the program.

For the third step in his merchandising program, Mr. Silver uses regular direct mailings to his active customer list. This includes about 4,000 names, and for

Self-service is already an integral part of Silver's business. This new rack has increased his album sales.

a larger monthly mailing, 14,000 pieces.

"I found out early in my direct mail work," Mr. Silver reports, "that a good mailing list is the key to results in this field. My smaller active list is kept up-to-date by my clerks. It is part of their responsibility to get the names of new, steady customers, and weed out those who aren't producing business.

"Then, it is the job of the mailing piece to make sales. In this I have found that we get the greatest success from the mailing pieces which we have produced here in Evansville, with the help of outside consultants."

In these mail pieces which Mr. Silver has developed, no attempt is made at large expense or elaborateness. Some of them have been printed postal cards, small envelope stuffers, and other leaflets. An effort is made to vary each one so that the customer never gets the feeling, as he opens his mail, that he has received this one before.

A fourth step is also used to which Mr. Silver gives partial credit for the growth in his business. That step is in-store merchandising procedures.

"It is all right to have advertising to get the customer into the store," Mr. Silver says, "but it takes something more to turn the prospect into a closed sale."

Along one wall of the store are album racks from which the customer may make his own choices, and then take that choice to one of the three adjoining booths. The counter which runs down the other side of the store is broken into several sections allowing the customer a better view of the shelved single records.

With a new display rack which Mr. Silver designed, further self service of single records will be made available. This four-sided rack will be placed in the center of the long narrow store near the record booths, and from it customers may pick their own records, play them, and bring them to a cashier for wrapping.

"It may have been the location that started my promotion campaign, but somehow I never seem to slack off on it. I always feel that we're not getting places if we aren't always doing something," Mr. Silver concluded.



*Builds Consumer
Good Will and
Confidence . . .*

THE NEW

GEM

Natural

**SAPPHIRE JEWELLED
PHONOGRAPH NEEDLE**

A superlatively fine needle . . . acclaimed by musicians and music lovers alike for unvarying brilliance of performance . . . crystal clear reproduction . . . as well as for remarkable wearing qualities. The Gem's balanced construction eliminates distortion and vibration . . . the triple-tested natural sapphire point assures smooth groove action. All these features accomplish one all-important result . . . complete customer satisfaction.



YOUR CUSTOMERS
SEE THE POINT!

The Telescopic
Package Shows
The Needle Point
Greatly Enlarged
For Careful
Examination . . .



\$2.50

TRADE MARK REG. U. S. PATENT OFFICE

**UNCONDITIONALLY
GUARANTEED**

If, after playing the Gem needle, your customers are not satisfied that it is the finest needle they have ever heard, the purchase price will be refunded in full.

GEM PHONO MANUFACTURING, INC. 33 WEST 46th ST. NEW YORK 19, N. Y.

PHILIP

PHILIP

PHILIP

PHILIP

PHILIP

PHILIP

