

SECTION 2 · MARCH 21, 1970  
**Billboard**

1970 INTERNATIONAL  
**TAPE DIRECTORY**

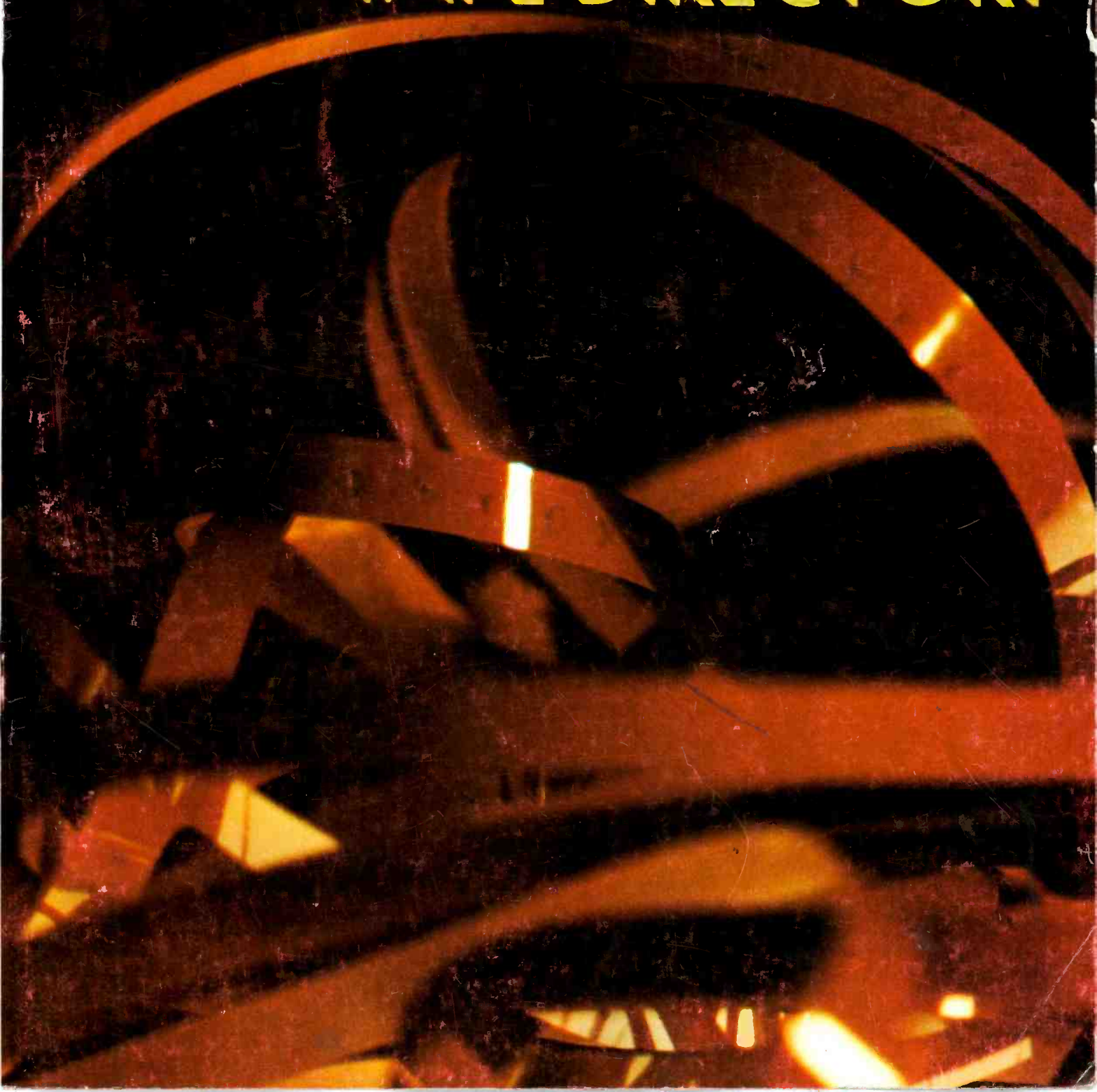

Did the fact  
that we created Dynapak,  
the world's first  
no-return cartridge,  
saddle us with the responsibility  
of designing a  
no-return cassette, too?



Damn right.

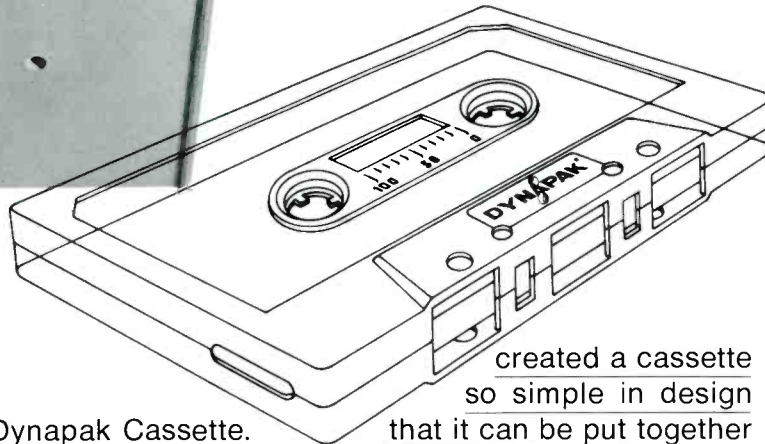

So we did.  
We call it Dynapak Cassette.  
It's as superior to the cassette  
you're accustomed to as Dynapak  
is to old-fashioned tape cartridges.

It contains only ten parts. The  
present most-widely used cassette  
has seventeen. Thus, the Dyna-  
pak Cassette eliminates seven  
chances for assembly line or oper-  
ating foul-ups.

Simplicity is the keynote of its  
design.

For example: Its two halves  
snap onto a one-piece hub. No  
sonic welding. No screws.

For example: The loading of  
its spring pad assembly is so un-  
complicated, its slot design so in-  
genious, the tape can be dropped  
into place.

Do you begin to see the impli-  
cations of this? Stereodyne has

created a cassette  
so simple in design  
that it can be put together  
on a 100% automated assembly  
line.

In short, the Dynapak Cas-  
sette is so brilliantly engineered to  
be fool-proof that it is now the  
cassette against which all others  
must be judged.

**Stereodyne**

2810 Elliott  
Troy, Michigan 48084  
(Area 313) 585-6585  
STERODYNE LTD.  
6 Evans Court  
Etobicoke  
Ontario, Canada  
(Area 416) 259-4202



# we're selling sound!

sound engineering...  
sound taste...  
sound organization...  
sound profits!



THE FINEST CASSETTES AND 8 TRACK CARTRIDGES

**POP • JAZZ • CLASSICAL • FOLK • SOUL • INTERNATIONAL**

CALL MANNY KOPELMAN, AT 212/689-8861 FOR DETAILS OF OUR PROMOTIONAL AIDS AND MERCHANDISING PLANS, OR WRITE:



cassette music corporation  
220 east 23rd street, new york, n.y. 10010 (212) 689-8861

# SECTION 2: MARCH 21, 1970 Billboard

## 1970 INTERNATIONAL TAPE DIRECTORY

Billboard Publications, Inc., 165 W. 46th St.,  
New York, N.Y. 10036  
Area Code 212, PL 7-2800  
Cable: BILLBOARD NEWYORK

President, WILLIAM D. LITTLEFORD  
Vice President of Business Publications, HAL COOK  
Publisher: MORT L. NASATIR  
Associate Publisher: LEE ZHITO

### TAPE DIRECTORY STAFF

Manager of Directory Services: John P. Hays  
Directory Editor: Dorothy J. Kobs

Directory Associates: Suzanne Osborne, Robert  
Hudoba, Donald Levin, Les Barkdull, Holly  
Hosford, Kent Paul.

Art Director: Virgil Arnett

Director of Sales: Ron Carpenter

Advertising Manager: Ronald Willman

Midwest General Manager: T. L. Herrick

West Coast Gen. Mgr.: Willis Wardlow

Nashville Gen. Mgr.: Robert L. Kendall

Production Manager: Bob Phillips

### U. S. BRANCH OFFICES

CHICAGO, Ill. 60601, 188 W. Randolph. Area Code  
312, CE 6-9818

LOS ANGELES, Calif. 90069, 9000 Sunset Blvd.  
Area Code 213, 273-1555

NASHVILLE, Tenn. 37203, 1905 Broadway. Area  
Code 615, 244-1836

WASHINGTON, D. C. 20005, 733 15th St., N.W.  
Woodward Bldg., Rm. 533. Area Code 202, 393-  
2580

EUROPEAN DIRECTOR: Andre de Vekey, 7 Carnaby  
St., London W.1. Phone 486-5971  
Cable: Billboard London

EUROPEAN EDITOR: Mike Hennessey, 7 Carnaby St.,  
London W.1. Phone 486-5971

Italy: Germano Ruscitto, Billboard Gruppo sri.,  
Pizzale Loreto 9, Milan. Phone: 70.15.15

Japan: Kanji Suzuki/Japan, Trade Service Ltd.,  
Ikejiri 3-1-1-1008, Setagaya-ku, Tokyo, Tel: 413-  
2871

Mexico: Enrique Ortiz, Nueleo Radio Mil, Insurgentes  
Sur 1870, Mexico, 20, D.F.

Subscription rates payable in advance. One year,  
\$30 in U. S. A. (except Alaska, Hawaii and Puerto  
Rico) and Canada, or \$45 by airmail. Rates in  
other foreign countries on request. Subscribers when  
requesting change of address should give old as well  
as new address. Published weekly. Second-class  
postage paid at New York, N.Y., and at additional  
mailing offices. Copyright 1970 by Billboard Publi-  
cations, Inc. The company also publishes Amusement  
Business, Discografia Internazionale, Gift & Table-  
ware Reporter, Merchandising Week, Record Mirror,  
Record Retailer, Vend, World Radio Television Hand-  
book, American Artist, High Fidelity, Modern  
Photography, Photo Weekly. Postmaster, please send  
Form 3579 to Billboard Publications, Inc., 2160  
Patterson St., Cincinnati, Ohio 45214.

## CONTENTS

TAPE CARTRIDGE HISTORICAL NOTES .....	7
WHERE TAPE EQUIPMENT UNITS ARE PURCHASED .....	8
RECORD MANUFACTURERS WITH TAPE PRODUCT .....	12
(including manufacturers with product available only on pre-recorded tape)	
DUPLICATOR MARKETERS .....	26
TAPE PLAYBACK EQUIPMENT MANUFACTURERS & IMPORTERS .....	32
TAPE WHOLESALERS .....	40
(including DISTRIBUTORS, ONE-STOPs, RACK JOBBERS & IMPORTERS/EXPORTERS)	
<b>TAPE SUPPLIES</b>	
RAW TAPE MANUFACTURERS .....	64
EMPTY CARTRIDGE, CASSETTE & REEL MANUFACTURERS .....	66
BLANK LOADED TAPE MANUFACTURERS .....	70
CARTRIDGE PARTS MANUFACTURERS .....	74
MANUFACTURERS OF TAPE DUPLICATING EQUIPMENT .....	74
<b>TAPE SERVICES</b>	
CUSTOM DUPLICATION .....	86
DESIGN & ARTWORK .....	102
PACKAGING & LABELING .....	106
PRINTING & LITHOGRAPHING .....	108
<b>TAPE DEALER ACCESSORIES &amp; SUPPLIES</b>	
BROWSER BOXES .....	114
BURGLAR ALARMS & LOCKS .....	114
CARRYING & STORAGE CASES .....	114
CATALOG SERVICES .....	114
CONVERTERS & TUNERS .....	114
DISPLAY RACKS .....	114
PRE-LEADERED & SPLICING TAPE .....	144
HEAD CLEANERS & DEMAGNETIZERS .....	144
<b>INTERNATIONAL SECTION</b>	
Argentina .....	116
Australia .....	116
Austria .....	118
Belgium .....	118
Brazil .....	120
Canada .....	122
Denmark .....	130
Ecuador .....	130
Finland .....	130
France .....	131
Germany, West .....	132
Hong Kong .....	135
Israel .....	135
Italy .....	135
Japan .....	137
Mexico .....	137
Netherlands .....	138
New Zealand .....	138
Norway .....	139
Portugal .....	139
Puerto Rico .....	139
Singapore .....	140
Spain .....	140
Sweden .....	141
Switzerland .....	141
United Kingdom .....	141
Venezuela .....	143

# You name it. We've got it.

**AUDIO COMMUNICATIONS, INC.** The most complete manufacturing and marketing facilities you'll ever need.

## MANUFACTURING

**American Contract Jobbers**  
Custom duplicating and loading of 8 track and cassettes

**Tapette Inc.**  
Manufacturers of cassette tape, magnetic and lubricated

**P.M.E. (Precision Mold Engineering)**  
Injection molding of cassettes, and manufacturers of tools and dies (we also mold a norelco-type box)

**C.C.C. (Cassette Cartridge Components)**  
Small parts manufacturing of a wide variety of 8 track and cassette components

**C.C.D. (Cassette and Cartridge Division)**  
Manufacturing and assembly of 8 track and cassette consumer products

**U.M.C. (Universal Music Corporation)**  
Producers, publishers, licensing of music rights, talent management and recording studios

**Audio Sonic Inc.**  
Manufacturers and importers of playback equipment, 8 track and cassette

## MARKETING

**U.M.C. (Universal Music Corporation)**  
Marketing via distributors of all creative and licensed music product

**C.C.D. (Cassette Cartridge Division)**  
Marketing division on all consumer oriented accessory and blank cassette products

**E.S.P. (Educational Sales Programs)**  
Creating and marketing premium offers for industrial, educational, medical and other professional fields

**Audio Sonics, Inc.**  
Marketing of playback tape equipment for the home and car both 8 track and cassette

**Modern Sound Inc.**  
Distributor of all manufacturers music both 8 track and cassettes; all allied accessories; playback equipment for the home and the car.

**World Music Corporation—83 reps**  
Nationwide repping for Capitol on cassette equipment to all non-related music stores; repping for musical instrument lines

**Stereo World Inc.**  
Chain of music stores, company owned and franchised

# Contact us. We'll show it to you.

Write or telephone for inquiries, catalogs or brochures



**AUDIO COMMUNICATIONS, INC.** Route 10, Randolph Industrial Park, Dover, N.J. • (201) 361-7600



## **“Grade A” Tape.**



The leader in sound duplication for the entertainment industry, Dubbings provides “Grade A” quality and dependability in all configurations of tape duplication. We produce cassettes, 8 track cartridges and open reel to the tune of almost 3 billion feet of tape per year! With that kind of production, you can be assured that Dubbings maintains the most modern automated duplicating, editing and packaging equipment available.

And you can be assured, too, that whether your needs are for “1 dozen” units or for “a crateful,” you’ll find Dubbings ready—and able—to fill your immediate or future needs.

*Sound thinking leads to Dubbings*



**DUBBINGS**  
ELECTRONICS, INC.  
A NORTH AMERICAN PHILIPS COMPANY

1305 SO. STRONG AVE., COPIAGUE, N.Y.

# Tape CARtridge

## Historical Notes

- 1954 — George Eash invents 4-track continuous loop cartridge.
- 1958 — RCA unveils reel-to-reel tape cartridge.
- 1962 — TelePro Industries manufactures Eash device (Fidelipac cartridge) for broadcast use.
- 1962 — Earl Muntz forms Autostereo to market 4-track automobile CARtridge players. Acquires duplication and distribution rights from several disk companies.
- 1963 — Philips cassette launched at Berlin Radio Show.
- 1964 — North American Philips bows cassette recorder in U. S.
- 1965 — William Lear Sr., president of Lear Jet Corp., discloses 8-track stereo tape CARtridge system. Company launches configuration in conjunction with RCA, Ford Motor Co. and Motorola.
- 1965 — Larry Finley forms International Tape Cartridge Corp. to license record labels for tape CARtridge duplication and distribution rights.
- 1965 — GRT formed. Ampex Stereo Tape division enters CARtridge field.
- 1965 — First pre-recorded cassettes hit market.
- 1966 — Columbia, Capitol and Decca release 8-track CARtridges. Others follow suit.
- 1966 — Chevrolet, Pontiac, Oldsmobile, American Motors and Volkswagen offer stereo 8 as optional equipment on 1967 models. Ford includes 8-track accessory for all models.
- 1967 — Eight-track home units debut.
- 1967 — Automobile factory-installations top 165,000 units.
- 1967 — Pre-recorded tape sales equal 10 per cent of total record industry sales. Industry leaders predict 25 per cent in 1968.
- 1968 — Low price Carry-Player cassette portable introduced in U.S. and Europe.
- 1968 — Slot-load cassette players shown for automobile use.
- 1969 — Auto manufacturers unofficially consent to offer cassette equipment as optional equipment on 1971 models. Chrysler and Ford are planning to offer the equipment. Automatic reversible cassettes and continuous loop cassettes make debut. Best selling books on tape introduced.

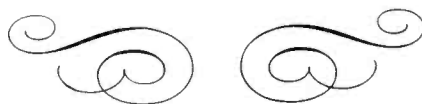

# WHERE TAPE EQUIPMENT UNITS ARE PURCHASED

(ALL CONFIGURATION, INCLUDING OPEN REEL)

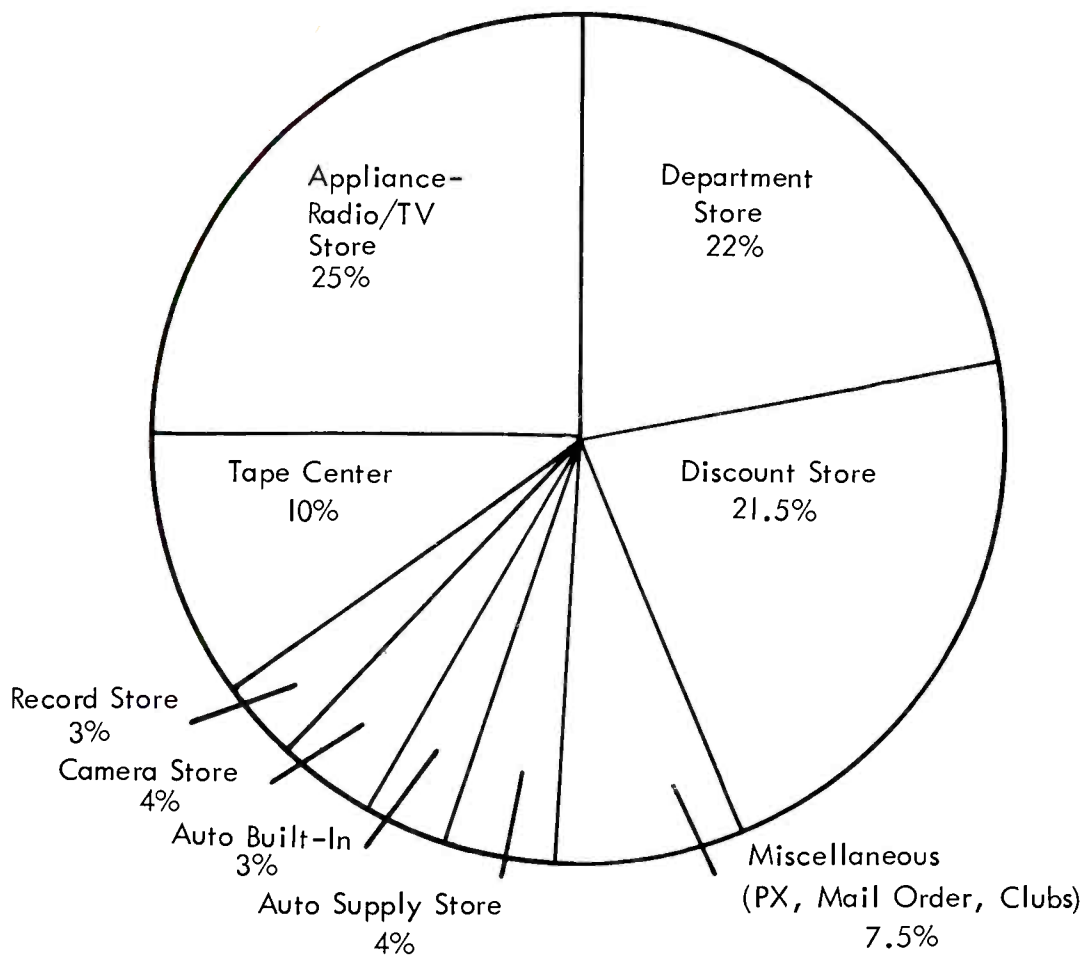



# YES for palette



**TAPES**  
is a  
growing  
business  
**YES**  
we are  
still / open  
to deal  
with you



BRASS HATS



DIGNO GARCIA

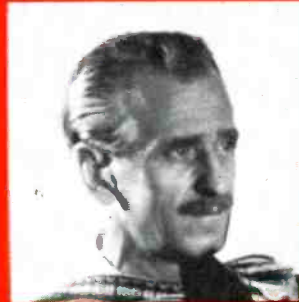

JOE MAYAS



LUIGI



RITA DENEVE

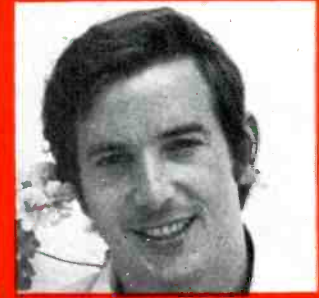

WILL TURA



JESS AND JAMES



JEAN CLAUDE DELLETIER

#### PALETTE RECORDS

NEW YORK 10017  
LONDON W.C.I.  
1000 3F JSSELS

6 EAST 45th STREET  
10 GRAY'S INN SQUARE  
13 MADELEINE STREET

**WHERE 8-TRACK EQUIPMENT IS PURCHASED**

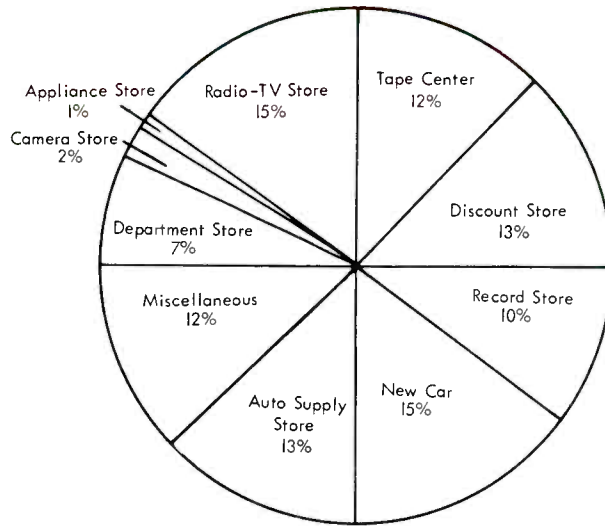

**WHERE 4/8 TRACK EQUIPMENT IS PURCHASED**

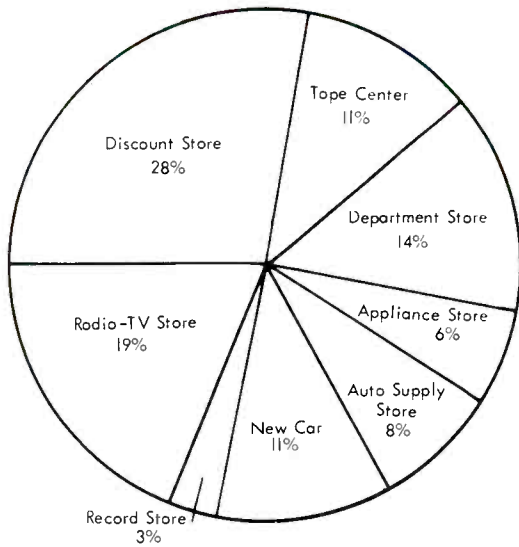

**WHERE 4-TRACK TAPE EQUIPMENT IS PURCHASED**

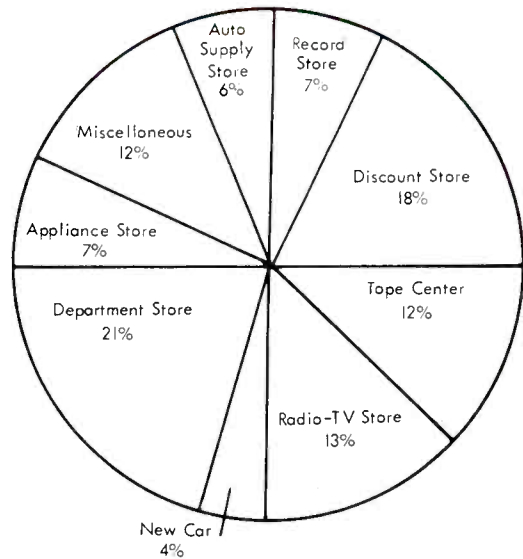

**WHERE CASSETTE EQUIPMENT IS PURCHASED**

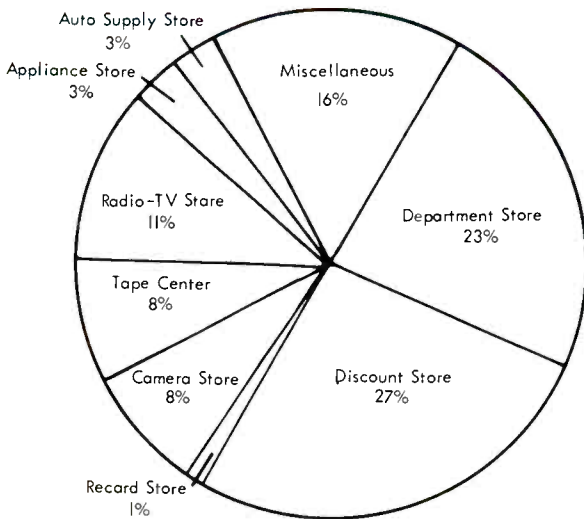

**WHERE REEL-TO-REEL EQUIPMENT IS PURCHASED**

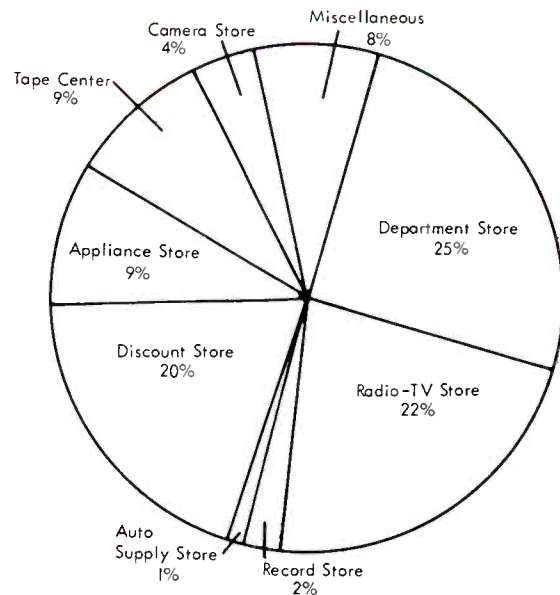



## Stereo for the open road.

Unfortunately the song for the open road these days is "Hey stupid, the light changed."

In these times that make driving not exactly a pleasure, Columbia has come up with a possible solution: 8-track stereo a driver could even enjoy in a traffic jam.

Who could argue against Simon & Garfunkel instead of honking horns. Or Andy Williams instead of noisy relatives. Or listening to Johnny Cash instead of loveable cab drivers.

Columbia 8-track stereo:  
It's for the open road even at 10 miles an hour.



On Columbia Stereo Tape.

Other new releases also available:

- 18 10 0880\* Leaving on Jet Plane—Percy Faith
- 18 11 0144\* "The Well-Tempered Synthesizer"—Walter Carlos
- 18 10 1005\* Raindrops Keep Fallin' on My Head—Johnny Mathis
- 18 10 0850\* Raiders Collage
- 18 10 0886 Arizona—Mark Lindsay

# RECORD MANUFACTURES WITH TAPE PRODUCT

- A**
- A A Recs. Inc.**, 250 W. 57 St., New York, N.Y. 10019. Tel: (212) 765-3350. Tape Sales Mgr.: Shy Raiken.  
**Cartridge 8-tr.**: Golden licensed to GRT & Cassette Communications; Yew licensed to Cassette Communications.  
**Cartridge 4-tr.**: Golden, Yew licensed to Cassette Communications.  
**Cassette**: Golden licensed to Ampex & Cassette Communications; Yew licensed to Cassette Communications.
- A & M Recs.**, 1416 N. La Brea Ave., Hollywood, Calif. 90028. Tel: (213) 461-9931. Tape Div. Mgr.: J. Robert Elliott.  
**Cartridge 4-tr., 8-tr., cassette & open reel**: Self-mfd.
- A B C Recs.**, 1330 Ave. of the Americas, New York, N.Y. 10019. Tel: (212) LT 1-7777. Pres.: Larry Newton, VP. ABC Div.: Howard Stark.  
**Cartridge 8-tr.**: ABC, Impulse, Bluesway, Command (includes Grand Award), Probe, Dunhill, Tangerine, Riverside licensed to Ampex & GRT; Westminster (includes Music Guild, Whitehall) licensed to Ampex; 20th Century-Fox (includes Movietone) licensed to ITCC.  
**Cartridge 4-tr.**: ABC, Impulse, Bluesway, Command (includes Grand Award), Probe, Dunhill, Westminster (includes Music Guild, Whitehall, Tangerine, Riverside licensed to Ampex & GRT; 20th Century-Fox (includes Movietone) licensed to Ampex, GRT & ITCC.  
**Open reel**: ABC, Impulse, Bluesway, Command (includes Grand Award), Dunhill, 20th Century-Fox (includes Movietone) licensed to Ampex & GRT; Westminster (includes Music Guild, Whitehall), Riverside licensed to Ampex.
- A R I** (see Academic Rec'g Institute).
- A S T** (see Duplicator/Marketers section: Ampex Stereo Tapes).
- A V R** (see A-V Research).
- A-V Research Corp.**, 1 Goddard Dr., Rockaway, N.J. 07866. Tel: (201) 625-1000. Pres.: R. Strauss; Gen. Mgr.: N. Quesado; Mgr.: J. Cadenas.  
**Cartridge 8-tr., cassette & open reel**: AVR self-mfd.
- Abnak Music Ent's.**, 825 Olive at Ross, Dallas, Tex. 75201. Tel: (214) RI 2-6111. Pres.: John Abdnor Sr.  
**Cartridge 4-tr. & 8-tr.**: Abnak licensed to GRT.
- Academic Rec'g Institute**, 4727 Oakshire, No. 1, Houston, Tex. 77027. Tel: (713) 621-5266. Pres.: Mack G. Reed.  
**Cassette**: ARI self-mfd. & available through Tapes Unlimited in Detroit, Mich.  
**Open reel**: ARI self-mfd.
- Accent Recs.**, 6533 Hollywood Blvd., Hollywood, Calif. 90028. Tel: (213) 469-1621. Tape Div. Mgr.: Scott Seely.  
**Cassette & open reel**: Accent, Lessons in Living self-mfd. (Also see GNP Crescendo).
- Acta** (see Paramount).
- Adell Corp.**, 43700 Adell Blvd., Novi, Mich. 48050. Tel: (313) 349-6300. Tape Div. & Sales Mgr.: David Salah.  
**Cartridge 8-tr.**: Self-mfd.
- Adultos** (see Met Richmond).
- Aeolian-Skinner Organ Co. Inc.**, Pacella Park Dr., Randolph, Mass. 02368. Tel: (617) 961-2705. Tape Div. Mgr.: John Kellner.  
**Open reel**: Aeolian-Skinner licensed to Ampex.
- Afro Request** (see Request).
- Age of Aquarius** (see Cuca).
- Aia Ent's. Inc.**, 2683 S. La Cienega Blvd., Los Angeles, Calif. 90034. Tel: (213) 836-0930. Tape Div. & Sales Mgr.: Louis Drozen.  
**Cartridge 8-tr. & Cassette**: Latt self-mfd.
- AlCee Ent's. Int'l.**, PO Box 163, Wallington, N.J. 07055. Tel: (201) 778-6554. Pres.: Alfred G. Curven; VP: Francis A. Neff.  
**Cartridge 8-tr.**: Chery Laine licensed to ITCC.
- Alector Recs. Ltd.**, 367 W. 34 St., New York, N.Y. 10001. Tel: (212) 563-2831. Pres.: Ted Starke.  
**Cartridge 8-tr.**: Self-mfd.
- Alegre** (see Roulette).
- Allison Audio Prods. Inc.**, 175 Bridge Rd., Hauppauge, L.I., N.Y. 11787. Tel: (516) 234-2010; NYC Tel: (212) 895-6449. Pres.: Louis Ligator; Nat'l Sales Mgr.: Henry Rosenberg.  
**Cartridge 8-tr. & cassette**: Allison self-mfd.
- Alshire Int'l**, 222 W. Orange Grove Ave., Burbank, Calif. 91502. Tel: (213) 849-4671. Pres.: Al Sherman; Mgr.: Dick Ceja.  
**Cartridge 4-tr., 8-tr., cassette & open reel**: Audio Spectrum (includes Alshire, Somerset) licensed to Ampex.
- Altone** (see Radiant).
- Amaret Recs.**, 1717 N. Highland Ave., No. 803, Hollywood, Calif. 90028. Tel: (213) 466-3361. Pres.: Kenneth S. Myers; Sales Mgr.: David Fox.  
**Cartridge 4-tr., 8-tr., cassette & open reel**: Licensed to Ampex.
- Amazon** (see Shelby Singleton).
- Americana** (see Phono-Record).
- American Airlines** (see Duplicator/Marketers section: Ampex Stereo Tapes).
- Amexar Corp.**, 3018 W. Pico Blvd., Los Angeles, Calif. 90006. Tel: (213) 735-6261. Pres.: Carlos L. Campbell; Sales Mgr.: Alberto L. Campbell; Adv. Dir.: A. Palacio.  
**Cartridge 8-tr.**: Amexar, Del Valle, Moda, Whittier self-mfd.  
**Cartridge 4-tr.**: Del Valle, Moda, Whittier self-mfd.  
**Cassette**: Amexar, Del Valle, Whittier self-mfd.
- Amos Recs.**, 6565 Sunset Blvd., Hollywood, Calif. 90028. Tel: (213) 466-3249. Gen. Mgr.: Bruce Hinton.  
**Cartridge 4-tr., 8-tr., cassette & open reel**: Licensed to Ampex.
- Ampex Stereo Tapes** (div. of Ampex Corp.), 555 Madison Ave., New York, N.Y. 10022. Tel: (212) 758-8900. Pres.: Don Hall; Sales Mgr.: Jules Cohen; Adv. Dir.: Jim Johnson.  
**Cartridge 4-tr., 8-tr. & open reel**: Ampex self-mfd.
- Amsterdam** (see Flying Dutchman).
- Amy** (see Bell).
- Angel** (see Capitol).
- Angel/Melodiya** (see Capitol).
- Anea** (see Goldband).
- Ansonia Recs. Inc.**, 992 Columbus Ave., New York, N.Y. 10025. Tel: (212) UN 5-2121. Owners: Herman & Mercedes Glass.  
**Cartridge 8-tr.**: Self-mfd.
- Apple** (see Capitol).
- Archive** (see Polydor).
- Archive of Folk Music** (see Everest).
- Archive of Gospel Music** (see Everest).
- Archive of Jazz** (see Everest).
- Argo Sight & Sound Ltd.**, 539 W. 25 St., New York, N.Y. 10001. Tel: (212) OR 5-6060.  
**Open reel**: L'Oiseau Lyre licensed to Ampex.
- Arhoolie Recs. Inc.**, PO Box 9195, Berkeley, Calif. 94709. Tel: (415) 841-8624. Pres.: C. Strachwitz.  
**Cartridge 4-tr.**: Licensed to Muntz.  
**Cassette**: Self-mfd.
- Artia** (see Connoisseur).
- Art Recs. Mfg. Co.**, 991 SW 40 Ave., Fort Lauderdale, Fla. 33310. Tel: (305) 584-1904.  
**Cartridge 4-tr.**: Licensed to Muntz.
- Ashley Rec. Co.**, 1700 Broadway, Nashville, Tenn. 37203. Tel: (615) 256-1169. Pres.: Leon Ashley.  
**Cartridge 8-tr. & cassette**: Licensed to GRT.
- Associated Inds. Inc.**, 2150 Hamilton Ave., Cleveland, Ohio 44114. Tel: (216) 696-3773. VP: Robert W. Schachner; Gen. Mgr.: William Larence.  
**Cartridge 8-tr.**: Gateway self-mfd. & licensed to GRT; Dyno, Rim self-mfd.  
**Cassette**: Gateway, Dyno, Rim self-mfd.
- Astex** (see Duplicator/Marketers section: Ampex Stereo Tapes).
- Atco** (see Atlantic).
- Athena** (see Stereo Dimension).
- Atlantic Rec'g Corp.**, 1841 Broadway, New York, N.Y. 10023. Tel: (212) 757-6306. VP Tape Sales: Bob Kornheiser.  
**Cartridge 8-tr.**: Atlantic, Atco, Cotillion, Dakar, Enterprise, Pompeii, Vortex self-mfd. & licensed to Ampex; Dial self-mfd.; SGC licensed to GRT.  
**Cartridge 4-tr.**: Atlantic Atco, Dakar, Enterprise, Pompeii licensed to Ampex.  
**Cassette**: Atlantic, Atco, Cotillion, Dakar, Enterprise, Pompeii, Vortex licensed to Ampex; SGC licensed to GRT.  
**Open reel**: Atlantic, Atco licensed to Ampex & GRT; Cotillion, Enterprise, Vortex licensed to Ampex; SGC licensed to GRT.
- Audio Bible Studios**, 9000 Sunset Blvd., Los Angeles, Calif. 90069. Tel: (213) 275-4191. Pres.: Earle E. Williams.  
**Cassette**: Self-mfd.
- Audio Book Co.**, 4220 W. Jefferson Blvd., Los Angeles, Calif. 90016. Tel: (213) 731-8880. VP & Sales Mgr.: E. M. Rush.  
**Cassette & open reel**: Self-mfd. & licensed to ADT.

continued on page 14

# The Hits Keep Coming On Atlantic-Atco-Cotillion Cartridges & Cassettes

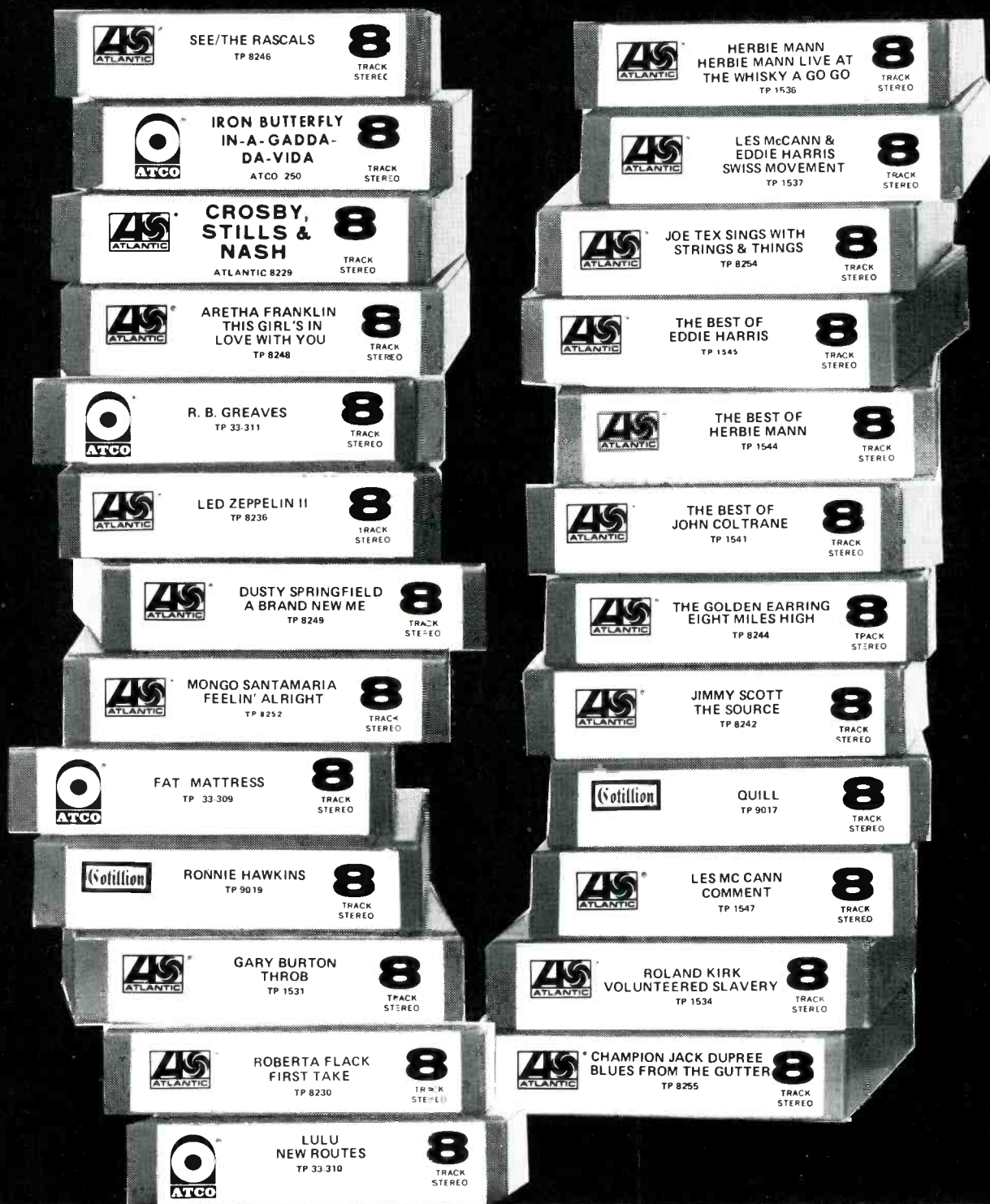

# RECORD MANUFACTURERS WITH TAPE PRODUCT

Continued from page 12

Audio Fidelity Recs. Inc., 221 W. 57 St., New York, N.Y. 10019. Tel: (212) PL 7-7111.  
**Cartridge 8-tr.:** Licensed to ITCC.  
**Cartridge 4-tr.:** Licensed to Muntz.  
**Cassette:** Licensed to Mercury.  
**Open reel:** Licensed to Ampex.  
 Audio Spectrum (see Alshire).  
 Audio Trax (see Duplicator/Marketers section: Audio Physics).  
 Avant Garde Recs. Inc., 250 W. 57 St., New York, N.Y. 10019. Tel: (212) 246-1343. Pres. & Sales Mgr.: Frank Siegfried.  
**Cartridge 4-tr., 8-tr., cassette & open reel:** Licensed to Livingston.  
 Avco Embassy Rec. Corp. (div. of Avco Embassy Pictures), 1301 Ave. of the Americas, New York, N.Y. 10019. Tel: (212) 956-5500. VPs: Hugo Peretti, Luigi Creatore; Gen. Mgr.: Bud Katzfel.  
**Cartridge 4-tr. 8-tr., cassette & open reel:** Licensed to Ampex.

**B**

B T Puppy, 2 Penn Plaza, New York, N.Y. 10001. Tel: (212) 947-5656.  
**Cartridge 4-tr., 8-tr., cassette & open reel:** Licensed to ATD.  
 Backbeat (see Duke/Peacock).  
 Balboa Rec. Co., 16027 Sunburst St., Sepulveda, Calif. 91343. Tel: (213) 892-0044.  
**Cartridge 4-tr., 8-tr., cassette & open reel:** Licensed to ATD.  
 Banff (see Marvel).  
 Bang Recs., 1650 Broadway, New York, N.Y. 10019. Tel: (212) 581-3740. Tape Div. Mgr.: Ilene Berns.  
**Cartridge 8-tr.:** Bang licensed to Ampex & GRT; Shout licensed to Ampex.  
**Cartridge 4-tr.:** Bang licensed to Ampex, GRT & Muntz.  
**Cassette:** Bang licensed to Ampex & GRT; Shout licensed to Ampex.  
**Open reel:** Bang licensed to Ampex & GRT.  
 Banner Recs., 1290 Ave. of the Americas, New York, N.Y. 10019. Tel: (212) 265-7760. Sales Mgr.: Leonard Lewis.  
**Cartridge 8-tr. & cassette:** Self-mfd.  
 Banyan Tree (see Jad).  
 Barnaby (see CBS/Columbia).  
 Beat (see High Fidelity).  
 Bell Recs., 1776 Broadway, New York, N.Y. 10019. Tel: (212) 757-6081. LP Sales & Mds. Dir.: Gordon Bossin.  
**Cartridge 8-tr.:** Bell licensed to Ampex, GRT, ITCC & NAL; Philly Groove licensed to Ampex, GRT & NAL; Page One licensed to Ampex & NAL; Windfall licensed to GRT & NAL; New Voice licensed to Ampex; Goldwax licensed to ITCC; Amy, Mala, Elf licensed to NAL.  
**Cartridge 4-tr.:** Bell, New Voice licensed to Ampex & Muntz; Amy, Elf, Goldwax, Mala, Page One, Philly Groove licensed to Muntz.  
**Cassette:** Bell licensed to Ampex, GRT, ITCC & NAL; Philly Groove licensed to Ampex, GRT & NAL; Page One licensed to Ampex & NAL; Windfall licensed to GRT & NAL; Amy, Elf, Mala licensed to NAL.  
**Open reel:** Bell licensed to Ampex, GRT, NAL; Philly Groove licensed to Ampex & NAL; Amy, Elf, Mala, Page One, Windfall licensed to NAL; New Voice licensed to Ampex.  
 Berkshire (see Duplicator/Marketers section: Dubbings Electronics).  
 Berlitz Publ'g Inc., 866 Third Ave., New York, N.Y. 10022. Tel: (212) 935-7985. Tape Div. & Sales Mgr.: George Kaufmann.  
**Cartridge 8-tr. & cassette:** Berlitz self-mfd.  
 Bernal (see Tanner 'N' Texas).  
 Bible Voice Inc., PO Box 3521, Van Nuys, Calif. 91407. Tel: (213) 985-5600. Tape Div. & Sales Mgr.: David J. Keklikian.  
**Cartridge 4-tr.:** Licensed to Muntz.  
**Cassette & open reel:** Self-mfd.  
 Black-Beauty (see Kiderian).  
 Blue Book (see Sue).  
 Blue Horizon (see CBS/Columbia).  
 Blue Note (see Liberty/UA).  
 BluesTime (see Flying Dutchman).  
 Bluesway (see ABC).  
 Blue Thumb Recs. Inc. (div. of GRT Corp.), 427 N. Canon Dr., Beverly Hills, Calif. 90210. Tel: (213) 278-4065.  
**Cartridge 8-tr., cassette & open reel:** Self-mfd. by GRT.  
 Boone Recs. Inc., 119 Two Mile Pike, Goodlettsville, Tenn. 37072. Tel: (615) 859-1310. Gen. Mgr.: Hal Smith.  
**Cartridge 8-tr.:** Licensed to GRT.  
 Bravo (see Viva).  
 Bright Orange (see Modern).  
 Brite-Star, 14881 Overlook Dr., Newbury, Ohio 44065. Tel: (216) 564-2211. Tape Div. & Sales Mgr.: Jill Sinatra.  
**Cartridge 4-tr. & cassette:** Brite-Star, Bryte, Elgin, Roy self-mfd.  
 Brunswick (see Decca).  
 Bryte (see Brite-Star).

Buddah Recs., 1650 Broadway, New York, N.Y. 10019. Tel: (212) 582-6900.  
**Cartridge 8-tr. & cassette:** Buddah (includes Cobblestone, Curtom, Pavilion, Smobro, Super K, T-Neck, United Talent) licensed to ITCC; Kama Sutra licensed to Ampex.  
**Open reel:** Kama Sutra licensed to Ampex.  
**PlayTape:** Buddah, Kama Sutra.  
 Buena Vista (see Disneyland).  
 Burdette (see Tower).

## C

C B S/Columbia Recs., 51 W. 52 St., New York, N.Y. 10019. Tel: (212) 765-4321. Special Prods. Sales Dir.: George Novak; Nat'l Sales Dir., Pre-recorded Tape: Mel A. Price.  
**Cartridge 8-tr.:** Columbia, Date, Epic, Okeh, Ode, Barnaby, Fillmore, Blue Horizon self-mfd.  
**Cartridge 4-tr.:** Columbia, Date, Epic, Okeh, Ode, Blue Horizon self-mfd.  
**Cassette:** Same as 8-tr.  
**Open reel:** Columbia, Date, Epic, Ode, Blue Horizon self-mfd.  
 C G C Recs. (div. of The Crewe Group of Cos.), 1841 Broadway, New York, N.Y. 10023. Tel: (212) 245-3535. VP & Gen. Mgr.: Vito Samela.  
**Cartridge 8-tr. cassette & open reel:** Crewe licensed to GRT.  
 C M C Recs. & Tapes, 1201 Research Blvd., St. Louis, Mo. 63132. Tel: (314) 997-0016. Tape Div. Mgr.: Robert F. Phippot.  
**Cartridge 4-tr., 8-tr. & cassette:** Self-mfd.  
 Cabot Entertainment Corp., 2223 S. Dale Mabry Hwy., Tampa, Fla. 33609. Tel: (813) 253-5397.  
**Cartridge 8-tr., cassette & open reel:** Sundi licensed to GRT.  
 Cadet (see GRT).  
 Cadet/Concept (see GRT).  
 Caedmon Recs. Inc., 505 Eighth Ave., New York, N.Y. 10018. Tel: (212) 594-3122. Tape Div. & Sales Mgr.: Bob O'Brien.  
**Cartridge 4-tr., 8-tr., cassette & open reel:** Licensed to Ampex.  
 Canaan (see Word).  
 Candide (see Vox).  
 Capitol Recs. Dist'g Corp., 1750 N. Vine, Hollywood, Calif. 90028. Tel: (213) 462-6252. Special Mkts. Mds. Mgr.: Hal Rothberg; Special Prods. Sales Mgr.: Roger Brown.  
**Cartridge 8-tr.:** Capitol, Angel, Melodiya/Angel, Apple, Harvest, Fame self-mfd.  
**Cartridge 4-tr.:** Apple, Capitol licensed to Ampex.  
**Open reel:** Angel, Apple, Capitol licensed to Ampex.  
**Playback equip.:** Capitol.  
**Accessories:** Display racks, storage cases (Capitol).  
 Car Books (see The Smith Studio).  
 Carib (see Island Music).  
 Carole (see GNP Crescendo).  
 Cartucho Moda (see Modern).  
 Cascom (see Duplicator/Marketers section: Cassette Communications Corp.).  
 Celestial (see Scepter).  
 Certron Corp. Music Div., 1226 16 Ave. S., Nashville, Tenn. 37212. Tel: (615) 291-5137. Div. Head: Aubrey Mayhew; Nat'l Promo Mgr.: Jeff Clark.  
**Cartridge 8-tr.:** Certron, Sunglow, Vivid Sounds, Vivid Country Sounds self-mfd. Falcon self-mfd. & available on GRT.  
**Cartridge 4-tr.:** Falcon, Sunglow self-mfd.  
**Cassette:** Certron, Falcon, Sunglow, Vivid Sounds, Vivid Country Sounds self-mfd.  
**Open reel:** Certron, Falcon, Sunglow, Vivid Sounds self-mfd.  
 Cetra Opera Highlights (see Everest).  
 Challenge, 9220 Sunset Blvd., Suite 312, Los Angeles, Calif. 90069. Tel: (213) 273-6860. Pres.: Joe E. Johnson.  
**Cartridge 8-tr. & cassette:** Licensed to GRT.  
 Chart Recs. Inc., 806 16 Ave. S., Nashville, Tenn. 37203. Tel: (615) 254-7708. Pres.: B.L. Williamson.  
**Cartridge 8-tr.:** Licensed to Ampex, GRT, ITCC & RCA.  
**Cartridge 4-tr.:** Licensed to Ampex & Muntz.  
**Cassette:** Licensed to Ampex, GRT, ITCC, Mercury & RCA.  
**Open reel:** Licensed to Ampex & RCA.  
 Checker (see GRT).  
 Cheryl Laine (see AlCee).  
 Chess (see GRT).  
 Christian Faith (see Skylite-Sing).  
 Christian Folk (see Skylite-Sing).  
 Coach (see High Fidelity).  
 Cobblestone (see Buddah).  
 Colgems (see RCA).  
 Coliseum (see London).  
 Columbia (see CBS/Columbia).  
 Columbus Recs., 30 Nashua St., Woburn, Mass. 01801. Tel: (617) 935-4700. Pres.: Robert D. Levinson.  
**Cartridge 8-tr.:** Colonial, Standard Phono. Self-mfd.  
 Command (see ABC).  
 Concert Tapes (see Met Richmond).  
 Connoisseur Rec. Corp., 160 Passaic Ave., Kearny, N.J. 07032. Tel: (201) 998-8181; NYC Tel: (212) WH 4-5148. Mgr.: Frank A. Favata.  
**Open reel:** Artia self-mfd.  
 Contemporary Recs. Inc., 8481 Melrose Pl., Los Angeles, Calif. 90069. Tel: (213) 656-1560. Pres.: Lester Koenig.  
**Cartridge 8-tr., cassette & open reel:** Contemporary (includes Contemporary Composers

Series, Good Time Jazz, SFM, Society for Forgotten Music) licensed to Ampex.  
 Continental Airlines (see Duplicator/Marketers section: Ampex Stereo Tapes).  
 Conversa-Phone Institute Inc., 225 W. 34 St., New York, N.Y. 10001. Tel: (212) 695-5386.  
**VP & Tape Div. Mgr.:** Edmund L. Owen; Tape Sales Mgr.: Larry Sockell.  
**Cassette:** Self-mfd.  
 Coral (see Decca).  
 R. D. Cortina Co. Inc., 136 W. 52 St., New York, N.Y. 10019. Tel: (212) 582-3845. Tape Div. Mgr.: Robert E. Livesey.  
**Cassette:** Cortina Language Method self-mfd.  
 Cotillion (see Atlantic).  
 Cotique Rec. Corp. 477 Park Ave., East Hartford, Conn. 06108. Tel: (203) 289-6028. Contact: Morton Waters.  
**Cartridge 8-tr.:** Licensed to Ethnic Tapes & NAL.  
 Country Gems (see Ralph's Radio).  
 Country Jubilee (see Ralph's Radio).  
 Country Sound (see NAL).  
 Country Star (see Process).  
 Creed (see Nashboro).  
 Crestview Rec. Dist'g Inc., 8560 Sunset Blvd., Suite 401, Los Angeles, Calif. 90069. Tel: (213) 874-5095. Gen. Mgr.: Randall Wood; Sales Mgr.: R. E. Kelly.  
**Cartridge 8-tr. & cassette:** Crestview licensed to Ampex; Mira, Mirwood licensed to ITCC; Surrey Int'l licensed to NAL.  
**Open reel:** Crestview licensed to Ampex.  
 Crewe (see GCG).  
 Criterion Music Corp., 6124 Selma Ave., Hollywood, Calif. 90028. Tel: (213) 469-2296. Pres.: Michael H. Goldsen.  
**Cartridge 8-tr.:** Reo Tahiti licensed to GRT.  
 Cuca Rec. Corp., 123 Water St., Sauk City, Wis. 53583. Tel: (608) 643-3304. Pres.: Jim Kirchstain; Sales & Mktg.: Gloria Bohannon.  
**Cartridge 4-tr. & 8-tr.:** Cuca (includes Age of Aquarius, Night Owl, Sara, Shamrock, Sounds of Aquarius) licensed to GRT.  
 Curtom (see Buddah).

## D

D G G (see Polydor).  
 Dakar (see Atlantic).  
 Dandelion (see Elektra).  
 Date (see CBS/Columbia).  
 Decca Recs., 445 Park Ave., New York, N.Y. 10022. Tel: (212) 759-7500. Nat'l Tape Prod. Mgr.: Joel A. Schneider.  
**Cartridge 8-tr. & cassette:** Decca, Brunswick self-mfd.; also license for Bravo, Viva, **Open reel:** Decca, Coral, Brunswick-self-mfd.  
 De-Lite Recs., 300 W. 55 St., New York, N.Y. 10019. Tel: (212) 581-4500. Pres.: Fred Fioto.  
**Cartridge 8-tr. & cassette:** Licensed to GRT.  
 Delmark Recs., 7 W. Grand, Chicago, Ill. 60610. Tel: (312) 222-1467. Tape Div. Mgr.: Robert G. Koester.  
**Cartridge 8-tr.:** Licensed to GRT.  
**Cartridge 4-tr.:** Licensed to GRT & Muntz.  
**Cassette:** Licensed to GRT.  
 Delta Int'l Recs., 1584 E. 31 St., Cleveland, Ohio 44114. Tel: (216) 861-7286. Pres. & Sales Mgr.: John R. Gayer.  
**Cartridge 8-tr. & cassette:** Delta Int'l, Starlight self-mfd. by Consolidated Tape Cartridges.  
 Del Valle (see Amexar).  
 Deram (see London).  
 Deutsche Grammophon (see Polydor).  
 Dial (see Atlantic).  
 Diamond Recs. Inc. (div. of Edwin H. Morris & Co. Inc.), 31 W. 54 St., New York, N.Y. 10019. Tel: (212) 582-5656. Pres.: Joe Kolsky.  
**Cartridge 8-tr.:** Licensed to GRT & RCA.  
**Cartridge 4-tr.:** Licensed to Muntz.  
**Cassette:** Same as 8-tr.  
**Open reel:** Licensed to RCA.  
 Dick/Hike (see Kiderian).  
 Direction (see Bell).  
 Disco Grande (see Tanner 'N' Texas).  
 Discos Fuentes (see Miami).  
 Discos Premier (see Ferмата).  
 Discuba (see Musical Tapes).  
 Disko (see Velvet).  
 Disneyland Recs., 800 Sonora Ave., Glendale, Calif. 91201. Tel: (213) 845-3141 x 1125. Nat'l Sales Mgr.: Jerry Weiner.  
**Cartridge 8-tr. & cassette:** Disneyland self-mfd.; Buena Vista licensed to RCA.  
**Open reel:** Buena Vista licensed to RCA.  
 Dooto Rec. Corp., 13440 S. Central Ave., Compton, Calif. 90222. Tel: (213) 774-0743. Pres.: Dootsie Williams; Tape Div. Mgr.: Erma Jean Ewing; Tape Sales Mgr.: Youra D. Johnson.  
**Cartridge 4-tr., 8-tr., & cassette:** Self-mfd.  
 Dot (see Paramount).  
 Double-Shot Recs., 6565 Sunset Blvd., Hollywood, Calif. 90028. Tel: (213) 461-3471. Tape Div. & Sales Mgr.: Irwin Zucker.  
**Cartridge 8-tr. & cassette:** Self-mfd.  
 Duke/Peacock Recs. Inc., 2809 Erastus St., Houston, Tex. 77026. Tel: (713) 673-2611/1225. Pres.: Don D. Robey.  
**Cartridge 8-tr.:** Duke, Peacock, Backbeat licensed to GRT.  
**Cartridge 4-tr.:** Duke, Peacock, Backbeat licensed to Muntz.  
**Cassette:** Duke, Backbeat licensed to GRT.  
**Open reel:** Duke licensed to GRT.

continued on page 16

# 1970 Compacts from Detroit.



T-8-1297



G-8-1949



S-8-1721



M-8-1702

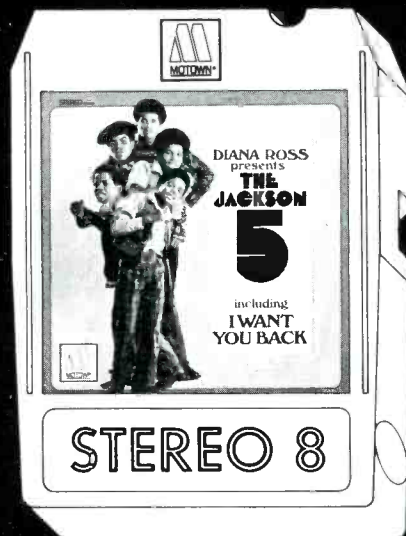

M-8-1700



T-8-1299

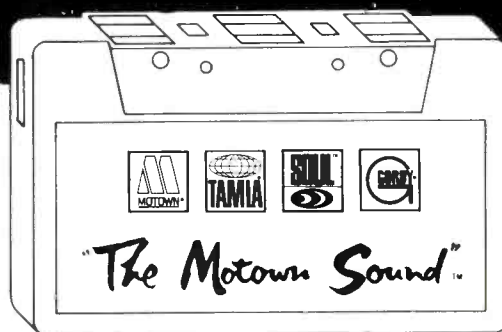

Same models in the small economy-size, too.

**JUBILEE GROUP**  
**No. 1 IN COMEDY**

**JUBILEE**

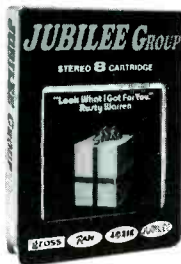

**LOOK WHAT I GOT FOR YOU**

Rusty Warren

8 Track ..... JST 8-2074  
Cassette ..... EEC-2074

**RAW**

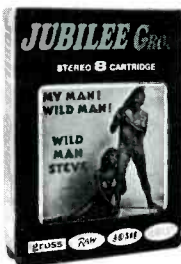

**MY MAN! WILD MAN!**

Wild Man Steve

8 Track ..... RST 8-7000  
Cassette ..... AWC-7000

**GROSS**

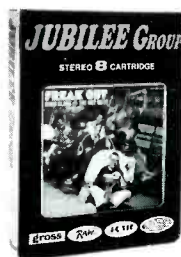

**FREAK OUT**

Doug Clark & The Hot Nuts

8 Track ..... GST 8-8  
Cassette ..... SSC-8

Complete Tape Catalog Upon Request  
Products of Jay-Gee Record Co., Inc.  
1790 Broadway, New York, N.Y. 10019  
Subsidiary of Jubilee Industries

**RECORD MANUFACTURERS WITH TAPE PRODUCT**

Continued from page 14

Dunhill Recs. Inc., 8255 Beverly Blvd., Los Angeles, Calif. 90048. Tel: (213) 651-5530. (See ABC).  
Dynamo (see Musicor).  
Dyno (see Associated Inds).  
DynoVoice (see Paramount).

**E**

E S P-Disk' Ltd., 300 W. 55 St., New York, N.Y. 10019. Tel: (212) 265-0470. Pres.: Bernard Mindlin; Sec'y: Bernard Stollman.  
Cartridge 8-tr. & cassette: Licensed to GRT.  
Elektra Recs., 1855 Broadway, New York, N.Y. 10023. Tel: (212) JU 2-7711. Tape Div. & Sales Mgr.: Mel Posner.  
Cartridge 8-tr.: Elektra self-mfd. & licensed to Ampex; Dandelion self-mfd.; Nonesuch licensed to Ampex.  
Cartridge 4-tr.: Elektra licensed to Ampex & Muntz; Nonesuch licensed to Ampex.  
Cassette: Elektra self-mfd. & licensed to Ampex; Dandelion, Nonesuch self-mfd.  
Open reel: Elektra, Nonesuch licensed to Ampex.  
Elf (see Bell).  
Elgin (see Brite-Star).  
Ember Recs. Int'l, 135 E. 44 St., Suite 409, New York, N.Y. 10017. Tel: (212) 986-5414. Mgr.: Louis Zinman.  
Home office: England.  
Cartridge 8-tr., cassette & open reel: Licensed to ITCC.  
Enterprise (see Stax & Atlantic).  
Epic (see CBS/Columbia).  
Era (see Happy Tiger).  
Eurotone Int'l Ltd., 130 W. 42 St., New York, N.Y. 10036. Tel: (212) 594-9670. Pres. & Sales Mgr.: George Curtiss.  
Cartridge 8-tr. & cassette: Self-mfd. & licensed to Dubbings & Specialty Sounds.  
Everest Recs. Inc., 10920 Wilshire Blvd., Los Angeles, Calif. 90024. Tel: (213) BR 2-4391. Pres.: Bernard C. Solomon; VP: Lee Palmer.  
Cartridge 8-tr.: Everest, Archive of Folk Music, Archive of Gosep Music, Archive of Jazz, Life, HiFi, Tradition licensed to GRT.  
Cassette: Same as 8-tr. plus Cetra Opera Series.  
Everyman (see Vanguard).  
Evolution (see Stereo Dimension).  
Excello (see Nashboro).

**F**

Falcon (see Certron).  
Fame Recs. Inc., 603 E. Avelon, Muscle Shoals, Ala. 35660. Tel: (205) 381-0801. Pres.: Rick Hall; VP: Frank Daily. (see Capitol).  
Family (see Request).  
Fantasy/Galaxy Recs., 1281 30 St., Oakland, Calif. 94608. Tel: (415) 451-1515. VP Sales & Mdsq. Mgr.: Ted Ponseti.  
Cartridge 4-tr., 8-tr., cassette & open reel: Fantasy, Galaxy licensed to Ampex.  
Fax (see Modern).  
Federal (see Steady).  
Fermata Int'l Melodies Inc., 6290 Sunset Blvd., Hollywood, Calif. 90028. Tel: (213) 462-7473. Mgr.: Mrs. D. Frenkiel.  
Cartridge 4-tr.: Producoes Fermata, Discos Premier, RGE, Som/Maior imported & licensed to Muntz.  
Fiesta Rec. Co. Inc., 1619 Broadway, New York, N.Y. 10019. Tel: (212) PL 7-7760. Pres.: Jose Morand; Sales Mgr.: Morton Gilbert.  
Cartridge 8-tr. & cassette: Self-mfd.  
Fillmore (see CBS/Columbia).  
Firebird Rec. Co. Inc., 1650 Broadway, New York, N.Y. 10019. Tel: (212) 757-2750. Owners: Sam & George Goldner.  
Cartridge 8-tr., cassette & open reel: Licensed to NAL.  
Flair (see Modern).  
Fleetwood Rec'g Co. Inc., 321 Revere St., Revere, Mass. 02151. Tel: (617) 284-0750. Tape Div. Mgr.: Raymond G. Samora; Tape Sales Mgr.: Vincent P. Giarrusso.  
Cartridge 8-tr., cassette & open reel: Self-mfd.  
Flying Dutchman Prod'n's Ltd., 65 W. 55 St., New York, N.Y. 10019. Tel: (212) 765-1653. Pres.: Robert Thiele.  
Cartridge 4-tr., 8-tr. & cassette: Flying Dutchman, Amsterdam, BluesTime licensed to Ampex.  
Fontana (see Mercury).  
Four Corners of the World (see Kapp).

**G**

G M S (see Playette).  
G N P Crescendo Recs., 9165 Sunset Blvd., Los Angeles, Calif. 90069. Tel: (213) 275-1108. Pres. & Sales Mgr.: Gene Norman.  
Cartridge 8-tr.: GNP Crescendo licensed to GRT, ITCC & NAL; Carole licensed to Ampex & NAL; Accent licensed to GRT & NAL.  
Cartridge 4-tr.: GNP Crescendo licensed to GRT & Muntz; Accent, Carole licensed to Muntz.  
Cassette: GNP Crescendo, Accent licensed to GRT & NAL; Carole licensed to Ampex & NAL.  
Open reel: GNP Crescendo licensed to GRT & NAL; Accent licensed to NAL.  
G R T Recs. (div. of GRT Corp.), 9000 W. Sunset

Bldv., Suite 615, Los Angeles, Calif. 90069. Tel: (213) 278-7380.

Cartridge 8-tr., cassette & open reel: GRT, Blue Thumb, Checker, Chess, Cadet, Cadet/Concept, Janus self-mfd. by GRT; also see Duplicator/Marketers section for licensed labels.  
G W P Recs. (sub. of Gerard W. Purcell Assocs. Ltd.), 150 E. 52 St., New York, N.Y. 10022. Tel: (212) PL 3-7600. Pres.: Gerard W. Purcell; VP: Paul Robinson.  
Cartridge 8-tr. & cassette: Licensed to ITCC.  
Gail (see Kiderian).  
Galaxy (see Fantasy/Galaxy).  
Gamble Recs. Inc., 1650 Broadway, New York, N.Y. 10019. Tel: (212) 757-2750. VP & Sales Mgr.: Sam Goldner.  
Cartridge 8-tr.: Licensed to GRT, ITCC, NAL, RCA & Livingston.  
Cartridge 4-tr.: Licensed to GRT & Livingston.  
Cassette: Same as 8-tr.  
Open reel: Licensed to GRT, NAL & Livingston.  
Gateway (see Associated Inds).  
Gayten Recs. Inc., 6725 Sunset Blvd., Hollywood, Calif. 90028. Tel: (213) 466-8147.  
Cartridge 8-tr.: Pzazz licensed to GRT.  
General Mfg. Co., 501 W. 28 St., Hialeah, Fla. 33010. Tel: (305) 887-4522, 888-5336. Pres.: Manuel J. Mato; Tape Mgr.: Melvin F. Noriega.  
Cartridge 8-tr. & cassette: General, Riviera self-mfd.  
General Recorded Tape (see GRT).  
Giantstar (see Tamesi).  
Ginger (see Kiderian).  
Glad-Hamp Recs. Inc., 165 W. 46 St., New York, N.Y. 10036. Tel: (212) PL 7-8486. Gen. Mgr.: Bill Titone.  
Cartridge 4-tr. & 8-tr.: licensed to ITCC.  
Goldband Rec'g Corp., PO Box 1485, Lake Charles, La. 70601. Tel: (318) 439-8839. Pres.: Eddie Shuler; Tape Mgr.: Jeff LeJune.  
Cartridge 8-tr. & cassette: Goldband, Anla self-mfd.  
Golden (see AA).  
Goldwax (see Bell).  
Good Time Jazz (see Contemporary).  
Gordy (see Motown).  
Gospel (see Savoy).  
Gospel Gems (see Ralph's Radio).  
Gospel Jubilee (see Ralph's Radio).  
Gross (see Jay Gee).  
Grand Award (see ABC).  
Grand Staff Recs., PO Box 343, Pacoima, Calif. 91331. Tel: (213) 896-4411. Owner & Mgr.: Harry J. Jenkins.  
Cartridge 4-tr., 8-tr. & open reel: Self-mfd.

**H**

H R (see Malynn).  
Happy Tiger Recs., 6565 Sunset Blvd., Los Angeles, Calif. 90028. Tel: (213) 464-7335. Pres.: Richard H. Peirce.  
Cartridge 8-tr.: Happy Tiger (includes Era) licensed to Ampex.  
Harvest (see Capitol).  
Heart Warming/Impact Recs., 136 Fourth Ave. N., Nashville, Tenn. 37291. Tel: (615) 254-6558. VP & Tape Mgr.: John T. Benson III.  
Cartridge 8-tr. & cassette: Heart Warming, Impact self-mfd.  
Heritage (see MGM).  
Hi (see London).  
Hickory Recs. Inc., 2510 Franklin Rd., Nashville, Tenn. 37204. Tel: (615) 297-8558. Nat'l Sales Mgr.: Lester F. Rose.  
Cartridge 8-tr.: Hickory, TRX licensed to GRT & ITCC.  
Cartridge 4-tr.: Hickory, TRX licensed to Muntz.  
Cassette: Hickory, TRX licensed to GRT, ITCC & Mercury.  
Open reel: Hickory, TRX licensed to GRT.  
HiFi (see Everest).  
High Fidelity Rec'g Inc., 1059 Porter, Wichita, Kan. 67203. Tel: (316) 262-6456. Tape Div. Mgr.: James Strattan; Sales Mgr.: Don Clyne.  
Cartridge 4-tr., cassette & open reel: Kanwic, Beat, Coach self-mfd.  
Highland (see Malynn).  
Hilltop (see Pickwick).  
Hi-Oldies (see Malynn).  
Hip (see Stax).  
Hob (see Scepter).  
House of Menorah Inc., 52 E. Broadway, New York, N.Y. 10002. Tel: (212) WA 5-7573. Gen. Mgr.: Sol Tischler; Sales Rep.: Sol Rosenberg.  
Cartridge 8-tr.: Menorah self-mfd.  
Hula Recs. Inc., 345 Kamakee St., Honolulu Hawaii 96805. Tel: (808) 531-6118. Pres.: Don McDiarmid Jr.  
Cartridge 8-tr., cassette & open reel: Hula, Surfside self-mfd.

**I**

I L L (see Kiderian).  
I L S (see Institute for Language Study).  
I R C (see International Rec'g Co.).  
I T C C (International Tape Cartridge Corp.), 1275 Bloomfield Ave., Fairfield, N.J. 07006. Tel: (201) 228-1050. Pres.: Gary Salter; VP: Jimmie Tyrrell; Nat'l Tape Dir.: Miss Gerry Cousins.  
Cartridge 8-tr. & cassette: Itco self-mfd.; also see Duplicator/Marketers section for licensed labels.  
Illinois Prod'g Corp. (see Kiderian).  
Impact (see Heart Warming).  
Imperial (see Liberty/UA).  
Impulse (see ABC).

continued on page 18



# STACKED DECK

When it comes to the big sounds that everyone wants to hear, the odds are they're ours.



© EPIC. Marca Reg. T.M. PRINTED IN U.S.A.

Also available on \*cassette †4-track stereo tape cartridge ‡ reel-to-reel stereo tape.

# RECORD MANUFACTURERS WITH TAPE PRODUCT

Continued from page 16

Institute for Language Study (ILS), 71 Plymouth St., Montclair, N.J. 07042. Tape Div. Mgr.: Robert Shaw.  
**Cartridge 8-tr.:** Licensed to Ampex & RCA.  
**Open reel:** Licensed to Ampex.  
 International Rec'g Co., 1649 W. Evergreen, Chicago, Ill. 60622. Tel: (312) 227-2000. Pres.: Vern Ruvalds; VP: J. V. Man.  
**Cartridge 4-tr., 8-tr., cassette & open reel:** IRC, Royal Blue self-mfd.  
 International Tape Cartridge Corp. (see ITCC).  
 Island Music Dist's. Ltd., PO Box 748, Miami Springs, Fla. 33166. Sales Mgr.: Ron Christopher.  
**Cartridge 8-tr.:** Carib licensed to ITCC.  
 Itco (see ITCC).

J

Jad Recs., 225 W. 57 St., New York, N.Y. 10019. Tel: (212) 586-0111. Pres.: Danny D. Sims Jr.; Tape Div. Mgr.: Warren Ling; Tape Sales Mgr.: Irwin Brasso.  
**Cartridge 8-tr. & cassette:** Jad (includes Turntable, Banyan Tree) licensed to Ampex & ITCC.  
**Open reel:** Jad (includes Turntable, Banyan Tree) licensed to Ampex.  
 Jamie/Guyden Dist'g Corp., 919 N. Broad St. Philadelphia, Pa. 19123. Tel: (215) 232-8383. Pres.: Harold B. Lipsius; Mgr.: Paul Fein; Sales Mgr.: Larry Cohen.  
**Cartridge 8-tr.:** Jamie, Phil-L.A. of Soul licensed to GRT & ITCC.  
**Cartridge 4-tr., cassette & open reel:** Jamie, Phil-L.A. of Soul licensed to GRT.  
 Janus Recs. (div. of GRT Corp.), 1700 Broadway, New York, N.Y. 10019. Tel: (212) 765-7980.  
**Cartridge 8-tr., cassette & open reel:** Self-mfd. by GRT.  
 Jay Gee Rec. Co. Inc. (sub. of Jubilee Inds.), 1790 Broadway, New York, N.Y. 10019. Tel: (212) 757-8570. Tape Div. Mgr.: Irwin Lisabeth; Ass't. Sales Mgr.: Miss Billie Dove Dobson.  
**Cartridge 8-tr. & cassette:** Gross, Josie, Jubilee, Raw self-mfd.  
 Jay Jay Rec. Co., PO Box 4155, Normandy Branch, Miami Beach, Fla. 33141. Tel: (305) 865-9057. Pres.: Walter Jay.  
**Cartridge 8-tr.:** Self-mfd.  
 Jerden (see Tower).  
 Jewel Recs., 728 Texas St., Shreveport, La. 71101.

Tel: (318) 422-7182. Tape Dept. Mgr.: Jessie Camp; Sales Mgr.: Lee Delcambre.  
**Cartridge 8-tr. & cassette:** Jewel, Paula licensed to GRT.  
 Josie (see Jay Gee).  
 Jubilee (see Jay Gee).

K

Kama Sutra (see Buddha).  
 Kanwic (see High Fidelity).  
 Kapp Recs. (div. of MCA), 136 E. 57 St., New York N.Y. 10022. Tel: (212) 759-8500. Tape Sales Mgr.: Louis J. Sebok.  
**Cartridge 8-tr.:** Kapp, Four Corners of the World self-mfd. & available through Ampex, GRT & NAL.  
**Cartridge 4-tr.:** Kapp, Four Corners of the World available through Ampex.  
**Cassette:** Kapp, Four Corners of the World self-mfd. & available through Ampex.  
**Open reel:** Kapp, Four Corners of the World available through Ampex.  
 Kiderian Recs. Prod'ns Ltd., 4926 W. Gunnison St., Chicago, Ill. 60630. Tel: (312) 545-0861. Pres.: George Peck; Tape Div. Mgr.: Ginger Wadiopian; Tape Sales Mgr.: Tom Petrelli.  
**Cassette:** Kiderian, Black-Beauty, Dick/Hike, Gail, Ginger, ILL (Illinois Prod'g Corp.), S. T. Lewis self-mfd.  
 Kirshner (see RCA).  
 King (see Starday-King).  
 Kubaney (see Universal).

L

L L P (see Leonard Lewis Prod'ns).  
 Ladd (see White Rock).  
 Laff (see Ala).  
 La Louisiana Recs., 2823 Johnston St., Lafayette, La. 70501. Tel: (318) 234-4118. Tape Div. & Sales Mgr.: Carol J. Rachou.  
**Cartridge 8-tr.:** Self-mfd.  
 Laurie Recs. Inc., 165 W. 46 St., New York, N.Y. 10036. Tel: (212) 582-2975. Gen. Mgr.: Robert M. Schwartz.  
**Cartridge 8-tr. & cassette:** Laurie, President self-mfd.  
 Lessons in Living (see Accent).  
 Leonard Lewis Prod'ns Inc., 345 W. 58 St., New York, N.Y. 10019. Tel: (212) 581-4877. Pres.: Lenny Lewis.  
**Cartridge 8-tr., cassette & open reel:** LLP licensed to NAL.  
 S. T. Lewis (see Kiderian).  
 Liberty/UA Stereo-Tape, 6920 Sunset Blvd., Hollywood, Calif. 90028. Tel: (213) 461-9141. Gen. Mgr.: Earl D. Horwitz; Nat'l Sales Mgr.: Charles P. Bratnober.

**Cartridge 8-tr.:** Liberty (includes Blue Note, Imperial, Liberty, Solid State, Soul City, World Pacific, World Pacific Jazz), United Artists (includes Minit, United Artists), Sunset self-mfd.  
**Cartridge 4-tr. & cassette:** Same as 8-tr. excluding Sunset.  
**Open reel:** Blue Note, Imperial, Liberty, Minit, Solid State, Soul City, United Artists, World Pacific licensed to Bell & Howell.  
 Life (see Everest).  
 Light (see Word).  
 Limelight (see Mercury).  
 Linguatape (see Northmoor).  
 Living Rec. Library (see The Smith Studio).  
 Livingston Audio Prods. Corp., 1275 Bloomfield Ave., Fairfield, N.J. 07006. Tel: (201) 226-8300. Pres.: Darrell D. Scholten; VP Sales: Thomas J. Hofbauer.  
**Cartridge 4-tr., 8-tr., cassette & open reel:** Livingston self-mfd.; also see Duplicator/Marketers section for licensed labels.  
 L'Oiseau Lyre (see Argo).  
 London Recs. Inc., 539 W. 25 St., New York, N.Y. 10001. Tel: (212) OR 5-6060.  
**Cartridge 8-tr.:** London, Coliseum, Deram, Hi, Parrot, phase 4, Press, Sire licensed to Ampex.  
**Cartridge 4-tr.:** London, Deram, Hi, Parrot, Sire licensed to Ampex.  
**Cassette:** Same as 8-tr.  
**Open reel:** London, Deram, Hi, Parrot, phase 4, Press, Richmond, Sire, licensed to Ampex.  
 Lou-Neita Rec. Co. Inc., 1608 Thompson Ave., East Point, Ga. 30344. Tel: (404) 766-3641. Tape Div. Mgr.: Jeff Brannon; Tape Sales Mgr.: Martin C. Haley.  
**Cartridge 8-tr. & cassette:** Lou-Neita, Lou-Neita Goldentone self-mfd.  
 Lynn's Prod'ns, 551 Muscadine St., Greenville, Miss. 38701. Tel: (601) 332-8665, 335-4594.  
**Cartridge 8-tr.:** Reginald self-mfd.

M

M G M Recs., 1350 Ave. of the Americas, New York, N.Y. 10019. Tel: (212) 262-3131. Cable: METRECORD.  
**Cartridge 8-tr. & cassette:** Heritage, MGM, Stormy Forest, Verve licensed to Ampex.  
**Micro cassette:** MGM, Verve licensed to Ampex.  
**Open reel:** Heritage, MGM, Verve licensed to Ampex.  
 M T A Recs., 40 W. 55 St., New York, N.Y. 10019. Tel: (212) 581-8650. Pres.: Robert Thompson.  
**Cartridge 8-tr., cassette & open reel:** Licensed to GRT.

continued on page 20

# Get them while they're hot.

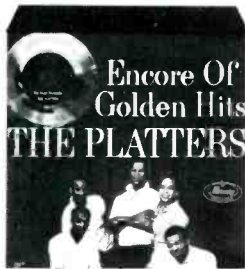

8 Track—MC8 60243  
 Musicassette—MCR4 64007



8 Track—MC8 61227  
 Musicassette—MCR4 61227

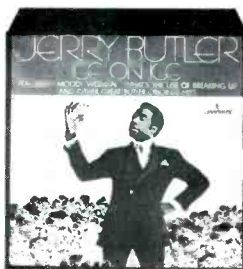

8 Track—MC8 61234  
 Musicassette—MCR4 61234



8 Track—PC8 600-196  
 Musicassette—PCR4 600-196

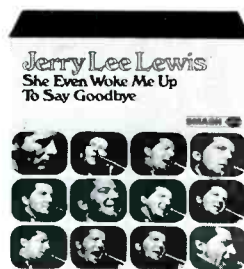

8 Track—SC8 67128  
 Musicassette—SCR4 67128

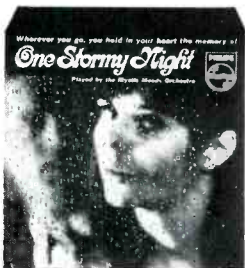

8 Track—PC8 600-205  
 Musicassette—PCR4 600-205

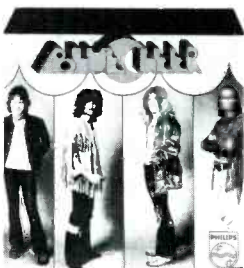

8 Track—PC8 600-333  
 Musicassette—PCR4 600-333



8 Track—PC8 600-221  
 Musicassette—PCR4 600-221

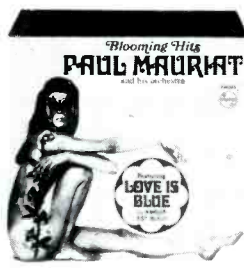

8 Track—PC8 600-248  
 Musicassette—PCR4 600-248

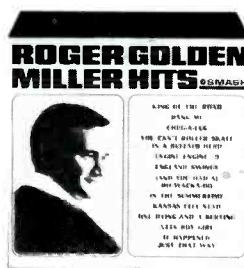

8 Track—SC8 67073  
 Musicassette—SCR4 68001

From The Mercury Record Corporation Family of Labels / Mercury • Philips • Smash • Fontana • Limelight • Intrepid  
 A Product Of Mercury Record Productions, Inc. / 35 East Wacker Drive, Chicago, Illinois 60601 / A North American Philips Company



# Question

From whom can you buy Scepter 8-track tapes and cassettes—including Dionne Warwick and B.J. Thomas?

DIONNE WARWICK'S GOLDEN HITS

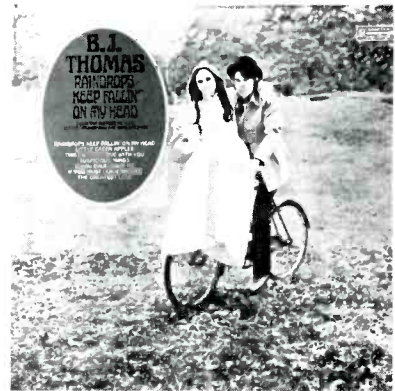
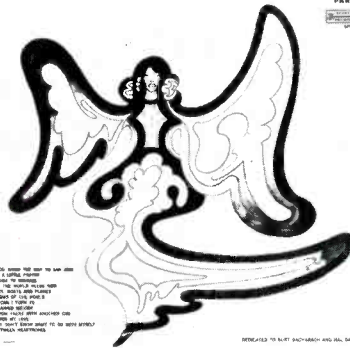

# Answer

Only from the tape "mavin," Jerry Geller or the son-of-the-tape "mavin," Al Abraskin. At (212) 245-2170.



# All

**Scepter Tapes—Now Exclusively Distributed by Scepter Records**

Check These 'Profitable Sounds' on 8-Track and Cassettes.



and America's #1 Budget Line



**SCEPTER RECORDS**

254 West 54th Street  
New York, N.Y. 10019

# RECORD MANUFACTURERS WITH TAPE PRODUCT

Continued from page 18

Mainstream Recs. Inc., 1700 Broadway, New York, N.Y. 10019. Tel: (212) 247-0655. Pres.: Bob Shad; Sales: Chet Woods.  
**Cartridge 4-tr., 8-tr., cassette & open reel:** Licensed to Ampex.

Mala (see Bell).

Malynt Ent's. Inc., 2580 W. Pico Blvd., Los Angeles, Calif. 90006. Tel: (213) 385-9161. Mgr.: Guy Ward.  
**Cartridge 8-tr. & cassette:** Hi-Oldies, HR (Highland Recs. includes product from Rexford) self-mfd.

Marvel Recs., 825 Elm St., Manchester, N.H. 03101. Tel: (603) 623-9749. Mng. Dir. & Int'l: James N. Parks.  
**Cartridge 4-tr., 8-tr. & cassette:** Marvel, Banff, Melbourne, Rodeo Int'l self-mfd.  
**Open reel:** Banff, Rodeo Int'l self-mfd.

Melbourne (see Marvel).

Menorah (see House of Menorah).

Mercury Rec. Corp., 35 E. Wacker Dr., Chicago, Ill. 60601. Tel: (312) 332-5788. Tape Prod. Mgr.: Harry Kelly.  
**Cartridge 8-tr.:** Mercury, Philips, Smash, Fontana, Limelight self-mfd.  
**Cartridge 4-tr.:** Mercury, Philips, Smash, Fontana, Limelight, Wing licensed to Muntz.  
**Cassette:** Same as 8-tr.; also licensee for Audio Fidelity, Chart, Hickory, Roulette, TRX, Tico.  
**Open reel:** Mercury, Philips, Smash, Fontana, Limelight, Wing licensed to Ampex.

Mersey (see Process).

Met Richmond Rec. Sales Inc., 1637 Utica Ave., Brooklyn, N.Y. 11234; 718 10 Ave., New York, N.Y. 10019. Tel: (212) 253-4600, 265-9480.  
**Cartridge 8-tr.:** Adults, Concert Tapes, Met Rico, Seeco self-mfd.

Met Rico (see Met Richmond)

Metromedia Recs., 1700 Broadway, New York, N.Y. 10019. Tel: (212) 245-4800. Tape Div. & Sales Mgr.: Pete Vescovo.  
**Cartridge 8-tr., cassette & open reel:** Licensed to GRT.

Miami Recs. Dist'g Corp., 2819 NW Seventh Ave., Miami, Fla. 33127. Tel: (305) 635-7925. Owner: Carlos Diaz-Granados V.  
**Cartridge 8-tr.:** Discos Fuentes self-mfd.

Milestone Recs. Inc., 119 W. 57 St., New York, N.Y. 10019. Tel: (212) 765-5590. VP & Gen. Mgr.: Orrin Keepnews.  
**Cartridge 8-tr., cassette & open reel:** Licensed to NAL.

Minit (see Liberty/UA).

Mio Int'l Recs. Inc., 185 West End Ave., New York, N.Y. 10023. Tel: (212) 362-9812. Pres. & Tape Div. Mgr.: Marty Wilson.  
**Cartridge 8-tr.:** Licensed to ITCC.

Mira (see Crestview).

Mobile Fidelity Recs., PO Box 336, Burbank, Calif. 91505. Tel: (213) 848-5367. Pres.: Brad S. Miller.  
**Cartridge 8-tr., cassette & open reel:** Licensed to GRT.

Moda (see Amexar).

Modern Tape Corp., 5810 S. Normandie Ave., Los Angeles, Calif. 90044. Tel: (213) 753-2481. Pres.: Joe Bihari; VP: Bob Demain.  
**Cartridge 8-tr. & cassette:** Modern, Cartucho Moda, Fax, Flair, Mother Goose self-mfd.

Monitor Rec'g's Inc., 156 Fifth Ave., New York, N.Y. 10010. Tel: (212) YU 9-2323. Pres: Michael Stillman; VP: Rose N. Rubin.  
**Cartridge 8-tr.:** Licensed to Ampex & NAL.  
**Cartridge 4-tr.:** Licensed to Muntz.  
**Cassette & open reel:** Licensed to Ampex.

Monmouth-Evergreen Recs., 1697 Broadway, Suite 502, New York, N.Y. 10019. Tel: (212) 757-5105. Sales Mgr.: Patrick A. Sabatino.  
**Cartridge 8-tr., cassette & open reel:** Licensed to NAL.

Montilla (see Spanish World).

Monument Rec. Corp., 530 W. Main St., Hendersonville, Tenn. 37075. Tel: (615) 824-6565. VP: Steve Poncio.  
**Cartridge 8-tr.:** Monument, Rising Sons, Sound Stage 7 licensed to GRT.  
**Cartridge 4-tr.:** Monument, Rising Sons, Sound Stage 7 licensed to Muntz.  
**Cassette & open reel:** Same as 8-tr.

Moonglow Recs., 23007 Ventura Blvd., Rm. 3, Woodland Hills, Calif. 91364. Tel: (213) 346-3232. Pres.: Ray Maxwell.  
**Cartridge 8-tr.:** Licensed to ITCC.

Mother Goose (see Modern).

Motown Rec. Corp., 2457 Woodward Ave., Detroit, Mich. 48201. Tel: (313) 965-9250. Mktg. Dir.: Mel DaKroob; Nat'l Sales Dir.: Joe Louis.  
**Cartridge 8-tr.:** Motown, Gordy, Soul, Tamla self-mfd.  
**Cartridge 4-tr.:** Motown, Gordy, Soul, Tamla licensed to Muntz.  
**Cassette:** Same as 8-tr.  
**Open reel:** Motown, Gordy, Soul, Tamla licensed to Ampex.

Movietone (see ABC).

Musart (see Musical Tapes).

Musical Tapes Inc., 790 W. 27 St., Hialeah, Fla. 33010. Tel: (305) 887-2638. Gen. Mgr.: Angel Tamargo.  
**Cartridge 4-tr., 8-tr. & cassette:** Musart, Discuba, Musidisc, Nilser, Peerless self-mfd.

Music Guild (see ABC).

Musico (see Musico).

Musico Recs. (div. of Talmadge Prod'ns), 240 W. 55 St., New York, N.Y. 10019. Tel: (212) LT 1-4680. Pres.: Art Talmadge; VP Chris Spinosa.  
**Cartridge 8-tr.:** Musico licensed to ITCC; Dynamo licensed to GRT; Musico self-mfd.  
**Cassette:** Dynamo licensed to GRT; Musico self-mfd.  
**Open reel:** Musico licensed to GRT.

Musidisc (see Musical Tapes)

## N

N A L (North American Leisure Corp.), 1776 Broadway, New York, N.Y. 10019. Tel: (212) 265-3340. Pres.: Larry Finley; VP Mktg.: Art Danish.  
**Cartridge 8-tr., cassette & open reel:** NAL, Country Sound, Tennessee Sound self-mfd.; also see Duplicator/Marketers section for licensed labels.

Nashboro Rec. Co. Inc., 1011 Woodland St., Nashville, Tenn. 37206. Tel: (615) 227-5081. Pres.: B.S. Howell Jr.  
**Cartridge 8-tr. & cassette:** Nashboro, Creed, Excello licensed to GRT.

Nashville (see Starday-King).

National Rec. Sales (sub. of Jervis Ent's.), 160 Broadway, New York, N.Y. 10038. Tel: (212) BA 7-9493. Owner & Mgr: Reginald M. Jervis.  
**Cartridge 8-tr. & cassette:** Ren Bob self-mfd.

New Voice (see Bell).

Night Owl (see Cuca).

Nilser (see Musical Tapes).

Nina Rec. Co. Inc., 614 Eighth Ave., New York, N.Y. 10018. Tel: (212) OX 5-7696. Tape Div. & Sales Mgr.: Nick Iseperis.  
**Cartridge 8-tr.:** Self-mfd.

Nivco (see Pacific Int'l).

Nonesuch (see Elektra).

North American Leisure Corp. (see NAL).

Northmoor Rec'g Co., 229 East Pkwy. S., Memphis, Tenn. 38114. Tel: (901) 274-0565. Pres.: Dean Moore; VP: Libby Moore.  
**Cartridge 4-tr., cassette & open reel:** Northmoor, Linguatape self-mfd.

continued on page 22

# Big Value for Small Spenders.

Under \$4.<sup>95</sup>



Pickwick-the leading economy priced cartridges and cassettes. **pickwick/8**

PICKWICK INTERNATIONAL, INC. 8-16 43rd Avenue, L.I.C. N.Y. 11101 (212) 361-8811

Dick Anthony  
Jamall Badry  
Cliff Barrows  
Blue Ridge Quartet  
Frank Boggs  
Ralph Carmichael  
Dixie Echoes Quartet  
Willa Dorsey

Mary Jayne  
Jimmie McDonald  
Melody Four Quartet  
New World Singers  
Ohman Brothers  
Bill Pearce  
Flo Price  
Revivaltime Choir

# MUSIC IS PEOPLE

Phil Driscoll  
Florida Boys Quartet  
Four Galileans  
Happy Goodman Family  
Hemphills  
Ray Hildebrand  
Jerome Hines  
Burl Ives  
Kurt Kaiser  
LeFevres  
Lewis Family  
Fred Lowery  
Lowell Lundstrom  
Bill Mann

Jim Roberts  
Richard Roberts  
The Royal Heirs  
Sonny Salsbury  
Salvation Army Chorus  
Steve Sanders  
Tedd Smith  
The Spurrllows  
Thrasher Brothers  
Bud Tutmarc  
Vonda Kay Van Dyke  
World Action Singers  
The Young and Free  
Norma Zimmer

# WORD IS MUSIC

LARGEST PRODUCER OF  
RELIGIOUS MUSIC ON TAPE

WORD RECORDS

WACO, TEXAS 76703

# RECORD MANUFACTURERS WITH TAPE PRODUCT

Continued from page 20

Ode (see CBS/Columbia).  
L'Oiseau Lyre (see Argo).  
Okeh (see CBS/Columbia).  
Orbit (see Scepter).  
Original Sound Rec. Co., 7120 Sunset Blvd., Hollywood, Calif. 90046. Tel: (213) 466-6255. Pres.: Art Laboe.  
Cartridge 4-tr., 8-tr. & cassette: Self-mfd.

**P**  
P I (see Peters Int'l).  
Pacific Int'l, 1223 N. Kingsley Dr., Los Angeles, Calif. 90029. Tel: (213) 666-2704. Tape Div. & Sales Mgr.: Tom T. Saiki.  
Cartridge 8-tr.: Nivico, Pony Pak imported & self-mfd.  
Cartridge 4-tr.: Nivico imported & self-mfd.  
Cassette: Pony Pak imported & self-mfd.  
Page One (see Bell).  
Palette, 250 W. 57 St., New York, N.Y. 10019. Tel: (212) JU 6-3087. Pres.: F.R. Faecq; VP: R. Kluger.  
Cartridge 8-tr., cassette & open reel: Licensed to GRT. (Distributed by Kapp).  
Palisade (see Duplicator/Marketers section: GRT).  
Paramount Recs., 1507 N. Vine St., Hollywood, Calif. 90028. Tel: (213) 462-3141. Nat'l Tape Sales Mgr.: Louis C. Verzola.  
Cartridge 8-tr. & cassette: Paramount (includes Acta, Dot, DynoVoice, Paramount, Steed) self-mfd.  
Open reel: Paramount licensed to GRT.  
Parrot (see London).  
Paula (see Jewel).  
Pavilion (see Buddah).  
Peacock (see Duke/Peacock).  
Peerless (see Musical Tapes).  
Pete Recs., 8451 Melrose Ave., Los Angeles, Calif. 90069. Tel: (213) 653-4231. Pres.: Chris Petersen Jr; VP & Gen. Mgr.: Robert D. Kirstein.  
Cartridge 8-tr. & cassette: Licensed to GRT.  
Peters Int'l Inc., 600 Eighth Ave., New York, N.Y. 10018. Tel: (212) 524-4020. Gen. Mgr.: James C. Banthos; Sales Mgr.: Irving Cherne.  
Cartridge 8-tr. & cassette: PI self-mfd.; also see Tape Wholesaler section for product imported.  
phase 4 (see London).  
Phillips (see Mercury).  
Phil-L.A. of Soul (see Jamie/Guyden).  
Philly Groove (see Bell).  
Phono-Record Mgmt. Inc., 3420 W. Pico Blvd., Los Angeles, Calif. 90019. Tel: (213) 731-5782. Owner: Leonard Silver; Mgr.: Bernie Sparago.  
Cartridge 8-tr. & cassette: Americana, Stereo Sounds self-mfd.  
Pickwick Int'l USA, 8-16 43 Ave., Long Island City, N.Y. 11101. Tel: (212) EM 1-8811. Chm: Cy Leslie; Pres.: Ira L. Moss; Mktg. Dir.: Rich Lionetti.  
Cartridge 4-tr., 8-tr. & cassette: Pickwick, Hilltop self-mfd.  
Plantation (see Shelby Singleton).  
Playette Corp., 301 East Shore Rd., Great Neck, N.Y. 11032. Tel: (212) BR 9-5379. Pres.: Sidney A. Evans.  
Cartridge 4-tr. & cassette: Visaphone self-mfd.  
Open reel 2-tr.: GMS self-mfd.  
Polydor Inc., 1700 Broadway, New York, N.Y. 10019. Tel: (212) 245-0600. Mktg. Dir.: James J. Frey; Tape Sales Mgr.: Sid Love.  
Cartridge 8-tr. & cassette: Polydor self-mfd. & licensed to GRT; Archive, DGG self-mfd.  
Open reel: Polydor, Archive, DGG licensed to Ampex.  
Pompeii (see Atlantic).  
Pony Pak (see Pacific Int'l).  
Poppy Recs., 1133 Ave. of the Americas, New York, N.Y. 10036. Tel: (212) 586-3000.  
Cartridge 8-tr., cassette & open reel: Licensed to RCA.  
Premier Albums Inc., 1650 Broadway, New York, N.Y. 10019. Tel: (212) JU 6-5253. Pres.: Phil Landwehr; Mktg. Dir.: Jeff Toffler.  
Cartridge 8-tr.: Premier self-mfd.  
President (see Laurie).  
Press (see London).  
Prestige Recs. Inc., 203 S. Washington Ave., Bergenfield, N.J. 07621. Tel: (201) 384-6900. Tape Div. Mgr.: Bob Porter; Tape Sales Mgr.: Bob Weinstock.  
Cartridge 8-tr.: Prestige licensed to Livingston; Prestige/MPS self-mfd.  
Cartridge 4-tr.: Prestige licensed to Livingston.  
Cassette: Same as 8-tr.  
Open reel: Same as 4-tr.  
Probe (see ABC).  
Process Rec. Co., 439 Wiley Ave., Franklin, Pa. 16323. Tel: (814) 432-4633. Gen. Mgr.: Norman Kelly.  
Cartridge 4-tr. & open reel: Process, Country Star, Mersey self-mfd.  
Producos Fermata (see Fermata).  
Project 3 (see The Total Sound).  
Protone (see Super Sound).  
Public Recs., 6565 Sunset Blvd., Hollywood, Calif.

90028. Tel: (213) 464-9205. Bd. Chm.: Joseph C. Koistra.  
Cartridge 8-tr.: Licensed to Ampex.  
Gerard W. Purcell Assocs. Ltd. (see GWP).  
Pzazz (see Gayten).

## R

R C A Recs., 1133 Ave. of the Americas, New York, N.Y. 10036. Tel: (212) 586-3000. Pres.: Norm Racusin; Sales Mgr.: J. Y. Burgess Jr.; Adv. Dir.: W. Lucas.  
Cartridge 8-tr.: RCA, Camden, Victorola self-mfd.; also licensee for Buena Vista, Chart, Colgems, Diamond, Institute for Language Study (ILS), Kirshner, Poppy.  
Cassette: RCA self-mfd.; also licensee for Buena Vista, Chart, Colgems, Diamond, Kirshner, Poppy.  
Open reel: RCA, Camden self-mfd.; also licensee for Buena Vista, Chart, Colgems, Diamond, Kirshner, Poppy.  
R G E (see Fermata).  
Radiant Cassette/Cartridge Corp. (sub. of Radiant Corp.), 250 W. 57 St., New York, N.Y. 10019. Tel: (212) 765-1820. Pres.: Cary Wang; Sales Mgr.: Donald J. Pasin; Adv. Dir.: Edward M. Cohen.  
Cartridge 8-tr. & cassette: Radiant, Altone self-mfd.  
Rally (see Ralph's Radio).  
Ralph's Radio Music, PO Box 127, Demorest, Ga. 30535. Tel: (404) 723-3884. Owner: Ralph M. Raper; Sales & Mktg.: Bernice Raper.  
Cartridge 8-tr.: Country Gems, Country Jubilee, Gospel Gems, Gospel Jubilee, Rally, Sunlite self-mfd.  
Rama Rama Recs., 8733 Sunset Blvd., Los Angeles, Calif. 90069. Tel: (213) 652-7290. Pres.: Hy Mizrahi; Sales Mgr.: Norman Cole.  
Cartridge 8-tr.: Rama Rama licensed to Ampex & GRT; Remember licensed to GRT.  
Cassette: Remember licensed to GRT.  
Ranwood Recs., 9034 Sunset Blvd., Los Angeles, Calif. 90069. Tel: (213) 278-7222. VP: Larry Welk.  
Cartridge 4-tr., 8-tr. & cassette: Licensed to GRT.  
Open reel: Licensed to Bell & Howell.  
Raw (see Jay Gee).  
Recorded Treasures Inc. (Welte Legacy of Piano Treasures), 11955 Hesby St., North Hollywood, Calif. 91607. Tel: (213) 763-3173. Pres.: Walter S. Heebner.  
Cartridge 4-tr., 8-tr., cassette & open reel: Licensed to Ampex.  
Recotape (see Super Sound).  
Regent (see Savoy).  
Reginald (see Lynn's).  
Remember (see Rama Rama).  
Ren Bob (see National).  
Reo Tahiti (see Criterion).  
Reprise (see Warner Bros.-Seven Arts).  
Request Recs. Inc., 66 Memorial Hwy., New Rochelle, N.Y. 10801. Tel: (914) 633-6055. Pres.: H.J. Lengsfelder; Mgr.: Ruth B. Gamba.  
Cartridge 8-tr. & cassette: Request self-mfd. & licensed to GRT; Afro Request, Family, Sounds of the Caribbean self-mfd.  
Revue (see Uni).  
Rexford Recs., 6223 Selma Ave., Hollywood, Calif. 90028. Tel: (213) 462-6088. Mgr.: Selma Reid.  
Cartridge 8-tr. & cassette: Product available through Malynn Ent. on HR (Highland Recs).  
Richmond (see London).  
Rim (see Associated Inds.).  
Rising Sons (see Monument).  
Riverside (see ABC).  
Riviera (see General Mfg. Co.).  
Rodeo Int'l (see Marvel).  
Roper Recs. Inc., 43-48 48 St., Long Island City, N.Y. 11104. Tel: (212) HA 6-1190. VP & Gen. Mgr.: Franc Peri; Sales Mgr.: C. Grossman.  
Cartridge 8-tr., cassette & open reel: Self-mfd.  
Roulette Recs., 17 W. 60 St., New York, N.Y. 10023. Tel: (212) PL 7-9880. VP: Richard P. Myers Jr.  
Cartridge 8-tr.: Roulette licensed to GRT; Tico self-mfd. by Ethnic Tapes & licensed to GRT; Alegre self-mfd. by Ethnic Tapes.  
Cassette: Roulette licensed to GRT & Mercury; Alegre, Tico self-mfd. by Ethnic Tapes & licensed to Mercury.  
Open reel: Roulette licensed to GRT.  
Note: Also see Duplicator/Marketers section: Ethnic Tapes for licensed labels.  
Roy (see Brite-Star).  
Royal Blue (see International Rec'g).

**S**  
S F M (see Contemporary).  
S G C (see Atlantic).  
S S S Int'l (see Shelby Singleton).  
S. T. Lewis (see Kiderian).  
Sacred (see Word).  
Sara (see Cuca).  
Savoy Rec. Co. Inc., PO Box 1000, 56 Ferry St., Newark, N.J. 07105. Tel: (201) MA 3-7470.  
NYC Tel: (212) WO 2-3354. Pres.: Herman Lubinsky.  
Cartridge 4-tr., 8-tr., cassette & open reel: Savoy (includes Gospel, Regent, Sharp, World Wide) licensed to Livingston.  
Scepter Recs. Inc., 254 W. 54 St., New York, N.Y. 10019. Tel: (212) CI 5-2170. VP & Gen. Mgr.: Jerry Geller; Tape Sales Mgr.: Al Abraskin.

Cartridge 8-tr.: Scepter, Wand, Celestial, Hob, Orbit self-mfd.  
Cartridge 4-tr.: Scepter, Wand licensed to Ampex.  
Cassette: Same as 8-tr.  
Open reel: Same as 4-tr.  
Seeco (see Met Richmond).  
Sentry (see Duplicator/Marketers section: Atlas-Rand).  
Shamrock (see Cuca).  
Sharp (see Savoy).  
The Shelby Singleton Corp., 3106 Belmont Blvd., Nashville, Tenn. 37212. Tel: (615) 291-2003. VP Mktg.: Dick Bruce.  
Cartridge 8-tr. & cassette: SSS Int'l, Plantation self-mfd. & licensed by GRT & NAL; Sun Int'l self-mfd. & licensed to GRT; Amazon self-mfd. & licensed to NAL.  
Open reel: Plantation licensed to GRT & NAL; Sun Int'l licensed to GRT; SSS Int'l, Amazon licensed to NAL.  
Shout (see Bang).  
Sidewalk (see Tower).  
Sing (see Skylite-Sing).  
Sire (see London).  
Skye Rec'g Co. Inc., 40 W. 55 St., New York, N.Y. 10019. Tel: (212) 581-0488. Pres.: Norman Schwartz.  
Cartridge 8-tr.: Licensed to Ampex, GRT & ITCC.  
Cartridge 4-tr.: Licensed to Ampex.  
Cassette: Same as 8-tr.  
Open reel: Licensed to Ampex & GRT.  
Skylite-Sing Inc., 1516 Hawkins St., Nashville, Tenn. 37203. Tel: (615) 244-6116. Pres.: Joel E. Gentry; VP Sales: Joe B. Brown.  
Cartridge 8-tr.: Skylite, Sing, Christian Faith, Christian Folk self-mfd.  
Smash (see Mercury).  
The Smith Studio, 3141 SW 22 Ct., Fort Lauderdale, Fla. 33312. Tel: (305) 581-7300. Owner: Fletcher Smith.  
Cartridge 8-tr., cassette & open reel: Stereoditties, Living Rec. Library, Car Books self-mfd.  
Smobro (see Buddah).  
Society for Forgotten Music (see Contemporary).  
Solid State (see Liberty/UA).  
Som/Maior (see Fermata).  
Somerset (see Alshire).  
Songs of Faith (see Spar).  
Soul (see Motown).  
Soul City (see Liberty/UA).  
Sounds of Aquarius (see Cuca).  
Sounds of the Caribbean (see Request).  
Sound Stage 7 (see Monument).  
Spanish World Rec. Inc., 151 W. 14 St., New York, N.Y. 10011. Tel: (212) 989-3177. Pres.: Marcos Garcia.  
Cartridge 4-tr., 8-tr., cassette & open reel: Montilla licensed to Livingston.  
Spar Recs. Corp., 110 21 Ave. S., Nashville, Tenn. 37203. Tel: (615) 244-1636. Owners: Bill Beasley, Alan Bubis.  
Cartridge 8-tr.: Spar, Songs of Faith self-mfd.  
Specialty Recs. Inc., 8300 Santa Monica Blvd., Hollywood, Calif. 90069. Tel: (213) 656-7711. Gen. & Tape Mgr.: Mike Akopoff.  
Cartridge 8-tr. & cassette: Self-mfd. & licensed to GRT.  
Spoken Arts Inc., 59 Locust Ave., New Rochelle, N.Y. 10801. Tel: (914) 636-5482. Mktg. Dir.: Peter Redgrove.  
Cassette & open reel: Self-mfd.  
Starday-King Rec'g & Publ'g Inc., PO Box 8188, Nashville, Tenn. 37207. Tel: (615) 228-2575. VP Mktg.: Col. Jim Wilson.  
Cartridge 8-tr.: Starday licensed to GRT & ITCC; King, Nashville licensed to GRT.  
Cartridge 4-tr.: King, Nashville licensed to GRT.  
Cassette: Same as 8-tr.  
Open reel: Starday, King licensed to GRT.  
Starlight (see Delta).  
Stax Rec. Co. (div. of Famous Music Corp., a G&W Co.), 926 E. McLemore, Memphis, Tenn. 38106. Tel: (901) 774-1600. Pres.: Jim Stewart; Mktg. & Mdsq. Dir.: Herb Kole.  
Cartridge 8-tr.: Stax, Volt, Hip, Enterprise self-mfd.  
Cartridge 4-tr.: Stax, Volt, Hip, Enterprise licensed to Ampex.  
Cassette: Same as 8-tr.  
Open reel: Same as 4-tr.  
Steady Recs., 846 Seventh Ave., New York, N.Y. 10019. Tel: (212) 581-6911. Pres.: Arthur Trefferson.  
Cartridge 8-tr.: Steady, Federal self-mfd.  
Steed (see Paramount).  
Stereoditties (see The Smith Studio).  
Stereo Dimension Recs., 118 W. 57 St., New York, N.Y. 10019. Tel: (212) 582-6855. Pres.: Loren Becker.  
Cartridge 8-tr., cassette & open reel: Evolution, Athena licensed to Ampex & NAL.  
Stereo Experience (see Duplicator/Marketers section: Metra Electronics).  
Stereo Sounds (see Phono-Record).  
Stinson Recs., PO Box 3415, Granada Hills, Calif. 91344. Tel: (213) 368-1612. Mgr.: Jack M. Kall.  
Cartridge 8-tr. & cassette: Self-mfd.  
Stop Recs. Inc., 809 18 Ave. S., Nashville, Tenn. 37203. Tel: (615) 255-8388. Owners: Pete Drake, Tommy Hill.  
Cartridge 8-tr. & cassette: Licensed to ITCC.  
Stereo Sounds see Phono-Record).

continued on page 24



**We've taken the Phantom  
out of the  
Opera.**

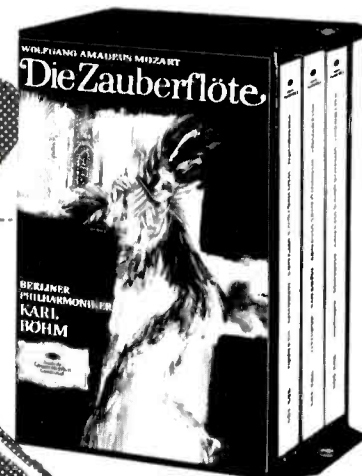
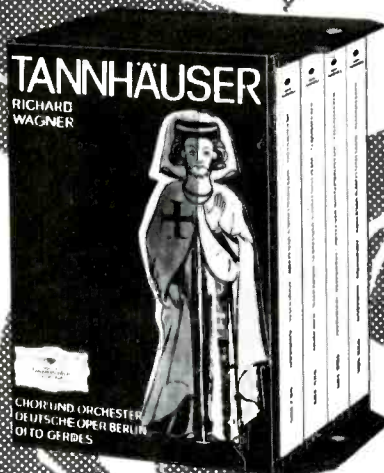

We made it grand again. But with today's young style. A slim, modern line. On MusiCassettes. You know. We practically invented them. You've sold them. Beyond expectations. Now we've multiplied. And put them in a box for portability. We've expanded our repertoire to expand your sales.

Just show your customers our new works and watch them subscribe.  
In multiples. Compound sales are no apparition.

The World's Largest Selection of Classical

**MusiCassettes**  
on



Deutsche Grammophon MusiCassettes are distributed in the USA by Polydor Incorporated; in Canada by Polydor Records Canada Ltd.

# RECORD MANUFACTURERS WITH TAPE PRODUCT

Continued from page 22

Stormy Forest (see MGM).  
Sue Recs. Ltd., 265 W. 54 St., New York, N.Y. 10019. Tel: (212) 581-9290.  
Cartridge 8-tr. & cassette: Sue (includes Blue Book) licensed to Ampex.  
Summit Sound Systems Co., 38 Atlantic Ave., Ocean Grove, N.J. 07756. Tel: (201) 775-4952. Pres.: William Jelley.  
Cartridge 8-tr. & open reel: Summit self-mfd. Sundi (see Cabot).  
Sundown (see White Whale).  
Sunglow (see Certron).  
Sun Int'l (see Shelby Singleton).  
Sunlite (see Ralph's Radio).  
Sunset (see Liberty/UA).  
Super K (see Buddah).  
Super Sound Studios, 6478 Santa Monica Blvd., Hollywood, Calif. 90038. Tel: (213) 462-9884. Owners: James Welton, Jane Courtland.  
Open reel: Protone, Recotape self-mfd.  
Sure Music & Rec. Co. Inc., PO Box 94, Broomall, Pa. 19008. Tel: (215) EL 6-2996. Pres.: Leonard Rosen.  
Cartridge 8-tr.: Self-mfd.  
Surfside (see Hula).  
Surrey Int'l (see Crestview).

## T

T R X (see Hickory).  
Tamesi Recs. Inc., PO Box 130, Clinton Corners, N.Y. 12514. Tel: (914) 266-3035. Pres.: Raymond Meltzer.  
Cassette & open reel: Giantstar self-mfd.  
Tamla (see Motown).  
Tangerine Recs., 2107 W. Washington Blvd., Los Angeles, Calif. 90018. Tel: (213) 732-0171. (See ABC).  
Tanner 'N' Texas, 1422 W. Poplar St., San Antonio, Tex. 78207. Tel: (512) PE 2-8072. Pres.: Bob Tanner.  
Cartridge 4-tr. & 8-tr.: Bernal, Disco Grande licensed to Certron.  
Tape House Int'l (see Duplicator/Marketers section: Livingston Audio Prods.).  
Tapes Unlimited, 13001 Puritan Ave., Detroit, Mich. 48227. Tel: (313) 341-7550. Gen Mgn.: Dave Lannon.  
Cassette & open reel: Self-mfd.  
Tapeworld (see Duplicator/Marketers section).  
Tennessee Sound (see NAL).  
Tetragrammaton Recs. (div. of Campbell, Silver

Corp.), 359 N. Canon Dr., Beverly Hills, Calif. 90210. Tel: (213) 278-7680. Pres.: Arthur Mogull; Liaison Dir.: Michel L. Michel.  
Cartridge 8-tr.: Licensed to Ampex, GRT, ITCC & NAL.  
Cartridge 4-tr.: Licensed to Ampex & Muntz.  
Cassette & open reel: Licensed to Ampex, GRT & NAL.  
PlayTape.  
Thunder Rec. Corp., PO Box 271, Cedar & West Ave., Jenkintown, Pa. 19046. Tape Div. Mgr.: Otis Knight; Tape Sales Mgr.: Samantha Knight.  
Cartridge 8-tr.: Self-mfd.  
Tico (see Roulette).  
T-Neck (see Buddah).  
The Total Sound Inc., 1270 Ave. of the Americas, New York, N.Y. 10020. Tel: (212) 765-9760. Pres. & Int'l: Enoch Light.  
Cartridge 8-tr.: Project 3 licensed to Ampex & ITCC.  
Cassette: Project 3 licensed to Ampex, GRT, ITCC & NAL.  
Open reel: Project 3 licensed to Ampex & GRT.  
Turnabout (see Vox).  
Tower Recs. Corp. (sub. of Capitol Recs. Inc.), 1750 N. Vine St., Hollywood, Calif. 90028. Tel: (213) 462-6252.  
Cartridge 8-tr.: Tower, Burdette, Jerden, Sidewalk licensed to GRT.  
Cassette: Tower, Jerden, Sidewalk licensed to GRT.  
Open reel: Tower licensed to GRT.  
Tradition (see Everest).  
Traveltime (see Duplicator/Marketers section: Metra Electronics).  
Tucker (see Duplicator/Marketers section: Tucker Prod'ns).  
Turntable (see Jad).  
20th Century-Fox Rec. Corp., 444 W. 56 St., New York, N.Y. 10019. Tel: (212) 957-5070. (See ABC).

## U

Uni Recs. (div. of MCA), 8255 Sunset Blvd., Hollywood, Calif. 90046. Tel: (213) 656-8310. Exec VP: Ned Tanen; VP: Russ Regan; Nat'l Sales Mgr.: Rick Frio.  
Cartridge 8-tr.: Revue licensed to GRT; Uni self-mfd. & available on GRT.  
Cartridge 4-tr.: Uni licensed to Muntz.  
Cassette: Uni self-mfd. & available on GRT.  
Open reel: Uni licensed to GRT.  
United Artists (see Liberty/UA).  
United Talent (see Buddah).  
Universal Music (sub. of Audio Communications Inc.), Rt. 10, Randolph Ind'l Park, Dover, N.J. 07801. Tel: (201) 261-7600.  
Cartridge 8-tr. & cassette: Self-mfd.  
Universal Rec'g & Dist'g Corp., 170 W. 29 St., Hialeah, Fla. 33012. Tel: (305) 888-2365. Sales Mgr.: Frank Garcia.  
Cartridge 8-tr. & cassette: Kubaney self-mfd.

## V

V M C (see Vance Music Corp).  
Valtron Rec'g Studio, 305 Allen St., Helena, Mont. 59601. Tel: (406) 442-0734. Owner & Mgr.: Lester Liedle.  
Cartridge 4-tr., cassette & open reel: Valtron self-mfd.  
Vance Music Corp., 6922 Hollywood Blvd., Suite 804, Hollywood, Calif. 90028. Tel: (213) 463-4181. Pres.: Steven A. Vail; Nat'l Sales & Promo.: Jeff Clark.  
Cartridge 8-tr.: VMC licensed to GRT.  
Vanguard Rec'g Society, 71 W. 23 St., New York, N.Y. 10010. Tel: (212) 255-7732. Regional Sales Mgr.: Harold Lewis.  
Cartridge 8-tr.: Vanguard self-mfd. & licensed to Ampex.  
Cartridge 4-tr.: Vanguard licensed to Ampex & Muntz.  
Cassette: Vanguard self-mfd. & licensed to Ampex & Mercury.  
Open reel: Vanguard, Vanguard Everyman licensed to Ampex.  
Vault Rec'g Corp., 2525 W. Ninth St., Los Angeles, Calif. 90006. Tel: (213) 386-1821. Pres.: Jack Lewerke.  
Cartridge 8-tr.: Licensed to Ampex & GRT.  
Cartridge 4-tr.: Licensed to Ampex.  
Cassette: Self-mfd. & licensed to Ampex & GRT.  
Open reel: Licensed to Ampex.  
Vegas (see White Whale).  
Velvet Recs., 124 W. 29 St., Hialeah, Fla. 33011. Tel: (305) 888-1377. Gen. Mgr.: Antonio Moreno.  
Cartridge 8-tr. & cassette: Disco, Velvet self-mfd.  
Verve (see MGM).  
Visaphon (see Playette).  
Vista (see Disneyland).  
Viva Recs. (div. of Snuff Garrett Prod'ns), 6922 Hollywood Blvd., Hollywood, Calif. 90028. Tel: (213) 466-1641. Exec. VP: Ed Silvers.  
Cartridge 8-tr.: Viva, Bravo licensed to Ampex, GRT, Decca & NAL.  
Cartridge 4-tr.: Viva, Bravo licensed to Ampex.  
Cassette: Same as 8-tr.  
Open reel: Viva licensed to Ampex, GRT & NAL; Bravo licensed to Ampex & NAL.  
Vivid Country Sounds (see Certron).  
Vivid Sounds (see Certron).  
Vocab Inc., 3071 S. Broad, Chicago, Ill. 60608. Tel: (312) 254-8047. Pres.: A.J. Batko.

Cassette & open reel: Vocab, Wordcraft self-mfd.  
Volt (see Stax).  
Vortex (see Atlantic).  
Vox Prod'ns Inc., 211 E. 43 St., New York, N.Y. 10017. Tel: (212) 867-9360. Tape Sales Mgr.: Thomas Di Vita.  
Cassette: Vox (includes Candide, Turnabout) self-mfd.

## W

Wand (see Scepter).  
Warner Bros.-Seven Arts Recs., 4000 Warner Blvd., Burbank, Calif. 91503. Tel: (213) HO 9-1251. Nat'l Tape Sales Mgr.: Richard S. Sherman.  
Cartridge 8-tr.: Warner Bros.-Seven Arts, Reprise self-mfd.  
Cartridge 4-tr.: Warner Bros. Seven Arts, Reprise licensed to Muntz.  
Cassette: Warner Bros.-Seven Arts, Reprise self-mfd. & licensed to Ampex.  
Open reel: Warner Bros.-Seven Arts, Reprise licensed to Bell & Howell.  
PlayTape: Warner Bros.-Seven Arts, Reprise.  
Welte Legacy of Piano Treasures (see Recorded Treasures).  
Westminster (see ABC).  
Whitehall (see AVC).  
White Rock Recs., 401 Wintermantle Ave., Scranton, Pa. 18505. Tel: (717) 343-6718. Owner: Phil Ladd; Mgr.: Joyce Shandra.  
Cassette & open reel: White Rock, Ladd self-mfd.  
White Whale Rec. Co. Inc., 8961 Sunset Blvd., Los Angeles, Calif. 90069. Tel: (213) 278-2266. Pres.: Ted Feigin.  
Cartridge 8-tr.: White Whale (includes Sundown & Vegas) licensed to Ampex, GRT, ITCC & NAL.  
Cartridge 4-tr.: White Whale (includes Sundown & Vegas) licensed to Ampex & GRT.  
Cassette: Same as 8-tr.  
Open reel: White Whale (includes Sundown, Vegas) licensed to Ampex, GRT & NAL.  
Whittier (see Amexar).  
Windfall (see Bell).  
Wing (see Mercury).  
Word Inc., 4800 W. Waco Dr., Waco, Tex. 76710. Tel: (817) 772-7650. Pres.: Jarrell McCracken.  
Cartridge 8-tr. & cassette: Word, Canaan, Light, Sacred self-mfd.  
Wordcraft (see Vocab).  
World Pacific (see Liberty/UA).  
World Pacific Jazz (see Liberty/UA).  
World Wide (see Savoy).

## Y

Yew (see AA).

NOTE: The following is a list of companies whose recorded product is available on tape through a Duplicator/Marketer but who are currently reported inactive or have failed to supply us with information on their company by press time. In parenthesis after each label is the name of the Duplicator/Marketer from whom the product is available.

Anvil (Ampex)  
A R V (Certron)  
Bego (Certron)  
Bouquet (GRT)  
Buckboard (GRT)  
Buena Suerte (Certron)  
Carnival (Livingston)  
Century City (GRT)  
Chartmaker (Ampex)  
Colossus (Ampex)  
Col-Pix (Ampex)  
Crimson (Ampex)  
Cyclone (Ampex)  
Disco Largo Vida (Certron)  
Discos Ventura (Certron)  
El Pato (Certron)  
El Zarape (Certron)  
Hobitt (GRT)  
Horizon (ITCC)  
I T C (Ampex)  
Impacto (Certron)  
Ivan (Certron)  
Keyloc (Certron)  
L H I (Ampex)  
Latin Showcase (NAL)  
Little Darlin' (ITCC)  
Major Minor (GRT)  
Mathew Katz (GRT)  
Norteno (Certron)  
Oracle (GRT)  
Poison Ring (ITCC)  
Pulsar (GRT)  
Republic (NAL)  
Senate (Ampex)  
Sound-In (Livingston)  
Speed (GRT)  
Stella (ITCC)  
Studio 10 (GRT)  
Tear Drop (ITCC)  
Texas (Certron)  
Tomi (Certron)  
U S A (Ampex)  
Vee Jay (ITCC)  
Wonderland (GRT)



**DON'T WASTE  
TIME . . .**

searching for all hard-to-  
find information—just check  
Buyer's Guide. It's at-a-glance  
information.



# SMASH STEREO SOUNDS

TAPES BY:



plantation  
Records



THE SHELBY SINGLETON CORP., NASHVILLE, U.S.A.

# DUPLICATOR/MARKETERS

A T D (American Tape Dupl'rs Inc.), 5727 W. Jefferson Blvd., Los Angeles, Calif. 90016. Tel: (213) 870-6832. Pres.: Richard Allen; Exec. VP: Warren D. Gray; VP Sales & Mktg.: Jay Leanse. **Cartridge 8-tr., cassette & open reel:** ATD, Tape Mates.

Allied Tape Corp., 1201 Research Blvd., St. Louis, Mo. 63132. Tel: (314) 997-0016. Pres.: Byrle A. Northup; Exec. VP: Robert F. Philpot; Adv. Dir.: Donald E. Lobbig. **Cartridge 4-tr., 8-tr., cassette & open reel:** CMC.

American Tape Dupl'rs, see ATD.

Amexar Corp., 3018 W. Pico Blvd., Los Angeles, Calif. 90006. Tel: (213) 735-6261. Pres.: Carlos L. Campbell; Sales Mgr.: Alberto L. Campbell; Adv. Dir.: A. Palacio. **Cartridge 8-tr.:** Amexar, Del Valle, Moda, Whittier. **Cartridge 4-tr.:** Del Valle, Moda, Whittier. **Cassette:** Amexar, Del Valle, Whittier.

Ampex Stereo Tapes (div. of Ampex Corp.), 555 Madison Ave., New York, N.Y. 10022. Tel: (212) 758-8900. Pres.: Don Hall; Sales Mgr.: Jules Cohen; Adv. Dir.: Jim Johnson. **Cartridge 8-tr.:** ABC, Amaret, Amos, Ampex, Anvil, Atco, Athena, Atlantic, Audio Spectrum, Avco Embassy, Bang, Bell, Bluesway, Bravo, BT Puppy, Caedmon, Chart, Chartmaker, Coliseum, Colossus, Command, Cotillion, Contemporary, Crestview, Crimson, Cyclone, Dakar, Deram, Dunhill, DynoVoice, Elektra, Evolution, Fantasy, Four Corners of the World, Galaxy, Good Time Jazz, Happy Tiger, Heritage, Hi, Hob, ILS, ITC, Impulse, Institute for Language Study, Jad, Jay Jay, Kama Sutra, Kapp, LHI, London, MGM, Mainstream, Monitor, New Voice, Nonesuch, Original Sound, Page One, Palette, Parrot, phase 4, Philly Groove, Pompeii, Press, Probe, Project 3, Public, Rama Rama, Riverside, Senate, Scepter, Shout, Sire, Skye, Stormy Forest, Sue, Tetragrammaton, Time, USA, Vanguard, Vault, Verve, Viva, Vortex, Wand, Westminster, White Whale. **Cartridge 4-tr.:** ABC, Amos, Ampex, Apple, Atco, Atlantic, Audio Spectrum, Bang, Bell, Bluesway, Bravo, BT Puppy, Capitol, Chart, Chartmaker, Command, Crimson, Dakar, Deram, Dunhill, Elektra, Enterprise, Fantasy, Hi, ITC, Impulse, Kapp, LHI, London, Mainstream, New Voice, Parrot, Polydor, Pompeii, Probe, Scepter, Skye, Stax, Sire, Tetragrammaton, Vanguard, Vault, Viva, Wand, White Whale. **Cassette:** ABC, Amaret, Amos, Ampex, Anvil, Atco, Athena, Atlantic, Audio Spectrum, Avco Embassy, Bang, Bell, Bluesway, Bravo, BT Puppy, Caedmon, Chart, Chartmaker, Coliseum, Colossus, Command, Contemporary, Cotillion, Crimson, Cyclone, Dakar, Deram, Dunhill, Elektra, Evolution, Fantasy, Four Corners of the World, Galaxy, Good Time Jazz, Heritage, Hi, Impulse, Jad, Jay Jay, Kama Sutra, Kapp, LHI, London, MGM, Mainstream, Monitor, Original Sound, Page One, Parrot, Philly Groove, Pompeii, Probe, Project 3, Rama Rama, Reprise,

Riverside, Scepter, Shout, Sire, Skye, Stormy Forest, Sue, Tetragrammaton, Time, 20th Century-Fox, USA, Vanguard, Vault, Verve, Viva, Vortex, Wand, Warner Bros.-Seven Arts, Westminster, White Whale. **Micro cassette:** ABC, Acta, Atco, Atlantic, Bell, Deram, Dunhill, Elektra, Golden, Hi, Kama Sutra, London, MGM, Mainstream, Parrot, Reprise, Scepter, Spar, Vanguard, Verve, Viva, Warner Bros.-Seven Arts, White Whale. **Open reel:** ABC, AST, Acta, Aeolian-Skinner, American Airlines, Amos, Ampex, Angel, Anvil, Apple, Archive, Artia, Astex, Atco, Athena, Atlantic, Audio Fidelity, Audio Spectrum, BT Puppy, Bang, Bell, Blue Rock, Bluesway, Bravo, Buena Vista, Caedmon, Capitol, Chart, Col-Pix, Command, Contemporary, Continental Airlines, Cotillion, Crimson, Cyclone, DGG, Deram, Dunhill, DynoVoice, Enterprise, Elektra, Evolution, Fantasy, Fontana, Four Corners of the World, Galaxy, Good Time Jazz, Gordy, Heritage, Hi, ILS, Impulse, Jad, Jay Jay, Kama Sutra, Kapp, LHI, Limelight, London, MGM, Mainstream, Mercury, Monitor, Motown, New Voice, Nonesuch, L'Oiseau Lyre, Paramount, Parliament, Parrot, phase 4, Philips, Philly Groove, Polydor, Pompeii, Press, Project 3, Recorded Treasures, Richmond, Riverside, Scepter, Senate, Sire, Skye, Smash, Soul, Stax, Steed, Tamla, Tetragrammaton, Time, 20th Century-Fox, USA, Vanguard, Vanguard/Everyman, Vault, Verve, Viva, Vortex, Wand, Westminster, Wing, White Whale.

Atlas-Rand Corp., 2 Keystone Pl., Paramus, N.J. 07652. NYC Tel: (212) 563-6663. Pres.: Harold Rosen; Sales Mgr.: Barry Rosen; Adv. Dir.: Stuart Better. **Cartridge 4-tr., 8-tr., cassette & open reel:** Sentry.

Audiomasters, 16711 Roscoe Blvd., Sepulveda, Calif. 91343. Tel: (213) 892-0716. Pres.: George Panos; Mktg. Dir.: Howard Siegel. **Cartridge 8-tr., cassette & open reel:** Audiomasters.

Audio Physics Inc., 16449 Vanowen St., Van Nuys, Calif. 91406. Tel: (213) 782-3638. Pres.: Don Washbrook; Gen. Mgr.: John David; Sales Mgr.: Bill Richards. **Cartridge 4-tr., 8-tr. & cassette:** Audio Trax.

Audio Trax, see Audio Physics.

Bell & Howell Magnetic Tape Co. (formerly Green-tree Electronics), Div. of Bell & Howell, 2602 Michelson Dr., Irvine, Calif. 92664. Tel: (714) 833-0020. Pres.: Sidney Brandt; Sales Mgr.: J. A. Rubinstein. **Open reel:** Blue Note, Double Shot, Imperial, Liberty, Minit, Ranwood, Reprise, Solid State, Soul City, United Artists, Veep, Warner Bros.-Seven Arts, World Pacific.

Berkshire, see dubbings.

Budget Tape Cartridge Mfg. Co., 2035-37 S. La Brea Ave., Los Angeles, Calif. 90016. Tel: (213) 933-5867. Pres. & Sales Mgr.: Don Macmillan.

**Cartridge 8-tr. & cassette:** Budget Tape & private labels.

C M C, see Allied Tape.

Cascom, see Cassette Communications Corp.

Cassette Communications Corp., 932 Broadway, New York, N.Y. 10010. Tel: (212) 533-3150. Pres.: Arnold Maxin; VP & Gen. Mgr.: Jack A. Somer; Sales Mgr.: Art Denish. **Cartridge 8-tr. & cassette:** Cascom.

Caytronics Corp., 240 Madison Ave., New York, N.Y. 10016. Tel: (212) 683-7911. Pres.: Joe Cayre; Sales Mgr.: Ed Ash; Adv. Dir.: Dick Schaeffer. **Home office: Mexico, Stereo Jet de Mexico. Cartridge 4-tr., 8-tr. & cassette:** CBS Latin prod., CBS Int'l, Caytronics, Rico Vox, Tone Latino.

Certron Corp., 1701 S. State College Blvd., Anaheim, Calif. 92806. Tel: (714) 633-4280. Pres.: Edwin Gamson; Sales Mgr.: James Neiger. **Cartridge 8-tr.:** ARV, Bego, Bernal, Buena Suerte, Certron, Disco Grande, Disco Largo Vida, Discos Ventura, El Pato, El Zarape, Falcon, Impacto, Ivan, Keyloc, Norteno, Sunglow, Texas, Tomi, Vivid Country Sounds, Vivid Sounds. **Cartridge 4-tr.:** ARV, Bego, Bernal, Buena Suerte, Certron, Disco Grande, Disco Largo Vida, Ventura, El Pato, El Zarape, Falcon, Impacto, Ivan, Keyloc, Norteno, Sunglow, Texas, Tomi. **Cassette:** Certron, Disco Largo Vida, Discos Ventura, Falcon, Sunglow, Vivid Country Sounds, Vivid Sounds. **Open reel:** Certron, Falcon, Sunglow, Vivid Sounds.

Consolidated Tape Cartridges, 1584 E. 31 St., Cleveland, Ohio 44114. Tel: (216) 861-7286. Pres.: J. R. Gayer. **Cartridge 8-tr. & cassette:** Delta Int'l, Starlight.

D B I Tape Ents., 6725 Sunset Blvd., Suite 315, Hollywood, Calif. 90028. Tel: (213) HO 2-6613. Pres.: Don Blocker. **Cartridge 4-tr., 8-tr. & cassette:** DBI, Tape House Int'l.

Decca Recs., 445 Park Ave., New York, N.Y. 10022. Tel: (212) 759-7500. Nat'l Tape Prod. Mgr.: Joel A. Schneider. **Cartridge 8-tr. & cassette:** Decca, Bravo, Brunswick, Coral, Viva. **Open reel:** Decca, Brunswick, Coral.

Dubbings Electronics Inc., 1305 S. Strong Ave., Copiague, N.Y. 11726. Tel: (516) 893-1000. Pres.: Paul C. Smith; Mktg. Dir.: R. Gittings. **Cartridge 8-tr., cassette & open reel:** Berkshire.

Ethnic Tapes Inc., 17 W. 60 St., New York, N.Y. 10023. Tel: (212) PL 7-9880. VP: Richard P. Myers Jr.; Adv. Dir.: Miriam Deutsch. **Cartridge 8-tr. & cassette:** Alegre, Anima d'Italia, Cesta, Cofique, Deutsche Heimats Lieder, Emmess Yiddish, Fania, Jazz From the Vault, Musicor, Polskie Melodie, Roulette Birdland Series, Soul of Africa, Speed, Tico.

continued on page 30

**UNI's  
doing its own  
thing...**

**TAPES!**

**(Cassettes & Eight Track)**



UNIVERSAL CITY RECORDS • A DIVISION OF MCA INC.

When the home education market publishes its first top 40 chart, Imperial International Learning will be No. 1.

We "broke the ice" for educational tape in the nation's schools during the 1960's. In the 1970's, we'll be doing the same for the home education market.

Drawing upon our vast array of existing programs, and our educational "know-how," we'll help children enjoy learning everything from the alphabet to zoology. □ For Imperial International Learning, the step into the consumer market is a natural one. We believe that the high national interest in education, combined with the "cassette revolution," indicates that the home education market is ready for tape. And *the tape people* are ready for the home education market.

Get to know *the tape people* !

For more information, write or call G. Searls, Consumer Division, Imperial International Learning, P. O. Box 548, Kankakee, Illinois 60901  
Telephone (815) 933-7735

**IMPERIAL INTERNATIONAL LEARNING**  
*the tape people*

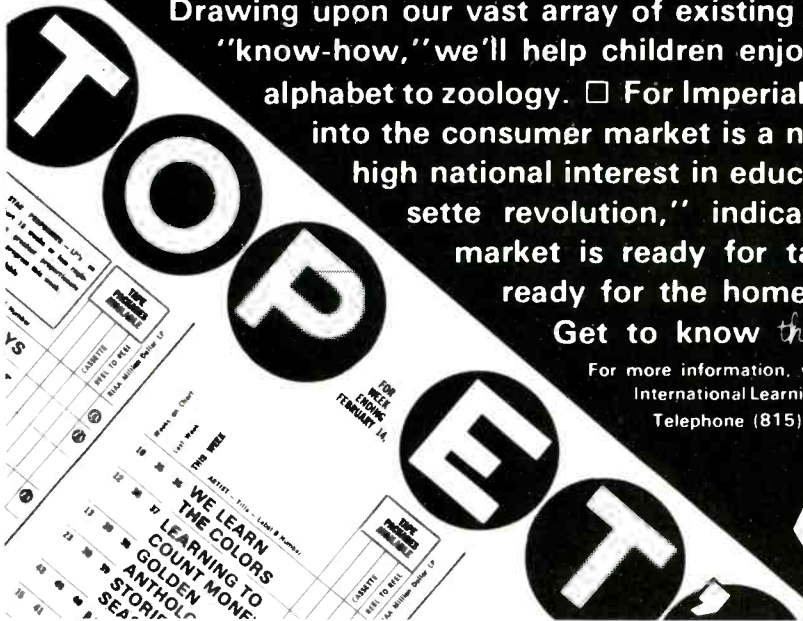

**HUNTING  
FOR THAT  
HARD-TO-  
FIND  
INFORMATION?**

**Billboard** makes it  
easy-to-find for everyone.

# Stop the Confusion • Choose Your Sound 8 Track • 4 Track • Cassette

## **AR** AUTOMATIC-ally

You have no problem in choosing what kind of sound to sell when you're an Automatic Radio Stereo dealer. Because from Automatic Radio, 50 years a leader in making sound products sound better, you get the Total Stereo Sound line.

Total stereo means everything from Home stereo entertainment centers to portables. Even car stereo. From 8 or 4 track cartridges to cassettes. From Fado Pak Tuner cartridges to built in FM Radio Multiplex.

But that's just for starters. When you choose Sound — Automatically — you get a total merchandising program designed to help you sell. National Advertising on television (Johnny Carson Sat.-Sun. TONIGHT SHOW) Automatic-ally you get P.O.P. sales aids. Ads in Esquire, Sports Illustrated, Hot Rod, Motor Trend. Even special display centers.

Stop being confused. Sell the one line that gives you everything in stereo.

SMX-3901  
COMBINATION  
STEREO  
TAPE PLAYER



SHG-1010 STEREO TAPE SOUND CENTER

CHX-9912  
HOME CASSETTE  
RECORD/PLAYER



CHG-1045  
HOME STEREO  
TAPE PLAYER



FMX-4000 HOME ENTERTAINMENT CENTER

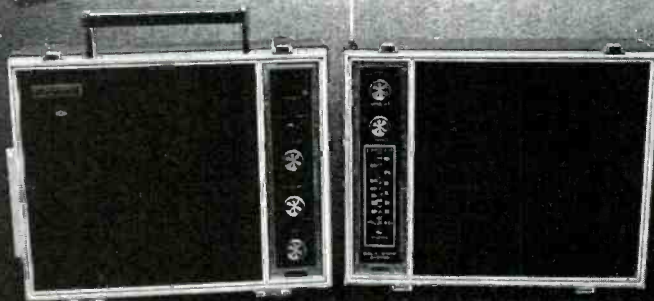

PEX-1032 PORTABLE STEREO TAPE PLAYER



2 Main Street, Melrose, Mass. 02176

# ALL UNDER ONE ROOF

Package Planning

Design & Artwork

Complete Printing Facilities

(Simple to Full Color)

Mastering

Matrix

Quality Control

(Acoustavoiced)

Shipping

PVC Manufacturing

To Serve You with

## CUSTOM DUPLICATING

with  
Revolutionary

### Star-Sound

The Dramatic New  
Full Stereo Spectrum  
On

8-Track Cartridge

Cassettes

Open Reel

Record Pressing

SAMPLE BROCHURES ON REQUEST

**KEYSOR-CENTURY CORP.**

26000 Springbrook Road  
Saugus, California 91350

(213) 365-3991

## DUPLICATOR/MARKETERS

Continued from page 26

G R T Corp. (General Recorded Tape Inc.), 1286 Lawrence Station Rd., Sunnyvale, Calif. 94086. Tel: (408) 734-2910. Pres.: Alan J. Bayley; VP: Thomas L. Bonetti; Sales Mgr.: Ed Berson.

**Cartridge 8-tr.:** ABC, Abnak, Accent, Archive of Folk Music, Archive of Gospel Music, Archive of Jazz, Ashley, Backbeat, Bang, Bell, Bluesway, Blue Thumb, Boone, Bouquet, Bravo, Buckboard, Burdette, Cadet, Cadet/Concept, Century City, Challenge, Chart, Checker, Chess, Command, Command/Probe, Crewe, Cuca, De-Lite, Delmark, Diamond, Duke, Dunhill, Dynamo, ESP-Disk, Era, Everest, Excello, Falcon, GNP Crescendo, GRT, Gamble, Gateway, Hickory, HiFi, Hob, Hobitt, Impulse, Jamie, Janus, Jerden, Jewel, Kapp, King, MTA, Major Minor, Mathew Katz, Metromedia, Mobile Fidelity, Monument, Nashboro, Nashville, Oracle, Palette, Paula, Peacock, Pete, Phil-L.A. of Soul, Philly Groove, Plantation, Polydor, Pulsar, Pzazz, Rama Rama, Ranwood, Remember, Reo Tahiti, Request, Revue, Riverside, Roulette, SGC, SSS Int'l, Scepter, Sidewalk, Skye, Sound Stage 7, Specialty, Speed, Sphere Sound, Starday, Studio 10, Sundi, Sun Int'l, Tetragrammaton, Tico, Tower, Tradition, Uni, VMC, Vault, Viva, Wand, White Whale, Windfall, Wonderland.

**Cassette:** ABC, Accent, Archive of Folk Music, Archive of Gospel Music, Archive of Jazz, Ashley, Backbeat, Bang, Bell, Bluesway, Blue Thumb, Bravo, Buckboard, Cadet, Cadet/Concept, Challenge, Chart, Checker, Chess, Command, Command/Probe, Crewe, De-Lite, Delmark, Diamond, Duke, Dunhill, Dynamo, ESP-Disk, Era, Everest, Excello, GNP Crescendo, GRT, Gamble, Hickory, HiFi, Hob, Impulse, Jamie, Janus, Jerden, Jewel, King, MTA, Major Minor, Metromedia, Mobile Fidelity, Monument, Musicor, Nashboro, Nashville, Palette, Paula, Pete, Phil-L.A. of Soul, Philly Groove, Plantation, Polydor, Project 3, Ranwood, Remember, Request, Riverside, Roulette, SGC, SSS Int'l, Scepter, Sidewalk, Skye, Sound Stage 7, Specialty, Starday, Sundi, Sun Int'l, Tetragrammaton, Tower, Tradition, 20th Century-Fox, Uni, Vault, Viva, Wand, Westminster, White Whale, Windfall, Wonderland.

**Open reel:** ABC, Atco, Atlantic, Bang, Bell, Bluesway, Blue Thumb, Cadet, Cadet/Concept, Checker, Chess, Command, Crewe, Duke, Dunhill, Everest, GNP Crescendo, GRT, Gamble, Hickory, Impulse, Jamie, King, MTA, Major Minor, Metromedia, Mobile Fidelity, Monument,

Musicor, Palette, Phil-L.A. of Soul, Plantation, Project 3, Roulette, SGC, Scepter, Skye, Sound Stage 7, Starday, Sundi, Sun Int'l, Tetragrammaton, Tower, 20th Century-Fox, Uni, Viva, Wand, White Whale.

General Recorded Tape Inc., see GRT.

Greentree Electronics, see Bell & Howell.

I T C C (International Tape Cartridge Corp.), 1275 Bloomfield Ave., Fairfield, N.J. 07006. Tel: (201) 228-1050. Pres.: Gary Salter; VP: Jimmie Tyrrell; Nat'l Dir. Tape Sales & Promo.: Miss Gerry Cousins.

**Cartridge 8-tr.:** Audio Fidelity, Barry, Bell, Buddah, Carib, Chart, Chery Laine, GNP Crescendo, GWP, Gamble, Goldwax, Hickory, Horizon, Itco, Jad, Jamie, Little Darlin', Mio Int'l, Mira, Moonglow, Musicor, Palisade, Phil-L.A. of Soul, Plantation, Poison Ring, Project 3, SSS Int'l, Skye, Sphere Sound, Starday, Stella, Stop, Tear Drop, Tetragrammaton, 20th Century-Fox, Vee Jay, White Whale.

**Cassette:** Alegre, Bell, Buddah, Chart, GWP, Gamble, Hickory, International Artists, Itco, Jad, Mira, Plantation, Project 3, Skye, Starday, Stella, Stop, Tear Drop, 20th Century-Fox, Vee Jay, White Whale.

International Tape Cartridge Corp., see ITCC.

Livingston Audio Prods. Corp., 1275 Bloomfield Ave., Fairfield, N.J. 07006. Tel: (201) 226-8300. Pres.: Darrell D. Scholton; VP Sales: Thomas J. Hoffbauer; Consumer Mktg. & Sales Dir.: Ray Rand.

**Cartridge 4-tr., 8-tr., cassette & open reel:** Avant Garde, Carnival, DBI, Gamble, Kubaney, Livingston, Prestige, Savoy, Spanish World, Tape House Int'l, Universal.

Mercury Rec. Corp., 35 E. Wacker Dr., Chicago, Ill. 60601. Tel: (312) 332-5788. Pres.: Irving B. Green; Sales Mgr.: Lou Simon.

**Cartridge 8-tr.:** Fontana, Lmelight, Mercury, Philips, Smash.

**Cassette:** Audio Fidelity, Chart, Fontana, Hickory, Lmelight, Mercury, Philips, Roulette, Smash, TRX, Tico, United Artists, Vanguard, Veep.

Metra Electronics Corp., 660 McDonald Ave., Brooklyn, N.Y. 11218. Tel: (212) 871-4100. Pres. & Sales Mgr.: Charles R. Fox.

**Cartridge 8-tr.:** Metra, Stereo Experience, Travelttime.

**Cartridge 4-tr.:** Metra, Travelttime.

Modern Tape Corp., 5810 S. Normandie Ave., Los Angeles, Calif. 90044. Tel: (213) 753-2481. Pres.: Joe Biharis; Sales Mgr.: Robert J. Demain.

**Cartridge 8-tr.:** Cartucho Moda, Fax, Flair 30, Modern, Mother Goose.

**Cassette:** Cartucho Moda, Fax, Flair 30, Modern.

**Open reel:** Flair 60, Flair 180.

Muntz Stereo-Pak Inc., 7715 Densmore Ave., Van Nuys, Calif. 91406. Tel: (213) 989-5000. Pres.: Earl Muntz.

N A L (North American Leisure Corp.), 1776 Broadway, New York, N.Y. 10019. Tel: (212) 265-3340. Pres.: Larry Finley; Sales Mgr.: Joseph Berger.

**Cartridge 8-tr., cassette & open reel:** Amazon, Athena, Bell, Bravo, Cotique, Country Sound, Direction, DynoVoice, Elf, Evolution, Firebird, Four Corners of the World, GNP Crescendo, Gamble, Jad, Kapp, LLP, Latin Showcase, Milestone, Monitor, Monmouth-Evergreen, NAL, New Voice, Page One, Philly Groove, Plantation, Project 3, Republic, Roulette, SSS Int'l, Skye, Tennessee Sound, Tetragrammaton, Viva, White Whale, Windfall.

North American Leisure Corp., see NAL.

Pacific Tape, 2978 W. Pico Blvd., Los Angeles, Calif. 90006. Tel: (213) 387-8797. Pres.: Spiros Biliouris; Sales Mgr.: Sam Billis; Adv. Dirs.: Anderson Belvin, Jack Frost.

**Cartridge 4-tr., 8-tr. & cassette:** Fabulous Sound, Flashbacks, Pacific, Rampart.

PlayTape, 1115 Broadway, New York, N.Y. 10010. Tel: (212) OR 5-8050. Pres.: Frank Stanton.

RCA Recs., 1133 Ave. of the Americas, New York, N.Y. 10036. Tel: (212) 586-3000. Pres.: Norm Racusin; Sales Mgr.: J. Y. Burgess Jr.; Adv. Dir.: W. Lucas.

**Cartridge 8-tr.:** Buena Vista, Camden, Chart, Colgems, Diamond, Institute for Language Study (ILS), Kirshner, Poppy, RCA, Victrola.

**Cassette:** Buena Vista, Chart, Colgems, Diamond, Kirshner, Poppy, RCA.

**Open reel:** Buena Vista, Camden, Chart, Colgems, Diamond, Kirshner, Poppy, RCA.

Entry, see Atlas Rand.

Specialty Sounds Inc., 33515 Kelly Rd., Fraser, Mich. 48026. Tel: (313) 294-5200. Pres.: L. Allan Bazy; Gen. Mgr.: Jerry Danko; Sales Mgr.: Danny R. Witsens.

**Cartridge 8-tr.:** Eurotone Int'l.

**Cassette:** Eurotone Int'l, Specialty Sounds.

**Open reel:** Specialty Sounds.

Stereo Experience, see Metra Electronics.

Stereo Jet de Mexico, see Caytronics.

Tape House Int'l, see DBI.

Tape Mates, see ATD.

Tapeworld Inc. (sub. of Radiant Corp.), 250 W. 57 St., New York, N.Y. 10019. Tel: (212) 765-1820. Pres.: Edward M. Cohen.

**Cartridge 4-tr., 8-tr., cassette & open reel:** Tapeworld & private labels.

Travelttime, see Metra Electronics.

Tucker Prod'n. Ltd., 853 Seventh Ave., New York, N.Y. 10019. Tel: (212) CO 5-0408. Pres.: George Tucker; Sales Mgr.: Cherie Shaw.

**Cartridge 4-tr., cassette & open reel:** Tucker & private labels.



## CASCOM offers you

Golden Book & Tape Sets:

- Golden Tape Favorites
  - Vox Classical Series
  - Folkways
  - Orpheum
  - Yew
- and others

**CASSETTE**  
COMMUNICATIONS CORP.  
932 Broadway, N. Y., N. Y. 10010  
Phone #212-533-3150

# Lear Jet: the tape measure.

Lear Jet is the tape cartridge the rest of the industry has to measure itself by.

Lear has long been the leader. Top quality and reliability are qualities you routinely expect from Lear Jet. Now you receive our cartridges in three simple pieces.

And they're so easy to assemble or disassemble, you could do it by hand.

No machine pressing. No fuss. No bother. Just snap . . . and your taped music is neatly packaged. Inside a Lear Jet Stereo 8 quality tape cartridge.

The cost? Comparable or less than lesser products. For free samples of our snap-together cartridge, write to AVSCO, Incorporated, subsidiary of Gates-Lear Jet Corp., Highway 69 and Corum Road, Excelsior Springs, Missouri 64024, or call (316) 637-2114.

If you're putting out good tape, don't just put it in any old dispenser.  
Put it inside the tape measure . . . by Lear Jet.



AVSCO, Incorporated  
Subsidiary of Gates-Lear Jet Corporation

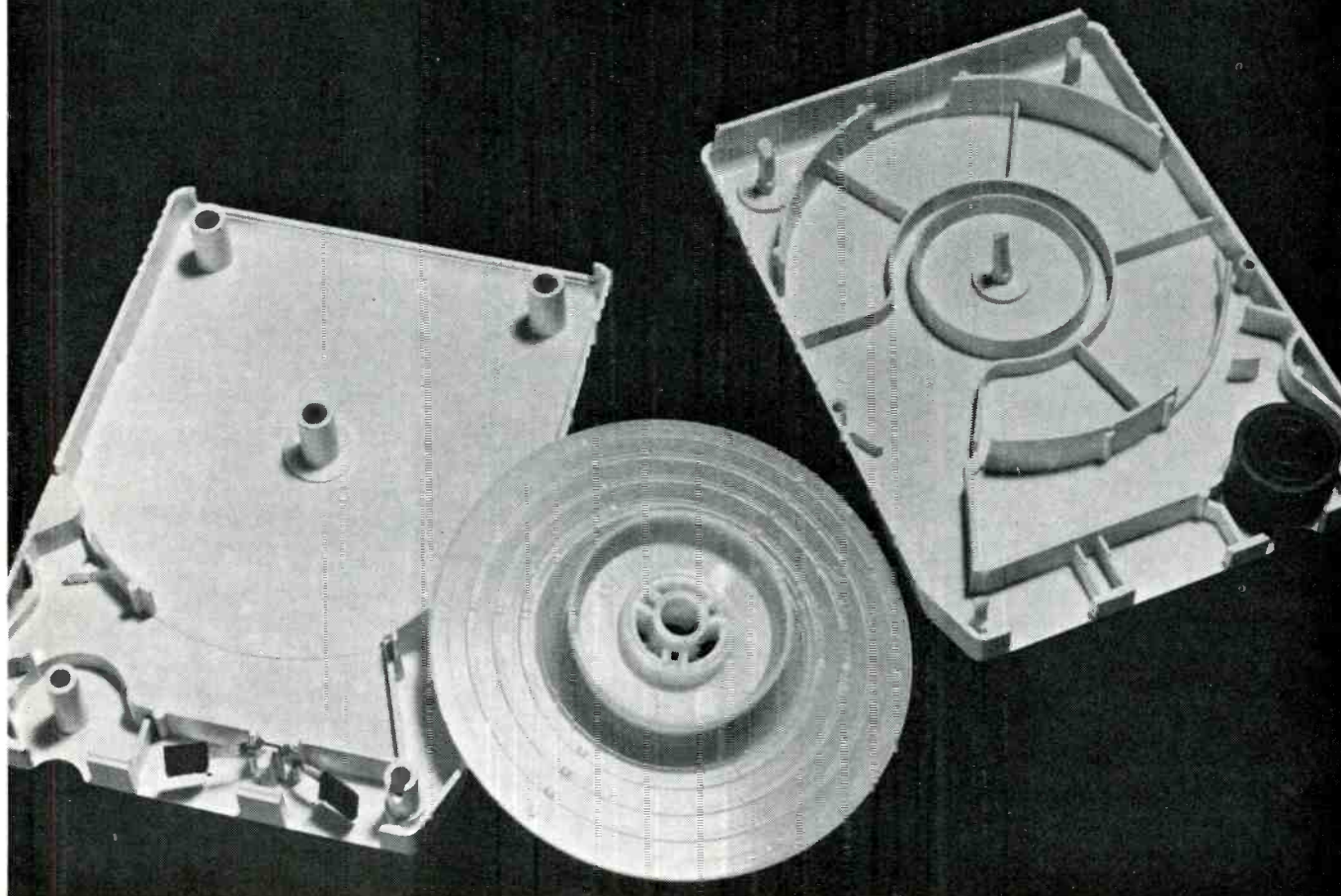

# TAPE PLAYBACK EQUIPMENT MANUFACTURERS & IMPORTERS

**A G S** (see Sterling Hi Fidelity Inc.).  
Admiral Corp., 3800 Cortland St., Chicago, Ill. 60647.  
Tel: (312) 292-2600. Pres.: Ross D. Siragusa Jr.; VP Sales: Jack Daly; VP Adv.: Thomas R. Chadwick.  
**Cartridge** (1 model) 8-tr. home. Price: \$70.  
**Cassette**: (5 models) portable. Price range: \$24.95-\$69.95.

**Aimcee** (see York Radio Corp.).  
**Aiwa** (see Selectron).

**Alaron** (see B&B Import-Export Co.).  
**Allied Radio**, 100 N. Western Ave., Chicago, Ill. 60612. Tel: (312) HA 1-6800. Pres.: Shelby Young; Mdse. Mgr.: Gerald Orbach; Sales Mgr.: Nate Miller; Adv. Dir.: Larry Blostein.  
**Cartridge**: (4 models) 2 8-tr. auto, 2 8-tr. home. Price range: \$69.95-\$159.95.  
**Cassette**: (6 models) 1 auto, 1 home, 4 portable. Price range: \$39.95-\$99.95.  
**Open reel**: (1 model) 4-tr. portable. Price: \$179.95.

**American** (see Royal Sound Co. Inc.).  
**American Gelo** Electronics, 251 Park Ave. S., New York, N.Y. 10010. Tel: (212) AL 4-2282. Pres. & Sales Mgr.: Bernard L. Cahn; Adv. Dir.: P. Mastrangelo.  
**Cassette**: (1 model) home/portable. Price: \$89.50.  
**Open reel**: (2 models) 2-tr. Price range: \$94.50-\$129.50.  
**Brand name**: Gelo.

**Ampex Consumer Equip. Div.**, 2201 Estes Ave., Elk Grove Village, Ill. 60007. Tel: (312) 956-1800. VP & Gen. Mgr.: E. P. Larmer; Mktg. Mgr.: L. R. Pugh; Sales Mgr.: James Lantz; Promo. Mgr.: W. A. Feitz.  
**Cassette**: (14 models) 2 auto, 4 home, 8 portable. Price range: \$24.95-\$269.95.  
**Open reel**: (5 models) 1 4-tr. home, 4 4-tr. portable. Price range: \$249.95-\$695.95.

**Aristocrat** (see Dejay Corp.).

**Arvin Inds. Inc.**, 1531 13 St., Columbus, Ind. 47201. Tel: (812) 372-7271. Pres.: E. I. Anderson; Sales Dir.: Harlan Scheidt; Adv. Dir.: Ross Faires; Adv. & Sales Promo. Mgr.: Fred Meyer.  
**Cartridge**: (4 models) 4&8-tr. compatible. Price range: \$110-\$160.  
**Cassette**: (5 models) 1 home, 4 portable. Price range: \$22-\$190.  
**Open reel**: (4 models) 1 4-tr. home, 3 2-tr. portable. Price range: \$27-\$140.

**Astrosonix** (see California Auto Radio).  
**Atlas-Rand Corp.**, Keystone Pl., Paramus, N.J. 07652. Tel: (201) 262-7500; NYC Tel: (212) 563-6663. VP: Harold Rosen; Nat'l Tape Sales Mgr.: Dick Price; Adv. Dir.: Stuart Belter.  
**Cartridge**: (3 models) 1 8-tr. auto, 1 8-tr. home, 1 8-tr. portable. Price range: \$39.95-\$149.95.  
**Cassette**: (10 models) 2 auto, 2 home, 6 portable. Price range: \$19.95-\$229.95.  
**Brand name**: Keystone.

**Audiosphere Dual Galaxy** (see Livingston Audio Prods. Corp.).

**Audio/Stereo** (see Muntz).

**Audiovox Corp. & Audiovox West Corp.**, 300 Denton Ave., New Hyde Park, N.Y. 11040. Tel: (516) 248-0500. Pres.: John Shalam; Sales Mgr.: Martin Novick; Adv. Dir.: John Petallides.  
**Cartridge**: (15 models) 8 auto-7 8-tr., 1 4&8-tr. compatible; 5 8-tr. home; 2 8-tr. portable. Price range: \$19.95-\$249.95.  
**Cassette**: (3 models) 1 auto, 2 portable. Price range: \$19.95-\$99.50.

**Automatic Radio Sales**, 2 Main St., Melrose, Mass. 02176. Tel: (617) 321-2300. Pres.: Edward L. Housman; Sales Mgr.: Joseph Spinale.  
**Cartridge**: (25 models) 16 auto-14 8-tr, 2 4&8-tr. compatible; 6 8-tr. home; 3 8-tr. portable. Price range: \$49.95-\$199.95.  
**Cassette**: (7 models) 2 auto, 2 home, 3 portable. Price range: \$49.95-\$199.95.

**Auto-Sonic** (Automotive Div. of Maretel), 2339 S. Cotner Ave., Los Angeles, Calif 90064. Tel: (213) 479-4491. Pres.: Sheldon Krehman; Mktg. Dir.: Anthony Antonelli.  
**Cartridge**: (5 models) 3 auto-1 8-tr., 2 4&8-tr. compatible; 1 8-tr. home; 1 8-tr. portable. Price range: \$39-\$99.

**B & B Import-Export Co.**, 185 Park St., Troy, Michigan. 48084. Tel: (313) 585-8400. Sales Mgr.: Emery I. Klein.  
**Cartridge**: (6 models) 1 8-tr. auto, 3 8-tr. home, 2 8-tr. portable. Price range: \$29.95-\$124.95.  
**Cassette**: (6 models) portable. Price range: \$24.95-\$54.95.  
**Open reel**: (3 models) 2-tr. portable. Price range: \$11.88-\$29.95.  
**Brand names**: Alaron, Rhapsody.

**Bandachrome**, 936 Mahar Ave., Wilmington, Calif. 90744. Tel: (213) 830-4444. Pres.: J. L. Bleiweis; Sales Mgr. & Adv. Dir.: A. Hepner.  
**Cartridge**: (2 models) 8-tr. auto. Price range: \$32.60-\$34.50.  
**Brand name**: Universal Sound.

**Belair Enterprises**, 5873 Rodeo Rd., Los Angeles, Calif. 90016. Tel: (213) 870-9273. Pres.: Ed Mason; Sales Mgr.: Rod Pierce; Adv. Dir.: S. M. Newmark.  
**Cartridge**: (12 models) 4 auto-3 8-tr., 1 4&8-tr. compatible; 4 8-tr. home; 4 8-tr. portable. Price range: \$59.95-\$199.95.  
**Cassette**: (2 models) 1 home, 1 portable. Price range: \$159.95-\$249.95.

**Bell & Howell Consumer Electronics Div.**, 7235 N. Linder Ave., Chicago, Ill. 60076. Tel: (312) 677-2100. Sales Mgr.: Bruce MacFarlane; Mktg. Mgr.: George Simkowski; Prod. Mgr.: Harry Heinze; Adv. Dir.: Lynn Stewart.  
**Cassette**: (15 models) 8 home, 7 portable. Price range: \$39.95-\$279.95.

**Belle Wood Corp.**, 2751 Lake Cook Rd., Deerfield, Ill. 60015. Tel: (312) 498-1030. Pres.: Vincent R. Vecchione; VP Mktg. & Sales Mgr.: Arthur F. Connolly; Adv. Dir.: Richard J. Riffner.  
**Cartridge**: (9 models) 8 8-tr. auto, 2 8-tr. home, 1 8-tr. portable. Price range: \$39.95-\$139.95.

**Brand names**: Belle Wood (home), Cartable (auto).

**Boman** (see California Auto Radio).

**C B S Records, Masterwork Audio Prod. Div.**, 51 W. 52 St., New York, N.Y. 10019. Tel: (212) 765-4321. Audio Prods. Dir.: M. Selkowitz; Sales Dir.: Shelly Rudin.  
**Cartridge**: (4 models) 1 8-tr. auto, 2 8-tr. home, 1 8-tr. portable. Price range: \$79.95-\$175.00.  
**Cassette**: (4 models) 1 home, 3 portable. Price range: \$39.95-\$149.95.  
**Open reel**: (1 model) 4-tr. portable. Price: \$139.95.  
**Brand name**: Masterwork.

**C M C** (see Custom Music Corp.).

**California Auto Radio**, 9426 Stewart & Gray Rd., Downey, Calif. 90241. Tel: (213) 923-9846. Pres.: Robert P. Maniaci; Sales Mgr.: Tony Gable; Adv. Dir.: Bob Mohler.  
**Cartridge**: (11 models) 8 auto-1 4-tr., 7 8-tr.; 1 8-tr. home; 2 8-tr. portable. Price range: \$29.95-\$89.95.  
**Brand names**: Astrosonix, Boman, Continental, Pianola.  
**Cassette**: (2 models) auto. Price range: \$39.95-\$59.95.  
**Brand name**: Boman.

**Caltrade Mfg. & Trading Co.**, 360 Ninth St., San Francisco, Calif. 94103. Tel: (415) 626-6565. Pres.: Irwin M. Randolph; Sales Admin'r: Judy Sutherland.  
**Cartridge**: (3 models) 8-tr. home. Price range: \$98-\$240.  
**Cassette**: (4 models) 2 home, 2 portable. Price range: \$29.95-\$69.95.  
**Open reel**: (2 models) 2-tr. portable. Price: \$13.95.  
**Brand name**: Encore.

**Capitol Records Dist'g Corp.**, 1750 N. Vine St., Hollywood, Calif. 90028. Tel: (213) 462-6252. Pres.: Salvatore J. Iannucci; Sales Mgr.: John J. Jossey; Adv. Dir.: Dennis P. Killeen.  
**Cassette**: (6 models) portable. Price range: \$29.95-\$110.95.

**Cartable** (see Belle Wood Corp.).

**Car Tapes Inc.**, 320 W. Ohio St., Chicago, Ill. 60610. Tel: (312) 943-5158. Pres.: James LeVitus; Sales Mgr.: Edwin Swire.  
**Cartridge**: (3 models) 2 8-tr. home, 1 8-tr. portable.  
**Cassette**: (2 models) auto. Price range: \$79-\$99.  
**Brand name**: Cartape.  
**Caytronics Corp.**, 240 Madison Ave., New York, N.Y. 10016. Tel: (212) 683-7911. Pres.: Joe Cayre; Sales Mgr.: Ed Ash; Adv. Dir.: Dick Schaeffer  
**Cartridge**: (3 models) 1 8-tr. auto, 1 8-tr. home, 1 8-tr. portable. Price range: \$39.95-\$99.95.  
**Cassette**: (3 models) 1 auto, 1 home, 1 portable. Price range: \$39.95-\$99.95.

*continued on page 34*



# The NOW Sound of 8 Track PROFIT



## The 811R Cartridge Recorder

Listen . . . and you can hear the sound of profit. It's the 811R 8 Track Stereo Cartridge Recorder. Designed to sell and sell and sell.

Records and plays 8 track stereo cartridges for car or home from Stereo FM, phonograph or any tape recorder. Engineered for studio quality performance with exclusive logic circuits to eliminate timing problems. Exquisite styling and convenience features to captivate your customers.

Best of all, model 811R is available now. We deliver immediately from stock. Hear the sound of profit now . . . and be ready for holiday sales. Model 811R. Made in the U.S. to sell for under \$190.00.

Contact Russ Molloy

PRODUCTS OF SOUND RESEARCH

**TELEX**

COMMUNICATIONS DIVISION

9600 Aldrich Avenue South  
Minneapolis, Minnesota 55420

# TAPE PLAYBACK EQUIPMENT MANUFACTURERS & IMPORTERS

Continued from page 32

Channel Master Corp., Rt. 209, Ellenville, N.Y. 12428. Tel: (914) 647-5000. Pres.: Harry Resnick; Sales Mgr.: Martin Charles; Adv. Dir.: Peter Swenson.  
**Cartridge:** (2 models) 1 8-tr. auto, 1 8-tr. home. Price range: \$64.95-\$189.95.  
**Cassette:** (7 models) 1 auto, 1 home, 5 portable. Price range: \$29.95-\$189.  
**Open reel:** (3 models) 2 4-tr. home, 1 2-tr. portable. Price range: \$99.95-\$219.95.

Claricon Prods. Inc., 663 Dowd Ave., Elizabeth, N.J. 07201. Tel: (201) 289-4600. Pres.: H. Katovsky; VP, Sales & Adv. Dir.: R. Katovsky.  
**Cartridge:** (1 model) 8-tr. auto. Price: \$89.95.  
**Cassette:** (1 model) portable. Price: \$38.88.  
**Open reel:** (1 model) 2-tr. portable. Price: \$12.44.

Commodore Import Corp., 507 Flushing Ave., Brooklyn, N.Y. 11205. Tel: (212) JA 2-3407. Sales Mgr.: Jack Schneider.  
**Cartridge:** (3 models) 1 8-tr. auto, 1 8-tr. home, 1 8-tr. auto/home. Price range: \$39.95-\$69.95.  
**Cassette:** (2 models) home. Price range: \$49.95-\$69.95.  
**Open reel:** (1 model) 2-tr. portable. Price: \$16.99.  
**Brand name:** Commodore.

Concertone Inc. (div. of Monarch Electronics Int'l Inc.), 7035 Laurel Canyon Blvd., North Hollywood, Calif. 91605. Tel: (213) 765-1810. Pres.: Meyer B. Price; Sales Mgr.: John Norman Miller; Adv. Dir.: Richard W. Price.  
**Cassette:** (3 models) home. Price range: \$79.95-\$179.95.  
**Open reel:** (3 models) 4-tr. home. Price range: \$179.95-\$189.95.

Concord Electronics Corp., 1935 Armacost, Los Angeles, Calif. 90025. Tel: (213) 478-2541. Pres.: Howard P. Ladd; Sales Mgr.: William B. Minkin.  
**Cartridge:** (1 model) 8-tr. home. Price: \$69.95.  
**Cassette:** (9 models) 2 home, 7 portable. Price range: \$49.95-\$249.95.

Consolidated Mds. Corp., 59-50 Queens Midtown Expwy., Maspeth, N.Y. 11378. Tel: (212) 894-5150. Pres.: Victor Reichenstein; Sales Mgr.: Milf Dolnick.  
**Cartridge:** (7 models) 2 auto-1 8-tr., 1 4&8-tr. compatible; 3 8-tr. home; 2 8-tr. portable.

Price range: \$12.95-\$175.  
**Cassette:** (16 models) 2 auto, 6 home, 8 portable. Price range: \$21.95-\$199.95.  
**Open reel:** (9 models) home-1 2-tr., 8 4-tr. Price range: \$8.45-\$359.95.  
**Brand names:** Webcor, Viscount.

Continental (see California Auto Radio).  
 Craig Corp., 2302 E. 15 St., Los Angeles, Calif. 90021. Tel: (213) 623-2421. Pres.: Robert Craig; Gen. Sales Mgr.: Lauren Davies; Nat'l Sales Mgr.: Steve Solot.  
**Cartridge:** (14 models) 8 auto-1 4-tr., 5 8-tr., 2 4&8-tr. compatible; 6 home-5 8-tr., 1 4&8-tr. compatible. Price range: \$69.95-\$169.95.  
**Cassette:** (17 models) 1 auto, 7 home, 9 portable. Price range: \$47.95-\$239.95.  
**Open reel:** (8 models) 6 4-tr. home, 2 2-tr. portable. Price range: \$47.95-\$349.95.

Crown (see Industrial Suppliers Co.).  
 Custom Music Corp., 1201 Research Blvd., St. Louis, Mo. 63132. Tel: (314) 997-0016. Pres.: Byrle A. Northup; Adv. Dir.: Donald E. Lobbig.  
**Cartridge:** (2 models) 1 8-tr. auto, 1 8-tr. home. Price range: \$69.95-\$99.95.  
**Cassette:** (1 model) portable. Price: \$39.95.  
**Brand name:** CMC.

Decca (div. of MCA Inc.), Home Entertainment Div., 445 Park Ave., New York, N.Y. 10022. Tel: (212) 759-7500. Exec. VP: Jack Loetz; Sales Mgr.: Marvin Paris.  
**Cartridge:** (5 models) 1 8-tr. auto, 3 8-tr. home, 1 8-tr. portable. Price range: \$69.95-\$159.95.  
**Cassette:** (4 models) portable. Price range: \$29.95-\$79.95.

Dejay Corp., 90 N. Washington St., Boston, Mass. 02114. Tel: (617) 523-1439. Pres. & Sales Mgr.: W. P. Blotnick.  
**Cartridge:** (2 models) 8-tr. home. Price range: \$100-\$200.  
**Cassette:** (2 models) home. Price range: \$150-\$300.  
**Brand names:** Dejay, Aristocrat.

Delmonico Int'l Corp. (div. of Elgin Nat'l Inds. Inc.), 59-35 56 Rd., Maspeth, N.Y. 11378. Tel: (212) EX 2-7100. Elgin Opns. Dir.: Bob Scholle; Sales Mgr.: Irving Murray.  
**Cartridge:** (1 model) 8-tr. portable. Price: \$99.95.  
**Brand name:** Elgin.

Dokorder (see Royal Sound Co. Inc.).  
 Dyn Electronics Inc., 3095 NW 77 Ave., Miami, Fla. 33122. Tel: (305) 885-0711. Pres.: Charles Dascal; Sales Mgr.: Salomon Yüken.  
**Cartridge:** (16 models) 7 auto-6 8-tr., 1 4&8-tr. compatible; 6 8-tr. home; 3 8-tr. portable. Price range: \$49.95-\$199.95.

**Cassette:** (4 models) 2 auto, 2 home. Price range: \$129.95-\$299.95.  
**Brand name:** Dyn-sonic.  
 Dyn-sonic (see Dyn Electronics Inc.).  
 Electra Radio Corp., 30 W. 23 St., New York, N.Y. 10011. Tel: (212) 675-7640. Pres.: Richard Beda.  
 Electro Brand Inc., 220 W. Chestnut St., Chicago, Ill. 60610. Tel: (312) 944-5460. Sales Mgr.: Richard L. Ertelson.  
**Cartridge:** (9 models) 1 8-tr. auto, 5 8-tr. home, 3 8-tr. portable. Price range: \$69.95-\$149.95.  
**Cassette:** (4 models) portable. Price range: \$29.95-\$59.95.  
**Brand name:** Electro-Brand.  
 Electronic Inds. Inc., 901 Daniel St., Kenner, La. 70062. Tel: (504) 721-2392.  
**Brand name:** Transworld.  
 Electrophonic (see Morse Electro Prods. Corp.).  
 Elgin (see Delmonico Int'l Corp.).  
 Emerson Television Sales Corp., PO Box 499, Stamford, Conn. 06904. NYC Tel: (212) 993-4300. Pres.: C. R. Feldmann; VP Sales: John Ryan; Adv. Dir.: John Delavigne.  
**Cassette:** (1 model) portable. Price: \$125.  
 Encore (see Caltrade Mfg. & Trading Co.).  
 Faraday Inc., 805 S. Maumee St., Tecumseh, Mich. 49286. Tel: (313) 423-2111. Pres.: Fred J. Kluin; Sales Mgr.: Joseph C. Meidt; Adv. Dir.: Charles S. Buhman.  
**Cartridge:** (5 models) 2 8-tr. auto, 3 8-tr. home. Price range: \$69.95-\$169.95.  
**Brand names:** Goodyear, Orrtronics, Sears, White Motors.  
 Fisher Radio Corp., 11-40 45 Rd., Long Island City, N.Y. 11101. Tel: (212) 937-2100. Pres.: Avery Fisher; Nat'l Sales Mgr.: William Kist.  
**Cassette:** (1 model) home. Price: \$149.95.  
 Arthur Fulmer, 260 Monroe Ave., Memphis, Tenn. 38101. Tel: (901) 525-5711. Pres.: Arthur Fulmer; Sales Mgr.: R. T. Edmundson; Adv. Dir.: Gerard J. Aubuchon.  
**Cartridge:** (16 models) 8 auto-7 8-tr., 1 4&8 tr. compatible; 5 8-tr. home; 3 8-tr. portable. Price range: \$19.95-\$144.95.  
**Cassette:** (3 models) 1 auto, 2 portable. Price range: \$29.95-\$99.95.  
**Brand names:** Arthur Fulmer, Stereosonic.  
 Geloso (see American Geloso Electronics).  
 General Electric Co., 1001 Broad St., Utica, N.Y. 13501. Tel: (315) 798-4585. Gen. Mgr.: J. S. Chamberlin; Sales Mgr.: A. N. Stewart; Adv. Dir.: B. Werges.  
**Cartridge:** (1 model) 8-tr. home. Price: \$129.98.  
**Cassette:** (5 models) portable. Price range: \$29.98-\$99.98.  
 Gibbs Special Prods. Corp., 450 N. Main St., Janesville, Wis. 53545. Tel: (608) 756-1261. VP & Gen. Mgr.: Paul A. Reemnyder; Mktg. Dir.: Robert H. Falk; Adv. Dir.: Howard J. Sayre.  
**Cartridge:** (16 models) 12 8-tr. auto, 4 8-tr. home. Price range: \$50-\$120.  
**Cassette:** (7 models) 4 auto, 2 home, 1 portable.  
**Brand names:** Gibbs, Hammond.  
 Goodyear (see Faraday Inc.).  
 Granada (see Manhattan Novelty Corp.).  
 Grundig Electronic Sales Inc., 355 Lexington Ave., New York, N.Y. 10017. Tel: (212) 661-2020. Pres.: W. B. Keepin; Sales Mgr.: K. Emmer.  
**Cassette:** (3 models) portable. Price range: \$99.95-\$189.95.  
**Open reel:** (5 models) 3 4-tr. home, 2 2-tr. portable. Price range: \$179.95-\$289.95.  
 Hammond (see Gibbs Special Prods. Corp.).  
 Harman-Kardon Inc., 55 Ames Ct., Plainview, N.Y. 11803. Tel: (516) 681-4000. Pres.: Walter Goodman; Sales Mgr.: Tom Donohue; Adv. Dir.: Leon Kuby.  
**Cartridge:** (2 models) 4-tr. auto.  
**Cassette:** (2 models) home. Price range: \$149.95-\$159.50.  
**Brand names:** Harman-Kardon, Slimline.  
 Hitachi Sales Corp. of America, 48-50 34 St., Long Island City, N.Y. 11101. Tel: (212) 361-3090. Pres.: Eizo Matsumura; Sales Mgr.: Gene Schilling; Adv. & Mktg. Dir.: Morton M. Schwartz.  
**Cartridge:** (3 models) 1 8-tr. auto, 2 8-tr. home. Price range: \$79.95-\$199.95.  
**Cassette:** (17 models) 2 auto, 15 home. Price range: \$19.95-\$199.95.  
**Open reel:** (4 models) 4 2-tr. home. Price range: \$29.95-\$349.95.  
 Haskel Howard Co. Inc., 21 Hazellon Rd., Yonkers, N.Y. 10710. Tel: (914) 779-4131.  
**Brand name:** Robette.  
 Industrial Suppliers Co., 755 Folsom St., San Francisco, Calif. 94107. Tel: (415) 781-3030. Pres.: C. C. Chiang; Sales Mgr.: C. W. Hancock; Adv. Dir.: H. Aizawa.  
**Cassette:** (12 models) 2 auto, 4 home, 6 portable. Price range: \$19.95-\$299.95.  
**Brand name:** Crown.  
 J V C America Inc. (sub. of Victor Co. of Japan Ltd.), 50-35 56 Rd., Maspeth, N.Y. 11378. Tel: (212) 392-2668. Pres.: T. Masuda; Sales Mgr.: H. Kikuchi; Adv. Mgr.: Tony Y. Tamaki.  
**Cartridge:** (5 models) 1 8-tr. auto, 4 8-tr. home. Price range: \$69.95-\$189.95.  
**Cassette:** (6 models) 2 home, 4 portable. Price range: \$34.95-\$279.95.  
**Open reel:** (6 models) 2 4-tr. home, 4 2-tr. portable. Price range: \$59.95-\$369.95.  
**Brand name:** JVC.  
 Juliette (see Topp Electronics Inc.).  
 Kapner (see York Radio Corp.).

## Play it for Full Profits with PEERLESS in 1970!

Recognized for Quality • Styling • Values in Home/Auto Consumer Electronics

- CASSETTE RECORDERS AND PLAYERS
  - TAPE PLAYERS (HOME, AUTO, PORTABLE)
  - COMBINATION STEREO/RADIOS/TAPE PLAYERS
- STEREO SYSTEMS
- CASSETTE-RADIO Recorder Combinations
- DIGITAL CLOCK RADIOS
- PORTABLE 8-TRACK TAPE PLAYERS
- AUTO STEREO PLAYERS
- PREMIUM & SPECIALTY RADIOS
  - Desk Radios, Ash Tray Radios, Binoocular-Radio combinations.
- RADIO-PHONOGRAPH COMBINATIONS
- PORTABLE Multiple-Band RADIOS
- POLICE BAND RADIOS
- AM-FM RADIOS
- TRANSCEIVERS



Model HSP-25A: 8-TRACK TAPE SYSTEM, AM-FM STEREO  
Solid State; 8-track tape player, blackout slide rule dial.  
Hand-rubbed, oiled walnut-finish, wood cabinet with matching speakers.



Model PSP-444: PORTABLE 8-TRACK STEREO TAPE PLAYER  
Separate left-right volume controls.  
AC-DC, detachable speakers.  
Built-in telescopic antenna for FM Stereo tuner.

**IMMEDIATE DELIVERY**

**PEERLESS TELERAD, INC.** a DERO subsidiary

37-15 61st Street, Woodside, N.Y. 11377 (212) 779-1515  
62 East 13th Street, Chicago, Ill. 60605 (312) 922-1922

continued on page 36

# ONE GOOD TURN-ON DESERVES ANOTHER

The sounds on Decca 8-track cartridges and cassettes sound great. No matter what. They sound even better on Decca's '970 Home Entertainment equipment.



DTP-189 An 8-track cartridge player, AM-FM multiplex radio, 7 controls, 6½" wood-enclosed speakers.

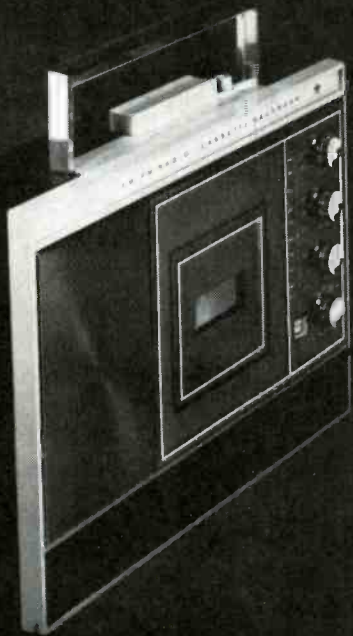

DTP-195 Portable cassette unit that can record from its own AM-FM radio.

"TOMMY"  
The Who  
6-2500  
73-250C

CASTLES  
OF SPAIN  
Andrés  
Segovia  
6-10171  
73-10171

RICK NELSON  
IN CONCERT  
6-5162  
73-5162

THE KAEMPFFERT TOUCH  
Bert Kaempfert  
and his Orchestra  
6-5175 73-5175



# TAPE PLAYBACK EQUIPMENT MANUFACTURERS & IMPORTERS

Continued from page 34

Katone Corp., 37 W. 28 St., New York, N.Y. 10001. Tel: (212) 889-6240. Pres.: Maurice Katz; Sales Mgr.: Harold Davidow.  
Cartridge: (2 models) 8-tr. home. Price range: \$69.95-\$200.  
Cassette: (3 models) home. Price range: \$29.95-\$59.95.  
Open reel: (2 models) 2-tr. home. Price range: \$15-\$25.  
Keystone (see Atlas-Rand Corp.).  
Kraco Prods. Inc., 2411 N. Santa Fe Ave., Compton, Calif. 90223. Tel: (213) 774-2550. Pres.: Maurice Kraines; VP Sales: Larry Kraines; Adv. Dir.: Owen Gilleran.  
Cartridge: (7 models) 6 auto, 5 8-tr., 1 4&8-tr. compatible; 1 8-tr. auto/home. Price range: \$59.95-\$139.95.  
Cassette: (2 models) auto. Price range: \$99.95-\$119.95.  
Lafayette Radio Electronics Corp., 111 Jericho Tpk., Syosset, N.Y. 11791. Tel: (516) 921-7700. Pres.: A. Pletman; Adv. Dir.: C. Piotrowski.  
Cartridge: (3 models) 2 8-tr. auto, 1 8-tr. home. Price range: \$54.95-\$169.95.  
Cassette: (18 models) 2 auto, 6 home, 10 portable. Price range: \$17.95-\$279.95.  
Open reel: (6 models) 6 home-1 2-tr., 5 4-tr., 1 2-tr. portable. Price range: \$14.95-\$299.95.  
Lear Jet Stereo Inc., 6868 S. Plumer, Tucson, Ariz. 85706. Tel: (602) 294-4461. Pres.: Charles G. Gates Jr.; VP & Gen. Mgr.: Ed G. Campbell; VP Mktg.: James Gali; Adv. Dir.: Mike Seiler.  
Cartridge: (18 models) 8 8-tr. auto, 6 8-tr. home, 4 8-tr. portable. Price range: \$59.95-\$289.95.  
Livingston Audio Prods. Corp., 1275 Bloomfield Ave., Fairfield, N.J. 07006. Tel: (201) 226-8300. Pres.: Darrell D. Scholten; VP Sales: Thomas J. Hofbauer; Consumer Mktg. & Sales Dir.: Ray Rand.  
Cartridge: (1 model) 4&8-tr. compatible auto. Price \$129.95.  
Brand name: Audiosphere Dual Galaxy.  
Lloyd's Electronics, 59 N. Fifth St., Saddle Brook, N.J. 07662. Tel: (201) 843-5115. Pres.: Abe Zagha; Eastern Sales Mgr.: Mark Boone.  
Cartridge: (3 models) 8-tr. home. Price range: \$99.95-\$159.95.  
Cassette: (7 models) 2 home, 5 portable. Price range: \$29.95-\$149.95.  
MS (see Metro of California).  
Macys (see York Radio Corp.).  
Magnavox Consumer Electronics, 1700 Magnavox Way, Fort Wayne, Ind. Tel: (219) 432-6511. Pres.: G. H. Fezell; Sales Mgr.: J. Egan; Adv. Dir.: K. Carstens.  
Cassette: (7 models) portable. Price range: \$39.90-\$99.90.  
Open reel: (6 models) 2 4-tr. home, 4 2-tr. portable. Price range: \$34.90-\$329.90.  
Manhattan Novelty Corp., 263 Canal St., New York, N.Y. 10013. Tel: (212) CA 6-1081. Pres.: N. Flomenloft; Sales Mgr.: Ben Schrage; Adv. Dir.: H. Weiss.  
Cassette: (2 models) portable. Price range: \$49.95-\$59.95.  
Brand names: Granada, Saint Moritz.  
Marlin Radio Corp., 45 W. 27 St., New York, N.Y. 10001. Tel: (212) 686-8630. Sales Mgr.: Elliot Dweck.  
Cartridge: (1 model) 8-tr. home. Price: \$69.95.  
Martel Electronics Sales Inc., 2339 S. Cotner Ave., Los Angeles, Calif. 90064. Tel: (213) 479-4491. Pres.: David Krechman; Sales Mgr. & Adv. Dir.: George A. Rose.

Open reel: (5 models) 3 home-2 2-tr., 1 4-tr.; 2 portable-1 2-tr., 1 4-tr. Price range: \$249.50-\$550.  
Brand name: Uher.  
Masterwork (see C B S Recs.).  
Matsushita Electric Corp. of America (Panasonic), 200 Park Ave., New York, N.Y. 10017. Tel: (212) 973-5700. Pres.: K. Isomura; Sales Mgr.: Jeffrey C. Berkowitz; Adv. Dir.: Russ Johnson.  
Cartridge: (4 models) 8-tr. home. Price range: \$59.95-\$349.95.  
Cassette: (14 models) 6 home, 8 portable. Price range: \$39.95-\$349.95.  
Brand name: Panasonic.  
Mayfair Sound Prods. Inc., 666 W. Kinzie St., Chicago, Ill. 60610. Tel: (312) 243-8050. Pres.: Art Braver; Sales Mgr.: Charles Hakimian.  
Cartridge: (14 models) 2 8-tr. auto; 8 home-7 8-tr., 1 4&8-tr. compatible; 4 8-tr. portable. Price range: \$49.95-\$149.95.  
Cassette: (15 models) 1 auto, 2 home, 12 portable. Price range: \$24.95-\$189.95.  
Open reel: (4 models) 2-tr. portable. Price range: \$12.88-\$22.50.  
Mays (see York Radio Corp.).  
Medallion (see Midland Int'l).  
Mercury (see Pax Ltd.).  
Metro of California, 4861 Santa Monica Blvd., Los Angeles, Calif. 90029. Tel: (213) 664-1908. Pres.: Ralph Slotnick; Sales Mgr.: Frank Andre; Adv. Dir.: Frank Johnson.  
Cartridge (10 models) 7 auto-1 4-tr., 3 8-tr., 3 4&8-tr. compatible; 2 home-1 4-tr., 1 8-tr.; 1 8-tr. portable. Price range: \$39.95-\$129.95.  
Brand names: MS, Metro Sound.  
Metro Sound (see Metro of California).  
Midland Int'l, 1909 Vernon St., North Kansas City, Mo. 64116. Tel: (816) VI 2-0511. Pres.: E. L. Benson; Sales Mgr.: Jack M. Lose; Adv. Dir.: R. Caldwell.  
Cartridge: (12 models) 6 auto-5 8-tr., 1 4&8-tr. compatible; 5 8-tr. home; 1 4&8-tr. compatible portable. Price range: \$29.95-\$139.95.  
Brand name: Midland, Medallion.  
Cassette: (11 models) 1 auto, 3 home, 7 portable. Price range: \$19.95-\$199.95.  
Open reel: (3 models) 2 2-tr. home, 1 2&4-tr. home. Price range: \$14.95-\$199.95.  
Brand name: Midland.  
Monarch Electronics Int'l Inc., 7035 Laurel Canyon Blvd., North Hollywood, Calif. 91605. Tel: (213) 765-1810. Pres.: Meyer B. Price; Sales Mgr.: John Norman Miller; Adv. Dir.: Richard W. Price.  
Cartridge: (4 models) 2 auto-1 8-tr., 1 4&8-tr. compatible; 2 8-tr. home. Price range: \$54.95-\$119.  
Morse Electro Prods. Corp., 9200 Atlantic Ave., Ozone Park, N.Y. 11416. Tel: (212) 441-6600. Pres.: Philip Morse; Adv. Dir.: Gerald Wisset.  
Cartridge: (18 models) 8-tr. home. Price range: from \$129.95.  
Brand names: Morse, Electrophonic.  
Cassette: (1 model) home. Price: \$150.  
Brand name: Electrophonic.  
Motorola Automotive Prods. Inc., 9401 W. Grand Ave., Franklin Park, Ill. 60131. Tel: (312) 625-6000. Pres.: Oscar P. Kusisto; Sales Mgr.: T. K. Norton; Adv. Dir.: Anthony J. Raef; Int'l Opns. Dir.: Richard A. Winsauer.  
Cartridge: (55 models) 38 8-tr. auto, 18 8-tr. home, 4 8-tr. portable.  
Brand names: Motorola, Stratoline.  
Note: Also manufacturer for Ford, Chrysler, American Motors, Volkswagen (Sapphire Brand), Volvo.  
Muntz Stereo-Pak Inc., 7715 Densmore Ave., Van Nuys, Calif. 91406. Tel: (213) 989-5000. Pres.: Earl W. Muntz; Sales Mgr.: James Muntz; Adv. Dir.: Tod Faulkner.  
Cartridge: (15 models) 8 auto-1 4-tr., 3 8-tr., 4 4&8-tr. compatible; 5 home-1 4-tr., 4 4&8-tr. compatible; 2 portable-1 4-tr., 1 4&8-tr. compatible. Price range: \$50-\$130.  
Cassette: (2 models) 1 auto, 1 portable. Price range: \$40-\$120.  
Brand names: Muntz Stereo, Audio/Stereo.  
NordMende (see Sterling Hi Fidelity Inc.).  
Norelco (see North American Philips Corp.).  
North American Foreign Trading Corp., 1115 Broadway, New York, N.Y. 10010. Tel: (212) 255-5400. Pres.: Maurice Lowinger; Mgr.: Angelo Lowinger.  
Cartridge: (4 models) 3 auto, 1 home. Price range: \$69-\$170.  
Brand name: North American.  
Cassette: (4 models) portable. Price range: \$39.95-\$79.95.  
Open reel: (3 models) 2-tr. portable. Price range: \$18.45-\$24.95.  
Brand names: North American, Unisonic.  
North American Philips Corp., 100 E. 42 St., New York, N.Y. 10017. Tel: (212) OX 7-3600. Sales Mgr.: C. F. Borgard; Adv. Dir.: Paul B. Nelson Jr.  
Cassette: (2 models) 1 auto, 1 portable. Price range: \$21.95-\$99.95.  
Brand name: Norelco.  
Nuvox Electronics Corp., 150 Fifth Ave., New York, N.Y. 10011. Tel: (212) 243-2110. Pres.: Edmond S. Sassoon; Sales Mgr.: Abraham Liniado.  
Cartridge: (6 models) 2 auto-1 8-tr., 1 4&8-tr. compatible; 3 8-tr. home; 1 8-tr. portable. Price range: \$39.95-\$149.95.  
Cassette: (2 models) portable. Price range: \$39.95-\$89.95.

Olympic Radio & TV Sales Corp., 2 Penn Plaza, New York, N.Y. 10001. Tel: (212) 564-5300. Pres.: Harry M. Kane; Sales Mgr.: Ralph M. Kaufman.  
Cartridge: (2 models) 8-tr. portable. Price range: \$109.95-\$139.95.  
Cassette: (2 models) home. Price range: \$99.95-\$239.95.  
Ortronics (see Faraday Inc.).  
Packard Bell (see Teledyne Packard Bell).  
Panasonic (see Matsushita Electric Corp. of America).  
Pax Ltd., 5125 Church St., Skokie, Ill. 60076. Tel: (312) 966-1690. Pres.: Harry Graw; Sales Mgr.: Lester Smith.  
Cassette: (9 models) 2 home, 7 portable. Price range: \$29.95-\$169.95.  
Brand name: Mercury.  
Peerless Telerad Inc., 37-15 61 St., Woodside, N.Y. 11377. Tel: (212) 779-1515. Pres.: Harry Dver; Sales Mgr.: Jimmie Weiss.  
Cartridge: (7 models) 3 8-tr. auto, 3 8-tr. home, 1 8-tr. portable. Price range: \$49.95-\$199.95.  
Brand name: Peerless.  
Cassette: (3 models) portable. Price range: \$49.95-\$99.95.  
Brand names: Peerless, Telerad.  
Pfanstiehl, 3300 Washington St., Waukegan, Ill. 60085. Tel: (312) 623-1360. Pres.: R. Bruce Wight; Sales Mgr.: C. A. Clinton.  
Cassette: (1 model) home. Price: \$59.50.  
Philco-Ford Corp., "C" & Tioga St., Philadelphia, Pa. 19134. Tel: (215) 443-5008. Sales Mgr.: R. A. Houtz.  
Cartridge: (2 models) 8-tr. portable. Price range: \$79.95-\$89.95.  
Cassette: (10 models) portable. Price range: \$19.95-\$179.95.  
Open reel: (3 models) 2 4-tr. home, 1 4-tr. portable. Price range: \$109.95-\$349.95.  
Phonola (see Waters Conley Co. Inc.).  
Pianola (see California Auto Radio).  
PlayTape Inc., 1115 Broadway, New York, N.Y. 10010. Tel: (212) OR 5-8050. Pres.: Frank Stanton.  
Qatron Corp., 12000 Old Georgetown Rd., Rockville, Md. 20852. Tel: (301) 881-1810. Pres.: Daniel A. Honig.  
Cartridge: (2 models) 1 8-tr. auto, 1 8-tr. home. Price: \$289.95.  
R C A Sales Corp., 600 N. Sherman Dr., Indianapolis, Ind. 46201. Tel: (317) 635-9000. Exec. VP: Barton Kreuzer; Exec. VP & Sales Opns.: R. J. O'Neil; VP Adv. Servs.: J. R. Andersen.  
Cartridge: (4 models) 2 8-tr. home, 2 8-tr. portable. Price range: \$40.00-\$100.00.  
Cassette: (7 models) portable. Price range: \$30.00-\$130.00.  
Open reel: (6 models) 4-tr. portable. Price range: \$20.00-\$250.00.  
R S C/Telex (see Royal Sound Co. Inc.).  
Radiant Corp., 8220 N. Austin Ave., Morton Grove, Ill. 60053. Tel: (312) YO 6-4200. Mktg. Dir.: Ed Wiebe; Sales Mgr.: George Arnold.  
Cassette: (3 models) portable. Price range: \$94.50-\$109.50.  
Radio Shack (see York Radio Corp.).  
Ranger (see Tenna Corp.).  
Rangertone Electronics Corp. (professional playback equip. only), see Tape Supplies section—Manufacturers of Tape Duplicating Equip.  
Realtone (see Soundesign).  
Rhapsody (see B&B Import-Export Co.).  
Roberts (div. of Rheem Mfg. Co.), 5922 Bowcroft St., Los Angeles, Calif. 90016. Tel: (213) 870-9631. VP & Gen. Mgr.: C. E. Phillips; Nat'l Sales Mgr.: Larry Winn; Adv. Dir.: Geri Langsner.  
Cartridge: (6 models) 2 8-tr. auto, 4 8-tr. home. Price range: \$59.95-\$429.95.  
Cassette: (12 models) 3 auto, 5 home, 4 portable. Price range: \$99.95-\$299.95.  
Open reel: (17 models) 4 4-tr. home, 13 4-tr. portable. Price range: \$199.95-\$699.95.  
Robette (see Haskel Howard).  
Ross Electronics Corp., 2834 S. Lock St., Chicago, Ill. 60608. Tel: (312) 376-9660. Pres.: A. R. Bernard; Sales Mgr.: Bernard Leavitt; Adv. Dir.: Samuel Levin.  
Cartridge: (6 models) 2 8-tr. home, 4 8-tr. portable. Price range: \$45.95-\$164.95.  
Cassette: (11 models) 2 home, 9 portable. Price range: \$44.95-\$199.95.  
Open reel: (1 model) 2-tr. portable. Price: \$17.95.  
Royal Sound Co. Inc., 409 N. Main St., Freeport, L.I., N.Y. 11520. Tel: (516) 868-2880. Pres.: M. A. Dayan; Sales Mgr.: N. Greenberg; Adv. Dir.: J. E. Corbin.  
Cartridge: (6 models) 2 auto-1 4-tr., 1 8-tr.; 4 8-tr. home.  
Brand name: RSC/Telex.  
Open reel: (8 models) 4-tr. home.  
Brand names: American, Dokorder.  
Note: Product available for overseas customers only.  
Safetech, 15515 Minnesota Ave., Paramount, Calif. 90723. Tel: (213) 636-9338. Pres.: Fred Plotkin; Sales Mgr.: Jack Goldner.  
Cartridge: (3 models) 8-tr. portable. Price range: \$100-\$170.  
Cassette: (4 models) portable. Price range: \$140-\$220.  
Brand name: Soundtech.  
Saint Moritz (see Manhattan Novelty Corp.).  
Scully Rec'g Instruments Co. (professional playback equip. only), see Tape Supplies section—Manufacturers of Tape Duplicating Equip.  
Sears (see Faraday Inc.).

continued on page 38

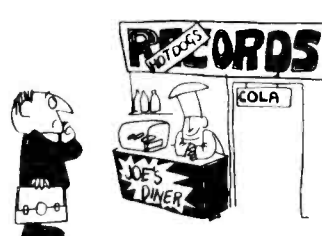

**BEEN SOME  
CHANGES MADE!**

Buyer's Guide keeps everybody  
right up to date. . . .



In the big,  
booming, blossoming  
world of 8 track stereo...

# MOTOROLA<sup>®</sup>

is a world leader!

## The world of 8 track for 1970 is big!

- It's a \$400,000,000 market in players and accessories.
- It's worth \$425,000,000 in 8 track cartridges.
- It will account for 3,300,000 units.
- Detroit auto manufacturers use 8 track stereo exclusively, and Motorola is their largest independent supplier of 8 track units.
- It's world wide. Already the biggest seller in Norway. Coming on strong in Italy, France, West Germany, England, Japan.

## The world of 8 track is booming!

- 8 track stereo cartridge sales alone will soon reach an annual rate of a half billion dollars.

## The world of 8 track is blossoming!

- In America alone there's a virtually untapped market of 95,000,000 cars without 8 track units.
- It's highly youth oriented. The people who are buying 8 track fastest are under 27 years old... and that's over half the population.

## Motorola is a leader in the world of 8 track stereo sound!

**we're building new 8 track production facilities expanding our product line designing new 8 track players**  
... players with such outstanding features as record, fast forward and complete pre-selection of cartridge track and music number.

**the industry is planning creative new programing in 8 track tapes**  
... programing which will include foreign languages, children's stories, briefings for salesmen and doctors, audio digests of current events, points of interest for tourists as they drive along scenic or historical highways, and countless others.

**MOTOROLA**  
is out to stay a leader in  
the world of 8 track stereo...

Want to join us?

For more information on Motorola 8 Track Stereo,  
Write: DEPT. AC-9, Motorola Inc., 9401 W. Grand Avenue,  
Franklin Park, Illinois 60131

# TAPE PLAYBACK EQUIPMENT MANUFACTURERS & IMPORTERS

Continued from page 36

Selectron Int'l Co. Inc., 4215 W. 45 St., Chicago, Ill. 60632. Tel: (312) 254-7900. Pres.: Nicholas Milovac; Sales Mgr.: Jack Mikulski; Mktg. Dir.: Jerold R. Peterson.  
**Cartridge** (1 model) 4&8-tr. compatible auto. Price: \$159.95.  
**Cassette**: (37 models) 7 auto, 16 home, 14 portable. Price: \$19.95 and up.  
**Open reel**: (34 models) 20 home—12 2-tr., 4 4-tr., 4 2&4-tr.; 14 portable—12 2-tr., 2 4-tr. Price: \$11.95 and up.  
**Brand names**: Aiwa/Selectron.  
 Sharp Electronics Corp., 178 Commerce Rd., Carlstadt, N.J. 07072. Tel: (201) 933-4200. Exec. VP: K. Saitoh; Sales Mgr.: Gene Gold; Adv. Dir.: R. Cooperman.  
**Cassette**: (6 models) 1 home, 5 portable. Price range: \$39.95—\$89.95.  
**Open reel**: (5 models) 3 4-tr. home, 2 2-tr. portable. Price range: \$34.95—\$299.50.  
 Slimline (see Harman-Kardon Inc.).  
 Sony/Superscope (see Superscope Inc.).  
 Soundesign Corp., 34 Exchange Pl., Jersey City, N.J. 07302. Tel: (201) 434-1050. Sales Mgr.: Harry Franco.  
**Cartridge**: (6 models) 8-tr. home. Price range: \$49.95—\$149.95.  
**Brand name**: Soundesign.  
**Cassette**: (6 models) portable. Price range: \$29.95—\$89.95.  
**Brand names**: Soundesign, Realtone.  
 Soundtech (see Safetech).  
 Standard Radio Corp., 60-09 39 Ave., Woodside, N.Y. 11377. Tel: (212) 651-6100. Pres.: H. Miyazawa; Sales Mgr.: Melvin J. Kaplan.  
**Cartridge**: (1 model) 8-tr. home. Price: \$79.95.  
**Cassette**: (3 models) portable. Price range: \$34.95—\$89.95.  
 Stereo Magic (div. of Eastern Specialties Corp.), 169 Rt. 46, Dover, N.J. 07801. Tel: (201) 361-7990. Pres.: Robert F. Kenny; Sales Mgr.: R. Kramer; Adv. Dir.: John Cullen.  
**Cartridge**: (11 models) 5 auto—4 8-tr., 1 4&8-tr. compatible; 5 8-tr. home; 1 8-tr. portable. Price range: \$29.95—\$179.95.  
**Cassette**: (4 models) 2 auto, 1 home, 1 portable. Price range: \$29.95—\$99.95.  
 Stereosonic (see Arthur Fulmer).

Sterling Hi Fidelity Inc., 22-20 40 Ave., Long Island City, N.Y. 11101. Tel: (212) EM 1-8989. Pres.: L. Silver; Sales Mgr. & Adv. Dir.: R. Silver.  
**Cartridge**: (3 models) 8-tr. home. Price range: \$89.95—\$149.95.  
**Brand name**: NordMende.  
**Cassette**: (4 models) 2 home, 2 portable. Price range: \$39.95—\$149.95.  
**Brand names**: NordMende, AGS.  
**Open reel**: (1 model) 4-tr. home. Price: \$429.95.  
**Brand name**: NordMende.  
 Stratoline (see Motorola Automotiva Prods. Inc.).  
 Superscope Inc., 8150 Vineland Ave., Sun Valley, Calif. 91352. Tel: (213) 767-9750. Pres.: Joseph Tushinsky; Sales Mgr.: Paul Markoff.  
**Cartridge**: (1 model) 8-tr. home. Price: \$135.  
**Cassette**: (12 models) 1 auto, 2 home, 9 portable. Price range: \$49.50—\$199.50.  
**Open reel**: (25 models) 19 home—4 2-tr., 15 4-tr.; 6 portable—5 2-tr., 1 4-tr. Price range: \$49.50—\$99.5.  
**Brand name**: Sony/Superscope.  
 Sylvania Electric Prods. Inc., 700 Ellicott St., Batavia, N.Y. 14020. Tel: (716) 343-3470. Sr. VP & Gen. Mgr.: Thomas H. Cashin; Sales Mgr.: G. Lee Thompson; Adv. Dir.: William R. Dixon.  
**Cassette**: (2 models) portable. Price range: \$49.95—\$69.95.  
 Symphonic Radio & Electronic Corp., foot of John St., Lowell, Mass. 08152. Tel: (617) 454-7871; NYC Tel: (212) 889-6800. Pres.: J. J. Baughan; Sales Mgr.: P. J. Morahan; Mktg. Servs. Mgr.: Ronald Dennis.  
**Note**: 1970 line in advance planning stages and will include a full line of cartridge 8-tr. and several cassette models.  
 T E A C Corp. of America, 2000 Colorado Ave., Santa Monica, Calif. 90404. Tel: (213) 394-0240. Pres.: T. Tani; Sales Mgr. & Adv. Dir.: Mikio Matsubayashi.  
**Cartridge**: (1 model) portable. Price: \$139.50.  
**Open reel**: (7 models). Price range: \$299.50—\$849.50.  
 Tandberg of America Inc., 8 Third Ave., Pelham, N.Y. 10803. Tel: (914) PE 8-0772. Pres.: Kjell Ekornhoel; VP & Sales Mgr.: Robert J. Bowman Jr.  
**Open reel**: (20 models) portable 2-tr., 4-tr. & full-tr. Price range: \$250—\$499.  
 Teledyne Packard Bell, 12333 W. Olympic Blvd., Los Angeles, Calif. 90064. Tel: (213) 272-6141. Pres.: Robert S. Goodell; VP & Mktg. Dir.: William J. Horn; Adv. Dir.: William T. Reedy.  
**Cartridge**: (2 models) 8-tr. home. Price range: \$59.95—\$69.95.  
**Cassette**: (1 model) home. Price: \$99.95.

Telefunken-Magnetophon, (professional playback equip. only), see Tape Supplies section—Manufacturers of Tape Duplicating Equip.: Sonic Arts Corp.  
 Telefunken Sales Corp., South St., Roosevelt Field, Garden City, N.Y. 11530. Tel: (516) 741-1390. Sec'y Treas.: A Reichenberg; Sales Mgr.: Mort Tillman.  
**Cassette**: (3 models) 1 home, 2 portable. Price range: \$69.95—\$399.95.  
**Open reel**: (13 models) 11 home—5 4-tr., 6 2&4-tr.; 2 portable—1 2-tr., 1 4-tr. Price range: \$199.95—\$349.95.  
 Telex (see Waters Conley Co. Inc.).  
 Telex Communications Div., 9600 Aldrich Ave. S., Minneapolis, Minn. 55420. Tel: (612) 884-4051. Pres.: Ansel Kleiman; Sales Mgr.: Russ Molloy; Adv. Dir.: Peter Schwarz.  
**Cartridge**: (5 models) 8-tr. home. Price range: \$89.95—\$169.95.  
**Brand names**: Telex, Viking.  
**Open reel**: (5 models) 4 4-tr. home, 1 4-channel stereo. Price range: \$124.95—\$1544.  
**Brand name**: Viking.  
 Tenna Corp., 19201 Cranwood Pkwy., Cleveland, Ohio 44128. Tel: (216) 475-1400. Pres.: Harvey Ludwig; VP Sales: Stan Goss; Adv. Dir.: Donald Slack.  
**Cartridge**: (15 models) auto—2 4-tr., 8 8-tr., 5 4&8-tr. compatible. Price range: \$49.95—\$199.95.  
**Cassette**: (3 models) auto. Price range: \$99.95—\$149.95.  
**Brand names**: Tenna, Ranger.  
 3 M Co., Mincom Div., 3M Center, St. Paul, Minn. 55101. Tel: (612) 733-1110. Pres.: Harry Heltzer; Sales Mgr.: R. J. Brown; Adv. Dir.: J. Andrews.  
**Cassette**: (6 models) 1 home, 5 portable. Price range: \$49.95—\$239.95.  
**Open reel**: (12 models) 11 home—2 2-tr., 9 4-tr.; 1 2-tr. portable. Price range: \$89.95—\$659.95.  
**Brand name**: Wollensak.  
 Topp Electronics Inc., 4201 NW 77 Ave., Miami, Fla. 33166. Tel: (305) 887-6201. Pres.: Louis Topp; Sales Mgr.: Charles Kates; Adv. Dir.: Selwyn Kent.  
**Cartridge**: (4 models) 3 8-tr. home, 1 8-tr. portable. Price range: \$99.95—\$229.95.  
**Cassette**: (8 models) portable. Price range: \$32.95—\$89.95.  
**Open reel**: (3 models) 2-tr. portable. Price range: \$14.95—\$21.95.  
**Brand name**: Juliette.  
 Toshiba America Inc., 477 Madison Ave., New York, N.Y. 10022. Tel: (212) 758-6161. Pres.: Tony Sugisaki; Sales Mgr.: Bernie Mitchell; Adv. Dir.: E. Rittenband.  
**Cartridge**: (2 models) 1 8-tr. auto, 1 8-tr. home. Price range: \$99.95—\$249.95.  
**Cassette**: (5 models) 1 home, 4 portable. Price range: \$49.95—\$199.95.  
**Open reel**: (4 models) home—1 2-tr., 3 4-tr. Price range: \$119.50—\$279.95.  
 TransWorld (see Electronic Inds.).  
 Uher (see Martel Electronics Sales Inc.).  
 Unisonic (see North American Foreign Trading Corp.).  
 Universal Sound (see Bandachrome).  
 V-M Corp., PO Box 659 Benton Harbor, Mich. 49111. Tel: (616) 925-8841. Pres.: Victor Miller; Adv. Dir.: Ken Markel.  
**Cassette**: (4 models) portable. Price range: \$29.95—\$99.95.  
**Open reel**: (7 models) portable—2 2-tr., 5 4-tr. Price range: \$69.95—\$399.95.  
**Brand name**: Voice of Music.  
 Viking (see Telex Communications Div.).  
 Viscount (see Consolidated Mdsq. Co.).  
 Voice of Music (see V-M Corp.).  
 Waters Conley Co. Inc., 645 N. Michigan Ave., Chicago, Ill. 60611. Tel: (312) 944-5125. Pres.: H. M. Greenspon; Sales Mgr.: E. Boba.  
**Cartridge**: (1 model) 8-tr. portable. Price: \$69.95.  
**Cassette**: (3 models) portable. Price range: \$21.95—\$59.95.  
**Open reel**: (1 model) 4-tr. home. Price: \$279.95.  
**Brand name**: Telex-Phonola.  
 Webcor (see Consolidated Mdsq. Corp.).  
 Western Auto (see York Radio Corp.).  
 Westinghouse Electric Corp., Rt. 27 & Vineyard Rd., Edison, N.J. 08817. Tel: (201) 287-2000. Sales Mgr.: Charles N. Daigneault; Adv. Dir.: Ed Gezzik.  
**Cassette**: (6 models) 1 home, 5 portable. Price range: \$26.95—\$189.95.  
**Open reel**: (1 model) 4-tr. portable. Price: \$219.95.  
 White Motors (see Faraday Inc.).  
 Whites (see York Radio Corp.).  
 Wollensak (see 3M Co.).  
 York Radio Corp., 15 Empire Blvd., South Hackensack, N.J. 07606. Tel: (201) 488-7400. Pres.: Morris J. Feldman; Sales Mgr.: Harris Bryant; Adv. Dir.: Jack Olney.  
**Cassette**: (9 models) portable. Price range: \$27.95—\$109.50.  
**Brand names**: Aimcee, Kapner, Lafayette, Macys, Mays, Radio Shack, Western Auto, Whites.  
 Zenith Radio Corp., 1900 N. Austin Ave., Chicago, Ill. 60639. Tel: (312) 745-2000. Pres.: Sam Kaplan; Sales Mgr.: J. D. Dougherty; Adv. Dir.: Gordon Hurt.  
**Cassette**: (8 models) 4 home, 4 portable. Price range: \$19.95—\$129.95.



## HUNTING FOR THAT HARD-TO-FIND INFORMATION?

BUYER'S GUIDE makes it easy-to-find for everyone.

# Tape Power

"The Heavyweights" now available  
on stereo 8-track cartridges  
and cassettes

Call your local Paramount Record Distributor now for immediate stock.



"Memphis, Tennessee"  
Charles Musselwhite

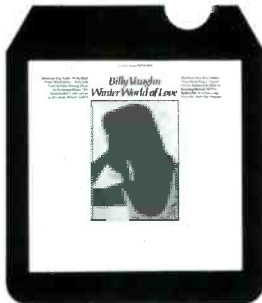

"Winter World of Love"  
Billy Vaughn



"The Other Side of Roy Clark"  
Roy Clark



"If It's So/Let It Be"  
The Illusion

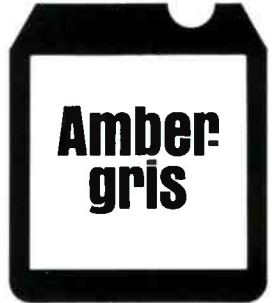

"Ambergris"  
Ambergris



"Paint Your Wagon"  
Soundtrack

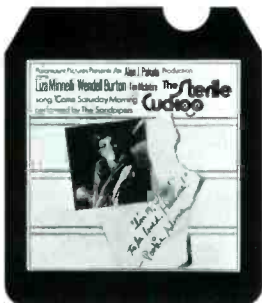

"The Sterile Cuckoo"  
Soundtrack



"Coco"  
Original Broadway Cast



"The Molly Maguires"  
Soundtrack



"The Adventurers"  
Soundtrack



# TAPE WHOLESALERS

DISTRIBUTORS

ONE STOPS

RACK JOBBERS

IMPORTERS/EXPORTERS

The wholesale function(s) of all companies is set in **bold face** and parenthesis after each listing. The following abbreviations identify these functions. (D) Distributor; (OS) One Stop; (RJ) Rack Jobber; (I) Importer; (E) Exporter.

The identification of a branch or home office is indicated only when it differs from that of the listing.

## ALABAMA

### ● ATTALLA (Area Code 205)

Reliable Recs. & Tape Co. Inc., Rt. 3. Zip: 35954. Tel: 538-6043. Owner & Buyer: C. R. O'Neal. (RJ).

### ● BIRMINGHAM (Area Code 205)

Alabama Auto Parts Co., 514 S. 18 St. Zip: 35233. Tel: 322-7601. Pres.: Terry Siegal; Mgr.: Howard Edge. (D).  
Branch: Cullman, Ala.  
Cartridge 8-tr.: All lines.

Angel Tape Dist. Co., 3003 Sixth Ave. S. Zip: 35233. Tel: 328-2548. Owner & Buyer: Robert H. Angel; Mgr.: David Ivey. (D, OS & RJ).  
Cartridge 8-tr.: ABC, Ampex, Atco, Atlantic, Capitol, Columbia, Decca, Dooto, GRT, Gordy, Gross, Heart Warming, ITCC, Jubilee, Kapp, Liberty, MGM, Mercury, Motown, NAL, Philips, RCA, Reprise, SOF, Scepter, Smash, Soul, Tamla, United Artists, Warner Bros.-Seven Arts.  
Cassette: Ampex, Atco, Atlantic, Capitol, Columbia, Decca, Dooto, GRT, Gordy, Heart Warming, ITCC, Jubilee, Kapp, Liberty, MGM, Mercury, Motown, NAL, Philips, RCA, Reprise, SOF, Scepter, Smash, Soul, Tamla, United Artists, Warner Bros.-Seven Arts.  
Playback equip.: Craig.  
Accessories: Le-Bo.

Music Centeg Rec. Dist., 1400 Second Ave. N. Zip: 35204. Tel: 251-8252. Mgr. & Buyer: Virgil Lugar. (OS).

Nel-Bran (div. of Nelson-Brantley Glass Co. Inc.), 300 S. 22 St. Zip: 35205. Tel: 328-4310. Pres.: Larry D. Striplin Jr.; Mgr.: Travis T. Lackey; Buyer: Miss Jan Catanzano. (D).  
Branches: Fayette, Florence, Mobile, Montgomery, Ala.

Cartridge 8-tr.: A&M, Ampex, Capitol, Columbia, Decca, GRT, Heart Warming, ITCC, Jubilee, Mercury, Motown, NAL, RCA, Skylite, Warner Bros.-Seven Arts, Word.  
Cassette: Sub-dist. for Ampex, Capitol, Columbia, Decca, GRT, ITCC, Mercury, Motown, NAL, RCA, Warner Bros.-Seven Arts.  
Playback equip.: Capitol, Hitachi, Kraco, Lear Jet, Muntz, Sharp; sub-dist. for Ampex, Bell & Howell.

Accessories: Caddies (Amberg, RCA, Recoton); head cleaners (RCA); Tape Carrier.  
Victory Rec. Serv., 1608 First Ave. N. Zip: 35204. Tel: 324-9505. Owner & Mgr.: Morris S. Corona. (OS & RJ).

### ● CULLMAN (Area Code 205)

Alabama Auto Parts Co., 900 Second Ave. W. Zip: 35055. Mgr. & Buyer: Verley Calvert. (D).  
Home office: Birmingham, Ala.  
Cartridge 8-tr.: All lines.

### ● FAYETTE (Area Code 205)

Nel-Bran (div. of Nelson-Brantley Glass Co. Inc.). Zip: 35555. Tel: 932-6755. Mgr.: Charles Cummings. (D).  
Home office: Birmingham, Ala. (see for prod. distributed).

### ● FLORENCE (Area Code 205)

Nel-Bran (div. of Nelson-Brantley Glass Co. Inc.). 201 Eugenia St. Zip: 35630. Tel: 764-0784. Mgr.: Paul Risner. (D).  
Home office: Birmingham, Ala. (see for prod. distributed).

### ● MOBILE (Area Code 205)

Music City Rec. Serv. Inc., 4008 Dauphin Island Pkwy. Zip: 36605. Tel: 471-2437. Mgr. & Buyer: Raeford Booth. (RJ).

Nel-Bran (div. of Nelson-Brantley Glass Co. Inc.), 403 St. Louis St. Zip: 36602. Tel: 433-2556. Mgr.: Jerry Phillips. (D).  
Home office: Birmingham, Ala. (see for prod. distributed).

### ● MONTGOMERY (Area Code 205)

Nel-Bran (div. of Nelson-Brantley Glass Co. Inc.), 750 W. Fairview Ave. Zip: 36105. Tel: 269-4337. Mgr.: Joe Pouncey. (D).  
Home office: Birmingham, Ala. (see for prod. distributed).

## ARIZONA

### ● PHOENIX (Area Code 602)

A R C Inc., 2029 N. Black Canyon Hwy. Zip: 85009. Tel: 252-4013. Buyer: M. Grover. (D).

Cartridge 8-tr. & cassette: A&M, Atco, Atlantic, Crewe, Dooto, Elektra, King, Monument, Musicor.

All Label Rec. Serv., 704 E. Weldon St. Zip: 85014. Tel: 279-3154. Mgr. & Buyer: Jim Robinett. (D & RJ).

Home office: Cleveland, Ohio.  
Arizona Western Supply Div., 2950 N. 30 Ave. Zip: 85017. Tel: 272-1383. Owner: George Souvall; Mgr.: John Youmans; Buyer: E.R. Simonds. (D & RJ).

Cartridge 4-tr., 8-tr., cassette & open reel: All lines.  
Playback equip.: Lear Jet.  
Accessories: Amberg, Le-Bo.

Associated Dist. Inc., 3803 N. 36 Ave. Zip: 85019. Tel: 278-5584. Mgr.: Leonard M. Singer; Buyer: Angela C. Singer. (D, OS & RJ).

Cartridge 8-tr.: Ampex, Capitol, Caytronics, Columbia, DGG, Decca, Del Valle, Dooto, Double Shot, Enterprise, Fiesta, GRT, Gordy, Gross, Heart Warming, Hob, Jubilee, Kapp, Laff, Liberty, Mercury, Modern, Modiner, Motown, Musart, Original Sound, Paramount, Pickwick, Polydor, RCA, Rare Earth, Scepter, Soul, Stax, Tamla, United Artists, Volt, Whittier, Word.  
Cartridge 4-tr.: Ampex, Caytronics, Decca, Del Valle, Dooto, Double Shot, GRT, Liberty, Modern, Modiner, Muntz, Musart, Original Sound, Pickwick, United Artists, Whittier.

Cassette: Ampex, Capitol, Caytronics, Columbia, DGG, Decca, Del Valle, Dooto, Double Shot, Enterprise, Fiesta, GRT, Gordy, Gross, Heart Warming, Hob, Jubilee, Kapp, Laff, Liberty, Mercury, Modiner, Motown, Musart, Original Sound, Paramount, Pickwick, Polydor, RCA, Rare Earth, Scepter, Soul, Stax, Tamla, United Artists, Whittier, Word.  
Playback equip.: Belair, Norelco, Panasonic.  
Accessories: Amberg, Le-Bo.

Endisco Inc., 2943 W. Fairmount Ave. Zip: 85017. Tel: 264-5835. Owner & Mgr.: Bob Cowen; Buyer: Ralph E. Goshorn. (D).

Cartridge 8-tr. & cassette: Reprise, Straight, Warner Bros.-Seven Arts.

Transcontinental Music Corp., 3036 N. 30 Ave. Zip: 85017. Tel: 272-9343. Mgr.: Jack Sharpe. (RJ).  
Home office: New York, N.Y., Transcontinental Investing Corp.

## ARKANSAS

### ● LITTLE ROCK (Area Code 501)

Bill Fisher Auto Air Conditioning Inc., 2905 Cantrell Rd. Zip: 72202. Tel: 664-0275. Pres.: W.S. Fisher Jr.; Mgr. & Buyer: W.S. Fisher III. (D, OS & RJ).

Cartridge 8-tr. & cassette: All lines.  
Playback equip.: Lear Jet, Norelco.  
Accessories: Blank loaded tape, storage cases, various accessories (Athena, Lear Jet, Le-Bo, Norelco).

Siebert News Agency Inc., 6301 Forbing Rd. Zip: 72209. Tel: LO 5-5521. Owner: Sieg Siebert; Mgr.: John Young; Buyer: Jackie Pate. (D & RJ).  
Cartridge 8-tr. & cassette: All lines.  
Playback equip.: Automatic Radio, Mayfair.  
Accessories: Le-Bo.

*continued on page 42*



# UHD

ULTRA HIGH DENSITY GAMMA-ORIENTED MAGNETIC RECORDING TAPE



**BELL & HOWELL**

600 FEET OF 1/4" ± 1.5 MIL ACETATE, ULTRA HIGH DENSITY AUDIO RECORDING TAPE ON 5-INCH REEL.

The front  
of our new  
reel-to-reel  
and cassette  
recording  
tape makes  
a big promise.

The back  
backs it up.

## The technology and characteristics of UHD Gamma-Oriented recording tape

### WHAT IS UHD?

UHD (Ultra High Density) fulfills the need for a high performance magnetic recording tape to match the high performance of today's and tomorrow's "state-of-the-art" high-fidelity audio systems. It is the result of a unique gamma ferric oxide coating process developed by the research laboratories of Bell & Howell. Advanced technology had led to the ability to deliver an ultra-high-density (UHD) of ferric oxide particles—every one encapsulated within an ultra-thin insulating shield—to each square centimeter of tape—more dense than in any conventional audio tape.



UHD TAPE CONVENTIONAL TAPE  
WHAT IS GAMMA ORIENTATION?

Once the super-fine ferric oxide particles have been applied to the tape base, a critical gamma orientation process is executed under exacting conditions to precisely align each particle in the same direction. This vital step assures maximum consistency and density; and, therefore, makes certain that UHD tape will demonstrate "hotter" and more consistent signal characteristics in both recording and playback.

A less dense, less precisely-oriented tape leaves oxide "holes" in the coating—and in your recordings as well. The illustration below shows how UHD compares with conventional tape.



GAMMA ORIENTED TAPE CONVENTIONAL TAPE  
WHAT CAN UHD DO FOR YOU?

The combination of ultra-high-density and gamma orientation give UHD the characteristics you need to create the finest-quality recordings. UHD delivers higher output, extended frequency response (see chart), broader dynamic range, and a better signal-

to-noise ratio than has ever been possible with conventional recording tape. Furthermore, it produces a "hotter" signal, permitting you to avoid distortion by recording at lower input levels. The dense, gamma-oriented particles assure that recordings made at 3 1/2 ips will sound as good as those made at 7 1/2 ips on conventional tape.

Every reel of UHD recording tape is supplied with color-coded leader and trailer. It also has an all new, integral lifetime lubricant that increases tape life and reduces head wear.

Because of the advanced formulation and coating techniques, UHD performs superbly on all tape recorders, regardless of factory bias setting.

Welcome, therefore, to UHD gamma-oriented magnetic recording tape. Made possible by the advanced technology of the audio laboratories of Bell & Howell.

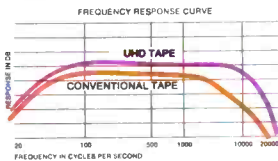

	RECORDING TIME (EACH TRACK)			
	1 1/2 IPS	1 1/4 IPS	3/4 IPS	7 1/2 IPS
800'	120 MIN.	80 MIN.	30 MIN.	15 MIN.
900'	180 MIN.	80 MIN.	45 MIN.	22 1/2 MIN.
1200'	240 MIN.	120 MIN.	60 MIN.	30 MIN.
1800'	360 MIN.	180 MIN.	90 MIN.	45 MIN.
2400'	480 MIN.	240 MIN.	120 MIN.	60 MIN.
3600'	720 MIN.	360 MIN.	180 MIN.	90 MIN.

**BELL & HOWELL**

**WARRANTY:** This tape is warranted only to the extent of the description on the box. If defective, Bell & Howell will replace it. Except for such replacement, tape is sold without liability, including liability for either direct or consequential damages.

For you: in-store displays, promotional materials and an attractive buy-in program. For full details on our tapes, reel-to-reel player/recorders and decks, compact cassette systems, stereo cassette player/recorders and decks, and portable monaural cassette player/recorders, call this toll-free number: 800-323-7657. Consumer Electronics Division, Bell & Howell.



## DISTRIBUTORS

Continued from page 40

## CALIFORNIA

### • BAKERSFIELD (Area Code 805)

Bakersfield Music Ents., 1223 N. Chester. Zip: 93308. Tel: 399-1674. Gen. Mgr.: Al Wilson; Sales Mgr.: L. D. Wilson. (D).  
Cartridge 8-tr.: Heart Warming, Sing, Skylite. Cassette: Heart Warming.

### • CAMPBELL (Area Code 408)

Curto's Auto Stereo, 2228 S. Bascom Ave. Zip: 95008. Tel: 371-1476. Owner & Mgr.: Gary P. Curto; Buyer: Donna Curto. (D & OS).  
Cartridge 4-tr. & 8-tr.: Muntz.  
Playback equip.: Automatic Radio, Car Tapes, Muntz.  
Accessories: Cases (Recoton).

### • DANVILLE (Area Code 415)

M & M Recs. (div. of Vertair Corp.), 295 N. Hartz Ave. Zip: 94526. Tel: 837-6922. Mgr. & Buyer: Gordon C. George. (RJ).

### • HERLONG (Area Code 916)

M B Rec. Corral, Post Restaurant Bldg. Zip: 96113. (RJ).  
Home office: Reno, Nev.

### • LOS ANGELES METROPOLITAN AREA (Area Code 213)

A B C Rec. & Tape Sales Corp., 3334 La Cienega Pl. Zip: 90016. Tel: 870-8711. Mgr.: Norman Larson. (OS & RJ).  
Home office: Seattle, Wash.

Atlas-Rand Corp., 1011 Chestnut St., Burbank 91502. Tel: 845-2401. VP Sales: Phil Klaffer. (D).

Home office: See New York, N.Y.  
Cartridge 8-tr., cassette & open reel: Sentry & all major lines.  
Playback equip.: Keystone.

Bertel Dist'g Co. Inc., 523 Victoria Ave., Venice 90291. Tel: 392-4844. Mgr. & Buyer: Rod Wilson. (RJ).

California Music Co., 2933 W. Pico Blvd. Zip: 90006. Tel: 733-1181. Owner: Sam Ricklin; Mgr.: Buddy Robinson. (OS & E).

Capitol Recs. Dist'g Corp., 3117 San Fernando Rd. Zip: 90065. Tel: 257-8224. (D).

Cartridge 8-tr. & cassette: Capitol, Angel, Melodiya/Angel, Apple, Harvest, Fame.

Playback equip.: Capitol.

Accessories: Display racks, storage cases (Capitol).

Car Tapes Inc., 16725 Roscoe Blvd., Van Nuys 91406. Tel: 894-8368. Mgr.: Gene J. Becker. (D, RJ & I).

Home office: Chicago, Ill. (see for prod. distributed).

Celebrity Concert Corp., 315 S. Beverly Dr., Beverly Hills 90212. Tel: 273-3330. Bd. Chm.: Sidney Justin; Pres.: Bernard Lubber. (I).

Imports: Tape prod. from USSR.

Certron Corp. Music Div., 2437 W. Pico Blvd. Zip: 90006. Tel: 380-1711. Mgr.: Ray Shevin. (D, OS & RJ).

Home office: Nashville, Tenn.

Cartridge 8-tr. & cassette: Certron, Vivid Sounds, Vivid Country Sounds, Ampex; Mexican prod. on Bego, Bernal, Buena Suerte, Columbia, Disco Grande, El Zarape, Falcon, Impacto, Keyloc, Marsol, Musart, Norteno, Orfeon, Peerless, RCA, Sunglow, VLV.

Accessories: Blank loaded tape (Certron).

Chapman Dist'g Co., 2645 W. Pico Blvd. Zip: 90006. Tel: 385-3636. Owner, Mgr. & Buyer: Al Chapman. (D).

Cartridge 8-tr. & cassette: Adell, Ambassador, Canaan, Country Dew, Heart Warming, Light, Monitor, Sacred, Swampfire, Word; religious prod. of Capitol, Columbia, RCA.

Columbia Recs. Sales, 6430 Sunset Blvd., Hollywood 90028. Tel: 466-2481. Sales Mgr.: Bob Murphy; Audio Sales Mgr.: Charles Ross. (D).

Cartridge 8-tr.: Columbia, Date, Epic, Okeh, Ode, Barnaby, Fillmore, Blue Horizon.

Cartridge 4-tr.: Columbia, Date, Epic, Okeh, Ode, Blue Horizon.

Cassette: Same as 8-tr.

Open reel: Same as 4-tr.

Playback equip.: Masterwork.

Accessories: Blank loaded tape, storage cases (Columbia).

Decca Dist. Corp., 6750 Santa Monica Blvd. Zip: 90038. Tel: HO 3-7126. Mgr.: Mario De Filippo. (D).

Cartridge 8-tr.: Decca, Coral, Brunswick, Bravo, Viva, Berlitz, Colonial, Standard Phono.

Cassette: Decca, Coral, Brunswick, Bravo, Viva.

Open reel: Decca, Coral, Brunswick.

Playback equip.: Decca.

Accessories: Blank loaded tape, head cleaners, storage cases (Decca).

Fermata Int'l Melodies Inc., 6290 Sunset Blvd., Hollywood 90028. Tel: 462-7473. Mgr.: Mrs. D. Frenkiel. (I).

Cartridge 4-tr.: Producoes Fermata, Discos Premier, RGE, Som/Maior (Brazil).

G & G Recs. Dist's., 2360 W. Pico Blvd. Zip: 90006. Tel: 385-2151. Owner & Mgr.: Jose Garcia. (OS).

Garbell Rec. Rack Inc., 13400 Saticoy St., North Hollywood 91605. Tel: 785-9777. (RJ).

Branch: Nationwide Rec. & Tape Dist's.

H G W Inc., 5066 W. Jefferson Blvd. Zip: 90016. Tel: 836-2722. Mgr.: Warren Gray. (E).

Branch: Houston, Tex.

Exports: Pre-recorded tape.

Handelman Co., 1550 N. Knowles Ave. Zip: 90063. Tel: 261-0268. Mgr.: Leland Davis. (RJ).

Home office: Detroit, Mich.

John's Music, 11020 S. Main St. Zip: 90061. Tel: 755-1165. Owner: John L. Jackson; Mgr.: Mary L. Jackson. (OS).

Leader Sales Inc., 3416 W. Pico Blvd. Zip: 90019. Tel: 731-3119. Owner: Leonard Silver; Mgr. & Buyer: Ben Sheldon. (RJ).

Branch: San Jose, Calif.

Liberty/UA Dist'g Corp.—Los Angeles Branch, 1024 N. Orange Dr. Zip: 90038. Tel: 462-6733. Mgr.: Stu Marlowe. (D).

Cartridge 8-tr.: Liberty, United Artists, Sunset. Cartridge 4-tr. & cassette: Liberty, United Artists.

Linden Dist'g Co., 929 Larrabee St., No. 12. Zip: 90069. Tel: 657-6534. Owner, Mgr. & Buyer: L. Blaskey. (OS, RJ & E).

Merchandise Promos. of America Inc., 1348 W. Venice Blvd. Zip: 90006. Tel: 748-0477. Pres.: Mrs. Mildred Weiss. (RJ).

Modern Sound (sub. of Audio Communications Inc.), 9321 Melvin Ave., Northridge 91324. Tel: 885-0930. Mgr.: Roger Brown. (OS).

Home office: Raeford, N.C.

Musical Isle of America Inc. (An Entertainment Serv. of Transamerica Corp.), 6920 Sunset Blvd. Zip: 90028. Tel: 461-9141. Pres.: Ron Bledsoe; VP: Russ Bach. (Exec. offices only).

Branches: San Francisco, Calif. (RJ); Chicago, Ill. (OS & RJ); New Orleans, La. (RJ); Kansas City, St. Louis, Mo. (OS & RJ); Memphis, Nashville, Tenn. (RJ).

Musical Tapes Inc., 2958 W. Pico Blvd. Zip: 90006. Tel: 737-0937. Mgr.: Valentin Velasco. (D).

Home office: Miami, Fla. (see for prod. distributed).

continued on page 44

# KEEP AN EYE ON

CERTRON  
VIVID SOUNDS  
FALCON  
BRONCO  
SUNGLOW  
CARTRIDGES & CASSETTES



## CERTRON CORPORATION MUSIC DIVISION

# PICK A PACK OF E.T.I.

## SOUL OF AFRICA

ETI-100

Drums, Drums, Drums/Olatunji  
Songs of New Nations/De Pau Chorus with Native  
Drums & Percussion  
Life in the Bush/The Young Congo Singers  
Music From West Africa/Gilbert Rouget  
Dahomey, Musique du Roi; Guinba; Musique Melinke

## JAZZ FROM THE VAULT

ETI-200

ROULETTE BIRDLAND SERIES

The Most, Vol. I/Basie, Vaughan, Eckstine, etc.  
The Most, Vol. II/Basie, Vaughan, Eckstine, etc.  
The Most, Vol. III/Basie, Vaughan, Eckstine, etc.  
The Most, Vol. IV/Basie, Vaughan, Eckstine, etc.  
The Most, Vol. V/Basie, Vaughan, Eckstine, etc.

## JAZZ FROM THE VAULT

ETI-300

ROULETTE BIRDLAND SERIES

The Kid from Red Bank/Count Basie & His Orchestra  
A Man Ain't Supposed to Cry/Joe Williams  
A Message From Newport/Maynard Ferguson  
Basie/Eckstine, Inc./Count Basie-Bill Eckstine  
Dreamy/Sarah Vaughan

## JAZZ FROM THE VAULT

ETI-400

ROULETTE BIRDLAND SERIES

Vaughan-Basie/Sarah Vaughan Count Basie  
After Hours/Sarah Vaughan  
Together For The First Time/Armstrong-Ellington  
The Best of Birdland Vol. 1/Coltrane Morgan  
Bobo's Beat/Willie Bobo

## JAZZ FROM THE VAULT

ETC-500

ROULETTE BIRDLAND SERIES

We Three/Dinah, Joe, Sarah  
Sweet 'n' Sassy/Sarah Vaughan  
Jazz/John Handy III/John Handy III  
Afro-Zzzzic/Herbie Mann  
Let's Go Bobo/Willie Bobo

## EMMESS YIDDISH

ETI 600

Let's Sing Yiddish/Orig. Cast Album  
At Home With Barry Sisters/The Barry Sisters  
Shalom/The Barry Sisters  
The Barry Sisters in Israel/The Barry Sisters  
Favorite Jewish Folk Songs/Sung by Tova Ven-Tsvi

ETHNIC TAPES, INC., presents a Compact Counter-Browser Box that inspires impulse buying of high profit 8 track stereo tapes

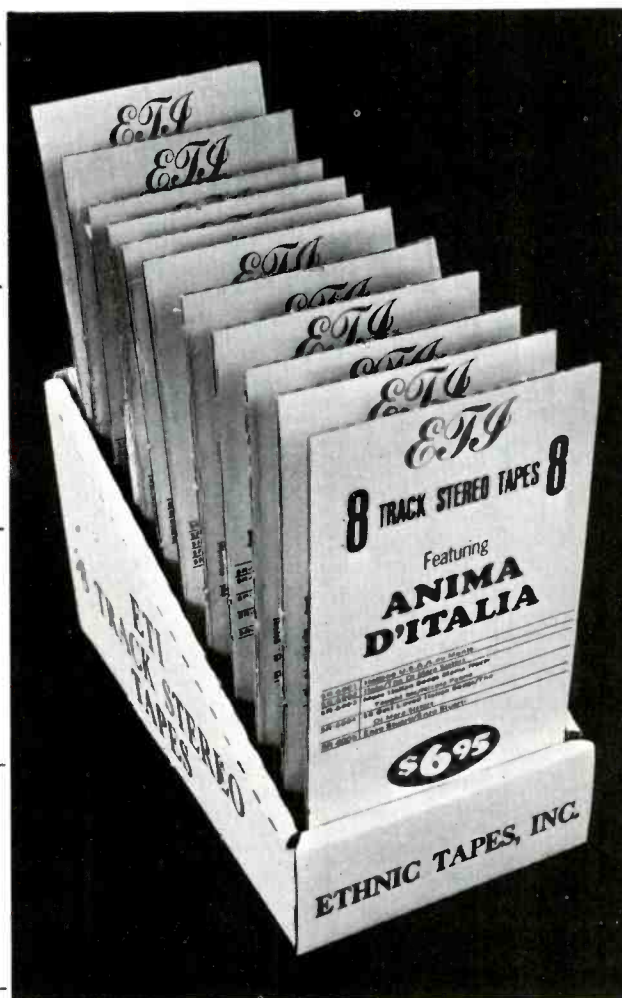

Each Pre-Pack includes 10 tapes  
2 each of 5 different selections

LIMITED OFFER

We will give you 1 free tape of your choice  
with the purchase of each Pre-Pack

**MORE THAN DOUBLE YOUR PROFIT PER UNIT IN YOUR STEREO 8 DEPARTMENT**

For more information, write or call:

Richard Myers, Jr., Ethnic Tapes, Inc., 17 W. 60th St.  
New York, N.Y. 10023 Area Code (212) 757-9880

## POLSKIE MELODIE

ETI 700

(MELODIES OF POLAND)

It's Happy Polka Time/Kenny Bass  
The Top Million Polka Sellers/Kenny Bass  
Polish Songs Mama Never Taught Me/Ray Budzitek  
More Polish Songs Mama Never Taught Me/Ray Budzitek  
Polka Spectaculars/Kenny Bass

## POLSKIE MELODIE

ETI-800

(MELODIES OF POLAND)

Polka-Polka-Polka/Kenny Bass  
Old Country Polka/Kenny Bass  
Polka Memories/Kenny Bass  
Favorite Wedding Polkas and Waltzes/Kenny Bass

## DEUTSCHE HEIMATS LIEDER

ETI-900

Der grosse Volksmusikschatz/Various Artists  
Caruso Der Berge/Sepp Viellechner-Alfons Bauer  
In Einem Kuhljan Grunde/Der Werkchor, Leitung: Max Lillie  
Kameraden der Berge/Franzi, Lang, Leitung: C. Diernhammer  
Urlaub Im Schwarzwald/Various Artists

## DEUTSCHE HEIMATS LIEDER

ETI-1000

Du Wunderschoner Rhein/Orchester Simon Krapp  
Auf Weidersh'n in Tirol/Das Schroll-Trio  
Ein Abend mit der Engel-Familie/Eine Auswahl  
Oktoberfest-Oktoberfest/Various Artists  
Urlaub in Bayern/Various Artists

## DEUTSCHE HEIMATS LIEDER

ETI-1100

Das grosse Heimatlleder-Potpourri/Alfons Bauer  
Rundum Den Watzmann/Alfons Bauer  
Alfons Bauer und seine Almdudler/Rita Fendt, Alnglocken und Hackbrett  
Der grosse Alpenrosenstrauß/Alfons Bauer-Rita Fendt  
Das grosse Wanderlieder-Potpourri/Alfons Bauer und grosses orchester

## ANIMA D'ITALIA

ETI-1200

Italiano U.S.A./Lou Monte  
Italy Vol. 2/The Di Mara Sisters  
More Italian Songs Mama Never Taught Me/Nicola Paone  
50 Best Loved Italian Songs/The Di Mara Sisters  
Enzo Stuarti/Enzo Stuarti





Complete,  
Full Line  
Record,  
Tape &  
Cassette  
Music  
Department  
Merchandising  
On All  
Labels  
PROMOTION IS  
OUR BUSINESS

ALAN WOLK, PRESIDENT  
MORTON MARKS,  
SEC. & TREAS.



## United Record & Tape Industries, inc.

9880 N.W. 77 AVE., HIALEAH  
GARDENS, FLA. 33016  
(305) 821-3100

# the best in happiness



## Lil' Wally

### 8 TRACK TAPES

T 5127	THANK YOU	qty. _____
T 5129	LOVABLE POLKAS (instrumental)	qty. _____
T 5123	MORE NEW POLISH	qty. _____
T 5122	POLISH SEX	qty. _____
T 5118	POLISH SING-ALONG #4	qty. _____
T 5113	POLISH ADULTS ONLY	qty. _____
T 5099	WALLY & ZIMA	qty. _____
T 5098	NICE, POLISH SPICE	qty. _____
T 5091	POLISH SONGS (Big Band)	qty. _____
T 5079	NO BEER IN HEAVEN	qty. _____
T 5078	15 GREAT HITS	qty. _____
T 5077	POLISH PARTY (Adults Only)	qty. _____
T 5058	HERE COMES LIL' WALLY	qty. _____
T 5057	JOHNNIE'S KNOCKIN'	qty. _____
T 5056	SING ALONG #3	qty. _____
T 5034	SING ALONG #4	qty. _____
T 5023	BEAUTIFUL POLKAS	qty. _____
T 5022	SING ALONG #1	qty. _____
T 5019	WISH I WAS SINGLE AGAIN	qty. _____

Ship to \_\_\_\_\_ Total qty \_\_\_\_\_  
Address \_\_\_\_\_  
City \_\_\_\_\_ State \_\_\_\_\_  
Zip Code \_\_\_\_\_ Signed \_\_\_\_\_

THE GREATEST IS ON JAY JAY RECORDS  
P.O. Box 4155 Normandy Br.,  
Miami Beach, Florida 33141

## DISTRIBUTORS

Continued from page 42

- N M C Corp., 1535 W. Rosecrans Ave., Gardena 90249. Tel: 532-9561. Mgr.: Bill Hanna; Buyer: Mike Colestock. (RJ).  
**Home office:** Oceanside, N.Y.
- Nationwide Rec. & Tape Dist., 6138 Washington Blvd., Culver City 90230. Mgr. & Buyer: Sid Newman. (RJ).  
**Home office:** Garbell Rec. Rack Inc.
- Nehi Rec. Dist'g Co., 615 W. Washington Blvd. Zip: 90015. Tel: 746-1808. Pres.: Tom Heiman; Gen. Mgr.: Wayne Volat. (OS & RJ).
- Pacific Int'l, 1223 N. Kingsley Dr. Zip: 90029. Tel: 666-2704. Owner & Mgr.: Tom T. Saiki. (D & I).  
**Cartridge 4-tr., 8-tr., cassette & open reel:** Pony Pak (Japan).
- Pacific Music Import & Export Corp., 2525 W. Ninth St. Zip: 90006. Tel: 386-1821. Owner: Jack Lewerke; Mgr.: Greg Lewerke. (I & E).  
**Imports:** Cassettes (UK).  
**Exports:** Pre-recorded tape.
- Paramount Rec. Dists., 6666 W. Lexington, Hollywood 90038. Tel: 466-5356. Mgr.: Bob Chilton. (D).  
**Cartridge 8-tr. & cassette:** Paramount.
- Pep Rec. Sales Inc., 3009 W. Pico Blvd. Zip: 90006. Tel: 731-8565. Owner: Ron Riclin. (D).  
**Cartridge 8-tr.:** Adell, Kapp, Pickwick, Plantation, Project 3, Ranwood, Vanguard.  
**Cassette:** Same as 8-tr., except for Adell.  
**Accessories:** Storage racks (Recoton, Royal); carrying cases (Recoton).
- M. Stewart & Co., 204 S. Beverly Dr., Beverly Hills 90212. Tel: 272-0103/0987. Owner: Mendel Stewart; Mgr.: L. King. (E).
- Sun State Music Dists. Inc., 2669 W. Pico Blvd. Zip: 90006. Tel: 383-4137. Mgr. & Buyer: James Vought. (OS).
- T D K Electronics Corp., 6151 W. Century Blvd. Zip: 90045. Tel: OR 0-5515. (I & E).  
**Home office:** New York, N.Y.  
**Cassette & open reel:** TDK (Japan).
- Taiko Corp., see West Coast Tape Cartridge Co.
- Tape Mdsq. Co. Inc., 5873 Rodeo Rd. Zip: 90016. Tel: 870-0246. Mgr.: John McDaniel; Buyer: Lennie Cummins. Branch: 2565 W. Pico Blvd. Zip: 90006. Tel: 387-8201. (D, OE & RJ).  
**Branch:** 2565 W. Pico Blvd. Zip: 90006. Tel: 387-8201.  
**Branch:** San Diego, Calif.
- Cartridge 4-tr., 8-tr., cassette & open reel:** All lines.  
**PlayTape.**  
**Playback equip.:** Automatic Radio, Belair, GW, Muntz, Norelco, Stereodyne.  
**Accessories:** Blank loaded tape & converters (all lines); head cleaners (RCA); lock mounts (Kustom Kreations); storage cases (Amberg, Le-Bo, Recoton); Automatic Radio.
- Transcontinental Dist'g Corp., 15500 S. Main St., Gardena 90427. Tel: 321-6260. Mgr.: Larry Nunes. (D), (RJ as Transcontinental Music Corp.).  
**Home office:** New York, N.Y., Transcontinental Investing Corp.  
**Cartridge 8-tr. & cassette:** Disneyland.
- Transcontinental Music Corp. (RJ), see Transcontinental Dist'g Corp.
- West Coast Music Sales, 2833 W. Pico Blvd. Zip: 90006. Tel: 735-1565. Owner & Buyer: Joel Miller; Mgr.: Alan Atkins. (OS).
- West Coast Tape Cartridge Co. (Taiko Corp.), 11656 Pendleton St., Sun Valley 93152. Tel: 768-1601. Pres.: Sol Zamek; Exec. VP: Sam Tobe. (D, Mfrs. Rep.).  
**Cartridge 8-tr.:** DGG, Hob, ITCC, Orbit, Polydor, Scepter, Wand.  
**Cartridge 4-tr.:** ITCC.  
**Cassette:** DGG, ITCC, Polydor, Scepter.  
**Open reel:** ITCC.  
**Accessories:** Channel Mktg.
- Worldex Mfg. Co. Ltd., 1248 S. Berendo St. Zip: 90006. Tel: 388-9669. Pres. & Sales Mgr.: Louis R. Baptista; Gen. Mgr.: Claudio Jara. (E).  
**Exports:** High-speed tape duplicators, masters, slaves, loaders.

### • MONROVIA (Area Code 213)

Arthur Fulmer, 426 E. Duarte Rd. Zip: 91016. Tel: 357-1171. Mgr.: Ken Brown. (D & I).  
**Home office:** Memphis, Tenn. (see for prod. distributed).

### • ORANGE (Area Code 714)

Southland Recs. Dists., 291 Spinnaker St. Zip: 92668. Tel: 537-1546. Owner: Bill Bacin. (D, I & E).  
**Cartridge 8-tr.:** Happy Jazz Band.  
**Cassette:** New Orleans Jazz Rec's, Storyville (Denmark), Vault.

### • PASADENA (Area Code 213)

Canterbury Recs. Inc., 805 E. Colorado Blvd. Zip: 91101. Tel: MU 1-4922. Mgr.: Leonard Gordon; Buyers: Eddy Allen, Jerry Simon. (RJ).

### • SACRAMENTO (Area Code 916)

Central Valley Rec. Rack (div. of MTS Inc.), 505 N. 10 St. Zip: 95814. Tel: 457-5705. Pres.: Russell Solomon; Gen. Mgr.: John Schair. (RJ).

### • SAN DIEGO (Area Code 714)

Discount Rec. Serv., 6178 University Ave. Zip: 92115. Tel: 286-3333. Owner & Sales Mgr.: Milton Levine; Tape Div. Mgr.: Charles Bush. (D, OS & RJ).  
**Cartridge 8-tr.:** GRT, ITCC.  
**Cartridge 4-tr.:** GRT, ITCC, Muntz.  
**Cassette:** GRT, ITCC.  
**Accessories:** Blank loaded tape, head cleaners (Certron, ITCC).

Tape Mdsq. Co. Inc., 4959 El Cajon Blvd. Zip: 92115. Tel: 286-4650. Mgr.: Ed Runge. (D, OS & RJ).  
**Home office:** Los Angeles, Calif.  
**Cartridge 4-tr., 8-tr., cassette & open reel:** All lines.  
**PlayTape.**

### • SAN FRANCISCO & BAY AREA (Area Code 415)

H. R. Basford Co., 800 Mariposa. Zip: 94107. Tel: 626-5494. Mgr.: Jack Solinger; Buyer: David C. Town. (D, OS & RJ).  
**Cartridge 8-tr.:** A&M, Chisa, Cotillion, DGG, Embryo, Gordy, King, Laurie, Modern, Motown, Original Sound, Polydor, Rare Earth, Scepter, Soul, Tamla, VIP, Wand, Weed.  
**Cartridge 4-tr.:** A&M, Chisa, Gordy, King, Modern, Motown, Rare Earth, Scepter, Soul, Tamla, VIP, Wand, Weed.  
**Cassette:** A&M, Chisa, Cotillion, DGG, Embryo, Gordy, King, Motown, Original Sound, Polydor, Rare Earth, Scepter, Soul, Tamla, VIP, Wand, Weed.  
**Open reel:** A&M.  
**Playback equip.:** Zenith.

Capitol Recs. Dist'g Corp., PO Box 7676, Rincon Annex, 680 Beach St., Suite 307. Zip: 94119. Tel: 771-3210. (D).  
**Cartridge 8-tr. & cassette:** Capitol, Angel, Melodiya/Angel, Apple, Harvest, Fame.  
**Playback equip.:** Capitol.  
**Accessories:** Display racks, storage cases (Capitol).

Chalfon Dist'g Co., 2517 San Pablo Ave., Oakland 94612. Tel: 444-5677. Mgr. & Buyer: Vince Cosgrave. (D).  
**Cartridge 8-tr. & cassette:** Atlantic.

Columbia Recs. Sales, 680 Beach St., Suite 311, Wharfside. Zip: 94109. Tel: 771-8550. Regional Sales Mgr.: Henry Aubuchon; Audio Sales Mgr.: Phil Goldbeck. (D).  
**Cartridge 8-tr.:** Columbia, Date, Epic, Okeh, Ode, Barnaby, Fillmore, Blue Horizon.  
**Cartridge 4-tr.:** Columbia, Date, Epic, Okeh, Ode, Blue Horizon.  
**Cassette:** Same as 8-tr.  
**Open reel:** Same as 4-tr.  
**Playback equip.:** Masterwork.  
**Accessories:** Blank loaded tape, storage cases (Columbia).

Eric-Mainland Dist. Co., 645 Bryant St. Zip: 94107. Tel: 989-6286. (D).  
**Cartridge 8-tr. & cassette:** Atco, Enterprise, Jubilee, Laff, NAL, Prestige, Savoy, Stax, Volt, Vortex.

Liberty/UA Dist'g Corp.—San Francisco Branch, 680 Beach St., Suite 357, Wharfside. Zip: 94109. Tel: 775-5353. Mgr.: Jack Mesler. (D).  
**Cartridge 8-tr.:** Liberty, United Artists, Sunset.  
**Cartridge 4-tr. & cassette:** Liberty, United Artists.

Melody Sales Co. Inc. (div. of National Tape Dists. Inc.), PO Box 2646, 324 Harbor Way, South San Francisco. 94080. Tel: 589-5667. Mgr.: Albert R. Bramy, Anthony C. Valerio. (D & RJ).  
**Home office:** Brookfield, Wis.  
**Cartridge 8-tr. & cassette:** Crewe, Elektra, Fantasy, Metromedia, Reprise, Warner Bros.—Seven Arts.

Musical Isle of America Inc. (An Entertainment Serv. of Transamerica Corp.), 1461 Park Ave., Emeryville. 94608. Tel: 654-0773. Mgr.: Vern Cupples. (RJ).  
**Home office:** Los Angeles, Calif.

Music West, 460 Talbert St., Daly City 94014. Tel: 467-5800. Pres.: Merritt B. Kirk. (D).  
**Branch:** Torrance, Calif.  
**Cartridge 4-tr., 8-tr., cassette & open reel:** All lines.  
**Playback equip.:** Belle Wood.  
**Accessories:** Amberg, Le-Bo, Recoton, 3M.

Nor Cal Super Stop. Mgr.: John Iott. (OS). See Transcontinental Dist'g Corp.

Paramount Rec. Dists., 680 Beach St., Suite 360. Zip: 94109. Tel: 771-1570. Mgr.: Richard Hughes. (D).  
**Cartridge 8-tr. & cassette:** Paramount.

Transcontinental Dist'g Corp., 868 Cowan Rd., Burlingame 94010. Tel: 697-6800. Mgr.: William Hall. (D), (OS as Nor Cal Super Stop), (RJ as Transcontinental Music Corp.).  
**Home office:** New York, N.Y., Transcontinental Investing Corp.  
**Cartridge 8-tr. & cassette:** Decca, Coral, Brunswick, Bravo, Viva.  
**Open reel:** Decca, Coral, Brunswick.

Transcontinental Music Corp. (RJ), see Transcontinental Dist'g Corp.

### • SAN JOSE (Area Code 408)

Leader Sales Inc., 666-J Stockton Ave. Zip: 95126. Tel: 294-3942. Mgr.: Jay Cahail. (RJ).  
**Home office:** Los Angeles, Calif.

continued on page 46

# no one is more skilled at reproduction...



## than American Sound!

### *Cassettes and 8-track cartridges*

Able to handle tremendous duplication orders at a single hop. From the moment you impregnate us with your masters, we start delivering—thousands of duplicated products within 24 hours. We move like a rabbit in getting your product to the market place. Our five years' experience is your guarantee of flawless reproduction and prompt delivery every time. Our advanced technology (we were the first custom duplicator to acquire Gauss Equipment) has resulted in outstanding service, dependability, and the highest level of duplication quality—these are the reasons why American Sound has never lost a customer. They're also the reasons why your next duplication job can be done better at American Sound.

*—Give us the music and we'll hop to it.*



3319 E. Ten Mile Road • Warren, Michigan 48091 • Phone (313) 539-2900

ARISTOCRAT OF SOUND



**ALTAIR  
RECORDS**

A PRODUCT OF  
KEYSOR-CENTURY CORP.

Offers

**A Mushrooming  
Catalogue  
Of Hot Numbers**

Offered  
In The

**DRAMATICALLY NEW**



A

**FULL STEREO SPECTRUM**

Proven By  
Extensive Use  
For  
Equipment Demo

A Product Of

**KEYSOR-CENTURY CORP.**

26000 Springbrook Road  
Saugus, California

**(213) 365-3991**

## DISTRIBUTORS

Continued from page 44

### • SANTA ANA (Area Code 714)

Rantra Recs., 1136 Arapahoe Dr. Zip: 92704. Tel: 546-1876. Owner: Stewart Douglas; Mgr.: Julia Mallow. (I & E).

Rapid Mdsq. Co., 17421 Daimler St. Zip: 92705. Tel: 546-7940. (D & RJ).  
Home office: Minneapolis, Minn.  
Cartridge 4-tr., 8-tr. & cassette: All lines.

### • SUSANVILLE (Area Code 916)

M B Rec. Corral, 920 Main St. Zip: 96130. (RJ).  
Home office: Reno, Nev.

### • TORRANCE (Area Code 213)

Music Mdsrs. of America (RJ), see United Tape Corp.  
Music West, 19110 S. Vermont. Zip: 90502. Tel: 321-5666. Contact: Dave Pearce. (D).  
Home office: San Francisco, Calif. (see for prod. distributed).

United Tape Corp. (div. of National Tape Dists. Inc.), 22433 S. Vermont. Zip: 90507. Tel: 775-7591. Mgr.: Ralph Kaffel. (D & OS), (RJ as Music Mdsrs. of America).  
Home office: Brookfield, Wis.  
Cartridge 4-tr., 8-tr., cassette & open reel: All lines.

## COLORADO

### • DENVER (Area Code 303)

A B C Rec. & Tape Sales Corp., 10625 E. 47 Ave. Zip: 80216. Tel: 343-7822. Mgr.: Ron Rasmussen. (OS & RJ).  
Home office: Seattle, Wash.

Alert One Stop. Mgr.: Paul Black. (OS). See Transcontinental Dist'g Corp.

Boyd Dist'g Co. Inc., 1661 W. Third Ave. Zip: 80223. Tel: 222-7701. Owner: Cecil H. Boyd; Mgr.: Joe Caravana; Buyer: Bruce Mercer. (D).  
Cartridge 8-tr. & cassette: Capitol, Angel, Apple, Harvest, Tower.  
Playback equip.: Capitol, Lear Jet, Lloyd, Roberts.

Craig Corp., 4959 Colorado Blvd. Zip: 80216. Tel: 399-0434. Owner: Robert Craig; Mgr.: Al Bergamo. (D).  
Cartridge 8-tr. & cassette: Columbia, Date, Epic, Okeh, Ode, Barnaby, Fillmore, Blue Horizon.  
Open reel: Columbia, Date, Epic, Okeh, Ode, Blue Horizon.  
Playback equip.: Craig, Masterwork.  
Accessories: (Craig); blank loaded tape, storage cases (Columbia).

Davis Sales Co., 3825 Newport. Zip: 80207. Tel: 321-1226. Owner: S. William Davis; Mgr. & Buyer: Stephen Davis. (D), (OS & RJ as Music Mdsrs. of Denver).  
Cartridge 8-tr.: A&M, Ampex, Atco, Atlantic, DGG, GRT, ITCC, Liberty, Mercury, Modern, NAL, Paramount, RCA, Reprise, Scepter, Stax, Vanguard, Wand, Warner Bros.-Seven Arts.  
Cartridge 4-tr.: Same as 8-tr. plus Muntz.  
Cassette & open reel: Same as 8-tr.  
Playback equip.: Belair, Car Tapes, Muntz, Orrtronic, Sharp, Telex.  
Accessories: Amberg, Le-Bo, Recoton.

Infal Recs. Inc., 2144 Champa St. Zip: 80202. Tel: 892-7141. Mgr.: Victor M. Hernandez. (OS & RJ).

J L Rack (RJ), see Pan American Rec. Supply Co.  
Mile Hi One Stop Inc. (OS), see Pan American Rec. Supply Co.

Music Mdsrs. of Denver (OS & RJ), see Davis Sales Co.

Pan American Rec. Supply Co., 77 Kalamath St. Zip: 80223. Tel: 255-2021. Owners: Joe & Louis Oxman; Mgr.: Louis Oxman; Buyer: Larry Rees. (D), (OS as Mile Hi One Stop Inc. & RJ as J L Rack).  
Cartridge 4-tr., 8-tr., cassette & open reel: All lines except Ampex.  
PlayTape.  
Playback equip.: Capitol, Craig, Juliette, Kraco, Muntz, VM.  
Accessories: Blank tape.

Transcontinental Dist'g Corp., 1111 S. Platte River Dr. Zip: 80223. Tel: 733-2407. Mgr.: Earl Woolf. (D), (OS as Alert One Stop), (RJ as Transcontinental Music Corp.).  
Home office: New York, N.Y., Transcontinental Investing Corp.  
Cartridge 4-tr., 8-tr. & cassette: Ampex, Elextra, GRT, Motown, Muntz, NAL, United Artists.  
Playback equip.: Concord, Decca, Panasonic, Sharp, Tenna.  
Accessories: All accessories.

Transcontinental Music Corp. (RJ), see Transcontinental Dist'g Corp.

## CONNECTICUT

### • HARTFORD & EAST HARTFORD (Area Code 203)

Central Rec. & Tape Dist. Inc., 477 Park Ave., East Hartford 06108. Tel: 289-4349. Mgr.: Edward E. Stein; Buyer: Robert L. Hoyt. (D, OS & RJ).

Cartridge 8-tr. & cassette: Capitol, Columbia, Decca, NAL.

Accessories: Cases, head cleaners, blanks (Le-Bo).  
Columbia Recs. Sales, 100 Constitution Plaza, Rm. 600. Zip: 06103. Tel: 522-7151. Mgr.: Stephen J. Capone; Audio Sales Mgr.: Al Kaiser. (D).  
Cartridge 8-tr.: Columbia, Date, Epic, Okeh, Ode, Barnaby, Fillmore, Blue Horizon.  
Cartridge 4-tr.: Columbia, Date, Epic, Okeh, Ode, Blue Horizon.

Cassette: Same as 8-tr.  
Open reel: Same as 4-tr.  
Playback equip.: Masterwork.  
Accessories: Blank loaded tape, storage cases (Columbia).

Dave's One-Stop Inc., 313 Park Ave., East Hartford 06108. Tel: 289-6122. Owner & Mgr.: Dave Bratler. (OS).

Eastern One Stop. Tel: 528-9333. (OS). See Transcontinental Dist'g Corp.

Globe Rec. Dist'g Corp., 328 Tolland St., East Hartford 06108. Tel: 289-6424. Owner: Gene Gotthelf; Mgr.: Wayne Marshall. (OS).

Leslie Dist. Northeast (div. of Roskin Dists. Inc.). Mgr.: Sidney Dicker; Buyer: Tom Markoski. (RJ). See Seaboard Dists.

Liberty/UA Dist'g Corp.—Hartford Branch, 477 Connecticut Blvd., East Hartford 06108. Tel: 528-9511. Mgr.: Ron Orsini. (D).

Cartridge 8-tr.: Liberty, United Artists, Sunset.  
Cartridge 4-tr. & cassette: Liberty, United Artists.

Park Rec. & Tape Dist. (div. of Roskin Dists. Inc.). Mgr.: Sidney Dicker; Buyer: Tom Markoski. (RJ). See Seaboard Dists.

Seaboard Dists. (div. of Roskin Dists. Inc.), 275 Park Ave., East Hartford 06108. Tel: 289-9361. Owner: Samuel Roskin; Mgr. & Buyer: Marvin Ginsburg. (D), (OS as Leslie Dist. Northeast & RJ as Park Rec. & Tape Dist.).

Cartridge 8-tr. & cassette: Ampex, Disneyland, GRT, Mercury, Stax, Volt.  
Playback equip.: Belle Wood, Philco.

Transcontinental Dist'g Corp., 734 Tolland St., East Hartford 06108. Tel: 289-8631. Mgr.: Richard J. Godlewski. (D), (OS as Eastern One Stop), (RJ as Transcontinental Music Corp.).  
Home office: New York, N.Y., Transcontinental Investing Corp.

Cartridge 8-tr. & cassette: DGG, Fiesta, Fontana, Kapp, Mercury, Musicor, Phillips, Polydor, RCA, Reprise, Smash, Vanguard, Warner Bros.-Seven Arts.

Transcontinental Music Corp. (RJ), see Transcontinental Dist'g Corp.

### • NORTH BRANFORD (Area Code 203)

Sound Dists. of New England Inc., Rt. 80, Village Shopping Ctr. Zip: 06471. Tel: 484-0211. Gen. Mgr.: Frank Forrest. (D).

Cartridge 8-tr. & cassette: Fiesta, Jubilee, Spar, Starday.

Playback equip.: Mikado, Muntz, Selectron, Standard Radio.

## DISTRICT OF COLUMBIA

### • WASHINGTON (Area Code 202) (Also see listings under Baltimore & Silver Spring, Md.)

Autoscope Inc., 3188 Bladensburg Rd. NE. Zip: 20018. Tel: 526-8500. Buyer: Charles M. Levinson. (OS).

Capitol Recs. Dist'g Corp., 1000 Vermont Ave. NW. Zip: 20005. Tel: 737-3246. (D).

Cartridge 8-tr. & cassette: Capitol, Angel, Melodiya/Angel, Apple, Harvest, Fame.  
Playback equip.: Capitol.  
Accessories: Display racks, storage cases (Capitol).

District Recs. Inc., 2146 24 Pl. NE. Zip: 20018. Tel: 832-3600. Owners: James, Stuart & Bertram Schwartz; Mgr.: Stan Hoffman; Buyer: James Walker. (D, OS & RJ).  
Home office: Schwartz Bros Inc. (see for prod. distributed).

Potomac Music & Rec. Serv., 3746 10 St. NE. Zip: 20017. Tel: 529-0882. Pres.: Michael P. Mackulic; VP: John E. Kmiec. (OS).

Quality Music Co., 5772 Second St. NE. Zip: 20011. Tel: 529-5048. Owners: Max Silverman, Gene Levy, Herb Cohen. (OS).

continued on page 48

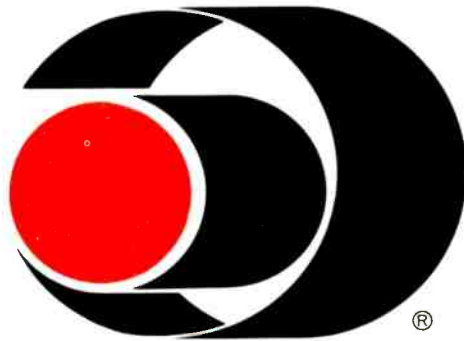

# We're getting known by the companies we keep.

But that's good. Because they're the type of companies you'd want to hang around with. Companies like Alltapes—the complete pre-recorded tape distribution center with just as much emphasis on open reels as cassettes and cartridges. Like Royal Disc—the fastest growing record distributor in the Midwest with lines like Ampex, Atco, Buddah, DGG, and 60 others. Like Rapid One-Stop—the fastest one stop in Chicago with 45's, albums, oldies and a complete merchandising system. Like Alltapes Distributing—providing special services to all our customers including advertising and new merchandising techniques. We're getting known by the companies we keep—but that's good.



**Alltapes Inc.**

2623 North Pulaski, Chicago, Ill. 60639 Phone (312) 342-6600  
9009 Governors Row, Dallas, Texas 75247 Phone (214) 631-1530

## DISTRIBUTORS

Continued from page 46

Schwartz Bros. Inc., 2146 24 Pl. NE. Zip: 20018.  
Tel: 529-5700. Owners: James, Stuart & Bertram Schwartz; Mgr.: Stan Hoffman; Buyer: James Walker. (D). Branch: District Recs. Inc. (D, OS & RJ).  
Cartridge 4-tr., 8-tr., cassette & open reel: All lines.  
Playback equip.: Automatic Radio, Capitol, Masterwork, Muntz, Telex.  
Accessories: Amberg, Recoton, Royal Racks.

## FLORIDA

### • CASSELBERRY (Area Code 305)

Record Supply Co. Inc., 290 Iris Rd. Zip: 32707.  
Tel: 831-1116. Owner & Mgr.: Richard N. Stultz. (D, OS, RJ & E).  
Cartridge 8-tr., cassette & open reel: Ampex, Disneyland, Dot, GRT, ITCC, Mercury, NAL, Paramount, Philips, RCA, Smash.  
Playback equip.: Automatic Radio.  
Accessories: Le-Bo.

### • MIAMI METROPOLITAN AREA (Area Code 305)

Adrian Assocs. Inc., 6660 Biscayne Blvd. Zip: 33138.  
Tel: 757-1626. Owner: Michael Adrian; Mgr.: J. C. Witt. (I & E).  
Imports: Fragoso, Guarany, Hispavox, Marvela, Rico-Vox, Verne (Puerto Rico).  
Campus Rec. Dist'g Co. Inc., 7250 NW 36 Ave. Zip: 33147. Tel: 691-3140. Owner: Harold Lipsius; Mgr.: J. Stanzione; Buyer: Steve Blum. (D, OS & RJ). (E as Musical Export Supply Co. Inc.).  
Cartridge 4-tr., 8-tr., cassette & open reel: A&M, Ampex, GRT, ITCC, Jay-Gee, NAL, Scepter, Wand.  
Accessories: Blank loaded tape, cleaners (J. J. Paulsen).  
Capitol Recs. Dist'g Corp., 7425 NW 48 St. Zip: 33166. Tel: 885-6446. (D).  
Cartridge 8-tr. & cassette: Capitol, Angel, Melodiya/Angel, Apple, Harvest, Fame.  
Playback equip.: Capitol.  
Accessories: Display racks, storage cases (Capitol).  
Columbia Recs. Sales, 3641 NW 67 St. Zip: 33147.

Tel: OX 6-0033. Mgr.: Bob Beasley. (D).  
Cartridge 8-tr.: Columbia, Date, Epic, Okeh, Ode, Barnaby, Fillmore, Blue Horizon.  
Cartridge 4-tr.: Columbia, Date, Epic, Okeh, Ode, Blue Horizon.  
Cassette: Same as 8-tr.  
Open reel: Same as 4-tr.  
Playback equip.: Masterwork.  
Accessories: Blank loaded tape, storage cases (Columbia).  
Decca Dist. Corp., 2452 NW 77 Terr. Zip: 33147. Tel: 691-4816. District Mgr.: Carmen LaRosa. (D).  
Cartridge 8-tr.: Decca, Coral, Brunswick, Bravo, Viva, Berlitz, Standard Phono.  
Cassette: Decca, Coral, Brunswick, Bravo, Viva.  
Open reel: Decca, Coral, Brunswick.  
Playback equip.: Decca.  
Accessories: Blank loaded tape, head cleaners, storage cases (Decca).  
Arthur Fulmer, 3445 NW Second Ave. Zip: 33127. Tel: 379-4702. Mgr.: Ken Miller. (D & I).  
Home office: Memphis, Tenn. (see for prod. distributed).  
Handleman Co., 2346 NW 147 St., Opa Locka 33054. Tel: 681-4618. Mgr.: Robert Bryan. (RJ).  
Home office: Detroit, Mich.  
Liberty/UA Dist'g Corp.—Miami Branch, 561 NE 79 St., Suite 235. Zip: 33138. Tel: 759-1670/1678. Mgr.: Paul Diaz. (D).  
Cartridge 8-tr.: Liberty, United Artists, Sunset.  
Cartridge 4-tr. & cassette: Liberty, United Artists.  
M & M Recs. Dist's. Inc., 501 W. 28 St., Hialeah 33010. Tel: 887-4522, 888-5336. Pres.: Manuel J. Mato; Mgr.: Melvin F. Noriega. (D).  
Branch: Tampa, Fla.  
Cartridge 8-tr. & cassette: Gema, General, Kristal, Kubaney, Montilla, Star, Riviera, Velvet, Vergara.  
Musical Export Supply Co. Inc., 7250 NW 36 Ave. Zip: 33147. Tel: 822-7440. Mgr.: Raoul Shapiro. (E). See Campus Rec. Dist'g Co. Inc.  
Exports: Pre-recorded tape & playback equip.  
Musical Tapes Inc., 790 W. 27 St., Hialeah 33010. Tel: 887-2638. Mgr.: Angel Tamargo. (D, OS, RJ, I & E).  
Branches: Los Angeles, Calif. (D); New York, N.Y. (D); San Antonio, Tex. (D).  
Int'l branch: Puerto Rico (D).  
Cartridge 8-tr.: Boringuen, Columbia, Discuba, Eco, Fuentes, Gema, Kubaney, Marvela, Modiner, Musart, Musidisc, Nilser, Orfeon, Orion, Panart, Parnaso, Peerless, RCA, Ramy, Rex, Rico-Vox, Sonolux, Spanoramix, Velvet.  
Cartridge 4-tr.: Discuba, Musart, Musidisc, Peerless.

Cassette: Boringuen, Discuba, Eco, Gema, Kubaney, Modiner, Musart, Musidisc, Nilser, Peerless, Rex, Rico-Vox, Velvet.  
Imports & exports: Pre-recorded tape throughout Latin America.  
Music Sales of Florida Inc., 2450 NW 77 Terr. Zip: 33147. Tel: 691-0340. Gen. Mgr.: Donald C. Smith. (D & OS).  
Cartridge 8-tr. & cassette: Ampex, Capitol, Decca, Dooto, GRT, ITCC, NAL, Prestige, Word.  
Open reel: Ampex, Capitol, Decca, GRT, ITCC, NAL, Stereo Tape.  
Playback equip.: Automatic Radio, Belle Wood, Hitachi, Norelco, Philco-Ford, Telex-Viking.  
Accessories: Amberg, Le-Bo, Recoton.  
Paramount Rec. Dist's., 561 NE 79 St., Suite 221. Zip: 33138. Tel: 758-2581. Mgr.: Bernard Polakoff; Sales: Stephan Jack. (D).  
Cartridge 8-tr. & cassette: Paramount.  
Ernest C. Reyer Whse. Recs., PO Box 7253, Ludlam Branch. Zip: 33155. Tel: 233-1829. Owner & Buyer: Ernest C. Reyer. (OS).  
Sea Coast Appliance Dist. Inc., 3575 NW 60 St. Zip: 33165. Tel: 635-0951. Mgr.: J. W. Shockey. (D).  
Cartridge 8-tr.: RCA, Colgems, Chart, Kirshner, Request, Buena Vista.  
Cassette: RCA, Colgems, Chart, Kirshner, Request.  
Open reel: RCA, Colgems, Chart, Kirshner.  
Playback equip.: RCA.  
Accessories: Head cleaners, storage cases (RCA).  
Southern Rec. & Tape Servs. Inc., 1020 E. 14 St., Hialeah 33010. Tel: 885-4625. Pres. & Buyer: David E. Shedd; Mgr.: John Stutz. (D, OS, RJ & E).  
Cartridge 8-tr. & cassette: Decca, Dooto, GRT, ITCC, Mercury, Modern; sub-dist. for Atlantic, Capitol, Columbia, Motown, RCA, Reprise, Tamla, Warner Bros.-Seven Arts.  
Accessories: Duotone, Le-Bo.  
Exports: Pre-recorded tape.  
Tone Dist. Inc., 495 SE 10 Ct., Hialeah 33010. Tel: 888-1685. Owner: Henry Stone; Mgr.: Dave Benjamin; Export Mgr.: Edward Llopis; Buyer: Dom Nanocchio. (D, OS & RJ). (E as Tone Int'l Inc.).  
Cartridge 8-tr.: Ampex, Atco, Atlantic, Motown-Tamla group, Reprise, Warner Bros.-Seven Arts; sub-dist. for Capitol, Columbia, Decca, Liberty, United Artists.  
Cartridge 4-tr.: Ampex, Columbia, Liberty, Muntz, United Artists.  
Cassette: Same as 8-tr.  
Open reel: Ampex.  
Playback equip.: Tenna.  
Exports: Pre-recorded tape & playback equip.  
*continued on page 50*

# TMC is No. 1 in tapes. Why?

Overnight service from 15 warehouses.  
Local TMC specialist to tell you what's selling... the TMC computer to keep your inventory up to date.  
Complete merchandising service: money-making promotions, displays, department layouts, advisory service. Let TMC help you become No. 1 in your area.



**TMC HAS THE MOST OF WHAT THEY'RE BUYING!**



201 East 42nd Street, New York, New York • (212) 697-8610



# NATIONAL TAPE DISTRIBUTORS, INC.



**WE SERVICE  
NATIONWIDE**

**8 Strategically Located  
Distributor Centers to  
Fill Your Pre-Recorded  
Music Needs.**

## DISTRIBUTORS

### B & K Record Distributing Co., Inc.

1411 Round Table Drive  
Dallas, Texas 75247  
(214) 637-1920

### B & K Record Distributing Co., Inc.

129 N.W. 23rd Street  
Oklahoma City, Oklahoma  
73103  
(405) 525-7509

### Melody Sales

Post Office Box 2646  
324 Harbor Way  
South San Francisco,  
California 94080  
(415) 589-5667

### Stereo South

2201 Faulkner Road N.E.  
Atlanta, Georgia 30324  
(404) 636-5971

### United Tape Corporation

22433 South Vermont  
Torrance, California 90507  
(213) 775-7591

## ONE STOPS

### B & K Record Distributing Co., Inc.

1411 Round Table Drive  
Dallas, Texas 75247  
(214) 637-1920

### United Tape Corporation

22433 South Vermont  
Torrance, California 90507  
(213) 775-7591

## CORPORATE OFFICES

National Tape Distributors, Inc.  
3515 North 124th Street  
Brookfield, Wisconsin 53005  
(414) 781-2200

### New York Office

Suite 1805 1250 Broadway  
New York, New York 10001  
(212) 239-4547

## RACK JOBBERS

National Tape Distributors, Inc.  
530 North 22nd Street  
Milwaukee, Wisconsin 53233  
(414) 342-3188

### National Tape Distributors of New Jersey, Inc.

609 Commerce Road  
Linden, New Jersey 07036  
(201) 925-9101

### Melody Sales

Post Office Box 2646  
324 Harbor Way  
South San Francisco,  
California 94080  
(415) 589-5667

### Music Merchandisers of America

22433 South Vermont  
Torrance, California 90507  
(213) 775-7591

### Record Distributing Company, Inc.

5631 Old Clinton Road  
Houston, Texas 77020  
(713) 675-7527

### Sound Marketing

2201 Faulkner Road N.E.  
Atlanta, Georgia 30324  
(404) 636-5971

## WE HAVE THE BEST IN SOUND



## DISTRIBUTORS

Continued from page 48

- Tone Int'l Inc. (E), see Tone Dist. Inc.  
 Transcontinental Music Corp., 8160 NW 36 Ave.  
 Zip: 33147. Tel: 696-6261. Mgr.: Edward  
 Chapman. (RJ).  
**Home office:** New York, N.Y., Transcontinental  
 Investing Corp.  
**United Rec. & Tape Inds.,** 9880 NW 77 Ave., Hialeah  
 33016. Tel: 821-3100. Owners: Morton Marks,  
 Allen Wolk; Mgr. & Buyer: Jack Roberge. (D  
 & RJ).  
**Cartridge 8-tr. & cassette:** Ampex, RCA.  
**Playback equip.:** Automatic Radio.
- **ORLANDO (Area Code 305)**  
 Arthur Fulmer, 1415 N. Orange Ave. Zip: 32804.  
 Tel: 241-5319. Mgr.: Dick Curle. (D & I).  
**Home office:** Memphis, Tenn. (see for prod.  
 distributed).
- **SARASOTA (Area Code 813)**  
 Distributors Inc., 258 Shopping Ave. Zip: 33577.  
 Tel: 955-9191. Owner: Ernest C. Kuban; Mgr.:  
 W. G. Potter. (RJ).
- **TALLAHASSEE (Area Code 904)**  
 M M M Dist. Inc., Box 31A, Rt. 1. Zip: 32301. Tel:  
 224-4015. Owner: M. M. Martin; Mgr. & Buyer:  
 Hugh Martin. (D).  
**Cartridge 8-tr.:** Columbia, GRT, ITCC, NAL, RCA.  
**Cartridge 4-tr.:** ITCC, Muntz.  
**Playback equip.:** Boman, Muntz.
- **TAMPA (Area Code 813)**  
 Florida Electronics Inc., 2106 Main St. Zip: 33607.  
 Tel: 251-3169. Pres.: Linda L. Santos; Buyer:  
 Vincent Lubrano. (OS).  
**M & M Recs. Dist. Inc.,** 3010 Hudson St. Zip:  
 33605. Tel: 626-2660. Mgr.: Romeo Cesari. (D).  
**Home office:** Miami, Fla. (see for prod. dis-  
 tributed).  
**Tampa Recs.,** 1416 Seventh Ave. Zip: 33605. Tel:  
 876-5314. Owner & Buyer: S. Delgado. (RJ).

## GEORGIA

- **ATLANTA METROPOLITAN AREA  
 (Area Code 404)**  
**A B C Rec. & Tape Sales Corp.,** 720 14 St. NW.  
 Zip: 30318. Tel: 875-5565. Mgr.: Jack Geldbart.  
 (OS & RJ).  
**Home office:** Seattle, Wash.  
**Capitol Recs. Dist'g Corp.,** 1670 NE Freeway Access  
 Rd. Zip: 30329. Tel: 636-9407. (D).  
**Cartridge 8-tr. & cassette:** Capitol, Angel,  
 Melodiya/Angel, Apple, Harvest, Fame.  
**Playback equip.:** Capitol.  
**Accessories:** Display racks, storage cases  
 (Capitol).  
**Columbia Rec. Sales,** 8 Executive Park West NE.  
 Zip: 30329. Tel: 633-8806. Regional Mgr.: Don  
 Dempsey. (D).  
**Cartridge 8-tr.:** Columbia, Date, Epic, Okeh,  
 Ode, Barnaby, Fillmore, Blue Horizon.  
**Cartridge 4-tr.:** Columbia, Date, Epic, Okeh,  
 Ode, Blue Horizon.  
**Cassette:** Same as 8-tr.  
**Open reel:** Same as 4-tr.  
**Playback equip.:** Masterwork.  
**Accessories:** Blank loaded tape, storage cases  
 (Columbia).  
**Comstock Dist'g Co.,** 2201 Faulkner Rd. NE. Zip:  
 30324. Tel: 634-6121. Owner: Don Comstock;  
 Gen. Mgr.: Mike King. (D).  
**Cartridge 8-tr.:** Columbia, Date, Epic, Okeh,  
 Ode, Barnaby, Fillmore, Blue Horizon.  
**Cartridge 4-tr.:** Columbia, Date, Epic, Okeh,  
 Ode, Blue Horizon.  
**Cassette:** Same as 8-tr.  
**Open reel:** Same as 4-tr.  
**Playback equip.:** Ampex, Concord, Masterwork,  
 Roberts, Tenna.  
**Accessories:** Blank loaded tape, storage cases  
 (Columbia).  
**Decca Dist. Corp.,** 2231 Faulkner Rd. NE. Zip: 30324.  
 Tel: 636-3028. Mgr.: Kent Ortman; District  
 Mgr.: Ed Russell. (D).  
**Cartridge 8-tr.:** Decca, Coral, Brunswick, Bravo,  
 Viva, Berlitz, Standard Phono.  
**Cassette:** Decca, Coral, Brunswick, Bravo, Viva.  
**Open reel:** Decca, Coral, Brunswick.  
**Playback equip.:** Decca.  
**Accessories:** Blank loaded tape, head cleaners,  
 storage cases (Decca).  
**Godwin Dist'g Co.,** 1270 Tacoma Dr. NW. Zip: 30318.  
 Tel: 351-5110. Owner: Art Godwin; Mgr.:  
 Romeo Davis; Buyer: Jean Warren. (D, OS & RJ).  
**Cartridge 8-tr. & cassette:** Canaan, Capitol,  
 Columbia, Decca, Dooto, Epic, Fantasy, GRT,  
 Gordy, Gross, Heart Warming, ITCC, Jay-Gee,  
 Joste, Modern, Motown, NAL, RCA, Rare Earth,  
 Reprise, Sacred, Scepter, Skylite, Soul, Sun,  
 Tama, Wand, Warner Bros.-Seven Arts.  
**Playback equip.:** Craig, Dynsonic, Electro-Brand,  
 Hitachi, Mercury/Pax, Sound Tech, Stradavaro.  
**Accessories:** Carrying cases (Amberg, Reoton),  
 head cleaners & blank loaded tape (BASf).

- Handleman Co., 1532 Stone Ridge Dr., Stone Mountain  
 30083. Tel: 938-9467. Mgr.: John F.  
 Langlois. (RJ).  
**Home office:** Detroit, Mich.  
**Liberty/UA Dist'g Corp.—Atlanta Branch,** PO Box  
 20175. Sta. N. Zip: 30325; 1184 Logan Circle  
 NW. Zip: 30318. Tel: 355-9350. Mgr.: Bobby  
 Fisher. (D).  
**Cartridge 8-tr.:** Liberty, United Artists, Sunset.  
**Cartridge 4-tr. & cassette:** Liberty, United  
 Artists.  
**Lou-Neita Dist'g Co.,** 1608 Thompson Ave., East  
 Point 30344. Tel: 766-3641. Mgr.: Martin C.  
 Haley; Buyers: James F. Brannon Jr., Martin C.  
 Haley. (OS & RJ).  
**Mainline Atlanta,** 1225 Logan Circle NW. Zip: 30318.  
 Tel: 351-4150. Mgr. & Buyer: Chuck Huesman.  
 (D, OS & RJ).  
**Home office:** Cleveland, Ohio (see for prod.  
 distributed).  
**One-Stop Rec. House,** 252 Peachtree Circle. Zip:  
 30309. Tel: 892-2834. Pres.: Hugh West; VP:  
 Carol Sanford. (OS).  
**Paramount Rec. Dist.,** 1226 Zonolite Rd. NE. Zip:  
 30306. Tel: 876-5731. Mgr.: Jim Wardlaw. (D).  
**Cartridge 8-tr. & cassette:** Paramount.  
**Sound Mktg. (RJ),** see Stereo South.  
**Southland Recs. Dist'g Co.,** 1073 Huff Rd. Zip:  
 30318. Tel: 351-4821. Owner: Gerald M. Fried-  
 man; Mgr.: Bill Binkley; Buyer: Jack McIntyre.  
 (D).  
**Cartridge 8-tr. & cassette:** Ampex, Atco, At-  
 lantic, GRT, Gross, ITCC, Jubilee, Kapp, Musicor,  
 Scepter, Stax, Vanguard, Volt, Wand.  
**Playback equip.:** Automatic Radio, Belle Wood,  
 Mayfair, Stradivaro.  
**Accessories:** Le-Bo.  
**Stereo South (div. of National Tape Dist. Inc.),**  
 2201 Faulkner Rd. NE. Zip: 30324. Tel: 636-  
 5971. Mgr.: Michael G. King. (D), (RJ as  
 Sound Mktg.).  
**Home office:** Brookfield, Wis.  
**Cartridge 8-tr.:** RCA, Camden, Colgems, Chart,  
 Kirshner, Poppy, Diamond.  
**Cassette:** RCA, Colgems, Chart, Kirshner, Poppy.  
**Open reel:** RCA, Camden, Colgems, Kirshner.  
**Accessories:** Blank cassettes, caddies, head  
 cleaning cartridges, test cartridges (RCA).  
**Transcontinental Music Corp.,** 660 Great Southwest  
 Pkwy. Zip: 30336. Tel: 344-6791. Mgr.: Dean  
 White. (RJ).  
**Home office:** New York, N.Y., Transcontinental  
 Investing Corp.
- **CLARKESVILLE (Area Code 404)**  
**Clarksville Rec. Sales Co.,** PO Box 198, 608 N.  
 Washington St. Zip: 30523. Tel: 754-2152.  
 Owner: Peter J. Rosetty; Mgr.: James Stockton;  
 Buyer: Wanda Stockton. (D, OS & RJ).  
**Cartridge 8-tr.:** Dooto, GRT, ITCC, Jubilee, NAL,  
 Sing, Skylite, Word.  
**Playback equip.:** Audio-Sonic, Automatic Radio,  
 Boman, Car Tapes, Electra, Mayfair, Mikado,  
 Monacor, Ranger-Tenna.  
**Accessories:** Amberg, Le-Bo, Specialty Sounds.
- **DEMOREST (Area Code 404)**  
**Ralph's Radio Music,** PO Box 127. Zip: 30535. Tel:  
 723-3884. Owner & Mgr.: Ralph Raper; Buyer:  
 Bernice Raper. (D, OS & RJ).  
**Cartridge 8-tr.:** GRT, ITCC, Mark IV.  
**Cassette:** GRT, ITCC.
- **SAVANNAH (Area Code 912)**  
**Southeast Georgia Parts Inc.,** 4111 Bull St. Zip:  
 31405. Tel: 233-6653. Owner: Robert T. Mitch-  
 ell; Mgr.: Ed Lehman; Buyer: Carol Mitchell.  
 (D).  
**Cartridge 8-tr. & cassette:** Capitol, Decca, Dooto,  
 GRT, ITCC, Liberty, Mercury, Paramount, Skylite,  
 United Artists, Word.  
**Playback equip.:** Automatic Radio, Hitachi,  
 Kraco, Ranger.  
**Accessories:** Le-Bo.

## HAWAII

- **HILO (Area Code 808)**  
**Radio Television Corp. Ltd.,** 28 Pookela St. Zip:  
 96720. Tel: 935-5468. Mgr.: Larry Tanimoto.  
 (D).  
**Home office:** Honolulu, Hawaii (see for prod.  
 distributed).
- **HONOLULU (Area Code 808)**  
**Ampex Hawaii,** 419 Waiakamilo Rd. Zip: 96817. Tel:  
 847-2157. Mgr.: Skippy Hamamoto. (D).  
**Cartridge 4-tr., 8-tr., cassette & open reel:**  
 Ampex.  
**Accessories:** Ampex.  
**Craig Corp.,** 620 Coral St. Zip: 96813. Tel: 536-8771.  
 Mgr.: Carleton Smith; Buyer: Masao Tanaka.  
 (D).  
**Cartridge 4-tr., 8-tr. & cassette:** Columbia, Date,  
 Epic, Ode, Okeh.  
**Open reel:** Columbia, Date, Epic, Ode.  
**Playback equip.:** Craig.  
**Accessories:** Craig.  
**Eric of Hawaii Inc.,** 2071 S. Beretania. Zip: 96814.  
 Tel: 946-6522. Owner: Irv Pinensky; Mgr.:  
 Emil Sabate; Buyers: Irv Pinensky, Emil Sabate.  
 (D), (OS & RJ as Rack Serv. Hawaii Inc.).  
**Cartridge 4-tr., 8-tr., cassette & open reel:**

- ABC, Avco Embassy, Blue Thumb, Dunhill,  
 Elektra, MGM, Polydor, Reprise, United Artists,  
 Verve, Warner Bros.-Seven Arts.  
**K & A Dist.,** 2320 S. A King St. Zip: 96814. Tel:  
 946-7737. Mgr.: Don Ayers. (D).  
**Cartridge 8-tr. & cassette:** Decca, Coral, Brunsw-  
 ick, Bravo, Viva.  
**Open reel:** Decca, Coral, Brunswick.  
**Playback equip.:** Decca.  
**Accessories:** Blank loaded tape, head cleaners,  
 storage cases (Decca).  
**Kona-Kai Dist.,** PO Box 2135. Zip: 96805. Tel:  
 531-6118. Owner & Mgr.: Don McDiarmid Jr.  
 (D).  
**Cartridge 8-tr., cassette & open reel:** Hula,  
 Surfside.  
**Microphone Music Inc.,** 2077 S. Beretania St. Zip:  
 96814. Tel: 946-1488. Owner & Mgr.: Ken  
 Kaizawa. (D).  
**Cartridge 8-tr. & cassette:** Atco, Atlantic, Dooto,  
 Dot, GRT, Jubilee, Kapp, Paramount, Scepter,  
 Stax, Wand.  
**Open reel:** GRT.  
**Accessories:** Le-Bo.  
**Music Craft Dist. of Hawaii Ltd.,** 636 Queen St.  
 Zip: 96813. Tel: 533-1223. Owner & Mgr.:  
 Walter Y. Kurokawa. (D).  
**Cartridge 8-tr.:** Fontana, Lighthouse, Mercury,  
 Original Sound, Philips, Project 3, Roper,  
 Smash, Vanguard.  
**Cartridge 4-tr.:** Original Sound.  
**Cassette:** Fontana, Lighthouse, Mercury, Original  
 Sound, Philips, Project 3, Smash, Vanguard.  
**Nylen Bros. & Co. Ltd.,** 820 S. Beretania St. Zip:  
 96813. Tel: 538-1171. Pres.: William Nylen;  
 Mgr. & Buyer: Ed Nielsen. (D).  
**Cartridge 4-tr. & 8-tr.:** A&M, DBI, Fantasy,  
 ITCC, Liberty, Livingston, Tama-Motown.  
**Cassette:** A&M, Cetra, DBI, DGG, Fantasy, ITCC,  
 Liberty, Livingston, Tama-Motown.  
**Open reel:** A&M, Bell & Howell, Fantasy.  
**Playback equip.:** Automatic Radio, Lear Jet,  
 Standard, Phono.  
**Rack Serv. Hawaii Inc.,** 2320 S. King St. Zip:  
 96814. Tel: 946-7737. Mgr. & Buyer: Don Ayers.  
 (OS & RJ). (See Eric of Hawaii Inc.).  
**Radio Television Corp. Ltd.,** 432 Keawe St. Zip:  
 96815. Tel: 533-2901. Owner: Roy R. Bright;  
 Mgr. & Buyer: Hector H. Venegas. (D).  
**Branch:** Hilo, Hawaii.  
**Cartridge 8-tr.:** Buena Vista, Camden, Chart,  
 Colgems, Columbia (Latin prod.), Kirshner,  
 Poppy, RCA, White Whale.  
**Cassette:** Colgems, RCA.  
**Open reel:** Colgems, Kirshner, RCA.  
**Playback equip.:** RCA.  
**Accessories:** Blank loaded tape, head cleaners,  
 storage cases, test tapes (RCA).  
**Records Hawaii Inc.,** 1280 Kapiolani Blvd. Zip:  
 96814. Tel: 536-3888. Owner & Mgr.: John F.  
 Leonard. (OS).  
**Surfside Hawaii Inc.,** 1412 Colburn St. Zip: 96817.  
 Tel: 847-0855. Owner: C. R. Clarke; Mgr. &  
 Buyer: Mac Laris. (D).  
**Cartridge 8-tr. & cassette:** Capitol, Angel,  
 Melodiya/Angel, Apple, Harvest, Fame.

## ILLINOIS

- **CANTON (Area Code 309)**  
**Curtis Eng'g Stereo Village,** 661 N. Main St. Zip:  
 61520. Tel: 647-7734. Owner & Buyer: William  
 A. Curtis; Mgr.: Lyle D. Curtis. (D).  
**Cartridge 8-tr.:** Capitol, Columbia, Decca, GRT,  
 ITCC, Liberty, Muntz.  
**Cartridge 4-tr.:** Columbia, Decca, Liberty, Muntz.  
**Cassette:** Capitol, Columbia, Decca, GRT, ITCC,  
 Liberty.  
**Playback equip.:** Aiwa, Automatic Radio, Craig,  
 Decca, Kraco, Masterwork, Muntz.
- **CHICAGO METROPOLITAN AREA  
 (Area Code 312)**  
**A B C Rec. & Tape Sales Corp.,** PO Box 66186, Zip:  
 60666; 120 King St., Elk Grove Village 60007.  
 Mgr.: George Smith. (RJ).  
**Home office:** Seattle, Wash.  
**All Rec. Serv. Co.,** 2931 N. Pulaski Rd. Zip: 60641.  
 Tel: 725-4426. Owner: Thomas B. Fanelli; Mgr.  
 & Buyer: Don Zimmerman. (OS).  
**All Tapes Inc.,** 2623 N. Pulaski Rd. Zip: 60639. Tel:  
 342-6600. Mgr.: Kent Beauchamp, Ed Yalowitz;  
 Buyer: Dave Remedi. (D, OS, RJ & E).  
**Cartridge 8-tr., cassette, & open reel:** All lines.  
**Accessories:** Blank loaded tape (Ampex); blank  
 cassettes (Certron); Le-Bo, Reoton.  
**Exports:** Pre-recorded tapes.  
**K. O. Asher Inc.,** 7818 S. Stony Island Ave. Zip:  
 60649. Tel: RE 1-1741. Mgr.: K. O. Asher. (D).  
**Cartridge 4-tr., 8-tr., cassette & open reel:**  
 Alecto, Caedmon, Conversa-Phone, Monitor,  
 Nina, Spoken Arts.  
**Atlas-Rand Corp.,** 3770 W. Pratt Ave., Lincolnwood  
 60465. Tel: 679-4680. VP, Mgr. & Buyer: Jim  
 Caffagno. (D).  
**Home office:** See New York, N.Y.  
**Cartridge 8-tr., cassette & open reel:** Sentry &  
 all major lines.  
**Playback equip.:** Belair, Keystone.  
**Barney's One Stop,** 3234 W. Roosevelt. Zip: 60624.  
 Tel: 826-1828. Mgr.: W. J. Barney; Buyer:  
 Alice Warbington. (OS).

Capitol Recs. Dist'g Corp., 6401 Gross Point Rd., Niles 60648. Tel: 647-8338. (D).  
**Cartridge 8-tr. & cassette:** Capitol, Angel, Melodiya/Angel, Apple, Harvest, Fame.  
**Playback equip.:** Capitol.  
**Accessories:** Display racks, storage cases (Capitol).

Car Tapes Inc., 320 W. Ohio St. Zip: 60610. Tel: 943-5158. Pres.: James A. LeVitus; Buyer: Joe Werschling. (D, RJ & I).  
**Branch:** Los Angeles, Calif.  
**Cartridge 8-tr. & cassette:** Ampex, Capitol, Columbia, Decca, GRT, ITCC, Liberty, Paramount, Scepter, Wand.  
**Playback equip.:** Car Tapes (Japan).

Casa Panamericana, 1344 S. Halsted St. Zip: 60607. Tel: SE 3-1530. Mgr. & Buyer: C. Flores. (D).  
**Home office:** Chicago, Ill., Pan American Recs. (see for prod. distributed).

Columbia Rec. Sales, 5404 W. Touhy Ave., Skokie 60076. Tel: 463-0900. Sales Mgr.: Mert Paul; Audio Sales Mgr.: Steven Lesley. (D).  
**Cartridge 8-tr.:** Columbia, Date, Epic, Okeh, Ode, Barnaby, Fillmore, Blue Horizon.  
**Cartridge 4-tr.:** Columbia, Date, Epic, Okeh, Ode, Blue Horizon.  
**Cassette:** Same as 8-tr.  
**Open reel:** Same as 4-tr.  
**Playback equip.:** Masterwork.  
**Accessories:** Blank loaded tape, storage cases (Columbia).

Decca Dist. Corp., Mandel-Lear Bldg., 425 N. Michigan Ave. Zip: 60611. Tel: DE 7-1100. District Mgr.: Jim O'Brien. (D).  
**Cartridge 8-tr.:** Decca, Coral, Brunswick, Bravo, Viva, Berlitz, Standard Phono.  
**Cassette:** Decca, Coral, Brunswick, Bravo, Viva.  
**Open reel:** Decca, Coral, Brunswick.  
**Playback equip.:** Decca.  
**Accessories:** Blank loaded tape, head cleaners, storage cases (Decca).

Galgano Dist. Corp., 4135 W. Armitage Ave. Zip: 60639. Tel: 227-6110. Owners: Anthony & John Galgano; Mgr. & Buyer: John Galgano. (OS).

Handleman Co., 3477 Touhy Ave., Lincolnwood 60645. Tel: 583-0770. Regional VP & Mgr.: Hal Scovill. (RJ).  
**Home office:** Detroit, Mich.

Hit Recs. Inc., 10614 S. Mackinaw Ave. Zip: 60617. Tel: 734-2244. Owner: Charles N. Stephens; Mgr.: Charles Gillis; Buyer: Martha Cox. (D & RJ).  
**Cartridge 8-tr. & cassette:** GRT, ITCC, NAL.  
**Playback equip.:** Belle Wood, Capitol, Craig, Decca, Mayfair.

Liberty/UA Dist'g Corp.—Chicago Branch, 7901 N. Caldwell, Morton Grove 60053. Tel: 478-1133, 966-0150. Mgr.: Robert Golinsky. (D).  
**Cartridge 8-tr.:** Liberty, United Artists, Sunset.  
**Cartridge 4-tr. & cassette:** Liberty, United Artists.

Little Al's Recortapes, 3216 W. Lawrence Ave. Zip: 60625. Tel: 478-6114. Owner & Mgr.: Al Temaner. (OS).

London Recs. Midwest Dist'g Corp., 6363 Gross Point Rd., Niles 60648. Tel: 647-0410. Mgr.: Mel Kahn; Buyer: Stan Meyers. (D & OS).  
**Cartridge 8-tr. & cassette:** All lines.  
**Open reel:** London.  
**Playback equip.:** Belle Wood, Pax.

M S Dist'g Co., 7901 N. Caldwell, Morton Grove 60053. Tel: 478-1133. VP & Gen. Mgr.: Vic Faraci; Buyer: Ralph Kick. (D).  
**Cartridge 8-tr.:** Crewe, DBI, Elektra, Kapp, Reprise, Warner Bros.-Seven Arts.  
**Cassette:** Crewe, Elektra, Reprise, Warner Bros.-Seven Arts.  
**Playback equip.:** Mercury, Peerless, Tenna.

Musical Isle of America Inc. (An Entertainment Serv. of Transamerica Corp.), 7901 N. Caldwell, Morton Grove 60053. Tel: 478-1133. Mgr.: Vic Faraci. (OS & RJ).  
**Home office:** Los Angeles, Calif.

Pan American Recs. Inc., 3751 W. 26 St. Zip: 60623. Tel: 521-1100. Owners: H. & M.S. Frenkel; Mgr. & Buyer: F. Nava. (D & OS).  
**Branch:** Casa Panamericana (D).  
**Cartridge 8-tr. & cassette:** Ansonia, Bego, Bernal, CBS de Mexico, Cap-Latino, DLV, Del Rio, Del Valle, Falcon, Impacto, Keyloc, Magda, Marsol, Mex-Melody, Musart, Musicor, Norteno, Orfeon, Pato, Peerless, Sunglow, Ventura, Zarape.  
**Accessories:** Caddies (Athena); head cleaners (Specialty Sounds).

Paramount Rec. Dists., 6643 W. Howard St., Niles 60648. Tel: 647-0464, 775-6840. Mgr.: Dick Masters. (D).  
**Cartridge 8-tr. & cassette:** Paramount.

Singer One Stop Recs. Inc., 1812 W. Chicago Ave. Zip: 60622. Tel: 486-7400. Branch: 2959 W. 63 St. Zip: 60629. Tel: 778-3534. Mgr.: Joseph Siporia. (OS).

Summit Dists. Inc., 7447 Linder Ave., Skokie 60076. Tel: 677-1621. Mgr. & Buyer: Harold Davis. (D).  
**Branch:** Cincinnati, Ohio.  
**Cartridge 8-tr. & cassette:** A&M, Audio Fidelity, Disneyland, Era, Fantasy, Fiesta, ITCC, Metro-media, Vault.  
**Open reel:** A&M, Fantasy.

Susan Dist'g Co. Inc./Sam Sales (div. of Lieberman Ent's.), 7330 Niles Center Rd., Skokie 60076. Tel:

674-4390. Mgr.: Harry S. Losk; Buyer: Larry L. Backe. (OS & RJ).  
**Home office:** Minneapolis, Minn., Acme Music Serv./Sam Sales.

T D A Inc., 3035 W. 47 St. Zip: 60632. Tel: 254-4612. Mgr.: Morton A. Ohren; Buyer: Jack Krug. (D, OS, RJ, I & E).  
**Cartridge 8-tr.:** A&M, Ampex, Atco, Atlantic, Dooto, Ethnic, GRT, Gordy, ITCC, Jubilee, Kapp, Laff, Mercury, Motown, NAL, Rare Earth, Reprise, Request, Roulette, Scepter, Soul, Stax, Tamla, Thunderbird.  
**Cartridge 4-tr.:** GRT, ITCC, Muntz.  
**Cassette:** Same as 8-tr.  
**Playback equip.:** Aiwa, Mayfair, Ross, Soundtech, Telex, Tenna, Tobin (Japan).  
**Accessories:** Amberg, GW, Le-Bo, Modern, Rosewood.  
**Exports:** Pre-recorded tape.

T D K Electronics Corp., 2906 W. Peterson. Zip: 60648. Tel: 973-1222. (I & E).  
**Home office:** New York, N.Y.  
**Cassette & open reel:** TDK (Japan).

Taylor Electric Co., 3553 W. Peterson. Zip: 60645. Tel: 588-2729. Sales Mgr.: Chuck Schroeder. (D).  
**Home office:** Milwaukee, Wis. (see for prod. distributed).

Transcontinental Dist'g Corp., 5301 Dansher Rd., Countryside 60525. Tel: 354-6804. Mgr.: Matt Edwards. (D), (RJ as Transcontinental Music Corp.).  
**Home office:** New York, N.Y., Transcontinental Investing Corp.  
**Cartridge 4-tr., 8-tr., cassette & open reel:** All lines.  
**PlayTape.**  
**Playback equip.:** Belle Wood, Decca, PlayTape.  
**Accessories:** TMC, Le-Bo, RecoTon.

Transcontinental Music Corp. (RJ), see Transcontinental Dist'g Corp.

United Rec. Dists. Inc., 1827 S. Michigan Ave. Zip: 60616. Tel: 225-6605. Owner: Ernest Leaner; Mgr.: Billy Leaner; Buyer: Phyllis White. (D).  
**Cartridge 8-tr. & cassette:** Ampex, GRT, ITCC, Laff, Lavell, Livingston, Modern, Motown, Scepter, Stax.  
**Playback equip.:** Craig.  
**Accessories:** Blank loaded cassettes.

Universal Music Mdrs. Inc., 9047 N. Terminal, Skokie 60076. Tel: 965-1810. Owners: Joe & Arthur Weiss; Pres. & Mgr.: Joe Weiss; Buyer: Bette Andrews. (OS & RJ).

*continued on page 52*



**QUALITAPE  
DUPLICATION  
LABS, INC.**

**TOM STEELE  
PRESIDENT**

**DICK MARTIN  
GENERAL MANAGER**

**MIKE FLOOD  
CHIEF ENGINEER**

**MAIN OFFICE AND PLANT**  
**101 BROADWAY RUNNEMEDE, N.J. 08078**  
**PHONE AREA 609-933-2500**

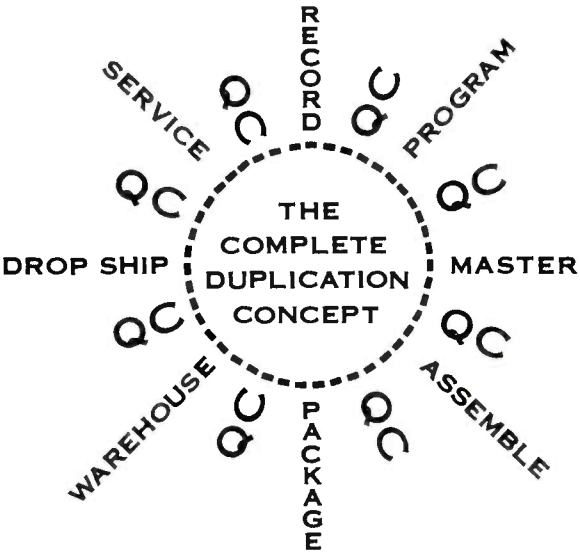

---

**WRITE TODAY FOR OUR DETAILED BROCHURE AND SAMPLE TAPES**

**CASSETTES - 8 TK CARTRIDGES - REEL TO REEL**

## DISTRIBUTORS

Continued from page 51

### INDIANA

- **DECATUR (Area Code 219)**  
Midwest Dist., 138 N. Second St. Zip: 46733. Mgr. & Buyer: Dolores Harker. (D, OS & RJ).  
Home office: Fort Wayne, Ind.  
Cartridge 8-tr. & cassette: Adell Int'l, Ambassador, Cadet, GRT, ITCC, Jubilee, Pickwick, Premier, Spar.  
Playback equip.: Tenna.  
Accessories: Pfanstiehl.
- **FORT WAYNE (Area Code 219)**  
Car-Tape Dist., 211 E. State Blvd. Zip: 46805. Tel: 484-2922. Owner & Mgr.: Robert W. Carreau; Buyer: Larry Radke. (D & OS).  
Cartridge 8-tr.: A&M, Ampex, Canaan, Capitol, Columbia, Decca, Dooto, Epic, Fiesta, GRT, Gordy, Gross, Heart Warming, ITCC, Liberty, Mercury, Motown, RCA, Rare Earth, Reprise, Sacred, Savoy, Sing, Skylite, Soul, Tamla, United Artists, Warner Bros.-Seven Arts, Word.  
Cartridge 4-tr.: Ampex, Capitol, Columbia, Decca, Epic, ITCC, Liberty, Muntz, United Artists.  
Cassette: A&M, Ampex, Canaan, Capitol, Columbia, Decca, Dooto, Epic, GRT, Gordy, Gross, ITCC, Liberty, Mercury, Motown, RCA, Rare Earth, Sacred, Soul, Tamla, United Artists, Word.  
Playback equip.: Ampex, Belair, Belle Wood, Craig.  
Accessories: G&W, Le-Bo.  
Midwest Dist., 2415 Forest Park Blvd. Zip: 46805. Tel: 483-8230. Owner & Mgr.: Walt Ostermeyer. (D, OS & RJ).  
Branch: Decatur, Ind.  
Cartridge 8-tr. & cassette: Adell Int'l, Ambassador, Cadet, GRT, ITCC, Jubilee, Pickwick, Premier, Spar.  
Playback equip.: Tenna.  
Accessories: Pfanstiehl.
- Tri State Dist., 3434 Broadway. Zip: 46807. Tel: 474-5607. Owner: Cliff Ayers Ostermeyer; Mgr.: Kayla Spillson; Buyer: Sue Collier. (D).  
Cartridge 8-tr. & cassette: Elektra, GRT, ITCC, Jubilee, Modern, Motown, Pickwick.  
Cartridge 4-tr.: Pickwick.
- **GARY (Area Code 219)**  
Woodard's Rec. Serv., 2011 Madison St. Zip: 46407. Tel: 885-1908. Owner & Mgr.: Dewitt W. Woodard. (RJ).
- **INDIANAPOLIS (Area Code 317)**  
Arthur Fulmer, 25 W. Ninth St. Zip: 46204. Tel: 635-2504. Mgr.: Jerry Kahns. (D & I).  
Home office: Memphis, Tenn. (see for prod. distributed).  
Sound Classics Inc. (sub. of Associated Dist. Inc.), 333 W. Ninth St. Zip: 46204. Tel: 634-2591. Mgr.: Lynn Jenks; Buyer: James Coffin. (D, OS & RJ).  
Cartridge 8-tr., cassette & open reel: Ampex, Disneyland, GRT, ITCC, RCA.  
Playback equip.: Belle Wood, Craig, Lear Jet.  
Accessories: Amberg, Le-Bo.  
Wholesale Rec. & Tape Sales, 1312 N. Capitol Ave. Zip: 46202. Tel: 639-5491. Owner & Mgr.: Don Gobrecht. (OS).
- **RICHMOND (Area Code 317)**  
Airtown Recs. Ents. Inc., PO Box 973, 723 N. 10 St. Zip: 47374. Tel: 966-6135. Pres.: Tommy Willis; Sales Mgr.: John Rettig. (OS & RJ).

### IOWA

- **DES MOINES (Area Code 515)**  
A B C Rec. & Tape Sales Corp., 1520 Walnut St. Zip: 50309. Tel: 288-7001. Mgr.: Jack Silverman. (OS & RJ).  
Home office: Seattle, Wash.  
J. L. Marsh Inc. (div. of Pickwick Int'l Inc.), 1630 Locust. Zip: 50309. Tel: 282-8185. (RJ).  
Home office: Minneapolis, Minn., Hellicher Bros. (D).

### KANSAS

- **KANSAS CITY (Area Code 913)**  
Custom Music Corp., 837 Osage. Zip: 66105. Tel: 371-4640. Mgr.: Joseph Mayo. (D).  
Home office: St. Louis, Mo. (see for prod. distributed).
- **LAWRENCE (Area Code 913)**  
Kief's Rec. & Stereo Supply, PO Box 2, 711 W. 23 St. Zip: 66044. Tel: 842-1544. Owner & Mgr.: John Kiefer; Buyer: Jim Brown. (OS & RJ).

### ● SHAWNEE MISSION (Area Code 913)

National Auto Sound Inc., 8006 Foster, Overland Park 66204. Tel: 381-1818. Owner: Carl Galler; Mgr. & Buyer: Jeanette Galler. (D).  
Branch: Kansas City, Mo.  
Cartridge 8-tr. & cassette: Ampex, Capitol, Columbia, Decca, GRT, ITCC, Jubilee, Kapp, Mercury, Motown, Paramount, Pickwick, RCA, Scepter, Warner Bros.-Seven Arts.  
Cartridge 4-tr.: All lines.  
Playback equip.: Audiovox, Automatic Radio, Belle Wood, Boman, Clasonic, Craig, Decca, Dynasonic, Lloyd, Mayfair, Motorola, Norelco, Ranger-Tenna, Toshiba, Webcor.  
Accessories: Le-Bo, Recoton.

### ● WICHITA (Area Code 316)

Davidson's One Stop, 1559 S. Broadway. Zip: 67211. Tel: 265-0012. Owner: Mildred Davidson; Mgr.: Evelyn Oakes. (D & OS).  
Home office: Kansas City, Mo. (see for prod. distributed).  
Giant One Stop, 203 E. Douglas. Zip: 67202. Tel: AM 5-7508. Owner: I. Albert. (OS), (RS as Reco-Rak Dist.).  
Reco-Rak Dist. (RJ), see Giant One Stop.

## KENTUCKY

### ● CAMPBELLSVILLE (Area Code 502)

Central Electronics, PO Box 340, 113 N. Central Ave. Zip: 42718. Tel: 465-5631. Owner: Randall B. Herron. (D, OS & RJ).  
Cartridge 8-tr.: ITCC, NAL, Paramount, Pickwick, Premier, Radiant, Sing, Skylite, Songs of Faith, Stateswood.  
Cartridge 4-tr.: ITCC, NAL, Pickwick.  
Cassette: ITCC, NAL, Premier, Radiant, Sing, Skylite.  
Open reel: ITCC, Stereo Tape.  
Playback equip.: Arthur Fulmer, Juliette, Major, Stradivaro.  
Accessories: Caddies (Amberg, Athena); head-cleaners (ITCC, NAL); Channel Mktg.

### ● LOUISVILLE (Area Code 502)

Arthur Fulmer, 950 S. Third St. Zip: 40203. Tel: 584-0263. Mgr.: Les Rushing. (D & I).  
Home office: Memphis, Tenn. (see for prod. distributed).  
Handleman Co., 4500 Louisville Ave. Zip: 40209. Tel: 361-1336. Mgr.: Fred H. Carter. (RJ).  
Home office: Detroit, Mich.  
Kentuckiana Rec. Sales, PO Box 261, 560 S. Fourth St. Zip: 40202. Tel: 582-3331. VP & Mgr.: Kenneth Vine. (OS).  
Kincheloe Radio Serv. Inc., 830 S. First St. Zip: 40203. Tel: 585-5126. Owner & Mgr.: Bill Douglas. (D).  
Cartridge 8-tr.: Ampex, Capitol, Columbia, Decca, Liberty.  
Playback equip.: Motorola.  
Accessories: Caddies (Amberg).  
Kings Rec. Shop, 240 W. Jefferson St. Zip: 40202. Tel: 584-5535. Owner & Mgr.: Gene King. (OS).  
Orbit Radio, 831 W. Main. Zip: 40201. Tel: 895-1143. Mgr.: S. A. Cisler. (I & E).  
Imports: Pre-recorded tape; playback equip. (Germany, Japan; Revox from Switzerland).  
Exports: Pre-recorded tape, playback equip.  
Shively One Stop, 4464 Shively Center. Zip: 40216. Tel: 447-4951. Owner & Mgr.: A. R. Brown. (OS).  
Tiff's Discount Rec. Store, 309 S. Fourth St. Zip: 40202. Tel: 584-4933. Owner: Martin Cohn; Mgr.: Ralph Gunning; Buyer: Gregory Searcy. (OS).

### ● OWENSBORO (Area Code 502)

Wax Works Inc., 320 Washington Ave. Zip: 42301. Tel: 683-1585. Owners: Leroy & Terry Woodward; Buyer: Terry Woodward. (OS & RJ).  
Webster's Inc., 320 Washington Ave. Zip: 42301. Tel: 684-2791. Owner & Mgr.: Doug Webster. (RJ).

## LOUISIANA

### ● ALEXANDRIA (Area Code 318)

Music Racks, 1406 Fourth St. Zip: 71301. Tel: 443-0540. Mgr.: R.D. Davis; Buyer: John Davis. (RJ).

### ● METAIRIE (Area Code 504)

Hel-Lo Rec. Co. Inc., 710 Aris Ave. Zip: 70005. Tel: 831-1356. Pres.: Vincent P. Lofaso. (RJ).

### ● MONROE (Area Code 318)

Rack Serv. Mdsrs. Inc., 2601 Newcomb St. Zip: 71201. Tel: 322-1446. Mgr.: W.H. Chambliss; Buyer: Patricia Chambliss. (RJ).

### ● NATCHITOCHE (Area Code 318)

R & S Recs., 111 Second St. Zip: 71457. Tel: 352-9255. Owner & Mgr.: S. Vance. (OS).

### ● NEW ORLEANS (Area Code 504)

- All South Dist'g Corp., 1924 Lafayette St. Zip: 70113. Tel: 522-1157. Owner & Mgr.: Henry Hildebrand Jr.; Buyer: Elmo Sonnier. (D, OS & RJ).  
Cartridge 4-tr., 8-tr. & cassette: All lines.  
Open reel: A&M, Ampex.  
PlayTape.  
Playback equip.: Belair, Craig, Crown, Electra, Mayfair, Qatron, Stereodyne, Telex, Tenna, Webcor.  
Accessories: Le-Bo.  
Bernard Rec. & Tape Sales, PO Box 13487, 4006 Eden St. Zip: 70125. Tel: 822-1418. Owner & Mgr.: Jack Bernard. (OS).  
Columbia Rec. Sales, John Hancock Bldg., St. Charles Ave. at Lee Circle. Zip: 70130. Tel: 524-4546. Sales Mgr.: Bill Shaler; Audio Sales Mgr.: Bert Cass. (D).  
Cartridge 8-tr.: Columbia, Date, Epic, Okeh, Ode, Barnaby, Fillmore, Blue Horizon.  
Cartridge 4-tr.: Columbia, Date, Epic, Okeh, Ode, Blue Horizon.  
Cassette: Same as 8-tr.  
Open reel: Same as 4-tr.  
Playback equip.: Masterwork.  
Accessories: Blank loaded tape, storage cases (Columbia).  
Decca Dist. Corp., 8135 Earhart Blvd. Zip: 70118. Tel: 486-6026. Mgr.: Stan Layton. (D).  
Cartridge 8-tr.: Decca, Coral, Brunswick, Bravo, Viva, Berlitz, Elektra, Standard Phono.  
Cassette: Decca, Coral, Brunswick, Bravo, Viva.  
Open reel: Decca, Coral, Brunswick.  
Playback equip.: Decca.  
Accessories: Blank loaded tape, head cleaners, storage cases (Decca).  
Delta Rec. Dist'g Co. Inc., 1023 Baronne St. Zip: 70113. Tel: 525-7104. Mgr.: Gene Burley; Buyer: Lenny Samuel. (D & OS).  
Cartridge 8-tr. & cassette: Ampex, DGG, GRT, Kent, Modern, NAL, Stax, Volt.  
Playback equip.: Mayfair, Philco-Ford.  
McDonald Sales Corp., 5000 River Rd. Zip: 70123. Tel: 733-6653. Owner: David Oreck; Mgr.: J. M. Clapp. (D).  
Cartridge 8-tr. & cassette: Ampex, Atco, Atlantic, GRT, RCA.  
Open reel: Ampex, RCA.  
Playback equip.: RCA.  
Musical Isle of America Inc. (An Entertainment Serv. of Transamerica Corp.), 757 Central Ave. Zip: 70121. Tel: 833-3735. Mgr.: George Berry. (RJ).  
Home office: Los Angeles, Calif.  
Paramount Rec. Dist., PO Box 29406. Zip: 70127. Tel: 522-3661. Mgr.: Jim Flatman. (D).  
Cartridge 8-tr. & cassette: Paramount.  
Record Sales of Louisiana Inc., 800 Central Ave. Zip: 70121. Tel: 831-2631. Mgr.: Lee Clark. (D).  
Cartridge 8-tr.: Double Shot, Liberty, Metro-media, United Artists.  
Cartridge 4-tr.: Double Shot, Liberty.  
Cassette: Liberty, Metro-media, United Artists.  
Open reel: Stereo Tapes.  
Accessories: Carrying cases.  
Territo's, 510 Lafayette St., Gretna 70053. Tel: 361-9168. Owner & Buyer: Samuel C. Territo. (OS).
- **SHREVEPORT (Area Code 318)**  
B & B Sales Inc., 211 N. Market. Zip: 71107. Tel: 422-9382. Buyer: Al Bell. (D).  
Cartridge 4-tr., 8-tr. & cassette: Adell, Capitol, Columbia, Decca, Dooto, ITCC, Jay Gee, Liberty, Mercury, Modern, Muntz, Radiant, Spar, Vivid Sound.  
Playback equip.: Automatic Radio, Belair, Craig, Muntz, Panasonico.  
Stan's Rec. Serv., 728 Texas St. Zip: 71102. Tel: 422-7182. Owner: Stanley J. Lewis; Mgrs.: Ronnie Lewis & Jessie Camp. Buyer: Jessie Camp. (D, OS & RJ).  
Cartridge 4-tr., 8-tr. & cassette: Ampex, Atco, Atlantic, Disneyland, GRT, Jewel, Kama Sutra, Kapp, La Louisianne, MGM, Motown, Musicor, Paramount, Paula, RCA, Soul, Stax, Swallow, Tamla.  
Playback equip.: Automatic Radio.  
Accessories: Blank loaded tape, head cleaners, storage cases (Le-Bo).
- **VILLE PLATTE (Area Code 318)**  
Floyd's Rec. Shop, PO Box 506. Zip: 70586. Tel: 363-2184. Owner: Floyd Soileau; Mgr.: Ray Lafleur; Buyer: Terry Lafleur. (D & OS).  
Cartridge 8-tr.: Swallow & various Cajun prod.  
Playback equip.: Lear Jet, Panasonic.

## MAINE

### ● PORTLAND (Area Code 207)

Commercial Dist., 212 Anderson St. Zip: 04101. Tel: 774-5362. Owner: Jack Holmes; Mgr. & Buyer: V. Harry Mooradian. (D, OS & RJ).  
Cartridge 8-tr. & cassette: All lines.  
Maine Rec. Dist., 200 Anderson St. Zip: 04101. Tel: 772-5665. Pres.: John Jannace; Mgr.: Dave Gonyer; Sales Mgr.: Russell Mundi. (D).  
Cartridge 8-tr.: ABC, A&M, Archive, Atco, Atlantic, Bang, Bell, Capitol, Columbia, Com-

mand, Decca, Deram, Dunhill, Elektra, Kapp, London, MGM, Mercury, Monument, New Voice, Parrot, RCA, Reprise, Scepter, Vanguard, Warner Bros.-Seven Arts, White Whale.  
**Cassette:** Archive, Atco, Atlantic, Capitol, Columbia, Decca, Deram, Dunhill, Elektra, London, MGM, Parrot, Reprise, Warner Bros.-Seven Arts.  
**Portland Recs. Inc.,** 84 W. Cove St. Zip: 04101. Tel: 772-6551. Mgr. & Buyer: C. Roy Rice. (D & RJ).  
**Cartridge 8-tr. & cassette:** ABC, Bang, Bell, Bluesway, Buddah, Checker, Command, Decca, Diamond, Dot, Dunhill, Hickory, Kama Sutra, Kapp, King, Monument, Moonglow, Musicor, New Voice, Paramount, Plantation, Project 3, Ranwood, Roulette, Scepter, Starday, Tower, 20th Century-Fox, Uni, Verve, Wand, White Whale.  
**Playback equip.:** Lear Jet, Masterwork, Toshiba.  
**Accessories:** Le-Bo, Recoton.

## MARYLAND

• **BALTIMORE (Area Code 301)**  
 (Also see listings under District of Columbia)

**Atlas Rack** (div. of General Dist'g Co. Inc.), 2329 Pennsylvania Ave. Zip: 21217. Tel: 669-6411. Pres.: Henry Nathanson; Dist. Mgr.: Charles E. Gray; RJ & OS Mgr.: Barry J. Dalnekoff; Buyer: Barry J. Dalnekoff. (D, OS & RJ).  
**Cartridge 8-tr. & cassette:** ABC, Abnak, Accent, Alegre, Amy, Arctic, Audio Fidelity, Backbeat, Bang, Barry, Bell, Bluesway, Blue Thumb, Boone, Bouquet, Buddah, Bunky, Cadet, Cadet/Concept, Canyon, Celestial, Century City, Chart, Checker, Chess, Command, Crescendo, Crewe, Diamond, Douglas, Duke, Dunhill, Dynamo, Dyno-voice, Era, Excello, Fiesta, Four Corners of the World, GNP Crescendo, GRT, Gamble, Goldwax, Gospel, Hickory, Hob, Impulse, ITCC, International Artists, Jad, Jamie, Kapp, Kent, King, Laurie, Little Darlin', Livingston, MTA, Mace, Metromedia, Mobile Fidelity, Modern, Monument, Moonglow, Mud, Musicor, NAT, Nashboro, Nashville, New Voice, Orbit, Palisade, Paula, Peacock, Pete, Phil-L.A. of Soul, Philly Groove, Plantation, Polydor, Prestige, Project 3, Ranwood, Request, Revue, Rising Sons, Riverside, Roulette, SSS Int'l, Savoy, Scepter, Senate, Sidewalk, Skye, Starday, Stop, Sun, TRX, Tetragrammaton, Tico, Tower, Tradition, 20th

Century-Fox, Uni, VMC, Vault, Vee Jay, Wand, Westminster, White Whale.  
**Coronet Music, 4724 Bonnie Brae Rd.** Zip: 21208. Tel: 655-5145. Owners & Mgrs.: Sam Anoff, Leonard Radinsky; Buyer: Sam Anoff. Branch: 3626 1/2 Woodland Ave. Zip: 21215. Tel: 542-4496. (RJ).  
**D & H Dist'g Co., 2025 Worcester St.** Zip: 21230. Tel: 727-5100. Mgr.: David Press; Buyers: Eugene Diveglia, Gerhardt Stronkowski. (OS & RJ).  
**Home office:** Harrisburg, Pa.  
**Decca Dist. Corp., 2921 Alexander Ave.** Zip: 21215. Tel: 367-0710. Mgr.: J. Edward Keelan. (D).  
**Cartridge 8-tr.:** Decca, Coral, Brunswick, Bravo, Viva, Berlitz, Colonial, Standard Phono.  
**Cassette:** Decca, Brunswick, Bravo, Viva.  
**Open reel:** Decca, Coral, Brunswick.  
**Playback equip.:** Decca.  
**Accessories:** Blank loaded tape, head cleaners, storage cases (Decca).  
**Ellis Dist'g Corp., 5256 Fairlawn Ave.** Zip: 21215. Tel: 367-0700. Owner: Edgar H. Ellis; Mgr.: James Gayhardt; Buyer: Thomas Ansteatt. (D & RJ).  
**Cartridge 8-tr. & cassette:** Capitol, Columbia, Decca, GRT, ITCC, RCA.  
**Playback equip.:** Capitol, Dyn Sonic, Mayfair.  
**Accessories:** Amberg, Capitol, Le-Bo, Recoton.  
**Jalen Amusement Co. Inc., 1215 S. Howard St.** Zip: 21230. Tel: 837-2670. Buyers: J. M. Jones, C. Rogers. (D & RJ).  
**Cartridge 8-tr. & cassette:** GRT, ITCC, Wand-Scepter; all budget lines.  
**Liberty/UA Dist'g Corp.—Baltimore Branch, 11151 Viers Mill Rd., Wheaton 20902.** Tel: 946-7242. Mgr.: Lou Monette. (D).  
**Cartridge 8-tr.:** Liberty, United Artists, Sunset.  
**Cartridge 4-tr. & cassette:** Liberty, United Artists.  
**Marshall/Mangold Dist'g Co. Inc., 4805 Nelson Ave.** Zip: 21215. Tel: 542-7214. Owner: Mandy Goldberg; Mgr.: Frances Youngblood; Sales Mgr.: William Rich. (D).  
**PlayTape.**  
**Musical Sales One Stop Inc., 134 W. Mount Royal Ave.** Zip: 21201. Tel: 837-5757. Owner: Milton Bereson; Buyer: John Lagenfelder. (OS).  
**Redisco (The Records Dist'g Co.), 1815 Guilford Ave.** Zip: 21202. Tel: 727-6420. Owner: Oscar Buchman; Mgr.: Milton Mehlman. (OS).  
**Y R S Dist's., 3123 W. North Ave.** Zip: 21216. Tel: 566-5400. Owner: Earnest L. Burston; Mgr.: Otto Burston. (D). Branch: Your Super Music. (OS).  
**Cartridge 8-tr. & cassette:** Apex, Laff.

*continued on page 54*

NEW FROM...

# Audiotrax

## A COLLECTION OF CURRENT TOP-HITS ON ONE TAPE

THE NO.1 SONGS TOGETHER  
 IN THE CATAGORY OF...  
**ROCK, BLUES, SOUL,  
 FOLK, COUNTRY,  
 JAZZ, ETC. WITH  
 RELEASES EACH MONTH**

A NEW CONCEPT IN  
 PROGRAMING OF STEREO  
 CARTRIDGE TAPES; TO GIVE  
 THE PUBLIC WHAT THEY WANT  
 AND WHICH IN TURN WILL  
 BOOST SALES; USING OUR  
 EXCLUSIVE BI-SONIC  
 SPECTRUM SOUND PROCESS  
 WE CAN PRODUCE AN  
 EXCEPTIONAL AND EXCITING  
 STEREO SOUND REPRODUCTION.

AVAILABLE ON 8 TRACKS & CASSETTES

**HIGHEST QUALITY  
 LOWEST PRICES**

**NATION-WIDE  
 DISTRIBUTION**

WRITE

**Audiotrax**

16449 VANOWEN ST.  
 VAN NUYS, CALIFORNIA 91406

A DIVISION OF *cap*

**YOUR ONE-STOP DISTRIBUTOR  
 FOR TAPES AND EQUIPMENT**

**CAROLINA SALES CORP.**

**EXCLUSIVE DISTRIBUTOR FOR**

**LEAR JET STEREO-8**

**FOR THE**

**COMPLETE CAROLINAS**

... also ...

**ALL MAJOR 8-TRACK  
 TAPE LABELS**

— Sales and Service • Wholesale Only —

★ **CAROLINA  
 SALES CORP.** ★

P.O. Box 1927, Greenville, North Carolina 27834

(919) 752-3143

## DISTRIBUTORS

Continued from page 53

Your Super Music, 509 N. Gay St. Zip: 21202. Tel: BR 6-3770. Owner: Earnest L. Burston; Mgr.: Otto Burston. (OS). (See YRS Dist.).  
Jos. M. Zamoiski Co., 1101 DeSoto Rd. Zip: 21223. Tel: 644-2900. Dist. Mgr.: Art Gelles; OS Mgr.: Maury Bass; RJ Mgr.: Ed Fitch; Buyer: Al Shevitz. (D, OS, RJ).  
Cartridge 8-tr. & cassette: Ampex, GRT, ITCC, Kapp, Mercury, NAL, RCA, Scepter.  
Playback equip.: Belair, Norelco, Tenna.

### • CHEVERLY (Area Code 301)

D & H Dist'g Co., 2500 Schuster Dr. Zip: 20781. Tel: 322-3500. Mgr.: George Nesline. (D).  
Home office: Harrisburg, Pa. (see for prod. distributed).

### • HAGERSTOWN (Area Code 301)

Interstate Rec. Dist. Inc., 211 S. Locust St. Zip: 21740. Tel: 733-1378. Owners: Richard & Melvin Greenwald; Mgr.: Carlton Smith. (OS & RJ).

### • LAUREL (Area Code 301)

Transcontinental Music Corp., 333 Marshall Ave. Zip: 20810. Tel: 792-7775. Mgr.: Larry Goldberg. (RJ).  
Home office: New York, N.Y., Transcontinental Investing Corp.

### • ROCKVILLE (Area Code 301)

Chase Mktg. Co., 12160 Parklawn Dr. Zip: 20852. Tel: 933-5880. Owner: Jack Black; Mgr.: Robert Wilson; Buyer: Edith Black. (D, OS & RJ).

Cartridge 8-tr.: ABC, A&M, Atco, Atlantic, Bang, Bell, Capitol, Columbia, Command, DGG, Decca, Deram, Dunhill, Elektra, Fantasy, Impulse, Kama Sutra, Kapp, King, London MGM, Monument, Motown, Musicor, New Voice, Paramount, Parrot, RCA, Reprise, Roulette, Savoy, Scepter, Starday, 20th Century-Fox, Uni, Vanguard, Verve, Viva.  
Cassette: ABC, A&M, Atco, Atlantic, Bang, Bell, Cadet, Capitol, Columbia, Command, Decca, Deram, Dunhill, Elektra, Fantasy, Impulse, Kama Sutra, Kapp, King, London, MGM, Mercury, Monument, Motown, Paramount, Parrot, RCA, Reprise, Roulette, Scepter, 20th Century-Fox, Verve, Warner Bros.-Seven Arts.  
Open reel: Ampex.

Playback equip.: Belair, Craig, Roberts.  
Accessories: Blank cassettes (TDK); car stereo speakers (Sparkomatic); carrying cases (Le-Bo); demagnetizers, jacks (Calrad); power converters (ATC).

### • SILVER SPRING (Area Code 301)

Columbia Rec. Sales, 8720 Georgia Ave. Zip: 20910. Tel: 587-5000. Sales Mgr.: George Deacon; Audio Sales Mgr.: Jack Cassidy. (D).  
Cartridge 8-tr.: Columbia, Date, Epic, Okeh, Ode, Barnaby, Fillmore, Blue Horizon.  
Cartridge 4-tr.: Columbia, Date, Epic, Okeh, Ode, Blue Horizon.  
Cassette: Same as 8-tr.  
Open reel: Same as 4-tr.  
Playback equip.: Masterwork.  
Accessories: Blank loaded tape, storage cases (Columbia).

## MASSACHUSETTS

### • BOSTON METROPOLITAN AREA (Area Code 617)

Boston Rec. Dist. Inc., 150 Vernon St. Zip: 02120. Tel: 442-2345. Owner & Buyer: Jerry Flatto. (OS & RJ).

Bulldog Dist. Inc., 58 Buffum St., Lynn 01902. Tel: 593-3920. Mgr.: Nicholas Sentas. (D).  
Cartridge 8-tr.: Conversa-Phone, Eurotone, Monitor.  
Cassette: Vox.

Capitol Recs. Dist'g Corp., 71 Fourth Ave., Needham Heights 02194. Tel: 449-0770. (D).  
Cartridge 8-tr. & cassette: Capitol, Angel, Melody/Angel, Apple, Harvest, Fame.  
Playback equip.: Capitol.  
Accessories: Display racks, storage cases (Capitol).

Circle Dist. Corp. (OS), see Music Suppliers Inc.  
Columbia Rec. Sales, John Hancock Bldg., 75 Third Ave., Waltham 02154. Tel: 899-3814. Mgr.: George Ryan; Audio Sales Mgr.: Reggie Gussman. (D).  
Cartridge 8-tr.: Columbia, Date, Epic, Ode, Okeh, Barnaby, Fillmore, Blue Horizon.  
Cartridge 4-tr.: Columbia, Date, Epic, Okeh, Ode, Blue Horizon.  
Cassette: Same as 8-tr.  
Open reel: Same as 4-tr.  
Playback equip.: Masterwork.  
Accessories: Blank loaded tape, storage cases (Columbia).

Decca Dist. Corp., 900 Providence Hwy. Rear, Dedham 02026. Tel: 329-1165. Mgr.: Allan M. Ross. (D).  
Cartridge 8-tr.: Decca, Coral, Brunswick, Bravo, Viva, Berlitz, Colonial, Standard Phono.  
Cassette: Decca, Coral, Brunswick, Bravo, Viva.  
Playback equip.: Decca.  
Accessories: Blank loaded tape, head cleaners, storage cases (Decca).

Dick's Rec. Co. Inc., 890 Providence Hwy. Rear, Rt. 1, Dedham 02026. Tel: 326-8790. Owner: Richard L. Mitchell; Mgr. & Buyer: Richard Peach. (OS).  
Disc Dist. Inc. & Hitsville of Boston, 19 Walnut St., West Roxbury 02132. Tel: 327-1234. Owner: Jack Sager; Mgr.: Red Spellman; Sales Mgr.: Frank Spellman. (D).  
Cartridge 8-tr. & cassette: Cotillion, GRT, Gordy, Kent, Modern, Motown, Soul, Tamla.  
Playback equip.: Automatic Radio.  
Accessories: Blank loaded cassettes, magnetic tape.

Disco Inc., 339 Broadway, Everett 02149. Tel: 389-7200. Buyer: Fred Traub. (OS & RJ).  
E-Z One Stop Rec. Serv. Inc., 893 Dorchester Ave., Dorchester 02125. Tel: 282-8700. Owners: Michael Sciarappa, Robert Levin; Mgr.: Wes Bonner; Buyer: Mickey Sciarappa. (OS).  
Eastco, 26 Dartmouth St., Westwood 02090. Tel: 329-3000. Mgr.: Alan Sack; Buyer: Tony Pagliocca. (D).  
Cartridge 8-tr.: RCA, Buena Vista, Chart, Colgems, Diamond, Gamble, Kirshner, Poppy, Prestige, Request, White Whale.  
Cassette: RCA, Chart, Colgems, Kirshner, Request.

Liberty/UA Dist'g Corp.—Boston Branch, 480 Neponset St., Canton 02021. Tel: 828-6040. Mgr.: Richard Fitzsimmons. (D).  
Cartridge 8-tr.: Liberty, United Artists, Sunset.  
Cartridge 4-tr. & cassette: Liberty, United Artists.

Massachusetts Rec. Dist'g Co., 633 Massachusetts Ave. Zip: 02118. Tel: 266-1002. Owner: Fred LeBlanc; Mgr.: Skippy White. (D & OS).  
Cartridge 8-tr.: Dooto, GRT, ITCC, Laff, LaVal, Livingston, NAL, Redd Foxx, Scepter, Specialty.  
Cassette: Dooto, GRT, ITCC, Livingston, NAL, Redd Foxx, Scepter, Specialty.  
Playtape.  
Playback equip.: Belle Wood, PlayTape.  
Accessories: Blank tape (BASF, Channel Mktg., Irish); head cleaners (Channel Mktg.).  
Merrec Dist. Inc., 375 Elliot St., Newton Upper Falls. 02164. Tel: 969-6505. Mgr.: John Penney. (D).  
Cartridge 8-tr.: Mercury, Philips, Smash, Fontana, Limelight.  
Cassette: Mercury, Philips, Smash, Fontana, Limelight, Audio Fidelity, Chart, Hickory, Roulette, Tico, United Artists, Vanguard, Veep.  
Music Suppliers Inc., 75 N. Beacon St. Zip: 02134. Tel: AL 4-1780. Pres.: Harry Carter; Dist. Mgr.: James Lawson; OS Mgr.: Vahon Aghadjanian; Buyer: James Lawson. (D, OS as Circle Dist. Corp.).  
Cartridge 8-tr., cassette & open reel: All lines.  
New England One-Stop Rec. Dist. Inc., 290 Moody St., Waltham 02154. Tel: 894-4800. VP. & Mgr.: Robert Kallish. (OS).  
Paramount Rec. Dist. Inc., 1725 Revere Beach Pkwy., Everett 02149. Tel: 387-7770. Mgr.: Don Masters. (D).  
Cartridge 8-tr. & cassette: Paramount.  
Riverboat Ent., 141 Columbia St., Cambridge 02139. Tel: 868-9788. Owner: Ralph Dompemeyer; Mgr. & Buyer: Dave Wilson. (D).  
Cartridge 8-tr.: International Artists.

Royal Dist., 895 Dorchester Ave. Zip: 02125. Tel: 282-1411. Owner & Buyer: Aaron Gross. (D).  
Cartridge 8-tr. & cassette: Flair 30, Modern.

Temple Sales Inc., 359 Washington St., Malden 02148. Tel: 321-2600. Mgr.: Richard D. Siegal; Buyer: Paul Shumsker. (D, OS & RJ).  
Cartridge 8-tr. & cassette: Capitol, Columbia, Decca, GRT, ITCC, Jubilee, Kapp, NAL, Scepter.  
Playback equip.: Automatic Radio, Capitol, Juliette.

Transcontinental Dist'g Corp., 30 Nashua Ave., Woburn 01801. Tel: 935-4700. Mgr.: Glenn Mosley. (D), (RJ as Transcontinental Music Corp.).  
Home office: New York, N.Y., Transcontinental Investing Corp.  
Cartridge 8-tr. & cassette: A&M, Atco, Atlantic, Crewe, FBI, Disneyland, Elektra, Enterprise, Fantasy, Fiesta, Grecophon, Gross, Josie, Jubilee, Kapp, Metromedia, Musicor, Original Sound, Prestige, Project 3, San Francisco, Stax, Volt, Wand.  
Open reel: A&M.

Transcontinental Music Corp. (RJ), see Transcontinental Dist'g Corp.

W S One Stop Inc., 40 Teed Dr., Randolph 02368. Tel: 963-5080. Mgr. & Buyer: Peter McDermott. (OS).

### • NEW BEDFORD (Area Code 617)

Penco Rec. Co., 428 Wood St. Zip: 02745. Tel: 995-0595. Owners: Francisco Penha, Americo Afonso; Mgr.: Francisco Penha. (I & E).  
Imports: Pre-recorded tapes—Alvorada, Coimbra, Estudio, Lisboa, Rapsodia, Tecla (Portugal).  
Exports: Pre-recorded tapes.

### • SOMERSET (Area Code 617)

Northeast Recs. Inc., 185 Riverside Ave. Zip: 02725. Tel: 676-3061. Pres. & Mgr.: Dan Gittelman. (D).  
Cartridge 8-tr.: Camden, Mercury, RCA.  
Cassette: Mercury, RCA.  
Open reel: Camden, RCA.

### • SPRINGFIELD (Area Code 413)

Decca Dist. Corp., 293 Graystone Ave., West Springfield 01089. Tel: 736-9113. Mgr.: Harry Borrelli. (D).  
Cartridge 8-tr.: Decca, Coral, Brunswick, Bravo, Viva, Berlitz, Colonial, Standard Phono.  
Cassette: Decca, Coral, Brunswick, Bravo, Viva.  
Playback equip.: Decca.  
Accessories: Blank loaded tape, head cleaners, storage cases (Decca).

## MICHIGAN

### • DEARBORN (Area Code 313)

Radio Frank Inc., 1444 Michigan Zip: 48126. Tel: LU 4-6880. Owner: F. M. Neckrock; Mgr. & Buyer: W. F. Neckrock. (D & OS).  
Cartridge 8-tr. & cassette: A&M, Ampex, Atlantic, Capitol, Colonial, Columbia, Fiesta, GRT, Gross, ITCC, Liberty, Motown, RCA, Reprise, Scepter, United Artists, Warner Bros.-Seven Arts.  
Playback equip.: Ampex, Audiovox, Automatic Radio, Boman, Concord, Craig, Crown, Electro-Brand, Electro-Phonic, Kraco, Lloyds, Motorola, Muntz, Pax, RCA, Ranger, Roberts, Sharp, Sony, Stradivaro, Tenna.  
Accessories: Clips (Capitol); head cleaners (own brand); storage cases (Amberg, Capitol, Le-Bo).

### • DETROIT (Area Code 313)

Angott Rec. Sales, 2616 Puritan St. Zip: 48238. Tel: 341-7053. Owners: Allen Walker, Ron Rogers; Buyer: Ron Roger. (OS).

Arc-Jay Kay Dist'g Co. (div. of Handleman Co.), 2211 W. Edsel Ford Pkwy. Zip: 48208. Tel: 361-5500. Mgrs.: Henry Droz, John Kaplan (D).  
Home office: Detroit, Mich., Handleman Co. (RJ).  
Cartridge 4-tr., 8-tr., cassette & open reel: All lines.

Auto Sound Dist. Inc., 20322 Livernois. Zip: 48221. Tel: 864-2892. Owner: Jack Frankford; Mgr. & Buyer: Bob Weaver. (D, OS & RJ).

Cartridge 8-tr.: A&M, Ampex, Capitol, Columbia, Decca, Dooto, GRT, ITCC, Kapp, Liberty, Mercury, Motown, NAL, Paramount, RCA, United Artists, Warner Bros.-Seven Arts.  
Cassette: A&M, Capitol, Columbia, Decca, Dooto, GRT, Kapp, Liberty, Mercury, Motown, Paramount, RCA, United Artists, Warner Bros.-Seven Arts.  
Playback equip.: Ampex, Belair, Craig, Panasonic.

Accessories: Capitol, Recoton, Specialty Sound, Vari-Prod.  
Cadet Dist. Co. Inc., 13380 Capital Ave., Oak Park 48237. Tel: 548-3171. Owners: Harry & Isadore Levin; Buyer: Harry Levin. (D & OS), (RJ as Cornell Recs. Inc.).  
Cartridge 8-tr. & cassette: Ampex, GRT, ITCC, RCA.  
Playback equip.: Belair.  
Accessories: Storage cases (Amberg, Le-Bo).

Capitol Recs. Dist'g Corp., 18921 Wyoming Ave. Zip: 48221. Tel: 864-5001. (D).  
Cartridge 8-tr. & cassette: Capitol, Angel, Melody/Angel, Apple, Harvest, Fame.  
Playback equip.: Capitol.  
Accessories: Display racks, storage cases (Capitol).

Columbia Rec. Sales, 16141 W. Eight Mile Rd. Zip: 43245. Tel: 273-8616. Sales Mgr.: John Kotecki; Audio Sales Mgr.: Lee Hubbard (D).  
Cartridge 8-tr.: Columbia, Date, Epic, Okeh, Ode, Barnaby, Fillmore, Blue Horizon.  
Cartridge 4-tr.: Columbia, Date, Epic, Okeh, Ode, Blue Horizon.  
Cassette: Same as 8-tr.  
Open reel: Same as 4-tr.  
Playback equip.: Masterwork.  
Accessories: Blank loaded tape, storage cases (Columbia).

Cornell Recs. Inc. (RJ), see Cadet.  
Handleman Co., 670 E. Woodridge St. Zip: 48226. Tel: WO 1-9563. Pres.: David Handleman; Mgr.: David Strome; Buyer: Jerry Adams. (RJ).  
Branches: Los Angeles, Calif.; Miami, Fla.; Atlanta, Ga.; Chicago, Ill.; Louisville, Ky.; Kansas City, Mo.; Pennsauken, N.J.; Charlotte, N.C.; Cleveland, Ohio; Pittsburgh, Pa.; All Brands Inc.; Dallas, Houston, Tex. (All RJ).  
Int'l branches: Canada—Calgary, Alta.; Toronto, Ont.

Joyline Rec. & Tape, 14643 Joy Rd. Zip: 48228. Tel: 584-1260. Owner: Armen Boladian; Mgr. & Buyer: Carl Mooradian. (OS & RJ).

Lear Jet Stereo Inc. (div. of Gates Rubber Co.), 13131 Lyndon. Zip: 48227. Tel: 491-1200. Mgr.: Marvin Morrison; Buyer: Pat Barrett. (D & OS).  
Cartridge 8-tr. & cassette: Adell, Ampex, Capitol, Columbia, Decca, GRT, ITCC, Kapp, Laff, Liberty, Livingston, Mercury, NAL, Paramount,

## MISSOURI

### ● KANSAS CITY (Area Code 816)

A B C Rec. & Tape Sales Corp., 2901 Grand St. Zip: 64108. Tel: 931-7652. Mgr.: Tom Kelley. (OS & RJ).  
Home office: Seattle, Wash.

Capitol Recs. Dist'g Corp., 3611 Main St., Suite 106. Zip: 64111. Tel: 531-0435. (D).  
Cartridge 8-tr. & cassette: Capitol, Angel, Melodiya/Angel, Apple, Harvest, Fame.  
Playback equip.: Capitol.  
Accessories: Display racks, storage cases (Capitol).

Choice Rec. Dists., 321 1/2 Southwest Blvd. Zip: 64108. Tel: HA 1-2540. Mgr.: Harold Hassler. (D).  
Cartridge 8-tr. & cassette: Sun, Chart, Scepter, Wand.  
Accessories: Fidelitone.

Davidson's One Stop, 321 Southwest Blvd. Zip: 64108. Tel: VI 2-5220. Owner: Mildred S. Davidson; Mgr.: L. L. Lee; Buyer: Warren C. Wright. (D & OS).  
Branches: Wichita, Kan.; Omaha, Neb.  
Cartridge 8-tr., cassette & open reel: GRT, ITCC, Mercury, NAL, Phillips, Scepter, Smash, Sun, Wand.  
Playback equip.: Dynasonic, Lear Jet, Tenna.  
Accessories: Le-Bo.

Handleman Co., 1125 Saline St., North Kansas City 64116. Tel: 421-0135. Mgr.: Frank Rochman. (RJ).  
Home office: Detroit, Mich.

Kansas City News Dist., 4231 E. 75 Terr. Zip: 64132. Tel: 373-7171. Buyer: Allan Levy. (OS).

J. L. Marsh Inc. (div. of Pickwick Int'l), 3230 (D).

Musical Isle of America Inc. (An Entertainment Roanoke Rd. Zip: 64111. Tel: 753-7444. (RJ).  
Home office: Minneapolis, Minn., Heilicher Bros. Serv. of Transamerica Corp.), 1800 Truman Rd. Zip: 64127. Tel: 221-6965. Mgr.: Tony Burasco. (OS & RJ).  
Home office: Los Angeles, Calif.

National Auto Sound Inc., 5319 Troost Ave. Zip: 64110. Tel: 333-8787. Mgr.: Ben Evans. (D).  
Home office: Shawnee Mission, Kan. (see for prod. distributed).

### ● ST. LOUIS (Area Code 314)

Columbia Recs. Sales, 1144 Hampton Ave. Zip: 63139. Tel: 647-5101. Sales Mgr.: Bob Van Metre; Audio Sales Mgr.: Neal Spencer. (D).  
Cartridge 8-tr.: Columbia, Date, Epic, Okeh, Ode, Barnaby, Fillmore, Blue Horizon.  
Cartridge 4-tr.: Columbia, Date, Epic, Okeh, Ode, Blue Horizon.  
Cassette: Same as 8-tr.  
Open reel: Same as 4-tr.  
Playback equip.: Masterwork.  
Accessories: Blank loaded tape, storage cases (Columbia).

Commercial Music Inc. (div. of Pickwick Int'l), 2020 Delmar Blvd. Zip: 63107. Tel: 241-8618. Mgr.: Bernie Barr; Buyer: Jim Meredyk. (D), (RJ as J. L. Marsh Inc.).  
Home office: Minneapolis, Minn., Heilicher Bros. (D).

Cartridge 8-tr. & cassette: A&M, Brunswick, Coral, Decca, Fantasy, Fontana, Gordy, Lime-light, Mercury, Motown, Phillips, Reprise, Smash, Soul, Tamlam, Warner Bros.-Seven Arts.  
Playback equip.: Decca.  
Accessories: Music Master.

continued on page 56

Philips, Premier, RCA, Scepter, Smash, Stax, United Artists, Volt, Wand.

Liberty/UA Dist'g Corp.—Detroit Branch, 24123 Greenfield Rd., Suite 208, Southfield 48075. Tel: 444-1698, 352-3818. Mgr.: Kevin Cummings. (D).

Cartridge 8-tr.: Liberty, United Artists, Sunset, Cartridge 4-tr. & cassette: Liberty, United Artists.

Martin & Snyder One Stop, 8880 Hubbell Ave. Zip: 48228. Tel: 272-7800. Pres.: Chet Kajeski; Mgr. & Buyer: Joe Ginter. (OS).

Merit Music Dists. Inc., 15761-65 Wyoming Ave. Zip: 48238. Tel: 863-9119. Owners: John H. Schlee, Eugene L. Silverman; Gen. & Sales Mgr.: John H. Schlee. (OS).

Rissi Electronic Supply Co., 14405 Wyoming. Zip: 48238. Tel: 834-8420. Mgr.: Mel Sisson; Buyer: Donn Rissi. (D & OS).

Home office: Grand Rapids, Mich., Radio Electronic Supply (see for prod. distributed).  
Royal Stereo Tape Co., 2950 W. Davison. Zip: 48238. Tel: 883-6565. Sales Mgr.: Stan Byrd. (D, OS & RJ).

Cartridge 4-tr., 8-tr. & cassette: All lines.  
Playback equip.: Goodway, Keystone, Kraco. Accessories: Storage cases (Amberg); Le-Bo. Trico Dist. Corp., 14130 Fenkell Ave. Zip: 48227. Tel: 835-7425. Owners: John Genna, Edwin Bugai; Mgr.: Edwin Bugai; Buyer: John Genna. (OS & RJ).

### ● ESCANABA (Area Code 906)

Lake Shore Dist'g Co., 2605 Lake Shore Dr. Zip: 49829. Tel: 786-4100. Owner & Buyer: Larry Deming. (RJ).

### GRAND RAPIDS (Area Code 616)

Kent One-Stop Inc., 41 S. Division Ave. Zip: 49502. Tel: 459-4549. Owner: William Van Gussel; Mgr. & Buyer: Tom Bowles. (OS).

Monroe Dist'g Co., 2431 Clyde Park SW. Zip: 49509. Tel: GL 2-9744. Owner: Herman Rubin; Mgr.: Alan Rubin. (RJ).

Radio Electronic Supply Co., 505 Jefferson SE. Zip: 49503. Tel: 456-1180. Owner: Emil J. Rissi; Mgr.: Douglas F. Rissi; Buyer: Donn Rissi. (D, OS & RJ).

Branches: Detroit, Mich., Rissi Electronic Supply Co. (D & OS); Kalamazoo, Mich. (D & OS); Traverse City, Mich. (D & OS).

Cartridge 8-tr.: Ampex, Capitol, Columbia, Epic, GRT, ITCC, Liberty/UA, Livingston, Mercury, NAL, Pickwick, Savoy, Scepter, Word. Cassette: Capitol, Columbia, Epic, GRT, ITCC, Liberty/UA, Mercury, NAL, Pickwick, Scepter, Sentry.  
Open reel: Columbia, GRT.  
Playback equip.: Concord, Lear Jet, Motorola, Roberts, Telex.

Accessories: Amberg, Freedman Artcraft, Reco-ton.

### ● KALAMAZOO (Area Code 616)

Lee Dist'g Co., 5159 E. Main St. Zip: 49004. Tel: 343-3736. Owner & Mgr.: Ted G. Howell. (OS).  
Radio Electronic Supply Co., 822 Mills. Zip: 49001. Tel: 382-2250. (D & OS).

Home office: Grand Rapids, Mich. (see for prod. distributed).

### ● NEW HAVEN (Area Code 313)

Music City Dists. Inc., 56830 North Ave. Zip: 48048. Tel: 749-5182. Mgr.: Johnny Powers. (D & OS).

Cartridge 8-tr. & cassette: Cupid, Ethnic, Jay Jay, Keepsake, Sound, Universal Sound.

### ● OWOSSO (Area Code 517)

Warren Radio Co., 311 S. Cedar. Zip: 48867. Tel: 723-5239. Mgr.: Arnold Beemer. (D).  
Cartridge 8-tr. & cassette: All lines.

Playback equip.: Automatic Radio, Channel Master.  
Accessories: Fidelitone head cleaners.

### ● TRAVERSE CITY (Area Code 616)

Radio Electronic Supply Co., 715 Beitner. Zip: 49684. Tel: WI 6-5153. (D & OS).  
Home office: Grand Rapids, Mich. (see for prod. distributed).

Cartridge 8-tr. & cassette: Capitol, Angel, Melodiya/Angel, Apple, Harvest, Fame.  
Playback equip.: Capitol.

Accessories: Display racks, storage cases (Capitol).

Columbia Rec. Sales, 4570 W. 77 St., Suite 224, Minneapolis 55435. Tel: 920-8655. Sales Mgr.: Ron Piccolo; Audio Sales Mgr.: Bob Ewald. (D).  
Cartridge 8-tr.: Columbia, Date, Epic, Okeh, Ode, Barnaby, Fillmore, Blue Horizon.

Cartridge 4-tr.: Columbia, Date, Epic, Okeh, Ode, Blue Horizon.

Cassette: Same as 8-tr.  
Open reel: Same as 4-tr.  
Playback equip.: Masterwork.

Accessories: Blank loaded tape, storage cases (Columbia).

Dart Recs. Inc., 730 N. Lyndale Ave., Minneapolis 55411. Tel: 374-3420. Mgr.: Richard J. Daly; Buyer: Joel Coryell. (OS & RJ). See Jather Dist'g Corp.

Heilicher Bros. Inc. (div. of Pickwick Int'l Inc.), 7600 Wayzata Blvd., Minneapolis 55426. Tel: 544-4201. Mgr.: Ken Hegstrom; Buyer: Robert Dahle. (D), (OS as J. L. Marsh Inc., RJ as All Rec. Sales Inc.).

Branches: Des Moines, Iowa, J. L. Marsh Inc. (RJ); Kansas City, Mo., J. L. Marsh Inc. (RJ); St. Louis, Mo., Commercial Music Inc. (D), J. L. Marsh Inc. (RJ); Arlington, Tex., J. L. Marsh Inc. (RJ).

Cartridge 8-tr.: A&M, Atco, Atlantic, Brunswick, Camden, Colgems, Coral, Decca, Elektra, Fontana, Gordy, Gross, Hip, Jubilee, Kirshner, Liberty, Mercury, Motown, Phillips, Poppy, RCA, Reprise, Scepter, Smash, Soul, Stax, Tamlam, Volt, Warner Bros.-Seven Arts.

Cartridge 4-tr.: A&M, Brunswick, Coral, Decca, Liberty.

Cassette: A&M, Atco, Atlantic, Brunswick, Camden, Colgems, Coral, Decca, Elektra, Gordy, Gross, Jubilee, Kirshner, Liberty, Mercury, Motown, Phillips, Poppy, RCA, Reprise, Smash, Soul, Stax, Tamlam, Warner Bros.-Seven Arts.

Open reel: A&M, Brunswick, Camden, Colgems, Coral, Decca, Kirshner.

Playback equip.: Belle Wood, Craig, Lear Jet, Lloyds, Telex, V-M.

Accessories: Amberg, GW, Gusdorf, Le-Bo, Meryon, Music Master, Recoton, Rubbermaid, Seebro, Soma.

Jather Dist'g Corp., 730 N. Lyndale Ave., Minneapolis 55411. Tel: 374-3420. Owner: Jack A. Taylor; Mgr.: Walter Frit; Buyer: Dianne Clinton. (D), (OS & RJ as Dart Recs. Inc.).

Cartridge 4-tr., 8-tr. & cassette: United Artists. J. L. Marsh Inc. (div. of Pickwick Int'l Inc.) (RJ), see Heilicher Bros.

Rapid Mdsq. Co., 8175 Lewis Rd., Minneapolis 55427. Tel: 544-3561. VP: Noel Korengold. (D & RJ).

Branches: Santa Ana, Calif.; Middlesex, N.J.

Cartridge 8-tr. & cassette: All lines.  
Re-Mark-Co., 528 Hennepin Ave., Suite 217, Minneapolis 55403. Tel: 335-0124. Owner & Buyer: J. L. Goldstein. (OS & RJ).

Select-O-Rax Inc., 6930 Rosemary Rd., Hopkins 55343. Tel: 941-2586. Owners: Eugene C. & Joyce D. Finch; Buyer: Joyce Finch. (D & RJ).

Cartridge 8-tr., cassette & open reel: Capitol, Columbia, NAL, Pickwick Int'l, Re-Car, Word.

Playback equip.: Capitol, Masterwork.

Accessories: Head cleaners (Capitol, Columbia).

## MISSISSIPPI

### ● GREENVILLE (Area Code 601)

Electronic Workshop, 101 Hwy. One S. Zip: 38701. Tel: 332-8261. Owner: C. W. Sidney. (OS).  
Lynn's Rec. Dists., 551 N. Muscadine St. Zip: 38701. Tel: 335-4594. (OS & RJ).

## MINNESOTA

### ● MINNEAPOLIS-ST. PAUL AREA (Area Code 612)

Acme Music Serv./Sam Sales (div. of Lieberman Ents.), 9549 Penn Ave. S., Minneapolis 55431. Tel: 888-5521. Owner: David Lieberman; Mgr.: Sylvester Vanyo. (OS & RJ).  
Branch: Chicago, Ill., Susan Dist'g Co./Sam Sales.

All Rec. Sales Inc. (div. of Pickwick Int'l Inc.), Mgr. & Buyer: Tom Prenevost. (OS). See Heilicher Bros.

Bigelow Stereo Tape Inc., 11950 12 Ave. S., Burnsville 55378. Tel: 890-6161. Mgr.: Don Bigelow; Buyer: Niles Bigelow. (RJ).

Capitol Recs. Dist'g Corp., 4010 W. 65 St., Suite 207, Edina 55435. Tel: 927-4522. (D).

# MODERN SOUND, INC.

Distributors of all manufacturer's stereo tape lines, equipment and accessories

### MODERN SOUND EAST

106 Campus Ave., Raeford, N.C. 28376  
(919) 875-4266  
Les Hudson, V.P. Sales

### MODERN SOUND WEST

9321 Melvin Ave., Northridge, Calif. 98324  
(213) 885-0930  
Roger Brown, V.P. Sales

## DISTRIBUTORS

Continued from page 58

Custom Music Corp., 1201 Research Blvd. Zip: 63132. Tel: 997-0016. Pres.: Byrle A. Northup; Buyer: Robert F. Philpot. (D).

**Branch:** Kansas City, Kan.

**Cartridge 8-tr.:** Columbia, GRT, ITCC, Liberty, London, Scepter, Word.

**Cartridge 4-tr.:** Columbia, GRT, ITCC, Liberty, Muntz.

**Cassette:** Columbia, GRT, Liberty.

**Open reel:** Columbia, GRT, ITCC, Liberty.

**Playback equip.:** Automatic Radio, Craig, Kraco, Telex, Viking.

**Accessories:** Blank loaded tape (GRT, Irish, Robins, 3M), carrying cases (Amberg, Le-Bo), head cleaners (Channel Mktg.).

Arthur Fulmer, 311 S. 14 St. Zip: 63103. Tel: 241-3575. Mgr.: Wally Hoock. (D & I).

**Home office:** Memphis, Tenn. (see for prod. distributed).

Liberty/UA Dist'g Corp.—St. Louis Branch, 1815 Locust St. Zip: 63103. Tel: 621-7171. Mgr.: Jim Saltzman. (D).

**Cartridge 8-tr.:** Liberty, United Artists, Sunset.

**Cartridge 4-tr. & cassette:** Liberty, United Artists.

J. L. Marsh Inc. (div. of Pickwick Int'l Inc.) (RJ), see Commercial Music.

Musical Isle of America Inc. (An Entertainment Serv. of Transamerica Corp.), 1815 Locust St. Zip: 63103. Tel: 621-7171. Mgr.: Norman Wienstroer. (OS & RJ).

**Home office:** Los Angeles, Calif.

N M C Corp., 1906 Washington Ave. Zip: 73103. Tel: 621-1225. Mgr. & Buyer: Jim White. (RJ).

**Home office:** Oceanside, N.Y.

Paramount Rec. Dist., 2938 Lawton Pl. Zip: 63103. Tel: 535-5310. Mgr.: Bud Murphy. (D).

**Cartridge 8-tr. & cassette:** Paramount.

Uptown Music Inc., 617 N. Kingshighway. Zip: 63108. Tel: 367-2602. Owner: Harry Brockman; Mgr.: Mrs. Betty Dorrin; Buyers: Harry Brockman, Betty Dorrin. (OS).

## MONTANA

### • BILLINGS (Area Code 406)

Billings Hardware Co. (div. of American Hoist & Derrick Co.), 1300 First Ave. N. Zip: 59103. Tel: 245-3066. Mgr.: Paul Pearson; Buyer: Marion Massick. (D).

**Cartridge 8-tr. & cassette:** Angel, Apple, Capitol, Disneyland, Harvest.

**Playback equip.:** Panasonic.

**Accessories:** Duotone.

Interstate Dist'g Co., 457 Daniel St. Zip: 59102. Tel: 245-5141. Owner & Mgr.: James A. Whitson; Buyer: Jim L. Oblander. (D).

**Cartridge 8-tr. & cassette:** Mercury, NAL, RCA.

**Open reel:** NAL, RCA.

**Playback equip.:** Norelco, RCA.

**Accessories:** Le-Bo, RCA.

### • GREAT FALLS (Area Code 406)

Music Serv. Co., 316 Sixth St. S. Zip: 59401. Tel: 761-2420. Pres. & Gen. Mgr.: R. E. Holm; Buyer: W. Dudley James. (D & RJ).

**Cartridge 8-tr. & cassette:** A&M, Adell, Ampex, Atco, Atlantic, Dot, GRT, Impulse, ITCC, Jubilee, Liberty, Mercury, Orbit, Palisade, Philips, Pickwick, Scepter, Smash, United Artists, Vivid Sounds, Wand.

**Playback equip.:** Lear Jet, Telex, Toshiba, V-M.

**Accessories:** Empty cartridge 8-tr. & cassette (ITCC); head cleaners (ITCC, Spray); blank loaded tape (3M); splicers & head demagnetizers (Fidelitone).

### • HELENA (Area Code 406)

Sundry Shops Inc., Playhouse Div., 1015 Poplar. Zip: 59601. Tel: 442-5470. Owner: March E. Hopkins; Mgr.: Dennis C. Brooks; Buyer: Nancy Stevens. (RJ).

## NEBRASKA

### • OMAHA (Area Code 402)

Davidson's One Stop, 1214 Farnam. Zip: 68102. Tel: 341-4088. Owner: Mildred Davidson; Mgr. & Buyer: Joseph Quattoroli. (D & OS).

**Home office:** Kansas City, Mo. (see for prod. distributed).

## NEVADA

### • HAWTHORNE (Area Code 702)

M B Rec. Corral, 700 Sierra Way. Zip: 89415. (RJ).

**Home office:** Reno, Nev.

### • LAS VEGAS (Area Code 702)

Music City Rec. Racks of Nevada ("Vegas-World" Tapes Corp.), 5409 Gipsy Ave. Zip: 89107. Tel: 870-4959. Owners: Alex & Betty Fox; Mgr.: Steve Fox; Buyer: Doreen Fox. (RJ).

"Vegas-World" Tapes Corp., see Music City Rec. Racks of Nevada.

### • RENO & ENVIRONS (Area Code 702)

M B Rec. Corral, 544 Greenbrae Dr., Sparks 89431. Tel: 358-1502. Owner & Mgr.: Charley E. Barber. Branch: 1115 California Ave., Reno 89502. Tel: 329-0731. Mgr.: Robert F. Clarke. (RJ).

**Branches:** Herlong, Susanville, Calif.; Hawthorne, Nev.

## NEW JERSEY

### • BRIDGEWATER (Area Code 201)

Mona Rec. Corp., 1116 Cambridge Ln. Zip: 08876. Tel: 658-4276. Mgr. & Buyer: Fred Castler. (RJ).

**Home office:** Somerville, N.J.

### • CAMDEN (Area Code 609)

Decca Dist. Corp., 1722 Federal St. Zip: 08105. Tel: 966-7111. Phila. Tel: (215) WA 2-5659. Mgr.: Bob Specia; District Mgr.: Sam Passamano. (D).

**Cartridge 8-tr.:** Decca, Coral, Brunswick, Bravo, Viva, Berlitz, Colonial, Standard Phono.

**Cassette:** Decca, Coral, Brunswick, Bravo, Viva.

**Open reel:** Decca, Coral, Brunswick.

**Playback equip.:** Decca.

**Accessories:** Blank loaded tape, head cleaners, storage cases (Decca).

### • ELIZABETH (Area Code 201)

Able Rec. Sales, 730 Division St. Zip: 07201. Tel: 243-8701. Mgr.: Jack Glauben. (RJ).

**Home office:** Newark, N.J., Service One Stop.

### • FAIRFIELD (Area Code 201)

Chancellor Inc., 8 Spielman Rd. Zip: 07006. Tel: 227-4010. Pres.: Joel Koenig; Mgr.: Hal Bronstein; Buyer: Susan Zaitz. (D, OS & RJ).

**Cartridge 8-tr. & cassette:** Ampex, Capitol, Columbia, Decca, GRT, ITCC, Motown, NAL.

**Open reel:** Ampex, Capitol, Columbia, Decca, GRT, NAL.

**Playback equip.:** Bell & Howell, Lear Jet.

**Accessories:** Blank loaded tape (Bell & Howell, Le-Bo).

### • HACKENSACK (Area Code 201)

Eastern Automotive Tape Dist., Inc., 205 Essex St. Zip: 07601. Tel: 342-1636. Owner: Robert Warhol; Mgr. & Buyer: Vincent Giracello. (D, OS & RJ).

**Cartridge 8-tr. & cassette:** Capitol, Columbia, Decca, Double Shot, Eutotone, Fiesta, GRT, ITCC, Jubilee, Liberty, Modern, Original Sound, Paramount, Peters Int'l, Premier, Radiant, United Artists, Word.

**PlayTape.**

**Playback equip.:** Belle Wood, Decca, Motorola, PlayTape, RCA, Weltron.

**Accessories:** Cleaning kits, dust clips, storage cases (Le-Bo); cleaning cartridges (Specialty Sounds).

### • HILLSIDE (Area Code 201)

New Jersey One Stop Corp., 467 Mundet Pl. Zip: 07205. Tel: 923-7474/6472. Owner: Joseph C. Martin; Mgr.: Jerry Leflier; Buyer: Jerry Cohen. (D, OS & RJ).

**Cartridge 8-tr., cassette & open reel:** A&M, Capitol, Columbia, ITCC, Liberty, Motown, NAL, Straight, SSS Int'l, United Artists.

**Accessories:** Walco.

### • LINDEN (Area Code 201)

National Tape Dist. of New Jersey Inc., 609 Commerce Rd. Zip: 07036. Tel: 925-9101. Mgr.: Robert Fleck. (RJ).

**Home office:** Brookfield, Wis.

### • LITTLE FERRY (Area Code 201)

Solfo Recs. Co., 87 Wilson. Zip: 07643. Tel: 489-8136. Owner & Buyer: Anibal Torres; Mgr.: Ana Torres. (D).

**Branch:** New York, N.Y. (D & OS).

**Cartridge 4-tr. 8-tr. & cassette:** Hopes, Milly Latino, Starbright.

**Playback equip.:** Mikado, Tempo.

**Accessories:** Mikado, Tempo.

### • MEDFORD (Area Code 609)

National Mdsq. Serv. Corp., Stokes Rd. Zip: 08055. Tel: 0L 4-4990. Mgr.: Jack Logue. (RJ).

### • MIDDLESEX (Area Code 201)

Rapid Mdsq. Co., 201 Pond Ave. Zip: 08846. Tel: 752-1000. (D & RJ).

**Home office:** Minneapolis, Minn.

**Cartridge 4-tr., 8-tr. & cassette:** All lines.

### • NEWARK (Area Code 201)

All-State New Jersey Inc., 321 Sherman Ave. Zip: 07114. Tel: 242-6500. Owner & Buyer: Sherman

Koenig; VP & Sales Mgr.: Irwin R. Fink; Mgr.: Len Capito. (D, OS & RJ).

**Cartridge 4-tr. & 8-tr.:** All lines.

**Cassette:** All lines excluding RCA.

**PlayTape.**

**Playback equip.:** Automatic Radio, Belle Wood, PlayTape, Tenna.

**Accessories:** Display racks (Channel, Guy Barry, Le-Bo, Recotone).

R. Bab Co., 12 Cutler St. Zip: 07104. Tel: 484-1368. Owner: R. Bab. (D).

**Cartridge 4-tr., 8-tr., cassette & open reel:** Eutotone, Fiesta, Monitor; all foreign labels available on tape.

**Playback equip.:** Fortunestar, Grundig, Lear Jet, Dance Rec. Center (div. of Folkraft Publ'g Co. Inc.), 1159 Broad St. Zip: 07114. Tel: 622-0024. Mgr.: B. Brooks. (E).

**Exports:** Pre-recorded tape & playback equip.

Dierickx Discount Music Inc., 1316 Springfield Ave., Irvington 07111. Tel: 371-0777. Owner: Mrs. A. Dierickx; Mgr. & Buyer: Tony Villanova. (OS & RJ).

Essex Rec. Dist., Inc., 10 Fenwick St. Zip: 07114. Tel: 243-7700. Owners: Joe & Irving Cohen; Mgr.: Joe Cohen; Buyer: Rick McGruder. (D).

**Cartridge 8-tr. & cassette:** Atlantic, Cadet, Checker, Chess, GRT, Hob, ITCC, Josie, Jubilee, NAL, Original Sound, Roulette, Scepter, Stella, Wand.

J & J Corp., 333 Clinton Pl. Zip: 07112. Tel: 926-3700. Owners: Irwin & Jay Jennis; Buyer: Jay Jennis. (D, OS & RJ).

**Cartridge 8-tr. & cassette:** Ampex, Capitol, Columbia, Decca, GRT, ITCC, Liberty, Mercury, Motown, Original Sound, RCA, United Artists.

**Playback equip.:** Aiwa, Belair, Norelco, Panasonic, Telex.

**Accessories:** Blank loaded tape (Le-Bo).

Jack's One Stop Inc., 357 Lyons Ave. Zip: 07112. Tel: 923-3636/1212. Owner & Buyer: Jack Kosloff; Mgr.: Lou Caporaso. (D, OS & RJ).

**Cartridge 8-tr.:** Capitol, Columbia, Decca, Liberty, NAL, Pickwick, Reprise, United Artists, Warner Bros.-Seven Arts.

Krich New Jersey Inc., 428 Elizabeth Ave. Zip: 07112. Tel: 248-7400. Mgr. & Buyer: Norris I. Saurman. (D).

**Cartridge 8-tr. & cassette:** RCA, Camden, Colgems, Kirshner, Poppy.

**Playback equip.:** RCA.

Laredy Rec. Dist. Corp., 46 Green St. Zip: 07101. Tel: 623-5984. Pres.: Joseph Fechner; Mgr.: George Signoretti; Buyers: Joseph Fechner, George Signoretti. (D).

**Cartridge 8-tr. & cassette:** Disneyland, Project 3, Reprise, Warner Bros.-Seven Arts.

Liberty/UA Dist'g Corp.—Newark Branch, 1835 Burnet Ave., Union 07083. Tel: 964-1560. Mgr.: Jack Bridges. (D).

**Cartridge 8-tr.:** Liberty, United Artists, Sunset.

**Cartridge 4-tr. & cassette:** Liberty, United Artists.

Service One Stop Dist., Inc., 16 Fenwick St. Zip: 07114. Tel: 243-8700. Owners: Joe & Irv Cohen; Mgr.: Harold Ladell, Hal Price; Buyer: Hal Price. (OS & RJ).

**Branch:** Elizabeth, N.J. (RJ).

Wendy Dist. Inc., 37 William St. Zip: 07102. Tel: 623-5845. Owner & Mgr.: Jerry Winston. (D).

**Cartridge 8-tr. & cassette:** Ampex, GRT, ITCC, Livingston, Prestige, Radiant.

### • PARAMUS (Area Code 201)

Atlas-Rand Corp., see listing under New York, N.Y.

### • PENNSAUKEN (Area Code 609)

A B C Rec. & Tape Sales Corp., 7025 Colonial Hwy. Zip: 08109. Tel: 663-0720. Mgr.: Pete Voss. (OS & RJ).

**Home office:** Seattle, Wash.

Handleman Co., 7135 Colonial Ln. Zip: 08109. Tel: 665-5460. Mgr.: Joseph Glaser. (RJ).

**Home office:** Detroit, Mich.

Liberty/UA Dist'g Corp.—Philadelphia Branch, 7025 Colonial Hwy. Zip: 08109. Tel: 662-3101; Phila. Tel: (215) 923-4196. Mgr.: Dave Levey. (D).

**Cartridge 8-tr.:** Liberty, United Artists, Sunset.

**Cartridge 4-tr. & cassette:** Liberty, United Artists.

### • ROCHELLE PARK (Area Code 201)

Garden State Rec. Dist. (div. of Interstate Rec. Dist., New York, N.Y.), 68 W. Passaic St. Zip: 07662. Tel: 843-2670. Pres.: Manny G. Wells; Gen. Mgr.: Stan Sterling. (RJ).

### • SOMERVILLE (Area Code 201)

Mona Rec. Corp., PO Box 487. Zip: 08876. Tel: 469-0444. Owner: Fred Castler; Mgr.: Joe Cohen; Buyer: Emmy Vinas. (RJ).

**Branch:** Bridgewater, N.J.

### • SPRINGFIELD (Area Code 201)

Program One-Stop Inc., Rt. 22 & Fadem Rd. Zip: 07081. Tel: 467-0003. Owner: Ralph Schechtman; Mgr.: David Casey; Buyer: Frank Di Marsico. (OS & RJ).

### • TENAFLY (Area Code 201)

Decca Dist. Corp., 95 Engle St. Zip: 07670. Tel: 642-3200. Mgr.: Noah Jenkins. (D).

**Cartridge 8-tr.:** Decca, Coral, Brunswick, Bravo, Viva, Berlitz, Colonial, Standard Phono.

**Cassette:** Decca, Coral, Brunswick, Bravo, Viva.

**Open reel:** Decca, Coral, Brunswick.



**Playback equip.:** Decca.  
**Accessories:** Blank loaded tape, head cleaners, storage cases (Decca).

• **TRENTON (Area Code 609)**

Allied Rec. Sales, 65 Annabelle Ave. Zip: 08609. Tel: 392-0211. Owner: John T. Gervasoni; Mgr.: Rodney Mortillaro. (OS & RJ).  
Associated Tape Serv. Inc., 1721 N. Olden Ave. Zip: 08638. Tel: 882-1660. Gen. Mgr.: J. L. Rounds. (D & RJ).  
Cartridge 8-tr.: Kapp, Liberty, MGM, Mercury, Motown group, Scepter, United Artists.  
Cartridge 4-tr.: Atco, Atlantic, Capitol, Decca, Mercury, Motown group, Scepter.  
Cassette: Same as 8-tr.  
Accessories: Stereoriginals.

## NEW YORK

• **ALBANY (Area Code 518)**

Bee Gee Recs. & Tape, Shaker Park, Latham 12110. Tel: 785-1350. Owner: Leonard Smith; Dist. Mgr.: Robert Dooley; OS & RJ Mgr.: Jack Miorin; Buyer: Robert Langford. (D, OS & RJ).  
Cartridge 8-tr. & cassette: Ampex, Camden, GRT, ITCC, NAL, Pickwick, RCA, Scepter.  
Accessories: Le-Bo, Recoton, 3M.  
R T A Dist. Inc., 991 Broadway. Zip: 12204. Tel: 463-3251. Mgr.: Joseph Paone. (D).  
Cartridge 8-tr.: RCA, Camden, Victrola, Buena Vista, Chart, Colgems, Diamond, Institute for Language Studies (ILS), Kirshner, Poppy.  
Cassette & open reel: RCA, Camden, Victrola, Chart, Colgems, Kirshner, Poppy.  
Transcontinental Music Corp., 100 Watervliet Ave. Zip: 12206. Tel: 438-3571. Mgr.: Charles Schlang. (RJ).  
Home office: New York, N.Y., Transcontinental Investing Corp.  
Universal Tape Inc., 98 Everett Rd. Zip: 12205. Tel: 489-5446. Pres.: Joseph Spence; Mgr.: Ronald Spence; Buyer: Larry Grandy. (D & RJ).  
Cartridge 8-tr. & cassette: ITCC, NAL, Radiant, Spar.

• **AMSTERDAM (Area Code 518)**

Almor Playtime Co. Inc., Wallins Corner Rd. Zip: 12010. Tel: 842-2500. Owner: Albert A. Hyman; Mgr. & Buyer: Dick Sukel. (D, OS & RJ).  
Branches: Syracuse, N. Y.; South Burlington, Vt.  
Cartridge 8-tr. & cassette: Ampex, Capitol, Columbia, Decca, Liberty, Mercury, Pickwick, RCA.  
Accessories: Amberg, Le-Bo, Recoton.

• **ARMONK (Area Code 914)**

Mozart Edition Inc., 4 Mill Ln. Zip: 10504. Tel: 273-9529. Owner: Joseph E. Zerga. (I).  
Imports: Pre-recorded tape from Austria, Germany, Italy, Switzerland, UK.

• **BINGHAMTON (Area Code 607)**

G & G Rec. Dist., 176 Clinton St. Zip: 13905. Tel: 723-3275. (RJ).

• **BUFFALO (Area Code 716)**

Best & Gold Rec. Dist., 1790 Main St. Zip: 14208. Tel: 882-0427. Owners: Leonard Silver, Steve Brodie; Sales Mgr.: Dave Colson. (D).  
Cartridge 4-tr., 8-tr. & cassette: All lines.  
Buffalo One Stop. (OS & RJ), see Transcontinent Rec. Sales.  
Decca Dist. Corp., Shers Rd., Rt. 2, Hamburg 14075. Tel: 852-8318. Mgr.: Maury Bloom. (D).  
Cartridge 8-tr.: Decca, Coral, Brunswick, Bravo, Viva, Berlitz, Colonial, Standard Phono.  
Cassette: Decca, Coral, Brunswick, Bravo, Viva.  
Open reel: Decca, Coral, Brunswick.  
Playback equip.: Decca.  
Accessories: Blank loaded tape, head cleaners, storage cases (Decca).  
Discerics Inc., 861 Washington St. Zip: 14203. Tel: 856-8477. (RJ).  
Gold Dist., 1790 Main St. Zip: 14208. Tel: 882-0427. Owners: Leonard Silver, Steve Brodie; Sales Mgr.: Dave Colson. (D).  
Cartridge 4-tr., 8-tr. & cassette: All lines.  
Jet TV Inc., 773 Niagara Falls Blvd., Zip: 14226. Tel: 835-0070. Owner: Martin Lebovits. (D).  
Cartridge 8-tr.: Capitol, Columbia, GRT, ITCC.  
Transcontinent Rec. Sales, 1790 Main St. Zip: 14208. Tel: 882-0427. Owners: Leonard Silver, Steve Brodie; Sales Mgr.: Dave Colson. (D), (OS & RJ) as Buffalo One Stop).  
Branches: Rochester, N.Y., Rochester One Stop; Syracuse, N.Y., Syracuse One Stop; Cincinnati, Ohio, Ambat Recs.; Cleveland, Ohio, Northern Rec. Sales; Dayton, Ohio, Ambat Recs. (All OS & RJ).

• **CHESTER (Area Code 914)**

Associated Rec. Serv. Inc., PO Box 578, Main St. Zip: 10918. Tel: 469-4454. Owners: Mat Ropiecki, Arthur Morris; Mgr. & Buyer: Samuel Mehaffie. (D & OS).  
Cartridge 8-tr.: Avant Garde, Bible Voice, Heart Warming, Impact, RCA, Skylite, Summit, Supreme, Word.  
Cassette: Avant Garde, Bible Voice, Heart Warming, Impact, Supreme, Word.  
Open reel: Bible Voice.

**Accessories:** Blank cartridges 8-tr. & cassette, head cleaners, storage cases, store displays, (Le-Bo).

• **COHOES (Area Code 518)**

Decca Dist. Corp., Vliet & Mohawk Sts. Zip: 12047. Tel: CE 7-9000. Mgr.: Howard McGrath. (D).  
Cartridge 8-tr.: Decca, Coral, Brunswick, Bravo, Viva, Berlitz, Colonial, Standard Phono.  
Cassette: Decca, Coral, Brunswick, Bravo, Viva.  
Open reel: Decca, Coral, Brunswick.  
Playback equip.: Decca.  
Accessories: Blank loaded tape, head cleaners, storage cases (Decca).

• **FARMINGDALE, L.I. (Area Code 516)**

Variety Audio Prods., 170 Central Ave. Zip: 11735. Tel: 293-5858. Owner & Mgr.: David Shichman. (D & RJ).  
Cartridge 8-tr., cassette & open reel: Ampex, GRT.

• **FREEPORT, L.I. (Area Code 516)**

Double B Recs. & Tape Corp., 240 E. Merrick Rd. Zip: 11520. Tel: FR 8-2222. Mgr.: Bernard Boorstein; Buyer: Zeke Lengua. (D).  
Cartridge 8-tr. & cassette: Ampex, Capitol,

Columbia, Decca, GRT, ITCC, Kapp, Liberty, NAL, RCA, Scepter, United Artists, Wand.  
Open reel: Ampex, Bell & Howell, Columbia, Decca, GRT, ITCC, RCA.  
Playback equip.: Belle Wood, Capitol, Fisher, Harman-Kardon, Masterwork, Panasonic, RCA, Universal Sound.  
Accessories: All lines.

Royal Sound Co. Inc., 409 N. Main St. Zip: 11520. Tel: 868-2880. Owner: M.A. Dayan; Mgr. & Buyer: N. Greenberg. (D & E).  
Cartridge 4-tr., 8-tr., cassette & open reel: Ampex.  
Playback equip.: Dokorder, RSC, Telex.  
Accessories: Channel Mk1g., RSC.  
Exports: Pre-recorded tape & playback equip.

Universal Stereo Studios Ltd., 24-26 Brooklyn Ave. Zip: 11520. Tel: 868-0491. Mgr. & Buyer: Roger Cooper. (D & OS).  
Cartridge 4-tr., 8-tr. & cassette: Columbia, ITCC, Liberty, United Artists.  
Playback equip.: Automatic Radio, Belair, Belle Wood, Concord, JVC, Kraco, Monarch, Morse, Nivico, Panasonic, USA.  
Accessories: J. J. Paulson.

*continued on page 58*

# TAPES—“REEL-TO-REEL”

# Cartridges—4 TRACK/8 TRACK

# Cassettes—ALL AMERICAN BRANDS

COMBINED IN ONE SHIPMENT

## ELTRON EXPORT CO.

159 Maiden Lane, New York, New York 10038 • Cable: Eltroncomp

EASTERN PENNSYLVANIA  
SOUTHERN NEW JERSEY  
DELAWARE

EXCLUSIVE FULL LINE DISTRIBUTOR  
FOR AMPEX TAPES

ONLY COMPLETE  
FULL SERVICE PROGRAM  
TAPE DISTRIBUTOR  
AND RACKER  
IN THE AREA . . .

REEL-TO-REEL—CASSETTE  
8-TRACK—SELF-SERVICE RACKS  
ONE-STOP

# A&L

DISTRIBUTORS, INC.

SPECIALIZING IN RECORDS,  
TAPES AND ELECTRONICS

S.E. Corner 30th & Thompson St.  
Philadelphia, Pa.  
(215) POplar 5-4300



Open reel: Ampex, Imperial, Liberty, Reprise, Sentry, Soul City, Tape Mates, Vivid Sounds, Warner Bros.-Seven Arts.

**Playtape.**

Accessories: Blank loaded tape (SMG).

Albert Schultz Inc., 116 W. 14 St. Zip: 10011. Tel: 924-1122; Cable: ALBYREP. Pres.: Albert Schultz; VP: Stanley Atsdisis. (E).

Exports: Pre-recorded tape; pre-leadered & empty cassettes; blank rec'g cassettes; 4-tr. & 8-tr. empty cartridges—all lengths; cassette & cartridge component parts & magnetic rec'g tape; open reel magnetic rec'g tape—packaged & bulk; empty reels—all sizes; cartridge 4-tr., 8-tr. & cassette head cleaners—packaged & bulk; head cleaning & splicing materials; all tape accessories.

M. Sluis Co. Inc., 15 Park Row. Zip: 10038. Tel: 349-0590. Mgr.: H. Elion. (E).

Exports: Pre-recorded tape & playback equip.

Solfo Recs. Co., 429 W. 46 St. Zip: 10036. Owner & Buyer: Anibal Torres; Mgr.: Ofoniel Ortiz. (D & OS). Branch: 280 St. Ann's Ave., Bronx 10454. Mgr.: Marcial Sofo. (D & OS). Home office: Little Ferry, N.J. (see for prod. distributed).

Stanley-Lewis Rec. Dist. Co. Inc., 23-80 48 St., Long Island City 11103. Tel: 726-4343. Owner: Harry Lew; Mgr.: Curt Schott. (D).

Cartridge 8-tr.: DGG, Monitor. Cassette: Barclay, Conversa-Phone, DGG, Fontana, Monitor, Philips, Vox.

David Sternberg Int'l Sales, 136 W. 46 St. Zip: 10036. Tel: 581-6368. Owner: David Sternberg. (J & E).

Imports: Pre-recorded tape (Germany, France, Netherlands, UK).

Exports: Pre-recorded tape.

Stratford Dist., 184-23 Jamaica Ave., Hollis 11423.

Tel: 454-8800. Owner: Nathan Kaplan; Mgr.: Sam Selwin; Buyer: Allan Silverman. (D & OS). Cartridge 8-tr. & cassette: All lines.

Playback equip.: Automatic Radio.

Accessories: Amberg, Capitol, Columbia.

Sylvan Ginsbury Ltd., 425 Park Ave. S. Zip: 10016. Tel: 689-5212. (E).

Exports: Pre-recorded tape, blank loaded tape, cassettes & cartridges.

T D K Electronics Corp., 23-73 48 St., Long Island City 11103. Tel: 721-6881. Mgrs.: H. Kawamura, G. T. Saddler. (I & E).

Branches: Los Angeles, Calif.; Chicago, Ill.

Int'l office: Japan.

Cassette & open reel: TDK (Japan).

Transcontinental Dist'g Corp. (D), see Transcontinental Investing Corp.

Transcontinental Investing Corp., 201 E. 42 St. Zip: 10017. Tel: 697-8610. Bd. Chm.: Howard Weingrow; Exec. VP & VP of Leisure & Entertainment Group: Arnold Greenhut; Transcontinental Music Corp. Pres.: Alfred Lorber. (Exec. office only). (D as Transcontinental Dist'g Corp.), (OS as indicated below), (RJ as Transcontinental Music Corp.).

Branches: Phoenix, Ariz., (RJ as TMC); Los Angeles, Calif. (D as TDC), (RJ as TMC); San Francisco, Calif., (D as TDC), (OS as Nor Cal Super Stop), (RJ as TMC); Denver, Colo., (D as TDC), (OS as Alert One Stop), (RJ as TMC); Hartford, Conn., (D as TDC), (OS as Eastern One Stop), (RJ as TMC); Miami, Fla., (RJ as TMC); Atlanta, Ga., (RJ as TMC); Chicago, Ill., (D as TDC), (RJ as TMC); Laurel, Md., (RJ as TMC); Boston, Mass., (D as TDC), (RJ as TMC); Albany, N.Y. (RJ as TMC); Dallas, Tex., (RJ as TMC); Seattle, Wash., (D as TDC), (RJ as TMC).

Transcontinental Music Corp. (RJ), see Transcontinental Investing Corp.

Win Rec. Inc., 858 Ninth Ave. Zip: 10019. Tel: JU 2-0130. Owner: Sam Weiss; Mgr. & Buyer: George Weiss. (D, OS, RJ, I & E).

Cartridge 8-tr., cassette, & open reel: A&M, Atlantic, Capitol, Columbia, Decca, GRT, ITCC, Liberty, Mercury, Motown, RCA, Reprise, Tamla, United Artists, Warner Bros.-Seven Arts.

**PlayTape.**

Accessories: Recoton.

Imports & exports: Pre-recorded tape.

● **OCEANSIDE, L.I. (Area Code 516)**

N M C Corp., 3580 Oceanside Rd. Zip: 11572. Tel: 678-6770. Pres.: Jesse Selter; Mgr.: Theodore Shapiro; Buyer: Irving Glasser. (RJ). Branches: Los Angeles, Calif.; St. Louis, Mo.

● **PORT CHESTER (Area Code 914)**

Band Stand Music Shop, 151/2 N. Main St. Zip: 10573. Tel: WE 7-4092. Owner & Mgr.: Lenny Cooper. (OS).

● **POUGHKEEPSIE (Area Code 914)**

Toy House of Hudson Valley (div. of Kustas Bros. Inc.), Manchester Rd. Zip: 12603. Tel: 471-2740. Mgr. & Buyer: Louis J. Kustas. (D & RJ). Cartridge 8-tr. & cassette: Fiesta, GRT, ITCC, Modern, NAL, Pickwick, Scepter. Accessories: Le-Bo, Recoton.

● **ROCHESTER (Area Code 716)**

Clinton Mds. Inc., 80 Commerce Dr. Zip: 14623. Tel: 334-2700. (RJ).

Rochester One Stop (div. of Transcontinent Rec. Sales), 685 South Ave. Zip: 14620. Tel: 454-6968. Mgr.: Herb Derman. (OS & RJ).

Home office: Buffalo, N.Y.

*continued on page 60*

## ATTENTION: ALL TAPE DISTRIBUTORS, DEALERS AND IMPORTERS!

**NOW:** You can have a convenient export one stop source for ALL of your blank and prerecorded tape requirements.

Write to us for quotations on:

**PRERECORDED CASSETTES—ALL LABELS  
PRERECORDED CARTRIDGES—ALL LABELS  
PRERECORDED OPEN REELS—ALL LABELS  
BLANK LOADED CASSETTES AND CARTRIDGES  
MAGNETIC RECORDING TAPE  
COMPLETE LINE OF TAPE ACCESSORIES**

**ENJOY:** Quick replies to your inquiries and prompt, efficient handling of your orders by an export specialist with 24 years of experience in the tape and record industries.

**SAVE:** On shipping costs through consolidation of all of your requirements.

**BENEFIT:** From competitive prices on all items.

**WRITING TO US MAY BE THE BEST INVESTMENT YOU HAVE EVER MADE.**

ACT TODAY!

**ALBERT SCHULTZ, INC.**

116 W. 14th St., New York, N. Y. 10011  
Telephone: 924-1122 Cable: ALBYREP, NEW YORK



**CARTRIDGE  
CONTROL  
CORPORATION**

**QUALITY TAPE  
DUPLICATING**



**CARTRIDGE  
CONTROL  
CORPORATION**

2091 FAULKNER RD., N.E.  
ATLANTA, GEORGIA 30324  
Telephone (404) 633-4577

Bill Evans Genl. Mgr.

## DISTRIBUTORS

Continued from page 59

### ● SYRACUSE (Area Code 315)

Almor Playtime Co. Inc., Midler Park Dr. Zip: 13206. Tel: 463-3351. Mgr.: George Valenti. (D, OS & RJ)  
Home office: Amsterdam, N.Y.  
Mage Serv. Mdsq. Inc., 112 Ronnell Dr. Zip: 13219. Tel: 488-2512. Owner & Mgr.: Mathew Orlando; Buyer: Gerry Orlando. (RJ)  
Morris Dist'g Co. Inc., 1153 W. Fayette St. Zip: 13204. Tel: 475-6531. Mgr. & Buyer: Oscar Dachs. (D)  
Cartridge 8-tr.: Ampex, GRT, ITCC, RCA.  
Cassette: GRT, ITCC, RCA.  
Open reel: RCA.  
Accessories: RCA, Recoton.  
Syracuse One Stop (div. of Transcontinent Rec. Sales), 333 W. Fayette St. Zip: 13202. Tel: GR 6-4019. Mgr.: Ralph La Rosa. (OS & RJ).  
Home office: Buffalo, N.Y.

### ● WESTBURY, L.I. (Area Code 516)

All Rec. Dists. Inc., 118 Swalm St. Zip: 11590. Tel: 997-7160. Owners: Charles Nero, Michael Cono; Mgr. & Buyer: Thomas Hoffman. (D, OS & RJ).  
Cartridge 8-tr. & cassette: Capitol, Columbia, Decca, GRT, ITCC, Liberty, RCA, United Artists.  
Accessories: Blank reels, cassettes & cartridges (Uni-Tape); carrying cases, head cleaners (Le-Bo).

### ● WHITE PLAINS (Area Code 914)

Fairfield Stereo Corp., 87 Central Ave. Zip: 10606. Tel: 761-7569. Owner & Mgr.: Tony Tsoconas. (D)  
Cartridge 8-tr. & cassette: GRT, ITCC, Capitol, Fiesta, sub-dist. for Ampex, Columbia, Decca, Liberty, RCA, United Artists.  
Playback equip.: Belle Wood, Motorola, Muntz, Panasonic, Tokia.  
Accessories: Le-Bo.

## NORTH CAROLINA

### ● ASHEVILLE (Area Code 704)

Alexander News Co., 25 Carolina Ln. Zip: 28801. Tel: 253-2631. Owner: William G. Alexander; Mgr.: Clarence N. Suttle; Buyers: Clarence Suttle, Mack Baker. (RJ)

### ● CHARLOTTE (Area Code 704)

Bertos Sales Corp., 2214 W. Morehead St. Zip: 28208. Tel: 375-2517. Owner & Buyer: Phil Goldberg; Mgr.: Mickey Beheler. (D & OS).  
Cartridge 4-tr., 8-tr. & cassette: Epic, GRT, Gross, Heart Warming, Jubilee, Motown, SSS Int'l, Starday, Sun Int'l.  
Bib Dist'g Co., 126 W. Morehead St. Zip: 28201. Tel: 372-2032. Mgr.: Bill Norman; Buyer: Harold Mitchell. (D, OS & RJ).  
Cartridge 8-tr.: Ampex, Dooto, Enterprise, GRT, RCA, Scepter, Stax, Volt, Wand.  
Cartridge 4-tr.: Same as 8-tr. except for GRT, RCA.  
Cassette: Same as 8-tr.  
Open reel: Ampex.  
Capitol Recs. Dist'g Corp., 416 East Blvd. Zip: 28203. Tel: 375-6078. (D).  
Cartridge 8-tr. & cassette: Capitol, Angel, Melodiya/Angel, Apple, Harvest, Fame.  
Playback equip.: Capitol.  
Accessories: Display racks, storage cases (Capitol).  
Carol Dist. Co. Inc., 124 W. Morehead St. Zip: 28202. Tel: 333-9457. Owner: Joseph F. Vovnow; Mgr.: John Gammon; Buyer: Frances Snyder. (D).  
Cartridge 8-tr.: Decca, Coral, Brunswick.  
F & F Arnold Dist'g Co. Inc., PO Box 1126, 2704 Freedom Dr. Zip: 28201. Tel: 399-9741. Pres.: Bert Fleishman; Sales Mgr.: John Towles. (D), (OS & RJ) as Southeastern Rec. Mdsrs. Inc.).  
Cartridge 8-tr. & cassette: All major lines except Ampex.  
Playback equip.: Automatic Radio, Car Tapes, Concord, Craig, Mayfair, Panasonic.  
Accessories: Blank tape, head cleaners, carrying cases.  
Arthur Fulmer, 229 W. Morehead St. Zip: 28202. Tel: 375-3726. Mgr.: E. B. Lewis. (D & I).  
Home office: Memphis, Tenn. (see for prod. distributed).  
Handleman Co., 2309 Dunavant St. Zip: 28203. Tel: 372-1845. Mgr.: William Hanson. (RJ).  
Home office: Detroit, Mich.  
Liberty/UA Dist'g Corp.—Charlotte Branch, PO Box 3186, 1409 East Blvd., Suite 217. Zip: 28203. Tel: 334-9454. Mgr.: Jim Epting. (D).  
Cartridge 8-tr.: Liberty, United Artists, Sunset.  
Cartridge 4-tr. & cassette: Liberty, United Artists.  
Mangold Dist. Inc., 2212 W. Morehead St. Zip: 28208. Tel: 334-0866. Owner: Herb Weisman; Buyer: Dub Plyler. (D & OS).  
Cartridge 8-tr. & cassette: Ampex, Capitol, Dooto, Dot, Mercury.

### PlayTape.

Accessories: Le-Bo.  
Southeastern Rec. Mdsrs. Inc., PO Box 1697, Zip: 28201; 2706 Freedom Dr. Zip: 28208. Tel: 399-5633. Sales Mgr. & Buyer: Charles Hartley. (OS & RJ).  
Home office: F&F Arnold Dist'g Co. Inc.  
Southern Radio Corp., 1625 W. Morehead St. Zip: 28208. Tel: 376-4461. Pres.: Thomas J. Jamison; Mgr.: Phil Morgan. (D & RJ).  
Cartridge 8-tr. & cassette: Capitol, Columbia, Decca, GRT, Heart Warming, ITCC, Liberty, Mercury, NAL, Philips, Smash, RCA, United Artists, Word.  
Open reel: RCA.  
Playback equip.: Belle Wood, Craig.  
Accessories: Head cleaners (RCA).

### ● FAYETTEVILLE (Area Code 919)

A A A Co. Inc., PO Box 5625, 5511 Bragg Blvd. Zip: 28303. Tel: 867-6165. Buyer: Al Metzger. (D).  
Cartridge 8-tr.: All lines.  
Accessories: Major lines.

### ● GREENVILLE (Area Code 919)

Carolina Sales Corp., 101 W. 14 St. Zip: 27834. Tel: 752-3143. Owner: J. T. Little; Mgr.: J. T. Little Jr.; Buyer: David Taylor. (D & OS).  
Cartridge 8-tr.: Ampex, Capitol, GRT, ITCC, RCA.  
Playback equip.: Lear Jet.  
Accessories: Caddies (Le-Bo, RCA, Rubbermaid).

### ● RAEFORD (Area Code 919)

Modern Sound (sub. of Audio Communications Inc.), 106 Campus Ave. Zip: 28376. Tel: 875-4266. Mgrs.: Thomas Malia, L. John Davidson. (OS).  
Branch: Los Angeles, Calif.

### ● ROCKY MOUNT (Area Code 919)

Rocky Mount News Agency Inc., 1600 S. Franklin St. Zip: 27801. Tel: 446-6812. Owner: Ellie P. Glenn; Mgr. & Buyer: Bill McCarver. (RJ).

## OHIO

### ● CANTON (Area Code 216)

Stark Rec. & Tape Serv., 8000 Freedom Ave. NW, North Canton 44720. Tel: 494-2282. Owner: Paul David; Mgr.: Phil Shannon; Buyer: Joe Bressi. (D, OS & RJ).  
Cartridge 8-tr.: Ampex, GRT, ITCC, Muntz, NAL; sub-dist. for A&M, RCA, Reprise, Warner Bros.-Seven Arts.

### ● CINCINNATI (Area Code 513)

A & I Recs. Dist'g Co. Inc., 1000 Broadway. Zip: 45202. Tel: 241-7644. Owner: Sam Klayman; Mgr. & Buyer: Jim Yates. (D).  
Cartridge 4-tr., 8-tr., cassette & open reel: Atco, Duke, Jubilee, Kapp, Philips, Prestige, Roulette, Savoy, Scepter, Volt.  
Album Rec. Sales of America Inc., 229 W. McMillan. Zip: 45219. Tel: 621-8710. Pres. & Buyer: LeRoy R. Goodlander. (RJ).  
Ambat Recs. (div. of Transcontinent Rec. Sales), 1667 Central Pkwy. Zip: 45214. Tel: 621-3252. Mgr.: Vern Hawks. (OS & RJ).  
Home office: Buffalo, N.Y.  
Capitol Recs. Dist'g Corp., 35 E. Seventh St., Suite 612. Zip: 45202. Tel: 721-5616. (D).  
Cartridge 8-tr. & cassette: Capitol, Angel, Melodiya/Angel, Apple, Harvest, Fame.  
Playback equip.: Capitol.  
Accessories: Display racks, storage cases (Capitol).  
Columbia Rec. Sales., Carew Tower, Suites 444-47. Zip: 45202. Tel: 241-4088. Sales Mgr.: Bill Kelly; Audio Sales Mgr.: Norm Finkelstein. (D).  
Cartridge 8-tr.: Columbia, Date, Epic, Okeh, Ode, Barnaby, Fillmore, Blue Horizon.  
Cartridge 4-tr.: Columbia, Date, Epic, Okeh, Ode, Blue Horizon.  
Cassette: Same as 8-tr.  
Open reel: Same as 4-tr.  
Playback equip.: Masterwork.  
Accessories: Blank loaded tape, storage cases (Columbia).  
Decca Dist. Corp., 940 Warehouse Dr. Zip: 42502. Tel: PA 1-4210. Mgr.: Jack Brown. (D).  
Cartridge 8-tr.: Decca, Coral, Brunswick, Bravo, Viva, Berlitz, Colonial, Standard Phono.  
Cassette: Decca, Coral, Brunswick, Bravo, Viva.  
Open reel: Decca, Coral, Brunswick.  
Playback equip.: Decca.  
Accessories: Blank loaded tape, head cleaners, storage cases (Decca).  
Liberty/UA Dist'g Corp.—Cincinnati Branch, 11750 Chesterdale Rd., Suite 3103, Atkinson Square 45246. Tel: 771-4832. Mgr.: Art Liberatore. (D).  
Cartridge 8-tr.: Liberty, United Artists, Sunset.  
Cartridge 4-tr. & cassette: Liberty, United Artists.  
Ohio Appliances Inc., 7624 Reinhold Dr. Zip: 45237. Tel: 621-6414. Mgr.: Jack Shue; Buyer: Frank Shue. (D, OS & RJ).  
Cartridge 8-tr. & cassette: Ampex, Disneyland, GRT, ITCC, NAL, RCA.

### Playback equip.: Belle Wood.

Accessories: Le-Bo.  
Summit Dists. Inc., 211 E. Fourth St. Zip: 45202. Tel: 241-6361. Sales Mgr.: Harold Davis; Promo.: Lee Fogel. (D).  
Home office: Chicago, Ill. (see for prod. distributed).  
Supreme Dist'g Co., 1000 Broadway. Zip: 45202. Tel: 421-0747. Owner: Sam Klayman; Mgr. & Buyer: Al Klayman. (D).  
Cartridge 8-tr. & cassette: ABC, Atco, Atlantic, Bluesway, Command, Dunhill, Fantasy, GRT, Mercury, Monument, Musicor, Philips, Smash, Stax, Volt.  
Accessories: Blank loaded tape (3M).

### ● CLEVELAND (Area Code 216)

All Label Rec. Serv., 7777 Exchange St. Zip: 44125. Tel: 524-4260. Owner: Hess Budin; Mgrs.: Cary Budin, Don Weiss; Buyer: Cary Budin. (D & RJ).  
Branch: Phoenix, Ariz.  
Cartridge 8-tr.: Ampex, GRT, ITCC.  
Cassette: GRT, ITCC.  
Accessories: Capitol, Le-Bo, Recoton.  
Capitol Recs. Dist'g Corp., 7777 Exchange St. Zip: 44125. Tel: 524-8200. (D).  
Cartridge 8-tr. & cassette: Capitol, Angel, Melodiya/Angel, Apple, Harvest, Fame.  
Playback equip.: Capitol.  
Accessories: Display racks, storage cases (Capitol).  
Claber Dists. Inc., 16501 Rockside Rd. Zip: 44137. Tel: GR 5-1000. Buyer: Louis Rivituso. (RJ).  
Columbia Rec. Sales, 3510 Chester Ave. Zip: 44114. Tel: 431-6300. Sales Mgr.: Bud Rieland; Audio Sales Mgr.: Gilbert Yezbak. (D).  
Cartridge 8-tr.: Columbia, Date, Epic, Okeh, Ode, Barnaby, Fillmore, Blue Horizon.  
Cartridge 4-tr.: Columbia, Date, Epic, Okeh, Ode, Blue Horizon.  
Cassette: Same as 8-tr.  
Open reel: Same as 4-tr.  
Playback equip.: Masterwork.  
Accessories: Blank loaded tape, storage cases (Columbia).  
Dean's House of Jazz Inc., 8601 Hough Ave. Zip: 44106. Tel: 231-9531. Buyer: Wilbur E. Dean. (OS).  
Decca Dist. Corp., 1721 Superior Ave. Zip: 44114. Tel: 621-9770. Mgr. & Buyer: Bill Green; District Mgr.: Bill Glaseman. (D).  
Cartridge 8-tr.: Decca, Coral, Brunswick, Bravo, Viva, Colonial, Standard Phono, Word.  
Cassette: Decca, Coral, Brunswick, Bravo, Viva.  
Open reel: Decca, Coral, Brunswick.  
Playback equip.: Decca.  
Accessories: Blank loaded tape, head cleaners, storage cases (Decca).  
Handleman Co., 13900 Broadway, Garfield Heights 44125. Tel: 587-5550. Mgr.: Robert Prenatt (RJ).  
Home office: Detroit, Mich.  
Keynote Int'l Music Dists., 1584 E. 31 St. Zip: 44114. Tel: 861-7286. Owner & Mgr.: John R. Gayer. (D).  
Cartridge 8-tr. & cassette: Delta Int'l.  
Liberty/UA Dist'g Corp.—Cleveland Branch, 7777 Exchange St., Valley View 44125. Tel: 524-4230. Mgr.: Byron Giles; Buyer: Ralph Weiskopf. (D).  
Cartridge 8-tr.: Liberty, United Artists, Sunset.  
Cartridge 4-tr. & cassette: Liberty, United Artists.  
Main Line Cleveland Inc., 1260 E. 38 St. Zip: 44114. Tel: 391-1800. Owner: James Shipley; Dist. Mgr.: Joe Simone; OS & RJ Mgr.: Gene Halamay; Buyer: Mabel Bland. (D, OS & RJ).  
Branches: Atlanta, Ga.; Pittsburgh, Pa.  
Cartridge 8-tr.: A&M, Ampex, DGG, Elektra, Gordy, Motown, Musicor, Polydor, Prestige, RCA, Reprise, Soul, Tamla, Thunderbird, Vanguard, Warner Bros.-Seven Arts.  
Cassette: A&M, Ampex, DGG, Elektra, Gordy, Motown, Musicor, Polydor, RCA, Reprise, Soul, Tamla, Vanguard, Warner Bros.-Seven Arts.  
Open reel: RCA.  
Merrec Dists. Inc., 2800 Euclid Ave. Zip: 44115. Tel: 696-7666. Mgr.: August DiBlasi. (D).  
Cartridge 8-tr. & cassette: Mercury, Philips, Smash, Fontana, Limelight.  
Modern Rec. Serv. Inc., 18434 Cranwood Pkwy., Warrensville Heights 44128. Tel: 475-8900. Pres.: David W. Burke; Mgr.: Robert A. Burke. (OS & RJ).  
Northern Rec. Sales (div. of Transcontinent Rec. Sales), 2006 Prospect Ave. Zip: 44115. Tel: 781-7080. Mgr.: Don Rothenberg. (OS & RJ).  
Home office: Buffalo, N.Y.  
Piks/All Rec. & Tape, 2150 Hamilton. Zip: 44114. Tel: 696-7666. Owners: Ronald Schafer, Sheldon Tirk; Buyer: Sheldon Tirk. (D & OS).  
Branch: Pittsburgh, Pa.  
Cartridge 8-tr. & cassette: ABC, Cotillion, Crewe, Mercury, Roulette, SSS Int'l, Sun Int'l.  
Playback equip.: Mercury/Pax.  
Accessories: Storage cases (Walco).  
Seaway Dist'g Co. (div. of Famous Music Corp.), 12415 Euclid Ave. Zip: 44106. Tel: 421-8200. Mgr.: Robert Wilcox; Buyer: Nat Kulklin. (D).  
Cartridge 8-tr.: Atco, Atlantic, Fantasy, GRT, ITCC, Paramount, Scepter, Stax.  
Cartridge 4-tr.: Atco, Atlantic, Fantasy, Scepter, Stax.  
Cassette: Same as 8-tr.  
Open reel: Atco, Atlantic, Fantasy, GRT, Scepter, Stax.

Stark Rec. Serv. Inc., 2797 Hamilton Ave. Zip: 44114. Tel: 696-5300. Owner: Charles Murray; Buyer: Henry Caldwell. (RJ).  
 United Dist'g Inc., 2330 St. Clair. Zip: 44114. Tel: 696-4533. Owner: Saul Moss; Mgr. & Buyer: M. Broudy. (OS & RJ).

• **COLUMBUS (Area Code 614)**

Car Stereo of Columbus Inc., 4147 E. Main St. Zip: 43213. Tel: 237-0263. Owner: William Goldberg; Mgr. & Buyer: Robert Boren. Branch: 1000 Dublin Rd. Zip: 43207. Tel: 488-0763. Mgr.: Harriet Jones; Buyer: Robert Boren. (D, OS & RJ).  
 Cartridge 8-tr.: Ampex, Capitol, Columbia, Decca, GRT, ITCC, Jubilee, Liberty, Modern, United Artists.  
 Cassette: Capitol, Columbia, Decca, GRT, ITCC, Jubilee, Liberty, Modern, United Artists.  
 Open reel: Ampex, Capitol, Columbia, Decca, GRT.  
 Playback equip.: Automatic Radio, Capitol, Craig, Kraco, Masterwork, Motorola, Panasonic, Ranger.  
 Accessories: Complete line.

• **DAYTON (Area Code 513)**

Ambet Recs. (div. of Transcontinent Rec. Sales), 509 Xenia Ave. Zip: 45410. Tel: 256-4212. Mgr.: Martha Farris. (OS & RJ).  
 Home office: Buffalo, N.Y.  
 Dayton Rec. Serv. Inc., 24 W. Ferry St., Miamisburg 45342. Tel: 866-6431. Mgr. & Buyer: Morris Leach. (RJ).  
 Home office: Portsmouth, Ohio.

• **PORTSMOUTH (Area Code 614)**

Dayton Rec. Serv. Inc., 24 Union St. Zip: 45662. Tel: 354-3188. Mgr. & Buyer: Joe Taylor. (RJ).  
 Branch: Dayton, Ohio.

• **SPRINGFIELD (Area Code 513)**

Buckeye Rec. Co., 44 Warden St. Zip: 45504. Tel: 325-7313. Owner: Asen Kristoff. (OS & RJ).

• **TOLEDO (Area Code 419)**

Bartley Co., 1001 Brown Ave. Zip: 43607. Tel: 241-5563. Owner: Richard Peckinpaugh; Mgr. & Buyer: W. L. Crane Jr. (RJ).  
 Northwestern Dist. Inc., 1020 Sylvania Ave. Zip: 43612. Tel: 479-5241. Owner & Buyer: George La Course. (RJ).

• **YOUNGSTOWN (Area Code 216)**

Plaza Recs. Inc., 309 Boardman Plaza. Zip: 44512. Tel: 758-5795. Owners: Frank A. Valicenti, Jack Smith. Mgr.: Gerold Kaufman. (OS).

**OKLAHOMA**

• **OKLAHOMA CITY (Area Code 405)**

All Recs. Inc., 520 Classen Blvd. Zip: 73106. Tel: CE 5-3381. Mgr. & Buyer: Bill Hill. (OS).  
 B & K Dist'g Co. Inc. (div. of National Tape Dist. Inc.), 129 NW 23 St. Zip: 73103. Tel: JA 5-7509. Mgr.: Cliff Keeton. (D).  
 Home office: Brookfield, Wis.  
 Cartridge 8-tr. & cassette: Atco, Atlantic, Cotillion, Dakar, Enterprise, Liberty, Stax, Sunset, Volt.  
 Communication Electronics Inc., 7501 N. Broadway. Zip: 73114. Tel: 848-2266. Buyer: Richard Hainebach. (RJ).  
 Decca Dist. Corp., 1733 NW 63 St. Zip: 73116. Tel: VI 3-3635. Mgr.: Troy Bowen (D).  
 Cartridge 8-tr.: Decca, Coral, Brunswick, Bravo, Viva, Berlitz, Colonial, Standard Phono.  
 Cassette: Decca, Coral, Brunswick, Bravo, Viva.  
 Open reel: Decca, Coral, Brunswick.  
 Playback equip.: Decca.  
 Accessories: Blank loaded tape, head cleaners, storage cases (Decca).  
 Dulaneys Inc., 100 NW 44 St. Zip: 73118. Tel: 528-0511. Mgr.: Jake McDonald; Buyer: Clyde C. Ball. (D & OS).  
 Cartridge 8-tr.: Ampex, Camden, ITCC, NAL, RCA.  
 Cartridge 4-tr.: Ampex.  
 Cassette: Ampex, ITCC, NAL, RCA.  
 Open reel: Ampex, Camden, RCA.  
 Playback equip.: Lear Jet.  
 Arthur Fulmer, 310 E. Sheridan St. Zip: 73104. Tel: 235-0388. Mgr.: Ralph Mays. (D & I).  
 Home office: Memphis, Tenn. (see for prod. distributed).  
 Mid-Continent News Co., 7001 N. Broadway Expwy. Tel: 843-9383. Mgr.: Curley Albro; Buyer: Steve Munroe. (D).  
 Home office: Tulsa, Okla., Oklahoma News (see for prod. distributed).  
 Music Box Dist. Inc., 3114 N. Western. Zip: 73118. Tel: 525-5515. Owner & Mgr.: Jerry Gregory. (RJ).  
 Oklahoma Operating Co., 2040 NW 10 St. Zip: 73106. Tel: 236-5471. Mgr.: James N. Cotton; Buyer: Lil Mays. (D).  
 Cartridge 8-tr.: Capitol, Dot, ITCC, Muntz, NAL.  
 Playback equip.: Automatic Radio, Craig, Elgin, Kraco, Lear Jet, Muntz.  
 Accessories: Arkay, Channel Mktg., Gibbs, Recoton, Specialty Sounds.

Western Mdrs. Inc., 133 NW 23 St. Zip: 73103. Tel: 525-3632. Mgr.: Junior Baldwin. (D & RJ).  
 Home office: Amarillo, Tex. (see for prod. distributed).

• **TULSA (Area Code 918)**

Bill's T Recs. Inc., 19 N. Harvard. Zip: 74115. Tel: 939-6305. Pres. & Buyer: Kenneth A. Horn; Mgr.: Connie Moore. (OS).  
 Oklahoma News Co., 909 W. 23 St. Zip: 74107. Tel: 584-4754. Owner: R. Glenn White; Mgr.: S. E. White; Buyer: John Goodnight. (D, OS & RJ).  
 Branch: Oklahoma City, Okla., Mid-Continent News. (D).  
 Cartridge 8-tr. & cassette: Capitol, Columbia, Decca, GRT, ITCC, Mercury, Paramount, RCA.  
 Playback equip.: Automatic Radio, Belle Wood, Capitol.  
 Accessories: Complete line of name brands.

**OREGON**

• **EUGENE (Area Code 503)**

Cascade Rec. Serv. (E), see Orwaka Dist'g Co.  
 Orwaka Dist'g Co. (div. of Able Inds. Inc.), PO Box 767, Zip: 97401; 50 E. 25 St. Zip: 97405. Tel: 345-6834. Mgr.: Gary E. Seibert. (D), (E as Cascade Rec. Serv.).  
 Cartridge 8-tr.: DGG, ITCC.  
 Cassette: Cetra, DGG, ITCC.  
 Open reel: ITCC.  
 Exports: Pre-recorded tape, playback equip. (Canada only).

• **PORTLAND (Area Code 503)**

Portland One Stop, 511 SW Sixth Ave. Zip: 97204. Tel: 226-3669. Owner & Mgr.: Martin C. McMahon. (OS).  
 Sea-Port One Stop (div. of Fidelity Northwest Inc.), 21 NE Seventh Ave. Zip: 97232. Tel: 234-0965. Mgr.: Tom Choate. (OS & RJ).  
 Home office: Seattle, Wash.

• **ROSEBURG (Area Code 503)**

Paul Jackson Whsle. Co., 1308 NW Park St. Zip: 97470. Tel: 672-4262. Pres.: Paul Jackson; Mgr.: Bob Davis. (RJ).

**PENNSYLVANIA**

• **CONEMAUGH (Area Code 814)**

Page Rec'g Co., 345 Second St. Zip: 15909. Tel: 539-8117. Owner & Mgr.: Al Page. (D & RJ).  
 Cartridge 8-tr.: Carnaby, Delta Int'l, Jay Jay, Majestic.  
 Cassette: Carnaby, Jay Jay, Majestic.

• **HARRISBURG (Area Code 717)**

D & H Dist'g Co. (Rec. & Tape Div.), 500 Terminal Rd., Camp Hill 17011. Tel: 761-2805. Mgr.: David Press; Buyer: Eugene Diveglia. (D, OS & RJ). Exec. office: 2525 N. Seventh St. Zip: 17105. Tel: 236-8001.  
 Branches: Baltimore, Md. (OS & RJ); Cheverly, Md. (D).  
 Cartridge 8-tr. & cassette: Ampex, Capitol, Columbia, Decca, Disneyland, Epic, GRT, Gordy, ITCC, Jubilee, Kapp, Liberty, Mercury, Modern, Motown, Musicor, NAL, Original Sound, Paramount, Pickwick, Polydor, RCA, Radiant, Scepter, Soul, Springboard, Tamla, United Artists, Word.  
 Playback equip.: Belle Wood, Capitol, Lear Jet, Mercury, Philco-Ford, RCA.  
 Accessories: Amberg, Capitol, Decca, Le-Bo, RCA, Recoton, Rubbermaid, TDK.

• **KINGSTON (Area Code 717)**

Record Town Inc., 449 Northampton St. Zip: 18704. Tel: 288-6536. Owner & Buyer: Joe Nardone. (RJ).

• **LEHIGHTON (Area Code 717)**

Barnes Rec. Dist., PO Box 296. Zip: 18235. Tel: 645-2321. Owner & Mgr.: William Barnes. (OS & RJ).

• **McKEESPORT (Area Code 412)**

Richmark Sales Co., 3806 Oneil Blvd. Zip: 15132. Tel: 673-4668. Owner: Alvin Ackerman. (D & RJ).  
 Cartridge 8-tr. & cassette: All lines.

• **PHILADELPHIA (Area Code 215)**

(Also see listings in Camden & Pennsylvania, N.J.)

*continued on page 62*

**KING KAROL'S** PRICES ARE LOWEST!  
 SERVICE IS FASTEST!  
 INVENTORY IS LARGEST!

Now YOU can buy ANY  
**TAPE**  
 on ANY LABEL!

**WORLD'S LARGEST SELECTION**  
 thru KING KAROL'S  
 World Famous **ONE-STOP** TAPE SERVICE!

**FREE SHIPPING & HANDLING ANYWHERE IN U.S.A.!**  
 FOB N.Y.C. on Foreign Shipments.

INSTANT SERVICE — ORDER PROCESSED DAY RECEIVED!

OUR PRICES ARE LOW . . .  
 OUR SERVICE & FILL IS HIGH—  
**TEST US**  
 BUY ITEMS YOU'VE HAD TROUBLE GETTING AND SEE IF WE DON'T CONVINCE YOU!

**WE HAVE EVERYTHING!**

Especially items not found anywhere else!  
 8 Track • Cassettes • Extra Large Open Reel Inventory  
 Complete Selection Blank Tapes (all configurations) Scotch, Audio, etc.

ANY record or tape mentioned or advertised in this publication is available thru KING KAROL'S world famous one-stop service!  
 YOU NAME IT—WE'LL GET IT FOR YOU!  
**FREE CATALOG SENT ON REQUEST**  
**KING KAROL RECORDS**  
 444 West 42nd St., N.Y.C. 10036

## DISTRIBUTORS

Continued from page 61

A & L Dists. Inc., SE Corner 30 & Thompson Sts. Zip: 19121. Tel: PD 5-4300. Owner: Albert Melnick; Mgr.: Si Paul; Buyer: Larry Jacobs. (D, OS & RJ).  
Cartridge 4-tr., 8-tr., cassette & open reel: All lines.  
Playback equip.: Capitol, Hitachi, Pax, Standard.  
Accessories: Channel Mktg., Le-Bo, Recoton.  
Bandstand Rec. Serv. Inc. (div. of Chip's Dist'g Corp.), 1400 W. Somerset St. Zip: 19132. Tel: BA 9-9110. Pres. & Mgr.: Ernie Santone. (OS & RJ).  
Capitol Recs. Dist'g Corp., 7708 City Line Ave. Zip: 19151. Tel: 877-4167. (D).  
Cartridge 8-tr. & cassette: Capitol, Angel, Melodiya/Angel, Apple, Harvest, Fame.  
Playback equip.: Capitol.  
Accessories: Display racks, storage cases (Capitol).  
Chip's Dist'g Corp., 2750 N. Broad St. Zip: 19132. Tel: 226-4600. Pres. & Mgr.: Ernie Santone. (D). Branches: Hittsville of Pennsylvania (D), Bandstand Rec. Serv. Inc. (OS & RJ).  
Cartridge 8-tr. & cassette: Ampex, DGG, Disneyland, GRT, Mercury, Polydor, NAL.  
Accessories: Fidelitone.  
Columbia Rec. Sales, 4 Penn Center Plaza, Suite 224. Zip: 19103. Tel: LO 8-4445. Sales Mgr.: Ed Masterson; Audio Sales Mgr.: John Arrow. (D).  
Cartridge 8-tr.: Columbia, Date, Epic, Okeh, Ode, Barnaby, Fillmore, Blue Horizon.  
Cartridge 4-tr.: Columbia, Date, Epic, Okeh, Ode, Blue Horizon.  
Cassette: Same as 8-tr.  
Open reel: Same as 4-tr.  
Playback equip.: Masterwork.  
Accessories: Blank loaded tape, storage cases (Columbia).  
Norman D. Cooper Inc., 6222 Lebanon St. Zip: 19151. Tel: TR 8-9591. Pres.: Norman D. Cooper; Mgr.: Val Shively. (OS).  
Hittsville of Pennsylvania (div. of Chip's Dist'g Corp.), 2750 N. Broad St. Zip: 19132. Tel: 226-4600. Pres. & Mgr.: Ernie Santone. (D).  
Cartridge 8-tr. & cassette: Gordy, Motown, Rare Earth, Soul, Tamla, VIP.  
Marnel Rec. Dists. Inc., 2512 N. Broad St. Zip: 19132. Tel: BA 6-1222. Mgr.: Marshall Verbit. (D).  
Cartridge 8-tr.: Ampex, Atlantic, Dooto, Ethnic, Fiesta, GRT, Gross, Humorsonic, Jubilee, Laurie, Prestige, Project 3, Savoy, Starday, Stax.  
Cassette: GRT.  
Robert Nash Dists. Inc., 2780 Limekiln Pike, Glenside 19038. Tel: WA 7-6100, TU 6-6430. Owner: Robert Nash; Buyer: Andy Nash. (D & OS).  
Cartridge 8-tr. & cassette: Ampex, Capitol, Columbia, Decca, Epic, ITCC, Jubilee, Kapp, Liberty, Mercury, Motown, RCA, Reprise, Scepter, Stax, Warner Bros.-Seven Arts.  
Playback equip.: Belair, Lear Jet, Panasonic.  
Accessories: Blank tape & head cleaners (TSI), storage cases (Amberg, Le-Bo).  
Paramount Rec. Dists., 349 W. Lancaster Ave., Haverford 19041. Tel: 642-4110. Mgr.: R. James O'Rourke. (D).  
Cartridge 8-tr. & cassette: Paramount.  
Rec O Rac Dists., 7345 Westchester Pike, Upper Darby 19082. Tel: 734-1606. Owner & Mgr.: Harry Blauffeld. (RJ).  
Record Rendezvous, 134 S. 20 St. Zip: 19103. Tel: LO 7-9424. Owner: Edward R. Marcus; Mgr.: R. Richard; Buyer: Francine E. Morgan. (OS & RJ).  
Richman Bros. Recs. Inc., 4308 Parkside Ave. Zip: 19104. Tel: GR 7-1742. Owners: Jerold, Allen & Richard Richman. (D & OS).  
Cartridge 8-tr. & cassette: All lines.  
Playback equip.: Capitol, Decca, Mastermind.  
David Rosen Inc., 853 N. Broad St. Zip: 19123. Tel: CE 2-2900. Owner: David Rosen; Mgr. & Buyer: Lewis Rosen. (D).  
Cartridge 8-tr. & cassette: GRT, Kapp, Reprise, Scepter, Warner Bros.-Seven Arts.  
Raymond Rosen Music Prods. Inc., 51 St. & Parkside Ave. Zip: 19131. Tel: TR 8-2200. Mgr.: Myron Zacker; Buyers: Al Fario, Myron Zacker. (D & RJ).  
Cartridge 4-tr., 8-tr. & cassette: All lines.  
Scorpio Music Dist. Inc., 6512 Lawnton Ave. Zip: 19126. Tel: 549-5772. Owner: Michael Adler; Mgr.: Sy Cole; Buyer: Joseph Brodsky. (OS).  
Shulman Rec. Co. Inc., 428 N. 13 St. Zip: 19123. Tel: 627-4902. Owners: Jerry Shulman, Lee Swede; Mgr.: Manny Drucker; Buyer: Jerry Shulman. (D & RJ).  
Cartridge 8-tr. & cassette: Capitol, Columbia, Decca, GRT, ITCC, Liberty.  
Playback equip.: Capitol, Craig, Panasonic, Sony.  
Accessories: Capitol, Le-Bo, 3M.  
Universal Tape City One Stop & Rack Serv. (div. of Universal Recs.), 919 N. Broad St. Zip: 19123. Tel: 235-2727. Owner: Harold Lipsius; Mgr. & Buyer: Robert Perloff. (D, OS & RJ).  
Cartridge 8-tr. & cassette: A&M, Ampex, Atco, Atlantic, GRT, ITCC, Original Sound, Scepter, Vanguard.  
Open reel: A&M, Ampex.

Williams One Stop, 817 N. Broad St. Zip: 19123. Tel: CE 2-2020. Owner: Sidney Williams. (OS).

### ● PITTSBURGH METROPOLITAN AREA (Area Code 412)

A & C Tape Dist., 2731 Brownsville. Zip: 15227. Tel: 884-2127. Owners & Mgrs.: John R. Hoebler, Gene Jakiela. (D, OS, RJ, I & E).  
Cartridge 4-tr., 8-tr., cassette & open reel: All lines.  
All Brands Inc. (div. of Handleman Co.), 1388 Island Ave., McKees Rocks 15136. Tel: 331-6972. Mgr.: Vera Powell. (RJ).  
Home office: Detroit, Mich., Handleman Co.  
Arc-Jay Kay Dist'g Co. (div. of Handleman Co.), 40 24 St. Zip: 15222. Tel: 391-8573. Mgr.: Herbert Cohen. (D).  
Cartridge 4-tr., 8-tr., cassette & open reel: All lines.  
Home office: Detroit, Mich., Handleman Co.  
Decca Dist. Corp., 1331 Fifth Ave. Zip: 15219. Tel: 391-4450. Promo.: Rick Weber. (D).  
Cartridge 8-tr. & cassette: Decca, Coral, Brunswick, Bravo, Viva.  
Open reel: Decca, Coral, Brunswick.  
Playback equip.: Decca.  
Accessories: Blank loaded tape, head cleaners, storage cases (Decca).  
Handleman Co., see All Brands.  
Klein's Logan Variety, 227 Fort Pitt Blvd. Zip: 15222. Tel: 261-6176. Owner: Isadore Klein; Mgr. & Buyer: Travis Klein. (D & OS).  
Cartridge 8-tr. & cassette: ABC, Cadet, Cadet/Concept, Capitol, Checker, Chess, Columbia, Decca, Dunhill, Fantasy, GRT, Gamble, ITCC, Livingston, Mercury, Monument, Philips, Prestige, Savoy.  
Lomakin Music, 633 Liberty Ave. Zip: 15222. Tel: 281-6344. Owner: Nick Lomakin. (OS).  
Main Line Pittsburgh, B4 Van Braam St. Zip: 15219. Tel: 471-6686. Mgr.: Dick Iezzi; Buyer: Bob Sholes. (D, OS & RJ).  
Home office: Cleveland, Ohio.  
Cartridge 4-tr., 8-tr., cassette & open reel: A&M, Audio Fidelity, Blue Thumb, Demarc, Elektra, Hi, MGM, Motown group, Musicor, Parrot, Polydor, Uni, Verve.  
Playback equip.: RCA.  
Mobile Rec. Serv. Co., 2716 Penn Ave. Zip: 15222. Tel: 391-0452. Owner & Buyer: Maurice Oseroff. (OS & RJ).  
Branch: Friendly, W. Va.  
Piks/All Rec. & Tape, 256 Fifth Ave. Zip: 15222. Tel: 471-3484. Mgr.: M. Nagel; Buyer: S. Tirk. (D & OS).  
Home office: Cleveland, Ohio (see for prod. distributed).  
Jack H. Samuels & Co. Inc., 5117 Baum Blvd. Zip: 15224. Tel: 683-8800. Owner: Jack H. Samuels; Mgr.: Roy Leger. (D).  
Cartridge 8-tr. & cassette: All lines except Ampex & GRT.  
Playback equip.: Lear Jet, Motorola.  
Accessories: Amberg, Le-Bo.  
● SCRANTON (Area Code 717)  
Tapes Ltd., 80 Elmhurst Blvd. Zip: 18505. Tel: 346-9436. Mgrs.: Dick Plotkin, Robert Cohen. (RJ).  
● TYRONE (Area Code 814)  
Central One Stop Inc., RD 4, Rt. 220. Zip: 16686. Tel: 684-3900. Mgr. & Buyer: Richard Heaton. (D, OS & RJ).  
Cartridge 8-tr. & cassette: Amy, Audio Fidelity, Bell, Buddha, Four Corners of the World, GNP Crescendo, ITCC, Jubilee, Kapp, Laurie, Mala, Musicor, NAL, New Voice, Paramount, Roulette, Scepter, Starday, Steed, Wand, White Whale.  
Playback equip.: Belair, Hitachi, Panasonic, Telex, Tenna.  
Accessories: Amberg, Recoton, Walco.

## RHODE ISLAND

### ● PROVIDENCE (Area Code 401)

A B C Rec. & Tape Sales Corp., 725 Branch Ave. Zip: 02904. Tel: 351-6700. Mgr.: Milton Israeloff. (RJ).  
Home office: Seattle, Wash.  
H. V. Papazian Corp., 387 Charles St. Zip: 02904. Tel: 351-5099. Owners: Harold V. Papazian, Haig Yaghoobian. (RJ).

## SOUTH CAROLINA

### ● ABBEVILLE (Area Code 803)

Savitz Rec. Center, 115 Court Sq. Zip: 29620. Tel: 459-2172. Owner: Allen Savitz; Mgr.: Cregg Booth. (RJ).

### ● COLUMBIA (Area Code 803)

Brown Sales Co., 1423 Ellerbe St. Zip: 29204. Tel: 787-3581. Owner: H. G. Brown Jr.; Mgr. & Buyer: Steve Sturkie. (D & RJ).

Cartridge 8-tr. & cassette: Capitol, ITCC, Liberty, Mercury, NAL, RCA.  
Playback equip.: Automatic Radio, Craig.  
Accessories: Head cleaners (RCA); storage cases (Le-Bo).

## TENNESSEE

### ● CLEVELAND (Area Code 615)

Pathway Press, PO Box 850, 1080 Montgomery. Zip: 37311. Tel: 476-5197. Gen. Sales Mgr.: H. Bernard Dixon. (D).  
Cartridge 8-tr.: Sing, Skylite.

### ● COOKEVILLE (Area Code 615)

Rack Entis., 1570 Brown Ave. Zip: 38501. Tel: 526-5148. Mgr. & Buyer: Bill Amonette. (RJ).

### ● KNOXVILLE (Area Code 615)

Knox Rec. Rack Co., PO Box 4045, 1539 Amherst Rd. Zip: 37921. Tel: 584-8531. Owners: Sam Morrison, Jay Jacobs; Mgr. & Buyer: Jay Jacobs. (D & RJ).  
Cartridge 8-tr. & cassette: Ampex, Capitol, Columbia, Decca, GRT, ITCC, Kapp, Liberty/UA, Mercury, Music Tape, Pickwick, RCA, Scepter.  
Playback equip.: Automatic Radio, Pax/Mercury, Panasonic, Stereosonic.  
McClung Appliance Inc., 5915 Casey Dr. Zip: 37919. Tel: 584-8611. VP & Mgr.: Frank Trevena; Buyer: Albert W. Smith. (D & OS).  
Cartridge 8-tr.: Camden, GRT, Heart Warming, ITCC, Jubilee, Liberty, Pickwick, RCA, United Artists.  
Cassette: GRT, RCA.  
Open reel: Camden, RCA.  
Playback equip.: Lear Jet, RCA.  
Accessories: Le-Bo, RCA.

### ● MEMPHIS (Area Code 901)

Blackwood Bros. Recs., 209 N. Lauderdale. Zip: 38105. Tel: 527-4349. Owner: James Blackwood; Mgr. & Buyer: Doyle Blackwood. (OS).  
Decca Dist. Corp., 3132 Birchfield Dr. Zip: 38217. Tel: 358-6654. Mgr.: Graham Hediker. (D).  
Cartridge 8-tr.: Decca, Coral, Brunswick, Bravo, Viva, Berlitz.  
Cassette: Decca, Coral, Brunswick, Bravo, Viva.  
Open reel: Decca, Coral, Brunswick.  
Playback equip.: Decca.  
Accessories: Blank loaded tape, head cleaners, storage cases (Decca).  
Arthur Fulmer, 260 Monroe Ave. Zip: 38101. Tel: 525-5711. Owner: Arthur Fulmer; Mgr. & Buyer: Ron Edmundson. (D & I).  
Branches: Monrovia, Calif.; Miami, Orlando, Fla.; Indianapolis, Ind.; Louisville, Ky.; St. Louis, Mo.; Charlotte, N.C.; Oklahoma City, Okla.; Dallas, Houston, Tex.; Richmond, Va.  
Cartridge 8-tr. & cassette: All major lines.  
Playback equip.: Arthur Fulmer (Japan).  
Hot Line Rec. Dists. Co. Inc., 596 Lane Ave. Zip: 38105. Tel: 525-0756. Mgr. & Buyer: Jim W. Crudgington. (D, OS & RJ).  
Cartridge 8-tr. & cassette: Atco, Atlantic, Camden, Colgems, Enterprise, Fantasy, Gross, ITCC, Jubilee, Kirshner, Modern, RCA, Stax.  
Musical Isle of America Inc. (An Entertainment Serv. of Transamerica Corp.), 3000 Fleetbrook Dr. Zip: 38116. Tel: 332-3650. Mgr.: Bill Biggs. (RJ).  
Home office: Los Angeles, Calif.  
Poplar Tunes Inc., 308 Poplar Ave. Zip: 38103. Tel: 525-6348. Owner: Joe Cuoighi; Mgr.: Frank Berretta; Buyer: Fred Rogers. Branch: 4195 Summer Ave. Zip: 38122. Tel: 324-3855. Mgr.: Tommy Strange; Buyer: Rose Slais. (OS).  
Record Vending Inc., 746 Galloway Ave. Zip: 38105. Tel: 525-8673. Pres.: Sidney R. Melvin; Mgr.: James H. McCormick. (RJ).  
Branch: Nashville, Tenn.  
Stereo Dists.-Memphis Inc., 1481 Airways Blvd. Zip: 38114. Tel: 323-3449. Owner: Bill Crosno; Buyer: Suzy Martin. (D).  
Cartridge 8-tr. & cassette: All lines.  
Playback equip.: Lear Jet.  
Accessories: Amberg, K&R, Le-Bo.

### ● NASHVILLE (Area Code 615)

Certron Corp. Music Div., 1226 16 Ave. S. Zip: 37212. Tel: 291-5137. Div. Head: Aubrey Mayhew; Nat'l Promo. Mgr.: Jeff Clark. (Exec. office only).  
Branches: Los Angeles, Calif. (D, OS & RJ); Lubbock, Tex. (D, OS & RJ); San Antonio, Tex. (D, OS & RJ).  
Musical Isle of America Inc. (An Entertainment Serv. of Transamerica Corp.), 435 37 Ave. N. Zip: 37209. Tel: 269-5617. Mgr.: Harvey Kilgore. (RJ).  
Home office: Los Angeles, Calif.  
Music City Rec. Dists. Inc., 25 Lincoln St. Zip: 37202. Tel: 255-7315. Mgr.: Hutch Carlock; Buyer: Ted Adams. (D).  
Cartridge 4-tr., 8-tr. & cassette: Ampex, Atlantic, Fantasy, GRT, Mercury, Monument, Philips, Plantation, Redd Foxx, Scepter.  
Playback equip.: Belair.  
Accessories: Blank tapes (Fidelitone, Mercury).

National Music Sales (div. of Spar Recs.) 702 Harrison St. Zip: 37210. Tel: 244-9280. Mgr.: Randy Davidson. (D & OS).  
**Cartridge 8-tr. & cassette:** GRT, ITCC, NAL, Sun.  
Record Vending Inc., 467 Chestnut St. Zip: 37203. Tel: 256-6946. Pres.: Sidney R. Melvin. (RJ).  
**Home office:** Memphis, Tenn.  
Southern Rec. Dists., 467 Chestnut St. Zip: 37203. Tel: 254-1991. Mgr.: Dean Hunter. (D, OS & RJ).  
**Cartridge 4-tr., 8-tr. & cassette:** A&M, DGG, Gordy, Heart Warming, ITCC, Motown, Pickwick, Sing, Skylite, Soul, Tamla.

Decca Dist. Corp., 139 Cole St. Zip: 75207. Tel: 742-3739. Mgr.: Thomas Rodden; District Mgr.: Chick Doherty. (D).  
**Cartridge 8-tr.:** Decca, Coral, Brunswick, Bravo, Viva, Elektra, Berlitz.  
**Cassette:** Decca, Coral, Brunswick, Bravo, Viva, Nonesuch, Elektra.  
**Playback equip.:** Decca.  
**Accessories:** Blank loaded tape, head cleaners, storage cases (Decca).  
Arthur Fulmer, 2516 Hickory St. Zip: 75226. Tel: 421-5357. Mgr.: Joe Finan. (D & I).  
**Home office:** Memphis, Tenn. (see for prod. distributed).

H G W Inc., 8385 Westview Dr. Zip: 77055. Mgr.: Bill Wylds (E).  
**Home office:** Los Angeles, Calif.  
**Exports:** Pre-recorded tapes.  
Handleman Co., 7432 Ardmore St. Zip: 77021. Tel: 747-0151. Mgr.: Gene Tilley. (RJ).  
**Home office:** Detroit, Mich.  
Art Jones & Co. Inc., 4301 Gulf Fwy. Zip: 77023. Tel: 748-6000. Owner: Art Jones; Mgr. & Buyer: W. L. Whitehead. (D).  
**Cartridge 8-tr. & cassette:** RCA, Buena Vista, Chart, Colgems, Diamond, Gamble, Kirshner, Poppy, Prestige, White Whale.  
**Open reel:** RCA, Colgems, Kirshner.  
**Playback equip.:** Belle Wood, RCA.

## TEXAS

### ● AMARILLO (Area Code 806)

Western Mdsrs. Inc., PO Box 1969, 401 S. Adams. Zip: 79105. Tel: 376-6251. Owner: Sam Marmaduke; Mgr.: R. H. Williamson; Buyer: Ed Perry. (D & RJ).  
**Branches:** Oklahoma City, Okla.; Houston, Tex.  
**Cartridge 8-tr. & cassette:** All lines.  
**Playback equip.:** Ampex, Lear Jet, Mayfair, Tenna.  
**Accessories:** Le-Bo, Recoton.

### ● ARLINGTON (Area Code 817)

J. L. Marsh Inc. (div. of Pickwick Int'l Inc.), PO Box 1443, 3107 Ave. "E" E. Zip: 76010. Tel: 261-0303. (RJ).  
**Home office:** Minneapolis, Minn., Heilicher Bros.

### ● AUSTIN (Area Code 512)

Tom Bishop Whsle., Box 119D, Rt. 5. Zip: 78704. Tel: 282-1773. Owner & Mgr.: Tom Bishop. (RJ).

### ● DALLAS (Area Code 214)

A B C Rec. & Tape Sales, 4841 Topline Dr. Zip: 75247. Tel: 637-4580. Mgr. & Buyer: William M. Pennington. (RJ).  
**Home office:** Seattle, Wash.

Adleta Co., 1914 Cedar Springs Ave. Zip: 75201. Tel: 741-3151. Owners: E. C. Adleta Jr., H. J. Adleta; Gen. Mgr.: E. P. Miles; Tape Mgr.: David Eisenlohr (D).  
**Cartridge 8-tr.:** RCA, Camden, Kirshner, Chart, Colgems, Buena Vista, Diamond, Gamble, Poppy, White Whale.  
**Cassette:** RCA.  
**Open reel:** RCA, Camden, Kirshner, Colgems.  
**Accessories:** Blank loaded tape (RCA, VIP); storage cases (RCA).

Atlas-Rand Corp., 7900 Sovereign Row. Zip: 75247. Tel: ME 7-2760. VP Sales: Al Gitleman. (D).  
**Home office:** see New York, N. Y.  
**Cartridge 8-tr., cassette & open reel:** Sentry & all major lines.  
**Playback equip.:** Keystone.

B & K Dist'g Co. Inc. (div of National Tape Dists. Inc.), 1411 Round Table Dr. Zip: 75247. Tel: ME 7-1920. Mgr.: William C. Burton. (D & OS).  
**Home office:** Brookfield, Wis.

**Cartridge 4-tr., 8-tr. & cassette:** Ampex, DGG, Disneyland, GRT, Gross, ITCC, Jubilee, Kapp, Modern, NAL, Polydor, Prestige, Reprise, United Artists, Warner Bros.-Seven Arts.  
**Open reel:** Ampex, Bell & Howell, GRT, ITCC.  
**Playback equip.:** Belle Wood, Craig, Gibbs, Orrtronics.  
**Accessories:** Ampex, Dyn, Le-Bo, Micro-Power, Muntz.

Big State Dist'g Corp., 1337 Chemical St. Zip: 75207. Tel: 631-1100. Mgr.: Bill Emerson; Sales Mgr.: Wright Borden. (D & OS).  
**Cartridge 8-tr. & cassette:** A&M, Atco, Atlantic, BT Puppy, Bell, Cotillion, Dakar, Deram, Diamond, Dooto, Double Shot, Enterprise, Era, Fantasy, Galaxy, Gamble, Gordy, Gross, Hi, Hickory, Hob, Humorsonic, Jad, Jamie, Josie, Jubilee, Laff, Liberty, London, MF, Mainstream, Metromedia, Modern, Monument, Motown, Musicor, New Voice, Parrot, Paula, Phil-L.A. of Soul, Philly Groove, Plantation, Pompeii, Press, Roulette, Scepter, Soul, Starday, Stax, Sunset, Tamla, United Artists, Vanguard, Volt, Wand, White Whale.  
**Open reel:** A&M.

Capitol Recs. Dist'g Corp., 6730 Oakbrook Blvd. Zip: 57235. Tel: 637-1890.  
**Cartridge 8-tr. & cassette:** Capitol, Angel, Melodiya/Angel, Apple, Harvest, Fame.  
**Playback equip.:** Capitol.  
**Accessories:** Display racks, storage cases (Capitol).

Columbia Rec. Sales, 8808 Empress Row. Zip: 75247. Tel: ME 1-5680. Audio Sales Mgr.: Joseph Konas; Sales Mgr.: Tom Cade. (D).  
**Cartridge 8-tr.:** Columbia, Date, Epic, Okeh, Ode, Barnaby, Fillmore, Blue Horizon.  
**Cartridge 4-tr.:** Columbia, Date, Epic, Okeh, Ode, Blue Horizon.  
**Cassette:** Same as 8-tr.  
**Open reel:** Same as 4-tr.  
**Playback equip.:** Masterwork.  
**Accessories:** Blank loaded tape, storage cases (Columbia).

Handleman Co., 2931 Irving Blvd., Suite 106. Zip: 75247. Tel: 631-2943. Regional VP & Mgr.: George Braun. (RJ).  
**Home office:** Detroit, Mich.

Jay Kay Dist'g Co. (div. of Handleman Co.), 2931 Irving Blvd., Suite 105. Zip: 75247. Tel: 637-2440. Mgr.: Marion Coburn. (D).  
**Home office:** Detroit, Mich., Handleman Co.  
**Cartridge 4-tr., 8-tr., cassette & open reel:** All lines.

M & S Rec. Serv., 2020 Housley Dr. Zip: 75228. Tel: 321-3161. Owner & Buyer: M. Lauer; Mgr.: Sylvia Lauer. (RJ).

Merrec Dists. Inc., Stemmons Tower West, Suite 903, 2730 Stemmons Fwy. Zip: 75207. Tel: 631-3531. Mgr.: Jack Bernstein. (D).  
**Cartridge 8-tr. & cassette:** Mercury, Philips, Smash, Fontana, Limelight.  
**Playback equip.:** Mercury.

Paramount Rec. Dists., 1347 Chemical St. Zip: 75207. Tel: ME 1-0630. Mgr.: Jim McCauley. (D).  
**Cartridge 8-tr. & cassette:** Paramount.

Records of Dallas Inc., 1345 Chemical St. Zip: 75207. Tel: 631-7263. Owners: H. W. Daily Jr., Bill Emerson; Mgr.: Ken Marrs. (RJ).

Transcontinental Music Corp., 4845 Cash Rd. Zip: 75247. Tel: 637-0552. Mgr.: Al Driscoll. (RJ).  
**Home office:** New York N.Y., Transcontinental Investing Corp.

Westex Rec. Serv. Inc., 1102 Lupo St. Zip: 75247. Tel: ME 7-1810. Mgr.: B. C. Switzer. (OS & RJ).

### ● EL PASO (Area Code 915)

M. B. Krupp Dists. Inc., 311 S. Santa Fe St. Zip: 79942. Tel: 532-4961. Mgr.: Ruben Irizarry. (D & OS).

**Cartridge 8-tr.:** A&M, Checker, Chess, Colossus, Jad, Original Sound, Plantation, SSS Int'l, Stax; (Spanish & Mexican prod.) Bernal, Cap-Latino, Del Rio, Del Valle, Disco Grande, Disco Mexico, Falcon, Impacto, Keyloc, Musart, Norteno, Peerless, Sunflow, Tear Drop, Tomi, Ventura, Zarape.

Sunland Supply Co. Inc., 2227 Texas Ave. Zip: 79949. Tel: 533-5901. Pres.: William M. Shapiro; Buyer: Gilbert Venegas. (D & OS).  
**Cartridge 4-tr. & 8-tr.:** Ampex, Capitol, Columbia, Columbia Mexican, Decca, GRT, Liberty, Mercury, RCA.  
**Cassette & open reel:** Ampex, Capitol, Columbia, RCA, Stereo Tape.  
**Playback equip.:** Emerson, Juliette, Monarch, Sharp.

### ● HOUSTON (Area Code 713)

Acme Dist'g Co., 3743 University Blvd. Zip: 77005. Tel: 665-0741. Owner & Mgr.: Kenneth Parish. (RJ).

Allied Recorded Sound Inc., 2704 Polk Ave. Zip: 77003. Tel: CA 7-2316. Owner: Ben Baker; Mgr.: D. P. Armentrout; Buyer: John Gonzalez. (D).  
**Cartridge 8-tr.:** Ampex, Capitol, Certron, Columbia, Decca, GRT, ITCC, Kapp, Mercury, NAL, Paramount, Scepter.  
**Cartridge 4-tr.:** Ampex, Certron, GRT, ITCC, Muntz.

**Cassette:** Capitol, Columbia, Decca, ITCC, GRT, Mercury, NAL, Paramount, Scepter.  
**Open reel:** Ampex, Capitol, Columbia, GRT, Mercury, NAL.  
**Playback equip.:** Capitol, Craig, Keystone.  
**Accessories:** Blank loaded tape, head cleaners, storage cases (Amberg).

Capitol Recs. Dist'g Corp., 6400 Westpark Dr., Suite 265. Zip: 77027. Tel: 782-7922. (O).  
**Cartridge 8-tr. & cassette:** Capitol, Angel, Melodiya/Angel, Apple, Harvest, Fame.  
**Playback equip.:** Capitol.  
**Accessories:** Display racks, storage cases (Capitol).

Central Sales Inc., 2104 Leeland St. Zip: 77003. Tel: CA 4-2626. Owner: George Jamail; Mgr.: Marge McIntyre. (OS).

H. W. Daily Inc., 314 E. 11 Ave. Zip: 77008. Tel: 861-6868. Owners: H. W. Daily Jr., Don Daily; Mgr. & Buyer: Don Daily. (D & OS), (RJ as Records of Houston).

**Cartridge 8-tr. & cassette:** Deram, Fantasy, GRT, ITCC, London, Parrot, Vanguard.  
**Open reel:** Deram, Fantasy, London, Parrot, Vanguard.  
**Playback equip.:** Tenna.  
**Accessories:** Amberg, Le-Bo.

Arthur Fulmer, 1109 Chenevert St. Zip: 77003. Tel: 227-5146. Mgr.: Joe Savarese. (D & I).  
**Home office:** Memphis, Tenn. (see for prod. distributed).

Liberty/UA Dist'g Corp.—Houston Branch, 2701 Louisiana, Suite 203. Zip: 77006. Tel: 528-2919. Mgr.: Murray Habbaz (D).  
**Cartridge 8-tr.:** Liberty, United Artists, Sunset.  
**Cartridge 4-tr. & cassette:** Liberty, United Artists.

Lotusco, PO Box 10860, 1634 Wakefield Dr. Zip: 77018. Tel: 686-1155. Owner & Buyer: A. H. Eickenhorst. (OS & RJ).

Record Dist'g Co. Inc. (div. of National Tape Dists. Inc.), 5631 Old Clinton Rd. Zip: 77020. Tel: 675-7527. Mgr.: Lawrence M. Rosmarin. (RJ).  
**Home office:** Brookfield, Wis.

Record Serv. Co., 614 Dennis. Zip: 77002. Tel: 528-5521. Mgr.: Russ Reeder; Buyers: Tex Schofield, Lilian Ford. (OS & RJ).

Records of Houston (RJ), see H. W. Daily Inc.  
Record Specialty's Co., PO Box 19132, 9799 Pine-lake. Zip: 77024. Tel: HO 8-2765. Owner & Mgr.: H. V. Hood. (RJ).

United Rec. Dist. Co., 1613 St. Emanuel. Zip: 77003. Tel: 228-8151. Owner: Steve Poncio; Mgr.: J. D. Copley; Buyer: Richard Poncio. (OS & RJ).

Western Mdsrs. Inc., 2916 White Oak Dr. Zip: 77077. Tel: 861-3179. Mgr. & Buyer: Ronald Lewis. (D & RJ).  
**Home office:** Amarillo, Tex. (see for prod. distributed).

### ● LUBBOCK (Area Code 806)

Certron Corp. Music Div. (formerly Recordland USA Inc.), 2612 Ave. A. Zip: 79404. Tel: 747-4443. Mgr.: Allan Rosen. (D, OS & RJ).

**Home office:** Nashville, Tenn.  
**Cartridge 4-tr., 8-tr. & cassette:** All lines except Motown.  
**Playback equip.:** Automatic Radio, Belle Wood, Muntz.  
**Accessories:** Certron.

### ● SAN ANTONIO (Area Code 512)

Certron Corp. Music Div., 600 W. Evergreen. Zip: 78212. Tel: 225-5881. Gen. Mgr.: Charels M. Cole. (D, OS & RJ).

**Home office:** Nashville, Tenn.  
**Cartridge 8-tr., cassette & open reel:** ARV, Bernal, CBS, Capri, Certron, DLV, Del Valle, Disco Grande, El Zarape, Falcon, Impacto, Keyloc, Musart, Norteno, Nuevo, Sunflow, Tear Drop, Tomi.  
**Playback equip.:** Mercury/Pax.

Musical Tapes, Inc., 8339 San Pedro Ave., Industrial Park, Bldg. 5. Zip: 78201. Tel: 342-2621. Mgr.: Carlos Balido. (D).  
**Home office:** Miami, Fla. (see for prod. distributed).

Rangel Rec. Dists. (div. of Rangel Music Co. Inc.), 809 Fredericksburg Rd. Zip: 78201. Tel: 735-6111. Mgr. & Buyer: Manuel E. Rangel. (D & OS).  
**Cartridge 8-tr. & cassette:** BCM, Corona, Discos Dominante, RMC.

### ● SAN BENITO (Area Code 512)

Rio Grande Music Co., PO Box 861, 119 S. Sam Houston Blvd. Zip: 78586. Tel: 399-1471. Owner: Paco Betancourt; Mgr. & Buyer: John E. Phillips. (D & OS).

**Cartridge 4-tr., 8-tr. & cassette:** ARV, Bego, Bernal, Buena Suerte, CBS Latin, Capri, Chico, Columbia, Del Valle, Disco Grande, Falcon, Ideal, Impacto, Keyloc, Marsol, Mex-melody, Musart, Norteno, Tear Drop, Tomi, Zarape.  
**Playback equip.:** RCA, V-M.  
**Accessories:** Head cleaners, leader tape, splicing tape (3M).

## UTAH

### ● SALT LAKE CITY (Area Code 801)

A B C Rec. & Tape Sales Corp., PO Box 15607, 3575 South 700 West. Zip: 84115. Tel: 266-3548. Mgr.: Ray Peterson. (D, OS & RJ).  
**Home office:** Seattle, Wash.  
**Cartridge 4-tr., 8-tr., cassette & open reel:** All lines.  
**Playback equip.:** Lear Jet.  
**Accessories:** All lines.

*continued on page 84*

# TAPE SUPPLIES

## RAW TAPE MANUFACTURERS

Agfa-Gevaert Inc., 275 North St., Teterboro, N.J. 07608. Tel: (201) 288-4100; NYC Tel: (212) LO 5-7850. Pres.: R. Aerts; Gen. Mgr.: A. P. Germer; Sales Mgr.: H. Kuhlmann.  
**Brand name:** Agfa Magneton.  
 Agfa Magneton, see Agfa-Gevaert.  
 American, see Bell & Howell.  
 Atlas-Rand Corp., 2 Keystone Pl., Paramus, N. J. 07652. NYC Tel: (212) 563-6663. Pres.: Harold Rosen; Sales Mgr.: Barry Rosen; Adv. Dir.: Stuart Better.  
**Brand name:** Keystone.  
 Audio Communications Inc., Rt. 10, Randolph Ind'l Park, Dover, N.J. 07801. Tel: (201) 361-7600. Pres.: E. Michael Daspin; Sales Mgr.: Thomas J. Malia.  
**Brand name:** Tapette.  
 Audio Devices Inc., 100 Research Dr., Glenbrook, Conn. 06906. Tel: (203) 327-6500. Pres.: W. A. Estabrook; VP Mktg. & Sales: William L. Goldstein; Nat'l Sales Mgr.: A. P. Cunha.  
**Brand name:** Audiotape.  
 Audio Magnetics Corp., 14600 S. Broadway, Gardena, Calif. 90247. Tel: (213) 321-6841. Pres.: Irving B. Katz; Sales Mgr.: Ray Allen.  
 Audiotape, see Audio Devices.  
 B A S F Systems Inc., Crosby Dr., Bedford, Mass. 01730. Tel: (617) 271-4000. Pres.: D. Ambros; Mktg. Dir.: T. Dempsey; Audio Prod. Mgr.: H. Preston.  
**Home office:** Germany.  
 Bell & Howell Magnetic Tape Co. (formerly Greentree Electronics), 2602 Michelson Dr., Irvine, Calif. 92664. Tel: (714) 833-0020. Pres.: Sidney Brandt; Audio Tape Prod. Sales Mgr.: J. Sack; Precision Tape Prod. Sales Mgr.: R. McKenzie.  
**Brand name:** Bell & Howell, American.  
 Brand Five, see Robins.  
 Brand Seven, see Robins.  
 C C A, see Cassette Corp. of America.  
 Cassette Corp. of America, 640 S. Commercial Ave., Carlstadt, N. J. 07072. Tel: (201) 933-9125. Pres.: Walter Elterman; Gen. Mgr.: Allen Braverman; Mktg. Dir.: Arthur F. Etro; Sales Mgr.: Milton Blutter.  
**Brand name:** CCA.  
 Celanar, see Celanese Plastics.  
 Celanese Plastics Co. (div. of Celanese Corp.), 550 Broad St., Newark, N. J. 07102. Tel: (201) 877-2300. Pres.: Robert T. Daily; Gen. Mgr.: T. E. Brydon; Sales Mgr.: G. J. Monaghan.  
**Brand name:** Celanar (polyester film tape base).  
 Cerron Corp., 1701 S. State College Blvd., Anaheim, Calif. 92806. Tel: (714) 633-4280. Pres.: Edwin Gamson; Mktg. Admin. Dir.: Brian McCourt; Sales Mgr.: James Neiger.  
**Brand name:** Variou.  
 Coach, see Dict-O-Tape.  
 M. M. Cole, 251 E. Grand, Chicago, Ill. 60611. Tel: (312) 527-2160. Pres.: Shepard Stern; Gen. Mgr.: A. Bernstein; Sales Mgr.: J. Davidson.

Dict-O-Tape Inc., 9090 Krier Pl., Brooklyn, N. Y. 11236. Tel: (212) 257-3355. Pres.: Erwin Damsky; VP & Gen. Mgr.: Rudy Schwartz; Sales Mgr.: Oscar Goren.  
**Brand name:** Coach, Shannon, Kilts.  
 E. I. du Pont de Nemours & Co. Inc., Film Dept., Substrates Div., 10 & Market Sts., Wilmington, Del. 19898. Tel: (302) 774-6817. Gen. Mgr.: C. D. Bell; Sales Mgr.: P. G. Gillease.  
**Brand name:** Mylar (polyester film & polyester film type T).  
 Dynarange, see 3M.  
 Emerald, see Irish.  
 Fidelitone Inc., 6415 N. Ravenswood Ave., Chicago, Ill. 60626. Tel: (312) 274-0075. Pres.: Douglas F. Hudson; VP Sales: William R. Anton; Sales Mgr.: Hiram A. Prince.  
 Finebilt Mfg. Co., 931 N. Citrus Ave., Los Angeles, Calif. 90038. Tel: (213) 466-9511. Pres.: Alwin P. Schmid; VP: Joseph Bouzoglou.  
**Brand name:** Fine-Tape.  
 Fine-Tape, see Finebilt.  
 Fine-Tone Tapes Unlimited Inc., 24 Cobek Ct., Brooklyn, N. Y. 11223. Tel: (212) 336-6662. Pres.: Leonard Finkel; Gen. Mgr.: Stuart Mont; Sales Mgr.: Jack Haddad.  
 Forbes Electronics Inc., 19-21 Heyward St., Brooklyn, N. Y. 11211. Tel: (212) 855-0600. Pres. & Gen. Mgr.: Clifford K. Forbes; VP & Sales Mgr.: Eugene L. Aaronson.  
**Brand name:** Various private brands.  
 G R T Corp., 1286 Lawrence St., Rd. Sunnyvale, Calif. 94086. Tel: (408) 734-2910. Pres.: Alan J. Bayley; Mktg. Mgr.: Chris Coburn; Mktg. Servs. Dir.: Ronald Rader.  
**Brand name:** Magnem, Magnetic Media.  
 General Magnetic Tape, see Tapemaker.  
 Greentree, see Bell & Howell.  
 Irish Magnetic Tape Div., 458 Broadway, New York, N.Y. 10013. Tel: (212) 925-1257. Pres.: Sol Zigman; Gen. Mgr.: Hy Zigman; Sales Mgr.: Bill Grossman.  
**Brand name:** Emerald, Irish.  
 Jay-Cher Ents., PO Box 175, Fairmount, Ga. 30139. Tel: (404) 337-2510. Pres.: John Carter.  
**Brand name:** Regency.  
 Keystone, see Atlas-Rand.  
 Kilts, see Dict-O-Tape.  
 Le-Bo Prods. Co. Inc., 71-08 51 Ave., Woodside, N.Y. 11377. Tel: (212) 458-7700. Pres.: Leslie Bokor; VP & Sales Mgr.: Leslie Dame; Gen Mgr.: Herbert Hartman.  
**Brand name:** Lebotone.  
 Lebotone, see Le-Bo Prods.  
 Magnem, see GRT.  
 Magnetic Media Corp. (sub. of GRT Corp.), 616 Fayette Ave., Mamaroneck, N. Y. 10543. Tel: (914) 698-8660. Pres.: Aaron Wasserstrom.  
 Mylar, see E. I. du Pont de Nemours.  
 Nassau, see Telephone Dynamics.  
 Northridge Magnetics Inc., 19017 Parthenia, Northridge, Calif. 91324. Tel: (213) 394-0661. Pres.: R. B. Huffman; Exec. VP: S. J. Baker; Mfg. Superintendent: Norman Badgett.  
**Brand name:** Northridge Magnetics, Sound Track.

R C A Magnetic Prods. Div., 201 E. 50 St., New York, N. Y. 10022. Tel: (212) 586-3000. VP & Gen. Mgr.: J. Stephan; Mktg. Mgr.: D. C. Creswell; Audio Sales Mgr.: A. C. Fritolo.  
 Regency, see Jay-Cher.  
 Robins Inds. Corp., 15-58 127 St., College Point, N. Y. 11356. Tel: (212) 445-7200. Pres.: Herman D. Post; VP & Sales Mgr.: Jack Friedland.  
**Brand name:** Brand Five, Brand Seven, Sonoramic.  
 Royal Sound Co. Inc., 409 N. Main St., Freeport, N. Y. 11520. Tel: (516) 868-2880. Pres.: M. A. Dayan; Gen. Mgr.: N. Greenberg; Sales Mgr.: J. Corbin.  
 Sarex Corp., 3850 W. Side Ave., North Bergen, N. J. 07041. Tel: (201) 864-9400; NYC Tel: (212) 227-6354. Pres.: O. Louis Seda; Exec. VP: D. Max Brightmore; Sales Eng.: William M. Blethen.  
 Saxitone Tape Sales, 1776 Columbia Rd. NW, Washington, D. C. 20009. Tel: (202) 462-0800. Pres.: Harry Sackser; Gen. Mgr.: David Walstrom; Sales Mgr.: Ernest Holt.  
 Albert Schultz Inc. (exports only), see Tape Wholesalers section: New York, N.Y.  
 Scotch, see 3M.  
 Shannon, see Dict-O-Tape.  
 Sonoramic, see Robins.  
 Soundcraft-CBS Recs. (div. of CBS Inc.), Great Pasture Rd., Danbury, Conn. 06810. Tel: (203) 744-3555. Gen. Mgr.: Peter Landskroener; Mktg. Dir.: Robert E. Ward; Sales Mgr.: Charles Beriman.  
 Sound Track, see Northridge Magnetics.  
 T D K Electronics Corp., 23-73 48 St., Long Island City, N. Y. 11103. Tel: (212) 721-6881. Pres.: H. Kawamura; Mktg. Mgr.: George T. Saddler; Sales Mgr.: A. Otsuka.  
**Branches:** Los Angeles, Calif., 6151 W. Century Blvd. Zip: 90045. Tel: (213) OR 0-5515—Chicago, Ill., 2906 W. Peterson Ave. Zip: 60645. Tel: (312) 973-1222. Pres.: Katsuro Kamiya; Gen. Mgr.: Kiyoshi Hiromoto; Sales Mgr.: Yoshio Hirasaka.  
**Int'l branch:** Japan.  
 Tapemaker Sales Co. Inc., 2255 Broadway, New York, N. Y. 10024. Tel: (212) 874-4258. Pres.: Arthur Brandwein; Gen. Mgr.: Aubrey Stove Jr.  
**Brand name:** General Magnetic Tape.  
 Tapette, see Audio Communications Inc.  
 Telephone Dynamics Corp., 1333 Newbridge Rd., North Bellmore, N. Y. 11710. Tel: (516) 221-9870. Pres.: Leonard Young.  
**Brand name:** Nassau.  
 Tenzar, see 3M.  
 3 M Co., Magnetic Prods. Div., 3M Center, St. Paul, Minn. 55101. Tel: (612) 733-1110. Pres.: H. Heltzer; Magnetic Prods. Div. Mgr.: M. C. Hegdal; Magnetic Prods. Div. Sales Mgr.: W. H. Madden; Adv. & Sales Promo. Mgr.: Charles L. Arden.  
**Brand name:** Dynarange, Scotch, Tenzar.

continued on page 66



THINK  
TOUGH  
THINK "MYLAR"  
TYPE "T" POLYESTER FILMS

Du Pont developed MYLAR\* Type "T" polyester film as a base for pre-recorded and blank cassette tapes with exceptional strength.

Leading tape manufacturers use MYLAR Type "T" films in a variety of gauges for various cassette play/record times.

In addition to high strength and thinness, MYLAR Type "T" films offer excellent stretch-resistance that means better fidelity during duplication and playback.

The combination of the tape manufacturers' and duplicators' skills plus the reliability of the film base of MYLAR Type "T" is your assurance of quality, trouble-free cassette tape performance. Ask your supplier about MYLAR Type "T" polyester films—made only by Du Pont.

\*Reg. U. S. Pat. Off. for Du Pont's polyester film



MYLAR.

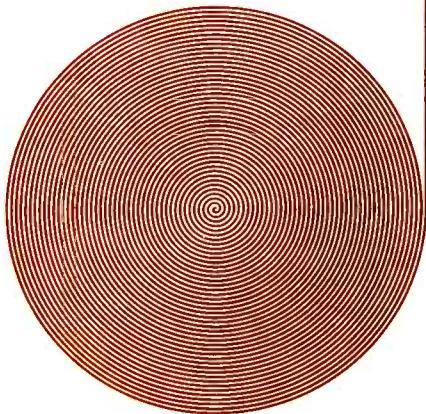



**C-60  
C-90  
C-120  
1/4" lubed  
audio tape  
for quality  
duplication**

When it comes to supplying raw tape for duplication or color coded pre-leadered tape for blank loaded cassettes we are THE specialists. And since that is all we do, we try to manufacture the very best. We begin with DuPont tensilized Mylar and carefully control our quality every step of the way.

But besides our quality, we are also known for our service, dependability and problem solving ability.

We would like to serve you too. Call us or drop us a line and we'll send you our specs and samples.

# Magnetic Media

MAGNETIC MEDIA CORPORATION, 616 Fayette Street, Mamaroneck, N.Y. 10543

a subsidiary of **GRT**

## TAPE SUPPLIES

Continued from page 64

### EMPTY CARTRIDGE, CASSETTE & REEL MANUFACTURERS

- A C I, see Audio Communications Inc.  
Adell Corp., 43700 Adell Blvd., Novi, Mich. 48050. Tel: (313) 349-6300. Pres.: Robert Adell; Gen. Mgr.: Frank Adell; Sales Mgr.: Frank McLaughlin.  
**Configuration:** Cartridge 8-tr.
- Alloy Surfaces Co. Inc. (sub. of Reeves Inds.), 100 S. Justison St., Wilmington, Del. 19899. Tel: (302) 655-6344. Pres.: George H. Cook; Gen. & Sales Mgr.: Charles S. Mueller.
- American Sound Corp., 3319 E. Ten Mile Rd., Warren, Mich. 48091. Tel: (313) 539-2900. Pres.: Frank S. Day; VP & Gen. Mgr.: William D. Adams.  
**Configuration:** Cassette.
- Amerline Corp. (sub. of Certron Corp.), 1800 W. Fullerton Ave., Chicago, Ill. 60614. Tel: (312) 348-4300. Gen. Mgr.: Fred Bassett; Sales Mgr.: Frank Glaubitz.  
**Configuration:** Cassette.
- Audio Communications Inc., Rt. 10, Randolph Ind'l Park, Dover, N.J. 07801. Tel: (201) 361-7600. Pres.: E. Michael Daspin; Sales Mgr.: Thomas J. Malia.  
**Configuration:** Cartridge 4-tr., 8-tr. & cassette.  
**Brand name:** ACI.
- Audio Devices Inc., 100 Research Dr., Glenbrook, Conn. 06906. Tel: (203) 327-6500. Pres.: W. A. Estabrook; VP Mktg. & Sales: William L. Goldstein; Nat'l Sales Mgr.: A. P. Cunha.  
**Configuration:** Cartridge 4-tr., 8-tr. & cassette.  
**Brand name:** Audiopak.
- Audio-Electronics, 7221 Atoll Ave., North Hollywood, Calif. 91605. Tel: (213) 764-4700. Pres.: Sheldon Howard.  
**Configuration:** Cartridge 8-tr. & cassette.  
**Brand name:** Private label.
- Audio Magnetics Corp., 14600 S. Broadway, Gardena, Calif. 90247. Tel: (213) 321-6841. Pres.: Irving B. Katz; Sales Mgr.: Ray Allen.  
**Configuration:** Cartridge 4-tr., 8-tr. & cassette.
- Audiopak, see Audio Devices.  
Audio Vendor, see Faraday.  
AutoMate, see Faraday.
- B A S F Systems Inc., Crosby Dr., Bedford, Mass. 01730. Tel: (617) 271-4000. Pres.: D. Ambros; Mktg. Dir.: T. Dempsey; Audio Prod. Mgr.: H. Preston.  
**Home office:** Germany.  
**Configuration:** Cartridge 4-tr., 8-tr., cassette & open reel.
- Budget Tape Cartridge Mfg. Co., 2035-37 S. La Brea Ave., Los Angeles, Calif. 90016. Tel: (213) 933-5867. Pres. & Sales Mgr.: Don Macmillan.  
**Configuration:** Cassette.
- C C A, see Cassette Corp. of America.
- Cable Machinery Corp., 156 Fifth Ave., New York, N.Y. 10010. Tel: (212) 989-4434. Pres.: Sol Dubin; VP & Gen. Mgr.: Leonard Ripley; Sales Mgr.: V. J. DePaul.  
**Configuration:** Cassette.
- Carsan Ents., 2009 N. Parmalee, Compton, Calif. 90222. Tel: (213) 636-4138. Pres.: D. Aronoff; Gen. Mgr.: G. R. Wells.  
**Configuration:** Cartridge 8-tr., cassette & open reel.
- Cassette Corp. of America, 640 S. Commercial Ave., Carlstadt, N.J. 07072. Tel: (201) 933-9125. Pres.: Walter Elterman; Gen. Mgr.: Allen Braverman; Mktg. Dir.: Arthur F. Etro; Sales Mgr.: Milton Blutter.  
**Configuration:** Cartridge 8-tr., cassette & open reel.  
**Brand name:** CCA, Plio-Magic.
- Cassette/Tech Corp., 543 W. 43 St., New York, N.Y. 10036. Tel: (212) 868-3520. Pres.: Eugene V. Liposki; VP Sales: Donald W. MacClean.  
**Configuration:** Cartridge 8-tr. & cassette.
- Certron Corp., 1701 S. State College Blvd., Anaheim, Calif. 92806. Tel: (714) 633-4280. Pres.: Edwin Gamson; Mktg. Admin. Dir.: Brian McCourt; Sales Mgr.: James Neiger.  
**Configuration:** Cartridge 4-tr., 8-tr., cassette & open reel.  
**Brand name:** Various brands.
- Channel Mktg. Inc., 26 Springdale Rd., Cherry Hill, N.J. 08034. Tel: (609) 424-3344. Pres.: Ronald Obsgarten; Gen. Mgr.: Arthur Zakharian; Sales Mgrs.: Arnold Kaminer, Marv Rabin; Adv. Dir.: Joseph A. McHugh Sr.  
**Brand name:** Channel, Coronet.
- M. M. Cole, 251 E. Grand, Chicago, Ill. 60611. Tel: (312) 527-2160. Pres.: Shepard Stern; Gen. Mgr.: A. Bernstein; Sales Mgr.: J. Davidson.
- Coronet, see Channel Mktg.

continued on page 68

Your sound. Our silence. Beautiful.  When you play a tape in our new pin-type cassette, all you hear is the tape.  And not one peep from us.  There's no chance of crosstalk. No cassette chatter. No flutter. No wow. No static electricity.  Nothing but **your** sounds.  And because our new cassette has two lubricated steel pins, you get smoother wind and rewind for a flat tape pancake.  All of which means that your tape will sound better longer, and that our cassette will unsound better longer.  Your sound. And our silence. In the long run, they'll make a quality name for both of us.  Available assembled or un-assembled. Write for complete information. Cassette Corporation of America, 640 So. Commercial Ave., Carlstadt, N.J. 07072.

# Introducing the silent partner to your great sound.

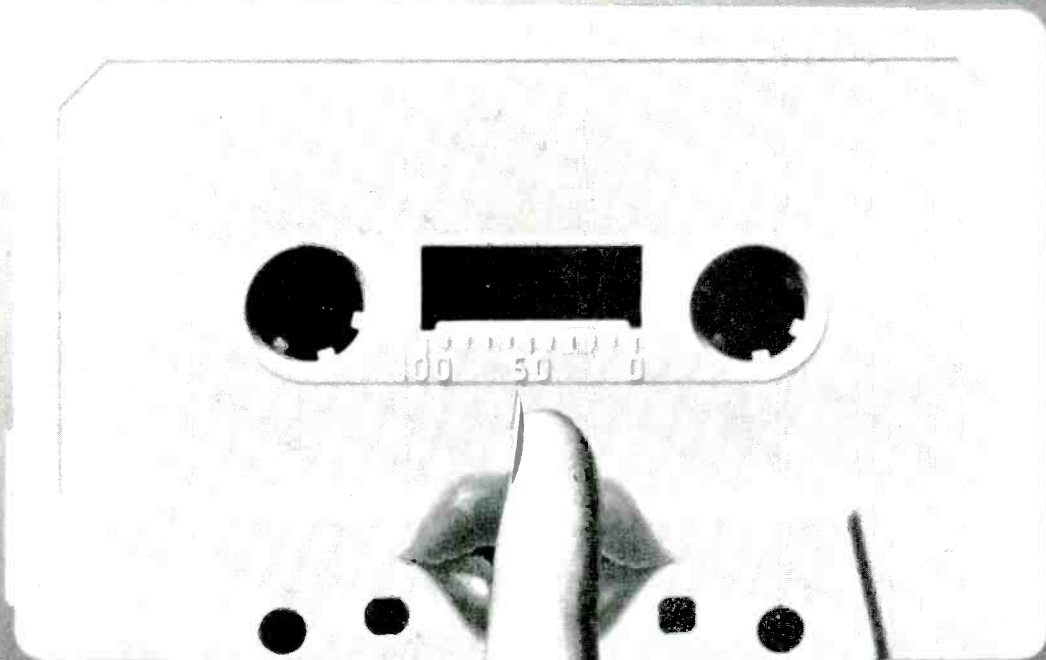

Cassette  
Corporation  
of America

# Sound Simple



The precision Playmate Industries Cassette is the finest performing, most trouble-free instrument on the market.

It is constructed from only 3 different parts; 2 covers, 2 hubs, and 1 pad and shield unit. Assembled, the cassette contains a total of only 5 parts.

The Playmate's sophisticated engineering reduces friction and static buildup to a minimum and allows for fully automated assembly. Assembled (leader or tape loaded) or unassembled, the Playmate Industries Cassette is a proven performer.



## Marketing Headquarters:

14505 East Proctor Avenue • Industry, California 91747

Offering International Manufacturing Facilities To Serve You

Telephone (213) 968-5641

## TAPE SUPPLIES

Continued from page 66

- Data Packaging Corp., 205 Broadway, Cambridge, Mass. 02139. Tel: (617) 868-6200. Pres.: Otto Morningstar; VP: Larry A. Grundy; Gen. Mgr.: William Stevens; Sales Mgr.: George Gross.  
**Configuration:** Cartridge 4-tr., 8-tr. & cassette.
- Data Technology Corp., Cassette Div., 1600 Las Plumas Ave., San Jose, Calif. 95133. Tel: (408) 272-0300. Pres.: Luigi Contini; Gen. Mgr.: Thomas Lazor; Sales Mgr.: William Patsuris; Mktg. Dir.: Raymond Valle.  
**Configuration:** Cassette.
- Data Technology Corp., Plastronics/Perfection Div., 1600 Las Plumas Ave., San Jose, Calif. 95133. Tel: (408) 272-0300. Pres. & Gen. Mgr.: Luigi Contini; Mktg. Dir.: Raymond Valle; Sales Mgr.: William Patsuris.  
**Configuration:** Cassette.
- Dictation Prods. Inc., 2525 Park Ln., Hallandale, Fla. 33009. Tel: (305) 981-6161. Pres.: Sy Scher; Gen. Mgr.: L. Schwartz; Sales Mgr.: M. Sebban.  
**Configuration:** Cartridge & cassette.  
**Brand name:** Professional, Rochester, Rosette.
- Dict-O-Tape Inc., 9090 Krier Pl., Brooklyn, N.Y. 11236. Tel: (212) 257-3355. Pres.: Erwin Damsky; VP & Gen. Mgr.: Rudy Schwartz; Sales Mgr.: Oscar Goren.  
**Configuration:** Cartridge 8-tr.
- Dubbings Electronics Inc., 1305 S. Strong Ave., Copiague, N.Y. 11726. Tel: (516) 893-1000. Pres.: Paul C. Smith; Opns. Mgr.: P. M. Shoorer; Sales Mgr.: Michael Thaler.  
**Configuration:** Cassette.
- Dynapak, see Stereodyne.
- EchoMatic, see Faraday.
- El Mar Plastics, 1940 W. 144 St., Gardena, Calif. 90249. Tel: (213) 327-1540. Pres.: Harry Schor; Sales Mgr.: Allen Schor.  
**Configuration:** Cassette & open reel.
- Fairfield Tape Dupl'g/Assembling Corp. (div. of A-V Research Corp.), 601 Kennedy Blvd., North Bergen, N.J. 07047. Tel: (201) 864-1210. Pres.: Robert Strauss; Gen. Mgr.: J. Cadenas; Sales Mgr.: N. Quesado.  
**Configuration:** Cassette.
- Faraday Inc., 805 S. Maumee St., Tecumseh, Mich. 49286. Tel: (313) 423-2111. Pres.: Fred J. Kluin; Sales Mgr.: Joseph C. Meidt.  
**Configuration:** Cartridge 4-tr., 8-tr. & open reel.  
**Brand name:** Audio Vendor, AutoMate, EchoMatic.
- Irish Magnetic Tape Div., 458 Broadway, New York, N.Y. 10013. Tel: (212) 925-1257. Pres.: Sol Zigman; Gen. Mgr.: Hy Zigman; Sales Mgr.: Bill Grossman.  
**Brand name:** Irish, Mortone.
- Livingston Audio Prods. Corp., 1275 Bloomfield Ave., Fairfield, N.J. 07006. Tel: (201) 226-8300. Pres.: Darrell D. Scholten; VP Sales: Thomas J. Hofbauer.  
**Branch:** West Los Angeles, Calif., 10687 Santa Monica Blvd. Zip: 90025. Tel: (213) 474-4559. Mgr.: John Anderson.  
**Configuration:** Cartridge 4-tr., 8-tr., cassette & open reel.
- Mann Cassette Inds., PO Box 1121, 3700 Sacramento St., San Francisco, Calif. 94101. Tel: (415) 221-2000. Owners: Herman & Donald Mann.  
**Configuration:** Endless loop cassette.
- Marathon Prods. Corp., 334 W. Boylston St., West Boylston, Mass. 01583. Tel: (617) 853-0988. Pres.: R. D. Myers.  
**Configuration:** Cartridge 4-tr. & 8-tr.
- Mastro Inds. Inc., 3040 Webster Ave., Bronx, N.Y. 10467. Tel: (212) 547-5600. Pres.: Mario Maccaferri; Gen. Mgr.: Max Studli.  
**Configuration:** Cartridge 8-tr.
- Metra Electronics Corp., 660 McDonald Ave., Brooklyn, N.Y. 11218. Tel: (212) 871-4100. Pres. & Sales Mgr.: Charles R. Fox.  
**Configuration:** Cartridge 4-tr. & 8-tr.  
**Brand name:** Traveltime.
- Modern Tape Corp., 5810 S. Normandie Ave., Los Angeles, Calif. 90044. Tel: (213) 753-2481. Pres.: Joe Bihari; VP: Bob Demain.  
**Configuration:** Cartridge 8-tr.
- Mortone, see Irish.
- J. J. Paulson Assocs., 24 Brooklyn Ave., Freeport, N.Y. 11520. Tel: (516) 868-0491. Pres. & Gen. Mgr.: Jerry Katcher.  
**Configuration:** Cartridge 8-tr. & cassette.
- Plastic-Ware Inc., 1100 Leggett Ave., Bronx, N.Y. 10474. Tel: (212) 991-0100. VP: William Demucci; Sales Mgr.: Phil Lazarus.
- Playmate Inds. Inc., 14505 E. Proctor Ave., Industry, Calif. 91747. Tel: (213) 968-5641. Pres.: Ted Rltz; Gen. Mgr.: Joe Richtfarclik; Sales Mgr.: R. F. Atkinson.
- PlayTape Inc., 1115 Broadway, New York, N.Y. 10010. Tel: (212) 675-8050. Pres.: Frank Stanton.
- Plio-Magic, see Cassette Corp. of America.
- Polymer Processing Inc., Broyhill Park, Lenoir, N.C. 28645. Tel: (704) 754-3421. Gen. Mgr.: E. Dean Boldt; Sales Mgr.: Paul J. Casabonne.  
**Configuration:** Cassette.
- Professional, see Dictation Prods.

continued on page 70



**Open reel tape from the leading manufacturer of cassettes?  
Think about it.**

It makes a lot of sense. Audio Magnetics is the Nation's number one producer of compact cassettes, manufacturing over 3,000,000 cassettes per month. And every one of our cassettes carries our Lifetime Guarantee. So, it only stands to reason that if we can make such great cassettes, our full line of open reel tapes must be every bit as good.

Here's another idea. Audio also manufactures tape for duplicators and cassette components, as

well as the most extensive array of specialized cassette packaging materials available.

From now on, when you think about audio tape, think about us.



14600 So. Broadway • P.O. Box 140 • Gardena, Calif. 90247 • (213) 321-6841 • Telex: 67-4311

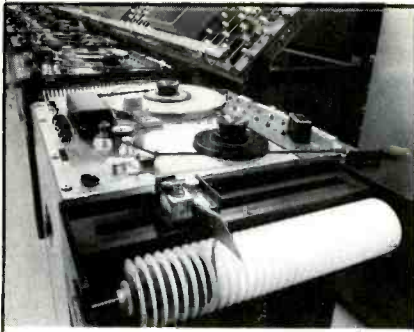

# THIS IS THE LIVINGSTON SIDEWINDER

Mounted on the side of a recording deck, it winds the tape directly into the cartridge hub as it is being recorded. It thus combines duplicating and winding into one high speed continuous operation.

Contact:

**Livingston Audio Products Corp.**  
1275 Bloomfield Avenue  
Fairfield, New Jersey 07007  
Telephone: (201) 226-8300

• Increase Efficiency  
• Improve Quality  
• Double Output  
with the  
**LANG**  
HIGH-SPEED  
BULK  
DUPLICATING  
MASTER  
SYSTEM



120 ips for 2, 4, or 8 track production

### FEATURES:

• High speed operation: up to 16x master speed. • No rewinding: continuous running master tape loop. • Automation control for pre-selecting any number of master tape passes, at which time the master and slaves are automatically shut down. • Superior performance specifications. • Rapid reloading facilitated with interchangeable tape bins.

Standard 3202 Slave Transports are equipped with LANG junction panels, plug-in head assemblies and tape guides for interchangeable duplication of 150 mil cassette and 1/4 inch cartridge tapes.

For Complete details and  
new Lang Catalog write:

**LANG ELECTRONICS INC.**  
507 FIFTH AVE., N. Y. 10017  
For all your audio needs look to Lang!

## TAPE SUPPLIES

Continued from page 68

Recoton Corp., 46-23 Crane St., Long Island City, N.Y. 11101. Tel: (212) 392-6442. Pres.: Herbert Borchardt; Exec. VP: Robert Borchardt; Sales Mgr.: Peter Wisch.

Robins Inds. Corp., 15-58 127 St., College Point, N.Y. 11356. Tel: (212) 445-7200. Pres.: Herman D. Post; VP & Sales Mgr.: Jack Friedland. Configuration: Cassette.

Rochester, see Dictation Prods.

Rosette, see Dictation Prods.

Royal Sound Co. Inc., 409 N. Main St., Freeport, N.Y. 11520. Tel: (516) 868-2880. Pres.: M. A. Dayan; Gen. Mgr.: N. Greenberg; Sales Mgr.: J. Corbin. Configuration: Cartridge 8-tr., cassette & open reel.

Rozinante Electronics Corp., 9135 General Ct., Plymouth, Mich. 48170. Tel: (313) 455-2500. Pres. & Gen. Mgr.: Donald D. Merry; Sales Mgr.: Walter Hess. Configuration: Cartridge 4-tr., 8-tr. & cassette.

Sarex Corp., 3850 W. Side Ave., North Bergen, N.J. 07047. Tel: (201) 864-9400; NYC Tel: (212) 227-6354. Pres.: O. Louis Seda; Exec. VP: D. Max Brightmore; Sales Eng.: William M. Blethen. Configuration: Cassette & open reel. Brand name: Sarex & private label.

Albert Schultz Inc. (exports only), see Tape Wholesalers section: New York, N.Y.

Scotch, see 3M.

Simpac Int'l Inc., 1643 19 St., Santa Monica, Calif. 90404. Tel: (213) 393-7353. Pres. & Gen. Mgr.: Robert Wallace; Sales Mgr.: A. R. Robbins. Configuration: Cartridge 4-tr., 8-tr. & cassette.

Sony/Superscope, see Superscope.

Soundcraft-CBS Recs. (div. of CBS Inc.), Great Pasture Rd., Danbury, Conn. 06810. Tel: (203) 744-3555. Gen. Mgr.: Peter Landskroener; Mktg. Dir.: Robert E. Ward; Sales Mgr.: Charles Berman. Configuration: Cassette.

Specialty Sounds Inc., 33515 Kelly Rd., Fraser, Mich. 48026. Tel: (313) 294-5200. Pres.: L. Allan Bazy; Gen. Mgr.: Jerry Danko; Sales Mgr.: Danny R. Wilssens. Configuration: Cartridge 8-tr. & cassette. Brand name: Specialty Sounds & private labels.

Stereodyne Inc., 2810 Elliott, Troy, Mich. 48064. Tel: (313) 585-6585. Exec. VP & Gen. Mgr.: Paul Wyatt. Int'l office: Canada. Configuration: Cartridge & cassette. Brand name: Dynapak.

Superscope Inc., 8150 Vineland Ave., Sun Valley, Calif. 91352. Tel: (213) 767-9780. Pres.: Joseph Tushinsky; Sales Mgr.: Paul Markoff. Configuration: Open reel. Brand name: Sony/Superscope.

T D K Electronics Corp., 23-73 48 St., Long Island City, N.Y. 11103. Tel: (212) 721-6881. Pres.: H. Kawamura; Mktg. Mgr.: George T. Saddler; Sales Mgr.: A. Otsuka. Branches: Los Angeles, Calif., 6151 W. Century Blvd. Zip: 90045. Tel: (213) OR 0-5515—Chicago, Ill., 2906 W. Peterson Ave. Zip: 60645. Tel: (312) 973-1222. Pres.: Katsuro Kamiya; Gen. Mgr.: Kiyoshi Hiromoto; Sales Mgr.: Yoshiro Hirotsuka. Int'l branch: Japan. Configuration: Cassette.

T E A C Corp of America, 2000 Colorado Ave., Santa Monica, Calif. 90404. Tel: (213) 394-0240. Pres.: T. Tani; Gen. Mgr.: H. H. Oye; Sales Mgr.: Mikio Matsubayashi.

3 M Co., Magnetic Prods. Div., 3M Center, St. Paul, Minn. 55101. Tel: (612) 733-1110. Pres.: H. Heltzer; Magnetic Prods. Div. Mgr.: M. C. Hegdal; Magnetic Prods. Div. Sales Mgr.: W. H. Madden; Adv. & Sales Promo. Mgr.: Charles L. Arden. Configuration: Open reel. Brand name: Scotch. Traveltime, see Metra Electronics.

## BLANK LOADED TAPE

A C I, see Audio Communications Inc.

Able Turntable & Tape, 6912 Hollywood Blvd., Hollywood, Calif. 90028. Tel: (213) 466-8338. Pres. & Sales Mgr.: Ted Gardner. Configuration: Cassette.

Agfa-Gevaert Inc., 275 North St., Teterboro, N.J. 07608. Tel: (201) 288-4100; NYC Tel: (212) LO 5-7850. Pres.: R. Aerts; Gen. Mgr.: A. P. Germer; Sales Mgr.: H. Kuhlmann. Configuration: Cassette & open reel. Brand name: Agfa Magnetron.

Agfa Magnetron, see Agfa-Gevaert.

Alaron, see B&B Import-Export.

Allied Tape Corp., 1201 Research Blvd., St. Louis, Mo. 63132. Tel: (314) 997-0016. Pres.: Byrle A. Northrup; Exec. VP: Robert F. Philpot; Gen. Mgr.: Roger Frederickson. Configuration: Cartridge 4-tr. & 8-tr. Brand name: CMC & various private labels. American, see Bell & Howell.

American Sound Corp., 3319 E. Ten Mile Rd., Warren, Mich. 48091. Tel: (313) 539-2900. Pres.: Frank S. Day; VP & Gen. Mgr.: William D. Adams. Configuration: Cartridge 8-tr. & cassette.

Ampex Corp., 401 Broadway, M.S. 7-22, Redwood City, Calif. 94063. Tel: (415) 367-3887. Pres.: William E. Roberts; Sales Mgr.: Brian Trankle. Configuration: Cartridge 4-tr., 8-tr., cassette & open reel.

Atlas-Rand Corp., 2 Keystone Pl., Paramus, N.J. 07652. NYC Tel: (212) 563-6663. Pres.: Harold Rosen; Sales Mgr.: Barry Rosen; Adv. Dir.: Stuart Belfer. Brand name: Keystone.

Audio Communications Inc., Rt. 10, Randolph Ind'l Park, Dover, N.J. 07801. Tel: (201) 361-7600. Pres.: E. Michael Daspin; Sales Mgr.: Thomas J. Malia. Configuration: Cartridge 4-tr., 8-tr. & cassette. Brand name: ACI.

Audio Devices Inc., 100 Research Dr., Glenbrook, Conn. 06906. Tel: (203) 327-6500. Pres.: W. A. Estabrook; VP Mktg. & Sales: William L. Goldstein; Nat'l Sales Mgr.: A. P. Cunha. Configuration: Cartridge 4-tr., 8-tr., cassette & broadcast cartridges. Brand name: Audiopak.

Audio-Electronics, 7221 Atoll Ave., North Hollywood, Calif. 91605. Tel: (213) 764-4700. Pres.: Sheldon Howard. Configuration: Cartridge 8-tr. & cassette. Brand name: Private label.

Audio Magnetics Corp., 14600 S. Broadway, Gardena, Calif. 90247. Tel: (213) 321-6841. Pres.: Irving B. Katz; Sales Mgr.: Ray Allen. Configuration: Cartridge 4-tr., 8-tr. & open reel.

Audiomasters, 16711 Roscoe Blvd., Sepulveda, Calif. 91343. Tel: (213) 892-0716. Pres.: George Panos; Mktg. Dir.: Howard Siegel. Configuration: Cartridge 8-tr., cassette & open reel.

Audiopak, see Audio Devices.

Audio Physics Inc., 16449 Vanowen St., Van Nuys, Calif. 91406. Tel: (213) 782-3638. Pres.: Don Washbrook; Gen. Mgr.: John David; Sales Mgr.: Bill Richards. Configuration: Cartridge 4-tr., 8-tr. & cassette.

Audio Vendor, see Faraday.

AutoMate, see Faraday.

B & B Import-Export Co., 185 Park St., Troy, Mich. 48084. Tel: (313) 585-8400. Gen. Mgr.: Bernard Klein; Sales Mgr.: Emery I. Klein. Brand name: Alaron.

B A S F Systems Inc., Crosby Dr., Bedford, Mass. 01730. Tel: (617) 271-4000. Pres.: D. Ambros; Mktg. Dir.: T. Dempsey; Audio Prod. Mgr.: H. Preston. Home office: Germany. Configuration: Cartridge 4-tr., 8-tr., cassette & open reel. Brand name: BASF, Sound-Loop.

Bell & Howell Magnetic Tape Co. (formerly Greentree Electronics), 2602 Michelson Dr., Irvine, Calif. 92664. Tel: (714) 833-0020. Pres. & Gen. Mgr.: Sidney Brandt; Audio Tape Prod. Sales Mgr.: J. Sack; Precision Tape Prod. Sales Mgr.: R. McKenzie. Configuration: Cartridge, cassette & open reel. Brand name: American, Bell & Howell & private labels.

Berkshire, see Dubbings.

Brand Five, see Robins.

C C A, see Cassette Corp. of America.

C B S Recs., Masterwork Audio Prod. Dept., 51 W. 52 St., New York, N.Y. 10019. Tel: (212) 765-4321. Masterwork Audio Prods. Dept. Dir.: Milton Selkowitz; Prod. Development Dir.: Richard F. Smith. Configuration: Cassette & open reel. Brand name: Columbia.

C E E Rec'g Serv. (div. of Customized Electronic Eng'g), PO Box 8921, Albuquerque, N.M. 87108. Tel: (505) 299-5581. Gen. & Sales Mgr.: John H. Hughes. Configuration: Cartridge 4-tr., 8-tr. & broadcast cartridges.

C M C, see Allied Tape.

Cable Machinery Corp., 156 Fifth Ave., New York, N.Y. 10010. Tel: (212) 989-4434. Pres.: Sol Dubin; VP & Gen. Mgr.: Leonard Ripley; Sales Mgr.: V. J. DePaul. Configuration: Cassette.

Canon, see Double Sixteen.

Capitol Recs. Dist'g Corp., 1750 N. Vine St., Hollywood, Calif. 90028. Tel: (213) 462-6252. Pres.: Salvatore J. Iannucci; Special Markets Mds. Mgr.: Hal Rothberg; Sales Mgr.: John J. Jossey. Configuration: Cartridge 8-tr. & cassette. Cartridge Control Corp., 2091 Faulkner Rd. NE, Atlanta, Ga. 30324. Tel: (404) 633-4577. Pres.: R. D. Comstock; Gen. Mgr.: Bill Evans. Configuration: Cartridge 8-tr. & cassette.

Cassette Corp. of America, 640 S. Commercial Ave., Carlstadt, N.J. 07072. Tel: (201) 933-9125. Pres.: Walter Elterman; Gen. Mgr.: Allen Braverman; Mktg. Dir.: Arthur F. Eftro; Sales Mgr.: Milton Blutter. Brand name: CCA.

Certified Tapes Inc., 610 Clayton St., Orlando, Fla. 32804. Tel: (305) 425-7996. Pres.: Michael J. Rizzo. Configuration: Cartridge, cassette & open reel.

continued on page 72

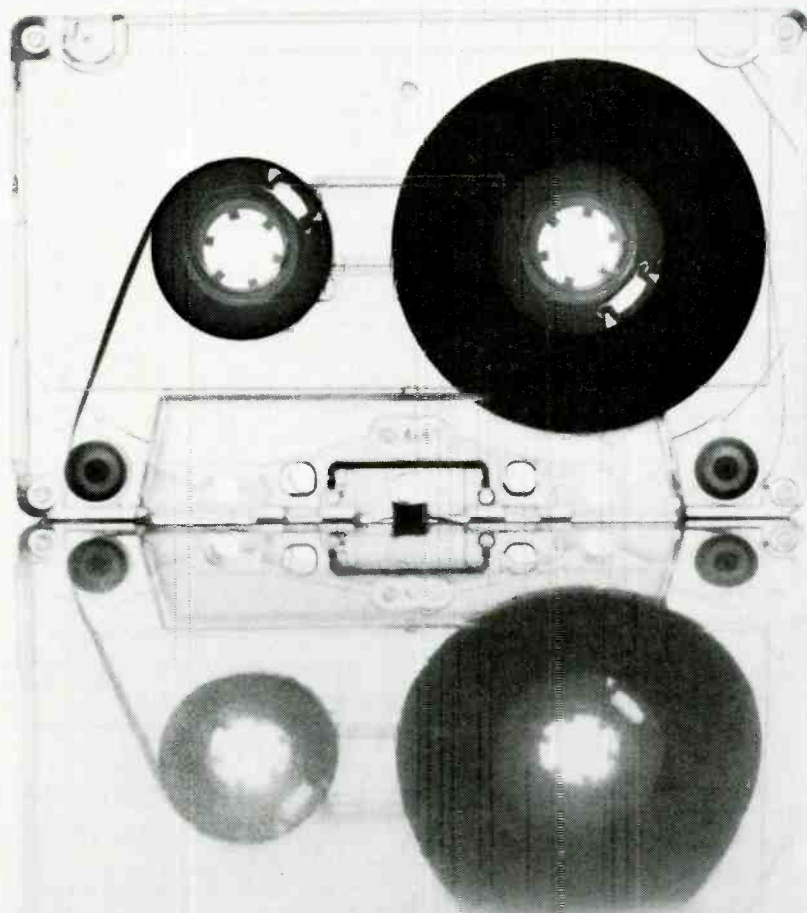

An expert who never speaks fiction  
Informed us from deepest conviction  
That cassettes running silent,  
Like love-ins nonviolent,  
Avoid the affliction of friction.

World's largest manufacturer of precision-  
molded cassettes and cartridges.  
Unloaded, leader-loaded, or tape-loaded.

Data Packaging Corporation



205 Broadway, Cambridge, Massachusetts 02139 / Tel. (617) 868-6200 / TWX 710-320-0840

# SONIC SELLS IT! (THESE COMPANIES MAKE IT!)

Whatever you do, large or small, in **DUPLICATING** or **RECORDING** in the 11 Western States, and if top quality is your objective **SONIC ARTS** can fill your plant with the equipment and supplies you need. We are the exclusive factory distributors of these great companies:

## DUPLICATING

**GRT**—Masters, Slaves, production loaders, and QC equipment.

**INFONICS**—Table-top duplicators, cassette, cartridge, reel-to-reel.

**AGFA-GEVAERT**—Tape for cassettes and mastering.

**CABLE**—The only fully automatic cassette assembly line in the U.S.

## RECORDING

\***TELEFUNKEN MAGNETOPHON**—The foremost recorder in the industry.

**MRS**—The only DC controlled tape transport in the industry.

**GATELY**—Mixers, Limiters, Switchers, EQ, Portable Consoles.

\***ASTRONIC**—Finest active graphic equalizer in the market.

**AGFA-GEVAERT**—Mastering tapes for the best recorded performance.

\***Exclusive U.S. Importers**

**CALL  
(415) 781-6306**

**SONICARTS  
CORPORATION**

665 Harrison St.  
San Francisco, CA 94107

**DEALER FRANCHISES  
AVAILABLE NOW**

## TAPE SUPPLIES

Certron Corp., 1701 S. State College Blvd., Anaheim, Calif. 92806. Tel: (714) 633-4280. Pres.: Edwin Gamson; Mktg. Admin. Dir.: Brian McCourt; Sales Mgr.: James Neiger.  
**Configurations:** Cartridge 4-tr., 8-tr., cassette & open reel.  
**Brand name:** Various brands.

Channel Mktg. Inc., 26 Springdale Rd., Cherry Hill, N.J. 08034. Tel: (609) 424-3344. Pres.: Ronald Obsgarten; Gen. Mgr.: Arthur Zakharian; Sales Mgrs.: Arnold Kaminer, Marv Rabin; Adv. Dir.: Joseph A. McHugh Sr.  
**Configuration:** Cartridge 4-tr., 8-track, & cassette.

Coach, see Dict-O-Tape.

Columbia, see CBS.

Communications Electronics Inc., 7501 N. Broadway, Oklahoma City, Okla. 73114. Tel: (405) 848-2266. Pres.: Tommy Hoshall; VP: Richard Hainebach; Sales Mgr.: Joe Patrick.  
**Configuration:** Cartridge 8-tr. & cassette.  
**Brand name:** Stereo Test.

Concord Electronics Corp., 1935 Armacost Ave., Los Angeles, Calif. 90025. Tel: (213) 478-2541. Pres.: Howard P. Ladd; VP Sales: William Byron; Gen. Mgr.: Robert Halpern; Nat'l Sales Mgr.: William B. Minkin.  
**Configuration:** Cassette.

Craig Corp., 3410 S. La Cienega Blvd., Los Angeles, Calif. 90016. Tel: (213) 936-6171. Owner: Robert Craig; VP Distribution: D.D. Carson; Sound Div. Mgr.: Jack Baker.  
**Configuration:** Cassette.

Criterion, see Lafayette.

Custom, see Dubbings.

Data Packaging Corp., 205 Broadway, Cambridge, Mass. 02139. Tel: (617) 868-6200. Pres.: Otto Morningstar; VP: Larry A. Grundy; Gen. Mgr.: William Stevens; Sales Mgr.: George Gross.  
**Configuration:** Cartridge 4-tr., 8-tr. & cassette.  
**Brand name:** Dynasound.

Data Technology Corp., Cassette Div., 1600 Las Plumas Ave., San Jose, Calif. 95133. Tel: (408) 272-0300. Pres.: Luigi Contini; Gen. Mgr.: Thomas Lazor; Mktg. Dir.: Raymond Valle; Sales Mgr.: William Patsuris.  
**Configuration:** Cassette.

Decca Recs. (div. of MCA Inc.), 445 Park Ave., New York, N.Y. 10022. Tel: (212) 759-7500. Exec. VP: Jack Loetz; Nat'l Tape Prod. Mgr.: Joel A. Schneider; Sales Dir.: Harold Komisar.  
**Configuration:** Cassette.

Dictation Prods. Inc., 2525 Park Ln., Hallandale, Fla. 33009. Tel: (305) 981-6161. Pres.: Sy

Scher; Gen. Mgr.: L. Schwartz; Sales Mgr.: M. Sebban.  
**Configuration:** Cartridge & cassette.

**Brand name:** Professional, Rochester, Rosette.

Dict-O-Tape Inc., 9090 Krier Pl., Brooklyn, N.Y. 11236. Tel: (212) 257-3355. Pres.: Erwin Damsky; VP & Gen. Mgr.: Rudy Schwartz; Sales Mgr.: Oscar Goren.  
**Brand name:** Coach, Kits, Shannon.

Double Sixteen Co., PO Box 1616, 1028 College Ave., Wheaton, Ill. 60187. Tel: (312) 653-1616. Pres.: James W. Canon; Sales Mgr.: Thomas W. Canon.  
**Configuration:** Cassette.

**Brand name:** Canon, Made-To-Measure.

Dubbings Electronics Inc., 1305 S. Strong Ave., Copiague, N.Y. 11726. Tel: (516) 893-1000. Pres.: Paul C. Smith; Opns. Mgr.: P.M. Shoorer; Sales Mgr. Michael Thaler.  
**Configuration:** Cassette.

**Brand name:** Berkshire, Custom, Philips.

Duotone Co. Inc., 6875 SW 81 St., South Miami, Fla. 33143. Tel: (305) 665-1121. Pres.: Stephen Nester; Gen. Mgr.: Benjamin Rosenberg.

Dynapak, see Stereodyne.

Dynasound, see Data Packaging.

EchoMatic, see Faraday.

Electra Radio Corp., 30 W. 23 St., New York, N.Y. 10010. Tel: (212) 675-7640. Pres.: Richard Beda.  
**Configuration:** Cassette & open reel.

Fairfield Tape Dupl'g/Assembling Corp. (div. of A-V Research Corp.), 601 Kennedy Blvd., North Bergen, N.J. 07047. Tel: (201) 864-1210. Pres.: Robert Strauss; Gen. Mgr.: J. Cadenas; Sales Mgr.: N. Quesado.  
**Configuration:** Cartridge 8-tr. & cassette.

Faraday Inc., 805 S. Maumee St., Tecumseh, Mich. 49286. Tel: (313) 423-2111. Pres.: Fred J. Kluin; Sales Mgr.: Joseph C. Meidt.  
**Configuration:** Cartridge 4-tr., 8-tr. & open reel.  
**Brand name:** Audio Vendor, AutoMate, EchoMatic.

Fidelitone Inc., 6415 N. Ravenswood Ave., Chicago, Ill. 60626. Tel: (312) 274-0075. Pres.: Douglas F. Hudson; VP Sales: William R. Anton; Sales Mgr.: Hiram A. Prince.  
**Configuration:** Cartridge 4-tr., 8-tr. & cassette.

Finebill Mfg. Co., 931 N. Citrus Ave., Los Angeles, Calif. 90038. Tel: (213) 466-9511. Pres.: Alwin P. Schmid; VP: Joseph Bouzaglou.  
**Configuration:** Cartridge & cassette.

Forbes Electronics Inc., 19-21 Heyward St., Brooklyn, N.Y. 11211. Tel: (212) 855-0600. Pres. & Gen. Mgr.: Clifford K. Forbes; VP & Sales Mgr.: Eugene L. Aaronson.  
**Brand name:** Various private brands.

## ATTENTION: ALL CASSETTE, CARTRIDGE AND REEL DUPLICATORS, LOADERS AND DISTRIBUTORS!

**NOW:** You can have a convenient export one stop source for ALL of your tape supplies. Write to us for quotations on:

- Pre-leaded and empty cassettes
- Blank recording cassettes—C-30, C-60, C-90, C-120
- 4 and 8 Track Empty Cartridges
- 4 and 8 Track Blank Recording Cartridges—all lengths
- Component parts for cassettes and cartridges
- Magnetic Recording Tape for cassettes and cartridges
- Open Reel Magnetic Recording Tape—Packaged and Bulk
- Empty Reels for Magnetic Tape—All Sizes
- Cassette, 4 and 8 Track Head Cleaners—Packaged and Bulk
- Head Cleaning and Splicing Materials
- And a host of other tape supplies!

**ENJOY:** Quick replies to your inquiries and prompt, efficient handling of your orders by an export specialist with 24 years of experience in the tape and record industries.

**SAVE:** On shipping costs through consolidation of all of your requirements.

**BENEFIT:** From competitive prices on all items.

**WRITING TO US MAY BE THE BEST INVESTMENT YOU HAVE EVER MADE.**

**ACT TODAY!**

**ALBERT SCHULTZ, INC.**

116 W. 14th St., New York, N. Y. 10011  
Telephone: 924-1122 Cable: ALBYREP, NEW YORK



G R T Corp., 1286 Lawrence Sta. Rd., Sunnyvale, Calif. 94086. Tel: (408) 734-2910. Pres.: Alan J. Bayley; Mktg. Mgr.: Chris Coburn; Mktg. Servs. Dir.: Ronald Rader.  
**Configuration:** Cassette.  
**Brand name:** Magnem.

General Cassette Corp., 1324 N. 22 Ave., Phoenix, Ariz. 85009. Tel: (602) 258-7059. Pres.: Herbert J. Miller; VP & Gen. Mgr.: Edward L. Martin; Sales Mgr.: Warren Buescher.  
**Configuration:** Cartridge 8-tr. & cassette.

Greentree, see Bell & Howell.

Infodex Cassette Corp., 7 Cherry Ave., Waterbury, Conn. 06702. Tel: (203) 757-9291. Pres.: Roger S. Swain; Gen. Mgr.: John W. Berry; Sales Mgr.: Ernest H. Ulm.  
**Configuration:** Cassette.

Irish Magnetic Tape Div., 458 Broadway, New York, N.Y. 10013. Tel: (212) 925-1257. Pres.: Sol Zigman; Gen. Mgr.: Hy Zigman; Sales Mgr.: Bill Grossman.  
**Configuration:** Cartridge 8-tr., cassette & open reel.

Juliette, see Topp Electronics.

Keystone, see Atlas-Rand.

Kilts, see Dict-O-Tape.

Lafayette Radio Electronics Corp., 111 Jericho Tnpk., Syosset, N.Y. 11791. Tel: (516) 921-7700. Pres.: A. Pletman; Adv. Dir.: C. Piotrowski.  
**Configuration:** Cassette & open reel.  
**Brand name:** Criterion, Lafayette.

Le-Bo Prods. Co. Inc., 71-0B 51 Ave., Woodside, N.Y. 11377. Tel: (212) 458-7700. Pres.: Leslie Bokor; VP & Sales Mgr.: Leslie Dame; Gen. Mgr.: Herbert Hartman.  
**Configuration:** Cartridge 4-tr., 8-tr., cassette & open reel.  
**Brand name:** Lebotone.

Lebotone, see Le-Bo.

Livingston Audio Prods. Corp., 1275 Bloomfield Ave., Fairfield, N.J. 07006. Tel: (201) 226-8300. Pres.: Darrell D. Scholten; VP Sales: Thomas J. Hofbauer.  
**Branch:** West Los Angeles, Calif., 10687 Santa Monica Blvd. Zip 90025. Tel: (213) 474-4559. Mgr.: John Anderson.  
**Configuration:** Cartridge 4-tr., 8-tr., cassette & open reel.

Made-To-Measure, see Double Sixteen.

Magnem, see GRT.

Magnetix Corp., 770 W. Bay St., Winter Garden, Fla. 32787. Tel: (305) 656-4494. Pres.: John C. Lory; Gen. Mgr.: Stan Sides; Sales Mgr.: James D. Ivey.

Make-A-Tape, 131 W. Main St., No. 2, Los Gatos, Calif. 95030. Tel: (408) 354-4595. Owners: Michael P. Papp, Louis Chiaramonte.  
**Configuration:** Cartridge 4-tr., 8-tr. & cassette.

J. S. Maloney Assocs., Box 628, Rt. 1, Batavia, Ill. 60510. Tel: (312) TR 9-5998. Pres.: John S. Maloney.  
**Configuration:** Cassette.  
**Brand name:** Private label.

Marathon Prods. Corp., 334 W. Boylston St., West Boylston, Mass. 01583. Tel: (617) 853-0988. Pres.: R. D. Myers.  
**Configuration:** Cartridge 4-tr., 8-tr. & broadcast cartridges.

Metra Electronics Corp., 660 McDonald Ave., Brooklyn, N.Y. 11218. Tel: (212) 871-4100. Pres. & Sales Mgr.: Charles R. Fox.  
**Configuration:** Cartridge 4-tr. & 8-tr.  
**Brand name:** Metra, Traveltime.

Monarch Electronics Int'l Inc., 7035 Laurel Canyon Blvd., North Hollywood, Calif. 91605. Tel: (213) 765-1810. Pres.: Meyer B. Price; Sales Mgr.: John Norman Miller; Adv. Dir.: Richard W. Price.  
**Configuration:** Cassette.

Music Master (div. of Pickwick Int'l Inc.), 7600 Wayzata Blvd., Minneapolis, Minn. 55426. Tel: (612) 544-4201.  
**Configuration:** Cassette & open reel.

Nassau, see Telephone Dynamics.

J. J. Paulson Assocs., 24 Brooklyn Ave., Freeport, N.Y. 11520. Tel: (516) 868-0491. Pres. & Gen. Mgr.: Jerry Katcher.  
**Configuration:** Cartridge 8-tr. & cassette.

Pfanstiel Chemical Corp., 3300 Washington St., Waukegan, Ill. 60085. Tel: (312) 623-1360. Pres. & Gen. Mgr.: R. Bruce Wight; Sales Mgr.: C. A. Clinton.  
**Configuration:** Cartridge 4-tr., 8-tr., cassette & open reel.

Philips, see Dubblings.

Playmate Inds. Inc., 14505 E. Proctor Ave., Industry, Calif. 91747. Tel: (213) 968-5641. Pres.: Ted Ritz; Gen. Mgr.: Joe Richtarcik; Sales Mgr.: R. F. Atkinson.  
**Configuration:** Cartridge 4-tr., 8-tr., cassette & open reel.  
**Brand name:** Private label.

Professional, see Dictation Prods.

R C A Magnetic Prods. Div., 201 E. 50 St., New York, N.Y. 10022. Tel: (212) 586-3000. VP & Gen. Mgr.: J. Stefan; Mktg. Mgr.: D. C. Creswell; Audio Sales Mgr.: A. C. Fritog.  
**Configuration:** Cartridge 8-tr. & cassette.

Radiant Cassette/Cartridge Corp. (sub. of Radiant Corp.), 250 W. 57 St., New York, N.Y. 10019. Tel: (212) 765-1820. Sales Mgr.: Donald J. Pasin; Adv. Dir.: Edward M. Cohen.  
**Configuration:** Cassette.

Raynor Sales Co. Inc., 2698 W. Pico Blvd., Los Angeles, Calif. 90006. Tel: (213) 737-3737.

Pres.: Ray Abrams; Gen. Mgr.: Norine Abrams; Sales Mgr.: Jim Whelpley.  
**Configuration:** Cartridge 4-tr. & 8-tr.

Recoton Corp., 46-23 Crane St., Long Island City, N.Y. 11101. Tel: (212) 392-6442. Pres.: Herbert Borchardt; Exec. VP: Robert Borchardt; Sales Mgr.: Peter Wish.  
**Configuration:** Cartridge 4-tr., 8-tr. & cassette.

Robins Inds. Corp., 15-58 127 St., College Point, N.Y. 11356. Tel: (212) 445-7200. Pres.: Her- man D. Post; VP & Sales Mgr.: Jack Fried- land.  
**Configuration:** Cartridge 8-tr. & cassette.  
**Brand name:** Brand Five, Sonoramic.

Rochester, see Dictation Prods.

Rosette, see Dictation Prods.

Ross Electronics Corp., 2834 S. Lock St., Chicago, Ill. 60608. Tel: (312) 376-9660. Pres.: A. R. Bernard; Sales Mgr.: Bernard Leavitt; Adv. Dir.: Samuel Levin.  
**Configuration:** Cassette & open reel.

Royal Sound Co. Inc., 409 N. Main St., Freeport, N.Y. 11520. Tel: (516) 868-2880. Pres.: M. A. Dayan; Gen. Mgr.: N. Greenberg; Sales Mgr.: J. Corbin.  
**Configuration:** Cartridge 8-tr. & cassette.

Rozinante Electronics Corp., 9135 General Ct., Plym- outh, Mich. 48170. Tel: (313) 455-2500. Pres. & Gen. Mgr.: Donald D. Merry; Sales Mgr.: Walter Hess.  
**Configuration:** Cartridge 4-tr., 8-tr. & cassette.

S M G Dists. Inc. (div. of Sam Goody Inc.), 46-35 54 Rd., Maspeth, N.Y. 11378. Tel: (212) 361- 7211. Mgr.: Jack Cohen.  
**Configuration:** Cassette.

Sarex Corp., 3850 West Side Ave., North Bergen, N.J. 07041. Tel: (201) 864-9400; NYC, Tel: (212) 227-6354. Pres.: O. Louis Seda; Exec. VP: D. Max Brightmore; Sales Eng.: William M. Blethen.  
**Configuration:** Cassette.  
**Brand name:** Sarex & private label.

Albert Schultz Inc. (exports only), see Tape Whole- salers section: New York, N.Y.

Scotch, see 3M.

Shannon, see Dict-O-Tape.

Sonoramic, see Robins.

Sony/Superscope, see Superscope.

Soundcraft-CBS Recs. (div. of Columbia Broadcasting System Inc.), Great Pasture Rd., Danbury, Conn. 06810. Tel: (203) 744-3555. Gen. Mgr.: Peter Landskroener; Mktg. Dir.: Robert E. Ward; Sales Mgr.: Charles Berman.  
**Configuration:** Cassette.  
 Sound-Loop, see BASF.

continued on page 74

# MAGTEC HAS CONSTANT QUALITY CONTROL

And a bona fide  
**FREE OFFER - of a Tape, with a String and a Clincher attached!**

You send us any master — Music or Educational — and we'll return it with the following:

One of our Tape duplications in any configuration you specify — cassette, cartridge, or reel to reel — **ABSOLUTELY FREE!**

The String is that you'll be hooked on MAGTEC'S great reproduction of your program . . . a result of MAGTEC'S exclusive CQC . . . Constant Quality Control.

The Clincher is the price. The sample is free. Production runs are a bit higher.

8120 WEBB AVENUE, NORTH HOLLYWOOD, CALIFORNIA 91605  
 (213) 875-1707 • Call Mr. Jim Walker, Vice President Marketing .. COLLECT

## TAPE SUPPLIES

Continued from page 73

- Specialty Sounds Inc., 33515 Kelly Rd., Fraser, Mich. 48026. Tel: (313) 294-5200. Pres.: L. Allan Bazy; Gen. Mgr.: Jerry Danko; Sales Mgr.: Danny R. Wilssens.  
**Configurations:** Cartridge 4-tr., 8-tr., cassette & broadcast cartridges.  
**Brand name:** Specialty Sounds & private labels.
- Stereodyne Inc., 2810 Elliott, Troy, Mich. 48084. Tel: (313) 585-6585. Exec. VP & Gen. Mgr.: Paul Wyatt.  
**Int'l office:** Canada.  
**Configuration:** Cartridge & cassette.  
**Brand name:** Dynapak.
- Stereoriginals, 1721 N. Olden Ave., Trenton, N.J. 08638. Tel: (609) 882-1660. Gen. Mgr.: Arthur Brown.  
**Configuration:** Cartridge 8-tr. & cassette.
- Stereo Test, see Communications Electronics.
- Superscope Inc., 8150 Vineland Ave., Sun Valley, Calif. 91352. Tel: (213) 767-9780. Pres.: Joseph Tushinsky; Sales Mgr.: Paul Markoff.  
**Configuration:** Cartridge 8-tr., cassette & open reel.  
**Brand name:** Sony/Superscope.
- T D K Electronics Corp., 23-73 48 St., Long Island City, N.Y. 11103. Tel: (212) 721-6881. Pres.: H. Kawamura; Mktg. Mgr.: George T. Saddler; Sales Mgr.: A. Otsuka.  
**Branches:** Los Angeles, Calif., 6151 W. Century Blvd. Zip: 90045. Tel: (213) OR 0-5515—Chicago, Ill., 2906 W. Peterson Ave. Zip: 60645. Tel: (312) 973-1222. Pres.: Katsuro Kamiya; Gen. Mgr.: Kiyoshi Hiromoto; Sales Mgr.: Yoshiro Hirotsaka.  
**Int'l branch:** Japan.  
**Configuration:** Cassette.  
**Brand name:** TDK & private label.
- Tape Servs. Inc., 100 York House E., 214 W. Main St., Moorestown, N.J. 08057. Tel: (609) 235-6332. Pres. & Gen. Mgr.: W. F. Mulcahy.  
**Configuration:** Cartridge 8-tr. & cassette.  
**Brand name:** Private label.
- Tape-Tronics, 750 Mandoline, Madison Heights, Mich. 48071. Tel: (313) 588-8281. Pres. & Sales Mgr.: Burton Mahler; VP & Gen. Mgr.: A. S. Hart.
- Telephone Dynamics Corp., 1333 Newbridge Rd., North Bellmore, N.Y. 11710. Tel: (516) 221-9870. Pres.: Leonard Young.  
**Brand name:** Nassau.
- Tele Pro Inds. Inc., Cherry Hill Ind'l Center, Cherry Hill, N.J. 08034. Tel: (609) 424-3344. Pres.: Dennis Boardman; NAB Cartridge Sales Mgr.: Norman Regan.  
**Configuration:** NAB broadcast cartridge.
- 3M Co., Magnetic Prods. Div., 3M Center, St. Paul, Minn. 55101. Tel: (612) 733-1110. Pres.: H. Heltzer; Magnetic Prods. Div. Mgr.: M. C. Hegdahl; Magnetic Prods. Div. Sales Mgr.: W. H. Madden; Adv. & Sales Promo. Mgr.: Charles L. Arden.  
**Configuration:** Cartridge 8-tr. & cassette.  
**Brand name:** Scotch.
- Topp Electronics Inc., 4201 NW 77 Ave., Miami, Fla. 33166. Tel: (305) 887-6201. Pres.: Louis Topp; Gen. Mgr.: David Topp; Sales Mgr.: Charles Kates.  
**Configuration:** Cassette & open reel.  
**Brand name:** Juliette.
- Traveltime, see Metra Electronics.
- Walco Electronics (div. of Walco Linck Corp.), 1234 State Hwy. 46, Clifton, N.J. 07015. Tel: (201) 471-1070. Pres.: H. A. Bodkin.  
**Configuration:** Cartridge 8-tr. & cassette.

## CARTRIDGE PARTS MANUFACTURERS

- A V S C O Inc. (sub. of Lear Jet Stereo Inc.), Hwy. 69 & Corum Rd., Excelsior Springs, Mo. 64024. Tel: (816) 637-2114. Pres.: Ed G. Campbell; VP & Ass't Gen. Mgr.: Ralph Haberstock; Gen. Mgr.: Kenneth Douglas; Sales Mgr.: Robert Adams.  
**Chief product:** All parts for cartridge 4-tr., 8-tr. & cassette; custom molders.
- Adell Corp., 43700 Adell Blvd., Novi, Mich. 48050. Tel: (313) 349-6300. Pres.: Robert Adell; Gen. Mgr.: Frank Adell; Sales Mgr.: Frank McLaughlin.  
**Chief product:** All parts for cartridge 8-tr.
- Alloy Surfaces Co. Inc. (sub. of Reeves Inds.), 100 S. Justison St., Wilmington, Del. 19899. Tel: (302) 655-6344. Pres.: George H. Cook; Gen. & Sales Mgr.: Charles S. Mueller.
- Audio Communications Inc., Rt. 10, Randolph Ind'l Park, Dover, N.J. 07801. Tel: (201) 361-7600. Pres.: E. Michael Daspin; Sales Mgr.: Thomas J. Malia.  
**Chief product:** Pressure pads, shields, springs.

- Audio Magnetics Corp., 14600 S. Broadway, Gardena, Calif. 90247. Tel: (213) 321-6841. Pres.: Irving B. Katz; Sales Mgr.: Ray Allen.  
**Chief product:** Plastic & all internal parts for cassettes.
- Cable Machinery Corp., 156 Fifth Ave., New York, N.Y. 10010. Tel: (212) 989-4434. Pres.: Sol Dubin; VP & Gen. Mgr.: Leonard Ripley; Sales Mgr.: V. J. DePaul.  
**Chief product:** All parts for cassettes.
- Cartridge Component Corp. (sub. of Audio Communications Inc.), Rt. 10, Randolph Ind'l Park, Dover, N.J. 07801. Tel: (201) 361-7600. Pres.: Joe Jamieson; Sales Mgr.: Bob Baker.  
**Chief product:** Pinch rollers & pressure pads for cartridge 8-tr.; spring pads & springs for cassettes.
- Cassette Corp. of America, 640 S. Commercial Ave., Carlstadt, N.J. 07072. Tel: (201) 933-9125. Pres.: Walter Elterman; Gen. Mgr.: Allen Braverman; Mktg. Dir.: Arthur F. Etro; Sales Mgr.: Milton Blutter.  
**Chief product:** All parts for cartridge 8-tr.
- Celanese Plastics Co. (div. of Celanese Corp.), 550 Broad St., Newark, N.J. 07102. Tel: (201) 877-2300. Pres.: Robert T. Daily; Gen. Mgr.: R. C. Schroeder; Sales Mgr.: D. D. Cowan.  
**Chief product:** Celcon (acetal copolymer resin for reels, platforms & wafers).
- Celcon, see Celanese Plastics.
- Certron Corp., 1701 S. State College Blvd., Anaheim, Calif. 92806. Tel: (714) 633-4280. Pres.: Edwin Ganson; Mktg. Admin. Dir.: Brian McCourt; Sales Mgr.: James Neiger.  
**Chief product:** All parts for cartridge 4-tr., 8-tr. & cassette; pre-leaded cassettes.
- Data Technology Corp., Cassette Div., 1600 Las Plumas Ave., San Jose, Calif. 95133. Tel: (408) 272-0300. Pres.: Luigi Contini; Gen. Mgr.: Thomas Lazor; Mktg. Dir.: Raymond Valle; Sales Mgr.: William Patsuris.  
**Chief product:** All parts for cassettes.
- Dow Corning Corp., Saginaw Rd., Midland, Mich. 48640. Tel: (517) 636-8000. Pres. & Gen. Mgr.: William Goggin; VP Mktg.: William Pedersen; Mkt. Supervisor: James R. Russell.  
**Chief product:** Silicone rubber raw material for cartridge 8-tr. pinch roll.
- Duotone Co. Inc., 6875 SW 81 St., South Miami, Fla. 33143. Tel: (305) 665-1121. Pres.: Stephen Nester; Gen. Mgr.: Benjamin Rosenberg.  
**Chief product:** Pins for rollers.
- Dynapak, see Stereodyne.
- El Mar Plastics, 1940 W. 144 St., Gardena, Calif. 90249. Tel: (213) 327-1540. Pres.: Harry Schor; Sales Mgr.: Allen Schor.  
**Chief product:** All cassette parts.
- Espo Eng'g Corp., 5334 W. 65 St., Chicago, Ill. 60638. Tel: (312) 581-0123. Pres.: Eugene Esposito; VP & Gen. Mgr.: Donald J. Esposito; Sales Mgr.: Dennis Machul.  
**Chief product:** Mylar wafer (washer & shim) for cassette; cassette parts automation equip. & special engineered assembly systems.
- Indiana Molding Co. Inc., PO Box 444, Huntington, Ind. 46750. Tel: (219) 356-4810. VP Mktg. & Sales Mgr.: W. P. Kelley; VP Eng'g: J. A. Abbott.  
**Chief product:** Pinch rollers for cartridge 8-tr.
- Inland Plastics Inc., 19800 E. Nine Mile Rd., St. Clair Shores, Mich. 48080. Tel: (313) PR 7-3200. Pres.: David C. Lowe.  
**Chief product:** All plastic parts.
- Mastro Inds. Inc., 3040 Webster Ave., Bronx, N.Y. 10467. Tel: (212) 547-5600. Pres.: Mario Maccaferri; Gen. Mgr.: Max Studli.  
**Chief product:** All parts for cartridge 8-tr.
- Overland Prods. Co., 515 N. Pierce St., Fremont, Neb. 68025. Tel: (402) 721-7270. Pres. & Gen. Mgr.: Howard J. Pearson.  
**Chief product:** Spring pressure pads & shields for cartridge & cassette.
- Plastic-Ware Inc., 1100 Leggett Ave., Bronx, N.Y. 10474. Tel: (212) 991-0100. VP & Gen. Mgr.: William DeMucci; Sales Mgr.: Phil Lazarus.  
**Chief product:** All parts for cassettes.
- Playmate Inds. Inc., 14505 E. Proctor Ave., Industry, Calif. 91747. Tel: (213) 968-5641. Pres.: Ted Ritz; Gen. Mgr.: Joe Richtaric; Sales Mgr.: R. F. Atkinson.  
**Chief product:** All parts for cartridge 8-tr.
- Roller Corp. of America, 3601 S. Clinton Ave., South Plainfield, N.J. 07080. Tel: (201) 757-7330. Pres. & Sales Mgr.: Edward Monett; VP: Jack E. Monett; Gen. Mgr.: Joseph F. Simmons.  
**Chief product:** Rubber pinch rollers for cartridge 8-tr.
- Rozinante Electronics Corp., 9135 General Ct., Plymouth, Mich. 48170. Tel: (313) 455-2500. Pres. & Gen. Mgr.: Donald D. Merry; Sales Mgr.: Walter Hess.  
**Chief product:** Pinch rollers & pressure pads.
- Sarex Corp., 3850 W. Side Ave., North Bergen, N.J. 07041. Tel: (201) 864-9400; NYC Tel: (212) 227-6354. Pres.: O. Louis Seda; Exec. VP: D. Max Brightmore; Sales Eng.: William M. Blethen.  
**Chief product:** All parts for cassettes.
- Albert Schultz Inc. (exports only), see Tape Wholesalers section: New York, N.Y.

- Stereodyne Inc., 2810 Elliott, Troy, Mich. 48084. Tel: (313) 585-6585. Exec. VP & Gen. Mgr.: Paul Wyatt.  
**Int'l office:** Canada.  
**Chief product:** All parts for cartridge & cassette.
- T D K Electronics Corp., 23-73 48 St., Long Island City, N.Y. 11103. Tel: (212) 721-6881. Pres.: H. Kawamura; Mktg. Mgr.: George T. Saddler; Sales Mgr.: A. Otsuka.  
**Branches:** Los Angeles, Calif., 6151 W. Century Blvd. Zip: 90045. Tel: (213) OR 0-5515—Chicago, Ill., 2906 W. Peterson Ave. Zip: 60645. Tel: (312) 973-1222. Pres.: Katsuro Kamiya; Gen. Mgr.: Kiyoshi Hiromoto; Sales Mgr.: Yoshiro Hirotsaka.  
**Int'l branch:** Japan.  
**Chief product:** All parts for cassettes.

## MANUFACTURERS OF TAPE DUPLICATING EQUIPMENT

- Aerovox Corp., PO Box 157, Moncks Corner, S. C. 29461. Tel: (803) 899-2132. Pres.: M. Owen; Gen. Mgr.: E. J. Wershey; Sales Mgr.: Loris Murray.  
**Chief product:** Degaussers.
- American Magnetic Tape Equip. Corp., 55 Central Ave., Farmingdale, N. Y. 11735. Tel: (516) 293-5710.  
**Chief product:** Complete system.
- Ampex Corp., 401 Broadway, Redwood City, Calif. 94063. Tel: (415) 367-2641. Pres.: William E. Roberts; Gen. Mgr.: A. Sroka; Mktg. Mgr.: Tom Scholten; Sales Mgr.: Don Smith.  
**Chief product:** Tape transports, heads & electronics, head cleaners & degaussers.
- Arvin Magnetics (div. of Arvin Inds. Inc.), 1531 13 St., Columbus, Ind. 47201. Tel: (812) 372-7271. Pres.: E. I. Anderson; Prod. Mgr.: M. V. Jewett.  
**Chief product:** Tape heads.
- Audio Magnetics Corp., 14600 S. Broadway, Gardena, Calif. 90247. Tel: (213) 321-6841. Pres.: Irving B. Katz; Sales Mgr.: Ray Allen.  
**Chief product:** Pre-leaded cassettes.
- Audiomatic Corp., 915 Westchester Ave., New York, N. Y. 10459. Tel: (212) LU 9-3500. Pres. & Sales Mgr.: Milton B. Gelfand.  
**Chief product:** Masters, slaves, winders; distributes complete equip.
- F. T. C. Brewer Co., Town & Country Plaza, Pensacola, Fla. 32505. Tel: (904) 433-7932. Owner: Frederic T. C. Brewer.  
**Chief product:** Master units for open reel.
- C A D C O Audio Inds. Corp., 55 Oak St., Norwood, N. J. 07648. NY Tel: (914) 359-4434. Pres.: H. Philip Lehle.  
**Chief product:** Consoles & mixers.
- Canon, see Double Sixteen.
- Cassette Rec'g Corp., 41-34 27 St., Long Island City, N. Y. 11101. Tel: (212) 937-3344. Pres.: Carl Lustig; Gen. Mgr.: Matthew Polakoff; Sales Mgr.: Chuck Barclay.  
**Chief product:** Winders.
- Creative Artists, 6 Van Ness Rd., Binghamton, N. Y. 13905. Tel: (607) 797-3909. Pres. & Opns. Mgr.: Johnathan K. Solak; Sales Mgr.: Charles Solak.  
**Chief product:** Studio consoles & tape duplicators.
- Custom Audio-JPL Rec. Co., 1088 Sixth Ave., Des Plaines, Ill. 60016. Tel: (312) 299-0220. Pres.: Paul H. Luttgens; Prod'n & Sales Mgr.: Thomas E. Larsen.  
**Chief product:** Custom modification units for automation of equip.
- Daven (div. of McGraw Edison Co.), Grenier Field, Manchester, N. H. 03103. Tel: (603) 669-0940. Gen. Mgr.: Ed Allman; Mktg. Dir.: Fred Martini; Prod. Mgr.: Henry Baker.  
**Chief product:** Slide wire attenuators, headset amplifiers, inline amplifiers & interphone amplifiers.
- Diskmakers Inc., 925 N. Third St., Philadelphia, Pa. 19123. Tel: (215) MA 7-2277. Pres.: Morris Ballen; Gen. Mgr.: John Fermani.  
**Chief product:** Cartridge 8-tr. loaders, cartridge & cassette bulk handling trays.
- Double Sixteen Co., PO Box 1616, 1028 College Ave., Wheaton, Ill. 60187. Tel: (312) 653-1616. Pres.: James W. Canon; Sales Mgr.: Thomas W. Canon.  
**Chief product:** Canon professional tape splicer.
- Dubbings Electronics Inc., 1305 S. Strong Ave., Copiague, N. Y. 11726. Tel: (516) 893-1000. Pres.: Paul C. Smith; Opns. Mgr.: P. M. Shooer; Sales Mgr.: Michael Thaler.  
**Chief product:** Tape strobes.
- Electrodyne Corp., 7315 Greenbush Ave., North Hollywood, Calif. 91605. Tel: (213) 875-1900. Pres.: Donald N. McLaughlin; Gen. Mgr.: Lee W. Grundeis; Project Dir.: Barry Cool; Sales Mgr.: F. Donald Schliff.
- Electro Sound Inc. (div. of Bell Sound Studios Inc.), 237 W. 54 St., New York, N. Y. 10019. Tel: (212) 582-4812. Pres.: Allan Weintraub.  
**Chief product:** Complete system.

continued on page 79

INTRODUCING THE  
UNDER \$75,000  
TAPE DUPLICATING  
SYSTEM\*

\*The same high volume system that produces GRT's stereo music tapes.

# The GRT 260 Tape Duplicating System

Sound  
as it was  
originally recorded

The new GRT 260 system offers you higher quality, higher yield at a lower cost. Duplicated tape at playback speeds of 1 7/8 ips (cassette) and 3 3/4 ips (8-track cartridge) has negligible generation losses in fidelity.

Production yield from the 260 system is over 6,000 cassettes or 12,000 8-track albums in an 8-hour shift. Unit cost is under 8 cents per copy, including labor and overhead, excluding materials.

This type of performance comes naturally with the 260 because all components are production oriented.

For example, the Master Duplicator employs a simple dial for the number of copies. With the push of a "start" button, it permits transport systems to

## The components that make up the 260 System

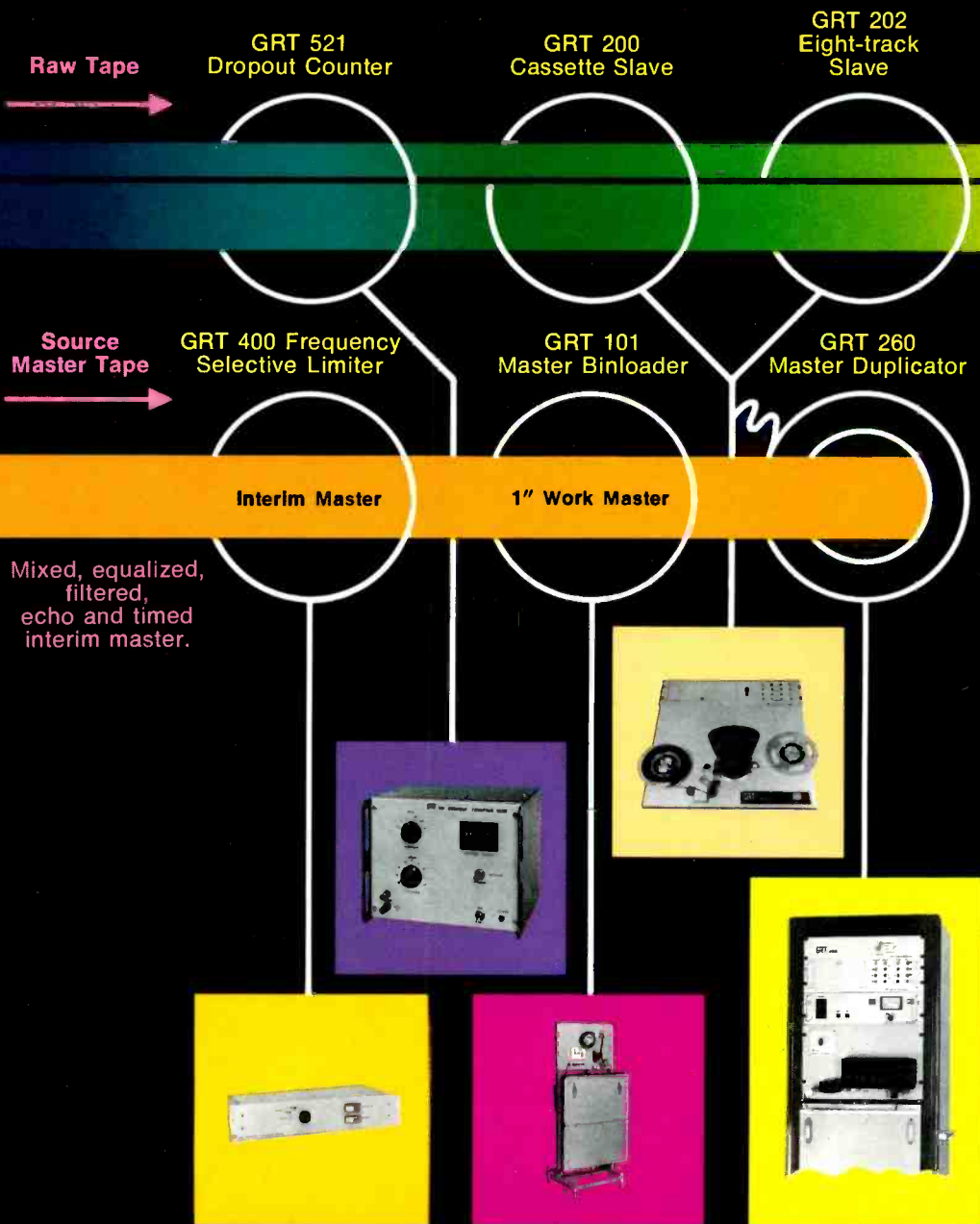

stabilize, automatically leader, duplicate, place test tones for quality control and stop on completion. The Master Duplicator is maintained with pull-out drawers, interchangeable circuit boards and front panel monitoring.

Highly stable tape transports and interchangeable circuit boards are key features on the 200 and 202 Slaves. Slaves may be added or deleted from the line with no change in slave bias.

The 521 Dropout Counter controls incoming tape for instantaneous amplitude variations (dropouts) resulting from inconsistencies in the oxide coating.

For an audible check of material before assembly, the 505 and 508 QC

Product Checkers permit monitoring of the bulk duplicated material and auditing of the test tones placed on the duplicated reels.

Assembly production is speeded by the 100 and 150 Tapewinders which respond to inaudible tailoring tone and stop and cut tape between albums.

Further quality control on 8-track cartridges is accomplished with the 110 Recycle Unit. It checks mechanical stability by running the tape a complete revolution and automatically stopping.

All GRT components are available individually or as a complete 260 system. Complete details on the total system are covered in our new catalog. Write for it today.

GRT QC  
Product Checkers  
505 (cassette)  
and 508  
(eight-track)

GRT 150  
Cassette Winder

Labeling  
and Packaging

GRT 100  
Eight-track Winder

GRT 110  
Eight-track  
Recycle Unit

Labeling  
and Packaging

Duplicated  
Reels of Tape



# Here are just some of the specifications that make the GRT 260 Tape Duplicating System a top performer

## GRT Master Duplicator and Slave

**Format:** 7½ ips NAB, four or eight 70-mil tracks on one-inch tape

**Type:** Continuous loop, 1200-foot capacity, remotely loaded (1800-foot bin under development).

**Speed:** 240 ips

**Duplication ratio:** 32 to 1 (slave speed 120 ips for 3¾ ips copies, 60 ips for 1⅞ ips copies). (Approx. 2-sec duplication time per minute of program)

**Frequency response of copy (Deviation from master):** ±2 dB 50 Hz–10,000 Hz

**Distortion:** Reproduce and record electronics each generate less than ½% THD at any frequency from 1600 Hz to 400 kHz at any level up to 15 dB above operating level. Bias system generates less than ½% even order distortion in recorded signal

**Signal-to-noise ratio:** System contributes less than 3 dB weighted noise over that of bulk erased tape

**Flutter:** .25% rms, 0.2 to 200-Hz unweighted

**Master/copy speed error:** 0.5% max.

## GRT 400 Frequency Selective Limiter

**Frequency response:** (below limiter threshold) ±1 dB (25 Hz–25 kHz)

**Output clipping level:** +24 dBm

**Noise:** (unweighted 20 Hz–20 kHz) = -70 dBm

**Input impedance:** 200 k ohms, single-ended

**Output impedance:** 12 ohms, single-ended

**Attack time:** Full limiting within the first half-cycle of input signal

**Release time:** 50 ms maximum

## GRT 521 Dropout Counter Unit

**Threshold:** Adjustable in 2 dB steps, -12 dB, to +4 dB

**Dropout duration:** (selectable) 2.5 ms., 5 ms., 10 ms., 20 ms., 40 ms., 80 ms.

**Input signal:** Any "carrier" between 1 kHz and 100 kHz may be employed

**Counter capacity:** Six digits with push-button reset

**Maximum counting rate:** 10 counts per second

## GRT 100 8-track Tapewinder

**Max. reel size:** 14" dia. NAB hub

**Winding speed:** Approx. 100 ips

**Tailoring tone requirements:** 10–20 Hz at approx. operating level on both channels of a single stereo pair

## GRT 150 Cassette Tapewinder

**Max. reel size:** 10½" NAB hub

**Winding speed:** Averages 120 ips

**Winding time:** Approx. 17 seconds for average length cassette album

**Tailoring tone requirements:** 10–20 Hz at approx. operating level on both channels of a single stereo pair

**Blank tape winding feature:** (optional) precision timing circuit with 3 pre-settable winding times for C-60, C-90 and C-120 cassettes

## GRT 110 8-track Recycle Unit

**Tape speed:** 60 ips

## GRT 508 QC Product Checker

**Tape width:** (nominal) ¼ inch

**Tape speed:** 3.75 ips ±0.3%

**Frequency response:** 50–10,000 Hz ±2 dB

**Signal-to-noise ratio:** Peak record level to unweighted noise, 20–20,000 Hz 52 dB

**Output:** 0 dBm operating level, clipping greater than +20 dBm



For further specifications on individual components of the total 260 System, write:

# GRT

GRT CORPORATION  
Industrial Division  
1286 Lawrence Station Road  
Sunnyvale, California 94086

## TAPE SUPPLIES

Continued from page 74

Ferroxcube Corp., PO Box 359, Mount Marion Rd., Saugerties, N. Y. 12477. Tel: (914) 246-2811. Pres.: J. J. Sacco; Gen. Mgr.: J. A. Robinson; Mktg. Mgr.: John Turnbull; Sales Mgr.: A. Sanders.  
**Chief product:** Duplicating heads for cartridge & cassette equip.

Finebilt Mfg. Co., 931 N. Citrus Ave., Los Angeles, Calif. 90038. Tel: (213) 466-9511. Pres.: Alwin P. Schmid; VP: Joseph Bouzaglou.  
**Chief product:** Cartridge & cassette loaders, open reel duplicating equip., coating & slitting equip.

G R T Corp., 1286 Lawrence Sta. Rd., Sunnyvale, Calif. 94086. Tel: (408) 734-2910. Pres.: Alan J. Bayley; Mktg. Mgr.: Chris Coburn; Mktg. Servs. Dir.: Ronald Rader.  
**Chief product:** Complete systems, winders, drop-out counters, frequency selective limiters & slave units.

Gauss Electrophysics (div. of MCA Technology Inc.), 1653 12 St., Santa Monica, Calif. 90404. Tel: (213) 451-8611. Pres.: K. O. Johnson; VP Mktg.: W. L. Cara; Gen. Mgr.: George Halamandarus.  
**Chief product:** Complete ultra high speed systems & accessories.

Grandy Inc., 1275 Bloomfield Ave., Fairfield, N.J. 07006. Tel: (201) 228-1433. Pres.: Edward J. Kissack.  
**Chief product:** Magnetic heads, complete duplicating systems.

Infonics Inc., 1723 Cloverfield Blvd., Santa Monica, Calif. 90404. Tel: (213) 828-6471. Pres.: Peter H. Stanton; Sales Mgr.: Paula Nelson.  
**Chief product:** Complete cartridge 8-tr., cassette & open reel duplicators.

International Telecomm Inc., Box 405, Cockeysville, Md. 21030. Tel: (301) 666-7770. Pres.: F. J. Beste; VP & Sales Mgr.: Burgess Macneal Jr.  
**Chief product:** Cassette duplication transports.

Irish Magnetic Tape Div., 458 Broadway, New York, N.Y. 10013. Tel: (212) 925-1257. Pres.: Sol Zigman; Gen. Mgr.: Hy Zigman; Sales Mgr.: Bill Grossman.  
**Chief product:** Leader tape, splicing tape & tape splicers.

Island Magnetic Electronics Corp., 96-18 43 Ave., Corona, N. Y. 11368. Tel: (212) 651-8900. Pres. & Sales Mgr.: Trevor W. Kendall; Gen. Mgr.: Harry Sussman.  
**Chief product:** Duplicators, winders, loaders, automatic assembly equip., QC machines, sonic welders, cartridge exercisers & splicing equip.

King Instrument Corp., 11 Fox Rd., Waltham, Mass. 02154. Tel: (617) 899-5110. Pres.: James L. King; Gen. Mgr.: James L. King Jr.  
**Chief product:** Cassette loader for blank & pre-recorded tape.

Lang Electronics Inc., 507 Fifth Ave., New York, N. Y. 10017. Tel: (212) 682-7147. Pres.: Lou Lang; Gen. Mgr.: Thomas M. Malone.  
**Chief product:** Complete systems, mixers & equalizers.

Langevin (div. of Scientific Inds. Inc.), 1801 E. Carnegie, Santa Ana, Calif. 92705. Tel: (714) 546-8830. Pres.: John Swanson; Gen. Mgr.: Heinz Ross; Sales Mgr.: Marvin Headrick.  
**Chief product:** Controls, amplifiers, professional tape deck, mixers & all individual components.

Livingston Audio Prods. Corp., 1275 Bloomfield Ave., Fairfield, N. J. 07006. Tel: (201) 226-8300. Pres.: Darrell D. Scholten; VP Sales: Thomas J. Hofbauer.  
Branch: West Los Angeles, Calif., 10687 Santa Monica Blvd. Zip: 90025. Tel: (213) 474-4559. Mgr.: John Anderson.  
**Chief product:** Winders, degaussers & splicers.

Marathon Prods. Corp., 334 W. Boylston St., West Boylston, Mass. 01583. Tel: (617) 853-0988. Pres.: R. D. Myers.  
**Chief product:** Strobe test & torque test cartridges.

Metra Electronics Corp., 660 McDonald Ave., Brooklyn, N. Y. 11218. Tel: (212) 871-4100. Pres. & Sales Mgr.: Charles R. Fox.  
**Chief product:** Winders & automatic tape splicing applicators.

Nor-Mag, see Northridge Magnetics.

Northridge Magnetics Inc., 19017 Parthenia, Northridge, Calif. 91324. Tel: (213) 394-0661. Pres.: R. B. Huffman; Exec. VP: S. J. Baker; Mfg. Superintendent: Norman Badgett.  
**Chief product:** Nor-Mag degaussers.

Nortronics Co. Inc., 6140 Wayzata Blvd., Minneapolis, Minn. 55416. Tel: (612) 544-0381. Pres.: John A. Yngve; Mktg. Dir.: Mervin Kronfeld; Sales Mgr.: Roger J. Czerniak; Ass't Sales Mgr.: T. M. Johnson.  
**Chief product:** Magnetic tape heads.

Playmate Inds. Inc., 14505 E. Proctor Ave., Industry, Calif. 91747. Tel: (213) 968-5641. Pres.: Ted Ritz; Gen. Mgr.: Joe Richtarcik; Sales Mgr.: R. F. Atkinson.  
**Chief product:** Winders, splicers & automated assembling machines for cassettes.

Pulse Techniques Inc., 1411 Palisade Ave., West Englewood, N. J. 07666. Tel: (201) 837-2575. Pres.: Eugene R. Shenk; VP Sales: W. Oliver Summerlin.  
**Chief product:** Program equalizers, filters.

Rangertone Electronics Corp. (div. of A-V Research Corp.), 73 Winthrop St., Newark, N.J. 07104. Tel: (201) 485-2550. Pres.: George Zazzali.  
**Chief product:** Winders, duplicators, QC & professional playback equip.

Recorder Corp., 3227 Cains Hill Pl., Atlanta, Ga. 30305. Tel: (404) 237-7000. Pres.: W. R. Matthews; Gen. Mgr.: Bill Hammonfree; Sales Mgr.: Al Cottrell.  
**Chief product:** High speed cassette duplicators & winders.

Rozinante Electronics Corp., 9135 General Ct., Plymouth, Mich. 48170. Tel: (313) 455-2500. Pres. & Gen. Mgr.: Donald D. Merry; Sales Mgr.: Walter Hess.  
**Chief product:** Cartridge 8-tr. run-in machines & cassette loading fixtures.

Albert Schultz Inc. (exports only), see Tape Wholesalers section: New York, N. Y.

Scully Rec'g Instruments Co. (div. of Dictaphone Corp.), 480 Bunnell St., Bridgeport, Conn. 06607. Tel: (203) 335-5146. Pres.: Lawrence J. Scully; VP & Gen. Mgr.: H. H. Brosious.  
**Chief product:** Professional tape recorders, master recorders, tape transports.

Sonic Arts Corp., 665 Harrison St., San Francisco, Calif. 94107. Tel: (415) 781-6306. Pres.: Leo

de Gar Kulka; Exec. VP: Herbert P. Haas; Nat'l Sales Mgr.: Dale W. Roe.  
**Chief product:** Telefunken-Magnetophon professional recorders (sole importer).

Soundcraft-CBS Recs. (div. of Columbia Broadcasting System Inc.), Great Pasture Rd., Danbury, Conn. 06810. Tel: (203) 744-3555. Gen. Mgr.: Peter Landskroener; Mktg. Dir.: Robert E. Ward; Sales Mgr.: Charles Bertram.  
**Chief product:** Colored leader tape, splicing tape, conductive, cueing & reversing tape, Magna-see solution to see magnetic track recorded on tape.

Sound Technique Inc., 321 W. 78 St., New York, N. Y. 10024. Tel: (212) 877-1730. Pres.: Sidney Feldman.  
**Chief product:** Custom-built audio equip. & Teletronix leveling amplifiers.

Stereo Magic (div. of Eastern Specialties Corp.), 169 Rt. 46, Dover, N.J. 07801. Tel: (201) 361-7990. Pres.: Robert F. Kenny.  
**Chief product:** RP-1000 cartridge 8-tr. recorder/playback deck.

Switchcraft Inc., 5555 N. Elston Ave., Chicago, Ill. 60630. Tel: (312) 774-1515. Pres. & Gen. Mgr.: W. L. Larson; Sales Mgr.: A. F. Anderson.  
**Chief product:** Mixers, plugs, jacks, patch cords.

Tapemaker Sales Co. Inc., 2255 Broadway, New York, N.Y. 10024. Tel: (212) 874-4258. Pres.: Arthur Brandwein; Gen. Mgr.: Aubrey Stove Jr.  
**Chief product:** Slitting equip. for magnetic tape, winding equip. for cassettes or cartridges, loops for 8-tr. head cleaners, sensing-splicing tape with or without a liner, tape wipers, non-abrasive head cleaning material for 8-tr., cassette & video, abrasive materials for head cleaners, colored leader material for cassettes, aluminized leader material, graphite coated slip sheets, graphite coated slip sheets with zone in center, buff rolls of magnetic tape for 8-tr. or cassette, test cartridges & cassettes.

Tape Servs. Inc., 100 York House E., 214 W. Main St., Moorestown N. J. 08057. Tel: (609) 235-6332. Pres. & Gen. Mgr.: W. F. Mulcahy.  
**Chief product:** Test cartridges.

Teletronix, see Sound Technique.

3 M Co., Magnetic Prods. Div., 3M Center, St. Paul, Minn. 55101. Tel: (612) 733-1110. Pres.: H. Heltzer; Magnetic Prods. Div. Mgr.: M. C. Hegdal; Magnetic Prods. Div. Sales Mgr.: W. H. Madden; Adv. & Sales Promo Mgr.: Charles L. Arden.  
**Chief product:** Splicing tape, sensing tape, leader tape.

Worldex Mfg. Co. Ltd. (exports only), see Tape Wholesalers section: Los Angeles, Calif.

## A RECIPE FOR SUCCESS:

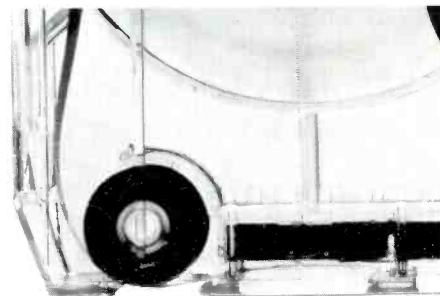

## ADD A PINCH OF MINNESOTA RUBBER

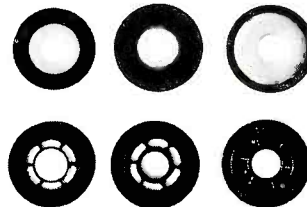

Minnesota Rubber has developed and produced millions of pinch rollers for 8 track stereo cartridges. Pinch rollers that snap on. Pinch rollers that are molded on. Tires and inserts. Just tires. Just inserts. Elastothane® urethane pinch rollers. Silicone. Nitrile. Other rubbers. Standard sizes. Special designs. Combinations. You name it.

Minnesota Rubber has done it, or will do it for you. For over 21 years we've been producing drive belts, pressure rollers, idler wheels and special molded rubber and plastic parts for the sound reproduction industry. For more information, contact your local Minnesota Rubber Representative or write.

© ELASTOTHANE IS A REGISTERED TRADEMARK OF THIKOL CHEMICAL CO.



**MINNESOTA RUBBER COMPANY**

■ Creativity in Rubber

3630 WOODDALE AVENUE, MINNEAPOLIS, MINNESOTA 55416

**Billboard**  
has the... "IN" side story  
on  
Tape  
**Billboard**

# FINEBILT HI-SPEED COMPACT TAPE DUPLICATOR

FINEBILT'S latest achievement in the tape field is the HI-SPEED compact tape duplicator.

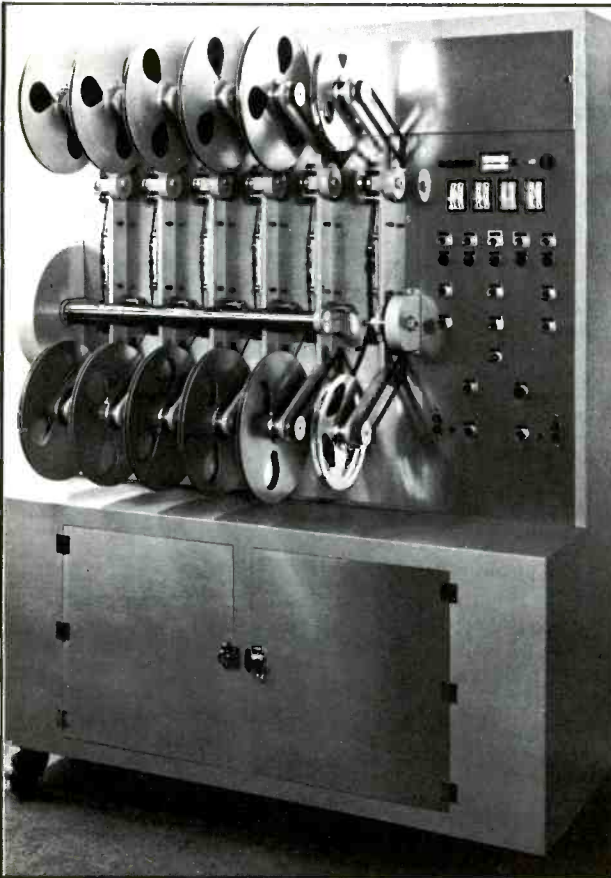

This superbly engineered hardware is the Finebilt 69-5 highspeed tape duplicator system.

There never has been anything like it, and it is going to shake up the tape duplicating scene.

Here are just a few features:

- Precise highspeed duplication of 4-track, 8-track, cassette, reel-to-reel or play tapes . . . 5 positions in one machine!
- Produces up to 2000 one hour subjects per 8 hour shift.
- Quick 10-minute format changeover . . . thanks to Finebilt's exclusive "plug in/plug out" head assembly.
- Value engineering throughout. Electronics are solid state and plug-in.
- The single self-contained unit occupies just 14 sq. ft. of floorspace.
- No installation required. The 69-5 rolls on casters to any position—plugs in readily into an ordinary electrical outlet.
- Smaller original cost, minimum maintenance and operating cost, plus matchless performance, make the multipotent 69-5 the unduplicated duplicator.

## ALSO—these Extra Bonus features!

- ★ Common capstan transport—no introduction of wow or flutter.
- ★ Big reel capability—7200 ft. per position at high speed without stop.
- ★ Any of the positions can be stopped without interrupting operation of duplicator.

## FINEBILT Fine-Coat Manufacturing Equipment

The complete plant package to fit your requirements. Now you can establish a compact, automatic tape plant which can produce the highest quality recording tape at a minimum investment. How? With FINEBILT Fine-Coat Magnetic Tape Manufacturing Equipment, another industry "breakthrough" by FINEBILT, the quality name in precision phonograph record pressing, and plating equipment.

Backed by unmatched experience gained in the special design and installation of sound industry facilities throughout the world, Fine-Coat Tape Equipment was developed to enable you to set up a modern plant with a maximum of efficiency. This equipment represents a total concept in plant operation. We are not merely selling factory machinery . . . **WE ARE MARKETING A SELF-CONTAINED BUSINESS WITH AN UNLIMITED PROFIT POTENTIAL**

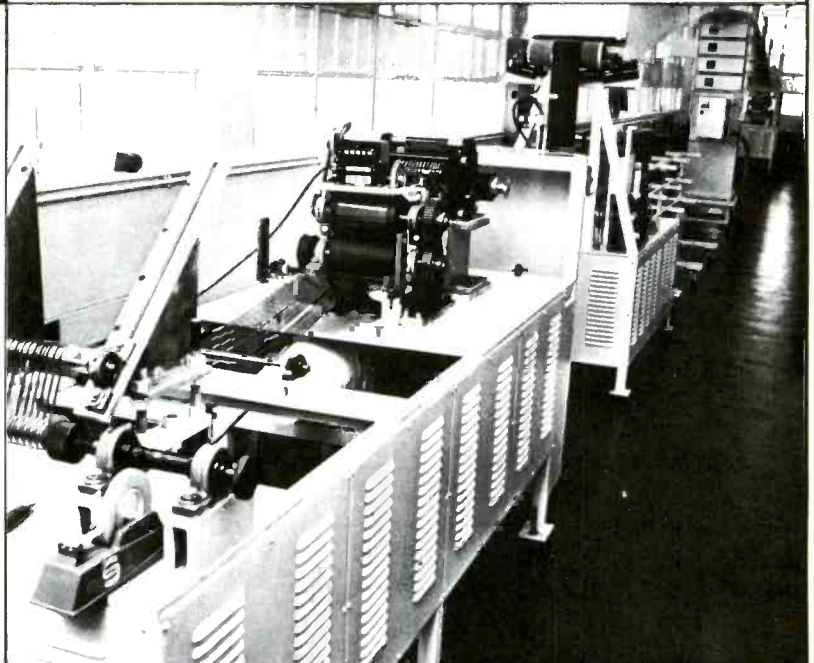

**finebilt**  
MANUFACTURING COMPANY

931 NORTH CITRUS AVENUE / HOLLYWOOD, CALIFORNIA 90038

Telephone 466-9511 / Area Code 213

CABLE "COEXPORT"





If it's good  
on tape...  
it's better  
on  
**BASF**

*Leading supplier of tape products to the Music Industry: Cassette Tape • Cassettes • Cartridge Tape • Video Tape • Calibration Tape • Mastering Tapes • Instrumentation Tape • Duplicating Tape*

**BASF SYSTEMS INC**  
Bedford, Massachusetts  
BASF, Ludwigshafen Am Rhein, West Germany

# OUR BIGGEST

# PLUS

# IS US

We start at our "THINK FACTORY". . .

We edit. We duplicate. We design packages.

We color print. We package. We warehouse. We make drop shipments. We maintain inventory.

We do A&R programming, if you like. We offer fulfillment service. We can solve your distribution problems, if you have any.

Add up our custom tape services. You reach the highest total in the industry. There are many reasons for the happy arithmetic. The biggest one is our people.

Check us out. We've got the talent, the training, the research, and the experience. Also, our parent organization is with us. As well as all subsidiary organizations . . . including Gauss Electrophysics, Inc., Saki Magnetics, Inc., and of course the manufacturing facilities of Decca Records.

We also have geography going for us. Duplicating plants on the East and West coast as well as in Canada. And, most important, fulfillment centers at all strategic points in the U.S. and Canada.

But back to us.\* We are competitive in a field where the competition is good. And that's where it counts.

\*Contact:

Mr. Charles Blake

MCA Custom Service

a division of MCA, Inc.

445 Park Avenue

New York City, New York 10022

(212) 759-7500



**This U.S. business loses over \$1,000,000,000 and 20% of its employees every year—and you pay the losses.**

It's the Post Office. Your taxes must be about \$1.2 billion greater to make up its annual deficits. And your postal service suffers because of the high employee turnover.

Fire the management? You can't do that with the Post Office. Its basic management decisions are made by 535 members of Congress. They control its spending for facilities, its employment costs and conditions, and the rates it can charge for services.

That was fine in 1789 when it all started, but it's time for a change—a complete change. There's a bill, HR 11750, now before Congress which provides true Postal Reform. It creates a government authority (something like TVA) to run the Post Office on a businesslike basis. President Nixon and Postmaster General Blount are behind it. So are ex-President Johnson and his Postmaster General, Lawrence O'Brien. You should be, too, unless you don't mind paying the deficits. Or wouldn't be bothered by a total breakdown of service in your city (like Chicago in 1966).

You can do something. Write or wire your congressman; ask him to support HR 11750, the only bill that will bring true Postal Reform. Do it today.

**Citizens Committee for Postal Reform**

1725 Eye Street, N.W., Washington, D.C. 20006  
Lawrence F. O'Brien/Thurston B. Morton  
National Co-Chairmen

**NOW!**

# Splice Twice as Fast



Cassette loading gets a dramatic speed-up with this new professional Canon Model 150 Tape Splicer. Gives precision results for any user, every time.

- Strong, uniform splices.
- Easy, efficient operation.
- Compact size: 3 3/8" x 5 7/8"

**Canon™**

Professional Model 150  
Cassette Tape-Splicer

Only **\$189<sup>50</sup>**

Call or write now for priority delivery

**DOUBLE SIXTEEN CO.**

Box 1616, Wheaton, Illinois 60187 • (312) 653-1616

## Plastic-Ware Inc.

A  
NORTH AMERICAN PHILIPS  
COMPANY

**INNOVATORS & LEADING MANUFACTURERS  
OF A FULL LINE OF COMPACT CASSETTES  
MANUFACTURERS OF NORELCO & AMPEX STYLE BOXES**

WE INVITE YOUR INQUIRIES

Plastic-Ware Inc.  
A North American Phillips Co.  
1100 Leggett Avenue  
Bronx, N.Y. 10474 (212) 991-0100  
Please send information on Cassettes & Boxes.

Name & Title \_\_\_\_\_  
Company \_\_\_\_\_  
Address \_\_\_\_\_  
City \_\_\_\_\_ State \_\_\_\_\_ Zip \_\_\_\_\_

## DISTRIBUTORS

Continued from page 63

Cordova's Importers & Dists., PO Box 16065, 543 West Third North. Zip: 84116. Tel: 355-0642. Owner & Mgr.: Carl C. Cordova. (D).  
**Cartridge 8-tr.:** Bego, Bernal, Cap-Latino, Chico, Columbia, Del Valle, El Pato, El Zarape, Falcon, Ideal, Marsol, Musart, Norteno, Orfeon, Tear Drop.  
**Cartridge 4-tr.:** Columbia, Del Valle, Falcon, El Zarape, Musart, Norteno.  
**Cassette:** Cap-Latino, Del Valle, Musart.  
 Huish Dist'g Co., 2525 South Eighth West. Zip: 84115. Tel: 486-7611. Owner: Paul Huish; Mgr. & Buyer: Ross J. Davis. (D & RJ).  
**Cartridge 8-tr.:** Ampex, GRT, ITCC, RCA.  
**Cartridge 4-tr.:** Ampex, GRT, ITCC.  
**Cassette:** GRT, ITCC, Mercury, RCA.  
**Open reel:** RCA.  
**Playback equip.:** Belle Wood, RCA.  
**Accessories:** RCA.  
 Mountain West Dist., 2195 SW Temple. Zip: 84115. Tel: 467-0202. Owners & Buyers: R. A. Brower, Rulon G. Reynolds; Mgr.: R. A. Brower. (D & RJ).  
**Cartridge 8-tr.:** All lines.



**DON'T WASTE TIME . . .**

searching for all hard-to-find information—just check Buyer's Guide. It's at-a-glance information.

**REQUEST 8-TRACK STEREO CARTRIDGES**  
 Leads the INTERNATIONAL FIELD with  
**MUSIC OF MANY LANDS** (beautifully packaged)  
 featuring the finest  
 AFRICAN/ALBANIAN/AMERICAN/ARABIC/ARMENIAN/AUSTRIAN  
 BALINESE/BRAZILIAN/BULGARIAN  
 CANADIAN/CAUCASIAN/CUBAN/CZECHOSLOVAKIAN/FRENCH  
 GERMAN/GREEK/GUIANIAN/GYPSY/HAITIAN/HUNGARIAN  
 INDIAN/IRISH/ISRAELI/ITALIAN/JAPANESE/JEWISH/KOREAN  
 LATIN AMERICAN/LITHUANIAN/MEXICAN/POLISH/PORTUGUESE  
 ROUMANIAN/RUSSIAN/SCOTTISH/SPANISH/TURKISH  
 UKRAINIAN/WEST INDIAN/YIDDISH/YUGOSLAVIAN  
 artists . . . and many more to come  
 Distribution for Some Countries Still Available  
**REQUEST RECORDS** 66 Mechanic Street, New Rochelle, N. Y. 10801  
 Telephone 914 633-6055, 914 633-6059

## VERMONT

- **ST. JOHNSBURY (Area Code 802)**  
 St. Johnsbury Rec. Dists. Inc., PO Box 248, Zip: 05819. Tel: 748-8150. Owner & Buyer: Loren D. Phelps; Mgr.: Keith A. Phelps. (RJ).
- **SOUTH BURLINGTON (Area Code 802)**  
 Almor Playtime Co. Inc., Dorset St. Zip: 05401. Tel: 864-4087. Mgr.: Ray Baron. (D, OS & RJ).  
**Home office:** Amsterdam, N.Y. (see for prod. distributed).

## VIRGINIA

- **FALLS CHURCH (Area Code 703)**  
 Giant Music Whslers., 133 S. Washington St. Zip: 22046. Tel: 532-3773. Owner: Jack Shaver; Mgr. & Buyers: Skip Blackburn. (OS).
- **McLEAN (Area Code 703)**  
 Dance Recs., 7915 Lewinsville Rd. Zip: 22101. Tel: 356-9113. Owners & Mgrs.: Dick & Sheila Mason. (D, I & E).  
**Cartridge 8-tr. & open reel:** Roper.  
**Imports:** Philips (West Germany), Pye (UK).  
**Exports:** Pre-recorded tape.
- **RICHMOND (Area Code 703)**  
 Arthur Fulmer, 2911 W. Moore St. Zip: 23230. Tel: 355-7933. Mgr.: Stuart Dillenger. (D & I).  
**Home office:** Memphis, Tenn. (see for prod. distributed).  
 Dean's One Stop Ltd., 214 E. Main St. Zip: 23219. Tel: 648-0169. Owner & Buyer: G. Dean Hogue; Mgr.: Robert Marshall. (OS & RJ).  
 Liberty/UA Dist'g Corp.—Richmond Branch, 2111 Spencer Rd. Zip: 23230. Tel: 288-3053. Mgr.: Adam Strickland. (D).  
**Cartridge 8-tr.:** Liberty, United Artists, Sunset.  
**Cartridge 4-tr. & cassette:** Liberty, United Artists.  
 Meridian Electronics Inc., 1001 W. Broad St. Zip: 23220. Tel: 355-6521. Mgr. & Buyer: Abraham J. Dere. (D, OS & RJ).  
**Cartridge 8-tr.:** Ampex, Capitol, Columbia, Decca, GRT, ITCC, Liberty, United Artists.  
**Cassette:** Same as 8-tr. excluding Ampex.  
**Playback equip.:** Capitol, Channel Master, Mayfair, Sony.  
**Accessories:** Recoton, Robins.  
 Mollen Bros. Inc., 2727 W. Broad St. Zip: 23230. Tel: 353-4477. Owners: A. N. & Alfred Mollen; Mgr.: Alfred Mollen; Buyer: Brent Lovren. (D).  
**Cartridge 8-tr.:** All lines.  
**Cassette:** Capitol, Orbit, RCA, Scepter.  
**Playback equip.:** Cartable, Lear Jet, Norelco.  
**Accessories:** Recoton.  
 Pat's One Stop (div. of Entertainment Inc.), PO Box 2219. Zip: 23217. Tel: MI 8-4791. Pres.: Pat Cohen. (OS & RJ).
- **ROANOKE (Area Code 703)**  
 Turner Candy Co., 516 Rorer Ave. SW. Zip: 24016. Tel: 342-0500. Owner: A. L. Turner Jr. (RJ).

## WASHINGTON

- **SEATTLE (Area Code 206)**  
 A B C Rec. & Tape Sales Corp. (div. of ABC Recs.), 729 S. Fidalgo St. Zip: 98055. Tel: RO 3-8600. Mgr.: Stan Sulman; Buyer: Guy Stewart. (D & RJ).  
**Branches:** Los Angeles, Calif. (OS & RJ); Denver, Colo. (OS & RJ); Atlanta, Ga. (OS & RJ); Chicago, Ill. (RJ); Des Moines, Iowa (OS & RJ); Kansas City, Mo. (OS & RJ); Pennsauken, N.J. (OS & RJ); New York, N.Y. (D); Providence, R.I. (RJ); Dallas, Tex. (RJ); Salt Lake City, Utah (D, OS & RJ).  
 Tex. (RJ); Salt Lake City, Utah (D, OS & RJ).  
**Cartridge 8-tr.:** A&M, Ampex, Atco, Atlantic, Brunswick, Coral, Decca, DGG, Elektra, Fantasy, GRT, ITCC, Liberty, Mercury, Motown, NAL, Original Sound, Paramount, Polydor, RCA, Reprise, Scepter, United Artists, Vanguard, Wand, Warner Bros.-Seven Arts.  
**Cartridge 4-tr.:** A&M, Ampex, Atco, Atlantic, Elektra, Fantasy, Liberty, Mercury, Motown, Muntz, Original Sound, RCA, Reprise, Scepter, United Artists, Vanguard, Wand, Warner Bros.-Seven Arts.  
**Cassette:** Same as 8-tr.  
**Open reel:** A&M, Ampex, Bell & Howell, Brunswick, Coral, DGG, Decca, Elektra, Fantasy, GRT, Motown, NAL, Original Sound, Paramount, Polydor, RCA, Reprise, Scepter, Vanguard, Wand, Warner Bros.-Seven Arts.  
**Playback equip.:** Belair, Belle Wood, Decca, Kraco, Tenna.  
**Accessories:** Head cleaners, storage cases, demagnetizers, cleaning kits (Le-Bo); storage cases (Amberg).  
 Capitol Recs. Dist'g Corp., 115 N. 85 St., Suite 230. Zip: 98103. Tel: 784-3066. (D).  
**Cartridge 8-tr. & cassette:** Capitol, Angel, Melodiya/Angel, Apple, Harvest, Fame.  
**Playback equip.:** Capitol.  
**Accessories:** Display racks, storage cases (Capitol).  
 Craig Corp., 540 S. Front St. Zip: 98108. Tel: 763-2450. Owner: Robert Craig; Mgr.: James Fuscaldo; Buyer: Richard A. Meston. (D).  
**Cartridge 8-tr.:** Columbia, Date, Epic, Okeh, Ode, Barnaby, Fillmore, Blue Horizon.  
**Cartridge 4-tr.:** Columbia, Date, Epic, Okeh, Ode, Blue Horizon.  
**Cassette:** Same as 8-tr.  
**Open reel:** Same as 4-tr.  
**Playback equip.:** Craig, Masterwork.  
**Accessories:** Blank loaded tape, storage cases (Columbia).  
 Disc City One Stop (Record Sales & Servs. Inc.), 410 Elliott Ave. W. Zip: 98119. Tel: AT 2-7555. Owner & Mgr.: Larry Dolgoff; Buyer: Norma Bigelow. (OS).  
 Fidelity Northwest Inc., 5301 Shilsole NW. Zip: 98107. Tel: 784-9100. Dist. Mgr.: Wallis J. Tolles; OS Mgr.: Lew Choate; Buyer: Mark Anderson. (D), (OS as Seattle One Stop; RJ as Washington Rec. Outlet).  
**Branch:** Portland, Ore., Sea-Port One Stop (OS & RJ).  
**Cartridge 8-tr. & cassette:** Ampex, ITCC, Mercury, RCA.  
**Playback equip.:** Tenna.  
 General Rec. Serv. Inc., 6565 Seventh Ave. S. Zip: 98108. Tel: RO 7-7444. Gen. Mgr. & Buyer: Paul H. Porteus. (RJ).  
 Major Dists., 620 Bright St. Zip: 98107. Tel: 789-1600. Mgr.: Robert Anderson; Buyer: Robert Gardner. (RJ).  
 Seattle Rec. One Stop (div. of Fidelity Northwest Inc.), 125 First Ave. N. Zip: 98109. Tel: 284-8990. Mgr.: Lew Choate (OS), (RJ as Washington Rec. outlet).  
**Home office:** Fidelity Northwest Inc. (D).  
 Tape-Tronics, 300 Elliott W. Zip: 98119. Tel: AT 4-4020. Owners: Jim McGuire, Lew Choate; Mgr. & Buyer: Lew Choate. (D, OS & RJ).  
**Cartridge 4-tr. & 8-tr.:** Capitol, GRT, ITCC.  
**Playback equip.:** Automatic Radio, Panasonic.  
 Transcontinental Dist'g Corp., 9860 40 Ave. S. Zip: 98118. Tel: 725-2500. Mgr.: Al Zangrillo. (D), (RJ as Transcontinental Music Corp.).  
**Home office:** New York, N.Y., Transcontinental Investing Corp.  
**Cartridge 8-tr. & cassette:** DBI.  
 Transcontinental Music Corp. (RJ), see Transcontinental Dist'g Corp.  
 Washington Rec. Outlet (RJ), see Seattle Rec. One Stop.

## WEST VIRGINIA

- **FRIENDLY (Area Code 304)**  
 Mobile Rec. Serv. Co., PO Box 67. Zip: 26146. Tel: 657-2748. (OS & RJ).  
**Home office:** Pittsburgh, Pa.

• **HUNTINGTON (Area Code 304)**

Music Man Inc., 803 Eighth Ave. Zip: 25701. Tel: 522-7551. Pres.: F. J. McGlynn; Mgr.: C. L. Blankenship; Buyer: Billy Simpson. (OS & RJ).

**WISCONSIN**

• **BROOKFIELD (Area Code 414)**

National Tape Dists. Inc., 3515 N. 124 St. Zip: 53005. Tel: 781-2200. Pres.: James J. Tiedjens. (Exec. office only).  
Exec. branch office: New York, N.Y.  
Branches: San Francisco, Calif., Melody Sales Co. Inc. (D & RJ); Torrance, Calif., United Tape Corp. (D & OS); Music Mdsrs. of America (RJ); Atlanta, Ga., Stereo South (D), Sound Mktg. (RJ); Linden, N.J., National Tape Dists. of New Jersey Inc. (RJ); Oklahoma City, Okla., B&K Dist'g Co. Inc. (D); Dallas, Tex., B&K Dist'g Co. Inc. (D & OS); Houston, Tex., Record Dist'g Co. Inc. (RJ); Milwaukee, Wis., National Tape Dists. Inc. (RJ).

• **BURLINGTON (Area Code 414)**

Music Mart, 164 E. Washington St. Zip: 53105. Tel: 763-3361. Pres.: Robert Ruedebusch. (OS).

• **EAU CLAIRE (Area Code 715)**

Arrow Racks, 1609 Laurel Ave. Zip: 54701. Tel: 832-2533. Owner: R.W. Meyer. (RJ).

• **MADISON (Area Code 312)**

Rapid Sales Co. Inc., 1019 Jonathon Dr. Zip: 53713. Tel: 271-2551. Owner: Rolf V. Voegelin; Buyer: Donald E. Smith. (D & RJ).  
Cartridge 4-tr., 8-tr., cassette & open reel: Ampex, Coral, Decca, Fontana, GRT, ITCC, Jubilee, Kapp, Mercury, NAL, Philips, Scepter, Smash, Vanguard, Wand.  
Playback equip.: Tenna.

• **MILWAUKEE (Area Code 414)**

Decca Dist. Corp., 325 E. Chicago St. Zip: 53202. Tel: 272-1086. Mgr.: Bob Blie. (D).  
Cartridge 8-tr.: Decca, Coral, Brunswick, Bravo, Viva, Berlitz, Colonial, Standard Phono.  
Cassette: Decca, Coral, Brunswick, Bravo, Viva.  
Open reel: Decca, Coral, Brunswick.  
Playback equip.: Decca.  
Accessories: Blank loaded tape, head cleaners, storage cases (Decca).

National Tape Dists. Inc., 530 N. 22 St. Zip: 53233. Tel: 342-3188. Pres. & Mgr.: James J. Tiedjens. (RJ).  
Home office: Brookfield, Wis.

John O'Brien Dist'g Inc., 5825 N. 96 St. Zip: 53225. Tel: 462-5590. Owner & Sales Mgr.: John F. O'Brien; Gen. Mgr.: Robert A. Hertzberg. (D).  
Cartridge 8-tr. & cassette: Atco, Atlantic, Cotillion, Motown group, Plantation, Sun.

Radio Doctors Inc., 240 W. Wells St. Zip: 53203. Tel: 276-6422. Owner: L. M. Glassman; Mgr.: Stuart L. Glassman. (OS). Branch: 2225 N. Third St. Zip: 53212. Tel: 562-7607. Mgr.: Michael Mowers. (OS).

Record City Inc. (div. of Taylor Electric Co.), PO Box 2359. Zip: 53212. Tel: 241-3970. Mgr.: Harold E. Rietz; Buyer: Gordon Pelzek. (OS & RJ).

Taylor Electric Co., 1000 Donges Bay Rd., Mequon 53092. Tel: 964-4321. Owner: James Taylor; Buyer: Vera Ugoretz. (D, OS & RJ). (Also OS & RJ as Record City Inc.).  
Branch: Chicago, Ill. (D).  
Cartridge 8-tr.: Ampex, Columbia, Decca, Epic, GRT, ITCC, Liberty, MGM, Mercury, Motown, NAL, Pickwick, RCA.  
Cartridge 4-tr.: Ampex, Columbia, Epic, ITCC, Liberty, MGM, Motown, NAL, Pickwick.  
Cassette: Ampex, Columbia, Decca, Epic, GRT, Liberty, Mercury, Motown, Pickwick, RCA.  
Open reel: Ampex, Columbia, Decca, Bell & Howell, GRT, RCA.  
Playback equip.: Belle Wood, RCA.  
Accessories: Amberg, Channel Mktg., Le-Bo, Specialty Sounds.

• **RACINE (Area Code 414)**

Soulville, 507 Main St. Zip: 53403. Tel: 634-9633. Owner: John Huennekens; Mgr. & Buyer: Bob Huennekens. (OS & RJ).

• **WAUSAU (Area Code 715)**

B M I Music Dists., 229 Third St. Zip: 54401. Tel: 842-3995. Owner & Buyer: Robert Peyovich. (D, OS & RJ).  
Cartridge 8-tr. & cassette: Atco, Atlantic, Elektra, GRT, Gordy, ITCC, Liberty, London, Mala, Motown, RCA, Reprise, Stax, United Artists, Volt, Warner Bros.-Seven Arts.  
Playback equip.: Belair, Hitachi, Qatron, Telex, Tenna.  
Accessories: Amberg, GC Electronics, Le-Bo.

# Compare Our Prices On

## TAPE — 8 TRACK CARTRIDGES — CASSETTES

### LOADING MACHINES

Call (Area Code 212) 257-3355 for Quotes

We Offer Top Quality—Fast Delivery—and Highly Competitive Prices

Dict-O-Tape is an important trade source for top quality cassette and cartridge components and finished goods. We suggest that before you buy again you get our prices on the following items:

**TAPE**—blank reel-to-reel tape

**CASSETTES**—blank cassettes—pre-leadered cassettes—cassette parts—cassette tape—cassette albums

**8 TRACK**—blank cartridges—parts—lubricated tape

**LOADING MACHINERY**—8-track and cassette loading machines

**ACCESSORIES**—3-pack cassette albums, and others



9090 Krier Place

Brooklyn, N.Y. 11236



## HUNTING FOR THAT HARD-TO-FIND INFORMATION?

BUYER'S GUIDE makes it  
easy-to-find for everyone.

# TAPE SERVICES

## CUSTOM DUPLICATION

### ALABAMA

#### • BIRMINGHAM (Area Code 205)

New London Rec'g Center, 1817 Oxmoor Rd. Zip: 35209. Tel: 871-4221. Mgr.: Randy Richards. Configurations: Cartridge 8-tr. & open reel.

#### • MOBILE (Area Code 205)

Channel 1 Prod'ns, 1061 Elmira St. Zip: 36604. Tel: 432-4845. Owner: Lee A. Pistole Jr.; Mgr.: Sexton Kari. Configuration: Open reel.

### ARIZONA

#### • PHOENIX (Area Code 602)

Audio Rec'rs of Arizona Inc., 3830 N. Seventh St. Zip: 85014. Tel: 277-4723. Owner & Mgr.: Floyd M. Ramsey. Configurations: Cassette & open reel.  
General Cassette Corp., 1324 N. 22 Ave. Zip: 85009. Tel: 258-7059. Pres.: Herbert J. Miller; VP & Gen. Mgr.: Edward L. Martin. Configurations: Cartridge 4-tr., 8-tr., cassette & open reel.

### ARKANSAS

#### • LITTLE ROCK (Area Code 501)

Jaggars Audio Prod'ns, 1804 S. Johnson St. Zip: 72204. Tel: 663-4275. Owner & Mgr.: S. J. Jaggars. Configurations: Cartridge 8-tr., cassette & open reel.

### CALIFORNIA

#### • ANAHEIM (Area Code 714)

Certron Corp., 1701 S. State College Blvd. Zip: 92806. Tel: 633-4280. Pres.: Edwin Gamson; Sales Mgr.: James Neiger. Configurations: Cartridge 4-tr., 8-tr., cassette & open reel.

#### • EL CAJON (Area Code 714)

Fanfare Rec'g Studios, 120 E. Main St. Zip: 92020. Tel: 447-2555. Owner: Ronald L. Compton. Configuration: Open reel.

#### • GARDEN GROVE (Area Code 714)

Telaudio Centre, 9929 Chapman Ave. Zip: 92641. Tel: 530-5108. Owner: Oliver Berliner; Mgr.: John Olson. Configurations: Cassette & open reel.

#### • LOS ANGELES METROPOLITAN AREA (Area Code 213)

A T D (American Tape Dupl'rs Inc.), 5727 W. Jefferson Blvd. Zip: 90016. Tel: 870-6832. Pres.: Richard Allen; Exec. VP: Warren D. Gray; VP Sales & Mktg.: Jay Lease. Configurations: Cartridge 4-tr., 8-tr., cassette & open reel.  
Abbey Tape Dupl'rs, 737 N. Seward St., Hollywood 90038. Tel: 464-4554. Owner & Mgr.: Norman C. Cooke. Configurations: Cartridge 4-tr., 8-tr., cassette & open reel.  
Able Turntable & Tape, 6912 Hollywood Blvd., Hollywood 90028. Tel: 466-8338. Owners: Ted Gardner, Mike Dutton; Mgr.: Mike Dutton. Configurations: Cassette & open reel.  
Advance Recs., 6376 Yucca St., Hollywood 90028. Tel: 463-2151. Pres.: Tim Gayle; Gen. Mgr.: Morry Perrigo. Configurations: Cartridge 4-tr., 8-tr., cassette & open reel.  
Alto Fonic Programming Inc., 6362 Hollywood Blvd., Hollywood 90028. Tel: 466-9261. Gen. Mgr.: Lee Tate. Configurations: Cartridge 4-tr. & open reel.  
Audio Physics Inc., 16449 Vanowen St., Van Nuys, 91406. Tel: 782-3638. Pres.: Don Washbrook; Gen. Mgr.: John David. Configurations: Cartridge 4-tr., 8-tr. & cassette.  
Bible Voice Inc., PO Box 3521, Van Nuys 91406. Tel: 781-2900. Pres.: George Otis II; Gen. Mgr.: David J. Keklikian. Configurations: Cassette & open reel.  
Ted Brinson's Rec'gs, 1900 Fifth Ave. Zip: 90018. Tel: 737-9008. Owner & Mgr.: Ted Brinson. Configurations: Cartridge 4-tr. & open reel.  
Budget Tape Cartridge Mfg. Co., 2035-37 S. La Brea Ave. Zip: 90016. Tel: 933-5867. Pres. & Sales Mgr.: Don Macmillan. Configurations: Cartridge 8-tr. & cassette.  
Capitol Recs. Dist'g Corp., 1750 N. Vine St., Hollywood 90028. Tel: 462-6252. Mgr.: Pete Dent. Configurations: Cartridge 8-tr. & cassette.  
Columbia Rec. Prod'ns, 6430 Sunset Blvd., Hollywood 90028. Tel: 466-2481. Contact: Mike Coolidge.  
Communications Inc., 626 S. Hudson Ave. Zip: 90005. Tel: WE 1-6111. Pres.: G. David Schine. Configurations: Cartridge 4-tr., 8-tr., cassette & open reel.  
Creative Sound, 9000 Sunset Blvd. Zip: 90069. Tel: 271-4843. Pres.: Robert C. Cotterell; Gen. Mgr.: Maritha Roche. Configuration: Cassette.  
Custom Fidelity Inc., 7925 Santa Monica Blvd., Hollywood 90046. Tel: 654-4522. Pres.: David W. Berkus; Mgr.: Michael Levey. Configurations: Cassette & open reel.  
Film City Studios, 6087 Sunset Blvd., Hollywood 90028. Tel: 462-9539. Owner & Gen. Mgr.: John S. MacQuarrie. Configuration: Open reel.

I D Sound Studios, 1556 N. La Brea Ave., Hollywood 90028. Tel: 462-6477. Owner: Ivan Fisher; Mgr.: Dawn Fisher. Configuration: Open reel.

Livingston Audio Prods. Corp., 10687 Santa Monica Blvd., West Los Angeles 90025. Tel: 474-4559. Mgr.: John Anderson. Home office: Fairfield, N.J. Configurations: Cartridge 4-tr., 8-tr., cassette & open reel.

Location Rec'g Servs., 2201 W. Burbank Blvd., Burbank 91506. Tel: 849-1321. Pres.: Allen J. Fraiberg; Gen. Mgr.: Steven A. Guy. Configurations: Cassette & open reel.

Magtec (Magnetic Tape Eng'g Corp.), 8120 Webb Ave., North Hollywood 91605. Tel: 875-1707. Pres.: S. Gerald Stone; Exec. VP & Gen. Mgr.: Kenneth S. Goates. Configurations: Cartridge 4-tr., 8-tr., cassette & open reel.

Modern Tape Corp., 5810 S. Normandie Ave., Zip: 90044. Tel: 753-2481. Pres.: Joe Bihari; VP: Bob Demain. Configurations: Cartridge 4-tr., 8-tr., cassette & open reel.

Monarch Tape Dupl'g, 3416-20 Vineyard Ave. Zip: 90016. Tel: 731-2228. Gen. Mgr.: Nathan Du-Roff. Configurations: Cartridge 4-tr., 8-tr., cassette & open reel.

R C A Recs. Rec'g Studio, 6363 Sunset Blvd., Hollywood 90028. Tel: HO 1-9171. Mgr.: C. Pruzansky. Configurations: Cartridge 4-tr., 8-tr., cassette & open reel.

Radio Rec'rs (div. of EMC Corp.), 7000 Santa Monica Blvd., Hollywood 90038. Tel: 463-3282. VP & Gen. Mgr.: Jerome Greenfield. Configurations: Cassette & open reel.

Stereo Cartape, 6734 Sunset Blvd., Hollywood 90028. Tel: HO 2-8888. Owner: S. M. Gordon; Mgr.: Barry Wosk. Configurations: Cartridge 4-tr., 8-tr., cassette & open reel.

Sunset Sound Rec'rs, 6650 Sunset Blvd., Hollywood 90028. Tel: 469-1186. Owner: T. Camarata; Mgr.: William L. Robinson. Configurations: Cartridge 4-tr., 8-tr., cassette & open reel.

Superscope Rec'd Tape Div., 455 Fox St., San Fernando 91340. Tel: 365-1191. Pres.: Joseph S. Tushinsky; Gen. Mgr.: Richard L. Stover. Configurations: Cartridge 8-tr., cassette & open reel.

T D K Electronics Corp., 6151 W. Century Blvd. Zip: 90045. Tel: OR 0-5515. Home office: New York, N.Y. Configuration: Cassette.

Whitney Rec'g Studio Inc., 1516 W. Glenoaks Blvd., Glendale 91201. Tel: 245-6801. Owners & Mgrs.: Mr. & Mrs. Lorin J. Whitney. Configurations: Cassette & open reel.

*continued on page 88*

# No one can duplicate

Telex's new reel-to-cassette-to-cassette-to-cassette-to-cassette-to-cassette-to-cassette-to-cassette-to-cassette duplicator.

**PRODUCTIVITY.** Up to 126 C-30 cassettes per hour.

**QUALITY.** Two speed hysteresis synchronous drive. 30-10,000 Hz  $\pm 3$ dB at  $1\frac{7}{8}$  ips playback. Crosstalk rejection 45dB or better. Singal-to-noise within 3dB of master. Flutter and wow less than 0.24% rms. Bias frequency 300 kHz. Made in U.S.

**FLEXIBILITY.** Half track or quarter track. Single channel,

dual channel and four channel simultaneous configurations can be mixed in a single system. Front panel equalization switching. Solid state plug-in electronics. Slaves also fit open-reel duplicator models 235.

**ECONOMY.** Basic three slave systems from \$1,860. And for a nominal cost, slave modules may be added to create a six or nine slave system without modifications or additional amplifiers.

For more information, contact James R. Dow

PRODUCTS OF SOUND RESEARCH  
**TELEX**<sup>®</sup>  
COMMUNICATIONS DIVISION  
9600 Aldrich Avenue South  
Minneapolis, Minnesota 55420

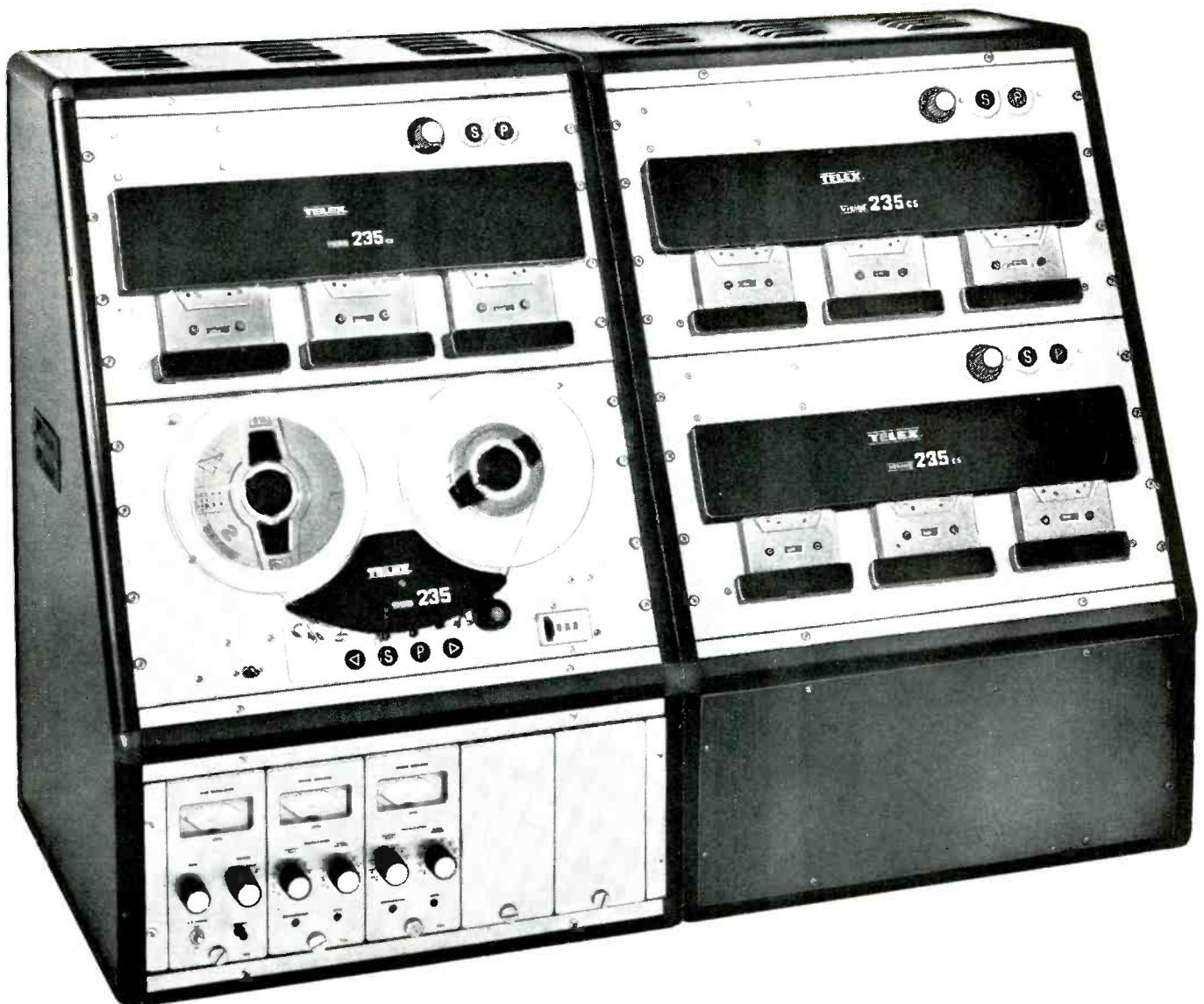

## TAPE SUPPLIES

Continued from page 86

- **LOS GATOS (Area Code 408)**  
Make-A-Tape, 131 W. Main St., No. 2. Zip: 95030. Tel: 354-4595. Owners: Michael P. Papp, Louis Chiaramonte.  
Configurations: Cartridge 4-tr., 8-tr., cassette & open reel.
- **SACRAMENTO (Area Code 916)**  
Brandt's Rec'g Studios, 1030 48 St. Zip: 95819. Tel: 451-3400. Owners: C. M. & E. A. Brandt; Mgr.: Charles M. Brandt.  
Configurations: Cartridge 4-tr., cassette & open reel.
- Bill Rase Rec'g Studio, 2904 Franklin Blvd. Zip: 95818. Tel: 452-4266. Owner & Mgr.: Bill Rase.  
Configurations: Cartridge 8-tr., cassette & open reel.
- **SAN FRANCISCO & BAY AREA (Area Code 415)**  
Action Rec'g Co., 2207 El Camino Real, San Mateo 94403. Tel: 341-1500. Mgr.: Fred F. Cohn.  
Configurations: Cartridge 4-tr., cassette & open reel.
- Coast Rec'rs Inc. (div. of United Rec'g), 829 Folsom St. Zip: 94107. Tel: 397-7676. Gen. Mgr.: Mel Ryan.  
Configuration: Open reel.
- Gambit Ent's., 690 Monterey Blvd. Zip: 94127. Tel: 587-3111. Owner: Bruce C. Grant.  
Configurations: Cartridge 8-tr., cassette & open reel.
- Golden State Rec'rs Inc., 665 Harrison St. Zip: 94107. Tel: 781-6306. Owners: Leo de Gar Kulka, Herb Haas; Mgr.: Herb Haas.  
Configurations: Cartridge 4-tr., 8-tr., cassette & open reel.
- McCune Sound Studios, 915 Howard St. Zip: 94103. Tel: 433-0850. Owner: Harry D. McCune; Mgr.: Don C. Geis.  
Configurations: Cassette & open reel.
- Newcomb Rec'g Studio, 4834 Bissell Ave., Richmond 94805. Tel: 233-7487. Owner & Mgr.: William S. Newcomb.  
Configurations: Cartridge 4-tr., cassette & open reel.
- Sonic Arts Corp., 665 Harrison St. Zip: 94107. Tel: 781-6306. Pres.: Leo de Gar Kulka; Exec. VP: Herbert P. Haas; Nat'l Sales Mgr.: Dale W. Roe.

- Configurations: Cassette & open reel.  
Studio 10, 10 Claude Ln. Zip: 94108. Tel: 986-9949. Owner & Mgr.: Tom Press.  
Configurations: Cartridge 4-tr., 8-tr., cassette & open reel.
- **SAUGUS (Area Code 213)**  
Keysor-Century Corp., 26000 Springbrook Rd. Zip: 91350. Tel: 365-3991. Pres.: Richard Keysor; Gen. Mgr.: A. P. McGuire.  
Configurations: Cartridge 8-tr., cassette & open reel.
- **SUNNYVALE (Area Code 408)**  
G R T Corp., 1286 Lawrence Station Rd. Zip: 94086. Tel: 734-2910. Pres.: Alan J. Bayley; Mktg. Dir.: Ronald Rader; Mktg. Mgr.: Chris Coburn.  
Configurations: Cartridge 8-tr., cassette & open reel.
- **SUN VALLEY (Area Code 213)**  
Superscope Inc., 8150 Vineland Ave. Zip: 91352. Tel: 767-9780. Pres.: Joseph Tushinsky; Sales Mgr.: Paul Markoff.  
Configurations: Cartridge 8-tr., cassette & open reel.

## COLORADO

- **DENVER (Area Code 303)**  
Fred Arthur Prod'ns, 1218 E. 18 St. Zip: 80218. Tel: 255-4686. Owner & Mgr.: Fred Arthur.  
Configurations: Cartridge 4-tr. & open reel.
- Century Recs., 995 S. Clermont. Zip: 80222. Tel: 757-3377. Pres.: Jack H. Dunham.  
Configurations: Cartridge 4-tr., 8-tr., cassette & open reel.
- Jackson Sound Prod'ns, 1401-1403 S. Lipan. Zip: 80223. Tel: 722-7019. Owner: Joseph J. Jackson; Mgr.: Mark Damerst.  
Configurations: Cartridge 4-tr., cassette & open reel.
- Summit, 1130 W. Evans. Zip: 80223. Tel: 936-7405. Owners: Preston Smith, Jay Salam; Mgr.: Preston Smith.  
Configurations: Cartridge 4-tr. & cassette.
- Western Cine Serv. Inc., 312 S. Pearl St. Zip: 80209. Tel: 744-1017. VP: Herman Urschel; Mgr.: Harry Landon.  
Configuration: Open reel.

## CONNECTICUT

- **HAMDEN (Area Code 203)**  
Sleeping Giant Films Inc. (div of SGF Inc.), 3019 Dixwell Ave. Zip: 06518. Tel: 248-9323. VP

- Prod'n: Anthony Guarino Jr.; Mgr.: Gordon Johnson.  
Configurations: Cassette & open reel.
- **HARTFORD (Area Code 203)**  
Sound-Art Studios Inc., 135 Day St. Newington 06111. Tel: 522-7253. Owner: Arthur L. Annetcharico; Gen. Mgr.: Paul J. Gregory.  
Configurations: Cartridge 8-tr., cassette & open reel.
- **STAMFORD (Area Code 203)**  
Cook Labs. Inc., 351 Courtland Ave. Zip: 06906. Tel: 348-7578. Pres.: Emory Cook; Sales Mgr.: John R. Moriarty.  
Configuration: Cassette.
- **WATERBURY (Area Code 203)**  
Infodex Cassette Corp., 7 Cherry Ave. Zip: 06702. Tel: 757-9291. Pres.: Roger S. Swain; Gen. Mgr.: John W. Berry.  
Configurations: Cartridge 8-tr. & cassette.

## DELAWARE

- **WILMINGTON (Area Code 302)**  
Ken-Del Prod'ns Inc., 111 Valley Rd., Richardson Park. Zip: 19804. Tel: 655-7488. Pres.: H. Edwin Kennedy; Gen. Mgr.: M. Leap.  
Configurations: Cartridge 4-tr., 8-tr., cassette & open reel.

## DISTRICT OF COLUMBIA

- **WASHINGTON (Area Code 202)**  
(Also see listings under Baltimore, Md.)  
Lion Rec'g Servs. Inc., 1905 Fairview Ave. NE. Zip: 20002. Tel: 832-7885. Pres. & Mgr.: Harold H. Lion.  
Configurations: Cassette & open reel.
- Tri Con Prod'ns Inc., 2741 34 St. NW. Zip: 20008. Tel: 333-7474. Owner: Jules M. Damian; Mgr.: R. N. Rollison Jr.  
Configurations: Cartridge 8-tr., cassette & open reel.

## FLORIDA

- **FORT LAUDERDALE (Area Code 305)**  
Audio Adv. Prod'ns (AAP), 790 NE 45 St. Zip: 33308. Tel: 564-5008. Mgr.: Jerry Musgrove.  
Configurations: Cassette & open reel.
- The Smith Studio, 3141 SW 22 Ct. Zip: 33312. Tel: 581-7300. Owner: Fletcher Smith.  
Configurations: Cartridge 4-tr., 8-tr., cassette & open reel.

continued on page 90

# SERVICE QUALITY ECONOMY

For information on  
8-track cartridges,  
cassettes and  
reel-to-reel duplication,  
contact:

# CRP

COLUMBIA RECORD PRODUCTIONS  
A Custom Service of CBS Records

New York/212/765-4321  
Hollywood/213/466-2481  
Chicago/312/944-6000  
Nashville/615/255-0371



# 46 of the world's leading Tape Duplicating Companies can't be wrong.

## Each uses the Gauss 32:1 ratio system.

The basic Series 1200 System consists of a Model 1260 Loop Bin, Model 1210 Master Reproducer, and a Model 1220 Slave Recorder. Each slave in the system will produce 100 C-30 cassettes per hour at the standard Gauss 32:1 duplication ratio. The master tape is reproduced at 240 ips and the duplicate copies are of peerless fidelity.

Slaves are easily and quickly convertible to any tape format i.e., 8 and 4 track cartridge, 4 track / 2 track / full track reels, Phillips cassettes and any other future formats. There is no obsolescence in a Gauss 1200 System.

Because of the 32:1 ratio, the Series 1200 System requires 1/2 or 1/4 the number of slaves of any other system, thereby reducing maintenance time and requiring much less floor space for a given production capacity. The Gauss System is easily expanded to produce millions of copies by simply adding more slave recorders — up to 20 per master reproducer.

#### CHECK THESE GAUSS FEATURES:

Gauss Patented Focused-Gap Recording Process □ Duplication at Ratios of 32:1, 16:1 or 8:1 □ Easy Threading Tape Path □ Dual Capstan Closed Loop Tape Drive □ Servo Controlled Tape Tensions □ Hi-Reliability Solid State Circuitry Throughout □ Modular Plug-in Heads and Electronics □ Swing-up Transports for Easy Maintenance □ Free Factory 5-Day Training Course □ Every installation is visited at least once every 6 months by a Gauss Engineer — No Charge. □ 1 year warranty on all components □ 2 year warranty on all Heads (Prorated wear)



### gauss electrophysics

1649-53 12th street, santa monica, california 90404 u.s.a.

telephone: 213/451-8611 cable: gauss santa monica

a division of mca technology inc. an mca inc. company.

#### These world leaders use the Gauss Series 1200 System

Capitol Records,  
Los Angeles, California  
Certron Corporation,  
Anaheim, California  
Decca Records,  
Los Angeles, California  
Memorex Corporation,  
Santa Clara, California  
Superscope,  
Sun Valley, California  
United Controls, Data Division,  
El Monte, California  
Capitol Records,  
Jacksonville, Illinois

Viatron,  
Burlington, Massachusetts  
American Sound Corporation,  
Warren, Michigan  
3M Company,  
St. Paul, Minnesota  
Audio Communications,  
Dover, New Jersey  
Cinematape,  
Englewood, New Jersey  
National Tape Service,  
West Caldwell, New Jersey  
Allison Audio Corporation,  
Hauptpage, L.I., New York

Decca Records,  
Gloversville, New York  
National Recording,  
New York, New York  
Plastics Products,  
Memphis, Tennessee  
Capitol Records,  
Winchester, Virginia  
EMI Australia, Ltd.,  
Sydney, Australia  
Diims Consolidated, Ltd.,  
St. Peters, Australia  
Cinram Corporation,  
Montreal, Canada

Compo Records,  
Cornwall, Canada  
Decca Records,  
London, England  
EMI Records,  
Hayes, England  
Tempo Tape,  
London, England  
Deutsche Grammophon, GmbH,  
Hannover, Germany  
EMI-Europa (Electrola),  
Köln-Braunsfeld, Germany  
ITP Tonband-Produktions-KG,  
Berlin, Germany

Sono Press Rheinhard-Mohn (Ariola),  
Gutersloh, Germany  
General Recording Sound,  
Milano, Italy  
RCA, S.P.A.,  
Roma, Italy  
Hitachi Maxell, Ltd.,  
Kyoto, Japan  
Sony Corporation,  
Tokyo, Japan  
TDK Electronics,  
Tokyo, Japan  
Toshiba Musical Industries,  
Tokyo, Japan

Toyo Kasei,  
Yokohama, Japan  
EMI Records, S.E. Asia,  
Singapore, Malasia  
Discos Musart, S.A.,  
Mexico, D.F., Mexico  
Philips' Phonographische Industrie,  
Baarn, Netherlands  
Roger Arnhoff — Lydstudio  
Oslo, Norway  
Werner Weber,  
Zurich, Switzerland  
Plus 11 ve more systems to be  
installed in April 1970

GET IN ON THE ACTION — See the world's finest Cassette Duplicating System in action at the Los Angeles AES Convention, May 4-7 at the Statter Hilton Hotel.

## TAPE SUPPLIES

Continued from page 88

### ● JACKSONVILLE (Area Code 904)

Norm Vincent Assocs. Inc., 4551 Brown Ave. Zip: 32207. Tel: 396-2529. Owner: Norman F. Vincent; VP & Mgr.: James W. Sutton. Configurations: Cassette & open reel.

### ● MIAMI METROPOLITAN AREA (Area Code 305)

Adrian Assocs. Inc., 6660 Biscayne Blvd. Zip: 33138. Tel: 757-1626. Owner: Michael Adrian; Mgr.: Gene Sayet. Configurations: Cartridge 4-tr., 8-tr., cassette & open reel.

Ben-Scott Rec'g, 6123 SW 6B St., South Miami 33143. Tel: 665-0431. Pres.: Murry Woroner; Mgr.: Frank Linale. Configurations: Cartridge 4-tr. & open reel.

Cinemasound Inc., 1755 NE 149 St. Zip: 33161. Tel: 947-5611, 949-8611. Owner: Grant H. Gravitt, M. L. Emerman; Mgr.: Grant H. Gravitt. Configurations: Cartridge 4-tr., 8-tr., cassette & open reel.

Criteria Rec'g Co., 1755 NE 149 St. Zip: 33161. Tel: 947-5611. Owner: M. L. Emerman; Mgr.: Edith L. Murphy. Configurations: Cartridge 4-tr., 8-tr., cassette & open reel.

Tape Dupl'rs of Florida, 785 W. 83 St., Hialeah 33014. Tel: 822-7585. Pres. & Gen. Mgr.: Aldo Vazquez. Configurations: Cartridge 8-tr. & cassette.

Universal Rec'g & Dist. Corp., 170 W. 29 St., Hialeah 33010. Tel: 888-7411. Pres.: Matthew San Martin; Sales Mgr.: Frank Garcia. Configurations: Cartridge 8-tr. & cassette.

Voice Inc., 5810 W. Flagler St. Zip: 33144. Tel: 661-3164. Pres.: Jim Rowe. Configurations: Cartridge 8-tr., cassette & open reel.

● TAMPA (Area Code 813)  
All-Purpose Rec'g Studios (div. of Cabot Entertainment Cos.), 2223 S. Dale Mabry Hwy. Zip: 33609. Tel: 877-5704. Pres. & Mgr.: Gilbert A. Cabot. Configurations: Cartridge 4-tr., 8-tr., cassette & open reel.

● WINTER GARDEN (Area Code 305)  
Magnetix Corp., 770 W. Bay St. Zip: 32787. Tel: 656-4494. Pres.: John C. Lory; Gen. Mgr.: Stan Sides.

Configurations: Cartridge 4-tr., 8-tr., cassette & open reel.

### ● WINTER PARK (Area Code 305)

Bee Jay Rec'g Studios, Box T. Zip: 32789; 2500 Silver Star Rd. Zip: 32804. Tel: 293-1781. Owner: Eric T. Schabacker; Mgr.: James A. Katt. Configuration: Open reel.

## GEORGIA

### ● ATLANTA (Area Code 404)

Cartridge Control Corp., 2091 Faulkner Rd. NE. Zip: 30324. Tel: 633-4577. Pres.: R. D. Comstock; Gen. Mgr.: Bill Evans. Configurations: Cartridge 8-tr., cassette & open reel.

Doppler Ents. Inc. (div. of Doppler Corp.), 3720 Oakcliff Rd. NE. Zip: 30340. Tel: 451-4333. Pres.: Tom Wells; Mgr.: Beth Rowedder. Configuration: Open reel.

Kin-Tel Prod'ns & Sound Studios, 1200 Spring St. NW. Zip: 30309. Tel: 874-3668. Owner & Mgr.: Rod Kinder. Configurations: Cassette & open reel.

LeFevre Sound Corp., 1314 Ellsworth Industrial Dr. NW. Zip: 30318. Tel: 355-8680. Owners: Pierce & Meurice LeFevre; Gen. Mgr.: Meurice LeFevre. Configurations: Cartridge 8-tr., cassette & open reel.

Mark Educational Rec'gs Inc., 2543 Raintree Dr. NE. Zip: 30329. Tel: 636-0289. Mgr.: William D. Bailey Jr. Configurations: Cartridge 4-tr., 8-tr., cassette & open reel.

Recorder Corp., 3227 Cains Hill Pl. Zip: 30305. Tel: 237-7000. Pres.: Ron Matthews; Gen. Mgr.: Bill Hammontree. Configuration: Cassette.

● DEMOREST (Area Code 404)  
Ralph's Radio Music, PO Box 127. Zip: 30535. Tel: 723-3884. Owner: Ralph Raper; Mgr.: Bernice Raper. Configurations: Cartridge 8-tr. & open reel.

● FAIRMOUNT (Area Code 404)  
Jay-Cher Ents., PO Box 175. Zip: 30139. Tel: 337-2510. Pres.: John Carter. Configuration: Open reel.

● HONOLULU (Area Code 808)  
Commercial Rec'g Inc., 333 Cooke St. Zip: 96813. Tel: 536-5439, 537-4841. Pres.: Donn V. Tyler; Mgr.: Ken Hiller.

Configurations: Cartridge 8-tr., cassette & open reel.

Configurations: Cartridge 4-tr., 8-tr., cassette & open reel.

Configurations: Cartridge 8-tr., cassette & open reel.

Configurations: Cartridge 8-tr., cassette & open reel.

## ILLINOIS

### ● CHICAGO METROPOLITAN AREA (Area Code 312)

Agency Rec'g Studios Inc., 20 N. Wacker Dr. Zip: 60606. Tel: CE 6-3632. Owner & Mgr.: John G. Garamoni. Configuration: Open reel.

Alteen Rec'g Studios (div. of Alteen Rec. Corp.), 8208 Stony Island. Zip: 60617. Tel: 721-7300. Mgr.: August H. Jones. Configurations: Cartridge 4-tr., 8-tr. & cassette.

Ampex Corp., 2201 Lunt Ave., Elk Grove Village 60007. Tel: 439-8700. Pres.: William E. Roberts. Configurations: Cartridge 4-tr., 8-tr., cassette & open reel.

Balkan Rec'g Studio, 6917 W. Cermak Rd., Berwyn 60402. Tel: GU 4-6436. Owner & Mgr.: Slavko A. V. Hlad. Configurations: Cartridge 8-tr. & cassette.

Boulevard Rec'g Studios Inc., 632 N. Dearborn St. Zip: 60610. Tel: 944-2752. Owners: Hal & Eleanor Kaitchuck; Mgr.: Hal Kaitchuck. Configurations: Cassette & open reel.

Columbia Rec. Prod'ns, 630 N. McClurg Ct. Zip: 60611. Tel: WH 4-6000. Contact: Dick Hutter. Custom Audio-JPL Rec. Co., 1088 Sixth Ave., Des Plaines 60016. Tel: 299-0220. Pres. & Mgr.: Paul H. Luttgens. Configurations: Cassette & open reel.

Double Sixteen Co., PO Box 1616, 1028 College Ave., Wheaton 60187. Tel: 653-1616. Pres.: James W. Canon; Sales Mgr.: Thomas W. Canon. Configuration: Cassette.

Eight Track Rec'g Co., 664 N. Michigan. Zip: 60611. Tel: 664-4335. VP & Mgr.: James Cunningham. Configuration: Open reel.

International Rec'g Co., 1639 W. Evergreen. Zip: 60622. Tel: 227-2000. Pres.: Vern Ruvalds; VP & Gen. Mgr.: Jerome Man. Configurations: Cartridge 4-tr., 8-tr., cassette & open reel.

Kiderian Recs. Prod'ns Ltd., 4926 W. Gunnison St. Zip: 60630. Tel: 645-0861. Pres.: Ray Peck. Configurations: Cartridge 4-tr., 8-tr. & cassette.

Parliament Studio, 4005-07 W. Washington Blvd. Zip: 60624. Tel: 638-6851. Owner & Mgr.: E. S. Alexander. Configuration: Cartridge 8-tr.

Persuasion Systems, 15 E. Pearson St. Zip: 60611. Tel: 642-9840. Pres.: Arnold Midlash; Mgr.: Rudy Wright. Configurations: Cassette & open reel.

continued on page 92

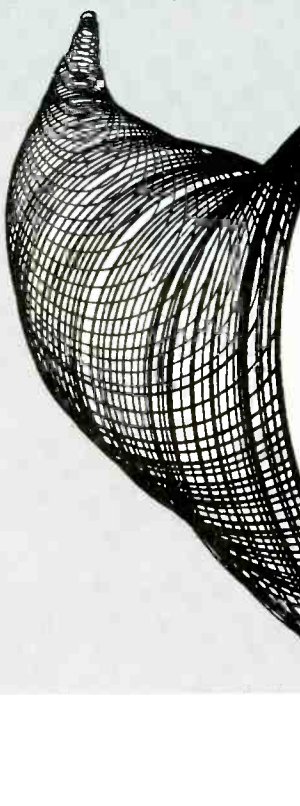

**THE COMPLETE TAPE  
DUPLICATOR—Mastering,  
Production, Quality Control,  
Warehousing, Inventory Control,  
Shipping, Graphics, Package Design,  
Printing** Complete one stop service designed  
to reproduce your masters on time with the  
minimum amount of work for you. Just  
place your order—send your master—we  
will do the rest.

750 E. MANDOLINE AVE.  
MADISON HEIGHTS, MICHIGAN 48071  
CALL COLLECT (313) 588-8281



from Brahms to the Beatles, perfect cassette performance  
time, after time, after time, after time, after time, after  
time, after time, after time, after time, after time, after  
time, after time, after time, after time, after time, after  
time, after time, after time, after time, after time, after  
time, after time, after time, after time, after time, after  
time, after time, after time, after time, after time, after  
time, after time, after time, after time, after time, after  
time, after time, after time, after time, after time, after  
time, after time, after time, after time, after time, after  
time, after time, after time, after time, after time, after  
time, after time, after time, after time, after time, after  
time, after time, after time, after time, after time, after  
time, after time, after time, after time, after time, after  
time, after time, after time, after time, after time, after

## TAPE SUPPLIES

Continued from page 90

- R C A Rec. Sales Inc., 1 N. Wacker Dr. Zip: 60606. Tel: 641-5880. Mgr.: W. F. Reilly. Configurations: Cartridge 8-tr., cassette & open reel.
- Sonic Film Rec'g Inc., 1230 W. Washington Blvd. Zip: 60607. Tel: 243-2600. Owner: Jack H. Lieb; Mgr.: Warren H. Lieb. Configurations: Cassette & open reel.
- Sound Studios Inc. (div. of Diversa-Graphics Inc.), 230 N. Michigan Ave. Zip: 60601. Tel: 236-4814. Pres.: Michael P. Eisenmenger; Mgr.: Larry Glick. Configurations: Cassette & open reel.
- Streeterville Studios Inc. (div. of Shield Prod'ns), 161 E. Grand. Zip: 60611. Tel: 644-1666. Mgr.: Preston Wakeland. Configurations: Cassette & open reel.
- T D K Electronics Corp., 2906 W. Peterson Ave. Zip: 60645. Tel: 973-1222. Pres.: Katsuro Kamiya; Gen. Mgr.: Kiyoshi Hiromoto. Home office: New York, N. Y. Configuration: Cassette.
- Ter-Mar Rec'g Studios (div. of Chess Prod'g Co., div. of GRT), 2030 S. Calumet. Zip: 60616. Tel: 225-2770. Mgr.: Ron Malo. Configurations: Cartridge 4-tr., 8-tr., cassette & open reel.
- Tono-Tape Inc., 57 W. Grand Ave. Zip: 60610. Tel: 642-6465. Pres.: A. B. Clapper; Gen. Mgr.: M. J. Snyder. Configurations: Cartridge 4-tr., 8-tr., cassette & open reel.
- Wright Rec'gs, 6460 N. Claremont. Zip: 60645. Tel: SH 3-6160. Owner & Mgr.: Spencer Wright. Configurations: Cartridge 4-tr., 8-tr., cassette & open reel.
- **URBANA (Area Code 217)**  
RoFran Ent's., 117 W. Washington. Zip: 61801. Tel: 367-9076. Owner & Mgr.: Roger Francisco. Configurations: Cartridge 4-tr., 8-tr., cassette & open reel.

### INDIANA

- **DAYTON (Area Code 317)**  
Jones & Assocs., PO Box 142. Zip: 47941. Tel: 447-4616. Owner & Mgr.: James D. Jones. Configurations: Cassette & open reel.
- **GARY (Area Code 219)**  
Bud Pressner Rec'g Serv., 4839 Broadway. Zip:

46409. Tel: 884-5214. Owner & Mgr.: Bud Pressner. Configurations: Cartridge 4-tr., cassette & open reel.

### • INDIANAPOLIS (Area Code 317)

Commercial Features Inc., 1411 N. Illinois St. Zip: 46202. Tel: 639-0134. Owners: Hal Jaynes, Paul Bender; Mgr.: Hal Jaynes. Configuration: Open reel.

Ohmit Rec'g Studio, 6102 E. 10 St. Zip: 46219. Tel: 356-9187. Owner & Mgr.: L. E. Ohmit. Configurations: Cassette & open reel.

### • SOUTH BEND (Area Code 219)

Thomas Zoss Prod'ns, 1255 E. Madison. Zip: 46624. Tel: 232-2804. Owner: N. A. Tompsett; Mgr.: Michael Chamberlin. Configuration: Cassette.

### IOWA

#### • COUNCIL BLUFFS (Area Code 712)

Moss Rec'g Serv., 708 W. Broadway. Zip: 51501. Tel: 322-4513. Owner: Terry L. Moss. Configuration: Open reel.

#### • DAVENPORT (Area Code 319)

Fredlo Rec'g Studios, 2224 E. 12 St. Zip: 52803. Tel: 326-2841. Owner: Frederick R. Mauck; Mgr.: Lois R. Mauck

#### • DES MOINES (Area Code 515)

Lariam Assocs. Inc., 515 28 St. Zip: 50312. Tel: 282-8306. Pres. & Gen. Mgr.: Larry A. McKeever. Configurations: Cassette & open reel.

### KANSAS

#### • EMPORIA (Area Code 316)

Webb Recs., 1234 Luther St. Zip: 66801. Tel: 342-7405. Owner: John Thomas Webb; Mgr.: Tom Webb. Configurations: Cartridge 4-tr., 8-tr. & open reel.

#### • WICHITA (Area Code 316)

High Fidelity Rec'g Inc., 1059 Porter. Zip: 67203. Tel: 262-6456. Mgr.: Raymond O. Creely. Configurations: Cartridge 4-tr., cassette & open reel.

### KENTUCKY

#### • LEXINGTON (Area Code 606)

Lemco Sound Studio, 2518 Southview Dr. Zip: 40503. Tel: 277-1184. Owner & Mgr.: Cecil Jones. Configurations: Cassette & open reel.

### • LOUISVILLE (Area Code 502)

Orbit Radio, PO Box 1644. Zip: 40201; 831 W. Main. Zip: 40202. Tel: 895-1143. Pres. & Mgr.: S. A. Cislser. Configurations: Cartridge 4-tr., 8-tr., cassette & open reel.

Samba Sound, 9912 Taylorsville Rd. Zip: 40299. Tel: 267-5466. Owners: Ray Allen, Hardy Martin; Mgr.: Ray Allen. Configurations: Cartridge 4-tr. & open reel.

### LOUISIANA

#### • BATON ROUGE (Area Code 504)

Ron Recs., PO Box 14602. Zip: 70808. Tel: 927-0119. Owner & Pres.: Ron Shaab. Configurations: Cartridge 4-tr., 8-tr. & cassette.

#### • NEW ORLEANS (Area Code 504)

Rosemont Rec'g Studio, 4634 Wilson Ave. Zip: 70126. Tel: 242-1581. Owner & Mgr.: Alfred E. Taylor. Configuration: Open reel.

#### • RUSTON (Area Code 318)

Americana Rec'g Studios (div. of Americana Business Ent's.), 707-709 W. California Ave. Zip: 71270. Tel: 255-0287. Configurations: Cartridge 4-tr., 8-tr., cassette & open reel.

### MARYLAND

#### • BALTIMORE METROPOLITAN AREA (Area Code 301)

(Also see listings under Washington, D. C.)

Accent Sound Ltd., 48 W. Biddle St. Zip: 21201. Tel: 727-4930. Owner: David C. Smith; Pres. & Mgr.: Anthony A. Smelgus. Configurations: Cartridge 4-tr., 8-tr., cassette & open reel.

Bradley Rec'g Co., 531 N. Howard St. Zip: 21201. Tel: 727-0950. Owner & Mgr.: J. Joseph Bradley. Configurations: Cassette & open reel.

International Telecomm Inc., PO Box 405, Cockeysville 21030. Tel: 666-7770. Pres.: F. J. Beste; VP & Sales Mgr.: Burgess Macneal Jr. Configurations: Cartridge 4-tr., cassette & open reel.

continued on page 94

# EVERY ONE A PERFECT COPY

We're making tracks in Arizona — every one a perfect duplication of the master. We put so much emphasis on quality you'd wonder where we find the time to give that rapid service you want. If you'd like to be perfectly satisfied with duplications of your finest master recordings, write or call our sales department. Tel. (602) 258-7059. 1324 N. 22nd. Ave., Phoenix, Arizona 85009.

## GENERAL CASSETTE CORPORATION

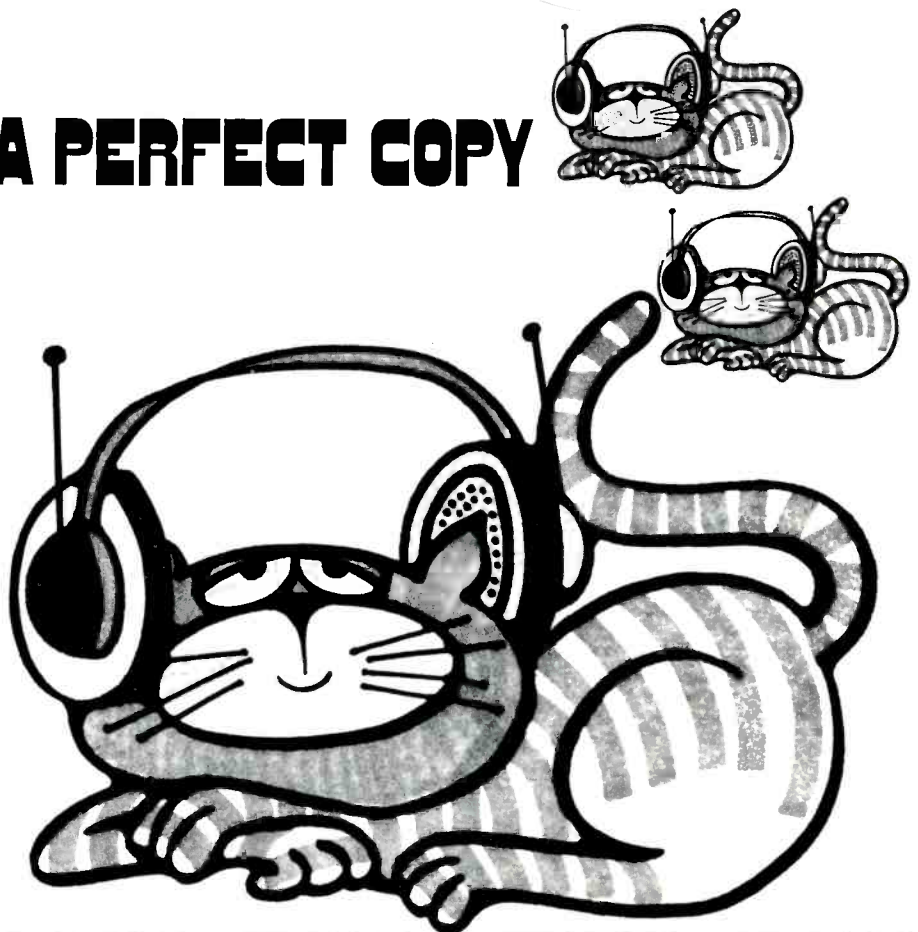
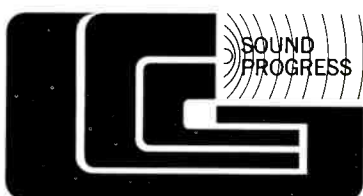

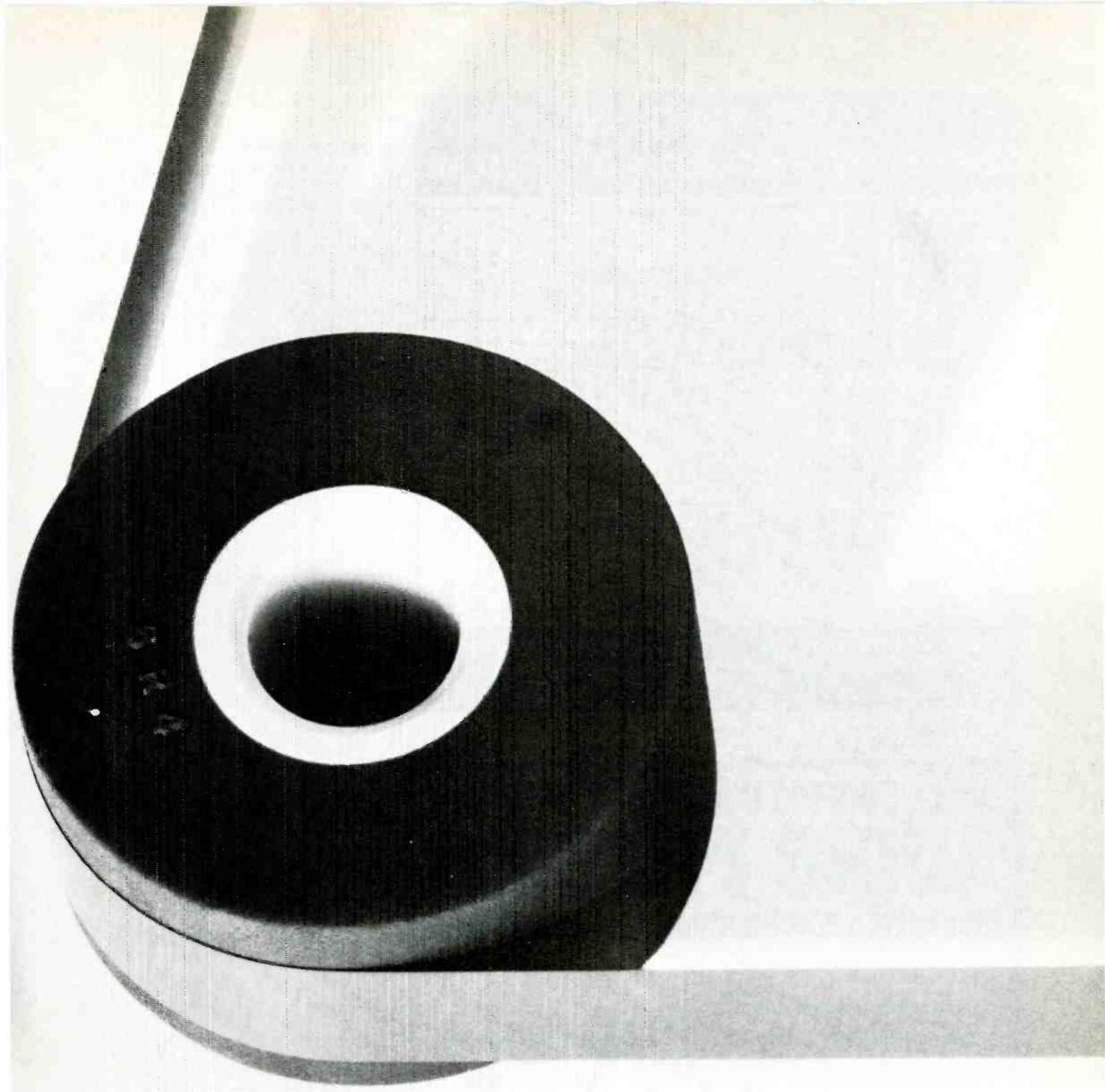

# Sound investment: silicone rubber pinch rollers

It doesn't pay to pinch pennies by using nonsilicone rubber pinch rollers in your stereo 8 cartridge units. Sacrifice proven performance reliability, and you'll soon get squeals from your distributors, dealers, and customers. Silicone rubber pinch rollers cost a bit more, but they've been proven more than worth it. They withstand temperature extremes better than any other material—and it can get pretty hot under a car dashboard. Silicone rubber pinch rollers won't stick or get flat spots, so tapes will run through smoothly without sound distortion.

Pinch rollers made of silicone rubber can help give your customers the kind of sound they're counting on. For more information, call or write our audio sound specialist, Jim Russell. He's tuned in. Dow Corning Corporation, Dept. A-9360, Midland, Michigan 48640.

*Silicone rubber from*

***DOW CORNING***

**DOW CORNING**

# ESPO-SUPERLINE CASSETTE PACKAGING SYSTEM

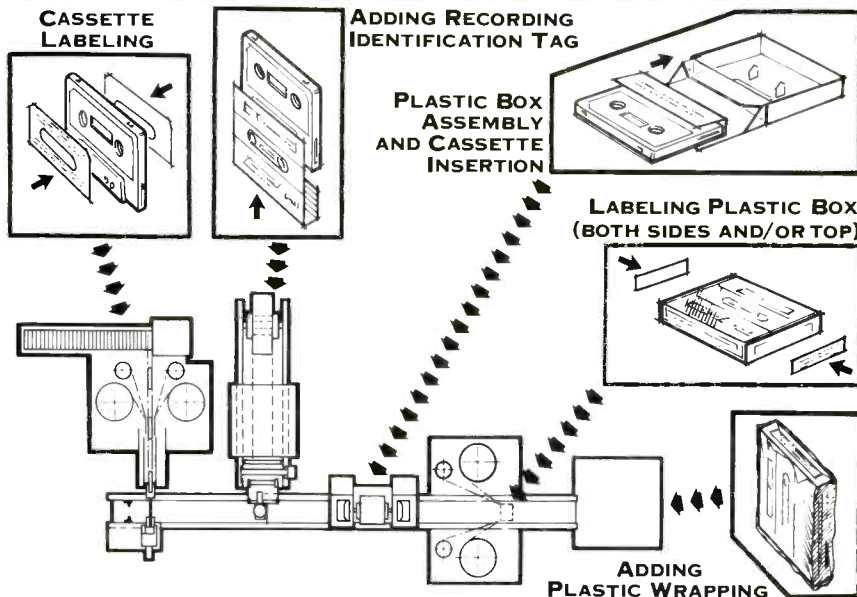

**AUTOMATION  
CONSULTANTS**  
ESPO ENGINEERING CORP.

5334 WEST 65TH STREET  
CHICAGO, ILLINOIS 60638  
PHONE (312) 581-0123

## We're Sharing Our Profits With You!

# AUDIO PHYSICS

## Magnetic Tape Duplicating & Packaging

Single, Two, Four &  
Eight Track Duplication

Reel to Reel, Cartridge & Cassette

Ampex Recorders & Gauss  
Duplicators

Complete Labeling & Packaging

Warehousing & Shipping

Cartridge Loading Service

For Complete Information  
Regarding Our Services  
Write:

### Audio Physics, Inc.

19320 Londelius Street  
Northridge, Calif. 91306  
(213) 885-0221

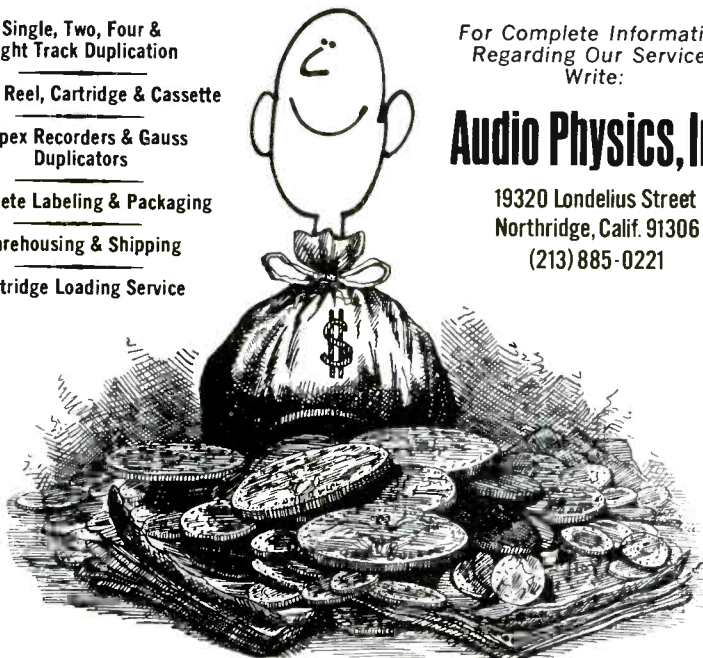

## TAPE SUPPLIES

Continued from page 94

### MASSACHUSETTS

- **BOSTON METROPOLITAN AREA** (Area Code 617)
  - Ace Rec'g Studios Inc., 1 Boylston Pl. Zip: 02116. Tel: 482-8580. Owners: Milton & Herbert Yakus; Studio Mgr.: Milton Yakus. Configurations: Cassette & open reel.
  - Continental Rec'gs Inc., 12 Irving St., Framingham 01701. Tel: 879-2430. Pres.: L. Daniel Flynn; Gen. Mgr.: John F. Flynn. Configurations: Cassette & open reel.
  - Data Packaging Corp., 205 Broadway, Cambridge 02139. Tel: 868-6200. Pres.: Otto Morningstar; VP: Larry A. Grunoy; Gen. Mgr.: William Stevens. Configurations: Cartridge 4-tr., 8-tr., cassette & open reel.
  - Fleetwood Rec'g Co. Inc., 321 Revere St., Revere 02151. Tel: 284-0750. Mgr.: Raymond G. Samora. Configurations: Cartridge 8-tr. & cassette.
  - Waverley Rec'g Studio, 24 Carroll St., Watertown 02172. Tel: 924-8555. Owner: Thomas G. Walters; Mgr.: Bobby Thayer. Configurations: Cartridge 4-tr., 8-tr., cassette & open reel.
- **HOLYOKE** (Area Code 413)
  - Century Rec'g, 2 Portland St. Zip: 01040. Tel: 533-3302. Owner & Mgr.: Earl Fortin. Configurations: Cassette & open reel.
  - W G Recs., 66 Elmwood Ave. Zip: 01040. Tel: 536-1793. Owner & Mgr.: Walter J. Gonet Jr. Configurations: Cartridge 8-tr., cassette & open reel.
- **WEST SPRINGFIELD** (Area Code 413)
  - Universal Rec'g Studios, 26 Colton Ave. Zip: 01089. Tel: 736-7727. Owner: Flem DeAngelis. Configurations: Cassette & open reel.
- **ROME** (Area Code 315)
  - Audio Sound Servs., 104 E. Bloomfield St. Zip: 13440. Tel: 336-3810, 337-6022. Owner & Mgr.: Roger W. Jones. Configurations: Cartridge 8-tr., cassette & open reel.
- **ST. JAMES, L.I.** (Area Code 516)
  - Sound by St. James Inc., 649 Jericho Tnpk. Zip: 11780. Tel: 724-2828. Owners: Michael Ingram, Rays O'Brien; Mgr.: Arthur Schiff. Configurations: Cartridge 8-tr. & cassette.

### NORTH CAROLINA

- **CHARLOTTE** (Area Code 704)
  - Arthur Smith Studios, 5457 Old Monroe Rd. Zip: 28212. Tel: 536-0424. Owner: Arthur Smith; Mgr.: A. Reginald Smith. Configuration: Open reel.
- **GREENSBORO** (Area Code 919)
  - Crescent-City Sound Studios Inc., 1060 Gatewood Ave. Zip: 27405. Tel: 274-2441. Owner: Julian Price II; Mgr.: Walter E. Copeland. Configurations: Cartridge 8-tr., cassette & open reel.
- **RALEIGH** (Area Code 919)
  - Audiofonics (div. of Jimmy Capps Prod'ns Inc.), 15 W. Lenoir St. Zip: 27602. Tel: 833-3924. Pres. & Mgr.: Larry Gardner. Configurations: Cassette & open reel.

### OHIO

- **CINCINNATI** (Area Code 513)
  - Artist Rec'g & Rec. Pressing Inc., 320 Mill St. Zip: 45215. Tel: 761-0011. Mgr.: Chester Royse. Configurations: Cartridge 4-tr. & open reel.
  - Queen City Album Inc., 2832 Spring Grove Ave. Zip: 45225. Tel: 681-8400. Pres.: Edward R. Bosken; Gen. Mgr.: Chet Barnett. Configurations: Cartridge 4-tr., 8-tr., cassette & open reel.
- **CLEVELAND** (Area Code 216)
  - Agency Rec'g Studios Inc., 1730 E. 24 St. Zip: 44114. Tel: 621-0810. Pres.: Donald R. White; Mgr.: Larry Gorjup. Configuration: Open reel.
  - Alcon Rec'g Studios Inc., 4435 Mayfield Rd. Zip: 44121. Tel: 291-1616. Owners: R. J. Nowac, R. J. Lasky; Gen. Mgr.: R. J. Nowac. Configurations: Cartridge 4-tr., cassette & open reel.
  - Associated Inds. Inc., 2150 Hamilton Ave. Zip: 44114. Tel: 696-3773. VP: Robert W. Schachner; Gen. Mgr.: William Larence. Configurations: Cartridge 8-tr., cassette & open reel.
  - Boddie Rec'g Studio-Lab, 12202 Union Ave. Zip: 44105. Tel: 751-2578. Owner & Mgr.: Thomas Boddie. Configuration: Open reel.

Cleveland Rec'g, 1515 Euclid Ave. Zip: 44115. Tel: 621-9362. Owner & Mgr.: F. C. Wolf.  
**Configurations:** Cassette & open reel.  
 Qualitapes Inc., Penthouse East, Terminal Tower. Zip: 44113. Tel: 241-0900. Pres.: Sanford Ketchum; Gen. & Opns. Mgr.: Robert Conrad.  
**Configurations:** Cassette & open reel.  
 Szappanos Rec'gs, 11705 Buckeye Rd. Zip: 44120. Tel: 561-5524. Owner & Mgr.: Frank Szappanos.  
**Configurations:** Cartridge 8-tr. & cassette.

● **COLUMBUS (Area Code 614)**

Harmonic Sounds Inc., 1482 Felix Dr. Zip: 43207. Tel: 253-5283, 491-1461. Owner: Clem Price Jr.; Mgr.: George D. Beter.  
**Configurations:** Cartridge 4-tr., 8-tr., cassette & open reel.  
 Magnetic Studios Corp., 1670 W. First Ave. Zip: 43212. Tel: 486-2469. Owner: Richard M. Wolfe; Mgr.: John Fippin.  
**Configurations:** Open reel.

● **DAYTON (Area Code 513)**

Dynaphonics Inc., 2975 Far Hills Ave. Zip: 45419. Tel: 294-0347. Pres.: Drummond F. Gaines; Gen. Mgr.: Dr. Fran Jones.  
**Configurations:** Cassette & open reel.

● **FREMONT (Area Code 419)**

Courier-Empire Rec'g Ent., 414 Croghan St. Zip: 43420. Tel: 332-4775. Owner & Mgr.: Robert T. Brown.  
**Configuration:** Open reel.

● **YOUNGSTOWN (Area Code 216)**

United Audio Rec'g Studio, 10 Ellenwood Ave. Zip: 44507. Tel: 744-2166. Owner & Mgr.: Bill Warner.  
**Configurations:** Cartridge 4-tr., cassette & open reel.

**OKLAHOMA**

● **OKLAHOMA CITY (Area Code 405)**

Benson Sound Studio, 3707 S. Blackwelder Ave. Zip: 73119. Tel: 685-9442. Owner & Mgr.: Larry Benson.  
**Configuration:** Cartridge 8-tr.  
 Century Recs., 1220 NW 39. Zip: 73118. Tel: 528-4077. Owner & Mgr.: Richard Gilleland.  
**Configurations:** Cartridge 8-tr., cassette & open reel.

● **TULSA (Area Code 918)**

Derrick Rec'g Studios (div. of Granada Ents. Inc.), 1448-52 N. Harvard. Zip: 74110. Pres. & Mgr.: William P. Davis.

**Configurations:** Cartridge 4-tr., cassette & open reel.

**OREGON**

● **PORTLAND (Area Code 503)**

Rex Rec'g Co., 931 SW King Ave. Zip: 97205. Tel: 228-4393. Owner: Rodney F. Johnson; Gen. Mgr.: Russell Gorsline.  
**Configuration:** Open reel.

**PENNSYLVANIA**

● **FRANKLIN (Area Code 814)**

Process Rec. Co., 439 Wiley Ave. Zip: 16323. Tel: 432-4633. Owners: Norman & Delbert Kelly; Gen. Mgr.: Norman Kelly.  
**Configuration:** Open reel.

● **HARRISBURG (Area Code 717)**

Laird Prod'ns Inc., 412 N. Second St. Zip: 17105. Tel: 238-9688. Owner: J. Ira Laird Jr.; Mgr.: E. V. Di Martile.  
**Configurations:** Cartridge 4-tr., cassette & open reel.

● **JENKINTOWN (Area Code 215)**

Thunder Rec'g Studio, Cedar & West Ave. Zip: 19046. Tel: OS 2-5926. Owner: Stan Peahota; Mgr. Marian Ryan.  
**Configurations:** Cartridge 8-tr. & open reel.

● **MECHANICSBURG (Area Code 717)**

Baldwin Sound Prod'ns Inc., 5252 Trindle Rd. Zip: 17055. Tel: 766-0787. Owner: Donald E. Baldwin; Gen. Mgr.: Donald P. Whitticar.  
**Configurations:** Cartridge 8-tr., cassette & open reel.

● **PHILADELPHIA METROPOLITAN AREA (Area Code 215)**

Air-Tone Sound & Rec'g Co., 2330 Market St. Zip: 19103. Tel: 563-8388. Owner: Eugene Hessel; Mgr.: Peter Kiefer.  
**Configurations:** Cassette & open reel.  
 Diskmakers Inc., 925 N. Third St. Zip: 19123. Tel: MA 7-2277. Pres.: Morris Ballen; Gen. Mgr.: John Fermani.  
**Configurations:** Cartridge 8-tr. & cassette.  
 Educational Servs. (div. of Triangle Publ'ns Inc.), PO Box 85, Radnor 19087. Tel: 687-4700. Mgr.: Frederic Karch.  
**Configurations:** Cartridge 4-tr., cassette & open reel.

Helfrich Rec'g Labs., East Texas Rd. West, RD 2, Allentown 18103. Tel: 395-5511. Mgr.: Peter Helfrich.

**Configurations:** Cartridge 4-tr., 8-tr., cassette & open reel.

● **PITTSBURGH (Area Code 412)**

Gateway Assoc'd (div. of Associated Inds.), 256 Fifth Ave. Zip: 15222. Tel: 471-3484. Gen. Mgr.: Robert W. Schachner.  
**Configurations:** Cartridge 8-tr. & cassette.  
 Hardman Assocs. Inc., 213 Smithfield St. Zip: 15222. Tel: 281-4450. VP & Mgr.: Frank Doak.  
**Configurations:** Cassette & open reel.  
 W R S Rec'g Studio, 210 Semple St. Zip: 15213. Tel: 683-6300. Mgr.: F. Jack Napor.  
**Configurations:** Cassette & open reel.

● **READING (Area Code 215)**

James K. Hodgkins, 405 N. Front St. Zip: 19601. Tel: 373-7600. Owner & Mgr.: James K. Hodgkins.  
**Configurations:** Cartridge 4-tr., cassette & open reel.

● **SCRANTON (Area Code 717)**

Ladd Music Co., 401 Wintermantle Ave. Zip: 18505. Tel: 343-6718. Pres.: Phil Ladd; Gen. Mgr.: Joyce Shandra.  
**Configurations:** Cassette & open reel.

● **SHARON (Area Code 412)**

Marjon Recs., 159 Easton Rd. Zip: 16146. Tel: 347-4726. Pres.: John Krizancic; Mgr.: Martha Krizancic.  
**Configuration:** Open reel.

● **YORK (Area Code 717)**

Dee-Bee Rec'g Serv., S. Camp St. Extension, Windsor 17366. Tel: 244-5411. Owner: Stanley L. Deppen Jr.; Mgr.: Pat Gerrick.  
**Configurations:** Cartridge 8-tr., cassette & open reel.  
 Trout Audio Labs., 1784 San Gabriel Dr. Zip: 17402. Tel: 755-4103. Owner: Thomas A. Trout.  
**Configuration:** Open reel.

**RHODE ISLAND**

● **PROVIDENCE (Area Code 401)**

Fedco Audio Labs., 37 Clarendon Ave. Zip: 02906. Tel: 272-3157. Owner: Lyle Fain; Mgr.: Fred Ehrhardt.  
**Configurations:** Cartridge 4-tr. & open reel.

*Continued on page 98*

# Get total tape production service faster, for less — from Fairfield!

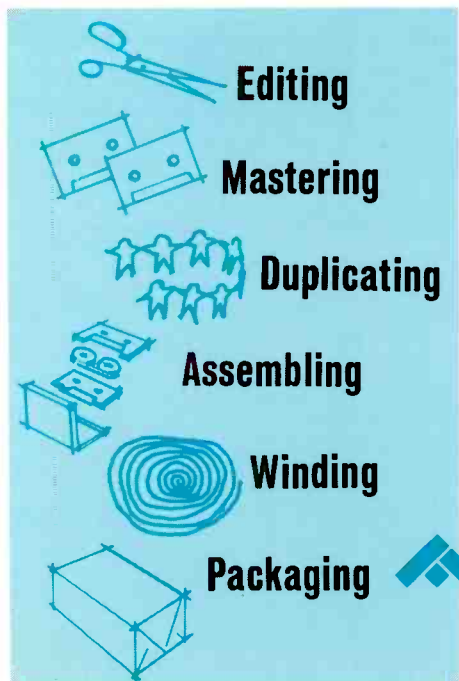

**Short runs or long runs,** Fairfield can take your recordings through *all* the stages — tape editing, mastering, duplicating, assembling, winding, label printing, packaging and shipping. Or any step in between. And we work in every tape configuration . . . cassette, 8-track, 4-track, open-reel . . . at prices that are *really* competitive.

To help guarantee the quality and delivery you need, we have some of the most sophisticated equipment around (built by some of the best names in the industry), and we have top industry professionals to run it. So when you need quality tapes fast, ask us to quote . . . you'll be glad you did!

Write or phone Fairfield today for full details of our services.  
 Address: Dept. B-1.

## Fairfield Tape Duplication / Assembling Corp.

601 Kennedy Blvd., North Bergen, N.J. 07047  
 TEL: 201-864-1210 TWX: 710-987-8404  
 a subsidiary of Fairfield Technology Corp.



# A TRUE SERVICE IN SOUND

Service has always been our bag—  
And now we parlay two audio GIANTS  
to help you speed your products  
into the stores.

---

## TODAY:



At **Bell Sound Studios Corp.**—  
Record in one of our studios on  
12 track or 8 track, remix your  
tapes, and cut your stereo lacquers!

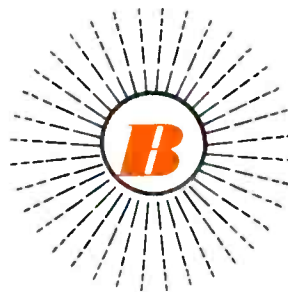

and

---



At **A & B Duplicators, Ltd.**—  
Duplicate 8 track cartridges and  
cassettes at one of the world's  
largest and most modern plants.

## TOMORROW:

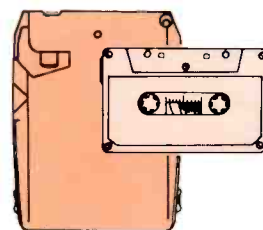

---

# BELL SOUND and A & B

237 W. 54th Street, New York, N.Y. 10019 (212) 582-4812

Known Internationally For Dependability In The World Of Audio

A SUBSIDIARY OF  **iewlex** INC.





**ELECTRO  
SOUND**  
**4000**

the  
world's  
most  
versatile



tape  
duplicating  
system...

***Electro-Sound, Inc.***

237 W. 54th Street, New York, N.Y. 10019 (212) 582-4812

We design and manufacture all equipment necessary for a tape duplicating plant and are the only single source supplier who can offer customers a full line of basic equipment of its own manufacture. We produce the duplicating equipment itself, as well as winders, quality control equipment, playback equipment and mastering devices, and accessories required for a fully operating plant.

Exclusive international distributor of Audio Corporation  
915 Westchester Ave., Bronx, N.Y. 10459 (212) 589-3500

A SUBSIDIARY OF  **viewlex INC.**

## TAPE SERVICES

Continued from page 95

### SOUTH CAROLINA

#### ● GREENVILLE (Area Code 803)

Mark V. 10 Michael Dr. Zip: 29610. Tel: 269-3961. Admin. Mgr.: Bob Edwards.  
Configurations: Cartridge 8-tr. & cassette.

### TENNESSEE

#### ● MEMPHIS (Area Code 901)

American Rec'g, 827 Thomas St. Zip: 38107. Tel: 526-3935, 526-0409. Owner: Chips Moman; Admin. VP & Mgr.: Marty Lacker.  
Configurations: Cartridge 4-tr. & 8-tr.  
Blackwood Rec'g Studio, 3933 Summer. Zip: 38122. Tel: 324-4434. Owners: H. B. Brewster & Blackwood Bros.; Mgr.: H. B. Brewster.  
Configurations: Cartridge 8-tr. & cassette.  
Century Rec'g Serv., 11 S. Idlewild. Zip: 38104. Tel: 276-4208. Owner & Mgr.: Mrs. Margaret Tucker.  
Configurations: Cartridge 4-tr., 8-tr., cassette & open reel.

### MICHIGAN

#### ● DEARBORN (Area Code 313)

P A C-3 Rec'g Co., 7106 Greenfield. Zip: 48126. Tel: 581-0520. Owner: Richard G. Becker; Mgr.: James Monoro.  
Configurations: Cassette & open reel.  
Sound Studios Inc., 2019 Russell. Zip: 48128. Tel: 563-8097. Owner & Mgr.: Cory Drake.  
Configuration: Open reel.

#### ● DETROIT METROPOLITAN AREA (Area Code 313)

Adell Corp., 43700 Adell Blvd., Novi 48050. Tel: 349-6300. Pres.: Robert Adell; Gen. Mgr.: Frank Adell.  
Configurations: Cartridge 8-tr. & cassette.  
American Sound Corp., 3319 E. 10 Mile Rd., Warren 48091. Tel: 539-2900. Pres.: Frank S. Day; Gen. Mgr.: William D. Adams.  
Configurations: Cartridge 8-tr. & cassette.  
Artie Fields Prod'ns Inc., 9430 Woodward Ave. Zip: 48202. Tel: 873-8900. Owner: Arthur H. Fields; VP & Mgr.: Morris D. Mounts.  
Configuration: Open reel.

Fortune Rec'g Co., 3942 Third Ave. Zip: 48201. Tel: TE 3-5383. Owners: Jack & Devora Brown; Mgr.: Jack Brown.  
Configurations: Cartridge 4-tr., 8-tr., cassette & open reel.

Pioneer Rec'g Studio Inc., 20014 James Couzens. Zip: 48235. Tel: 341-5868, 341-0447. Pres. & Mgr.: Gary A. Rubin.  
Configurations: Cartridge 8-tr., cassette & open reel.

Specialty Sounds Inc., 33515 Kelly Rd., Fraser 48026. Tel: 294-5200. Pres.: L. Allan Bazy; Gen. Mgr.: Jerry Danko.  
Configurations: Cartridge 8-tr., cassette & open reel.

Tape-Tronics, 750 Mandoline, Madison Heights 48071. Tel: 588-8281. Pres.: Burton Mahler; VP & Gen. Mgr.: A. S. Hart.  
Configurations: Cartridge 8-tr. & cassette.

United Sound Systems Inc., 5840 Second Ave. Zip: 48202. Tel: 871-2570. Owners: James V. & Esther Siracuse; Mgr.: William Beltz.  
Configurations: Cartridge 4-tr., cassette & open reel.

#### ● HUDSONVILLE (Area Code 616)

Sound Assocs., 3546 Van Buren. Zip: 49426. Tel: 669-1273. Mgr.: E. C. Miller.  
Configurations: Cassette & open reel.

#### ● KALAMAZOO (Area Code 616)

Barbara Allan Prod'ns Inc., PO Box 207. Zip: 49005. Tel: 327-6746. Pres.: Allan Horn; Mgr.: Russ Emmerling.  
Configurations: Cassette & open reel.

#### ● LANSING (Area Code 517)

Haka Prod'ns, 3612 Tecumseh. Zip: 48906. Tel: 485-6137. Owner & Mgr.: Philip G. Haka.  
Configuration: Open reel.

#### ● TROY (Area Code 313)

Stereodyne Inc., 2810 Elliott. Zip: 48084. Tel: 585-6585. Exec. VP & Gen. Mgr.: Paul Wyatt.  
Configurations: Cartridge 4-tr., 8-tr. & cassette.

### MINNESOTA

#### ● MINNEAPOLIS-ST. PAUL AREA (Area Code 612)

Audioteck Rec'g Studios (div. of Audiotek Systems Inc.), 711 W. Broadway, Minneapolis 55411. Tel: 521-7631. Mgr.: Dan R. Holmes.  
Configurations: Cartridge 4-tr., 8-tr., cassette & open reel.  
E M C Corp., 180 E. Sixth St., St. Paul 55101. Tel: 227-7366. Pres.: David E. Feinberg.  
Configurations: Cassette & open reel.

Sound 80 Inc., 4444 W. 76 St., Minneapolis 55435. Tel: 920-7781. Pres.: Herb Pilhofer; VP & Mgr.: Tom Jung.  
Configuration: Open reel.

Universal Audio Corp., 2541 Nicollet Ave. S., Minneapolis 55404. Tel: 827-5442. Pres.: John A. Michaelson; Gen. Mgr.: Joel Papa.  
Configurations: Cassette & open reel.

#### ● MOORHEAD (Area Code 218)

Maik Custom Recs., 1518 S. Seventh St. Zip: 56560. Tel: 233-5803. Owner: Don Geiken.  
Configuration: Cassette.

### MISSISSIPPI

#### ● TUPELO (Area Code 601)

Triangle Sound Inc., 1129 S. Green. Zip: 38801. Tel: 842-5118. Pres.: Larry D. Eades; Mgr.: Larry Nicols.  
Configurations: Cartridge 4-tr., 8-tr., cassette & open reel.

### MISSOURI

#### ● COLUMBIA (Area Code 314)

Mark Rec'gs of Missouri, 1220 Jake Ln. Zip: 65201. Tel: 445-5624. Owner & Mgr.: Dick Bailey.  
Configurations: Cassette & open reel.

#### ● INDEPENDENCE (Area Code 816)

Cavern Sound Corp., 16400 E. Truman Rd. Zip: 64050. Tel: 254-5600. Gen. Mgr.: John Pearson.  
Configurations: Cassette & open reel.

#### ● KANSAS CITY (Area Code 816)

Fremerman Rec'g & Tape Dupl'g Co., 4041 Central. Zip: 64111. Tel: 753-6868. Pres.: Marvin Fremerman; Gen. & Sales Mgr.: Bernie Fremerman.  
Configurations: Cassette & open reel.

Stage III Sound Prod'ns, 12 E. 39 St. Zip: 64111. Tel: 531-1375. Owner: Don Warnock; Mgr.: Jon Lammers.  
Configurations: Cartridge 4-tr., 8-tr., cassette & open reel.

#### ● ST. LOUIS (Area Code 314)

Allied Tape Corp., 1201 Research Blvd. Zip: 63132. Tel: 997-0016. Pres.: Byrle A. Northup; Exec. VP: Robert F. Philpot; Gen. Mgr.: Roger Frederickson.  
Configurations: Cartridge 4-tr., 8-tr., cassette & open reel.

Continued on page 100

# ATD creative custom duplicators since 1962 offering complete quality tape services

Concept • Programming • Packaging • Labeling • Distribution

## ATD

LOS ANGELES: 5727 W. Jefferson Boulevard, L. A. 90016; (213) 870-6832  
NEW YORK: 76 Madison Avenue, NYC 10016; (212) 685-2342

# audio brings you the world's outstanding tape duplicating system



The Electro Sound 4000 Series from Audiomatic is simply the best tape duplicating system around.

- The ES 4000 is the only system which *consistently* produces finished tapes of the highest quality with *minimum attention* and maintenance. It is designed and built to work around the clock using labor with minimal skills. It just turns out great tapes, day-in, day-out, with no fuss and no trouble.
- The ES 4000 is the only system which permits really quick changeover from one configuration to another. We guarantee, for example, that production can be switched from cassettes to 8-track cartridges in about *1 minute per slave*, or *less than 10 minutes for a 10-slave system*.
- We are the only supplier who offers a single source for all of the equipment needs of the modern tape duplicating plant. We furnish not only the duplicating machines themselves, but also our own mastering and playback equipment, quality control equipment, the finest available winders and our latest addition, semi-automatic splicers. We can also supply you with run-in, labeling, gluing and packaging machines and, for that matter, we can set up a complete plant for you from scratch.

If you are now in tape duplicating and want to expand or improve your facilities *or* if you want to get into this fast-growing business, the best of everything is available from Audio. To find out just how good it is, ask some of the many industry leaders who use it.

*Write or call us for references and for full details.*

## **AUDIOMATIC CORPORATION**

915 Westchester Avenue, Bronx, N. Y. 10459  
212 LU 9-3500 Cable **AUDIOMATIC**

Distributors of Electro Sound duplicating equipment in the United States and exclusive distributors everywhere else in the world.

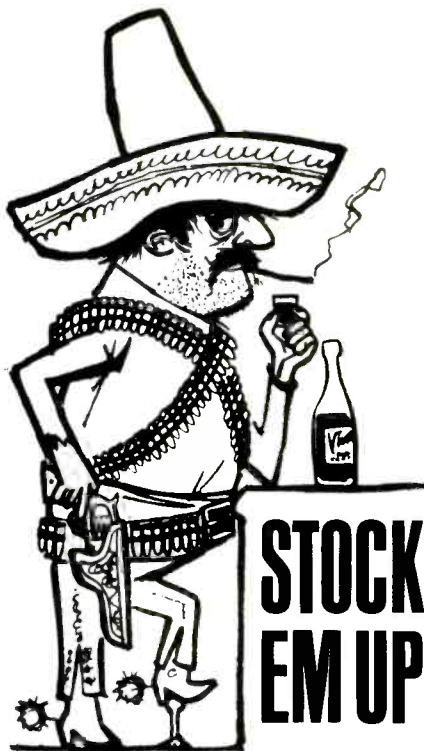

**MOST WANTED  
IN THE INDUSTRY**

**THE FINEST IN PROMOTIONAL  
PRE-RECORDED TAPES!**

8 TRACK  
CASSETTE  
OPEN REEL

**BLANK TAPES:**

8 TRACK  
CASSETTE  
CASSETTE & 8 TRACK  
HEAD CLEANERS

**TAPE CARTRIDGE  
CARRYING CASES**

IF YOU'VE EVER BEEN  
HELD UP WITH PRICE,  
QUALITY OR SERVICE...  
GIVE US A SHOT!  
**WE'LL STOCK IT TO YA!**



**AUDIOMASTERS CORP.**  
16711 ROSCOE BLVD.  
SEPULVEDA, CALIF. 91343  
(213) 892-0716

## TAPE SERVICES

*Continued from page 98*

Technisonic Studios, 1201 S. Brentwood Blvd. Zip: 63131. Tel: 727-1055. VP & Mgr.: Edward H. Canter.  
Configuration: Open reel.

### • SPRINGFIELD (Area Code 417)

Bi-Lu Ents., PO Box 801, Zip: 65801; 420 E. Chestnut. Zip: 65806. Tel: 869-1296. Mgr.: Billy Wolfe.  
Configurations: Cartridge 4-tr., 8-tr., cassette & open reel.

Century Custom Rec'g Serv., PO Box 862. Zip: 65801. Tel: 862-8443. Owner & Mgr.: Joseph H. Higgins.  
Configurations: Cartridge 8-tr. & cassette.

## MONTANA

### • HELENA (Area Code 406)

Valtron Rec'g Studio, 305 Allen St. Zip: 59601. Tel: 442-0734. Pres. & Gen. Mgr.: Lester Liedle; Sales Mgr.: Sandy Liedle.  
Configuration: Open reel.

## NEBRASKA

### • LINCOLN (Area Code 402)

Williams Rec'g Serv., 2650 N. 48 St. Zip: 68504. Tel: 434-4745. Owner & Gen. Mgr.: Lee A. Williams.  
Configuration: Open reel.

### • OMAHA (Area Code 402)

Liberty Tape Dupl'g, 1201 Pacific St. Zip: 68108. Tel: 348-1770. Gen. Mgr.: Leo Colvin.  
Configurations: Cartridge 4-tr., 8-tr., cassette & open reel.

Sound Rec'rs, 206 S. 44 St. Zip: 68131. Tel: 553-1165. Owner & Mgr.: Don Sears.  
Configurations: Cassette & open reel.

## NEVADA

### • LAS VEGAS (Area Code 702)

United Rec'g Corp. of Nevada, 3143 Industrial Rd. Zip: 89102. Tel: 735-7131. Owner & Mgr.: Bill R. Porter.  
Configuration: Open reel.

## NEW JERSEY

### • CAMDEN (Area Code 609)

Recorded Publ'ns Labs., 1558 Pierce Ave. Zip: 08105. Tel: 963-3000. Pres.: Edward J. Goodman; Gen. Mgr.: David H. Goodman; Sales Mgr.: Pat Landon.  
Configurations: Cartridge 4-tr., cassette & open reel.

### • DOVER (Area Code 201)

Audio Communications Inc., Rt. 10, Randolph Ind'l Park. Zip: 07081. Tel: 361-7600. Pres.: E. Michael Daspin; Sales Mgr.: Thomas J. Malia.  
Configurations: Cartridge 8-tr. & cassette.

### • ENGLISHTOWN (Area Code 201)

Nemo Rec'g Labs., 382 Taylors Mills Rd. Zip: 07726. Mgr.: Peter M. Vaas.  
Configurations: Cartridge 4-tr., 8-tr., cassette & open reel.

### • FAIRFIELD (Area Code 201)

Grandy Inc., 1275 Bloomfield Ave. Zip: 07006. Tel: 228-1433. Pres. & Sales Mgr.: Edward J. Kissack.  
Configurations: Cartridge 4-tr., 8-tr., cassette & open reel.

Livingston Audio Prods. Corp., 1275 Bloomfield Ave. Zip: 07006. Tel: 226-8300. Pres.: Darrell D. Scholten; VP Sales: Thomas J. Hofbauer.  
Branch: Los Angeles, Calif.  
Configurations: Cartridge 4-tr., 8-tr., cassette & open reel.

### • JERSEY CITY (Area Code 201)

Realtone Electronics (div. of Soundesign Corp.), 34 Exchange Pl. Zip: 07302. Tel: 434-1050. Pres.: Ely E. Ashkenazi; Gen. Mgr.: Morris Franco.  
Configurations: Cartridge 8-tr. & cassette.

### • METUCHEN (Area Code 201)

R-C Sound Studios, 50 Plainfield Ave. Zip: 08840. Tel: 494-1424. Owner & Mgr.: Ralph A. Nielsen.  
Configuration: Open reel.

### • MOORESTOWN (Area Code 609)

Kimco Tape Accessories, York House East, 214 W. Main St. Zip: 08057. Tel: 235-6332. Pres.: Theodore D. Cohen.  
Configurations: Cartridge 4-tr., 8-tr. & cassette.

### • NORTH BERGEN (Area Code 201)

Fairfield Tape Dupl'g/Assembling, 601 Kennedy Blvd. Zip: 07047. Tel: 864-1210. Pres.: Robert Strauss; Gen. Mgr.: J. Cadenas.  
Configurations: Cartridge 4-tr., 8-tr. & cassette.

Sarex Corp., 3850 West Side Ave. Zip: 07041. Tel: 864-9400; NYC Tel: (212) 227-6354. Pres.: O. Louis Seda; Exec. VP: D. Max Brightmore.  
Configuration: Cassette.

### • SCOTCH PLAINS (Area Code 201)

H M R Prod'ns, 574 W. Court. Zip: 07076. Tel: 889-1767. Owner: Harry M. Randel.  
Configurations: Cartridge 4-tr., 8-tr., cassette & open reel.

### • WEST CALDWELL (Area Code 201)

National Tape Serv. Inc., 3 Fairfield Crescent. Zip: 07006. Tel: 228-2424; NYC Tel: (212) 233-3520. Pres.: J. White; Gen. Mgr.: J. Verille.  
Configurations: Cartridge 4-tr., 8-tr., cassette & open reel.

## NEW MEXICO

### • ALBUQUERQUE (Area Code 505)

Cee Rec'g Serv. (div. of Customized Electronic Eng'g), PO Box 8921, Zip: 87108. Tel: 299-5581. Gen. Mgr.: John H. Hughes.  
Configurations: Cartridge 4-tr., 8-tr. & open reel.

## NEW YORK

### • BINGHAMTON (Area Code 607)

Creative Artists, 6 Van Ness Rd. Zip: 13905. Tel: 797-3909. Pres.: Johnathan K. Solak; Sales Mgr.: Charles Solak.  
Configurations: Cartridge 4-tr., 8-tr., cassette & open reel.

De Clercq Studio, 127 Main St. Zip: 13905. Tel: 724-2062. Owner & Mgr.: Gilbert W. de Clercq.  
Configurations: Cartridge 8-tr., cassette & open reel.

### • BRONXVILLE (Area Code 914)

International Rec'g Co., 49 Desmond Ave. Zip: 10708, NYC. Tel: (212) CH 2-1455. Owner & Mgr.: C. Rie.  
Configurations: Cartridge 8-tr., cassette & open reel.

### • COPIAGUE, I.I. (Area Code 516)

Dubbings Electronics Inc., 1305 S. Strong Ave. Zip: 11726. Tel: 893-1000. Pres.: Paul C. Smith; Opns. Mgr.: P. M. Shooer.  
Configurations: Cartridge 4-tr., 8-tr., cassette & open reel.

### • HAUPPAUGE, I.I. (Area Code 516)

Allison Audio Prods. Inc., 175 Bridge Rd. Zip: 11787. Tel: 234-2010; NYC Tel: (212) 895-6449. Ass't Sales Mgr.: Kenneth P. Levitz.  
Configurations: Cartridge 8-tr. & cassette.

### • ITHACA (Area Code 607)

Alcor Inc./Pyramid, 215 S. Tioga St. Zip: 14850. Tel: AR 3-4242. Pres.: Max Mattes; Mgr.: Bill Storm.  
Configuration: Open reel.

### • NEW YORK CITY (Area Code 212)

A & B Dupl'rs (sub. of Bell Sound Studios Corp.), 237 W. 54 St. Zip: 10019. Tel: 582-4812. Mgr.: Irv Jerome.  
Configurations: Cartridge 4-tr., 8-tr., cassette & open reel.

A-1 Sound Studios Inc., 242 W. 76 St. Zip: 10024. Tel: CI 6-3594, 362-2603. Owner & Mgr.: Herb Abramson.  
Configurations: Cartridge 4-tr., 8-tr., cassette & open reel.

Artcraft Rec'g Studios, 285 E. 49 St., Brooklyn 11203. Tel: 778-5150. Owner: Mike Serby; Mgr.: Anthony Serbiniano.  
Configurations: Cartridge 4-tr., 8-tr., cassette & open reel.

Avery & Elkins Inc., 653 11 Ave. Zip: 10036. Tel: 586-6235. Pres.: Julius Elkins; Sales Mgr.: Ron Silberman.  
Configurations: Cassette & open reel.

Cable Machinery Corp., 156 Fifth Ave. Zip: 10010. Tel: 989-4434. Pres.: Sol Dubin; Gen. Mgr.: Leonard Ripley.  
Configuration: Cassette.

Capitol Recs. Dist'g Corp., 151 W. 46 St. Zip: 10036. Tel: 582-8040. Mgr.: J. Lansky.  
Configurations: Cartridge 4-tr., 8-tr., cassette & open reel.

Cassette-Cartridge Corp., 220 E. 23 St. Zip: 10010. Tel: 689-8861. Pres.: Lorence Press; Gen. Mgr.: Peter Pittas.  
Configurations: Cartridge 4-tr., 8-tr., cassette & open reel.

Cassette Communications Corp., 932 Broadway. Zip: 10010. Tel: 533-3150. Pres.: Arnold Maxin; Gen. Mgr.: Jack A. Somer.  
Configurations: Cartridge 8-tr., cassette & open reel.

Cassette Data Corp. (div. of Avery & Elkins Inc.), 653 11 Ave. Zip: 10036. Tel: 586-6235. Pres.: Julius Elkins; Sales Mgr.: Ron Silberman.  
Configuration: Cassette.

Cassette Development Corp. (div. of Avery & Elkins Inc.), 653 11 Ave. Zip: 10036. Tel: 586-6235; 295 Madison Ave. Zip: 10017. Tel: 683-9811. Pres.: Julius Elkins; Sales Mgr.: Ron Silberman.  
Configuration: Cassette.

Cassette Rec'g Corp., 41-34 27 St., Long Island City 11101. Tel: 937-3344. Pres.: Carl Lustig; Gen. Mgr.: Matthew Polakoff.  
Configurations: Cartridge 8-tr., cassette & open reel.

Cassette/Tech Corp., 543 W. 43 St. Zip: 10036. Tel: 868-3520. Pres.: Eugene V. Liposki; VP Sales: Donald W. MacClean.  
**Configurations:** Cartridge 8-tr. & cassette.  
 Dick Charles Rec'g Serv. Inc., 729 Seventh Ave. Zip: 10019. Tel: JU 2-7920. Owner & Mgr.: Dick Charles.  
**Configurations:** Cartridge 4-tr. & open reel.  
 Cine-Vox Studios (div. of Cine Vox Prod'ns Inc.), 12 E. 41 St. Zip: 10017. Tel: 889-2180. Mgr.: Keith A. Leach.  
**Configuration:** Open reel.  
 Columbia Rec. Prod'ns, 49 E. 52 St. Zip: 10022. Tel: 765-4321. Contact: Tom Van Gessel.  
 Cue Rec'gs Inc., 117 W. 46 St. Zip: 10036. Tel: PL 7-3641. Owners: Mel Kaiser, Bernard Rubinstein; Mgr.: Mel Kaiser.  
**Configurations:** Cassette & open reel.  
 Darwin Studio, 100 St. Marks Pl. Zip: 10009. Tel: 982-9797. JU 6-0909. Owners: John Darren, Harold Vincent.  
**Configuration:** Open reel.  
 Decca Recs. (div. of MCA Inc.), 445 Park Ave. Zip: 10022. Tel: 759-7500. Custom Div. Mgr.: Charles Blake.  
**Configurations:** Cartridge 4-tr., 8-tr., cassette & open reel.  
 Delta Rec'g Corp., 1564 Broadway. Zip: 10036. Tel: 265-4876. Owners: Bernard Zimney, Joseph Garafalo; Mgr.: Tony Romeo.  
**Configurations:** Cassette & open reel.  
 Direct Rec'gs Inc., 18 E. 50 St. Zip: 10022. Tel: PL 9-7979. Owner: Norman Levin; Mgr.: Leo J. Launer.  
**Configurations:** Cassette & open reel.  
 Fine Rec'g Inc., 118 W. 57 St. Zip: 10019. Tel: 245-6969. Owner: C. Robert Fine; Mgr.: Arthur Berkow.  
**Configurations:** Cartridge 4-tr., 8-tr., cassette & open reel.  
 Gotham Rec'g Corp. (div. of TeleGeneral Corp.), 2 W. 46 St. Zip: 10036. Tel: 586-5577. Mgr.: Arnold L. Rosen.  
**Configurations:** Cartridge 4-tr., 8-tr., cassette & open reel.  
 Metra Electronics Corp., 660 McDonald Ave., Brooklyn 11218. Tel: 871-4100. Pres.: Charles R. Fox.  
**Configuration:** Cassette.  
 N A L (North American Leisure Corp.), 1776 Broadway, New York, N.Y. 10019. Pres.: Larry Finley; Gen. Mgr.: Karl Baumgartner.  
**Configurations:** Cartridge 8-tr., cassette & open reel.  
 Olmsted Sound Studios Inc., 80 W. 40 St. Zip: 10018. Tel: 868-3342. Pres.: Richard B. Olmsted; Mgr.: Arthur Shaer.  
**Configuration:** Open reel.

Philips Rec'g Co. Inc., 609 Fifth Ave. Zip: 10017. Tel: PL 2-4300. Mgr.: R. Teitelman.  
**Configurations:** Cartridge 4-tr., 8-tr., cassette & open reel.  
 Posthorn Rec'gs, 185 Ave. C. Zip: 10009. Tel: OR 7-4082. Owner & Mgr.: Jerry Bruck.  
**Configuration:** Open reel.  
 R C A Recs. Rec'g Studio, 110 W. 44 St. Zip: 10036. Tel: 586-3000. Mgr.: H. Eitelbach.  
**Configurations:** Cartridge 4-tr., 8-tr., cassette & open reel.  
 R K O Dupl'g (see National Tape Sales Inc., West Caldwell, N.J.).  
 Radiant Cassette/Cartridge Corp. (sub. of Radiant Corp.), 250 W. 57 St. Zip: 10019. Tel: 765-1820. Sales Mgr.: Donald J. Pasin.  
**Configurations:** Cartridge 8-tr. & cassette.  
 Richcraft Rec'g Co., 1706 Flatbush Ave., Brooklyn 11210. Tel: 377-1664. Mgr.: Richard Rahmey.  
**Configurations:** Cartridge 4-tr., 8-tr., cassette & open reel.  
 Select Sound Studio Inc., 1790 Broadway. Zip: 10019. Tel: 757-8570. Mgr.: Bob Stephens.  
**Configurations:** Cartridge 4-tr., 8-tr., cassette & open reel.  
 Sound Center Inc., 750 Eighth Ave. Zip: 10036. Tel: 582-5692. Mgr.: Lucien Esposito.  
**Configurations:** Cartridge 8-tr. & open reel.  
 Stereo Sound Studios, 238 E. 26 St. Zip: 10010. Tel: MU 3-5240. Owner: Jerry Newman; Mgr.: Ted Krysty.  
**Configuration:** Open reel.  
 T D K Electronics Corp., 23-73 48 St., Long Island City 11103. Tel: 721-6881. Pres.: H. Kawamura; Mktg. Mgr.: George T. Saddler.  
 Branches: Los Angeles, Calif.; Chicago, Ill.  
 Int'l branch: Japan.  
**Configuration:** Cassette.  
 Tucker Prod'ns Ltd., 853 Seventh Ave. Zip: 10019. Tel: CO 5-0408. Pres.: George Tucker; Sales Mgr.: Cherie Shaw.  
**Configurations:** Cartridge 4-tr., cassette & open reel.  
 Variety Rec'g Studio, 130 W. 42 St. Zip: 10036. Tel: 594-7536. Owners: Warren Allen Smith, Fred Vargas; Mgr.: Fred Vargas.  
**Configuration:** Open reel.  
 Deryck Waring Rec'gs Inc., 25 W. 43 St. Zip: 10036. Tel: 736-0878. Pres. & Mgr.: Deryck H. Waring.  
**Configurations:** Cassette & open reel.  
 ● **PEEKSKILL (Area Code 914)**  
 G & G Rec'g Serv., 12 Lake Rd. Zip: 10566. Tel: 737-2772. Owner & Mgr.: Guy Heitmann.  
**Configurations:** Cassette & open reel.

● **NASHVILLE (Area Code 615)**  
 C & M Sound Studios Inc., 805 18 Ave. S. Zip: 37203. Tel: 259-3710. Owners: Rex E. Collier, Jim P. Deal.  
**Configuration:** Open reel.  
 Columbia Rec. Prod'ns, 804 16 Ave. S. Zip: 37203. Tel: 255-0371. Contact: Cecil Scaife.  
 D B M Rec'g Studio, 1516 Hawkins St. Zip: 37203. Tel: 244-9589. Owners: Ben Hall, Dr. P. W. Melone; Mgr.: Ben Hall.  
**Configuration:** Open reel.  
 Globe Rec'g Studio Inc., 420-A Broadway. Zip: 37203. Tel: 255-7645. Pres. & Gen. Mgr.: Jim Maxwell.  
**Configurations:** Cassette & open reel.  
 Queen of Sound (div. of East Coast Sound Corp.), 1314 Pine St. Zip: 37203. Tel: 259-3965. Pres.: Don Scoggins; Mgr.: Bob Beasley.  
**Configuration:** Open reel.  
 R C A Recs. Rec'g Studio, 800 17 Ave. S. Zip: 37203. Tel: 255-5781. Mgr.: C. Eberhardt.  
**Configurations:** Cartridge 4-tr. & 8-tr.

**TEXAS**

● **AUSTIN (Area Code 512)**  
 General Audio Servs. Inc., 308 W. Sixth St. Zip: 78701. Tel: 451-1701. Owners: Richard Gembler, Bruce Hooper, Steve Shields; Gen. Mgr.: Richard Gembler.  
**Configurations:** Cartridge 8-tr. & open reel.  
 P S G Rec'g Co., 4322A N. Lamar. Zip: 78767. Tel: 454-5652. Owner & Mgr.: Pedro S. Gutierrez.  
**Configurations:** Cartridge 4-tr., 8-tr., cassette & open reel.  
 ● **DALLAS (Area Code 214)**  
 Taplex Co., 809 N. Hampton Rd. Zip: 75208. Tel: WH 6-1515. Pres.: R. E. Thomas.  
**Configurations:** Cartridge 4-tr., 8-tr., cassette & open reel.  
 ● **HOUSTON (Area Code 713)**  
 Jimmy Duncan's Soundville, 8208 Westpark Dr. Zip: 77042. Tel: 781-6300. Mgr.: Bill Gilliligian.  
**Configuration:** Open reel.  
 ● **SAN ANTONIO (Area Code 512)**  
 Texas Sound Studios, 506 W. Hildebrand Ave. Zip: 78212. Tel: 733-1721. Owner: Jeff Smith; Mgr.: Jack Bond.  
**Configurations:** Cassette & open reel.

*continued on page 102*

2 3 5 8 7 9  
 1 4 5 8 9  
 6 5 9 7 7 4  
 5 8 7 6 1 2  
 2 5 8 8 6  
 3 5 8 8 6



6  
 1  
 3 6 9  
 1 2 5

**4-TRACK**  
**8-TRACK**  
**CASSETTES**  
**REEL-TO-REEL**

For Quality Tape Duplicating . . .

# IT ALL ADDS UP!

**Recording**  
**Mastering**  
**Production**  
**Package Design**  
**+ Distribution**

---



## Allied Tape Corporation

A SUBSIDIARY OF CUSTOM MUSIC CORPORATION  
 LINDBERGH-WARSON INDUSTRIAL CT. / 1201 RESEARCH BLVD.  
 ST. LOUIS, MISSOURI 63132 / (314) 997-0016

## TAPE SERVICES

Continued from page 101

### VERMONT

- **BRATTLEBORO** (Area Code 802)  
Vanguard Prod'ns, 8 Winter St. Zip: 05301. Tel: 257-7131. Pres. & Mgr.: David S. Calef.  
Configuration: Open reel.

### VIRGINIA

- **NORFOLK** (Area Code 702)  
Norfolk Rec'g Studio, 622 W. 35 St. Zip: 23508.  
Tel: 623-5565. Owner: Frank Guida; Mgr.: Thomas M. Chilton.  
Configurations: Cassette & open reel.  
Studio Center (div. of Broadcasting Servs. Inc.), 200 W. 22 St. Zip: 23517. Tel: 622-2111. Pres. & Exec. Prod'r: Warren M. Miller.  
Configurations: Cassette & open reel.
- **RICHMOND** (Area Code 703)  
Richmond Sound Stages, 2314 W. Cary St. Zip: 23220. Tel: EL 5-5778. Mgr.: Frank Brooks.  
Configurations: Cassette & open reel.

### WASHINGTON

- **OLYMPIA** (Area Code 206)  
Apollo Ent's., 1915 N. Quince. Zip: 98501. Tel: 352-9097. Owner & Mgr.: Allen P. Giles.  
Configurations: Cartridge 4-tr., cassette & open reel.
- **TACOMA** (Area Code 206)  
Wiley Sound Studio, 5103 N. 46 St. Zip: 98407.  
Tel: SK 2-8583. Owner & Mgr.: Bill Wiley.  
Configurations: Cartridge 4-tr. & open reel.

### WISCONSIN

- **MILWAUKEE** (Area Code 414)  
Dave Kennedy Rec'g Studios, 2755 N. Third St. Zip: 53212. Tel: 372-2750. Owner & Mgr.: Dave Kennedy.  
Configurations: Cassette & open reel.
- **SAUK CITY** (Area Code 608)  
Sara Sound Studios Inc., 123 Water St. Zip: 53583.  
Tel: 643-3304. Owner & Mgr.: Jim Kirchstein.  
Configurations: Cassette & open reel.

### WYOMING

- **CHEYENNE** (Area Code 307)  
Rocky Mountain Rec'g, PO Box 82. Zip: 82001.  
Tel: 638-8733. Pres. & Gen. Mgr.: Ray Alexander.  
Configuration: Open reel.

## DESIGN & ARTWORK

### CALIFORNIA

- **ANAHEIM** (Area Code 714)  
Cerron Corp., 1701 S. State College Blvd. Zip: 92806. Tel: 633-4280. Pres.: Edwin Gamson; Mktg. Admin. Dir.: Brian McCourt; Sales Mgr.: James Neiger.
- **LOS ANGELES METROPOLITAN AREA** (Area Code 213)  
A T D (American Tape Dupl'rs Inc.), 5727 W. Jefferson Blvd. Zip: 90016. Tel: 870-6832. Pres.: Richard Allen; Exec. VP: Warren D. Gray; VP Sales & Mktg.: Jay Lease.  
Advance Recs., 6376 Yutca St., Hollywood 90028. Tel: 463-2151. Pres.: Tim Gayle; Gen. Mgr.: Mordy Perrigo; Sales Mgr.: Eddie Edwards.  
Audio Physics Inc., 16449 Vanowen St., Van Nuys 91406. Tel: 782-3638. Pres.: Don Washbrook; Gen. Mgr.: John David; Sales Mgr.: Bill Richards.  
Communitronics Inc., 626 S. Hudson Ave. Zip: 90005. Tel: WE 1-6111. Pres.: G. David Schine.  
Creative Sound Prod'ns, 9000 Sunset Blvd. Zip: 90069. Tel: 271-4843. Pres.: Robert C. Cotterell; Gen. Mgr.: Martha Roche; Sales Mgr.: John Webb.  
Custom Fidelity Inc., 7925 Santa Monica Blvd., Hollywood 90046. Tel: 654-4522. Pres.: David W. Berkus; Sales Mgr.: Ellis Fertig.  
E M C Corp. (Radio Rec'rs Div.), 7000 Santa Monica Blvd. Zip: 90038. Tel: 463-3282. Pres.: David Feinberg; VP & Gen. Mgr.: J. Greenfield.  
Gilmore Envelope Corp., 4000 Medford St. Zip: 90063. Tel: 268-3401. Pres.: Howard Gilmore.  
Kahana Film Prod'ns, 1909 N. Curson Pl., Hollywood 90046. Tel: 876-8208. Pres.: Yoram Kahana; Gen. Mgr.: Peggy Halper.  
Kittyhawk Graphics, 7783 Sunset Blvd., Hollywood 90046. Tel: 874-1534. Pres. & Gen. Mgr.: Dean O. Torrence.  
Livingston Audio Prods. Corp., 10687 Santa Monica Blvd., West Los Angeles 90025. Tel: 474-4559. Mgr.: John Anderson.  
**Home office:** Fairfield, N.J.  
Location Rec'g Serv., 2201 W. Burbank Blvd., Burbank 91506. Tel: 849-1321. Pres.: Allen J. Fraiberg; Gen. Mgr.: Steven A. Guy; Sales Mgr.: Kent Duncan.  
Modern Album of California Inc., 3104 Vanowen St., Burbank 91504. Tel: 845-7655. Pres. & Gen. Mgr.: James R. Gordon; Sales Mgr.: Carl Reinschild.  
**Home office:** New York, N.Y.  
Modern Tape Corp., 5810 S. Normandie Ave. Zip: 90044. Tel: 753-2481. Pres.: Joe Bihari; VP: Bob Demain.  
Edward Shaw & Assocs., 9887 Santa Monica Blvd., Beverly Hills 90212. Tel: 274-8307. Pres.: Edward S. Shaw; Gen. Mgr.: Charles E. Pike.  
Soltys Assocs., 5481 Santa Monica Blvd. Zip: 90029. Tel: 465-5605. Pres. & Mgr.: Gene Soltys.  
Superscope Rec'd Tape Div., 455 Fox St., San Fernando 91340. Tel: 365-1191. Pres.: Joseph S. Tushinsky; Gen. Mgr.: Richard L. Stover; Sales Mgr.: Richard O. Ware.  
T D K Electronics Corp., 6151 W. Century Blvd. Zip: 90045. Tel: OR 0-5515.  
**Home office:** New York, N.Y.  
Talent Assocs., 4024 Radford Ave., Studio City 91604. Tel: 763-8411. Art Dir.: Wayne Kimbell.

### ● SAN FRANCISCO & BAY AREA (Area Code 415)

- Charles Conlan Lithographers Inc., 1655 Folsom St. Zip: 94103. Tel: 431-7373. Pres.: Robert D. Conlan; VP & Sales Mgr.: Richard T. Conlan.  
Lights by Dr. Zarkov, 2146 Stuart, Berkeley 94705. Tel: 841-8524. Contact: Vince Catalaina.

### ● SAUGUS (Area Code 213)

- Keycor-Century Corp., 26000 Springbrook Rd. Zip: 91350. Tel: 365-3991. Pres.: Richard Keycor; Gen. Mgr.: A. P. McGuire; Mktg. Dir.: G. E. Disch.

### DELAWARE

#### ● WILMINGTON (Area Code 302)

- Ken-Del Prod'ns Inc., 111 Valley Rd., Richardson Park. Zip: 19804. Tel: 655-7488. Pres.: H. Edwin Kennedy; Gen. Mgr.: M. Leap.

### DISTRICT OF COLUMBIA

#### ● WASHINGTON (Area Code 202)

- M S A, 143 Kennedy St. NW, Suite 11. Zip: 20011. Tel: RA 3-4215. Pres.: Saul Menick.

# ROBERTS 450A

## 3-HEAD STEREO TAPE DECK

including  
1-MICRON GAP PLAY HEAD WITH LTG\*





\*Life-Time Guarantee  
to Original Owner

The smaller the gap, the higher the frequency response... and ROBERTS has narrowed the gap to an incredible 1/25,000th of an inch, making possible a superb frequency response! And as though that weren't enough, ROBERTS guarantees the Play Head for the life of the recorder to the original owner. (Replacement installation charges not included.) Show your customers this beautifully-engineered, elegantly-designed tape deck. Then tell them the price: just \$199.95.  
**And watch the frequency response of your sales go up!**

**OTHER FEATURES:** 3 Heads · Erase, Record, Playback · Sound-with-Sound · Tape Lifters · Built-in Tape Cleaner · 2 VU Meters · Automatic Stop · Stereo Headphone Jack · 2-Speed Operation · Other Professional Features

for complete information write to:  
The Pro Line  
**ROBERTS**  
Div. of Rheem Manufacturing Co.  
Los Angeles, California 90016

## FLORIDA

### ● MIAMI METROPOLITAN AREA (Area Code 305)

Adrian Assocs. Inc., 6660 Biscayne Blvd. Zip: 33138. Tel: 757-1626. Pres.: Michael Adrian; Gen. Mgr.: Gene Sayet; Sales Mgr.: Curt Witt.  
Criteria Rec'g Co. Inc., 1755 NE 149 St. Zip: 33161. Tel: 947-5611. Pres.: M. L. Emerman.  
Tape Dupl'rs of Florida, 785 W. 83 St., Hialeah 33014. Tel: 822-7585. Pres. & Gen. Mgr.: Aldo Vazquez.  
Unitel, 2515 NE 207 St., North Miami Beach 33160. Tel: 945-2819. Mng. Dir.: Charles H. Barkhaus.  
Universal Rec'g & Dist'g Corp., 170 W. 29 St., Hialeah 33010. Tel: 888-7411. Pres.: Matthew San Martin; Sales Mgr.: Frank Garcia.

## GEORGIA

### ● FAIRMOUNT (Area Code 404)

Jay-Cher Ent's., PO Box 175. Zip: 30139. Tel: 337-2510. Pres.: John Carter.

## ILLINOIS

### ● CHICAGO METROPOLITAN AREA (Area Code 312)

Album Graphics Inc., 745 N. Dearborn St. Zip: 60610. Tel: 642-9161. Pres. & Gen. Mgr.: Donald W. Kosterka; VP & Sales Mgr.: James Ladwig.  
Breidun Assocs., PO Box 744, Skokie 60076. Tel: 676-3722. Owner & Gen. Mgr.: Bill Dunn; Sales Mgr.: J. N. Breckenridge.  
M. M. Cole, 251 E. Grand. Zip: 60611. Tel: 527-2160. Pres.: Shepard Stern; Gen. Mgr.: A. Bernstein; Sales Mgr.: J. Davidson.  
Double Sixteen Co., PO Box 1616, 1028 College Ave., Wheaton 60187. Tel: 653-1616. Pres.: James W. Canon; Sales Mgr.: Thomas W. Canon.  
Espo Eng'g Corp., 5334 W. 65 St. Zip: 60638. Tel: 581-0123. Pres.: Eugene Esposito; VP & Gen. Mgr.: Donald J. Esposito; Sales Mgr.: Dennis Machul.  
Fort Dearborn Lithograph, 6035 W. Gross Point Rd. Zip: 60648. Tel: SP 4-4321. Pres.: Tom Adler; VP & Sales Mgr.: Richard J. Adler; Gen. Mgr.: Bernie Kelly.  
Ian Assocs. Inc., 8334 Kedvale, Skokie 60076. Tel: 674-3992. Pres.: Ian Scher; Sales Mgr.: Ronny Ross.  
International Rec'g Co., 1639 W. Evergreen. Zip: 60622. Tel: 227-2000. Pres.: Vern Ruvalds; VP & Gen. Mgr.: Jerome V. Man; Sales Mgr.: Leonard March.

J S & A Advertising, 2623 N. Pulaski Blvd. Zip: 60639. Tel: 342-6600. Pres.: Joseph Sugarman.  
Kiderian Recs. Prod'ns Ltd., 4926 W. Gunnison St. Zip: 60630. Tel: 545-0861. Pres.: Ray Peck; Sales Mgr.: Tom Petrelli.

J. S. Maloney Assocs., Box 628, Rt. 1, Batavia 60510. Tel: TR 9-5998. Pres.: John S. Maloney.  
T D K Electronics Corp., 2906 W. Peterson Ave. Zip: 60645. Tel: 973-1222. Pres.: Katsuro Kamiya; Gen. Mgr.: Kiyoshi Hiromoto; Sales Mgr.: Yoshiro Hirotsaka.  
Home office: New York, N.Y.

## INDIANA

### ● SOUTH BEND (Area Code 219)

Thomas Zoss Prod'ns, 1255 E. Madison. Zip: 46624. Tel: 232-2804. Pres.: Nikki A. Tompsett; Gen. Mgr.: Michael Chamberlin; Sales Mgr.: Warren Taylor.

## MARYLAND

### ● COCKEYSVILLE (Area Code 301)

International Telecomm Inc., Box 405. Zip: 21030. Tel: 666-7770. Pres.: F. J. Beste; VP & Sales Mgr.: Burgess Macneal Jr.

## MASSACHUSETTS

### ● BOSTON METROPOLITAN AREA (Area Code 617)

Continental Rec'gs Inc., 12 Irving St., Framingham 01701. Tel: 879-2430. Pres.: L. Daniel Flynn; Gen. Mgr.: John F. Flynn; Sales Mgr.: James Leshinski.

Fleetwood Rec'g Co. Inc., 321 Revere St., Revere 02151. Tel: 284-0750. Tape Mgr.: Raymond G. Samora; Sales Mgr.: Vincent P. Giarrusso.

### ● CHICOPEE (Area Code 413)

Album Design, 40 Marion St. Zip: 01013. Tel: 592-1789. Pres.: Robert S. Bator.

## MICHIGAN

### ● DETROIT METROPOLITAN AREA (Area Code 313)

Adell Corp., 43700 Adell Blvd., Novi 48050. Tel: 349-6300. Pres.: Robert Adell; Gen. Mgr.: Frank Adell; Sales Mgr.: Frank McLaughlin.

R. A. Carrier Music Co., 35224 Hatherly, Sterling Heights 48077. Tel: 268-1770. Pres.: R. A. Carrier; Gen. Mgr.: Hardie Daniel; Sales Mgr.: Dorothy Carrier.

Tape-Tronics, 750 Mandoline, Madison Heights 48071. Tel: 588-8281. Pres. & Sales Mgr.: Burton Mahler; VP & Gen. Mgr.: A. S. Hart.

## MINNESOTA

### ● MINNEAPOLIS-ST. PAUL AREA (Area Code 612)

Creative Impressions, 2614 Nicollet Ave. S., Suite 200, Minneapolis 55408. Tel: 827-3821. Pres.: Michael Jann; Sales Mgr.: David Wachter.  
E M C Corp., 180 E. Sixth St., St. Paul 55101. Tel: 227-7366. Pres.: David E. Feinberg; Customer Serv. Dir.: Patricia M. Stoohs.  
M M I Advertising/Mktg., 1415 N. Lilac Dr., Minneapolis 55422. Tel: 544-2606. Pres.: David Hersk; Gen. Mgr.: David Berkus; Sales Mgr.: William Morris.

## MISSOURI

### ● POPLAR BLUFF (Area Code 314)

Ken Keene & Assocs., PO Box 1068. Zip: 63901. Tel: 436-4281. Pres.: Ken Keene; Gen. Mgr.: R. W. Villinger; Sales Mgr.: Arthur Kraatz.

### ● ST. LOUIS (Area Code 314)

Allied Tape Corp., 1201 Research Blvd. Zip: 63132. Tel: 997-0016. Pres.: Byrle A. Northrup; Exec. VP: Robert F. Philpot; Gen. Mgr.: Roger Frederickson.

## NEBRASKA

### ● OMAHA (Area Code 402)

Liberty Tape Dupl'n, 1201 Pacific. Zip: 68108. Tel: 348-1770. Gen. Mgr.: Leo Colvin.

## NEW JERSEY

### ● FAIRFIELD (Area Code 201)

Livingston Audio Prods. Corp., 1275 Bloomfield Ave. Zip: 07006. Tel: 226-8300. Pres.: Darrell D. Scholten; VP Sales: Thomas J. Hofbauer. Branch: Los Angeles, Calif.

### ● MOORESTOWN (Area Code 609)

Kimco Tape Accessories, York House E., 214 W. Main St. Zip: 08057. Tel: 235-6332. Pres.: Theodore D. Cohen.

## NEW YORK

### ● BINGHAMTON (Area Code 607)

Creative Artists, 6 Van Ness Rd. Zip: 13905. Tel: 797-3909. Pres. & Opns. Mgr.: Johnathan K. Solak; Sales Mgr.: Charles Solak.

*continued on page 104*

# The KING of Tape Tailoring

## LOAD MORE CASSETTES EVERY DAY

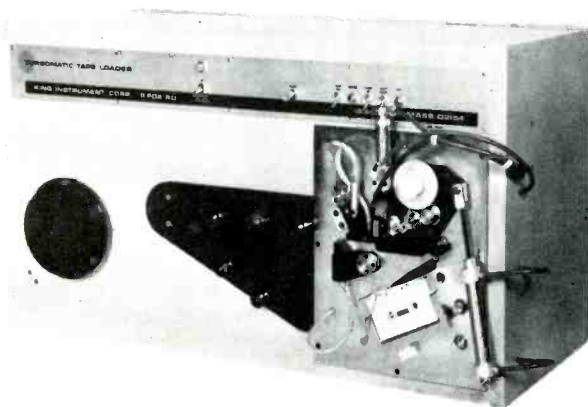

- Choice of models available to load:
  - Pre-leadered cassettes.
  - Pre-leadered hubs outside cassette.
  - Magnetic tape or pre-leadered tape staked directly to hubs before the cassette is assembled.
- 1,600 Cassettes per shift, per operator.
- Two loaders per operator.
- Blank or pre-recorded tape.
- AUTOMATIC SPLICING and CUTTING on pre-leadered models.
- Loose tape and leader ends handled by loader not by operator.
- Precisely controlled tape tension.
- Synchronized air turbines for gentle start and rapid acceleration.
- King loaded cassettes are qualified for computer use.

*King Instrument Corporation*

11 FOX ROAD / WALTHAM, MASS. 02154 / TEL. 899-5110

# THE FINEST CUSTOM DUPLICATING FIRM IN THE COUNTRY

## COMPLETE HIGH FIDELITY CASSETTE DUPLICATING SERVICES

- Two & Four Track
- Edu-Trak for Teaching Machines
- Mastering, etc.
- Labeling & Packaging
- Warehousing & Shipping



**Open Reel**  
Check our low, low prices

15 YEARS' EXPERIENCE IN DUPLICATING WORK

## CASSETTE DEVELOPMENT CORPORATION

Sales  
295 Madison Ave.  
(212) 683-9811

A DIVISION OF *Avery & Elkins, Inc.*

Plant  
653 Eleventh Ave.  
(212) JU 6-6235

# MODERN ALBUM

"Sound Packaging for the Music Industry"

- TAPES
- RECORDS
- SPECIALTY PACKAGING

New York, Indiana, California,  
New Jersey; Toronto, Canada

## TAPE SERVICES

Continued from page 103

- **COPIAGUE, L.I. (Area Code 516)**  
Dubblings Electronics Inc., 1305 S. Strong Ave. Zip: 11726. Tel: 893-1000. Pres.: Paul C. Smith; Opns. Mgr.: P. M. Shooer; Sales Mgr.: Michael Thaler.
- **HAUPPAUGE, L.I. (Area Code 516)**  
Globe Albums Inc., Gilpin Ave. Zip: 11787. Tel: 234-1100; NYC Tel: (212) 291-7600. Pres.: Lee Halpern; Gen. Mgr.: Leo Margolies; Sales Mgr.: Howard Roseff.
- **NEW YORK CITY (Area Code 212)**  
George Alexander Printing Corp., 36-25 Prince St., Flushing 11354. Tel: 886-5600. Pres.: Kev Devejian; Gen. Mgr.: Fred Hass; Sales Mgr.: Jimmy Gielbert.  
Alexis Adv. Co., 147 W. 42 St. Zip: 10036. Tel: 524-4138. Pres.: Alexis DeJesus.  
Artwork: Plain & Fancy, 176 1/2 E. 75 St. Zip: 10021. Tel: RE 4-4000. Pres. & Sales Mgr.: Alan Hartwell.  
Associated Design, 360 E. 65 St. Zip: 10021. Tel: 249-1904. Pres.: Alan Wolsky.  
Atelier 57 Ltd., 24 W. 57 St. Zip: 10019. Tel: 245-8938. Pres.: Stephen P. Haas.  
Ely Besalel Ltd., 156 E. 52 St. Zip: 10022. Tel: 759-7820. Pres.: Ely Besalel; Gen. Mgr.: Anita Calef.  
Tad Brown Inc., 301 E. 47 St. Zip: 10017. Tel: 753-6456. Pres.: Tad Dejewski.  
Cassette Rec'g Corp., 41-34 27 St., Long Island City 11101. Tel: 937-3344. Pres.: Carl Lustig; Gen. Mgr.: Matthew Polakoff; Sales Mgr.: Chuck Barclay.  
Farmlett, Barsanti & Assocs. Inc., 1182 Broadway. Zip: 10001. Tel: 686-8230. Pres.: Anthony Barsanti; VP: Harry Farmlett.  
Joel Frederick Guerin Prod'ns, 292-3 Central Park West, Suite 4C. Zip: 10023. Pres.: Joel Frederick Guerin; Gen. Mgr.: Robert M. Klein; Sales Mgr.: Paul Wilcynsky.  
Hartwell Magicolor Printing, 825 Madison Ave. Zip: 10021. Tel: 734-4000. Pres.: Alan Hartwell; Gen. & Sales Mgr.: Austin P. O'Brien.  
Lee-Myles Assocs., 160 E. 56 St. Zip: 10022. Tel: 758-3232. Pres.: Robert M. Miller.  
MacMurray Press Inc., 22 Jones St. Zip: 10014. Tel: WA 4-1530. Pres. & Sales Mgr.: Max Finesmith; Gen. Mgr.: Arthur Gray.  
The Music Agency Ltd., 888 Eighth Ave. Zip: 10019. Tel: 765-2154. Pres.: Jay Leipzig; Gen. Mgr.: Joe Borowka.  
Profile Press, 245 Seventh Ave. Zip: 10001. Tel: 675-3144. Mgr.: Fred R. Siegle.  
Progressive Label Co., 286-290 Stanhope St., Brooklyn 11237. Tel: HY 7-2320. Pres. & Sales Mgr.: Jerome J. Rood; VP: Bernard Stein.  
Queens Lithographing Corp., 52-35 Barnett Ave., Long Island City 11104. Tel: 457-7700. Pres.: Jack L. Hecht; VP: Eric Kaltman.  
Random Advertising/Leo Litho, 156 Fifth Ave. Zip: 10010. Tel: BU 8-6000. Pres. & Gen. Mgr.: Leo Elner; Sales Mgr.: S. J. Schiada.  
Sound Packaging Corp., 56 E. 53 St. Zip: 10022. Tel: 421-8255. Pres.: Craig Braun; VP & Gen. Mgr.: Anthony Grabois.  
T D K Electronics Corp., 23-73 48 St., Long Island City 11103. Tel: 721-6881. Pres.: H. Kawamura; Mktg. Mgr.: George T. Saddler; Sales Mgr.: A. Otsuka.  
Branches: Los Angeles, Calif.; Chicago, Ill.  
Int'l Branch: Japan.

## OHIO

- **AKRON (Area Code 216)**  
United Promotional Prod'ns, PO Box 6015. Zip: 44312. Sales Mgr.: Roma Smith; Promo. Dir.: Bill Cruise.
- **CINCINNATI (Area Code 513)**  
Queen City Album Inc., 2832 Spring Grove Ave. Zip: 45225. Tel: 681-8400. Pres.: Edward R. Bosken; Gen. Mgr.: Chet Barnett.  
Rite Rec. Prod'ns Inc., 9745 Lockland Rd. Zip: 45215. Tel: 733-5533.
- **CLEVELAND (Area Code 216)**  
Associated Inds. Inc., 2150 Hamilton Ave. Zip: 44114. Tel: 696-3773. VP: Robert W. Schachner; Gen. Mgr.: William Larence.
- **COLUMBUS (Area Code 614)**  
Harmonic Sounds Inc., 1482 Felix Dr. Zip: 43207. Tel: 491-1461. Pres.: Clem Price Jr.; Gen. Mgr.: George D. Beter; Sales Mgr.: Minola Price.
- **DAYTON (Area Code 513)**  
Dynaphonics Inc., 2975 Far Hills Ave. Zip: 45419. Tel: 294-0347. Pres.: Drummond F. Gaines; Gen. Mgr.: Dr. Fran Jones; Sales Mgr.: Jim Hartsock.
- **OBERLIN (Area Code 216)**  
Collegiate Art & Design, PO Box 161. Zip: 44074. Pres.: Paul J. Wilczynski; Gen. Mgr.: Robert Klein.

continued on page 106



# Anyone can learn to print tape graphics at your expense.

Just because tape graphics are small, you might think anyone can print them.

But you'd be wrong.

Printing tape graphics is tough.

It takes an expert to handle the sophisticated materials and many complex finishing operations needed to produce the final product.

Forget any problems in translating record graphics to tapes. Just give us the selection number and program information. We'll take it from there . . . design to mechanicals.

We've got a complete plant set up to manufacture nothing but tape graphics, including heatseal and pressure sensitive materials.

Queens Litho can supply you with just about every kind of tape packaging there is. If you have an idea for something different, we'll even help you develop it.

We'll never charge you extra for standard die-cuts because we've got dies for every tape style.

And our round-the-clock operation can give you delivery as fast as you need it, regardless of quantity.

It all means that we make your job easier.

**Queens Lithographing Corporation**

52-35 Bennett Avenue • Long Island City, N.Y. 11104 • (212) 457-7700

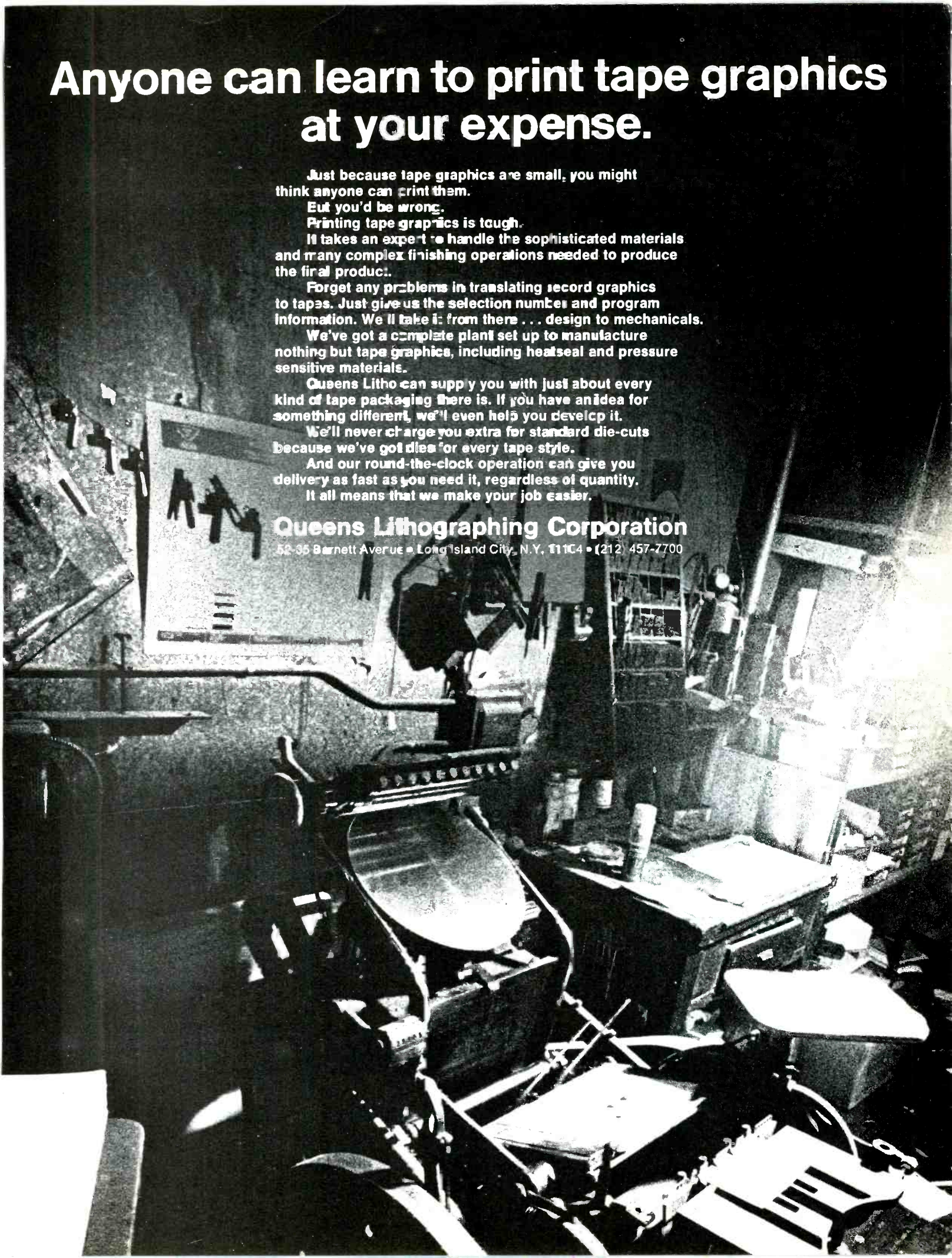

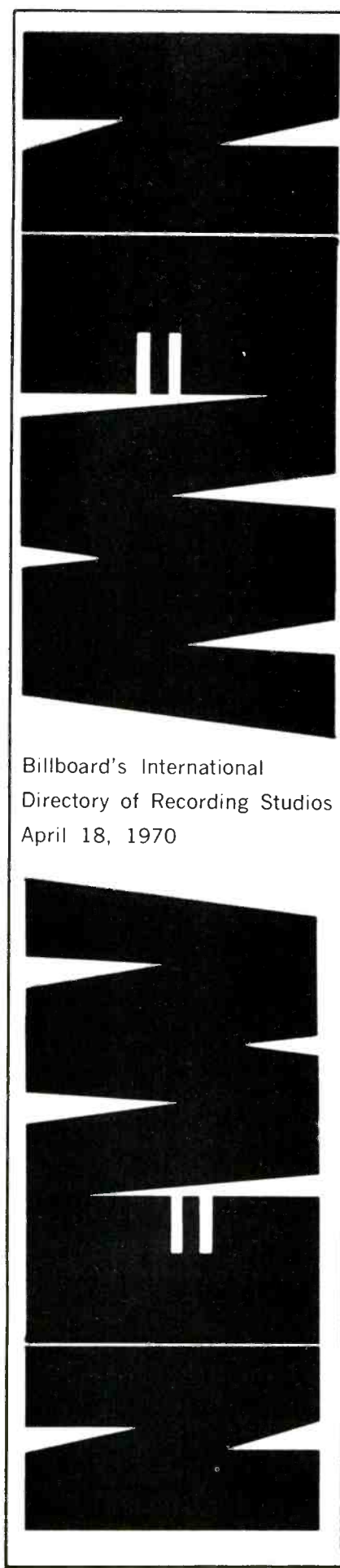

Billboard's International  
Directory of Recording Studios  
April 18, 1970

## TAPE SERVICES

Continued from page 104

### PENNSYLVANIA

- **PHILADELPHIA (Area Code 215)**  
Diskmakers Inc., 925 N. Third St. Zip: 19123. Tel: MA 7-2277. Pres.: Morris Ballen; Gen. Mgr.: John Fermani.
- **SCRANTON (Area Code 717)**  
Ladd Music Co., 401 Wintermantle Ave. Zip: 18505. Tel: 343-6718. Pres.: Phil Ladd; Gen. Mgr.: Joyce Shandra; Sales Mgr.: John Poplawski.
- **SHARON (Area Code 412)**  
Marion Recs., 159 Easton Rd. Zip: 16146. Tel: 347-4726. Pres.: John Krizancic; Sales Mgr.: Martha Krizancic.

### TENNESSEE

- **NASHVILLE (Area Code 615)**  
Dan Quest Art Studio, 1905 Broadway. Zip: 37203. Tel: 242-5305. Pres.: Dan Quest.  
Southern Album Serv. Inc., Box 303. Zip: 37202. Tel: 254-1022. Pres.: Charles Potter Jr.; Exec. VP & Mgr.: Betty C. Cox.

### WASHINGTON

- **OLYMPIA (Area Code 206)**  
Northwest Publ'g Co., 1915 N. Quince. Zip: 98501. Tel: 352-9097. Pres.: Allen P. Giles; Gen. Mgr.: Tom McMurcagic.

### WISCONSIN

- **ELKHART LAKE (Area Code 414)**  
Sohn Mfg. Inc., PO Box X. Zip: 53020. Tel: 876-3361. Pres.: A. O. Sohn; Sales Mgr.: Fred Lubeley.
- **SAUK CITY (Area Code 608)**  
Cuca Rec. Corp., 123 Water St. Zip: 53583. Tel: 643-3304. Pres.: Jim Kirchstein; Gen. & Sales Mgr.: Art Sullivan.

## PACKAGING & LABELING

### CALIFORNIA

- **LOS ANGELES METROPOLITAN AREA (Area Code 213)**  
A T D (American Tape Dupl'rs Inc.), 5727 W. Jefferson Blvd. Zip: 90016. Tel: 870-6832. Pres.: Richard Allen; Exec. VP: Warren D. Gray; VP Sales & Mktg.: Jay Leanse.  
Abbey Tape Dupl'rs, 737 N. Seward St., Hollywood 90038. Tel: 464-4554. Owner & Mgr.: Norman C. Cooke.  
Able Turntable & Tape, 6912 Hollywood Blvd., Hollywood 90028. Tel: 466-8338. Pres. & Sales Mgr.: Ted Gardner.  
Advance Recs., 6376 Yucca St., Hollywood 90028. Tel: 463-2151. Pres.: Tim Gayle; Gen. Mgr.: Mordy Perrigo; Sales Mgr.: Eddie Edwards.  
Allied Rec. Co., 2423 E. 57 St. Zip: 90058. Tel: 582-0841. VP: Jack Wagner.  
Audio Physics Inc., 16449 Vanowen St., Van Nuys 91406. Tel: 782-3638. Pres.: Don Washbrook; Gen. Mgr.: John David; Sales Mgr.: Bill Richards.  
Bertco Ents., 1855 Glendale Blvd. Zip: 90026. Tel: 665-5137. Pres.: Bert Couturier; VP Mktg.: R. J. Hein; Gen. Mgr.: Robert Couturier.  
Communitronics Inc., 626 S. Hudson Ave. Zip: 90005. Tel: WE 1-6111. Pres.: G. David Schine.  
Container Kraft Inc., 724 E. 61 St. Zip: 90001. Tel: 232-3281. Pres.: Arthur Garson.  
El Mar Plastics, 1940 W. 144 St., Gardena 90249. Tel: 327-1540. Pres.: Harry Schor; Sales Mgr.: Allen Schor.  
Product: Cassette boxes.  
Hurst Tape & Label, 4138 Eagle Rock Blvd. Zip: 90065. Tel: 256-4147. Pres.: Sam Allenberg; Gen. Mgr.: Lloyd Cannon.  
Livingston Audio Prods. Corp., 10687 Santa Monica Blvd., West Los Angeles 90025. Tel: 474-4559. Mgr.: John Anderson.  
Home office: Fairfield, N.J.  
Location Rec'g Serv., 2201 W. Burbank Blvd., Burbank 91506. Tel: 849-1321. Pres.: Allen J. Fraiberg; Gen. Mgr.: Steven A. Guy; Sales Mgr.: Kent Duncan.  
Magtec (Magnetic Tape Eng'g Corp.), 8120 Webb Ave., North Hollywood 91605. Tel: 875-1707. Pres.: S. Gerald Stone; VP & Mktg.: James S. Walker; Gen. Mgr.: Kenneth S. Goates.  
Modern Album of California Inc., 3104 Vanowen St., Burbank 91504. Tel: 845-7655. Pres. & Gen. Mgr.: James R. Gordon; Sales Mgr.: Carl Reinschild.  
Home office: New York, N.Y.  
Modern Tape Corp., 5810 S. Normandie Ave. Zip: 90044. Tel: 753-2481. Pres.: Joe Bihari; VP: Bob Demain.

- Monarch Tape Dupl'g, 3416-20 Vineyard Ave. Zip: 90016. Tel: 731-2228.
- Playmate Inds. Inc., 14505 E. Proctor Ave., Industry 91747. Tel: 968-5641. Pres.: Ted Ritz; Gen. Mgr.: Joe Richtarcik; Sales Dir.: R. F. Atkinson.
- Simpac Int'l Inc., 1643 19 St., Santa Monica 90404. Tel: 393-7353. Pres. & Gen. Mgr.: Robert Wallace; Sales Mgr.: A. R. Robbins.  
Product: Cassette boxes.
- Soltys Assocs., 5481 Santa Monica Blvd. Zip: 90029. Tel: 465-5605. Pres. & Mgr.: Gene Soltys.
- T D K Electronics Corp., 6151 W. Century Blvd. Zip: 90045. Tel: OR 0-5515.  
Home office: New York, N.Y.

- **MONROVIA (Area Code 213)**

- Avery Label Co., 1616 S. California. Zip: 91016. Tel: 357-1131. Pres.: S. Russell Smith; Gen. Mgr.: Richard J. Pearson; Sales Mgr.: J. J. Johnston; Adv. Mgr.: W. D. Sarnoff.

- **SAN FRANCISCO & BAY AREA (Area Code 415)**

- Gopher Prods. Corp., Box 812, Berkeley 94701. Tel: 843-5836. Pres.: Burf Perkins.

- **SAN JOSE (Area Code 408)**

- Data Technology Corp., Cassette Div., 1600 Las Plumas Ave. Zip: 95133. Tel: 272-0300. Pres.: Luigi Contini; Gen. Mgr.: Thomas Lazor; Mktg. Dir.: Raymond Valle; Sales Mgr.: William Patsuris.  
Product: Cassette boxes.

- **SAUGUS (Area Code 213)**

- Keysor-Century Corp., 26000 Springbrook Rd. Zip: 91350. Tel: 365-3991. Pres.: Richard Keysor; Gen. Mgr.: A. P. McGuire; Mktg. Dir.: G. E. Disch.

### CONNECTICUT

- **STAMFORD (Area Code 203)**

- Cook Labs. Inc., 351 Courtland Ave. Zip: 06906. Tel: 348-7578. Pres.: Emory Cook; Sales Mgr.: John R. Moriarty.

- **WATERBURY (Area Code 203)**

- Infodex Cassette Corp., 7 Cherry Ave. Zip: 06702. Tel: 757-9291. Pres.: Roger S. Swain; Gen. Mgr.: John W. Berry; Sales Mgr.: Ernest H. Ulm.

## EL MAR PLASTICS

Preleaded Cassettes

Unassembled Cassettes  
and Components

Norelco Style Boxes  
¼" Tape Reels

Video Tape Reels ½"

Reels for Bulk  
Cassette Tape

Specialists in Plastics for  
Magnetic Recording Tape

## EL MAR PLASTICS

1940 W. 144th St.  
Gardena, Calif. 90249  
(213) 327-1540

## DELAWARE

### • WILMINGTON (Area Code 302)

Alloy Surfaces Co. Inc. (sub. of Reeves Inds.), 100 S. Justison St. Zip: 19899. Tel: 655-6344. Pres.: George H. Cook; Plastics Div. & Sales Mgr.: Charles S. Muefler.  
Product: Cassette boxes.

Ken-Del Prod'ns Inc., 111 Valley Rd., Richardson Park. Zip: 19804. Tel: 655-7488. Pres.: H. Edwin Kennedy; Gen. Mgr.: M. Leap.

## FLORIDA

### • MIAMI METROPOLITAN AREA (Area Code 305)

Adrian Assocs. Inc., 6660 Biscayne Blvd. Zip: 33138. Tel: 757-1626. Pres.: Michael Adrian; Gen. Mgr.: Gene Sayet; Sales Mgr.: Curt Witt.  
Tape Dupl'rs of Florida, 785 W. 83 St., Hialeah 33014. Tel: 822-7585. Pres. & Gen. Mgr.: Aldo Vazquez.  
Universal Rec'g & Dist'g Corp., 170 W. 29 St., Hialeah 33010. Tel: 888-7411. Pres.: Matthew San Martin; Sales Mgr.: Frank Garcia.

## ILLINOIS

### • CHICAGO METROPOLITAN AREA (Area Code 312)

Custom Audio-JPL Rec. Co., 1088 Sixth Ave., Des Plaines 60016. Tel: 299-0220. Pres.: Paul H. Luftgens; Prod'n & Sales Mgr.: Thomas E. Larsen.  
Double Sixteen Co., PO Box 1616, 1028 College Ave., Wheaton 60187. Tel: 653-1616. Pres.: James W. Canon; Sales Mgr.: Thomas W. Canon.  
Espo Eng'g Corp., 5334 W. 65 St. Zip: 60638. Tel: 581-0123. Pres.: Eugene Esposito; VP & Gen. Mgr.: Donald J. Esposito; Sales Mgr.: Dennis Machul.  
J. S. Maloney Assocs., Box 628, Rt. 1, Batavia 60510. Tel: TR 9-5998. Pres.: John S. Maloney.  
T D K Electronics Corp., 2906 W. Peterson Ave. Zip: 60645. Tel: 973-1222. Pres.: Katsuro Kamiya; Gen. Mgr.: Kiyoshi Hiromoto; Sales Mgr.: Yoshiro Hirotsaka.  
Home office: New York, N.Y.

## INDIANA

### • SOUTH BEND (Area Code 219)

Thomas Zoss Prod'ns, 1255 E. Madison. Zip: 46624. Tel: 232-2804. Pres.: Nikki A. Tompsett; Gen. Mgr.: Michael Chamberlin; Sales Mgr.: Warren Taylor.

### • TERRE HAUTE (Area Code 812)

Modern Album & Finishing Co., 1299 Voorhees St. Zip: 47808. Tel: 235-6001. Gen. Mgr.: Richard Fields.  
Home office: New York, N.Y.  
Woodburn Printing Co., 25 S. Sixth. Zip: 47808. Tel: 232-0164. Pres.: R. Woodburn.

## MARYLAND

### • COCKEYSVILLE (Area Code 301)

International Telecomm Inc., Box 405. Zip: 21030. Tel: 666-7770. Pres.: F. J. Beste; VP & Sales Mgr.: Burgess Macneal Jr.

## MASSACHUSETTS

### • BOSTON METROPOLITAN AREA (Area Code 617)

Continental Rec'gs Inc., 12 Irving St., Framingham 01701. Tel: 879-2430. Pres.: L. Daniel Flynn; Gen. Mgr.: John F. Flynn; Sales Mgr.: James Leshinski.  
Data Packaging Corp., 205 Broadway, Cambridge 02139. Tel: 868-6200. Pres.: Otto Morningstar; VP: Larry A. Grundy; Gen. Mgr.: William Stevens; Sales Mgr.: George Gross.  
Product: Complete service for cartridges & cassettes.

## MICHIGAN

### • DETROIT METROPOLITAN AREA (Area Code 313)

Tape-Tronics, 750 Mandoline, Madison Heights 48071. Tel: 588-8281. Pres. & Sales Mgr.: Burton Mahler; VP & Gen. Mgr.: A. S. Hart.

## MINNESOTA

### • ST. PAUL (Area Code 612)

E M C Corp., 180 E. Sixth St. Zip: 55101. Tel: 227-7366. Pres.: David E. Feinberg; Customer Serv. Dir.: Patricia M. Stooths.

## MISSOURI

### • ST. LOUIS (Area Code 314)

Allied Tape Corp., 1201 Research Blvd. Zip: 63132. Tel: 997-0016. Pres.: Byrl A. Northrup; Exec. VP: Robert F. Philpot; Gen. Mgr.: Roger Frederickson.

## NEBRASKA

### • OMAHA (Area Code 402)

Liberty Tape Dupl'n, 1201 Pacific. Zip: 68108. Tel: 348-1770. Gen. Mgr.: Leo Colvin.

## NEW JERSEY

### • BERGENFIELD (Area Code 201)

Custom Label & Tag Corp., 112 S. Washington Ave. Zip: 07621. Tel: 384-8500. Pres.: Anthony Ippolito; Sales Mgr.: Ralph Kerner.  
Product: Printed labels.

### • CARLSTADT (Area Code 201)

Cassette Corp. of America, 640 S. Commercial Ave. Zip: 07072. Tel: 933-9125. Pres.: Walter Elterman; Gen. Mgr.: Allen Braverman; Mktg. Dir.: Arthur F. Etro; Sales Mgr.: Milton Blutter.  
Product: Cassette boxes.

### • DOVER (Area Code 201)

Audio Communications Inc., Rt. 10, Randolph Ind'l Park. Zip: 07801. Tel: 361-7600. Pres.: E. Michael Daspin; Sales Mgr.: Thomas J. Malia.

### • FAIRFIELD (Area Code 201)

Livingston Audio Prods. Corp., 1275 Bloomfield Ave. Zip: 07006. Tel: 226-8300. Pres.: Darrell D. Scholtzen; VP Sales: Thomas J. Hofbauer.  
Branch: Los Angeles, Calif.

### • HOBOKEN (Area Code 201)

New Jersey Machine Corp., 16 St. & Willow Ave. Zip: 07030. Tel: 659-0483; NYC Tel: (212) 943-6122. Pres.: Dick Wellbrock; Exec. VP: Art Schaefer; Nat'l Sales Mgr.: Ken Leeson.  
Product: Labeling & cartoning machines.

### • MOORESTOWN (Area Code 609)

Tape Servs. Inc., 100 York House E., 214 W. Main St. Zip: 08057. Tel: 235-6332. Pres. & Gen. Mgr.: W. F. Mulcahy.

### • NEWARK (Area Code 201)

Celanese Plastics Co. (div. of Celanese Corp.), 550 Broad St. Zip: 07102. Tel: 877-2300. Pres.: Robert T. Daily; Gen. Mgr.: T. J. Welsh; Sales Mgr.: J. B. Mitchell.  
Product: Cellulose acetate sheet & propionate sheet for blister packaging.  
Newark Phono Labels (div. of Folkraft Publ'g Co.), 1159 Broad St. Zip: 07114. Tel: 622-0024. Pres.: J. Shifrin; Gen. Mgr.: Len DeValle.

Recording for



# BRAD SWANSON

AMERICA'S NO. 1 ORGANIST

NOW ON CASSETTE  
AND 8-TRACK

THE WHISPERING ORGAN  
SOUND OF BRAD SWANSON

8 Track TT-8-9001;  
Cassette TH 8-9001

PEG OF MY HEART

8 Track TT 8-9002;  
Cassette TH 8-9002

THOSE WERE THE DAYS

8 Track TT 8-9003;  
Cassette TH 8-9003

QUENTIN'S THEME

8 Track TT 8-9004;  
Cassette TH 8-9004

LOVE MAKES THE WORLD  
GO ROUND

8 Track TT 8-9005;  
Cassette TH 8-9005

## A Great New Act!!

# THE SEVEN

with their first  
THUNDERBIRD RELEASE

THE SONG IS SONG—  
THE ALBUM IS ALBUM

8 Track TT 8-9006;  
Cassette TH 8-9006

Also for 1970 . . .

THE MOONLIGHTERS  
DALE McBRIDE  
DON REESE  
GAP MANGIONE

Distributed nationally by:

STEVE BRODIE, President  
THUNDERBIRD RECORDS  
c/o MASTERS RELEASING INC.

1790 Main St., Buffalo, N. Y. 14209  
(716) 882-0427, 882-7056

## Low-Down and Dirty!!!

our wildest album yet!

FUNNIER  
THAN  
REDD  
FOX

# LOW-DOWN AND DIRTY

BOLDER  
THAN  
HATTIE  
NOEL



Richard & Willie  
DTL 842  
STEREO

Uninhibited fun for  
"Adults Only"



ADULTS ONLY  
DTL 840  
REDD FOX

Daring, Spicy, Red Hot  
The latest and greatest

OTHER BEST  
SELLING HITS

## 8 TRACK STEREO CARTRIDGES & CASSETTES

REDD FOX

214 Laff of the Party	290 Redd Foxx Fun
219 Laff of the Party	295 Sly Sex
234 Best of Foxx	804 Wild Party
253 The Sidesplitter, I	809 This Is Foxx
270 The Sidesplitter, II	830 The New Fugg
274 Best of Party Fun	834 Crack Up
275 The Race Track	838 Naughties-Goodies

NEW RELEASES

840 Adults Only/Redd Foxx
842 Low Down and Dirty/Richard & Willie
843 Willie and Rising Dick/Richard & Willie
844 Big George's Party Jokes/George Kerr
845 Jokes I Can't Tell On T.V./Redd Foxx
846 Shedhouse Humor/Redd Foxx
847 Favorite Party Jokes/Redd Foxx
848 The Race Track/Richard & Willie

## RECORDS • CARTRIDGES • CASSETTES

# DOOTO RECORDS

13640 South Central Avenue / Los Angeles, California 90059

## TAPE SERVICES

Continued from page 107

### • NORTH BERGEN (Area Code 201)

Sarex Corp., 3850 West Side Ave. Zip: 07041.  
Tel: 864-9400; NYC Tel: (212) 227-6354. Pres.:  
O. Louis Seda; Exec. VP: D. Max Brightmore;  
Sales Eng.: William M. Blethen.  
Product: Cassette boxes & mailers.

### NEW YORK

#### • BINGHAMTON (Area Code 607)

Creative Artists, 6 Van Ness Rd. Zip: 13905. Tel:  
797-3909. Pres. & Opns. Mgr.: Johnathan K.  
Solak; Sales Mgr.: Charles Solak.

#### • COPIAGUE, L.I. (Area Code 516)

Dubbings Electronics Inc., 1305 S. Strong Ave. Zip:  
11726. Tel: 893-1000. Pres.: Paul C. Smith;  
Opns. Mgr.: P. M. Shoer; Sales Mgr.: Michael  
Thaler.

#### • FARMINGDALE, L.I. (Area Code 516)

Pressure Sensitive Tape & Label Corp., 135 Schmitt  
Blvd. Zip: 11735. Tel: 293-7304. Pres.: Daniel  
Cooper; Gen. Mgr.: Michael Cooper; Sales Mgr.:  
Frank R. Camp.

#### • FREEPORT, L.I. (Area Code 516)

Royal Sound Co. Inc., 409 N. Main St. Zip: 11520.  
Tel: 868-2880. Pres.: M. A. Dayan; Gen. Mgr.:  
N. Greenburg; Sales Mgr.: J. Corbin.

J. J. Paulson Assocs., 24 Brooklyn Ave. Zip: 11520.  
Tel: 868-0491. Pres. & Gen. Mgr.: Jerry Katcher.

#### • HAUPPAUGE, L.I. (Area Code 516)

Globe Albums Inc., Gilpin Ave. Zip: 11787. Tel:  
234-1100; NYC Tel: (212) 291-7600. Pres.: Lee  
Halpern; Gen. Mgr.: Leo Margolies; Sales Mgr.:  
Howard Roseff.

#### • NEW YORK CITY (Area Code 212)

George Alexander Printing Corp., 36-25 Prince St.,  
Flushing 11354. Tel: 886-5600. Pres.: Kev Deve-  
jian; Gen. Mgr.: Fred Hass; Sales Mgr.: Jimmy  
Gielbert.

Artwork: Plain & Fancy, 176 1/2 E. 75 St. Zip: 10021.  
Tel: RE 4-4000. Pres. & Sales Mgr.: Alan Hart-  
well.

Cable Machinery Corp., 156 Fifth Ave. Zip: 10010.  
Tel: 989-4434. Pres.: Sol Dubin; VP & Gen.  
Mgr.: Leonard Ripley; Sales Mgr.: V. J. DePaul.

Cassette Data Corp. (div. of Avery & Elkins Inc.),  
653 11 Ave. Zip: 10036. Tel: 586-6235. Pres.:  
Julius Elkins; Sales Mgr.: Ron Silberman.

Cassette Development Corp. (div. of Avery & Elkins  
Inc.), 653 11 Ave. Zip: 10036. Tel: 586-6235.  
Pres.: Julius Elkins; Sales Mgr.: Ron Silberman.

Cassette Rec'g Corp., 41-34 27 St., Long Island  
City 11101. Tel: 937-3344. Pres.: Carl Lustig;  
Gen. Mgr.: Matthew Polakoff; Sales Mgr.:  
Chuck Barclay.

Lee-Myles Assocs., 160 E. 56 St. Zip: 10022. Tel:  
758-3232. Pres.: Robert M. Miller.

Linear Prods. Inc., 37 W. 20 St. Zip: 10011. Tel:  
255-2917. Pres.: Robert Irwin; Gen. Mgr.:  
Frank Vogel.

MacMurray Press Inc., 22 Jones St. Zip: 10014.  
Tel: WA 4-1530. Pres. & Sales Mgr.: Max Fine-  
smith; Gen. Mgr.: Arthur Gray.

Metra Electronics Corp., 660 McDonald Ave., Brook-  
lyn 11218. Tel: 871-4100. Pres. & Sales Mgr.:  
Charles R. Fox.

Modern Album & Finishing Co. Inc., 119-01 22 Ave.,  
College Point, L.I. 11356. Tel: 353-5701. Pres.:  
Miss G. D. Thomas; VP Sales: Guy M. Froehlig;  
Gen. Mgr.: Donald House.  
Branches: Los Angeles, Calif.; Terre Haute, Ind.

Passantino Printing Co. Inc., 250 W. 49 St. Zip:  
10019. Tel: JU 6-1540. Pres.: Charles V. Pas-  
santino; Gen. Mgr.: Robert Passantino.

Plastic-Ware Inc., 1100 Leggett Ave., Bronx 10474.  
Tel: 991-0100. VP: William DeMucci; Sales  
Mgr.: Phil Lazarus.  
Product: Cases.

Progressive Label Co., 286-290 Stanhope St., Brook-  
lyn 11237. Tel: HY 7-2320. Pres. & Sales Mgr.:  
Jerome J. Rood; VP: Bernard Stein.

Queens Lith'g Corp., 52-35 Barnett Ave., Long  
Island City 11104. Tel: 457-7700. Pres.: Jack  
L. Hecht; VP: Eric Kaltman.

Shorewood Packaging Corp., 724 Fifth Ave. Zip:  
10019. Tel: 582-6885. Pres.: Paul Shore; VP  
Mktg.: Floyd Glinert.

Sound Packaging Corp., 56 E. 53 St. Zip: 10022.  
Tel: 421-8255. Pres.: Craig Braun; VP & Gen.  
Mgr.: Anthony Grabois.

T D K Electronics Corp., 23-73 48 St., Long Island  
City 11103. Tel: 721-6881. Pres.: H. Kawamura;  
Mktg. Mgr.: George T. Sandler; Sales Mgr.:  
A. Otsuka.

Branches: Los Angeles, Calif.; Chicago, Ill.  
Int'l branch: Japan.

Edward R. White Inc., 18 E. 41 St. Zip: 10017. Tel:  
657-2167. Pres.: Lawrence Goldstein.

### OHIO

#### • CINCINNATI (Area Code 513)

Queen City Album Inc., 2832 Spring Grove Ave. Zip:  
45225. Tel: 681-8400. Pres.: Edward R. Bosken;  
Gen. Mgr.: Chet Barnett.

#### • CLEVELAND (Area Code 216)

Associated Inds. Inc., 2150 Hamilton Ave. Zip:  
44114. Tel: 696-3773. VP: Robert W. Schach-  
ner; Gen. Mgr.: William Lawrence.

#### • COLUMBUS (Area Code 614)

Harmonic Sounds Inc., 1482 Felix Dr. Zip: 43207.  
Tel: 491-1461. Pres.: Clem Price Jr.; Gen.  
Mgr.: George D. Beter; Sales Mgr.: Minola  
Price.

#### • DAYTON (Area Code 513)

Dynaphonics Inc., 2975 Far Hills Ave. Zip: 45419.  
Tel: 294-0347. Pres.: Drummond F. Gaines;  
Gen. Mgr.: Dr. Fran Jones; Sales Mgr.: Jim  
Hartscock.

### PENNSYLVANIA

#### • PHILADELPHIA METROPOLITAN AREA (Area Code 215)

Allentown Rec. Co. Inc., 1002 Walnut St., Allentown  
18102. Tel: 433-7405. Pres.: S. L. Martell.

Fenton Label Co., Coral & Buckius Sts. Zip: 19124.  
Tel: CU 8-2910. Pres. & Sales Mgr.: John  
Kirby Tompkins III; Gen. Mgr.: Floyd L. Tomp-  
kins; Adv. Mgr.: A. Uknalis.

#### • SCRANTON (Area Code 717)

Ladd Music Co., 401 Wintermantle Ave. Zip: 18505.  
Tel: 343-6718. Pres.: Phil Ladd; Gen. Mgr.:  
Joyce Shandra; Sales Mgr.: John Poplawski.

### WISCONSIN

#### • ELKHART LAKE (Area Code 414)

Sohn Mfg. Inc., PO Box X. Zip: 53020. Tel: 876-  
3361. Pres.: A. O. Sohn; Sales Mgr.: Fred  
Lubeley.

### WYOMING

#### • CHEYENNE (Area Code 307)

Rocky Mountain Rec'g, PO Box 82. Zip: 82001.  
Tel: 638-8733. Pres. & Gen. Mgr.: Ray Alex-  
ander.

## PRINTING & LITHOGRAPHING

### CALIFORNIA

#### • EL MONTE (Area Code 213)

Graham Printing (div. of Keyser-Century Corp.), 1751  
Floradale Ave., South El Monte 91733. Tel:  
443-6938.

#### • LOS ANGELES METROPOLITAN AREA (Area Code 213)

A T D (American Tape Dupl'rs Inc.) 5727 W. Jeffer-  
son Blvd. Zip: 90016. Tel: 870-6832. Pres.:  
Richard Allen; Exec. VP: Warren D. Gray; VP  
Sales & Mktg.: Jay Leanse.

Abbey Tape Dupl'rs, 737 N. Seward St., Hollywood  
90038. Tel: 464-4554. Owner & Mgr.: Norman  
C. Cooke.

Advance Recs., 6376 Yucca St., Hollywood 90028.  
Tel: 463-2151. Pres.: Tim Gayle; Gen. Mgr.:  
Mordy Perrigo; Sales Mgr.: Eddie Edwards.

Bertco Ents., 1855 Glendale Blvd. Zip: 90026. Tel:  
665-5137. Pres.: Bert Couturier; VP Mktg.: R.  
J. Hein; Gen. Mgr.: Robert Couturier.

Communitronics Inc., 626 S. Hudson Ave. Zip:  
90005. Tel: WE 1-6111. Pres.: G. David Schine.

Container Kraft Inc., 724 E. 61 St. Zip: 90001. Tel:  
232-3281. Pres.: Arthur Garson.

Custom Fidelity Inc., 7925 Santa Monica Blvd.,  
Hollywood 90046. Tel: 654-4522. Pres.: David  
W. Berkus; Sales Mgr.: Ellis Fertig.

Gilmore Envelope Corp., 4000 Medford St. Zip:  
90063. Tel: 268-3401. Pres.: Howard Gilmore.

Ivy Hill Lithograph Corp., 4800 S. Santa Fe Ave.  
Zip: 90058. Tel: 583-8974. Gen. Mgr.: Ben-  
jamin S. Imershein.  
Home office: Great Neck, N.Y.

continued on page 145

## INFODEX CASSETTES

High quality  
cassette duplicating  
All new plant  
Finest equipment  
Full technical staff  
Complete service

MASTERING • DUPLICATING  
LABELLING • PACKAGING

Large and small runs handled  
promptly and economically

INFODEX CASSETTE  
CORPORATION

7 Cherry Avenue Waterbury, Conn. 06702  
203-757-9291

# There's a Forbes in your future!



When you need the most reliable source  
for quality cassette and open reel tape.

**Forbes Electronics, Inc.**

19 Heyward St., Brooklyn, N.Y. 11211 • (212) 365-0600

# KUSTOM KREATIONS UNIQUE QUALITY LINE

## UNIVERSAL STEREO LOCK MOUNT

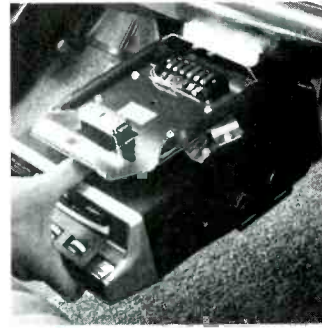
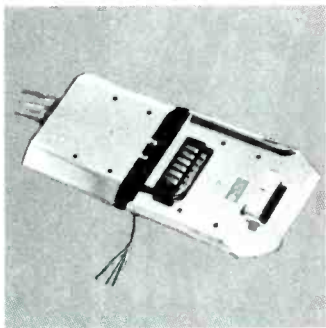

## CAR - HOME - BOAT - DUNE BUGGY PORTABLE

### THE NEW STEREO LOCK MOUNT:

- PREVENTS THE THEFT OF CAR STEREOS
- MAKES YOUR UNIT REMOVABLE
- MAKES ANY CAR STEREO PORTABLE
- TAKES JUST MINUTES TO INSTALL
- ADJUSTABLE AND ADAPTS TO ANY CAR STEREO, RADIO OR CB UNIT
- BEAUTIFULLY SKIN-PACKED FOR EASY STORAGE AND DISPLAY
- INCREASES SALES AND PROFITS
- RECOMMENDED BY INSURANCE COMPANIES
- FULLY WARRANTED
- Foreign Patent Pending • U.S. Patent Allowed

### MALE MOUNT



By removing your stereo when your car is left unprotected you insure safety from theft. The lock mount is universal, adjustable and adapts to any car stereo, radio or CB unit. Positive or negative ground — 6 or 12 volts.

An additional male mount makes it possible to play any car stereo in either home, boat or other car, with no screws or wires to disconnect.

## UNIVERSAL FLOOR MOUNT

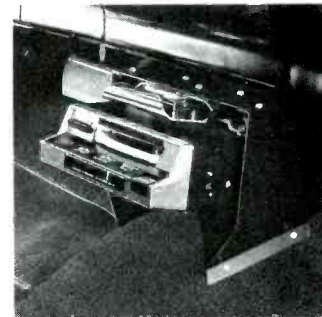
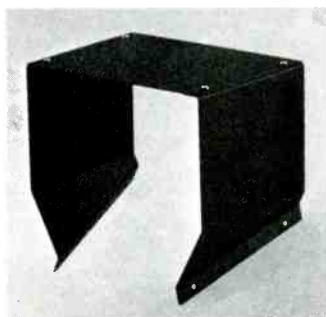

### THE NEW FLOOR MOUNT:

- ADJUSTABLE AND ADAPTS TO ANY CAR STEREO
- TAKES JUST MINUTES TO INSTALL
- MADE OF HEAVY GAUGE STEEL
- DISASSEMBLED IN PACKAGE FOR EASY STORAGE AND DISPLAY

ADAPTS TO OUR STEREO LOCK MOUNT WHICH PREVENTS THE THEFT OF CAR STEREOS.

- INCREASES SALES AND PROFITS
- FULLY WARRANTED

## UNIVERSAL CAR STEREO POWER CONNECTOR

### THE NEW CAR STEREO POWER CONNECTOR:

- ADAPTS TO ALL CAR STEREOS
- FITS ALL UNITS
- COMPLETELY FUSED
- REDUCES INVENTORY
- INCREASES PROFITS
- SENSATIONALLY PRICED
- AVAILABLE IN BULK OR SKIN-PACK
- PATENT PENDING



ONE PLUG FOR ALL

HERBERT KRAUSS CO.		B-21
4565 SHERMAN OAKS AVENUE SHERMAN OAKS, CALIFORNIA 91403		
<input type="checkbox"/> Send information.		
<input type="checkbox"/> Have representative call.		
NAME _____		
TITLE _____		
COMPANY _____		
STREET ADDRESS _____		
CITY _____	STATE _____	ZIP _____

# TAPE DEALER ACCESSORIES & SUPPLIES

*The following is a directory of manufacturers, listing the product available from each firm. After this master list is a breakdown by product category.*

- Adell Corp., 43700 Adell Blvd., Novi, Mich. 48050. Tel: (313) 349-6300. Pres.: Robert Adell; Gen. Mgr.: Frank Adell; Sales Mgr.: Frank McLaughlin. **Product:** Head cleaners & demagnetizers.
- Adrian Assocs. Inc., 6660 Biscayne Blvd., Miami, Fla. 33138. Tel: (305) 757-1626. Pres.: Michael Adrian; Gen. Mgr.: Gene Sayet; Sales Mgr.: Curt Witt. **Product:** Catalog servs., head cleaners.
- Advance Recs., 6376 Yucca St., Hollywood, Calif. 90028. Tel: (213) 463-2151. Pres.: Tim Gayle; Gen. Mgr.: Mordy Perrigo; Sales Mgr.: Eddie Edwards. **Product:** Browser boxes, display racks.
- George Alexander Printing Corp., 36-25 Prince St., Flushing, N.Y. 11354. Tel: (212) 886-5600. Pres.: Kev Devejian; Gen. Mgr.: Fred Hass; Sales Mgr.: Jimmy Gielbert. **Product:** Browser boxes, display racks.
- Amberg File & Index Co., 1625 Duane Blvd., Kankakee, Ill. 60901. Tel: (815) 933-3351. Sales Mgr.: Robert T. O'Neil; Adv. & Sales Promo. Dir.: Paul Hubart. **Product:** Carrying cases (Ampak).
- Ampex Corp., 401 Broadway, Redwood City, Calif. 94063. Tel: (415) 367-2641. Pres.: William E. Roberts; Gen. Mgr.: A. Sroka; Mktg. Mgr.: Tom Scholten; Sales Mgr.: Don Smith. **Product:** Head cleaners.
- Art-Phyl Creations, 508 Frelinghuysen Ave., Newark, N.J. 07114. Tel: (201) 248-5100. Sales Mgr.: Art Hochman; Adv. Mgr.: L. Siegler. **Product:** Browser boxes, display racks, peg-board hooks & mdsq. aids.
- Athena Inds. Inc., PO Box 42, LaGrange, Ill. 60525. Tel: (312) 485-6140. Pres.: D. N. G. Metcalf; VP & Sales Mgr.: D. J. Razez. **Product:** Carrying cases (Auto Butler).
- Atlas-Rand Corp., Keystone Pl., Paramus, N.J. 07652. Tel: (201) 262-7500; NYC Tel: (212) 563-6663. VP: Harold Rosen; Nat'l Tapes Sales Mgr.: Dick Price; Adv. Dir.: Stuart Better. **Product:** Head cleaners & demagnetizers.
- Audio Communications Inc., Rt. 10, Randolph Ind'l Park, Dover, N.J. 07801. Tel: (201) 361-7600. Pres.: E. Michael Daspin; Sales Mgr.: Thomas J. Malia. **Product:** Head cleaners & demagnetizers.
- Audio Devices Inc., 100 Research Dr., Glenbrook, Conn. 06906. Tel: (203) 327-6500. Pres.: W. A. Estabrook; VP Mktg. & Sales.: William L. Goldstein; Nat'l Sales Mgr.: A. P. Cunha. **Product:** Display racks.
- Audio Magnetics Corp., 14600 S. Broadway, Gardena, Calif. 90247. Tel: (213) 321-6841. Pres.: Irving B. Katz; Sales Mgr.: Ray Allen. **Product:** Head cleaners & demagnetizers, pre-leadered cassettes.
- Audio Physics Inc., 16449 Vanowen St., Van Nuys, Calif. 91406. Tel: (213) 782-3638. Pres.: Don Washbrook; Gen. Mgr.: John David; Sales Mgr.: Bill Richards. **Product:** Head cleaners.
- Audiotex, 400 S. Wyman, Rockford, Ill. 61109. Tel: (815) 968-9661. Pres.: A. C. Valiulis; VP: Steve Henwigan; Sales Mgr.: Ted Peterson. **Product:** Head cleaners & demagnetizers.
- B A S F Systems Inc., Crosby Dr., Bedford, Mass. 01730. Tel: (617) 271-4000. Pres.: D. Ambros; Mktg. Dir.: T. Dempsey; Audio Prod. Mgr.: H. Preston. **Product:** Starter kit.
- Guy Barry Ents. Inc., 92 Columbia Ave., Cedarhurst, N.Y. 11516. Tel: (516) 239-8227. Pres.: Guy Barry; Gen. Mgr.: M. Barry. **Product:** Browser boxes, display racks, head cleaners, storage cases.
- C B S Recs., Masterwork Audio Prod. Dept., 51 W. 52 St., New York, N.Y. 10019. Tel: (212) 765-4321. Masterwork Audio Prods. Dept. Dir.: Milton Selkowitz; Prod. Development Dir.: Richard F. Smith. **Product:** Carrying cases.
- Capitol Recs. Dist'g Corp., 1750 N. Vine St., Hollywood, Calif. 90028. Tel: (213) 462-6252. Pres.: Salvatore J. Iannucci; Sales Mgr.: John J. Jossey. **Product:** Carrying cases, display racks, head cleaners.
- Car Tapes Inc., 320 W. Ohio St., Chicago, Ill. 60610. Tel: (312) 943-5158. Pres.: James LeVitus; Sales Mgr.: Edwin Swire. **Product:** Convertors, display racks.
- Cartridge Stereo West Inc., 964 E. Colorado, Pasadena, Calif. 91101. Tel: (213) 681-2721. Pres.: Sidney Weisblat; VP: M. Weisblat. **Product:** Convertors.
- Cassette Corp. of America, 640 S. Commercial Ave., Carlstadt, N.J. 07072. Tel: (201) 933-9125. Pres.: Walter Elterman; Gen. Mgr.: Allen Braverman; Mktg. Dir.: Arthur F. Etro; Sales Mgr.: Milton Blutter. **Product:** Head cleaners & demagnetizers.
- Cassettes Int'l Inc., PO Box 80, Elmwood Park St., Chicago, Ill. 60635. Tel: (312) 889-0025. Pres.: Tom Kilfoyle; Gen. Mgr.: Oren Stempel; Sales Mgr.: Don Alger. **Product:** Storage cases, cassette storage cards.
- Certron Corp., 1701 S. State College Blvd., Anaheim, Calif. 92806. Tel: (714) 633-4280. Pres.: Edwin Gamson; Mktg. Admin. Dir.: Brian McCourt; Sales Mgr.: James Neiger. **Product:** Head cleaners.
- Channel Mktg. Inc., 26 Springdale Rd., Cherry Hill, N.J. 08034. Tel: (609) 424-3344. Pres.: Ronald Obsgarten; Gen. Mgr.: Arthur Zakharian; Sales Mgrs.: Arnold Kaminer & Mary Rabin; Adv. Dir.: Joseph A. McHugh Sr. **Product:** Burglar alarms, cartridge cleaners, display racks, dust covers, erasers, head cleaners & demagnetizers, maintenance kits, storage cases, tuners.
- Claricon Prods. Inc., 663 Dowd Ave., Elizabeth, N.J. 07201. Tel: (201) 289-4600. Pres.: H. Katovsky; VP Sales & Adv. Dir.: Robert Katovsky. **Product:** Demagnetizers, splicing tape.
- M. M. Cole, 251 E. Grand, Chicago, Ill. 60611. Tel: (312) 527-2160. Pres.: Shepard Stern; Gen. Mgr.: A. Bernstein; Sales Mgr.: J. Davidson. **Product:** Catalog servs., storage cases.
- Communications Electronics Inc., 7501 N. Broadway, Oklahoma City, Okla. 73114. Tel: (405) 848-2266. Pres.: Tommy Hoshall; VP: Richard Hainebach; Sales Mgr.: Joe Patrick. **Product:** Display racks.
- Creative Artists, 6 Van Ness Rd., Binghamton, N.Y. 13905. Tel: (607) 797-3909. Pres. & Opns. Mgr.: Jonathan K. Solak; Sales Mgr.: Charles Solak. **Product:** Storage cases.
- Custom Fidelity Inc., 7925 Santa Monica Blvd., Hollywood, Calif. 90046. Tel: (213) 654-4522. Pres.: David W. Berkus; Sales Mgr.: Ellis Fertig. **Product:** Head cleaners & demagnetizers.
- Data Packaging Corp., 205 Broadway, Cambridge, Mass. 02139. Tel: (617) 868-6200. Pres.: Otto Morningstar; VP: Larry A. Grundy; Sales Mgr.: George Gross. **Product:** Head cleaners.
- Decca Recs. (div. of MCA Inc.), 445 Park Ave., New York, N.Y. 10022. Tel: (212) 759-7500. Exec. VP: Jack Loetz; Nat'l Tape Prod. Mgr.: Joel A. Schneider; Sales Dir.: Harold Komisar. **Product:** Carrying cases, head cleaners & demagnetizers.
- Dictation Prods. Inc., 2525 Park Ln., Hallandale, Fla. 33009. Tel: (305) 981-6161. Pres.: Sy Scher; Gen. Mgr.: L. Schwartz; Sales Mgr.: M. Sebbah. **Product:** Head cleaners & demagnetizers.
- Dict-O-Tape Inc., 9090 Krier Pl., Brooklyn, N.Y. 11236. Tel: (212) 257-3355. Pres.: Erwin Damsky; VP & Gen. Mgr.: Rudy Schwartz; Sales Mgr.: Oscar Goren. **Product:** Display racks, head cleaners & demagnetizers.
- Display Equip. Co., 1016 First Ave. S., Seattle, Wash. 98134. Tel: (206) 763-8600. Pres.: Lou Lavinthal; Gen. & Sales Mgr.: Weldon Dalgoff. **Product:** Browser boxes, display racks, storage cases (DEMCO).

*continued on page 112*

# Ampak

## CARRYING CASES FOR TAPES

### CASSETTE CASES

The new Ampak® Double-Deck style case holds two dozen Cassettes. Twelve in a handy lift-out tray and twelve in the bottom compartment. Individual cells for each Cassette keep them free from dust, moisture and scratches. An attractive compact case, covered in luxurious gold and black plastic coated material. Red interior.



Smaller capacity cases for ten Cassettes are also popular items for Cassette owners. Ampak® makes several styles. Priced to sell.

STOCK NO. 1110



STOCK NO. 1124

### 4 & 8-TRACK CASES



STOCK NO. 1024

Write or call today for color brochure and complete information about Amberg's complete line of Ampak® Tape Cases.



Ampak® Tape Cases are made in several styles and capacities to meet the growing demand of 4 and 8-track tape owners. 10, 15 and 24 capacity cases are available at attractive prices. Ampak® cases are exceptionally well made and designed to appeal to all ages. Prompt delivery on all orders.

STOCK NO. 810



AMBERG FILE AND INDEX CO., KANKAKEE, ILLINOIS 60901, PHONE 815/933-3351

**TAPE DEALER  
ACCESSORIES & SUPPLIES**

*Continued from page 110*

Double Sixteen Co., PO Box 1616, 1028 College Ave., Wheaton, Ill. 60187. Tel: (312) 653-1616. Pres.: James W. Canon; Sales Mgr.: Thomas W. Canon.

**Product:** Storage cases (Canon cassette carousel system).

Dubbings Electronics Inc., 1305 S. Strong Ave., Copiague, N.Y. 11726. Tel: (516) 893-1000. Pres.: Paul C. Smith; Opns. Mgr.: P. M. Shooer; Sales Mgr.: Michael Thaler.

**Product:** Head cleaners & demagnetizers, tape strobes.

Duotone Co. Inc., 6875 SW 81 St., South Miami, Fla. 33143. Tel: (305) 665-1121. Pres.: Stephen Nester; Gen. Mgr.: Benjamin Rosenberg.

**Product:** Head cleaners & demagnetizers.

Fairmont Electronics Inc., 55 W. 39 St., New York, N.Y. 10018. Tel: (212) 244-3887. Pres.: Lou Kostin; Gen. Mgr.: Julie Kervin; Sales Mgr.: Jack Steinman.

**Product:** Browser boxes, display racks.

Fidelitone Inc., 6415 N. Ravenswood Ave., Chicago, Ill. 60626. Tel: (312) 274-0075. Pres.: Douglas F. Hudson; VP Sales: William R. Anton; Sales Mgr.: Hiram A. Prince; Regional Sales Mgr.: Richard D. Stoll.

**Product:** Display racks, head cleaners & demagnetizers, storage cases.

Fine-Tone Tapes Unlimited Inc., 24 Cobek Ct., Brooklyn, N.Y. 11223. Tel: (212) 336-6662. Pres.: Leonard Finkel; Gen. Mgr.: Stuart Mont; Sales Mgr.: Jack Haddad.

**Product:** Head cleaners & demagnetizers, storage cases.

Freedman Aircraft Eng'g Corp., PO Box 228, Charlevoix, Mich. 49720. Tel: (616) 547-6501. Pres.: Gordon L. Freedman; Gen. Mgr.: Jack C. Grubaugh; Prod'n & Sales Mgr.: Leonard L. Espich.

**Product:** Browser boxes, display racks.

Arthur Fulmer Co., 260 Monroe Ave., Memphis, Tenn. 38101. Tel: (901) 525-5711. Pres.: Arthur Fulmer Jr.; Sales Mgr.: Ron Edmundson.

**Product:** Convertors, tuners, portable power jacks.

G W Electronics Inc., 24049 S. Frampton Ave., Harbor City, Calif. 90710. Tel: (213) 534-0440. Pres. & Sales Mgr.: L. J. Heilman; Gen. Mgr.:

George Olenick; Mkt. Planning Mgr.: Jay T. Gerber.

**Product:** FM cartridge tuners.  
Glass Publ'g Co., 919 N. Michigan Ave., Chicago, Ill. 60611. Tel: (312) 337-8000. Pres.: Paul Glass; Gen. Mgr.: Mort Ohren; Editor: Ralph P. Gadiel.

**Product:** Catalog servs. (The Glass List).

Gopher Prods. Corp., Box 812, Berkeley, Calif. 94701. Tel: (415) 843-5836. Pres.: Burt Perkins.

**Product:** Browser boxes, display racks, divider & header cards.

Gusdorf & Sons Inc., 6900 Manchester Ave., St. Louis, Mo. 63143. Tel: (314) 647-1207. Pres. & Gen. Mgr.: Paul A. Gusdorf; Sales Mgr.: R. L. Fridley.

**Product:** Display racks.

M. & N. Harrison Inc., 274 Madison Ave., New York, N.Y. 10016. Tel: (212) 685-5383. Pres. & Publ'r: Mrs. Molly Harrison; Gen. Mgr.: Max Gilman; Sales Mgrs.: Mrs. Molly Harrison & Max Gilman.

**Product:** Catalog servs. (Harrison Tape Catalogs).

I T C C (International Tape Cartridge Corp.), 1275 Bloomfield Ave., Fairfield, N.J. 07006. Tel: (201) 228-1050. Pres.: Gary Salter; Mktg. Dir.: Miss Gerry Cousins.

**Product:** Head cleaners.

Irish Magnetic Tape Div., 458 Broadway, New York, N.Y. 10013. Tel: (212) 925-1257. Pres.: Sol Zigman; Gen. Mgr.: Hy Zigman; Mktg. & Sales Mgr.: Bill Grossman.

**Product:** Leader tape, splicing tape & tape splicers.

Kimco Tape Accessories, York House E., 214 W. Main St., Moorestown, N.J. 08057. Tel: (609) 235-6332. Pres.: Theodore D. Cohen.

**Product:** Capstan cleaners, carrying cases, head cleaners, test cartridges & cassettes.

Kustom Kreations Inc., 18736-2 Parthenia St., Northridge, Calif. 91324. Tel: (213) 886-8383. Pres.: Thomas V. Kemper; VP: Norman R. Boutin; Adv. Dir.: Myron S. Harris.

**Product:** Stereo lock mount, floor mount, car stereo power connector (Universal).

Le-Bo Prods. Co. Inc., 71-08 51 Ave., Woodside, N.Y. 11377. Tel: (212) 458-7700. Pres.: Leslie Bokor; VP Sales Mgr.: Leslie Dame; Gen. Mgr.: Herbert Hartman.

**Product:** Browser boxes, carrying cases, display racks, head cleaners & demagnetizers, storage cases, all cartridge & open reel accessories.

Liberty Tape Dup'n, 1201 Pacific, Omaha, Neb. 68108. Tel: (402) 348-1770. Gen. Mgr.: Leo Colvin.

**Product:** Pre-leaded cassettes.

Linda Jill Ent's., 3875 Waldo Ave., New York, N.Y. 10463. Tel: (212) 543-5122. Pres.: Murray Kirschner; Sales Mgr.: Bob Greendorfer.

**Product:** Storage albums (Tape-O album).  
Listen Magazine (div. of Rittenhouse Corp.), 1808 Rittenhouse Sq., Philadelphia, Pa. 19103. Tel: (215) PE 5-9804. Publ'r: Ron Solovitz.

**Product:** Catalog servs.

List-O-Tapes (div. of Trade Serv. Publ'ns Inc.), 2720 Beverly Blvd., Los Angeles, Calif. 90057. Tel: (213) 385-4211. Pres.: A. H. Gudie; Gen. Mgr.: J. F. Simpson; Sales Mgr.: W. A. Mundy.

**Product:** Catalog servs. (List-O-Tapes, All-in-One Tape Catalog).

Livingston Audio Prods. Corp., 1275 Bloomfield Ave., Fairfield, N.J. 07006. Tel: (201) 226-8300. Pres.: Darrell D. Scholten; VP Sales: Thomas J. Holbauer.

**Branch:** West Los Angeles, Calif., 10687 Santa Monica Blvd., Zip: 90025. Tel: (213) 474-4559.

**Product:** Convertors, head cleaners & demagnetizers, storage cases, tuners.

Marathon Prods. Corp., 334 W. Boylston St., West Boylston, Mass. 01583. Tel: (617) 853-0988. Pres.: R. D. Myers.

**Product:** Head cleaners & demagnetizers, strobe test cartridges, torque test cartridges.

Metra Electronics Corp., 660 McDonald Ave., Brooklyn, N.Y. 11218. Tel: (212) 871-4100. Pres. & Sales Mgr.: Charles R. Fox.

**Product:** Carrying cases, display racks, head cleaners & demagnetizers, locks, mounting kits.

Modern Album & Finishing Co. Inc., 119-01 22 Ave., College Point, L.I., N.Y. 11356. Tel: (212) 353-5701. Pres.: Miss G. D. Thomas; VP Sales: Guy Froehlig; Gen. Mgr.: Donald House.

**Branches:** Burbank, Calif., 3104 Vanowen St. Zip: 91504. Tel: (213) 845-7655. Pres. & Gen. Mgr.: James R. Gordon; Sales Mgr.: Carl Reinschild-Terre Haute, Ind., 1299 Voorhes St. Zip: 47808. Tel: (812) 235-6001. Gen. Mgr.: Richard Fields.

**Product:** Storage cases.

Music Master (div. of Pickwick Int'l Inc.), 7600 Wayzata Blvd., Minneapolis, Minn. 55426. Tel: (612) 544-4201.

**Product:** Carrying cases, dust clips.

Helen Neushaefer (div. of Supronics Corp.), 114-01 14 Ave., College Point, N.Y. 11356. Tel: (212) 359-8100. Pres.: Herman Johnson; VP Sales Mgr.: Robert L. Koller.

**Product:** Carrying cases (Evoorg).

J. J. Paulson Assocs., 24 Brooklyn Ave., Freeport, L.I., N.Y. 11520. Tel: (516) 868-0491. Pres. & Gen. Mgr.: Jerry Katcher.

**Product:** Capstan cleaners, carrying cases, display racks, dust clips, head cleaners.  
Pfanstiehl Chemical Corp., 3300 Washington St., Waukegan, Ill. 60085. Tel: (312) 623-1360. Pres. & Gen. Mgr.: R. Bruce Wight; Sales Mgr.: C. A. Clinton.

**Product:** Head cleaners & demagnetizers.

Plastic-Ware Inc., 1100 Leggett Ave., Bronx, N.Y. 10474. Tel: (212) 991-0100. VP: William De-Mucci; Sales Mgr.: Phil Lazarus.

**Product:** Display racks, storage cases.

Playmate Inds. Inc., 14505 E. Proctor Ave., Industry, Calif. 91747. Tel: (213) 968-5641. Pres.: Ted Ritz; Gen. Mgr.: Joe Richtarcik; Sales Mgr.: R. F. Atkinson.

**Product:** Head cleaners & demagnetizers.

The Printing Press, 3925 Oakton St., Skokie, Ill. 60076. Tel: (312) 676-3270. Pres.: Arnold Martin; Gen. Mgr.: Jack McDonald; Sales Mgr.: H. Matalon.

**Product:** Divider cards for all configurations.

Queens Lith'g Corp., 52-35 Barnett Ave., Long Island City, N.Y. 11104. Tel: (212) 457-7700. Pres.: Jack L. Hecht; VP: Eric Kallman.

**Product:** Catalog servs., display racks.

R C A Electronic Components, 415 S. Fifth St., Harrison, N.J. 07029. Tel: (201) 485-3900. Mktg. Mgr.: W. Seaton.

**Product:** Carrying cases, display racks.

Raynor Sales Co. Inc., 2698 W. Pico Blvd., Los Angeles, Calif. 90006. Tel: (213) 737-3737. Pres.: Ray Abrams; Gen. Mgr.: Norine Abrams; Sales Mgr.: Jim Whelpley.

**Product:** Head cleaners & demagnetizers, storage cases.

Recordaid Inc., 924 Cherry St., Philadelphia, Pa. 19107. Tel: (215) 922-6871. Pres. & Sales Mgr.: Stan Muffs; Editor & Gen. Mgr.: William Martin.

**Product:** Catalog servs.

Recoton Corp., 46-23 Crane St., Long Island City, N.Y. 11101. Tel: (212) 392-6442. Pres.: Herbert Borchardt; Exec. VP: Robert Borchardt; Sales Mgr.: Peter Wish.

**Product:** Carrying cases, display racks, head cleaners & demagnetizers, storage cases.

Robins Inds. Corp., 15-58 127 St., College Point, N.Y. 11356. Tel: (212) 445-7200. Pres.: Herman D. Post; VP & Sales Mgr.: Jack Friedland.

**Product:** Carrying cases, erasers, head cleaners & demagnetizers, splicing kits, storage cases and all accessories for all configurations.

Rose-Wood of California Inc., Box 347, Redondo Beach, Calif. 90277. Tel: (213) 373-3883. Pres.: Herbert M. Rose.

**Product:** Display racks, storage cases.

# NEW BEST-SELLER...

## Walco CASE-ETTE®

### Cassette Album/Carry Case



**\$4.98**  
SUGGESTED  
RETAIL



**STAYS AT HOME -**  
on the shelf, it looks and stores like a book.



**GOES ALONG -**  
snap-out handles converts it into a carry case.

**AND IT HOLDS 24 CASSETTES!**

- Rugged, lightweight construction of rigid molded plastic
- Library quality album looks like Moroccan leather book
- Convenient retractable handles
- Complete with number tabs & index
- Neat compact (9" x 7" x 3")

CAT. # CAC 24

**WALCO ELECTRONICS DIVISION**  
WALCO LINCK CORP. • JUNCTION RTES. 3 & 46 • CLIFTON, NEW JERSEY

*continued on page 114*



# "THE LEADER" IN TAPE CARTRIDGE & CASSETTE ACCESSORIES



**Cat. #TA-52**  
Brand New Deluxe Wood Tape Cartridge Carrying Case, Leatherette Covered. Holds 15 cartridges, 60 cassettes or combination of both. Use for 4 or 8 track cartridges.  
Suggested List - \$9.95



**Cat. #TA-54**  
Brand New Deluxe Wood Tape Cartridge Carrying Case, Leatherette Covered. Holds 24 cartridges, 96 cassettes or combination of both. Use for 4 or 8 track cartridges.  
Suggested List - \$11.95



**Cat. #TA-64**  
Alligator Leatherette covered wood construction - Holds 30 Cassettes - A brand new concept in design - High pile, attractive red velvet flocked interior - Individual compartments - Suggested List - \$11.95



**Cat. #TA-66**  
Alligator Leatherette covered wood constructions - Holds 30 Cartridges, 8 or 4 track - A brand new concept in design - High pile, attractive red velvet flocked interior - Individual compartments - Suggested List - \$14.95

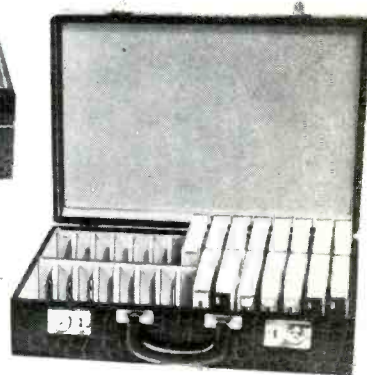

**Cat. #TA-70**  
A Brand New Attractive Inexpensive Stereo 8 Cartridge Carrying Case made of black or brown heavy duty vinyl. This versatile case holds 10 to 12 cartridges.  
Suggested List - \$2.98

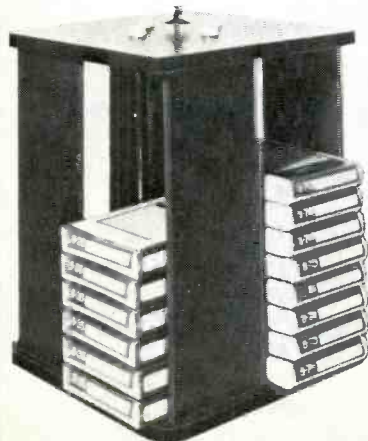

**Catalog #TA-56**  
**Cassette #TA-60**  
Four (4) and Eight (8) track tape cartridge Revolving Rack. Attractive Walnut Finished Wood and Masonite Cartridge Rack, which holds up to 48 tapes. TA-60 for Cassettes.  
Suggested List - \$14.95

## "LE-BO" HAS EVERYTHING!"

TAPE CARTRIDGE CARRYING CASES  
TAPE CARTRIDGE ACCESSORIES  
REEL TO REEL ACCESSORIES  
TAPE DISPLAYS  
LOADED BLANK TAPES  
LOADED BLANK CASSETTES  
DISPLAY FIXTURES FOR  
CARTRIDGES, CASSETTES

Contact your nearest distributor or call LE-BO Products for more information.

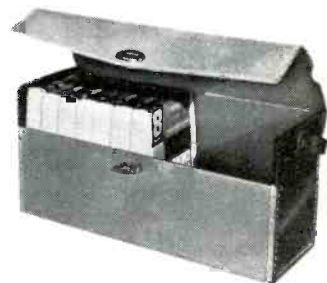
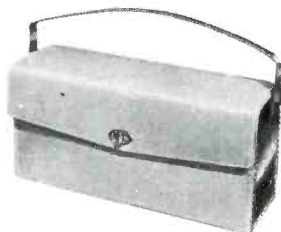

**Cat. #TA-72**  
The Jet Set Stereo 8 Tape Cartridge Carrying Case made of a high gloss leatherette in 6 decorator colors red & black, orange & black, green & black.  
Suggested List - \$3.98



## TAPE DEALER ACCESSORIES & SUPPLIES

Continued from page 112

- Royal Rec. & Tape Racks (div. of Paramount Wire Prods.), 5164 Alcoa Ave., Los Angeles, Calif. 90058. Tel: (213) 589-5721. Pres. & Gen. Mgr.: Joseph D. Winston; Sales Mgr.: Ray Lawrence.  
Product: Display racks, wire storage racks for home use.
- Royal Sound Co. Inc., 409 N. Main St., Freeport, N.Y. 11520. Tel: (516) 868-2880. Pres. & Gen. Mgr.: N. Greenberg; Sales Mgr.: J. Corbin.  
Product: Head cleaners & demagnetizers, storage cases.
- Rozinante Electronics Corp., 9135 General Ct., Plymouth, Mich. 48170. Tel: (313) 455-2500. Pres. & Gen. Mgr.: Donald D. Merry; Sales Mgr.: Walter Hess.  
Product: Display racks, head cleaners & demagnetizers, storage cases.
- Rubbermaid Inc., 1205 E. Bowman, Wooster, Ohio 44691. Tel: (216) 264-6464. Pres.: Don Noble; Sales Mgr.: Jim Hamlin; Adv. Mgr.: Jim Andres.  
Product: Carrying cases.
- Sarex Corp., 3850 W. Side Ave., North Bergen, N.J. 07047. Tel: (201) 864-9400; NYC Tel: (212) 227-6354. Pres.: O. Louis Seda; Exec. VP: D. Max Brightmore; Sales Eng.: William M. Blithen.  
Product: Display racks, head cleaners & demagnetizers, storage cases.
- Albert Schultz Inc. (exports only), see Tape Wholesalers section: New York, N.Y.
- Seebro Prods. Co., 2416 S. Michigan Ave., Chicago, Ill. 60616. Tel: (312) 842-8221. Pres.: Irving Siegal; Sales Mgr.: Robert Siegal.  
Product: Portable storage wire racks for cartridge 8-tr. & cassette.
- Selective Prods. Corp., 49 E. 41 St., New York, N.Y. 10017. Tel: (212) MU 7-4185. Sales Mgr.: John Edwards.  
Product: Storage cases for automobile use.

*The following guide lists the names of manufacturers of Dealer Accessories & Supplies under each product category. For detailed information on these firms, refer to the preceding Directory of Manufacturers section.*

### BLANK LOADED TAPE, see TAPE SUPPLIES SECTION

### BROWSER BOXES

- Advance Recs.  
George Alexander Printing Corp.  
Art-Phyl Creations.  
Guy Barry Ent's. Inc.  
Display Equip. Co.—DEMCO.  
Fairmont Electronics Inc.—pilfer-proof tape displays.  
Freedman Aircraft Eng'g Corp.  
Gopher Prods. Corp.  
Le-Bo Prods. Co. Inc.  
Albert Schultz Inc. (exports only), see Tape Wholesalers section: New York, N.Y.

### BURGLAR ALARMS & LOCKS

- Channel Mktg. Inc.—burglar alarms.  
Kustom Kreations Inc.—stereo lock mount & floor mount.  
Metra Electronics Corp.—lock-in device.  
Stereoriginals—burglar alarms, locks.  
Tape Servs. Inc.—burglar alarms.

### CARRYING & STORAGE CASES

- Amberg File & Index Co.—Ampak carrying cases for all tapes.  
Athena Inds. Inc.—Auto Butler.  
Guy Barry Ent's. Inc.  
C B S Recs.—Masterwork.  
Capitol Recs. Dist'g Corp.  
Cassettes Int'l Inc.—storage cases, cassette storage cards.  
Channel Mktg. Inc.  
M. M. Cole.  
Creative Artists.  
Decca Recs.

- Simpac Int'l Inc., 1643 19 St., Santa Monica, Calif. 90404. Tel: (213) 393-7353. Pres. & Gen. Mgr.: Robert Wallace; Sales Mgr.: A. R. Robbins.  
Product: Carrying cases.
- Soma (div. of Pickwick Int'l Inc.), 7600 Wayzata Blvd., Minneapolis, Minn. 55426. Tel: (612) 544-4201.  
Product: Storage cases.
- Soundcraft-CBS Recs. (div. of CBS Inc.), Great Pasture Rd., Danbury, Conn. 06810. Tel: (203) 744-3555. Gen. Mgr.: Peter Landskroener; Mktg. Dir.: Robert E. Ward; Sales Mgr.: Charles Berman.  
Product: Colored leader tape, splicing tape.
- Sound Packaging Corp., 56 E. 53 St., New York, N.Y. 10022. Tel: (212) 421-8255. Pres.: Craig Braun; VP & Gen. Mgr.: Anthony Grabois.  
Product: Catalog servs.
- Specialty Sounds Inc., 33515 Kelly Rd., Fraser, Mich. 48026. Tel: (313) 294-5200. Pres.: L. Allan Bazy; Gen. Mgr.: Jerry Danko; Sales Mgr.: Danny R. Willssens.  
Product: Carrying cases, dust covers, head cleaners.
- Stereodyne Inc., 2810 Elliott, Troy, Mich. 48084. Tel: (313) 585-6585. Exec. VP & Gen. Mgr.: Paul Wyatt.  
Int'l office: Canada.  
Product: Head cleaners.
- Stereo Magic (div. of Eastern Specialties Corp.), 169 Rt. 46, Dover, N.J. 07801. Tel: (201) 361-7990. Pres.: Robert F. Kenny.  
Product: Head cleaners & demagnetizers.
- Stereo Mobile Inc., 214 W. Highland, San Bernardino, Calif. 92405. Tel: (714) TU 2-7116. Pres.: Hal Ludwig; Gen. Mgr.: Mrs. Naomi Ludwig.  
Product: Head cleaners.
- Stereoriginals, 1721 N. Olden Ave., Trenton, N.J. 08638. Tel: (609) 882-1660. Gen. Mgr.: Arthur Brown.  
Product: Burglar alarms, capstan cleaners, clean & test kit, cross-talk kit, dust covers, power & trouble fuses, head cleaners & demagnetizers, locks, noise suppressors, storage cases.
- Strathmore Sales Inc., 495 Wythe Ave., Brooklyn, N.Y. 11211. Tel: (212) 387-3900. Pres. & Sales Mgr.: Stanley C. Samuel.  
Product: Storage albums.

- Display Equip. Co.—DEMCO.  
Double Sixteen Co.—Canon cassette carousel system storage cases.  
Fidelitone Inc.  
Fine-Tone Tapes Unlimited Inc.  
Kimco Tape Accessories.  
Le-Bo Prods. Co. Inc.  
Linda Jill Ent's.—Tape-O cartridge & cassette albums.  
Livingston Audio Prods. Corp.  
Metra Electronics Corp.  
Modern Album & Finishing Co. Inc.—Stor-A-Tape for cartridge 8-tr. & cassette.  
Music Master.  
Helen Neushafer—Evoorg carrying cases.  
J. J. Paulson.  
Plastic-Ware Inc.  
R C A Electronic Components.  
Raynor Sales Co. Inc.  
Recoton Corp.  
Robins Inds. Corp.  
Rose-Wood of California Inc.—home storage racks for cartridge 8-tr. & cassette.  
Royal Rec. & Tape Racks—wire storage racks for home use.  
Royal Sound Co. Inc.  
Rozinante Electronics Corp.  
Rubbermaid Inc.  
Sarex Corp.  
Albert Schultz Inc. (exports only), see Tape Wholesalers section: New York, N.Y.  
Seebro Prods. Co.—portable storage wire racks for cartridge 8-tr. & cassette.  
Selective Prods. Corp.—storage cases for automobile use.  
Simpac Int'l Inc.  
Some-home storage cases.  
Specialty Sounds Inc.  
Stereoriginals.  
Strathmore Sales Inc.—cartridge & cassette storage albums.  
Tape Phonics Int'l Inc.  
3 M Co.  
Tone-King Corp.  
Walco Electronics—cassette album/carry case.  
Wellington Eight Inds. Inc.

### CATALOG SERVICES

- Adrian Assocs. Inc.  
M. M. Cole.  
Glass Publ'g Co.—The Glass List.  
M. & N. Harrison Inc.—Harrison Tape Catalogs.  
Listen Magazine.

- Superscope Inc., 8150 Vineland Ave., Sun Valley, Calif. 91352. Tel: (213) 767-9780. Pres.: Joseph Tushinsky; Sales Mgr.: Paul Markoff.  
Product: Head cleaners & demagnetizers.
- T E A C Corp. of America, 2000 Colorado Ave., Santa Monica, Calif. 90404. Tel: (213) 394-0240. Pres.: T. Tani; Gen. Mgr.: H. H. Oye; Sales Mgr.: Mikio Matsubayashi.  
Product: Cleaner set, demagnetizers, dust covers, erasers.
- Tape Phonics Int'l Inc., 1101 State Rd., Princeton, N.J. 08540. Tel: (609) 924-9723.  
Product: Carrying cases.
- Tape Report Publ'ns, 4507 Harvest Hill Rd., Dallas, Tex. 75234. Tel: (214) 239-0320. Editor & Publ'r: David B. Rosen.  
Product: Catalog servs. (The Consumer Rec. & Tape Report).
- Tape Servs. Inc., 100 York House E., 214 W. Main St., Moorestown, N.J. 08057. Tel: (609) 235-6332. Pres. & Gen. Mgr.: W. F. Mulcahy.  
Product: Burglar alarms, capstan cleaners, dust covers, head cleaners, test cartridges.
- Tape-Tronics, 750 Mandoline, Madison Heights, Mich. 48071. Tel: (313) 588-8281. Pres. & Sales Mgr.: Burton Mahler; VP & Gen. Mgr.: A. S. Hart.  
Product: Convertors.
- 3 M Co., Magnetic Prods. Div., 3M Center, 220-6W, St. Paul, Minn. 55101. Tel: (612) 733-5426. VP & Gen. Mgr.: Melvin C. Hegdal; Magnetic Prods. Div. Sales Mgr.: W. H. Madden.  
Products: Display racks, leader & splicing tape, storage cases.
- Tone-King Corp., 354 Long Island Ave., Wyandanch, N.Y. 11798. Tel: (516) 643-8333. Pres.: Rudolf A. Poike; Gen. Mgr.: Robert Poike; Sales Mgr.: Anthony Rabbito.  
Product: Head cleaners & demagnetizers, storage cases.
- Walco Electronics (div. of Walco Linck Corp.), 1234 State Hwy. 46, Clifton, N.J. 07015. Tel: (201) 471-1070. Pres.: H. A. Bodkin.  
Product: Carrying case-albums, head cleaners & demagnetizers.
- Wellington Eight Inds. Inc., 1721 N. Olden Ave., Trenton, N.J. 08638. Tel: (609) 882-1660. Pres.: Irving S. Rosenberg; VP Ops.: Charles Siegen-dorf; VP Mdsq.: Donald Zarmer.  
Product: Head cleaners & demagnetizers, storage cases and a complete line of accessories.

- List-O-Tapes.  
Queens Lith'g Corp.  
Recordaid Inc.  
Sound Packaging Corp.  
Tape Report Publ'ns—The Consumer Rec. & Tape Report.

### CONVERTORS & TUNERS

- Car Tapes Inc.—convertors.  
Cartridge Stereo West Inc.—convertors.  
Channel Mktg. Inc.—tuners.  
Arthur Fulmer Co.—convertors, tuners.  
G W Electronics Inc.—FM cartridge tuners.  
Livingston Audio Prods. Corp.—convertors, tuners.  
Tape-Tronics—convertors.

### DISPLAY RACKS

- Advance Recs.  
George Alexander Printing Corp.  
Art-Phyl Creations.  
Audio Devices Inc.  
Guy Barry Ent's. Inc.  
Capitol Recs. Dist'g Corp.  
Car Tapes Inc.  
Channel Mktg. Inc.  
Communications Electronics Inc.  
Dict-O-Tape Inc.  
Display Equip. Co.—DEMCO.  
Fairmont Electronics Inc.—convertible tape/record racks, pilfer-proof tape displays.  
Fidelitone Inc.  
Freedman Aircraft Eng'g Corp.  
Gopher Prods. Corp.  
Gusdorf & Sons Inc.  
Le-Bo Prods. Co. Inc.  
Metra Electronics Corp.  
J. J. Paulson.  
Plastic-Ware Inc.  
Queens Lith'g Corp.  
R C A Electronic Components.  
Recoton Corp.  
Rose-Wood of California Inc.  
Royal Rec. & Tape Racks.  
Rozinante Electronics Corp.  
Sarex Corp.  
3 M Co.

continued on page 144

# A single source for all your tape and cassette accessories

## 85TC\* Deluxe Tape Cartridge Cases

Holds 24 tape cartridges.  
Available in black, blue, brown, white.  
99TC\* and 100TC\* Holds 15 tape cartridges.  
Available in 4 colors.

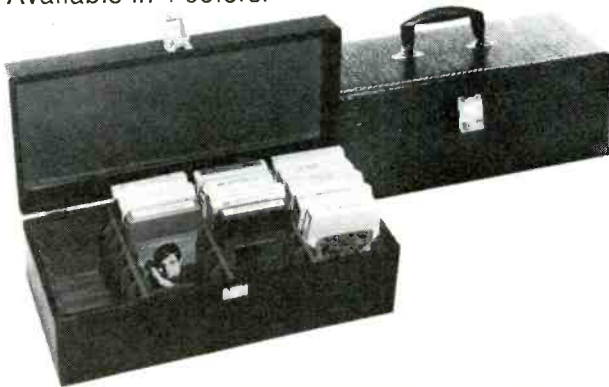

## Home Tape Storage Cabinets

Modern walnut finish swivel  
base allowing easy  
accessibility.

**82TC**  
Holds 48  
cartridges.  
**84TC**  
Holds 48  
cassettes.



## 86TC\* Deluxe Cassette Cases

Holds 30 cassettes.  
Available in brown and black.

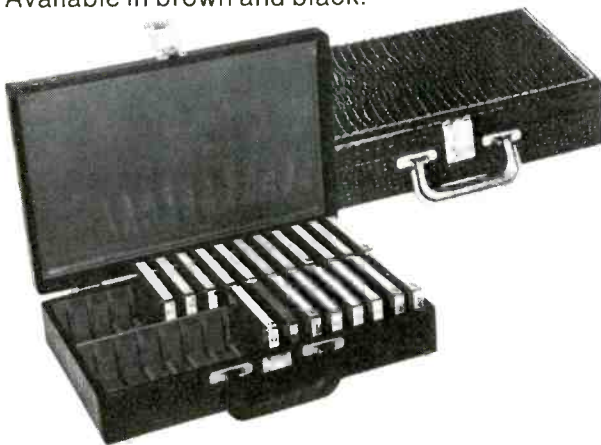

## Tape-Stor Deluxe Storage Cabinets

**97TC**—Holds 30 Cartridges  
**98TC**—Holds 36 Cassettes  
Sliding styrene doors in walnut finished  
cabinets protect tapes. Individual tape  
compartments. May be used in bookcases,  
on wall, top of desk or stereo cabinet.



\*Deluxe Tape Cases feature solid wood construction, vinyl alligator exterior, attractive red plush interior, lock and key.

All sizes of  
Cassette and 8 Track  
Blank Cartridges.

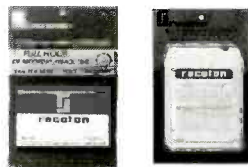

For full information, contact your local distributor, or write:

# recoton<sup>®</sup>

46-23 Crane Street, Long Island City, N.Y. 11101

Full line merchandisers of Tape Accessories,  
Diamond Needles, Record Accessories  
and Guitar Accessories.

# INTERNATIONAL TAPE SECTION

## ARGENTINA

Population: 22,500,000.  
Per capita income: \$960 (US).  
Official rate of exchange: \$1 (US)=350 pesos.  
Average retail price per tape: 8-track cartridge—\$9; 4-track cartridge—\$8; cassette—\$6.55.  
**Tape market:** This is a very new market in this country. Approximately 25,000 auto cartridge players are in use and 5,500 home models. It is estimated that sales of 8-track cartridge units have so far reached 190,000 and 4-track units, 220,000. There are practically no sales of open reel.  
**Type of distribution:** The only type of distribution is from manufacturer-to-dealer.  
**Import/Export regulation:** There is an import duty of 120% on all tapes.

RUBEN MACHADO.

### ● record manufacturers with tape product

C B S/Columbia, Paraguay 1583, Buenos Aires. Tel: 42-1201. Cable: COLRECORD. VP: John Truden; Gen. Mgr.: Harold Morris; Mgr.: Hecio Cuomo; Sales Mgr.: Luis Aguado; Pub. & Adv. Mgr.: Orlando Roseberg; Promo. Mgr.: Hugo Piombi. Cartridge 4-track & 8-track.  
Disc-Jockey, Pedro Goyena 70-72, Buenos Aires. Tel: 927700. Pres.: Manuel Rodriguez Luque; VP: Tata Rodriguez Luque; Sales Mgr.: Ricardo Portela; Pub. Mgr.: Roberto Quirno; Promo.: Jose Rodriguez. Cartridge 4-track & 8-track (distributed through Kenia).  
Microfon, Lavalle 1759, Buenos Aires. Tel: 49-6128. Pres. & Gen. Mgr.: Mario R. Kaminsky; VP: Norberto Kaminsky; Promo.: Edmundo Calcagno; Co-ord.: Osvaldo Guerra. Cartridge 4-track & 8-track (distributed through Kenia).  
Music Hall (see Sicamericana).  
Philips (see Phonogram).  
Phonogram, Moreno 2038, Buenos Aires. Gen. Mgr.: Hugo A. J. Persichini; Sales Mgr.: Leo Bentivoglio; Pub. & Adv. Mgr.: Italo Bartolome, Alfredo Zucotti; Promo. Mgr.: Alfredo Leutgeweger. Cassette.  
Prodisa SRL, Thames 2472, Buenos Aires. Tel: 72-1862. Gen. Mgr.: Jorge Cesar Esperon; Sales Mgr.: Facundo J. Martinez; Sales: Luis Pissolito; Import/Export Mgr.: Ian Wilson. Cassette.  
R C A Victor, Paroissin 3960, Buenos Aires. Tel: 704171. Pres.: Robert F. Cook; Gen. Mgr.: Adolfo Pino; Sales Mgr.: Manuel Sylva; Pub., Adv. & Promo. Mgr.: Carlos Garbarino. Cartridge 8-track.

Sicamericana (SACIFI), Jose E. Uriburu 40, Buenos Aires. Tel: 46-9807. Pres.: Nestor Selasco; VP: Luis Galvo; Sales Mgr.: Ricardo Taverna; Pub. & Adv. Mgr.: Jorge Montes; Promo. Mgr.: Roque Yacomo; Mgr.: Elsa Ferreyra. Cartridge 4-track, 8-track & cassette: Music Hall.

### ● manufacturers and/or importers of playback equipment

Continental SACIFI, Alsina 3255, Buenos Aires. Configuration: Cassette.  
Brand: Sony.  
Interelectric SeCPA, Gascon 581, Buenos Aires. Configuration: Cartridge.  
Kenia, Emilio Mitre 1851, Buenos Aires. Configuration: Cartridge.  
Philips Argentina, Vedia 3892, Buenos Aires. Configuration: Cassette.

### ● services & supplies

#### TAPE DUPLICATORS

Estudios Ion, Hipolito Yrigoyen 2519, Buenos Aires. Pres.: Tiberio Kertesz. Configuration: Cartridge.  
Kenia, Emilio Mitre 1851, Buenos Aires. Pres.: Pedro Chernajovsky; Sales Mgr.: David Pesachovich. Configuration: Cartridge.  
Philips Argentina, Vedia 3892, Buenos Aires. Configuration: Cassette.

#### MANUFACTURER OF TAPE DUPLICATING EQUIPMENT

South American Electric Co., Cordoba 657, Buenos Aires. Tel: 392-3845, 32-5596. Cable: ELECTRO-SUR. Dir.: Hugo Ferrari; Tech. Mgr.: M. Gornstein. Chief product: All facilities for mastering & duplication.

## AUSTRALIA

Population: 12,000,000.  
Per capita income: \$3,360.  
Rate of exchange: \$1 (US)=\$0.93 Australian.

### ● record manufacturers with tape product

Australian, 11-19 Hargrave St., East Sydney, N.S.W.; PO Box 267, Darlinghurst, N.S.W. Tel: 31-4111.

Cable: COLRECORD. Mng. Dir.: A. W. T. Smith; Gen. Sales Mgr.: R. C. Bull. Cartridge 8-track & cassette: Columbia, Epic.  
Carinia Co. Pty. Ltd., Carinia House, 2 Northcote St., St. Leonards, Sydney 2065. Tel: 43-5056. Gen. Mgr.: M. Kulakowski.  
Cartridge 8-track: Represented—Cetra, Hispavox, Metronome, Monitor, Telefunken, Vedette, Vox. Cassette: Owned—Carinia; represented—Cetra, Hispavox, Metronome, Monitor, Telefunken, Vedette, Vox. Open reel: Same as 8-track.  
Clarion Recs., 63 Thompson Rd., North Fremantle, W. A. 6159. Tel: 54970. Pres.: Martin Clarke. Label available on tape: Clarion.  
Concert Rec'g, 10 Caloola Rd., Wentworthville, N.S.W. 2145. Tel: 631-6189. Gen. Mgr.: John Clancy; Sales Mgr.: Mary Clancy. Cartridge 4-track & open reel: Concert Rec'g.  
Delron Recs. Pty Ltd., 14 W. Parade, West Ryde, N.S.W. 2114. Tel: (02) 80-6334, 80-3193. Pres.: Brian P. Flaherty; Gen. Mgr.: Brian P. Armstrong; Sales Mgr.: Brian J. Keneally. Cartridge 8-track, cassette & open reel: Owned—Delron, Casino, Vee Jay; distributed—DDG, Dewdrop; represented—DDG, Vee Jay (USA).  
E M I, Emiron House, 301 Castlereagh St., Sydney, N.S.W. Tel: 2-0912. Cable: EMITRON. Chm. & Mng. Dir.: J. M. Burnett, CBE; Ass't Mng. Dir.: N. W. Scott. Cassette: EMI group.  
Festival, PO Box 16, 63-79 Miller St., Pyrmont, Sydney, N.S.W. Exec. Dir.: F. C. Marks; Sales Mgr.: N. W. Brown.  
Phonogram, 69-79 Clarence St., Sydney, N.S.W. Tel: 2-0223. Mgr.: Paul Turner. Cassette: Philips, DGG, Fontana, Polydor.  
R C A Ltd., 11 Khartoum Rd., North Ryde, N.S.W. Tel: 88-5444. Pres.: J. W. Tyler; Gen. Mgr.: W. J. Walsh; Sales Mgr.: B. Witte; Mds. Mgr.: J. J. Cuff. Cartridge 8-track, cassette, & open reel: Camden, RCA.  
W & G, 185 a'Beckett St., Melbourne 3000, Vic. Tel: 329-7255. Mgr.: Ron Gillespie.

### ● tape distributor & importer

Allans Music (Australia) Pty. Ltd., 276 Collins St., Melbourne 3000, Vic. Tel: (03) 63-0451. Mng. Dir.: Geoffrey H. Allan; Ass't Dir.: R. E. Bare.

### ● custom duplicator

Festival, PO Box 16, 63-79 Miller St., Pyrmont, Sydney, N.S.W. Exec. Dir.: F. C. Marks; Sales Mgr.: N. W. Brown.

continued on page 118

Now  
**AMPEX  
STEREO  
TAPES**  
in Europe, Africa,  
Middle East.

Our customers for open-reel, cartridges and cassettes are served by duplicating plants at Reading, England and Nivelles, Belgium. — Strategically sited to straddle the E.F.T.A. and E.E.C. communities. We have set up sales offices in London, Brussels, Cologne and Milan. Headquarters of the new Ampex Stereo Tape Division for the Europe, Africa and Middle East area has been established at 72 Berkeley Avenue, Reading, Berkshire, England.

**AMPEX**  
STEREO TAPES

AMPEX GREAT BRITAIN LIMITED

Pioneers and Leaders in Magnetic Recording.

## INTERNATIONAL TAPE SECTION

Continued from page 116

### ● tape services & supplies

#### DESIGN & ARTWORK PACKAGING & LABELING PRINTING & LITHOGRAPHING

Concert Rec'g, 10 Caloola Rd., Wentworthville  
2145, N.S.W. Tel: 631-6189. Gen. Mgr.: John  
Clancy; Sales Mgr.: Mary Clancy.

## AUSTRIA

Population: 7,320,000.

Per capita income: \$1,130.

Rate of exchange: \$1 (US)=25.8 schillings.

Pre-recorded tape manufactured for domestic & export sale: Open reel 1967-4,000 units, \$20,400.

Pre-recorded tape imported from countries other than USA: 1967-17,000 units, \$115,600.

Average retail price per tape: Cartridge 8-track—\$11.60; cassette—(LPs) \$7.00, (EPs) \$2.60; open reel—(mono) \$7.12, (stereo) \$7.40.

Market: Philips and Polydor lead in sales of musicassettes and stereo open reels. Last year the sale of musicassettes increased over 50%. The sales of 8-track cartridges were not as successful, a fact which is attributed to the high cost of the playback equipment.

Type of distribution: The manufacturer-to-retailer system is beginning to replace the manufacturer-to-wholesaler-to-retailer system.

Type of promotion: Promotion for open reels, cassettes and cartridges is limited to catalogues and posters in record shops.

Import/Export regulations: Imports from EFTA (European Free Trade Ass'n) countries are taxed approximately 13% and those from EWG (European Common Market) countries, 15% plus 13% federal tax.

Manfred Schreiber

### ● record manufacturers with tape product

Amadeo, Untere Donaustr. 17, A-1020 Vienna. Tel: (0222) 24-35-98 Cable: AMAEODISC. Gen. Mgr.: Stephan von Friedberg; Pop Promo.: Wilhelm J. Lauringer; Classical Promo.: Rudolf Mraz.

Cassette: Owned—Amadeo; represented—Barclay (France), Ricordi (Italy).

Ariola, Meidinger Hauptstr. 63, A-1120 Vienna. Tel: (0222) 83-65-45. Mng. Dir.: Egmont Lueftner; Sales Dir.: Elisabeth Rossbacher; Pub., Adv. & Promo.: Walter Scherling; Int'l: Gunther Zitta. Cassette: Owned—Ariola (Germany); represented—Eurodisc (Germany), Golden Guinea (UK), Hansa (Germany), Imperial (USA), Liberty (USA), Melodiya (USSR), Pacific Jazz (USA), Picadilly (USA), Pye (UK), Stax (USA), Volt (USA), World Pacific (USA).

C B S, Stubenring 6, A-1010 Vienna. Tel: (0222) 52-31-31. Cable: COLRECORD. Mgr.: Dipl. Kfm. Jaroslav Sevcik.

Cartridge 8-track: CBS (USA). Cassette: CBS (UK, Germany).

Centrocord, Untere Donaustr. 17, A-1020 Vienna. Tel: (0222) 24-35-98. Cable: AMAEODISC. Gen. Mgr.: Stephan von Friedberg; Ass't Mgr.: Picco Pachter.

Cassette: Represented—Durium (Italy), Elite Special (Switzerland), Intercord (Germany), MPS (Germany), Musica (Germany), Tempo (Germany). Open reel: Represented—MPS (Germany).

Columbia Graphophon, Fuehrichgasse 2, A-1010 Vienna. Tel: (0222) 52-36-75. Cable: COLPHO. Mng. Dir.: Frank W. Beh; Sales Mgr., Pub., Adv., Promo.: Dr. Erich Firon.

Branches: Kaerntnerstr. 30, A-1010 Vienna. Tel: (0222) 52-36-75. Mgr.: Karl Pfeiffer; Sigmundplatz 2, A-5010 Salzburg. Tel: (0622) 83-215. Mgr.: Edmond Pichler.

Cartridge 8-track: Represented—Capitol (Italy), Columbia (Italy, UK) Columbia Regal (Italy, UK), Electrola (Italy, UK), HMV (Italy), Odeon (Italy, UK), Parlophone (UK), Pickwick (USA), Stateside (UK).

Cassette: Represented—Apple (UK), Capitol (UK), Columbia (Germany, UK), Electrola (Germany), Hoer Zu (Germany), Odeon (Germany), Pathe (France).

Metronome, Untere Donaustr. 17, A-1020 Vienna. Tel: (0222) 24-35-98. Cable: AMAEODISC. Gen. Mgr.: Stephan von Friedberg; Promo.: Mogamat Esau.

Cassette: Represented—Atco (USA), Atlantic (USA), Metronome (Denmark, Germany, Sweden).

Musica, PO Box 132, Neustiftgasse 3, A-1070 Vienna. Tel: (0222) 93-65-48. Gen. Dir.: Rudolf Friedmann; Pub. & Promo.: Katharina Friedmann. Cassette: Represented—Coral (USA), Hoer Zu (Germany), London (UK), Monument (USA), RCA (USA), Reprise (USA), Warner Bros.—Seven Arts (USA).

Polyphon, Mariahilferstr. 127, A-1060 Vienna. Tel: (0222) 56-35-06. Mng. Dir.: Gerhard Gebhardt; Sales Mgr.: Ing. Gerald Jacobs; Adv.: Miss Waltraud Buchmaier; Promo.: Alfred Mihats; Prod.: Franz Pippal.

Cassette: Represented—A&M (USA), ABC (USA), Archiv (Germany), DGG (Germany), Fontana (USA), MGM (USA), Mercury (USA), Philips (Germany), Polydor (Germany).

Note: This company pre-records tapes for Philips and Polydor in stereo, not only for Austria but also for Switzerland, Holland, and Germany. This company also has a 7% share of the musicassette market in Austria.

### ● tape playback equipment

#### MANUFACTURERS

A K G (Akustische-und Kino-Geraete GmbH), Markgraf Ruedigerstr. 6, A-1150 Vienna. Tel: (0222) 92-16-47.

Hornophon, Dr. Bohrgasse 7, A-1030 Vienna. Tel: (0222) 72-51-81.

Philips, Triesterstr. 64, A-1100 Vienna. Tel: (0222) 64-55-11.

Revox Ernst (Elektroakustische Geraete GmbH), Rupertusplatz 1, A-1170 Vienna. Tel: (0222) 46-52-42, 46-52-50.

Stuzzi, Viktor, Staatermayergasse 28-30, A-1150 Vienna. Tel: (0222) 92-76-76.

#### IMPORTERS

A E G Austria GmbH, Schwarzenbergplatz 11, A-1040 Vienna. Tel: (0222) 65-57-11, 65-65-51, 65-19-79, 65-32-55.

Brand name: Telefunken (Germany). Arlett Johann, Kirchengasse 15, A-1070 Vienna. Tel: (0222) 93-42-55.

Brand name: Dual (Germany). Cladowa Lothar, Graf Starnhembergasse 4-6, A-1040 Vienna. Tel: (0222) 65-17-37.

Brand name: Grundig (Germany). Sound Studio, Alserstr. 49, A-1080 Vienna. Tel: (0222) 43-12-73. Gen. Mgr.: Heinrich Marenzi; Sales Mgr.: Martin Pauker.

Brand name: Sony (Japan).

Tungstram (Watt AG), Heiligenstaedterstr. 134, A-1190 Vienna. Tel: (0222) 36-24-50.

Brand name: Ferguson (UK). Wiener A. GesmbH, Karl Schweighofergasse 12, A-1070 Vienna. Tel: (0222) 93-35-05, 93-52-29, 93-23-32, 93-71-22.

Brand names: B&O (Denmark), National (Japan).

### ● tape distributor/importers

Musidisc-Schallplatten, PO Box Vienna 103/213; Stuwertstr. 35, A-1020 Vienna. Tel: (0222) 72-29-333. Gen. Dir.: Erich Moser.

Cassette: Europa (Germany), Falcon (Germany), Florett (Germany), Somerset (Germany).

Sound Studio, Alserstr. 49, A-1080 Vienna. Tel: (0222) 43-12-73. Gen. Mgr.: Dr. Heinrich Marenzi; Sales Mgr.: Martin Pauker.

Cartridge 8-track: Imported—Atco, Atlantic, CBS, Capitol, MGM, Pickwick, Reprise, Verve, Warner-Bros.—Seven Arts (all USA).

### ● tape supplies

#### EMPTY CARTRIDGE & CASSETTE MANUFACTURER

Audev GmbH, Hintere Zollamstr. 9, 1030 Vienna. Int'l home office: USA, Audio Devices. Configuration: Cartridge 4- & 8-track & cassette. Brand: Audiopak.

#### RAW TAPE MANUFACTURER

Audev GmbH, Hintere Zollamstr. 9, 1030 Vienna. Int'l home office: USA, Audio Devices. Brand: Audiotope.

#### BLANK LOADED TAPE

Audev GmbH, Hintere Zollamstr. 9, 1030 Vienna. Int'l home office: USA, Audio Devices. Configuration: Cartridge 4- & 8-track, cassette & NAB broadcast cartridges. Brand: Audiotape.

### ● tape services

#### CUSTOM DUPLICATING

Austrophon GmbH, Lothringerstr. 20, A-1030 Vienna. Tel: (0222) 72-44-01. Gen. Mgr.: Gerhard Mendelson.

Musikproduktion Sued, Lothringerstr. 20, A-1030 Vienna. Tel: (0222) 72-44-01.

Polyhymnia Linzerstr. 297, A-1140 Vienna. Tel: (0222) 94-23-31.

Symphonia (Wiener Symphoniker Tonaufnahme GmbH), Lothringerstr. 20, A-1030 Vienna. Tel: (0222) 72-44-48, 57-72-41. Gen. Mgr.: Prof. Herbert Wegrich.

Tonstudio, Kaerntnerstr. 51, A-1010 Vienna. Tel: (0222) 52-27-56. Gen. Mgr.: Ing. Leo Haubenwaller.

Veritas, Haarrachstr. 5, A-4010 Linz. Tel: (7222) 24-5-76, 24-0-76, 20-5-15. Gen. Mgr.: Karl Gruber.

Branch: Singerstr. 26, A-1010 Vienna. Tel: (0222) 52-12-81. Mgr.: Ludwig Kommenda.

### ● tape dealer accessories & supplies

#### DISPLAY RACKS HEAD CLEANERS & DEMAGNETIZERS

Audev GmbH, Hintere Zollamstr. 9, 1030 Vienna. Int'l home office: USA, Audio Devices.

## BELGIUM

Population: 9,825,000.

Per capita income: \$1,927.

Rate of exchange: \$1 (US)=50 Belgian francs.

Pre-recorded tape imported from USA: (factory value) 1968-6,000 units, \$15,000; 1967-1,900 units, \$5,000.

Pre-recorded tape imported from countries other than USA: (factory value) 1968-120,000 units, \$720,000; 1967-60,000 units, \$360,000.

Average retail price per tape: Cartridge 8-track—\$8; cassette—\$6; open reel—\$10.

Market: The Philips musicassettes were being strongly promoted in this country as early as 1966. Sales began to boom in 1968 when other companies, such as EMI and DGG, joined the field. At the same time increased sales of playback equipment gave a further boost to the cassette market. Now practically all record companies offer cassettes and sales of all labels are believed to have reached some 200,000 units by the end of 1969. Four-track cartridges were never introduced in Belgium. Eight-track cartridges were pioneered by Inelco (RCA) in 1967, but really began selling in 1968 when 8-track playback equipment (mainly Voxson) became available, with sales developing rapidly in the automotive market. Eight-track cartridges probably sold some 25,000 units in 1969. Open reels were never sold in appreciable quantity due to high prices of tapes and playback equipment. Ampex has now set up duplicating facilities for both cassettes and cartridges and is offering custom duplication to all record companies. They also intend to sell their own repertoire through all possible channels during 1970, opening further the Belgian market for both cassettes and cartridges.

Type of distribution: Importer-to-retailer. In the case of cartridges, garages and auto accessories dealers proved important.

Import/Export regulations: To be reviewed in 1970 upon introduction of the TVA (taxe a la valeur ajoutee), a tax on added value (ad valorem), adopted throughout Common Market countries.

### ● record manufacturers with tape product

African (see Fonior). Anters Radio SA, 10 Place de l'Yser, Brussels. Tel: (02) 18.74.00. Mgr.: W. Goldschmidt.

Archiv (see Siemens). Barclay (Compagnie Phonographique Franco Belge), 31 Rue du Lombard, Brussels. Tel: 11.81.97.

Mgr.: Mr. Bral. Home office: France. Cartridge 8-track & cassette: Barclay, Classic, Riviera.

Classic (see Barclay).

Cygnus (see Fonior).

DGG (see Siemens).

Dureco (see Fonior).

E M I (see Gramophone).

Fiesta (see Fonior).

Fonior SA, 26/28 Quai des Charbonnages, 1080 Brussels. Tel: (02) 25.40.10. Pres.: Pelgrims de Bigard; Gen. Mgr.: A. E. Palmans; Sales Mgr.: R. Dauw.

Cassette: Owned—African, Cygnus, Dureco, Fiesta, Omega, Pink Elephant, Vega, Weekend; represented—Alhambra, Decca, Deram, Emerald, Jad, London, Major Minor, Something'else, Threshold.

Fontana (see Polygram). Gramophone, 171 Blvd. Maurice Lemonnier, Brussels. Tel: 12.98.15. Mng. Dir.: John Kirsch; Ass't Gen. Mgr.: S. J. Robins.

Branch: 72 Quai des Charbonnages. Tel: 27.43.90. Comm'l Mgr.: Emile Garin; Pub. & Adv. Mgr.: Robert Huysens; Promo. Mgr.: Jose Langlois.

Cartridge 8-track, cassette & open reel: EMI group.

continued on page 120



**IN CANADA  
ONE COMPANY  
STANDS OUT!**

- Developing Talent for the Canadian Market
- Distribution
- 8 Track Tapes ● Cassettes ● Records
- Blank Cassettes

*Exclusively with*

**NAL**

**TAPE WORLD**

**RADIANT**

**PREMIER**

**ITCC**

**FIREBIRD**

**GAMBLE**

**LEISURE SIGHT  
& SOUND**

**MODERN TAPE | INTERNATIONAL  
CARTRIDGE CORP. | TAPE CARTRIDGE  
OF CANADA, LTD. | CORP. OF CANADA, LTD.**

1179 Finch Avenue West, Downsview, Ontario

(416) 630-8494

## INTERNATIONAL TAPE SECTION

Continued from page 118

Inelco Belgium SA, 24 Rue de l'Hopital, 1000 Brussels. Tel: (02) 11.22.20. Gen. Mgr.: P. J. Goemaere; Sales Mgr.: R. Colpin.  
Cartridge 8-track, cassette & open reel: Represented—RCA, CBS, Capitol, MCA.

Mercury (see Polygram).  
Metronome (see Siemens).

Omega (see Fonior).  
Palette Reels, 13 Rue Madeleine, 1000 Brussels  
Telex: 23539.

Cartridge 4-track, 8-track, cassette, open reel & PlayTape: Palette.

Philips (see Polygram).

Pink Elephant (see Fonior).

Polydor (see Siemens).

Polygram SA, 37 Rue d'Anderlecht, Brussels. Tel: (02) 12.50.04. Pres.: P. Lebbink; Gen. Mgr.: C. Licoppe; Prod. Mgr.: D. Poutrain.

Cassette: Owned—Philips, Fontana, Mercury; represented—CNR, Carrere, Durium, Fleche, Island.

Open reel: Owned—Philips, Fontana, Mercury. Riviera (see Barclay).

Siemens, 146 Chasse de Charieroi, Brussels. Pres.: Mr. Holzappel; Gen. Mgr.: Mr. Mertens.

Cassette: Owned—Archiv, DGG, Metronome, Polydor; represented—A&M, Kama Sutra, MGM, Riverside, Storyville, Verve.

Open reel: Represented—A&M, Kama Sutra, MGM, Riverside, Storyville, Verve.

Vega (see Fonior).

Weekend (see Fonior).

### ● duplicator/marketer

Ampex SA, Rue de l'Industrie, Nivelles. Tel: L67.-249.21. Telex: 51330.

Cartridge 8-track & cassette: Ampex, Audio Fidelity, Avco Embassy, Bang, Commonwealth United, Fantasy, Flying Dutchman, Galaxy, Gulf Pacific, Lee Hazlewood, Monitor, Ovation, Time.

### ● importer/exporter

Ampex SA, Rue de l'Industrie, Nivelles. Tel: L67.-249.21. Telex: 51330.

Imports: Ampex playback equip. (USA).

Inelco Belgium SA, 24 Rue de l'Hopital, 1000 Brussels. Tel: (02) 11.22.20. Gen. Mgr.: P. J. Goemaere; Sales Mgr.: R. Colpin.

Imports: Playback equip.—Voxson (Italy).

Telecontrol-Belgium Sprl, 42 Ave. Des Mimosas, 15 Brussels. Telex: 21790. Mgr.: S. N. Zveny.  
Imports: Motorola 8-track playback equip. (USA).

### ● supplies & services

MANUFACTURER OF TAPE  
DUPLICATING EQUIPMENT  
DESIGN & ARTWORK  
PACKAGING & LABELING  
PRINTING & LITHOGRAPHING

Ampex SA, Rue de l'Industrie, Nivelles. Tel: L67.-249.21. Telex: 51330.

### ● manufacturer of tape accessories & supplies

CATALOG SERVICES  
DISPLAY RACKS  
HEAD CLEANERS & DEMAGNETIZERS  
STORAGE CASES

Ampex SA, Rue de l'Industrie, Nivelles. Tel: L67.-249.21. Telex: 51330.

## BRAZIL

Population: 92,000,000.

Per capita income: \$320.

Rate of exchange: \$1 (US)=4.29 cruzeiros.

Pre-recorded tape manufactured for domestic and export sale: Cartridge 8-track 1969 (to Nov.)—150,000 units; 1968—30,000 units. Cartridge 4-track 1969 (to Nov.)—80,000 units; 1968—250,000 units. Cassette 1969 (to Nov.)—150,000 units; 1968—30,000 units. Open reel 1969 (to Nov.)—1,000 units; 1968—0 units.

Pre-recorded tape imported from USA: 1969—5,000 units; 1968—50,000 units.

Average retail price per tape: Cartridge 8-track—\$8.50; cartridge 4-track—\$7; cassette—\$8.50; open reel—\$10.

Market: The Brazilian market is growing at the rate of about 30 per cent yearly. The cassette is rapidly taking precedence over the cartridge.

Two companies now are making recorders while two others assemble foreign recorders.

Type of promotion: Displays.

Import/Export regulations: The import tariff is over 100 per cent. There are no obstacles to exports beyond the paper work.

### ● record manufacturers with tape product

C B S-Discos, PO Box 5304, Rua Visconde do Rio Branco 53, Rio de Janeiro. Tel: 31-4040. Cable: COLRECORD. Pres.: Dr. Terencio Cattley; VP: Evandro Ribeiro.

Cartridge 8-track & cassette: Owned—CBS; represented—Entre, Epic, Okeh.

Chantecler, Rua Aurora 1011, Sao Paulo. Tel: 34-7141. Pres.: Helio Muniz de Souza; Gen. Dir.: Joao Rhamy.

Cartridge 8-track & cassette: Chantecler.

Codil-Comercial de Discos, Av. Rio Branco 277, grupo 1505, Rio de Janeiro. Pres.: Jose Pinheiro Ramos; Exec. Dir.: Jose Stockler de Moraes; Mgr.: Rodolfo Zuckermann.

Cartridge 8-track & Cassette: Codil.

Companhia Brasileira de Discos, Av. Rio Branco 311, 4 andar, Rio de Janeiro. Tel: 42-0964. Cable: DISCOSINTER. Exec. Dir.: Alain Trossat.

Cartridge 8-track & cassette: Owned—Philips; represented—Polydor.

Continental (see Gravacoes Eletricas).  
Copacabana (see Som Industria & Comercio).

Equipe, Av. Rio Branco 156-1, sobreloja-n 233, Rio de Janeiro. Tel: 52-8921. Pres.: Oswaldo S. Cadaxo; Int'l Dept.: Roberto Nunes.

Cartridge 8-track & cassette: Equipe.

Fermata do Brasil, Av. Ipiranga 1123 Sao Paulo. Tel: 239-5638, 37-2660. Pres.: Enrique Lebendig.

Cartridge 4-track: Fermata.

Gravacoes Eletricas, Rua 7 de Abril 59, 8 andar, Sao Paulo. Tel: 37-5439, 33-2416. Pres.: Alberto Byington Neto; Sales Mgr.: Wilson Rodrigues Poso; Promo: Luiz Mocarzel.

Cartridge 8-track & cassette: Continental.

Industrias Eletricas e Musicais Fabrica Odeon (EMI), Rua Evaristo da Veiga 20, Caixa Postal 2752, Rio de Janeiro. Tel: 22-9887. Cable: Turntable.

Mng. Dir.: Dr. Henry Jessen; Int'l Div.: Luis Amaral.

Cartridge 8-track & cassette: Owned—Odeon; represented—A&M, London (USA).

Mocambo (see Rozenbit).

continued on page 122

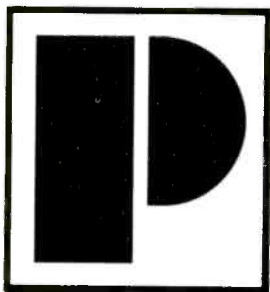

Precision Tapes Ltd.

# Precision Tapes Ltd.

## The only Comprehensive Tape Company in the U.K.

Precision Cassettes & 8 Track Cartridges

Precision Marketing & Distribution

Precision Duplicating

Precision Service



Phone. 262 5502 Cable Address. Pyrec London W.1. ATV House 17 Gt. Cumberland Place London W1H 8AA





**Progress**  
WITH A  
**Progressive**  
**Company**

- **Contract duplicating—8 track and cassette**
- **Most modern and efficient equipment**
- **Custom high speed winding and loading**
- **Blank cassettes** (Private label available at no extra charge)
- **All jobs treated as custom work regardless of size**

**CALL NOW!**

Ask for Mr. Gold (416) 630-1303 or (416) 630-1510

***PROGRESSIVE TAPE CARTRIDGE OF  
CANADA, LTD.***

Division of A and E Plastics Pak, 4478 Chesswood Drive, Unit #11, Downsview, Ontario, Canada

## INTERNATIONAL TAPE SECTION

Continued from page 120

Musidisc, Rua da Lapa 120, 12 andar, Rio de Janeiro. Tel: 52-0474. Pres.: Nilo Santos-Pinto. Cartridge 8-track & cassette: Musidisc. Odeon (see Industrias Electricas e Musicais Fabrica Odeon). Philips (see Companhia Brasileira de Discos). RCA Electronica Brasileira, Av. Ipiranga 1097, Sao Paulo. Tel: 35-0178. Cable: RADIOINTER. Pres.: Douglas J. M. Reid; Exec. Dir.: David W. Jones. Cartridge 8-track & cassette: RCA. R G E, Av. Ipiranga 1123, Sao Paulo. Tel: 34-8990, 37-2660. Pres.: Enrique Lebendiger. Cartridge 4-track: RGE. Rozenblit, Estrada dos Remedios 855, Recife. Cable: MOCAMBODISCOS. Pres.: Jose Rozenblit; Sales: Isaac & Adolfo Rozenblit; Int'l Kurt Sondermann. Cartridge 8-track & cassette: Mocambo. Som Industria & Comercio, Av. Rio Branco 43, 9 andar, Rio de Janeiro. Tel: 43-4862. Cable: SOMDISCOS. Pres.: Emilio M. Vitale. Cartridge 8-track & cassette: Copacabana. Som/Maior, Av. Ipiranga 1123, Sao Paulo. Tel: 37-2660. Pres.: Enrique Lebendiger; Mgr.: Julio Nagib. Cartridge 4-track: Som/Maior.

### ● distributor & importer

Tape Car Gravacoes S/A, 17 Fevereiro 159, Rio de Janeiro. Tel: 2-304255. Pres.: Manuel Camero; Gen. Mgr.: Fernando Neves; Sales Mgr.: Newton Fragali. Cartridge 8-track & cassette: Distributed—Ebrau, Codil, Musa, Tapeacar; represented—Barclay, Decca, Motown, Tamla.

### ● duplicating equipment importer

Tape Car Gravacoes S/A, 17 Fevereiro 159, Rio de Janeiro. Tel: 2-304255. Pres.: Manuel Camero; Gen. Mgr.: Fernando Neves; Sales Mgr.: Newton Fragali. Imports: Ampex, AB Duplicators.

### ● supplies & services

#### EMPTY CARTRIDGE, CASSETTE & REEL MANUFACTURER PACKAGING & LABELING

Tape Car Gravacoes S/A, 17 Fevereiro 159, Rio de Janeiro. Tel: 2-304255. Pres.: Manuel Camero; Gen. Mgr.: Fernando Neves; Sales Mgr.: Newton Fragali.

#### CUSTOM DUPLICATORS

A P G Gravacoes Ltda., Rua Jose 46, S/1103 Rio de Janeiro. Tel: 232-9129. Plant: Rua Clodomiro Amazonas, 1427 Sao Paulo. Tel: 61-5479. Dirs.: Alberto Pittigliani, Sebastiao R. Bastos. Cartridge 8-track & cassette: Auto Fitas Musical, Beverly, CBS, Cartaz, Cia. Brasileira de Discos, Copacabana, Equipe, Musidisc, Odeon, RCA, Top Tape.

Tape Car Gravacoes S/A, 17 Fevereiro 159, Rio de Janeiro. Tel: 2-304255. Pres.: Manuel Camero; Gen. Mgr.: Fernando Neves; Sales Mgr.: Newton Fragali.

Cartridge 8-track & cassette: CBS, Codil, Continental, Ebrau, Musa, Odeon, Philips, RCA, Tapeacar.

## CANADA

Population: 21,060,000.

Per capita income: \$2,850.

Rate of exchange: \$1 (US)=\$1.0725 Canadian.

Average retail price per tape: Cartridge 8-tr.—\$7.50; cartridge 4-tr.—\$6.55; cassette & open reel—\$7.50 (All prices higher for Broadway shows and classics).

Market: Tape sales are rapidly growing and represent around 23% of the music industry. The government's Dominion Bureau of Statistics has not yet done an exhaustive study of the tape market. A survey initiated by GRT of Canada Ltd. shows that although the 8-track system continues to dominate the pre-recorded tape market, sales of cassette playback equipment are well over the 8-track figures. The survey indicates that people are buying massive quantities of blank cassette tape and using the recording capacities of cassette players to tape music from television and radio. GRT found that in 1968, 590,000 8-track cartridges were sold as opposed to 75,000 cassettes, but only 92,000 8-track players were sold compared with 120,000 cassette players. The previous year, 36,000 8-track players had been sold versus 34,000

cassette machines. Projected figures for 1969 were that 1,600,000 8-track, 300,000 cassettes tapes would be sold, while in playback equipment the figures would be 120,000 8-track cartridge units to 150,000 cassette players. The study notes that there is no longer a 4-track market here.

Type of distribution: About 60% manufacturer-to-distributor-to-dealer and 40% manufacturer-to-retailer. Rack jobbers and one stops are involved in tape distribution on a small scale.

Type of promotion: Record and tape product are released and promoted together. There had been very little promotion until Ampex initiated an extensive national campaign on the radio and in newspapers in October, 1969. Other companies have since followed their lead.

Import/Export regulations: Import customs duty is 20%; federal sales tax is 12%.

RITCHIE YORK

### ● record manufacturers with tape product

A & M (see Capitol).  
A S T (see Ampex).  
A Z (see Trans World).  
Abnak (see The Compo Co.).  
Accent (see The Compo Co.).  
Allied Rec. Corp., PO Box 517, 104 Doncaster Ave., Willowdale, Ont. Tel: (416) 889-8566. Sales Mgr.: Jack Boswell. Cartridge 8-tr. & cassette: Paragon self-mfd.

Alshire (see Arc Sound).  
Ampex of Canada Ltd., 100 Skyway Ave., Rexdale, Ont. Tel: (416) 677-2370. VP & Gen. Mgr.: James E. Detlor; Sales Mgr.: Joe Pariselli; Adv. Dir.: Joanne E. Messham. Home office: USA.

Cartridge 8-tr. & cassette: Owned—Ampex self-mfd. Open reel: Owned—AST, Ampex, Astex self mfd.; also see Duplicator/Marketers section for licensed labels.

Amusement (see Trans World).  
Angel (see Capitol).  
Apex (see The Compo Co.).  
Arc Sound Ltd., 20 Cranfield Rd., Toronto 16, Ont. Tel: (416) 751-1613. VP Mktg.: Bill Gilliland. Cartridge 8-tr. & cassette: Owned—Varitape; distributed—Alshire.

Astex (see Ampex).  
Atco (see Warner Bros.).  
Atlantic (see Warner Bros.).  
Audio Fidelity (see Phonodisc).  
Bam (see Trans World).  
Barclay Recs. Ltd., 189 Rockland Rd., Ville Mont Royal, Montreal, P.Q. Tel: (514) 731-8571. Mgr.: Mr. Gadoue. Home office: France. Cartridge 8-tr. & cassette: Barclay distributed by Trans-Canada.

Barry (see Quality).  
Bel-Air (see London).  
Berkshire (see Musimart).  
Birchmount (see Quality).  
Bravo (see Canadian Music Sales).  
Brunswick (see The Compo Co.).  
Caedmon (see Trans World).  
Camden (see RCA).  
Canaan (see Word).  
Canadian Music Sales Corp. Ltd., 58 Advance Rd., Toronto 570, Ont. Tel: (416) 239-2361. Tape Div. Mgr.: Jury Krytiuk; Sales Mgr.: Terry Regan. Cartridge 8-tr. & cassette: Owned—Bravo, Crown-Vetch, Dominion licensed to Stereodyne; distributed—Ricordi (Italy).

Canusa (see Trans-Canada).  
Capilano (see Studio 3).  
Capitol Recs. (Canada) Ltd., 3109 American Dr., Malton Ont. Tel: (416) 677-5050. Nat'l Sales Mgr.: E. T. Campbell. Cartridge 8-tr.: Owned—Capitol, Angel, Pathe; distributed—A&M, Disneyland, Pickwick. Cartridge 4-tr.: Distributed—A&M, Pickwick. Cassette: Same as 8-tr.

Caprice (see Rodeo & London).  
Carroussel (see Trans-Canada).  
Chart (see Phonodisc).  
Colgems (see RCA).  
Columbia Recs. Dist. Canada Ltd., 1121 Leslie St., Don Mills, Ont. Tel: (416) 447-3311. VP Mktg.: J. Robertson; Sales Dir.: W. Eaton. Cartridge 8-tr. & cassette: Owned—Columbia, Epic, Date self-mfd.; distributed—Immediate, Musico, Ode, Starday self-mfd. Open reel: Owned—Columbia, Epic, self-mfd.; distributed—Immediate, Musico, Ode self-mfd. La Compagnie (see London). The Compo Co. Ltd., 2377 Remembrance St., Lachine, P.Q. Tel: (514) 637-2561. Sales Mgr.: S. D. Roberts. Cartridge 8-tr.: Owned—Apex, Brunswick, Coral, Decca, Kapp, Revolver, Scepter, Straight, Uni, United Artists, White Whale self-mfd.; distributed—Abnak, Accent, Double Shot, GNP Crescendo.

Cassette: Owned—Apex, Brunswick, Coral, Decca, Kapp, Revolver, Scepter, Uni, United Artists, White Whale self-mfd.; distributed—Double Shot, GNP Crescendo. Open reel: Owned—Brunswick, Coral, Decca self-mfd. Coral (see The Compo Co.). Crown-Vetch (see Canadian Music Sales).

D G G (see Polydor).  
D S P (see Trans-Canada).  
Date (see Columbia).  
Decca (The Compo Co.).  
Deram (see London).  
Deutsche Grammophon Gesellschaft (see Polydor).  
Diamond (see RCA).  
Disc AZ (see Trans World).  
Disc Bam (see Trans World).  
Disneyland (see Capitol).  
Dominion (see Canadian Music Sales).  
Dorval (see Trans-Canada).  
Double Shot (see The Compo Co.).  
Douglas (see Trans World).  
Dunhill (see RCA).  
Emerald (see Trans World).  
Epic (see Columbia).  
Eurotone (see Musimart).  
Fantasy (see Musimart).  
Fiesta (see Trans World).  
Folklore (see Musimart).  
Fontana (see London).

G N P Crescendo (see The Compo Co.).  
G R T of Canada Ltd., 1045 Hargrrieve Rd., London, Ont. Tel: (519) 434-4535. Pres.: Ross B. Reynolds; Nat'l Sales Mgr.: Edward P. LaBuck; Promo. Mgr.: Edward J. A. Lawson; Opns. Mgr.: James B. Blum. Home office: USA.

Cartridge 4-tr., 8-tr., cassette & open reel: Owned—GRT, Blue Thumb, Checker, Chess, Cadet, Cadet/Concept, Janus self-mfd.; also see Duplicator/Marketers section for licensed labels.

Gala (see RCA).  
Galaxy (see Musimart).  
Gamble (see RCA).  
Gamma Recs. Ltd., 389 St. Paul St. W., Montreal 125, P.Q. Tel: (514) 288-0242. Pres.: J. Lazare; VP: D. Lazare. Cartridge 8-tr. & cassette: Gamma (distributed by London).

Gordy (see Phonodisc).  
Grand Prix (see London).  
Guitare (see Trans-Canada).  
Hi (see London).  
Hickory (see Phonodisc).

I T C C (International Tape Cartridge of Canada Ltd), 1179 Finch Ave. W., Downsview, Ont. Tel: (416) 630-8494. Pres.: Abe Salter; Gen. Mgr.: Fred Gold; Sales Mgr.: Harold Gottlieb; Promo. Mgr.: Bob Martin; PR: John Driscoll. Home office: USA.

Cartridge 8-tr. & cassette: Owned—Itco self-mfd.; also see Duplicator/Marketers section for licensed labels.

Immediate (see Columbia).  
Imperial (see London).  
Itco (see ITCC).  
Jacques Canetti (see London).  
Jamie (see London).  
Jubilee (see Phonodisc).  
Jupiter (see London).  
Kapp (see The Compo Co.).  
Kirshner (see RCA).  
Liberty (see London).  
Light (see Word).  
Limelight (see London).

London Recs. of Canada (1967) Ltd., 190 Graveline St., St. Laurent, P.Q. Tel: (514) 735-5551. Pres.: F. C. Jamieson; Sales Mgr.: Adrian Bilodeau. Cartridge 8-tr.: Owned—London, phase 4, Deram, Parrot, Hi licensed to Ampex; distributed—Bel-Air, Jacques Canetti, Caprice, La Compagnie, Fontana, Gamma, Grand Prix, Jamie, Jupiter, Liberty, Limelight, Mercury, Monument, Philips, Rodeo, Smash.

Cassette: Owned—London, phase 4, Deram, Parrot, Hi licensed to Ampex; distributed—Jacques Canetti, Caprice, Fontana, Gamma, Grand Prix, Jamie, Liberty, Limelight, Mercury, Monument, Philips, Rodeo, Smash, Teldec. Open reel: Owned—London, phase 4, Parrot licensed to Ampex; distributed—Imperial, Liberty, Mercury, Philips, Soul City, World Pacific Jazz.

Major Minor (see Trans World).  
Mercury (see London).  
Montagnard (see Trans World).  
Monument (see London).  
Motown (see Phonodisc).  
Musico (see Columbia).  
Musimart Ltd., 970 McEachran Ave., Montreal 154, P.Q. Tel: (514) 273-8354. Sales Mgr.: Jack Inhaber. Cartridge 8-tr.: Distributed—Eurotone, Fantasy, Galaxy, Rostige, Roper. Cassette: Distributed—Berkshire, Eurotone, Fantasy, Folklore, Galaxy, Tempo, Vox.

New Syndrome (see Studio 3).  
Nobel (see Trans-Canada).  
Nova (see Rodeo & Polydor).  
Ode (see Columbia).  
Paragon (see Allied).  
Parrot (see London).  
Passe-Temps (see Trans-Canada).  
Pathe (see Capitol).  
phase 4 (see London).  
Philips (see London).  
Phonodisc Ltd., 30 Malley Rd., Toronto, Ont. Tel: (416) 751-9610. Tape Div. & Sales Mgr.: Bill Osbourne. Cartridge 8-tr. & cassette: Distributed—Audio Fidelity, Chart, Gordy, Hickory, Jubilee, Motown, Pye, Soul, Tamla, Vanguard. Pickwick (see Capitol).

Polydor Recs. Canada Ltd., 4115 Sherbrooke St. W., Montreal, P.Q. Tel: (514) 933-4201. Mng. Dir.: Fred Exon; Mktg. Mgr.: Guy Bertrand; Tape Mgr.: Rudi Assaly.  
**Cartridge 8-tr. & cassette:** Owned—Polydor, DGG licensed to Stereodyne.

Poppy (see RCA).

Prestige (see Musimart).

Project 3 (see Trans World).

Pye (see Phonodisc).

Quality Recs. Ltd., 380 Birchmount Rd., Scarborough, Ont. Tel: (416) 698-5511. VP & Mng. Dir.: George L. Keane; Ass't Mng. Dir.: George R. Struth; Gen. Sales Mgr.: Lee W. Farley.

**Cartridge 4-tr., 8-tr., cassette & open reel:** Owned—Quality, Barry, Birchmount, Reo self-mfd.; also see Duplicator/Marketers section for licensed labels.

R C A Ltd., 3333 Cavendish Blvd., Montreal 261, P.Q. Tel: (514) 482-9912. Mktg. Mgr.: W. A. Gilmeister; Nat'l Sales Mgr.: A. Nagy.

**Cartridge 8-tr.:** Owned—RCA, Camden, Gala, Victrola; distributed—Colgems, Diamond, Dunhill, Kirshner, Gamble, Poppy.  
**Cassette:** Owned—RCA; distributed—Colgems, Dunhill, Kirshner.  
**Open reel:** Owned—RCA.

Reo (see Quality).

Reprise (see Warner Bros.).

Revolver (see The Compo Co.).

Riviera (see Trans-Canada).

Rodeo Recs. Ltd., 215 Victoria St., Toronto, Ont. Tel: (416) 368-3362. Mgr.: George Taylor.

**Cartridge 8-tr. & cassette:** Owned—Rodeo Int'l. Caprice licensed to Ampex; Rodeo Int'l. Banff, Celtic also released through Polydor on the Nova label.

Roper (see Musimart).

Sacred (see Word).

Scepter (see The Compo Co.).

Skye (see Trans World).

Smash (see London).

Soul (see Phonodisc).

Soul City (see London).

Spoken Arts (see Trans World).

Starday (see Columbia).

Straight (see The Compo Co.).

Studio 3 Prod'ns Ltd., 2190 W. 12 Ave., Vancouver 9, B.C. Tel: (604) 736-7626. Gen. Mgr.: Ralph Harding.

**Cartridge 8-tr. & cassette:** Owned—Capilano, New Syndrome self-mfd. & licensed to DBS. Summit (see Word).

Tamla (see Phonodisc).

Teldec (see London).

Tempo (see Musimart).

Trans-Canada Music Serv. Inc., 189 Rockland Rd., Town of Mount Royal, Montreal, P.Q. Tel: (514) 735-5661. Owner: Jean Paul Rickner; Mgr.: Jean Desrosiers.

**Cartridge 8-tr. & cassette:** Owned—Trans-Canada licensed to Stereodyne; distributed—Barclay, Canusa, Caroussel, DSP, Dorval, Guitare, Nobel, Passe-Temps, Riviera, Vedette.

Trans World Rec. Corp., 1230 Monte de Liesse, Montreal 384, P.Q. Tel: (514) 336-3110. Pres.: Art Young.

**Cartridge 8-tr.:** Owned—Trans World, Amusement, Montagnard; distributed—Caedmon, Disc AZ, Disc Bam, Douglas, Emerald, Fiesta, Major Minor, Project 3, Skye.  
**Cassette:** Same as 8-tr. plus distributed—Spoken Arts.

Uni (see The Compo Co.).

United Artists (see The Compo Co.).

Vanguard (see Phonodisc).

Vari tape (see Arc Sound).

Vedette (see Trans-Canada).

Victrola (see RCA).

Vogue (see Warner Bros.).

Vox (see Musimart).

Warner Bros. Recs. of Canada Ltd., 220 Brunswick Blvd., Pointe-Claire, P.Q. Tel: (514) 697-7440. Tape Div. Mgr.: M. W. Doyle; Sales Mgr.: Clyde McGregor.

**Cartridge 8-tr. & cassette:** Owned—Warner Bros.-Seven Arts. Reprise self-mfd.; distributed—Atco, Atlantic, Vogue self-mfd.

White Whale (see The Compo Co.).

Word Recs. of Canada, 7555 Cambie St., Vancouver, B.C. Tel: (604) 321-6785. Pres.: Gerry B. Scott.  
**Home office:** USA.

**Cartridge 8-tr. & cassette:** Owned—Word, Canaan, Light, Sacred self-mfd.; distributed—Summit self-mfd.  
World Pacific Jazz (see London).

## • duplicator/marketers

Ampex of Canada Ltd., 100 Skyway Ave., Rexdale, Ont. Tel: (416) 677-2370. VP & Gen. Mgr.: James E. DeIlor; Sales Mgr.: Joe Pariselli; Adv. Mgr.: Joanne E. Messham.

**Home office:** USA.

**Cartridge 8-tr.:** Amaret, Ampex, Athena, BT Puppy, Bang, Boone, Bravo, Caprice, Caravan, Contemporary, Deram, Elektra, Evolution, Fantasy, Galaxy, Good Time Jazz, Heritage, Hi, ILS, Jad, London, Monitor, Nonesuch, Parrot, phase 4, Project 3, Rodeo Int'l, Skye, Time, Vanguard, Viva.

**Cassette:** Amaret, Ampex, Athena, BT Puppy, Bang, Boone, Bravo, Caprice, Contemporary, Deram, Elektra, Evolution, Fantasy, Galaxy, Good Time Jazz, Heritage, Hi, Jad, London, Monitor, Nonesuch, Parrot, phase 4, Project 3, Rodeo Int'l, Skye, Time, Vanguard, Viva.

**Open reel:** AST, Ampex, Astex, Audio Fidelity, BT Puppy, Bang, Bravo, Buena Vista, Contemporary, Elektra, Evolution, Fantasy, Good Time Jazz, ILS, London, Monitor, Nonesuch, Parrot, phase 4, Project 3, Recorded Treasures, Vanguard, Viva.

G R T of Canada Ltd., 1045 Hargrieve Rd., London, Ont. Tel: (519) 434-4535. Pres.: Ross B. Reynolds; Nat'l Sales Mgr.: Edward P. La-Buick; Nat'l Promo. Mgr.: Edward J. A. Lawson; Opm. Mgr.: James B. Blum.

**Home office:** USA.

**Cartridge 4-tr., 8-tr., cassette & open reel:** Abnak, Alegre, Arctic, Ashley, Backbeat, Bang, Blue Thumb, Boone, Bouquet, Bunky, Burdette, Cadet, Cadet/Concept, Chart, Checker, Chess, De-Life, Diamond, Duke, ESP, Elephant V, Ex-cello, Falcon, GRT, Gamble, Gateway, Jamie, Janus, Hickory, Hob, King, MTA, Major Minor, Mathew Katz Prod'ns, Metromedia, Middle Earth, Monmouth-Evergreen, Monument, Nash-boro, Nashville, Palette, Paula, Peacock, Pete, Phil-L.A. of Soul, Project 3, Pzazz, RSVP, Reo Tahiti, Request, Rising Sons, Roulette, Scepter, Sidewalk, Skye, Sound Stage 7, Specialty, Starday, TRX, Tico, Tower, Vault, Wand, White Whale.

I T C C (International Tape Cartridge of Canada Ltd.), 1179 Finch Ave. W., Downsview, Ont. Tel: (416) 630-8494. Pres.: Abe Salter; Gen. Mgr.: Harold Gottlieb; PR: John Driscoll.

**Home office:** USA.

**Cartridge 8-tr.:** Audio Fidelity, Barry, Bell, Buddha, Carib, Chart, Cheryl Laine, GNP Crescendo, GWP, Gamble, Goldwax, Hickory, Horizon, Itco, Jad, Jamie, Little Darlin', Mio Int'l, Mira, Moonglow, Musicor, Palisade, Phil-L.A. of Soul, Plantation, Poison Ring, Project 3, SSS Int'l, Skye, Sphere Sound, Starday, Stella, Stop, Teardrop, Tetragrammaton, 20th Century-Fox, Vee Jay, White Whale.  
**Cassette:** Alegre, Bell, Buddha, Chart, GWP, Gamble, Hickory, International Artists, Itco, Jad, Mira, Plantation, Project 3, Skye, Starday, Stella, Stop, Teardrop, 20th Century-Fox, Vee Jay, White Whale.

International Tape Cartridge of Canada Ltd. (see ITC).

Quality Recs. Ltd., 380 Birchmount Rd., Scarborough, Ont. Tel: (416) 698-5511. VP & Mng. Dir.: George L. Keane; Ass't Mng. Dir.: George R. Struth; Gen. Sales Mgr.: Lee W. Farley.

**Cartridge 4-tr., 8-tr., cassette & open reel:** A&M, Acta, Barry, Bell, Birchmount, Buddha, CASL, Crewe, Cufom, Direction, Dot, Dyno-Voice, Elf, Goldwax, Heritage, Kama Sutra, Enterprise, Laurie, MGM, Maverick, New Voice, Paramount, Pavilion, Philly Groove, Quality, Ranwood, Reo Tahiti, Ringside, Royal American, SSS Int'l, Smobro, Stax, Steed, Stormy Forest, Sun Int'l, T-Neck, Together, United Talents, Verve, Verve/Forecast, Volt, Windfall.

Stereodyne (Canada) Ltd., 6 Evans Ct., Etobicoke, Ont. Tel: (416) 259-4201. Gen. Mgr.: H. R. Newman; Sales Mgr.: R. B. Kerr.

Branches: Edmonton, Alta., 10931 166A St. Tel: (403) 489-6861. Mgr.: Don Stumpf—Halifax, N.S., 1890 Granville St. Tel: (902) 429-3527. Mgr.: Tom Burney—Montreal, P.Q., 177 Pine Ave. E. Tel: (514) 849-5143. Mgr.: Jacques Portailance—Quebec City, P.Q., 210 Dupont St. Tel: (418) 523-9923. Mgr.: Andre Beaudoin.  
Int'l branch: USA.

## • tape playback equipment manufacturers

Automatic Radio of Canada Ltd., 25 Bermondsey Rd., Toronto 374, Ont. Tel: (416) 757-8771. Pres.: A. B. McLeod; VP: George E. Lyall; Sales Mgr.: Art F. Icton.

**Cartridge:** (28 models) 20 auto—19 8-tr., 1 4&8-tr. compatible; 6 8-tr. home; 2 8-tr. portable. Price range: \$59.95—\$199.95.  
**Cassette:** (9 models) 4 auto, 2 home, 3 portable. Price range: \$49.95—\$239.95.

**Brand names:** Artisan, Automatic Radio, Titan, Capitol Recs. (Canada) Ltd., 3109 American Dr., Malton, Ont. Tel: (416) 677-5050. Nat'l Sales Mgr.: E. T. Campbell.

**Cassette:** (6 models) portable. Price range: \$29.95—\$110.95.

Double Diamond Electronics Ltd., 34 Progress Ave., Scarborough, Ont. Tel: (416) 291-2503. Buyer: Ben Cass.  
**Cassette:** (1 model).

**Brand name:** Siera.  
Electrohme Ltd., 809 Wellington St. N., Kitchener, Ont. Tel: (519) 744-7111. Pres.: C. A. Pollock; Sales Mgr.: B. F. Ellis; Adv. Dir.: D. B. Buglass.

**Cassette:** (3 models) 1 home, 2 portable. Price range: \$119.50—\$159.50.

Muntz Stereo-Pak Canada Ltd., 61 Sanford Ave. N., Hamilton 23, Ont. Tel: (416) 525-0268. Pres.: David Hoffman; Sales Mgr. & Adv. Dir.: Douglas G. Martyniuk.

**Cartridge:** (9 models) 3 auto—1 8-tr., 2 4&8-tr. compatible; 2 4&8-tr. compatible home; 1 8-tr. portable. Price range: \$59.95—\$119.95.  
**Cassette:** (1 model) auto. Price: \$119.95.

Philips Electronics Inds. Ltd., Consumer Prods. Div., 116 Vanderhoof Ave., Toronto 17, Ont. Tel: (416) 425-5161. Pres.: H. A. C. Van Beurden;

Sales Mgr.: N. F. Wester; Adv. Dir.: R. C. Ward  
**Cassette:** (9 models) 1 auto, 2 home, 6 portable. Price range: \$49.95—\$219.95.

**Open reel:** (3 models) 4-tr. home. Price range: \$279.95—\$399.95.

RCA Ltd., 21001 N. Service Rd., Trans-Canada Hwy., Ste. Anne de Bellevue 810, P.Q. Tel: (514) 453-9000. Pres.: J. D. Houlding; Sales Mgr.: A. D. MacLellan; Adv. Dir.: L. Small.

**Cartridge:** (1 model) 8-tr. portable. Price: \$99.95.  
**Cassette:** (6 models) portable. Price range: \$29.95—\$129.95.

**Open reel:** (3 models) home—2 2-tr., 1 4-tr. Price range: \$89.95—\$219.95.

## • tape wholesalers

### ALBERTA

#### • CALGARY (Area Code 403)

Abel's Recs. Unlimited, 1425 Ninth Ave. SE. Tel: 264-6340. Mgr. & Buyer: Chuck Faas. (D, OS & RJ).

**Home office:** Toronto, Ont. (see for prod. distributed).  
Acklands Ltd., 2918 11 St. SE. Tel: 243-4488. (D).

**Cartridge 8-tr.:** Abnak, Accent, Apex, Brunswick, Coral, Decca, Double Shot, GNP Crescendo, Kapp, Revolver, Scepter, Straight, Uni, United Artist, White Whale.  
**Cassette:** Apex, Brunswick, Coral, Decca, Double Shot, GNP Crescendo, Kapp, Revolver, Scepter, Uni, United Artists, White Whale.

**Open reel:** Brunswick, Coral, Decca.  
All Recs. Supply Co. of Canada Ltd., 4620 Manitoba Rd. Tel: 287-2679. Mgr.: Howard Edge; Buyer: Mrs. Fran Kidd. (OS & RJ).

**Home office:** Toronto, Ont.  
Central Rec. Co., 4511 Manitoba Rd. SE. Tel: 243-2586. Owner: Dave Jones; Mgr. & Buyer: Les Furze. (D), (RJ) as Musictape Co.).

**Cartridge 8-tr.:** Audio Fidelity, Gordy, Jubilee, Motown, Pye, Soul, Tamla, Vanguard.  
**Cassette:** Gordy, Jubilee, Motown, Soul, Tamla, Vanguard.  
**Playback equip.:** Webcor.

**Accessories:** Le-Bo.

Columbia Recs. Dist. Canada Ltd., 4624 Manitoba Rd. Zone: 24. Tel: 287-1322. (D).

**Home office:** Toronto, Ont.  
**Cartridge 8-tr. & cassette:** Columbia, Epic, Date, Immediate, Musicor, Ode, Starday.  
**Open reel:** Columbia, Epic, Immediate, Musicor, Ode.

Conway Marshall Ltd., 423 Manitou Rd. SE. Zone: 24. Tel: 287-2233. Mgr. & Buyer: Dave Brownlee. (RJ).

**Home office:** Vancouver, B.C., E. A. Morris Ltd.  
Double Diamond Electronics Ltd., 619 Manitou Rd. SE. Tel: 243-7737. (D).

**Home office:** Toronto, Ont. (see for prod. distributed).  
Handlman Co. of Canada Ltd., 4644 Pacific Rd. NE. Tel: 276-2224. (RJ).

**Home office:** USA, Detroit, Mich.  
Kensington Dists., 519 Manitou Rd. SE. Tel: 287-0980. Sales Mgr.: K. Jordan; Buyer: R. Hiscox. (RJ).

**Home office:** Toronto, Ont., Waco-Sherman/Kensington Dists.  
London Recs. of Canada (1967) Ltd., 429 Manitou Rd. SE. Tel: 243-1313. (D).

**Home office:** Montreal, P.Q.  
**Cartridge 8-tr.:** London, phase 4, Deram, Parrot, Hi, Bel-Air, Jacques Canetti, Caprice, La Compagnie, Fontana, Gamma, Grand Prix, Jamie, Jupiter, Liberty, Limelight, Mercury, Monument, Philips, Rodeo, Smash.

**Cassette:** London, phase 4, Deram, Parrot, Hi, Jacques Canetti, Caprice, Fontana, Gamma, Grand Prix, Jamie, Liberty, Limelight, Mercury, Monument, Philips, Rodeo, Smash, Teldec.  
**Open reel:** London, phase 4, Parrot, Imperial, Liberty, Mercury, Philips, Soul City, World Pacific Jazz.

Musictape Co., 4511 Manitoba Rd. SE. Tel: 243-8722. Owner & Buyer: Dave Jones; Mgr.: Neil Courtney. (RJ), (D as Central Rec. Co.).

**Branch:** Vancouver, B.C.  
R C A Ltd., PO Box 5158, Sta. A, 4120 Sixth St. SE. Tel: CH 3-4661. (D).

**Home office:** Montreal, P.Q.  
**Cartridge 8-tr.:** RCA, Camden, Gala, Victrola, Colgems, Diamond, Dunhill, Gamble, Kirshner, Poppy.

**Cassette:** RCA, Colgems, Dunhill, Kirshner.  
**Open reel:** RCA.  
**Accessories:** Head cleaners & demagnetizers (RCA).

T P C-Rec. Div., 3207 Ninth St. SE. Zone: 24. Tel: 287-1461. Mgr.: John H. Watson. (D).  
**Branch:** Edmonton, Alta.

**Cartridge 4-tr., 8-tr., cassette & open reel:** A&M, Acta, Barry, Bell, Birchmount, Buddha, CASL, Crewe, Dot, DynoVoice, Elf, Enterprise, Heritage, Kama Sutra, Laurie, MGM, Maverick, New Voice, Paramount, Pavilion, Plantation, Verve, Verve/Forecast, Windfall.  
**Accessories:** Caddies (Rubber Maid), head cleaners, racks (Quality).

(continued on page 124)

## INTERNATIONAL TAPE SECTION

Continued from page 123

Van Dusen Bros. Ltd., 723 10 Ave. SW. Tel: 263-1150. (D).  
Home office: Edmonton, Alta. (see for prod. distributed).

Warner Bros. Recs. of Canada Ltd., 4640 Manhattan Rd. Tel: 243-7164. (D).  
Home office: Montreal, P.Q.  
Cartridge 8-tr. & cassette: Warner Bros.-Seven Arts, Reprise, Atco, Atlantic, Vogue.

### • EDMONTON (Area Code 403)

Double Diamond Electronics Ltd., 30 Airport Rd. Tel: 454-0302. (D).  
Home office: Toronto, Ont. (see for prod. distributed).

Kensington Dists., 6128 103 St. Tel: 434-8783.  
Supervisor: A. Andruchow. (RJ)  
Home office: Toronto, Ont., Waco-Sherman Kensington Dists.

Pro-Sound Dists. Ltd., 6028 103 St. Tel: 435-3891.  
Mgr.: Jack Hewer; Buyer: Dawn Taylor. (D, OS & RJ).  
Home office: Vancouver, B.C. (see for prod. distributed).

Stereodyne (Canada) Ltd., 19031 166A St. Tel: 489-6861. Mgr.: Don Stimpf. (D, OS, RJ & I).  
Home office: Toronto, Ont. (see for prod. distributed & imported).

Stereo Tape Prods., 10118A 124 St. Tel: 488-3814.  
Mgr.: Bob Rowe. (OS).  
Home office: Toronto, Ont.

T P C-Rec. Div., PO Box 580. Tel: 482-1531. Rep.: Garry McDonall. (D).  
Home office: Calgary, Alta. (see for prod. distributed).

Tape Dists. (div. of Neonex Int'l), 14615 124 Ave. Zone 42. Tel: 454-9101. Mgr.: S. A. Senuk; Buyer: Mrs. J. Meckling. (RJ).

Branch: Vancouver, B.C. Select Music Co. (D).  
Van Dusen Bros. Ltd., 10357 109 St. Tel: 423-1191.  
Mgr. & Buyer: Bill Maxim. (D).

Cartridge 8-tr.: Abnak, Amaret, Ampex, Ashley, Audio Fidelity, BT Puppy, Backbeat, Bang, Barclay, Blue Thumb, Boone, Bravo, Buddha, Cadet, Cadet Concept, Caedmon, Caravan, Chant, Checker, Chess, Country Sound, Cuca, DGG, Deram, Diamond, Duke, Elektra, Evolution, Euronote, Excello, Fantasy, Fiesta, GRT, Galaxy, Gamble, Good Time Jazz, Heritage, Hickory, HiFi Life, Hobbit, ITCC, Impulse, Itco, Jad, James, Jamie, King, Little Darlin', London, MTA, Mainstream, Major Minor, Metromedia, Mobile Fidelity, Monitor, Monument, Nashville, Nonesuch, Palette, Parrot, Paula, phase 4, Phil-L.A. of Soul, Polydor, Project 3, Pzazz, Reo Tahiti, Request, Rodeo Int'l, Roulette, Scepter, Sidewalk, Skye, Sound Stage 7, Specialty, Starday, Stella, Stereodyne, Stop, Tennessee Sound, Time, Tower, Trans World, 20th Century-Fox, V, Vanguard, Vault, Vee Jay, Viva, Wand, White Whale, Wonderland.  
Cassette: Same as 8-tr plus Living Language.  
Open reel: Same as cassette plus Rack & Reel.  
Playback equip.: Capitol.  
Accessories: Walco.

### BRITISH COLUMBIA

#### • VANCOUVER (Area Code 604)

All Recs. Supply Co. of Canada Ltd., 118 SE Marine Dr. Tel: 321-0055. Mgr.: Paul Bartsch; Buyer: Viola Bradley. (OS & RJ).  
Home office: Toronto, Ont.

Cascade Rec. Serv., PO Box 8584, Sta. H. Mgr.: William Dwyer. (I).

Imports: Pre-recorded tape from USA.  
Columbia Recs. Dists. Canada Ltd., 116 SE Marine Dr. Zone: 15. Tel: 327-0291. (D).  
Home office: Toronto, Ont.

Cartridge 8-tr. & cassette: Columbia, Epic, Date, Immediate, Musicor, Ode, Starday  
Open reel: Columbia, Epic, Immediate, Musicor, Ode.

Double Diamond Electronics Ltd., 3605 Grandview Hwy. Tel: 434-6647. (D).

Home office: Toronto, Ont. (see for prod. distributed).  
Emerson Sales Ltd., 1859 W. Fourth Ave. Tel: 733-3525. Owner: Emerson Short; Mgr. & Buyer: Jean Leskiw. (D).

Cartridge 8-tr.: Ampex, Barclay, Fiesta, GRT, Trans World.  
Cassette: Ampex, GRT.  
Accessories: Blank cassettes (Magnum), display racks.

Johnston Appliances Ltd., 5239 Victoria Dr. Tel: 325-3261. Mgr. & Buyer: Miss P. van Kleeck. (D).

Cartridge 8-tr.: Abnak, Accent, Apex, Brunswick, Coral, Decca, Double Shot, GNP Crescendo, Kapp, Revolver, Scepter, Straight, Uni, United Artists, White Whale.  
Cassette: Apex, Brunswick, Coral, Decca, Double Shot, GNP Crescendo, Kapp, Revolver, Scepter, Uni, United Artists, White Whale.  
Open reel: Brunswick, Coral, Decca.

Kensington Dists., 3624 E. First Ave. Tel: 291-7731.  
Sales Mgr.: R. Gallo; Buyer: L. Alden. (RJ).  
Home office: Toronto, Ont., Waco-Sherman/Kensington Dists.

London Recs. of Canada (1967) Ltd. 3166 Lake City Way, Lake City Ind'l Park, Burnaby 2. Tel: CY 8-6471. (D).  
Home office: Montreal, P.Q.

Cartridge 8-tr.: London, phase 4, Deram, Parrot, Hi, Bel-Air, Jacques Canetti, Caprice, La Compagnie, Fontana, Gamma, Grand Prix, Jamie, Jupiter, Liberty, Limelight, Mercury, Monument, Philips, Rodeo, Smash.

Cassette: London, phase 4, Deram, Parrot, Hi, Jacques Canetti, Caprice, Fontana, Gamma, Grand Prix, Jamie, Liberty, Limelight, Mercury, Monument, Philips, Rodeo, Smash, Teldec.  
Open reel: London, phase 4, Parrot, Imperial, Liberty, Mercury, Philips, Soul City, World Pacific Jazz.

E. A. Morris Ltd., 475 E. Broadway. Zone: 10. Tel: 876-4141. Owner: J. P. Delf; Mgr.: W. B. Kinsman; Buyers: Barry Wilson, Miss R. Anderson. (RJ).

Branch: Calgary, Alta, Conway Marshall Ltd. Musicape Co., 990 W. Seventh Ave. Zone: 9. Tel: 738-7611. Mgr. & Buyer: Murray Pearce. (RJ).  
Home office: Calgary, Alta.

Phonodisc Ltd., 4235 E. Hastings St., Burnaby. Tel: 298-5585. (D).  
Home office: Toronto, Ont.

Cartridge 8-tr. & cassette: Audio Fidelity, Chart, Gordy, Hickory, Jubilee, Motown, Pye, Soul, Tamla, Vanguard.  
Accessories: Carrying cases, display racks, head cleaners & demagnetizers (Le-Bo).

Polydor Recs. Canada Ltd., 196 Smithe St. Tel: 681-0268. (D).  
Home office: Montreal, P.Q.

Cartridge 8-tr. & cassette: Polydor, DGG.

Pro-Sound Dists. Ltd., 575 Beatty St. Zone: 3 Tel: 682-7321. Mgr.: Ray Gora; Buyer: Mrs. Leota Valleau. (D, OS & RJ).  
Branch: Edmonton, Alta.

Cartridge 8-tr. & cassette: All lines.  
Accessories: Amberg, Le-Bo, Transatlantic.

R C A Ltd., 2876 Rupert St. Tel: 433-6881. (D).  
Home office: Montreal, P.Q.

Cartridge 8-tr.: RCA, Camden, Gala, Victrola, Colgems, Diamond, Dunhill, Gamble, Kirshner, Poppy.  
Cassette: RCA, Colgems, Dunhill, Kirshner.  
Open reel: RCA.  
Accessories: Head cleaners & demagnetizers (RCA).

Select Music Co., 133 W. Fifth Ave. Zone: 10. Tel: 876-3368. Mgr.: Wally Kiss. (D), (RJ) as Tape Dists.).  
Home office: Edmonton, Alta., Tape Dists.

Cartridge 8-tr.: ITCC, Pickwick Int'l, Stereodyne, V&K.  
Cassette: ITCC, Living Language, Pickwick Int'l, V&K.

Tape Dists. (RJ), see Select Music (D).  
Warner Bros. Recs. of Canada Ltd., 40 E. Fifth Ave. Zone 10. Tel: 879-8681. (D).

Home office: Montreal, P.Q.  
Cartridge 8-tr. & cassette: Warner Bros.-Seven Arts, Reprise, Atco, Atlantic, Vogue.

### • VICTORIA (Area Code 604)

Double Diamond Electronics Ltd., Mayfair Plaza, 3159 Douglas St. Tel: 386-0512. (D).  
Home office: Toronto, Ont. (see for prod. distributed).

### MANITOBA

#### • WINNIPEG (Area Code 204)

Campus Recs. Dists. Ltd., 1131 Fife St. Zone: 17. Tel: 589-5327. Pres.: Norman Stein; Mgr.: Neil Thorndyraft; Buyer: Audrey Glass. (RJ).

Double Diamond Electronics Ltd., 540 Marjorie St. Zone: 21. Tel: 786-5978. (D).  
Home office: Toronto, Ont. (see for prod. distributed).

Laurel Recs. Ltd., 1299 Strathcona St. Tel: 783-0436 Owner & Mgr.: E. Gore-Smith; Buyers: E. Gore-Smith, Shirley Choy. (D).

Cartridge 4-tr., 8-tr., cassette & open reel: Ampex, GRT.

London Recs. of Canada (1967) Ltd., 23 Keith Ct. Zone: 21. Tel: 775-7125. (D).

Home office: Montreal, P.Q.  
Cartridge 8-tr.: London, phase 4, Deram, Parrot, Hi, Bel-Air, Jacques Canetti, Caprice, La Campagne, Fontana, Gamma, Grand Prix, Jamie, Jupiter, Liberty, Limelight, Mercury, Monument, Philips, Rodeo Int'l, Smash.

Cassette: London, phase 4, Deram, Parrot, Hi, Jacques Canetti, Caprice, Fontana, Gamma, Grand Prix, Jamie, Liberty, Limelight, Mercury, Monument, Philips, Rodeo Int'l, Smash, Teldec.  
Open reel: London, phase 4, Parrot, Imperial, Liberty, Mercury, Philips, Soul City, World Pacific Jazz.

National Rec. Dist. Ltd., 358 Colony St. Tel: 783-7081. (RJ).

Branch: Regina, Sask.

Phonodisc Ltd., 1117 Sanford St. Tel: 774-7318. (D).

Home office: Toronto, Ont.  
Cartridge 8-tr. & cassette: Audio Fidelity, Chart, Gordy, Hickory, Jubilee, Motown, Pye, Soul, Tamla, Vanguard.

Accessories: Carrying cases, display racks, head cleaners & demagnetizers (Le-Bo).  
R C A Ltd., 2070 Notre Dame Ave. Tel: 772-0481. (D).

Home office: Montreal, P.Q.  
Cartridge 8-tr.: RCA, Camden, Gala, Victrola, Colgems, Diamond, Dunhill, Gamble, Kirshner, Poppy.

Cassette: RCA, Colgems, Dunhill, Kirshner.  
Open reel: RCA.  
Accessories: Head cleaners & demagnetizers (RCA).

Thomas Rathwell Ltd., 575 Roseberry St. Zone: 21. Tel: 774-4561. Owner & Mgr.: M. C. T. Rathwell. (D).

Cartridge 8-tr.: Abnak, Accent, Apex, Brunswick, Coral, Decca, Double Shot, GNP Crescendo, Kapp, Revolver, Scepter, Straight, Uni, United Artists, White Whale.  
Cassette: Apex, Brunswick, Coral, Decca, Double Shot, GNP Crescendo, Kapp, Revolver, Scepter, Uni, United Artists, White Whale.  
Open reel: Brunswick, Coral, Decca.

Warner Bros. Recs. of Canada Ltd., 24 Stevenson Rd., St. James. Tel: 786-6934. (D).  
Home office: Montreal, P.Q.

Cartridge 8-tr. & cassette: Warner Bros.-Seven Arts, Reprise, Atco, Atlantic, Vogue.

### NEW BRUNSWICK

#### • MONCTON (Area Code 506)

Crawford-Atlantic Ltd., 42 Brandon St. Tel: 382-9301. Cable: CRATCO. Pres.: R. W. Crawford. (RJ).

Branches: St. John's, Nfld.; Halifax, N.S.  
Maritime Recs. Ltd., 188 Mountain Rd. Tel: 389-1341. Mgr.: William D. Mitton; Buyer: Miss E. Bourque. (D, OS, RJ & I).

Cartridge 8-tr. & cassette: Ampex, Capitol, Columbia, ITCC, Phonodisc, RCA.  
Open reel: Ampex.

Playback equip.: Ampex, Automatic Radio, Craig, Holiday.  
Accessories: Channel Mktg.

Imports: Premier Albums.  
Stereo Tape Prods., 55 Maple St. Tel: 855-9866.  
Mgr.: Jim London. (OS).

Home office: Toronto, Ont.  
Waco-Sherman Dists., 1540 Main St. Tel: 382-9373.  
Sales Mgr. & Buyer: J. MacLeod. (RJ).  
Home office: Toronto, Ont.

### NEWFOUNDLAND

#### • ST. JOHN'S (Area Code 709)

Crawford-Atlantic Ltd., 139 Gower St. Tel: 726-6970. (RJ).  
Home office: Moncton, N.B.

continued on page 126

# STEREO JAUBERT

105, rue de Normandie, 92-COURBEVOIE, FRANCE  
Tel: 788. 0923-4

LEADING DISTRIBUTOR  
OF CAR AND HOME STEREOs IN EUROPE  
USING GAUSS MACHINES WITH DOLBY  
FOR ALL DUPLICATION

COMMON BUYER ASSOCIATION MEMBER  
Manufacturers of Pre-Recorded Cartridges

# **16 000 and 1 reasons for duplicating with I.T.P.**

**Ultra High Speed Tape Custom Duplicating  
8-track  
Cassette  
Reel to Reel  $3\frac{3}{4}$  &  $7\frac{1}{2}$  i.p.s.  
1" Mastering**

Equipment GAUSS, SCULLY and own make

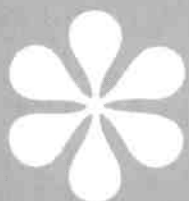

**Capacity of 16 000 tape units per day  
PLUS Made in Western Germany**

Enquires: ITP Tonband-Produktions-KG, 1 Berlin 15, Kurfürstendamm 236. Tel. 8833122

In association with Auto Stereo Anlagen GmbH Frankfurt/Main, Friedrichstraße 40, Tel. 727872 Telex 414894

## INTERNATIONAL TAPE SECTION

Continued from page 128

Double Diamond Electronics Ltd., 445 Water St.  
Tel: 726-0709. (D).  
Home office: Toronto, Ont. (see for prod. distributed).

### NOVA SCOTIA

#### • AMHERST (Area Code 902)

Avalake Dists., Station St. Tel: 667-3307. Owners: Mr. & Mrs. W. S. A. Daley; Mgr.: Mrs. Allie Daley; Buyer: N. Harrison. (D).

Cartridge 8-tr. & cassette: Atco, Atlantic, Cotillion, Reprise, Vogue, Warner Bros.-Seven Arts.

Canadian Assemblies Ltd., Station St. Tel: 667-3309. Mgr.: W. S. A. Daley; Buyer: Ted Evans. (D).

Cartridge 8-tr.: GRT, Quality.  
Waldale Ltd., Station St. Tel: 667-3308. Owner & Mgr.: Mrs. W. S. A. Daley; Buyer: Marie Harrison. (D).

Cartridge 8-tr.: Abnak, Accent, Apex, Brunswick, Coral, Decca, Double Shot, GNP Crescendo, Kapp, Lero, Point, Revolver, Scepter, Solid State, Straight, Uni, United Artists, White Whale.

Cassette: Apex, Brunswick, Coral, Decca, Double Shot, GNP Crescendo, Kapp, Revolver, Scepter, Uni, United Artists, White Whale.  
Open reel: Brunswick, Coral, Decca.

#### • HALIFAX (Area Code 902)

Crawford-Atlantic Ltd., PO Box 936, 1890 Granville St. Tel: 429-3537. (RJ).

Home office: Moncton, N.B.  
Double Diamond Electronics Ltd., Bayers Rd. Shopping Centre. Tel: 455-7279. (D).

Home office: Toronto, Ont. (see for prod. distributed).

R C A Ltd., 3611 Commission St. Tel: 455-7247. (D).

Home office: Montreal, P.Q.

Cartridge 8-tr.: RCA, Camden, Gala, Victrola, Colgems, Diamond, Dunhill, Gamble, Kirshner, Poppy.

Cassette: RCA, Colgems, Dunhill, Kirshner.  
Open reel: RCA.

Accessories: Head cleaners & demagnetizers (RCA).

Stereodyne (Canada) Ltd., 1890 Granville St. Tel: 429-3527. Mgr.: Tom Burney. (D, OS, RJ & I).  
Home office: Toronto, Ont. (see for prod. distributed & imported).

### ONTARIO

#### • COOKSVILLE (Area Code 416)

Polydor Recs. Canada Ltd., 3279 Lenworth Dr. Tel: 625-3990. (D).

Home office: Montreal, P.Q.  
Cartridge 8-tr. & cassette: Polydor, DGG.

#### • HAMILTON (Area Code 416)

Muntz Stereo-Pak Canada Ltd., 61 Sanford Ave. N. Tel: 525-0268. Pres.: David Hoffman; Gen. Mgr.: Murray Hoffman; Sales & Adv. Mgr.: Doug Marzyniuk. (D).

Cartridge 8-tr.: A&M, Ampex, Capitol, Columbia, Decca, GRT, ITCC, London, Polydor, RCA, Warner Bros.-Seven Arts.

Cartridge 4-tr.: Muntz.  
Cassette: Same as 8-tr.  
Playback equip.: Muntz.

#### • LONDON (Area Code 519)

G R T of Canada Ltd. (see listing in Duplicator/Marketers section).

#### • OTTAWA (Area Code 613)

Double Diamond Electronics Ltd., 715 Richmond St. Tel: 728-1109/7195. (D).

Home office: Toronto, Ont. (see for prod. distributed).

Waco-Sherman Dists., 29 Bayswater Ave. Tel: 729-1421. Sales Mgr.: B. Newton. (RJ).  
Home office: Toronto, Ont.

#### • TORONTO METROPOLITAN AREA (Area Code 416)

Abel's Recs. Unlimited, 137 Jarvis St. Zone: 210. Tel: 364-1077. Owner: Ted G. Abel; Mgr.: Sam Zaffuto; Buyers: Ted G. Abel, Mike Lais. (D, OS & RJ).

Cartridge 4-tr., 8-tr., cassette & open reel: All lines.  
Playback equip.: Bell & Howell, Lear Jet.

Accessories: Bell & Howell, Lear Jet, Recoton.

Alldisc Dists. Ltd., 2316 Queen St. E. Zone: 260. Tel: 691-9948. Mgr.: Tony R. Frank; Buyer: Bill Sparksman. (OS & RJ).

Allied Rec. Corp., PO Box 517, 104 Doncaster Ave., Willowdale. Tel: 889-8566. Sales Mgr.: Jack Boswell. (D).

Branch: Montreal, P.Q.  
Cartridge 8-tr. & cassette: Paragon.

All Recs. Supply Co. of Canada Ltd. (div. of CBS), 1149 Bellamy Rd., N., Scarborough. Tel: 291-7341. Mgr. & Buyer: Ken Higgenbottom. (OS & RJ).

Branches: Calgary, Alta.; Vancouver, B.C.

Ampex of Canada Ltd. (see listing in Duplicator/Marketers section).

Apex Recs. Ltd., MCA Bldg., 2450 Victoria Park Ave., Willowdale 425. Tel: 449-3000. Mgr.: George Offer; Buyer: James Austin. (D).

Cartridge 8-tr.: Abnak, Accent, Apex, Brunswick, Coral, Decca, Double Shot, GNP Crescendo, Kapp, Revolver, Scepter, Solid State, Straight, Uni, United Artists, Wand, White Whale.

Cassette: Apex, Brunswick, Coral, Decca, Double Shot, GNP Crescendo, Kapp, Revolver, Scepter, Uni, United Artists, Wand, White Whale.

Open reel: Brunswick, Coral, Decca.  
Playback equip.: Decca.

Canada Rec. Sales, 686 Richmond St. W. Tel: 363-1019. Owner: Herbert Berne; Mgr. & Buyer: B. Benedetti. (D, OS & RJ).

Cartridge 4-tr., 8-tr., cassette & open reel: All lines.

Canadian Music Sales Corp. Ltd., 58 Advance Rd. Zone: 570. Tel: 239-2361. Owner: T. St. Clair Low; Mgr.: Jury Krytiuk. (D & I).

Cartridge 8-tr. & cassette: Bravo, Dominion, Crown-Vetch.  
Imports cartridge 8-tr. & cassette: Ricordi (Italy).

Caravan Rec. Sales Ltd., 117 Midwest Rd., Scarborough. Tel: 757-2455. Owner & Buyer: Frank P. Swain; Mgr.: H. Littlejohn. (D).

Cartridge 8-tr. & cassette: Fiesta, Grecophon, Merrydisc, Recording Artists, U Recs., UK Recs. Accessories: Walco; blank loaded tape (Bel Clear).

William Cohen Corp., 56 Ridgevale Dr. Zone: 392. Tel: 789-1600. Mgr.: Perry Cohen. (D).

Home office: Montreal, P.Q.  
Cartridge 8-tr. & cassette: Vivid Sounds.

Columbia Recs. Dists. Canada Ltd., 1121 Leslie St., Don Mills. Tel: 447-3311. Branch: 1113 Leslie St., Don Mills. Tel: 444-6651. (D).

Branches: Calgary, Alta.; Vancouver, B.C.; Montreal, P.Q.

Cartridge 8-tr. & cassette: Columbia, Epic, Date, Immediate, Musicor, Ode, Starday.

Open reel: Columbia, Epic, Immediate, Musicor, Ode.

Double Diamond Electronics Ltd., 34 Progress Ave., Scarborough. Tel: 291-2503. Buyer: Ben Cass. Branches: 6 Leswyn Rd., Toronto 390. Tel: 781-5201; 115 Vanderhoof Ave., Toronto. Tel: 425-5777. (D & I).

Branches: Calgary, Edmonton, Alta.; Vancouver, Victoria, B.C.; Winnipeg, Man.; St. John's, Nfld.; Halifax, N.S.; Ottawa, Ont.; Montreal, Quebec City, P.Q.; Regina, Sask.

Cartridge 4-tr., 8-tr. & cassette: Allied, Ampex, Apex, Capitol, Columbia, GRT, London, Phonodisc, Polydor, Quality, Warner Bros.-Seven Arts.

Playback equip.: Siera (Japan & Netherlands).  
Accessories: Siera blank loaded cassettes; blank loaded tape, head cleaners & display racks.

Handleman Co. of Canada Ltd., 132 Manville Rd., Scarborough. Tel: 759-1166. Mgr.: L. Hammett; Buyer: James N. Pegg. (RJ).  
Home office: Detroit, Mich., USA.

I T C C (see Modern Tape Cartridge Corp. & also listing in Duplicator/Marketers section).  
Kensington Dists. (RJ) (see Waco-Sherman/Kensington Dists.).

London Recs. of Canada (1967) Ltd., 1630 Midland Ave., Scarborough. Tel: 755-3373. (D).  
Home office: Montreal, P.Q.

Cartridge 8-tr.: London, phase 4, Deram, Parrot, Hi, Bel-Air, Jacques Canetti, Caprice, La Compagnie, Fontana, Gamma, Grand Prix, Jamie, Jupiter, Liberty, Limelight, Mercury, Monument, Philips, Rodeo Int'l, Smash.

Cassette: London, phase 4, Deram, Parrot, Hi, Jacques Canetti, Caprice, Fontana, Gamma, Grand Prix, Jamie, Liberty, Limelight, Mercury, Monument, Philips, Rodeo Int'l, Smash, Teldec.

Open reel: London, phase 4, Parrot, Imperial, Liberty, Mercury, Philips, Soul City, World Pacific Jazz.

Modern Tape Cartridge Corp. Ltd. (div. of ITCC), 1179 Finch Ave. W., Unit 20, Downsview. Tel: 630-8494. Mgr.: A. B. Salter. (I).

Imports: Pre-recorded tape—ITCC, NAL, Premier Albums, Radiant (all USA); playback equip.—Metro of California (USA).

One Stop Rec. & Tape Dists., 30 Bridgman Ave. Tel: 536-2131. Owners: Nat Segal, Daryl Clarkson; Mgr.: Joe Shaw; Buyer: Daryl Clarkson. (D, OS & RJ).

Cartridge 4-tr., 8-tr., cassette & open reel: All lines.  
Playback equip.: Lear Jet, Magnasonic, Sanyo.

Phonodisc Ltd., 30 Malley Rd. Tel: 751-9610. Tape Div. & Sales Mgr.: Bill Osbourne. (D).

Branches: Vancouver, B.C.; Winnipeg, Man.; Montreal, P.Q.

Cartridge 8-tr. & cassette: Audio Fidelity, Chart, Gordy, Hickory, Jubilee, Motown, Pye, Soul, Tama, Vanguard.

Accessories: Carrying cases, display racks, head cleaners & demagnetizers (Le-Bo).

Quality Recs. Ltd. (see listing in Duplicator/Marketers section).

R C A Ltd., 1450 Castlefield Ave. Tel: 651-6550. (D).  
Home office: Montreal, P.Q.

Cartridge 8-tr.: RCA, Camden, Gala, Victrola, Colgems, Diamond, Dunhill, Gamble, Kirshner, Poppy.

Cassette: RCA, Colgems, Dunhill, Kirshner.  
Open reel: RCA.

Accessories: Head cleaners & demagnetizers (RCA).

Stereodyne (Canada) Ltd., 6 Evans Ct., Etobicoke. Tel: 259-4201. Gen. Mgr.: H. R. Newman; Sales Mgr.: R. B. Kerr; Buyer: Tom Audet. (D, OS, RJ & I).

Branches: Edmonton, Alta.; Halifax, N.S.; Montreal, Quebec City, P.Q.

Cartridge 8-tr.: Accent, Bang, Barclay, Bravo, Condor, Crown-Vetch, DGG, Dominion, Everest, Hickory, HiFi, Montagnard, Polydor, Select, Tradition, Trans-Canada, Venus.

Cassette: Accent, Barclay, Bravo, Crown-Vetch, Dominion, Trans-Canada.

Playback equip.: Imports Lear Jet (Japan & USA).

Accessories: Blank loaded tape, head cleaners (Dynapak); carrying cases & demagnetizers (Recoton).

Stereo Tape Prods. Ltd., 1106 Dovercourt Rd. Zone: 170. Tel: 537-2534. Owners: Norman & Sam Bornstein; Mgr.: Norman Bornstein; Buyer: P. J. McQuade. (OS & RJ).

Branches: Edmonton, Alta.; Moncton, N.B.; Montreal, P.Q.

Trans World Rec. Corp., 117 Midwest Rd., Scarborough. Tel: 759-1638. Mgr. & Buyer: Frank Swain. (D).

Home office: Montreal, P.Q. (see for prod. distributed).

Waco-Sherman/Kensington Dists., 3109 American Dr., Malton. Tel: 677-6230. Nat'l Sales Mgr.: L. S. Bud Farquharson; Sales Mgr.: A. Reid; Buyer: E. Crosby. (RJ).

Branches: Calgary, Edmonton, Alta.; Vancouver, B.C.; Regina, Sask.—Kensington Dists.; Moncton, N.B.; Ottawa, Ont.; Montreal P.Q.—Waco-Sherman Dists.

Warner Bros. Recs. of Canada Ltd., 4480 Chesswood Dr., Downsview. Tel: 630-3033. (D).  
Home office: Montreal, P.Q.

Cartridge 8-tr. & cassette: Warner Bros.-Seven Arts, Reprise, Atco, Atlantic, Vogue.

#### • WATERLOO (Area Code 519)

Carl H. Sattler & Assoc. Ltd., 160 Columbia St. W. Tel: 578-5110. Owner & Mgr.: Carl H. Sattler; Buyer: Doug Robinson. (RJ).

FIRST IN  
CANADA!



To provide complete manufacturing and distribution facilities in phonograph records, reel to reel, 4 & 8 track cartridges and cassettes.



CONTACT US NOW FOR ALL OF YOUR DUPLICATING AND DISTRIBUTION NEEDS CALL

**Quality**

RECORDS LIMITED

380 BIRCHMOUNT ROAD,  
SCARBOROUGH, ONT.  
TELEPHONE 698-5511-2-3-4-5

continued on page 128

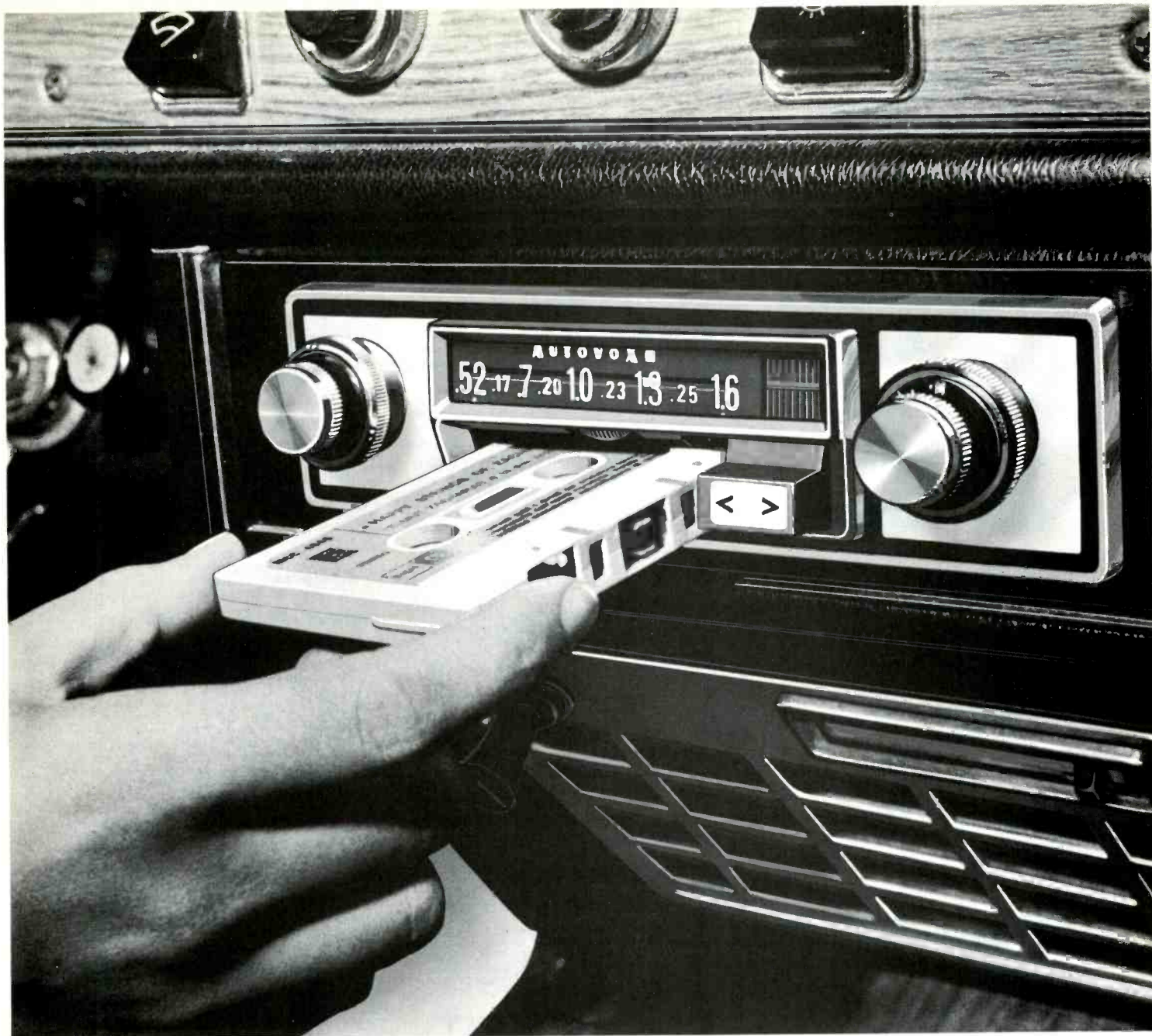

## the nicest idea for the best solution

This is the idea of AUTOVOX who—in one set to be easily mounted indash the car—presents an excellent car radio coupled with a perfect tape-player for the reproduction of compact tapes named "musicassette." MELODY STEREO RADIO (mod. MA 363), stereo tape-player complete with all transistor car radio operating on MW and LW. Indash installation. Single key for: ON switching and beginning of the magnetic tape reproduction, OFF switching and

quick ejection of the cartridge; rapid slipping of the magnetic tape in the two directions. Special signaling device, with flasher, indicating the end of the magnetic tape. Tangential knob for the balancing of the two channels. Knob for tone regulation. Total power output: 10 W. Other models belonging to "MELODY" series: mod. MA 341 mono-aural tape-player which can be coupled with car radio; mod. MA 351 stereo tape-player complete with amplifier.

# AUTOVOX

The "number one" of the carradio in Italy.

AUTOVOX EXPORT DEPARTMENT C.P.2377 R.A.D.—00185 ROMA (ITALY)

# ECOFINA

The trade mark of a high quality stereo-tape product.

**1970**  
6,000 cassettes and 3,000  
8-track cartridges a day

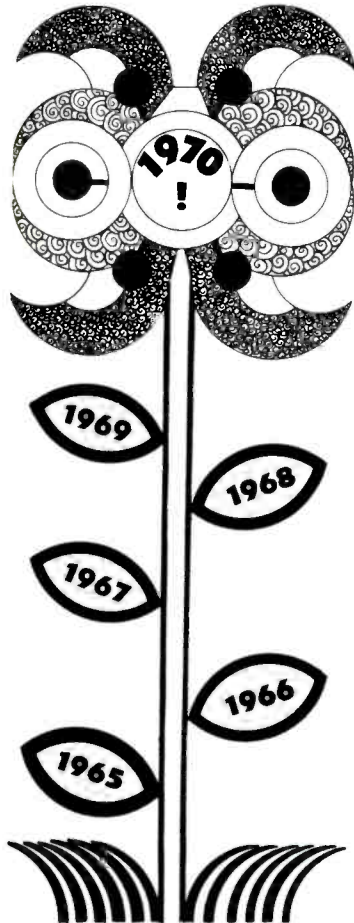

**1965** Only distributors  
**1966** 30 cassettes a day  
**1967** 100 cassettes a day  
**1968** 800 cassettes a day  
**1969** 3,000 cassettes and 1,500  
8-track cartridges a day

## ON THE FOREFRONT OF THE TAPE WORLD

Ecofina has been the first company in the Common Market to have licensing agreements with record companies, since 1965, for duplication and sales of 4 and 8-track cartridges and cassettes.

We also manufacture cartridge and cassette players.

Exhibiting at all Italian Trade Fairs.

Ecofina s.r.l.

Via Leopardi 8  
Tel.: 806125/8690121 Milan, Italy

## INTERNATIONAL TAPE SECTION

Continued from page 126

### QUEBEC

#### • MONT-JOLI (Area Code 418)

Disbec Inc., PO Box 219. Tel: 775-7226. Mgr.: Ray Paradis; Buyer: Jacques Michaud. (D, OS & RJ). Cartridge 8-tr., cassette & open reel: RCA, Camden, Dunhill. Playback equip.: RCA. Accessories: RCA.

#### • MONTREAL METROPOLITAN AREA (Area Code 514)

Allied Rec. Corp., 190 Ronald Dr. Tel: 489-9729. (D).

Home office: Toronto, Ont.

Cartridge 8-tr. & cassette: Paragon.

Almada Corp., 380 Craig St. W. Zone: 126. Tel: 844-4006. Mgr.: Marvin Drimer; Buyer: Aaron Lipsin. (D & I).

Cartridge 8-tr.: Afro-Request, Alegre, Anima d'Italia, Cesta, Cotique, Deutsche Heimats Lieder, Emmess Yiddish, Fania, Jazz From the Vault, Monitor, Musicor, Pickwick, Polskie Melodie, Request, Soul of Africa, Sounds of the Caribbean, Speed, Tico.

Cassette: Afro-Request, Alegre, Cotique, Everest/Cetra, Falcon, Fania, Floret, Living Language, Monitor, Pickwick, Request, Roulette, Soul of Africa, Tico.

Accessories: Blank loaded tape (Pan Canada), head cleaners (Almada, Metrosound), tape splicers & splicing tape (Metrosound).

William Cohen Corp., 8900 Park Ave. Zone: 354. Tel: 382-2132. Pres.: William Cohen; Sales Mgr.: Syd Goldstein; Adv. Dir.: Robina Lavigne. (D).

Branch: Toronto, Ont.

Cartridge 8-tr. & cassette: Vivid Sounds.

Columbia Recs. Dists. Canada Ltd., 1168 Montee de Liesse. Zone: 9. Tel: 336-1744. (D).

Home office: Toronto, Ont.

Cartridge 8-tr. & cassette: Columbia, Epic, Date, Immediate, Musicor, Ode, Starday.

Open reel: Columbia, Epic, Immediate, Musicor, Ode.

The Compo Co. Ltd., 2377 Remembrance St., Lachine. Tel: 637-2561. Gen. Mgr.: R. A. Chislett; Sales Mgr.: S. D. Roberts. (D).

Cartridge 8-tr.: Abnak, Accent, Apex, Brunswick, Coral, Decca, Double Shot, GNP Crescendo, Kapp, Revolver, Scepter, Straight, Uni, United Artists, White Whale.

Cassette: Apex, Brunswick, Coral, Decca, Double Shot, GNP Crescendo, Kapp, Revolver, Scepter, Uni, United Artists, White Whale.

Open reel: Brunswick, Coral, Decca.

Double Diamond Electronics Ltd., 5930 Cote de Liesse Rd. Zone: 9. Tel: 342-2043. (D).

Home office: Toronto, Ont. (see for prod. distributed).

General Stereo Inds. Corp., 1871 St. Louis St., St. Laurent. Tel: 747-7633. Owner: M. J. Israel; Mgr.: A. Israel; Buyer: S. Israel. (D).

Cartridge 8-tr. & cassette: Ampex, Capitol, Columbia, Decca, Fiesta, GRT, ITCC, Kapp, Kiddy Pak, London, Motown, NAL, Philips, Polydor, Quality, RCA, Reprise, Trans-Canada, Trans World, Traveltime, United Artists, Warner Bros.-Seven Arts.

Playback equip.: Dynatronics, Lloyds, Panasonic, RCA, Ravel, Tenna.

Accessories: Carrying cases & head cleaners.

London Recs. of Canada (1967) Ltd., 190 Graveline St., St. Laurent. Tel: 735-5551. Pres.: F. C. Jamieson; Sales Mgr.: Adrian Bilodeau. (D).

Branches: Calgary, Alta.; Vancouver, B.C.; Winnipeg, Man.; Toronto, Ont.; Quebec City, P.Q.

Cartridge 8-tr.: London, phase 4, Deram, Parrot, Hi, Bel-Air, Jacques Canetti, Caprice, La Compagnie, Fontana, Gamma, Grand Prix, Jamie, Jupiter, Liberty, Limelight, Mercury, Monument, Philips, Rodeo Int'l, Smash.

Cassette: London, phase 4, Deram, Parrot, Hi, Jacques Canetti, Caprice, Fontana, Gamma, Grand Prix, Jamie, Liberty, Limelight, Mercury, Monument, Philips, Rodeo Int'l, Smash, Teldec.

Open reel: London, phase 4, Parrot, Imperial, Liberty, Mercury, Philips, Soul City, World Pacific Jazz.

Phonodisc Ltd., 809 William St. Tel: 861-5891. (D).

Home office: Toronto, Ont.

Cartridge 8-tr. & cassette: Audio Fidelity, Chart, Gordy, Hickory, Jubilee, Motown, Pye, Soul, Tamla, Vanguard.

Accessories: Carrying cases, display racks, head cleaners & demagnetizers (Le-Bo).

Polydor Recs. Canada Ltd., 4115 Sherbrooke St. W. Tel: 933-4201. Mng. Dir.: Fred Exon. (D).

Branches: Vancouver, B.C.; Cooksville, Ont.

Cartridge 8-tr. & cassette: Polydor, DGG.

R C A Ltd., 3333 Cavendish Blvd. Zone: 261. Tel: 482-9912. Mktg. Mgr.: W. A. Gillmeister.

Branch: 5575 Royal Mount Ave. Tel: 342-9220. (D).

Branches: Calgary, Alta.; Vancouver, B.C.; Winnipeg, Man.; Halifax, N.S.; Toronto, Ont.

Cartridge 8-tr.: RCA, Camden, Gala, Victrola,

Colgems, Diamond, Dunhill, Gamble, Kirshner, Poppy. Cassette: RCA, Colgems, Dunhill, Kirshner. Open reel: RCA. Accessories: Head cleaners & demagnetizers (RCA).

Stereodyne (Canada) Ltd., 177 Pine Ave. E. Tel: 849-5143. Mgr.: Jacques Portance. (D, OS, RJ & I).

Home office: Toronto, Ont. (see for prod. distributed & imported).

Stereo Tape Prods., 2405 Rome Blvd. Tel: 678-1794.

Mgr.: Claude Goulet. (OS).

Home office: Toronto, Ont.

Trans-Canada Musique Serv. Inc., 189 Rockland Rd., Town of Mount Royal. Tel: 735-5661. Owner: Jean Paul Rickner; Mgr.: Jean Desrosiers; Buyer: Maurice Gignac. (D & OS).

Branch: Quebec City, P.Q.

Cartridge 8-tr. & cassette: Barclay, Canusa, Caroussel, DSP, Dorval, Guitare, Nobel, Passe-Temps, Riviera, Trans-Canada, Vedette.

Playback equip.: Clasonic, Ten Car Stereo.

Trans World Rec. Corp., 1230 Montee de Liesse. Zone: 384. Tel: 336-3110. Pres., Mgr. & Buyer: Art Young. (D).

Branch: Toronto, Ont.

Cartridge 8-tr.: Amusement, Caedmon, Disc AZ, Disc Bam, Douglas, Emerald, Fiesta, Major Minor, Montagnard, Project 3, Skye, Trans World.

Cassette: Same as 8-tr. plus Spoken Arts.

Waco-Sherman Dists., (sales office) 155 Port Royal St. W. Tel: 382-2930. Supervisor: J. Grandbois; Sales Mgr.: J. Y. Lamothe. (Distribution Centre) 9255 Cote de Liesse Rd., Dorval 760. Tel: 631-9071. Buyer: M. Girard. (RJ).

Home office: Toronto, Ont.

Warner Bros. Recs. of Canada Ltd., 220 Brunswick Blvd., Pointe-Claire. Tel: 697-7400. Tape Div. Mgr.: M. W. Doyle; Sales Mgr.: Clyde McGregor. (D).

Branches: Calgary, Alta.; Vancouver, B.C.; Winnipeg, Man.; Toronto, Ont.

Cartridge 8-tr. & cassette: Warner Bros.-Seven Arts, Reprise, Atco, Atlantic, Vogue.

#### • QUEBEC CITY (Area Code 418)

Double Diamond Electronics Ltd., La Canardiere Shopping Centre, St. Anne Blvd. Tel: 667-1822. (D).

Home office: Toronto, Ont. (see for prod. distributed).

London Recs. of Canada (1967) Ltd., 383 St. Paul St. Tel: 529-0261. (D).

Home office: Montreal, P.Q.

Cartridge 8-tr.: London, phase 4, Deram, Parrot, Hi, Bel-Air, Jacques Canetti, Caprice, La Compagnie, Fontana, Gamma, Grand Prix, Jamie, Jupiter, Liberty, Limelight, Mercury, Monument, Philips, Rodeo Int'l, Smash.

Cassette: London, phase 4, Deram, Parrot, Hi, Jacques Canetti, Caprice, Fontana, Gamma, Grand Prix, Jamie, Liberty, Limelight, Mercury, Monument, Philips, Rodeo Int'l, Smash, Teldec.

Open reel: London, phase 4, Parrot, Imperial, Liberty, Mercury, Philips, Soul City, World Pacific Jazz.

Stereodyne (Canada) Ltd., 210 Dupont St. Tel: 523-9923. Mgr.: Andre Beaudoin. (D, OS, RJ & I).

Home office: Toronto, Ont. (see for prod. distributed & imported).

Trans-Canada Musique Serv. Inc., 315 St. Paul St. Tel: 524-4671. Mgr.: Jean Desrosiers; Buyer: Roger Pilon. (D & OS).

Home office: Montreal, P.Q. (see for prod. distributed).

### SASKATCHEWAN

#### • REGINA (Area Code 306)

Double Diamond Electronics Ltd., 156 Broad St. N. Tel: 543-0446. (D).

Home office: Toronto, Ont. (see for prod. distributed).

Kensington Dists., 1350 Scarth St. Tel: 525-5684. (RJ).

Home office: Toronto, Ont., Waco-Sherman/Kensington Dists.

A. A. Murphy & Sons Ltd., 1322 McIntyre St. Tel: 522-0620. Mgr.: C. Burlingham. (D).

Home office: Saskatoon, Sask. (see for prod. distributed).

National Rec. Dist. Ltd., 1115 Rose St. Tel: 527-1071. (RJ).

Home office: Winnipeg, Man.

#### • SASKATOON (Area Code 306)

A. A. Murphy & Sons Ltd., 2120 St. George Ave. Tel: 652-6622. Owner: W. A. Murphy; Tape Div. Mgr.: J. L. Smith; Tape Buyer: P. Bateman. (D).

Branch: Regina, Sask.

Cartridge 8-tr., cassette & open reel: Bang, Buena Vista, Cadet, Camden, Checker, Chess, Colgems, Diamond, Dunhill, GRT, Gamble, Hickory, Jamie, Kirshner, Monument, Nashville, Poppy, RCA, Roulette, Scepter, Starday, Tower, Wand, White Whale.

Playback equip.: Metro, RCA.

Accessories: Carrying cases & head cleaners (Le-Bo, RCA).

continued on page 130



## ● tape supplies

### RAW TAPE

Webcor Electronics Ltd., 222 Front St. E., Toronto, Ont. Tel: (416) 363-7359. Pres.: S. Sadomsky; VP Sales & Gen. Mgr.: W. G. Patterson.

### EMPTY CARTRIDGE, CASSETTE & REEL MANUFACTURERS

Dynapak (see Stereodyne).

Sarex-Canada Ltd., 9421 Cote de Liesse Rd., Montreal 760, P.Q. Tel: (514) 636-0533. Pres.: Herbert Z. Goldstein.

Home office: USA.

Configuration: Cassette.

Brand name: Sarex, private labels.

Stereodyne (Canada) Ltd., 6 Evans Ct., Etobicoke, Ont. Tel: (416) 259-4201. Gen. Mgr.: H. R. Newman; Sales Mgr.: R. B. Kerr.

Configuration: Cartridge 4-tr., 8-tr. & cassette.

Brand name: Dynapak.

Webcor Electronics Ltd., 222 Front St. E., Toronto, Ont. Tel: (416) 363-7359. Pres.: S. Sadomsky; VP Sales & Gen. Mgr.: W. G. Patterson.

### BLANK LOADED TAPE

Double Diamond Electronics Ltd., 34 Progress Ave., Scarborough, Ont. Tel: (416) 291-2503. Buyer: Ben Cass. (Imports only).

Configuration: Cassette.

Brand name: Siera.

Dynapak (see Stereodyne).

Sarex-Canada Ltd., 9421 Cote de Liesse Rd., Montreal 760, P.Q. Tel: (514) 636-0533. Pres.: Herbert Z. Goldstein.

Home office: USA.

Configuration: Cassette.

Brand name: Private label.

Siera (see Double Diamond).

Stereodyne (Canada) Ltd., 6 Evans Ct., Etobicoke, Ont. Tel: (416) 259-4201. Gen. Mgr.: H. R. Newman; Sales Mgr.: R. B. Kerr.

Configuration: Cartridge 4-tr., 8-tr. & cassette.

Brand name: Dynapak.

Webcor Electronics Ltd., 222 Front St. E., Toronto, Ont. Tel: (416) 363-7359. Pres.: S. Sadomsky; VP Sales & Gen. Mgr.: W. G. Patterson.

### CARTRIDGE PARTS MANUFACTURER

Stereodyne (Canada) Ltd., 6 Evans Ct., Etobicoke, Ont. Tel: (416) 259-4201. Gen. Mgr.: H. R. Newman; Sales Mgr.: R. B. Kerr.  
Chief product: All parts.

## ● tape services

### CUSTOM DUPLICATION

Ampex of Canada Ltd., 100 Skyway Ave., Rexdale, Ont. Tel: (416) 677-2370. VP & Gen. Mgr.: James E. DeLor; Sales Mgr.: Joe Pariselli.  
Configurations: Cartridge 8-tr., cassette & open reel.

Eastern Sound Co. Ltd., 48 Yorkville Ave., Toronto, Ont. Tel: (416) 920-2211. Pres.: Patrick Clever; VP & Gen. Mgr.: Murray A. Shields.  
Configurations: Cassette & open reel.

G R T of Canada Ltd., 1045 Hargrrieve Rd., London, Ont. Tel: (519) 434-4534. Pres.: Ross B. Reynolds; Nat'l Sales Mgr.: Edward P. LaBuick.  
Configurations: Cartridge 8-tr. & cassette.

Philips Electronics Inds. Ltd., Consumer Prod. Div., 116 Vanderhoof Ave., Toronto 17, Ont. Tel: (416) 425-5161. Pres.: H. A. C. Van Beurden; Gen. Mgr.: D. H. Prentice; Sales Mgr.: N. F. Wester.  
Configuration: Cassette.

Quality Recs. Ltd., 380 Birchmount Rd., Scarborough, Ont. Tel: (416) 698-5511. VP & Mng. Dir.: George L. Keane; Ass't to Mng. Dir.: George R. Struth; Gen. Sales Mgr.: Lee W. Farley.  
Configurations: Cartridge 4-tr., 8-tr., cassette & open reel.

Stereodyne (Canada) Ltd., 6 Evans Ct., Etobicoke, Ont. Tel: (416) 259-4201. Gen. Mgr.: H. R. Newman; Sales Mgr.: R. B. Kerr.  
Configurations: Cartridge 4-tr., 8-tr. & cassette.

Studio 3 Prod'ns Ltd., 2190 W. 12 Ave., Vancouver, B.C. Tel: (604) 736-7626. Pres. & Sales Mgr.: Ralph Harding; Mng. Dir.: Jack Herschorn.  
Configurations: Cartridge 4-tr., 8-tr., cassette & open reel.

### DESIGN & ARTWORK

Ever-Reddy Dupl'g Serv. Inc., 5505 Cote de Liesse Rd., St. Laurent, P.Q. Tel: (514) 747-1158. Pres.: Martin Tauber; Gen. Mgr.: S. Goloff; Sales Mgr.: G. Harrison.

Lord Thaxton Ltd., Box 1425, Sta. B, Ottawa, Ont. Tel: (613) 713-0921. Pres.: F. P. Belwa; VP Mktg.: George Pollard; Gen. Mgr.: Bob Schultz.

Parr's Print & Litho Ltd., 625 Yonge St., Toronto 284, Ont. Tel: (416) 925-5166. Pres.: Victor W. Parr.

Studio 3 Prod'ns Ltd., 2190 W. 12 Ave., Vancouver, B.C. Tel: (604) 736-7626. Pres. & Sales Mgr.: Ralph Harding; Mng. Dir.: Jack Herschorn.

Webcor Electronics Ltd., 222 Front St. E., Toronto, Ont. Tel: (416) 363-7359. Pres.: S. Sadomsky; VP Sales & Gen. Mgr.: W. G. Patterson.

What's Happenin' Publ'ns, 871 Cosburn Ave., Toronto 13, Ont. Tel: (416) 421-5537. Pres.: Mike Smith.

### PACKAGING & LABELING

Lord Thaxton Ltd., Box 1425, Sta. B, Ottawa, Ont. Tel: (613) 731-0921. Pres.: F. P. Belwa; VP Mktg.: George Pollard; Gen. Mgr.: Bob Schultz.

Metro Graphic Corp., 9880 Parc Georges Blvd., Montreal North, P.Q. Tel: (514) 321-6750. Pres.: Paul Kizner; Sales Mgr.: Morris L. Cohen.

R C A Ltd., 3333 Cavendish Blvd., Montreal 261, P.Q. Tel: (514) 482-9912.

Sarex-Canada Ltd., 9421 Cote de Liesse Rd., Montreal 760, P.Q. Tel: (514) 636-0533. Pres.: Herbert Z. Goldstein.

Home office: USA.

Product: Cassette boxes & mailers.

Stereodyne (Canada) Ltd., 6 Evans Ct., Etobicoke, Ont. Tel: (416) 259-4201. Gen. Mgr.: H. R. Newman; Sales Mgr.: R. B. Kerr.

Studio 3 Prod'ns Ltd., 2190 W. 12 Ave., Vancouver, B.C. Tel: (604) 736-7626. Pres. & Sales Mgr.: Ralph Harding; Mng. Dir.: Jack Herschorn.

### PRINTING & LITHOGRAPHING

Ever-Reddy Dupl'g Serv. Inc., 5505 Cote de Liesse Rd., St. Laurent, P.Q. Tel: (514) 747-1158. Pres.: Martin Tauber; Gen. Mgr.: S. Goloff; Sales Mgr.: G. Harrison.

Karn & Garber Ltd., 100 Simcoe St., Toronto 1, Ont. Tel: (416) 364-6224. Pres. & Gen. Mgr.: Irving Garber.

Lord Thaxton Ltd., Box 1425, Sta. B, Ottawa, Ont. Tel: (613) 731-0921. Pres.: F. P. Belwa; VP Mktg.: George Pollard; Gen. Mgr.: Bob Schultz.

Metro Graphic Corp., 9880 Parc Georges Blvd., Montreal North, P.Q. Tel: (514) 321-6750. Pres.: Paul Kizner; Sales Mgr.: Morris L. Cohen.

Parr's Print & Litho Ltd., 625 Yonge St., Toronto 284, Ont. Tel: (416) 925-5166. Pres.: Victor W. Parr.

Stereodyne (Canada) Ltd., 6 Evans Ct., Etobicoke, Ont. Tel: (416) 259-4201. Gen. Mgr.: H. R. Newman; Sales Mgr.: R. B. Kerr.

Studio 3 Prod'ns Ltd., 2190 W. 12 Ave., Vancouver, B.C. Tel: (604) 736-7626. Pres. & Sales Mgr.: Ralph Harding; Mng. Dir.: Jack Herschorn.

What's Happenin' Publ'ns, 871 Cosburn Ave., Toronto 13, Ont. Tel: (416) 421-5537. Pres.: Mike Smith.

*continued on page 130*

# EMITAPE

## magnetic recording tape

the choice of the professional  
throughout the world



The original and largest British manufacturer  
of magnetic recording tape

E. M. I. TAPE LIMITED · HAYES · MIDDLESEX · ENGLAND

# TAPES IN SCANDINAVIA?



## ALL IN ONE HAT

### 8-TRACKS CASSETTES

### DUPLICATING ACCESSORIES

## MUSIC PRODUCTION

Represented Companies and Labels:

BERKSHIRE • CHESS • EPIC • EUROPA  
• GRT • HICKORY • MUSIC-ON-TAPE •  
NASHVILLE • POWER • PREMIER • PROJ-  
ECT 3 • RECOTON • REPRISÉ • ROU-  
LETTE • SCASON • SOMERSET • SONET  
• STARDAY • TAPETRONICS • TMC •  
TRIOLA • VANGUARD • VOGUE • WARNER

—ALWAYS INTERESTED IN  
MAKING NEW FRIENDS.

JUST WRITE TO



OSTERDALSØGT. 1, OSLO  
TLF. 67 67 90, CABLEADR.:  
«BENDIKMUSIC»

## INTERNATIONAL TAPE SECTION

Continued from page 129

### ● manufacturers of tape dealer accessories & supplies

Almada Corp., 380 Craig St. W., Montreal 126, P.Q. Tel: (514) 844-4006. Mgr.: Marvin Drimer. Product: Head cleaners.

Le-Bo, see Phonodisc.

Metro Graphic Corp., 9880 Parc Georges Blvd., Montreal North, P.Q. Tel: (514) 321-6750. Pres.: Paul Kizner; Sales Mgr.: Morris L. Cohen. Product: Browser boxes, catalog servs.

Phonodisc Ltd., 30 Malley Rd., Toronto, Ont. Tel: (416) 751-9610. Mgr.: Bill Osbourne. (Distributes only).

Product: Carrying cases, display racks, head cleaners & demagnetizers (Le-Bo).

R C A Ltd., 3333 Cavendish Blvd., Montreal 261, P.Q. Tel: (514) 482-9912.

Product: Head cleaners & demagnetizers.

Stereodyne (Canada) Ltd., 6 Evans Ct., Etobicoke, Ont. Tel: (416) 259-4201. Gen. Mgr.: H. R. Newman; Sales Mgr.: R. B. Kerr.

Product: Display racks, head cleaners.

Webcor Electronics Ltd., 222 Front St. E., Toronto, Ont. Tel: (416) 363-7359. Pres.: S. Sadomsky; VP Sales & Gen. Mgr.: W. G. Patterson.

Product: Display racks, head cleaners & demagnetizers.

## DENMARK

Population: 4,900,000.

Per capita income: \$1,100.

Rate of exchange: \$1 (US) = 6.5 kroner.

Average retail price per tape: Cassette—\$6-\$6.75.

Market: This is still a very small market. Cassettes lead the field, as marketed by Nordisk Polyphon, but EMI and Hede Nielsens are working on 8-track cartridges. The last months of 1969 showed a noticeable increase in sales, cassettes for home and portable units, 8-track for cars.

Type of distribution: Wholesaler-to-retailer is standard.

Import/Export regulations: Duty on non-EFTA imports.

### ● record manufacturers with tape product

C B S, Dortheavej 39, 2400 Copenhagen. Tel: (01) 348505.

Label available on tape: CBS.

E M I (Electric & Musical Inds.) A/S, Hoffdingsvej 18, Copenhagen, Valby. Tel: (01) 306711. Cable: GRAMMOPHON. Mng. Dir.: B. B. G. Jeffery; Mktg. Mgr.: K. Hviid Mikkelsen; Adv. Mgr.: Marianne Hølslev; Int'l: Morten Koefoed Eriksen. Labels available on tape: Columbia, Dot, Electrola, HMV, Liberty, Motown, Odeon, Parlophone, Tamla.

Metronome Recs. A/S, 31 Vibevej, 2400 Copenhagen NV. Tel: AEGIR 8112. Cable: METRORECORDS. Mng. Dir.: Bent Fabricius-Bjerre. Labels available on tape: Atco, Atlantic, Metronome.

Hede Nielsens Fabrikker A/S, Grundtvigsvej 10 A, Copenhagen V. Tel: 214120. Cable: HENIGRAM. Gen. Mgr.: Leif Risell. Labels available on tape: RCA, Reprise, Warner Bros.-Seven Arts.

Nordisk Polyphon Emdrupvej 115, Copenhagen NV. Tel: 692522. Mng. Dir.: W. Hamburger; Pub.: Elisabeth Skovdam; Adv.: H. Karlens; Promo.: (DGG) A. Arfmann, (Decca) H. Jensen, (Philips) O. Wiilsholm. Labels available on tape: DGG, Decca, Fontana, Mercury, Philips, Polydor.

### ● playback equipment manufacturers/importers

Internorth Music, Chr. IX's gade, 6, Copenhagen K. Tel: (office) 118526; (factory) Hellerup 2956. Cable: CENTROPRESS. Pres.: K. B. Friberg-Jacobsen; Chief Eng.: Sven O. Jensen. (Manufactures).

Cartridge 4- & 8-track compatible.

Brand: Audio Master.

T B A, 6000 Kolding. Mgr.: Mr. Larsen. (Imports). Cartridge 8-track.

Brand: Motorola.

## ● services

### CUSTOM DUPLICATION

F H C-Electronics, Landgreven 7, Copenhagen K. Tel: 146993. Pres.: Henning B. Petersen.

Internorth Music Studio, Chr. IX's gade 6, Copenhagen K. Tel: 118526. Cable: CENTROPRESS. Pres.: K. B. Friberg-Jacobsen; Sound Eng.: Boerge Rasmussen.

## ECUADOR

Population: 5,649,800.

Per capita income: \$201.

Rate of exchange: \$1 (US) = 18.18 sucres.

Pre-recorded tape imported from USA: (factory value) 1967—\$47,300.

Pre-recorded tape imported from countries other than USA: (factory value) 1967—\$18,650.

Average retail price per tape: Cassette—\$18.

### ● record manufacturers with tape product

Emporio Musical SA, Appo. 1276, Guayaquil. Tel: 14174. Cable: EMPORMUSIC. Mgr.: Carlos Pino Plaza.

Cartridge 8-tr: Orion (distributed by IFESA).

I F E S A (Industria Fonografica Ecuatoriana SA), PO Box 3885, Guayaquil. Tel: 514102. Pres.: Luis Pino Y.; Gen. Mgr.: Joe Magen; Sales Mgr.: Carlos Pino Plaza.

Cartridge 8-tr: Distributed—Estelar, Orion; represented—A&M, Falcon, Hispavox, Marfer, Mercury, Musart, Odeon, Reprise, Warner Bros.-Seven Arts. Note: Cartridge 8-track product self-manufactured. Cassette: Philips.

Philips Ecuador CA, Casilla 343, Av. Patria 786, Esquina Calle Paez, Quito. Tel: 39080. Cable: PHILRADIO. Contact: H. Garzan. Cassette: Philips.

## FINLAND

Population: 4,700,000.

Per capita income: \$950.

Rate of exchange: \$1 (US) = 4.20 markka.

Pre-recorded tape imported from USA: 1968—\$19,775.

Pre-recorded tape imported from countries other than USA: 1968—\$66,630.

Pre-recorded tape exported to USA: 1968—\$732.

Pre-recorded tape exported to countries other than USA: 1968—\$2,930.

Average retail price per tape: Cartridge 8-track—\$8.30-\$10; cassette—\$6.10-\$6.60; open reel—\$8.30.

Market: First Finnish-produced cassettes were marketed in late 1969. All duplication is done abroad. Tape comprises about 5 to 10% of the combined tape/record market. 8-track playback units are almost all imported from Japan, while Philips dominates the cassette market.

Type of distribution: Manufacturer-to-distributor-to-retailer predominates in the record dealer market, but all companies with tape product may also distribute to electrical shops, gas stations, etc., themselves.

Type of promotion: Wholesaler-dealer tie-ins and some newspaper advertising.

Import/Export regulations: There is no tax for goods imported from member countries of EFTA if the work or material is at least 50% EFTA origin. There is a 12% purchase tax plus a 6% tax charged on all goods not EFTA origin.

KARI HELOPALTIO

### ● record manufacturers with tape product

Blue Master, see PSO.

Columbia, see EMI.

Discophon, Takomontie 1B, Helsinki 37. Tel: 453007. Mng. Dir.: Johan Vikstedt; Sales: Risto Kaijane, Eeva Kayhko.

Cartridge 8-track: Owned—RCA; represented—RCA, MCA.

Note: Product duplicated by RCA in Italy.

E M I, Suomen Osasto, Hoylaamontie 7, Helsinki 37. Mng. Dir.: Reino Backman.

Cartridge 8-track & cassette: Owned—Columbia; represented—ABC, Capitol, Command, Dot, Dunhill, Liberty, Pickwick, Regal, Tamla-Motown. Note: Product duplicated by EMI in UK.

Finlandia, see PSO.

## FRANCE

Finnlevy Valimontie 2, Helsinki 37. Tel: 453136.  
VP: Roger Lindberg; Mng. Dir.: Erik Westo;  
Sales Dir.: O. A. Ruuskanen.  
**Cartridge 8-track:** Represented—Barclay, CBS,  
DGG, Decca, Philips, Pye.  
**Cassette:** Owned—Finnlevy; represented—Barclay,  
CBS, DGG, Decca, Philips, Pye.  
**Note:** Product duplicated by DGG in West  
Germany & Philips in The Netherlands.

P S O, Vuorikatu 14, Helsinki 10. Tel: 12651.  
Dir.: O. W. & Lauri Rokkanen; Music Dept.  
Dir.: Martti Piha.  
**Cassette:** Owned—Blue Master, Finlandia, Top  
Voice; represented—Riviera, Vogue.

R C A, see Discophon.

Sahkoliikkeiden, Takomontie 1B, Helsinki 37. Tel:  
453007. Mng. Dir.: Erkki Korvenranta; Music  
Dept. Dir.: Johan Vikstedt.  
**Cartridge 8-track:** Represented—Monument, Re-  
prise, Telefunken, Warner Bros.—Seven Arts.

Scandia Musiikki, Arinatie 8C. Tel: 458402. Mng.  
Dir.: Harry Orvoma; Sales Dir.: Eric Forsman.  
**Cartridge 8-track & cassette:** Owned—Scandia,  
Sonet (8-track product available on RCA logo,  
cassette on Finnlevy); represented—Atco, At-  
lantic, Elektra, Europa.  
**Note:** 8-track product duplicated by RCA in  
Italy, cassette by DGG in West Germany &  
Philips in The Netherlands.

Sonet, see Scandia Musiikki.

Top Voice, see PSO.

### ● tape distributors & importers/exporters

Discophon, Takomontie 1B, Helsinki 37. Tel: 453007.  
(See Record Manufacturers section for product  
distributed.)

E M I, Suomen Osasto, Hoylaamontie 7, Helsinki 37.  
(See Record Manufacturers section for product  
distributed.)

Finnlevy, Valimontie 2, Helsinki 37. Tel: 453136.  
**Cartridge 8-track & cassette:** Owned—Finnlevy;  
distributed—RCA, Columbia; represented—EMI  
group, RCA group.

P S O, Vuorikatu 14, Helsinki 10. Tel: 12651. (See  
Record Manufacturers section for product dis-  
tributed.)

Scandia Musiikki, Arinatie 8C, Helsinki 37. Tel:  
458402.  
**Cartridge 8-track & cassette:** Represented—  
Atco, Atlantic, Elektra, Europa.

### ● tape playback equipment manufacturers & importers

Braun Electric, Suomen, Karvaamokuja 3, Helsinki  
37. Tel: 457785.  
**Imports:** NordMende (cassette).

Discophon, Takomontie 1B, Helsinki 37. Tel: 453007.  
**Imports:** Voxson (8-track) from Italy.

E M I, Suomen Osasto, Hoylaamontie 7, Helsinki 37.  
**Imports:** Mini-8 (8-track) from UK.

Fazer Musiikki, Alekski 11, Helsinki 10. Tel: 10751.  
**Imports:** Sonyo (cassette) from Japan.

Helvar, Purotie 1-3, Helsinki 37. Tel: 450121.  
**Imports:** Sony (cassette) from Japan.

Iskumetalli, Oraspolku 9, Helsinki 68. Tel: 725166.  
**Imports:** Hitachi (8-track, cassette) from Japan.

Jon Auto AB, Salomon Katu 17, Helsinki-Autotalo.  
Cable: JON. Telex: 12.1020. Contact: J.  
Nyholm.  
**Distributors:** Motorola playback equip.

Kaukomarkkinat, Fabianinkatu 9, Helsinki 13. Tel:  
13215.  
**Imports:** Akai, Toshiba & National (8-track,  
cassette) from Japan.

Lamco, Mechelininkatu 39A, Helsinki 26. Tel:  
448671.  
**Imports:** Accord (cassette).

P S O, Vuorikatu 14, Helsinki 10. Tel: 12651.  
**Imports:** Schaub Lorenz (cassette) from West  
Germany.

Philips, Kaivokatu 8, Helsinki 10. Tel: 10915.  
**Imports:** Philips, Dux & Siera (cassette). Also  
manufactures under license from Philips & Dux.

Radloutukku, Hoylaamontie 11, Helsinki 37. Tel:  
458484.  
**Imports:** Blaupunkt (cassette) from West Ger-  
many.

Sahkoliikkeiden, Satamakatu 5, Helsinki 16. Tel:  
11501.  
**Imports:** Telefunken (cassette) from West  
Germany.

Suomen Eref, 3 Linja 11B, Helsinki 53. Tel: 710332.  
**Imports:** Aiwa (cassette), Auto-Sonic, Harmony,  
Standard, Takara, Wecton (8-track) from Japan.

Teledict, Kumpulantie 1, Helsinki 51. Tel: 765177.  
**Imports:** Grundig (cassette) from West Germany.

**Population:** 50,000,000.

**Per capita income:** \$3,000.

**Rate of exchange:** \$1 (US)=4.95 francs.

**Market:** Philips dominates the market, producing  
for most of the major companies. After a  
trial period, 4-track cartridge has almost com-  
pletely disappeared from the market and sales  
for pre-recorded open reel tapes are very slow.

**Average retail price per tape:** Cartridge 8-track—  
\$9-\$13.80; cassette—\$7; open reel—\$11 (mono),  
\$12.80 (stereo).

### ● record manufacturers with tape product

Ades, 141 Rue La Fayette, Paris 10. Zone: 75.  
Tel: 878.05.31/72.92. Pres.: Lucien Ades;  
Artistic Dir.: Jacques Pradere; Pub. Dir.:  
Monique Navratil.  
**Cassette:** Ades.

Archiv (see Polydor).

Arion (see CBS).

Barclay, 20 Rue d'Armenonville, 92 Neuilly sur  
Seine. Tel: SAB 19.50. Pres.: Eddie Barclay;  
Gen. Mgr.: Hubert Ballay; Sales Mgr.: Gerard  
Dubos.

**Cartridge 8-track & cassette:** Owned—Barclay,  
Classic, Riviera; distributed—Erato; represented  
—Atco, Atlantic, Buddah, Chess, Major Minor,  
Monument, Project 3, Stax, 20th Century-Fox,  
Vanguard, Yameta.

C B S Disques, 3 Rue Freycinet, Paris 16. Tel:  
PAS 26.45. Pres.: Jacques Souplet; Gen. Mgr.:  
Jean Queinnet; Sales Mgr.: Francois Dacla.  
**Cartridge 8-track:** Owned—CBS, Top 12; dis-  
tributed—Arion; represented—CBS, Epic, Blue  
Horizon.  
**Cassette:** Owned—CBS, Top 12; distributed—  
Arion.

Chant du Monde (Le), 32 Rue Beaujon, Paris 8.  
Zone: 75. Tel: 924.67.73. Cable: CHAMODISC.  
Pres.: Jean Roire; Gen. Mgr.: Jean Mialheil;  
Sales & Mktg.: Andre Mercier; Pub., Adv. &  
Promo.: Melle Anne Marical.  
**Cartridge 4-track, 8-track & cassette:** Le Chant  
du Monde self-mfd.

Classic (see Barclay).

Columbia (see Pathe Marconi).

D G G (see Polydor).

Ducretet-Thomson (see Pathe Marconi).

Erato (see Barclay).

Festival (Disques de France), 3 Rue de Gramont,  
Paris 2. Zone: 75. Tel: 742.96.10. Pres.:  
Pierre Duprat; Gen. Dir.: Andre Chagneau;  
Sales Dir.: J. L. Dasque; Adv. Mgr.: A.  
Tisserand; Press Officer: Monique Perou.  
**Cassette:** Festival made by Philips.

Fontana (see Philips).

Janeret (see Societe Francaise du Son).

Mercury (see Philips).

Musidisc-Europe, 7 Rue Traversiere, Courbevoie.  
Zone 92. Tel: 333.59.49. Pres.: Philippe  
Thomas; Int'l Mgr.: Pierre Beriot.  
**Cartridge 8-track & cassette:** Musidisc (in-  
cludes Visadisc, Score, America) self-mfd.

Odeon (see Pathe Marconi).

Pathe Marconi (Les Industries Musicales et  
Electriques), 19 Rue Lord Byron, Paris 8.  
Zone: 75. Tel: 225.53.00. Pres.: Mr. Minchin;  
Sales Mgr.: Mr. Helard; Tape Mgr.: Mr.  
Dorsemaine.  
**Cartridge 8-track & cassette:** Owned—Columbia,  
Ducretet-Thomson, Odeon, Pathe, Trianon, Voix  
de son Maitre; represented—Bell, Dot, Durium,  
Immediata, Liberty, Motown, Scepter, Tamla,  
United Artists.

Pergola (see Philips).

Philips (Societe Phonographique), 6 Rue Jenner,  
Paris 13. Zone 75. Tel: 707.75.28. Cable:  
PHILIDISC. Pres.: Georges Meyerstein-Maigret;  
Gen. Dir.: Louis Hazan; Sales Dir.: Jacques  
Caillart; Adv. Mgr.: Robert Laplace; PR Dir.:  
Andre Asseo; Int'l Mgr.: Roger Maruani.  
**Cassette:** Owned—Fontana, Mercury, Pergola,  
Philips; represented—Beacon (UK), Connoisseur  
(USA), Ember (UK), Island (UK), Mercury (USA),  
President (UK), Stable (UK). (Self-mfd. Minimal  
amount imported from West Germany & Nether-  
lands. Half of the Philips France product is  
exported to Europe, Canada, the Middle East &  
Africa, principally the franc zone).  
**Open reel:** DMS.

Polydor SA, 2 Rue Cavallotti, Paris 18. Zone 75.  
Tel: 522.05.39. Pres.: Jacques Kerner; Gen.  
Mgr.: H. Simon; Sales Mgr.: M. Mangin.  
**Cassette:** Owned—Polydor, Triumph; distributed  
—Archiv, DGG; represented—King, MGM, Verve.

R C A (Societe AREA), 49 Av. Hoche, Paris 8.  
Zone: 75. Tel: 227.16.34. Cable: AREADIS.  
Pres.: Andre Jeanneret; Sales Dir.: Claude  
Gagniere; Adv.: Mary Burlet.  
**Cartridge 8-track:** RCA (90% imported from  
USA & Italy, 10% produced in France).

Riviera (see Barclay).

Societe Francaise du Son, 30 Rue Beaujon, Paris 8.  
Zone 75. Tel: 924.1901. Pres. & Gen. Mgr.:  
E. W. Pelgrims de Bigard; Sales Mgr.: Claude  
Boutin.  
**Cartridge 4-track, 8-track & cassette:** Owned—  
Vega; distributed—Janeret; represented—Decca,  
Deram, London.

Top 12 (see CBS).

Trianon (see Pathe Marconi).

Triumph (see Polydor).

Valois, 19 Rue de Vanves, Boulogne-Billancourt.  
Zone: 92. Tel: 825.99.99. Owner: Michel  
Bernstein.  
**Cassette:** Valois.

Vega (see Societe Francaise du Son).

Vogue Productions Internationales Phonographiques,  
82 Rue Maurice Grandcoing, 93 Villetaneuse.  
Tel: 752.73.00. Pres.: Leon Cabat; Gen. Mgr.:  
Cesar Rossini.  
**Cartridge 8-track & cassette:** Owned—Vogue;  
represented—Elektra, Reprise, Roulette, Warner  
Bros.—Seven Arts.

Voix de son Maitre (see Pathe Marconi).

### ● playback equipment manufacturers & importers

Agfa-Gevaert, 274 Av. Napoleon Bonaparte, Rueil-  
Malmaison. Zone: 92. Tel: 967.37.60. (Imports).

B A S F (Imaco), 39 Blvd. de Vaugirard, Paris 15.  
Zone: 75. Tel: 273.84.00. (Imports).

Jaubert, 105 Rue de Normandie, 92 Courbevoie.  
(Manufactures & Imports).

Mood Music, 143 Rue de Verdun, 92 Suresnes.  
Tel: 506.20.19. Pres.: H. da Silva Ramos.  
(Imports).

Philips ELA, 6 Rue Jenner, Paris 13. Zone: 75.  
Tel: 707.75.28. (Manufactures).

### ● supplies

#### RAW TAPE MANUFACTURERS

Kodak, 37 Av. Montaigne, Paris 8. Zone: 75. Tel:  
256.48.11.

Minnesota de France, 135 Blvd. Serurier, Paris 16.  
Zone: 75. Tel: 205.71.19.

Pyral, 47 Rue de l'Echat, Creteil. Zone: 94. Tel:  
207.48.90.

Suma, Route de la Saulaie, Gien. Zone: 47. Tel:  
Gien 613.

#### EMPTY CARTRIDGE CASE MANUFACTURER

Diffusion Magnetique Sonore, 29 Rue Hautpoul,  
Paris 19. Zone: 75. Tel: 208.12.80. Sales Dir.:  
Hubert de la Selle.

### ● services

#### CUSTOM DUPLICATION

Jaubert, 105 Rue de Normandie, 92 Courbevoie.  
**Cartridge 8-track:** Arion, CBS, Janeret, Pacific,  
Reprise, Roulette, Top 12, Vega, Vogue, Warner  
Bros.—Seven Arts.

Mood Music, 143 Rue de Verdun, 92 Suresnes.  
**Cartridge 8-track:** Barclay, Classic, Columbia,  
Ducretet-Thomson, Erato, Odeon, Pathe, Riviera,  
Trianon, Voix de son Maitre.

**Cassette:** Barclay, Classic, Erato, Riviera.

Philips, 6 Rue Jenner, Paris 13. Zone 75. Tel:  
707.75.28.

**Cassette:** Ades, Arion, Barclay, CBS, Chant du  
Monde, Classic, Columbia, DGG, Decca, Ducretet-  
Thomson, Erato, Festival, Janeret, Manuiti,  
Odeon, Pathe, Polydor, RCA, Riviera, Salvador,  
Top 12, Trianon, Valois, Vega, Vogue, Voix  
de son Maitre.

#### DESIGN & ARTWORK PACKAGING & LABELING PRINTING & LITHOGRAPHING

C B S Disques, 3 Rue Freycinet, Paris 16. Zone 75.  
Tel: PAS 26.45. Pres.: Jacques Souplet; Gen.  
Mgr.: Jean Queinnet; Sales Mgr.: Francois  
Dacla.

### ● dealer accessories & supplies

#### CATALOG SERVICES

C B S Disques, 3 Rue Freycinet, Paris 16. Zone 75.  
Tel: PAS 26.45. Pres.: Jacques Souplet; Gen.  
Mgr.: Jean Queinnet; Sales Mgr.: Francois  
Dacla.

continued on page 132

**INTERNATIONAL  
TAPE SECTION**

*Continued from page 131*

**GERMANY, WEST**

**Population:** 60,842,000.  
**Per capita income:** \$1,935.  
**Rate of exchange:** \$1 (US)=3.72 marks.  
**Pre-recorded tape manufactured for domestic & export sale:** (factory value) cassette 1968—540,000 units, \$2,957,000; 1967—360,000 units, \$1,909,000, open reel 1968—\$403,200.  
**Pre-recorded tapes imported from USA:** (factory value) 1968—under \$500,000.  
**Average retail price per tape:** Cartridge 8-track—\$7.50; cassette—(pop) \$5.65, (classical) \$7.25; open reel—\$5.38.

**Tape market:** The rapid growth of the pre-recorded tape market was documented by 1,000,000 compact cassette recorders and players sold by the end of 1968, and 1,000,000 more in 1969. Of these about 90% were recorders and 10% players only. This brings the total of playback units of all types to about 6,500,000, covering 20% of households. The ratio of pre-recorded to blank compact cassettes is 1:5. The first step into 8-track cartridges was made by Electrola and CBS. The use of 8-track is said to be due to US-manufactured cars. While the DGG-Philips group was the sole manufacturer of musicassettes till the end of 1968 (and still produces 75% of this market), during 1969 all leading record companies began issuing almost all LPs on tape. By the end of 1969 there were about 1,200 musiccassette titles available, 10% of which are from the classical repertoire. Imports from outside the Common Market are almost nil.

**Type of distribution:** 90% of distribution is from manufacturer-to-retailer, the rest, manufacturer-to-wholesaler-to-retailer.

● **record manufacturers  
with tape product**

Amadeo (see Phonogram).  
Archiv (see Deutsche Grammophon).

Ariola-Eurodisc GmbH, Arabellastr. 4, Munich 81. Tel: (0811) 911071. Gen. Mgrs.: Egmont Lueftner, Friedrich Schmidt.

**Cartridge 8-track, cassette & open reel:** Owned—Ariola, Eurodisc, Melodia-Eurodisc; distributed—Hansa, TWR; represented—Supraphon, President, Major-Minor.

Autoplay Music-Cassetten GmbH, Kurgartenstr. 11, 851 Fuerth. Tel: (0911) 73 39 03. Gen. & Sales Mgr.: H. Brauns.

**Cassette:** (Owned)—autoplay, Hit Music.  
Barclay Schallplatten, Glockenjiesserwall 26V, Hamburg 1. Tel: 33 08 17. Mgr.: Mr. Bachmann.  
**Home office:** France.

**Cartridge 8-track & cassette:** Owned—Barclay, Riviera.

C B S-Schallplatten, Sontraerstr. 13, 6 Frankfurt/Main. Tel: (0611) 41 71 21. Mng. Dir.: Bernhard Mikulski; Sales & Mktg.: Herbert Giesewetter.

**Cartridge 8-track & cassette:** CBS.  
Capitol (see Electric & Musical Inds.).  
Columbia (see Electric & Musical Inds.).  
D G G (see Deutsche Grammophon).  
D R K (see Phonogram).

Deutsche Austrophon, Schallplatten-Vertriebs GmbH, Postfach 187, D-284 Diepholz/Hannover. Tel: (05441) 2293, 2812. Mgr.: Rolf Neumann.

**Cassette:** Represented—Elite Special  
Deutsche Grammophon Gesellschaft mbH (DGG), Rothenbaumchausee 5, 2 Hamburg 13. Tel: 44 17 91. Cable: GRAMMOPHON. Mng. Dir.: Richard Busch; Sales Mgr.: Heinz Holle; Tape Mgr.: Peter Danneberg.

**Cartridge 8-track & cassette:** Deutsche Grammophon, Polydor, Archiv.

Deutsche Vogue Recs., Zur Muehle 2, 5021 Gross-koenigsdorf bei Cologne. Tel: (02234) 3961. Gen. Mgr.: Guy Khavessian.

**Cassette:** Vogue.  
Durium (see Phonogram).  
E M I (see Electric & Musical Inds.).  
Electric & Musical Inds. (Europa) GmbH, 149 Maarweg, Braunsfeld-Cologne. Tel: 49 31 31. Pres.: M. O. Hamilton; Mktg. Mgr.: N. B. Christensen.

**Cassette:** Electrola, Capitol, Columbia, Odeon, Parlophone.  
Electrola (see Electric & Musical Inds.).  
Eurodisc (see Ariola-Eurodisc).

Europa (see Miller Int'l).  
Falcon Schallplatten Rosner & Co. OHG, Beim Gesundbrunnen 11, 2 Hamburg 26. Tel: 2502442.

Fire (see Orange).  
Fontana (see Phonogram).  
Hansa Musik Produktion GmbH, 18 Wittelsbacherstr., 1 Berlin 31. Tel: (0311) 881 4057. Pres.: Peter Meisel; Int'l Mgr.: Irmtrud Meisel; Sales Mgr.: Hans Blume.

**Cartridge 8-track, cassette & open reel:** Hansa (distributed by Ariola-Eurodisc).

Hit Music (see Autoplay).  
Hoer Zu Schallplatten, Postfach 827, 5000 Cologne 1; Kaiser-Wilhelmstr. 6, 2000 Hamburg 36.

**Cassette:** Hoer Zu.  
Inmus (see Orange).  
Intercord Tongesellschaft, Libanonstr. 6, 7 Stuttgart 13.

**Cassette:** Intercord.  
Island (see Phonogram).  
Liberty/UA GmbH, Herzog-Rudolfstr. 7, 8 Munich 22. Tel: 22 13 61. Mng. Dir.: Siegfried E. Loch; Sales Mgr.: Peter Hube.

**Cartridge 8-track & cassette:** Liberty, United Artists.

M P S (see Saba).  
Melodia-Eurodisc (see Ariola-Eurodisc).  
Mercury (see Phonogram).  
Metronome Recs. GmbH, Heidenkampsweg 76B, 2 Hamburg 1. Tel: (0411) 24 12 61. Pres. & Gen. Mgr.: Leif E. Kraul; Sales Mgr.: Claus H. Lehfeldt.

**Cartridge 8-track:** Represented—Atco, Atlantic, Barclay, Elektra, Riviera, Transatlantic.

**Cassette:** Owned—Metronome, Perl; distributed—Mondial, Musica Golden 12; represented—Atco, Atlantic, Barclay, Elektra, Riviera, Transatlantic.

Miller Int'l Schallplatten GmbH (div. of MCA Int'l), Justus von Liebig-Ring 2-4, Quickborn. Tel: (04106) 2885. Cable: MILLIN. Mng. Dir.: Harald A. Kirsten; Tape Mgr.: Dr. Wille & Dr. Beurmann.

**Cassette:** Europa, Somerset.  
Mondial (see Metronome).  
Musica Golden 12 (see Metronome).

Odeon (see Electric & Musical Inds.).  
Orange Recs., Franz-Josefstr. 2, 8 Munich 13. Tel: (0811) 34 63 08, 33 86 88. Owner: Hans Wewerka.

**Cassette & open reel:** Owned—Orange, Inmus, Fire.  
Parlophone (see Electric & Musical Inds.).  
Perl (see Metronome).

Philips (see Phonogram).  
Phonogram Tongesellschaft mbH, Moenckebergstr. 7, Hamburg. Tel: (0411) 33 92 21. Pres.: Baarn Sollefeld; Gen. Mgr.: Dr. Vogelsang; Sales Mgr.: Herr Baum.

**Cassette:** Owned—Philips, Fontana, Durium, Mercury, Island, Amadeo, UNO, DRK.  
**Open reel:** Owned—Philips.

Polydor (see Deutsche Grammophon).  
Popular (see Richter).

*continued on page 134*

15000 good reasons  
for listening to Redif  
fusion on tape

The Rediffusion music library contains over 15,000 song titles and includes the best of Britain's music makers. □ The music is good, and is available on discs—33½ r.p.m. microgroove stereo compatible on tape or on metal parts. □ Don't take our word for it, send for a demonstration tape or album right away.



SOUNDS GREAT

**REDIFFUSION INTERNATIONAL MUSIC**  
2-16 Goodge Street, London, W.1. Tel: 01-580 9506

New York enquiries to: Columbia Special Products Division, 51 W. 52nd Street, New York, N.Y. 1009. Tel: (212) 765-4321.

# From Rome with music!

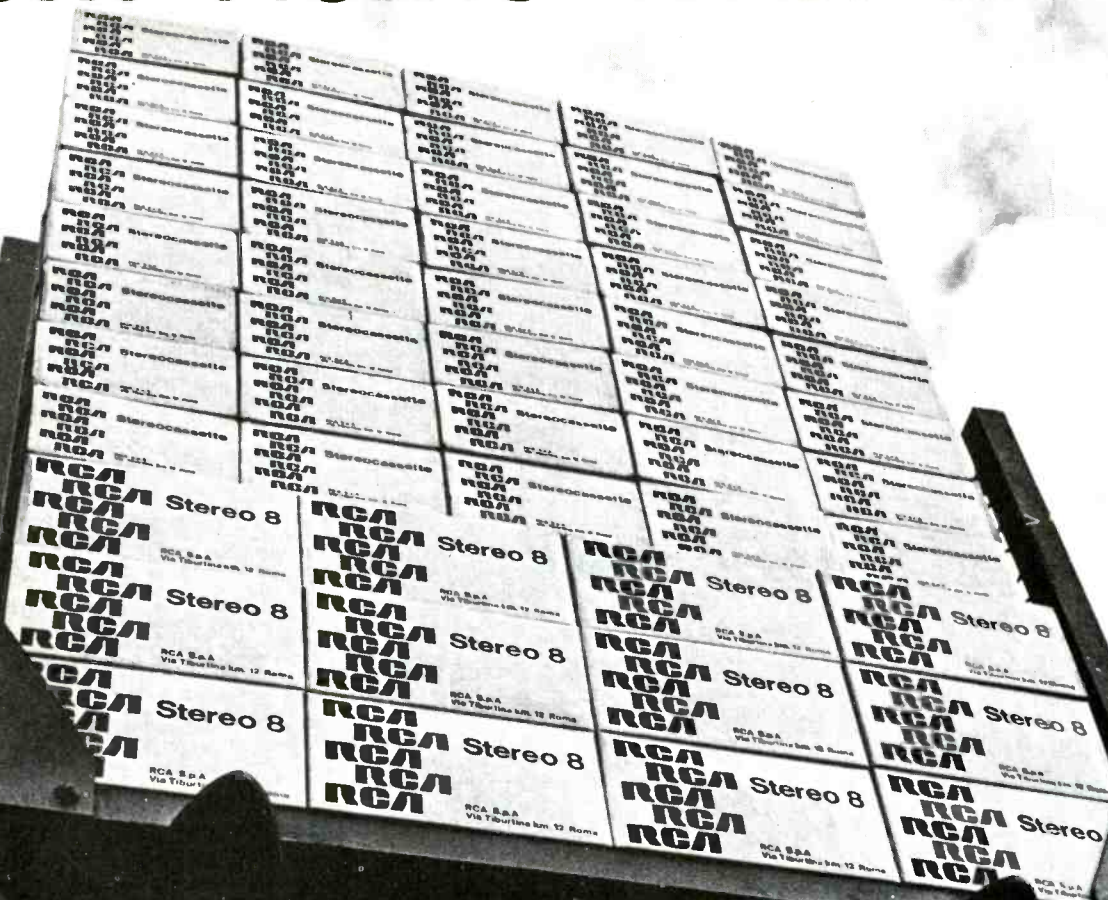

The RCA Stereo 8 and Stereocassettes output in Rome for the European Prerecorded Tapes market is growing, day by day.

# RCA

RCA S.p.A. Via Tiburtina Km. 12  
Rome, Italy

## INTERNATIONAL TAPE SECTION

Continued from page 132

Richter GmbH, PO Box 682, Sittardsberger Allee 99, 41 Duisburg. Tel: (02131) 77 16 34. Gen. Mgr.: Hans-Georg Michael; Sales Mgr.: Wolfgang Rothhaupt.  
Cassette: Popular.

Saba, Hermann Schwerstr. 2, 7730 Villingen Schwarzwald. Tel: (07721) 33 51/37. Gen. Mgr.: Hans Georg Brunner-Schwer; Sales Mgr.: Michael Pfeiffer.  
Cassette & open reel: MPS.

Somerset (see Miller Int'l).

Special-Record, Rotwandstr. 16, 8021 Grosshesselohe bei Munich. Tel: (0811) 79 42 86/66. Gen. Mgr.: Oscar Meissner; Sales Mgr.: Gerhard Draenkow.  
Cassette: Tempo.

Starlet (see Supertone).

Supertone Schallplattendienst, Klugstr. 136 & Nymphenburgerstr. 38, Munich. Tel: (0811) 528685, 156930. Pres. & Gen. Mgr.: Dr. Heinz Stein; Sales Mgr.: W. Simon.  
Cartridge 4-track & 8-track: Owned—Starlet, Supertone.

T W R (see Ariola-Eurodisc).

Teldec Telefunken-Decca Schallplatten GmbH, Heussweg 25, 2 Hamburg. Tel: (0411) 40191. Pres.: Hans Lieber; VP: Kurt Richter; Sales Mgr.: Gerhard Schulze.  
Cartridge 8-track: Represented—Decca, RCA, London, Reprise, Warner Bros.-Seven Arts, Deram, Monument.  
Cassette: Owned—Telefunken Decca; represented Decca, RCA, London, Reprise, Warner Bros.-Seven Arts, Deram, Monument.

Telefunken Decca (see Teldec).

Tempo (see Special-Record).

U N O (see Phonogram).

United Artists (see Liberty/UA).

### ● manufacturer with tape product only

Stereo Tape Inc., c/o Jan Famira, Eppendorfer Landstr. 44, Hamburg. Tel: 48 10 74, 34 31 37. Pres. & Gen. Mgr.: Jan Famira.

### ● tape playback equipment manufacturers & importers

Autoplay Music-Cassetten GmbH, Kurgartenstr. 11, 851 Fuerth. Tel: (0911) 73 39 03. Gen. & Sales Mgr.: H. Brauns.  
Configuration: Cassette.

Auto Stereo Anlagen GmbH, Friedrichstr. 40, 6 Frankfurt/Main. Tel: 72 78 72, 72 37 28. Admin. Dir.: Christopher von Meister; Sales & Mktg. Dir.: Gottlieb Bauer-Schlichtegroll.  
Configuration: Cartridge 8-track auto, home & portable (imported).  
Brand name: Meister.

Robert Bosch, Forckenbeckstr. 9-13, 1 Berlin 33.  
Configuration: Cassette.

Braun AG, Ruesselsheimerstr. 6, Frankfurt/Main. Tel: (0611) 73 00 11. Pres.: Karl Buresch; Gen. Mgr.: Alf T. Amend; Sales Mgr.: Fritz Nitsch.  
Configuration: Open reel.

Philipp Gather KG, Postfach, 402 Mettmann 2. Telex: 858-1156. Cable: ILGA. Mgr.: H. Gather.  
Configuration: 8-track (imports).  
Brand name: Motorola.

Supertone Schallplattendienst, Klugstr. 136 & Nymphenburgerstr. 38, Munich. Tel: (0811) 528685, 156930. Pres. & Gen. Mgr.: Dr. Heinz Stein; Sales Mgr.: W. Simon.

### ● tape wholesalers

(also see record manufacturers section).

#### DISTRIBUTOR/IMPORTER

Fono Schallplatten GmbH, Diepenbrockstr. 28, 44 Muenster. Tel: (0251) 402 17. Pres.: Heinz Brockhoff.  
Cassette: Vox (USA).

#### RACK JOBBER

Auto Stereo Anlagen GmbH, Friedrichstr. 40, 6 Frankfurt/Main. Tel: 72 78 72, 72 37 28. Admin. Dir.: Christopher von Meister; Sales & Mktg. Dir.: Gottlieb Bauer-Schlichtegroll. (Cartridge 8-track only).

### ● tape supplies

#### RAW TAPE MANUFACTURERS

Agfa-Gevaert, Leverkusen. Tel: 02172-301.  
Badische Anilin- & Soda Fabrik AG, M-Gruppe, Poststelle E 100, Zimmer 306, 67 Ludwigshafen/Rhine.  
Brand name: BASF.

#### EMPTY CARTRIDGE & CASSETTE MANUFACTURERS

Auto Stereo Anlagen GmbH, Friedrichstr. 40, 6 Frankfurt/Main. Tel: 72 78 72, 72 37 28. Admin. Dir.: Christopher von Meister; Sales & Mktg. Dir.: Gottlieb Bauer-Schlichtegroll.  
Configuration: Cartridge 8-track.

Badische Anilin- & Soda Fabrik, AG. (BASF), 6700 Ludwigshafen. Tel: (0621) 60 8643.  
Configuration: Cassette.

#### MANUFACTURER OF TAPE DUPLICATING EQUIPMENT

Auvis KG, Stollbergstr. 17, 8 Munich 22. Tel: 22 50 57. Mgr.: Ing. A. Kurzeder.  
Chief product: Cassette & open reel dupl'g machines, loaders & measurers.

### ● tape services

#### CUSTOM DUPLICATION

Autoplay Music-Cassetten GmbH, Kurgartenstr. 11, 851 Fuerth. Tel: (0911) 73 39 03. Gen. & Sales Mgr.: H. Brauns.  
Deutsche Grammophon GmbH, Podbielskistr. 164, 3 Hannover.

Electric & Musical Inds. Europa GmbH (EMI), 149 Maarweg, Braunsfeld-Cologne. Tel: 49 31 31. Pres.: M. O. Hamilton.

I T P Tonbandproduktions KG, Kurfuerstendamm 236, 1 Berlin. Tel: 88 33 122. Admin. Dir.: Christopher von Meister; Sales & Mktg. Dir.: Gottlieb Bauer-Schlichtegroll.  
Configuration: Cartridge 8-tr., cassette & open reel.

Metronome Recs. GmbH, Heidenkampsweg 76B, 2 Hamburg 1. Tel: (0411) 24 12 61. Pres. & Gen. Mgr.: Leif E. Kraul; Sales Mgr.: Claus H. Lehfeldt.

Schallplattenfabrik Pallas GmbH, Auf dem Esch 8, 284 Diepholz, Hannover. Tel: (05441) 2812, 2293. Pres.: Karl Neumann, Hans Oestreicher; Gen. & Sales Mgr.: Rolf Neumann.

Polyband, Sonnenstr. 20, 8 Munich 15. Tel: 55 41 98. Contact: W. G. Winkel.

Rhenus Music GmbH & Co. KG, Caesarstr. 6-10, 5 Cologne/Bayenthal.

Sonopress, Friedrichsdorferstr. 75, 483 Guetersloh. Tel: 7522.

Studio Hamburg, Tonndorfer Hauptstr. 90, Hamburg 70. Tel: 66 88 1. Gen. Mgr.: Gyula Trebitsch; Mgr.: Joachim Frels, Claus Kuehn.

Supertone Schallplattendienst, Klugstr. 136 & Nymphenburgerstr. 38, Munich. Tel: (0811) 528685, 156930. Pres. & Gen. Mgr.: Dr. Heinz Stein.

Teldec Telefunken-Decca Schallplatten GmbH, Heussweg 25, 2 Hamburg. Tel: (0411) 40191. Pres.: Hans Lieber.

#### DESIGN & ARTWORK PACKAGING & LABELING PRINTING & LITHOGRAPHING

Teldec Telefunken-Decca Schallplatten GmbH, Heussweg 25, 2 Hamburg. Tel: (0411) 40191. Pres.: Hans Lieber; VP: Kurt Richter; Sales Mgr.: Gerhard Schulze.

### ● tape dealer accessories & supplies

#### BROWSER BOXES CATALOG SERVICE DISPLAY RACKS STORAGE CASES

Phonogram Tongesellschaft mbH, Moenckebergstr. 7, Hamburg. Tel: (0411) 33 92 21. Pres.: Baarn Sollefeld; Gen. Mgr.: Dr. Vogelsang; Sales Mgr.: Herr Baum.

#### DEMAGNETIZERS

Braun AG, Ruesselsheimerstr., 6 Frankfurt/Main. Tel: (0611) 730011. Pres.: Karl Buresch; Gen. Mgr.: Alf T. Amend; Sales Mgr.: Fritz Nitsch.

### ● services

#### CUSTOM DUPLICATION

Israphon, Industrial Zone B, Azur. Tel: (03) 86542.

## OUR NEWEST HIT

the combined  
duplicator—and  
cassette—winder first  
to be seen at the

## HANNOVER FAIR

cut down your  
costs  
by using the



## ASONA-CASSETTES-SYSTEM

For further information wire or write to:

**AUVIS-K.G.** 8000 Munich 22, West Germany  
Ing. A. Kurzeder Stollbergstrasse 17  
tel. 0811/225057 cable: ASONA—Munich

## HONG KONG

Population: 3,900,000.  
Per capita income: \$521 (US).  
Rate of exchange: \$1 (US) = \$6.06 (Hong Kong).  
Pre-recorded tape imported from USA: (factory value) 1968—\$526,243 (US); 1967—\$305,201 (US).  
Pre-recorded tape imported from countries other than USA: (factory value) 1968—\$765,784 (US); 1967—\$463,375 (US).  
Pre-recorded tape exported to countries other than USA: (factory value) 1968—\$987 (US).  
Average retail price per tape: 8-track cartridge—\$7 (US); cassette—\$5 (US); open reel—\$9 (US).  
Type of distribution: Manufacturer-to-wholesaler-to-retailer.  
Type of promotion: Manufacturers and wholesalers advertise line or label; retailers advertise contents.  
Import/Export regulations: None—this is a free port.

### ● tape importers/distributors

Ampex World Opns. SA, 102 Kayamally Bldg., 22 Queen's Rd., Central Hong Kong, B.C.C. Tel: H-227059.  
Cartridge 4-track, 8-track, cassette & open reel: Ampex Stereo Tapes imported from USA.  
Colonial Trading Co., Luk Hoi Tung Bldg., 1st fl., Hong Kong, B.C.C. Tel: H-221109. Gen. Mgr.: R.A. Da Silva; Sales Mgr.: L.M. Da Silva.  
Cartridge 8-track & cassette: Represented—Liberty (USA), United Artists (USA).  
Cosdel Ltd., PO Box 2567, 1330-32 Prince's Bldg., Hong Kong, B.C.C. Tel: H-247047. Mng. Dirs.: Kenneth L. Cole, T.K. Whang, S.P. Sim.  
Far East Div: Sales Mgr.: Max E. Bissey.  
Cartridge 4-track, 8-track, cassette & open reel: Represented—RCA, Camden, Colgems, Chart, Kirshner (all USA).  
Hong Kong Div.: Sales Mgr.: Robert Wong.  
Cartridge 4-track, 8-track, cassette & open reel: Acta (USA), Atco (USA), Atlantic (USA), Cadet (USA), Checker (USA), Chess (USA), Dot (USA), Durium (Italy), Elektra (USA), Ember (UK), Everest (USA), Gordy (USA), Hickory (USA), Motown (USA), Nonesuch (USA), Paramount (USA), Prestige (USA), Pye (UK), Ranwood (USA), Reprise (USA), Soul (USA), Steed (USA), Tamlia (USA), Time (USA), Turnabout (USA), Vogue (France), Vox (USA), Warner Bros.-Seven Arts (USA).  
Tsang Fook Piano Co., 19 Queen's Rd., Central Hong Kong, B.C.C.  
Sin Guen Trading Co., Man Cheong Bldg., 14th fl., Hong Kong, B.C.C.  
Shun Hing Electronic Trading Co. Ltd., 602 Central Bldg., Hong Kong, B.C.C.  
Wo Kee Hong Ltd., Loke Yew Bldg., 5th fl., Hong Kong, B.C.C.  
Jardine Matheson & Co. Ltd., 22 Pedder St., Hong Kong, B.C.C. Tel: H-228011. Import Dept. Mgr.: R.D. Johnstone; Sales Mgr.: J.H. Lawson.  
Labels available on tape: Angel, Audio Fidelity, Capitol, Columbia, Monument, Parlophone, Stateside.  
Jebson & Co., Prince's Bldg., 24th fl., Hong Kong, B.C.C.  
Lisonda Ltd., Alexandra House, ground fl., Hong Kong, B.C.C.  
Moufrie & Co. (HK) Ltd., 7 Des Voeux Rd., Central Hong Kong, B.C.C. Tel: H-243098, H-226059. Gen. Mgr.: Napoleon Ng; Sales Supervisor: Fung Chi To.  
Cartridge 4-track, 8-track, cassette & open reel: Represented—Ampex, DGG, Decca, London, Philips, Polydor.  
Tatt Sing Sanyo Electric Co. Ltd., 34-37 Connaught Rd. C, 4th fl., Wang Kee Bldg., Hong Kong, B.C.C.  
P.H. Shek Ltd., United Chinese Bank Bldg., 4th fl., Hong Kong, B.C.C.  
T.K. Whang & Co., PO Box 1575, 1330-1332 Prince's Bldg., Hong Kong, B.C.C. Tel: H-247047. Prop. & Gen. Mgr.: T. K. Whang; Sales Mgr.: Robert Wong.  
Cartridge 4-track, 8-track, cassette & open reel: Represented—Audio Spectrum, Barclay, Somerset, Stereo Fidelity.

### ● tape playback equipment manufacturers/importers

Ampex World Opns. SA, 102 Kayamally Bldg., 22 Queen's Rd., Central Hong Kong, B.C.C. Tel: H-227059.

Cosdel Ltd., PO Box 2567, 1330-1332 Prince's Bldg., Hong Kong, B.C.C. Tel: H-247047. Mng. Dirs.: Kenneth L. Cole, T. K. Whang, S. P. Sim.  
Sony Corp. of Hong Kong Ltd., 3 Lane Crawford House, 6th fl., Hong Kong, B.C.C.  
T. K. Whang & Co., PO Box 1575, 1330-1332 Prince's Bldg., Hong Kong, B.C.C. Tel: H-247047. Prop. & Gen. Mgr.: T. K. Whang; Sales Mgr.: Robert Wong.

### ● tape supplies & accessories

#### RAW TAPE, BLANK LOADED TAPE, TAPE DUPLICATING EQUIPMENT

Ampex World Opns. SA, 102 Kayamally Bldg., 22 Queen's Rd., Central Hong Kong, B.C.C. Tel: H-227059.  
Minnesota Mining & Manufacturing (3 M Co.) Hong Kong Ltd., Luk Hoi Tong Bldg., 7th fl., Hong Kong, B.C.C.

#### HEAD CLEANERS & DEMAGNETIZERS

Ampex World Opns. SA, 102 Kayamally Bldg., 22 Queen's Rd., Central Hong Kong, B.C.C. Tel: H-227059.

## ISRAEL

Population: 2,808,000.  
Per capita income: \$1,386.  
Rate of exchange: \$1 (US) = 3.5 Israeli pounds.  
Average retail price per tape: Cartridge 8-track—\$9; cassette—\$6.90.  
Market: Open reel leads the market, distributed mainly by Sonocolor, Scotch, and Philips. Philips, CBS, and Pax have begun manufacture of cassettes and 8-track cartridges. Most tape equipment is imported from Europe and the USA, but Tadiran has now started local production.  
Type of distribution: Manufacturer or licensee-to-distributor-to-wholesaler-to-retailer.  
Import regulations: No import license required subject to customs and purchase tax.

AVNER ROSENBLUM

### ● record manufacturers with tape product

C B S Recs. Israel, PO Box 681, Tel Aviv; 50 Tehon St., Holon. Tel: (03) 840191. Mng. Dir.: Simon Schmidt; Creative Servs. Dir.: Mrs. Shirley Schmidt; Sale Mgr.: Abe Fineberg.  
Cartridge 8-track & cassette: Owned—CBS, Epic; represented—Liberty, Motown, Tamlia, United Artists (all USA).  
Columbia (see Palestine Orient).  
Epic (see CBS).  
Israelectra, 12 Allenby St., Haifa. Tel: (04) 526231. Mng. Dir.: Leon L. Levy.  
Cartridge 8-track & cassette: Owned—Phonodot; represented—A&M, DGG, Fontana, MGM, Mercury, Philips, Polydor, Riverside, Verve.  
Palestine Orient Co. Ltd., PO Box 230, 4 Hertzl St., Tel Aviv. Tel: (03) 57557, 50440. Mng. Dir.: Igal Kimchi; Int'l: Avshalom Rubin.  
Cassette: Owned—Columbia, Parlophone, Stateside; represented—Capitol, Apple, Dunhill, EMI group.  
Parlophone (see Palestine Orient).  
Pax (see Symphonia).  
Phonodot (see Israelectra).  
Stateside (see Palestine Orient).  
Symphonia (Whsle.) Ltd., 296 Hayarkon St., Tel Aviv. Tel: (03) 449940. Mng. Dir. & Sales Mgr.: Gad Barkuz.  
Cassette: Owned — Pax; represented — Decca (France, UK).

### ● playback equipment importer

C B S Recs. Israel, PO Box 681, Tel Aviv; 50 Tehon St., Holon. Tel: (03) 840191. Mng. Dir.: Simon Schmidt; Creative Servs. Dir.: Mrs. Shirley Schmidt; Sales Mgr.: Abe Fineberg.

## ITALY

Population: 53,129,000.  
Per capita income: \$1,000 (US).  
Rate of exchange: \$1 (US) = 623.50 lire.  
Pre-recorded tape manufactured for domestic & export sale: (factory value) 8-track cartridge 1968—\$65,000. 4-track cartridge 1968—\$15,000. Cassette 1968—\$202,000.  
Pre-recorded tapes imported from countries other than USA (mainly Netherlands & Germany): (factory value) 1968—\$445,000.

Average retail price per tape: 4-track cartridge—(EP) \$2.40, (LP) \$7.20; 8-track cartridge—\$7.82; cassette—(EP) \$2.40, (LP) \$6.33; open reel—\$15. (All prices plus 10% luxury tax and 4% income tax.)  
Type of distribution: Most record companies distribute their tape product through record wholesalers and retailers. RCA-Italiana is branching out into other forms of distribution and is selling 8-track product through gas stations.  
Type of promotion: Posters, racks and newspaper ads are used. Extra sales stimulation comes from discounts to retailers and an exchange program—an old cartridge plus 80¢ gets a new cartridge.  
Import/Export regulations: There is no duty on goods from Common Market countries. Duty on goods from other countries varies according to reciprocal agreements. All imports are subject to accessories fees and 10% luxury tax. Export is free with 4% return income tax in favor of exporters. Germano Ruscitto

### ● record manufacturers with tape product

Amico (see DET).  
Ariston (see IFI).  
Belldisc-Italiana, Via Turati 28, Milan. Tel: 650-675. Mng. Dir. & Gen. Mgr.: Antonio Casetta; Sales Mgrs.: Onda Malcotti (North), Vincenzo Napolitano (South); Pub.: Nicoletta Arcari.  
Cartridge 4-track & 8-track: Belldisc licensed to Ecofina.  
Cassette: Bluebell licensed to Phonogram; Belldisc licensed to Ecofina & Phonogram.  
Bluebell (see Belldisc-Italiana).  
C B S-Italiana, Galleria del Corso 4, Milan. Tel: 70.25.63. Cable: COLREC. Mng. Dirs.: Ladislao & Piero Sugar; Mgrs.: Giuseppe Giannini, Franco Crepax, Sandro Delor; Promo. & Pub.: Gian Borasi; Press: Marina Testori; Int'l: Andrea Bianchi.  
Cartridge 8-track & cassette: CBS catalog (distributed thru Messaggerie Musicali).  
C G D (Compagnia Generale del Disco), Galleria del Corso 4, Milan. Tel: 79.48.41. Cable: COMGEDISC. Admsins.: Ladislao & Piero Sugar; Mgrs.: Giuseppe Giannini, Franco Crepax, Sandro Delor; Promo.: Johnny Porta; Int'l: Andrea Bianchi; Press: Marina Testori.  
Cartridge 8-track: Owned—CGD; represented—A&M (USA), Audio Fidelity (USA), Festival (France), GNP Crescendo (USA), Hickory (USA), Musicor (USA), Project 3 (USA), Reprise (USA), Scepter (USA), Warner Bros.-Seven Arts (USA)—self-mfd. (distributed thru Messaggerie Musicali).  
Cartridge 4-track: Owned—CGD; represented—A&M (USA), Audio Fidelity (USA), Festival (France), GNP Crescendo (USA), Hickory (USA), Musicor (USA), Project 3 (USA), Reprise (USA), Scepter (USA), Warner Bros.-Seven Arts (USA) licensed to Ecofina.  
Cassette: Same as 8-track.  
Cam (see DET).  
Carisch, Via General Fara 39, Milan. Tel: 650.741. Mng. Dir.: Sandro Galli; Sales Dir. & Int'l: Giuseppe Cremascoli.  
Cartridge 4-track & cassette: Carisch catalog—self mfd.  
Carosello (CEMED), Galleria del Corso 4, Milan. Tel: 794.747, 793.008. Cable: CURCIMUSIC. Pres.: Giuseppe Gramitto Ricci; VP: Theo Treppiedi; Gen. Mgr. & Int'l: Davide Matalon; Press & Pub.: Luisa de Toni.  
Cartridge 8-track & cassette: Owned—Carosello catalog; represented—United Artists (USA).  
Cellograf-Simp SpA, Via Maffucci 18, Milan. Tel: 37.63.141. Mng. Dir.: Natale Sciascia; Gen. Mgr.: Riccardo Rofa; Sales Mgr.: Giovanni Albani.  
Cartridge 4-track: Phonocolor, Style licensed to SIL.  
Cassette: Phonocolor, Style licensed to Phonogram & SIL.  
Cetra (see Fonit-Cetra).  
Clan (see Clan Celentano SRL).  
Clan Celentano SRL, Corso Europa 5, Milan. Tel: 704.261. Mng. Dir. & Gen. Mgr.: Corrado Pintus; Promo. & Pub.: Gabriella Zanotti.  
Cartridge 8-track: Clan licensed to RCA-Italiana. EP & LP cassette: Clan licensed to Phonogram.  
D E T (Discografica Editrice Tirrenna) SpA, Via Virgilio 8, Rome. Tel: 38.20.21. Cable: CAMUSIC. Pres.: Giuseppe Campi; Gen. Mgr.: Sergio Federici; Sales Mgr.: Bruno Bianchi; Press & Promo.: Franca Crocchio; Int'l Mgr.: Luigi Campi.  
Cartridge 8-track: Det licensed to RCA-Italiana. EP & LP cassette: Det, Amico, Cam licensed to Phonogram.  
D G G (see Phonogram SpA).  
Decca Dischi Italia, Via Brisa 3, Milan. Tel: 874.048. Cable: DECCITAL. Gen. Mgr.: Romano Bacchini; Mgr. & Int'l: Paolo Tosi; Sales Mgr.: Luigi Negro.  
Cassette: Decca imported.

continued on page 136

## INTERNATIONAL TAPE SECTION

Continued from page 135

- Durium SpA, Via Manzoni, 40/42, Milan. Tel: 70.17.05/03. Pres. & Mng. Dir.: Krikor Mintangian; Admin.: Franco Martinengo; Export Mgr.: Elisabet Mintangian.  
**Cartridge 8-track:** Durium, PDU licensed to RCA-Italiana.  
**EP & LP cassette:** Durium, PDU licensed to Phonogram.
- E M I-Italiana, Piazza Cavour 1, Milan. Tel: 652.577/668.738. Cable: EMIGRAM. Mng. Dir.: Michel Bonnet; Sales & Int'l: Carlo Barbareschi; Pub. & Press.: Eraldo di Vita; Int'l Rep.: Co-ord.: Sergio Bono.  
**Cartridge 8-track & cassette:** Self-mfd. & imported.
- F P 4 (see Folklore).  
Folklore, Via Pietro Micca 17, Turin. Tel: 518.668. Mng. Dir.: Carlo Margaria.  
**Cartridge 4-track & 8-track:** FP 4 licensed to Ecofina.  
**Cassette:** FP 4 self-mfd. & licensed to Ecofina.  
Fonit-Cetra, Via Bertola 34, Turin. Tel: 57-53. Cable: CETRA. Pres.: Enrico Carrera; Mng. Dir.: Renato Zaccane; Sales: Luigi Arduino; Int'l: Maurizio Golla; Pub. & Press.: Rosita Robba.  
**Cartridge 8-track:** Owned—Fonit-Cetra catalog; represented—Kapp (USA) self-mfd.  
**Cartridge 4-track:** Owned—Fonit-Cetra catalog; represented—Kapp (USA) self-mfd. & licensed to SIL.  
**Cassette:** Fonit-Cetra licensed to Phonogram.
- Fontana (see Phonogram).  
F I L (Ariston), Piazzetta Pattari 1/2, Milan. Tel: 89.77.45. Pres.: Alfredo Rossi; Co-ord. & Promo.: Giuseppe Tarozzi; Sales Dir.: Gaetano Papadia; Int'l: Pier Tacchini.  
**Cartridge 4-track:** Ariston licensed to Ecofina & SIL.
- Meazzi, Via Piatti 4/6, Milan. Tel: 867.361. Cable: MEFROM. Mng. Dir. & Int'l: Enrico Meazzi.  
**Cartridge 4-track & 8-track:** Licensed to Ecofina.
- Mercury (see Phonogram).  
Miura, Corso Europa 5, Milan. Tel: 79.47.51. Pres.: Lorenzo Sampietro; Gen. Mgr.: Iller Pattacini.  
**Cartridge 4-track, 8-track & cassette:** Licensed to Ecofina.
- Muscor (see CGD).  
P D U (see Durium).  
Philips (see Phonogram).  
Phonocolor (see Cellograf-Simp).  
Phonogram SpA, Via Borgogna 2, Milan. Tel: 79.60.94. Cable: COMINFON. Mng. Dir.: Alain Trossat; Sales Mgr.: Franco Paradiso; Pub.: Dario Pogliani.  
**Cassette:** Philips, DGG, Polydor, Mercury, Fontana catalogs self-mfd.  
**Cartridge 4-track:** Ricordi catalog licensed to Ecofina & RCA-Italiana.  
**Cartridge 4-track:** Ricordi catalog licensed to Ecofina & SIL.  
**EP cassette:** Ricordi catalog licensed to Phonogram.  
**LP cassette:** Ricordi catalog self-mfd.
- Ri-Fi Rec. Co., Corso Buenos Aires 77, Milan. Tel: 273.641. Dir.: Giovanbattista Ansoldi; Int'l Mgr.: Giuseppe Velona; Sales Mgr.: Piero La Falce; Pub. & Promo.: Vladimiro Albera; USA Business Agent: Richard H. Roemer, 400 Madison Ave., New York, N.Y.  
**Cartridge 8-track:** Self-mfd.  
**Cartridge 4-track:** Licensed to Ecofina & SIL.  
**Cassette:** Self-mfd. & licensed to Phonogram.
- Saar, Viale di Porta Vercellina 14, Milan. Tel: 46.96.251. Mng. Dir.: Walter Gurtler; Gen. Mgr.: Italo Prandin; Sales Mgr.: Sergio Baloni; Prod'n Mgr. & Int'l: Giuseppe De Gioia.  
**Cartridge 8-track & cassette:** Licensed to SIL.
- Sidet Edizioni, Piazzetta Pattari 4, Milan. Tel: 804.818. Int'l: Emanuele Daniel.  
**Cartridge 4-track, 8-track & cassette:** Licensed to Ecofina.
- Style (see Cellograf-Simp).  
Tiffany, Galleria del Corso 2, Milan. Tel: 78.16.94.  
**Cartridge 4-track, 8-track & cassette:** Licensed to Ecofina.
- Vedette, Via Lumiere 2 (Cinelandia), Cologno Monzese (Milan). Tel: 912.46.91.  
**Cartridge 8-track:** Owned—Vedette; represented—Everest (USA) self-mfd. & licensed to Ecofina; Ember (UK), Lyra (Greece) self-mfd.  
**Cartridge 4-track:** Owned—Vedette; represented—Everest (USA) licensed to Ecofina.
- Cassette: Owned—Vedette; represented—Ember (UK), Everest (USA), Lyra (Greece) self-mfd.
- ### ● duplicator/marketers
- Ecofina SRL, Via Leopardi 8, Milan. Tel: 86.90.121, 806.125. Gen. Mgr.: Mourad Sabet.  
**Cartridge 8-track:** Belldisc, Everest, FP 4, Meazzi, Miura, Ricordi, Sidet, Tiffany.  
**Cartridge 4-track:** A&M, Ariston, Audio Fidelity, Belldisc, CGD, Everest, FP 4, Festival, GNP Crescendo, Hickory, Meazzi, Miura, Muscor, Project 3, Reprise, Ricordi, Rifi, Scepter, Sidet, Tiffany, Warner Bros.-Seven Arts.  
**Cassette:** Belldisc, FP 4, Miura, Sidet, Tiffany.  
Phonogram SpA, Via Borgogna 2, Milan. Tel: 79.60.94. Cable: COMINFON. Mng. Dir.: Alain Trossat; Sales Mgr.: Franco Paradiso; Pub.: Dario Pogliani.  
**EP cassette:** Philips, Fontana, Mercury, DGG, Polydor catalogs; Amico, Belldisc, Bluebell, Cam, Clan, Det, Durium, Fonit-Cetra, PDU, Phonocolor, RRR, Ricordi, Rifi, Style.  
**LP cassette:** Philips, Fontana, Mercury, DGG, Polydor catalogs; Amico, Belldisc, Bluebell, Cam, Clan, Det, Durium, PDU, Phonocolor, RRR, Style.  
R C A-Italiana, Via Tiburtina Km. 12, Rome. Tel: 41.60.41. Cable: RADIOINTER. Mng. Dir. & Gen. Mgr.: Giuseppe Ornato; Tape Dept. Mgr.: Benito Vassura; Ass't Gen. Mgr.: Ennio Melis; Opns. Mgr.: Luciano Bernacchi; Pub. Mgr.: Giacomo Peroni.  
**Cartridge 8-track:** RCA-Italiana, RCA International catalogs; Clan, Det, Durium, Motown, PDU, Ricordi, Tamla.  
S I L SpA, Via Gaudenzio Ferrari 3, Turin. Tel: 87.17.26. Gen. Mgr.: Mr. Boldetti.  
**Cartridge 8-track:** Saar.  
**Cartridge 4-track:** Ariston, Fonit-Cetra, Kapp, Phonocolor, Ricordi, Rifi, Style, Westminster.  
**Cassette:** Phonocolor, Saar, Style.
- ### ● tape distributors
- Messaggerie Musicali, Galleria del Corso 4, Milan. Tel: 79.48.41. Cable: SUGARMUSIC. Sales Mgr.: Sergio Di Gennaro.  
**Branches:** Turin, Milan, Genoa, Padua, Rome, Florence, Bari, Catania, Naples.  
**Cartridge 8-track:** CBS catalog; CGD, A&M, Audio Fidelity, Festival, GNP Crescendo, Hickory, Muscor, Project 3, Reprise, Scepter, Warner Bros.-Seven Arts.  
**Cartridge 4-track:** CGD, A&M, Audio Fidelity, Festival, GNP Crescendo, Hickory, Muscor, Project 3, Reprise, Scepter, Warner Bros.-Seven Arts.  
**Cassette:** Same as 8-track.  
Phonogram SpA, Via Borgogna 2, Milan. Tel: 28.26.241. Cable: COMINFON. Mng. Dir.: Alain Trossat; Sales Mgr.: Franco Paradiso; Pub.: Dario Pogliani.  
**Cassette:** Philips, Fontana, Mercury, DGG, Polydor catalogs; Amico, Ariston, Belldisc, Bluebell, Cam, Clan, Det, Durium, Fonit-Cetra, PDU, Phonocolor, RRR, Ricordi, Rifi, Style.
- ### ● tape playback equipment
- Amaco Morbegno (Sondrio).  
**Configuration:** Cassette.  
Anpadovani, Via Principe Amadeo 5, Milan. Tel: 65.27.19.  
Atlantic Electric SpA, Via Fantoli 5/7, Milan. Tel: 504.741.  
**Configuration:** Cassette.  
Autovox SpA, Via Salaria 981, Rome. Tel: 83.70.91.  
**Configuration:** Cassette.  
Gianni Baunberger, Via Privata Perugia, Milan. Tel: 70.94.02.  
**Configuration:** Cassette.  
Robert Bosch, Via Petitti 15, Milan. Tel: 39.96.  
**Configuration:** Cassette.  
Carlo Buzzi, Via Maggio 5, Legnano. Tel: 484.16.  
**Configuration:** Cartridge 4-track, 8-track & 4&8-track compatible.  
Century, Via Overdan 24, Brescia.  
**Configuration:** Cassette.  
Condor of Giuseppe Gallo, Via Ugo Bassi 23/A, Milan. Tel: 60.628.  
**Configuration:** Cassette.  
Crespi & Zaretti, Via Milano, Cassano d'Adda (Milan).  
**Configuration:** Cassette.  
Davoli, Via F. Lombardi 6/8, Parma. Tel: 40.885.  
**Configuration:** Cassette.  
De Gasperi, Via Fonzo 5, Milan.  
**Configuration:** Cassette.  
Dino Del Maso, Via Giotto 65, Lissone (Milan).  
**Configuration:** Cassette.  
Ecofina SRL, Via Leopardi 8, Milan. Tel: 86.90.121. Gen. Mgr.: Mourad Sabet.  
**Configuration:** Cartridge 4-track, 8-track & 4&8-track compatible.  
Europhon, Via Mecenate 86, Milan. Tel: 50.35.51.  
**Configuration:** Cassette.  
F A R T, Via Volturno 31, Quinto de' Stampi Rossano (Milan).  
**Configuration:** Cassette.  
F I A M di Ludovico Marchese, Via Regio Parco 32, Settimo Torinese (Turin). Tel: 56.31.36.  
**Configuration:** Cassette.
- Fonit-Cetra, Via Bertola 34, Turin. Tel: 57.53.  
**Configuration:** Cartridge 4-track, 8-track & 4&8-track compatible.  
Fonmusik, Via Cadolini 3, Milan. Tel: 58.55.67.  
**Configuration:** Cassette.  
Fraem, Via Niccodemi 5, Milan.  
**Configuration:** Cassette.  
G B O Italiana, Via Matteotti 56, Cinisello Balsamo (Milan). Tel: 9.28.28.91.  
**Configuration:** Cassette.  
Gammavox, Via M. Melloni 32, Milan. Tel: 71.13.80.  
**Configuration:** Cassette.  
Geloso SpA, Via Brenta 29, Milan.  
**Configuration:** Cassette.  
I N C I S, Via Novara 28, Saronno (Varese).  
**Configuration:** Cassette.  
Imar, Via Trebbia 29/A, Quinto di Rozzano (Milan).  
**Configuration:** Cassette.  
Lear (see Marelli).  
Lesia, Via Bergamo 21, Milan. Tel: 55.43.41.  
**Configuration:** Cassette.  
Magnetofoni Castelli SpA, S. Pedrino di Vignate (Milan). Tel: 95.60.41.  
**Configuration:** Cassette.  
Marelli, Corso Venezia 51, Milan (Lear licensees).  
**Configuration:** Cartridge 8-track.  
Midget Electronics, Via Cilea 4, Pioletto (Milan).  
**Configuration:** Cassette.  
Moel, Via Orembelli 13, Milan.  
**Configuration:** Cassette.  
Muntz (see Stereo-Pak SRL).  
Musicalnastro SRL, Via Lamarmora 33, Milan. Tel: 58.26.01.  
**Configuration:** Cassette.  
Offel, Via Lato di Mezzo 32-42, Lugo di Ravenna (Ravenna). Tel: 225.42.  
**Configuration:** Cartridge 4-track.  
Perser, Via Cimarosa 35, Vicenza. Tel: 31.801.  
Philips, Piazza IV Novembre 3, Milan. Tel: 69.94.  
**Configuration:** Cassette.  
Radio SARCA, Via Anfossi 6, Milan.  
**Configuration:** Cassette.  
S E I, Via Emilia 52/54, Ozzano Emilia (Bologna). Tel: 71.91.01.  
**Configuration:** Cartridge 8-track & cassette.  
S F C Italiana, Via Roma 8, Gorle (Bergamo).  
S I L SpA, Via Gaudenzio Ferrari 3, Turin. Tel: 87.17.26. Gen. Mgr.: Mr. Boldetti.  
**Configuration:** Cartridge 4&8-track compatible.  
Selimco, Piazza IV Novembre 4, Milan. Tel: 69.06.54.  
**Configuration:** Cassette.  
Siera, Via Vittor Pisani 12, Milan. (Philips affiliate).  
**Configuration:** Cassette.  
Sincom SRL, Via Washington 89, Milan. Tel: 47.91.97.  
**Configuration:** Cartridge 4-track & 8-track.  
Stereo-Pak SRL, Trezzo Sull'Adda (Milan). Tel: 90.90.138/2; Via I. Nieve 28/a, Milan. Tel: 46.95.271. (Muntz licensees).  
**Configuration:** Cartridge 4-track, 8-track & 4&8-track compatible.  
Telewatt SAS, Via Piemonte 21, Cinisello Balsamo (Milan). Tel: 92.86.566.  
**Configuration:** Cassette.  
Giovanni Vaiani, Via Leonardo da Vinci 50, Corsico (Milan).  
**Configuration:** Cassette.  
Voxson-Faret SpA, Via di Tor Cervara 286, Rome. Tel: 22.09.51.  
**Configuration:** Cartridge 8-track.  
Wilco, Via Barnabo Visconti 7, Milan. Tel: 40.43.0555.  
**Configuration:** Cassette.  
Wilson, Via Gardone 7, Milan.  
**Configuration:** Cassette.  
Giuseppe Zanotto, Via Zambelli 12, Milan.  
Zanussi Industrie, Pordenone (Udine).  
**Configuration:** Cassette.
- ### ● service & supplies
- #### RAW TAPE MANUFACTURERS
- Agfa Gevaert, Viale Certosa 126/130, Milan. Tel: 390.151. Mng. Dir.: Helmut Schultze-Battman. Ferrania (controlled by 3M), Corso Matteotti 12, Milan. Tel: 70.16.77.
- #### EMPTY CARTRIDGE, CASSETTE & REEL MANUFACTURER
- 3 M Minnesota, Via Gozzi 1, Milan. Tel: 73.93. Cable: TRIMINCO.
- #### TAPE DUPLICATING EQUIPMENT
- A E G Italiana, Via G. B. Pirelli 12, Milan.  
S I L SpA, Via Gaudenzio Ferrari 3, Turin. Tel: 87.17.26. Gen. Mgr.: Mr. Boldetti.
- #### CUSTOM DUPLICATION
- Durema SpA, Via Rita Tonoli 1, Milan. Tel: 38.15.81.  
Ecofina SRL, Via Leopardi 8, Milan. Tel: 96.90.121, 806.125.  
Folklore, Via Ventimiglia 194, Turin. Tel: 697.125.  
Offel, Via Lato di Mezzo 42, Lugo di Ravenna.  
Phonogram SpA, Via Borgogna 2, Milan. Tel: 28.26.241. Cable: COMINFON. Mng. Dir.: Alain Trossat; Sales Mgr.: Franco Paradiso.



R C A-Italiana, Via Tiburtina Km. 12, Rome. Tel: 41.60.41. Cable: RADIOINTER. Mng. Dir. & Gen. Mgr.: Giuseppe Ornato; Tape Dept. Mgr.: Benito Vassura; Ass't Gen. Mgr.: Ennio Melis; Opns. Mgr.: Luciano Bernacchi; Pub. Mgr.: Giacomo Peroni.

S I L SpA, Via Gaudenzio Ferrari 3, Turin. Tel: 87.17.26. Gen. Mgr.: Mr. Boldetti.

3 M Minnesota (Istituto Dei Ciechi), Via Gozzi 1, Milan. Tel: 73.93.

Vedette, Via Lumiere 2 (Cinelandia), Cologno Monzese (Milan). Tel: 912.46.91.

## JAPAN

Population: 101,988,000.  
 Per capita income: \$1,110.  
 Rate of exchange: \$1 (US)=360 yen.  
**Pre-recorded tape manufactured for domestic & export sale:** (factory value) Cartridge 4-track & 8-track 1968=5,438,122 units. Cassette 1968-631,259 units. Open reel 1968-171,459 units.  
**Pre-recorded tape imported from USA:** (customs value) 1968-\$312,790; 1967-\$386,340.  
**Pre-recorded tape imported from countries other than USA:** (customs value) 1968-\$145,580; 1967-\$315,480.  
**Pre-recorded tape exported to USA:** (customs value) 1968-\$2,230,240; 1967-\$2,926,020.  
**Pre-recorded tape exported to countries other than USA:** (customs value) 1968-\$5,355,610; 1967-\$4,982,160.  
 Average retail price per tape: Cartridge 8-track-\$6.70; cassette-\$5.60; open reel-\$7.80.  
**Market:** The industry has been booming since the introduction of cartridges and cassettes in 1966 and it is estimated that the 1969 production will double that of 1968. The production ratio for 1968 was: 87% cartridge, 10% cassette and 3% open reel. The production of 4-track cartridges was discontinued in 1969. There is a sharp increase in the sale of stereo cartridges for cars, representing over half of the industry; home use is very small. Estimated 1969 production of tape players for export is around 8 million compared to 6.5 million in 1968, total production around 10 million.  
**Type of distribution:** Major manufacturers mostly deal directly with the retailer while the smaller manufacturers utilize wholesalers who also handle product from the large companies.  
**Type of promotion:** Weekly magazines and television.  
**Import/Export regulations:** Free.

J. Fukunishi

## ● manufacturers duplicating & marketing tape product

Appolon Ongaku Kogyo Co., 5 Wakaba-cho 1-Chome, Shinjuku-ku, Tokyo. Tel: (353)-0191. Pres. T. Kobayashi.  
**Label available on tape:** Appolon.

Asahi Broadcasting Co., 2 Oyodo-cho 2-Chome, Oyodo-ku, Osaka. Tel: (458)-5321. Pres. K. Shimoto.  
**Label available on tape:** Asahi.

Barclay Japan, 12 Otawa-cho 2-Chome, Bunkyo-ku, Tokyo. Mgr.: Mr. Kawazoe.  
**Home office:** France.

C B S-Sony Rec. Co., 17-7 Roppongi 3-Chome, Minato-ku, Tokyo. Tel: (585)-0411. Pres. A. Morita.  
**Label available on tape:** CBS-Sony.

Clarion (see Teikoku Dempa).

Columbia (see Nippon Columbia).

Echo Ent's., Dai-ichi Fujii Bldg., 93 Kashiwagi 1-Chome, Shinjuku, Tokyo. Tel: (363)-0275. Pres.: K. Kano.  
**Label available on tape:** Echo.

Electronic Research & Development Co., Shiozaki Bldg., 7 Hirakawa-cho 2-Chome, Chiyoda-ku, Tokyo. Tel: (263)-4841. Pres.: Robert Schreiber.  
**Express (see Toshiba).**

Fuji Tsu-un Co., 64 Tsukamoto, Nishiwaki, Ohkubo-cho, Akashi-shi, Hyogo-ken. Tel: (936)-1221.

King Rec. Co., 12-13 Ohta 2-Chome, Bunkyo-ku, Tokyo. Tel: (941)-3111. Mng. Dir.: M. Suzuki.  
**Labels available on tape:** King, Seven Seas.

Mecca Rec. Pak Co., 1236 Kamiike-cho 2-Chome, Toyota-shi, Aichi-ken. Tel: (2)-6111. Mng. Dir.: J. Suzuki.  
**Label available on tape:** Mecca.

Nippon Broadcasting System Serv., 7 Yuraku-cho 1-Chome, Chiyoda-ku, Tokyo. Tel: (281)-5251. Mng. Dir.: T. Ishida.  
**Label available on tape:** Pony.

Nippon Columbia Co., 14-14 Akasaka 4-Chome, Minato-ku, Tokyo. Tel: (548)-6111. Mng. Dir.: Y. Terajima.  
**Label available on tape:** Columbia.

Nippon Crown Co., Washin Bldg., 10-8 Akasaka 2-Chome, Minato-ku, Tokyo. Tel: (582)-4741. Mng. Dir.: S. Ito.

Nippon Gramophone Co., 6-6 Shimbashi 1-Chome, Minato-ku, Tokyo. Tel: (572)-6451. Mng. Dir.: K. Morita.

Nippon Victor Co., 2-4 Kasumigaseki 3-Chome, Chiyoda-ku, Tokyo. Tel: (580)-0211. Rep.: K. Kasajima.  
**Label available on tape:** Victor.

Pioneer Co., 15-5 Omori Nishi 4-Chome, Ota-ku, Tokyo. Tel: (763)-2111. Mng. Dir.: S. Matsumoto.

Pony (see Nippon Broadcasting).

Seven Seas (see King).

T B S Serv., TBS Bldg., 3-50 Akasaka 5-Chome, Minato-ku, Tokyo. Tel: (582)-7351. Pres.: S. Akimoto.  
**Label available on tape:** TBS.

Taiko Electric Mfg. Co., 10-13 Nakanobu 6-Chome, Shinagawa-ku, Tokyo. Tel: (782)-1111. Mng. Dir.: T. Ichinose.  
**Label available on tape:** Taiko.

Taiyei (see Teichiku).

Teichiku Rec. Co., 1 Nishi-Shimbashi 2-Chome, Minato-ku Tokyo. Tel: (502)-6651. Mng. Dir.: T. Nagamine.  
**Label available on tape:** Teichiku, Taiyei.

Teikoku Dempa Co., 35-2 Hakusan 5-Chome, Bunkyo-ku, Tokyo. Tel: (813)-5151. Mng. Dir.: Y. Oyamada.  
**Label available on tape:** Clarion.

Tokyo Denki Kagaku Kogyo Co., Kanasugi Bldg., 14-6 Kanda 2-Chome, Chiyoda-ku, Tokyo. Tel: (256)-6111. Mng. Dir.: Y. Takao.

Tokyo Tanshi Co., Dai-Ni Maruzen Bldg., 2 Edobashi 2-Chome, Nihombashi, Chuo-ku, Tokyo. Tel: (272)-3631. Rep.: T. Inouye.

Toshiba Electric & Musical Inds. Ltd., 2-17 Akasaka 2-Chome, Minato-ku, Tokyo. Tel: (583)-1111. Mng. Dir.: T. Sakai.  
**Label available on tape:** Toshiba, Express.

Victor Co. of Japan, 11 Honcho 4-Chome, Nihombashi, Chuo-ku, Tokyo. Tel: (241)-7811. Cable: V.I.C. Pres.: H. Momose; Tape Mgr.: K. Iwashita.  
**Label available on tape:** Victor.

## ● tape playback equipment manufacturers

Ace Sonic, 7 Yaesu 5-Chome, Chuo-ku, Tokyo. Tel: (212)-1111.

Aiwa, 2-3 Sotokanda 5-Chome, Chiyoda-ku, Tokyo. Tel: (833)-1531.

Alps Motorola, 247 Yukigaya-cho, Ota-ku, Tokyo. Tel: (541)-0281.

Crown Radio, 17-4, Ueno 3-Chome, Taito-ku, Tokyo. Tel: (832)-6271.

Electronic Research & Development, Shiozaki Bldg., 7 Hirakawa-cho 2-Chome, Chiyoda-ku, Tokyo. Tel: (263)-4841.

Funanaka Denki, 20 Ikaino Naka 3-Chome, Ikunokubo, Osaka. Tel: (717)-1101.

Hayakawa Denki Kogyo, 22-22 Nagaike-cho, Abenokubo, Osaka. Tel: (621)-1221.

Hitachi Seisakusho, 4 Marunouchi 1-Chome, Chiyoda-ku, Tokyo. Tel: (212)-1111.

Kobe Kogyo, 5 Wadayama-dori, Hyogo-ku, Kobe. Tel: (67)-5081.

Matsushita Tsushin Kogyo, 880 Tsunashima-cho, Kohoku-ku, Yokohama. Tel: (531)-1231.

Mecca Rec. Pak Co., 1236 Kamiike-cho 2-Chome, Toyota-shi, Aichi-ken. Tel: (763)-2111.

Mitsubishi Denki, 12 Marunouchi 2-Chome, Chiyoda-ku, Tokyo. Tel: (212)-6111.

Nippon Columbia Co., 14-14 Akasaka 4-Chome, Minato-ku, Tokyo. Tel: (584)-8111.

Nippon Victor Co., 2-4 Kasumigaseki 3-Chome, Chiyoda-ku, Tokyo. Tel: (580)-0211.

Perutech, 31-17 Nishi-Kojima 2-Chome, Ota-ku, Tokyo. Tel: (742)-3461.

Pioneer, 15-5 Omori-Nishi 4-Chome, Ota-ku, Tokyo. Tel: (763)-2111.

Sankei Seisakusho, 21-3 Shimo-Maruko 4-Chome, Ota-ku, Tokyo. Tel: (731)-2221.

Sanyo Denki, 2-18 Keihan Hon-dori, Moriguchi-shi, Osaka. Tel: (991)-1181.

Shin Nihon Denki, 20 Nishi-Shimbashi 3-Chome, Minato-ku, Tokyo. Tel: (434)-3211.

Sony, 351 Kita-Shinagawa 6-Chome, Shinakawa-ku, Tokyo. Tel: (442)-5111.

Standard Kogyo, 3622 Kami-Tsuruma, Sagamiharashi, Kanagawa-ken. Tel: (23)-1111.

Sumitomo-3M, 3M Bldg., 1 Akasaka 7-Chome, Minato-ku, Tokyo. Tel: (403)-1111.

T D K Electronics, 14-6 Uchi-Kanda 2-Chome, Chiyoda-ku, Tokyo. Tel: (256)-6111.

Taiko Denki Seisakusho, 10-13 Nakanobu 6-Chome, Shinagawa-ku, Tokyo. Tel: (782)-1111.

Teikoku Dempa, 35-2 Hakusan 5-Chome, Bunkyo-ku, Tokyo. Tel: (531)-1231.

Tokai Tsusiniki, 816 Nakahara, Shizuoka-shi. Tel: (85)-0141.

Tokyo Shibaura Denki, 72 Horikawa-cho, Kawasaki-shi, Kanagawa-ken. Tel: (52)-2111.

Van Denko, Makino, Nakamura-ku, Nagoya. Tel: (551)-4811.

Yanase, 6 Shibaura 1-Chome, Minato-ku, Tokyo. Tel: (452)-4311.

## ● tape wholesalers

Daichiku, 5-1 Uchi-Kanda 3-Chome, Chiyoda-ku, Tokyo.

Jujiya Gakki, 2 Ginza 3-Chome, Chuo-ku, Tokyo.

Katayama Shokai, 28 Miyauchi-cho, Fukuoka.

Keystone Denzhi, Ishikawa Bldg., Hirakawa-cho, Chiyoda-ku, Tokyo.

Kunihara Gakki, Nijo 8-Chome, Asahikawa.

Lilac Shoji, 50 Kawaraya-machi Niban-cho, Minami-ku, Osaka.

Lucky Shokai, 4 Suda-cho 2-Chome, Kanda, Chiyoda-ku, Tokyo.

Nishiyama Gramoshop, 157 Minami-Saka-machi, Minami-ku, Osaka.

Seiko-Do, 46-11 Itabashi-cho 2-Chome, Itabashi-ku, Tokyo.

Sumiya, 6-9 Gofuku-cho 1-Chome, Shizuoka.

Yamano Gakki, 2 Ginza 4-Chome, Chuo-ku, Tokyo.

## ● supplies

### RAW TAPE MANUFACTURERS

Fuji Shashin Film, O-kura Bldg., Ginza Nishi, Chuo-ku, Tokyo. Tel: (567)-9111.

Hitachi Maxell, 303 Kita-Shinagawa 3-Chome, Shinagawa-ku, Tokyo. Tel: (442)-7271.

Nippon Broadcasting System Serv., 7 Yuraku-cho 1-Chome, Chiyoda-ku, Tokyo. Tel: (281)-5251.

Nippon Columbia Co., 14-14 Akasaka 4-Chome, Minato-ku, Tokyo. Tel: (584)-8111.

Sony, 351 Kita-Shinagawa 6-Chome, Shinagawa-ku, Tokyo. Tel: (442)-5111.

Sumitomo-3M, 3M Bldg., 1 Akasaka 7-Chome, Minato-ku, Tokyo. Tel: (403)-1111.

Tokyo Denki Kagaku, Kanasugi Bldg., Asahi, Kanda, Chiyoda-ku, Tokyo. Tel: (252)-7151.

### EMPTY CARTRIDGE, CASSETTE & REEL MANUFACTURERS

Taiko Denki, 10 Nakanobu 6-Chome, Shinagawa-ku, Tokyo. Tel: (782)-1111.

Tokyo Denki Kagaku, Kanasugi Bldg., Asahi, Kanda, Chiyoda-ku, Tokyo. Tel: (252)-7151.

## ● services

### CUSTOM TAPE DUPLICATORS

Chuo Rokuun, Sone Bldg., Ginza Nishi, Chuo-ku, Tokyo. Tel: (571)-0851.

Kosoku Rokuun, Dai 4, Hidewa Bldg., Ginza, Chuo-ku, Tokyo. Tel: (571)-1985.

Video Serv., Asahi Bldg., Ginza Nishi, Chuo-ku, Tokyo. Tel: (572)-0404.

## MEXICO

POPULATION: 48,933,000.  
 PER CAPITA INCOME: \$520.  
 RATE OF EXCHANGE: \$1 (U.S.)=12.5 pesos.

## ● record manufacturers with tape product

A & M (see RCA).

Amaret (see Gamma).

Angel (see Capitol).

Apple (see Capitol).

Artia (see Gamma).

Atlantic (see Universales).

Audio-Spectrum (see Orfeon VideoVox).

Barclay (see Orfeon VideoVox).

Belart (see Universales).

Blue Bell (see Gamma).

Buddah (see Universales).

C B S/Columbia Internacional SA, 16 de Septiembre 51, Naucalpan. Pres.: Manuel Villarreal; Exec. VP: Armando de Llano.  
**Cartridge 4-track, 8-track & cassette:** Owned—CBS, Epic, Harmony licensed to Stereo Jet.

Camden (see RCA).

Capitol de Mexico SA (Discos), Ayuntamiento 54, Mexico 1, D.F. Tel: 518-13-20. Cable: CAP-RECORDS. Gen. Mgr.: Ramon Dosal.  
**Cartridge 4-track & 8-track:** Owned—Capitol; represented—Odeon, Motown, Tamla.  
**Cassette:** Owned—Capitol, Cap-Latino; represented—Angel, Apple.  
**Open reel:** Owned—Capitol; represented—Angel.

Cap-Latino (see Capitol).

Carosello (see Gamma).

Chess (see Gamma).

Cisne SA (Discos), Carracci 64, Mexico, D.F. Tel: 63-13-70. Pres.: Rafael Fiacchi; Gen. Mgr.: Raul Fiacchi; Admin. Mgr.: Raul J. Castro.  
**Cartridge 4-track & cassette:** Owned—Cisne, MD, Riff.

Corito (see Coro).

Coro SA, Bahia de Perula 80, Mexico 17, D.F. Tel: 31-29-00. Pres.: Federico Riojas.  
**Labels available on tape:** Owned—Coro, Corito, Selekt; represented—Seeco (USA).

Cygnus (see Gamma).

Decca (see Orfeon VideoVox).

Dimsa (see Orfeon VideoVox).

Discomoda (see Gamma).

Double Shot (see Gamma).

Durium (see Gamma).

Eco (see Peerless).

Epic (see CBS).

Erato (see Gamma).

continued on page 138

## INTERNATIONAL TAPE SECTION

Continued from page 137

Gamma SA, Apdo. 7762, Ejercito Nacional 167-1, Mexico 1, D.F. Tel: 45-73-60. Pres.: Jose M. Vidal Zapater; Gen. Mgr.: Carlos J. Camacho; Int'l Dir.: Luis M. Moyano.

**Cartridge 4-track & 8-track:** Owned—Gamma self-mfd.; represented—Amaret, Artia, Blue Bell, Carosello, Chess, Cygnus, Discomoda, Double Shot, Durium, Erato, Hispavox, Jewel, Laurie, Original Sound, Paula, Project 3, Pye, Reprise, Supraphon, Symphony Tone, 20th Century-Fox, Vanguard, Warner Bros.-Seven Arts.  
**Cassette:** Represented—Amaret, Artia, Blue Bell, Carosello, Chess, Cygnus, Discomoda, Double Shot, Durium, Erato, Hispavox, Jewel, Laurie, Original Sound, Paula, Project 3, Pye, Reprise, Supraphon, Symphony Tone, 20th Century-Fox, Vanguard, Warner Bros.-Seven Arts.

Harmony (see CBS).  
Hispavox (see Gamma).  
Jewel (see Gamma).  
Kama Sutra (see Universales).  
Kapp (see Orfeon VideoVox).  
Laurie (see Gamma).  
Liberty (see Musart).  
London (see Peerless).  
M D (see Cisne).  
M G M (see Universales).  
Mercury (see Universales).  
Motown (see Capitol).

Musart SA (Discos), Cuitlahuac 2335, Mexico 16, D.F. Tel: 5-27-01-00. Pres.: Eduardo L. Baptista; Sales Mgr.: Jose Luengo.  
**Cartridge 4-track, 8-track & cassette:** Owned—Musart self-mfd.; represented—Liberty, United Artists (USA).

Odeon (see Capitol).  
Orfeon VideoVox SA, Av. Universidad 1273, Mexico, D.F. Tel: 24-25-00. Cable: DISMEXSA. Pres.: Rogelio Ascanraga.  
**Labels available on tape:** Owned—Orfeon, Dimsa; represented—Audio-Spectrum (USA), Barclay (France), Decca (USA), Kapp (USA), Scepter (USA).

Original Sound (see Gamma).  
Paramount (see RCA).  
Paula (see Gamma).

Peerless SA (Fabrica de Discos), Laguna Mayran 232, Mexico 18, D.F. Tel: 5-45-63-40. Pres.: Heinz Klinckwort; Gen. Mgr.: Fritz Ulrich, Leo Porias; Sales Mgr.: Bruno Vogt.  
**Cartridge 4-track & 8-track:** Owned—Peerless, Eco self-mfd.; represented—London.  
**Cassette:** Represented—London.

Philips (see Universales).  
Polydor (see Universales).  
Project 3 (see Gamma).

Pye (see Gamma).  
R C A SA de CV, Rec. Div., AV., Cuitlahuac 2519, Mexico 16, D.F. Tel: 5-27-60-20. Rec. Div. Dir.: Jose M. Vias Jr.; Mktg. Mgr.: Guillermo Infante O.; Sales Mgr.: Arturo del Pozo.  
**Cartridge 8-track & cassette:** Owned—RCA, Camden self-mfd.; represented—A&M (USA), Paramount (USA).

Raff (see Cisne).  
Reprise (see Gamma).  
Scepter (see Orfeon VideoVox).  
Seeco (see Coro).  
Selekt (see Coro).

Son Art SA (Discos), Hamburgo 49, 4th piso, Mexico 6, D.F. Tel: 5-35-71-32. Pres.: Teodoro Mantecon Olavarrieta; Gen. Mgr.: Bernardo Gonzalez Bernaldez; Sales Mgr.: Jesus Humaran Vargas.  
**Cartridge 4-track, 8-track & cassette:** Owned—Son Art licensed to Stereo Jet.

Supraphon (see Gamma).  
Symphony Tone (see Gamma).  
Tamlá (see Capitol).  
20th Century-Fox (see Gamma).  
United Artists (see Musart).

Universales SA (Discos), Insurgentes Sur 1877/13, Mexico 20, D.F. Tel: 5-48-35-29. Gen. Mgr.: Luis Baston; Admin. Mgr.: C. P. Jaime Mejido; Sales Mgr.: Enrique de Noriega.  
**Cartridge 8-track:** Represented—Atlantic, Buddha, Kama Sutra, MGM, Mercury, Verve (all USA).  
**Cassette:** Owned—Belart, Philips, Polydor self-mfd.; represented—Atlantic, Buddha, Kama Sutra, MGM, Mercury, Verve (all USA).

Vanguard (see Gamma).  
Verve (see Universales).  
Warner Bros.-Seven Arts (see Gamma).

### ● duplicator/marketer

Stereo Jet de Mexico SA, Calle Dos 13-B, Naucalpan. Tel: 5-76-06-38. Gen. Mgr.: Casimiro P. Flores Ochoa; Sales Mgr.: Ramiro Gamboa Segui; Prod'n Dir.: Andrea Coytona Senora.  
Int'l branch: USA, Caytronics.  
**Cartridge 4-track, 8-track & cassette:** ABC, Alegre, CBS, Command, Command Classics, Epic, Grand Award, Harmony, Impulse, Mode, Music Guild, Panamusic, Roulette, Son Art, Tangerine, Tico, Vogue, Westminster, Whitehall.

### ● playback equipment manufacturers & importers

Ampex de Mexico SA de CV, Division del Norte 1832, Mexico 13, D.F. Tel: 5-39-68-70. Gen. Mgr.: M. A. Hernandez. (Imports).  
Corporacion Nacional Industrial SA, Apdo. Postal 14834, Sta. Clara Edo. de Mexico, La Villa, Mexico, D.F. Cable: KELVINATOR. (Imports).  
**Configuration:** 8-track.  
**Brand name:** Motorola.

Industrias Nacionales de Sonido SA, Apdo. 32036, Calz. Mexico-Xochimilco 4861, Mexico 22, D.F. Tel: 5-73-24-78, 5-73-24-13, 5-73-24-80. Pres.: David L. Romero; Gen. Mgr.: Raul C. Romero; Sales Mgr.: J. Perez Gavilan. (Manufactures).  
**Configuration:** Cassette.  
**Brand names:** Astrovox, Inssa, Sanyo.

Sovi SA, 243 Laguna de San Cristobal, Col. Anahuac, Mexico 17, D.F. Tel: 5-31-49-52. Pres.: Oscar Rivero Azcarraga; Gen. Mgr.: Gabriel Gonzalez de la O.; Sales Mgr.: Ing. Rodolfo Esquivel Ramirez. (Imports).  
**Brand names:** Ampex, Magnatech.

Teac-Crown, (see Tape Wholesaler listing for Acetatos Profesionales).

### ● tape wholesaler

Acetatos Profesionales SA, Londres 179, Mexico 6, D.F. Tel: 5-33-19-72. Gen. Mgr.: Teodoro Dehesa; Acoustic Mgr.: Fritz Jacobson.

**Cartridge 4-track, 8-track, cassette & open reel:** Ampex, CBS, Capitol, Decca, London, Musart, Peerless, Philips, RCA, Stereo Tape.  
**Playback equip.:** Teac-Crown imported.  
**Accessories & supplies:** Empty cassettes, cassette parts, head cleaners & demagnetizers.

### ● supplies

Acetatos Profesionales SA, Londres 179, Mexico 6, D.F. Tel: 5-33-19-72. Gen. Mgr.: Teodoro Dehesa.  
**Product:** Empty cassettes, cassette parts, head cleaners & demagnetizers.

### ● services

#### CUSTOM DUPLICATION

Musart SA (Discos), Cuitlahuac 2335, Mexico 16, D.F. Tel: 5-27-01-00. Pres.: Eduardo L. Baptista; Sales Mgr.: Jose Luengo.  
**Configurations:** Cartridge 4-track, 8-track & cassette.

Peerless SA (Fabrica de Discos), Laguna Mayran 232, Mexico 18, D.F. Tel: 5-45-63-40. Pres.: Heinz Klinckwort; Gen. Mgrs.: Fritz Ulrich, Leo Porias; Sales Mgr.: Bruno Vogt.  
**Configurations:** Cartridge 4-track & 8-track.

Sovi SA, 243 Laguna de San Cristobal, Col. Anahuac, Mexico 17, D.F. Tel: 5-31-49-52. Pres.: Oscar Rivero Azcarraga; Gen. Mgr.: Gabriel Gonzalez de la O.; Sales Mgr.: Ing. Rodolfo Esquivel Ramirez.  
**Configurations:** Cartridge 4-track, 8-track & cassette.

#### DESIGN & ARTWORK PACKAGING & LABELING PRINTING & LITHOGRAPHING

Sovi SA, 243 Laguna de San Cristobal, Col. Anahuac, Mexico 17, D.F. Tel: 5-31-49-52. Pres.: Oscar Rivero Azcarraga; Gen. Mgr.: Gabriel Gonzalez de la O.; Sales Mgr.: Ing. Rodolfo Esquivel Ramirez.

## NETHERLANDS

Population: 13,650,000.  
Per capita income: \$1,400.  
Rate of exchange: \$1 (US)=3.65 guilders.  
**Pre-recorded tape imported from USA:** (factory value) 1968—\$105,000; 1967—\$95,000.  
**Pre-recorded tape imported from countries other than USA:** (factory value) 1968—\$1,013,000; 1967—\$765,000.  
**Pre-recorded tape exported:** 1968—\$1,330,800; 1967—\$1,100,000.  
Average retail price per tape: Cartridge 8-track—\$6.90; cassette—\$2-\$6.40; open reel—\$8.

**Market:** The use of 8-track players has improved since the latest Firato-fair, especially in cars, but cassettes still dominate the market. In 1969 approximately 6,000 titles were available on cassette.

**Type of distribution:** Manufacturer or importer-to-retailer. Some retailers specialize in pre-recorded tapes.

**Type of promotion:** Strong promotion through radio, TV, newspapers and magazines by Philips. Cassettes offered at low prices to buyers of new players.

**Import/Export regulations:** There is no duty on tapes imported from Common Market countries.

### ● record manufacturers with tape product

Barclay Nederland, Sinjel 104, Amsterdam. Tel: 23.43.61. Mgr.: B. R. Maassen.  
**Home office:** France.

**Cartridge 8-track & cassette:** Owned—Barclay, Classic, Riviera.

Bovema, Bronsteweg 43, Heemstede. Tel: 023-80750. Mng. Dir.: G. M. Oord; Finance & Admin. Mgr.: N. L. A. Hutler; Pub Mgr.: C. J. Sprangers; Promo. Mgr.: H. Kleinjan.  
**Cassette:** EMI group, Motown, Tamlá, United Artists.

C B S, Artone Bldg., Kruisstraat 8-10, Haarlem. Tel: 17476. Cable: COLRECORD. Mng. Partners: Bill C. & Casper D. Slinger; Mktg. Dir.: John J. Vis; Mktg. Mgr.: Gerard Hulsebosch; Promo.: Ko Kooyang.  
**Cassette:** Artone, CBS.

C N R, Rembrandtstraat 17, Leiden. Tel: (01710) 44244. Cable: CENER. Mng. Dir.: Hans van Zeeland; Tape: Frad Hartog.  
**Cassette:** Owned—CNR; distributed—Barclay; represented—Ariola (Germany), Buddha (USA), Eurodisc (Germany), Melodiya (USSR), Telefunken (Germany).

Dureco, Beursstraat 21, Amsterdam. Tel: 242288. Cable: RECMUS. Mng. Dir.: Robert Aardse; Pub., Adv. & Promo.: E. de Raaff.

**Cassette:** Dureco, Metronome.  
Inelco, Arent Janszoon Ernststraat 801, Amsterdam, Z-2. Tel: 421722. Cable: INTELECT. Mng. Dir.: W. Brandsteder; Sales: J. Beutler; PR & Int'l: A. N. Prins; Pub.: P. F. J. Dam.

**Cartridge 8-track & cassette:** MCA, RCA.

Miller Int'l Holland, Pampuslaan 221, Weesp. Tel: (02940) 4557. Mng. Dir.: Henk C. Majoor.  
**Cassette:** Europa, Somerset.

Phonogram, Drenthestraat 21, Amsterdam-Buitenveldert. Tel: 440888. Mng. Dir.: Jack Haslinghuis; Sales Dir.: Reinhard H. Klassen; Int'l: Leo Boudewijns.

**Cassette:** Philips, Mercury, Decca.  
Polydor, Piet Heintlein 5, The Hague. Tel: 634955. Cable: POLNED. Mng. Dir.: E. Garretsen; Sales: Robert Oeges; Mktg. Mgr.: J. Assman; Int'l Dir.: J. van Bart, N. van Biemen, P. Niewerf.  
**Cassette:** A&M, Atlantic, DGG, Polydor.

Telgram, St. Maartenslaan 1-3, Weert. Tel: (04950) 2620, 4269. Pres. & Owner: Johnny Hoes; Int'l: Mrs. Jacqueline Hoes; Sales: Ch. P. Noordendorp; Pub.: J. D. Timman.  
**Cassette:** Ojee Telstar.

### ● services & supplies

#### CUSTOM DUPLICATION

Philips Phonographische Industrie (PPI), Torenlaan 17, Baarn. Tel: (02154) 3551.  
**Configuration:** Cassette.

#### MANUFACTURER OF TAPE DUPLICATING EQUIPMENT

Philips Phonographische Industrie (PPI), Torenlaan 17, Baarn. Tel: (02154) 3551. Technical Liaison Dept.: J. M. J. Hoks.

## NEW ZEALAND

Population: 2,776,265.  
Per capita income: \$2,176.  
Rate of exchange: \$1 (US)=\$0.87 (New Zealand dollars).  
**Pre-recorded tapes imported from countries other than USA:** 1968—2,500 units, \$3,045.

**Average retail price per tape:** Cassette—\$4.78.  
**Market:** Two companies are to initiate activity in the tape field in 1970. Both Philips and HMV will manufacture and distribute cassettes using their own labels and those labels for which they hold the distribution rights in New Zealand. There are an estimated 150,000 open reel recorders in the country.

**Import/Export regulations:** Little or no interest has been shown in taped pre-recorded music. Philips has allocated a minimum of funds for the import of cassettes to cater to travellers who have brought recorders into the country. All tapes have been imported.

### ● record manufacturers with tape product

H M V (New Zealand) Ltd., PO Box 296, 162-172 Wakefield St., Wellington C.1. Tel: 553-749. Cable: GRAMOPHONE. Sales Mgr.: Graham B. Feasey.

**Cassette:** Owned—HMV; distributed—Decca, EMI. (Self-manufactured).

Philips Recs. & Rentals (New Zealand), 181 Wakefield St., Wellington C.3. Tel: 59859. Gen. Mgr.: William Morton; Sales Mgr.: John McCready.  
**Cassette:** Owned—Philips, Polydor; represented—Philips, Polydor, Mercury.

## ● tape playback equipment manufacturers & importers

H M V (New Zealand) Ltd., PO Box 296, 162-172 Wakefield St., Wellington C.1. Tel: 553-749. Sales Mgr.: Graham B. Feasey.  
Manufactures: Cassette.  
Philips Recs. & Rentals (New Zealand), 181 Wakefield St., Wellington C.3. Tel: 59859. Gen. Mgr.: William Morton; Sales Mgr.: John McCready.  
Manufactures & imports: Cassette.

## NORWAY

Population: 3,900,000.  
Per capita income: \$2,200.  
Rate of exchange: \$1 US = 7.15 kroner.  
Average retail price per tape: Cartridge 8-track—\$8; cassette—\$6.25.  
Market: The boom in tape sales noticed in the beginning of 1969 continued. Seventy per cent of tapes are sold in gasoline stations and car accessories shops, 15% by radio dealers, and the rest by record retailers. The first local tape duplicating plant was set up in 1970 by Roger Arnhoff Lydstudio.

## ● record manufacturers with tape product

Arne Bendiksen, Osterdalsgaten 1, Oslo 6. Tel: 2/67 67 90. Cable: BENDIKMUSIC. Dir.: Arne Bendiksen; Sales Dir.: Erik Johansen; Pub.: Siri Lill Eide.  
Labels available on tape: CBS, Epic, Reprise, Scepter, Triola, Warner Bros.-Seven Arts.  
E M I Norsk A/S, Frysjaeveien 33, Korsvoll, Oslo 8. Tel: 2/23 14 88.  
Labels available on tape: Columbia, Dot, Electrola, HMV, Liberty, Motown, Odeon, Parlophone, Tamla.  
Nera, Pilestredet 75 c, Oslo 3. Tel: 2/46 19 50. Cable: MUSICA. Dir.: E. Meyer; Sales Mgr.: A. Tegmeier.  
Branch: Birger Gjestland, PO Box 219, Bergen. Contact: Ingv. Borhaug.  
Labels available on tape: RCA, Telefunken.  
Nor-Disc, Rosenborggaten 19, Oslo 3. Tel: 2/46 39 52. Cable: ASNORDISC. Telex 8521. Mng. Dir. & Int'l: Totto Johannessen; Pub., Adv. & Promo.: Karl Neegaard.  
Labels available on tape: A&M, Atco, Atlantic, DGG, Decca, Metronome, Polydor.  
Norsk Grammofonkompani, Wergelandsveien 1, Oslo 1. Tel: 2/20 86 53. Cable: NOGRAKO. Gen. Mgr.: O. Knudsen; Sales Mgr.: Arnt Hellum.  
Label available on tape: Pye.  
Norsk Phonogram, Rosenborggaten 19, Oslo 3. Tel: 2/69 59 02. Cable: PHONOGRAM. Mng. Dir.: Haakon Tveten.  
Labels available on tape: Philips, Fontana, Mercury.

## ● tape importer

Eurotron A/S, Manglerud Hovedgard, Oslo 6. Tel: 2/26 78 46. Dir.: Mr. Kast.  
Imports: CBS, Starday, Ambassador, USA.

## ● services

### CUSTOM DUPLICATOR

Roger Arnhoff Lydstudio, St. Olavsgate 26, Oslo 1. Tel: 2/20 09 23.

## PORTUGAL

Population: 10,000,000.  
Per capita income: \$400.  
Rate of exchange: \$1 (US) = 28 escudos.  
Pre-recorded tape manufactured for domestic & export sale: Cassette 1968—25,000 units, \$192,000.  
Pre-recorded tape imported from USA: 1968—8,500 units, \$79,000.  
Pre-recorded tape imported from countries other than USA: 1968—13,500 units, \$108,000.  
Pre-recorded tape exported to USA: 1968—2,500 units, \$19,200.  
Pre-recorded tape exported to countries other than USA: 1968—1,500 units, \$11,510.  
Average retail price per tape: Cartridge 8-track—\$10.71; cassette—\$7.70.  
Market: The Philips music cassette accounts for approximately 75 per cent of the industry; the remaining 25 per cent is 8-track cartridges which are imported. There is no market for cartridge 4-track or open reel. About 20,000

cassette and 10,000 cartridge 8-track playback units are in use. These are all imported.

RAFAEL REVERT

## ● record manufacturers with tape product

Belter Lda. (Discos), Rua Alegria 140-1, Porto. Tel: 25859. Pres.: F. Roses; Gen. Dir.: A. Guedes de Figueiredo.  
Cassette: Owned—Belter.  
Philips Portuguesa, Rua Joaquim Antonio de Aguiar 66, Lisbon 1. Tel: 683121. Cable: PHILAMP. Dir.: J. J. van de Panne.  
Cassette.  
Procope Sarl. (Movieplay), Rua Andrade Corvo 27, Lisbon. Tel: 562251. Pres.: Thomas Pinto Basto; Gen. & Sales Dir.: Carlos Perez Alvaro.  
Cartridge 8-track & cassette: Represented—Barclay (France), Decca (USA), Movieplay (Spain), Riviera (France).  
Radio Triunfo, 309 Praça do Municipio, Porto. Tel: 21445. Cable. RATRIL. Pres.: Rogerio de Stixas Costa Leal.  
Cassette.  
Tecla-Sociedade Comercial de Discos Lda., Rua Eca de Queiroz 20-3, Lisbon. Tel: 560405. Pres.: Jorge Costa Pinto; Sales Dir.: Domingos Costa Pinto.  
Cartridge 8-track & cassette: Owned—Tecla; represented—Ariston, Pickwick, Vedette.  
Telectra-Empresa Tecnica de Equipamentos Electricos Sarl, Rua Rodrigo da Fonseca 103, Lisbon 1. Tel: 686072. Pres.: A. Vaz Pinto; Gen. Dir.: F. Serrano; Sales Dir.: J. Varatojo.  
Cartridge 8-track & cassette: Represented—RCA, Clair 30.

## ● tape playback equipment importer

Belter SA (Discos), Rua Alegria 140-1, Porto. Tel: 25859. Pres.: F. Roses; Gen. Dir.: A. Guedes de Figueiredo.  
Brand names: Cosmo, Ingra.  
Sociedade da Representacoes Lda., Rua D. Joao V, 22-B-C-D, Lisbon. Contact: Mr. Da Costa.  
Brand name: Motorola.

## PUERTO RICO

Population: 2,735,900.  
Per capita income: \$1,129 (US).  
Currency: Same as USA.  
Average retail price per tape: Cartridge 8-track—\$6.95-\$7.95; cartridge 4-track—\$6.95; cassette—\$5.95-\$6.95; open reel—\$7.95 & up.  
Tape market: There is no manufacturing of tape products in Puerto Rico, most product is imported from New York and Hialeah, Fla. As statistical figures on these importation are furnished by the US Department of Commerce and are consolidated under the same classification as phonograph records, no exact figures are available. It is estimated that they represent about \$155,520 for the first 10 months of 1968. The demand is for about 85% Latin music and artists and 15% for all other. The sale of 4-track cartridges is very small.  
Import/Export regulations: Since Puerto Rico is governed by the same regulations that apply to the USA, there is no custom duty or local tax on tape product coming from the USA. On importations from other countries, the federal custom rate of about 15% ad valorem applies. ANTONIO CONTRERAS

## ● record manufacturers producing cartridges & cassettes sold in Puerto Rico

Belter (see Kubaney Recs.)  
Borinquen Tapes (see Producciones Discos Borinquen Inc.)  
C B S/Columbia (see Thomas McGuinness).  
Casa Fragos Inc., PO Box 2774, San Juan. Zip: 00903. Tel: (809) 723-0505. Pres.: Lino Fragoso.  
Cartridge 8-track: Fragoso.  
Discuba (see Musical Tapes Inc.)  
Fragoso (see Casa Fragoso Inc.)  
Gema Tape Corp., c/o G.M.A. Distis. Inc., 71 Rodriguez Serra St., Santurce. Zip: 00907. Tel: (809) 725-4408. Mgr.: Angel I. Mont.  
Home office: USA—693 10 Ave., New York, N.Y. 10036. Tel: (212) JU 2-4943. Pres.: Guillermo Alvarez Guedes.  
Cartridge 8-track, cassette & PlayTape: Gema. Guarani (see Rico-Vox Tapes).  
Island Recs. (see Rico-Vox Tapes).  
Kelvinator Sales of Puerto Rico Inc., PO Box BG, Rio Piedras. Zip: 00928. Tel: (809) 765-1360. Tape Mgr.: Ignacio Mena.  
Cartridge 8-track: RCA.

Kubaney Recs. Dist. Inc., 403 San Jorge St., Santurce. Zip: 00912. Pres.: Mateo San Martin.  
Home office: USA—South Eastern Rec. Co., 150 W. 29, Hialeah, Fla. 33012. Tel: (305) 887-7411.  
Branch: USA—Universal Rec'g Corp., 655 W. 83 St., Hialeah, Fla. 33012. Tel: (305) 821-1431.  
Cartridge 8-track & cassette: Kubaney, Belter, Vergara.  
Thomas McGuinness, 178 Hostos St., Suite 719, Hato Rey. Zip: 00918. Tel: (809) 765-4923.  
Cartridge 8-track: CBS, Columbia.  
Musart (see Musical Tapes Inc.)  
Musical Tapes Inc., c/o Eliseo Cepero, GPO Box 3353, San Juan. Zip: 00936. Tel: (809) 765-5301.  
Home office: USA—PO Box 75, Hialeah, Fla. Tel: (305) 887-2638. Pres.: Eliseo Valdes.  
Branches: USA—2854 W. Pico Blvd., Los Angeles, Calif. Tel: (213) 733-0937—502 W. 51 St., New York, N. Y. 10036. Tel: (212) 581-3235.  
Cartridge 4-track, 8-track & cassette: Musart, Musidisc, Discuba.  
Musidisc (see Musical Tapes Inc.)  
Producciones Discos Borinquen Inc., PO Box 4785, San Juan. Zip: 00936. Tel: (809) 764-3960. Pres.: Dario Gonzalez.  
Branch: USA—c/o Eduardo Cuervo, 446 W. 50 St., New York, N. Y. Tel: (212) 581-0655.  
Cartridge 8-track & cassette: Borinquen.  
R C A (see Kelvinator Sales of Puerto Rico Inc.)  
Rico-Vox Tapes, 504 Sirio St.—Urb. Altamira, Rio Piedras. Zip: 00920. Tel: (809) 782-7772. Pres.: Bernardo Herger.  
Cartridge 4-track, 8-track, cassette & open reel: Rico-Vox, Guarani, Island Recs.  
Velvet Recs. Inc., c/o Roberto Page, 558 Maximo Gomez St., Hato Rey. Zip: 00918. Tel: (809) 766-7137.  
Home office: USA—PO Box 398, Hialeah, Fla. 33012. Tel: (305) 888-1377.  
Cartridge 8-track: Velvet.  
Vergara (see Kubaney Recs.)

## ● tape wholesalers, distributors, rack jobbers & importers

Note: In Puerto Rico, due to accessibility to mainland suppliers, so-called wholesalers are also distributors, rack jobbers, one stops, importers and, in many cases, retailers.  
Allied Whsle. Co. of Puerto Rico Inc., PO Box 512, Cañano. Zip: 00632. Tel: (809) 788-1912. Pres.: Albert Dircie; Sales: Charles Tarrab.  
Note: They are wholesalers and rack operators with one of the largest record tape stocks in Puerto Rico. They operate a fleet of trucks that cover the island.  
Casa Fragoso Inc., PO Box 2772, San Juan. Zip: 00903. Tel: (809) 723-0505. Pres.: Lino Fragoso.  
Labels represented: Fragoso and South American labels.  
Note: They do a large wholesale business and carry heavy stock of many labels. They also operate a retail store in San Juan.  
Distribuidora Electronica Dec. Inc., GPO Box 3993, San Juan. Zip: 00936. Tel: (809) 783-5818. Pres.: Jack Delaster; Sales Mgr.: Willey Rosell.  
Home office: USA—Dyn Assocs. Inc., 270 W. 22 St., Hialeah, Fla. 33010.  
Label represented: Mercury.  
Note: They are wholesale distributors of all kinds of pre-recorded tapes with special attention to Latin Music. They import tape playback equipment manufactured in Japan under their own label "Galaxy."  
Distribuidora Nacional de Discos Inc., 606 Cerra St., Santurce. Zip: 00907. Tel: (809) 724-4964. Pres.: Gilberto Gonzalez.  
Labels represented: A&M, Borinquen, Liberty, Monument.  
Note: They carry a large stock of 4-track & 8-track cartridges, cassettes and open reel tapes of many labels.  
Galas Rec. Dist. Inc., 258 Central Ave. Ext.—University Gardens, Rio Piedras. Zip: 00927.  
Note: They operate record-tape concessions in local discount chain.  
Island Recs., 504 Sirio St.—Urb. Altamira, Rio Piedras. Zip: 00920. Tel: (809) 782-7772. Pres.: Bernardo Herger.  
Labels represented: Atco, Atlantic, Rico-Vox.  
Note: They carry a large stock of all pre-recorded tapes and operate record-tape concessions in two of the leading department stores in the San Juan area.  
Kelvinator Sales of Puerto Rico Inc., PO Box 8G, Rio Piedras. Zip: 00928. Tel: (809) 765-1360. Pres.: Carlos Rom; Sales Mgr.: Ignacio Mena.  
Label represented: RCA.  
Note: They operate several appliance stores that also carry records and tapes.  
Solfeo Rec. Dist'g Co., Bonaparte C-10, Villa Costanza. Tel: (809) 724-3013 x 259. Mgr.: Ismael Lopez.  
Branch: USA—New York, N. Y.  
Labels represented: Hopes, MRVA, Professional, Starbright.

continued on page 140

## INTERNATIONAL TAPE SECTION

Continued from page 139

J. Martinez Vela Inc., PO Box 2027, San Juan Zip: 00903. Tel: (809) 722-5171. Buyer: Juan J. Cue.  
Labels represented: United Artists & others.  
Note: They carry a large stock of all tape goods. They do little wholesaling but operate record-tape departments in local discount chain that moves a lot of merchandise.  
United Rec. Dists. Inc. (formerly Central Rec. Dists. Inc.), PO Box 228, Hato Rey. Zip: 00919. Tel: (809) 765-0270.

## SINGAPORE

Population: 2,700,000.  
Per capita income: \$600.  
Rate of exchange: \$1 (US) = 3 Singapore dollars.

### ● record manufacturers with tape product

Decca Orient (Pte.) Ltd., E6 MacDonald House, Orchard Rd., Singapore 9. Tel: 27071, 361196. Mng. Dir.: Derrick J. Coupland.  
Label available on tape: London.  
E M I Recs. (SEA) Ltd., MacDonald House, 4th fl., Orchard Rd., Singapore. Tel: 32001. Cable: EMITRON; Mng. Dir.: K. F. Bruce.  
Phonogram Far East (Pte.) Ltd., International Bldg., 8th fl., 360 Orchard Rd., Singapore 9. Tel: 362218. Mng. Dir.: F. Niewenhuis; Sales Mgr.: Lee H. King.  
Cassette: Owned—Philips, Fontana, Mercury, Polydor, DGG; represented—CBS, Ariola, MGM, Verve, Buddah.  
Open reel: Owned—Philips, Fontana, Mercury, Polydor, DGG.  
Note: Product is self-manufactured & distributed.

### ● tape importers/distributors

The Borneo Co. Sdn. Bhd., 71 Robinson Rd., Crosby House, Singapore 1. Tel: 79415. Chm. & Mng. Dir.: K. Gould; Deputy Mng. Dir.: J. A. Nelson; Div. Mgr.: I. D. Johnson; Mktg. Exec.: Philip Chng.  
Cartridge 4-track, 8-track, cassette & open reel: EMI, Capitol, Pickwick, Fuji.  
Chiang Huat Co., 164 S. Bridge Rd., Singapore 19. Tel: 74144, 97721. Gen. Mgr.: T. T. Quek.  
Cartridge 8-track & cassette: CBS, DGG, Decca, EMI, Liberty, Motown, Philips, Polydor, RCA, Reprise, Telefunken, Verve, Vic.  
Cosdel Singapore (Pte.) Ltd., 50E/F Armenian St., Singapore 6. Tel: 30480, 35047, 361684. Pres.: Kenneth Cole; Mng. Dir.: S. P. Sim; Sales: Cheong Yip Seng.  
Cartridge 8-track & cassette: A&M, Atco, Atlantic, Cadet, Checker, Chess, Dot, Elektra, Gordy, Monument, Motown, Pye, RCA, Ranwood, Reprise, Scepter, Soul, Sound Stage 7, Tamla, Warner Bros.-Seven Arts.  
Hup Hup Ltd., 13-A Upper Circular Rd., Singapore 1. Tel: 982819. Mng. Dir.: Ng Lian Chin.  
Cartridge 8-track, cassette & open reel: Decca, Life (MCA Int'l), CBS.  
Kwang Sia Rec. Co., 104 Hill St., Singapore 6. Tel: 332154, 34501. Gen. Mgr.: Ang Keng Hui; Ass't Mgr.: Ang Keng How.  
Cartridge 8-track, cassette & open reel: A&M, CBS, Capitol, DGG, General, Liberty, MGM, Motown, RCA, Reprise, Warner Bros.-Seven Arts.

### ● playback equipment importer

Ho Hua Co. (Pte.) Ltd., 24 Telok Ayer St., Singapore 1. Tel: 96984. Pres.: S. K. Tan; Gen. Mgr.: K. T. Khoo; Sales Mgr.: H. K. Koay.  
Brand name: Sony.

### ● supplies

#### RAW TAPE IMPORTERS

Ho Hua Co. (Pte.) Ltd., 24 Telok Ayer St., Singapore 1. Tel: 96984. Pres.: S. K. Tan; Gen. Mgr.: K. T. Khoo; Sales Mgr.: H. K. Koay.  
Configuration: Cartridge 4-track, 8-track, cassette & open reel.  
Brand name: Sony.  
Jesben & Jessen Singapore Ltd., Asia Insurance Bldg., Singapore 1. Tel: 79587. Gen. Mgr.: U. Kuycern.  
Configuration: Cassette & open reel.  
Brand name: Bass.

Maclaine Watson Singapore Import (Pte.) Ltd., Maritime Bldg., Singapore 1. Tel: 95741. Dir.: J. M. van Baak.  
Configuration: Cassette & open reel.  
Brand name: Agfa.  
Taurus Int'l Sdn. Bhd., 57 Ngee Ann Bldg., Orchard Rd., Singapore 9. Cable: TAURUSCO. Mgr.: Andrew B. P. Tan.  
Imports: Motorola 8-track playback equip. (USA).

### ● manufacturer of dealer accessories & supplies

#### BROWSER BOXES CATALOG SERVICES DISPLAY RACKS STORAGE CASES

Phonogram Far East (Pte.) Ltd., International Bldg., 8th fl., 360 Orchard Rd., Singapore 9. Tel: 362218. Mng. Dir.: F. Niewenhuis; Sales Mgr.: Lee H. King.

## SPAIN

Population: 33,400,000.  
Per capita income: \$500.  
Rate of exchange: \$1 (US) = 70 pesetas.  
Pre-recorded tape manufactured for domestic & export sale: (factory value) cassette 1969—500,000 units, \$2,678,500. Open reel 1969—5,000 units, \$40,000.  
Pre-recorded tape imported from USA: (factory value) 1969—5,000 units, \$28,570.  
Pre-recorded tape imported from countries other than USA: (factory value) 1969—50,000 units, \$214,300.  
Pre-recorded tape exported to countries other than USA: (factory value) 1969—15,000 units, \$42,850.  
Average retail price per tape: cartridge 4-track—\$7; cartridge 8-track—\$7.85; cassette—\$4, \$5.35, \$5.55; open reel—\$8.

Market: The Philips Musicassette system dominates the market with over 200,000 units sold, manufactured and imported by ten different labels. This market is expected to develop with a new language studies series and expanding distribution methods through gas stations, supermarkets and rack jobbers. In the last three months of 1969 Ingra began manufacturing portable players and DeVal, Skreibson and Autovox have started players for cars. The cartridge 8-track market has just been started in Spain with Ekipo the first to enter. RCA is expected to join this year but high costs and lack of playback equipment will hinder development of this market. The 4-track cartridge is seen as having no future in Spain and open reel is very limited and not expected to develop. All tapes are self-manufactured by the record companies.

Type of distribution: Manufacturer to retailer.  
Type of promotion: Limited to general product. There are a few catalogs and display racks.  
Import/Export regulations: Free exportation. Importation requires special import licenses involving high custom taxes.

### ● record manufacturers with tape product

Alondra (see Ekipo).  
Als 4 Vents, Trafalgar 78, Barcelona. Tel: 2.22.75. 21. Gen. Dir.: Angel Fabregues.  
Cassette: Owned—Als 4 Vents, Barlovento. (Duplicated by Espectra & distributed by Movieplay).  
Alhambra (see Columbia).  
Barclay (Cia. Fonografica Espagnola Discos), Calle Augusto Figueroa 39, Madrid 4. Tel: 2.22.74.74. Mgr.: Mr. Milhaud.  
Cassette: Barclay, Riviera. (Distributed by Movieplay).  
Barlovento (see Als 4 Vents).  
Belter, Gomis 1, Barcelona 6. Tel: 2.11.55.00. Exec. Dir.: Jose Ramon Batalla; Artistic Dir.: Joaquin Alfonso; Sales Mgr.: Juan Fernandez.  
Cassette: Owned—Belter; represented—Eurodisc (Germany), Eurovox (Belgium), Hansa (Germany), Hebra (Belgium), Minerva Music (Germany), Palette (Belgium). (Duplicated by Fonogram & Kolster Iberica).  
Canigo (see Sayton).  
Columbia SA (Fabrica de Discos), Libertad 24, Madrid 4. Tel: 2.21.10.95. Pres.: Aurora Inurrieta; Gen. Mgr.: Enrique Inurrieta; Sales Mgr.: Francisco Florez.  
Cassette: Owned—Columbia, Alhambra, Iberia; represented—Decca, Deram, London, Roulette. (Duplicated by Phonogram).  
Concentric, Muntaner 45, Barcelona. Tel: 2.53.73.82. Pres.: Jose Maria Espinar; Gen. Dir.: Mr. Pasola; Sales Mgr.: Jose Tordera.  
Cassette: Owned—Concentric. (Duplicated by Espectra).

Distribuidora Discografica SA, Cannedo 40, Madrid. Tel: 2.04.56.79. Gen. Dir.: Pablo Lopez Balada; Ass't Dir.: Pilar Lopez Betrian.  
Cassette: Owned—Palobal; represented—Polyband (Germany), Vedette (Italy). (Self-manufactured).

E M I (see Odeon).  
Ediga (see Editora General).  
Editora General SA, Av. Jose Antonio 654, Barcelona. Tel: 2.31.60.50. Pres.: Salvador Casanovas; Gen. Mgr.: Josep M. Macip.  
Cassette: Owned—Ediga. (Duplicated by Iberofon).

Ekipo SA, Rosellon 79, Barcelona. Tel: 3.21.02.50, 2.30.30.37. Gen. Dir.: Arturo Mas Aguado; Sales Dir.: Francisco L. Soler.  
Cartridge 8-track & cassette: Owned—Ekipo, Alondra, Exit Recs., Subur, Unic; represented—Crewe (USA), SSS Int'l (USA), Kent/Modern (USA), Turicaphon (Switzerland).  
Open reel: Owned—Ekipo, Alondra, Exit Recs., Subur, Unic. (Self-manufactured).  
Espectra SA, Joaquin Garcia Morato 17, Madrid 10. Tel: 2.23.98.81, 2.24.78.62. Pres.: Jose Miguel Esteban; Gen. Dir.: Bartolome Espadale Verges. Sales Mgr.: Fidel Lopez Del Moral.  
Cassette: Owned—Espectra, Sintonia; represented—Alcazar (Puerto Rico), Basart (Netherlands), Beat (UK), Ducale (Italy), MM (UK), Marco (France), President (UK), RIM (UK).  
Open reel: Owned—Espectra, Sintonia. (Self-manufactured).

Exit Recs. (see Ekipo).  
Fonogram SA, Av. America/Hernandez de Tejada, Madrid 17. Tel: 2.67.42.00. Gen. Dir.: Mariano de Zuniga; Sales Mgr.: Saul Tagarro; Tape Mktg.: Manuel Bejar.  
Cassette: Owned—Philips, Polydor; represented—Fontana, Mercury, DGG, Verve, MGM, Island, Buddah, Archiv. (Self-manufactured).  
Guitarra (see Movieplay).  
Happyband (see Sayton).  
Hisvapox SA, Torrelaguna 102, Madrid 17. Tel: 4.15.23.04. Gen. Dir.: J. M. Vidal Zapater; Sales Mgr.: Luis Vidal Zapater.  
Cassette: Owned—Hisvapox; represented—ABC (USA), A&M (USA), Amadeo (Austria), Atlantic (USA), Command (USA), Erato (France), Project 3 (USA), United Artists (USA), Warner Bros.-Seven Arts (USA). (Duplicated by Phonogram).

Iberia (see Columbia).  
Marfer SA, Paseo Alto Virgen Del Puerto 7, Madrid 5. Tel: 2.65.78.00. Gen. Dir.: Emilio Fernandez; Sales Dir.: Jose Luis Navarro.  
Cassette: Marfer. (Duplicated by Iberofon).  
Montilla (see Zafiro).  
Movieplay SA (Discos), Centro Movierecord, Av. America, Madrid 17. Tel: 2.45.82.00. Gen. Dir.: Manuel Sancho; Sales Dir.: Laurentino Ramos.  
Cassette: Owned—Movieplay; distributed—Als 4 Vents, Guitarra, Penelope; represented—Alshire (USA), Barclay (France), Beacon (UK), Coral (USA), MCA (USA & UK), M-N (France), Major Minor (UK), Monument (USA), Page One (UK), Riviera (France), Stax-Volt (USA), Transatlantic (UK). (Duplicated by Iberofon).

Novola (see Zafiro).  
Odeon (Cia. del Gramofono), Tuset 23-25, Barcelona 6. Tel: 2.27.31.81. Pres.: P. N. Brodie; Gen. Dir.: P. Maget; Sales Dir.: Mr. Gasco.  
Cassette: Owned & represented—all EMI labels. (Duplicated by Fonogram).

Palobal (see Distribuidora Discografica).  
Penelope (see Movieplay).  
Philips (see Fonogram).  
Polydor (see Fonogram).  
R C A, Dr. Flemin 43, Madrid. Tel: 2.48.49.12. Gen. Dir.: Gil Beltran; Sales Dir.: Alberto Galtes.  
Cassette: Owned—RCA Espanola; represented—RCA, Tamla/Motown. (Duplicated by Fonogram).

Riviera (see Barclay).  
Sayton SA, Gran Vía Carlos III, Barcelona. Tel: 2.30.31.04. Pres.: L. F. Puigdemont; Gen. Dir.: Luis Ferrer; Sales Mgr.: Carlos Capaces.  
Cassette: Owned—Sayton, Canigo, Happyband; represented—Clan (Italy). (Duplicated by Iberofon).

Sintonia (see Espectra).  
Subur (see Ekipo).  
Unic (see Ekipo).  
Vergara SA, P. Gral. Mola 9, Barcelona 9. Tel: 2.57.94.05. Pres.: Nicolas Suris; Gen. Dir.: Alberto Serra; Sales Mgr.: J. Antonio Ibanez.  
Cassette: Owned—Vergara; represented—Durium (Italy), Melodiya (USSR). (Duplicated by Iberofon).

Zafiro SA, Campomanes 10, Madrid. Tel: 2.41.50.04. Pres.: Patricio Gutierrez; Gen. Dir.: Esteban Garcia Morencos; Sales Dir.: Jose Sagi-Vela Barba.  
Cassette: Owned—Zafiro, Montilla, Novola; represented—Vogue, Musart. (Duplicated by Fonogram).

### ● supplies

#### RAW TAPE MANUFACTURERS

Agfa-Gevaert  
Audio Devices  
Bass  
E M I  
Irish  
Schott

## EMPTY CASSETTE MANUFACTURERS

Audio Devices  
Bass  
Fonogram  
Iberofon

## CARTRIDGE PARTS MANUFACTURER

Fonogram

## ● services

### CUSTOM DUPLICATION

Assimil, General Pardinias 82, Madrid. Tel: 2.76.16.57.  
Cassette: Assimil (language courses).  
Espectra SA, Joaquin Garcia Morato 17, Madrid 10. Tel: 2.39.98.81, 2.24.78.62. Pres.: Jose Miguel Esteban; Gen. Dir.: Bartolome Espadale Verges.  
Cassette: Concentric, Als 4 Vents.  
Fonogram SA, Av. de America, Hernandez de Tejada, Madrid 17. Tel: 2.67.42.00. Gen. Dir.: Mariano de Zuniga; Mktg. Mgr.: Manuel Belar.  
Cassette: Belter, Columbia, Hispavox, Odeon, RCA, Zafiro.  
Gramma, Av. Principe de Asturias 54, Barcelona. Gen. Mgr.: A. Aguado.  
Cassette & open reel.  
Iberofon, Av. de Valladolid 63, Madrid. Tel: 2.41.86.00. Gen. Mgr.: Carbo Figueras.  
Cassette: Edigsa, Marfer, Movieplay, Sayton, Vergara.  
Kolster Iberica, Nuestra Senora de las Nieves 29, Barcelona.  
Cassette: Belter.

### DESIGN & ARTWORK

### PRINTING & LITHOGRAPHING

Belter, Gomes 1, Barcelona 6. Tel: 2.11.55.00.  
Ediciones Deportivas ALG, San Raimundo, Madrid.  
Graficas Aramar, Juan de Austria 70, Barcelona.  
Graficas Caro, Isabelita Usera 69, Madrid.  
Graficas Foco, Av. de America, Hernandez de Tejada, Madrid.  
Luis Perez, Madrid.

## ● manufacturers of tape dealer accessories & supplies

### DISPLAY RACKS

Ekipo SA, Rosellon 79, Barcelona. Tel: 3.21.02.50, 2.30.30.37.  
Fonogram SA, Av. de America, Hernandez de Tejada, Madrid. Tel: 2.67.42.00.  
Marfer SA, Paseo Alto Virgen del Puerto 7, Madrid. Tel: 2.65.78.00.  
Zafiro SA, Campomanes 10, Madrid. Tel: 2.41.50.04.

## SWEDEN

Population: 8,000,000.  
Per capita income: \$3,400.  
Rate of exchange: \$1 (US)=5.18 kronor.  
Pre-recorded tape imported from USA: (estimated factory value) 1968—\$450,000.  
Pre-recorded tape imported from countries other than USA: (estimated factory value) 1968—\$75,000.  
Average retail price per tape: Cartridge 8-track—\$7; cassette—\$5.70; open reel—\$8.  
Market: Sweden is the leading market in Scandinavia and the last year has seen a boom in tape sales. Cartridges lead in sales by about 10 to 15 per cent, but cassettes are gaining rapidly. Open reel has lost all importance here and 4-track cartridges were never introduced. Most cartridges are designed for car units while the cassettes are for portable equipment. The cassettes, including a large number of blank cassettes, are bought chiefly by young people. There are no official statistics on imported tapes since all recorded music (records and tapes) goes into the same statistics. The first factory for cartridges and cassettes was started in early 1970 by Ulvsunda Gummitfabriks AB.  
Type of distribution: Manufacturer-to-retailer-to-consumer is most common, but there is some distribution through oil companies, car manufacturers and rack sales in gas stations.  
Type of promotion: Advertising, catalogs, posters, and mailing are used. Most tapes are promoted along with records, but 8-track cartridges are also promoted by ads in motor magazines by car manufacturers. EMI, Sweden, plans to make a "tape forum" later on.  
Import/Export regulations: None as long as copyrights are cleared.

## ● record manufacturers & distributors with tape product

E M I Svenska AB, Box 27053, 102 51 Stockholm.

Tel: (08) 22 45 80. Cable: GRAMMOPHON. Gen. Mgr. & Dir.: Anders Holmstedt; Tape Mgr.: Sture Wahlberg; Sales Mgr.: F. W. Bennett; Adv. Mgr.: Per Fagerholm.  
Cartridge 8-track & cassette: Owned—Capitol, Columbia, Electrola, Encore, HMV, Odeon, Parlophone, Regal, Stateside.  
G D C (Grammofonbolagens Distributions Central), PO Box 5153, 102 44 Stockholm; Jungfrugatan 19, 114 44 Stockholm. Tel: (08) 63 54 00. Pres.: Eddie Landqvist.  
Cartridge 8-track & cassette: Distributed—Amigo, Arr, Clavicord, Jet, Karusell, KnappUpp, Lido-Prod'n, Megafon, Metronome, Moonlight, Pan, Philips-Sonora, Polar, Scan-Disc, Septima, Sonet, Strike, Svenska Missionforbundet.  
Grammofon AB Electra, PO Box 1178, Ankdammsgatan 5, 171 23 Solna 1. Tel: (08) 82 04 80. Cable: JEFUNK. Telex: 1561. Gen. Mgr.: Sixten Eriksson; Ass't Mgr.: Hans-Ove Eriksson; Sales: Per Lindberg; PR: Goesta Linderholm.  
Cartridge 8-track & cassette: Celesta, Musica, Sagoton, Swedish Society Discofil, Telestar.  
Skason Svenska AB, Maria Skolgata 83, 116 52 Stockholm. Tel: (08) 69 04 60. Cable: DALPORT. Telex: 100 77. Pres.: Frank Dahlberg; PR: P-A Boquist.  
Cartridge 8-track: Imported—A&M, Amigo, Metronome, Pye.

## ● tape manufacturer & duplicator

Ulvsunda Gummitfabriks AB, Ekbacksvaegen 10-14, 161 31 Bromma. Tel: (08) 26 25 60. Cable: ULVSUNDAGUMMI. Gen. Mgr.: Bengt Lizell; Sales: Anders Key; Tape Eng. Dir.: Roland Skaerlund.  
Cartridge 8-track & cassette.

## ● tape playback equipment importer

Arthur Rydin, Spangavaegen 399-401, Spanga. Brand name: Motorola.

## SWITZERLAND

Population: 6,100,000.  
Per capita income: \$2,750.  
Rate of exchange: \$1 (US)=4.23 Swiss francs.  
Average retail price per tape: Cartridge 8-track—\$11.30; cassette—\$4.40-\$5.50; open reel—\$7.  
Market: Since tapes are sold at approximately the same price as records, Switzerland has the highest sales per capita in Europe.  
Type of distribution: Manufacturer or importer-to-retailer predominates.  
Type of promotion: Window displays and racks.  
Import/Export regulations: Imports from EFTA countries are tax free, those from EWG are taxed by weight. BERNIE SIGG

## ● manufacturers & distributors with tape product

Barclay Recs. SA, 14 Rue du Roveray, Geneva. Tel: 36 56 80. Mgr.: Mr. Aubert.  
Home office: France.  
Cartridge 8-track & cassette: Barclay, Riviera.  
C B S Schallplatten AG, Unter Alstadt 10, 6300 Zug. Tel: (042) 4 62 22. Cable: COLRECORD. Gen. Mgr.: Max Wyngaard.  
Cartridge 8-track & cassette: CBS, Epic.  
Columbia (see EMI).  
E M I Recs. (Switzerland) AG, Raemistr. 42, 8024 Zurich. Tel: (051) 34 52 77. Pres.: G. Alexander; Gen. Mgr.: M. Brunner; Sales Mgr.: P. Mampell.  
Cartridge 8-track & cassette: Distributed—Columbia, HMV, Odeon; represented—EMI group, ABC, Dot, Fantasy, Immediate, Liberty, Motown, Stax, Tamla, United Artists.  
Elite Special (see Turicaphon).  
Epic (see CBS).  
Euticas (see PIPs).  
HMV (see EMI).  
Hazel (see Mabel).  
Helvetia (see Phonag).  
Mabel Recs., 26 Schiffhaende, Zurich. Tel: (051) 47 24 28. Pres.: R. Hazy Osterwald; Gen. Mgr.: G. Sunny Lang; Sales Mgr.: Horst W. Stammler.  
Cartridge 8-track & cassette: Owned—Hazyland, Mabel.  
Musikvertrieb AG, Badenerstr. 555, Zurich. Tel: (051) 54 97 54. Pres.: M. A. Rosengarten; Ass't: J. Dimenstein; Sales Mgr.: L. Schmucki.  
Cartridge 8-track: Distributed—Swiss Sound; represented—Ariola, Monument, RCA, Reprise, Telefunken, Warner Bros.-Seven Arts.  
Cassette: Distributed—Elite Special; represented—Ariola, Monument, RCA, Reprise, Telefunken, Warner Bros.-Seven Arts.  
Odeon (see EMI).  
Oversea Recs. AG, CH-8154 Oberglatt. Tel: (051) 94 71 50. Gen. Mgr.: Michel Liber.

Cartridge 8-track & cassette: Owned—Oversea; represented—Cadi, Clan, Clariphon, Rifi.  
P I P S (Production Internationale de Propagande Sonore), PO Box 78, CH-8703 Erlenbach. Tel: (051) 90 85 85. Cable: TIELERLENBACH. Dir.: Eugene Tiel.  
Cassette: PIPS, RenoCas, Euticas.  
Philips, PO Box 27, Edenstr. 20, CH-8027 Zurich. Tel: (051) 44 22 11. Contact: A. Duchable.  
Cassette: Represented—Philips, Fontana, Mercury (Austria, France, Italy, Netherlands, UK); Blue Bell, CGD, Clan, Durium, Rifi, Tristan (Italy).  
Phonag Schallplatten AG, PO Box 66, Straulistr. 1, CH-8401 Winterthur. Tel: (052) 23 62 31. Gen. Mgr.: Helmut Bischof.  
Cartridge 8-track: Owned—Phonag; represented—Fonit/Cetra (Italy).  
Cassette: Owned—Helvetia, Phonag; represented—Amadeo (Germany), Fonit/Cetra (Italy), Inter-cord (Germany), Musica (Germany).  
Open reel: Represented—MPS (Germany), Saba (Germany).  
Pick, Brunnwiesenstr. 26, CH-8049 Zurich. Tel: (051) 56 44 40. Pres.: Anton Peterer; Gen. Mgr.: Mrs. Jane Peterer; Sales Mgr.: Edy Keiser.  
Cartridge 8-track, cassette & open reel: Pick, RenoCas (see PIPS).  
Riviera (see Barclay).  
Siemens EAG, Loewenstr. 35, CH-8021 Zurich. Tel: (051) 25 36 00.  
Swiss Sound (see Musikvertrieb).  
Turicaphon AG, Schweizer Schallplattenfabrik, 8611 Riedikon/Schweiz. Tel: (051) 87 4311. Pres. & Gen. Mgr.: Hans Oestreicher Sr.; Sales Mgr.: Hans Oestreicher Jr.  
Cassette: Owned—Elite Special. (Distributed by Musikvertrieb).

## ● playback equipment manufacturers

Car-Stereo Music/AutoCas, PO Box 78, 8703 Erlenbach. Pres. & Gen. Mgr.: Eugene Tiel. (Manufacturer).  
Elome Giebeleichstr. 70, 8152 Glattbrugg. Mgr.: K. Stoll.  
Imports: Motorola 8-track (USA).  
Musikvertrieb AG, Badenerstr. 555, Zurich. Tel: (051) 54 97 54. Pres.: M. A. Rosengarten; Ass't: J. Dimenstein; Sales Mgr.: L. Schmucki.  
Imports: Telefunken.  
Pick, Brunnwiesenstr. 26, CH-8049 Zurich. Tel: (051) 56 44 40. Pres.: Anton Peterer; Gen. Mgr.: Mrs. Jane Peterer; Sales Mgr.: Edy Keiser. (Manufacturer).  
Revox Int'l (div. of Ela), PO Box, CH-8105 Regensdorf.

## ● supplies

### RAW TAPE MANUFACTURERS

Audio Devices Inc., 34 Rue de l'Athenee, 1206 Geneva.  
Brand: Audiotape.

### EMPTY CARTRIDGE & CASSETTE MANUFACTURERS

Audio Devices Inc., 34 Rue de l'Athenee, 1206 Geneva.  
Configuration: Cartridge 4-track, 8-track & cassette.  
Brand: Audiopak.

### BLANK LOADED TAPE

Audio Devices Inc., 34 Rue de l'Athenee, 1206 Geneva.  
Configuration: Cartridge 4-track, 8-track, cassette & NAB broadcast cartridges.  
Brand: Audiotape.

## ● services

### CUSTOM DUPLICATORS

Atlantida, 9-11 Rue du Clos, CH-1207 Geneva. Tel: (022) 36 68 60. Cable: ASAINTE.  
Car-Stereo Music/AutoCas, PO Box 78, 8703 Erlenbach. Pres. & Gen. Mgr.: Eugene Tiel.  
Cartridge 8-track: Akai, Mabel, Phonag.  
Cassette: Phonag, Helvetia, Mabel, Turicaphon.  
P I P S (see Car-Stereo Music/AutoCas).  
Ruba Beerli & Co., Untere Rebgasse 18, CH-4000 Basel. Tel: (061) 33 23 94.

## ● dealer accessories & supplies

### HEAD CLEANERS & DEMAGNETIZERS DISPLAY RACKS

Audio Devices Inc., 34 Rue de l'Athenee, 1206 Geneva.

## UNITED KINGDOM

Population: 55,000,000.  
Per capita income: \$2,670.

continued on page 142

## INTERNATIONAL TAPE SECTION

Continued from page 141

**Rate of exchange:** \$1 (US)=B shillings, 4 pence.  
**Pre-recorded tape manufactured for domestic & export sale:** (factory value) cartridge 4-track 1969-180,000 units, \$784,800; 1968-150,000 units, \$546,000. Cartridge 8-track 1969-220,000 units, \$949,200; 1968-120,000 units, \$331,200. Cassette 1969-1,000,000 units; \$3,800,000; 1968-700,000 units, \$2,660,000. Open reel 1969-235,000 units, \$804,134; 1968-233,000 units, \$764,240.

**Average retail price per tape:** Cartridge 4-track & 8-track-\$6.54; cassette-\$5.70; open reel-\$4.85.

**Market:** An estimated eight million playback units are in use in Britain, 75 per cent of which are open reel. The musicassette market has expanded significantly during 1969 and continues to do so. Ninety per cent of cartridge units are installed in cars. Tapes carry a 55 per cent purchase tax. The musicassette was launched ahead of the cartridge systems and has retained its lead.

**Type of distribution:** Manufacturer-to-dealer is standard throughout the industry. About 30 per cent of cassettes and cartridges are sold through car dealers and electrical shops not stocking records.

**Type of promotion:** Musicassettes are promoted with records. All cartridges are promoted through car media such as motoring magazines.

**Import/Export regulations:** All tapes that have copyright clearance and are from non-Commonwealth countries are admitted without a license after payment of 25 per cent import duty, or 16 2/3 per cent from Canada and other Commonwealth territories.

KEN WILLMSER

## ● record manufacturers with tape product

**A & M, Recs. Ltd.,** Music House, 12 Neasden Ln., London N.W. 10. Tel: 459 0033. Cable: ALPER-MOSS. Contact: John Deacon, John Dyer.  
**Cassette:** A&M.

**A D-Rhythm Prod'ns,** 14a Broadwalk, Pinner Rd., North Harrow, Middx. Tel: 863 1841. Sales Dir.: David K. Burrows; Promo. Dir.: Jon A. Gummer; Int'l: John C. Jackson.

### Open reel.

**Ampex Stereo Tapes,** 72 Berkeley Ave., Reading. Tel: (0734) 55341. Cable: VIDEOTAPE. Gen. Mgr.: Gerald C. Hall; Prod. Mgr.: Stanley West; Mktg. Mgr.: Bertie Eccles; Sales Mgr.: Jim Humberstone.

**Cartridge 8-track & cassette:** Owned-Ampex; distributed-Major Minor, Transatlantic; represented-Ampex, Audio Fidelity, Avco Embassy, Bang, Barclay, Commonwealth United, Fantasy, Flying Dutchman, Galaxy, Gulf Pacific, Lee Hazlewood, Monitor, Ovation, Time.

**Archive** (see Polydor).

**Atco** (see Polydor).

**Atlantic** (see Polydor).

**Blue Horizon Recs. Ltd.,** 30 St. George St., Hanover Sq., London W.1. Tel: (01) 499 9477. Chm.: Mike Vernon; Mng. Dir.: Richard Vernon.  
**Cassette:** Licensed to Philips through CBS.

**Blue Note** (see Liberty).

**Buddah** (see Polydor).

**C B S Recs.,** 28/30 Theobalds Rd., London W.C.1. Tel: (01) 242 9000. Cable: COLRECORD. Mng. Dir.: Kenneth Glancy; Opns. Dir.: Maurice Oberstein; Mktg. Mgrs.: (pop) Derek Everett, (classical) Paul Myers; Sales Mgr.: Jack Florey; Pub.: Keith Howell; Sales Promo. Mgr.: Ken Rowlands; Export Mgr.: Fred Dennis.  
**Cartridge 8-track:** Licensed to University Rec'g. **Cassette:** Licensed to Philips.

**Canaan** (see Word).

**Capitol** (see EMI).

**Columbia** (see EMI).

**Decca, Decca House,** 9 Albert Embankment, London S.E.1. Tel: (01) 735 8111. Cable: DECCORD. Chm.: Sir Edward Lewis; Mng. Dir.: W. W. Townsley.  
**Cassette:** Decca, Deram, London.

**Deutsche Grammophon** (see Polydor).

**EMI (The Gramophone Co.),** EMI House, 20 Manchester Sq., London W.1. Tel: (01) 486 4488. Cable: EMIRECORD. Mng. Dir.: K. A. C. East; Mds. Dir.: J. R. Fruin; Mkt. Planning & Servs. Mgr.: C. A. S. Busby; Promo. Mgr.: Colin Burn; Int'l Sales Div. Mgr.: A. M. Smith.  
**Cartridge 8-track, cassette & open reel:** Capitol, Columbia, HMV, Parlophone, Regal-Zonophone, Immediate, Bell, Command, Dot, Impulse, Paramount, Probe, Stateside, Stax, Tamla-Motown.

**Elektra** (see Polydor).

**Ember Recs.,** Carlton Tower Pl., Suite 4, Sloan St., London S.W.1. Tel: (01) 245 9303/9. Cable: KRUGENT. Mng. Dir. & Int'l: Jeffrey S. Kruger; Sales Dir.: J. L. Horton; Pub.: Mike Gill, Keith Goodwin; Adv.: Gerry Fifer; Promo.: Jimmy Henney.

**Cartridge 8-track:** Ember, Famous Artists, Speciality-self-mfd.  
**Famous Artists** (see Ember).  
**Fontana** (see Philips).  
**H M V** (see EMI).  
**Immediate** (see EMI).  
**Imperial** (see Liberty).

**Island Recs. Ltd.,** 8-11 Basing St., London W.11. Tel: (01) 229 1229. Cable: ACKEE. Mng. Dir.: Christopher Blackwell; Sales Dir.: David Bett-ridge; Press Officer: B. P. Fallon.  
**Cassette:** Licensed to Philips.

**Liberty/UA Ltd.,** 37-41 Mortimer St., London W.1. Tel: (01) 580 3099. Mng. Dir.: Noel Rogers; Gen. Mgr.: Martin Davis; Sales & Mktg. Mgr.: Dennis Knowles; Promo. Mgr.: Ronnie Bell; Export Mgr.: Wim Schut.

**Cartridge 4-track, 8-track & cassette:** Liberty, Blue Note, Imperial, Minit, Pacific Jazz, Soul City, United Artists, World Pacific-self-mfd.

**Major Minor,** 58-59 Marlborough St., London W.1. Tel: (01) 437 5803. Mng. Dir.: Philip R. Solomon; Sales Dir.: Ian Brown; Pub.: Frances Baares; Adv.: Stephen Hill; Promo. Mgr.: Pat Campbell.

**Cartridge 4-track, 8-track & cassette:** Licensed to Ampex (UK), GRT (USA).

**Marmalade** (see Polydor).

**Mercury** (see Philips).

**Minit** (see Liberty).

**Motown** (see EMI).

**Pacific Jazz** (see Liberty).

**Page One** (see EMI).

**Parlophone** (see EMI).

**Philips Recs. Ltd.,** Stanhope House, Stanhope Pl., London W.2. Tel: (01) 262 7788. Cable: PHIL-RECORD. Mng. Dir.: Fred Marks; Gen. Mktg. Mgr.: Olav Wyper; Sales Mgr.: G. Hanington; Special Prods. Mgr.: Walter Woyda; Int'l Co-ord.: R. Mace; Promo. Mgr.: P. Fleming; Cas- sette Mgr.: Roy Tempest; Export Mgr.: C. Voufe.

**Cassette:** Philips, Fontana, Mercury, Page One, Vertigo-self-mf.

**Open reel:** Licensed to Ampex.

**Polydor Recs. Ltd.,** 17-19 Stratford Pl., London W1N 0BL. Tel: (01) 499 8686. Mng. Dir.: Roland Rennie; Admin. Dir.: Peter Erdmann; Mktg. Dir.: Alan Bates; Mktg. Co-ord.: Don Wedge; Tape Mktg. Mgr.: Sandor Kurucz; Sales Mgr.: Eddie Webster; Export Sales: George McManus.

**Cassette:** Polydor, Deutsche Grammophon, Ar- chive, Marmalade, Track, Atlantic, Atco, Elek- tra, Buddah, Riverside.

**Pye Recs. Ltd.,** ATV House, Great Cumberland Pl., London W1H 8AA. Tel: (01) 262 5502. Cable: PYREC. Mng. Dir.: Louis Benjamin; Gen. Mgr.: G. N. Bridge; Exec. Dir.: L. E. Cocks; Mktg. Dir.: T. Grantham; Sales Mgr.: C. Foakes; Special Projects Mgrs.: Monty Presky, J. Gill.  
**Cartridge 8-track & cassette:** Pye group-self- mfd. by Precision Tapes.

**R C A, RCA House,** 50 Curzon St., London W.1. Tel: 499 3901. Mng. Dir.: Bernard Ness; Sales: Walter Sparksman; Promo. & Adv. Mgr.: Peter Aldersley.

**Cartridge 8-track:** RCA.

**Reprise** (see Warner Bros.-Seven Arts).

**Riverside** (see Polydor).

**Sacred** (see Word).

**Soul City** (see Liberty).

**Speciality** (see Ember).

**Stateside** (see EMI).

**Tamla** (see EMI).

**Track** (see Polydor).

**Transatlantic,** 120-122 Marylebone Rd., London W.1. Tel: 486 4353. Cable: XTRA. Mng. Dir.: Nathan Joseph; Sales Mgr.: John Cooper. Adv. Mgr.: Daniel Halperin.

**Cartridge 8-track & cassette:** Transatlantic.

**United Artists** (see Liberty).

**Vertigo** (see Philips).

**Warner Bros.-Seven Arts,** 69 New Oxford St., London W.C.1. Mng. Dir.: Ian Ralfini.  
**Cartridge 8-track & cassette:** Warner Bros.-Seven Arts, Reprise.

**Word Ltd.,** Greycaine House, Greycaine Rd., North Watford Herts. Contact: W. T. Hamilton.  
**Cartridge 8-track & cassette:** Canaan, Sacred, Word-self-mfd.

**World Pacific** (see Liberty).

**World Rec. Club,** Parkbridge House, The Little Green, Richmond, Surrey. Tel: (01) 940 8331. Cable: DISCLUB. Admin. Dir.: John Becher; Promo. Dir.: Bruce Matthews.  
**Cartridge 8-track & open reel:** Licensed to Uni- versity Rec'g.

## ● duplicator/marketers

**Ampex Stereo Tapes,** 72 Berkeley Ave., Reading. Tel: (0734) 55341. Cable: VIDEOTAPE. Gen. Mgr.: Gerald C. Hall; Prod. Mgr.: Stanley West; Mktg. Mgr.: Bertie Eccles; Sales Mgr.: Jim Humberstone. (Duplicated in Belgium).  
**Cartridge 8-track:** A&M, Ampex, Audio Fidelity, Avco Embassy, Bang, Barclay, CBS, Chess, Commonwealth United, EMI, Fantasy, Flying Dutchman, Galaxy, Gulf Pacific, Lee Hazle- wood, Major Minor, Monitor, Ovation, Picca- dilly, Pye, RCA, Reprise, Time, Transatlantic, Warner Bros.-Seven Arts, World Rec. Club.  
**Cassette:** Ampex, Audio Fidelity, Avco Embassy, Bang, Barclay, Commonwealth United, Fantasy,

Flying Dutchman, Galaxy, Gulf Pacific, Lee Hazlewood, Major Minor, Monitor, Ovation, Time, Transatlantic.

**King Stereo,** 7 W. Halkin St., London S.W.1. Tel: (01) 235 6424.

**Philips Musicassettes,** Stanhope House, Stanhope Pl., London W.2. Tel: (01) 262 7788. Cassette Mgr.: Roy Tempest.

**Cassette:** A&M, CBS, EMI, Island, Liberty, Page One, Philips group, Polydor, Pye, Reprise, Transatlantic, Warner Bros.-Seven Arts.

**Precision Tapes Ltd.,** ATV House, 17 Great Cumber- land Pl., London, W.1. Tel: (01) 262 5502. Chm.: Louis Benjamin; Gen. Mgr.: Walter S. Woyda.

**Cartridge 8-track:** A&M, Chess, GRT group, Piccadilly, Pye group, Reprise, Warner Bros.-Seven Arts.

**Cassette:** A&M, Chess, GRT group, Piccadilly, Pye group.

**University Rec'g Ltd.-Tempo Tapes Ltd.,** Audio Works, Cartersfield Rd., Waltham Abbey, Essex. Tel: Waltham Cross 31933. Mng. Dir.: M. S. Myers; Tape Mgr.: D. Watson.

**Cartridge 8-track.**

## ● playback equipment manufacturers & importers

**A E G (Great Britain) Ltd.,** 27 Chancery Ln., Lon- don W.C.2. Tel: (01) 242 9944.

**Acme Electric Co. (Finsbury) Ltd.,** 74 Great Eastern St., London E.C.2. Tel: Shoreditch 6486.

**B. Adler & Sons Radio Ltd.,** 32a Coptic St., London W.C.1. Tel: (01) 636 9606.

**Allegro Sound Equip. Ltd.,** 91 Heath St., London N.W.3. Tel: (01) 435 0999.

**Ampex Stereo Tapes,** 72 Berkeley Ave., Reading. Tel: (0734) 55341. Cable: VIDEOTAPE. Gen. Mgr.: Gerald C. Hall; Prod. Mgr.: Stanley West; Mktg. Mgr.: Bertie Eccles; Sales Mgr.: Jim Humberstone.

**Audiorama Ltd.,** 138 Horton Rd., Datchet, Bucks. Tel: Slough 42242.

**Balmoral Electronics Ltd.,** 113 Victoria St., St. Albans, Herts. Tel: St. Albans 61634.

**Bang & Olufsen (UK) Ltd.,** Eastbrook Rd., Gloucester. **Binatone Electronics Ltd.,** 1 Paul St., London E.C.2. Tel: (01) 628 4577.

**Bosch Ltd.,** PO Box 166, Rhodes Way, Watford WD2 4LB, Herts. Tel: Watford 44233.

**Brenell Eng'g Co. Ltd.,** 231-5 Liverpool Rd., London N.1. Tel: (01) 607 8271.

**British Radio Corp. Ltd.,** 284 Southbury Rd., En- field, Middx. Tel: (01) 366 1155.

**Bush Radio** (div. of The Rank Org.), Power Rd., Chiswick, London W.4. Tel: (01) 994 6491.

**Cape Electronics Ltd.,** 43-45 Shirley High St., Southampton. Tel: Southampton 73077.

**Clarke & Smith Mfg. Co. Ltd.,** Melbourne Works, Wallington, Surrey. Tel: (01) 669 4411.

**Contronics Ltd.,** Garth Works, Deepcut Bridge Rd., Deepcut near Camberley, Surrey. Tel: Deepcut 5936.

**Co-operative Whsle. Society Ltd.,** CWS Manchester, New Century House, Manchester 4. Tel: BLAck- friars 1212.

**D T V Group Ltd.,** 126 Hamilton Rd., London S.E. 27. Tel: (01) 670 6166.

**Dual Electronics Ltd.,** Paramount Ind'l Estate, Mill Rd., Stokenchurch, Bucks. Tel: Radnage 3467.

**Electrical & Musical Inds. Ltd.,** Blyth Rd., Hayes, Middx. Tel: (01) 573 3888.

**Elizabethan Electronics Ltd.,** Nordenfeldt Rd., Erith, Kent. Tel: Erith 31581.

**A.C. Farnell (Leeds) Ltd.,** 81 Kirkstall Rd., Leeds LS3 1HR. Tel: Leeds 35111.

**Ferrograph Co. Ltd.,** Mercury House, 195 Knights- bridge, London S.W.7. Tel: (01) 589 4485. Cable: BRITFERRO.

**Fidelity Radio Ltd.,** 6 Olaf St., London W. 11. Tel: (01) 727 0131.

**Grundig (Great Britain) Ltd.,** Newlands Park, Syden- ham, London S.E. 26. Tel: (01) 778 2211.

**C.E. Hammond & Co. Ltd.,** 90 High St., Eton, Wind- sor, Berks. Tel: Windsor 63388.

**Hartley Electromotives Ltd.,** Octopus Works, Monk- moor, Shrewsbury. Tel: Shrewsbury 6343.

**Highgate Acoustics,** 184-188 Great Portland St., London W.1. Tel: (01) 636 2901. (Importer only).

**Holgates of Totton Ltd.,** 55-57 Commercial Rd., Totton, Hampshire. Tel: Southampton 3441.

**Kingsway Mills Ltd.,** 5-11 Worship St., London E.C. 2. Tel: (01) 628 6157.

**Lee Prods. (Great Britain) Ltd.,** 10-18 Clifton St., London E.C. 2. Tel: (01) 247 6711. Cable: LEPROD.

**Leavers-Rich Equip. Ltd.,** 319 Trinity Rd., London S.W. 1B. Tel: (01) 874 9054.

**Magneta (BVC) Ltd.,** Ackmar Works, Parsons Green Ln., London S.W. 6. Tel: (01) 736 5566.

**Martin Electronics Ltd.,** 154 High St., Brentford, Middx. Tel: (01) 560 1161.

**Motorola Automotive Prods. Ltd.,** Taylors Rd., Stot- ford, Hitchin, Herts. Telex: 82437. Deputy Dir.: Robin Bonham-Carter.  
**Cartridge:** 8-track auto.

**M. Murray Electronics Ltd.,** 5 Selkirk Rd., London S.W. 17. Tel: (01) 672 9175.

Musitapes, 49 Hertford St., London W1Y 7TE. Tel: (01) 499 8157. Pres.: P. J. Ashworth; Gen. Mgr.: M. H. Hazeldene.

**Imports:** Pioneer.  
Northern Radio Servs., 153 Fellows Rd., London N.W. 3. Tel: (01) 722 3314.

Racal-Therminoc Ltd., Hythe, Southampton, Hampshire SO4 6 ZH. Tel: Hythe 3265. Cable: TECHNICO.

Raw Audio-Visual Co., West End Showrooms, 146 Charing Cross Rd., London W.C. 2. Tel: (01) 836 3365.

Sanyo Marubeni (UK) Ltd., Sanyo House, Bushey Mill Ln., Watford, Herts. Tel: Watford 25354.

Sony (UK) Ltd., 11 Ascot Rd., Bedford, Feltham, Middx. Tel: Ashford 50021.

Sony UK Sales (div. of Debenhams Elec. & Radio Dist.), Eastbrook Rd., Gloucester.

Symphony Amplifiers Ltd., 153 Fellows Rd., London N.W. 3. Tel: (01) 722 3314.

Tape Recorder Centre (Blackpool) C. Braddock Ltd., 266 Waterloo Rd., Blackpool, Lancs. Tel: 45049.

Thorn Electrical Inds. Ltd., Thorn House, Upper St. Martin's Ln. London W.C. 2. Tel: (01) 836 2444.

Triumph Electronics Ltd., 118-122 Brighton Rd., Purley, Surrey CR 2 4DB. Tel: Uplands 2327.

Unamec Ltd., United Africa House, Blackfriars Rd., London S.E. 1. Tel: (01) 928 2070.

University Rec'g Ltd.—Tempo Tapes Ltd., Audio Works, Cartersfield Rd., Waltham Abbey, Essex. Tel: Waltham Cross 31933.

Volmar Ltd., 154 High St., Brentford, Middx. Tel: (01) 560 1161.

Vortexion Ltd., 257-263 The Broadway, London S.W. 19. Tel: (01) 542 6242. (Manufacturers only).

Winter Trading Co. Ltd., Winter House, 95-99 Ladbroke Grove, London W.11. Tel: (01) 727 1341.

## ● distributors

Active Recs. & Tapes, London.  
Disc Imports Ltd., 36 John Dalton St., Manchester N2 6LD.

**Imports:** Pre-recorded tape.  
Klik Stereo Ltd., 340-342 London Rd., Hadleigh, Essex. Tel: (0702) 556714. Dir.: Mike Price, Douglas Wiles, Tony Levene.

Musitapes, 49 Hertford St., London W1Y 7TE. Tel: (01) 499 8157. Pres.: P. J. Ashworth; Gen. Mgr.: M. H. Hazeldene.

**Cartridge 8-track:** A&M, Ampex, CBS, Chess, EMI, Pye, RCA, Reprise, Warner Bros.—Seven Arts.

University Rec'g Ltd.—Tempo Tapes Ltd., Audio Works, Cartersfield Rd., Waltham Abbey, Essex. Tel: Waltham Cross 31933. Sales Dir.: R. Lyons; Sales Mgr.: R. N. Myers.

## ● supplies

### RAW TAPE SUPPLIERS

A E G (Great Britain) Ltd., 27 Chancery Ln., London W.C. 2. Tel: Chancery 9944.

Adastra Electronics Ltd., 167 Finchley Rd., London N.W. 3. Tel: (01) 624 8164.

Agfa-Gevaert Ltd., Magnetic Tape Div., Brent House, Great West Rd., Brentford, Middx. Tel: (01) 560 2072.

Audev Ltd., 9 Willow Rd., Poyle Trading Estate, Colnbrook, Slough, Bucks.

**Brand name:** Audiotape.  
B A S F UK Ltd., PO Box 473, Knightsbridge House, 197 Knightsbridge, London S.W. 7. Tel: (01) 584 5080.

British Mfd. Bearings Co. Ltd., Fleming Way, Crawley, Sussex. Tel: Crawley 28765.

Chart Edge Ltd., 18 Jermyn St., London S.W. 1.  
Gordon J. King (Ents.) Ltd., Technical Author & Consultant (Electronics) Ent., N. Boundary Rd., Brixham, Devon. Tel: Brixham 2304.

Kodak Ltd., Kodak House, Kingsway, London W.C. 2. Tel: (01) 405 7841.

Leda Tapes, 17 Leigh Park Rd., Leigh On Sea, Essex. London Tel: (01) 226 7004.

Leavers-Rich Equip. Ltd., 319 Trinity Rd., London S.W. 18. Tel: (01) 874 9054.

Mastertape (Magnetic) Ltd., Blackthorne Rd., Poyle Trading Estate, Colnbrook, Bucks. Tel: Colnbrook 2431.

N. Miers & Co. Ltd., 28 Piercing Hill, Theydon Bois, Essex. Tel: Theydon Bois 2611.

K. Popper (RTC) Ltd., 55 Chaplin Rd., London N.W. 2. Tel: (01) 459 2141.

R C A Magnetic Prods. Ltd., Lincoln Way, Windmill Rd., Sunbury, Middx. Tel: Sunbury 85511.

Sony (UK) Ltd., 11 Ascot Rd., Bedford-Feltham, Middx.

Telcon Metals Ltd., Manor Royal, Crawley, Sussex. Tel: Crawley 28800.

### EMPTY CARTRIDGES, CASSETTE & REEL MANUFACTURERS

Audev Ltd., 9 Willow Rd., Poyle Trading Estate, Colnbrook, Slough, Bucks.

**Configuration:** Cartridge 4-track, 8-track & cassette.

**Brand:** Audiopak.  
Klik Stereo Ltd., 340-342 London Rd., Hadleigh, Essex. Tel: (0702) 556714. Dir.: Mike Price, Douglas Wiles, Tony Levene.

**Configuration:** Cartridge 8-track.

### BLANK LOADED TAPE

Audev Ltd., 9 Willow Rd., Poyle Trading Estate, Colnbrook, Slough, Bucks.

University Rec'g Ltd.—Tempo Tapes Ltd., Audio Works, Cartersfield Rd., Waltham Abbey, Essex. Tel: Waltham Cross 31933. Mng. Dir.: M. S. Myers; Tape Mgr.: D. L. Watson.

### MANUFACTURER OF TAPE DUPLICATING EQUIPMENT

Ampex, 72 Berkeley Ave., Reading. Tel: (0734) 55341. Cable: VIDEOTAPE. Gen. Mgr.: Gerald C. Hall; Prod. Mgr.: Stanley West; Mktg. Mgr.: Bertie Eccles; Sales Mgr.: Jim Humberstone.

**Chief prod.:** Master making equip., master & slave duplicating units.

## ● services

### CUSTOM DUPLICATORS

Ampex Stereo Tapes, 72 Berkeley Ave., Reading. Tel: (0734) 55341. Cable: VIDEOTAPE. Gen. Mgr.: Gerald C. Hall; Prod. Mgr.: Stanley West; Mktg. Mgr.: Bertie Eccles.

Commercial Drug & Chemical Co. Ltd. (Photographic Div.), 460 Holloway Rd., London N.7.

Ditchburn Org. Ltd., Lytham, Lancs. Tel: Lytham 3141.

King Stereo, 7 W. Halkin St., London S.W.1. Tel: (01) 235 6424.

Magneta (BVC) Ltd., Parsons Green Ln., London S.W. 6. Tel: (01) 736 5566.

Musichord (Sales) Ltd., Aston Tirrold near Didcot, Berks. Tel: Blewbury 303. (Industrial & background music servs.).

Music-On-Tape Ltd., Charlwood Rd., East Grinstead, Sussex. Tel: East Grinstead 23888.

Saga Recs. Ltd., 326 Kensal Rd., London W. 10. Tel: (01) 969 6651.

Sound Coverage Ltd., Charlwood Rd., East Grinstead, Sussex. Tel: East Grinstead 23888.

Sound Rec'gs for Industry, Aston Tirrold near Didcot, Berks. Tel: Blewbury 303. (Industrial & background music servs.).

Tape Music Dists., 11 Redvers Rd., London N. 22. Tel: (01) 888 0152.

Teletape, 84-88 Shaftesbury Ave., London W. 1. Tel: (01) 437 1615.

Tempo Tapes Ltd., Cartersfield Rd., Waltham Abbey, Essex. Tel: Waltham Cross 31933.

Trusound Mfg. Ltd., Crittall Rd., Industrial Estate W., Witham, Essex. Tel: Rivenhall 4101.

University Rec'g Ltd., Audio Works, Cartersfield Rd., Waltham Abbey, Essex. Tel: Waltham Cross 31933.

### DESIGN & ARTWORK

Ampex, 72 Berkeley Ave., Reading. Tel: (0734) 55341. Cable: VIDEOTAPE. Gen. Mgr.: Gerald C. Hall; Prod. Mgr.: Stanley West; Mktg. Mgr.: Bertie Eccles; Sales Mgr.: Jim Humberstone.

### PACKAGING & LABELING

Ampex, 72 Berkeley Ave., Reading. Tel: (0734) 55341. Cable: VIDEOTAPE. Gen. Mgr.: Gerald C. Hall; Prod. Mgr.: Stanley West; Mktg. Mgr.: Bertie Eccles; Sales Mgr.: Jim Humberstone.

King Stereo, 7 W. Halkin St., London S.W. 1. Tel: (01) 235 6424.

### PRINTING & LITHOGRAPHING

Ampex, 72 Berkeley Ave., Reading. Tel: (0734) 55341. Cable: VIDEOTAPE. Gen. Mgr.: Gerald C. Hall; Prod. Mgr.: Stanley West; Mktg. Mgr.: Bertie Eccles; Sales Mgr.: Jim Humberstone.

## ● dealer accessories & supplies

### CATALOG SERVICES

Advance Recs., 16 High St., Leicester. Tel: 57803. Contact: Mr. Bingham.

Ampex, 72 Berkeley Ave., Reading. Tel: (0734) 55341. Cable: VIDEOTAPE. Gen. Mgr.: Gerald C. Hall; Prod. Mgr.: Stanley West; Mktg. Mgr.: Bertie Eccles; Sales Mgr.: Jim Humberstone.

King Stereo, 7 W. Halkin St., London S.W. 1. Tel: (01) 235 6424. Chm.: Lionel Murray; Mng. Dir.: Martin Yale.

### DISPLAY RACKS

Ampex, 72 Berkeley Ave., Reading. Tel: (0734) 55341. Cable: VIDEOTAPE. Gen. Mgr.: Gerald C. Hall; Prod. Mgr.: Stanley West; Mktg. Mgr.: Bertie Eccles; Sales Mgr.: Jim Humberstone.

### HEAD CLEANERS & DEMAGNETIZERS

Ampex, 72 Berkeley Ave., Reading. Tel: (0734) 55341. Cable: VIDEOTAPE. Gen. Mgr.: Gerald C. Hall; Prod. Mgr.: Stanley West; Mktg. Mgr.: Bertie Eccles; Sales Mgr.: Jim Humberstone.

Audev Ltd., 9 Willow Rd., Poyle Trading Estate, Colnbrook, Slough, Bucks.

Klik Stereo Ltd., 340-342 London Rd., Hadleigh, Essex. Tel: (0702) 556714. Dir.: Mike Price, Douglas Wiles, Tony Levene.

### STORAGE CASES

Ampex, 72 Berkeley Ave., Reading. Tel: (0734) 55341. Cable: VIDEOTAPE. Gen. Mgr.: Gerald

C. Hall; Prod. Mgr.: Stanley West; Mktg. Mgr.: Bertie Eccles; Sales Mgr.: Jim Humberstone.

## VENEZUELA

Population: 10,000,000.

Per capita income: \$719.

Rate of exchange: \$1 (US)=4.5 bolivars.

Average retail price per tape: 8-track cartridge—\$7.77; 4-track cartridge—\$6.66; cassette—\$6.66; open reel—\$7.77.

**Market:** All equipment is imported from the USA and Japan. The estimated number of machines in use is (open reel) 150,000; (4-track) 30,000; (8-track) 80,000; (4- & 8-track compatible) 50,000; (cassette) 10,000.

**Type of distribution:** Manufacturer-to-retailer and importer-to-retailer.

## ● record manufacturers with tape product

Antor (Hnos.), Apdo. 40,200, Nueva Granada; Calle Baruta 60, El Valle, Caracas. Tel: 691881. Cable: CONTIDISCO. Pres. & Int'l: Antor Antor; VP: Jose Antor; Promo: Felix Escalona.

**Cartridge 8-track:** Called—RCA.

Buena Musica SA (La), Calle Las Nieves, El Paraiso, Las Fuentes, Caracas. Tel: 491336. Gen. Mgr.: Carlos Esparragoza Vega; Sales Mgr.: Manuel Berra.

**Cartridge 8-track & cassette:** Owned—Sello Verde, Soul; represented—Imperial (USA), Liberty (USA).

Corporacion Los Ruices SA, PO Box 40,251, Caracas. Tel: 344683. Cable: ODEONSA. Pres.: Wilhelm Ricken; Sales Mgr.: Stan W. Steinhilber.

**Cartridge 8-track & cassette:** Owned—Odeon; represented—Angel, Bell group, Capitol, Dunhill, EMI.

Discomoda (see Favedica).

Discoteca CA (La), Apdo. 70498, Caracas. Tel: 344681. Gen. Mgr.: Wilhelm Ricken; Sales Mgr.: Carlos Vidal.

**Cartridge 4-track, 8-track & cassette:** Owned—Sonus; distributed—Billo; represented—CBS, Dot, Musart, Plaza.

Distribuidora Nacional de Discos, Apdo. 8535, Caracas. Tel: 422019, 414062. Cable: DINADISCO. Gen. & Tape Div. Mgr.: Jose Page; Int'l: Raul Roges.

**Cartridge 4-track & 8-track:** Owned—Velvet; represented—Riviera (France).

Favedica (Fabrica Venezolana de Discos), Apdo. 3402, Caracas. Tel: 49791. Pres.: Cesar Roldan; VP & Prod'n: Benito Vieitez; Sales: Enrique Barros; Exports: Norma Martinez; Tape Div. Mgr. & Int'l: Jorge Ramirez.

**Cartridge 4-track & 8-track:** Discomoda.

Palacio de la Musica SA (El), PO Box 3637, Caracas. Tel: 451046, 454848. Pres.: Ernesto Aue; Gen. Mgr.: Miguel A. Pina; Sales Mgr.: Arlindo Silva.

**Cartridge 8-track & cassette:** Owned—Palacio; represented—A&M, ABC, Ethnic, London, Monument, Motown, Musicor, United Artists.

Philips, see Siemens Venezolana.

Polydor, see Siemens Venezolana.

Sello Verde, see Buena Musica.

Siemens Venezolana, Av. Principal Los Ruices, Caracas. Tel: 348561. Gen. & Tape Div. Mgr.: Harry Alex.

**Cassette:** Owned—Philips, Polydor, represented—Atlantic, Capitol, Polydor.

Soul, see Buena Musica.

Vida Recs. CA, Edif. Brion, Av. Mexico. Of. 62, Caracas. Tel: 550140, 558259. Pres.: Caleb W. White; Gen. Mgr.: Eugenio Rosenthal; Sales Mgr.: Luis E. Arismendi.

**Cartridge 8-track & cassette.**

## ● custom duplicators

Hogarama CA, Apdo. 2021, Caracas. Tel: 913691. Pres.: A. Leslie Escoffery Jr.

**Cassette:** Educational tapes.

Sonus Electronics CA, Apdo. 70380, Caracas. Tel: 344685. Pres.: Bernard Brecht; Sales Mgr.: Julian Gonzalez Marlin.

**Cartridge 4-track, 8-track & cassette:** Billo, CBS, Dot, Musart, Plaza, Sonus.

## ● tape distributors & importers/exporters

Casa Ultramar, Apdo. 1,901, Veroes A Ibarra 4, Caracas. Cable: CARBLOHM. Contact: C. Blohm.

**Distributes:** Motorola playback equip.

Don Disco CA, Apdo. 40,006, Caracas. Tel: 718056. Pres. & Gen. Mgr.: Gervasio Garcia Mundet.

**Distributes:** All domestic labels.

**Imports:** American, Dutch, German & Italian labels.

Hogarama CA, Apdo. 2021, Caracas. Tel: 913691. Pres.: A. Leslie Escoffery Jr.

**Imports:** Cassettes & Philips playback equip.

How does  
it feel  
to be

#1

in your segment  
of the  
International  
Music-Record-Tape  
Industry!

see for yourself  
as a **Billboard**  
subscriber

**TAPE DEALER  
ACCESSORIES & SUPPLIES**

*Continued from page 114*

**HEAD CLEANERS &  
DEMAGNETIZERS**

Adell Corp.  
Adrian Assocs. Inc.—head cleaners.  
Ampex Corp.—head cleaners.  
Atlas-Rand Corp.  
Audio Communications Inc.  
Audio Magnetics Corp.  
Audio Physics Inc.—head cleaners.  
Audiotex.  
Guy Barry Ents. Inc.—head cleaners.  
Capitol Recs. Dist'g Corp.—head cleaners.  
Cassette Corp. of America.  
Certron Corp.—head cleaners.  
Channel Mktg. Inc.  
Claricon Prods. Inc.—demagnetizers.  
Custom Fidelity Inc.  
Data Packaging Corp.—head cleaners.  
Decca Recs.  
Dictation Prods. Inc.  
Dict-O-Tape Inc.  
Dubblings Electronics Inc.  
Duotone Co. Inc.  
Fidelitone Inc.  
Fine-Tone Tapes Unlimited Inc.  
I. T. C.—head cleaners.  
Kimco Tape Accessories—head cleaners.  
Le-Bo Prods. Co. Inc.  
Livingston Audio Prods. Corp.  
Marathon Prods. Corp.—head cleaners & demagne-  
tizers for cartridge 4-tr.  
Metra Electronics Corp.  
J. J. Paulson—head cleaners.  
Pfanstiehl Chemical Corp.  
Playmate Inds. Inc.  
Raynor Sales Co. Inc.  
Recoton Corp.  
Robins Inds. Corp.  
Royal Sound Co. Inc.  
Rozinante Electronics Corp.  
Sarex Corp.  
Albert Schultz Inc. (exports only), see Tape Whole-  
salers section: New York, N.Y.  
Specially Sounds Inc.—head cleaners.

Stereodyne Inc.—head cleaners.  
Stereo Magic.  
Stereo Mobile Inc.—head cleaners.  
Stereoriginals.  
Superscope Inc.  
T E A C Corp. of America—demagnetizers.  
Tape Servs. Inc.—head cleaners.  
Tone-King Corp.  
Walco Electronics.  
Wellington Eight Inds. Inc.

**LOCKS, see BURGLAR ALARMS  
& LOCKS**

**PRE-LEADERED & SPLICING TAPE**

Audio Magnetics Corp.—pre-leadered cassettes.  
Claricon Prods. Inc.—splicing tape.  
Irish Magnetic Tape Div.—leader & splicing tape,  
tape splicers.  
Liberty Tape Dupl'n—pre-leadered cassettes.  
Robins Inds. Corp.—splicing kits.  
Albert Schultz Inc. (exports only), see Tape Whole-  
salers section: New York, N.Y.  
Soundcraft-CBS Recs.—colored leader tape, splicing  
tape.  
3 M Co.—leader & splicing tape.

**SPLICING TAPE, see PRE-  
LEADERED & SPLICING TAPE**

**STORAGE CASES, see CARRYING  
& STORAGE CASES**

**TUNERS, see CONVERTORS  
& TUNERS**



**we  
mean  
business**

**BILLBOARD** means . . .

Record Business  
Tape Business  
Talent Business  
Radio & TV Business  
Record Reviewing Business  
Sheet Music Business  
Album Jacket Business  
Rock-Jazz Business  
Rhythm & Blues Business  
Gospel & Country Business  
Classical Music Business  
Night Club Business  
Broadway Musical Business  
Musical Instrument Business  
College Concert Business  
Recording Studio Business

**SHOW BIZ!!!!**



## TAPE SERVICES

Continued from page 108

Livingston Audio Prods. Corp., 10687 Santa Monica Blvd., West Los Angeles 90025. Tel: 474-4559. Mgr.: John Anderson.  
Home office: Fairfield, N.J.

Location Rec'g Serv., 2201 W. Burbank Blvd., Burbank 91506. Tel: 849-1321. Pres.: Allen J. Fraiberg; Gen. Mgr.: Steven A. Guy; Sales Mgr.: Kent Duncan.

Modern Album of California Inc., 3104 Vanowen St., Burbank 91504. Tel: 845-7655. Pres. & Gen. Mgr.: James R. Gordon; Sales Mgr.: Carl Reinschild.  
Home office: New York, N.Y.

Modern Tape Corp., 5810 S. Normandie Ave. Zip: 90044. Tel: 753-2481. Pres.: Joe Bihari; VP: Bob Demain.

Soltys Assocs., 5481 Santa Monica Blvd. Zip: 90029. Tel: 465-5605. Pres. & Mgr.: Gene Soltys.

T D K Electronics Corp., 6151 W. Century Blvd. Zip: 90045. Tel: OR 0-5515.  
Home office: New York, N.Y.

### ● SAN FRANCISCO & BAY AREA (Area Code 415)

Charles Conlan Lithographers Inc., 1655 Folsom St. Zip: 94103. Tel: 431-7373. Pres.: Robert D. Conlan; VP & Sales Mgr.: Richard T. Conlan.

Gopher Prods. Corp., Box 812, Berkeley 94701. Tel: 843-5836. Pres.: Burt Perkins.

## CONNECTICUT

### ● BRIDGEPORT (Area Code 203)

Lithographic Corp. of America, 1501 State St. Zip: 06605. NYC Tel: (212) WO 6-4353. Pres.: Lou Lewis; VP, Gen. & Sales Mgr.: Jack Dienes.

## DELAWARE

### ● WILMINGTON (Area Code 302)

Ken-Del Prod'ns Inc., 111 Valley Rd., Richardson Park. Zip: 19804. Tel: 655-7488. Pres.: H. Edwin Kennedy; Gen. Mgr.: M. Leap.

## FLORIDA

### ● MIAMI METROPOLITAN AREA (Area Code 305)

Adrian Assocs. Inc., 6660 Biscayne Blvd. Zip: 33138. Tel: 757-1626. Pres.: Michael Adrian; Gen. Mgr.: Gene Sayet; Sales Mgr.: Curt Witt.  
Unitel, 2515 NE 207 St., North Miami Beach 33160. Tel: 945-2819. Mng. Dir.: Charles H. Barkhaus.

Universal Rec'g & Dist'g Corp., 170 W. 29 St., Hialeah 33010. Tel: 888-7411. Pres.: Matthew San Martin; Sales Mgr.: Frank Garcia.

## GEORGIA

### ● FAIRMOUNT (Area Code 404)

Jay-Cner Ent., PO Box 175. Zip: 30139. Tel: 337-2510. Pres.: John Carter.

## ILLINOIS

### ● CHICAGO METROPOLITAN AREA (Area Code 312)

Album Graphics Inc., 745 N. Dearborn St. Zip: 60610. Tel: 642-9161. Pres. & Gen. Mgr.: Donald W. Kosterka; VP & Sales Mgr.: James Ladwig.

Custom Audio-JPL Rec. Co., 1088 Sixth Ave., Des Plaines 60016. Tel: 299-0220. Pres.: Paul H. Luitgens; Prod'n & Sales Mgr.: Thomas E. Larsen.

Espo Eng'g Corp., 5334 W. 65 St. Zip: 60638. Tel: 581-0123. Pres.: Eugene Esposito; VP & Gen. Mgr.: Donald J. Esposito; Sales Mgr.: Dennis Machul.

Fort Dearborn Lithographic, 6035 W. Gross Point Rd. Zip: 60648. Tel: SP 4-4321. Pres.: Tom Adler; VP & Sales Mgr.: Richard J. Adler; Gen. Mgr.: Bernie Kelly.

The Printing Press, 3925 Oakton St., Skokie 60076. Tel: 676-3270. Pres.: Arnold Martin; Gen. Mgr.: Jack McDonald; Sales Mgr.: H. Matalon.

R C S Press Inc., 1130 W. Adams St. Zip: 60607. Tel: 733-3500. Pres.: James S. Farrell; Sales Mgr.: Jac Rager.

T D K Electronics Corp., 2906 W. Peterson Ave. Zip: 60645. Tel: 973-1222. Pres.: Katsuro Kamiya; Gen. Mgr.: Kiyoshi Hiromoto; Sales Mgr.: Yoshiro Hirotsuka.  
Home office: New York, N.Y.

## INDIANA

### ● SOUTH BEND (Area Code 219)

Thomas Zoss Prod'ns, 1255 E. Madison. Zip: 46624. Tel: 232-2804. Pres.: Nikki A. Tompsett; Gen. Mgr.: Michael Chamberlin; Sales Mgr.: Warren Taylor.

### ● TERRE HAUTE (Area Code 812)

Arto Press Inc., 133 S. Sixth. Zip: 47801. Tel: 232-0926. Pres.: James Roysse Jr.; Gen. Mgr.: George Moore; Sales Mgr.: John Avelis.

Woodburn Printing Co., 25 S. Sixth. Zip: 47808. Tel: 232-0164. Pres.: R. Woodburn.

## MARYLAND

### ● COCKEYSVILLE (Area Code 301)

International Telecomm Inc., Box 405. Zip: 21030. Tel: 666-7770. Pres.: F. J. Best; VP & Sales Mgr.: Burgess Macneal Jr.

## MASSACHUSETTS

### ● BOSTON METROPOLITAN AREA (Area Code 617)

Continental Rec'gs Inc., 12 Irving St., Framingham 01701. Tel: 879-2430. Pres.: L. Daniel Flynn; Gen. Mgr.: John F. Flynn; Sales Mgr.: James Leshinski.

Fleetwood Rec'g Co. Inc., 321 Revere St., Revere 02151. Tel: 284-0750. Tape Mgr.: Raymond G. Samora; Sales Mgr.: Vincent P. Giarrusso.

## MICHIGAN

### ● DETROIT METROPOLITAN AREA (Area Code 313)

Tape-Tronics, 750 Mandoline, Madison Heights 48071. Tel: 538-8281. Pres. & Sales Mgr.: Burton Mahler; VP & Gen. Mgr.: A. S. Hart.

## MINNESOTA

### ● ST. PAUL (Area Code 612)

E M C Corp., 180 E. Sixth St. Zip: 55101. Tel: 227-7366. Pres.: David E. Feinberg; Customer Serv. Dir.: Patricia M. Stooths.

## NEW JERSEY

### ● BERGENFIELD (Area Code 201)

Custom Label & Tag Corp., 112 S. Washington Ave. Zip: 07621. Tel: 384-8500. Pres.: Anthony Ippolito; Sales Mgr.: Ralph Kerner.

### ● FAIRFIELD (Area Code 201)

Livingston Audio Prods. Corp., 1275 Bloomfield Ave. Zip: 07006. Tel: 226-8300. Pres.: Darrell D. Scholten; VP Sales: Thomas J. Hofbauer.  
Branch: Los Angeles, Calif.

### ● NEWARK (Area Code 201)

Newark Phono Labels (div. of Folkraft Publ'g Co.), 1159 Broad St. Zip: 07114. Tel: 622-0024. Pres.: J. Shifrin; Gen. Mgr.: Len DeValle.

## NEW YORK

### ● BINGHAMTON (Area Code 607)

Creative Artists, 6 Van Ness Rd. Zip: 13905. Tel: 797-3909. Pres. & Opns. Mgr.: Johnathan K. Solak; Sales Mgr.: Charles Solak.

### ● FARMINGDALE, L.I. (Area Code 516)

Pressure Sensitive Tape & Label Corp., 135 Schmitt Blvd. Zip: 11735. Tel: 293-7304. Pres.: Daniel Cooper; Gen. Mgr.: Michael Cooper; Sales Mgr.: Frank R. Camp.

### ● FREEPORT, L.I. (Area Code 516)

Royal Sound Co. Inc., 409 N. Main St. Zip: 11520. Tel: 858-2880. Pres.: M. A. Dayan; Gen. Mgr.: N. Greenberg; Sales Mgr.: J. Corbin.

### ● GREAT NECK, L.I. (Area Code 516)

Ivy Hill Lithograph Corp., Community Dr. Zip: 11021. Tel: (516) 487-0200. Pres.: Murray Gordon; Exec. VP: Lewis Garlick; Gen. Mgr.: Murray M. Kurland.  
Branch: Los Angeles, Calif.

### ● HAUPPAUGE, L.I. (Area Code 516)

Globe Albums Inc., Gilpin Ave. Zip: 11787. Tel: 234-1100; NYC Tel: (212) 291-7600. Pres.: Lee Halpern; Gen. Mgr.: Leo Margolies; Sales Mgr.: Howard Roseff.

### ● MOUNT VERNON (Area Code 914)

County Box & Album Co. Inc., 201 S. Second Ave. Zip: 10550. Tel: MO 8-7862. Pres. & Sales Mgr.: William R. May.

### ● NEW YORK CITY (Area Code 212)

George Alexander Printing Corp., 36-25 Prince St., Flushing 11354. Tel: 886-5600. Pres.: Kev Devejian; Gen. Mgr.: Fred Hass; Sales Mgr.: Jimmy Gielbert.

Cable Machinery Corp., 156 Fifth Ave. Zip: 10010. Tel: 989-4434. Pres.: Sol Dubin; VP & Gen. Mgr.: Leonard Ripley; Sales Mgr.: V. J. DePaul.

Hartwell Magicolor Printing, 825 Madison Ave. Zip: 10021. Tel: 734-4000. Pres.: Alan Hartwell; Gen. & Sales Mgr.: Austin P. O'Brien.

Lee-Myles Assocs., 160 E. 56 St. Zip: 10022. Tel: 758-3232. Pres.: Robert M. Miller.

MacMurray Press Inc., 22 Jones St. Zip: 10014. Tel: WA 4-1530. Pres. & Sales Mgr.: Max Fine-smith; Gen. Mgr.: Arthur Gray.

Passantino Printing Co. Inc., 250 W. 49 St. Zip: 10019. Tel: JU 6-1540. Pres.: Charles V. Passantino; Gen. Mgr.: Robert Passantino.

Profile Press, 245 Seventh Ave. Zip: 10001. Tel: 675-3144. Mgr.: Fred R. Siegle.

Progressive Label Co., 286-290 Stanhope St., Brooklyn 11237. Tel: HY 7-2320. Pres. & Sales Mgr.: Jerome J. Rood; VP: Bernard Stein.

Queens Lith'g Corp., 52-35 Barnett Ave., Long Island City 11104. Tel: 457-7700. Pres.: Jack L. Hecht; VP: Eric Kaltman.

Random Advertising/Leo Litho, 156 Fifth Ave. Zip: 10010. Tel: BU 8-6000. Pres. & Gen. Mgr.: Leo Elner; Sales Mgr.: S. J. Schiada.

Shorewood Packaging Corp., 724 Fifth Ave. Zip: 10019. Tel: 582-6885. Pres.: Paul Shore; VP Mktg.: Floyd Glinert.

Sound Packaging Corp., 56 E. 53 St. Zip: 10022. Tel: 421-8255. Pres.: Craig Braun; VP & Gen. Mgr.: Anthony Grabois.

Supreme Printing Serv., 147 W. 15 St. Zip: 10011. Tel: AL 5-0600. VP: Irv Cohen.

T D K Electronics Corp., 23-73 48 St., Long Island City 11103. Tel: 721-6881. Pres.: H. Kawamura; Mktg. Mgr.: George T. Sandler; Sales Mgr.: A. Otsuka.  
Branches: Los Angeles, Calif.; Chicago, Ill.  
Int'l branch: Japan.

## OHIO

### ● CINCINNATI (Area Code 513)

Queen City Album Inc., 2832 Spring Grove Ave. Zip: 45225. Tel: 681-8400. Pres.: Edward R. Bosken; Gen. Mgr.: Chet Barnett.  
Rite Rec. Prod'ns Inc., 9745 Lockland Rd. Zip: 45215. Tel: 733-5533.

### ● COLUMBUS (Area Code 614)

Harmonic Sounds Inc., 1482 Felix Dr. Zip: 43207. Tel: 491-1461. Pres.: Clem Price Jr.; Gen. Mgr.: George D. Beter; Sales Mgr.: Minola Price.

## PENNSYLVANIA

### ● ALLENTOWN (Area Code 215)

Allentown Rec. Co. Inc., 1002 Walnut St. Zip: 18102. Tel: 433-7405. Pres.: S. L. Martell.

### ● SHARON (Area Code 412)

Marjon Recs., 159 Easton Rd. Zip: 16146. Tel: 347-4726. Pres.: John Krizancic; Sales Mgr.: Martha Krizancic.

## TEXAS

### ● ARLINGTON (Area Code 817)

Sword & Shield Recs., PO Box 211. Zip: 76010. Tel: 274-6762. Owner: Calvin L. Wills.

## WISCONSIN

### ● MILWAUKEE (Area Code 414)

Gugler Lithographic (div. of TCI), 1339 N. Milwaukee. Zip: 53202. Tel: 276-6969. Gen. Mgr.: Roy Schultz; Sales Mgr.: Roger Schultz.

Neu Printing Serv., 761 N. 29 St. Zip: 53208. Tel: 344-3925. Owner: Robert J. Neu.

### ● SAUK CITY (Area Code 608)

Cuca Rec. Corp., 123 Water St. Zip: 53583. Tel: 643-3304. Pres.: Jim Kirchstein; Gen. & Sales Mgr.: Art Sullivan.

## WYOMING

### ● CHEYENNE (Area Code 307)

Rocky Mountain Rec'g, PO Box 82. Zip: 82001. Tel: 638-8733. Pres. & Gen. Mgr.: Ray Alexander.

# Index to Advertisers

Advertiser	Page No.	Advertiser	Page No.
A & B Duplicators	96, 97	Gauss	89
A & L Dist. Corp.	57	General Cassette	92
Allied Tape Corp.	101	Gold State Rec.	72
All Tapes, Inc.	47	Imperial International Learning	28
Amberg File	111	Infodex	108
American Sound	45	J & J Records	44
American Tape Duplicators	98	Jubilee Group	16
Ampex	3rd Cover	Keysor Chem.	30, 46
Ampex Tapes Ltd.	117	King Instruments	103
Atlantic Records	18	King Karol	61
Audio Communications	5	Kustom Kreations	109
Audio Magnetics	69	Lang Electronics	70
Audio Masters	100	Lear Jet	31
Audiomatic Corp.	99	Le-Bo Products	113
Audio Physics	94	Livingston Audio	70
Audiotrax	53	Magnetic Media Corp.	66
Automatic Radio	29	Magtec	73
Auto Stereo (I. T. P.)	125	Mercury Rec.	18
Autovox	127	Minnesota Rubber	79
Auvis	134	Modern Album	104
B.A.S.F. Systems	81	Modern Sound, Inc.	55
Bell & Howell	41	Modern Tape Canada	119
Arne Bendiksen	130	Motorola	37
Carolina Sales	53	Motown Records	15
Cartridge Control	59	National Tape Distributors	49
Cassette Communication Corp.	30	Palette	9
Cassette Corp.	67	Peerless Telrad, Inc.	34
Cassette Development	104	Pickwick	20
Cassette Music Corp.	3	Plastic Ware	83
Certron	42	Playmate Industries	68
Columbia	11	Precision Tapes Ltd.	120
Columbia Record Production	88	Prog. Tape of Canada	121
D. G. G.	23	Qualitape Dupl. Labs	51
Data Packaging	71	Quality Rec. Ltd.	126
Data Tech	91	Queens Litho	105
Decca Records	35, 82	R. C. A. Italiana	133
Dict-O-Tape	85	Recoton	115
Dooto	107	Rediffusion	132
Dot Records	39	Request Rec.	84
Double Sixteen Co.	83	Rheem Roberts	102
Dow Corning	93	Scepter Rec.	19
Dubbings	6	Albert Schultz	59, 72
Dupont	65	Shelby Singleton	25
E. M. I. Tape Ltd.	129	Stereodyne	2nd Cover
Ecofina	128	Stereo Jaubert	124
El Mar	106	T. M. C.	48
Eltron Export	57	Tape-Tronics	90
Epic Records	17	Telex	33, 87
Espo Eng	94	Thunderbird Rec.	107
Ethnic Tapes	43	Uni Records	27
Fairfield Tape Duplicators	95	United Rec. & Tape Industries	44
Finebilt	80	Walco Linck Corp.	112
Forbes Electronics	108	Word Rec.	21
G. R. T.	75 to 78, Back Cover		

# Not too long ago Ampex meant equipment

Ampex has always produced the finest tape equipment to play music.

Today we make music. Ampex produces music, reproduces it, distributes it, promotes it, advertises it, and does more than anyone to assure dealers that Ampex music is the most profitable they can sell.

Ampex Stereo Tapes offers dealers a catalog of over 6500 selections on 75 different record labels, spanning the entire musical spectrum...pop, rock, soul, jazz, folk and classical. And they're available every way stereo tape is made...cartridge, cassette, micro-cassette and open reel.

Dealers stock the top hits on Ampex Stereo Tapes because Ampex built a manufacturing and distribution network big enough to get hits to dealers while they're still hits.

Ampex Records (that's right...Ampex Records) now gives dealers LP's that feature exciting new talents as well as established super stars.

From equipment to tape to records, Ampex has demonstrated its commitment to music...a total commitment to the present and to the future, whatever dimensions home entertainment assumes.

Today Ampex music is the most profitable music for dealers in the United States, Canada, and all points east.

And we still make the best equipment.

**today**  
**Ampex means**  
**total home**  
**entertainment**

Ampex Stereo Tapes 555 Madison Avenue, New York, N. Y.  
Ampex Records 555 Madison Avenue, New York, N. Y.  
Ampex of Canada 2832 Slauch, Walton, Ontario, Canada  
Ampex International 35 Soho Square, London, England W1V 5 DG

**AMPEX**



**Renda Blackler\* is our all-time great artist any week... because she'll make sure you get these great artists on time this week.**

(\*Customer Service Manager — GRT Music Tapes)



8023-50068



8035-8824

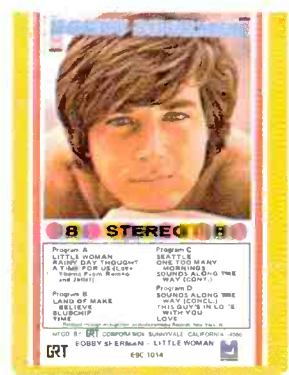

8000-1014



8023-73071



8044-18128



8045-42040



8058-8028



8032-8452



8022-700

**and these too....**

- Johnny Cash • The Exotic Guitars • B. B. King •
- Jerry Lee Lewis • Ramsey Lewis • Love •
- Oliver • Joe Simon • Steppenwolf •
- Ike & Tina Turner • Johnny Winter •



THE GREAT TAPES

Contract duplicating and licensing on 8-track, cassettes and reels from GRT Corporation, Sunnyvale, California. GRT of Canada, Ltd., London, Ontario.