

P 55 50 75

PRICE 15¢

The Billboard

124 PAGES

LIST NUMBER

February 28,
1925

(Printed in U. S. A.)



A Weekly
Theatrical Digest
AND
Review of the Show World

GRIFFIN MUSICAL SAWS

And Novelty Instruments. King of Musical Saws.
JACK GRIFFIN, 331 Tremont St., Boston, Mass.

Jazz Musicians Sax. Cornet, Clarinet, Trombone, Banjo, My Novelty "Blue" breaks will "make" you. 23 breaks, 50c. I write Novelty Blue Choruses to order, any song, 50c. My Handy Book on Improvising, Filling In, etc. 10c. of coin.
DARNELLE, 6422 Eggleston, Chicago.

96 SONGS Words and Music 25c

As sung by Leading Minstrels.
THE COLLINS CO., 197 Fulton St., Brooklyn, N. Y.

SPECIAL ARRANGING

For Dance or Vaudeville Orchestra. State instrumentation and what your men double. You get original manuscript—no two arrangements alike. Hot Choruses for any instrument, \$1.00, postpaid.
L. B. VAN PETTEN, PORTER PHILIPS,
701 S. University, Normal, Ill.

ACCORDIONS

The Best Made Accordion in the World
Send 25 cents for illustrated catalog and prices.
AUGUSTO IORIO & SONS
18 Prince St., NEW YORK.

"Syncopate the Christensen Way"

JAZZ AXEL CHRISTENSEN'S INSTRUCTION BOOKS FOR PIANO. BOOK 1—How To "Jazz-Up" Any Tune. Chord Work, etc. BOOK 2—Arpeggio-Raz, with Bass Melody, New Breaks, Fills, etc. Either book sent for \$2, or both for \$3. Circular sent free. TEACHERS WANTED to open Schools in cities where we are not already represented.
CHRISTENSEN SCHOOL OF POPULAR MUSIC,
Suite 4, 20 East Jackson, Chicago.

CENTRAL ENGRAVING CO.
ENGRAVER TO HIS MAJESTY OLD BILLY BOY
THEATRICAL DESIGNERS AND ENGRAVERS
MAKERS OF CUTS FOR THEATRICAL USES
SEND 15 CENTS FOR 1924 CATALOGUE OF THEATRICAL STOCK LETTER HEADS OF 100 DESIGNS
MINE McDONNELL, PROP., 137 W. 4th St. CINCINNATI, OHIO

"Tune House Hits"

These numbers may be played or sung without fee or license

DON'T FORGET, YOU'LL REGRET

Home Alone Blues

HE AIN'T NO COUSIN OF MINE (BLUES)

IT MAKES NO DIFFERENCE NOW (BLUES)

Broken Busted Blues

Dance Orchestration or Sheet Music specify which
25c each — 5 for \$1.00.
(REMIT WITH ORDER)

ORCHESTRA LEADERS—Have your name put on our list of Preferred Orchestra Leaders. Get any three of the above dance numbers now, and at least twelve others during the next twelve months. \$2.00 per year.

TUNE-HOUSE INC.
1547 BROADWAY NEW YORK CITY
HENRY TROY, PRES.
EDGAR DOWELL, SECY

How To Write and Make a Success Publishing Music

A book written by a successful music composer and publisher and covers in detail just what the ambitious composer desires to know. Includes list of Music Dealers, Band and Orchestra Leaders, Record and Piano Roll Manufacturers. The best book of its kind on the market. Only \$1.00, postpaid. Money back if book is not as claimed. Send for information.
THE UNION MUSIC CO., Cincinnati, Ohio.

MUSIC PRINTERS

ENGRAVERS AND LITHOGRAPHERS
PRINT ANYTHING IN MUSIC BY ANY PROCESS
ESTABLISHED 1876 ESTIMATES GLADLY FURNISHED REFERENCES, ANY PUBLISHER

THE OTTO ZIMMERMAN & SON CO., INC. CINCINNATI, OHIO.

A Real "NUT" Comedy Hit

(YOU'RE THE FLOWER OF MY HEART)

SWEET IODINE

Professional copies, song orchestrations, catch lines, special material, etc., now ready! Put it in your act—quick—and hear your audiences roar!

We will gladly send this number and your choice of any one of our current successes as your first allotment of numbers if you will forward \$2.00 (Foreign \$3.00) for a year's subscription to our Orchestra Club. You can't afford to be without them.

FRED FISHER, Inc.

224 West Forty-Sixth Street, NEW YORK, N. Y.

WANTED

A Pal by the Name of Mary

New 1925 copyright waltz-song that is making the pace and already in the second edition. Feature number with all the big users of popular songs. On the air with the broadcasters, on the floor with the dancers, in the Southern parks with the bands, on the stage with the singers who sing a song because it "gets over," and in the homes because those who hear it like to take it there and sing it for themselves. Published by the Roat Music Co., of Battle Creek, Michigan, who are picking the winners of late. Get a copy from your dealer, or send direct, 35c, postpaid. Orchestration, 35c.

The most convenient Memorandum Book for Managers, Agents and Performers in all branches of the show world is

The Billboard DATE BOOK
(Leather Covered)

Just fits the pocket. Plenty of space for writing memoranda for each day for 14 months, commencing January 1, 1925.

Contains complete calendars for the years 1924-1925-1926, maps, space for recording receipts and disbursements of money, census of the largest cities of the U. S. and much other valuable information.

Mailed to any part of the world for 25c each. Also on sale at all offices of The Billboard.

Address
THE BILLBOARD PUB. CO.
Date Book Dept. Cincinnati, Ohio.

EVERYONES

With Which is incorporated "AUSTRALIAN VARIETY AND SHOW WORLD." Covering, in a Trade Paper way the whole Entertainment Field of Australia and New Zealand. Communications: Editorial, MARTIN C. BRENNAN, Business, H. V. MARTIN, 114 Castlereagh St., Sydney, Australia.

BRAZILIAN AMERICAN

THE BUSINESS BUILDER OF BRAZIL. Illustrated. Filled with news and information about the richest and most fascinating country in two continents. SUBSCRIPTION PRICE, \$7.00 A YEAR. Send 10 Cents for Sample Copy. BRAZILIAN AMERICAN, Caixa Postal 629, Rio de Janeiro, Brazil.

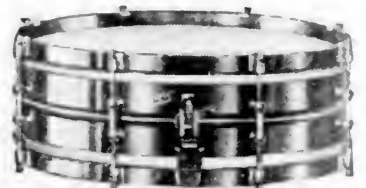

DRUMMERS— Get Your Copy Now!

The New **Ludwig** Catalog

Send for a copy of the new enlarged edition of the most complete Drum catalog ever issued.

Shows many photos of America's leading tympanists, drummers and orchestras using Ludwig Drums and accessories.

Write Us Today.

Ludwig & Ludwig
1611 N. Lincoln St. Chicago, Illinois

TRY THE SONG.
"Down By The Clothes Line, Maggie"
It's a "peach". H. BANKS, 1713 Massachusetts St., Gary, Indiana.

Established. Composer 1905.
A MOTHER'S PLEA
Heart-Touching Ballad, Sentimental Song, 35c copy; Band, 40c; Orch., 30c. Three together, \$1.00.
W. M. B. WADLEY, Chicago, Ill.
3644 Federal Street.

AUTHENTIC OFFICIAL NEWS AND UP-TO-DATE METHODS HAVE MADE "THE PERFORMER" A VITAL NECESSITY TO BRITISH VAUDEVILLE.

"THE PERFORMER"

(The Official Organ of the Variety Artists' Federation and all Other Variety Organizations.)
DEALS WITH VARIETY ONLY AND READ BY EVERYONE CONNECTED WITH BRITISH VARIETY.

The Paper That Shows Results to Advertisers.
ADVERTISING RATES:

Whole Page	52.00
Half Page	27.50
Third Page	21.00
Quarter Page	16.50
Sixth Page	15.00
Eighth Page	10.50
Wide Column, per inch	3.00
Narrow Column, per inch	2.50

THE PERFORMER is filed at all THE BILLBOARD OFFICES in America.
HEAD OFFICE: 18, Charing Cross Road, London, W. C. 2.
SCOTTISH OFFICE: 141 Bath Street, Glasgow.

NEW LINE STOCK MUSICAL COMEDY PAPER Smart and Snappy

GET OUR PRICES ON DATES, TACK CARDS, HERALDS, Etc.

SERVICE THE BEST

DONALDSON LITHO CO.
NEWPORT, KY.
Opposite Cincinnati, Ohio

It helps you, the paper and advertiser, to mention The Billboard.

JOHN TILLER'S

DANCING SCHOOL Of AMERICA

226 West Seventy-Seventh Street,
NEW YORK CITY

Teaching the World-Famous Tiller
Dancing

Special Rates to Professionals Now Working
Who May Wish To Improve. Classes Forming
in Groups of Six or Eight.

Warning!

It has been brought to our notice that several dancing teachers are using the name "Tiller" in such a way as to mislead the public into believing their establishments are connected with the original John Tiller School of London, Eng. Please note the above is the only address we have in America. Those using the title "Tiller" in connection with Dancing Schools or Studios are infringing upon the name of John Tiller, famous for 43 years as Europe's foremost Dance Arranger, Creator of the style known as Troupe Dancing made famous thru his Worldwide-Known Tiller Girls.

Special Attention to Children
MARY READ, Secretary.
PHONE, ENDICOTT 8215-6.

Al Moore and his U. S. Jazz Band an outstanding success on the Keith Circuit, completely equipped with Conn instruments.



"The Best Instruments In the World"

IN France, Al Moore was in charge of music and musical organizations in the U. S. Navy. When he organized his own band, he quite naturally named it the U. S. Jazz Band, and they have been together now for five years without a layoff.

Listen to what Moore has to say about instruments:

"During the time that I had charge of the naval musicians, I found that Conn instruments were much preferred to any other make. My band, the U. S. Jazz Band, is completely Conn equipped. To my way of thinking they are the best instruments in the world and during my time in Europe I had the chance to examine all the well known foreign makes."

That goes for all the big stars and traveling organizations, too—most of them use Conns, and there's a reason. Let us tell you about it; no obligation. Write today, mentioning instruments that interest you.

C. G. CONN, Ltd., 247 Conn Bldg., Elkhart, Ind.
Branches and Dealers Everywhere



1875 --- CONN GOLDEN ANNIVERSARY --- 1925

Three Big Hits from the Home of Blues

Everybody Loves
My Baby

Mama's Gone,
Good-Bye

PICKIN' ON YOUR BABY, 'CAUS

I'm A
Pickininy Rose

Dance Orchestrations, 35c Each.
NONE FREE.

Join our preferred mailing list (\$2.00 a year) and receive above numbers free, and at least 12 more during the year.
**CLARENCE WILLIAMS
MUSIC PUBLISHING CO., Inc.**
1547 Broadway, NEW YORK CITY, N. Y.
Dept. H. S.
Suite 415-420 Gayety Theatre Building.

ALL MUSICIANS

TRUMPET PLAYERS: GET EBY'S NO-PRESSURE METHOD FOR CORNET AND TRUMPET. Covers complete field. Results guaranteed. 100 Pages. Price \$3.00.
SAXOPHONISTS: GET EBY'S COMPLETE SCIENTIFIC METHOD FOR SAXOPHONE. Contains everything and all about Jazz. 314 Pages. Price, \$4.00.
TROMBONISTS: GET THE ARRAN METHOD BASS CLEF. Post marked. 236 Pages. Price, \$4.00.
B. A. O. LEADERS: GET PETERSON'S "ART OF DIRECTING." Price, \$1.00.
EVERYBODY: GET SAFRANEK'S "GUIDE TO HARMONY." Was a \$29 Mail Course. Price, \$2.00. At your Dealers, or order direct. Circulars free.

VIRTUOSO MUSIC SCHOOL (Dept. E), Buffalo, N. Y.

WHY NOT USE SONGS THAT WILL KEEP YOUR JOB?

"I'M TIRED OF THIS MARRIED LIFE"
"HOW YOU GOIN' TO TELL ME 'BOUT THE MORNING NEWS
(When It's Half Past Nine at Night)"
"CINCINNATI DREAM"—"STACK O'LEE"
"YOU'RE THE GIRL OF MY DREAMS"

Ten cents in postage must accompany all replies. Band and Orchestra, 25c

I. M. LAWSON (Music Publisher), 2289 Seventh Ave., New York City
N. R.—Male and Mixed Quartettes upon request.

WANT TO LEASE THEATRE in town in or near Pennsylvania, with 5,000 to 10,000 population. State all particulars in first letter. Address CARILL MOYER, Shenandoah, Pennsylvania.

Wanted, Manville Bros.

Clever General Business Team with Specialties, Jazz Orchestra with Novelities strong enough to feature, and real Comedian if one at liberty. Positively must make good. Elgin, Texas.

ATTENTION, ROAD SHOWS

CASINO, VANDERGRIFT, PA.
40 miles from Pittsburgh. Refurnished and reopened and ready for the best! Capacity, 900. Large stage and fly-loft. No road shows have played Vandergrift in over six years, consequently good business now. Equipped to handle big shows. Write or wire (CASINO, W. M. Elliot, Prop., Vandergrift, Pa.) NOTE—Can use Vaudeville if not too high-priced three days a week.

WANTED FOR THE FAMOUS ALABAMA MINSTRELS

COLORFUL PERFORMERS, MUSICIANS IN ALL LINES. Preference given those that double. State all you do and salary expected in first letter. Those already engaged acknowledge this call. Rehearsals start Waco, March 16. Address CHAS. E. BOWEN, Manager, Waco, Tex. Box 960.

Sunshine Cards from the Sunshine Girl, Dorothea Antel

Announcing a new assortment of 15 Beautifully Engraved EASTER Cards, neatly boxed. \$1.00.

Carry a box of my No. 2 Assortment in your trunk for various occasions such as Birthdays, Weddings, Convalescence, etc. 15 Engraved Cards \$1.00.

I shall be pleased to supply your needs in Gotham Gold Stripe Hosiery at standard prices and welcome your subscriptions to any periodical published, including The Billboard, at publishers' rates.

Complete Folder on Request.

Dorothea Antel
600 West 186th St.,
New York City.

Every Student and Trap Drummer

Should buy a copy of the self-instructor, "THE MODERN DRUMMER," by Mr. Harry Johnson. Results guaranteed. A Ludwig Snare Drum Free if you fail to improve. Price, \$1.50. ZIPP, & JOHNSON, 173 West Washington St., Chicago, Ill.

SCENERY

Diamond Dye, Oil or Water Colors.
SHELL SCENIC STUDIO, COLUMBUS, OHIO.

SCENERY and PLUSH DROPS FOR HIRE

The One Place in the Wide World.
Established 1820. AMELIA GRAIN, Philadelphia.

PARODIES

7 Parodies on all Late Songs, 50c. 25 Comedy Song Titles, just written, 75c. Parody on "We Have No Bananas," 25c. Or all for \$1.00, EDDIE MCGINLEY, 331 Tremont Street, Boston, Mass.

MR. CHAS. PFLUG or CHAS. GRAFFT

Your sister wants to hear from you, as your mother is in the hospital, not expected to live. MRS. HERMAN KRASCH, 1623 Madison Ave., Quincy, Ill.

WANTED—PIANO PLAYER

Must be able to read music, do some specialties, work in Acts. Money sure. Long season. Never close. Join at once. Prepay your wires. MANAGER SHOW, Gilbertsville, Pennsylvania.

GEO. B. HILL AT LIBERTY

COMEDIAN, Dutch, Jew. Play line of Characters. Specialties. Proscenium Feature Burlesque, Musical Comedy, Dramatic Stock preferred. Address Globe Theatre, Philadelphia, Pa., until Feb. 28; then 6 New Street, Merchantville, N. J.

At Liberty, A-1 Agent

For Rep. under canvas, or standard One-Nighter.
DICK CLEMENS, care Billboard, Critty Bldg., Chicago.

WANTED

TEAM, PIANO PLAYER, GOOD BLACK-FACE SINGER.

If you want work, all right. Kiekers and boozers lay off. Tickets if I know you. INDIAN GEORGE, General Delivery, Atchison, Kansas.

FREE SERVICE MUSICIANS

Why trouble to write each publisher for ORCHESTRA OR BAND MUSIC SEND TO US. We supply everything printed in Music, and send it postpaid at PUBLISHER'S PRICES OR LESS. Save time, save trouble, save money. Only one letter to write. Send today for free catalog of Music and Musical Merchandise.

ORCHESTRA MUSIC SUPPLY CO.
Dept. 12, 1658 Broadway, NEW YORK.

PHILADELPHIA

FRED K ULLRICH
Phone, Tioga 3525. 908 W. Sterner St.
Office Hours Until 1 P.M.

At the Theaters

Philadelphia, Feb. 21.—*Grounds for Divorce* made a good appeal at the Adelphi in its first-time-here presentation. *Plain Jane* with Joe Laurie, Jr., featured the Garrick Theater to success and a firsttimer. Another was *Earl Carroll's Yonities*, good, but got into a jam with the authorities on the scantiness of costumes worn by some of the performers. Joe Cook was the featured member.

Plays continuing are: *Moon Magic*, Broad; *Sweet Little Devil*, Shubert; *Conscience*, Walnut; *Dixie to Broadway*, Lyric; and *Blossom Time*, Chestnut Street Opera House.

Bits

Golden & Long's *Buzzin' Around*, tabloid show, with a good cast, is going big at the Globe Theater and will remain here until February 28.

Paul Specht and His Original Orchestra are at the Cafe Pandora (formerly the Claridge) and meeting with success and drawing good attendance nightly.

Ned Wayburn's *Honey-moon Cruise* is at the Earle, and J. Francis Haney's *Rouge* is at the Keystone, with *Knick-Knacks of 1925* at the Allegheny.

At the Fox Orville Harrold, noted tenor, was the added attraction, and Naham Franko from New York was the guest conductor of the orchestra.

The Stanley had Alexander Almkoff, baritone, and Doris Niles, dancer, who opened the photoplay, *Swan*, with her clever dance in the costume of a swan. *Romola* closes its run at the Aldine and will be followed by *The Lost World*.

A new march played for the first time at the Stanley, entitled *Our Heroes*, by the talented composer-pianist of this city, Marie Whiteman, met with generous applause during the whole week. It is a stirring military melody and dedicated to the Army and Navy of the U. S. A.

The annual entertainment given by the Stanley Company Employees' Beneficial Association will be held this year at the Earle Theater March 13.

Things are taking shape around the Sesqui-Centennial Celebration headquarters and contracts and other announcements will be given out soon. General Director Colonel D. C. Collier and his assistant, Col. G. W. B. Hicks, are busy men these days.

The New York Philharmonic Orchestra, with Willem Mengelberg conductor, comes to the Academy of Music for one night—only Philly appearance—March 9.

Gracie Emmett was the feature at the Desmond Theater in the comedy, *Mrs. Murphy's Second Husband*, to good business.

Pablo Casals, celebrated cellist, gave a recital February 20 at Witherspoon Hall to a crowded house which showed much enthusiasm.

Things are getting busier every day around the winter quarters of the carnival shows, viz.: Narder Brothers' Shows, World at Home Shows, Keystone Exposition Shows, Tip-Top Shows and Hegelman United Shows.

KANSAS CITY

IRENE SHELLEY
424 Chambers Bldg., 12th & Walnut Sts.
Phone, Delaware 2084.

Kansas City, Mo., Feb. 20.—The Kansas City Theater is presenting this week *Outward Bound* at its home theater, the Auditorium. This play has caused so much comment and favorable publicity, the newspapers praising both the production and the actors so highly, that each night a larger crowd goes to see this unique, extraordinary and "unforgettable" drama, and in consequence the Kansas City Theater is enjoying good business with a bigger attendance record than at any of its productions so far this season. This play is produced under the personal direction of Robert Peel Noble.

The National Pure Food Show and Exposition is going on this week at Convention Hall. Swarms of visitors, with many out-of-town people, are in the city for this interesting show.

W. J. (Doc) Allman, president of the Allman Car and Equipment Company and the Heart of America Showman's Club, has recovered from his protracted illness.

WANTED—LECTURER

Lady or Gentleman, who doubles Stage or Piano. Other real Med. Performers write. Stop best hotels. Say it all on K. JACK HENDLEY, Verona, Preble Co., O.

WANTED

Comedian, young Ingenue, Repertoire People with Specialties, male Pianist, real Agent who knows South. Long season. Tell all. Join on wire. FRED LAMAR, 318 Newman St., Jacksonville, Fla.

**COLORED PERFORMERS, COLORED MUSICIANS
FOR FAMOUS NEW ORLEANS CREOLE BEAUTIES (Under Canvas)**

For coming tenting season, opening April 10. Comedians, Singers, Dancers, fast-stepping Teams, good Novelty act. Arthur Prince, write. WANT four fast-stepping Chorus Girls. Following people answer: Will Watkins, Richard Williams, John Webb, Leon Pettiford, Dave Smith, Lawrence Erickson, Budd Donaldson, Noble Regan, J. D. Johnson, Slim Marshall, Sonny Love. Musicians address GEORGE CHRISTIAN, 129 Jones St., Macon, Ga. All others address C. C. SMITH, Box 91, Troy, Tenn.

**PULLMAN CAR
FOR SALE**

Wonderful Pullman Car, in A-No. 1 condition. Can be used with or without kitchen. Steel frame, 500 journals, straight. Has Staterooms and 12 lower and 12 upper berths. New Delco Light Plant and complete equipment of special mohair mattresses, and sheets, pillows, blankets, etc. VERY REASONABLE. Car in Cincinnati, Ohio. Wire or write
GEORGE E. WINTZ
2367 Wheeler St., CINCINNATI, OHIO. Phone, West 3104-Y.

and is once more able to be up and about.

Mr. and Mrs. A. N. Rice, of the A. N. Rice Lamp Factory, returned this week from a two weeks' stay at their 2,500-acre ranch at Houston, Mo. They will leave the first of the week on a trip to Chicago, New York and the East for buying purposes, as Mr. Rice intends to have a more complete line of aluminum ware, blankets and supplies for the concessionaires than ever and will increase his factory output in many ways and lines. Mr. Rice reports that the general mercantile store he opened recently in Richmond, Mo., is a great success.

Clarke B. Felgar and daughter, Birdie May, are putting on a clever little vaudeville act, entitled *Simply Impossible*, a comedy. They are playing suburban houses and going over very well. Mr. Felgar is well known in the show business, having been connected with many of its branches, but this is Miss Felgar's first introduction to the profession. Mr. Felgar will be assistant manager on the Walter Savidge Amusement Company this season.

John Francis, of the John Francis Shows, was here a day this week on his way to Chicago. Mr. Francis and Clarke B. Felgar were observed in conference at the Coates House.

Mrs. Joseph Paffen is ticket seller at the Lyric Theater (motion picture house) at 7th and Main streets. Mr. Paffen is a well-known magician, having his own show on the road in the spring and summer. They were callers recently and advised that they would organize soon to start their show in April.

Mr. and Mrs. A. H. Cooper left February 13 for Mobile, Ala. Mr. Cooper will manage the side show of the Gollmar Bros. Circus this season. They were in business here, but the lure of the "white tops" was too great.

The Ruby Latham Duo played the Globe Theater, February 8 to 10, and during their stay in the city paid this office a pleasant visit.

Gypsy Oshla, master of the crystal ball, and mental mystic, is here visiting friends and renewing acquaintances, but expects to leave shortly for New York to resume his tour. He has just finished an engagement in Australia.

G. B. McKay, of G. B. McKay's Louisiana Five Syncopators, was a caller February 16. Mr. McKay was on his way to St. Louis and reported business very good with his orchestra.

We are in receipt of a letter from Pearl Price, of 630 Guenther street, San Antonio, Tex., which reads: "After two years off the road, playing stock, am drifting back to the open air and canvas. Am opening with the Morris & Castle Shows and will be with Harry Calvert. My feet are itching for the grassy lots. I shall remain here until the shows open."

The Shubert Theater is dark this week and the stock company which was to have opened at the Missouri Theater did not arrive. That makes the presentation at the Kansas City Theater a very auspicious one.

Electric Park has been offered, rent free, for the National Convention of Florists to be held here the middle of March. The convention and flower show was to have taken place in the American Royal Building, but it was destroyed by fire last week.

BOSTON

JACK F. MURRAY
Phone, Beach 0651
821 Colonial Bldg., 100 Boylston St.

With the Shows

Boston, Feb. 19.—There's only one change among the legitimate attractions next week. The *Ziegfeld Follies* departs

for the road and *Kid Boots* with Eddie Cantor and Mary Eaton takes its place at the Colonial.

The continuing attractions are: *White Cargo*, *Simon Called Peter*, *Beggar on Horseback*, *Peter Pan*, *New Brooms*, *I'll Say She Is*, *Greenwich Village Follies* and *The Sicun*.

Rumor has it that A. E. Thomas' new play, *Spindrift*, will come to the New Park early in March, and that *Plain Jane* will be an early attraction at the Tremont. Rumor still insists that *Rose-Marie* and *Abie's Irish Rose* are due here this season.

Holiday Matinees

Special Washington's Birthday matinees have been announced for all the attractions remaining here. None has been announced for *Kid Boots*, however.

Hub-Bub

Business all over town has shown some improvement, partly due to the quality of the attractions now here and partly because of the nice weather that has been prevailing. The snow is off the ground and the weather remains moderate, with an occasional real cold day. Broadway producers are finally awakening to the fact that they must send the original stars in here with their productions if they want to get money in Boston. Only one of the shows now in town hasn't the original star. Boston theatergoers resent being treated as small-town folks, to be satisfied with a number two company, yet having to pay top prices for their entertainment.

The Four Marx Brothers and other members of the cast of *I'll Say She Is* journeyed to St. Vincent's Orphan Asylum at Roxbury and entertained the kiddies, giving each one a souvenir before leaving.

Catherine Willard, now here with *Simon Called Peter*, played for three seasons with the Jewett Players and is getting a very good reception from her old friends.

Nat Burgess dropped in the other day. He's just back from a trip to Florida with John Benson, who operated a zoo for the Hagenbeck Bros. in connection with a real estate development. Nat raved so much about the climate Boston will hardly suit him any more.

Carl Alberti was a pleasant caller recently. Alberti is past 70 but doesn't show it. He regaled us with tales of Norumbega Park back in the days when he built it a good many years ago.

Lyle Webster, manager of the City Opera House, Rochester, N. Y., writes to ask that we correct an impression that a paragraph which appeared in this letter recently might have created. Webster reports that Leon S. McCombe hires his house occasionally the same as any good legitimate show can.

Business with the stock companies in this territory is holding up pretty well, according to reports reaching us from various managers, despite depressing conditions thru here.

Carl Peterson dropped by to say hello. His seven-piece band keeps busy around here and hopes to be at one of the summer resorts the coming summer.

The picture houses around town report good business.

There are a number of carnivals getting lined up in and about Boston, most of which will start the season somewhere in this territory. They all seem confident that there's a good season ahead and are making plans accordingly.

The tab. shows in this territory don't seem to be having such an easy time of it.

"Dolly" O'Dell Seeks Aid

The *Billboard* is in receipt of a pathetic letter from Clara V. (Dolly) O'Dell, from Overland, St. Louis County, Mo., which requests that showfolks be made aware that she is in dire need of their assistance. It states that she has been paying on her little home, amounting to about \$10 a month, but that she has no funds or way of earning any, being unable to even walk, and that she must have more than \$60 to make up back payments or lose both the home and what she has paid into it. "I know I paid \$20.80 November 8," she states, "as Col. Owens of the Showmen's League loaned it to me, but now 'tis eluded I owe from September \$60.54." She further states that she needs assistance as soon as possible, and adds that her former appeal in this publication brought her but \$3.

WANTED—For Medicine Show that never closes, A-1 Novelty Man. Change strong for week. Work in acts. Best of treatment. Answer quick. Chas. Santsa, write. J. A. DUNCAN, Menasha, Wisconsin.

AT LIBERTY

FRANK SEAVEY (Cornet), OSCAR LUTINGER (Clarinet).
Locate or troupe. Address Gen. Del., Tampa, Fla.

Wanted, 3 Chorus Girls

Not over 5 ft., 3. Join immediately. This week, Dixie Theatre, Uniontown, Pa.; week March 2, Bello Theatre, Hella Vernon, Pa. Wire HALL HOYT.

BOOM AT PENSACOLA, FLO. 3DA.

The Government is ordering over 4,000 more men and officers to Pensacola. A new \$300,000 Theater is being built there by the Sangers. The Garden Theater there, which is fully equipped and has the largest seating capacity in the city, is now for rent. Wire LEROY V. HOLSBERRY, Pensacola. Best opportunity for good theatrical man in the South—and the South is where the money is today.

**WANTED
Small Girl**

Who can dance, professional, with Thurston, Magician. Send photograph, height, weight, age and experience immediately. Address: Grand Opera House Cincinnati, Feb. 22-28; Macaulay's Theatre, Louisville, March 1-7.

Wanted Quick

Manager for motorized Motion Picture Show under canvas. Must also act as projectionist. Boss Canvasman; must look after and take care of entire outfit. This is a three-truck, one-car outfit. Eat and sleep on lot. I furnish all after joining. Have 40x80 Tent. You must know the same and get results. Must know how to route and advertise. Playing two and three-night stands. WIRE QUICK. DON'T WRITE. NEED YOU NOW. State lowest and tell it all. All wires answered.

CLYDE LENOIR, Gilbertown, Ala.

VIOLINS



Big selection of new and old Violins at low prices.

Write for Catalog on Following Instruments:

- ACCORDIONS.
- BANJOS, GUITARS.
- MANDOLINS.
- DRUMS, CORNETS.
- SAXOPHONES.
- HARMONICAS.
- and MUSICAL NOVELTIES.

Fine Selection for Concessions.

GROSSMAN BROS. CO.,
1375 W. Sixth Street, CLEVELAND, OHIO

EXPERIENCE

Is forever explaining, but a wise man may avoid many unpleasant experiences by reading and recording the experiences of others.

The news in this issue of *The Billboard* is largely the experience of others, successful and otherwise. You may profit by reading it.

The subscription blank on another page is your opportunity.

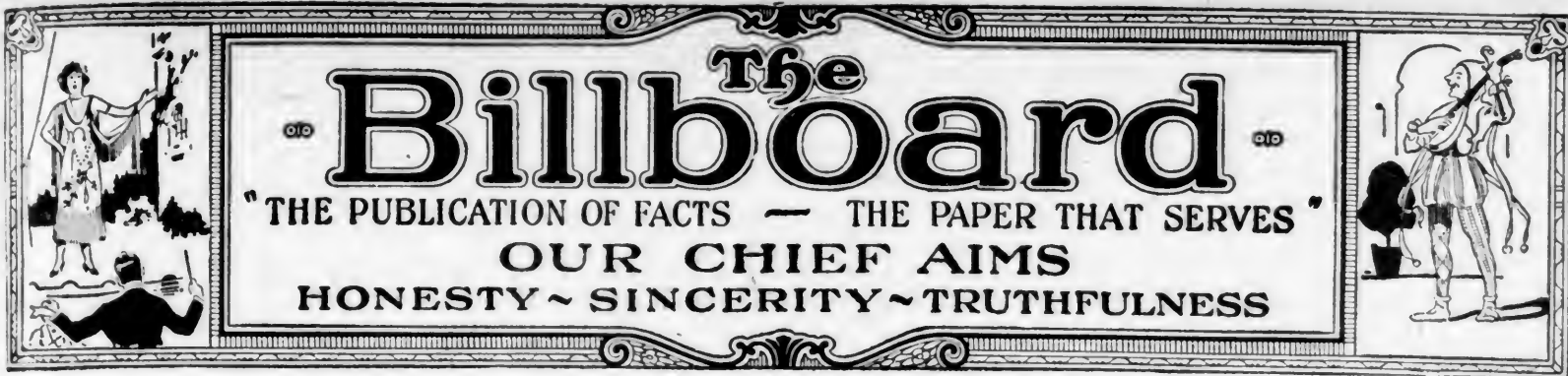

Published weekly at Cincinnati, O. Entered as second-class mail matter June 4, 1897, at Post Office, Cincinnati, under Act of March, 1879. 124 Pages, Vol. XXXVII, No. 9, Feb. 28, 1925.
 (Copyright 1925 by The Billboard Publishing Company.)

Top-Notch Acts at Popular Prices Bring Tremendous Increase in Orpheum Profits

Balance Sheet for 1924 Shows Net Income Almost Double Previous Year

MANY HEADLINERS TOURING CIRCUIT

New York, Feb. 23.—The tremendous popularity of the present policy of the Orpheum Circuit is reflected in the balance sheet for 1924 which shows a net income almost double that of the previous year.

The report, just issued by the circuit, covers the 12 months ending December 31 last and shows a net gain after taxes and other items of expense have been deducted of \$2,897,313.90, as against \$1,568,694 for 1923, when a substantial increase was realized over the former year.

This figure for 1924, establishing a peak and marking the highest increase in earnings in the circuit's history, is in excess of the figure for 1923 by \$1,328,619.50.

Disposal of the Orpheum Circuit's interest in the Greater New York Theaters Corporation and other companies during 1924 is partly responsible for the unusual increase in net earnings, these sales having been made at a substantial profit. At a meeting of the Board of Directors

(Continued on page 13)

Thousands Flock To Eastern Summer Resorts and Beaches

New York, Feb. 23.—The first sign of real spring weather yesterday brought thousands to the beaches and summer resorts here. An estimated 300,000 visited Coney Island and boardwalk places did an excellent business. The Rockaways and Long Beach also saw their first big crowds of this year, the railroads and buses carrying full loads during the entire day.

The balmy weather, coupled with the fact that it was Washington's Birthday, officially celebrated today when most of the commercial houses are closed, served to take the greater part of the city's population out of doors.

The temperature, which fluctuated little during the day, hovered around the 63-degree mark, seldom experienced this time of the year, and marking a considerable change in the prevailing weather conditions the latter part of this month, when much humidity and other depressing conditions have existed.

Elsie Janis Will Give Society Buds a Chance

New York, Feb. 23.—Elsie Janis has offered an engagement in her revue, *Puzzles of 1925*, to Pauline and Beatrice Carr, stage-struck Philadelphia society buds, who arrived here Saturday accompanied by a chaperon, 17 trunks and 2 private limousines, in search of a theatrical engagement.

The girls have beautiful red hair and are said to be exceptionally clever in singing and dancing. One is 18 years old, the other 19.

NEW YORK FAIRS' RECORD MEETING

Delegates in Large Numbers Gather at Albany—Old Officers Re-Elected

New York, Feb. 21.—The 37th annual meeting of the New York State Association of Agricultural Societies which was held at the Ten Eyck, Albany, N. Y., February 17, was one of the best attended meets in the history of the association. Visiting members, guests and entertainers began arriving the day preceding the meeting and it was with difficulty that all were housed in the numerous hotels due to the large number and to the presence of delegates to other meetings slated for the capital city on the same date.

The morning meeting was devoted to the reading of reports and the election of officers for the ensuing year. This election resulted in the retaining of the incumbents, who are: William E. Pearson of Ithaca, president; Robert Seaman, Jericho, first vice-president; Irving G. Wiswall, Ballston Spa, second vice-president; George W. Harrison, Albany, secretary, and A. E. Brown, Albany, treasurer. This, by the way, is the 30th season as treasurer for Mr. Brown.

At the conclusion of the morning meeting all members of the agricultural societies, accompanied by the delegates from the Union Agricultural Societies (Town Fairs), who were in session in Parlor B, attended a reception by Gov. Alfred Smith at the capitol.

The afternoon session was called to order at 2:15 by President Pearson, who introduced the first speaker of the day, C. P. Norgord, assistant commissioner, Department of Farms and Markets. Mr. Norgord held his audience in a masterful manner and delivered many interesting paragraphs on the betterment of fairs and exhibitions. Particularly interesting were the remarks pertaining to clean fairs and the entertainment fundamental

(Continued on page 113)

PLAY JURY PLAN ACCEPTED BY N. Y. DISTRICT ATTORNEY

Will Begin Functioning This Week—Belasco To Rewrite His Objectionable Plays—Brady Show Closes—"Desire Under Elms" May Go to Jury

New York, Feb. 21.—Following a conference this morning with John Emerson, president of the Actors' Equity Association, and the Reverend Charles K. Gilbert, of the New York Federation of Churches, who comprised a subcommittee of the Committee Opposed to Political Censorship, District Attorney Banton announced that the citizens' play-jury plan presented to him by the committee was an excellent one and would be put into effect. One hundred and thirty citizens have already been accepted to serve on the panel of 300 from which a play jury of 12 may be selected, and the remaining 170 citizens are to be selected with the utmost despatch, possibly by the end of next week. The play jury will begin to function Wednesday.

This action is the result of a meeting held yesterday by the Committee Opposed to Political Censorship in the Coffee House of Good Intent on East 53d street, at which time Owen Davis, the playwright, who is said to have originated the play-jury idea, was appointed

chairman and spokesman for the group. Those present at the meeting included John Emerson and Frank Gillmore, of Equity; Owen Davis and Channing Pollock, representing the dramatists; Winthrop Ames, the Reverend Charles K. Gilbert and others. The subcommittee that called on the district attorney today was appointed at this meeting.

In explaining the operation of the citizens' play jury the district attorney said that complaints against any play

(Continued on page 113)

I. A. ADOPTS NEW ROAD SHOW RULING

Attractions That Lay Off and Move to Another House in Same City Must Have Double Crew

New York, Feb. 23.—Theatrical productions that temporarily lay off and move to another house, even tho it is in the same city, come under the head of "road engagements", according to the ruling of the International Alliance of Theatrical Stage Employees and the Motion Picture Machine Operators as a result of its difficulties with Herman Gantvoort, producer of *Hell's Bells*. The show closed last week at Wallack's Theater and is laying off this week prior to opening at Daly's 63d Street Theater Monday.

When Gantvoort was unable to obtain a theater for this week he posted a notice that there would be a layoff of one week. The stage crew, with the backing of its union, took the stand that the closing of one house and the reopening after a layoff at another would constitute what is termed a "road engagement" and would necessitate the engagement of a full crew at road salaries for the remainder of the season.

As *Hell's Bells* was being played at Wallack's Theater with only the house crew and one electrician with the company, Gantvoort was unwilling to start a run at Daly's with a full stage crew. He argued that the play being presented in one set did not require two crews, the theater's and the production's stage hands,

(Continued on page 112)

DECEMBER SHOWS EMPLOYMENT GAIN

Survey Reveals Closing Month of 1924 Was Equaled in Its Increase Only Three Times Since 1914

New York, Feb. 23.—The year 1924 ended, according to latest figures of the Bureau of Labor Statistics as to the employment situation of the country, in a more favorable state than had been expected following the decrease shown in industries of the land during November.

According to the survey, made in the leading manufacturing industries of the United States, which serves as a reasonably accurate barometer of conditions in general, the increase in employment during December was in excess of two per cent.

Aggregate earnings for the last month of the year increased four and eight-tenths per cent. These increases are of importance, the report says, as indicating that the upward trend of August, Sep-

(Continued on page 112)

Widow of Composer of "Rosary" To Appear at Copyright Bill Hearing

Pearl Regay Beaten And Robbed by Thugs

New York, Feb. 21.—While on her way home after the show Thursday night Pearl Regay, whose dancing is a feature of *Rose-Marie* at the Imperial Theater, was attacked by two thugs, who beat her and took from her two diamond rings, a pearl necklace and about \$50 in cash. The hold-up took place in West Forty-seventh street shortly before midnight. In addition to hitting her over the head with a blunt instrument and inflicting several bruises on her face and body, the assailants cut Miss Regay's arm with a knife. Despite her experience, the dancer, with her arm bandaged, appeared at last night's performance and did her usual bit.

Mark Mason Honored

Philadelphia, Feb. 20.—The testimonial dinner to Clement H. Congdon, better known to the theatrical and newspaper world as Mark Mason, editor of *The Sunday Transcript*, held at the Hotel Walton Wednesday evening, was a gala event. The event commemorated the 35th anniversary of Mr. Congdon's activity in Pennsylvania, as well as the silver anniversary of his connection with *The Sunday Transcript*. More than 500 people sat down to a sumptuous dinner, during which an elaborate vaudeville bill was presented. After the various speakers had had their say Mr. Congdon closed the evening with an interesting speech on the newspaper field in all its many branches.

Late comers swelled the attendance close to the 1,000 mark.

Dance Hall Ownership Probed

Indianapolis, Feb. 21.—The Rev. F. A. Hayward, executive secretary of the Federated Baptist Churches of Indianapolis, and the Rev. Paul Judson Morris, pastor of the Emerson Avenue Baptist Church here, have been named by the Baptist Ministerial Union as a committee to confer with the Church Federation of Indianapolis concerning the relationship between dance halls and theaters. Mr. Hayward announced that an investigation showed that certain theaters in the city were connected with dance halls and that the Baptist Federation felt the situation needed investigation. A survey being made by the committee will be presented to the federation. It is hoped by Mr. Hayward that a city ordinance requiring a complete separation of theaters and dance halls will be the result of the investigation.

Hanley Sues Plunkett

New York, Feb. 21.—William J. Hanley has instigated suit against James E. Plunkett, Inc., for salary amounting to \$150 for two weeks, charging that the latter failed to live up to a contract which was signed in accordance with *The Rose of Killarney*, a road show.

A written agreement is in the hands of William Glancy, attorney for Hanley, in which the producer agrees to pay the manager the stipulated sum. The Gerald Griffin Company was to have put the show on, but for some unknown reason the piece never reached the boards. The contract with Hanley was for the season of 1924-25.

Twins Greet Braves With Colonel Miller

New York, Feb. 22.—Seventeen Sioux and Cheyenne braves, including three chieftains more than 90 years old, were greeted this week at the Grand Central Station by Colonel Joe C. Miller, accompanied by Daisy and Violet Hilton, San Antonio grown-together twins, who make their vaudeville debut for Marcus Loew Monday. The Indians are being furnished thru the Miller Brothers, of the 104 Ranch Wild West Show, to a German circus.

Preparing No. 3 "Show-Off"

New York, Feb. 23.—Stewart and French are preparing a third company of *The Show-Off* to send to the Coast. The play is now in its second year at the Playhouse. The new company will open in Wilmington, Del., April 13. Jessie Busley has been engaged for the role of Ma Fisher. None of the other parts has been assigned as yet.

Neil O'Brien Given Luncheon

New Orleans, Feb. 20.—Neil O'Brien spoke at the luncheon tendered him by the local council of the Knights of Columbus today at the Monteleone Hotel, at which many invited guests were present.

Mrs. Nevins Will Refute Statements Made by John G. Paine, Representing Victor Co.

Washington, Feb. 23.—Altho the final hearing before the Committee on Patents on the Perkins copyright bill tomorrow (Tuesday) is scheduled for airing of the motion picture producers' side of the situation, Mrs. Ethelbert Nevins, widow of the composer of *The Rosary* and other songs, is here prepared to go before the committee and refute the statements made at the last hearing by John G. Paine, of counsel for the Victor Talking Machine Company.

Attorney Paine stated that Ethelbert Nevins had sold his song, *The Rosary*, to the publishers for \$15 and that no royalties on phonograph records were due because it had been copyrighted prior to the Copyright Act of 1909. Since the composer's death, however, the Victor company, said Paine, had paid much money to the widow, including one settlement of \$15,000. This was done voluntarily on the part of his concern. Upon being questioned by Congressman Bloom Attorney Paine admitted that the payment was made after hundreds of letters were received from various people who thought the widow should share in the vast profits the manufacturers made from sale of the records of *The Rosary*.

It is understood that Mrs. Nevins will go before the committee and tell it that, despite the fact that her husband sold *The Rosary* for \$15 to the Boston Music Company, she has since received several hundred thousands of dollars from the music publishers. When *The Rosary* was recorded a rearrangement was made of the song, which technically brought the song into the realm of the present copyright law, making mechanical royalties applicable to the song, notwithstanding the fact that originally it was copyrighted before 1909. It was not a work in the public domain.

Upon this ground Mrs. Nevins instructed an attorney to bring suit against the Victor company, with the result that the \$15,000 settlement was made, altho it was estimated several times that amount was actually due the widow of the composer. These facts, it is known, Mrs. Nevins is desirous of having read into the records of the hearing.

At the hearing held Tuesday of last week, in addition to the statements of J. G. Paine, for the Victor company, representatives of the Columbia, Aeolian and Brunswick companies were also heard. The high lights included the remarks by Attorney Paine, that, speaking solely for his company, they were not against the repeal of the "compulsory license clause" which limited mechanical royalties to two cents a record for each song. As

(Continued on page 108)

Mrs. Simonton Wins "White Cargo" Case

New York, Feb. 23.—Settlement has been reached in the *White Cargo* plagiarism case and a substantial sum will be paid to Ida Vera Simonton, who received a verdict in Federal Court here by Justice Knox to the effect that Leon Gordon had written the show from her book called *Hill's Playground*. The play will continue here, as well as the six or more road companies thruout this country and the two in England.

Fifty per cent of the entire production, royalties and movie rights will be paid henceforth to Mrs. Simonton, asserted Arthur F. Driscoll, attorney for the authoress, and the agreed sum for prating will be turned over to her either Monday or Tuesday of this week.

Verdict for the plaintiff was reached on Tuesday last and it was thought at that time that the play would probably be stopped, as Mrs. Simonton had the right to do so.

Altho Mr. Driscoll said that he was unaware of any sale of the movie rights *The Billboard* learned that they have been sold for \$74,000. This, if correct, will net the authoress \$37,000 more immediately.

National University Of Music Expanding

The National University of Music, established a few years since in the former home of Madame Schumann-Heink, has outgrown those quarters and has purchased for \$55,000 the former home of Thomas E. Casey at 4427 Grand boulevard, Chicago. Mr. Casey, who was once a prominent Chicago politician but now resides in California, presented the school with the furnishings of the place. They are valued at \$20,000.

The Schumann-Heink property has been purchased by Jesse Binga, a Negro banker, for the South Side Community Service, a relief organization, for \$27,000. Possession will be taken May 1.

Pauline James Lee is the president and founder of the musical school. Bessie Hicks is its secretary. The faculty includes some of the most prominent Negro vocalists and musicians.

Clarinet Plays On

Muskegon, Mich., Feb. 21.—A clarinet recently stolen from Oscar Perrault, local musician, is working overtime these days and nights. The thief was arrested in Milwaukee and the instrument found in his possession. He was brought here for trial and the clarinet became "Exhibit A." But Perrault needs the instrument each evening to fill engagements, so it is obliged to work a double shift. He calls for it regularly and each morning brings the instrument back to court under the terms of an agreement made with the chief of police.

SAIL TO JOIN GERMAN CIRCUS



Mrs. Creeping Bear and Chief Black Wolf, both more than 80 years old, posed for the cameraman on the S. S. Deutschland just before sailing recently from New York for Europe, where, in arrangement with Miller Brothers, of Wild West show fame, they are to appear with a troupe of American Indians as a feature of a German circus.

TRIBUTE PAID EDYTH TOTTEN

More Than 2,000 Attend Drama Comedy Birthday Banquet at Hotel Astor

New York, Feb. 20.—More than 2,000 of the 4,000 members of the Drama Comedy assembled in the Grand Ballroom of Hotel Astor at high noon Sunday, February 15, to do homage to Edyth Totten, founder and president of Drama Comedy, with a birthday anniversary on its eighth anniversary.

The Grand Ballroom was decorated apropos to the occasion. Along one side of the spacious ballroom was a long table with Miss Totten presiding and on either side of her were the guests of honor, including Mildred Holland, Pauline deLisser, John H. Judge, Mrs. Judge, Mrs. Clarence Burns, Olive Stott (Gabriel), Muriel Pollock, Russell M. Fanning, Major Edward Havenmeyer Snyder, Nellie Revell, Fay Foster, Lyle Dale Andrews, Mrs. Andrews, Hon. Herman A. Metz, Mrs. Metz, Dennis Cleugh, Sophia Cleugh, Odette Myrtil.

Chief among the speakers was Nellie Revell, whose humorous anecdotes evoked continuous laughter and applause until Nellie becoming more serious made a sentimental, emotional plea for each and every member of Drama Comedy to continue their interest in Dorothea Antel, which brought tears to the eyes of many present. Mildred Holland did likewise in a more modified address, and the same is applicable to each of the other guests of honor, who commended Miss Totten for the organization and growth of Drama Comedy and its stimulating activities in the interest of the stage plays and players.

Prior to the addresses the reception committee had marshaled 94 hostesses including Mrs. Elizabeth Ashley, Mrs. Wm. Attridge, Mrs. E. R. Appleton, Paula Allen, Mrs. Harry P. Brearley, Mrs. Ella Bosworth, Mrs. E. R. Birkins, Mrs. Jennie Bloom, Mrs. F. F. Brady, Mrs. S. M. Bundy, Mrs. Blanche Bohrow, Mrs. H. R. Buckye, Mrs. L. Brown, Mrs. Kathryn Bohlen, Marie Cordes, Mrs. Mary Cole, Mrs. George Cozine, Mrs. H. B. Clarke, Mrs. J. M. Carples, Mrs. Ida Custer, Mrs. Ida Cohen, Mrs. Minnie Cohen, Mary Sadie Dolan, Pauline deLisser, Mrs. W. A. Dibbs, Mrs. Charles Dierlich, Katherine Noack Fluke, Russell M. Fanning, Mrs. H. K. Fruhauf, Carl Figue, Mrs. Oscar Gemunder, Mrs. DeWitt C. Gedney, Mrs. Elizabeth Gubitz, Mrs. Max Greenwald, Mrs. Kurt Gloeckner, Mrs. Anton Hilbert, Mildred Holland, Mrs. C. W. Jhane, Mrs. Florence Hargrave, Robert G. Hargrave, Mrs. Louis Helm, Mrs. Laurel Holzman, Mrs. Fanny Henning, Mrs. Sarah E. Hunter, Mrs. Paul H. Junghans, Bethel Johnson, Mrs. Joseph Josephs, Imogene King, Mrs. C. S. Jackson, Mrs. Jack W. Loeb, Elizabeth Kingston List, Mrs. Otilia Laung, Mrs. Bertha Lawson, Mrs. Madeline Levy, Mary Curtis Martin, Emma Maak, Mrs. W. R. Mearns, Mrs. M. S. Millar, Mrs. A. B. Melledge, Mrs. Selig Mayers, Mrs. John I. Meslek, Mrs. Isaac Mayer, Sadie Macdonald, Mrs. W. H. H. MacKellar, Mrs. Dora McDonald, Mrs. E. J. Oakes, Mrs. Sydney Ollendorf, Mrs. A. J. Pennell, Mrs. Hyman Parker, Mrs. Florence Rhoades, Mrs. Belle Rosenthal, Mrs. Madeline Reber, Mrs. W. F. Randal, Mrs. Nat C. Strong, Mrs. A. H. Sarasohn, A. Marla Schaffer, Mrs. Lucy Singer, Mrs. Alvina Schaefer, Edna Mae Stocker, Mrs. E. Strasburger, Mrs. J. Seligman, Helen Watson Sothorn, Mrs. Florence E. Shomo, Jules Seligman, Mrs. Mae Taylor, Edyth Totten, Dr. Frances Thornton, Mrs. W. L. Wagner, Mrs. W. W. Willmot, Mrs. R. J. Walsh, Mrs. Wm. Webb, Mrs. Clara Wuthe, Mrs. M. S. Titus-Werner, Mrs. P. N. Yonke.

Each hostess was accompanied by nine guests. In addition to the 54 tables in the Grand Ballroom, with 10 at a table, there were fully 50 tables of 10 each on the mezzanine floor overlooking the ballroom. With the banquet ended, the tables were removed and chairs filled the ballroom and mezzanine floor for the accommodation of the audience for the entertainment on stage.

Carl Figue, musical director of Drama Comedy, opened the entertainment with a piano recital that was really enthralling. Victor M. Boyhart followed with selections from *Pagliacci*, followed by *Nothing Matters* and *Maudslayi*. By special permission of the Shuberts, Odette Myrtil sang *Military Men I Love*, from *The Love Song*, now running at the Century Theater. Dennis Cleugh produced the presentation of a scene from *The Way of the World*, by William Cosgrove, now being presented at the Princess Theater by Bruce De Lette, under the stage management of Mr. Cleugh, cast viz: Marie Russell as Lady Wishfort, Sophie Wilds as Mrs. Marwood, Jeanne Owen as Foible and Margot Andre as Peg.

Achille, impersonating Mary Garden, singing *Memory Lane*, *Samson and Delilah* and *I Love You in French*, with Ida Benedict at the piano, fully merited the accolades given singer and songs and revealing a big surprise on bewigging and revealing himself as a handsome maseuline. Muriel Pollock accompanying herself at the piano proved title to "Queen of Jazz" in her instrumental vocalism. Mildred Holland with Fay Foster at the piano, in a dramatic recitation of *The Americans Come*, reminded us of the days when Miss Holland held her audiences en-

(Continued on page 108)

Jefferson Memorial Window Dedicated

Representatives of Church and Theater Participate in Services at "Little Church Around Corner"

New York, Feb. 21.—Another chapter in the history of the unting the bonds of friendship between the church and the stage was written yesterday at the Church of the Transfiguration, 1 West 29th street, internationally famous as "The Little Church Around the Corner," when a memorial window to Joseph Jefferson, who gave it that name, was unveiled and dedicated. Representatives of the clergy, theater and laymen attended to pay tribute to the actor famous for his creation of Rip Van Winkle on the 56th anniversary of his birth. Services were conducted by the Rev. Randolph Ray, rector, with Bishops Suffragan, Lloyd and Shipman participating. More than 1,200 people attended and heard addresses by Chas. A. Stevenson, of the Lambs' Club; Frank Gilmore, of the Actors' Equity Association; Henry Chesterfield, of the National Vaudeville Artists; the Rev. Canon Inwelly, of the Liverpool Cathedral, and John Drew, one of the few living contemporaries of Jefferson.

Metropolitan O. H. Orchestra Wants \$16 Increase on Week

New York, Feb. 23.—Claiming that their work which consists of seven days a week with two or three matinees and four and five rehearsals prohibits them from sideling that other symphony orchestras are getting, a committee of four men representing the Metropolitan Opera House Orchestra met Edward Ziegler, orchestra manager, and asked for an increase of \$16 a week. The men at present are getting \$88 a week and the increases that they want would bring their weekly stipend over the \$100 mark. Josef L. Maire and Simone Mantia, of the orchestra, and Edward Canavan and James Lawman, of Local 502, American Federation of Musicians, made up the committee. The discussion lasted for more than an hour and a half and while there was no settlement reached, Chairman Canavan asserted that he expected a compromise in the situation would be forthcoming before very long. Due to the fact that this orchestra has so varied a program from that of other symphony orchestras and that it has so much work on its regular schedule, it was not included in the recent bargaining of the Philharmonic Society and is allowed to make its own terms for contracts.

Motion Picture Stars Attend New York Charity Carnival

New York, Feb. 21.—Attracting both screen stars and society folk, the second annual motion picture carnival held at the Plaza Thursday evening was a pronounced success. The function took place under the auspices of the Film Mutual Benefit Bureau for the benefit of seven charitable organizations. The inaugural feature of the evening was the world premiere of *Grass*, being distributed by Famous Players-Lasky. A review of the picture will be found in the motion picture department of this issue. The excellent special musical score for the film was prepared by Jimmy Bradford, who conducted the orchestra. A tango competition was a pleasant entertainment number. Among the silversheet people present were: Babe Daniels, Richard Barthelmess, Mary Hay, Flora La Breton, Virginia Lee Corbin, Lenore Ulrich, Victor Hugo Halperin, Lambert Hillier and Bobby Williams.

Attaches Actress' Salary To Satisfy Judgment

New York, Feb. 22.—On order of City Court Justice Callahan the salary of Gertrude Vanderbilt, now hostess at the Club Artists on Upper Broadway, has been attached to satisfy a judgment of \$82,750 secured against her last fall by Peter Grimm, real estate agent, who at the time alleged this amount due him as commission in selling the actress' house for \$10,000. William A. Farrell was appointed by the court to collect Miss Vanderbilt's salary and discharge the debt.

How Shaw Stands in Burlington, Vt.

New York, Feb. 21.—The following displayed advertisement is copied verbatim from a Burlington (Vt.) newspaper of recent date:
PLAYHOUSE
Thos. A. Boyle, Mgr.
Burlington Theater Club, Inc.
Presents
The New York Success "CANDIDA"
Under Auspices of Rutland Woman's Club
Evidently George Bernard Shaw doesn't mean much in the life of Burlington's theater fans.

Hotel McAlpin Opens Broadcasting Studio

Many Theatrical and Newspaper Notables Take Part in Opening Program

New York, Feb. 23.—Still another broadcasting station was added to the large number already in this city when the Hotel McAlpin opened its own broadcasting studio last night, under the call letters of WJCA. The station has been testing for the past few weeks under the test letters of 2X11. It operates on a 428.6 meters wave length, making it one of the most powerful in the city. Many theatrical and newspaper notables attended the opening and did bits for the program. Among them were: Irving S. Cobb, Harry Hirschfeld, Walter Catlett, Ed Squires, Harry Archer, John P. Medbury, Constance Morling, Louis John Bartels, Franklyn Bauer, Holbrook Blinn, Countess Peggy Hopkins Joyce Morner, Al Plantadosi, Louis Baye, Joe Meyers, Joe E. Brown, Martha Pryor, Harry Puck, John Burke, Earl Carroll, Vladimir Radeff, Florence Richardson, John Carroll, Eva Clark, Henry Clark's Hawaiians, Don Roberts, Carson Robison, Milton Sills, Walter Donaldson, Josephine Davis, Harry Fox, Cliff Edwards, George Gershwin, Olga Steck, Abner Silver, Duncan Sisters, "Rube" Goldberg, Nell Brushingham Starr, Marguerite Sylva, Harry Von Tilzer, Ernie Golden and Bead, Harmon's Cinderella Orchestra, Milt Gross, Mary Hay, Edna Hubbard, Johnny Hines, Lou Holtz, Henry Hull, Madge Kennedy, William Kent, Fay King, Geo. McManus, Nydia Westman, Sierld Holmquist, Fred Klein, Jimmie Murphy, Wynny's Orchestra, Mary Young, Yerkes' Happy Six, Louis Wolheim, Kenneth Webb, Maj. J. A. White, Milton Wallace, Genevieve Tobin and Dolores Cassinelli.

Hear Charlie Chaplin Suit

Los Angeles, Feb. 21.—The suit of Charlie Chaplin to restrain Charlie (Ap- lin) Amador from alleged imitations was the feature attraction here yesterday before Judge R. F. Hudson. Joseph Pazen, old-time reviewer and a witness for the defense, testified, declaring that a famous French actor in St. Louis in 1905 antedated Chaplin with pants, cape, mustache, custard pies, flat feet, the street corner reverse glide and leaping eyebrows. "It was that famous old French tramp character which Chaplin picked up and which was known since 1890 by the Frenchmen's name, 'Pogens,'" Pazen asserted. Chaplin's witnesses testified that they had never heard of the man in question. C. L. Yarbey, former advertising manager of First National, said he handled the \$1,000,000 advertising campaign which made Chaplin an "international myth for two generations." Charlie testified that he got his famous waddle from an old London cab driver.

March King in Havana

Havana, Feb. 19.—John Philip Sousa, famous American band leader, and his wife and daughter are now in Havana. They are taking a trip down the island on the special Pullman train de luxe, which runs from Havana to Santiago three times a week especially for the tourists. Sousa was entertained by Judge Landis, who is also visiting in Cuba. Prof. Sousa is now working on his *Cuban Suite*, which will be one of the features of his coming 33d annual tour. The Suite is divided into three movements—1875, 1893 and 1925. The 1875 movement gives his impressions of Cuba under Spanish rule; that of 1893 employs the American regime under General Wood, with a bar or two of a "hot time," which is heard making its first influence on Cuban music. The last movement shows the composer's reaction to Latin-American jazz. Both the judge and the March King are enjoying their visit immensely.

25,000 Oppose Sunday Closing

Indianapolis, Feb. 21.—The desk of Russell V. Duncan, chairman of the House Moral Committee of the Indiana Legislature, is piled high with petitions bearing hundreds of names of persons opposed to the Kissinger Sunday blue-law bill. Duncan said the petitions contained approximately 25,000 names. It appears that friends of the theater can be rallied to the support of Sunday theaters if necessary.

Chicago Box-Office Men's Biggest Ball

Guests Number More Than 1,500 ---Net Profits Will Go to Sick and Benefit Funds

Chicago, Feb. 21.—The boys who sell you your tickets at the windows with the funny gratings at the theaters held their annual ball at the Hotel Sherman Thursday night and it was the biggest social success that the Treasurers' Club has yet achieved. There were more than 1,500 guests and the total receipts of the affair will exceed \$6,500. The net profits will go to the sick and benefit funds which the box-office men have formed. Movschine's Orchestra of 20 pieces furnished the music for the evening. Dancing started at 11 o'clock and continued until the black shadows of the streets began to turn gray. Stars and noted actors were there from all over the Loop-theatrical district. They came and went according to their individual bents and it was hard to keep track of them all. Among the lateststayers were: Louise Groody, Charlotte Greenwood, Skeets Gallagher, Myrtle Schaaf and Lester Allen. The Tiger Room, Rose Room, Crystal Room and every guest room on that floor were in use by the folks who came to join the treasurers in a good time. Leslie Wilcox, president of the Treasurers' Club, was in charge of the entire undertaking, with Carl Randolph chairman of the committee on arrangements. Besides Mr. Wilcox, the president of the club, other officers are: James Sheehan, vice-president; C. E. Wilder, treasurer; Louis Winkelman, financial secretary; T. J. Maloney, recording secretary, and Leon Berzaniak, club counselor. The members of the club are planning on more social events to follow Thursday night's success, announcement of which will be made later.

New York Picture Reviewers Have Another Studio Party

New York, Feb. 21.—Studio parties are having a tremendous vogue in Gotham. Ivan Abramson stepped into this variety of social activity yesterday afternoon when he entertained a number of newspaper, fan magazine and trade-paper reviewers at the Peck-Art Studio on West 44th street. In addition to an excellent repast, the menu of which was diversified to an amazing degree, Bee Jackson, of Club Kichman, pleased with the Charleston. Another division was watching the shooting of scenes in *Living Wines*, the principals being on hand to participate in the party. In the cast are Clara Kimball Young, Madge Kennedy, Edna Murphy, Niles Welch, J. Barney Sherry, Richard Bennett, Lita Lopez and others. Those who remained late into the afternoon observed pretty Miss Murphy do a stairway scene with Miss Young, concluding with a realistic but brutal fall down several steps. Arrangements for the party were in charge of David Bader, who was voted expert in the matter.

Beauty Enters Movies

New York, Feb. 21.—*The Hazel Wolf* will mark the screen debut of Hazel Goodwin, of Syracuse, international beauty contest winner, and also the entrance of Duane M. Mowat, formerly cinematographer with the late Thomas Ince, into the production field. The cast, which is now being assembled, will go to Quebec soon to shoot the exterior scenes of the actual scene of the story, written by Mr. Mowat. Interiors will be made at some studio in New York City. Mr. Mowat has invented a new system of lighting which he will use in filming his initial venture. He finds it more effective than arrangements in current usage and, at the same time, more economic and less difficult for the players to face.

Jeffery Theater Is Newest Of South-Side Film Houses

Chicago, Feb. 21.—The Jeffery Theater opened last week and is the south side's newest contribution to film exhibition. The house, which seats 2,000 and is located at 71st street and Jeffery avenue, is modern thruout. Its walls are inlaid with wood fiber as an aid to acoustics. Jacques Beaucalre, formerly with Graumann's Million-Dollar Theater, Los Angeles, has an orchestra of 20 pieces, and stage presentations are built up around the feature films. The theater is under the management of Lou M. Goldberg, with Vernon C. Weaver assisting. Peter Pau, with Betty Bronson, was the initial film.

Hines Paid in Full

New York, Feb. 22.—Dixie Hines, press agent, who entered suit in Municipal Court against Desiree Lohowska, Russian dancer, now in vaudeville, for the recovery of \$335.51, \$200 of which represented loans and the balance press work done for her when she rented the Greenwich Village Theater for a recital, was awarded judgment in full last week.

Actors' Equity Now in New Quarters

New York, Feb. 23.—Equity members, take notice! The Actors' Equity Association is now in its new spacious quarters at 45 West 47th street. Moving started on Saturday, with the final load of paraphernalia being transported today. The association's headquarters were formerly at 115 West 47th street, but due to the excessive rent the landlord demanded when its lease drew to a close the officials of the organization decided to buy a building and free themselves from any further exorbitant rent. The new building is a five-story and basement structure that runs approximately 100 feet deep by 50 feet in width. It is suitable in every way for the association's needs, as there is plenty of light and ventilation.

Concert Singer Seeks Damages for Arrest

Iva Josephine Rider Sues Art Dealer, Alleging Malicious Prosecution and Conspiracy To Defame

New York, Feb. 22.—Suit for \$250,000 damages, alleging false arrest, malicious prosecution and conspiracy to defame her name, has been brought in the Westchester County Supreme Court by Iva Josephine Rider, concert singer and interpreter of Indian folk songs and dances, against George H. Ainslie, Fifth avenue art dealer, who lives at Ardsley-on-the-Hudson. Miss Rider is also known by her Indian name, Princess Atalie Unkahunt. The suit is the result of the singer's arrest last October on a charge of grand larceny in connection with the disappearance of a number of valuable household items from the home of the art dealer, which Miss Rider occupied for a time last year as companion to Ainslie's daughter, Lucie Ainslie Benedict. It was the art dealer's daughter who preferred the charges against the concert entertainer, later dismissed for lack of sufficient evidence. Mrs. Benedict is named codefendant in the suit with her father and Fred Cross, a private detective. The complaint, filed thru Miss Rider's attorney, Thomas J. O'Neill, sets forth that the unfavorable publicity attendant upon the grand larceny charges against her caused her cancellation of a contract for a 40-week concert tour of this country at \$1,000 a performance. In the papers it is also alleged that the apartment of the plaintiff in the Hotel Waldorf was entered without a search warrant or other legal process and that articles declared to have been missed were planted there and Miss Rider declared to have stolen them. It is further alleged that after charges against her had been dismissed the Ainslies endeavored to have her indicted, but with no success. These acts were prompted by a malicious desire to harm her, the complaint continues.

Templeton in "Sky-High"

New York, Feb. 21.—Mercer Templeton, appearing this week in a vaudeville act at the Palace Theater, has been engaged thru James Dealy to replace James Liddy in the new Willie Howard musical comedy, *Sky-High*, which is playing a few weeks out of town preliminary to opening at the Shubert Theater the first week in March. Templeton's last musical comedy appearance was in *Sitting Pretty*. Liddy is expected to go with the Boston company of *The Student Prince*, now being organized by the Shuberts.

Green Room "Rag" a Success

London, Feb. 21 (Special Cable to The Billboard).—The Green-Room Club "Rag" held last Sunday proved a thoroughly enjoyable entertainment pow-wow, with Oscar Ashe as Chief Ragpicker and numerous actors and actresses assisting in a varied bill of sketches and musical items. This is the first "Rag" wherein ladies of the profession have appeared and their inclusion added greatly to the evening's success.

Billie Quinn Engaged

New York, Feb. 21.—Billie Quinn has been engaged thru the Georgia Wolfe office for a part in J. M. Barrie's *The Little Minister*, which Charles Dillingham is expected to put into rehearsal next week.

Jewish Actress Ill

Mme. Bertha Kalleh, playing in the *Kreutzer Sonata*, was taken ill suddenly at Chicago and will be unable to continue her tour for several days. The *Sonata* is being presented in Yiddish.

ETHEL LEGINSKA GIVES FIRST CONCERT SINCE DISAPPEARANCE

Famous Pianiste Declares Nervous Breakdown Caused Her To Disappoint New York Audience---Wrote Concerto While Secluded With Friends

NEW YORK, Feb. 23.—Ethel Leginska, concert pianiste, who also acquired fame as the only woman symphony orchestra conductor, resumes her concerts tonight in Joplin, Mo., the appearance being the first since her sudden disappearance on the night of January 26, when a capacity audience waited in vain for her appearance at Carnegie Hall.

Coogan Film Plus Vaude.

New York, Feb. 23.—Contrary to the usual custom Jackie Coogan's latest film, *The Rag Man*, "opened cold" today at Loew's State, this city, and Loew's Metropolitan in Brooklyn. Usually the Capitol has the initial display of Metro-Goldwyn features, but owing to the fact that spring is approaching and the Capitol's program is heavy it was decided to run it in Loew's houses along with vaudeville bills.

Bit of Realism Shown When Noose Tightens on Itow

New York, Feb. 23.—The matinee audience at Keith's 81st Street Theater Friday saw a bit of realism when Michio Itow, Japanese, featured in the Fokine Ballet playing there, nearly hung himself in a dance which required a noose around his neck.

Itow essays the role of a harlequin in love with three pretty women. Gloom overcomes him when Immortal Pierrot wins them away, and he hangs himself, to be later released by the girls. When he slipped the noose over his head and swung himself in the air it tightened up and he began to strangle. The girls came to his aid, however, and injuries he suffered from the incident were little beyond shock.

Engaged for Shubert Shows

New York, Feb. 21.—The following engagements for Shubert musical attractions have been effected thru James Dealy:

James E. Phillips, last seen in *Innocent Eyes*, and Mary Bay, a toe dancer in the latest *Music Box Revue*, for the Chicago company of *The Student Prince*, opening at the Great Northern Theater tomorrow.

Frank Cuthbert for the Boston company of *The Student Prince*, now in rehearsal.

Viola Heggli, toe dancer, for the *Blossom Time Company*, now playing in Philadelphia.

Virginia Watson, Joe McCallion, Leo Henning and Rose Kessner for *The Charm School*, now in rehearsal.

Stage Setting Falls

New York, Feb. 23.—Immediately following the final curtain of *The Rat* at the Colonial Theater Saturday night part of the setting fell to the floor, narrowly missing Toddie Gerard, Wallace McCutcheon, Martin Jones, Jr., and Lucille Upton, who were on the stage at the time.

Robert Edgar Long, press agent, and Harry Gorta, electrician, were standing near the scene when it collapsed, and they shouted a warning in time for the players to escape injury from the falling flats and lamps.

Theoria Entertains

New York, Feb. 21.—The Theoria, Mrs. Harold George Wood, president and founder, held its monthly meeting at the Hotel Astor February 18. The guests of honor were Genevieve Tobin and Henry Hull, stars of *The Youngest*, at the Gaiety Theater. The matinee which followed was the comic opera *Natja*, at the Knickerbocker Theater.

An Easter breakfast was given by Theoria to its members and guests, followed by a matinee, the entire theater being reserved for the occasion.

Salvini To Tour U. S.

Rome, Feb. 23.—Gustavo Salvini, actor and son of the late Tommaso Salvini, famous Italian tragedian, is getting together a company with which he will tour the United States beginning next October and remaining until the spring of 1926.

Salvini has played much in Italy and has also toured in South America.

S. W. Clauson Goes To John Robinson Circus

Chicago, Feb. 20.—S. W. Clauson, a newspaper man of Madison, Wis., has been engaged as press agent back with the John Robinson Circus.

Miss Leginska, for the first time, gave her version yesterday of how she vanished several weeks ago. It came thru a friend with whom she has been living. According to this friend, Mrs. Dorothy T. Bartholomew, the story is as follows: "I left my apartment the night of the concert to look for a taxicab. If I had found one right away I probably would have gone to the hall automatically, but as I slipped thru one dark west side street after another the world grew hazy and unsubstantial. I must have walked for about two hours like this. I have no recollection of becoming unconscious if I did and have no idea where I went. It was like being intensely preoccupied and then coming to with a start without being able to recall what you were preoccupied about. The thing which brought me to with a start was the sudden realization that the concert must be over.

"I felt desperate. I found that I had walked far downtown in Manhattan, and I did not have a cent of money with me. I remembered that some friends lived nearby, and I walked miserably on to their house. I told them that everything was over—my career, my work, my life—everything. I must have been badly hysterical. I told them that the one thing I could not bear was to be found. They gave their word to tell no one and kept it.

"I could hear music singing in my head. I asked for paper and sat down at my friend's piano and wrote. My friend's wife had been a nurse and understood the condition I was in. No one spoke to me. Food was brought to the piano and I ate it with one hand. At last much of the music in my head had been set down. I felt better and I knew I could face people again. On the second day I remembered that people must be worried and must be searching for me, so I telephoned my secretary, Lucille Oliver. I was persuaded to go to the home of another friend, who lives near Boston, where there was air and sunshine.

"I went directly to the train and from the train to my Boston friend's house. My clothes were sent to me. I returned to New York to Mrs. Bartholomew's apartment last Sunday night. While I was outside of Boston I finished my piano concerto. I think it is going to be very nice. I am sorry I disappointed my audience. I beg their forgiveness. I ask them to remember the 10 years I have kept faith with them. I had an utter nervous breakdown. I had worked too hard. I want to write music. I am willing to give all the rest of my life in saying in music what is in me."

Awarded \$2,053 Judgment

New York, Feb. 22.—The second judgment given Jay Gorney and Owen Murphy, who wrote the music and lyrics of the musical *Top Hole* and who sued the management of the attraction for royalties, was rendered in the City Court last week, when a verdict of \$2,053 was awarded.

The music writers alleged the producers of *Top Hole* had not paid them two per cent royalties due on \$100,000, representing the gross from October 13 to December 27, last year. In the first suit brought on similar grounds the authors won a verdict of \$926.04.

Court Approves Theater Sale

Indianapolis, Ind., Feb. 21.—Sale of the Capitol Theater property at Clinton, Ind., a part of the Consolidated Theaters and Realty Company, for \$47,000 has been approved by the probate court in Indianapolis. The purchaser, Hulbert M. Ferguson, of Clinton, said he was not in the theater business and did not intend to operate the property. He said he was buying for other persons, but did not disclose their names. In buying the property he assumed more than \$8,000 in unpaid taxes.

Give Censor Banquet

Albany, Feb. 21.—Albany women Democrats last night tendered a supper to Mrs. Elizabeth V. Colbert to celebrate her appointment to the motion picture commission. Political dopsters had Mrs. Sara Friedman, of the Bronx, picked for the place.

Friars' Frolic March 8

New York, Feb. 23.—The Friars' Club will hold its annual public Frolic at the Manhattan Opera House Sunday, March 8. Work on the show and the souvenir program is being started this week.

BILLY MAINE



This is the character Mr. Maine portrays in "The Dumbbell", a new play, produced by Col. J. L. Davis, that is meeting with success in the Middle West. The music for the piece was supplied by True Fristoe.

Indiana "Blue Sunday" Bill Advanced to Second Reading

Indianapolis, Ind., Feb. 21.—Bleached to a somewhat lighter shade thru an amendment submitted by its author, the Leonard "Blue Sunday" Bill in the Indiana Senate has been advanced to second reading. As amended, the measure would place Sunday regulation of moving picture shows, theatrical productions and the manufacture of necessary commodities on a local option basis. The bill itself is regarded as a compromise measure to satisfy the proponents and opponents of a stricter Sunday regulation. It is in the nature of an amendment to the present Sunday observance law.

"This is strictly a moral bill and not a religious measure," said Senator Leonard, "and should meet with the approval of all concerned."

The amendment as offered by the author and adopted by the senate would exempt moving picture and legitimate playhouses from the provisions of the existing law, but also would provide that such might be regulated by ordinance by cities and towns in accordance with the general sentiment of the communities concerned.

The amendment also provides that in cases where prosecuting attorneys fail to act in enforcing the law the attorney general may prosecute. As originally drafted the bill stipulated that the attorney-general "shall" act.

The Kissinger "Blue Sunday Bill, which was introduced in the House, is ready to be handed down for second reading, but it is understood action on it will be withheld pending the outcome of the Leonard Bill.

Orchestra Celebrates Max Dolin's Anniversary

San Francisco, Feb. 23.—This week marks the first anniversary of Max Dolin's advent as leader of the California Theater orchestra, for which a special program is being rendered.

Coming here early in 1924 on a tour of the Orpheum Circuit he established himself with the patrons of good music and was given an opportunity to wield the conductor's baton at the California, which he accepted and later entered into a contract with the management. As a conductor-violinist Dolin has made good here.

"Blue Peter" Is Stagers' First Production

New York, Feb. 23.—The Stagers, a group of players formed by Edward Goodman, will present *The Blue Peter*, by E. Temple Thurston, as their first production at the 52d Street Theater, opening about the middle of March. The play has been successful in London.

P. W. L. Get-Together

New York, Feb. 20.—The Professional Women's League, Mrs. Russell Bassett, president, held a "Get-Together" at the League Rooms, 56 West 53d Street, February 16. Miss Sarah Truax was the guest of honor.

The league gave a theater party the evening of February 19, attending a performance of *My Son*, Mrs. Martha Stanley's play at the Nora Hayes Theater.

Decision Revives Carmen-Fox Suit

Actress Wins Point in Action To Collect \$43,000 in Contract Interference Claim

New York, Feb. 23.—The suit brought by Jewel Carmen to recover \$43,000, alleged to be due her as damages from the Fox Film Corporation for alleged malicious interference with a contract she had with the Frank H. Keeney Pictures, Inc., was given a new lease of life last week when the Appellate Division of the Supreme Court handed down a decision reversing the action of the lower court which had denied her motion to strike out a defense that her complaint was insufficient in law. Miss Carmen's action against Fox began seven years ago. In the United States District Court, when she was one of the most sought after youthful screen stars.

She had a five-year contract with the Fox Films, but broke it to sign with Frank Keeney, at a large increase in salary, declaring that she entered into the Fox contract when she was a minor and for that reason it was null and void. Fox protested to Keeney against employing Miss Carmen, and Keeney, threatened with legal action in the event he carried out the contract, refused to employ her. Whereupon Miss Carmen brought an injunction and damage suit in the United States District Court and won a judgment against the defendant for \$43,000, the amount she claimed.

The case was taken to the United States Circuit Court of Appeals, where the judgment was reversed and decision in favor of the Fox Film Corporation was handed down. The decision also administered a scathing rebuke to Miss Carmen for coming into a court of Equity with "unclean hands" and pleading on one side that her contract with Fox was void because she had been a minor when it was made and on the other side that she was entitled to damages against Fox under the contract. Miss Carmen's attorneys went to the United States Supreme Court and asked for a writ of certiorari, but it was refused. They then started action in the New York Supreme Court against Fox Films for \$43,000 damages. The Appellate Term, where the case is pending, refused to strike out part of the defense submitted by the Fox Film Corporation alleging that the complaint did state sufficient facts of law to make out a case. This has now been reversed, which puts the case on the calendar for trial.

Theater Ordered Sold

Bridgeport, Conn., Feb. 21.—An order for foreclosure by sale was signed this week by Judge John W. Banks, of the Superior Court, in the case of the Security Mortgage Company against Peter Dawe. The property, which is to be sold February 23 to pay off a mortgage of \$70,000 with interest, comprises the former Dawe Theater on State street, now known as the Cameo, and operated by the Universal Film Company as a first-run house on a lease.

Revue Draws Big in Cuba

Havana, Feb. 19.—A French company by the name of BaTaClan has just finished a successful 10 weeks' tour of Cuba, playing one of the largest theaters in Havana with a \$10,000 house the opening night. The box-office receipts for the 10 weeks amounted to \$134,000, the company taking \$60,000 as its share. The show was a girl revue with performers numbering 50. It is now in Mexico, where it is booked for nine weeks before a return Cuban engagement.

Singer Undergoes Operation

Dallas, Tex., Feb. 21.—Guy Massey, well-known singer and vaudeville artist of Dallas, and vaudeville partner of Bobby Burns, Dallas boxer, underwent an operation in a local hospital last week. His nose was afflicted and interfered with his singing. Massey once sang with Caruso in New York and has appeared in leading theaters of the country.

Portland Theater Sold

Portland, Me., Feb. 20.—The Elm, a picture house, has been sold to the State Theater Company, of which Abraham Goodside is the principal owner. Goodside also is owner of the Empire, another picture house here, and leases the Strand, which also plays pictures, and the old Jefferson Theater, which houses road attractions.

Havana Theater Proposed

Havana, Feb. 20.—Centro Asturiano, one of the big Spanish Clubs in Havana, whose clubhouse, covering a whole block, recently burned, is again building and the association has received a proposal from the Suenger Amusement Company to build a theater in connection with the clubhouse.

Pulpit Fights Loose Morals of Theater

Dr. John Roach Straton Charges Commercialism Is Basis of Play Evils

New York, Feb. 23.—From practically every pulpit in the city yesterday came echoes of guns fired during the past week in the crusade for the purification of the stage. Rev. Doctor John Roach Straton, who recently debated morals of the stage versus morals of the church with William A. Brady, attacked the producer for his subsequent presentation of an objectionable play. Doctor Straton charged that a commercial basis was the root of all evil in the theater, which needs regeneration instead of reform, and added that next Sunday he would give some startling facts proving moral degeneracy of the times and tracing this tendency directly to the theater and movies.

Chief Magistrate McAduo, who occupied the pulpit at the morning services of the Church of Holy Communion, said that New York theaters have adopted morals of the sewers, and that many of the plays now being presented are disgraceful prostitution in the name of art.

The Rev. Dr. Christian P. Reiser deplored the appearance of fine actors in plays depicting excusableness of worst moral lapses and naturalness of illegal relations certain to wreck society and poison humanity.

Dr. Charles Francis Potter said that it is a singular commentary on change of leadership in moral and philosophical matters that the theater has for many intelligent people taken the place of the church, and that it is necessary to talk about the theater to get people to come to church.

"In a way I am glad the theaters are taking the leadership away from the church," Dr. Potter said, "for they are teaching the churches a method. Most church people shut their eyes to the facts of life. The modern theater is starkly realistic and therefore repugnant to those who think that to be blind is to be moral. But the danger lies in the fact that some producers will present plays that are sensual and profane purely for commercial reasons."

The Rev. Dr. J. Lewis Hartsook declared the only thing that can effectively purge the theater is a revival of the artistic spirit against the commercial.

Bishop Manning also attacked Brady and other producers of alleged filthy plays. Louis Wolheim, who plays the leading role in *What Price Glory*, speaking over the radio, said that the dramatic drycleaning by the police department is ridiculed, and that the public should judge the plays on their power and their truth to the realities of life. Wallace Ford, leading actor in *Pigs*, spoke at the Chelsea Methodist Church on the subject of cheap plays.

Busiest Actor

New York, Feb. 23.—The actor who probably has less time to himself than any other now appearing on the New York Stage is Frank H. Wilson, a Negro who is appearing in the leading role of *The Dreamy Kid* at the 52d Street Theater, a one-act play which is given as a curtain-raiser to *The Emperor Jones*.

Wilson is a mail-carrier by day, and is attached to the College station, 140th street and Eighth avenue. He lives at Corona 1, L. I. When he is on early duty, it is necessary for him to leave his home at 4 a. m., and when on his late shift at 6 a. m., in order to get to work on time. When he gets thru delivering mail he leaves the post office for the theater, does speaking parts and bits in two plays, and leaves for home shortly before 11 at night and gets to bed after midnight. Still he has shown no signs of fatigue other in his mail delivery or his acting.

Olive Bernard for Vaude.

New York, Feb. 23.—Olive Bernard, daughter of the comedian, Sam Bernard, who entered the profession last season, has returned to New York after playing in Havana, Cuba. She will open a tour of vaudeville shortly under the direction of H. B. Collins.

Collins is also presenting Moss' Bears in vaudeville. The bears have been playing fairs in the South all winter and are now breaking in the vaudeville act up State. They are due to appear in the New York houses shortly.

Here, Puss! Here, Puss!

New York, Feb. 23.—Leona Stephens, of Stephens and Hollister, has organized what is known as the "Cats", including among its members many prominent vaudeville artists. The nature of the organization and its purposes are not divulged.

"Son Dodger" on Pan. Time

New York, Feb. 23.—Charles R. Madge's production act, *The Son Dodger*, has been taken over by B. Murphy for a tour of the Pantages Circuit, on which it is now appearing. The offering has a new cast.

Irish Censors Reject Many American Films

Dublin, Feb. 23.—Many American super-feature films are being banned in the Free State, much to the dissatisfaction of the Irish exhibitors. A delegation from the industry recently went to London to interview James Montgomery, the Irish censor, and Prof. Magennis, a member of the Free State Appeal Board, and were informed that the commission will turn down all pictures dealing with sex and propaganda films of anti-social or anti-Christian character. Magennis contends that the Free State has the right to choose the pictures to be displayed in South Ireland.

Ban Placed on Sunday Dancing

Spokane, Wash., Feb. 20.—Sunday dancing in this county, except in incorporated towns not including Spokane, will not be permitted in the future, the county commissioners have decided. The unusual spectacle of amusement men dividing each other was seen at the final hearing when the resort, lake shore and other out-of-town dance managers were opposed in their efforts to continue Sunday business by the Spokane managers, who have not been permitted to operate on Sunday. The commissioners' decision will have a marked effect on resort business this year. In the past the lakes, for which the district is well known, have drawn practically all Sunday business away from the theaters and city dance halls and Natatorium Park, all within the city limits. With the dancing conditions now equal a scramble for new attractions is already under way.

\$10,000 Suit Is Ended

Spokane, Wash., Feb. 20.—The \$10,000 suit against Ralph Pollock, who has an extended contract with the Liberty Theater here, brought by Francis E. Woodward, music teacher, for alleged "mutilation of the classics", has blown over. Little likelihood of a favorable verdict was believed to be the reason by Woodward's latest action. "I have accomplished one thing," said the professor, "and that was to bring down a storm of protest against jazzing classic music and the works of the old masters." Some in Spokane believe this was one of the crack publicity stunts of the season. Regardless of the motive, it brought national publicity to the case.

New Loew House for N. O.

New Orleans, Feb. 21.—The Canal Realty and Improvement Company, erecting the new Loew Theater, is composed of the Erlanger, Loew and Saenger interests. Approximately \$1,000,000 will be expended on the structure, which includes the theater proper, stores and offices. The theater, which has been named the State, has been leased by Marcus Loew, who alone will control its policy, the Erlanger and Saenger interests taking their profits from the rentals which accrue.

Municipal Theater Pays

Lancaster, Wis., Feb. 20.—The management of the Grantland Theater has turned over \$1,000 to the city treasurer, who was short of funds. The theater was dedicated just a year ago and has proven a good investment.

Aged Musician Injured

New Orleans, Feb. 20.—John Almhoren, 67, a well-known local musician, was severely injured last night, the result of being hit by a motor truck. He is a member of the musician's union.

Cleveland May Get Convention

Cleveland, O., Feb. 21.—The annual convention of the National Association of Masters of Dancing, scheduled for this summer, may be brought to Cleveland.

Cooper's Big Gross

The Jimmy Cooper Show, Columbia attraction, it is learned from a good source, did a gross business of approximately \$17,500 at the Gayety Theater, Pittsburgh, Pa., February 9 to 14, and \$13,500 the week previous at the Gayety Theater, Washington, D. C.

McCormack Saved From Sea

Miami Beach, Fla., Feb. 22.—John McCormack, famous tenor, was rescued today after he had been tossed about for several hours in a disabled boat in the gulf stream. The engine of a motor-boat, in which he and two friends were fishing, stalled about three miles from shore.

Act Changes Hands

New York, Feb. 23.—*Husbands, Beware*, the vehicle by Aune Irish, in which Belmont and Conell appeared recently, is now being done by Hugh Carel and Tom Manning, with Maxine Wells in an assisting role.

Broadway Gives Rousing Sendoff To Eddie Cantor

New York, Feb. 23.—An enthusiastic demonstration marked the closing of the New York engagement of *Kid Boots* at the Selwyn Theater Saturday night. When Eddie Cantor came out for his characteristic song solos George Olsen's Band appeared without warning in the auditorium and marched down the aisle playing *Should Auld Acquaintance Be Forged*. Immediately the large audience took up the words of the song and there were cheers, bows and applause.

A speech was demanded of Cantor, but for once he could not respond. He broke down completely and only renewed cheers and the presence of Mary Eaton gave him courage. He finally became composed and thanked the audience and New York for the long Broadway run of the show.

According to announcement from Ziegfeld, *Kid Boots* will remain in Boston eight weeks, then return here for another engagement, which will probably be limited to a month.

New Protective Contract Adopted by Scenic Artists

New York, Feb. 23.—The United Scenic Artists' Association at a recent meeting adopted a standard form of contract whereby producers and corporations engaged in production must hereafter furnish a guarantee for payment of scenery. While the contract will be mutually protective between producers and scenic designers, it is principally aimed at the novices who enter the production field on chance and without assets. With this form of contract it is hoped to make him responsible for scenery which he orders and which remains unpaid for when the production turns out a failure. The contract also will eliminate competition among members of the Scenic Artists' Association. All producers, irrespective of their standing, will have to abide by the contract, but it is broad enough in the prospective clauses to give the more legitimate managers greater latitude in time payment.

Cast Announced for Revival Of "Little Minister"

New York, Feb. 23.—Charles Dillingham announced the complete cast for the revival of Sir James M. Barrie's *Little Minister* today. Ruth Chatterton will be starred, and in her support will be seen Ralph Forbes, Marjorie Wood, J. M. Kerrigan, Herbert Druce, Kenneth Hunter, Thomas Findlay, Robert Drysdale, Barlowe Borland, Walter Roy, Roy Cochrane, William Boyd Davis, William Quinn and Jean Gordon. The play will be staged by Basil Dean.

New Play for Hal Skelly And Frances White in April

New York, Feb. 23.—Hal Skelly, whose connection with Rufus Lemaire's musical comedy, *Betty Lee*, was terminated abruptly last week following the comedian's appearance in an encore number with Frances White at Keth's 51st Street Theater, has been engaged for a new musical play to be produced here early in April. Skelly will be featured with Frances White.

Ziegfeld Signs Romberg

New York, Feb. 23.—Sigmund Romberg, whose most recent work includes the score of *The Student Prince*, the season's musical hit, and of *Louis IV*, the new Ziegfeld production, which had its premiere last week in Baltimore, has been signed on a five-year exclusive contract by Florenz Ziegfeld.

"Iron Horse" Is Screened At State Capital of Utah

Salt Lake City, Feb. 20.—Governor George H. Dern and his staff, the State Legislature, city commissioners, early settlers, officials of the Union Pacific Railroad and newspaper men witnessed a special screening of the historical film, *The Iron Horse*, Tuesday night at the State Capital. The unique exploitation stunt was arranged by Manager E. S. Diamond of the Pantages Theater and the local Fox film office. The picture deals with the linking of the Atlantic and Pacific by rail and features the driving of the golden spike at Promontory Point, Utah.

His Majesty's, Montreal, Adopts Picture Policy

Montreal, Can., Feb. 23.—His Majesty's Theater, leading local legitimate house, will change to pictures this week due, it is reported, to the management's inability to book good stage attractions. The house has been dark for many weeks this season.

McDonald Is Candidate for Elks Trusteeship

New York, Feb. 21.—James E. McDonald, assistant district attorney, who is a popular figure among theatrical folk because of his long membership in New York Lodge No. 1 of the Elks, of which he is a past exalted ruler, is candidate for trustee of this lodge in a contest that promises to be one of the most strongly fought in years. A special committee is being formed to gather in the theatrical vote for McDonald and a thoro canvass will be made to insure his success. The position of trustee is particularly sought after this term because the New York Lodge contemplates building a new clubhouse and the trustees will have a great deal to do toward directing the project. Assistant District Attorney McDonald is the brother of William McDonald, one of the proprietors of the Kermac, a popular Times Square theatrical hotel.

Capacity Business

At Broadway Theaters' Washington's Birthday Matinees

New York, Feb. 23.—All Broadway theaters did capacity business with Washington's Birthday matinees, many playing to a considerable standing room. The morning started out with a threat of rain, but by one o'clock the atmosphere had cleared and the sun was shining. The turnout at Times Square was even bigger than the large Saturday afternoon crowds.

Less than half a dozen shows were left in the cut rates and these sold rapidly.

Brown Returns From Business Trip to New York

Ed C. Brown, of E. C. Brown & Co., Cincinnati, caterer to the concession trade, last week returned from his annual late winter business trip to New York to look over new items for the coming season. While in the metropolis Edward attended numerous locations of the Toy Fair at hotels and other places. Mr. Brown, who for years was a concessionaire and keeps close tab on conditions in that branch of show business, predicts that 1925 will show a very marked improvement in business over last year. During her husband's absence Mrs. Brown remained in charge of business at their establishment.

Two New Atlantic City Houses

Atlantic City, N. J., Feb. 22.—Definite announcement has been made that the Stanley million-dollar theatrical edifice now being constructed at Kentucky avenue and the Boardwalk will not be open before August. The Stanley will house a combination of vaudeville and motion pictures and is expected to rank as the leading theater in the resort upon completion. The Stanley Company has also secured a site in the central section of the city and will erect a huge playhouse. Work on the structure will commence January 1, 1926.

Urges Censor for Capital

Washington, Feb. 21.—Charging that plays "so indecent in plot and language as to shock the moral sense of the community" recently have been staged in Washington, Frederick W. Dallinger, Massachusetts Representative, has introduced a resolution asking the District of Columbia commissioners to take steps to prevent improper productions. Dallinger asks for a censorship board similar to the one functioning in Boston.

"Babette" To Chicago

St. Louis, Feb. 23.—"Babette" (Babo Berger) will close a two months' engagement Saturday night as featured toe, Russian and Oriental dancer with the Liberty Maids Stock Company at the Liberty Music Hall, where she has proven a big draw, and is booked to begin a series of vaudeville and cabaret dates the following day in Chicago. It is likely that she will join a musical comedy company following her engagements in the Windy City.

Benefit for Jacob Adler

New York, Feb. 23.—Last night a benefit performance was given at the Manhattan Opera House for Jacob P. Adler in commemoration of his 50 years of continuous appearance on the Jewish stage.

Adler appeared in the last act of Jacob Gordin's *The Stranger*. Harry Hershfield acted as master of ceremonies and a big bill of favorites appeared.

Another Cartoonist in Act

New York, Feb. 23.—Ad Carter, creator of the popular comic strip, *Just Kids*, is entering vaudeville via the Poll Circuit. Lads West, who closed recently with the Avery Hopwood farce, *Why Men Leave Home*, has been engaged by Carter thru Leslie Morosco to play the part of Muggs in the act.

THE NEW PLAYS ON BROADWAY

NEIGHBORHOOD PLAYHOUSE, NEW YORK

Commencing Thursday Evening, February 19, 1925

THE NEIGHBORHOOD PLAYERS Present

"EXILES"

A Play in Three Acts

By JAMES JOYCE

Directed by Agnes Morgan

CHARACTERS

Richard Rowan, a Writer... Ian Maclaren
Bertha... Phyllis Joyce
Archie, their son, aged eight years... Lois Shore

Act 1.—Drawing room of Richard Rowan's house at Merron. A June afternoon.
Act 2.—Robert Hand's house at Ranelagh. Evening of the same day.
Act 3.—Same as Act 1. Early the next morning.

The term "intellectual" has generally been hurled at the drama as one of reproach and I am far from denying that this use of it has been justified in only too many cases.

Now this latter property is one which I never remember coming across in a long round of playgoing. We all know that the stimulation of the emotions, the prime purpose of any theatrical exhibition, has little to do with intellect or intellectuality.

As to the plot of the piece that would be very hard to set forth without becoming hopelessly involved in a mass of details. Briefly then the play shows the hopelessness of doubt, particularly when it strikes intelligent, cultured men and women.

"Doubt is the child of knowledge and hope is all we have to guide us." The characters in the play are a man and wife and two friends, a man and a woman.

Mr. Mindlin has provided a good cast and a handsome mounting for the play. Vivienne Osborne, who plays the Japanese girl, is at once beautiful and capable.

The one fault which I see in Exiles, so far as the ensemble is concerned, is the lack of color. The direction has tended towards grayness, whereas something more chromatic is wanted.

We are in the debt of the Neighborhood Players once more for doing the unusual. It must have taken a lot of faith to attempt the production of Exiles, but the result is worth it all.

An unusually interesting play. GORDON WHYTE.

Sell Warner Stock

New York, Feb. 21.—McClure, Jones & Reed, members of the New York Stock Exchange, had no trouble in disposing of 175,000 shares of Warner Pictures, Inc., convertible Class A stock at \$15 a share.

HUDSON THEATER, NEW YORK

Beginning Tuesday Evening, February 17, 1925

MICHAEL MINDLIN (Houses of Sand, Inc.) Presents

"HOUSES OF SAND"

A Love Drama

By G. Marlon Burton

Staged by Clifford Brooke

CHARACTERS

In the Order in Which They Speak: Eric Ford... Theodore Westman, Jr.
Sachi... Naoko Kondo
Miss Kane (Golden Fragrance)... Vivienne Osborne

Scene 1.—Japanese Booth of the All-Nations Bazaar. Afternoon.
Scene 2.—Room of the Demarest Home. Evening. Same day.
ACT II.
Scene 1.—The Shop of Yumato. Some weeks later.
Scene 2.—Room in the Demarest Home. Later. Same evening.
Scene 3.—Same as Scene 1, Act II. Still later. Same evening.
ACT III.
Demarest Home. Same as Scene 2, Act I, the day following.

I suspect that G. Marlon Burton is trying to do a Sir Harry Johnston. You will recall that Sir Harry after a full life as explorer and government official in strange places retired on half pay and wrote novels.

It looks as if the Miss Burton had pondered this and decided to apply the Johnstonian principle to the drama. In Houses of Sand, tho without mentioning any names, she does the same thing with Madame Butterfly as Johnston did with Dombey and Son.

This young chap, named Arthur Demarest in the play, falls in love with a Japanese girl. His Japanese ancestry has been concealed from him and his parents try to break off the match because a woman is blackballing them into wedding him to her daughter thru threats of exposure of the story.

Now this idea is just as good as any Sir Harry Johnston had, but Miss Burton has not worked it out with the same skill he displayed. The piece is rather crude, and while it is quite able to wring a tear from willing eyes and cause a thrill or two the means of doing this are too mechanical, too obvious, to enthrall the sophisticated playgoer.

Mr. Mindlin has provided a good cast and a handsome mounting for the play. Vivienne Osborne, who plays the Japanese girl, is at once beautiful and capable.

The Japanese uncle received a finished portrayal at the hands of George Probert, Ethelbert Hales and Edith Shayne were the father and mother of the boy, and both did excellently by their roles. Elsie Bartlett played a young English girl very well, while Theodore Westman, Jr., and Charles A. Bickford, cast as a couple of college boys, were splendid. A vivid performance of the blackballing woman was rendered by Gladys Hanson, and Naoko Kondo, as a Japanese maid, was nicely fitted to the role.

Houses of Sand is a weepy play and those who have easily stimulated tear ducts will have a gorgeous time at it. Otherwise it is a more or less machine-made piece with climaxes and thrills obtained by methods so familiar in the theater that they have become as standardized as Ford parts.

An ordinary play; nicely produced and acted. GORDON WHYTE.

Alabama Theater Reopens

Huntsville, Ala., Feb. 21.—The Grand Theater, which was badly damaged by fire in December, has been reconstructed and is now a modern combination house under the management of Charles L. Hackworth. The formal reopening was held February 16.



Erci, prima donna and dancer, who arrived recently from Budapest and opened a temporary engagement at the Cafe Des Beaux Arts, New York. She is scheduled to open in a new musical comedy production in spring under the management of Frank Tannhill, who arranged for her engagements here. Erci is said to have appeared in more than 40 comic operas and musical comedies in Europe, many of which have been done in this country in English.

39TH STREET THEATER, NEW YORK

Beginning Tuesday Evening, February 17, 1925

EDMUND PLOHN Presents

"TANGLETOES"

A Modern American Play

By Gertrude Purcell

Staged by Edwin Maxwell and Hubert Druce

CHARACTERS

Julius Hart... Lee Kohlmar
Elinor Blake... Beatrice Nichols
Freddie... Max Montecole
Stella Loren... Agnes Sanford

ACT I. The Apartment of Elinor and Francie, New York City.
ACT II. Six months later. Suburban Home of Arthur Griswold.
ACT III. The next morning. New York Apartment of Tony Kemp.

A very pretty problem in playwriting was dangled before Miss Purcell when she put Tangletoes together. She formulated a plot in which a feather-headed chorus girl marries a serious young writer.

Now this is a pretty straightforward story. I dare say it has had more than one parallel in actual life. But translating it into theatrical terms set a nice problem before the author, and, in this instance, it is not met with altogether happy results.

Miss Purcell was confronted with the necessity of getting the viewpoints of the girl and the boy before the audience in such shape that one could see the justice of both. And she was under the further necessity of setting them forth so that one could sympathize with each.

I say Miss Purcell has not attained sympathy for both these characters in the writing because both are excellently played. They are played so well that this quality would have been brought out by Morgan Parley, I am sure, had it been in the part. Mildred McLeod does get it

REBELLION AGAINST SCRIBNER'S ORDERS

Activities of Hurtig & Seamon Presage Radical Changes in Conditions on Columbia Circuit

New York, Feb. 21.—Burlesquers in general and those allied with Columbia Circuit shows and houses in particular are discussing the recent activities of Hurtig & Seamon that presage radical changes in conditions on the Columbia Circuit.

That several of the more prominent franchise-holding producing managers of shows on the Columbia Circuit and their allies in control of houses on the Columbia Circuit are preparing to rebel against the former methods of Sam A. Scribner has been manifested for some time. But the fact that the more prominent producers are closely allied with the Columbia Amusement Company in shows and houses, and the voting trust agreement between the Columbia Amusement Company and franchise-holding producing managers, has prohibited any rebellion against Scribner's orders in the past.

While some of the producing managers on the Columbia Circuit are already making pleas for extra time after the close of the regular season, there are others who will welcome an earlier than usual close, and this is especially applicable to those who are allied with those in control of theaters on the Columbia Circuit not

(Continued on page 11)

all out, because it is in the words and action, and she has the talent to bring it out. Her performance was delightful, containing lots of light and shade and many deft touches of characterization.

The part of the lover was discreetly handled by Walker Ellis. Beatrice Nichols delivered an excellent impersonation of a worldly wise chorus lady, and Joaquin Souther gave a corking performance of a French servant in the last act.

I think Miss Purcell has missed writing a most interesting play by the mere slip in the handling of her theme. In both this play and Voltaire she shows talent beyond the ordinary. Some day she will hit upon a plot that will suit her more exactly than this one, and when she does I think she will turn out a fine play. Tangletoes has much in its favor.

A truthful play, but in need of revision; competently played and staged. GORDON WHYTE.

What the New York Critics Say

"Exiles" (Neighborhood Playhouse) TIMES: "This drama is in no sense innovative, but is safely in the school of Ibsen, with modern psychological details."—Stark Young. HERALD-TRIBUNE: "A perfect example of the type of literary play suitable for reading, but almost totally devoid of dramatic interest." TELEGRAM-MAIL: "A play which goes probing with extraordinarily sharp thought, removes them that touch the harp of a fine utterance."—Gilbert W. Gabriel.

MORE NEW PLAY REVIEWS ON PAGE 38

Manager Felled While Talking to Mary Garden

Famous Diva, However, Masters Nervous Condition in Singing to Cleveland Audience

Cleveland, O., Feb. 23.—Manager Lincoln H. Dickey, of the Public Auditorium, was struck on the head yesterday while talking to Mary Garden in the stage wing just before the conclusion of the matinee performance of *Thais* by the Chicago Civic Opera Company.

The famous diva, who sings the leading role, was awaiting her cue for the most temperamental part of the performance. Dickey was speaking to her when the iron, used as a counterweight, fell from the flies.

Dickey sank unconscious at Miss Garden's feet. She screamed and called stage hands, who took Dickey to the stage manager's office.

Miss Garden was forced to go on the stage in a highly nervous state to sing one of her most difficult parts. So well did she control her nerves that the audience was unaware of the accident. A four-inch gash in Dickey's head was dressed and he was taken home.

Jenie Jacobs Sues Savo

New York, Feb. 21.—A suit was begun recently in the Third District Municipal Court here by Jenie Jacobs, Keith-Albee agent, booking thru the Pat Casey Agency, against James Savo, vaudeville and musical comedy artiste, for \$528.85, alleged to be due her as commission in obtaining a long-term contract for Savo with the Shuberts.

Jimmy Savo, as he is familiarly known, left the two-a-day last season to appear in the Shubert show, *Vogues*, in which Odette Myrtil was featured.

In an effort to collect the \$528.85 Miss Jacobs also has instituted suit in various other cities of the United States, among them Boston, Chicago and Newark, these being cities which the show Savo is now appearing in. *The Ritz Revue*, is scheduled to play.

In making answer to the suit filed here Kendler & Goldstein, Savo's counsel, make a general denial of all the charges.

Ricciardi in Playlet

New York, Feb. 21.—William Ricciardi will be seen in vaudeville soon in an abridged version of *Papa Joe*, which he presented on Broadway a few seasons ago. The play, incidentally, had a short run. Ricciardi appeared in *The Music Master* with David Warfield, and also in *The Great Lover* in support of Leo Dietrichstein.

Violinist Booked Abroad

New York, Feb. 21.—Ducé De Kerekjarto plans to sail for Australia in July after he has completed a tour of the Orpheum Circuit, thence returning to Europe for a season of concerts. The violinist is said to have been court musician in Austria at the time of the downfall of the Austrian monarchy.

Dishwasher Astounds With Fine Tenor Voice

The Cincinnati Business Men's Club, at its annual Washington's Birthday party, in the club rooms, Saturday night, February 21, was given a great surprise when, unawares, Glover Davis, a dishwasher in the club's kitchen, burst into song, accompanied on a hidden piano by H. H. Clarke. With open-mouthed astonishment scores of well-dressed men and faultlessly gowned women in attendance gazed at the shabbily garbed tenor—stained and water-soaked apron and all—when he appeared in the dining room. At the conclusion of Davis' first song there was an outburst of applause, and this grew even greater as he sang four other numbers. The tenor took his bows as regally as if he had been well attired, and, after he had finished singing, he was overwhelmed by the crowd, which rushed to shake his hand, many of whom secretly handed him money.

Davis, according to Clarke, his coach and accompanist, was born about 22 years ago in Columbus, Ga., where he resided the greater part of his life. While in his youth he found that he possessed some singing ability, and he studied voice for one year. A few years later he went into vaudeville and also appeared on the musical comedy and tabloid stages. About a year ago he decided to go to Cincinnati in the hope of furthering his musical education, but his eyesight became poor and he accepted the job of dishwasher at the Business Men's Club. Almost all the money he earns goes to his musical education, he and Clarke, who hails from Long Beach, Calif., being students of Prof. Lina Mattioli, of the Cincinnati College of Music.

Because of the immense hit which Davis made at the Business Men's Club he, according to Clarke, plans to play Cincinnati engagements—dinners and the like—and it is possible that he will again go back to the professional stage.

Hearst Would Back Weber and Fields Hall

New York, Feb. 23.—According to advices from Hollywood, William Randolph Hearst is again rumored to be negotiating for the establishment of a new Weber and Fields music hall on Broadway.

The report says Hearst is willing to back the project and wants Sam Bernard also to join in the comedians' venture.

Weber and Fields are now working in films on the Coast.

Show of "Family" Acts

New York, Feb. 23.—By a freak of booking the entire bill at Keith's 81st Street Theater for the week of March 2 will consist of acts in which only members of the same family appear. The publicity department has seized upon this coincidence to bill the show as "Family Week." The show will consist of Joe and Willie Hink, brothers; Beatrice Leon and Sybil Dawn, sisters in reality; Pasquill Brothers; Fisher and Gilmore, man and wife; Frank and Joe Wilson, brothers, and The Four Mortons, father, mother, daughter and son.

New Theater for Indianapolis

Indianapolis, Ind., Feb. 21.—The proposal of the Zaring Realty Company to issue \$100,000 of preferred stock to finance the construction of a new motion-picture theater in Indianapolis has been approved by the Indiana securities commission. The proposed site of the new theater is near Fall Creek boulevard and Central avenue. A. C. Zaring is president of the realty company.

Goode's Latest Sketch

New York, Feb. 21.—Reginald Goode, author of *Ashes*, and the one-act version of this play, *Tinsel*, in which Florence Reed recently opened in vaudeville, has written another sketch, entitled *Checkmate*, in which he will be co-featured with the well-known picture star, Lillian Walker. Rehearsals of the sketch are expected to begin shortly.

Rosalie Stewart Has Farce

New York, Feb. 23.—Rosalie Stewart will place in rehearsal shortly a new act called *Whose Who and Why*, a farce by Bert Glassmaker, Jack and Harry Tower, Henrietta Adams and Arthur Shaw, who was last seen in the leading role of *The Torchbearers*, will compose the cast of the act. It will open late in March.

Kyra To Head Revue

Vienna, Feb. 23.—Kyra, American dancer, has opened at the Parlienne here and scored a big hit. She has been engaged to head a new revue which will open at the Ronacher Theater here next month. Johnson & Lowenthal are directing her foreign tour.

New McGuire Sketch

New York, Feb. 21.—William Anthony McGuire, author of *Six-Cylinder Love*, *It's a Boy*, and other plays, in addition to many vaudeville sketches, has written a one-act playlet as a vehicle for his wife and Ralph Sapperly, who are planning to appear together in the two-a-day shortly.

Dobson and Howard Team

New York, Feb. 23.—Frank Dobson and Charles Howard have combined in a new vaudeville offering which they are breaking in this week. They will be seen in the Keith-Albee houses shortly. Dobson headed C. B. Maddock's *Sirens* for several years and Charlie Howard is well known in production.

"Yarmark" on Loew Time

New York, Feb. 23.—*Yarmark*, the Russian flash, started a tour of the Loew Circuit in Boston last week. The act is appearing a second week in the Hub City, playing another Loew house, this holdover causing the bookings in New York to be set back one week. Samuel Baerwitz books the Russian offering.

Gaxton Rehearsing Act

New York, Feb. 23.—William Gaxton is returning to the two-a-day after three years' absence from that field. Two of these years were spent with *The Music Box Revue* and one playing the English music halls. Gaxton will be seen in a playlet by S. Jay Kaufman, entitled *Kisses*.

Jessie Kaye Recovers

New York, Feb. 23.—Jessie Kaye, assistant to Edgar Allan William Fox vaudeville booker, has recovered from a nasal operation which she underwent recently. She returned to the office this week.

Show Property Burns

Damage to Russell Bros.' Equipment Stored at Belleville (Ill.) Fair Grounds Estimated at \$14,000

St. Louis, Feb. 21.—Incendiarism is suspected in connection with the fire Tuesday which destroyed the Exhibit Hall of the fairgrounds at Belleville, Ill., where paraphernalia of Russell Bros.' Circus was stored. The damage is estimated at \$20,000, of which \$14,000 is said to fall to the show. The fire, according to people in the vicinity of the fairgrounds, started about 9 o'clock at night, following an explosion. The show property was attached last November after an exhibition in Turner Hall in Belleville on judgments said to total more than \$7,000, including judgment for more than \$4,000 in favor of the Kurzon-Salkin Co., the Dock Company for \$2,710 and the M. Shure Co., all of Chicago. Jim Russell, one of the owners of the show, was in Chicago when notified of the fire. The stock of carnival goods and supplies that the show had stored at the fairgrounds was insured for \$10,000, it is said.

Drug Stores as Box Offices

New York, Feb. 23.—Two houses operated by the Greater New York Vaudeville Theaters (Keith-Moss firm name) have inaugurated a system of branch box offices at no expense and which affords an agency accommodation for patrons of both houses for miles around. The houses are the Columbia, Far Rockaway and the Rivera, Brooklyn. Arrangements have been made by these theaters with 10 drug stores in the localities of each house to sell tickets to patrons at box-office prices. There is no profit attached to it for the druggists except for the good will and accommodation end of it.

The "branch box offices" were placed in operation this week. It is believed that it will boost business in the houses, as people who don't like to take a chance on going to the theater at the last minute for fear of getting poor seats can, in this manner, secure reserved seats within a few blocks of their home. The "agencies" are all located in different neighborhoods so that there will be no conflict.

"Bought and Paid For" With Love and Ware

New York, Feb. 23.—Montagu Love and Helen Ware will do a condensed version of George Broadhurst's old play, *Bought and Paid For*, in vaudeville shortly. They are scheduled to open within a fortnight and will be seen at the Palace within the month. Helen Ware is well known in legit., and Montagu Love, film star, has been playing vaudeville on and off for the past few years.

Jacobs Agency in Maine

Boston, Feb. 21.—E. M. Jacobs, of the Jacobs Amusement Agency here, announces the opening of a branch office in Portland, Me., with L. R. Gorman, of the Maine Theater Supply Company, serving as booking manager. This office also has an affiliation with the Chapman Amusement Agency, of Springfield, Mass. A special department has been installed to serve parks, beaches, fairs and outdoor expositions with attractions.

House Changes Bookers

New York, Feb. 23.—A change in the booking connections with the Liberty Theater, Herkimer, N. Y., which recently inaugurated a vaudeville policy of four acts on a split-week basis, will take place March 2, when Jack Linder places the house on his books. The Dow Agency has handled the Liberty since its vaudeville policy went into effect and will continue to book it until March.

Seed and Earle Combine

New York, Feb. 23.—Phil Seed, who recently returned to America after appearing in Jean Redini's *Cheerful Revue* in London, has teamed up with Frances Earle, with whom he will do a vehicle by William K. Wells, entitled *Love-Nots*. The act was to have opened last week to break in, but Miss Earle took ill with ptomaine poisoning and it has been temporarily postponed.

Vaudeville at Rivoli

New York, Feb. 23.—The Rivoli Theater, at Matteawan, N. J., this week inaugurates a policy of vaudeville, to be played in conjunction with a picture the last half of the week only. Four acts will comprise each bill, to be booked by the A. & B. Dow Agency here.

To Do "My Sweetie"

New York, Feb. 23.—Billy Collins, who recently closed in *When Love Is Young*, by Leroy Clowson, is rehearsing a new vehicle for the two-a-day, also to be sponsored by Lewis & Clowson, entitled *My Sweetie*. It is the work of Philip Bartholomae and calls for a supporting cast of four.

"When Summer Comes" Came and Went in Week and Day

New York, Feb. 23.—*When Summer Comes*, the Hammerstein & Quinn musical comedy starring James Barton, closed Saturday night at Poli's Theater, Washington, D. C., after struggling for a week and a day. The company was covered by bond with the Actors' Equity Association and an Equity representative went to Washington Saturday to arrange for transportation of the members back to Manhattan.

Business Records

New Incorporations

Delaware

Holy Land Film Co., Wilmington, \$2,250,000 (Delaware Registration Trust Company).

New York

S. & T. Productions, Manhattan, motion pictures, \$10,000; J. Oppenheimer, E. Hilton, E. Terris, Marlbor Corporation, Manhattan, theatrical, \$20,000; M. Lorber, J. R. Elliott, E. J. Clarke.

Kays Productions, Manhattan, motion pictures, \$20,000; A. O. Shever, W. A. Gutler, T. F. Patchell.

Dwight-Dodge-Wiman, Manhattan, motion pictures; 200 shares common stock, no par value; O. Gustafson, M. A. Polard, P. M. Phillips.

Broadway Distributing Co., Manhattan, motion pictures, \$5,000; D. C. Josephson, G. Weitzenberg.

Riegelweln Amusement Co., Brooklyn, motion pictures, \$10,000; S. Riegelhaupt, A. Riegelhaupt, M. Weingerter.

Fair Enterprises, Manhattan, motion pictures; 50 shares common stock, no par value; A. Schimel, H. W. Berg, R. Lipnick.

New York-Rome Grand Opera Co., Manhattan, theatrical; 100 shares common stock, no par value; U. Sorrentino, A. J. Shea, M. H. Ravel.

Delbert Productions, Manhattan, motion pictures, \$10,000; H. Herzbrun, W. Kessler.

Walbrook Theatrical Enterprises, Manhattan, \$20,000; L. D. Naisel, M. G. Cooper, E. R. Solowitz.

Stratton Amusement Corp., Manhattan, \$10,000; W. L. Schneider, M. Goldman, S. Petrides.

Manj Motion Pictures, Manhattan; 100 shares common stock, no par value; C. E. Kelly, N. D. Becker, J. Pincus.

Old Colony Orchestra, Inc., Manhattan, hooking agents; 200 shares common stock, no par value.

Maddock Producing "Al's Here"

New York, Feb. 23.—C. B. Maddock will produce a new farce comedy called *Al's Here*, the scene of which will be laid in the pre-Volstead barroom. John McNally, tenor, who is no relation to John McNally, Keith agent, will play the leading role, with a supporting cast of four men. The title is taken from a line in Don Marquis' *The Old Soak*.

Shepard With Walters Agency

Boston, Feb. 21.—Bud Shepard, formerly of the vaudeville team of Shepard and Ott, is now connected with the Walters Amusement Agency here in the capacity of booking manager and assistant to Louis E. Walters. Shepard knows both ends of the vaudeville business, as he was an artistes' representative for three years in New York City.

Rebellion Against Scribner's Orders

(Continued from page 10)

controlled by the Columbia Amusement Company.

Summer Stock for 125th Street Theater

Messrs. Hurlig & Seamon are now negotiating with featured comedies and feminine principals of various Columbia Circuit shows to participate in their summer season of stock at their 125th Street Theater. According to present plans it will be one of the largest assemblages of prominent burlesquers that has ever appeared in stock. There will also be a series of special nights under the personal direction of Howard Burkhardt, manager of the house.

Considering the fact that Hurlig & Seamon were the first to make known their plans along these lines, it is logical to assume that they will have several followers in control of houses on the Columbia Circuit who are not amenable to the orders of the Columbia Amusement Company, therefore there may be summer stock companies in various theaters at the close of the regular burlesque season for the presentation of Columbia Circuit shows.

Another Change in House Managers

Walter Leslie, manager of the Columbia Theater, Cleveland, has severed his connection with that house and been succeeded by William J. Riley, formerly with Constable & Gast, Shuberts and Henry W. Savage.

VAUDEVILLE

BY M. H. SHAPIRO

(Communications to 1493 Broadway, New York, N. Y.)

KEITH-ALBEE PRODUCERS TURN TO LOEW CIRCUIT FOR RELIEF

Productions Originally Intended for Big Time Exclusively, Get Money and Consecutive Bookings on Smaller Circuit

NEW YORK, Feb. 23.—Because it has become a difficult matter to secure consecutive bookings on the Keith-Albee Circuit or to obtain salaries anywhere near the figure given in the past, vaudeville producers of the front rank who heretofore have confined their activities solely to this circuit are now selling their flashes and other full-stage acts to Marcus Loew, who is in a position to offer from 20 to 30 weeks' time.

C. B. Maddock, Hockey, & Green, George Choo and M. Golden are a few of the prominent producers whose acts have been booked with the Loew Circuit this season. The situation became worse as the season advanced, until now it has reached an acute stage, with salaries on the big time continually coming down and the gamble in securing a route rising to greater odds.

Delay in getting acts and salaries set, the issuance of time and increase in layoffs have served to transport a goodly portion of the season's output of full-stage material to the Loew Time. The majority of the productions were put out with the express intention on the part of the producer to play them only in Keith and affiliated houses, but to this end not a little discouragement and impatience have been experienced.

Producers figure they have an investment to protect and that their turnover cannot be realized by playing three days then laying off two weeks, and getting another split-week date, because not only is little profit realized on this basis, but it is hard to keep one's cast together.

On the Loew Time, as was pointed out by one producer, altho the salaries in every case may not be as much as on the Keith-Albee, the act at least keeps working over a period of 20 weeks or more. Many of these, in addition, are full-week stands and on the whole making more money than can be made with the prospects on the big time as they now are.

On the Keith-Albee Time the trouble in getting acts booked, particularly full-stage acts, is centered in various conditions, among them an oversupply of this type of material. A condition operating toward the inability in more than a few instances of getting consecutive bookings lies in the practice of the big-time bookers to wait until the last minute before accepting flashes and similar offerings, doing this, it is understood, because they prefer to wait and see how much their salary list will amount to after signing the headline feature. This has resulted in week-to-week booking and an unprecedented scarcity of routes.

The Loew Circuit, on the other hand, headlines the flash acts going to it from Keith and builds the rest of the bill around the cost of the big act. By offering the producers a route of 25 or more weeks the Loew people have also been able to secure the acts cheaper than they would on a week-here-and-there policy.

While it may not be generally known, however the Loew people are doing out what might be called big-time salaries. One flash, produced last fall, which has been playing Keith-Albee dates interspersed with frequent layoffs until a few weeks ago, was accepted by Loew at a salary in excess of that offered on the big time. This was an act favorably reported on by the Keith-Albee bookers and which they evinced every indication of wanting.

C. B. Maddock's *Fifty Miles From Broadway* and *Kejhole Kamcos*, George Choo's *Realm of Fantastic*, Hockey & Green's *See America First* and *Stars of the Future*, Alex Gerber's *Co-Eds Revue* and M. Golden's *Yarmark* are among acts originally produced for the Keith-Albee Circuit which have been taken by Loew during the past month.

Charlie Foy in Big Act

New York, Feb. 23.—Charlie Foy, one of the famous Foy Family, who broke away last season and did a single, is now rehearsing a new act sponsored by Lew Cantor, in which young Foy will be supported by four girls. Cleo Bergain, ballet dancer, is featured in the supporting company, which includes, in addition to her, a dancing sister team and a specialty jazz dancer.

Hipp. Makes Bid for Concert Patrons

New York, Feb. 23.—The Keith-Albee Hippodrome is now making a concentrated bid for patrons of the concert field by playing artists from concert for one week only. These concert artists are only booked into the Hippodrome, no other vaudeville engagements being scheduled for them. The first of these was Walter McNally, who played the house two weeks ago, during a week when he had no concert engagements. Last week the De Feo Opera Company played the house. During the current week Magda Bradford, a French concert pianist, is appearing there.

None of these has thus far been booked into other vaudeville houses, preferring to remain in concert and take the Hippodrome engagements because of the prestige it gives and the opportunity to create a following. It is intended to play a well-known high-class attraction each week.

The Marie MacQuarrie Harp Ensemble, consisting of 15 people, has been booked into the house for two weeks, beginning March 9. This attraction is well known on the Pacific Coast, and will probably give a series of concerts in the East following its appearance at the Hippodrome.

SIAMESE TWINS BREAK RECORDS

Violet and Daisy Hilton Top Jack Dempsey Receipts in First Week on Loew Time

New York, Feb. 23.—All records in attendance and receipts for Loew's State, Newark, N. J., were broken by the Siamese Twins, Violet and Daisy Hilton, who made their debut in vaudeville there last week. The record set by Jack Dempsey when he appeared there was smashed, the Hilton girls topping his receipts by more than \$6,000. The demand for seats proved so big that it was necessary to give four shows daily instead of the customary three and each show had the house packed.

On the opening day, February 16, the Loew house and the Siamese Twins broke into the front pages of all the local newspapers, because the police reserves had to be called out in order to handle the crowd at the box office. The girls play Boston this week at the Orpheum, later going to Cleveland and then Buffalo. They are due at the State, this city, March 30.

The Siamese Twins have attracted a great deal of attention in the daily papers throughout the country and the exploitation department of the Loew office has elaborated on it greatly. They sing, dance and play instruments. Terry Turner wrote the act in which they appear. They are supported by a pianist, Ray Traynor.

Moss Empires' Balance Sheet Better Than 1923

London, Feb. 21 (Special Cable to *The Billboard*).—Moss Empires' balance sheet for 1924 is more than \$200,000 better than that of 1923—viz., \$475,000, as against \$260,000—so dividends will be at 7-1/2 per cent, as against 2-1/2 per cent in 1923. The circuit's carry-forward is \$100,000.

TO PASS ON MUSIC COPYRIGHT QUESTION

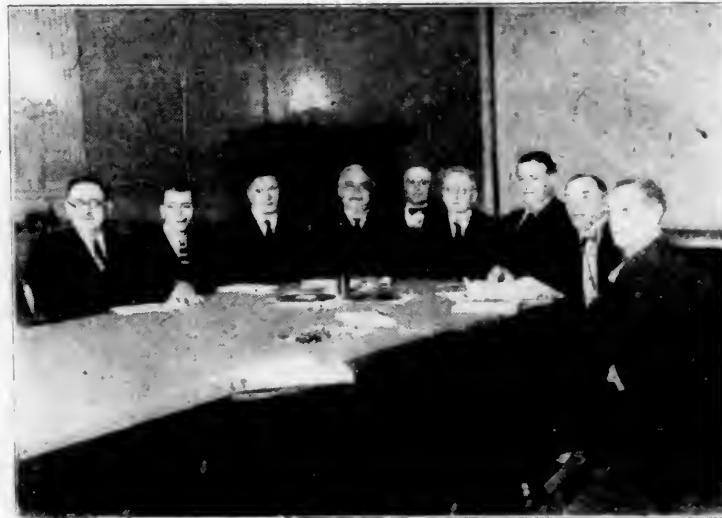

—I. & A. PHOTO.
The Patents Committee in Washington, which is considering the attempt of music authors and composers to bring about a law which will afford more stringent protection against use of their material and net them greater royalties than present legislation permits, ceased deliberation long enough to hear the camera click on this photo. Reading from left to right, the members are: Representatives Wefald, McLeod, Phillip, Lawpert (chairman), Cook, Hammer, Bloom, Lanham, and, in the rear, the clerk of the committee, Schlerf.

Pan. House for Pittsburgh

New York, Feb. 23.—Charles E. Hodgkins, general manager of the Pantages Circuit, was a visitor in this city the past week, and before leaving here announced the addition of the New Kenyon Theater, Pittsburgh, to the circuit. The theater, which has been dark for several months, will begin playing Pantages road shows during the week of March 2. It will follow Detroit on the Pantages route.

Hodgkins stated that there would be one or two more houses added to the circuit by the time he arrived in Chicago, and was to take up these deals on his way there. The names are to be given out shortly.

Frank Vincent Starts Annual Orpheum Inspection

New York, Feb. 23.—Frank Vincent, general booking manager of the Orpheum Circuit, left this city February 19 for his annual tour of the circuit's theaters. Vincent is going directly to San Francisco, via the Panama Canal, sailing on the President Monroe. He is due in San Francisco February 27 and from there will return to New York, visiting all the Orpheum houses on his way back.

Eva Tanguy and Maurice Costello on Loew Time

New York, Feb. 23.—Two more headliners have been added to the list of those playing and scheduled to play the Loew Circuit with the signing of Eva Tanguy and Maurice Costello to tour the time. Miss Tanguy played the Loew Time two years ago, and since her comeback this season has been playing the Keith houses. Her salary for Loew is reported to be \$2,500. She will begin her Loew tour in Newark March 16, following which she will play the Metropolitan, Brooklyn, and then the State, New York.

Maurice Costello will begin his tour at Loew's Orpheum, New York, March 2. He will appear in a playlet called *The Battle*, supported by Ann McDonald and Robert Wayne.

Mlle. D'Alroy Serves

New York, Feb. 23.—Mlle. Marceline D'Alroy, Parisian fashion expert, doing a fashion novelty on the Keith-Albee Time, recently served with a committee of New York artists, headed by Heyworth Campbell, art director of the Conde Nast publications, in selecting the American beauty for 1925. Jean La Mont, of New York, was chosen.

Moss Houses Tie Up With Legion in Amateur Revues

New York, Feb. 23.—A new idea in local amateur revues is being tried at Keith's Hamilton and Moss' Coliseum theaters during the first and last half of the current week. It consists of an American Legion Minstrel show, which has been staged by three legion posts in co-operation with each other. They are the Richard J. McNally, the Washington Heights and the Inwood posts of the American Legion.

The minstrel performance is given in addition to the regular bill of vaudeville, and has a cast of 75 local boys and girls. Samuel E. Dribben, who is well known politically in the locality of the theaters, is interlocutor for the show.

Should the idea prove successful in drawing business as well as in entertaining, it will probably be tried in other local Keith and Moss split-week houses. Arrangements will be made with the American Legion posts in the various neighborhoods to put them on.

Staging Five Flash Acts

New York, Feb. 23.—Morris, Greene & Smith have in preparation five new miniature musical comedies which they will present in vaudeville during the latter part of this season and the early part of next. Harry C. Greene is responsible for the book and lyrics, and Charles Smith for the music of each act. Phil Morris will stage and book them. Three will be known as *Fifty-Fifty*, *Next-Door Neighbors* and *His Girl*. The other two are as yet unnamed.

Al Wohlman at Wigwam

New York, Feb. 23.—Al Wohlman finished his vaudeville dates at the Fordham last week and opened today at the Wigwam, where he will do his act indefinitely. Recently Wohlman has been doing his single in the two-a-day. For a time Bert Cooper, songwriter, appeared with him, officiating at the ivory.

Charlie Nevins Ill

New York, Feb. 23.—Nevins and Gordon were compelled to cancel their Keith-Albee Time temporarily at Keith's Philadelphia, two weeks ago due to the sudden illness of Charlie Nevins, who has not yet recovered sufficiently to resume bookings. They do an act by Billy K. Wells.

Lauder Rival Coming

New York, Feb. 21.—Will Fyffe, Scotch comedian, who in his native land is said to be a serious rival of Sir Harry Lauder, will come to America for a tour of the Keith-Albee Circuit, commencing next September, according to announcement.

Top-Notch Acts at Popular Prices Bring Tremendous Increase in Orpheum Profits

(Continued from page 5)

of the circuit, shortly after the deal between it and the Greater New York Theaters Corporation had been consummated an increase of 30 cents a year on the annual dividend of the company's common stock was declared, raising the figure from \$1.50 to \$1.80.

The net income for 1924 allows \$4.29 a share on the outstanding 549,170 shares of common stock, as applicable for dividends, and a further increase over \$1.80 a year may be declared. On the New York Stock Exchange the stock is selling around \$27 a share, regarded as an excellent figure in view of the annual dividends now being given. Anticipation of an increase, or that a meron will be cut shortly, may have something to do with the quotations reaching this figure.

The long strides the Orpheum Circuit are making toward prosperity under the guidance of Marcus Hellman, its pilot, is interesting for various reasons aside from its real estate perspective and the profitable business deals it has entered into during the past year.

In spite of the fact that higher-salaried acts have been booked this year by the Orpheum, some of which have never appeared in the West before, and that the cost of operating the theaters has risen considerably over former years, the circuit has made more money than ever before.

On the opening of the season, early last September, a tremendous number of standard big-time acts were booked for tours and since then many others have been signed. The announcement of the headliners signed at the inception of the season stirred not a little comment among big-time vaudeville men, who saw in the Orpheum Circuit's move a veritable clean-up of big acts available in the East and the subsequent quality of the bills to be offered in the chain's houses this year.

Not a week has gone by since last fall but that the Orpheum organization has signed up well-known and high-salaried acts. The circuit has virtually picked the cream of the vaudeville profession and issued routes over the time. In many cases the salaries given have been what in former years was regarded on the Orpheum Circuit as prohibitive.

Among recognized vaudeville headliners touring the Orpheum this season are Weber and Fields, Ted Lewis, Mmc. Bernice de Pasquale, Chic Sale, Emma Trentini and Eric Zardo, Adelaide and Hughes, McIntyre and Heath, Leo Carrillo, Bessie Barriscale, Nan Halperin, Van and Schenck, Jack Norworth, Elliott Dexter, Frank Keenan, William Morris and Family, Ceclia Loftus and Arthur Byron. There are hundreds of others, many of whom are playing the Orpheum Circuit for the first time this season.

With this array of top-notch acts signed up and appearing on the Orpheum Time, the shows presented in the houses have been of extra fine quality. A perusal of the bills show that the headlining attraction in each instance is surrounded by a strong supporting cast of acts. The admission to these exemplary shows has remained at a reasonable figure, the top to many of the Orpheum houses being 50 cents.

This season the circuit has also been on the alert for novelties or acts which can be exploited to good results. The signing up of Harry Snodgrass and Wayne "Big" Munn, both of whom were given wide publicity, are examples.

Then, too, big acts produced in the East and awaiting time on the Keith-Albee or affiliated circuits have been grabbed up quickly when the merits of the offering in question warranted it. The Wright Dancers, a beautiful dance offering, which opened in New York recently and was delayed in securing a route, is among the many new productions that went to the Orpheum when a route was offered.

The result of this policy—the best of big-time vaudeville at a decent price—is not only shown by the 1924 balance sheet, but also by the increase in earnings for January of this year and the apparent continued prosperity of the circuit.

The Orpheum has about 15 theaters at present, including the big-time and junior houses. A number of new ones under construction will increase the number, it is said, to more than 50. Among them is the new house in Los Angeles and the one announced for Springfield, Ill. Fox's Theater in Oakland, Calif., was taken over by the Orpheum Circuit two weeks ago and renamed the Orpheum.

Sophie Tucker at Proctor's Fifth Avenue

New York, Feb. 23.—For the first time in more than 10 years Sophie Tucker will play Proctor's Fifth Avenue Theater during the first half of the week of March 23. This will also be the first Proctor house in New York City to be played by Miss Tucker in several years.

ENTERTAINING A HEAVY AUDIENCE



Mmc. Bernice De Pasquale, noted American coloratura soprano, and Margit Hegedus, violinist, are seen entertaining Powers' Elephants on the stage of the Orpheum Theater, Los Angeles, while members of the same bill.

S. Jay Kaufman Opens March 2 as Monologist.

New York, Feb. 23.—S. Jay Kaufman, conductor of the *Round the Town* column with *The Telegram-Mail*, writer and producer of several well-known big-time acts, and also of the *Round the Town* revue which played the Century Theater last summer, is entering vaudeville as a monologist. He will open on the Keith-Albee Circuit March 2, and may possibly go into the Palace, opening "cold". Kaufman is promoter of the Green Room Club and it is understood that the organization will hold a party in his honor at the Palace when he plays that house.

Frank Savilla Injured

Chicago, Feb. 20.—Frank Savilla, of the Savilla Brothers' act, narrowly escaped death or serious injury Sunday night when an automobile in which he and his brothers, George and Add Savilla, were driving turned entirely over on the road between South Bond and Laporte, Ind., while the party was driving to Chicago. The car, driven by Dan Donnelly, a friend of the artistes, plinned Frank Savilla under the machine as it turned over on a slippery spot. The others, escaping injury, raised the car from the prostrate man and continued the journey to Chicago, where he was given medical treatment. Mr. Savilla's injuries proved not dangerous and he will be able to take his place in the act in a few days.

Baby Peggy Tieup

New York, Feb. 23.—The Hippodrome drew an unusual amount of publicity during the past week, which will continue into the current one, thru a tieup between the house and *The New York Daily Mirror* on a "Baby Peggy Contest". Baby Peggy, the film star, is the big attraction at the house during this week, and *The Mirror* is running a line out of her in every edition each day. The contest, which is for children, consists of coloring the line picture. The children who do the best coloring are awarded prizes. Two hundred prizes are being given out, consisting of dolls, dolls' houses, passes to the Hippodrome and various toys.

Another Fokine Ballet

New York, Feb. 21.—A new Fokine ballet, called *The Immortal Pierrot*, is breaking in on the Keith-Albee Circuit under the direction of Martha Lober, the dancer. Michlo How heads a large ensemble, and Willy Pogany, famous mural designer, is responsible for the settings and costumes.

Ina Claire Entering Vaude.

New York, Feb. 23.—Ina Claire, who closed recently in *Grounds for Divorce*, is entering vaudeville for a 10 weeks' tour at a salary of \$3,000 a week. She is due at the Palace during the week of April 27. When Miss Claire last appeared in vaudeville her salary was \$400 a week.

Raquel Meller Censured

Paris, Feb. 23.—The use of a song during her vaudeville engagement here is alleged to have portrayed the church in an unfavorable manner, incurring the displeasure of the Pope, with the result that his emissaries notified Raquel Meller, the artiste in question, to discontinue singing the number.

She postponed her engagement following the notification and went to Rome to explain the innocence of the words. The number, entitled *During Holy Procession*, was considered by the Pope to be a mockery of religious sentiments, and in the warning sent to Miss Meller displeasure was expressed in having the church portrayed on the vaudeville stage.

The song in question is a plaintive contralto chant, in which Raquel specializes, and describes how a beautiful Madrid flower girl falls in love with a priest. It gained considerable popularity here.

W. V. M. A. Books Anaconda

Anaconda, Mont., Feb. 23.—The Bluebird Theater is playing vaudeville, booked by the Western Vaudeville Managers' Association, and Anaconda is getting its first taste of this type of popular entertainment.

The house, which offers vaudeville Friday of the week only, underwent extensive alterations prior to inaugurating the new policy, and the house was closed for some time while this was being done.

The stage of the house was enlarged and properly equipped to play vaudeville, stage scenery being installed and a better ventilating system put in.

Claire and Atwood, in *A Bunch of Thrills*, headed the opening bill.

V. A. F. 19th Anniversary

London, Feb. 23 (Special Cable to *The Billboard*).—The Variety Artists' Federation celebrated its 19th anniversary February 18. It has received from its members since its inception more than \$475,000 plus \$125,000 for its death levy. It has also spent the latter amount in law costs and \$290,000 in protecting performers' interests in show business, all obtained thru a nimbly 12 cents weekly. It owes no man and has a bankroll of more than \$60,000.

Richman Shaping New Act

New York, Feb. 23.—Harry Richman, who played a two weeks' engagement at the Palace recently, is to play a return date soon in an entirely new offering called *A Night at the Hotel Richman*. Next season, Richman announces, he will produce his first big musical revue.

W. C. Fields' Two Sketches

New York, Feb. 23.—W. C. Fields, whose first venture as a Ziegfeld star in *The Comic Supplement* didn't prove to be very successful, is returning to vaudeville in two of his sketches, *The Pool-room* and *Golfing*.

"Charleston Contests" Rage in Small Time

New York, Feb. 23.—"Charleston" nights, the latest wrinkle in local contests at split-week vaudeville houses, are rapidly displacing "Opportunity Nights" and "Dance Nights" as features to attract business. While the craze for the "Charleston" step is mostly responsible, almost any dancer who does it being surefire in all vaudeville houses, the craze for it as a local feature was started several weeks ago by four E. S. Moss theaters, the Franklin, Regent, Coliseum and Hamilton, which inaugurated these contests in conjunction with the McFadden daily, *The New York Evening Graphic*. These houses have been playing them for three weeks and the contests still have some time to run before the winners are announced.

Meanwhile other houses are seizing upon the idea and are throwing out their "Opportunity Nights" to make room for it, or are adding it on a different night. Fox's Audubon Theater will make a feature of a "Charleston Contest" during its "Mardi Gras Week", which will be held beginning March 2. The bill at the theater is also to be increased from six to eight acts for each half of the week. Proctor's Fifth Avenue Theater began running the contests on Monday night, last week. At this house each week one of the artistes on the bill is to be the judge of the contest. Last Monday night it was Frank Farnum, the jazz dancer, who decided who was to receive the prizes. Other local houses are also announcing them to start this week and next.

Yorke and Adams Return

New York, Feb. 23.—The well-known Yorke and Adams, who have not appeared in vaudeville in this country for years, are breaking in a new offering, called *Pullman Prattle*, in up-State houses. The vehicle was written by Billy K. Wells.

Yorke and Adams arrived here recently after completing a tour of England, Australia and other British possessions.

"Uke" Recruit for Vaude.

New York, Feb. 23.—Billy (Ukelele) Carpenter, who came into the city from Providence unknown in the business, has been signed by Alex Gerber, who is featuring him in his new act, *Town Topics*, for three years. It is said that Carpenter is a wonder on the uke.

Arrangements are being made by Gerber to have Carpenter make records, negotiations being under way with several leading phonograph concerns.

Colonial, Cleveland, Starts Well With Vaude. and Films

Cleveland, O., Feb. 23.—The Colonial Theater, formerly Shuberts', opened yesterday with vaudeville and pictures, featuring *Rose's 25 Midgets*. The four shows were given to capacity audiences, total attendance being estimated at more than 5,000, according to Mack P. Carrig, manager.

Farnum Invites Ambassador

New York, Feb. 23.—Senor Don Juan Riano y Gayango, Spanish Ambassador to the United States, has accepted an invitation from Ralph G. Farnum to attend the opening performance of Senorita Trini in Keith-Albee vaudeville, which takes place at the Palace Theater March 2. Many other prominent Spaniards also will attend.

Dale and Forsyth Team

New York, Feb. 23.—Billy Dale and Charles Forsyth have combined in a new comedy offering in which they will open shortly. Dale has been doing a sketch for several years, and Forsyth has been appearing with Jack Wilson for about four years.

To Begin Twelfth Season

Montgomery Dean, of the M. & M. Motorized Tent Show, writes that they will open their season in South Dakota early in May and will travel over practically the same route they have played for 12 years. The show consists of vaudeville, musical and novelty acts.

Nolan and Hallen in "1924"

New York, Feb. 23.—A new vaudeville offering, written by Alfred Regada, entitled 1924, will open soon, with Maude Nolan and Jim Hallen essaying the two roles called for in the script, Eddie Edwards, the producer, announces.

This Week's Reviews of Vaudeville Theaters

B. S. Moss' Broadway, New York

(Reviewed Monday Matinee, Feb. 23)

The Bellis Duo ordinarily would make any audience wake up in opening the show, for they do some exceptionally good stunts on the aerial rings. The girl does the brunt of the work, the man assisting capably in bits.

Lorraine and Ritz generally do much better than they did here the first show, the earliness of the hour accounting for the letdown. The boys sing and dance, including in their routine a series of impersonations which are effectively done. They look neat, have likable personalities and sell their material well.

Stappens and Hollister seem to be miscast in their present vehicle of *Watching the Parade*. At any rate it isn't half as effective as their *Berkeley Hills* offering was. In the other characters seemed more natural to them, particularly Len Hollister's, and in this one they seem to be forced. There are some bright spots in the offering, but not enough to make the act of universal appeal.

The show only began to pick up with the entrance of the Five Jolly Corks, an old-time offering presented in minstrel style which includes Eddie Moran, Al Edwards, George Cunningham, Tom English and Harry Armstrong in the cast. If youth is measured by the amount of vitality and pep displayed none of this quintet, every one of whom is over 60 in years, is actually over 20. The act is fast and so are the individual artists. All scored heavily.

Al Wohlman strolled on minus makeup and attired in his street clothes. Wohlman evidently had the wrong idea about this morning show, thinking it is attended mostly by men and that anything goes. Had he looked around the audience and noticed that there were almost as many women present as there were men probably he'd have thought twice before pulling the line about "picture from Paris". Wohlman is a good entertainer when he wants to be and he didn't want to be until almost 10 minutes of his act had passed, when he suddenly realized that the people present did want to be entertained.

Robbins' Baltimorean Orchestra, a novelty jazz organization combining the New Orleans Blues Blowers with it, closed the show and scored a big hit. They will be reviewed under "New Turns" in detail next week.

G. J. Hoffman.

Keith's, Cincinnati

(Reviewed Sunday Matinee, Feb. 22)

Pathe News, Aesop Fable, Topics of the Day.

Eddie Leonard and his irresistible crew of black-face acts were the blitzzers in *Oh, Didn't It Rain!* Eddie is the Babe Ruth of minstrelsy, except that Ruth's art admittedly is spasmodic, whereas Eddie has a hitting bee at every appearance. Those of the audience who had not succumbed to his infectious humor were added en bloc to the loyal legion of Leonard lovers. The object of their affections not only stopped the show but had to beg to be released in a certain speech. Leonard modestly shared the spotlight with Jack Russell, Gus Mulcahy and Charles Oberle of his company. And while Carroll Le Van was musical director Eddie insisted a couple of times on getting Jake Bohrer, veteran house orchestra leader, into the focus conspicuously. Thirty-five minutes, curtains and encores.

But Leonard's was by no means the only contribution to the afternoon's enjoyment. Ernest Hiatt, for instance, came perilously close to halting the continuity of events with his *Nothing Serious* monolog, reaching the apex of his achievement by working in the names of what seemed like half the streets of Cincinnati while trying to recall his sweetheart's address. Nineteen minutes, in one; bows and encore.

And before going farther we must mention the skit of Frank Rose and Olive Thorne, built around the sale of an automobile to a newly rich Swedish girl, wherein the comedians qualified for recognition as vanquishers of gloom in all countries, including the Scandinavian. Fourteen minutes, in full; encore.

Con Colleano brought forth a big demonstration by his work on the tight rope, proving as agile as a hummingbird on the wire and doing many things a bird never attempts. Colleano finished with what he claims is the only feet-to-feet forward somersault on a rope. Nine minutes, in full.

Walter Ward and Ethel Dooley presented novel rope-spinning stunts learned from compunchers, Ethel showing how a lady compuncher spins a 60-foot rope. Walter's impressions of Will Rogers and Fred Stone's rope dance went over in good shape, and he threw in trick bicycle riding for good measure. Twelve minutes, full stage.

Pagana, billed as "the Girl with the Piquant Personality," exhibited a wide range as a vocalist. Eight minutes, in one; two bows.

Violet and Partner, with dancing and singing novelties, closed the bill to good hand. Seven minutes, in two.

E. J. GALLAGHER.

THE PALACE NEW YORK

(Reviewed Monday Matinee, February 23)

Early sellout to a cordial holiday crowd composed of more than the usual percentage of suburban patrons. The 10 acts make up a strong bill, comedy predominating, yet there is sufficient contrast in the styles presented. There is Wallace Eddinger from legit, as a "name" offering, while a brand-new ballet gives additional class. The singles, in one, considered an indication of the strength of the show, are both women, representing English and American type comedienne respectively. The show itself was speeded up and ran smoothly.

Rose, Ellis and Rose, "The Jumping Jacks", held the interest thruout with their novel jumping and tumbling in and out of barrels. The set and props are attractive and the tricks so arranged that the dangerous element is always apparent, while the feature stunt is built up wonderfully well—so well that it goes free—altho it proves to be less of a feat than is expected. Half way thru the act the clown member of the trio proves to be a woman, who unfurls her hair as proof.

Chevalier Brothers, "Entertaining Entertainers", were on second with their balancing, tumbling and other acrobatic feats, finished off with hard-shoe dancing by the one who acts as topmounter. He ends the dance with a handspring and lands upon the arm of his partner, who walks on in time to catch him and keeps going. Other similar feats are in the routine requiring great strength and sense of balance. They wear tuxedos and affect and maintain a dignified style.

Willie West, McGinty and Company, in their panto-farce, "House Builders", offered just the kind of a slap-stick comedy to wow them after a couple of dumb acts had been on. In fact, they were the third dumb offering in succession, but no audience in the world could remain dumb while watching them, unless it was blind. One funny mishap after another to the carpenters occurs during the entire running time of the act. Most of the mishaps ingeniously contrived, timed, measured and executed to the second. One of the fine points of the trio is that they stay in well-defined character thruout, that of lazy, stupid laborers, with no sense of humor despite their mishaps.

Lily Morris, English comedienne, held over for a second week, repeated her success and kept the house in excellent spirits with comedy songs that will never miss as she sells them. It seems to be manifest to every patron that she is going to be good the moment she steps out, which is surely an enviable quality. Her cycle of songs more or less revolves about cockney-maid types, with marriage as the subject, either before, after or during that state. Incidentally she is doubling this week, playing also at the Riverside Theater, farther up Broadway.

Ben Bernie and His Hotel Roosevelt Orchestra closed the first half with a much better act than he has been doing for his last few appearances in vaudeville. Not that there is any material change, but the music is even of a better style, some of his gags are new, and an additional kick is supplied by a new member of the personnel, who doubles from bass violin to the marimba. At the latter instrument, where he did one number toward the close of the act, he proved a wow, and is quite a comedian. He followed with an eccentric comedy dance and further got in strong. A third piano, set in the rear upon a platform, is also in evidence, while almost all of the selections offered are musical comedy hits. Ben Bernie's orchestra will always be different and a novelty because his previous training as a single results in his being a leader who can get laughs while the boys are resting.

Pastelle Ballet, specially produced for this house by Albertina Rasch, and featuring Marita, with a company of 20 girls, all trained by Miss Rasch, is not quite so pretentious an offering as the one produced for the Hippodrome last season, but it is much better adapted for vaudeville. Marita is a clever little soloist, who is poorly assisted by Edward Georges, the only male member of the ballet. The rest of the company, both soloists, who also assist in the ensemble numbers, offer many dainty and unusual bits of dancing. Miss Rasch seems to have made a ballet conception of popular dances for the most part, one soloist really doing a toe-Charleston step. The music is arranged from various popular and classical courses, while the costumes, setting and general production may be said to definitely place Miss Rasch in the ranks of big-time producers. Will be further reviewed under "New Turns".

Mr. and Mrs. Jimmy Barry, in "Scandals of Hensfoot Corners", were received a little cold at first, but probably a reaction from the transient patrons who came to see the sophisticated style of stuff. The rube comedy vehicle is about the same, excepting the finish, which now differs in that the widow returning to the home town accepts the old-time lover and walks off with him, whereas he was formerly turned down and he philosophically went off playing his harmonica. They got the usual number of laughs as the act progressed.

Wallace Eddinger, in "Things Could Be Worse", by Edwin Burke, who also staged it, has one of the funniest and worth-while voices any star brought into vaudeville. This is about the best act Burke has written to date, and it fits Eddinger perfectly. Eddinger has the role of a man about town, who drops in on a friend about to commit suicide. Just to show him that things could be worse and prevent the friend from doing away with himself, he calls his wife in and blames the friend for stealing the five grand lost by himself at the race. Will be further reviewed under "New Turns".

Irene Ricardo, in "Whoa Pagliacci", finds herself filling the next-to-closing spot at her second appearance at this house. She is among the comers and is going stronger than ever. Yet her act is not so different from what it was when she was playing small time prior to going into the first edition of "Vanities". Her songs were the same as when last seen, the mainstay "Pagliacci" being followed by two other special numbers and two published songs.

General Pisano, assisted by Charlotte Cochrane, closed the show, presenting "At the Gun Club", a sharpshooting act, preceded by a film. The General, from the Italian army, according to the uniform and incidental music, does most of the regulation stunts, and his partner breaks the monotony with a song. A loose-fitting costume would be in better taste for Miss Cochrane, who wears army breeches as tho they were tights.

M. H. SHAPIRO.

Palace, Chicago

(Reviewed Sunday Matinee, Feb. 22)

The Babbs-Syrell and Lorraine offering is a most pretentious starter for a vaudeville program. It is a unique terpedorean act with some contortion dancing that is graceful as well as spec-

tacular. The splendidly costumed nimble stepper won big applause. This act deserves a better position on the bill. Fifteen minutes, in one, and full stage; three bows.

Paul Nolan and Company delighted with juggling of high hats, balls and miscellaneous articles. His pantomime is artistically executed and there is a

Majestic, Chicago

(Reviewed Sunday Matinee, Feb. 22)

Alphonso's Company opened the new bill. It is a circus performance of mannikins handled with rare skill and effect. Richly dressed. Special drops and settings. Ten minutes, in full; three bows.

Edwards and Dean, man and girl, in old songs with no comic features or adjuncts attempted or needed. An excellent act put over with the sure hand of showmanship. The man is a tenor and the woman a contralto. Opens with *Maggie* in special subsetting. Ancient ballads follow with splendid effect. Twelve minutes, special back drop; three bows.

Porter White and Company offer *The Visitor*, a dramatic sketch, which affords some of the best acting the Majestic has seen in many months. Mr. White practically divides honors in his fine character delineations with that excellent actor, John Conery, playing the straight role. Miss O'Connell assists most capably. It is a first-class offering. Fifteen minutes, in full; three curtains.

Throop and Phillips, man and girl, have an offering of comedy and songs. It is lively and went well. Fifteen minutes, in one; two bows.

Pierce and Ryan, two men, have a lot of comedy dialog, hokum, some singing, a little dancing and what not. Often here before. Fifteen minutes, in one; three bows.

The *Blue Bird Revue* has two men and two girls in songs. The act is well dressed and refined and met with good reception. The routine is well balanced and pleasing. Twelve minutes, in full; three bows.

The Great Lester, ventriloquist, came back again. He was always good, but seems to grow better. Some corking good new material. A fine act of its kind in every way. Fifteen minutes, in one; two bows.

Walter Davison and His Louisville Loons, a band, closed. Had a lot of novelty comedy material that went over strong. Twelve minutes, in full; two bows.

FRED HOLLMAN.

Loew's State, New York

(Reviewed Monday Matinee, Feb. 23)

In the opening spot Ford and Price have a neat offering for a show's beginner. A tight-wire act with a girl and boy stepping nicely, shooting tricky steps here and there, besides a short play on all of the latest ballroom creations. Ford has a good idea in his first gag, where he says "There is a wire waiting for you" to Miss Price. However, he does not put it over, for the audience couldn't get it right off the bat.

Latell and Vokes made the children happy as could be with their dog and baby antics. Today being a holiday the management showed good judgment by putting these people on. Many small boys nearly rolled off their chairs when Latell as the cat gets sick from smoking a pipe. Much fun was developed over Latell pecking at his partner's legs while she sang her two numbers.

Yates and Carson have a dignified comedy turn. Yates gets all there is out of kidding his partner about being stout in a nice way, while his voice is round and mellow in the two numbers he does. The finale where they are getting married in a bright spot with the back drop showing a church aisle made a strong appeal that brought out the response. They closed with enough applause to keep them happy for a while.

Myers and Hanford, nut comedians, formerly on Keith Time, dug up a new stunt today and it went for a wow. Myers throws a handful of caps, unseen by the audience, on the boards and then clap-trap dances with the little explosives going off at the same time. While their stuff needs no improvement they are always out to get the most out of a trick, so why not get the crowd early by doing this near the start of the turn? They use it twice with the laughs stronger on the second time. All their stuff registered well. Myers pulls another nutty idea by dancing in his bare feet, which gave him what the vaudevillian prays for.

Last but not least, better say last the best of all the game, came the Jack Powell Sextet. Jack has a new clown costume that shimmers in the spot like a handful of diamonds. While his drum antics were a little loud in spots, nevertheless he had them on the run. Jack is an excellent drummer, and the trick he has of tapping the sticks on one of the girl's horns gave him one of the best returns of the afternoon. Then there is the xylophone for the first laughproducer. He does a little straight stuff on this that also got him away nicely. The other three men and two girls are all good with their horns and their rendition today put them right up front when it comes to classing horn artists.

G. V. WALES.

finish to the act that is unusual. Twelve minutes, in one; three bows.

John B. Hymer and Company, returning here in *Tom Walker in Dixie*, were

(Continued on page 16)

From Coast to Coast by Special Wire

Orpheum, St. Louis

(Reviewed Sunday Evening, February 22)

Topics of the Day, Aesop's Fables. Kikuta's Japs, six males and two female versatile Oriental wonder workers, have a 14-minute scene that includes every manner and style of athletics, juggling, tossing and balancing. Elaborate hand-made scenery and settings, in four and full stage; four curtains.

Josie Heather, with John McLaughlin at the piano, and "Bobbie" Heather. We still contend that these English singing turns have a long way to go to "catch up" to our American songsters when it comes to putting over numbers. Miss Heather sang several songs and then gave an impression. She would do well to have Miss Juliet do the latter for her. Bobbie Heather sang one number fairly well. Twenty minutes, special, in three; a recitation for forced encore.

Harry Holman, in his new edition of *Hard-Boiled Hampton*. The one-act comedy playlet has the same knockout comedy lines, and these, perpetrated by Holman in his droll way, never fail to tickle the funny bone. Billy Austin and Edith Manson assist in good style. Fourteen minutes, office interior, in four; three curtains.

Then came Adler, Weil and Herman, a male trio of California syncopators, who put pep and feeling into their well-chosen repertoire of songs, in which they harmonized perfectly. They're performers, have voices, personality and appearance, and know how to combine the four to produce real entertainment. They carry a peripatetic piano, which is an oddity. The trio ran to Miss Juliet at this show in the applause honors. Fourteen minutes, in one; encores and bows.

Miss Juliet is a clever little artist and ranks with the highest of our impressionists. She is too well known to need further comment. Thirty-two minutes, special, in two; repeated encores.

Henry Bergman, with the Crisp Sisters, assisted by Lou Handman at the piano. Bergman, in a rather egotistical manner, sang several songs, did a short dance, whooped and pulled jokes, some of which were quite aged.

The Crisp Sisters, a pair of fifty twins, natty costumed, gave several graceful dance numbers. At the finish Handman plugged several of his late compositions. Twenty minutes, special, in full stage; four curtains.

Bob Hall is an extemporaneous chap. He gave some confidential dope on the artists backstage, kidded individuals in the audience, and then composed songs offhand on topics, data and names suggested by the auditors. Twenty-five minutes, in one; encore and "Thank you".

The Test. Following a farce comedy-drama travesty bit for an odd opening, 10 tuxedoed men dispense good jazz music. All are versatile and do specialties. Jack Richards is a pippin "stepper", while Monk Wilson is a good song and dance comedian. Miss Willie Stout is better in her song and dance bits than Tina Glen, altho the latter is featured. The whole dozen work hard and present a nifty act. Eighteen minutes, pretty hangings, in full stage; four curtains.

F. B. JOERLING.

Grand O. H., St. Louis

(Reviewed Sunday Matinee, Feb. 22)

Jaqueline Logan in *The House of Youth* is the feature photoplay.

Worden Brothers, two of the best in their line, have the same routine of splendid and difficult foot juggling and tossing with which they opened the Orpheum bill several weeks ago. Seven minutes, in four; two bows.

Wagner and Lela, man and woman, have a mediocre line of comedy cross talk. We failed to see the funny side of Wagner in this vehicle. With a different makeup and a changed style of comedy we are inclined to believe that he would fare much better. Fourteen minutes, in one; one bow.

Crest and Barrell have a cross-fire talk in "vop" dialect that landed many laughs. These men blended harmony in the rendition of *Take Me Back to That Little Old Shack* and closed with many verses of their own comedy song. Eleven minutes, in one; encore and two bows.

Lelia White's Entertainers. Miss White has surrounded herself with two good black-face funsters, a dandy lady singer and a youthful female impersonator, who completely took the audience off its feet when he pulled off his wig at the close of the act. It is a minstrel offering with burnt-cork jokes, dancing and singing. Miss White acts as interlocutor, one funster furiously twirls a silver cane, the female impersonator solos with syncopation and mean jazz, *Somebody's Wrong*, and when he disclosed himself the fans went wild following a moment of surprise. Seventeen minutes, special hangings in three; five bows.

Hays and Lillian, man and woman. The diminutive maid, while doing a song and high-kick dance, is interrupted by Hays from the audience, who acts the part of a booby exceptionally well and had 'em laughing continuously. He is un-decorated thin chap and the difference in height of the team adds to the comedy



(Reviewed Monday Matinee, February 23)

The Hippodrome took its toll of the crowds seeking entertainment this afternoon, but the show on tap far from knocked 'em dead, Washington's Birthday being officially celebrated today, the weather fair, and Baby Peggy as the featured attraction, combining to pack the house. The second balcony was thrown open and all three floors and boxes were well filled. Children, relieved from school because of the holiday, were in the majority, and many of them came to get a squint at Baby Peggy, which they got and little more. To draw 'em in this young star is a great attraction. To entertain 'em after they're in she is not half so great, anent which we will say more further down. Supporting Baby Peggy, if the artistes named will permit us to use this term, were Karyl Norman, May Wirth, Roger Wolfe Kahn, Henry Regal and others. Manuel Vega, programmed to open intermission, was out of this afternoon's show. Maurice Diamond and Company, held over from last week, were in his spot.

Rose, Irene Kress and Company, assisted by J. R. Moore, Elinore Bunting and Joseph Miller, awoke voluminous applause in the opening spot in what they call terpsichorean wheels—in other words dancing on skates. There is nothing which quite so beautifully expresses grace as skating, and this group of artistes brings it all out in admirable fashion.

Joe Tilyou and George Rogers danced and clowned thru the next spot to the tune of applause that might have been more obstreperous. They made their way to the finish not as smoothly and attention-compelling as if they had been further down, but passed muster as it was. The acrobatic novelties in the routine are worth more than the audience voted at this afternoon's performance.

Roger Wolfe Kahn followed with his symphonic jazz band, billed as "Inaugural Orchestra", the reason therefore being that the outfit is to play at the inaugural proceeding in Washington in March. There are a lot of orchestras better than this one, and, in justice to Kahn, a lot that are worse. Young Kahn buries himself behind a raft of saxophones, Joe Raymond conducting by permission of John McE. Bowman of the Biltmore Hotel, and doesn't present himself to the audience for a bow until the very finish. We wager scores thought Raymond was Kahn and still do. More will be said about the band and its routine of popular melodies in next week's issue.

The Royal Gascoignes were royal in their well-known standard juggling and dog-balancing turn. Teddy, the canine in question, is truly wonderful as the billing reads in both looks and feats, and Gascoigne himself is as much in his excellent juggling bits. To repeat what reviewers have said many, many times, the act scored big returns.

Karyl Norman, "The Crole Fashion Plate", followed in his tuneful, artistic song offering, assisted by Keno Clark and Bobby Simonds, capable pianists. He went over, as usual, with heavy demands for more. Norman's a clever showman and a talented entertainer, who well knows the value of punctilious presentations.

What everyone had been waiting for came, mayhap with not the fulfillment of all expectations, when Baby Peggy's name went up. It was just exactly 16 minutes after the act went on that the youthful picture star put in an appearance. This interminable time was taken up by the showing of a film labeled "From Hollywood to the Hippodrome", but which, from various incontrovertible signs, such as on the license plates of cars, was taken up in Massachusetts. In the short film she is transported surreptitiously to New York in a shipping box, which is carried onto the stage following the film. Baby Peggy is its cargo, and while the Hippodrome's Dancing Girls, Toytown and Tillis and LaRue, featured in the closing act, "Land of Fantasy", are lending the scene a picturesque background, she frequently peeks from under the lid. After coming out of the box and bowing her father gives the audience a typical Kiwanis speech, the chief appellation of which was his declaration that anyone could become a star like Baby Peggy thru obedience. After partaking of a short nap we awoke to find him on the same sermon and would like to have shouted out that we read the "Success" magazine every month. Coming down finally to the entertainment, if entertainment it might be, that Baby Peggy offered, we were treated to an exhibition of her motion-picture acting with happiness, surprise, gloom and tears duly registered. A couple of brief sayings, intended to be droll, completed her routine. A look at the crowded house, however, showed her appearance here was merited, for she served as a fine magnet for the box office. Shades of Barnum!

Maurice Diamond and Company opened intermission and we enjoyed the Stroud Twins as much as we did last week.

Marcel Salzinger, named as a Lieder singer and exponent of the art of belcanto, and who is popular in the opera houses at Vienna, where he was a conferee of Mme. Marie Jertza, now with the Metropolitan, Berlin, Hamburg, Dresden and other musical centers of Europe, was a tremendous hit in his routine of songs. He opened with an Italian air, then in English did "Your Eyes Have Told Me So," closing with a French number. He makes an impressive appearance and always has splendid control of his fine baritone voice. A warm reception was his.

May Wirth, peer of the equestrian world, was her usual immense hit, assisted by Noko, riding comedian. She was here late last fall, this being a return engagement before making ready for the Ringling Brothers and Barnum & Bailey Circus, which opens in March, and with which she is a featured attraction.

Henry Regal and Company, including Ida Gerber and O. Henry, were pitted next to closing in their unique acrobatic, dancing and singing novelty. The act registered solidly in spite of the late position, and was among the few to have a bouquet of flowers bestowed upon it. The featured toe catch in winding up is the piece de resistance of the offering.

George Choos' *Land of Fantasy*, featuring the dancing team, Tillis and LaRue, and the Eight Dancing Rockets, completed the program, holding 'em to the finish. The Rockets are quite to the king's taste in their Tiller routine. They put the Hipp's corps de ballet to shame and cause them to suffer terribly by comparison. Tillis and LaRue, who appeared in Baby Peggy's act without even so much as mention, afforded the eye not a little pleasure in their capably executed dancing specialties. The mounting, stinging and general dress of the Choos offering is of an aristocratic order.

ROY CHARTIER.

of the turn when Hays comes on the stage. Fifteen minutes, special in one; four bows.

His Little Revue is a beautiful offer-

ing of class, color, symmetry, music, song and dance by four women and one man. Two tall and pretty girls dance with grace and unison, one sings like a night-

Palace, Cincinnati

(Reviewed Sunday Evening, February 22)

Cinema program: *Pagan Passions*, with Wyndham Standing, Rosemary Theby and Tully Marshall. *Fatha News*.

A thrilling exhibition of balancing by the Three Orotos, well-known circus act, lasting five minutes, opened the vaudeville. Six other acts on the bill were packed with lively, up-to-the-minute comedy. All were presented with superb dash and there was never a second's slowing up anywhere. Nobody undertook to run away with the show, and applause laurels were quite evenly distributed among the galaxy of artistes.

Sylvia Snow and Dan Sigworth, in an out-of-the-ordinary skit, by Jack Norworth, entitled *Let's Pretend*, came off at least a shade the best for leading honors. After a merry song and dance "in one", the curtain rose on a love cote, on the stoop of which the couple enacted a spirited married-life argument. Their clever pantomime of taking care of the baby, which closed the act, was nothing short of a wow. Eighteen minutes; three bows.

Courtship Days was the label of another act filled to the brim with original comedy. Names of the three principals were not billed. A musical couple in the divorce court and a jolly judge, who sang, too. Court scene, followed by glimpses of the couple occupying separate apartments in hotel. The act was a perfect parody in rhyme on judicial procedure, with nifty nonsense interspersed. Much applause. Sixteen minutes; three bows.

The Fletcher-Clayton Revue, miniature musical comedy, by three girls and three men. Tabloid counterpart of modern revue ingeniously conceived and executed with singing and dancing numbers of high-grade caliber. Seventeen minutes, in cyc.; three curtains.

Pauline Saxon and Al Belasco, holding the second spot, averaged better than a laugh per minute in *A Box-Office Attraction*, Pauline being in a class by herself as a sweet little wisecracker. Seventeen minutes, drop of theater lobby, in one; three bows.

Otto Brothers slipped a raft of backstage and dressing-room secrets to the audience, recalled happy days in Cincy's famous "Over-the-Rhine" district, and in a sprightly offering burlesqued ballad singers and other vaudeville stock in trade. Twelve minutes, in one; two bows.

Dixie Hamilton's *A Syncopated Cocktail*, thanks to the singer's vivacity and fetching salesmanship, scored with *Tha's Georgia* and other numbers. Eight minutes. E. J. GALLAGHER.

Pantages, San Francisco

(Reviewed Sunday Matinee, Feb. 22)

The program which got under way this afternoon has six acts, varied and most of them good, and the cinema feature, *Fifth Avenue Models*, starring Mary Philbin and Norman Kerry, which is of the same high standard screened at this theater of late.

Murand and Leo, well developed and young-looking men, started the bill off with skillful gymnastics and feats of strength. Repeated rounds of applause attested the audience's approval of the merit of this athletic turn. Seven minutes, in full; two bows.

Mildred Myra contributed a song cycle replete with popular numbers well rendered. Scenic and lighting effects and frequent changes of charming costumes caught the fancy of those out front. Sixteen minutes, specials in one and two; two bows.

Langford and Frederick carried on with a satire titled *Shopping*, which is full of clever dialog, catchy songs and nifty hoofing. Fourteen minutes, special in full; two curtains.

Edna Wallace Hopper's offering includes the projection of pictures showing her being made beautiful, the results of which she permitted patrons to judge for themselves during the course of her monolog. The program states that the act was written especially for her by Raymond Hitchcock. For headline spot the offering seems weak, the audience failing to respond fully to its entertainment value. Fourteen minutes, full stage; two curtains.

Norton and Brower, comedians, in *Bughouse Fables*, sing a little and dance a little, but do that little well. They devote most of their time passing gags, patter and smart repartee in a way all their own. Registered the leading applause recognition of the afternoon. Thirteen minutes, in one; three bows.

Fairview, the closing act, is a musical farce featuring Dorothy Waters, comedienne of the Charlotte Greenwood type, and Freeman Stanley, comedian, assisted by a female quartet, the singing of which was capable and interspersed with considerable funmaking by Waters and Stanley. Colorful costumes and excellent staging made the presentation delightfully different from the usual closing act seen here. Twenty-four minutes, two curtains. E. J. WOOD.

ingale and a shapely model exhibits her form while vocalizing. The man is a crackerjack specialty dancer and clicks (Continued on page 16)

Loew's American Roof, New York

(Reviewed Thursday Evening, Feb. 19)

This week's vaudeville bill was over by 10:15 Thursday night. The Texans, man and woman, with rope-spinning stunts, opened and gave a fairly good start to the show.

Joe and Art Humby hoofed and sang. The lads are nimble dancers and, while they sing just as the average dancer does, they had no difficulty in scoring.

Latell and Vokes pleased with their familiar novelty. Latell still manages to find spots to get new laughs with his "dog" impersonation after all these years he has been doing it. The two are now working in one instead of full stage as they used to if we remember correctly.

The De Maria Five closed the first half with a singing and instrumental routine. The offering is reviewed in detail under "New Turns".

Flaw and Frazer, another offering reviewed fully under "New Turns", opened the second half. Most of the act took a "brodie" and parts of it did fairly well.

The hit of the bill for laughs and appreciation was Jack Conway and Company, doing *In the Cellar*, a skit. Conway does one of the best "tads" to be seen, and when he gets to his drunk bit there isn't an audience in the country that wouldn't scream at him. A straight man lends capable assistance and an attractive looking woman appears in bits with good effect.

Al Abbott was second for hit honors to Conway. This chap is one of the best entertainers we've seen in a long time. He is reviewed fully under "New Turns".

Happy Harrison's Circus, in which dogs, ponies, a couple of chimpanzees and a mule appear, closed the vaudeville portion of the show. Most of the stunts are cut too short to get best results, and if the time for them was taken from the comedy with the mule all the bits would be improved, for the latter is too long. Otherwise it's an entertaining act of its kind and well presented.

G. J. HOFFMAN.

Keith's Fordham, N. Y.

(Reviewed Thursday Evening, Feb. 19)

The Donald Sisters, acrobatic team of many accomplishments, some that would be envied by male exponents of this popular art, opened to better returns than this spot usually gets. The girls do their hand-to-hand and other bits in sure-fire manner, and among other things to their credit is the speed and snap put into their work.

Lois Bennett, formerly teamed with Muriel Pollock, but now seen with John Tuff, who holds down his job at the ivories competently, fared nicely in the spot following, winding up with a hand that threatened to provoke encores. Here is a thoroughly entertaining song offering.

Carlton Emmy and his Mad Wags, one of the few canine acts in the business to cop spots this far down the bill, registered as usual a heavy mitt. The offering has a great opening with Emmy giving the impression he is to unfold a kaleidoscopic girl act. The little dogs, remarkably well trained, do the rest, with Emmy slipping in a laugh here and there by well-thought-out comedy.

Alan Coogan and Mary Casey followed in their laugh-provoking skit, *The Shrinking Violet*, by Eugene Conrad. In the hands of others this amusing vehicle might not go over so big, but Coogan and Casey get its every value and put it over in convincing, diverting fashion.

Al Wohlman, next, walked out, laid his hat in the footlight trough, proceeded to entertain the folks in his own amusing style, donned the derby and walked right out again, with the clatter of a mighty hand ringing in his ears. He pleases in everything his routine contains, standing out in a series of imitations of Jack Norworth, Harry Fox, Al Jolson, Ted Lewis and others.

Olga Myra and the Bitter Sisters closed in a beautifully staged and executed offering by Allan K. Foster, entitled *Black and Gold*. The title is derived from the nature of the stage setting, black eye, and a gold frame (of the picture type) being used effectively. The offering registered solidly and ranks several points above the average classical dance act. It is reviewed in detail under "New Turns", this issue.

ROY CHARTIER.

Palace, Chicago

(Continued from page 14)

received with generous applause. Mr. Hymer is one of the few who successfully produces sketches of and acts the Negro of the kind popular in days gone by. There were continuous laughs and most generous applause at the close. Thirty minutes.

Jack Norworth, assisted by Dorothy Adolph, scored his usual success. The former does the singing, but the sweet and demure Miss Adolph adds much that is pleasing in a bit of comedy dialog and as pianist. Norworth, always a favorite, did enough of his kind of songs to maintain his popularity. Twenty-two minutes, in one; encore and three bows.

McGushion Twins, in *Let's Dance*, are assisted by Eddie Franklin, Chie Stanley and DuBow and Ross. That the act went over big was largely due to the four men. It was swift moving and there is enough of the eccentric type of dancing to satisfy, while those who

COLUMBIA BURLESQUE COLUMBIA THEATER ~ NEW YORK

"STOP AND GO", WITH JOHN BARRY

(Reviewed Monday Matinee, February 23)

A John G. Jermon attraction. Book by I. B. Hamp. Music by Ruby Cowan. Produced and presented under the personal direction of John G. Jermon week of February 23.

THE CAST—John Barry, Burton Carr, Jean Bodeni, Helen Carlson, Ethel DeVeaux, Anna Myers, Mabel Clifford, Bob Startzman, Dick Erford, Mr. Simmons, Veoletta, Raymond's Dancers.

Review

The scenic equipment in this presentation runs to classy and colorful full-stage sets, drapes and drops, and the same is applicable to the gowning and costuming, which is changed frequently, all of which evidenced more than the usual care given to equipment, for it is apparently as fresh today as when the show opened.

John Barry, the featured comique, is doing his usual characterization with frequent changes of comedy clothes somewhat different from those utilized by him in previous shows, but Comique Barry still retains his favorite slogan, "I'll kill 'em," which pulls a laugh on his each and every utterance by his dry, droll humorisms and eccentric acts, which are as laugh-evoking as ever.

Bob Startzman, cocomique, is given far more to do in this show than in any previous one in which we have reviewed him and in which we have always commended him for his dramatic ability. We further commend him for that ability in this show, likewise for his versatility in humoring his lines and actions for burlesquing purposes. A more co-operative combination of comiques would be hard to find.

Barry and Startzman worked together in all of the comedy scenes, giving and taking in support of each other. In the opening of the show they appear in a comedy singing and dancing act and down near the close of the show they put over an exceptionally funny, laugh-evoking comedy dance that fully merited the applause given dance and dancers.

In the second part of the show Comique Startzman makes a quick transformation from a comedy role in whiteface to a minstrel man singing role in blackface, which was fully encored.

Burton Carr, the operatic singing straight man, in classy attire and clear, distinct delivery of lines, humored them sufficiently for all the needs of the comiques, and in several characteristics Carr distinguished himself in his versatility.

Anna Myers, a pleasingly plump bobbed brunet leading lady, in scenes evidenced real dramatic ability, likewise her comediennehip and in her lyrics reminded us of a musical comedy star. In her singing specialty, supplemented by a graceful dance, Miss Myers is equal to many of the artistes featured in vaudeville. Miss Myers changed her costly and attractive gowns for her each and every reappearance and in doing so fully demonstrated the indisputable fact that she has mastered the art of gowning a la mode.

Ethel DeVeaux, the pretty, petite, bobbed brunet ingenue-soubret, has improved wonderfully over previous seasons in her personal appearance, for, cute as she was known for years, she has taken on some weight, which makes her features and form more modellesque. While it was evidently necessary for her to don ingenue gowns for her clever work in scenes, she was far more admirable in soubret costumes and tights for her singing and dancing numbers.

Jean Bodeni, a pretty, petite bobbed brunet soubret, led numerous numbers with pep and worked well in scenes. This was especially applicable in a traffic street scene with the comiques, in which she pulled a big laugh.

Helen Carlson, a pretty-face, bobbed blonde, slender, symmetrical, graceful contortionist, working from a web suspended from the flies, gave a wonderful exhibition of contortional, modellesque poses to the singing of Soubret Bodeni swinging at the end of the web.

Mr. Erford, manager of Erford's Aerial Act, took an active part in several of the scenes and evidenced notable acting ability, and the same is applicable to Charles Simmons, who, while not programed as a comique, nevertheless enacted the role in an able manner in several of the scenes.

There were two outstanding features in this presentation that included Erford's Oddities, a spectacular novelty with three personally attractive females in an aerial act, in which they swing from revolving ladders and trapeze. They adorn their wrists and ankles with belts that ring in harmony during their whirlwind revolution.

Veoletta, a personally attractive, slender, symmetrical, graceful dancer, appeared in an Egyptian scene and put over a dance that was a classic of its kind.

Adele Raymond's English Dancing Girls, eight pretty-faced, slender-formed, graceful dancing girls, distinguished themselves three times during the presentation with a series of ensembles altogether different from those heretofore seen in burlesque.

The members of the chorus, including Adele Raymond's English Dancing Girls, are for the most part youthful, pretty, talented and able. They sing in harmony and dance in unison, with far more pep and personality than is usually found in ordinary burlesque presentations. Brownie Walsh and Maud Sadler, two pretty choristers, stood out distinctively in several of the scenes.

Taking the presentation in its entirety, it is a series of burlesque bits that open with Ethel DeVeaux prolonging the show along the usual lines and run the gamut from opera to burlesque, followed by such old bits as *The Meeting*, *Why Am I Sad*, *In the Park*, *Jealous Wives*, *Vampire*, *Martha and Me*, *On the Nile*, *The Play's the Thing*, and a new bit, entitled *In 1965*, or *The Egg Inspector*, and a series of episodes from life a la burlesque, closing with Comique Barry's old standby, *The Traffic Cop*, with the stop and go signal.

There is no inclination on the part of anyone to ape the mannerisms of musical comedy principals, for outside of Miss Myers, who is equal to many of the so-called stars of musical comedy, the other principals confined themselves to real old-fashioned burlesque of the laugh-evoking, applause-getting kind that appeals to patrons of burlesque in general.

ALFRED NELSON (NELSE).

prefer the other types surely were pleased. All cleanly and cleverly done. Alternated between one and full stage. Fifteen minutes, in one and full stage; four curtains.

Charlie Alcott and Polly Ann, with Eddie Lambert at the piano, sang numbers of Alcott's composing. They did them well and were warmly received. Polly Ann's *When a Fellow Needs a*

Friend closed the act. Twenty minutes, in one; three bows.

Ensign Al Moore and His U. S. Orchestra are the liveliest and most versatile syncopators of the season. "Sonny" Hoey, Jack Spertzel and Fred Voght have individual stunts that make this act a real vaudeville bill all to itself. The singing, dancing, comedy and novelties made entertainment every minute.

AT LIBERTY FOR SUMMER ENGAGEMENT

A TWELVE-PIECE ORCHESTRA.

All first-stand players of one of the best American Symphony Orchestras. Leader a famous soloist of world-known reputation. International repertoire of 3,000 favorite numbers. 8 Soloists. Address: BOX 228, care The Billboard, 1493 Broadway, New York City.

Proctor's 58th St., N. Y.

(Reviewed Thursday Evening, Feb. 19)

Exactly the kind of a show that suits this house, for as usual they had them standing knee deep in the back of the theater.

The Willhat Trio took well as an opener in their bicycle routine preceded by a trick auto that has one of the three hidden away inside while Willhat himself plays the chauffeur. The girl shines out strongly on a bike while the other two work up fun with their distorted two-wheelers.

Stevens and Laurel, hard-shoe steppers, were received handsomely and are reviewed further in this issue under "New Turns".

Fenton and Fields, black-face lads, run to the usual in this kind of a turn. Impersonations of all of the black-face stars are indulged in with the mummy song hits that each is noted for. They break into their routine then with a number of gags that are kind of laugh-getting, with stepping now and then for deviation.

The Sutcliffe Family, a troupe of Scotch lads and lassies, did well in their novel arrangements. The hand-to-hand tricks with all performing received the warmest applause from the audience, while their babbling of the heather songs helped out considerably. The dancing of the Scottish reels and the bawling of the older members of the company brought forth a strong breath of Scotland and the stuff that made Harry Lauder famous.

Stephens and Hollister, who have played vaudeville for years, are doing a new act this time entitled *Watching the Parade*. This is also reviewed under "New Turns" in this issue.

King Solomon, Jr., formerly done by another cast, is an act composed of six girls and a girl and man principal. It has to do with what is supposed to be the vogue in 1940 when men will have as many wives as they desire. A comical skit that worked up well to a climax in its 25 minutes on the boards. It is reviewed fully under "New Turns".

G. V. WALES.

B. S. Moss' Regent, N. Y.

(Reviewed Thursday Evening, Feb. 19)

Alice Diaz and Harold Powers opened with their nifty wire specialties, including most of the latest dances. The girl works daintily in acrobatic stunts, and her partner skips the rope, jumps over obstacles and otherwise disports himself in breezy tempo.

Ed E. Ford, "the man of a thousand faces", His jaws and facial muscles seem to be made of india rubber. He opens with a song, does his mugging and later a few stories, concluding with a war-epic recitation.

Johnny Sully and Muriel Thomas, in *Beauty, Youth and Folly*, gathered the laughs at will with gags, songs and dances. The girl makes an admirable straight for her partner, who has many fine qualities as a comedian. His dances also are a strong feature of the routine. Newhoff, Phelps and Company are doing a new act that opens "in one" with a place drop and goes to full stage. An eight-piece orchestra works with the act and comes on in novel fashion, as the competitive suitors for the girl. The comedy is derived from the arguments, etc. There is too much singing in it at present, most of it done by the girl. Further reviewed under New Turns.

Walter Brower, monologist, in next to closing, did his usual stuff, which starts fair, but grows monotonous as it goes along. The delivery is all right for the most part, but the material is far from new.

Kimball, Goman and Company closed the show in a novelty dance routine, the juvenile and girl specializing in eccentric steps that are executed in a style out of the ordinary. They are assisted by a pianist.

S. H. MYER.

Special setting is used to good effect. Twenty-two minutes, full stage; two encores and three curtains.

Van and Schenck, harmonizers without a peer among acts of the kind, and a popular kind at that, repeated their former triumphs. There were so many encores that the count was lost. Thirty-seven minutes, in one, and encores in the orchestra pit.

The Herbert and Bolt Trio closed the bill in slow-motion, hand-to-hand balancing. Many new feats of strength, skillfully executed, held the audience to the end. An unusually good closing turn. Nine minutes, in three.

R. E. MORNINGSTAR.

Grand O. H., St. Louis

(Continued from page 15)

enhanced by nifty costumes. Fifteen minutes, three curtains.

Fred Lewis with his familiar makeup, carrying his everlasting book and with just about the same material he has been using for years, was next. It's always good to hear Lewis, who never fails to register solidly. Nineteen minutes, in one; two bows.

Ishikawa Brothers, a quartet of Far East athletes, are next workers and perform sensational hand-balancing stunts and other feats with ease. Their 11-minute exhibition brought a great haul for a closing turn. In two and four.

F. B. JOERLING.

FOX TO REPEAT OLD PICTURE FEATURES IN VAUDE. HOUSES

Experimenting With "Over the Hill" at the Crotona---To Play All Other Theaters if Drawing Power Proves Successful

NEW YORK, Feb. 23.—To determine whether "hit" super-special pictures can be played for return dates in similar fashion to vaudeville acts over its circuit, the Wm. Fox office will experiment at the Crotona Theater, Bronx, during the last half of this week with *Over the Hill*. The picture, made by Fox, was successful in all his houses prior to being released to independents more than three years ago. Should it succeed in drawing business at the Crotona during the last half of the week it will be played in all the other Fox vaudeville houses.

The success of *Over the Hill* will also be the determining factor in deciding whether to use other Fox specials which have been box-office draws in the past few years. Among them are *A Yankee in King Arthur's Court* and *Queen of Sheba*. These, as well as others, will be repeated if the business drawn by *Over the Hill* shows that a repeat after several years can be successful.

The Crotona, like all other Fox vaudeville houses with the exception of the City, plays two shows a day and three on Saturdays, Sundays and holidays. The experiment is being made not because of any shortage of films, it is said, but in order to save money on rentals for new films. Reissues cost much less than new pictures to exhibit and should the experiment prove successful enough to play the films in all the Fox houses a large saving will be the result.

Independent vaudeville managers are interested in the business done by the Crotona with *Over the Hill*, with an eye toward booking the old features. An opportunity to save a little money is the appealing angle to them.

Pisano's Mother Under Knife

Mrs. Anna Pisano, mother of General Pisano, was successfully operated upon February 14 at the Orange Memorial Hospital, Grange, N. J. Her appendix was inflamed and showed evidence of having been the cause of her trouble. This was removed. Altho Mrs. Pisano is 70 years old she stood the operation well and is making a satisfactory recovery. She has been in the hospital about four weeks.

General Pisano and his partner, Charlotte Cochran, who played the Palace Theater, Cincinnati, last week, left Saturday night for New York, where they play the Palace Theater this week. The New York engagement comes in nicely, as it will afford the General an opportunity to visit his mother in the hospital.

Plays Bathing Beauties and Stages Contest

New York, Feb. 23.—The Palace Theater, Red Bank, N. J., put on a special entertainment the first half of last week, featuring the "Original King Neptune" of the Atlantic City beauty pageants, Jack De Lange, who appeared with eight bathing girls. In addition the Palace put on a beauty contest, with two prizes, a silver loving cup and a bathing suit, awarded to the winners. The house plays Keith-booked vaudeville.

Perrin Writing Acts

New York, Feb. 21.—Adrian S. Perrin, of the Rycroft-Perrin offices, is writing a new act, entitled *Three Cheers and a Couple of Hips*, for Dorlan and Warner Anderson, who will present it for a try-out within the next week or two.

Perrin also is writing an act called *Tom Maag Crosswords*, a travesty on the crossword-puzzle fad, for May and Marty Maville. Special scenery to carry out the crossword-puzzle atmosphere will be a part of the offering.

Acts in Benefit

New York, Feb. 23.—Several vaudeville acts playing in New York volunteered for the entertainment and reception given February 19 at the 69th Regiment Armory, the proceeds of which go to the Save-a-Life Farm and other charitable activities of the Madonna House, in Cherry street. The Police Glee Club and Police Band also appeared.

Clark and Cassler Team

New York, Feb. 23.—Eva Clark and Ben Cassler, both well known in the two-day, have formed a partnership and opened today in a new act at White Plains, under the direction of William Morris. Following a few more break-in dates the team will be seen in the big Broadway houses.

Benny Ruben Returning

New York, Feb. 23.—Benny Ruben has just completed a tour of the Orpheum Time in his vehicle, *How It Happened*, by Billy K. Wells, and is now working east on the Interstate Circuit.

British Registration Bills Likely To Pass

Will Affect Theatrical Employers and Agencies---Performing Animals Bill Also Presented

London, Feb. 21 (Special Cable to *The Billboard*).—Sir Walter de Freese introduced the Variety Artists' Federation's registration of theatrical employers' bill in the House of Commons February 18 and the second reading is slated for February 23. The bill is backed by all shades of political opinion and has the fullest support of the Society of West End Theater Managers, the Theater Managers' Association, Association of Touring Managers, Entertainments' Protective Association, Actors' Association and Variety Artists' Federation. Unless something unforeseen happens there is every chance of its becoming a law this year.

If the second reading goes thru on Monday night, which is an automatic proceeding unless it is opposed, then it will be sent upstairs where in committee it will be more fully discussed and then returned to the full house for a third reading, when, if passed, it goes to the House of Lords. As it is an agreed measure its passage seems rosy unless the Provincial Managers' Association opposes it.

The Variety Artists' Federation is re-introducing its entertainments agencies registration bill, which has been shelved since 1923, and as the Surrey County Council is legislating along similar lines to the London County Council, Glasgow, Liverpool and Manchester, it is but a matter of time until every theatrical and vaudeville employer and agent will be registered.

Belgadler General Cockerill, supported by Sir Walter de Freese, on Thursday of this week presented an agreed bill in the House of Commons to regulate the exhibition and training of performing animals.

This bill is the outcome of arrangements made between all parties as a result of the fight put up before the select committee in which Sir James O'Grady, now governor of Tasmania, Walter de Freese, Monte Bayly and Joe Woodward took most strenuous and active part. As the bill is agreed it has every opportunity of becoming a law at this session, more so as the Home Secretary is fully sympathetic.

Pratt in Mid-West

New York, Feb. 21.—Purnell Pratt left the last-half bill at the Hamilton Theater last week after the performance Friday night so that he could open a Middle West engagement, starting with the Palace, Cleveland. Pratt is featured in Tom Barry's playlet, *Springfield*, produced by Lewis & Gordon. At the Hamilton the team Smith and Barker appeared the last day of the week in the spot left vacant by Pratt.

Irish Tenor for Vaude.

New York, Feb. 23.—Joseph Regan, Irish tenor, and his wife, Alberta Curtis, have just signed contracts for a tour of the Keith-Albee houses. They will present a singing sketch, called *My Firefly Lady*, written for them by Mr. and Mrs. William Smith Goldenburg, of Cincinnati. Arrangements for Regan's appearance in the two-day were made with Augustus Pitou, the tenor's manager.

Society Dancers in Vaude.

New York, Feb. 23.—Moss and Fontana, society dancers, who have become the big feature of the Club Mirador, are entering Keith vaudeville. They will be seen at the Palace during the week of March 2.

Film Star in Playlet

New York, Feb. 23.—Florence Turner, one of the pioneer stars of the motion picture industry, who was associated with Vitagraph some years ago, is entering vaudeville. She will be seen in a comedy playlet.

Harold Furney Sued For Booking Fees

Schallman Bros. Seek \$511 From Members of "The Four of Us" Act

New York, Feb. 23.—The members of the act *The Four of Us* have been named defendants in an action involving the sum of \$511 for booking fees. Lillian Planching has been authorized by the Schallman Brothers, booking agents, to sue Harold D. Furney, who is appearing in *Topsy and Eva* here now, but formerly with the act Billy Ballew and Guy Waters, the latter two on the road in the turn.

The Schallman Brothers have already been awarded judgment in Chicago against these three actors and the former are now attempting a like procedure in New York.

William Glancy, attorney for Furney, explained the situation by saying that the act in question was on the road when the Schallman Brothers obtained their judgment against Furney, Ballew and Waters. Glancy went on to say that Furney placed his act in the hands of two booking agents, Arthur Horwitz and the Schallmans, and that the agreement was whichever booking agent placed the turn was to receive the fee.

Glancy is in possession of a letter from the Vaudeville Managers' Protective Association signed by Casey that states that the latter has reviewed the case from correspondence received from both parties in question and that he (Casey) finds that the members of the act *The Four of Us* do not owe the Schallman Brothers a booking fee. Casey wrote that a fee had been paid to Horwitz, as he arranged the tour, and it would not be fair to expect that an act should pay two booking charges.

The turn was formerly known as *The Columbia Four*, but due to one of the members enlisting in the army in 1917 they changed it to *The Four of Us*. It was shortly after this that the trouble started.

"Charleston" Dance Contest in Proctor House

New York, Feb. 23.—Every Monday night, beginning with tonight, for four weeks there will be a "Charleston" dancing contest at Proctor's Fifth Avenue Theater. Frank Farnum, the judge, will choose the winner with the aid of the audience. A silver loving cup will be presented.

Orpheum Enters Oakland

New York, Feb. 23.—The Orpheum Circuit officially entered the Fox Theater, Oakland, Calif., which was recently added to the chain, last week with a bill of Orpheum acts headed by Weber and Fields. The theater has been renamed the Orpheum and takes the place of the old house in Oakland operated by the Orpheum Circuit.

Fox Augments Bills

New York, Feb. 23.—Fox's City and Audubon theaters will increase the size of their vaudeville bills for next week in honor of special celebrations. The City will hold a midwinter carnival and will play 10 acts each half of the week instead of the customary eight. The Audubon will play eight instead of the usual six each half of the week.

Phil Dwyer in Vaude.

New York, Feb. 23.—Phil Dwyer, who played the part of the cat, "Tom," in Billie Burke's show, *Amie Dear*, which closed recently at the Times Square Theater, opened the first half last week at Keith's Theater, Jersey City, returning to vaudeville in an act entitled *My Dog Rover*. He is assisted in the offering by Peggy Warner.

Coeur d'Alene Gets Vaude.

Spokane, Wash., Feb. 23.—Coeur d'Alene, Id., is to have vaudeville after all, arrangements having been completed by M. H. Newman, manager of the American Theater here, which plays acts booked by the W. V. M. A., to give the mining city the same show that plays his house one day each week. The American does not play vaudeville full week.

New Trio in Vaude.

Herkimer, N. Y., Feb. 21.—Jack Miller and Bert Collis, of this city, and Al Jennings, of Little Falls, near here, have formed a vaudeville offering. They opened recently at the State Theater, Ulen, and have been booked for a tour of up-State houses. A feature of their act is a parody on *The Face Upon the Floor*, often erroneously called *The Face on the Barroom Floor*.

Jackson's Dates Abroad

New York, Feb. 23.—Joe Jackson, tramp cyclist, now playing a five weeks' engagement at the Empire Music Hall in Paris, will go on tour thru Southern France on completion of this date, then return to England for further appearances there.

Work Starts on N. V. A. Week

New York, Feb. 23.—Active work has been started on exploitation thruout the country on N. V. A. Week, which is to be held in all V. M. P. A. affiliated theaters this year during the week of April 12 to April 19. The program committee for the benefit performances, which are to be held May 3, has also started soliciting commercial and professional advertisements for the souvenir program. Letters have been sent to all acts playing the V. M. P. A. houses asking whether they desire to reserve position and to send in their copy now. All commercial enterprises, which in any way cater to the theatrical profession or theaters, such as hotels, costume and scenic manufacturers, engravers, printers, luggage firms, etc., are being canvassed for ads. Motion picture trailers are being prepared to start the exploitation on the N. V. A. Week. The most proceeds of all theaters which are members of the V. M. P. A. for that week will be donated to the Sick and Benefit Fund of the N. V. A. Collections also will be taken up in the audiences.

Actor's Son Confirmed

New York, Feb. 23.—Horace Kola, of Kola, Sylvia and Company, standard act, celebrated the confirmation of his son, William Kola, last night, holding a reception at Laurel Garden, at which 50 couples attended. Kola, Sylvia and Company are now playing a route on the Keith-Albee Time.

Griffin Twins for Orpheum

New York, Feb. 23.—The Griffin Twins, youthful dancers, now on Keith-Albee Time, have been signed by the Orpheum Circuit for a tour of its houses, opening June 15.



VENTRILLOQUISM

Learn this wonderful art. POSITIVE GUARANTEE to make you a Ventriloquist in 10 lessons. Hear demonstration by WORLD'S GREATEST VENTRILLOQUIST. Catalogue mailed.

MARIE GREER MacDONALD.
2828 W. Madison St., Chicago, Ill

JAZZ LESSONS

One lesson will convince you that Graf's New Method is great. Try It. Popular price first lesson.

WHISTLING

Trills, Warbling, Double Teeth, Finger Whistling.

VOICE CULTURE

From beginning to Concert Stage. Send for free booklet. L. C. GROFF, 2828 West Madison Street, Chicago.

ACNE Kills Beauty!

In a world of beauty specialists, I specialize in clearing away pimples. Can the disease what you please. Acne means "pimples". Pimples, however caused, I clear away quickly. No matter what charm, grace, beauty of feature you have, one pimple drives away all chance for admiration. Consultation FREE. I guarantee you satisfaction or money refunded.

Acne Treatment, \$1.60 the Jar, by Mail. Send for Booklet.

FRANCES OWEN HARVEY,
185 Madison Ave. (Cor. 34th St.), NEW YORK.
Telephone, Ashland 6429.

DANCERS

No. 315

\$6



MUSICIANS

The ideal shoe for Dancers and Musicians. NEAT—No laces to mar the appearance. COMFORTABLE—Elastic arrangement takes care of that. SERVICEABLE—Made of patent cloth with solid leather construction throughout.

C. P. N. Merchandise Co.,
P. O. Box 32, College Sta., New York City.
Please send \$1 deposit and state size when ordering.

NEW TURNS AND RETURNS

De Maria Five

Reviewed Thursday evening, February 19, at Loew's American Roof, New York. Style—Singing and instrumental. Setting—Full stage. Time—Twelve minutes.

Three women and two men, who offer a series of classic vocal and instrumental efforts. All of the numbers were sung in Italian, and are more or less familiar as far as the melodies are concerned to vaudeville audiences. Only one woman sings, the other two playing violin and flute all thru the act. The two men also sing and one adds to the instrumental portion of the act with a guitar.

The voices are but ordinary as far as the type of act is concerned. The woman solos with *The Kiss Waltz* and when reviewed showed her only good tone at the finish. *O Sol Mio*, is used for a male solo and then for a duet with the woman. The three singers also use the *Stagetto* from *Lucia*, in other words a trio rendition of the *Sextet*. They close with a medley including part of *The Soldiers' Chorus* from *Faust*.

The act is properly placed in the same class of houses in which it was reviewed. With such audiences it will do well.

G. J. H.

Al Abbott

Reviewed Thursday evening, February 19, at Loew's American Roof, New York. Style—Character comedian. Setting—In one. Time—Twelve minutes.

There is a Santa Claus, and sometimes one has to believe in fairies. Abbott proves that it is worth watching small-time bills for new sensations. Not that Abbott is a sensation, but he is the type of artiste that makes up for a lot for the reviewer who has to catch several three-day shows a week. He won't be on the small time very long, and for that matter perhaps not in vaudeville. For Al Abbott, if he isn't on the big time soon, is a sure-fire bid for production.

He has all the necessary assets: a likable personality, a voice that pleases in both talk and songs, and plenty of ability. In fact, "entertainer" is the word which about best describes him. Abbott does a series of characters, mostly "hick". He appears in a street suit, and after his opening number offers an impression of characters he announces he saw at a town-hall entertainment. The best of these was the village cutup and his little "disorder" in a heart-rending number called *Have Courage, My Boy, To Say No*. Were this to be done in a production Abbott would be the hit of that particular show. Another classic is the one of the "champeen harmonica player". He sings, dances, talks and plays, and pleases every minute he's in view.

G. J. H.

Flatow and Frazer

Reviewed Thursday evening, February 19, at Loew's American Roof, New York. Style—Songs and piano. Setting—In one. Time—Fourteen minutes.

Flatow is said to be a songwriter, or to be more explicit he says so himself. Frazer, we understand, was formerly a member of a three act. The new combination is hopelessly small time. Both have voices which grate on the ear, and haven't the showmanship or delivery of numbers to make up for the lack of vocal quality. Flatow appears at the piano all thru the act, playing for numbers sung by both and in solo.

The boys unconsciously have one good bit of comedy in the offering, which at that won't be funny to the class of audience their offering will be shown to. This comes in one part of the act where after Frazer sings several very terrible attempts in verses to be suggestive both sing a number about the Ten Commandments immediately after. It just happens to be a coincidence of routine, but it gives an idea of what a lack of showmanship both possess. Flatow rendered a medley of his own numbers, and some are really well-known popular songs, but the auditors here evidently didn't hear much about them, for they refused to his cues, via a nod of the head, to applaud each number he played.

G. J. H.

Nixon and Sans

Reviewed Monday matinee, February 16, at B. S. Moss' Broadway Theater, New York. Style—Blackface novelty. Setting—In two and one. Time—Twelve minutes.

These folks went in strongly for color and they achieved it. They come on like a blaze out of a furnace, the lad wearing a light tan suit with a red vest while the girl has an orange-colored creation, cut very low. They are in front of their own drop showing a colored dance hall with a few wise-cracking posters adorning it.

Their routine starts by cracking smart about their varied ability in strutting the latest Charleston and what not in the colored land of terpsichore. They linger on a few gags that were funny enough for two bursts of enthusiasm and then Nixon falls into a chatter of jazz steps while Miss Sans goes off to make a change.

The girl is back again at Nixon's conclusion and sings a mammy song, *Shine Away Your Blues*. She follows this with

a show of fast steps that are high and agile, setting herself in the class of recognized jazz interpreters.

Nixon comes back again all tricked out in female attire, still wearing the burnt cork. His make-up is clever with a small hat, a tight multi-colored dress and white spats. He has a few gags with his partner and they both dance again. This time they are out for a strong registration with the audience and they show everything they know about jazzing it up. They know a lot, for their final dash brought forth a handful of appreciation.

G. V. W.

Gertrude Moody

Reviewed Tuesday matinee, February 17, at Proctor's Fifth Avenue Theater, New York. Style—Musical novelty. Setting—In one and four. Time—Twenty-one minutes.

There are three well-trained male voices with Miss Moody in this offering which has a plot involving the supremacy of voices, the American or the foreign trained.

The act opens with three men in front of a drop in one discussing the choice of a leading woman for a forthcoming production. A producer and his assistant are bickering with the composer of an operetta as to whether a girl by the name of Jenny Jones, an American, will fill the role. At this point she happens along the street where the interview is taking place and recognizes the composer. He introduces her to the producer and his assistant. They say that Miss Jones can not possibly carry the part and that a foreigner with a name must be engaged for it.

The composer hits upon an idea. He says that he knows of a Russian woman of ability who might be persuaded to take the role. He invites the producer and his assistant to go with him to his apartment where he will see what can be done. This is only a ruse in order to make the men hear Miss Jones under fair conditions.

They arrive at the apartment and find her singing. The composer had tipped off Miss Jones to pose as a Russian singer. The manager asks who is the possessor of the beautiful voice and is told that it is none other than Mme. Kaminoffsky. He sends his assistant across the hall to invite her in. He comes back raving about the charms of this Russian and what a marvelous woman she is, the same fellow having acted very impertinent at meeting Miss Jones on the street.

The Madame consents to come in and sing for the producer who immediately says that he is thrilled with her voice. He offers her a contract at \$1,000 a week which she refuses, but signs when the price is raised to \$1,200. The producer steps around very happy at this and can't wait until the document is in his hands.

When he gets it, he lets out an exclamation of wrath to find that the paper has been signed by Jenny Jones. She makes a long address on why Americans should be given the same opportunities as foreigners, saying that producers should not be deceived by European titles and names.

Miss Moody, formerly of Duncan and Moody, has a deep contralto voice but experiences no difficulty in reaching high notes in several classic selections. She uses the *Serenade*, *Bye and Bye*, *Bedelia* and a selection from *Faust*.

The player in the part of the composer sings tenor, while the producer and third man sing baritone. The tenor is a bit weak when it comes to filling the house, but the other chaps do fairly well when it comes to power.

The act is a long one for this style but received quite a healthy response at the curtain. Miss Moody's range is wide and her voice is beautifully clear. This audience enjoyed the plot and agreed with the American getting the first choice every time.

G. V. W.

Houdini

Reviewed at the Hippodrome, New York Monday matinee, February 16. Style—Mystery and escape. Setting—Special, in full stage. Time—Thirty minutes.

Houdini offers a materialization and dematerialization of his body in addition.

(Continued on page 21)

Al Green Back in Cleveland

Cleveland, O., Feb. 21.—Al Green, for the last 20 years a well-known orchestra director, has stepped into the orchestra pit at Loew's State Theater, coming from Detroit, where he directed the Temple Theater orchestra for several years. Green presided over Reade's Hippodrome orchestra many years ago when that playhouse was the leading Keith Theater in the city.

Fally Markus Agency Adds Four More Houses

New York, Feb. 23.—Four houses, one of them new, two of them remodeled and renovated, and the other making a change in booking connections, have been added to the long list booked by the Fally Markus Agency.

The new house is the Victoria, Tamaqua, Pa., put up by the Chamberlain Amusement Company of Shamokin, which owns a string of theaters in the Keystone State. The house has a seating capacity of 1,200, and opened last week with a policy of four acts and a picture on a split-week basis.

Those reopened after extensive renovation are the New Theater, Port Jervis, N. Y., which now plays four acts the last half of the week only, road shows being given the first half, and the Baker Theater, Dover, N. J., remodeled at a cost of \$200,000. The latter, now operated by R. Woodhall and A. Baker, with the seating capacity increased from 1,100 to 1,600, presents vaudeville the last half only and road shows the first half.

The Union Square, Pittsfield, Mass., which plays five acts twice weekly, went on the Markus books last week. It formerly was handled by the Walters Agency in Boston.

Another house Markus is now booking is the Strand, Far Rockaway, L. I., which plays four acts and a picture the last half of the week.

Lew Hearn Again in Vaude.

New York, Feb. 23.—Lew Hearn, last seen in *Innocent Eyes*, is returning to vaudeville after an absence of five years from that field. He was last seen in the two-a-day with Bonita. He left vaudeville to enter production in the cast of *Monte Cristo, Jr.*, at the Winter Garden. Frank Evans is directing Hearn in his return to vaudeville. *Gentlemen of the Evening* is the title of the skit in which Hearn will be seen, with a supporting cast of one man and one woman.

HART, WAGNER AND ELTUS REUNITE

New York, Feb. 23.—Hart, Wagner and Eltus have reunited in their three-act after being separated for three years. During that time Jack Hart has been working with Eugene Kern, who is now going into a production, and Wagner and Eltus have been doing other acts.

H. C. GREENE RECOVERING

New York, Feb. 23.—Harry Charles Greene, vaudeville author, has been discharged from the Israel Zion Hospital, where he had been confined for three weeks with inflammation of the brain. Greene will rest at home for a few weeks and after going South to recuperate hopes to be able to resume work during the latter part of March.

First Layoff in Two Years

New York, Feb. 21.—The first layoff of the act *Everybody Step*, in which the dancers, Calm and Dale, are featured, was the last half this week; this, after two years' solid work on various circuits. The first half of the week the act was at the Franklin. Jean De Mar and Doris Grange are the other members of the cast.

Empire, Liverpool, Reopening

London, Feb. 21 (Special Cable to *The Billboard*).—The Empire Theater, Liverpool, Britain's most up-to-date theater, reopens March 6 and contains many gadgets which R. H. Gillespie glimpsed in America.

Fyffe's Sailing Delayed

London, Feb. 28 (Special Cable to *The Billboard*).—Will Fyffe has been seriously ill since the royal show and his sailing to Australia has been canceled.

Sickness here has depleted show business both as regards audience and artistes.

Don Barclay Has Skit

New York, Feb. 23.—Don Barclay, last seen in the *Greenwich Village Follies*, is returning to vaudeville in a new act by Billy K. Wells and himself, called *Him-Plan*. He will be supported by four people in the act.

McCoy at Hamilton

New York, Feb. 23.—Howard W. McCoy, identified with the B. S. Moss Theatrical Enterprises for several years, became resident manager of the Hamilton last week, succeeding Charles Winston.

Fire Does Heavy Damage to Loew's Lincoln

Occupants of Studio Apartments in Old New York Structure Flee Early Morning Blaze

New York, Feb. 22.—Investigation by the authorities is expected as a result of the fire which early yesterday morning seriously damaged the building at Sixty-sixth street and Broadway, in which Loew's Lincoln Square Theater is situated and which, it is claimed, has been condemned on numerous occasions as a fire trap.

The structure is old and of wood construction, and, in addition to the theater, contains a number of studio apartments, occupied mostly by theatrical people.

Damage caused by the fire, origin of which has not been determined, has been estimated at \$500,000. It started in the basement of the building and quickly spread to the upper floors, endangering lives of occupants before it was extinguished.

Occurring at 3 o'clock in the morning, it gained considerable headway before fire apparatus could reach the scene. The orchestra floor of the Lincoln Square, which presents Loew vaudeville acts in addition to motion pictures, was flooded with water and considerable of the damage caused was confined to this part of the building.

Several occupants of the apartments, the entrance to which is at one side of the theater by stairway, were overcome by smoke and had to be taken to hospitals. No serious injury, however, was recorded.

"Mammy" Doing Single

New York, Feb. 23.—*Mammy*, formerly Mammy and Twins, but now doing a single, has been booked on the Loew Time thru the Baerwitz office, opening this week, the first half, at Loew's Delancey Street Theater.

ACTS

SKETCHES, MONOLOGUES, SONGS, ETC., WRITTEN TO ORDER. Guaranteed sure-fire big-time material. Write W. E. JOHNSON, 5428 So. Wells, Chicago.

AT LIBERTY Baritone and Trombone, 8 years' experience with Bartons and 6 months' with Trombone, J. B. KENNEDY, 425 South Michigan Avenue, Chicago. Phone, Kenwood 9257.

Diabetes

My book, "Eat and Get Well," sent FREE to all sufferers of this dreaded disease. No Dieting or other drastic treatment.

M. Richartz, Dept. 616, 220 W. 42d St., New York.

ACTS WRITTEN. Terms for Stamp. COMPLETE MINSTREL SHOW, 57 Acts, Monologues, Parodies, 31. Minstrel Song Book, \$1. E. L. GAMBLE, Playwright, East Liverpool, Ohio.

VENTRILLOQUISM! Or "Voice Throwing", expertly taught ANYONE at home. Terms reasonable. Information and proof, 75 stamp. PROF. L. T. SCOTT, 615 Goddard Bldg., New Orleans, La.

WANTED
Violinist and Wife Organist
Capable of eating pictures accurately. With good library and experienced. Address 800 AMUSEMENT CO., South St., Maric, Michigan.

SUPPLIES

Mercerized Tights, All Colors.....	\$2.50
Silkolena Tights.....	4.00
Cotton Puffed Trunks.....	.45
Mercerized Puffed Trunks.....	1.25
Man's Supporter.....	2.50
Ideal Woman's Supporter.....	2.75
Waas Woman's Supporter.....	2.50
Galley Shave.....	.35
Minstrel Wigs, Lined, Soft Hair, Elastic.....	2.00
New Waas Pink Sate Toe.....	4.50
New Waas Black Kid Toe.....	4.00
Black Kid Flats.....	2.75
Black Kid Tumbling Pumps.....	1.00
White Canvas Pumps.....	.50
White Canvas Pumps, Elk Sets.....	1.00
Opera Hosi, Woven Band Top, In Prevant Gar- ter Run.....	3.75
Opera Hosi, Lady Faira Grade, Full Regular.....	4.00
Finest on the Market.....	4.00
Mercerized Opera Hose.....	1.50

Send 12c postage for any above article.

You can rent costumes and wigs of any style or period from us.
A wonderful stock of minstrel goods always on hand.

Costumes made to order, designed by Madam Lewis. Prices and sketches on request.

WAAS & SON
123 S. 11th Street, Philadelphia, Pa.

COSTUMES
We manufacture for Burlesque and Tabloid. State your wants. Our prices are right. **TIMES SQUARE COSTUME CO., INC.**, 100 West 43rd St., New York. Morris Grange, Manager.

LOBBY DISPLAY PHOTOS SIZE 8x10 16c each
Why all for new photos when you can get fine reproductions on heavy double weight paper in 210 size, 25 for \$4.00, or 100 of Four Subjects for \$15.00? Send money order and photo to copy. 21-hour service. Money-back guarantee.
PHOTOCRAFT ADVERTISING CORPORATION, 8 S. Dearborn St., Chicago, Ill.

VAUDEVILLE NOTES

M. GOLDEN, producer of the recent hit, *The Bluebird*, now on the Orpheum Time, left Saturday for Battle Creek, Mich., to recuperate from a bad case of "nerves". His new musical act, on which work was begun after *The Bluebird* had been set, has been temporarily postponed.

AL ROGERS and ELI DAWSON, who joined forces in the producing field recently, announce the output of several miniature musical comedy revues at an early date written by DAWSON.

ALEX GERBER'S new flash, *Town Topics*, opened last week on the Poli Time with a cast headed by ARLENE COLEMAN, RAY COLE and BILLY (UKELELE) CARPENTER, and including BILLY RANDALL, GEORGETTE ARNHELD, EUGENE LE BLANC and BOBBY ROBERTS. It is written and produced by ALEX GERBER, with the music by GENE SCHEWARTZ. BERNARD BURKE is directing the bookings of the new act.



Arlene Coleman

The Palace Theater, Norwich, Conn., and the Palace, South Norwalk, which have been playing four acts of vaudeville booked by the A. & B. DOW Agency the last half only, instituted the same number of acts for the first half of the week Monday, with the policy hereafter to be four turns on split-week basis.

JOHN IRVING FISHER and His Ukrainian Orchestra are slated to open their Loew tour March 3 under the direction of SAMUEL BAERWITZ.

H. M. S. KENDRICK is now resident manager of Fox's Audubon Theater, New York. He succeeds MAX SILVERS, who has been appointed to an executive position in JOHN ZANFT'S Office.

KATHERINE MURRAY and JACK NEAL, who opened in a new act recently, opened on the Delmar Time last week.

MARY CARR, the motion picture "mother", is preparing a sketch in which she will be seen on the Orpheum Circuit. Keith-Albee houses will follow her Western tour.

HARRY STANTON and the BURTON SISTERS, well-known tabloid trio, are returning to vaudeville soon with a new act, written by STANTON and the dancing numbers of which have been put on by BILLY PIERCE, RUSSELL WOODING and JOHN H. LONG have contributed the music of the act.



James Doyle

JAMES DOYLE, formerly of the team DOYLE and DIXON, is doing a new turn with DOROTHY CURTIS, entitled *Demonstration*. The act is playing a break-in tour at present and will be seen in the New York houses in a few weeks.

JENNINGS and REID, banjoist and woman partner, until recently with *The Chocolate Dandies*, are doing a musical act in vaudeville, playing the T. O. B. A. Circuit.

CLOG DANCING
Learn From Our Book, *Clog Dancing Made Easy*, by Henry Tucker. The practice of this art is simply and fully explained, showing all steps and figures, examples, explanations and terms used necessary to become an expert dancer. Also music for different styles of dances and song and dance sketches with music. Price, 20c, postpaid.
THE COLLINS CO., 137 Fulton St., Brooklyn, N. Y.

THEATRICAL SHOES
Short Vamps for Stage and Street.
Italian Toe Dancing Slippers
Opera Hose and Tights
CLOGS, SANDALS, ETC.
Send for Price List.
CHICAGO THEATRICAL SHOE CO.
330 South Wabash Avenue, Dept. B, Chicago.

ORLANDO'S Harpists, a musical act of seven people, has been booked for the Hippodrome, New York, in May.

YORKE and LORD opened a tour of the Orpheum Circuit at the Palace Theater, Chicago, last week.

AL PIANTADOIS and EDNA ROBINS have teamed and will open soon under the direction of AL GROSSMAN in a new vaudeville act.

The reunited team of SIMMS and WARFIELD is on the Orpheum Junior Time, playing out of the Chicago offices. The act is booked for the summer with *Plantation Days*, a colored tabloid revue.



Richard Keene

INA WILLIAMS, and before that with EMMA HAIG.

Let's Dance, LEW CANTOR'S act in which the MCGUSHION Twins are featured, now on the Orpheum Circuit, has been booked solid until August.

HERMAN BECKER, vaude, producer, who took ill with typhoid fever not long ago, was released from the Polyclinic Hospital, New York, last week. He went to Lakewood, N. J., immediately to recuperate and is reported to be well on the way to recovery.

EMMA HAIG opened the second half last week at Mt. Vernon, N. Y., in a new offering, in which she is assisted by two untried men. The offering was written and produced by ALEX GERBER.

The ERETTOS, just off the Pantages Time, opened at Proctor's 58th Street Theater, New York, this week under the billing of "The Monneters". The aerialists, formerly under the direction of JAMES DEVLIN, are now being handled by ALF. T. WILTON.

The MANDEL BROTHERS, WILLIAM and JOE, open their two-year Keith-Albee route at the Hippodrome, New York, August 31. BERNARD BURKE booked the boys for this long stretch.

The trio, BRITT, RUBY and MACK,

otherwise BILLY BRITTON, RUBY BLACKMAN and GEORGE MacDONALD, opened in a new act at the State Theater, New Brunswick, N. J., last week.

FREDDIE GOODROW replaced JEROME MANN in ROBERT LEONARD'S English act, *Seventh Heaven* (not taken from JOHN GOLDEN'S play of the same name) this week. The offering is on the Keith-Albee Time under the direction of LEWIS & GORDON.

THELMA QUARELLA, singer and LEON LOVEDDE, JR., toe dancer and saxophonist, have joined the SHERWOOD SINGER Orchestra act.

W. E. JOHNSON has completed a new act for the MOBRETTE SISTERS; a monolog to be used by LESTER ELLIOTT and also special material for TEX COVEY and PARK MAHONEY.

The HERBERT and BOLT Trio finish their Orpheum tour at the Palace Theater, Chicago, February 28, and will open March 1 on the Keith-Albee Middle-West Time.

ALFRED LATELL is appearing on the Loew Time in his new act, doing the dog character of *Bonzo* by arrangement with *The Evening Journal*, where it has appeared in cartoon form for some time. ELSIE VOKES continue to support LATELL.

FORD CHESTER, formerly RUSSELL and FORD, opened last week on independent time with a new partner, HOOPER ATCHLEY.

MARTHA SLEEPER, daughter of W. B. SLEEPER, of the Keith-Albee organization, is leaving vaudeville for the nonce to appear in a new comedy starring ARTHUR STONE, to be filmed by HAL ROACH for Pathe. MISS SLEEPER is expected back in vaudeville after the picture is completed.



Martha Sleeper

LYTEL and FANT, standard song and dance act, have been booked for a Keith-Albee tour for next season by their agent, BERNARD BURKE, opening at Keith's Theater, Philadelphia, September 7.

Marriage vs. Divorce, well-known act, is scheduled to open a tour of the Loew Circuit March 2 under the direction of SAMUEL BAERWITZ.

KER and ENSIGN opened a second tour of the Loew Time last week at Providence, R. I.

FRED CROUCH and KATHERINE MOORE are playing the W. V. M. A. Time in their well-known musical and singing turn.

FOR SALE
A new Brick Theatre Building with modern equipment. Combination Vaudeville and Pictures. Seating Capacity, 700. In a modern town of 7,000 population in the heart of the biggest oil field in Oklahoma. For further information address
E. M. BILLINGS, 209 1/2 North Ind., Enid, Okla.

I STRAIGHTEN CROSS EYES
No Hospital. No Chloroform. Special Method. 6,000 Cases. Time Payments.
FRANKLIN O. CARTER, M. D. EYE, EAR, NOSE AND THROAT.
27 Years on State Street. Located at
177 NO. STATE STREET, CHICAGO, ILL.
Write for references from people in the profession.

Flying Codonas
Still the Best
Touring Europe for Their Health.
Sensational Hit.
WINTERGARTEN, BERLIN, for Two Months.

STAGE and CIRCUS FOOTWEAR
Mall Orders Filled Promptly.
MADE TO ORDER AND IN STOCK.
Fashions for Street, Evening and Sport Wear, RIDING BOOTS, Ballet and Toe Slippers, Clogs, Sandals, etc.
NEW YORK THEATRICAL SHOE CO
218 So. Wabash Avenue, CHICAGO.

DANCING
SUCCESS OR NO PAY
Waltz, Two-Step, Fox-Trot, One-Step. Guaranteed to All.
STAGE DANCING
Buck, Jig, Chorus, Skirt, Teacher Work, Etc., Taught Quickly
by P. J. RIDGE
America's Greatest Teacher.
157 E. Chicago St., Elgin, Ill.
Stamp for reply, etc.

BALLET DANCING
without a teacher. You can easily learn from "A Manual of Dancing Steps", by Elsa Pohl. Contains list of Technique Exercises (Russian School of Dancing), Polish Steps, Social Dancing Steps, etc. Full descriptions with 30 cuts and diagrams fully illustrating the positions and steps. Cloth bound. Price, postpaid, \$3.00.
Send for Catalogue of Books on Folk, Clog, Natural and Aesthetic Dancing.
"The teacher will find them valuable as reference books and the professional dancer ideas in them a-plenty."—GORDON WHYTE, in "The Billboard".
A. S. BARNES & CO.
11 W. 45th Street, New York

JUST OUT
McNally's No. 10 Bulletin
PRICE, ONE DOLLAR PER COPY
Gigantic collection of new, bright and original COMEDY MATERIAL for vaudeville stage use, embracing everything that can be of use to the performer, no matter what sort of an act, monologue, parody or fill-in bits he may require. Notwithstanding that McNally's Bulletin No. 10 is bigger in quantity and better in quality than ever before, the price remains as always, \$1.00 per copy. It contains the following still-edges, up-to-date Comedy Material:
21 SCREAMING MONOLOGUES
Each one a positive hit. All kinds, including Hebrew, Irish, Nut, Wop, Kid, Temperance, Black and Whiteface, Female, Tramp, Dutch and Stump Speech.
12 ROARING ACTS FOR TWO MALES
Each act an applause winner.
11 Original Acts for Male and Female
They'll make good on any bill.
68 SURE-FIRE PARODIES
on all of Broadway's latest song hits. Each one is full of pep.
GREAT VENTRILOQUIST ACT
entitled "That's Enough". It's a riot.
ROOF-LIFTING ACT FOR TWO FEMALES
This act is a 24-barrel sure-fire hit.
RATTLING TRIO, QUARTETTE and DANCE SPECIALTY ACT
Comical, humorous and rib-tickling.
4 CHARACTER COMEDY SKETCH
It's a scream from start to finish.
A TABLOID COMEDY AND BURLESQUE
entitled "The Vamp". It's bright, breezy and bubbles over with wit.
12 MINSTREL FIRST-PARTS
with side-splitting jokes and hot-shot cross-fire acts.
McNALLY'S MINSTREL OVERTURES
complete with opening and closing choruses for the minstrel.
GRAND MINSTREL FINALE
entitled "The Boss". It will keep the audience yelling for more.
28 MONOBITS
Everyone a sure-fire hit.
HUNDREDS
of cracker-jack Cross-Fire Jokes and Gags, which can be used for sidewalk conversation for two males and male and female.
BEHIDES
other comedy material which is useful to the vaudeville performer.
Remember the price of McNALLY'S BULLETIN NO. 10 is only One Dollar per copy; or will send you Bulletins Nos. 7, 8, 9 and 10 for \$2.50, with money-back guarantee.
WM. McNALLY
81 East 125th Street, New York

If you see it in The Billboard, tell them so.

Action Against Southern Resorts

Composers' Society Seeks To Stop Copyright Violations or Issue Licenses

New York, Feb. 23.—Special investigators are augmenting the regular representatives of the American Society of Composers, Authors and Publishers in a drive to get evidence on copyright violations by dance halls and cabarets in the South and Southwest. Most of the territory is being covered in automobiles by the representatives. The refusal of most of the resort proprietors to concede the right of the Society to collect a performing rights license fee when certain copyrighted music was used for profit has precipitated the investigations.

Heretofore the society has been chiefly concerned in looking after theaters which have taken out licenses in accordance with the provisions of the Copyright Act. But a survey made in Texas during January, when investigators from New York traveled there, 72 different establishments were found to be using the music in the society's catalog. All of these places were accorded the usual opportunity to secure a license before any legal action is taken. Unless licenses are issued to the various resorts J. C. Rosenthal, general manager of the A. S. of C. A. & P., states that suits for infringement of copyright will be started in the Federal Courts of Texas within a short time, sufficient evidence being already in the hands of local attorneys.

Two cases tried last week in the United States District Court of Atlanta, Ga., resulted in the usual award of \$250 damages plus counsel fees for the society's members, on whose behalf suit was brought. Edward S. Hurst, proprietor of a local dance hall, was the defendant, while the actions were started by Leo Feist, Inc., and M. Witmark & Sons, thru the society. United States District Judge Samuel H. Sibley heard the case.

Commenting on the two suits Mr. Rosenthal said: "This is the first of these actions which have been instituted against Southern establishments and was found necessary because Mr. Hurst refused to recognize the rights of copyright owners of music, and notwithstanding the many requests made upon him to refrain from using music belonging to members of the society he was found continually infringing the copyrights. . . . A recent decision of the United States Circuit Court of Appeals at Richmond (Va.) knocks the props out from under any defense thus far interposed by the infringers of copyright."

Meyer Davis' "The Swanee" Opens to Great Business

Washington, Feb. 21.—The Swanee, new ballroom built by Meyer Davis, opened Thursday evening with every indication of tremendous success for the rest of its natural life. More than 2,000 people crowded the resort, with many notables included from New York and other important cities.

Two bands supplied the music, the Swanee Synchronators, under the direction of Sam Brown, and Davis' famous Le Paradis Band from the cafe of that name.

The cost of the new ballroom is placed at more than \$250,000, and due to the elaborate decorations and general equipment visitors pronounced it "America's Finest Ballroom". Capacity was not intended to be more than 1,500.

New Hofbrau Opens

New York, Feb. 23.—The Hofbrau House, owned by the Jansen Corporation, which also has a place on lower Broadway, opened Thursday night with the Commanders Orchestra, which is playing in Elsie Jans' revue, *Prizes of 1925*. The band is slated to play from 6 p.m. until closing, substitutes being left at the restaurant while the band does its bit in the musical show.

A gala opening with 1,500 persons present, each one getting a valuable souvenir as a token of remembrance, started the place off well. It is expected that many theatrical folks will patronize the new place, as the Jansen cuisine stands ace high with the profession.

Cleveland Cafe Bankrupt

Cleveland, O., Feb. 21.—A schedule in bankruptcy showing liabilities of \$49,825.27 against \$13,200 assets has been filed in Federal Court by the Mandarin Cafe, one of the city's largest restaurant-dansants. The schedule follows the filing of an involuntary petition in bankruptcy against the cafe last December.

SAX. AND BANJO JAZZ

Short cut to faking and improvising. Heum, Blues Harmony, correct Four-String Harmony, Chord Charts and Illustrations. New easy System. Price, \$1.00. EARL HAEFNER, 410 S. Gilbert St., Ada, Okla.



Strand Roof Has Orchestra and Revue

New York, Feb. 21.—The Strand Roof Cascades occupies a unique position in local high-class cabarets inasmuch as it is the only pre-war resort remaining on Broadway. There is one other place, off the avenue, retaining its old name, but it is hardly a semblance of its former self. The Strand, however, retains its same atmosphere, management and certain class of patronage, which is composed mostly of suburban folk who seem to have taken a strong liking to the place, especially when in town to see a show and they wish to have their dinner during the usual hour.

Earl Lindsay, considered a comer among the young producers, is responsible for the new floor show at the Strand. He has five principals who work in and out with the chorus as well as doing a fine routine of specialties. Mignon Laird is doing acrobatic dancing, Jean Carroll, soubriet; Jack Edwards, eccentric dancer and comedian; Bud Kennedy, juvenile, and Sonia, soprano. The chorus of eight is a versatile ensemble, all of them capable of doing solos on their own. This is a feature of Lindsay's economic staging, for he knows how to pick his cast so that the best show can be given for the least money.

Outstanding numbers include a pirate novelty, in which the "pirates" hold up nearby patrons with toy pistols. This intimate style is clever without being offensive. Another novelty is the finale, done in minstrel style. There is plenty of room on the floor for a good act to extend itself, as the place is not so crowded for room. Contrary to the usual small cabaret downstairs, this one is upstairs, with two lines of windows the entire length of the floor, which is a feature many patrons appreciate. There is not a moment when the show is not full of interest, Miss Laird especially holding the audience tense with her acrobatic specialties in a way that will undoubtedly win her a spot in a good vaudeville or musical comedy production. The show runs almost an hour.

Henri Gendron and His Strand Roof Orchestra of 10 pieces supply the dance and show music. For the dances he uses the small stage, which is a great asset to the show. For playing the show music he rearranges the combination and plays from the floor. Gendron being held over for the new show is sufficient indication of how well the management thinks of his outfit.

At present the house is making a specialty of a dinner for \$2.25, with no cover charge during the hours of 5:30 to 10 p.m. The management is catering particularly to the early dinner patronage and seems to be unusually successful, doing an average of at least two-thirds of its capacity for that period when show was reviewed. The average capacity, without placing additional tables on the dance floor, is close to 400.

Reisenweber's Lease Sold-- To Be Motion Picture House

New York, Feb. 21.—The old Reisenweber restaurant is to be converted into a modern three-story theater building, according to the terms of a 12-year lease bought this week at a graduated yearly rental of \$35,000 to \$38,000.

Reisenweber's was one of the most successful and oldest of the cabarets until it ran afoul of the prohibition laws. For years it was "the only place" for hundreds of theatrical and lay patrons, and its entertainment usually held some of the highest-paid performers in the business. It was padlocked about two years ago by the Federal authorities and never reopened as a cabaret. One of the floors was operated for a time as a ballroom by another management. One or two of the owners of Reisenweber's in its latter days are now interested in a recently opened supper club.

The sale of the lease apparently dispels whatever hope many former habitués of the cabaret may have had that it would eventually reopen and stage a come-back.

Peggy Joyce To Have Club Revue by Arthur Buckner

New York, Feb. 23.—Peggy Hopkins Joyce is to be the hostess in a night club named after her in the roaring 40s right alongside of the El Foy Club, according to Arthur Buckner, who has joined forces with Frank Teller, Peggy's manager.

The Buckner Holding Corporation that was recently organized has taken an option on La Petite, which has changed hands three times within the last several months. This place Buckner intends to make the Peggy Hopkins Joyce Supper Club.

Along with this news concerning the world-famous blonde comes the announcement that she has signed a contract to star in a piece entitled *Married Mistress*. Teller holds the contracts for this and he says that while the play has been written no definite date has been set for rehearsals as yet.

At the supper club will be a revue produced by Buckner which will include 13 persons, six of whom are to be principals. The girls are to be chosen from Broadway successes and it is Buckner's plan, he said, to take one girl from each of the 12 best musical shows in town.

Bothwell Brown, female impersonator, is to be starred, according to the producer, who also states that he is going to make it the most elaborate and expensive cabaret show in town.

The club is slated to be exclusive, the theatrical populace being the favored patrons. It is expected that the opening will be about noon daily, remaining open until the early morning hours. Tea will be served in the afternoon, according to Buckner, and the place will be managed by H. M. Arden, who also will act as revue director.

Buckner announces that he has the nucleus of two other revues which will be ready and on the Rialto before another moon. He proposes to have female impersonators head the cast of both pieces.

Sues for Commission

New York, Feb. 21.—Al Lentz, booking agent, who booked one of Vincent Lopez's orchestras for the Silver Slipper, an exclusive night rendezvous at Miami, Fla., has started action against Lopez to recover commissions due for the engagement.

George J. Houtain, attorney for the orchestra leader, stated to Abner Greenberg, lawyer for Lentz, that Lopez agreed to pay the agent for the booking when Lopez received his fee for the band.

It was explained that \$1,450 was the price agreed upon before the band left for the South. Of this \$250 was to be paid to Lopez and the remainder turned over to the orchestra for salaries. Lopez has communicated to his attorney, the latter asserts, that so far he has not received his share.

Houtain has asked Lentz to wait until Lopez gets his money and he will then send him \$500 or \$50 per for the 10 weeks' booking. Another disagreement here arises, for Lentz claims that his fee is \$75 a week and not \$50.

Houtain avers that Lopez has a contract agreement with Lentz whereby Lopez agreed to pay the agent \$50 a week and it is only on this basis that the difficulties can be settled.

J. E. Horn, manager for Lopez, also has communicated with Greenberg, stating that Lopez will clear the matter up in accordance with the contract as soon as Harry Katz, manager of the Silver Slipper, pays Lopez his share of the orchestra's charge.

Dance Team Starts Action

New York, Feb. 21.—Fay White and Howard Mills, dancing team, have filed suit against Joseph Tenner, who recently staged a cabaret revue in the Knickerbocker Grill, charging that the latter failed to pay them their salary of \$300 for two weeks' work as agreed to in

contract form before starting the engagement.

Tenner has been seen by William Glancy, attorney for the plaintiffs, and the former asserted that he had not received his money for the show as yet. The engagement was following the written document of October 4, 1924.

New York Notes

New York, Feb. 23.—Elaborate arrangements have been completed to greet the members of Isham Jones' Orchestra when it arrives from Chicago at the Pennsylvania depot Tuesday morning, February 24. The Brunswick record company has been joined by many music publishers and local well-known orchestra leaders, especially Ray Miller, to welcome the boys who closed at the College Inn, Chicago, in royal fashion. At an early date the orchestra will open Rue de la Paix, where Lew Leslie is staging a big show. It is on the site of the short-lived Fay Folles supper club.

Change of policy is in effect at the Folles Inn, the management of which was taken over last week by Jack Bennett, Philadelphia restaurateur. *Broadway Butterflies*, a revue headed by Carlo Rinaldi, operatic tenor, made its debut there this week.

The Silver Slipper management pulled a good stunt for the benefit of its patrons last week when members of the *Yielded Follies* cast were invited to make themselves at home. Ann Pennington, Evelyn Law, Dorothy Knapp, Marie Callahan.

(Continued on page 23)

PIANIST AND ARRANGER
Desires to locate in Texas. Resort, Dance, Tab. Hotel. A. F. M. Married. Age 34. MUSICIAN. Box 52, Chicago, Illinois.

FOR SALE
Fine old Violin. Rich tone. In excellent condition. Will sell at \$250.00. CARLETON GOBBA, 1135 E. Church, Adrian, Michigan.

FOR SALE WURLITZER CONCERT PIANO AND ORCHESTRA, Single U. In first-class condition. Bargain for cash or time payment if preferred. Wire or write J. I. SAAD, care Billboard, Cincinnati, Ohio.

AT LIBERTY—BAND DIRECTOR
And Clarinet Virtuoso, formerly of Sousa's and Ingle's band; director of the Municipal Band of Lake Worth, season of 1924-'25. Address L. E. M. STEIN-ERT, Lake Worth, Fla., P. O. Box 582, until May 1, 1925.

AT LIBERTY—TRUMPET PLAYER
For Theatre or Band. Am also Band Leader. Address IRA HAYNES, care General Delivery, Ybor City, Florida.

TROMBONIST AT LIBERTY

Thoroughly experienced, reliable and competent. High-class player. Permanent location preferred. GEO. PIDDINGTON, 310 Madison Ave., Sharon, Pa.

PIANO JAZZ MADE EASY

And Arpeggio Synchronization intelligently graded for the beginner and advanced player. Unique Effects, Impassioned Jazz, African Rags, Left Hand Melodies with running Synchronizations in the Treble, are but a few of the many features not found in ordinary methods. Complete Course, in two volumes, each \$2.00, both \$3.00, postpaid. THE COLLINS CO., Music Dept., 187 Fulton St., Brooklyn, New York.

St. Louis Saxophone Shop

Repairers of All Brass and Woodwind Instruments. The Best Equipped Repair Shop in America. Gold and Silver Plating. Inventors of the MAVELE Tubing Device for Saxophones. Agent for the Famous COTTEURER Central Bore Instruments. (World's Most Perfect Saxophone). Saxophone Music. Rebuilt Saxophones. 629 CHESTNUT ST., ST. LOUIS, MO.

Alvione University OPERA DRAMA MUSIC COLLEGE OF DANCE ARTS

ELECTIVE
Courses for Acting, Teaching, Directing DRAMA, OPERA, PHOTOPLAY, STAGE DANCING and SINGING. Developing poise and personality essential for any calling in life. Alvione Art Theater and Glick Co. (appearances while learning). N. Y. debuts and careers stressed. For Prospectus write study desired to Secretary, 43 West 72d St., N. Y. Ext. B.

Directors:
Alan Dale
Wm. A. Brady
Henry Miller
Sir John Martin Harvey
J. J. Shubert
Marguerite Clark
Rose Coglian

Mr. Tenor Banjo Player: THEODORE DE HARPOT'S PRACTICAL METHOD for TENOR BANJO JAZZ—DUO—CHORDS

Synchronization, Ragging, Modulations in all keys, also Altered and Diminished seventh chords by note and diagram. How to play chords from first and second Violin and Piano parts. 216 MELODY NOTE CHORDS. RETAIL \$1.50. The CHAS. E. WELLS MUSIC CO. 1626 California St., DENVER, COLO. (Sole Agents.)

SAXOPHONISTS

Laugh, etc. Easiest methods only built into definite system. "STEPPING STONES TO SAX-CESS" will answer your questions and set you right—will give you a showy system that is easily understood and executed and requires but little study. Everything made easy and explained fully and clearly so you can understand it. Your copy by return mail. Price, \$1, postpaid.

KENVAL SALES CO., Dept. A., Canandaigua, New York.



Everything for BAND and ORCHESTRA

Brassier, Band Instruments, Vya Banjos, Ludwig Drums and Traps, Design Bells and Symbals, Violins and Sapphires. WE SELL, EXCHANGE AND REPAIR ALL MAKES. Write or send instrument for free estimate. BAND AND ORCHESTRA MUSIC. Free sample parts, catalogs and Musical Brouter Magazine sent FREE to all who write. CRAWFORD-RUTAN CO. 1017 D. Grand Avenue, KANSAS CITY, MO.



NEW TURNS AND RETURNS

(Continued from page 18)

tion to a strait-jacket escape for the sixth and final week of his appearance here.

The materialization and dematerialization in other words is an escape from a strong wooden box made of two-inch boards, all sides of which are pierced by iron rods welded so as to make his liberation from it an ostensibly impossible thing.

Houdini announces that there is nothing of the spiritualistic in his escape from the hermetically sealed box despite the fact that many persons, among them Sir Arthur Conan Doyle, have said that Houdini possessed occult powers. The mystifier assured the audience at Monday afternoon's show that his escape is effected by natural means only.

The huge box is freely exhibited to the audience and committed on stage being thoroughly examined before Houdini enters it. The bottom and all sides are shown. After Houdini gets inside and the top is put on steel rods are put thru the two-inch boards on the top, bottom and sides, so as to preclude sufficient space in any portion of the box whereby a board may be removed in making an escape. These rods are welded, making removal without severing them impossible.

When this process is completed and the committee is assured that the box is securely closed the curtains are drawn and Houdini does the apparently impossible. He took him several minutes to get out of the box and there was some wonder as to whether he would make it or not. He did finally, emerging with sweat pouring down his face, his collar wilted and his hair disheveled.

The strait-jacket escape, one of Houdini's most famous tricks, was done in closing his presentation. In mid-air he was suspended head downward from the floor, which causes blood to go to the head quickly and befuddle one as well as weaken. However, the mystifier effected his escape in quick order.

Frank Farnum and Band

Reviewed Tuesday matinee, February 17, at Proctor's Fifth Avenue Theater, New York. Style—Jazz stepping and jazz orchestra. Setting—A black patent-leather (Cyc.) drop. Time—Twenty-five minutes.

There are seven men and three girls with this new act of Farnum's. He has been dancing in cabarets of late, having forsaken vaudeville for the more lucrative night-club work.

The act opens with the band playing a medley of popular pieces with Farnum and his girl partner on shortly after in an East Side-West Side number. They are clad in the typical tough guy make-up, but do not do all of the rousing around that is usually embodied in this type of dance. Farnum throws the girl around roughly, but only marks time with a tricky little step between these spasms that are hard on the girl.

There are two blond girls in the cast that do the late jazz steps mixed with a lot of kicking. They perform in an attractive manner and the applause by this audience plainly showed that they were well liked.

The girl who danced with Farnum comes on again in a toe number that is careful and pleasing. She is followed by Farnum, who does his old strutting stuff that he has been doing for years, but gets fine returns for it.

The two blondes return, clad in purple costumes and have a more jazzy effect this time. The little Miss who accompanied Farnum in the original dance with the girls and then Farnum arrives. They all step together and are well rewarded for their endeavors.

This ordinarily closes the act, but applause was so profuse that Farnum came out and gave his impressions of Pat Brown, Fido and a Charleston. Farnum knows his stuff, there is no doubt about that. He has struck the jazz appealing spot in the present-day audience and reads a powerful hand for his act. The girls assisting him are all accomplished in this art and help a long way to bring the act up to the high pitch that it maintains. The band was also a great help for they kept the music to just what it should be in this kind of a turn. Their solo number was right out in front too when applause for the various departments of the act was considered.

Olga Myra and Bitter Sisters

—in—
"BLACK AND GOLD"
By Alan K. Foster
Staged by the Author

Reviewed Thursday evening, February 19, at the Fordham Theater, New York. Style—Dancing novelty. Setting—Specials, in full. Time—Seventeen minutes.

Black and Gold, the title of the artistic dance novelty serving to introduce to the American stage the Bitter Sisters, who arrived in this country recently from Germany, where Harry J. Mondorf, Keith's foreign agent, is said to have discovered them, is taken from the setting provided for the offering. The "black" is derived from the cyc of this color used, while the "gold" comes from the impressive frame, as of a picture, utilized in the foreground, and thru which, for the most part, the efforts of the artistes are viewed.

Olga Myra, appearing with the Bitter Sisters, was in vaudeville last season with her own jazz band, and formerly with Carlos Sebastian. She is best known, perhaps, for her violin novelty in which she does an intricate acrobatic exhibition while a classical tune is "sawed" out. In this specialty Miss Myra scored huge returns.

The dancing of the Bitter girls, graceful, lithe young ladies, is considerably above the average in the two-a-day. Their work runs to the classical, one doing toe ballet for the most part, the other, in male garb, essaying that type of role. They open the act in a beautifully executed classical dance, accompanied at the piano by an unbilled young lady who strikes the keys in masterly fashion. In fact, the pianist's work ranks among the many delights this offering affords. Miss Myra, whose numbers alternate with those of the Bitter Sisters, offers in addition to her violin novelty, an acrobatic dance that is par excellence, with high-kicking featured. She also does a straight violin solo and appears in the finale with the Bitters, joining in the dancing for the windup.

It is not only the artistic dancing of Miss Myra and the Bitter girls that makes this presentation an unusual one. The staging, mounting and general direction that has gone into its makeup have much to do with satisfying the entertainment appetite. Alan K. Foster gets the credit for the exemplary manner in which the act is put on. He has arranged each little scene with a careful hand, giving the eye much in which to revel. Miss Myra's violin-acrobatic specialty, "In the frame", gives one the illusion that a picture—a pretty picture—has come to life. So it is with the other specialties by Miss Myra and the Bitter Sisters. The deep, black background also helps to enhance the genuine optical beauty of these animated pictures.

While some may argue that dancing acts of the classical or semi-classical order are taboo in vaudeville unless there's sufficient "jazz" to carry them over, the generous applause accorded this one, when reviewed, utterly refutes any such argument. It closed the show.

Stevens and Laurel

Reviewed Thursday evening, February 19, at Proctor's 58th Street Theater, New York. Style—Song and dance novelty. Setting—In one. Time—Ten minutes.

A girl and boy team with hard-shoe stepping as their best bet. They start off with the lad first, his partner following on shortly after. They sing an introductory number and then both do a soft-shoe whirl.

Stevens remains on while Miss Laurel is off for a change, doing another fast boogie workout. His partner romps on again in hard shoes and clicks off a waltz clog in class style that extorted the desired pain whacking for some moments.

The lad is back again, this time with a harmonica. He plays while the girl does a few nifty steps and they both hop into a mixture of a waltz clog and steps of their own. Stevens has acquired hard shoes while off so that they are working in unison.

A neat little act of this kind. They showed real ability and were received with vehemence.

Lois Bennett

Assisted by John Tift

Reviewed Thursday evening, February 19, at the Fordham Theater, New York. Style—Songs. Setting—In one. Time—Eleven minutes.

This is a new turn for Lois Bennett, who formerly worked with Muriel Pollock, herself in vaudeville this season

with a new partner. John Tift, of neat appearance and a voice above the average, tho he does not use it much in this act, off-late at the ivories, where Miss Pollock did her stuff when with Miss Bennett. He does this job in an efficient manner, offering a classical solo between changes that pleases.

Miss Bennett's routine of numbers runs to the type that are best suited to her light soprano voice. She opens with a conventional tune, following with a special light comedy number, called *It Pays To Be a Modest Little Girl*. Well put over in a saccharine voice, clear of diction and tone, this soothing ditty, and Miss Bennett scored applause accordingly when reviewed. Following Tift's piano solo Miss Bennett works with him in a double version number, comprising the songs *I Need You Only and Honest and Truly*, making for a decidedly neat finish. When caught the act scored a big hand, threatening an encore. For the duce spot, in which it appeared here, the turn is ideal.

Stevens and Hollister

Reviewed Thursday evening, February 19, at Proctor's 58th Street Theater, New York. Style—Comedy stepping novelty. Setting—In one. Time—Sixteen minutes.

This team has been playing the Keith circuit for some time. They formerly did an act that had Berkeley Hills, Calif., portrayed on their drop. This time they term their stuff *Watching the Parade*.

Clad in the latest golf togs, they whip on and spring a lot of nifties about golf and all of the joys and sorrows that go with the game while sitting on a pair of empty gin cases which they bring with them. This brings them into their routine concerning the parade and they wise crack about those who are supposed to be passing by. They develop some fairly good laughs, playing up every possible angle that a lot of marchers create to the tune of some trick band.

The girl follows with the song *My Man*, which was instigated by the last few cracks from her partner, in which he is supposed to be the wise guy who lets his wife do all the work. She develops real pathos in this number and the audience here tonight liked her rendition. An encore was insisted on so she sang something new, called *Sally, Irene and Mary*, that has some catchy lines.

Stevens is out and mixing in with his partner's stuff again for the fadeout. They are cheered for more and this time Stevens announces that he will sing the hit song from their old act. It is done and they are away for the close.

Their turn is different. They both have personality and know vaudeville audiences and what goes best for the varied types.

Condensed Version of Verdi's "Aida"

Presented by George De Feo

Qualitiero Fabl, Conductor
CAST

Aida, Daughter of an Ethiopian King Grace White
Amneris, Daughter of an Egyptian King Bertha Garver
Radames, General in the Egyptian Army Ralph Cavaliere
Amnastro, King of the Ethiopians G. Martini
Egyptian Priestess Lina Berlin
Ballet Divertissement
Mlle. Sylvia Parady

Hippodrome Corps de Ballet

William A. McManus, Technical Director
Reviewed at the Hippodrome, New York, Monday matinee, February 16. Style—Operatic. Setting—Special, in full stage. Time—Twenty-six minutes.

Aida is the second of the standard grand operas to be condensed for vaudeville. The first was *Faust*, given at this theater last season by the Zuro Grand Opera Company. *Aida* is presented by the De Feo Grand Opera Company under the direction of George De Feo, with an able group of singers, headed by Grace White, who interprets *Aida*, and including among the principals Bertha Garver, as Amneris; Ralph Cavaliere, as Radames; G. Martini, as Amnastro, and Lina Berlin, as an Egyptian priestess. The cast, in all, numbers over 20 people.

Their combined voices rise to great heights in the several scenes from Verdi's popular opera that are embodied in the vaudeville version. The well-modulated voice of Miss White, who gives the role of *Aida* a picturesque glamour and evokes not a little thrill in her emotional scenes, stands far out from the rest. Of the others, all of whom play their parts in convincing manner, Ralph Cavaliere deserves especial mention. He does Radames, general in the Egyptian army, stirring and with deep feeling.

As for the adaptation of the opera it has been efficiently and judiciously handled. It does not embrace tabloid num-

Say It Out Loud—

THE LITTLEJOHNS—
RHINESTONES—
ARE A GILT-EDGE INVESTMENT TO THE PERFORMER. EASY TO PUT ON.

100 Pure White Fiery Rhinestones, \$2.00.
The Littlejohns, Inc., 254 West 46th St. NEW YORK

"NOISELESS TOE SLIPPERS"

Patented Dec. 30, 1924.

Teachers and Professionals are delighted with our "NOISELESS TOE SLIPPER". It makes no noise while dancing—needs absolutely no breaking in and fits perfectly. We also manufacture "THE PERFECT" Toe and Ballet Slipper.



Mail Orders Promptly Filled
BEN & SALLY
302 W. 37th St., New York.
"The Noiseless." Tel., Chickering 6493.

Dancing



LEARN TO PLAY AT HOME
SPANISH CATANET
BY
AURORA ARRIAZA
METHOD. PRICE TEN DOLLARS.
STUDIO 711, 1658 Broadway, New York City.

LOUIS VECCHIO

Dancing, Grace, Poise, Stage Arts.
Personal Instruction Moderate Fee.
Coaching for Professionals.
Exercises, Technique, Routine.
1440 Broadway, at 41st St., NEW YORK CITY.

MICHAEL
SCHOOL OF AEROBATICS
143-145 West 43d Street, NEW YORK.
Phone, Bryant 9045.

CLIFF JEROME

Formerly of "NED WAYBURN STUDIOS"
Specializing in STAGE DANCING
Sensational
A routine every week. Special Rates, \$5.00.
STUDIO 711, 1658 Broadway, New York City.
Phone, Circle 8121.

HERMANN & DEMUTH

School of Acrobatics
1658 Broadway, New York. Phone, Circle 10319.

STAGE DANCING

TAUGHT BY AMERICA'S GREATEST.
JACK BLUE
231 W. 51st St., NEW YORK. Circle 6136.

JOHN BOYLE

324 West 42nd St., New York. Penn 4738
Formerly Bayle & Brazil, Bayle & Boer's.
The Dance Master Who Starts in Where the Others Leave Off.
JUST A FEW OF MY PUPILS
Fred Stano, Francis White, Wellington Cross, Tam Patricia, Ida May Chedwick, Tom Diogio and a long list of other celebrities.

DON LENO

Who has been established 20 years, is known to every Theatrical Manager as an Actor, Producer of Novelty Stage Dances, Musical Comedy and Vaudeville Acts. Exhibition Dances created and arranged.

RUDOLPH VALENTINO

Was taught the ARGENTINE TANGO by the famous DON LENO. Maker of Stars and Dancing Teachers. 117 West 48th St., New York.

THE GENUINE ARGENTINE TANGO AND THE REAL APACHE DANCE

TAUGHT BY
FRED LE QUORNE

Acrobatic Classes for Business Girls, Evenings, including every type of Dancing, 1658 Broadway, Room, 607, New York City. Circle 7933.

JAC MAC'S FAMOUS SCHOOL OF AEROBATICS

223 West 46th St., New York
Phone, Chickering 3127.
Spacious Studios for Limbering and Practice.

Your Own Photo. Your Act, Your Show, \$7.50 and \$10.00 for 1,000 Samples. GEMO-CHEMOMATIC PROCESS CO., 150 Park Row, NEW YORK CITY.

COGHLAN'S JESTER No. 2 ONE DOLLAR
The only book of COMEDY claiming 100% ORIGINALITY. If this means anything to you investigate. 5 Monologues, 8 Double Acts, Burlesque Tab., Venetianologist Act, Quartette Act, 3 pieces of Single Acts, Musical First Paris, Musical Finale, Best Partly ever written on "Gunga Din", Poems and Parodies. Price, \$1.00. JAMES J. COGHLAN, 93 Wode St., Jersey City, N. J.



THE "VANETTE"

Mid-Winter Sale!

Featuring Barney's Latest Short Vamp Creation, SLIPPER WITH FRENCH ANKLET.

FOR STREET WEAR

FOR STAGE WEAR

Obtained in
Patent Leather \$9.85
Black Satin
Grey Kid
Brown Kid

White Satin or any Satin Col. or to Match Your Gown.....\$10.85
Silver and Gold Brocade..... 11.85

BARNEY'S 304-6 W. 42nd St., NEW YORK

Advertise in The Billboard—You'll be satisfied with results.

THE PUBLISHERS OF

"In Memoryland"

Waltz

"Maravan"

Fox-Trot

"Come On, Now, Lindy"

Novelty Fox-Trot

"Sounds From the Orient"

Oriental Fox-Trot

ANNOUNCE TWO NEW "HITS" FOR 1925

"ON THE AIR"

RADIO FOX-TROT

Written by HARRY M. SNODGRASS, "King of the Ivories", "The Most Popular Radio Entertainer in America". A radio sensation that sold thousands of copies before it was off the press. It's still growing stronger. COPIES FOR PROFESSIONALS.

"MY ALPINE GIRL"

ALPINE FOX-TROT

Written in ONLY two chords, different from anything ever published. You will agree that it's a "knockout". By writers of "In Memoryland". Special Quartet Arrangement—Special Yodel Quartet. Professional Copies to Professionals ONLY.

SOUTH BEND MUSIC PUBLISHING CO., INC., SOUTH BEND, INDIANA.

FEBRUARY mechanical statements rendered the publishers are coupled with figures "beyond belief", and paralyzing in their effects upon music men, writer or publisher. They show that the phonograph record sales during the past months are worse than was ever expected, radio and all other conditions notwithstanding.

Bad as were the statements a year ago, the present ones are 60 per cent lower. For the average large publisher with a terrific overhead there is nothing to look forward to any more insofar as royalties are heavy on phonograph records. Hit or no hit, the sale of records on the biggest one of the year would not pay the expenses of a big house for two days.

The Victor statement on the two outstanding ballad hits of the season brings \$2,800 to each publisher. This particular record had *All Alone*, backed with *I Wonder What's Become of Sally*. As it happens, Irving Berlin has an interest in the concern that bears his name, and Ager, Yellen & Bornstein, Inc., are fortunate in having Yellen and Ager write *Sally*. Otherwise the publishers would have one-fourth less than the amount mentioned above. Imagine a writer of the season's hit receiving \$700 for his big Victor statement. If there are two in on the song they get half of that sum. Thus the Victor presses 142,000 records of the season's leading songs.

It is but a matter of months when the Victor company was good for 250,000 to 400,000 of any kind of a disk made by Paul Whiteman, or another good orchestra. The song didn't even have to be a near-hit. Seven hundred and fifty thousand and 1,000,000 on a song hit was reached time and again by the Victor records. If all the other disks put together equaled the Victor statement, publishers were more than satisfied in the past.

Now the only gratifying thing about the record royalties is that the Brunswick company is fast and steadily mounting to the top with unusually large dance record sales. Comparatively speaking, there is no kick coming about the Brunswick statements. The lesser companies, with a possible exception or two, have long since failed to interest with worthwhile statements. From Canada there also is nothing to go crazy over. One house received a statement on an outstanding hit of 20-odd dollars.

Sheet music sales for the most part are deplorable. Hits such as *Sally* and *All Alone* did well enough, under the conditions. True, they were plugged long enough and nationwide campaigns were needed. *Sally* sold 1,000,000 copies, while *All Alone* is in its 900,000, and still selling.

There is much interest in what the sales will be of the John McCormack record of *All Alone*. This vocal disk was released shortly after the tenor sang it over the radio. It is generally conceded that it will go very good.

In the meantime both writers and publishers are taking comfort in the belief that some sort of legislation will stop the public performance of a song or its rendition in anyway unless payment is made to the creator of the tune. If radio is included in this a readjustment will probably be brought so that the usual royalties will again flow to the writer and publisher.

Major Arthur Hoffman, well-known music man, was presented with a handsome wrist watch last week on the occasion of his birthday anniversary. It was given by his associates for the many fine things he has done for them during close to 20 years' service with Leo Feist, Inc.

Jack Yellen, of Ager, Yellen & Bornstein, Inc., suffered a sudden attack of appendicitis last week while en route from Cleveland to Chicago. He was rushed to his home in Buffalo, where his family physician stated an operation might be necessary. Lew Pollack, of the A. Y. & B. professional department, left early this week for Chicago, where he will start a 10-week campaign on the concern's newer numbers.

Another new publishing house under way is to be called the White House Music Company, which is being incor-



(Communications to 1493 Broadway, New York, N. Y.)

porated under the laws of the State of New York for \$25,000. Bernie Grossman, Nat Osborne and Harry Jacobs are the incorporators.

The ranks of the publishers will be swelled shortly by the addition of Eugene West, writer, who believes there is nothing to lose by publishing himself. West has to his credit the coauthorship of *Broadway Rose*, *You Know You Belong to Somebody Else*, and other hits. He expects to take a suite of offices in the Columbia Theater Building not far from that of Chas. K. Harris, in New York, and will publish with the backing of a syndicate with considerable capital.

Alex Gerber is writing an American version of the English hit song, *Titina*, which started off strong as soon as it was introduced here in the new Elsie Janis musical show, *Puzzles*. Harms, Inc., will be the publishers, of course. The song has a peculiar history in that Chas. B. Dillingham, producer, heard it in London last summer and was much impressed by *Titina*, which was beginning to get in the air about that time. He purchased the American rights for a sum said to be \$5,000 and since then it has been tremendous in England. It bids fair to be equally powerful here.

John A. Hollman, broadcasting manager of the American Telephone and Telegraph Company and supervisor of station WEAJ, told 2,000 members of the Merchants' Association of New York at their annual luncheon last week that jazz music is on the wane with radio audiences.

Mr. Hollman read an analysis of letters received by station in criticism of its programs. The analysis showed that in 1923 the radio audience was divided into 75 per cent for jazz music, 20 per cent for good music and 5 per cent for talks. Good music is composed of concert and standard numbers, philharmonic concerts and the like.

As the report of the analysis continued a survey made in January, 1924, showed the public radio taste as 35 per cent for jazz, 30 per cent for good music and 35 per cent for talks; in January, 1925, they expressed themselves as 5 per cent for jazz, 30 per cent for symphonic dances and 45 per cent for good music and 20 per cent for talks.

This, however, does not compare favorably with other stations throughout the country making a similar analysis. Jazz or popular music has been the favorite, according to reports from the rest of the country.

The Ted Browne Music Company, Chicago, announces a new fox-trot song hit, called *How's Your Folks and My Folks Down in Norfolk Town*, by Cal DeVoll and Dudley Mecum. Mecum has been identified with the Duncan Sisters and DeVoll is the writer of many song successes, such as *Alabama Lullaby*, *Sunkist Rose*, *Sweetest Little Rose in Tennessee*, and cowriter of the radio hit, *How Do You Do?*

The Miller Music Company of Chicago has a fast moving song in *My Dixie Dream*, by Baxter and Iden. Altho off the press since the middle of January, it has taken hold like a veteran that has been plugged for months.

Boy-Days and *Out Where the West Still Is West*, new songs of the Westway Music Publishers, of Manson, Wash., are gaining favor in various sections of the country. J. Vincent Moore, New York representative for the concern, is exploiting the last named song over the radio and reports that this waltz ballad is making a genuine impression. Numbers are issued with quartet arrangements, also full orchestrations.

Cocoanut Trot, composed by Abe Lyman, Los Angeles orchestra man, who leaves there shortly for Chicago, is being

MUSIC

ARRANGED

C. E. WHEELER, 1587 Broadway, NEW YORK, N. Y.

By one of America's foremost and most capable arrangers. Has arranged leading hits from ZIEGFELD FOLLIES, MOONLIGHT, GREENWICH VILLAGE FOLLIES, POP-PIE, etc. Vocal, Orchestral and Phonograph Arrangements for Acts and Orchestras. Let the man who arranges for all the music publishers attend to your scoring requirements.

"ROLL ALONG." For Song, for Music. Fox-Trot. Singers, Dance Orchestras and Bands don't miss this

Number.
"LET'S GO." Pep Boogie Fox-Trot Song.
"MEL-LIE McREE." Kid Fox-Trot Song.
"IT'S GREAT TO BE A ROOSTER; COCK A DOODLE DOO." Pep Comedy Fox-Trot Song.
"MEET ME TONIGHT IN THE PARK." Pretty Waltz Song.

These numbers going around the world. Title Page Piano Song Copies, 10 cents; A-1 12-Piece Dance Orchestration, 25c, or two for 50c; Full Band, 25c, postpaid. No tax.

ENGLEWOOD MUSIC HOUSE

516 ENGLEWOOD AVENUE.

CHICAGO, ILLINOIS.

HERE IT IS! — HERE IT IS! — HERE IT IS!

THE WALTZ SONG THAT ALL LEADING SINGERS AND ORCHESTRAS ARE RAVING ABOUT.

"MOONLIGHT MAKES ME LONG FOR YOU"

The greatest waltz song HIT of the season. Ask any singer or orchestra. Sweet, tender words. Melody simple, yet very beautiful, the catchy waltz kind. It's sung, played and broadcasted all over the country. Get your copy now. Professional and full band Orchestration.

FRANK H. GILLESPIE, Music Publisher, 1112 Forbes St., PITTSBURGH, PA.

offered by the Brunswick company as a novelty selection from movieland. Lyman has been playing at Coccoanut Grove, which is frequented by motion picture stars and the leader has written the song as a descriptive one with the special arrangement working in a real movie atmosphere.

Litigation is surrounding Kay-Stern, Inc., music publishers, due to the song, *My Daug*. The Clarence Williams Music Publishing Company, Waterson, Berlin & Snyder and a mechanical company have all been named defendants in connection with the ditty.

Abner Greenberg, attorney for the Kay-Stern Company, asserted that the Clarence Williams Company has infringed on its melody in a piece entitled *West Indies Blues*. This case is slated to be heard in the United States District Court, but no date has been set.

Waterson, Berlin & Snyder have a song entitled *Poodle Dog* which the Kay-Stern Company says sounds similar to *My Daug*, and to which it has sold the mechanical rights. The recording company has already produced the disk and has refused to refrain from selling it.

Ed Smalle composed the music for the show, *Some Girl*, which is successfully playing in New England. There are several fine numbers in the show, the music of which is being published by the E. B. Marks Company.

One of the best ways of plugging songs in a theater, vaudeville or picture, is the animated film which at least one large publisher is just putting into effect. The title is screened, with the announcement "so and so presents", and the song is played by the house orchestra as its overture. The words are flashed on as they are played by the orchestra and at first a white ball hops from word to word, in time with the music. Thus the audience and orchestra leader both get just the right tempo. For the second chorus a little cartoon figure with a banjo hops from letter to letter, etc., doing odd stunts during variations or when a note is held. A Romeo and Juliet scene brings the song to a wow finish, as the last word of the song raises up and catapults the Romeo into the balcony.

MUSIC ARRANGED

Orchestra or Band, Special Symphonic and Novelty Arrangements for Modern Instrumentation. Piano Arrangement from Lead Sheet. Right prices. Write LEW GOULD, 306 W. 46th St., New York, N. Y.

Songwriters, Composers, Publishers

WRITE FOR MY PRICES

Engraving and Printing, Professional copies.

Regular Sheet Music, Orchestras and Bands.

EDWARD J. STEINER

Music Engraver and Printer.

613 Pine St., St. Louis, Missouri.

"A MAN'S A FOOL IF HE INTERFERES"

A Sensational Recitation. A Big Hit!
"The Blacksmith's Story", "Jenkins in the Bar Room", "Slim Jim", "Blue Velvet Band", "A Pack of Cards", "Oh, Mamma, Wanni-I Scarra". Send 10c for sample copy and catalog. FRANK HARDING, Music Printing and Publishing, 228 E. 22d St., New York.

WOODWIND PLAYERS! SOMETHING NEW!

For instructional purposes. Get Harder's Original Records in Modern Solos and Duets for Bb Clarinet, Alto Clarinet and Bass Clarinet. They are wonderful for tone, intonation, interpretation and phrasing. Composed and played by the eminent clarinet wizard, Double-Faced Records, \$1.00 each. Address E. E. HARDER, Woodwind School, 311 Center St., Chicago, Illinois.

POSITIVELY THE BEST

Clubaret Jazz Number out today, also wonderful for burlesque Show or Girl and Boy Act.

"You Started Something"

Send 5c in stamps for Piano, Vocal Copy. R. M. S. PUBL. CO., 3121 S. Grand Blvd., St. Louis, Mo.

New Turns and Returns

(Continued from page 21)

bers taken from Aida, as has been done in the past, but tells the story in short form without leaving too much to the imagination. The condensation includes briefly the blessing of the sword of Radames, his departure for battle, the triumphant return, the hero's love and death pact with Aida and the final tragedy.

Augmenting the De Feo group, Mlle. Sylvia Parady, ballet dancer, offers a divertissement in association with the Hippodrome dancing girls. Aside from dressing the stage by their presence, the dancing ensemble, who do a mediocre Egyptian number, would not be missed.

Mlle. Parady, too, does not impress deeply with her work. She failed to "click" at the Monday afternoon show, when the offering was reviewed, and as a matter of fact, the presentation of Aida doesn't require the ballet dances she offers.

Qualifero Fabi conducted the orchestra splendidly, and William A. McManus, technical director, has assisted in staging Aida in an efficient manner.

Surprising tho it may seem, the Monday afternoon audience, usually a sort of hard-boiled one, greatly relished the operatic presentation and applauded enthusiastically after each scene, requiring the principals, on the finale, to take a number of bows. Had not Nora Bayes, always a big applause hit, and Bill Robinson, who seldom fails to "take the house down" been in the same bill, Aida would probably have gotten the biggest

hand of the afternoon. As it was, the offering scored third in point of applause. This speaks well for it and upholds the argument that good music is appreciated when it really is good, even in these days when jazz and "comedy acts in one" are the chief holler.

Georgalis Trio

Reviewed Tuesday matinee, February 17, at Proctor's Fifth Avenue Theater, New York. Style—Target shooting. Setting—In full. Time—Twelve minutes.

Georgalis and his girl and man partner have changed their act, having substituted most of their old gun tricks for new ones and are wearing naval uniforms in their latest innovation.

All three shoot but most of the work rests with the principal himself. There are about 20 guns of the 22-caliber type. A number of gadgets are used, on and with the guns, at first followed by Georgalis leaving the stage and walking about three-quarters of the way up the aisle. He has been shooting at small clay disks about an inch in diameter, never missing a one.

There are six in all on a metal background and again he clips them off from the aisle. He walks to the last row and zips them again. He returns to the stage and shoots six more of the little pellets off the girl's shoulders and then shoots another off her garter which is holding it together.

The most remarkable trick of the lot to this writer was the one where the assisting fellow holds the gun on his shoulder facing away from the target and, under the direction of Georgalis, who stands several feet in front of him, tells him how to move the gun. The trigger is pulled by the assistant and breaks the clay piece into smithereens.

The chap and the girl with Georgalis showed perfect confidence in their principal's marksmanship for they both placed their noses alongside of two disks while Georgalis with a revolver and gun hit the two targets at the same time.

The rest of the act is for a routine of different positions that all three get in while shooting. They close the act with an amplifier attached to an instrument that has eight keys that are rung when the bullets hit the bull's eye. They play a tune, the assistant and Georgalis doing the shooting.

A novel gun act that pleased mightily. The little bullets whizzing around at a fast rate keep the interest high. Georgalis showed good showmanship by varying his program to not only stunts that some are doing but ideas that he dug up himself.

Max Lielon Troupe

Reviewed Wednesday evening, February 18, at Moss' Franklin Theater, New York. Style—Acrobatic. Setting—Special, full stage. Time—Five minutes.

Probably a Keith importation, but undoubtedly a foreign offering. Three men and a woman comprise the troupe, one of the men doing comedy in a "hoke" makeup and the other two lending a touch of novelty to an acrobatic act by working in formal day attire, viz.: Cut-away coat, wing collar and the customary dark-gray trousers. The men in the frock coats do most of the acrobatics, the major portion of the work consisting of tumbling stunts, using a "see-saw" to take unusually high leaps into midair.

They work smoothly, with speed and ease. They can fit nicely into the opening or closing spot of any bill and in houses catering to dumb acts, such as the Hipp., can be made worthy of a spot.

George Olsen and His Music

Reviewed Monday matinee, February 16, at the Palace Theater, New York. Style—Orchestra. Setting—In Three. Time—Twenty-five minutes.

Olsen's nine-piece aggregation, late of Kid Boots and also heard in one of the supper clubs, now closed, has been in New York for more than a year, coming here originally from Oregon to play for Paul Whiteman. Olsen was a hit right off the bat and has been steadily improving ever since. From the first few bars that the orchestra plays it is plain that it stands head and shoulders above the average nine-piece orchestra. The style is soft and distinct. There is no open brass and it is truly "whispered harmony". The banjo is the only string instrument. The rest of the instrumentation is saxophones, cornets, drums and piano, with the musicians doubling on clarinet and French horns as well as forming various combinations of brass and saxophones.

Few straight numbers are done at first, most of the program being taken up with the novelty rendition of specially arranged songs calling for fine musicianship on the part of the soloists and novelty combination effects. Among these is included a fantasy of My Buddy, which brings out bugle calls plus war effects, and Going Home Blues, which brings forth all the imitations of a railroad depot and its noise. Later there is a French horn quartet which is joined by a soprano saxophone and clarinet. Toward the close popular numbers are done somewhat along the usual lines.

Olsen himself is at the drums. He has a fine personality, is rather modest and is content to direct from the second row of musicians. The brass and saxophone sections comprise the first row. Everything is played in a smooth, even tempo

and it must be apparent to any novice in the audience that the orchestra is far ahead of anything in new ideas since Paul Whiteman contributed his dance music.

For vaudeville it is safe to assume that the orchestra can follow any combination into a big-time house and clean up. It has something for all who can appreciate music, whether their taste runs to "hot" stuff or a more subdued and finer sense of rhythm and harmony offered in clever style.

Ken Kling

Reviewed Wednesday evening, February 18, at B. S. Moss' Regent Theater, New York. Style—Cartoonist. Setting—One and one-half. Time—Twelve minutes.

Kling is the creator of The Evening World's sporting page comics, Joe and Asbestos, who sometimes run a sawbuck into the thousands, only to find themselves without a dime on other occasions. Sometimes they hand out hot tips on the races, and their success is watched by many readers. For this reason the cartoonist appearing in person, making his characters right before the audience, as is the usual thing with such acts, makes an irresistible appeal to the average theatergoer.

Opening the act is an animated film of Joe and Asbestos which is funny. Toward the close the characters call for Kling, saying, "Come on Out You Piece of Cheese", etc., and Kling answers that he will if they will get off, and Joe and Asbestos run around until they lose out.

Following the animated film, Kling comes on and does his cartooning on a paper-covered board mounted on an easel, so arranged that he can tear the sheets off or roll them out of sight. He uses charcoal and, after drawing his comics in sight of the audience, makes a few as tho he were copying them from nearby patrons. These turn out to be funny ones, some having handsome ruby-colored noses.

Toward the close he starts to draw the head of a woman in an upper box. She is conspicuous, inasmuch as she wears a red hat. The hat is drawn in red and the eyes of the house become riveted upon the box, when the lady in question holds a program before her face. He continues the picture by drawing her two hands first, with the square representing the program next. As soon as the two hands are seen by the patrons they anticipate the picture and it is a sure enough wow.

In closing, Kling, for the first time, speaks a few words, saying that he supposes the folks want to know why he is in vaudeville. Whereupon he brings Benny Leonard into the story, saying they were friends and lived in the same house until Leonard raised the rent on him, etc., and rings in a gag on his inother which seems to send him off nicely. With a little more showmanship, which he will undoubtedly acquire as he works more, the offering will be even better than it is.

George Lyons

Reviewed Wednesday evening, February 18, at Moss' Franklin Theater, New York. Style—Musical and singing. Setting—In one. Time—Twelve minutes.

George Lyons is of the former two act known as Lyons and Yosco. For his single, he is attempting one of the most difficult kind of offerings to put over alone in vaudeville, that of harpist, but seemed to have sufficient success on the night he was reviewed to stop the show. He will take more than just harp-playing to put his act over, and he adds to the instrumental work two ballads which he sings while he plays. He has evidently framed his offering for the family houses, using ballads with a tear in them—the kind generally burlesqued in revues and yet eaten up by the average family vaudeville audience. In those houses Lyons' act should find the going easy.

New York Notes

(Continued from page 20)

han, Pearl Eaton and others arrived and contributed a specialty each.

Paul Van Loan, who has been rehearsing the House of David Band for several years, has renewed his contract with the organization and March 5 will join the band in Washington to begin further rehearsals. The House of David will have another band out soon. Foyer & Jess, who booked the long-haired players on their present tour, report that turn-away business has been the rule all thru the Middle West.

The Roger Wolfe Kahn Orchestra, playing at the Biltmore Hotel, also will be on hand at the inaugural ceremonies to be held in Washington March 4. Kahn will be the youngest of the leaders among those selected to play on the occasion, the rest being well-known veterans. He will use 30 pieces. This week he is booked to play at the Hippodrome.

Eddie Elkins and His Orchestra are now doubling at the Crystal Room of the Ritz-Carlton Hotel in place of the Vincent Rose Orchestra, which went to Chicago to open at the College Inn, made vacant by Isham Jones. Elkins continues to play the Club Richman cabaret at night.

Advertisement for BARNEY'S TOE-DANCING SLIPPERS. Includes an illustration of a slipper and text: BARNEY'S, 304-6 W. 42d St., New York.

Most Wonderful Musical Instrument Ever Invented Play in a Minute!

Advertisement for Mussehl's Slide-Trumpet-Sax. Includes an illustration of a man playing a trumpet and text: Play Your Way to Popularity. No Lessons—No Practice. Greatest musical sensation of the age!

Mussehl's Slide-Trumpet-Sax

A big, full-sized musical instrument made of solid brass, polished and finished like the very finest Saxophone. You don't need to know the first thing about music. You don't have to practice, not a minute.

Advertisement for Mussehl's Slide-Trumpet-Sax. Includes an illustration of a woman playing a saxophone and text: You Can Play It. Just HUM a tune in it, that's all. And, oh how the music rolls out—sweet and mellow like the dreamy Saxophone or loud and clear like trombone or trumpet.

Advertisement for Mussehl's Slide-Trumpet-Sax. Includes text: FREE We will send you a beautiful solo played on Mussehl's Slide-Trumpet-Sax. You will simply be amazed at the sweet, mellow music produced by this wonderful instrument that sounds like a saxophone.

Form for requesting a FREE Phonograph Record Today—SURE. Includes fields for Name and Address, and contact information for MUSSEHL & WESTPHAL.

Advertisement for ACTS WRITTEN TO ORDER. CARL NIESSE, Author. 3604 East Washington, INDIANAPOLIS, IND. AT LIBERTY - VERSATILE GLOVETTES

Advertisement for REMOVAL NOTICE F. W. NACK—WIGS. New Address, 36 S. State St., Chicago. Write for Free Catalogue.

Advertisement for STAGE DANCING TAUGHT BY WALTER BAKER. (New York's Leading Dancing Master.) TEACHER OF BROADWAY CELEBRITIES.

Advertisement for SCENERY THAT SATISFIES DYE SCENERY-VELOUR CURTAINS. R. WESCOTT KING STUDIOS. 2215 Van Buren Street, Chicago, Ill.

Advertisement for ROMAN TRARES AND HIS BAND (A 7-PIECE ORCHESTRA). KSD and WCK Broadcasting Artists. Desire change of territory. AT LIBERTY APRIL 1. Hotel work preferred. Address care Billboard, St. Louis, Mo.

Advertisement for WANTED Small Girl. Who can dance, professional, with Thurston, Magician. Send photograph, height, weight, age and experience immediately. Address GRAND OPERA HOUSE, Cincinnati Feb. 22-28; Macauley's Theatre, Louisville, March 1-7.

Advertisement for GENUINE LUSTRUS GEM SCARF PIN. PLATINUM FINISH \$5.95. 10 DAYS FREE TRIAL. Compare LUSTRUS GEMS with genuine diamonds and judge for yourself. LUSTRUS GEM SCARF PINS are guaranteed to be blue white, absolutely perfect, and full of fiery sparkle and everlasting brilliancy.



COMEDY FARCE TRAGEDY THE DRAMATIC STAGE

News, Views and Interviews

CONDUCTED BY GORDON WHYTE

(Communications to 1493 Broadway, New York, N. Y.)



BROADWAY SEASON REACHES PEAK

Business Holding Up at Box Offices and Shows Getting Good Break—Six New Attractions Coming In

NEW YORK, Feb. 20.—The continued good business which is common to all plays which have anything at all to attract the public is the subject of much comment on Broadway. It was expected that a slump would take place before this but no signs of it are in sight. The season usually reaches its highest point around Washington's Birthday and business is likely to drop off after that time. This season the diminution in takings is not looked for so early.

One indication of the faith which the producers have in the remainder of the season is shown in the number of incoming attractions. This past week saw five new dramatic offerings and next week there will be half a dozen. For the following week there will probably be four. Such a number of new plays is not usual at this time of the year, for the producers figure business is due to drop off and rather than have a promising play hurt by warm weather they are apt to defer its presentation to the following season. Usually, at this time of year, all producing activities are directed towards spring tryouts in the outlying towns and while some of this is going now, more new plays are being headed definitely to Broadway.

Of the plays which opened here this week none scored a decided success. The one that looks the most promising is *Cape Smoke*, at the Martin Beck Theater, a melodrama which may hit the popular taste. *Tangletoes* and *Houses of Sand* have a chance, but neither is deemed sure-fire by any means.

Monday afternoon Lee Shubert will present *The Virgin of Bethulia* at the Ambassador. This play is by Henri Bernstein and was formerly known as *Judith*. It has been adapted by Gladys Unger and the cast will be headed by McKay Morris and Julia Hoyt. The supporting company includes Ann Davis, Thurlow Bergen, Effingham Pinto, George Baxter, Marjorie McLucas, Charles Glibney, Fred Beane, George N. Price, Lee Beggs, George Rogers and Gus Alexander. The play has been staged by Lawrence Marston.

The opening of *White Collars* will also take place on Monday afternoon. This play, by Edith Ellis, has run an unconscionable number of weeks in Los Angeles and is being presented here by Frank Egan, who also owns the Coast production. The cast includes John Marston, Clarke Silvernall, Mona Kingsley, Frances Underwood, Frederick Burton, Rea Martin, Robert Craig, Cornelia Otis Skinner and Donald McClelland.

The Theater Guild will make its fourth production of the current season on Monday night, at the Garrick Theater. The play is *Ariadne*, by A. A. Milne. In the cast are Laura Hope Crews, Lee Baker, Harry Mestayer, Orlando Daly, Frieda Inescort, Catherine Proctor and Armina Marshall. Philip Moeller directed the play and Carolyn Hancock designed the settings.

Two by Two is the second opening for Monday night. It will be presented by Jessie Trimble, Inc., at the Selwyn Theater. The piece is the joint work of John Turner and Eugene Woodward. It calls for a long cast and among those in it are Charlotte Walker, Howard Lindsay, Minnette Buddecke, Lawrence D'Orsay, Beatrice Bayfield, Arthur Lewis, St. Clair Bayfield, Frank I. Frayne, Maude Durand, W. Leete Stone, Haroldine Humphreys, Una Merkle, Robert Stevens, Elinor Wells and Robert Ryles.

The Actors' Theater will present *The Wild Duck*, by Henrik Ibsen, at the 48th Street Theater, Tuesday evening. The cast is made up of Tom Powers, Warburton Gamble, Blanche Yurka, Moffat Johnston, Cecil Yapp, Pearl Sindelar, Henry Carvel, Thomas Chalmers, Philip Leigh, Helen Chandler, Milton J. Bernd, Francis Sadtler, Charles Angela, John Brewster and Edgar Henning. Joseph Mielzner has designed the settings and Dudley Digges has staged the play.

At the Bijou Theater, Tuesday, Mulligan and Trebitsch will present *Night Hawk*, a play by Roland Oliver. The cast is headed by Mary Newcombe.

"Moon Magic" To Close

New York, Feb. 20.—Lewis & Gordon will close *Moon Magic* in Philadelphia tomorrow and hold it for production on Broadway next season.

Barrymore's "Hamlet" Well Received in London

London, Feb. 21 (Special Cable to *The Billboard*).—John Barrymore's production of *Hamlet*, with settings by Robert Edmund Jones, was well received at the Haymarket Theater, Thursday, by an audience which included a great number of celebrities—literary, theatrical and political.

Considerable success is expected for Barrymore's original and effective reading of the great part, but criticism is in nowise unanimously laudatory.

Malcolm Keen's *Claudius* was an unqualified success and Barrymore is fortunate in having Fay Compton as Ophelia. Settings of the play won high praise, tho they were somewhat cloistral, while the play seems to demand open-air treatment decoratively.

To Do "The Green Hat"

New York, Feb. 20.—One week from next Monday A. H. Woods will start rehearsals of *The Green Hat*, a play which Michael Arlen has made from his novel of the same name. Woods had previously announced that he would hold this play for production next season but has had a sudden change of mind and will do it for two weeks this spring, lay it off for the summer and do it on Broadway next season, providing it pans out all right in the tryouts.

An interesting situation arose over the announcement of Katherine Cornell's engagement to play the leading role as David Belasco had also announced her as the featured player of *The Doll Master*, his next production. Woods says he has Miss Cornell under contract to appear in *The Green Hat*, but as Belasco intends to show his play late this season it is possible that Miss Cornell may appear in both productions. The cast engaged to appear in *The Green Hat*, besides Miss Cornell, includes Leslie Howard, Eugene Powers, Ann Harding and A. P. Kaye. Guthrie McClintic will stage the piece.

Basil Dean Arrives

New York, Feb. 20.—Basil Dean, the English producer, has returned to Broadway to stage the revival of *The Little Minister*, which Charles Dillingham is about to produce. Ruth Chatterton will play the part done before by Maude Adams.

On arriving here Mr. Dean stated that he intended to bring *The Vortex*, a current London success, to this country next season. It had been reported previously that the rights to this play had been acquired by Joseph Bickerton, an attorney with a large theatrical practice in this city.

Heavy on Revivals

New York, Feb. 20.—This season is probably more prolific of revivals than any known in years and the end is not yet in sight. At least two managers are figuring on reviving old successes and *The Two Orphans* and *The Charity Ball* are mentioned in this connection. They will be done with all-star casts, in all probability.

Revivals of *The Little Minister* and *Pierrot, the Prodigal*, will be seen on Broadway within the next month and among others seen this season or about to be done are *Candida*, *Peter Pan*, several plays of Eugene O'Neill, *The Wild Duck* and *Caesar and Cleopatra*.

Postpone Opening

New York, Feb. 20.—The opening of *The Dunce Boy*, which was to have taken place next week at the Punch and Judy Theater, has been postponed until the middle of March. When it is done, Helen Ware will have the leading role.

CHARLES ELLIS



Mr. Ellis' moving portrayal of Eben Cabot, a young New Englander of misguided passions, in "Desire Under the Elms", is one of the outstanding characterizations of the piece that brought it from the comparative obscurity of the Greenwich Village Theater to the more affluent atmosphere of the Earl Carroll Theater, in the heart of Broadway's theatrical activities.

Costar in "Spin-Drift"

New York, Feb. 20.—Rehearsals of *Spin-Drift*, in which Margaret Lawrence and Wallace Eddinger will star, are now in progress here. George C. Tyler and Hugh Ford are presenting the play and it will open in Boston March 9 at the Park Theater. It is hoped that a summer run will be forthcoming there. The cast, besides the stars, includes Ellenbeth Bladon, Henrietta Crosman, Lionel Watts and Gilbert Douglas.

Spin-Drift is an adaptation of a play by Alexandre Dumas, Jr., called *The Demiandaine*, which was produced with great success in Paris many years ago. It was later translated into English and played in several versions. One of these was called *The Crust of Society*. The present adaptation by Mr. Thomas will have the scenes laid in England.

Cohan Accepts Play

New York, Feb. 20.—The rumors which Broadway has heard from time to time that George M. Cohan would again enter the producing field have finally had some substantiation. It is said on reliable information that he has accepted a play from Frederic Donaghey, dramatic critic for *The Chicago Tribune*. Whether Cohan will produce it this season is not known.

Start New Play

New York, Feb. 21.—Rehearsals for *Alhambra* have commenced under the direction of A. H. Van Buren. The piece will be presented by Carl Hood and the out of town opening will take place within a few weeks.

Alhambra was written by John B. Hymer and Leroy Clements.

Ruth Garland III

New York, Feb. 21.—Ruth Garland, who appeared recently in *Out of Step*, was suddenly taken ill and had to drop out of the cast two days before the show closed last Saturday. She is now at her home and probably will be able to be out again within a week.

Lambs To Gambol

New York, Feb. 20.—The only public Gambol of the Lambs' Club will be held April 26 at the Metropolitan Opera House. A big bill made up of sketches which have been presented at the private Gambols, and vaudeville turns, will be presented under the direction of Purnell Pratt.

Charles Ellis of "Desire Under the Elms" Was Artist Before Adopting Stage Career

Charles Ellis, who plays the role of Eben Cabot, the philandering youth in *Desire Under the Elms*, at the Earl Carroll Theater, New York, was a painter of portraits, murals, landscapes (and today cannot be excelled for the beauty of his batiks) before he became an actor. If he hadn't undertaken to paint a set of scenery for the Provincetown Players, the art editor of one of the big dailies would be writing a story about a young painter and this interview with a young actor of striking individuality would not exist.

While Mr. Ellis was wielding a brush on the set he was hastily drafted to take the place of a missing actor, in a minor part. He proved so good an impromptu actor that Eugene O'Neill suggested that he acquire experience as a real actor.

Following Mr. O'Neill's advice, given about seven years ago, Charles Ellis appeared in a number of one-act plays given at the Provincetown and made his first Broadway appearance in O'Neill's *Diff'rent* (now scheduled for revival) as the soldier boy.

The Theater Guild of New York then engaged Mr. Ellis as understudy to Joseph Schildkraut in *Lilom*, as a precaution against an accident befalling the latter, who was then doing motion picture work. When the star of *Lilom* was ill Mr. Ellis appeared in the title role and also played it on tour. When *Lilom* was taken from the road he appeared in two other Theater Guild productions, *Ambush* and *From Mori Till Midnight*, playing four roles in the latter.

He then returned to the Provincetown Theater and was cast for a series of plays. In addition to doing the cockney in *Emperor Jones* he played in *Fashion*, *George Dand*, *The Ancient Mariner* and *The Saint*.

Another Broadway play in which Charles Ellis was seen was *The Deluge*, followed by appearances in the road companies of *The Old Soak* and *Fashions for Men*. He has also had stock experience in Rochester and Brooklyn. Asked if he had forsaken painting entirely, Mr. Ellis replied that whatever spare time he had was devoted to that art. "In fact," added he, "I spent four months in Italy last year, devoting myself to painting exclusively."

Asked to express himself on the contention now in force over the deletion of certain so-called offensive lines from *Desire Under the Elms*, Mr. Ellis said that while the play does not attempt to preach a moral lesson, it does demonstrate the danger of the repression of wrong thoughts, constantly thinking about wrong things and never expressing them and harboring desires for things of no real value.

He admitted that he was at first unhappy in the role of Eben Cabot because of difficulty in acquiring the dialect requisite to the part. After long-sustained effort the dialect was acquired and he began to find possibilities in the role.

Mr. Ellis is an odd blend of the intellectual and vital types. There is in the contour of brow and head a suggestion of the poet and artist, and elegant, sensitive features suggest the idealist. But there is superb vitality in his voice and an alacrity to his movements that stamp him as the idealist of action rather than the idealist of dreams.

Asked if he had anything interesting in mind regarding the stage he replied playfully:

"Yes. My wife, Norma Millay, is appearing in *Patience* at the Greenwich Village Theater, Matinee Thursday and Saturday!" ELITA MILLER LENZ

Hands Broadway a Laugh

New York, Feb. 20.—While ingenious schemes to draw the attention of managers to players who are idle are by no means unknown to Broadway, the latest effort in this direction is handing the managerial forces a great laugh.

It comes from Mrs. Denman Miley and is in the form of a large card, engraved as tho it were a wedding or engagement notice. It reads: "Doris Richmond Miley announces the idleness of her husband, Denman, in New York City, commencing February 1, 1925. At home, receiving of others, 130 West 44th street, New York City."

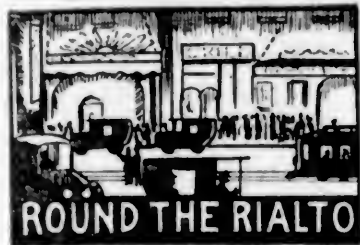

WE attended the blowout which THE GREEN ROOM CLUB gave to JAMES GLEASON and ROBERT ARMSTRONG. . . . JIM wrote *Is Zat So?* and is playing in it. . . . BOB is playing in the piece, too. . . . A novel bill was presented and there was much jollity. . . . J. M. KERRIGAN took it in with us and called it a fine evening. . . . We met ELISABETH RISDON, who informed us she had turned down half a dozen parts this season because they were too rowdy. . . . If the rest of the players were as conscientious as ELISABETH there would be an end to the dirty plays which are raising so much Cain in the theater at present. . . . CHARLES ELLIS dropped in to see us and says *Desire Under the Elms* is doing a whacking big business. . . . ED WYNN invited us to see his show, *The Greb Bug*, a bid which we quickly accepted. . . . ED is to our mind the few comedian *par excellence*. . . . For over two hours we howled at his comedy and every bit of it is clean. . . . To be able to give the joy to thousands that is ED's privilege must be a source of great satisfaction to him. . . . He should be very proud and happy for it. . . . EDWARD EVERETT PIDGEON also invited us to a show. . . . And a mighty good one. . . . It was BURTON HOLMES who delivered a travelog on *Rome*. . . . We had never heard MR. HOLMES and found his lecture very, very enjoyable and his pictures beautiful. . . . For which we thank our good friend ED. . . . CHARLES BARTHOLEMEW called on us and told us some of his experiences in a brand-new line of work. . . . It seems that CHARLIE is engaged to appear at banquets and impersonate an English nobleman. . . . He says the hoax never fails and the laughs that are handed him by the audience are quite as numerous as he hands them. . . . That should do for today.

TOM PEPPER.

Engaged for "Caesar"

New York, Feb. 20.—The long debated question as to who would play the leading parts in the revival of Shaw's *Caesar and Cleopatra*, with which the Theater Guild is to open its new theater, has been settled by the engagements of Lionel Atwill to play *Caesar* and Helen Hayes to play *Cleopatra*.

Miss Hayes is at present appearing in *Quarantine* at the Henry Miller Theater, but it is asserted she accepted the engagement with the understanding that she be permitted to leave when the Theater Guild wanted her to play *Cleopatra* for them. Mr. Atwill has been appearing in vaudeville this season.

The new Guild Theater, which is on West 52d street, is not completed yet but it is believed it will be ready for occupancy on April 6. Rehearsals for *Caesar and Cleopatra* will be called four weeks before the date of opening is definitely set.

"Bright Island" Mediocre

London, Feb. 21 (Special Cable to *The Billboard*).—Arnold Bennett's fantasy, *The Bright Island*, admirably played and magnificently produced by Theodore Comisar Jevski for the Incorporated Stage Society, proved an insipid, boring, mediocre affair. Its political and social satires were mildly amusing but, despite Arthur Pinney's perfection of listlessness as King Piero, Dorothy Holmes Gore's lascivious Columbine, Frederick Lloyd's workmanlike bluff sailor, Brember Willis' superb comic study of a revolutionary and Jeanne Deesell's amazingly resourceful and impudent Isabella, the piece failed to hold the audience's attention and represents an appalling waste of talent and the society's funds.

Replaces on Short Notice

New York, Feb. 26.—Walter J. Plimmer, Jr., son of the independent vaudeville hooker, has been given a run-of-the-play contract for the leading role of *The Small-Timers* at the Punch and Judy Theater for his performance in that role when he jumped into it without rehearsal this week. Plimmer replaces Leslie Cooley, who played the leading role since the play opened. Cooley retired from the cast after the night performance on Saturday, February 14, because of tonsillitis. It was reported, Plimmer played the role Monday night without the benefit of a rehearsal and was rewarded with the contract by Henry Schiffman, producer of the play.

Theater Guild Party

New York, Feb. 20.—The Theater Guild will hold its usual birthday party this year March 15. The scene of the festivities will be the Hotel Commodore and will include a vaudeville show and a buffet supper. Since those who attend will vote on the tapestries to be hung in the new Guild Theater, the affair is being called a Tapestry Ball.

The vaudeville show will be given by Jascha Heifetz, Laurette Taylor, Richard Hale, Fanny Brice, Albert Carroll, Martha Lorber, Mr. Boreo, Clifton Webb, Mary Hay, Tanya Smynova, June Walker, Donald Macdonald, Ilse Marvenga, William Ortman, Sidney Blackmer, Rose Rolando and the Duncan Sisters.

The guests of Honor will be: Franklin P. Adams, Glenn Anders, John Anderson, Ethel Barrymore, Richard Bennett, Heywood Brown, John Corbin, Laura Hope Crews, Frank Crowninshield, Alan Dale, Dudley Digges, Walter Pritchard Eaton, Florence Eldridge, Lynn Fontanne, Gilbert W. Gabriel, Margalo Gillmore, James K. Hackett, Percy Hammond, Jascha Heifetz, Sydney Howard, Frieda Inescort, S. Jay Kaufman, John Howard Lawson, Winifred Lenihan, Pauline Lord, Alfred Lunt, Kathlene MacDonnell, Burns Mantle, E. W. Osborne, Phyllis Povah, Stephen Rathbun, Lawrence Reamer, Elmer Rice, Arthur Richman, Emily Stevens, Laurette Taylor, Henry Travers, Alexander Woolcott, Margaret Wycherly, Stark Young, Blanche Yurka.

Name of Show Changed

New York, Feb. 20.—The revival of *Close Harmony* will be done under a new title and the show will be called *Next Door*. The opening date is set for Monday at the Teck Theater, Buffalo, with a run in Boston to follow. Wanda Lyon, who had to quit rehearsing on account of illness, has returned to the cast. The complete cast is made up of Wanda Lyon, James Spottswood, Valerie Valaire, Marie Curtis, Arline Blackburn, Franklin Fox, James L. Sealey and Mary Bruce.

"Candida" Will Move

New York, Feb. 20.—The Actors' Theater will move *Candida* from the 48th Street Theater to the Eltinge on Monday afternoon, playing a holiday matinee on that day. This means that *The Piker*, at present occupying the Eltinge Theater, will close tomorrow night. *The Wild Duck* will open at the 48th Street Theater on Tuesday night next. The same cast which has been playing *Candida* will continue in the play at the Eltinge.

Engagements

New York, Feb. 21.—Helen Robinson has placed Betty Aiden with *Tangletoes*, Stanley Kalkhurst with *The Crucible*, Frank Miller with *Tico by Two* and Teresa Guerini and Forbes Dawson with Doris Keane in *Starlight*.

Gaige Gets New Play

New York, Feb. 20.—Crosby Gaige, who with his first independent venture scored a success with *Silence*, has bought a play by W. J. Hurtout, called *The Nice Girl*, for early production.

DRAMATIC NOTES

Arnold Daly has deferred the production of *Dangerous People*. He will hold the piece over until next season.

Hell's Bells will lay off for a week and will reopen at Daly's Theater, New York, March 2, replacing *White Cargo*.

Able's Irish Rose, after playing 13 weeks in Kansas City, has gone to St. Louis. Yes, 13 weeks and Kansas City!

Lulu Vollmer is the author of *The Dione Boy*, which will be presented this season at the Punch and Judy Theater, New York.

William A. Brady, Jr., is to produce another play. The name is not for publication as yet, but Katherine Alexander will be seen in the leading role.

The Shuberts have taken over the lease of the Broadhurst Theater from George Broadhurst. They built the New York house several years ago.

The play which was called *The Stork* here and which played one consecutive week at the Cort Theater, New York, has been done in London as *Home Affairs*.

Mary Hone has replaced Kay Laurell in the leading part of *Nocturne*, now playing special matinees at the Punch and Judy Theater, New York.

Crane Wilbur has written a new play and will test it at the Fulton Theater,

THE ONLY WAY

There was a dirty man
Who had a dirty thought.
A dirty playwright came:
The dirty play was wrought.

Then some dirty actors
Played in the dirty stuff.
A dirty public paid
To see the dirty bluff.

They all dwelt together
And made one dirty street.
Each one blamed the other
For being indiscreet.

When the decent public
Objects to so much dirt
It means a stubborn fight—
Too many will be hurt.

We all want the drama—
A clean one we espouse.
Why not get together
And let us all clean house?
HARRY L. DIXSON.

"Grand Duchess" Not Likely To Be Success

London, Feb. 21 (Special Cable to *The Billboard*).—Harry Graham's adaptation from Alfred Savoir's play, *The Grand Duchess*, with Lawrence Anderson making delightfully amusing love to Margaret Bannerman, and Alfred Draydon good as ever as a Russian noble, is not likely, despite the distinguished playing, to make a great success.

"Sapphire Ring" To Open

New York, Feb. 20.—George Choos will open his production of *The Sapphire Ring* at Washington March 9 and bring the piece here one week later. The cast will include George Gaul, Helen Gahagan and Mildred Florence. This is the play which Choos claimed was infringed by *Episode*. The latter play concludes its engagement at the Bijou Theater tomorrow night.

Ready To Produce

New York, Feb. 20.—While Edward Goodman is ready to start rehearsals of his first offering at the 52d Street Theater, the opening play has yet to be decided on. The choice lays between *Black Waters*, by Ralph Cullinan, and *The Blue Peter*, an English play. If the latter is decided on, J. M. Kerrigan will appear in it.

French Play Next

New York, Feb. 20.—The next production at the Provincetown Playhouse will be *Michel Auclair*, by Charles Vildrac, in a translation by Sidney Howard. It will have its first performance on March 2, replacing *Diffrent* and *The Triumph of the Egg* at this theater.

Buys Third Play

New York, Feb. 20.—That Martin Beck intends to go in for production on a large scale next season is indicated by his purchase of *When Ships Come In*, a comedy in four episodes by George Middleton. This is the third play which Beck has bought in the past few weeks.

Indianapolis Guild Incorporates

Indianapolis, Ind., Feb. 21.—Articles of incorporation for the Indianapolis Theater Guild have been signed by the incorporators. The guild, they say, is designed primarily to foster Indiana dramatic ability and the work of Indiana playwrights especially. It will cater to the popular taste in the production of plays, presenting those which have a general appeal. It is the intention to give any one who wishes to become a member an opportunity to act, thus bringing to light latent talent. The Guild will not adhere to any one type of play nor to any one cast. The incorporators have in mind the Theater Guild of New York, which fills a place in the community life of all classes. No definite arrangements have been made, but the members expect to have club rooms and start work shortly.

British Stage Guild Holds House Warming

London, Feb. 21 (Special Cable to *The Billboard*).—Last Sunday the Stage Guild held a house-warming on its new premises, formerly the Kinema Club, in Great Newport street, where the Guild's three sections—actors, managers and dramatics—are now housed.

Sir Johnston and Lady Forbes-Robertson received the large company of guests, including many prominent stage folk.

Tour Is Carceled

Elgin, Ill., Feb. 20.—Owing to a serious throat operation, Mrs. Dee Vivien Schramm-Eiberink, local author, teacher and dramatic producer, has canceled contracts for the Quatre Novelty Entertainers, of which she is a member and manager. Mrs. Eiberink returned to her home from St. Joseph's Hospital, where she was confined for several weeks. She will not be able to continue her dramatic work for some time.

Mystery Play a Hit in Vienna

New York, Feb. 20.—According to cables received here *The Last Warning*, by Thomas Fallon, has scored a hit at the Lustspiel Theater in Vienna. It is the first American mystery play to be produced in that city and the translation is the work of A. Paul Maerker-Branden. On the strength of its success in the Austrian capital the play will be done in Berlin, Dresden and Leipzig.

Sells Play Rights

New York, Feb. 20.—A. E. Thomas has sold the play rights to his first novel, *The Double Cross*, to Hugh Ford, who will produce it with George C. Tyler. Mr. Thomas has hitherto been known as a dramatist, but it is not known whether he will undertake the dramatization of his novel or not.

"Tin Gods" Rehearsals

New York, Feb. 20.—Rehearsals of *Tin Gods* will start on Monday, with Lillian Foster and Louis Calhern in the leading roles. The production is being made by Sam H. Harris and Sam Forrest will direct the staging.

"Starlight" Opening Set

New York, Feb. 20.—Frank Egan will present Doris Keane in *Starlight* at the Broadhurst Theater on March 2. This play, which is by Gladys Unger, has been done on the Pacific Coast with Miss Keane in the leading role.

Looking for Play

New York, Feb. 20.—Gustav Blum is looking for a play in which to feature Claude Cooper, the character actor who is appearing in *My Son*. The requirements are that the piece give Mr. Cooper full scope for his talents in character portrayals.

Long-Run Dramatic Play Records Appear on Page 63

Dramatic Art

THEODORA IRVINE

DIRECTOR OF THE IRVINE PLAYERS
A Course in Acting, Voice, Pantomime, Fencing, Rhythmic Dancing.
OCTOBER 15 TO MAY 31.
Teacher of Alice Brady. Work approved by Eva Le Gallienne, Mr. and Mrs. Coburn and Edith Wynne Matheison.
31 Riverside Drive, NEW YORK CITY.
Telephone, 3345 Endicott.

Wanted, Competent Writer

Who was familiar with the life of the well-known theatrical manager, H. R. JACOBS, who will cooperate with me in writing a biography of his life. MRS. H. R. JACOBS, Hotel Rochester, Rochester, N. Y.

(Continued on page 43)

DRAMATIC STOCK

REVIEWS, NEWS AND COMMENT BY ALFRED NELSON COMMUNICATIONS TO 1493 BROADWAY, NEW YORK

EVERY STOCK COMPANY SHOULD HAVE PRESS AGENT ON STAFF

Publicity as Essential as Proper Production and Presentation of Plays. While Players Seeking Engagements Prefer Companies That Get Good Notices

NEW YORK, Feb. 20.—Due to the fact that the editor of this department also conducts a department in the interest of press and advance agents, he is the recipient of numerous inquiries from journalists who desire to become press agents.

In order to aid these aspirants for press-agent engagements we covered the entire subject in a special article in the "Press and Advance Agents" column some time ago, and had several thousand reprints of the article that are sent out on request.

With numerous aspirants to the press-agent in every town there is no logical reason why every stock company should not have a press agent to keep the local papers supplied with advance notices as well as *The Billboard* with information that can be converted into interesting and instructive news, giving recognition to plays and players throughout the country.

Several of the more prominent companies employ experienced press representatives who not only provide advance notices and ad copy for the local newspapers but supplement their work along those lines with house programs that carry additional information relative to plays and players.

Many such programs come to our desk weekly and we find much in them to commend.

Terry Turner, press representative of Loew's, Inc., operating stock companies at Loew's Seventh Avenue Theater, this city, and Loew's Alhambra Theater, Brooklyn; Gertrude Wilbur, press representative of Proctor's Twenty-Third Street Theater in this city and Proctor's East Jersey Street Theater, Elizabeth, N. J., and Grace Wynden Vail, press representative of the Harder-Hall Players, Port Richmond, Staten Island, are thoroughly experienced press representatives who keep us well posted relative to the theaters represented by them.

There are numerous other players throughout the country who are seldom heard of by their professional friends for the reason that the house managers and directors of productions aren't sufficiently interested in the players to employ a press agent or even contribute information that may be utilized as news.

As an illustration of what a press representative can do to keep prominently before readers of *The Billboard* we append contributions from Grace Wynden Vail, viz.:

The Harder-Hall Players

The Harder-Hall Players at the Palace Theater, Port Richmond, are having a successful season.

The company is headed by Robert Bentley and Jeanne Devereaux and includes Edith Spencer, Richard Moran, Marion Hall, John Moore, J. Harrison Taylor, Marguerite Slavin, Warren Wade, art director, and Edwin E. Vickery, stage director.

Particular interest and heavy patronage have been accorded such plays as *The Bat*, *Buddies*, *The Old Homestead*, *Uncle Tom's Cabin*, *The Fool and Iron*, *E. J. Hall* is the active manager, with William Harder dropping in to supervise frequently. Mr. Bentley and Miss Devereaux have won a large personal following, as has each member of the cast.

Way Down East is the play to follow, with a big Masonic theater party a feature of the Monday night performance.

Jeanne Devereaux Writes Feminine Fashion Column

Jeanne Devereaux, leading woman with the Harder-Hall Players, is conducting a *Whiff From the Avenue* column in the local paper once a week. She writes of her weekly visit to a smart shop in New York and tells of what she purchased and is wearing in the current play. The fact that Port Richmond has no Fifth Avenue shops makes the idea sell. It is a Grace Wynden Vail idea.

Doubling for Bentley

A good publicity stunt is being promoted by Grace Wynden Vail for Robert Bentley and the Harder-Hall Players thru the advertising in papers and programs for a man who looks enough like the popular leading man to double for him in the forthcoming performance of *The Masquerader*. Applicants are requested to send their photographs. A lobby display of them and frequent printing of applicants' pictures in the papers is keeping the thing alive. Bentley is an idol with Staten Islanders.

A Versatile Press Agent

Grace Wynden Vail, press representa-

tive and social director for the company, conducts a *Sally Ann* department in the house program of the Palace Theater that has a host of readers who are on the mailing list and others who obtain copies at the theater.

Miss Vail also acts as representative for the Bayonne Players at the Opera House, Bayonne, N. J., where she conducts a *Grace Genevieve* department in the house program.

In both programs Miss Vail replies to inquiries from the readers.

In addition to her regular duties Miss Vail plays the piano for chorus rehearsals when either of the companies stages a musical comedy.

Food for Thought

All companies throughout the country cannot employ experienced press representatives of the Terry Turner, Gertrude Wilbur and Grace Wynden Vail type, but every company in stock can employ some aspiring local journalist to jot down its activities for the local press and *The Billboard*, thereby obtaining publicity for plays and players that cannot be had otherwise.

A word to the wise, Mr. House Man and Director of Productions.

Men are known by their deeds, therefore show a personal interest in your players by giving them the publicity they desire in *The Billboard* and your players will show more interest in your presentations.

Publicity Essential to Players

Several months ago *The Billboard* caused a controversy in which the daily press of New York City became involved, for the writers on the daily press couldn't conceive David Belasco visiting stock companies in and around this city in quest of players for his productions.

But *The Billboard* had authentic information relative to Mr. Belasco's plans and the publicity given those plans worked to the advantage of several players who had received notice in this department, with the result that several of those players were seen in their stock presentations by Mr. Belasco, who later engaged them for his productions.

English Stock Company for Montreal

Montreal, Feb. 16.—In a recent issue of *The Billboard* appeared an article to the effect that the playgoers of this city would welcome an English-speaking dramatic stock company.

What part *The Billboard* article had in bringing about the desired results has not been made known, but suffice it to say that Raymond Beaudry, well known in racing and other sporting circles here, and secretary of the Dorval Jockey Club for many years, will open the Orpheum Theater March 9 for a season of English dramatic stock. Mr. Beaudry's intention is to present English plays that have never had production this side of the Atlantic and with a company of real English actors. He is now in New York recruiting players to complete his company. It is expected the season will last until September.

Mother Reviews Marion

Port Richmond, N. Y., Feb. 16.—Marion Hall, ingenue with the Harder-Hall Players and daughter of E. J. Hall and Maude Ebourne Hall, is playing the slavery role in *The Bat*. It was in this type of work that Maude Ebourne established her Broadway reputation, she having recently closed with the company of *Annie Dear*, being a featured member of Miss Burke's cast. Naturally the daughter feels her responsibility in playing the part before the discriminating judgment of her mother. Grace Wynden Vail, the company's press agent, has interviewed Maude Ebourne as to her opinion of her daughter's performance and we are awaiting Mother Maude's review of Marion.

EVETA NUDSEN



One of the most attractive and popular leading ladies of dramatic stock. Miss Nudsen is now heading the Eveta Nudsen Stock Company at the Plaza Theater, San Antonio, Tex.

Eveta Nudsen

A Vermont School Girl, Ambitious for a Stage Career, Well Schooled in Stock

Miss Nudsen was born in Rutland, Vt., and received her education at the Farmington School for Girls, Hartford, Conn. At an early age she began to aspire for a stage career and during vacation made her debut with the Hunter Bradford Stock Company of Hartford. The following summer vacations were spent playing with the Poli Stock Company in Hartford.

Her success in these companies encouraged her determination for a theatrical career, and following her graduation from school she put in two seasons in vaudeville for Win. A. Brady. This was followed by her playing leads with the Poli Players at Bridgeport and Waterbury, Conn.; later with the Boston Stock Company at the St. James Theater, Boston, and with the Alhambra Players at Loew's Alhambra Theater, Brooklyn. Later she played in Jacksonville, Fla., under the direction of Walter Baldwin, for the Southern Enterprises; from there to the Joel Friedkin Players at El Paso, Tex., then leading lady with the Hudson Players at the Hudson Theater, Union Hill, N. J., and with Ye Colonial Players at Lawrence, Mass.

Miss Nudsen again played under the direction of the dean of dramatic stock producers, Walter Baldwin, at the Palace Theater, Houston, Tex., until recently, when she decided to head a company of her own and completed arrangements with Frank J. McLoughlin for the presentation of the Eveta Nudsen Company at the New Plaza Theater, San Antonio, Tex.

Engagements

New York, Feb. 20.—Pauline Boyle has arranged engagements, viz.: Foster Williams and Maxine Flood for the Eveta Nudsen Players at the New Plaza Theater, San Antonio, Tex.; Bessie Gross, who closed recently with the musical comedy, *Top Hole*, has signed as ingenue of the Harder-Hall Players, Port Richmond, Staten Island.

Helen Robinson has arranged engagements, viz.: Allen Lee and Virginia Zollman for William Augustin's new stock company in Roanoke, Va.; Maxwell Kenney to produce the musical comedy *Mary* at Julius Leventhal's Rialto Theater, Hoboken, N. J., and has placed A. C. Henderson, Winifred Barry and Fred Conklin with the Old Dominion Production Company, doing motion pictures.

Irving J. White has arranged engagements, viz.: Ruthelma Stevens, Byron Hawkins, Claudine Johnson and Dolle Gray in *The Woman in Room 13* at Julius Leventhal's Fifth Avenue Theater, Brooklyn, N. Y., for the week of February 22; Nelly Nell in *Cheating Husbands* for Julius Leventhal's Rialto Players at the Rialto Theater, Hoboken, N. J., week of February 22.

Somerville Players

Boston, Feb. 18.—Busby Berkeley, at the Arlington Theater here last season, recently joined the Somerville Players at Somerville, Mass. He came here from Baltimore, where he staged *Seduction*. His first production at the Somerville will be the musical show, *No Other Girl*.

Edward Clarke Lilly, formerly leading man at the Somerville, has departed for the West to head his own company and has been succeeded by Alexis Luce, who is coming from St. Louis. His first appearance here will be in *Gypsy Jim*. For the week this show is on the lobby of the theater will be decorated after the fashion of a Gypsy camp, with fortune tellers and camp fire.

Clyde McArdle, genial house manager and part owner, reports he is doing big business right along. When a *Billboard* reporter dropped in recently of a Saturday night, he found 1,400 people jammed into a 1,200 house.

Co-Operative Company

Salem, Mass., Feb. 19.—Next week the stock company at the Empire Theater will present *The Girl From Child's* after which the house will be turned over to the Players, who have rented it for the balance of the season, so Budd Rafter, the wide-awake manager, reports. *Here Comes the Bride* will be the opening bill of the new company. The Gordon interests control this house and will continue to play feature pictures on Sundays as heretofore.

Gladys Klark Company Touring West Indies

Barbados, B. W. I., Feb. 18.—The Gladys Klark Stock Company, after two weeks' preliminary playing thru New England, set sail for its annual tour of the British West Indies.

The company arrived in Hamilton, Bermuda, January 9, opening the same night in *So This Is London* to the largest attendance in the history of the Colonial Theater. Hundreds were turned away and it was necessary to repeat the same bill Saturday matinee and night, both performances playing to capacity.

Saturday night Governor Aseot, his wife and staff attended the performance. The Governor was so pleased with the performance he sent his aide backstage to congratulate Miss Klark and her company upon their efforts. The engagement was for three weeks in Hamilton, so J. W. Jacobs, advance agent, left for Bridgetown, Barbados, January 20, which is an 8-day trip, and upon arrival there received a cable from Miss Klark to the effect that the big business being done in Hamilton warranted the company extending its engagement there for two weeks. Instead of opening in Barbados February 11 the opening was changed to February 26 for two weeks. Jacobs then left for Port of Spain, Trinidad, where the company will play after its engagement at Barbados. From Trinidad the company will tour Jamaica, Kingston and Panama Canal before returning to the States.

Rupert La Belle, leading man of the company, has become a big attraction for the feminine playgoers.

Mrs. Richard Mansfield To Return to the Stage

Beatrice Cameron, Who Was Her Husband's Leading Woman in Noised Plays, Joins Jessie Bonstelle

Detroit, Feb. 16.—Mrs. Richard Mansfield, widow of the famous stage star, will return to the stage, making her first appearance with the Bonstelle Players when they produce *The Goose Hangs High* the week of March 2.

It is more than 20 years since Mrs. Mansfield, then known as Beatrice Cameron, quit the stage, but she has been contemplating a return for some time past.

The engagement with the Bonstelle Company will not be a temporary return, but the first step in a permanent re-entry into stage life.

Emma Bunting's Return

Brooklyn, N. Y., Feb. 18.—Emma Bunting, leading lady of Julius Leventhal's Fifth Avenue Players at the Fifth Avenue Theater, who has been out for two weeks, due to illness, has recovered sufficiently to warrant her return to the cast for the presentation of *The Woman in Room 13*, week of February 23.

"My Lady Friends"

Presented by the Proctor Players at Proctor's 23d Street Theater, New York

A Comedy in Three Acts by Emil Nyltray and Frank Mandat
Staged by A. J. Edwards
Cast of Characters

Catherine Smith... Marie Louise Walker
Eva Johns... Marion Wells
Hilda... Jessie Brink
Lucille Early... Alice Buchanan
Edward Early... James Durkin
James Smith... Wilfred Lytell
Tom Trainor... Day Manson
Nora... Esther Somers
Gwendolyn... Frances Wood
Julia... Myra Marsh

Synopsis of Scenes
Act 1.—Drawing Room in Home of James Smith, New York City.
Act 2.—Chikadee Cottage, Atlantic City.
Act 3.—Same as Act 1.

Play
James Smith, a progressive, prosperous business man, married to Catherine Smith, a money-saving wife, who finds more pleasure in the kitchen with an apron and in her reception room in a simple frock than in supervising servants and gawking a la mode. He endeavors to expend some of his surplus money and philanthropic, platonic personality in spreading sunshine by choosing as proteges three apparently unsophisticated girls who in reality are "goldiggers".

Being absentminded, while visiting his proteges at different times in Boston, Philadelphia and San Francisco, James invites each one of them to be his guest at Chikadee Cottage, Atlantic City. Receiving long-distance phone messages at his home from each of his proteges, James engages his friend and lawyer, Edward Early, to get him out of his difficulties.

In another moment of absentmindedness James invites Eva Johns, a somewhat frivolous protege of his wife and a guest of their home, likewise the niece of Lawyer Early, to spend a few days at Chikadee Cottage, and in company they depart for Atlantic City.

The departure of James and Eva for Atlantic City and the departure of Lawyer Early on a professional trip for James arouse the suspicions of Early's wife, Lucille, a spendthrift, who induces Catherine to engage detectives to follow both men.

The denouement comes in Chikadee Cottage, where the three goldiggers come face to face, compare notes, and decide on a monetary settlement.

One of the trio, grasping the import of the denouement, induces her coworkers to acclaim Lawyer Early their platonic protector, and herein came perplexing situations that evoked continuous laughter and applause, heightened by the willing-to-be-bribed Irish housekeeper, Hilda, and the jealousy of Tom Trainor, juvenile sweetheart of Eva, who became an amateur detective seeking to rescue her from the wiles of James.

The reconciliation comes in the third and last act in the city home of James, with a settlement upon the goldiggers, the engagement of Eva and Tom, a satisfactory understanding of the Earlys and the disillusionment of James, whose eyes are opened to the wiles of certain feminine hangers-on.

Acting upon the advice of her friend, Mrs. Early, to keep husbands "broke" in order to make them less attractive victims to other women, Mrs. Smith blossoms out as a coquettish, beautifully gowned wife who demands all that a wealthy husband can purchase.

Taking the play in its entirety, it is a cleverly worked out comedy.

There isn't a line or action in the entire presentation that a puritanical moralist could possibly object to, and for those who like to laugh there is justifiable cause.

Players

Louise Walker, leading lady of the company, as Catherine Smith, enacted the role of the money-saving wife realistically, and in a crying scene was emotionally dramatic, her transition from a d-mure housewife to a fashionable spendthrift being a revelation of versatility.

Wilfred Lytell, leading man, as James Smith, the philanthropic victim, was admirable in his pleasing ability, by which he honored his lines in a legitimate manner, enabling him to dominate the entire presentation.

Marion Wells, as Eva Johns, has an adorable personality that scintillates in scenes and her delivery of lines revealed remarkable ability. Miss Wells made a change of gowns and costumes for every reappearance, manifesting her art in dressing a la mode.

Alice Buchanan, as Lucille Early, was typical of the role and in her reconciliation scene with her husband displayed her ability to handle heavy emotional roles.

James Durkin as Edward Early handled his role admirably.

Day Manson, as Tom Trainor, is a likable juvenile and able actor, altho the role did not give him much opportunity to distinguish himself.

Jessie Brink, as Hilda, the housekeeper, is not only a clever character woman but a comedienne.

Esther Somers, Frances Wood and Myra Marsh, trio of angel hunters, acted the parts artistically and realistically, and in one scene Miss Marsh gave the

STOCK MANAGERS!!!
When in need of a Scenic Artist for Stock call Bryant 6858, or write 161 West 44th Street, New York City.
UNITED SCENIC ARTISTS

EQUITY MEMBERS, ATTENTION!
All members please note that the following Resolution is in full force: "WHEREAS, it is the opinion of the Association that its members cannot otherwise procure satisfactory working conditions: RESOLVED, that on and after January 1, 1925, ALL EQUITY members shall refrain from making any contracts with W. I. SWAIN or his Shows, and that as and when they may lawfully do so, ALL EQUITY members, on and after January 1, 1925, will cease to work for W. I. SWAIN or his Shows. This Resolution will remain in effect until otherwise ordered by the Council."

impression that she can handle more important roles advantageously. The staging was in keeping with the play.

Vandeville

There were four acts of vaudeville, opening with a full-stage semi-cyc, pictorial ocean for the Vincent Brothers in sailor attire putting over a comedy acrobatic act on horizontal bars.

Second on the bill were the Bruce Reynolds Trio, a pretty singer and dancer and two comedy-making male vocalists. Third came Morris and Weber, two men, one at the piano, both singing several comedy songs.

Closing the vaudeville were Seymour and Jeanette, two seal-brown colored singers and dancers in classy attire. All four acts merited the encores given their turns.

Films

Acson Fable, Patho News and the featured film, *Tornado*, closed the show.

English Plays for Stock

New York, Feb. 20.—Frank Lindo, well-known English author, actor and producer, has arranged with Harry Clay Blaney of the Standard Play Company to handle the American rights for all of Lindo's plays on this side of the Atlantic.

The plays include *The Silver Spoon, Home, Sweet Home; My Soldier Boy, A Wise Child and The Rock of Ages*. The last named was written in collaboration with Philip Yale Drew, now starring most successfully in this play in English Provinces, and will shortly be seen in a West-End theater in London, giving every indication of being as popular as Channing Pollock's *The Fool*. Mr. Blaney has the American rights for production, stock and pictures.

"Red Kisses" Revived

New York, Feb. 20.—The Blaney Players at the Yorkville Theater will present a revival of Charles Blaney's *Red Kisses*, which was given its premiere production and presentation at the New Metropolis Theater by the Cecil Spooner Stock Company the early part of the current season.

This is the play in which Mr. Blaney figured a *Tondelero* character for the lead, but in which Cecil Spooner as a *Red Kiss* girl, doing a wise-cracking female of the streets, carried off the honors, thereby setting aside the author's calculation.

It will be interesting to watch the working out of the author's problem as to which characterization is entitled to the leading role.

Frances McGrath's Reception An Ovation at the Yorkville

New York, Feb. 21.—The return of Frances McGrath to the title role of *The Whole Town's Talking*, at the Yorkville Theater, established a record at that house for spontaneous and enthusiastic receptions accorded players. The welcome greeting given Miss McGrath continued for five minutes and concluded with the presentation of approximately 20 floral pieces from admirers who recalled the actress' work at that theater a few years ago. The floral tributes were later banked in the lobby, making an attractive spectacle.

Regina Players

Regina, Can., Feb. 18.—Due to lack of road shows thru this part of Canada the Regina Players at the Regina Theater, under the direction of J. F. Marlow, are in their 23d week here with but few days off.

Beatrice Savelle and Roscoe Patch continue as favorites and they have pleased the patrons with their work in *So This Is London, French Leave, Pals First and What's Your Wife Doing*.

Stock for Ithaca

Ithaca, N. Y., Feb. 20.—The Journal News is responsible for an announcement, viz:

"Presentation in Ithaca by a cast of professional actors and actresses of some of the most popular of current stage successes is contemplated by the Ithaca Conservatory of Music. It was announced today that if public sentiment seemed sympathetic the conservatory was prepared to go ahead with a program by which for 10 weeks, beginning about the third week of February, high-class legitimate plays would be produced in Ithaca by a stock company of professional players to be organized and directed by William W. Blair, a New York managing director of wide experience.

"The officers of the conservatory are considering this project because they believe that the people of Ithaca want and are entitled to the presentation here of legitimate plays. This privilege has been denied them by the closing down of the Lyceum Theater as a legitimate playhouse. Since that unhappy event Ithaca has been a 'hick' town as far as regular theatrical productions are concerned.

"The conservatory is therefore considering the experiment of bringing a high-class stock company to Conservatory Hall. This is a small auditorium, it is true, seating only 400, but under the plan under consideration each play to be presented would have a week's run; that it would be presented on five nights, Tuesday to Saturday, and at two matinees, Wednesday and Saturday afternoons. Under this plan all of Ithaca's theatergoers would have a good opportunity of seeing the plays.

"George C. Williams and Benjamin L. Johnson of the conservatory have just returned from New York, where they conferred with Mr. Blair and secured the rights for stock purposes of a number of plays that have 'gone over big'. The list already secured include *Little Old New York, So This Is London, Cat and the Canary, The Fool, Icebound, Just Married, Six-Cylinder Love and You and I*.

"If the plans go thru it is proposed to offer season tickets for the whole 10 weeks' engagement, as well as single admissions."

New York, Feb. 21.—Later reports convey the information that the Ithaca Company is now fully organized to open February 23 in *So This Is London*, with a cast engaged by Pauline Boyle, artist representative, that includes: W. W. Blair, director; William Shelley, leading man; Al McGovern, second man; Sue Jackson, second woman; William Bryant, characters. Students of the Dramatic Department of the conservatory will appear in minor roles.

Players' Get-Together Party

Detroit, Feb. 16.—The Woodward Players at the Majestic Theater gave a party Wednesday, February 11, in honor of Richard Taber, Alice Hanely and Nedda Harrigan, all former associates of the Woodward Players, who appeared at the Garrick Theater in *Is Zat So*, of which Richard Taber is coauthor with William Glendon, and which is scheduled for a run in Chicago. Mr. and Mrs. Taber (Alice Hanely) were presented with wrist watches by the members of the Woodward Players in appreciation of their long services in the company. All the members of the *Is Zat So* Company were among the guests present at the party.

Sweeney Joins Woodward

Detroit, Feb. 16.—Joseph Sweeney recently joined the cast of the Woodward Players, this city, making his first appearance February 8 in *In the Next Room*. Mr. Sweeney has been on the stage for 16 years, during which time he played with many noted actors. The past season he appeared in *Breathed in New York*. Previous to that Mr. Sweeney was with the Cleveland Repertoire Company.

Minister Criticises

But Consensus of Opinion Is Harder-Hall Players Emerge From Attack Unscathed

Port Richmond, Staten Island, N. Y., Feb. 16.—The Harder-Hall Players at the Palace Theater have been playing to an ever-increasing patronage since their establishment in this city over a year ago.

The company has members in various fraternal organizations, including those allied with various churches, therefore, when a local minister took it upon himself to become a "Letter-to-Editor" critic of plays and players he set the stage for a controversy that has had far-reaching effect, not the effect that he desired or foresaw, but the effect of stimulating local interest in the Harder-Hall Players and the plays they are producing and presenting.

According to Grace Wynden Vail, press representative and social director of the Harder-Hall Company, this is what has happened:

"Staten Island has been recently set upon its ears by a criticism of the Harder-Hall Players as voiced by a certain minister. The company has established itself so warmly and with such fine friendliness and respect that the printing of a letter by the doctor in *The Daily Advance* brought forth a storm of protest and incidentally excellent publicity for the players and theater. The controversy started when Robert Bentley, invited to attend and address a luncheon of the ministers' association on the Island, was quite heatedly attacked by this minister in question, following Mr. Bentley's speech. The minister had fairly enough warned Eugene Hall and Mr. Bentley he was going to take exception to some of the plays the company had been producing, but nothing quite as stirring and positive as his attack was expected. The minister produced the advertisement used for such plays as *Up in Mabel's Room, The Demi-Virgin and Tirtin Beds* and branded it salacious. He had not seen any of the plays. The argument was a warm one. The following Saturday the minister printed a long letter in the paper, again voicing his attitude toward the company and its policy. The letter was printed with a note from the editor disclaiming that the views contained therein were in any way a reflection of the attitude of the paper.

"Immediately the management, Mr. Bentley and Grace Wynden Vail, who had written the publicity, were swamped with letters of indignation against the minister, and in support of the theater it became incumbent upon Mr. Bentley to reply to the minister. Other letters followed in the paper, and finally it was mutually agreed to drop the entire matter. Several ministers who had been at the luncheon wrote personal letters of regret over the incident, some coming out clearly and warmly in support of the company. There was not another letter of criticism against the company. There was not much venom in the argument, as the minister was apparently sincere enough in his viewpoint. Unfortunately he had not attended any of the plays he attacked.

"As a final mark of faith and support the Trinity Men's Bible Class, with Senator Mark Allen as its president, sponsored a big theater party at the Palace for the opening night of *The Old Homestead* and again Wednesday of the week. Mr. Bentley and Richard Morgan of the company are both members of the Bible Class. The class has entertained the entire company at a chowder supper recently. Again Mr. Bentley addressed the class before becoming a member. It consists of more than 500 men and is a remarkable organization on the Island. Mr. Bentley spoke on the relations among church, theater, Lincoln and emancipation from the pulpit of the Methodist Church on Sunday, February 15, to a capacity audience. The leading man has established himself as one of the most beloved and respected men of the community and is in constant demand to address organizations and schools. His ease, charm of delivery and very fine intelligence win many friends for the theater and himself whenever he has appeared.

"Messrs. Harder and Hall should point with fine pride to the church and theater incident, for he brought forth with glowing plainness that they have established and conducted a group of players on Staten Island that has become truly a part of the best activities of the community and is a distinct credit to the theater, both the players' and the managerial end."

Berkell Players

Waterloo, Ia., Feb. 16.—The Charles Berkell Players at the Waterloo Theater are now in their 12th successful week after putting *The Old Soak* over to capacity audiences at every performance.

Their season will close here March 11 and the company will be transferred to the English Theater at Indianapolis for its third summer season of stock there, opening March 29.

Edyth Elliott and Milton Byron will continue as leads and many of last season's favorites at the English will be seen there again.

The Harkins Players

Montego Bay, Jamaica, Feb. 23.—The W. S. Harkins Players, on their annual (Continued on page 29)

HOUSE ~ TENT
REPERTOIRE
BOAT SHOWS - TOM SHOWS - MEDICINE SHOWS
By EDWARD J. GALLAGHER

(Communications to 25-27 Opera Place, Cincinnati, O.)

Clive Producing Co.
Inc. for \$100,000

Prominent Bostonians Serve as Directors in Organization Presenting Plays at Copley Theater

Boston, Feb. 21.—E. E. Clive, manager of the repertory company at the Copley Theater, has incorporated the Copley Producing Company for \$100,000. The stock is divided into two classes, 500 shares eight per cent cumulative preferred, par \$100, and 5,000 shares common, par value \$10. To date, it is said, about \$30,000 of this issue has been disposed of to patrons of this company and those interested in better dramas.

Besides Clive the incorporators are Benjamin F. Cheney, husband of Julia Arthur, and E. E. Underhill, business manager of the Copley. On the directorate are the following prominent Bostonians: Mrs. Ezra R. Thayer, Mrs. Richard M. Salmonstall, Albert C. Flower and Henry G. Wells, former president of the State Senate.

According to the incorporation papers the purpose of this stock issue is to "maintain a repertory company under the direction of E. E. Clive, to guarantee a lease already signed for the tenancy of the Copley Theater, to provide scenery and theatrical equipment necessary for the production of plays, to guarantee contracts with competent artists and notable playwrights, and to enable the directors to engage in such theatrical productions as they may at their discretion decide upon." The lease has about three and one-half years to run.

Clive hopes to make his theater a producing center, much the same as R. M. Field did with the Boston Museum years back when the Davenports and other famous stars appeared there. He hopes to make annual trips to England and secure sole rights to new plays, show them in Boston and then offer the American rights to New York producers. To put this program into immediate effect he has secured *Mary's John*, a new play by Harold Brighouse, author of *Hobson's Choice*, and will present it in the near future.

The 14 weeks the Clive Repertory Players have been at the Copley have been very successful. They have been presenting only the best of plays by such authors as Pinero, Shaw, Barrie and Galsworthy. With *Androcles and the Lion*, Shaw's satire on Christianity, last week they broke the house record of nine years standing, doing \$6,500 business at \$1.50 top in a house seating 1,038. This play was held over for a second week.

Clive is considering putting on Saturday morning shows for kiddies, such as *Punch and Judy* and magic programs. The house numbers among its patrons some of the most prominent people in Boston.

Good News for Ted and Virginia Maxwell

Mary Forrest, New York producer, has accepted Ted and Virginia Maxwell's dramatization of *The Sheriff of Dukehole* for New York production next fall. Mrs. Maxwell, who is at a sanatorium in Los Gatos, Calif., suffered a setback, due to overwork, but is feeling much better now. Last week Mattie Hyde, one of San Francisco's popular stock actresses, visited Mrs. Maxwell. On a recent Sunday her brother, Dr. Grant Maxwell, and Dr. and Mrs. Herbert Clarke visited Mrs. Maxwell. Dr. and Mrs. Clarke formerly were known in vaudeville as "The Kidders". Dr. Maxwell also was a well-known performer. Ed and Florence Smith have written from Los Angeles that soon they will be tramping up Virginia way and will drop in to see her.

Manager Thomas Aiton, of Mason Bros.' *Cuele Tom's Cabin* Company, reports two additions to his company. George Stone as band leader and Frank C. Cannon, late of the Vogel Minstrels. R. P. Woodworth is in charge of the orchestra. The company includes F. C. Scott, Carl Ludin, C. S. Fahl, T. I. Fahl, Fred Barker, E. D. Mason, Bill Mason, Chas. Lones, Fred Finley, Fred Mack, Gann McLaughlin, Isabel Hough, Frank D. Gannon, Marie Wells Redfield, Ermine Stewart, Belle Barrie, Harry L. Lloyd, Pete Wilson and Harry Scott. Dave Livingston is stage manager. Burt Stoddard stage carpenter, Billie Blythe company director. Three bloodhounds, two ponies and a donkey are carried.

GRACE E. CONNELLY



Miss Connelly has been the feature comedienne with the Seeman Players for the past five years. She was born in the profession, her mother being Lenora L. Connelly, a well-known musician. Grace made her first public appearance at the age of two and one-half years. She spent four years in Europe and the Orient, where she made an enviable reputation as a dancer. She contemplates returning to vaudeville later. In private life her name is Mrs. Martin Chapman.

H. F. Simpson Bookings

Kansas City, Mo., Feb. 20.—The Karl F. Simpson Exchange reports the recent placement of the following people: Harry P. Murrey, Jennett Reese, Oscar V. Howland, Mabel Broadley, Montle Montrose, Mr. and Mrs. Bart Couch, with Allen Bros.' Stock Company; Jack Vivian, manager; Vera Reno and Jack Ellison, with Pete Pate Show; Raleigh Dent, manager of stock at the Jefferson Theater, Dallas, Tex.; Chester De Whirst and Kenneth Carter, with the Earl Withrow Show; R. H. Wachtel and wife, Leonora Connelly and Dick Patterson, with the Leslie Kell Show; Albert Lee and Larry and Mrs. King, with the Gabe Garrett Show; Carl Fleming and wife, with Chase-Lister Stock Company; Marguerite Grady, with the Gordon musical show; Mr. and Mrs. Jos. Hoffman, with the Ed C. Nutt Players; George Temple, with Al Russell musical show; Harry Hugo and wife, with the Leon Bostwick Players; Vic Walters, with the Field Stock Company; the Daytons, with the J. Doug. Morgan Show; Charles Morrill, manager; the Ben Kaal musical act, with the same company; Al Urnh and wife, with the L. D. Brunk Show; Gladys Griswold, as musical director with the Earl Withrow Show, and Allen Allyn, boss canvasman and stage manager, with the Frank Norton Comedians.

Keystone Comedy Kompany

Jack (Bunnie) Earle, of the Keystone Comedy Kompany, reports doing good business at Stillwell, Ok. The show left Pittsburg, Kan., in December on a route thru Southwest Missouri, Arkansas and Eastern Oklahoma, and plans to open under canvas in May in Southwest Missouri for 20 weeks. On the show are: Jack Hamilton, manager and director; "Chick" Woods, pads and heavy roles; Charles K. McWilliams, comedy; Jack (Bunnie) Earle, comedies and leads; Mrs. Edith Hamilton, characters; Velma Long, Ingerue; Mrs. Helen Woods, general business.

Actors Escape Injury

Lawton, Ok., Feb. 21.—Albert Ferguson and Charles Rhea, members of the Ferguson Brothers' Stock Company, playing at the Dome Theater this week, narrowly escaped plunging into a 30-foot gully on their way here. The men rounded a sharp curve and came upon a bridge. The car smashed into the railing and before it could be stopped the front wheels were hanging over the gully.

Williams on Tour

Opens First of Three Stock Companies With Two Weeks at Fort Benning, Ga.

Concord, N. C., Feb. 23.—The first of the stock companies owned by Fannie Mason and John J. Williams opened at Fort Benning, Ga., under government contract February 2 for a two weeks' engagement. The John J. Williams Stock Company is the name of the unit which opened first, with two other companies soon to follow.

The company is booked here for three weeks, beginning today. Fort Benning is a camp containing 7,500 people, and all the folks in the Williams troupe worked with splendid enthusiasm. The members are young and attractive and there is much vaudeville talent. After the harmony singing and specialties were finished Miss Mason and Mr. Williams stopped the show with their old-dancing act, demonstrating that buck dancing still holds its own.

The roster includes Buford Maxwell, Spencer Taylor, Granville Bass, Preacher Parsons, Yannie Sanders, J. Paxton Hill, Cecil Simmons, Wesley Brown, Julian Hunter, George D. Bartlett, James McCraney, Harry Harvey, Leo Harris, Billy McQuage, Fred Lytell, John J. Williams, Miss Betty Williams, Fannie Mason, Gladys Jones, Thelma Taylor, Mayme Brown, Albina Hill, Jane Hill and Mabel Mason.

Sherman Bookings

Robert J. Sherman's new booking department in Chicago is reported to have opened with success. Albert Graybill, Eleanor Brandow, Carrie LeMoine, Stever Storer, Frank Seay, Sanford Anderson and Fred Bennett being placed for jobbing at Evanston, Ill.; Jack Harvey, with the Earl Ross Players, Waukegan, Ill.; Kathryn Cameron, with Rialto Players, Tampa, Fla.; Larry Foster, with the Chase-Lister Company; Irene Harper, leads with Block at Buffalo, N. Y.; Jap LaCour, Mrs. LaCour and Dorothy Dean, with the H. B. Marshall Company; Miss Freeman, with musical stock at Fort Wayne, Ind.; W. H. Pendexter and Vera Painter, with the Roberson Players at Kewanee, Ill.; Effie George, with the Eddie Hume vaudeville act; Julia Brown, pianist, and John Curtis, top tenor, with Rialto Players, Tampa, Fla.; Lorne Ellwin, with Karl Way Stock at Springfield, O.

Found License Fees on Tent Show Prohibitive

Winter Haven, Fla., Feb. 21.—The Original Williams Stock Company, under management of Elmer Lazone and Marie DeGafferly, has been touring Florida during the winter, using a beautiful canvas pavilion. While business has been quite satisfactory, no amazing records have been established. Mr. Lazone states, "The almost prohibitive licenses for tented attractions in Florida, he declares, make hard sledding for some of the smaller shows. This is the first winter spent by this company in this State under tent and the tour has been more of an introductory appearance in winter-resort towns. The membership of the troupe remains about the same as it has been for several seasons. After a few more weeks the company will return for the summer to North Carolina, where it has toured for a number of years, it is stated.

A. H. Van Buren Is Given Silver Service

Hartford, Conn., Feb. 21.—A. H. Van Buren, who directed the Poli Players during their stock season here last summer and who, previous to that time, had been the leading man of the company, was presented with a silver service at the Elks' clubhouse this week.

Mr. Van Buren is with Raymond Hitchcock in *The Sap*, and when playing at Parson's Theater here was entertained by a number of friends. Many members of the stage crew, orchestra and general staff of the Palace Theater and local friends of Mr. Van Buren were present at a supper which followed the evening performance at Parson's. Bert Miner, stage manager at Parson's, presented the silver service to Mr. Van Buren as a gift from those present.

Frank Cooley and wife, Gladys Kingsbury, who had the Cooley Company for years, have retired from the road and are working in pictures at Hollywood, Calif.

Notes on Swain Show

Several Entertainers and Feature Acts Already in New Orleans, Where Equipment Is Being Overhauled

New Orleans, Feb. 18.—Capt. and Mrs. W. I. Swain and secretary have returned here from a six weeks' business and pleasure trip. At the Swain Show winter quarters here Roy Garret, general mechanical superintendent, has had 14 men painting, repairing and rebuilding since the first of the year. James Fergo is in charge of outside mechanical work. Capt. Swain just bought a new truck which will be used on the advance.

C. B. McKinney, general agent, after consultation with Capt. Swain, has taken to the road.

Several entertainers and feature acts are already in New Orleans. A dancing act of four men and four women is rehearsing daily. Each Swain show will have two feature acts.

Recent arrivals were Mr. and Mrs. Corley, chef and cook, from Kansas City.

Carl Malone, band and orchestra leader, wears a broad smile these days, as Capt. Swain informed him he would have a 12-piece all-gold band and a 10-piece orchestra.

Mr. and Mrs. Perdiat, feature accordion player and prima donna, were recent callers at winter quarters.

Thirty-five rooms have been engaged within the vicinity of the building, as more people are expected to report next week.

DOROTHY LOCKHART
(for the Show).

REP. RIPPLES FROM K. C.

Kansas City, Mo., Feb. 18.—Frank Moore, who rejoined the J. Doug. Morgan Show as advance representative, left here February 14 to book a route to Corsicana, Tex., the show's winter quarters.

Abe Rosewald commenced rehearsals at the Gladstone Hotel February 17 for the new Dubinsky Bros.' Show, which opens at Richmond, Mo., February 26.

Jimmy Rice, Jr., joined the R. Frank Norton Players February 15 in Texas to get ready for the opening of this company at Marlin February 23.

Roy Rogers arrived yesterday from Jackson, Tenn., to join Abe Rosewald's Dubinsky Bros.' Show.

Howard Johnson and wife signed with the R. Frank Norton Players thru the Ed F. Feist Exchange.

Manley Streeter returned from Arkansas yesterday. He closed with the Ed. Ward Princess Stock Company February 7, when the show laid off to make ready for its spring opening.

Mr. and Mrs. Ed. Ward, after the close of their Princess Stock Company, remained in Arkansas for a hunting trip.

Tommy Dale has returned from a visit in Independence, Kan., and will again be with Abe Rosewald's Dubinsky Bros.' Show.

Frank De Attley and Dan Russell contemplate putting out a musical show.

The Withrow-Williams Stock Company, recently organized here, is playing a circuit of Kansas towns to satisfactory returns.

Bill Doherty has joined Allen Bros.' Stock Company as heavy man, and Milly Kurtz has rejoined as musical director.

Frank W. Capp, of the Baker-Lockwood Manufacturing Company, recently visited F. W. and Mrs. Jencks in Arkansas City, Kan. Mr. Jencks owns and manages the "Happy" Jencks repertoire company.

The Sherwood Play Company, of Nora Springs, Ia., has leased *The Blackbird*, a new mystery play, to the Walter Savidge Amusement Company and to stock in Omaha, Neb.

Eud Hawkins was in town February 10 on his way to Lawrence, Kan., where his company, the Vic Travers Musical Show, plays this week.

Mr. and Mrs. Charles Ellis, who have been a Dubinsky attraction for a number of years, are spending a few weeks in the city.

The Frank Norton Comedians closed in Texas late in January and most of the members are laying off here. The show will reopen in Texas about March 1.

Bartons Join Show Boat

Point Pleasant, W. Va., Feb. 18.—Mr. and Mrs. Frank C. Barton, who closed with the Buhler *Follies of 1925* at the Columbia Theater in Ashland, Ky., are getting ready to join the Majestic Showboat. They leave for Pittsburgh, Pa. March 1, making the trip on the boat. Mr. Barton is to do leads on the show, and his wife small parts. They also do vaudeville specialties. Barton formerly spent seven years on boatshows.

Barnes-Edwins Players

A letter from Edw. Barnes, of the Barnes-Edwins Players, announces that they opened to fair business at Inverness, Fla., February 16. All are well with the show, and enjoying the climate of Florida. The show is making good artistically and is doing fair business. Mr. Barnes states, Al Evans and Marlon Marsh (Mrs. Evans) stopped off to visit them recently while on their way in their sedan from their home in Tampa to join Tom's Comedians, which opens in March.

Raymond Whittaker, who headed many repertoire companies on the Pacific Coast in past years, is now playing vaudeville dates with his sketch.

REP. TATTLES

Toby Walters is operating a dramatic stock under canvas at Burbank, a suburb of Los Angeles.

Frank (Red) Fletcher and wife are working in stock at the Pearl Theater, Fort Worth, Tex.

Two former Middle-West managers, Will H. Locke and J. M. Angel, are now located at San Diego, Calif.

Half-page advertisements in *The Daily Star*, Corsicana, Tex., boosted the tent show appearance of the J. Doug Morgan Players in *The Flapper* last week.

The King-Thomas Dramatic Company No. 2, under the management of Harry E. Moles, opened at Claremont, Tex., February 12.

Roland Ardery, who appeared in repertoire in the Middle West with the Keighly and Gwen Lewis companies, has his own act in vaudeville.

R. Ferris Taylor, who had the misfortune to twice lose his tent outfit by fire the past season, has joined Joe Baird's Players.

The Kinkaid Players closed their season at Taft, Calif., after playing for more than a year in California and Oregon under canvas.

Shirley Carter, who was with the J. C. Williams Stock Company last season, will be with the Norman-White Players, opening near Atlanta, Ga., the latter part of March.

Zoe Bates, popular character woman, is closing with the *Kandy Box Revue* at Taft, Calif., to join the Joe Baird Players in Portland, Ore., with whom she appeared for several seasons.

After a successful winter at Waterloo, Ia. Robert St. Clair, popular juvenile man of the Barkell Players, has been re-engaged for their summer season at the English Theater in Indianapolis.

The California Quartet, featured with the Lole Bridge Company in stock at the Tootle Theater, St. Joseph, Mo., entertained their brothers of St. Joseph Lodge of Elks soon after their arrival. Kenneth Kempner, manager of the



Do You Know Doug Morgan?

"He's A Go-Getter"

The Tangley CALLIAPHONE is making money for Doug. He will tell you so. He says: "CALLIAPHONE, working fine, a wonderful advertiser. Sure having good luck since I had them. Ship by express, rush, Model O. H.-43, to use on stage." This is three Tangley's Morgan will have. He knows "his oil". He only bought one at first for No. 1 Show; receipts so great he bought another for No. 2 Show, now the third one. Did you ever hear Doug complain of "bad business"? Indeed not! He's up to "snuff", and we must take our hat off to him. Cut out your band, use the CALLIAPHONE, the greatest advertiser in the world. Cut out your heavy piano and use Model O. H.-43.

Muscatine, TANGLEY CO., Iowa



KARL F. SIMPSON
Theatrical Exchange, 17 Gayety Theatre Bldg., Kansas City, Mo.
WANTED—200 EQUITY ACTORS, ALL LINES. Managers now organizing. Tell it all. Send photos MANAGERS—Wire your wants. We are always ready. LEASING ROBERT J. SHERMAN PLAYS.

At Liberty for Rep. or Stock
Versatile Character Man, Heavy. Height, 5 ft., 11; weight, 165 lbs. Wife, Leads, Ingenues, Second Business, Height, 5 ft., 2; weight, 115 lbs. Young and correct type. Appearance, wardrobe and quick, sure studies. Double Specialties, Yodeling and Dancing when parts permit. Have a car. Will go anywhere—California preferred—that we can troupe the car, and to any responsible manager who pays regular salaries and offers steady work. Address R. M. STURDIVAN, General Delivery, Ft. Worth, Texas.

MR. MANAGER—Here are some sure-fire plays—By NEIL E. SCHAFFNER
"THE OLD GROUCH." Comedy Drama. Two acts. Cast 5-3 or 4-3. Star "Toby" part. As good as "The Future."
"WHAT EVERY DAUGHTER LEARNS." A feature play that will be remembered. Two acts. Cast 4-3. Star part for Ingenue Leading Woman. Two comedy parts.
"THE VULTURE." Biggest success of last summer. Going stronger than ever. Best "Toby" part ever written.
These plays, with special paper, \$30.00 Each. Can be leased from N. E. SCHAFFNER, E. L. PAUL, O. H. JOHNSTONE, 1220 1st Ave., N., Ft. Dodge, Ia., Gladstone Hotel, Kansas City, Mo., 36 W. Randolph St., Chicago, Ill.

SHOW PRINTING TYPE AND BLOCK WORK
DATES, CARDS AND HERALDS
Write for Prices
LITHOGRAPH PAPER FOR DRAMATIC ATTRACTIONS
Special Pictorial One Sheets for All Robert J. Sherman Plays
QUIGLEY LITHO. CO., 115-121 West 6th Street Kansas City, Missouri

LATEST RELEASE
"LITTLE MISS LIGHT FINGERS"
Cast 5-3. Two sets. Special One-Sheet ready now. \$5.00 deposit brings it for reading. THE BEST INGENUE PLAY WE HAVE EVER HAD. RESTRICTED TERRITORY.
WARNING To any shows playing "SPOOKS" without our permission, an interest in this play has been sold to CENTURY PLAY CO. A word to the wise should be sufficient. If your lease has expired, return material.
ROBERT J. SHERMAN, 648-650 North Dearborn St., Chicago, Ill.

Wanted Quick for the PAUL ENGLISH PLAYERS
Under canvas. Tall Heavy Man. Real Character Man. Juvenile Man with Singing and Dancing Specialties. Versatile General Business Man. Rehearsals start Monday, March 9, at New Orleans. Opening date, March 23. Write or write at once and please state exactly what you do. Also weight, height, age. Equity Contracts, Kansas City base. Forty-week Season. Address **PAUL ENGLISH PLAYERS, 2104 Canal St., Apt. A, New Orleans, La.**

quartet, has challenged four of the musicians at golf. The winners will receive prizes from Edgar Barnett, manager of the company.

Rodney Hildebrand, who had a repertoire company in the mountain towns of California and who has been in stock recently at the Majestic Theater, Los Angeles, paid a flying visit to San Francisco last week.

The Galvin Players, under the management of A. H. McAdam, have been confining their activities for the past year to Arizona and New Mexico. The Lackaye-Ewerts Players are in the same territory.

Eugene and Carolyn Bradley, who have been enjoying their stay in New Orleans since December, have finished work on a motion picture, *Tuding in With New Orleans*, and started rehearsals February 16 at Oklahoma City with the Davis Players.

The Harkins Players
(Continued from page 27)

tour of the British West Indies, open a five-night engagement here at the Strand Theater tonight with a repertoire that includes *The First Year*, *The Common Law*, *Some Baby*, *The Girl He Couldn't Buy*, *The Cat and Cowary* and *The Little French Maid*.

Angela Warde's Promotion
New York, Feb. 16.—Angela Warde, former leading woman in stock, and who has been appearing in Richard Henderson's *Play Without a Name*, at the Cort Theater, has been promoted to the leading

lady role, due to the exit of Florence Mason, who has been engaged to appear in a play with William Coiler.

Brooklyn Property Owners Hold Party at Loew's

Brooklyn, N. Y., Feb. 18.—The Brooklyn Property Owners' Association held a theater party at the Alhambra Theater last night. The entertainment committee had voted for a theater party, dinner and dance. They were much concerned over just how they would manage to hold together their big crowd after the show. Manager Elmer J. Walters came to their rescue with a suggestion that worked out well. Following the musical performance of *No Other Girl* the big party was supplied with carnival noise-makers, tissue-paper caps and balloons. A caterer supplied choice food, and several members of the association did stunts on the stage following a song-fest. This was succeeded by dancing back of the footlights. The party proved a most orderly one and those participating were loud in their praise of the complete success of the event, which certainly proved a novelty to say the least.

St. James Theater Parties

Boston, Feb. 20.—The popularity of the Boston Stock Company is responsible for the St. James Theater becoming a favorite rendezvous for various organizations. The St. James parties seem to be the fashion nowadays at local schools and colleges.
The dean of the Suffolk Law School is arranging a party for next week and there are several others who have chosen the St. James for gatherings.

18 DIALOGUES and DRAMAS, 50c.

By Edith Brown Everts. No royalty to pay. COLLINS CO., 197 Fulton Street, Brooklyn, N. Y.

CHRONICLE PRINTING CO. LOGANSPORT, IND.
Prompt service. Moderate prices. Write for complete Price List. Printers to the Profession since 1873.

AT LIBERTY, BOSS CANVASMEN
Sober and reliable. Good repair man. Sedgwick, write. C. H. BURNETT, 1433 York St., Denver, Col.

AT LIBERTY Director and Heavy Man. Stock or Rep. Some Characters. Age, 38; height, 5 ft., 8 in.; weight, 150. Wardrobe A-1. Equity. State salary. W. S. HURLEY, 1003 S. Independence St., Harrisonville, Mo.

Reproductions Post Cards
8x10, \$12.00 per 100. \$14.00 per 1,000.
Samples and List on request.
J. J. BECKER, JR., 211 S. E. 1st Ave., Davenport, Ia.

Lobby Photos—Post Cards
8x10, \$12.00 per 100. \$18.00 per 1,000.
GEORGE F. GIBBS, Successor to Commercial Photographic Co., Davenport, Iowa.

THE COST

That brand new play, with a cast of 4 and 3, in four acts, and one Interior Set. All excellent parts and a sure pleaser. New typed script and parts sent subject to approval, by express C. O. D., for \$15.00. RAY M. READ, 324 W. Division St., Springfield, Mo.

AT LIBERTY
CHARACTER ACTOR—4 ft., 170 lbs.; age 40. JUVENILE MAN—5 ft., 7; 130 lbs.; age 22. All essentials. Joint or separate. Do not require tickets. Prefer Tent Repertoire. HARRY H. HOYTE, care Elks' Club, Philadelphia, Pa.

Wanted for Mutt & Jeff
Tent, Motorized Show. MUSICIANS FOR ORCHESTRA. Must double Stage. Actors must double Orchestra. Write fully. JACK HOSKINS, Coates House, Kansas City, Missouri.

AT LIBERTY—ROSS & ROSS
For summer season. VIC—Comedy. Characters, General Business. 36; 5 ft., 7 in.; 165 lbs. Trombone. Specialties for week. ELOISE—Characters, General Business. 5 ft., 8 in.; 137 lbs. Reliable, experienced. Plenty wardrobe and congenial. VIC ROSS, Brockwayville, Pennsylvania.

CRAWLEY'S PLAYS
New, Original, Up to the Minute. Dallas, Texas, General Delivery, for two weeks; then GEO. J. CRAWLEY, Ironton, Missouri.

AT LIBERTY Dorothy Ray
GENERAL BUSINESS AND CHARACTERS. Experienced and reliable. 1200 Forrest Ave., Dallas, Tex.

FOR SALE CHEAP
Dramatic Tent Outfit, complete, ready to take road. Tent used one season. 7 lengths of Blues, Reserve Chairs and Canvas Benches to seat 450. Good stage, some scenery, piano; in fact, everything ready to open up. Terms cash. For all particulars address MANAGER, 121 N. Hudson St., Coldwater, Mich. P. S.—Outfit can be seen at Marmaduke, Arkansas.

FOR SALE, TENT
Khaki, 40x105, square both ends. Marquee, Proscenium, Sidewalk and 25 9-ft. Poles. Price, \$250. Stored near Ashland, Ky. BUD HAWKINS, week Feb. 22, New Grand Theatre, Mexico, Mo.; week March 2, Washington Theatre, Granite City, Ill.

BETTER PRINTING FOR LESS
Heralds, Tickets, Posters, Window Cards, Ladies' Free Tickets, Matinee Cards, School Cards, Card Headers, Advertising Blotters, Letter Heads, Envelopes, etc. Not in the "TRUST". No Price Agreements. WRITE FOR PRICES.
TIMES SHOW PRINT CO., P. O. Box 209, Pekin, Illinois.

Wanted for the Heffner-Vinson Stock Co.
Young, neat appearing Man for Leads, with singing voice. Must have ability and wardrobe and wear it. Second Business Woman with Specialties, mostly Soubrettes and Ingenues, some Heavies. Must have all essentials. Young General Business Man with Specialties. WANTED.—The following Musicians. Must be able to play standard Piano, Red-hot Jazz, Trumpet, Trombone, Drums, Clarinet, double Sax; Violin or Banjo, double Bass. If you do any Specialties say so. Trouble makers, grouchers, criers, etc., don't answer. Above all, don't misrepresent. Rehearsals March 2, open March 6. Boogie will absolutely not be tolerated. Also want Boss Canvasser. Address JIMMIE HEFFNER, week Feb. 23, Deland, Fla; after that, Valdosta, Georgia.

WANTED FOR BUD HAWKINS PLAYERS
TENT THEATRE, WEEK STANDS.
Juvenile Leading Man. Woman for Ingenues and Second Business. Character Man and Woman. Man for Heavies and General Business. Juvenile and General Business Man. Those doing Specialties or doubling Orchestra given preference. Equity. Chicago base. All must sign "as cast". Musicians: Piano, Violin, Saxophone, Drums. Will consider organized hot Jazz Orchestra, capable of playing for Specialties. Give age, weight, height, lowest salary. Rehearsals April 13; open April 27 near Ashland, Ky. BUD HAWKINS, week Feb. 22, New Grand Theatre, Mexico, Mo.; week March 2, Washington Theatre, Granite City, Ill.

AMONG THE BEST.
MAXWELL PLAYS
HOFFMAN PLAY COMPANY.
850 MARKET ST. SAN FRANCISCO.

BEN WILKES STOCK CO.
Character Man for Characters and Character Comedy. Must be A-1, with a strong line of Specialties. If you double Band so much the better. Under canvas, week stands. Pay own. Reliable show. Others write. Have several openings for versatile people. Send late photos. Will return them. Open middle of April at Albion, Ill. Address 1111 then, BEN WILKES, Albion, Ill. N. B.—Neat, experienced Workmen write.

AT LIBERTY--AGENT
Circus or Rep. Route, book, post. Handle press. (Also contractor, Suber, Drive Ford. Years of experience. Prefer Rep., but would consider motorized circus.
J. H. BLAIR, Bx 30, Freepart, Mich.

AT LIBERTY AGENT
On account of show closing. Can handle any kind of Attractions, Tent, Rep. House or Circus. Can sign on wire. Address CLARENCE AUSKINGS, General Delivery, Mt. Vernon, O.

WANTED FOR NORMA GINNIVAN DRAMATIC CO.
Tent Theatre. 21st Year. Week Stands. Rehearsal April 15.
Young Ingenue Leading Woman, Leading Man. Good appearance, wardrobe and ability. Prefer those who do Specialties. State lowest salary and send photos. Equity. Chicago. Musicians: Trombone and Clarinet who can drive truck. One more a week. NORMA GINNIVAN, Ginnivan Dramatic Co., 118 S. Euclid Ave., Dayton, Ohio.

ARLIE MARKS WANTS
General Business Team. Prefer Team doing Musical Act or first-class Specialties. Must be young, have good wardrobe and be able to join March 23. All summer engagement. Address all communications to
LINDSAY E. PERRIN, Mgr. Arlie Marks Co., St. Johns, N. F.

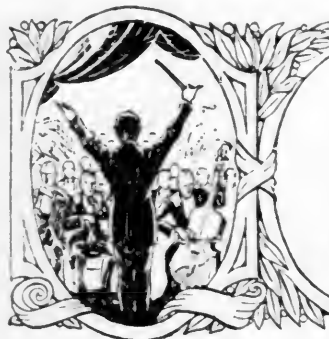

American Concert Field

and American Achievements in the World of Music

Pageantry

By
Izetta May McHenry

Classic Dancing



(Communications to 1493 Broadway, New York, N. Y.)

St. Louis Municipal Opera Season of 10 Weeks Starts May 25

St. Louis, Feb. 21.—The St. Louis Municipal Opera Association, thru David E. Russell, managing director, announced this week to *The Billboard* that the season will open May 25 and continue for 10 weeks at the amphitheater in Forest Park as in previous years. The repertoire will be by far the most elaborate ever undertaken by the association. There will not be repetition of operas as in former seasons.

The operas as they will be given during the summer are: *Count of Luxembourg*, *Riddgore*, *Dolly Varden*, *Rob Roy*, *A Night in Venice*, *Martha*, *Her Regiment*, *Ermione*, *Mlle. Modiste*, *Cavalleria Rusticana* and *Pinafore*. The last two operas are to be produced as a double bill each evening during the last week of the season.

Sweeping changes in the cast have been made. Only three of last year's members will again be in the company, they being Detmar Poppo, basso; William McCarty, second comedian, and Roland Woodruff, juvenile. Yvonne D'Arle will head the cast as ingenue-prima donna. The other principals include Eleanor Henry, prima donna; Beatrice Merston, contralto; Leo de Hierapolis, baritone; Forrest Huff, tenor; John E. Young, first comedian, and Fritzie Von Busing.

Frank A. Rainger, who has been general stage director for the last three seasons, will again stage the operas. Charles Previn will enter on his fourth season as musical director, which includes the direction of the immense orchestra as well as the chorus training school.

The chorus will consist of more than 100 young ladies and men from St. Louis, to be selected from approximately 300 singers now attending the Municipal Theater Association's free training school.

The St. Louis Municipal Opera Company is a wonderful civic institution, known from coast to coast and in foreign countries where music and opera people hold forth. And to David E. Russell, well-known showman, and years ago in the circus profession, goes most of the credit for putting it over. Mr. Russell has been managing director since its inception in 1919.

Cleveland Announces Dates For Spring Opera Festival

Cleveland is to have a Spring Opera Festival with 10 performances of opera in the Public Auditorium. The dates selected are April 27 to May 5, inclusive, and the productions will be given by the Metropolitan Opera Company with all of its principal singers. The repertoire is: Monday, April 27, *L'Africana*; Tuesday, *Faust*; Wednesday, *Il Trovatore*; Thursday, *Falstaff*; Friday, double bill, *LeCoq d'Or* and *I Pagliacci*; Saturday, *La Traviata*; Monday, *Tales of Hoffman*; Tuesday, *Aida*; and two matinees, one on Saturday, when *Parsifal* will be given, also on Sunday, when a gala concert will be presented. Those who will appear in the principal roles include Elisabeth Rethberg, Elfradie Wells, Lucrezia Bori, Florence Easton, Queena Mario, Frances Peralta, Rosa Ponselle, Frances Alda, Ralph Errolle, Giovanni Martinelli, Armand Tokatyan, Feodor Chaliapin, Giuseppe Danise, Giuseppe DeLuca, George Meader, Clarence Whitehill, Lawrence Tibbett and Michael Bohnen, and the conductors will be Bamboeschek, Hasselmann, Serafin and Papi, while the principal dancers will include Rosina Gall, Florence Rudolph, Giuseppe Binfiglio and Alexis Kosloff.

Joint Recital Announced for Olga Warren and Francis Moore

A joint recital is to be given by Olga Warren, soprano, and Francis Moore, pianist, at the American Institute of Applied Music, New York City, Friday afternoon, March 6. Mme. Warren will sing numbers by Brahms, Liszt, Watts and Warren, and Mr. Moore, among other compositions, will present the G-Minor Concerto by Schumann.

Mid-Season Concerts Bring Noted Artists to New York

With the present season almost half over, the concerts announced for the next few weeks in New York will be given by a number of celebrated artists. Harold Bauer has announced a piano recital in Aeolian Hall the afternoon of February 28, and in the same hall on March 1 Bruno Walter will conduct a concert by the New York Symphony Orchestra, while on that evening, also in Aeolian Hall, occurs a concert by the International Composers' Guild. On Tuesday afternoon, March 3,

Metropolitan Operas

To Include Another Production of "Falstaff" and "Giovanni Galluere"

The operas to be presented at the Metropolitan the last half of the current week include another production of *Falstaff* and the first presentation of *Giovanni Galluere*. On Wednesday evening there will be the double bill, *Pagliacci* and *LeCoq d'Or*, with Queena Mario, Edward Johnson and Giuseppe DeLuca in the principal roles of the former and Thalia Sabanieva, Adama Didur, Hen-

Music and Business Claim Henry Joslyn's Attention

Henry Joslyn, composer of *Native Moments*, the composition recently presented by Leopold Stokowski at one of the New York concerts of the Philadelphia Orchestra, has had a career in which business and music claimed his attention. We wrote Mr. Joslyn requesting that he tell something of his career, and he wrote so entertainingly that we are giving you his own account of his life. He states: "I began writing music somewhere between the years of 3 and 10. There are no musicians in the family or any of its branches so far as I know, no piano in the house where I was a child, an old guitar being the only instrument. I 'mastered' it at an early age and it was the first instrument I ever wrote for, and to this day I am not allowed to play a piano where anybody can hear it. I was born in Lindra, N. Y., but my studies have been haphazard in all parts of the country (I have never been outside of the United States). When 12 years of age I was playing a violin and beginning to study and always writing, and the accumulated sketches of 20 years fill a trunk. In the teens I thumped and banged and blew every instrument possible and wrote 'music' for all of them singly and in combination and, although artistically the results were poor, I certainly learned to 'know the instruments'. Since that time the sketches which have been accumulated include major works as follows: Three symphonies, *War*, *Pythagoras*, *The Symphony of the Low Downs*; First American Symphony (for Paul Whitman); symphonic odes, *Eulogy*, *Joy*, *The Day of Days*; symphonic suites, *The Seven Ages of Man*, *The Melting Pot*, *Symphony Miniature*, *Native Moments*, *Mitchie-Gaunce*, *Fairy Tales*; tone poems, *Down Wind*, *Prairie*, *Chicago*; concertos for piano, violin, cello, viola (for Louis Bailly); String Quartet, an opera in jazz idiom as yet unnamed, also some suites for instrumental combinations, songs and such lesser works. *Native Moments* is the first of these sketches to be produced and the first movement (*Widerness*) was scored and sent to Leopold Stokowski, at the suggestion of Modest Altschuler, of the Russian Symphony Orchestra, and Mr. Stokowski's encouragement caused me to score the other three movements and it is directly due to his influence that this, the first of my completed works, has been finished and brought to performance. In fact, it can be said to have been written for him.

"As a newspaper man, advertising man, violinist, conductor, etc., I have been a resident of Elmira, N. Y.; Rochester, Buffalo, New York City, Detroit, Toledo, Cleveland, Chicago, St. Louis, New Orleans, Dallas, Kansas City, Los Angeles and San Francisco. It reads like a time table and should make me as typically American as anyone can be who writes music. My attitude toward any art, however, is that it must be art first; its American attributes are of second consideration. If it happens to express America at the same time, so much the better for us who live here. But it must be a natural expression, not forced—it must come from a desire to express something, not from a desire to deliberately create 'an American art'. If it comes spontaneously and expresses this country—there's your American art."

Mr. Joslyn, in *Native Moments*, has given definite expression to phases of American life and the composition as presented recently by the Philadelphia Orchestra, under the direction of Mr. Stokowski, met with enthusiastic approval from the usual capacity audience which attends the concerts of this organization.



Henry J. Joslyn, American composer, has written several symphonies as well as many other compositions. His "Native Moments" was recently given first performance under the direction of Leopold Stokowski.

takes place the piano recital of Ernest Schelling, and on the evening of that date the Flonzaley Quartet gives another of its concerts. Then in Aeolian Hall, on the evening of March 6, the Elisehuco Trio, assisted by the Festival Quartet of South Mountain, presents the last concert in the series of this season. In Town Hall the American Orchestral Society gives a concert Saturday evening, February 28, under the auspices of the New York University, and Oliver Denton will present a special program of three piano concertos in Town Hall March 2, when he will be assisted by an orchestra with Chalmers Clifton as conductor. The only song recital that Dusolina Giannini, soprano, will give is scheduled for Carnegie Hall the evening of February 28, and another recital which will interest many is that of Mischa Levitski, which takes place in Carnegie Hall the evening of March 14. Benamino Gigli is to give but one concert in New York this season and this is announced for March 20 in Carnegie Hall, when the noted tenor will sing six operatic arias in addition to a number of songs.

So many subscriptions for the 1925-'26 season of the Civic Opera Company, of Philadelphia, have been received and so many applications filed that it has been decided by the management to open the subscription at once, thus giving everyone an equal chance to obtain good seats. These subscriptions are to be taken for the series of 10 performances.

riette Wakefield and Rafaelo Diaz in the cast of the latter opera. On Thursday afternoon occurs the second performance of the Wagner cycle, *Das Rheingold*, and on Thursday evening *Falstaff* will again be presented with the same cast as before, including Scotti, Tibbett, Bori and Alda. *Die Meistersinger* is the opera scheduled for Friday evening, and at the matinee on Saturday *Giovanni Galluere* will be given, with a cast including Giacomo Lauri-Volpi, Maria Mueller, Giuseppe Danise and Serafin as conductor. The opera on Saturday evening at popular prices will be *La Gioconda*, with Frances Peralta in the name part.

New York Musical Events

Only once in a long time does a young singer make as satisfactory an impression at her debut as did Jeanette Vreeland in Aeolian Hall Monday afternoon, February 16. Her voice, a soprano of wide range, is exceedingly clear and of a lovely quality, which should make her an artist much in demand. Forthcoming recitals by Miss Vreeland will be watched with much interest.

A second recital this season was given by George Morgan, baritone, in Aeolian Hall the evening of February 18 before a large-sized audience. Again his singing was marked by good diction, smoothness of tone, and the quality of his voice was very pleasing except in the high notes, which at times were hard.

Alexander Savine To Direct Opera Recital at Studio

As announced at the opening of his New York studio this season, Alexander Savine is presenting opera recitals at regular intervals in the auditorium of his studio, which has been specially fitted up for this purpose. The next opera recital to be given under the direction of Mr. Savine takes place February 28, when, with the assistance of an orchestra, selections from several operas will be presented. Among the singers to participate in the recital will be Lillian Gustafson, Helen Short, Frances Baviello, Harold Kravitt, Avo Bombarger, Augusta Schultz and Mazona Don.

Washington Awaits Opera
By All-American Cast

Washington, D. C. is awaiting with much interest the performance of *Aida* on March 3 by the Washington Opera Company with an all-American cast. The production will be given in the new Washington Auditorium by a cast of American stars, including Frances Peralta, soprano, and Jeanne Gordon, contralto, both of the Metropolitan Opera Company; John Charles Thomas, baritone; Charles Trowbridge Tittmann, basso, and Albert Shefferman, a young basso of Washington. This will be the second all-American cast presented by Mr. Albion, manager of the Washington Opera Company, in accordance with his policy of bringing attention to the artistic ability of singers of this country.

Many Noted Artists Scheduled
for Concert in Boston

During the next few weeks a number of distinguished artists will be heard in the concert halls of Boston. February 26 Francis MacMillen, American violinist, presents a program in Symphony Hall, and the same date in Jordan Hall Daisy Jean, cellist and pianist, will give a recital. On the first of March Maria Jeriza appears in a recital of songs, and on March 5 in Jordan Hall occurs the last concert in the season by the Flonzaley Quartet, and for this occasion these noted musicians will be assisted by Harold Bauer. Other artists to be heard in Boston during the early part of March are Sergei Rachmaninoff, pianist; Mme. Schumann-Helink, Gulomar Novaes, Ossip Gabrilowitsch and Alfredo Oswald.

More Than 40 Compositions
Submitted in Eastman Contest

Howard Hanson, director of the Eastman School of Music, reports more than 40 full orchestral scores have been submitted in the music contest for American composers being conducted in accordance with the offer of Mr. Eastman. The number of compositions submitted has been more than gratifying and in quality they average very high, according to Mr. Hanson, and it is his opinion they will give conclusive proof that considerable high-class musical talent in America is but awaiting opportunity for a hearing. The judges of the contest will soon begin examining the scores and will arrange them for production by the Rochester Philharmonic Orchestra some time in April.

Detroit Orchestra Appoints
Kolar as Associate Conductor

William H. Murphy, president of the Detroit Symphony Society, announces that a contract has been signed with Victor Kolar for the seasons 1925-'26 and 1926-'27. Mr. Kolar, at the suggestion of Ossip Gabrilowitsch, has been appointed associate conductor instead of assistant conductor, which latter title he has had for some little time.

Wolfsohn To Present
Two Noted Artists

The Wolfsohn Bureau announces early March dates for concerts by two noted artists in New York City. On March 1, in Carnegie Hall, Cecilia Hanson will give a violin recital. Marla Ivogun, distinguished coloratura soprano, is scheduled for a concert in Carnegie Hall Saturday afternoon, March 7.

Community Musical
Activities

Westchester County, New York, is organizing a large county chorus to present a three-day music festival next May. Choral bodies are being organized at White Plains, Yonkers, Mt. Vernon, Peekskill, New Rochelle and Fort Chester, with the smaller towns connecting themselves with the center most convenient. All these groups will join in one chorus for the festival to sing with some of the world's greatest soloists and a large orchestra of Westchester musicians. Several of the county's most prominent citizens are underwriting the plan and the only expense to a chorus member is dues of 10 cents per week. Morris G. Williams will be the musical director and C. Mortimer Wike, conductor of the Newark and Philadelphia festivals, will be festival director.

The Amphion Society, of Seattle, Wash., which last year won the first prize in the Male Voice Competition at the British Columbia Festival in Vancouver, recently presented the first concert of its 15th season at Meany Hall, on the University of Washington campus. Graham Morgan directed and Gertrude Huntley Green, pianist, and Cleveland Klehauer, dramatic reader, assisted in the program.

Rehearsals for a large municipal chorus are to begin soon in Sacramento, Calif., according to the announcement of George Sim, of the Sacramento Recreation Department, and Frank Dix, director of the Municipal Orchestra. The chorus will

sing with the orchestra and will cooperate with the choral organizations already organized in the city, and the plans include zoning the city into six or seven districts, with a chorus director conducting rehearsals in each.

A year ago a community chorus was organized in Moline, Ill., and this organization has grown from eight to 100 members in 12 months. The members are so enthusiastic that rehearsals were held through the entire year, and a feature of the work is the monthly recital open to the general public when families and friends of the singers are privileged to attend. The chorus has a wide repertoire of chorals and has given a number of concerts and is now preparing the opera *Robin Hood* for presentation early in the spring. A. L. Herring, of the Moline Community Service, is the director.

The Community Symphony Orchestra, of Elmira, N. Y., of which Gwynn S. Bement is conductor, a short time ago gave a program at the South Side High School. Fifty local musicians now play in the orchestra, which is sponsored by the Elmira Community Service, co-operating with the Board of Education and the American Legion.

Oxnard, Calif., has proved it likes community singing so Community Service of that city is planning to make "song fests" a permanent feature of its program. J. A. Lewis, of Los Angeles, led the first sing in the High School Auditorium and the Pirate Orchestra, Forsater's Orchestra, the High School Girls' Glee Club and several soloists contributed to the program.

A State-wide organization of community singing schools is the plan of an association of Jackson and Harmon County singers recently organized near Eldorado, Ok. The next meeting of the association will be held in that city March 29, when further plans will be outlined for this new State organization.

Concert and Opera
Notes

The New York Philharmonic Orchestra, directed by Willem Mengelberg, will give a concert in Philadelphia on Monday evening, March 9, at the Academy of Music.

A recital of piano music will be played by Frank Sheridan in New York Aeolian Hall on February 28.

The Little Symphony, directed by George Barrere, will give three concerts at the Scarborough (N. Y.) High School the afternoons of February 27, March 13 and 27.

Adele Bliss, soprano, assisted by Vladimir Dubinsky, cellist, and Frank Bibb at the piano, has announced a New York recital in Aeolian Hall Wednesday evening, March 4.

On March 16 the St. Louis Symphony, conducted by Rudolph Ganz, will give a concert in Indianapolis, marking the first appearance of the noted conductor-pianist in that city as director. Helen Traubel, dramatic soprano, will be soloist for this concert.

The noted baritone, Emilio de Gogorza, who gave his last recital in New York this season but recently, sails this week for Europe, where he will resume his engagements. He is planning to return to this country next November for a longer season's tour.

La Traviata was the opera chosen for the Sunday noon concert given at the Chicago Theater, Chicago, February 22. This performance, under the direction of Nathaniel Finston, sung in English and presented in concert form, had a cast of principals, a chorus of 50 voices, members of the Apollo Club and the Chicago Theater Symphony Orchestra.

In accordance with its usual custom of giving an opportunity for promising and deserving young artists to be heard before a large audience, the People's Chorus of New York has announced the appearance of Claire Brookhurst, American contralto, at a concert in the auditorium of the Washington Irving High School the evening of March 5.

The dates for the two remaining subscription concerts in the New York series presented by Willem Bachhaus have been announced for the evening of March 11 and the afternoon of April 11. The program for the first will consist of works of Beethoven, Scriabin, Brahms, Chopin, Albeniz-Godowsky and Debussy-Dohnanyi, and the second concert will be an all-Chopin program.

The debut concert of the Stringwood Ensemble will be given in Aeolian Hall, New York, on March 2. The players are: Josef Stouk, first violin; Samuel Kuskin, second violin; Michael Ceres, viola; Abram Borodkin, cello; Simeon Bellison, clarinet, and Arthur Loesser, piano. Included in the program is a Trio, *Suite de L'Histoire du Soldat*, by Stravinsky, for clarinet, violin and piano, and this will be the first public performance of this work in New York.

Motion Picture Music
Notes

In the group of divertissements included in this week's musical program at the New York Capitol Theater, S. L. Rothafel is presenting for the first time a new composition by Irving Berlin, called *Listening*, which is being sung by Gladys Rice and Joseph Wetzel. A second interesting contribution is a novel interpretation of Saint-Saens' *The Swan*, featuring Mlle. Gambarelli.

Randall's Royal Orchestra is playing an indefinite engagement at the Strand Theater, Omaha, Neb., as an added musical feature of the weekly bill.

Ellis McDiarmid, one of the best known of the younger flutists, is the featured soloist at the Piccadilly Theater, New York City, this week. Hosmer's *Southern Rhapsody*, played by the orchestra, under Fredric Fradkin's direction, introduces the supplementary divertissements and the prolog song, *Roses of Picardy*, is being sung by Carolyn Reynolds.

A *Canary Serenade*, in which Alberto and Rosina, violinists, imitate the songs of birds, occupies a prominent place on this week's bill at the Rivoli Theater, New York. There are special settings by John Wenger for this number, and the orchestra opens the program with the overture *Rigoletto*.

Fred Schmitt, who has directed the music for both the Victory and Rialto theaters of Denver for several years, will in the future devote his entire time to leading the orchestra at the Rialto, and Art Reynolds, well-known pianist of Denver, has been engaged as director of the Victory Orchestra. Both orchestras have been augmented and excellent musical programs will be heard, in both houses.

The well-known concert tenor, Judson House, is soloist at the Mark Strand Theater, New York City, this week. Mr. House is singing *The Nightingale and the Rose* in the first part of a four-numbered divertissement, the other soloists being Estelle Carey, soprano; Mlle. Klemova, dancer, and the Mark Strand Ballet Corps.

The overture from *Martha* opened the week's bill at the Eastman Theater, Rochester, N. Y., the week commencing February 15. During the daily organ recitals, at one and five p.m., Harold O. Smith played the overture to *The Bohemian Girl*, and as the prolog to the feature the novelty, *South of 36*, was presented.

A Balaban & Katz presentation, *South of the Rio Grande*, featured the week of February 16 Fowler and Tamara and their Pan-American Troubadours at the Chicago Theater, Chicago. *The Concert* was also an added attraction with the Chicago Theater Quartet and Louis Adrien, violinist.

The management of the Palace Theater, Dallas, Tex., presented Grace Freeman, violinist, as the feature of the program the week of February 14. Miss Freeman played a Polonaise of Wienlawski and Kreisler's *Caprice Viennois*.

Melody Week is being celebrated this week at the Missouri Theater, St. Louis, with the third edition of Ted Snyder's *Song Shop Revue*, in which are featured Fred Hughes, popular tenor; Malie and Stopt; Raymond Baird, called "the little Sousa" and an assisting chorus of 25. In this revue Mr. Snyder is presenting some clever novelties and his reappearance this week is in response to insistent demands by the patrons of the Missouri.

Selections from Victor Herbert's *Naughty Marietta* form the overture being directed by Oscar F. Baum at the Capitol Theater, St. Paul, Minn., this week. Martin Richardson, operatic tenor, is the week's soloist, and Leonard Leigh, at the organ, is featuring *You Can Be Just As Lonesome on Broadway*.

Two appearances of more than usual interest were those of Orville Harrold, distinguished operatic tenor of the Metropolitan Opera Company, and Naham Franko, well-known conductor and violinist, at the Fox Theater, Philadelphia, recently.

Announcement has been made by Manager Harry B. Watts, of the Rialto Theater, Omaha, Neb., that Hazel Eden, prima donna soprano of the Chicago

Civic Opera Association, will shortly make an appearance at the Rialto.

Mlle. Doris Morelle, of the Opera Comique, Paris, sang selections from Massenet's *Manon* on a recent program at McVicker's Theater in Chicago.

The sixth free noon concert by the Sunday Symphonic Society, with Josiah Zuro directing, is announced for Sunday, March 1, in the Criterion Theater, New York. This program will include excerpts from Berlioz's *Damnation of Faust*, the Adagio from Vivaldi's *Concerto in A* and Mozart's *Symphony in G-Minor*.

A pretentious production, entitled *The Birthday Banquet*, was given at the Tivoli Theater, Chicago, last week. In it were: L. Cogan, impersonating *The Speaker*; Charles B. Gash, tenor; Charlie Calvert, *The Perfect Clown*; Libbie Corem, Valentine dancer; Marcelle Granville and Fritz Zimmerman, yodelers; Ida Mar Cameron, soprano; Paul Darnell and the Dresden Dolls.

Directory of Music Teachers

EDOARDO PETRI

TEACHER OF SINGING.
Studio: 1425 Broadway, New York.
Phone, 2628 Pennsylvania.

GRANBERRY

Piano School, Carnegie Hall, New York. Booklet for Concert Players. Accompanists. Teachers.

Garibaldi Arrighi

TEACHER OF SINGING.
Established 25 Years.
Students of Limited Means Assisted.
2029 Broadway, NEW YORK. Endicott 6554.

LOUIS REILLY

TEACHER OF SINGING.
188 West 85th Street, New York City.
FOURTEENTH SEASON.
Phone, Schuyler 1281.

IVA KRUPP BRADLEY

THE CORRECTION OF MISUSED VOICES.
145 West 55th Street, New York City.

ROBERT GAYLER TEACHER OF ARTISTIC SINGING.
Among Professional Pupils are: Ciccolini (Keith and Schubert Circuits), Harriot Bennett (Dusman Sisters), Carl Fern, Althea Ripple, Nora Helms, Etc. Metropolitan Opera House Bldg., N. Y. Pennsylvania 2634.

WOODRUFF Dr. Arthur D.

TEACHER OF SINGING.
Studio, 810 Carnegie Hall, New York City.
Mondays in Philadelphia.

THE BROADWELL CONSERVATORY OF MUSIC
PIANO, VOICE, VIOLIN, THEORY, DRAMATIC ART, LANGUAGES, ENGLISH, RHETORIC.
1815 7th Ave., at 110th St., N. Y. Monument 8968.

"THE ART OF SINGING NATURALLY"
ISABEL LEONARD

VOICE TEACHER AND COACH.
50 West 67th St., New York. Endicott 9490.

Giuseppe BOGHETTI TEACHER OF SINGING

Studios: 35 PARK AVE., N. Y., Tuesday & Friday and 1710 CHESTNUT ST., PHILADELPHIA, PA.

ROSE ZANG

Teacher of Piano, Theory, Sight Playing, Musical Memory.
Studios, 133 West 74th Street, NEW YORK.
Phone, Endicott 7517.

Learn How To Sing CALL UP THE BENEDICT VOCAL STUDIO

(Rosland Building) Circle 5368. 1658 B'dway, N. Y.

Sight Singing Ear Training DEVELOPED THROUGH ELEMENTARY AURAL HARMONY.

EVA E. FRISBIE
100 Carnegie Hall, NEW YORK, Tel., Circle 1350.

ZOE FULTON Grand Opera Contralto TEACHER OF VOICE

Head of Vocal Department at Glen Eden Seminary, Stamford, Conn.
144 W. 57th St., NEW YORK. Circle 8698.

HARRIET DE YOUNG

SOPRANO (Formerly Chicago Grand Opera Co.). Vocal Instruction, Operatic and Concert Training. Practical experience given talented pupils. Met. Opera House Bldg. (Studio 44), 1425 Broadway, New York. Tel., 7425 Penn.

MME. NANNA PERA

ART OF SINGING. CASCIA METHOD.
Special Terms for Professionals.
54 W. 37th St., N. Y. Mon., Thurs., 3-7 p.m.

THE NEW YORK SCHOOL OF DALCROZE EURHYTHMICS
"The use of the body as a musical instrument."
MARGUERITE HEATON, Director.
168 E. 51st St., NEW YORK. Plaza 4426.

WANTED
ARTISTS OF VOICE, PIANO AND VIOLIN
As Teachers for Leading Schools and Colleges throughout the United States.
MUSICAL ARTIST TEACHERS' AGENCY,
425 W. 34th St., NEW YORK. Lackawanna 1818.

MUSICAL COMEDY

REVUE - TRAVESTY
CHORUS AND BALLET DANCING

BY DON CARLE GILLETTE

(Communications to 1493 Broadway, New York, N. Y.)

Dillingham Announces Plans for Next Fall

Will Do Musical Version of "Fortune Hunter"—New Marilyn Miller Piece Also Likely

New York, Feb. 21.—Charles Dillingham announces that he has acquired from Winchell Smith the rights to produce a musical comedy version of Smith's well-known comedy, *The Fortune Hunter*, and is planning to present it as his first offering next fall.

The musical version of the Smith comedy will have the title of *The Treasure Girl*. James Montgomery, who wrote the book of *Irene*, has been commissioned by Dillingham to make the adaptation, while Anne Caldwell has been engaged to write the lyrics and Jerome Kern will supply the music.

It is expected that the libretto and music will be completed by the first of August, when rehearsals will start immediately. After three weeks in Philadelphia the production will be brought to a Broadway theater.

Dillingham's plans for the summer or fall also are said to include a new vehicle for Marilyn Miller, who is now on the road with *Peter Pan*. A musical version of *In Old Kentucky*, which is now being adapted by William Anthony McGuire, is mentioned as the vehicle in which Miss Miller will very likely appear next, and Florenz Ziegfeld and Gilbert Miller are to be associated with Dillingham in sponsoring the production.

Incidentally, Dillingham has signed a contract for an annual production of *Puzzles*, the Elsie Janis revue at the Fulton Theater. The contract is to run for five years, provided the next and succeeding editions of the revue prove as popular as the current program. Miss Janis will continue to personally stage each production, devising and lighting all of the scenes, numbers and sketches. The present revue will continue at the Fulton Theater indefinitely. Early next season Miss Janis will make a brief tour of the principal cities and, under the new arrangement, will produce her *Puzzles* of 1926 the first week in January.

"Blue Bird" To Tour

New York, Feb. 21.—Yasha Yushny's *The Blue Bird*, the Russian revue at the Frolic Theater, will close its local engagement February 28 and leave for a tour of the principal cities. S. Hurok will direct the tour, which will comprise engagements in Montreal, Toronto, Detroit, Cleveland and Chicago. Yushny and his troupe will sail for Berlin the early part of May. In its two months at the Frolic Theater this attraction has failed to cover expenses. Two bills were offered. The first, under the title of *Senenaya Pitza*, was a dreary affair, but the second, called *The Blue Bird*, was a hilarious entertainment and should have drawn the crowds if there were a legitimate audience for this sort of vaudeville.

The Empress Players in Twenty-Fifth Week

Omaha, Neb., Feb. 20.—The Empress Players, starting tomorrow, will celebrate their Silver Jubilee Week, marking the 25th week that the company has been here and incidentally breaking all Omaha records for musical comedy stock. The previous record was 24 weeks, held by the Bert Smith Players. *A Woman in the Case*, a melodramatic farce, will be offered to celebrate the occasion. Among the principal players in the company are Bert Evans, Rudy Winter, Billy Maxwell and Harry Barber.

Singing School at Century

New York, Feb. 21.—The Shuberts announce that they have established a singing school at the Century Theater for members of the ensemble of *The Love Song*, the Offenbach opera that is now playing there. Frederick Manatt, stage manager of the show, has been appointed general manager of the school.

Kathlene Martyn in Film

New York, Feb. 21.—Kathlene Martyn, a principal in *Lady Be Good*, at the Liberty Theater, will appear shortly in a feature-length photoplay in which William T.ilden will make his screen debut. The picture is called *Haunted Hands* and will be directed by George Terwilliger.

VIOLET CARLSON



As Gretchen, in "The Student Prince", at the Jolson Theater, New York, Miss Carlson shows herself to be a clever little comedienne.

Jobyna Howland Quits Show

New York, Feb. 21.—Jobyna Howland, who has been appearing in *Kid Boots* since the show opened, left the cast last Saturday night and sailed this week for Europe. The retirement of Miss Howland from the Ziegfeld production, it is said, was brought about by the strained relations that have existed for some time between the actress and Eddie Cantor, star of the piece. Miss Howland plays the part of a lady osteopath, and in the course of the evening there is a scene in which she illustrates her art, with Cantor as the subject. Her handling of the little comedian kept getting rougher and Cantor's bones and muscles cried out in protest.

Cecil Cunningham took Miss Howland's place Monday night.

American Opera Comique

New York, Feb. 21.—Inspired by the singular success this season of the operetta form of entertainment, many noted literary persons, including Theodore Dreiser, Sherwood Anderson, Horace B. Liveright, Fanny Hurst, Jane Grant, Walter Lippman, S. J. Kaufman, Conde Nast and Frank Crowninshield, have been appointed honorary members of a committee whose purpose it is to sponsor an American Opera Comique. The project will present revivals on a small scale and call itself the Little Opera of America. Macchavelli's *Mandragola*, in the English version of Alfred Kreymborg, will be the first production, and it is scheduled to open at the Princess Theater March 4. Subsequent productions will be chosen from *Resurrection*, *Djamleh*, *Lazuli*, *Yankee*, *Doctor in Spite of Himself*, *Hugh the Drover*, *Ariadne auf Naxos*.

Jolson Gets Gold Watch

New York, Feb. 21.—A handsome gold watch was presented Al Jolson, star of *Big Boy*, Tuesday night by the members of the Level Club, a Masonic institution which devotes its life to charity for homeless boys. The club, of which Jolson is one of the most prominent and active members, bought out the Winter Garden for the Tuesday evening performance and the presentation to Jolson was a surprise feature. Sam Horowitz, president of the club, made the presentation speech. Jolson was so overcome that he entertained the audience for 45 minutes after the curtain went down. Senator Royal S. Copeland, Congressman Sol Bloom, Benny Leonard and many other notables were present.

Viola Gillette a D. A. R.

New York, Feb. 21.—Viola Gillette, one of the principals in the John Cort opera, *China Rose*, which reopened at Waldorf's Theater Monday, has been elected a member of the Daughters of the American Revolution. Miss Gillette's great-grandfather was a brigadier-general in the Continental Army.

Goodee Montgomery In "Puzzles of 1925"

New York, Feb. 21.—Goodee Montgomery, 17-year-old daughter of the late Dave Montgomery, of the famous team of Montgomery and Stone, has been engaged by Charles Dillingham as one of the featured dancers in the new Elsie Janis revue, *Puzzles* of 1925, at the Fulton Theater.

The engagement of Miss Montgomery has much sentimental interest back of it, because it brings her under the management of the producer who directed the affairs of Montgomery and Stone for many years. Miss Montgomery was a childhood playmate of Dorothy Stone. She is a beautiful girl and a talented dancer, having already appeared in Hassard Short's *Ritz Revue*.

New Edition of "Follies" With Fields and Dooley

New York, Feb. 21.—The "Spring Edition" of the Ziegfeld *Follies* will be presented at the New Amsterdam Theater the second week in March, with W. C. Fields, Ray Dooley and a number of the principal features of the late *Comic Supplement* incorporated into the program. Practically all of the present members of the *Follies*, including Will Rogers, Ann Pennington, Vivienne Segal, Irving Fisher, Tom Lewis and others, will remain.

Florence Eldridge In "School Belles"

New York, Feb. 21.—Florence Eldridge, who has heretofore appeared only in comedy-drama, has been chosen by the Shuberts for the leading part in *School Belles*, the musical comedy version of *The Charm School*, which has been rewritten and is expected to be tried out again within the next few weeks. In addition to singing Miss Eldridge will also have some dance numbers in the show.

Estelle Brody Makes Hit

New York, Feb. 21.—Estelle Brody, according to reports and newspaper clippings from various cities in the South, is making a real hit on tour as the leading lady of *Little Jessie James*. Tho not very strong on voice, Miss Brody is credited with having enough vivaciousness and showmanship to make up for other shortcomings. Donald Carroll also is meeting with good receptions, and others who are getting favorable mention include Robert Burns, Mildred Kent, Mildred Reed, Pearl Height, Vera Rial and Charles O'Connor.

Kahn To Back Wayburn In Series of Reques

New York, Feb. 21.—Otto H. Kahn, the financier and patron of art, is reported to be backing Ned Wayburn in a series of revues, the first of which will be presented at the Martin Beck Theater this summer. The deal for the theater, which is booked thru the Erlanger office, is said to have been completed by Beck and Wayburn before the owner of the house sailed for Europe recently.

Hirschfeld Conducting

New York, Feb. 21.—Max Hirschfeld, for many years associated with the New York Symphony Orchestra, is now conducting the orchestra for *Natya* at the Knickerbocker Theater. Karl Hajos, who adapted the Tschalkowsky melodies in this opera, conducted during the out-of-town engagement and for the Broadway premiere last Monday night, after which Hirschfeld took over the baton.

Back in "Topsy and Eva"

New York, Feb. 21.—Robert Halliday, leading man in *Topsy and Eva*, returned to the cast Wednesday after an absence of 10 days owing to a sprained knee. Bradford Kirkbride substituted for Halliday during the 10 days.

Harriet Hoctor, young premiere dancer in the show, who also was laid up for a period because of a sprained ankle, had planned to return to the cast last Saturday but did not make her reappearance until Tuesday.

Summer Revue by LeMaire

New York, Feb. 21.—George LeMaire, according to reports, is planning to produce a summer revue of the intimate type.

Conservatory Students in "The Pirate's Daughter"

Boston, Feb. 19.—Under the general direction of Clayton D. Gilbert, head of the dramatic department at the New England Conservatory of Music, the pupils of that institution presented in Jordan Hall last Friday and Saturday evenings a musical comedy in three acts, entitled *The Pirate's Daughter*, written by George M. Brown, a former student at the conservatory, and Dorothea Bassett, with music by Keith Crosby Brown. The production was staged under the auspices of the Sinfonia Fraternity, and the cast of principals included Yvonne Desrosiers, Ben Russell, Donald Selwe, Elsa Evans, Muriel MacLachlan, Victor Wrenn, Mortimer Bowe, May Silver, Joseph Lopez, Naomi Andrews, Charles Pearson, John Coakley, Ruth Chilton, Luke Gaskell, Genaro d'Allesandro, Louise Beach, Florence Owen, Aleene Grossart and Norman Strauss. In addition there was an ensemble of about 60 and an orchestra of 25 pieces, recruited entirely from the students of the school. The performances were run off in good professional style and met with excellent receptions.

Hal Skelly Out

New York, Feb. 21.—Hal Skelly, one of the featured players in *Betty Lee*, at the 44th Street Theater, has been dismissed from the show by Rufus LeMaire, the producer, because the comedian appeared for a few minutes last Sunday afternoon at Keith's 81st Street Theater in an encore number with Frances White. Skelly and Miss White were among the members who appeared at the annual benefit of the Catholic Actors' Guild at Jolson's Theater last Sunday night. On his way down town, it is said, Skelly called at the 81st Street Theater for Miss White and incidentally sang with her, as an encore, a song that they were to sing later at the Guild benefit. The appearance at the Keith house was held by LeMaire to constitute a violation of Skelly's contract.

It is understood that the relations between Skelly and the management of the show have not been any too friendly ever since the comedian refused to accept the cut in salary accepted by practically all of the members of the cast shortly after the show opened in New York.

Skelly was handed his dismissal on Monday night and on Wednesday following the circulation of the news and the general indignation over the narrow-mindedness of the action, he received an apology from an official of the Theatrical Managers' Protective Association, who had recommended his dismissal, and also a satisfactory cash settlement from LeMaire, by whom the summary dismissal was signed.

Carroll's "Vanities" Censored in Philly

Philadelphia, Feb. 20.—Altho Earl Carroll tried to present his *Vanities* at the Forrest Theater here just like the revue was presented in New York, and endeavored to gain public support for his action by appealing to the audience on the opening night, the Board of Censors, backed by the Mayor and the police, saw to it that the girls in the production were sufficiently draped to satisfy the claims of modesty as specified by local regulations.

"The Grab Bag" Benefit Nets \$3,500 for Church

New York, Feb. 21.—The benefit performance given by Ed Wynn's *The Grab Bag* at the Globe Theater Monday afternoon netted just about \$3,500 for the fund being raised to complete the Cathedral of St. John the Divine. Ed Wynn and A. L. Erlanger donated the performance and Charles Dillingham donated the use of the theater. Forty stagehands and the other house attaches also gave their services free.

Form Anti-John League

New York, Feb. 21.—At a meeting held last week in the offices of the Chorus Equity Association a group of chorines from Broadway shows had a lively discussion on the subject of suppressing the stage-door masher, and as a result it was resolved to have a "monitor" with every New York show who would see to it that the good little girls got home safely every night.

Selwyn and White To Do a Musical

New York, Feb. 21.—Arch Selwyn and George White have completed arrangements to produce a musical show together in the fall.

"Shuffle Along" Closes

Youngstown, O., Feb. 19.—*Shuffle Along*, the George B. Wintz all-colored show, closed here last night. The attraction had not been doing very good business the last few weeks of its tour.

Ent'acte Reflections

Seventy-five per cent of the artists in musical comedy are in need of lessons on how to act. An almost equally large percentage doesn't seem to have the knack of moving to music.

The importance of good acting, as well as good singing, to the success of a musical play is borne out by the invariable failure of productions that are short in either of these particulars.

Vocal expression cannot have a rousing effect when it emanates from a lifeless body. Every utterance should be accompanied by body movement.

Never has it been necessary for comedians to work as hard as they must work today, for never has genuine plot comedy been so scarce as it is now.

When will directors of ensembles learn to build their formations so that the various members will be arranged symmetrically according to height?

The big secret of success in theatrical presentation is the element of surprise. The unexpected always stimulates interest and brings a response from the audience.

Now that operettas are meeting with public favor, the musical producers instead of cultivating the demand gradually are hastening to choke the public with this kind of entertainment.

The fundamentals of the genuine revue are wit, travesty and satire. But the majority of Broadway producers pass those things up for girls, scenic effects and nude displays.

How many of the large number of promising young light comedians now on the horizon—some already well above it—will be able to survive the deadly material that most of them have to work with?

It is no easy matter to be funny when there is nothing to be funny about.

When is a musical comedy not a musical comedy? When it contains too much of the revue style of entertainment. Irrelevant specialties and broad departures of any kind, no matter how good they are in themselves, are always distracting and cheapening elements in a musical comedy.

Nikita Balleff says that if his *Chauve-Souris* is funnier this year than previously it is because his artists have learned so much more about comedy from the Americans since they first appeared. Balleff is a clever fellow. He said "if" his *Chauve-Souris* is funnier. All the comedy in his current Russian hodge-podge will fit very easily into the corner of a fly's eye.

Six New York reviewers described Balleff as "moon-faced". A seventh compared his face to a coconut. One out of seven showed a real sense of humor.

As Yasha Yushny, Balleff's contemporary, demonstrates in his *Blue Bird*, the Russians do not need to come over here for lessons in comedy. They already have a genius for picking the comic and the gay, the ludicrous and the grotesque, the fanciful and the boisterous, right from the everyday incidents of their lives. They know how to blend these elements into a colorful program with rhythmic sequence. There are plenty of incidents in American daily life that could be utilized after the manner of the Russians. But Americans live so

YSABEL CAYER



A talented dancer, appearing in the new Willie Howard revue, "Sky High".

WHY NOT BOOK THE BEST?

BILLY MAINE AND (20) TWENTY OTHER PEOPLE

"SOMEWHERE IN FRANCE" "GOLDBRICK'S RETURN" "THE DUMBELL"

Return date at Huntington, Ind., broke our previous record of four weeks before. SOME BUSINESS. Open time April and May. Write COL. J. L. DAVIS, Room 304, 36 West Randolph St., Chicago, Ill.

close to the ground that they can't see the things that are there.

The facial expression of Russian artists is a wonderful art in itself. Their nasal utterances also intrigue interest.

Morris Gest and his fashionable following are bringing success to the *Chauve-Souris*. Yushny's *Blue Bird*, tho a much better Russian revue, is a failure here because it has no Morris Gest and no fashionable following. The moral is that a Russian revue without a Morris Gest and a fashionable following is like a *Vanities* without an Earl Carroll and a fertile publicity agent.

Despite its transfer from the Astor Theater on Longacre Square to a less prominent location at the Casino farther down on Broadway, *Artists and Models* of 1924 continues to draw the crowds. A more elaborate and lifelike collection of enlarged nude pictures has been obtained and plastered all over the front and sides of the new location. The boys that used to walk a mile for a smoke are now trotting a mile and a half for a look at the *Artists and Models* photographic display.

A Berlin theatrical critic, after seeing an American musical comedy performed at the Neues Theatre am Zoo, broadcast his opinion that the operetta of the future will undoubtedly be a jazz-band operetta. He declared that jazz is a musical idiom, a language of the people of our time. By this time, no doubt, his attention has been called to *Rose-Marie*, *The Student Prince* and *The Love Song*.

TRY-OUT OPENINGS

"When Summer Comes"

Easton, Pa., Feb. 20.—*When Summer Comes*, starring James Barton and featuring Lucilla Gear, was presented here for its first showing last Saturday night and proved to be a very one-sided affair. Barton was just about the whole show.

Rhys Morgan, well-known Welsh tenor, will probably be seen in a Broadway musical comedy next season.

Carol Babin, daughter of Commander Provost Babin, has joined the cast of *Betty Lee* at the 44th Street Theater, New York.

Russell Mack, late of *My Girl*, is casting for his own production, *A Knight for a Day*, in which he will play the leading role.

Francis Fay, 5-year-old actor, who appeared in one of Thomas Meighan's latest pictures, is now playing the child part in *The Love Song* at the Century Theater.

Dorothy Campbell Young, former *Follies* girl, is now head of the women's department of the Bronx Baths in New York and says she is enjoying the work.

George White's name is now up in electric lights on 42d street, high over the theater that is now George White's Apollo.

Adele Astaire, dancing comedienne in *Lady Be Good*, at the Liberty Theater, New York, is compiling a record of her stage experiences both here and abroad.

Adolph Link, of *The Student Prince* company in New York, is writing his memoirs. He is 73 years old and has been acting 62 years.

Albert Von Tilzer, Andy Rice and Henry Creamer have written a 15-minute opera, which will be one of the numbers in the forthcoming revue, *Sam Shannon's Sinners*.

The Duncan Sisters, stars of *Topsy and Eva*, are reported to have bought a home in the suburbs of New York in anticipation of a long run for their show on Broadway.

The appearance of Mary Melish as the *Carina* in *Vafsa*, the Tchaikowsky operetta at the Knickerbocker Theater, New York, is the first engagement of this prima donna outside of grand opera.

Walter Catlett, Eddie Cantor and Jimmy Hlussey acted as masters of ceremonies at the 11th annual benefit performance for the Catholic Actors' Guild at the Jolson Theater, New York, February 15.

Margaret Armstrong, one of the principals in *My Girl*, at the Vanderbilt Theater, New York, was out of several

The libretto was worse than mediocre and the score only mildly pleasing. Lucilla Gear, Helen Carrington, Jack McGowan and Frank Andrews work hard, but are unable to overcome the handicap of poor material. Andrews' portrayal of a Southern judge is a fine bit of work. An exceptionally good chorus provides a delightful moment now and then, but it is not given enough opportunities.

Jack Arnold wrote the book and lyrics, A. Baldwin Sioane composed the score, Walter Wilson did the staging and Raymond Midgley arranged the dances. The principals, in addition to those already mentioned, include Ray Raymond, Irma Marwick, Joe Smith, William Lemuels, Jane Burley, Raymond Cullen and Royal C. Stout.

"Louis the 14th"

Baltimore, Feb. 18.—Florenz Ziegfeld's latest revue, *Louis the 14th*, starring Leon Errol, had its premiere at Ford's Theater last night. The production is a comic opera in two acts and six scenes, with book and lyrics by Arthur Wimperis and music by Sigmund Romberg. Edward Royce staged it.

Louis the 14th is a rich and colorful affair. The music is in Romberg's best vein and Wimperis has provided a fairly good vehicle for Errol's comic talents. When it gets whipped into shape it ought to be right in line with the best shows of the season. An excellent lineup of talented players has been brought together by Ziegfeld for this piece. The principals include Doris Patston, the young English prima donna, who is making her American debut in this production and promises to make many friends; Harry Fender, late of *Kid Boots*; Ethel Shutta, Hugh Wakefield, Frederick Graham, Charles Mast, Joe Latron, Al Baron, Al Harville, Edouard Dourand, Alfred James, Judith Vosselli, Simone De Bouvier, Pauline Mason, J. W. Doyle, Kathleen Calhoun Doucet, Vivien Glen, Florentine Gounova and Louis Cassavan.

The glorified girls of the ensemble include Virginia King, Dixie Boatwright, Catherine Littlefield, Gertrude McDonald, Lillian Brooks, Anastasia Belliy, Maybelle Swor, Maryland Jarboe, Consuelo

NOTES

performances last week on account of illness. Rose Adaire, a member of the chorus, took her place.

Colin Campbell, the English comedian in Al Jolson's *Big Boy*, was host to a party of English jockeys belonging to the British Turf Club at last Friday night's performance at the Winter Garden. Campbell is a former jockey.

Vera Michelena, in association with Fred Hildebrandt, is working on a new musical comedy, for which they will do both the book and the score. They also have written several vaudeville sketches, one of which opens this week in a Proctor house.

Bobby Watson, who was to have assumed the leading male role in *My Girl*, at the Vanderbilt Theater, New York, February 16, actually stepped into the part on the Saturday night previous owing to the withdrawal of Russell Mack after the matinee.

Claire DeVine, prima donna, now appearing in burlesque, has been signed on a three-year contract by A. L. Jones and Morris Green, of The Bohemians, and will make her debut in musical comedy next season as a member of the *Greenwich Village Follies*.

Theodore J. Hammerstein, who in association with Jerome Quinn is presenting James Barton in *When Summer Comes*, coached the chorus of the *Red Star Revue* of 1925, given by the employees of the R. H. Mack store at the Brooklyn Academy of Music last Wednesday night.

The Artist's Guild, the little theater group composed of members of *Artists and Models* who are seriously interested in the theater, will have its first program of one-act plays ready for presentation within a week. J. J. Shubert has consented to give the group one of his theaters for several matinee performances. Hugo Alexander, the Western artist who recently joined the cast, is now designing the sets for the Guild.

Bella Belmont, who closed recently with Gus Hill's *Barney Google* Company, is taking things easy at her newly purchased home in Harrisburg, Pa., where her husband, John Mack, is engaged in the real estate business. Miss Belmont may appear in one of the *Bringing 'Up* *Father* companies being organized by Hill for New York and Chicago. At present she is busy with engagements in Harrisburg.

Owens, Elsie Behrens, Mabel Barde, Ruth Fallows, Vera Coburn, Joan Clement, Anna May Denehy, Agathy Debussy, Noel Francis, Helen Herenden, Edna Johnson, Dorothy Leslie, Roma Lee, Nyo Lee, Betty Nevens, Teddy King, Fern Oakley, Helen Morgan, Dorothy Dickerson, Helen Haines, Theera Kelly, Marie Lambert, Lucy Monroe, Leslie McGuire, Elenora Ruggerl, Gertrude Seldon, Claire Wayne, Gene Wayne, Lee Baron, Lorraine Webb, Helen Reimickie, Camille Griffith, Peggy Fears, Louise Scott, Ida Barry, Pearl Soddars, Jessie Madison, Julia Warren, Lillian Dawn, Dorothy Dahra, Margaret Lang Thorn, Florence O'Neill, Ethel Kelly and Dorothy Brown.

"The Student Prince"

Rochester, N. Y., Feb. 20.—The Chicago company of *The Student Prince* opened at the Lyceum Theater here last night for two preliminary performances before making its bow at the Great Northern Theater, Chicago, Sunday night. Roy Cropper is cast in the role of the Prince and Olga Cook plays Kathie. Among the other principals are: Dallas Welford, John Goldsworthy, George A. Schiller, Josephine Adair, Charlotte Granville, Patricia Ann Manners, William McNally, Cliff Heckinger and R. Payton Gibbs. The orchestra is under the direction of Hans Linne. A large audience witnessed the initial performance last night and greeted the dashing operetta with enthusiastic demonstrations.

Frank Tinney's "Sometime" Pleases London Playgoers

London, Feb. 21.—Frank Tinney, in the American musical comedy, *Sometime*, after many postponements and delays, finally opened last week at the Vaudeville Theater and was received with great enthusiasm. The production, staged with great credit by William J. Wilson, is on a much smaller scale than the original American version and apparently did not entail a very heavy expenditure. Yet it is a very enjoyable and cozy entertainment. Tinney is in excellent form and his supporting company includes such able performers as Desiree Ellinger, Robert Chisholm, Joan Hay, Farren Soutar, Carlito Ackroyd, Josephine Earle, B.B. Delabere, Dodd A. Mehan and William Parry.

"Rue de la Paix" Coming

New York, Feb. 21.—The title *Rue de la Paix*, which was to have been the designation for the revue starring Raquel Meller, the Spanish actress, which the Selwyns, and later Ziegfeld, intended to produce here, has been secured by Lew Leslie, who is planning to use it for a show he now has in rehearsal, with Jauz Green in a principal role.

Charlot in November

New York, Feb. 21.—According to cable advices from Arch Selwyn, who has been touring England, the next Charlot revue will be brought over in November. It had been planned to do the show here this month, but the idea was abandoned at Charlot's request.

Another Lubliner & Trinz theater, to be erected at Milwaukee avenue and Rockwell street, Chicago, has been announced. It will be known as the Congress and has a seating capacity of 3,500. Work will get under way immediately and the theater is expected to be opened by October 1.

Long-Run Musical Play Records Appear on Page 62

STAGE DANCING! Buck and Wing Routine

Including Music (by mail), \$3.00. Arranged by JAMES P. KINSELLA. Pupil of Jack Blue. Private and Class Lessons by Appointment. 2530 May Street, CINCINNATI O.

Specializing in Acrobatic Instruction for Sensational Stage Dancing. GEO. COLE STUDIOS. 249 WEST 48th ST. NEW YORK. Phone C-6-2310 2435

Illustrated Book, \$1.25, Cash or M. O. Course contains Sensational Acrobatic Dancing, Buck and Wing, Bar and Stretching Exercises. Miss. Amy Mantora and Eddie Russell, both formerly N. Y. Hippodrome, are now with GEO. COLE STUDIOS, 249 West 48th St., NEW YORK

TELL THE ADVERTISER IN THE BILLBOARD WHERE YOU GOT HIS ADDRESS.

HARVEY (RUBE) SMITH is with Jack Middleton's *Top-Notch Revue* in and around Cincinnati, doing a musical turn.

FRANK ARENA and his *Pretty Baby* Company are at People's Theater in Beaumont, Tex., succeeding the Harding & Kimling Company.

MISS DAISY DeGRACE, of the *La Salle Musical Comedy* Company, is mourning the recent death of her mother at Champaign, Ill.

ANNA CONWAY, chorus producer at Dalton's Follies Theater in Los Angeles, has returned to work after seven months' illness. Miss Conway has been with Dalton Brothers for 10 years.

WILL KING chose *Love Letters* as the title of his show at the Strand in San Francisco last week, which, it was expected, would be the final week of his engagement at that house.

BOB McDANIELS, who closed a long engagement with the Pete Pate shows at Dallas, Tex., is visiting his mother in Los Angeles. Mrs. McDaniels, his wife, also late of the Pate shows, is with him.

JIMMIE WHITE, just off the Spiegelberg Time, where he closed with *The Musical Belles*, called at *The Billboard* offices in Cincinnati while on his way home to East Pittsburgh, Pa., where he planned to remain about a week.

BERT SHAW pens that he closed February 14 with *Clark Sisters' Revue* after being with the show one year and seven months, and that he has joined Irvin N. Lewis' *Nifties of Broadway* for specialties and second comic work.

DAVE BURT lately closed with Dave Marlon's show on the Columbia Burlesque wheel and joined the *Clark Sisters' Revue*. Dave wants to tell the world he is glad he is "back home in tab." and that he doesn't mean "maybe."

AFTER 20 WEEKS at the Royal Theater, Vancouver, B. C., during which all previous attendance records were broken, the Frank Morton Company has been booked for a 20-week season at the Playhouse in Victoria, opening March 2.

BILLY WILSON drops a line to say he has closed a 30-week engagement at the Palace Theater, Oklahoma City, breaking all records for that house, and that the best previous record was 12 weeks. Wilson has opened on the Corrigan Time, being routed toward Texas.

THE LOIE BRIDGE Players made their appearance in *Old Sweethearts* at the Tootle Theater, St. Joseph, Mo., and were enthusiastically greeted, a local paper declaring the company to be the strongest seen on the Tootle stage in several seasons.

DESMOND'S New York Roof Garden Revue have closed six weeks at the Columbia Theater, Casper, Wyo., and are on the Sun Time, opening at the Majestic in Des Moines, Ia. They now carry 17 people and offer vaudeville acts and a jazz orchestra.

MARGIE GRANT, late of the Baker Musical Comedy Company, Portland, Ore., has joined Dalton Bros.' *Hi Jinks Revue*, at the Burbank Theater, Los Angeles, replacing Mary Dawn, who is now with the *Birds of Paradise Revue*, another Dalton Bros.' attraction at Dalton's Broadway theater in the same city.

RALPH DAYTON has again entered tabloids, after being with Van Arnam's Minstrels for four months. He is doing juvenile leads, featured ballad singing and saxophone specialties, and reported to be going over strong. He is with the *Maid of the Mist* Company, playing Spiegelberg Time.

AS A RESULT of an extended Canadian trip by Tex Mason, traveling representative of the Detroit branch of Gus Sun's booking exchange, the exchange is now booking a theater in nearly every principal city in Ontario, besides many houses in Detroit and adjacent territory, all of which are

BILLY WILSON



Producing comedian, who, after enjoying a run of about 30 consecutive weeks at the Palace Theater, Oklahoma City, with his musical comedy company, is touring the South with the show.

TABLOIDS

By EDWARD J. GALLAGHER

(Communications to 25-27 Opera Place, Cincinnati, O.)

on the books of Jack Hubb, manager of the Detroit office.

IRVING'S Kitch Knack Company moved to Asheville, N. C., from the American Theater, Chattanooga, of which Mr. Irving writes: "Mr. Borecky is strong for tabloid and does everything possible to make the performer have an enjoyable week. My company did a remarkable business at the American, the S. R. O. sign having been in evidence six times during the week."

CASH BROTHERS' Frisco Frolic Company, which closed a 21-week engagement at the Capital Theater, Moose Jaw, Can., January 17, opened on the Gus Sun Time February 15, with nearly the same principals. The roster follows: Maurice J. Cash, Hebrew comic and producer; William Cash, straight and character; Billie Malone, Irish comic; Eleanor Pehl, soubret; Marnella Pedalaco, prima donna and character; Marie Euler, Bobbie Lomas, Pearl Jean, Rene Ellis and Blanche Doll, choristers.

JIMMIE JUKES and his *Chesterfield Girls* opened at the Palace Theater, Wortham, Tex., with a new show to succeed the Jenkins & Lawless *Pioneer Girls* Company. Jukes advises that he is featuring Joe Hegerty, "The Man From Cork"; "Good Old" Jack Wylie, and six beautiful girls in the line. Jukes announces his ambition to make it the best 11-people tab. in Texas. Principals include Thelma Lind, Ingenue; Jimmie Jukes, straight, and Joe Hegerty and Jack Wylie doing their stuff in black.

G. I. DAVIES, owner and manager of the *Tip-Top Revue*, booked over the Gus Sun Time, communicates from Franklin, Pa., reporting good business "and having a wonderful time." This tab. features Katherine Jenkins, Welsh lyric soprano; Bert (Slats) Watson, producer and comic; Willard (Smoke) Cole, comic with the "educated feet"; Earl Williams, straight; Leota Bryant, Ingenue and chorus producer; Eva Foy, soubret; Ella Anderson, Celia Elarney, Peggy Davidson, Peggy O'Connell, Betty Boyce, choristers.

DAVE EDELL and Jess Mack, "The Harmony Bugs", advise they have completed 20 weeks on the Spiegelberg Circuit with "Bill" Leitch's *Syncoated Syncoptors*, and that the show will now make a tour of the Gus Sun Circuit, having reopened at Beaver Falls, Pa., February 19. While in the South Edell and Mack scored with a double harmony act and in juvenile parts. Admirers of these boys report that they have plenty of pep and personality and that some enterprising manager likely will sign them for a production.

BUSINESS for the *Rarick Revue*, now playing Butterfield houses in Michigan, has been extra good, according to Manager Roy Sampson, who announces that the week of February 1 at the Majestic in Jackson, Mich., saw every record for the house smashed. Manager Franks was so impressed he booked the company for a return date. The same thing happened at the Gary Theater in Gary, Ind. Chas. Southern, well-known dancer, is one of the dancing features with the show, which now has 25 people recent additions being Jack Shackleton, orchestra leader, and Mr. and Mrs. Abby, late of the *Listen to Me* Company.

BEN MATTHEWS writes from Durham, N. C., that the *Hyler Revue* is now in its 16th week on the Spiegelberg Time, and during the last five weeks has played to capacity houses. Mr. and Mrs. Matthews will be on the show, he states, until the bluebirds sing, then North, where Ben operates his family circus and vaudeville show under canvas. While playing Spartanburg, S. C., Ben had a family reunion, the Musical Morrrows and Babe Matthews being over from Charlotte, N. C. The Matthews and their three children travel thru the country in their closed car, and claim roads are fine in the South.

GEO. E. WOODBURY saw the *Jimmie Brown Musical Revue* at the Maxine Theater, Martinsville, Ind., and writes: "The show is well up to the standard. The Sunny Southern Four are good, and the O'Brien Brothers, James and Edward, are hard to beat when it comes to dancing. The show had to work under bad condi-

tions all around, but, nevertheless, it went over every night. J. C. Murphy, musical director, is confined to bed by lumbago and was not able to go to Bicknell, Ind., for the engagement at the Colonial this week. At present I am Mr. Murphy's nurse. I open April 6 with the Lew Conn show in Kentucky."

LEO AND BOBBIE MULLARKEY write: "Just joined our old friends, Vic and Buddy Vernon, in Toronto. Vic is managing and producing the show, which is now in its third week and has a five months' contract. We are doing one show a night and none on Sundays. It's more like a vacation, after doing five a day in Denver. The show is doing banner business, notwithstanding the fact that there has been a bread line two blocks long every morning due to unemployment here. There are two legitimate tab. houses and three rotary stocks playing in and about Toronto at present, and all seem to be doing good business."

AFTER A 10 WEEKS run at People's Theater, Beaumont, Tex., the Harding & Kemling Company closed February 14, to open an indefinite engagement at the Elks' Theater, Port Arthur, Tex., for John C. Pitman. The company includes Harding and Kemling, comics; Jack Lewis, straight; Elsie Pevateux, soubret; Marie Montrose, prima donna; Tim Moore, general business; Bert La Dell, specialties; Mary Fulgum, Vineta Gibens, Beula Gibens, Dare Lewis, Inez Bell, Anna Buttons, Emma Brown, chorus. The Island Quartet consists of Tim Moore, bass; "Skinny" Kimling, tenor; Eddie Eckland, baritone; "Fat" Handlin, lead. A five-piece orchestra also is a feature.

A MOST SUCCESSFUL 10-people miniature musical comedy is *Boozo's Revue*, of Milwaukee, playing outlying picture houses and the Wisconsin Roof Garden. This company has been working steadily since September 15, and is booked until July 1. Never in Milwaukee has a similar show been so successful, it is reported, the big results being due to the efforts of Manager Larry Ball, producer and comic, and George De Syrette. The cast embraces Laura Schmitz, musical director; Helen Schuette, soubret; Alice Boyce, Ingenue; Lucille Craney, Mabel Storm, Ruby Reid, Helen Reltz, chorus; Eric Feldman, general business and straight; Geo. De Syrette, comic; Larry Ball (Boozo), comic; Andy Schmitz, business agent.

MARY BROWN has joined her husband, "Doc" Paul, at the Orpheum in Paducah, Ky., and they have merged their shows, *Mary Brown's Tropical Maids* and *Mary Brown's Kicky Koo Revue*. They will remain in Paducah for a few weeks, after which the Orpheum will be closed for redecorating. *The Paducah Evening Sun* had a lengthy notice of the show February 13, saying in part: "The consensus is that 'Doc' and Mary get better and better as the days pass. They are a sure cure for the blues, Memphis or otherwise, and as an antidote for gout, sleeping sickness, somnambulism and disappointment in love there is nothing comparable. We defy anybody to prove that 'Doc' isn't as good a comedian as Charlie Chaplin."

THERE WAS MORE than a hint of New York's Broadway on a recent Sunday in Dallas, Tex., as the result of Pete Pate, well-known producer, and Leon Miller returning from the big town and putting on a tabloid extravaganza that never before had been seen nor even expected in the Texas metropolises. The pair was sent to New York to review practically every show in the city, talk to producers and to get ideas and music for forthcoming productions. The first of these to be staged was billed widely as *Bringing Back Broadway*. Leon Miller, who directs the Jefferson Theater chorus in Dallas, conferred with Ned Wayburn and later promised Texans some interesting dances, it is said. They certainly do things up right in Dallas!

VERY FAVORABLE was the judgment pronounced on the work of the *Some Show* Company, under the management of Alex. Saunders and Doug. Fleming, which occupied the boards at the Hippodrome, Covington, Ky., last week. Mr. Fleming is well remembered as a

former member of the All-Star White Minstrels. His wife is in the costuming business in Cleveland, O., and the remarkably pretty hand-painted drops carried by Saunders and Fleming are her work. Saunders is the principal comic; Doug. Fleming, straight; Charles Nielson, characters; Ed. Walzer, second comedy; Marty Begley, juvenile; Blanche Lee, Ingenue; Anita Ereell, soubret; Mrs. Leona Diekey, musical director; Dot LeDuc, Mollie McCarthy, Luella Ereell, Eleanor Pfeifer, Dot Willis, Lucy Willis, Pauline Thompson and Delia Wallace choristers.

AL TINT, yodeler, has been with Don Davis' *Dancing Dolls* Company for the past three weeks as an added feature, he writes, having opened when the show started on the Spiegelberg Time at the American Theater, Chattanooga, Tenn. Tint is scheduled to be in New Orleans, La., for the Mardi Gras festivities. Tint reports the cast as: Davis, producing black-face comedian; Charles Houston, second comedy; Jack Wright, straight and general business; Tint, characters and yodeling specialties; William Terrell, general business; Pearl Davis, soubret; Nellie Houston, Ingenue. Al says Fred and Bennie Wayland did not join the show in Chattanooga as it was announced as the intentions of the boys in a visit to *The Billboard* offices and recently reported in these columns. The chorus: Mildred Woods, Mabel Tint, Ora Staberry, Lorain Deion, Ethel Smith, Bessie Emmet and Julia Christy.

GAIL HOOD and wife, the former a comedienne on Fred Hurler's *Big Town Revue*, called at *The Billboard's* Cin-

Be a Booster for Milt Schuster

WANTED—People in all lines. Chorus Girls at all times. 36 West Randolph St., Chicago, Ill.

AT LIBERTY—PIANO DIRECTOR For immediate engagement. Arranger and composer. Anything from Burlesque to Grand Opera. Years of experience on the road. Address CHAS. C. OST, Phoenix Hotel, Warsaw, Georgia.

WANTED, MUSICAL TABS. Must have six changes for week. Wire latest salary for immediate bookings. TOM MORROW, Bennett Theatre, Logan, West Virginia.

SOLADAR & MYERS THEATRICAL BOOKING AND PRODUCERS. 305 Shubert Theatre Building, Philadelphia, Pa. Placing people for Musical Comedy, Tabloid, Vaudeville, Circus, etc. Tab. Shows of 12 to 15 people, get in touch. Chorus Girls wanted at all times.

WANTED

Chorus Girls. State age, height and weight. ALEX. SANDERS, Grand, Washington, Ind.; week March 2, Grand, Bloomington, Ind.

Wanted, A-1 Chorus Girls

For Tab. Also Straight Man, Character Woman and Comedians. Wire H. A. POSTON, Pearl Theatre, Ft. Worth, Texas.

JOIN ON WIRE

Strong Specialty Team, also Team, man Second Comedy numbers, wife Chorus. Not over 5 ft., 3. Chorus Girls. Other people write. Don't misrepresent. Show booked solid over Sun Time. BILL WILKS' MIDNIGHT BANTAMS, Bennett Theatre, Logan, W. Va.

MILLER THEATRICAL COSTUMIER 236 So. 11th St. PHILA., PA. COSTUMES-WIGS ETC. TO HIRE FOR ANY PLAY (ANTATA-OPERA-TABLEAUX ETC. CATALOGUE & ESTIMATE FURNISHED

AT LIBERTY

LEADING OR SECOND BUSINESS WOMAN. age 24. Ingenue type. HEAVY. CHARACTER OR GENERAL BUSINESS MAN. 94 Specialties. All essentials.

JOHN T. PEARSON, Wallace Theater, Bradenton, Fla.

WANTED

FOR JENSEN'S ALL-AMERICAN GIRLS REVUE

People in all lines for Tab. CAN USE medium Chorus Girls. Salary sure, so make it right. Also people for tent show. Opening middle of April. Friends get busy, as this is sure. LEW LUTHELI, Lakeland Hotel, Pauls Valley, Oklahoma.

WANTED

For LaSalle Musical Comedy Co.

Blackface Comedian, strong, to feature. Must sing and dance. Wife Soubrette, who can put numbers over. Pop and singer, juvenile man, tenor or baritone, who can lead good, fast girl numbers. Must dance. CAN USE other useful people. Indiana Theatre, Bedford, Ind., week Feb. 23; Crystal Theatre, Anderson, Ind., week March 1.

Wanted Musical Comedy People In All Lines

... For ...

"The Piccadilly Revue"

Misrepresentation means instant cancellation. Artists doing Specialties given preference. Versatile Comedian. Prima Donna, Ingenue, Quartette who can play Paris, Dancing Team who can do Apache or Tango Specialty and eight fast-stepping Chorus Girls. Apply to E. V. CUPERO, Suite 304 Putnam Bldg., 1493 Broadway, New York. Phone. "Lackawanna 6679".

cinemat home while playing at the Hippodrome Theater, Covington, Ky.

ORTH AND COLEMAN'S *Tip Top Merry-makers* Company recently opened a two-weeks' engagement in Manitoba, and, judging by newspaper stories, met with splendid reception.

PAUL MILLER, musical director and an old-time friend of Nick Wilkie, visited the latter in Braddock, Pa., a short time ago.

A SONG ENTITLED *Save a Little Drop for Me*, written by Marshall Walker, manager and featured comedian of the *Whiz Bang Revue*, was used recently in a minstrel presentation given under the direction of "Slim" Livingston in Muncie, Pa.

SEVERAL RETURN dates have been played of late by (Jolly) Jew Williams and his *Chic Chic Revue*, including the Crescent Theater, Perth, Ontario, Can., and the Park Theater, 44th street and 5th avenue, Brooklyn, N. Y., for a third time.

CLARA LARINOFF, accomplished danseuse, now heads a ballet which has become one of the better advertising features for the Will King Company at the Strand Theater, San Francisco, we are advised. Howard Evans is putting on the dance numbers.

ROSE JACOBS and Betty Pyne have replaced Billy Hatt, impersonator, and Muriel Rose in the chorus of Hurley's *Jolly Follies*. The show is booked in West Virginia on the Gus Sun Time for about six weeks, to be followed by return dates in Pennsylvania.

FRED NEELEY, late of the Vogel & Miller show, visited Young's *Frivolties* show when the company played a week recently at the Lyric Theater, Braddock, Pa. Neeley and wife are working in and around Pittsburgh, in vaudeville, but probably will be back in tabloid before long, it is said.

CLYDE BUEHLER is reorganizing his *Follies* of 1925 show in Ashland, Ky., and writes he will take to the road again shortly. He will use his old title of *Buehler's Speed Queens*. "Rusty" Barton and wife have been replaced by George LaCroy and wife. Tom Dodd also has joined lately.

"CHICK" WARD and Eddie Kinloch have been replaced by Willard Dyer and Essie Calvert, late of Mury Brown's *Tropical Maids* Company, on Lewis Bros.' *Palm Garden Beauties Revue*, which has returned to the road for a tour of the Gus Sun Circuit after a stock engagement at the triphammer Theater, Marion, O.

J. J. DEVOL informs that he has started something "which will never die", being musical comedy presentations in the Dewey Theater, Minneapolis, Minn. Despite opposition "just across the street," he pens, "we have been standing 'em up." Musical tabloids seem to have a great future in the Twin Cities.

KITTY WARGO and Nina Uttrup, choristers, late of Arthur Harrison's *Big Lyric Revue*, joined Harvey D. Orr's *Honeymoon Misses* Company in Kokomo, Ind. Bessie Deno, character woman, who formerly was identified in repertoire circles with a stock company bearing her name, also has joined.

CHET EMPELBY, manager of the Sunny Southern Four, quartet identified with *Jimmy Burns' Big Show*, advises that the four singers have opened for the Burton Booking Agency in Indianapolis, for a number of dates, with the Bentley Time to follow in and around St. Louis.

HELEN YORK, chorister, closed with Fred Hurley's *Big Town Revue* at Covington, Ky., and left for her home in Cleveland, O., where she rejoined her husband, H. Van Boxell, non-professional. Catherine White, of Connersville, Ind., who was expected to take Miss York's place, worked on the show before.

NICK WILKIE has settled in Braddock, Pa., for an indefinite period, according to "Slim" Williams, featured comedian in Harry Young's *Frivolties* Company, who makes his deductions "judging," he says, "by the way Nick has made friends in that town." Nick is in business in Braddock and is well-known on the Joe Spieglerberg Circuit.

IN BOB FAGAN'S *Texas Steppers* Company are Fagan, principal comic; Gene Fagan, straight and general business man; Harry Brewster, general business, and Rose Fagan, characters. The chorus: Ruth Brewster, Edna Sellars, Agnes Smith, Martha Hopkins and Jean Holston. Ralph Holston does second comedy and specialties.

DANCING CONTESTS, in which the waltz and fox-trot are done by couples from the audience appearing on the stage, lately have proved popular at the Rialto Theater, Covington, Ky., the plan originating in that house thru Steed and Frank managers of the *Bijou Musical Comedy* Company, a Cincinnati rotary tab. Attendance has been greatly increased by this stunt, it is said.

FLETCHER SMITH, writing from Beaumont, Tex., states the *Diamond Musical Comedy* Company has opened an indefinite engagement at the Kyle Theater in that city, playing in opposition to the Harding & Kinling Company at the Peoples Theater, the only union house in

A never failing Attraction in Your Theatre

American Seating Company Theatre Chairs

TABLOID MANAGERS

Exceptional Offerings in DRAPERY SETS, DROP CURTAINS, SATINE FRONT CURTAINS, SATINE CYCLORAMAS, VELVET AND VELOUR DROPS, ETC. Get Our Low Prices.

NOVELTY SCENIC STUDIO 220 West 46th Street NEW YORK CITY.

THE GUS SUN BOOKING EXCHANGE CO.

MAIN OFFICE: New Regent Theatre Bldg., Springfield, O.

Branches: NEW YORK CITY, 311 Strand Theatre Building. CHICAGO, ILL., 806 Delaware Building.

Beaumont. The *Diamond* show succeeded the Wesselman Stock Company, which was at the Kyle since the first of the year.

POWERS AND BELVILLE have joined hands as owners and managers of *Casey's Ginger Girls* Company, playing thru Dixie. The team works comedy together while Lillian Powers is prima donna, Monilze Moore, soubret; Harry Bacon, character man; Lester Moore, straight man, and Frank Stevens, pianist. The chorus: Opal Smith, Ruth Brown, Hazel Kinslow, Rosalie Hammond, Muriel Davies and Charlotte Clark. The show is booked on the Corrigan Circuit.

WILL KING, San Francisco showman, is calling back to his company at the Strand Theater many of the favorites who were with him at the Casino Theater in that city four years ago, among whom is Clara LaValle, the "miniature Eddie Foy", the latest to return to the fold. She made her debut recently in *The Wrong Room*, a typical King revue, big and elaborate. Alma Astor and Jackie Adair are other members who have rejoined.

WHEN YOUR SHOW completes a week's engagement in a city do you leave a forwarding address for your mail with the local postmaster? It is suggested the show managers have a typed roster of the company ready to present the

post-office department along with a few weeks' route, so mail may be given the attention it rightfully deserves. This will lessen the chances of the mail of tabloid performers going astray, as is so often the case these days. Bear this in mind.

BENNIE KIRKLAND'S *Radio Revue* continues to do capacity business at Sam Lee's Gem Theater, Little Rock, Ark. Silliman and Miller, who recently closed, have been replaced by The Dancing Warrens, Floyd and Doty. The cast now includes Walter Nicols, straight man; Kenney Brenna, comic and general business; Bennie Kirkland, first comic and producer; Lillian Mack, ingenue and blues singer, and a chorus of eight. Script bills are presented with special scenery and musical scores.

AFTER OPENING January 11 at the Lyric Theater, Ft. Wayne, Ind., for an indefinite engagement, the *Danny Duncan Players'* roster now includes Duncan as principal comedian; W. R. Sutherland, manager and producer; Frank Hughes, straight; Jack Miller, juvenile; Jack Sexton, characters; Mrs. Danny Duncan, ingenue-prima, and Edna Cable, soubret. A quartet is comprised of Jerry Cox, bass; Tommy Griffin, tenor; Jack Miller, lead, and Duncan, baritone. BeBee Freeman is chorus producer, and Bobby and Gladys Conn do dancing specialties. The

chorus: BeBee Freeman, Betty Fair, Margaret Thornburg, Faith Ryan, Bessie Moyer, "Pinkie" Laughlin, Ellen Phillon, Marjorie Carter, Celia Miller and Gladys Conn.

FRED CARMEL'S *Musical Show* now is in its eighth week at the Plaza Theater, Ft. Dodge, Ia., it is reported. In the company are Jeanne Dixon, characters and managers; Freddie Walker, first comedy, singer and dancer; Shirley Green, parts and specialties with her husband, Mr. Walker; Harry Ferguson, straight; Cassie Ferguson, parts and chorus, and Paul Mahar, straight and character man. The chorus: Bone Mahar, Lella Archer, Flo Adel, Babe Bassor and Patty Jensen. Al Adel is pianist, he writes.

EXCELLENT PRESS notices and reviews have been given the cast and chorus of Golden & Long's *Buccini's Around Company*, now playing at the Globe Theater, Philadelphia. The company is being held there three weeks, by popular request. The Globe plays several acts of vaudeville, motion pictures and a tabloid show on its 3-in-1 policy and is operated on the Keith Time. Max Golden is back with the show after a trip to Boston, on account of the illness of his mother. In the company are Golden, Marvel Shackleton, Norma Fair, Mildred Steel, George Hill, Alan McDonald, Bob Fay, "Doc" Dorman, Carl Park, Bessie Belt and Snyder and Ramsey, hoofers. The chorus: Vera Fair, Louise Long, Betty Steel, Gypsy Queen, Ida Goldbeck, Dolly Belt, Hanna Goldbeck, Billie Lohr, Esther Dorman and Florence White. Bobby Golden is doing impersonation specialties. Ted Stover is musical director.



Schilling Auto-Camp THE QUICK AND EASY WAY

A perfect bed. Frame constructed of pressed steel, all parts attached. Only Mattress Fabric with supporting elements and resting surface woven into one complete unit. Not the canvas cot type, but a real sagless spring mattress. CAN'T TANGLE OR KINK. Waterproof tent. Outfit set up or collapsed in 3 minutes. NO BEDS TO TOTE. NO STAKES TO DRIVE. Furnished either set up with or detached from car. FROM FACTORY TO YOU.

For 1925 Catalogue address Dept. N. L. F. SCHILLING CO., Salem, Ohio.

H&C THEATRICAL ROOM 2 E.&C.BLDG. DENVER, COLO.

Musical Comedy of exceptional talent, principals and chorus, wanted at all times.

COLLINS' "COMICAL" COLLECTION OF MOCK TRIALS. 11 Courtroom Scenes, in Dialect, 25c. COLLINS CO., 197 Fulton Street, Brooklyn, N. Y.

"BECOME A LIGHTNING TRICK CARTONIST" Write for Free Big Lists of Chalk Talk Programs and Supplies. BALDA ART SERVICE, D-2, Oshkosh, Wisconsin.

AT LIBERTY Comic and Chorus Girl

Black, Jew, Eccentric and Light. Top Tenor or Baritone. Produce if wanted. Girl, 5 ft., 4; 20 years old. Lead numbers. Strong Specialties. JIMMY WHITE, East Pittsburgh, Pa.

WANTED Stock Engagement

To open March 2. Musical Tabloid, featuring KATHLEEN LEE, World's Champion High Jumper, official, and a young, fast-scrapping chorus. 8 rpt bill, change twice a week. 12 People. 12. The show then brings the business. BRENNAN'S BROADWAY THEATRE, Art Thornton, Manager, 824 North Clark St., Chicago, Illinois.

MADISON'S 18 BUDGET No. 18 ONE DOLLAR

The encyclopedia of comedy material that gives universal satisfaction. Contents include an almost endless assortment of bright sure-fire monologues, acts for two males, and for male and female, parodies, 200 single gags, minstrel first parts with finale, a sketch for four people, a tabloid farce for nine characters, etc. Send your dollar to L. J. K. KEIL, Business Manager of MADISON'S BUDGET, 1052 Third Ave., New York.

WELDON WILLIAMS & LICK TWO COLOR TICKETS FORT SMITH, ARK.

BURLESQUE

CONDUCTED BY ALFRED NELSON

(Communications to 1493 Broadway, New York, N. Y.)

Combination Show Colored Section of Hurtig & Seamon's Show Reviewed

New York, Feb. 20.—As announced in our last issue Hurtig & Seamon, managers of the Hurtig & Seamon 125th Street Theater, presenting Columbia Circuit shows, have completed arrangements whereby they will augment the *Fast Steppers* Company, a Columbia Circuit show, with a colored company in combination with a white company. The latter company was reviewed in detail in this publication at the time of its presentation at the Columbia Theater. A review of the colored company's presentation this week, by J. A. Jackson, follows:

The colored section of the performance was provided by George Immerman's Connie's Inn floor show and the Leroy Smith Band of that club, with which the public has become well acquainted thru the medium of its weekly radio programs. The show worked in full stage, with the orchestra seated upstage in a fancy interior.

House patrons have become accustomed to the pep and speed that characterize Negro choruses and know what to expect in this direction, so there was no surprise in that connection. The significant features of the hour and a half of this group was the total absence of talk save for the 50 words of introduction by Leonard Harper, producer and principal. Even this proved to be but the gentle leadup to a song number that served to introduce the chorus.

The next particularly noticeable feature was the dainty and uniform beauty of the 10 choristers. It was a nice collection of octoroon pulchritude that has been presented anywhere. The management had exercised taste and used a tidy sum in costuming the choristers.

The act opened with the band, under Leroy's direction, doing two jazz numbers after the conductor had acknowledged a reception band. Harper's speech ended with a song, *Nothing New Under the Sun*. Julia Moody followed in a mammy characterization, singing *There's Only One Mammy*, supported by four boys, who later danced to the refrain. The choristers followed in an old-fashioned minuet, costumed as was Miss Moody, minus the makeup indicating old age.

Wheaton and Bradley, dancing team, then hit up some steps that went over well, the smaller of the two being especially favored with applause.

An orchestra number was put in at this juncture, one that permitted the several musicians to demonstrate their individual abilities. "Fats" Waller, a round and genial-looking pianist, straddled the white with his eccentricities at that instrument.

Mexico, a costumed number, with Leonard Harper doing a dance number, was next and the colorful bit served to establish Bessie Allison as a little dancing mistress of a unique type for whom there is every reason to expect a great future. She has grace, piquancy and a nice mastery of her steps.

Billy Mitchell, "the boy with the insane feet", whom the audience thought must also be otherwise insane, simply riled them with his nonsensical delivery of *Sweet Iodine* and *My Little Dog* and his peculiar dances, made possible by his double-jointed ankles. The dance team and a chorus number, featuring *The Charleston*, followed him after he had declined encores.

Then came the Three Eddies, and those bespectacled black-faced boys walked away with their auditors. They sang and danced, substituting grotesque mimicry for talk which was equivalent to a big drink minus the froth.

Then the girls, this time in the familiar Hawaiian number made famous by the Florence Mills Company, leading to a finale that sent the folks away pleased, a fact that was indicated by comments freely passed between departing patrons.

It was just a period of singing and dancing, the orchestra working continuously from beginning to end.

Miss Moody did another number prior to the finale that gave opportunity to show her youth as well as her vocal ability.

The cast: Leroy Smith's Band, Leroy Smith, conductor; Leonard Harper, Toseh Hannid, Lloyd McDonald, Billy Mitchell, Julia Moody, Harry Duckert, the Three Eddies, Bessie Allison, J. Bradley, Dick Wheaton, Goldie Cisco, Lucille Smith, Jack Branch, May Fortune, Doty Irving, Billy Kelly, Clara Titus, Hazel Anderson, Alberta Smith and Alice Allison.

Feminine Stars for Mutual Next Season

New York, Feb. 16.—Emphasizing his belief that patrons of shows on the circuit of the Mutual Burlesque Association will appreciate a greater number of feminine stars and featured players next season, President I. H. Herk has announced his intention of engaging a number of prominent women to head Mutual shows. Analysis of the receipts of the various companies during the current season has disclosed the fact that with very few exceptions the shows in which women were prominently featured attracted the best gross receipts all along the line.

During the past few days Mr. Herk has either definitely engaged or effected tentative arrangements to star or feature Evelyn Cunningham, Kitty Madison, Mona Raymond and Jossie Rice next season. It is understood that other artistes widely and favorably known are being considered for similar honors.

In discussing the reasons that have led him to this conclusion Mr. Herk pointed out that from the moment of his association with Mutual he had declared his policy to be the presentation of real burlesque as that term was generally understood. He has repeatedly stressed his repudiation of any attempts on the part of Mutual producers to present feeble and colorless imitations of musical comedy and insisted upon their adherence to his policy of real burlesque. The amazing success of the Mutual Circuit this season is believed by Mr. Herk and his associates of the directorate to be directly traceable to this resolve.

The formation of shows of the type that have found the greatest favor during this season has included feminine stars or featured players, according to Mr. Herk, and the attractions that have appeared to reach the best average receipts were those in which Anna Toebe, Marjorie Pennington, Milla Germaine, Betty Palmer and a few others were prominent in all the advertising.

It is a historical fact that the first and most successful burlesque shows presented in this country were headed by feminine stars, of whom Lydia Thompson, Alice Oates, Elsie Holt, Alice Dunning Lingard, Pauline Markham, Ada Harland and Liza Weber were the pioneers.

Justifiable Promotion

When a reviewer of burlesque spots a chorister who distinguishes herself sufficiently to warrant favorable comment, and touts her as a prospective soubrette, it gives him more confidence in his own judgment when a producing manager of burlesque coincides with his view. This is especially applicable to Anne Darling, whom we referred to in a recent review of Manheim's *Road Box Revue* on the Mutual Circuit, viz:

Ann Darling is not conspicuous on the program, but she should be, for seldom have we seen a singing and dancing soubrette of her apparent youth with more winsome beauty, talent, ability, pep and personality, and if this attractive kiddie is not a featured soubrette ere long it will be because Manheim is blind to the possibility that in all probability will be grasped by some more discerning producing manager.

We are now informed that Sammy Krause, house manager for Dave Krause at the Olympic Theater, New York, presenting Mutual Burlesque shows, has signed Miss Darling to be a featured soubrette in his show on the Mutual Wheel for next season.

Wells and Thompson's New Play

New York, Feb. 18.—William K. Wells, franchise-holding producing manager of *The Red Pepper Revue* on the Columbia Circuit, likewise well-known writer of bits for Broadway producers of musical comedies, is now collaborating with Fred Thompson, author of *O Lady, Be Good*, in the writing of a new production for Broadway.

Pecks in Florida

George E. Peck, franchise-holding producing manager of the *Hippity Hop* show on the Columbia Circuit, was confined to his home at Ridesfield Park, N. J., for the past two months, but has recovered sufficiently to accompany Mrs. Peck to Florida, where they will visit several of the larger cities during the next eight weeks in the hope that Mr. Peck's health may be benefited.

MYRTLE ANDREWS



Leading lady-prima donna in Michels & Bentley's "Step Lively Girls" Company on the Mutual Burlesque Circuit.

Myrtle Andrews

A Scotch Kiddie and Amateur Contester, Who Has Won Fame and Fortune in Burlesque

Miss Andrews is a native-born Scotch Highlander, who accompanied her parents to this country when she was six years of age, at which time they settled in New York, where Myrtle received her early schooling and training, including singing in the choir and taking part in church entertainments, under the direction of a Baptist minister.

Being successful as a church entertainer Myrtle took active part in amateur contests in local theaters until she became sufficiently proficient to warrant her appearance as a vocalist in cabarets. This eventually led to her engagement as a singing ingenue in Fox & Stuart's *Keep Moving* musical comedy company on tour, in which she was seen by Joseph Oppenheimer, at that time manager of the *Broadway Belles*, on the American Circuit, who engaged Myrtle for the role of ingenue-prima donna. She remained under his management for seven successive seasons ere she accepted a similar engagement with *Sliding Billy Watson* and then with "Uncle" Bill Campbell for his *Youthful Ballies* on the Columbia Circuit last season.

Being offered a leading lady prima-donna role by Julius Michels and Harry Bentley for their *Step Lively Girls* on the Mutual Circuit, Miss Andrews joined that company at the opening of the current season and a review of her appearance in that company was published in a recent issue of *The Billboard*.

Miss Andrews has no aspirations of becoming a golf champion, but she is a leading outdoor sportswoman of burlesque and the only woman known on the Mutual Burlesque Circuit to be the owner of racing horses, for with the well-known Scot's ability to save money Miss Andrews saved sufficient of her salary to purchase the race horse "Crestwood", with Dee Hammond as trainer, which has won numerous races and enabled Miss Andrews to purchase "My Destiny" and "Wildlife", now running at New Orleans.

More Runways

New York, Feb. 18.—James Sutherland, manager of the Empire Theater, Brooklyn, has installed a runway in that house, which went into operation Monday with the presentation of *Tals a Lad*. What effect the runway will have on business at the Empire is problematic, as the Monday night audience evidenced little enthusiasm over the innovation.

There is every indication that a runway will be installed in the Gayety Theater, Washington, D. C., playing Columbia Circuit shows.

Pessimists Turn Optimists Increasing Patronage Converts Showmen

New York, Feb. 20.—Pessimistic producers on the Columbia Circuit have become optimistic during the past week. Reports reaching the Columbia Amusement Company are to the effect that while midnight shows in several cities have been bloomers, the rank and file of the companies are playing to an ever-increasing patronage.

Jimmie Cooper's "Beauty Revue"

Reports reaching Columbia Corner had it that Jimmie Cooper and his *Beauty Revue* at the Gayety Theater, Pittsburgh, had broken all records for 12 performances on the week, but there is reason to believe that Clark and McCullough, in the original *Peek-a-Boo* several seasons ago, broke all records at that house for 12 performances and that their record still holds good.

"Seven-Eleven" Colored Company

Hurtig & Seamon's *Seven-Eleven* all-colored company did big business at the Star and Garter Theater during the past week.

Mrs. Hastings Visits Revue

Mrs. Harry Hastings visited the *Silk Stocking Revue* Company at Montreal during its week's engagement there and satisfied herself that the show would fulfill all the requirements of the Columbia Amusement Company for its presentation at Lewiston, Me., where the *Silk Stocking Revue* opened the new three-day stand on the Columbia Circuit last night.

Reports to the Columbia Amusement Company evidence the fact that the theater was taxed to capacity by an appreciative audience.

Chief among those present were the chief executives of the town and several of them, when called upon for a speech, appeared upon the stage to commend the performers for their clean and clever presentation of burlesque and thank the patrons for their attendance.

Eddie Shifer, manager of the *Silk Stocking Revue* Company, resigned at Utica, N. Y., and was succeeded by Charles Falk. Shifer is now making his headquarters at the Hastings office in the Columbia Theater Building.

Weedon Resigns Management

Jimmie Weedon, an appointee of the Columbia Amusement Company for the house management of the Jefferson Theater, Portland, Me., has resigned and returned to Columbia Corner. While Jimmie is non-committal as to his reasons for giving up a lucrative position, close friends say that Jimmie found the climate and local conditions entirely too frigid for his Irish temperament.

Mina for Movies

[New York, Feb. 16.—During the engagement of Morris & Bernard's *Step Along* Mutual Circuit Company at the Star Theater, Brooklyn, a casting director of the Famous Players' Studio visited Sam Daymond, directing manager of the Star, and while taking in the *Step Along* presentation spotted Mina Bernard, the pretty, petite singing and dancing soubrette of that company, in a characteristic costume number singing *Sally*. He was so favorably impressed by her personality, talent and ability, and especially her characterization, that he immediately sought an interview with Manager Benjie Bernard, the father of Mina, and arranged with Benjie to have Mina visit the studio on Long Island for the purpose of having a test picture made of her in order to see if she would come up to the director's expectations as a prospective screen star.

Humanitarian Spirit

Some time ago this publication called the attention of burlesquers to the fact that they could do an act of humanitarianism by helping cheer into the lives of many unfortunates in hospitals and penal institutions, and it is gratifying to note that many of the shows have acted on the suggestion and have given up the time that could otherwise be devoted to their own recreation in entertaining the unfortunates in various institutions.

Among those who have done so recently are members of Ed. J. Ryan's *Bomb the Town* Company, on the Mutual Circuit. During their engagement at the Lyceum Theater, Elmira, N. Y., they entertained inmates of the State reformatory.

MUTUAL CIRCUIT

Prospect Theater, New York

(Reviewed Tuesday Evening, February 17, 1925)

VIOLA ELLIOTT and Her

"Bashful Babies"

Featuring BOB (BOX-CAR) BENNIE NUGENT

A Mutual Burlesque attraction. Book by Bob Nugent and Joe Perry. Dances by Ethel Bartlett. Presented by Joe Perry week of February 16.

CAST: Viola Elliott, Ethel Bartlett, Mary Delight, Jimmy Lennon, Harry N. Rose, Lloyd Collyer and Bob Nugent.

CHORUS: Emily Austin, Mary Anderson, Margie Carron, Buddy Damsy, Marian Farham, Tootsie Kurns, Sally Martin, Betty Richter, Helen Harris, Jackie Keller, Vera McGovern, Billy Whitney, Dotty Purcell, Ruth Harmon and Evelyn White.

REVIEW

The scenic and lighting effects of this presentation evidence good care since the opening of the season, for it is colorful and attractive and the same is applicable to the gowning and costuming.

Viola Elliott is a pretty face, mod-estly formed,碧翠 eyes, bob-brunet soubret, full of pep and personality and the life of the party in leading numbers and in specialties.

Bob Nugent, comique-in-chief, is doing his customary tramp characterization, in which he sings, dances and puts over his dry, droll, humorous laugh-evoking lines with telling effect, and never have we seen Nugent heretofore handle his material as cleverly or as cleanly as he does in this presentation.

Lloyd Collyer, a manly appearing com-ique in a somewhat different tramp characterization than Nugent, has an ingratiating smile that makes him like-able, and as a foil for Nugent he is par-excellence and gives every evidence of the ability that goes to the making of comiques-in-chief.

Jimmy Lennon, a nattily attired, clear-dictioned straight man, not only feeds the comiques well, but as a sweet singer of Irish songs he is in a class by himself.

Harry N. Rose is a classy appearing juvenile straight and in minor characters works well in scenes, leading numbers, singing and dancing and in a singing and dancing specialty.

Mary Delight, an intellectual, refined-appearing ingenue, working in scenes, evidenced previous dramatic training and in leading numbers reveals a sweetly modulated voice, and in a specialty with Lennon sings in harmony.

Ethel Bartlett, a pretty, petite, bob-brunet, singing and dancing soubret, is full of pep and personality and has a cute little mannerism that is really adorable, and this is especially applicable to her sweet singing and nifty dancing specialties.

All three of the feminine principals stepped the show cold at different times during the presentation.

The chorus is for the most part youth-ful with pretty faces, slender forms and full of pep, singing in harmony and dancing in unison, but with not a shimmy during the entire show.

Taking the presentation in its entirety it is of the bit and number type, with the bits worked sufficiently clean and clever to please, while the numbers were

classy and colorful. It was supplemented by the principals individually and collec-tively doing specialties frequently, which included a male quartet.

Mr. Perry and Miss Elliott have given the Mutual Circuit a typical burlesque show; while not at all boisterous, is sufficiently humorous to please the general run of burlesque patrons.

Sam Howe Out of Show

New York, Feb. 16.—Sam Howe, fran-chise-holding producing manager and principal comique in Sam Howe's *Love Makers* Company on the Mutual Circuit, was taken ill during the engagement at the Prospect Theater and, on the advice of his physician, exited from the cast prior to the Saturday matinee. He was succeeded in his Hebrew comique role by his brother, Charley, who had been holding himself in readiness to sub-stitute.

Mr. Howe is now receiving medical attention at his hotel in this city.

Ed E. Daley Shows

New York, Feb. 18.—Rita and Doris, a sister act, formerly with Lena Daley's *Miss Tobacco* Company, closed their en-gagement February 14 at the Empire Theater, Brooklyn, in order to open in vaudeville on Independent time in Albany, N. Y., tomorrow.

Ed E. Daley has secured thru the Ike

Weber Agency Hazzard and Spellman to open with the Scribner-Daley *Maude* Wild Company at the Casino Theater, Philadelphia.

QUESTIONS AND ANSWERS

F. W. A.—The last heard of Milt Bar- low, the minstrel, he was still living.

L. E.—George M(ichael) Cohan, was born July 4, 1878, at Providence, R. I., the son of Jerry John and Helen Frances Costigan.

G. H.—Sylvia Ashton and Charles Murray probably are the two well-known film players in question who formerly played opposite each other on the speak-ing stage. Miss Ashton was leading woman for Murray in *Finnigan's Ball* more than 20 years ago.

S. M. R.—Raymond Hitchcock was born at Auburn, N. Y., October 22, 1871. His first appearance was in *Ingomar* on tour, 1890. Principal appearances since have been in *The Brigand*, *The Golden Wedding*, *Charley's Aunt*, *The Night Clerk*, *Courted Into Court*, *Paul Jones*, *Boccaccio*, *Dorothy*, *A Trip to Africa*, *We Uns of Tennessee*, *A Dangerous Maid*, *Three Little Lambs*, *The Belle of Bridgeport*, *The Burgomaster*, *Viviana*, *Life*, *Miss Bob White*, *The Yankee Consul*, *Easy Daveson*, *The Galloper*, *The Student King*, *The Yankee Tourist*, *The Man Who Owns Broadway*, *The Red Window*, *The Beauty Shop*, *Betty and Hitchy-Koo* of 1917, '18, '19, '20, and '21 and later in the *Ziegfeld Follies* and other musical comedies.

pany on the Columbia Burlesque Circuit, is billing that show like a circus.

George Lackos, now general agent of J. W. Johnson's *Old Reliable Virginia Minstrels*, an all-colored company play-ing thru Texas, is carrying two bill- posters in advance of that attraction.

William Wilkinson is now in advan- ce of Robert Mantell for his tour of the South.

Robert Halcott, recently with Hol- camp's *Georgia Smart Set Minstrels*, is now resting up at Memphis, Tenn., and Martin Free will in all probability do the advance work for Holcamp, opening with the close of Halcott's three weeks' en-gagement at the Lafayette Theater, New York City, en route to Philadelphia.

Col. Sam Dawson, officiating in ad- vance of Sliding Billy Watson, Columbia Burlesque company, reports a good trip and pleasant renewals of acquaintanceships after an absence of several years from the road.

Joe Flynn was in Columbus, O., re- cently ahead of *Wildflower* and a few days afterwards he was in Washington, D. C., in advance of another show, so it seems that Joe is not letting the grass grow under his feet, as *Wildflower* closed February 7.

John Hogarty in Columbus, O., man- aging Jane Cowl in Shakespearean rep- ertoire, closed their engagements and put on the new show, *Depths*.

Peter Rice in his accustomed corner of the Friars' Club is feeling better than he has for years. Since the sudden demise of "Doc" Weaver Peter has been without a playmate, as they were in- separable for years.

Tom Grady has been managing the Lena Daley *Miss Tobacco* burlesque com- pany on the Columbia Circuit.

Hank Smith, Ed Dolan and Sam Levitt are back again on Broadway after having a short season.

Lee Levitt, former agent, is now man- aging Poole's Theater in Washington, D. C. Lee entertained George Atkinson re- cently. Lee always makes agents and managers feel welcome when they visit Washington.

Wallace Sackett has closed ahead of the Sistine Choir. He returned to the stage February 14, jumping there from San Francisco.

Press Agents Advance

Conducted by ALFRED NELSON

Communications to 1403 Broadway, New York, N. Y.)

Oldtimers' Reminiscences

A meeting that could properly be called Oldtimers' Night was recently held in Cleveland when Maurice Call, Walter Leslie, Brian Golden, Frank Wakelind, Henry Dixon and Stanley Dawson got together at the Olmsted Hotel. The evening was passed with a recital of pranks and experiences of this gang covering a period of the last 20 years. Each one recited and retold of adventures in which all had participated ranging in location from the Bowery to Frisco. The days of the old Star and Havlin Circuit were gone over, others followed by experiences with one-night-stand burlesque, minstrel shows, vaudeville, musical extravaganzas, drama, stock companies and carnivals. Henry Dixon could properly have been called the master story teller of the meet- ing only every time he started to tell of some incident of the old Bowery days every one would discredit his assertions in a kidding spirit.

The T. P. R. O. A. Quill

One of the newest newspapers that has ever come to our desk is *The T. P. R. O. A. Quill*, the official organ of the Theatrical Press Representatives of America.

Every press and advance agent on tour should subscribe to this publication, as it is as indispensable to the working agent as the official *Railroad Guide*.

Tom's Tribute to Jake

The recent death of Jake Lieberman has brought sorrow to many among the fraternity that knew him so well, and this is especially applicable to Tom Henry, an attaché of the Columbia Amusement Company, likewise manager of the Gayety Theater, Boston, Mass., presenting Columbia Burlesque shows. Tom's tribute to Jake follows:

"Jake" Lieberman

It was in the early '90s when you drifted into the Davis & Knogh offices at 33d street and 6th avenue. You were a graduate of the old Madison Square

Theater billroom and had a great school- ing.

You were the brightest "kid" on the street; you knew everyone from Union Square to the Casino. The Audie and the "Half-Way" house were your fa- vorite resorts, and there was little that happened "behind the scenes" that you did not know.

You were always "welcome company", and your witty speech found ready listeners. You were the original "in- formation kid" and you knew every- body and everybody knew you.

You deserved more of the good things of this earth than fortune bestowed up- on you, always ready and always glad to help the other fellow.

There was never anyone like you and no one will ever take your place.

You won't miss us, "Jake", for when you reach the Great Rialto you will be busy greeting all the "gang" that went ahead.

But we are going to miss you, so don't forget us, "Jake". We will always remember you. —TOM HENRY.

Salter in Hospital

Col. E. D. Lambricht, editor of *The Tampa Tribune*, in the February 10 is- sue of that well-read newspaper, devotes considerable space to the sayings and doings of Col. Ed J. Salter, the self- termed "Johnny J. Jones' Hired Boy", who was stricken ill in Tampa last week and removed from his hotel to the Gor- den Keller Hospital, where he will wel- come visits and letters from friends.

William Hale is now managing De Wight Sowings' and Frank Wil- cox's Production of *Seduction*, which opened at Wilkes-Barre, Pa., February 11, for a brief tour ere going into the Belasco Theater, Washington, D. C., Feb- ruary 22, for an indefinite engagement.

Mike Morris, the able assistant of Bert Goldberg in advance of Brother Jack Goldberg, manager of Seven-Elven, the new Hurtig & Seamon all-colored com-

DIGGING GOLD

Is tedious and hard work, but ultimately profitable. Seeking the value that lies in the contents of each issue of The Billboard may require a little time, but will prove profitable in the end.

For over 25 years the showman has found The Billboard a source of profit. Are you getting the advantage it affords?

The subscription blank on another page is your opportunity.

A YEAR-ROUND GIFT

AN ARMADILLO BASKET MAKES A MOST UNIQUE GIFT.

From the hoard shell of the unusually beautiful lit- tle animals, which abound in the hills of West Texas, Armadillo baskets are made. The handle is formed by bending the tail around until it meets the mouth, where it is se- curely fastened. The illustration shows an attractive silk trimmed work basket. Our cat- alogue, showing "The Basket Beautiful", will be sent free upon re- quest.



THE APELT ARMADILLO CO., Comfort, Texas.

DEALERS—Send for our interesting proposition.

WILLIAM F. ADER
The Theatrical Lawyer
11 South La Salle Street,
CHICAGO.

THEATRICAL CUTS
THE STANDARD ENGRAVING CO. Inc.
225 West 39 St., NEW YORK.

ST. LOUIS COSTUME CO.
WIGS, COSTUMES AND TIGHTS.
For Rent or Sale.
507 N. Broadway, ST. LOUIS, MO.

Plays - Dramas

Large list of new and standard Plays, royalty and non-royalty, Comedies, Farces, Dramas, Vaudeville Acts, Stage Monologues, Specialties, Minstrel First-Paris, Skits and Afterpieces; Musical Comedies and Revues, Short Cast Bills, new and old, for Stock and Repertoire; Boy Scout, Camp Fire Girls and other Juvenile Plays, all in book form. Complete line of Novelty Entertain- ment Books for all occasions.

T. S. DENISON & COMPANY
523 S. Wabash Ave., Dept. 16, CHICAGO, ILL.

THEATRICAL, POLITICAL, COMMERCIAL PRINTING

Heralds, Tonighters, Dodgers, Tack and Window Cards, Half-Sheets, One-Sheets, Three-Sheets, Cloth Banners, Card Heralds, Letterheads, Envelopes, Etc. Type Work Only. No Stock Pa- per. Everything Made to Order. Union label. Send for price list or write, stating your requirements, for an es- timate.

GAZETTE SHOW PRINT, Mattoon, Ill.

THE NEW PLAYS ON BROADWAY

KNICKERBOCKER THEATER, NEW YORK
Beginning Monday Evening, February 16, 1925

B. C. and F. C. WHITNEY Present
The Operetta "NATJA"

Score Adapted From TSCHAIKOWSKY

By Karl Hajos Book and Lyrics by Harry B. Smith
Staged by Edgar MacGregor
Max Hirschfeld, Musical Director

CAST

Catherine II., the Czarina.....Mary Mellish
Prince Potemkin, Governor of the Crimea.....George Reimherr
Count Panin, a Courtier.....Alexander Clark
Lieut. Vladimir Stroganoff of the Royal Guards.....Warren Proctor
Natja Narishkin.....Madeline Collins
Madame Mellin, Colonel of Hussars.....Claire Grenville
Princess Lubina, Major of Artillery.....Marguerite Anstin
Baron Wronsky, Manager of the Imperial Opera.....Matthew Hanley
Ali, a Crimean Peasant.....John Willard
The Czarina's Maid.....Jamie Zucca
A Crimean Peasant.....Leon Kariavin
A Peasant Girl.....Theresa Felleg
Pages.....Bettv Archer
Ladies in Waiting.....Laura Saunders
.....Theola Vincent

Alternate for Natja, Yra Jeanne
Alternate for Catherine, Fanille Davies

Court Ladies, Courtiers, Pages, Officers,
Cossacks, Men and Women of the Crimea.
Period—The Reign of Catherine II.

The visit of the Czarina to the Crimea and
the city built of scenery is founded on history.
Synopsis of Scenes

ACT I.—Reception Room in the Winter Palace
in St. Petersburg.
ACT II.—In the Crimea. On the Banks of
the Dnieper.
ACT III.—The same.

Two things stand out prominently in
Natja. One is the beautiful music. The
other is the deadly book.

The Whitneys may have had a grand
inspiration when they conceived the idea
of drawing upon Tschaiakowsky for the
musical nucleus for their operetta, but
they certainly must have suffered a grand
relapse when they permitted that wonderful
music to be invested with such an
atrocious book.

The trouble with the book of Natja
is that it is neither dramatic nor eventful,
neither well written nor humorous,
and neither consistent in locale and dialect
nor convincing in character portrayal.
Some of the weak characterizations may
be due to poor acting, it is true. But
even the best kind of acting could never
lift the libretto out of its rut. The acting
has nothing to do with the fact that some
of the lines start out in Russian court
style and wind up in American slang, nor
for the fact that vaudeville crossfire,
puns and other strictly American hokey are
resorted to in order to provoke a few
laughs. The atmosphere fluctuates so
feverishly that it is often hard to tell
whether the piece is an operetta, a musical
comedy, a farce, an opera or a comic
opera. There is a little of each in it.
Even some burlesque.

As far as the score goes Karl Hajos
did a creditable job. He took parts of
the Nutcracker Suite, the 1812 Overture,
Eugen Onegin, the March Slav, the
Patetique and the Fourth and Fifth
symphonies of Russia's most famous composer
and put them together with graceful
continuity. If the music were new there is
no doubt that it would attract considerable
attention. Being so familiar, however,
and having been played almost to
death in the concert halls, on victrolas,
over the radio, in the variety houses and
even among home talent, it is not likely
that a great many people will be induced
to pay good money to hear these favorites
again in their present context.

In addition to being dull the book of
Natja is developed in jerks and jumps.
Being only an excuse after all it is
pushed aside whenever the music is ready
for another outburst. As the story goes,
however, there is a Czarina, who has a
deceitful favorite. His name is Potemkin
and he is oppressing the people in the
Crimea terribly, at the same time making
the Czarina believe that they are
prosperous and happy. Natja, a young
Crimean countess, disguised as her twin
brother, comes to the palace to plead for
her people. She matches her wits with
Potemkin's and not only beats him but
also wins for herself a lieutenant of the
Royal Guards.

Mary Mellish plays the Czarina. She
sings beautifully and makes a pleasing
presence, but her acting is cold. George
Reimherr isn't very threatening as the
villainous Potemkin. He has a fine voice,
but his diction is muddled and his acting
is merely flimsy. Madeline Collins, a
winsome little lady with a delightful
voice, is altogether too light for the
role of Natja, which should be played
with dash and subtlety. Furthermore
Miss Collins is too girlish in appearance,
manner and talk to be masquerading as
a boy, and it is too much to expect any
audience to believe that such a Natja
could have gotten away with her disguise.

Warren Proctor has one opportunity
to display a good tenor voice, and several
opportunities to act a bit, which he does
with the proverbial stiffness of tenors.
Alexander Clark labors until he sweats
to promote some comedy, and eventually
gets fair results. His brother comedian,

Matthew Hanley, takes things much
easier, yet manages to get his share of
the returns.

Claire Grenville, a woman colonel,
strives for comic effects by injecting some
American suffrage jargon into some of
the situations, while Marguerite Anstin,
another woman officer, gives the most
natural portrayal of the job with
apparently the least amount of effort. The
minor characters, including Betty Archer,
Anne Tunney, Laura Saunders, Theola
Vincent, John Willard, Jamie Zucca, Leon
Kariavin and Theresa Felleg, are quite
satisfactory.

Of course, the logical excuse for the
generally lifeless acting is that the
producers had to choose between good actors
and good singers and deemed it more
propitious to have the latter. Unfortunately
audiences are not much given
to looking at these things logically. Even
if they were the fact would still remain
that the play was not satisfactory.

The lyrics in general are neither fanciful
nor happily fitted to the music. One
of the numbers, entitled Ups and Downs,
is absolutely irrelevant to the situation,
and there are a few others that have little
bearing on the trend of the play.
You'll Have To Guess, a comic duet between
Clark and Hanley, is good for several
encores, while Love Calls Me, Moonlight
and Love and a few other numbers
sung by Miss Mellish, Miss Collins and
Reimherr make strong impressions.

There is practically no dancing except
for a few steps by a sextet from the
chorus. The ensemble is of modest size.
It is also modest in looks and singing
ability. The scenery is just of ordinary
quality, while the costumes are handsome
enough without being too elaborate.

A genuine symphonic orchestra gives
full interpretation to the music.
With a better book and a better grade
of lyrics Natja would be one of the finest
operettas of the season. The plot outline
affords plenty of opportunities for dramatic
development and comic relief. It
is only a matter of playwrighting ability.
But the book and the lyrics should have
been done right before the play was
allowed to open.

DON CARLE GILLETTE.

PUNCH AND JUDY THEATER,
NEW YORK
Commencing Monday Afternoon, February
16, 1925

THE ART THEATER

Henry Stillman, General Director
Presents

"NOCTURNE"

A Play in Four Acts by Henry Stillman
From Frank Swinnerton's Novel
Staged by Henry Stillman
Production Designed by David S. Gaither

CAST

Emmy Blanchard.....Sydney Thompson
Pa Blanchard.....Mortimer White
Jenny Blanchard.....Kay Laurell
Alf Rylett.....Thomas Fadden
Chauffeur.....Sidney Stanislaus
Keith Redding.....Warren William
ACT I—The Blanchards' Kitchen. Evening.
ACT II—The Yacht. A few minutes later.
ACT III—The Kitchen. Midnight.
ACT IV—The same. Four months later.

Henry Stillman has made a first-rate
job of dramatizing Nocturne. Had he
staged it as well as he wrote it, it would
be a more than ordinarily interesting
play. As it is, too little of its value is
brought out in performance. There is a
reason for this, of course, and it is not
far to seek.

The story of Nocturne is one of small
incident rather than of big situation; of
character drawing thru dialog rather
than of action. Now, this sort of play
demands precise stage direction and
playing. It needs just about all of finish
in acting and staging that can be brought
to it and unless it gets both it loses
most of its meaning and nearly all of its
interest. The players must point their
characters, the director must take advantage
of every chance the manuscript
gives him for the depiction of mood in
character. In Nocturne the players cut
the surface of their characters over but
the depths elude them. This defect is
chargeable to both director and players.

The story of the play follows that of
the book quite closely, except for an
added scene of Mr. Stillman's handiwork,
which is quite in keeping with the rest of
the plot. The desire of Jenny Blanchard
for some of the color of life, the drabness
of her surroundings, her affair with the
skipper of the yacht, are all well brought
out. Mr. Stillman's additional scene
shows Jenny on the wedding day of her
sister, again obeying the summons of her
lover to come to him.

Kay Laurell is the Jenny. She looked
the part and one could understand everything
she said, but the characterization
of the role about ended there. There
was little trace of the girl's inner emotions
to be found in the performance.
Her sister, played by Sydney Thompson,
was done somewhat better but still lacked
completeness. Perhaps the most faithful
playing in the piece was done by
Mortimer White, as the father; the Warren
William as the captain and Thomas
Fadden as Alf had their moments. As
a whole, tho, none of the cast sounded all
the possibilities of their parts.
I am inclined to lay much of the blame

MARTIN BECK THEATER, NEW YORK
Beginning Monday Evening, February
16, 1925

Charles K. Gordon Presents

"CAPE SMOKE"

A Play of the African Veldt by Walter
Archer Frost

—with—

JAMES RENNIE

—and—

RUTH SHEPLEY

Entire Production Under Direction of
A. E. Anson

CAST OF CHARACTERS

(In the Order of Their First Appearance)

Umtata.....Donald Lashley
Kudu.....Louis Schooler
Saxence.....Allan Walth
Hugh Chadwell.....Percy Waram
Neal, Steward at the Club.....Horace Pollock
Daggy, Houseboy at the Club.....Henry Walters
Doctor Hammerstone.....Frazier Coulter
Jim Fraser.....Gerard Maxwell Willshire
Ann Netherby.....Alice Dunn
Sybott Jacobus Zelig.....George E. Romain
Catherine Bradbrooke.....Ruth Shepley
Gregory Bradbrooke, Her Brother.....John D. Seymour
John Ormsby.....James Rennie
Witch Doctor.....Francis Corbie
Bomba.....Nathaniel Sack
Bank Messenger.....Chandler Myers
Natives, Etc.

SYNOPSIS OF SCENES

ACT I—Veranda of the Regent Club, Regent
Mue, Northeast Cape Colony. Time: Evening.
ACT II—The old Zelig Farmhouse on the
Veldt. Time: Several days later.
ACT III—Doctor Hammerstone's Bungalow,
outside Regent. Time: The next afternoon.

Those who respond to purely theatrical
thrills, the sort devised to set the spine
quivering and the nerves tingling, will
have a great time at Cape Smoke. I consider
myself fortunate that this has not
been battered out of myself by an excessive
round of playacting and, by reason
of that, I had a thoroughly good time for
the first two acts of the play. I did feel
as tho I had been sold out when the third
stanza showed the thrills had all been
faked, but any show which entertains for
two-thirds of the way is worth while in
the reviewer's life.

The play is laid in South Africa and
the scheme of four white men working in
the diamond fields to trim a wealthy
American forms the basis of the plot. We
see a witch doctor put a curse on three
of these men and the American, and then
witness its carrying out, with three of
them struck down. These scenes are
impressive, particularly one carried out in
a terrifying thunder storm. The play ends
happily, too happily for my taste, and as
the management requests that the secret
be not divulged I shall refrain from doing
so.

The part of the American is well
played by James Rennie, who made quite
the most of all his chances; his sweet-
heart was given a good performance by
Ruth Shepley; her brother, as done by
John D. Seymour, was convincing; and
Gerard Maxwell Willshire gave a life-like
impersonation of a broken down Brit-
isher. A most creditable performance of
a scheming Englishman was contributed
by Percy Waram and in several scenes
he did some most excellent playing.
Frazier Coulter made an elderly doctor
seem very real, and Henry Walters and
Francis Corbie played natives very well
indeed. The balance of the cast were
quite all that was required of them.

Charles K. Gordon has managed a cork-
ing production for Cape Smoke, with
splendid scenery and effects. A. E. An-
son, who directed the piece, seems to
have realized all the possibilities of the
manuscript. Altogether, this is a play
which will vastly interest all those who
find pleasure and excitement in well-
played melodrama. The play is of no im-
portance as a dramatic work but as a
sheer theatrical thriller it has no equals
on Broadway at the present moment.

A first-rate melodrama; played
and directed with skill.
GORDON WHYTE.

for this on Mr. Stillman, acting as di-
rector, for there were several instances
of bad stage mechanics visible in the per-
formance, and if these got by him it is
easy to understand that the more subtle
nuances might elude him altogether. One
glaring instance of this was in the
dialects heard. The scene of the play is
in England and all the characters are
English, yet, with the exception of Mr.
White, none of the players was able to
convey this. Some of them spoke straight
American and others labored with what
they thought English as spoken by the
English, sounded like. All of these ef-
forts were lamentable and sounded like
nothing ever issued on land or sea from
the lips of Britshers. If Mr. Stillman
let this get by, his neglect of the finer
points is quite understandable. Before I
leave this subject, too, I should like to
point out that the English call the evening
meal either "tea" or "dinner", ac-
cording to their custom. The term "sup-
per" is reserved for a more or less sub-
stantial snack late at night. With all its
faults, tho, one feels that Nocturne is a
much better than ordinary play, and
were it produced with advantages of
playing and direction I think it would
prove highly enjoyable. I hope to see
it some time under better circumstances
than those surrounding it now.

A very interesting play; suffers
from faults of playing and staging.
GORDON WHYTE.

What the New York Critics Say

"Natja"

(Knickerbocker Theater)
TIMES: "Good music, but old-style book."
TRIBUNE: "Opera comique at its finest."
POST: "Musically it is a rare treat."
WORLD: "Best thing about 'Natja' is the score."
STN: "A great success musically. Better sung than acted."

"Houses of Sand"

(Hudson Theater)
TIMES: "An earnest and plodding play."
HERALD-TRIBUNE: "The whole thing, how-
ever, was imbecilic and therefore more to be
pitied than censured."—Percy Hammond.
STN: "Destined for the movies, the place
where so many poor plays go."—Stephen Rath-
burn.
TELEGRAM-MAIL: "Is pinkest pathos ex-
pressed in pigeon-jargon and youthful burrahs."
—Gilbert W. Gabriel.

"Tangletoes"

(Thirty-Ninth Street Theater)
TIMES: "Is not a profound play, not written
at a depth that you can take too seriously."—
Stark Young.
HERALD-TRIBUNE: "A little play that be-
gins well, falters in Act II and recovers con-
siderably in the third act."
STN: "A play that for the most part is as
workmanlike and as profound as an impromptu
charade."—Alexander Woolcott.
POST: "Two-thirds of the show at least is
stale, flat and to the last degree unprofitable."
—J. Ranken Towse.

"Cape Smoke"

(Martin Beck Theater)
TIMES: "A melodrama that at one point
almost brought the thrilled audience over the
footlights."—Stark Young.
HERALD-TRIBUNE: "A good, gaudy hair-
raiser for two acts—the rest is Gloriana or,
it may be, 'Sta-Comb.'"—Percy Hammond.
WORLD: "The sort of thriller which may
get you on the volley or the rebound."—Hey-
wood Brown.
TELEGRAM-MAIL: "As bugaboo drama it is
not to be denied its chills."—Gilbert W. Gab-
riel.

"Nocturne"

(Punch and Judy Theater)
WORLD: "Would be a good amateur show
if the cast were not professional."
HERALD-TRIBUNE: "A crude, undramatic
and slow-paced affair that has little to raise
it above the amateurish."
TIMES: "A much better play than 99 per
cent of those now on view in this town."
POST: "It plainly suffered a good deal in
the manner of its presentation."—J. Ranken
Towse.

Walburn Acted in Chicago
Stock 15 Years Ago

Chicago, Feb. 20.—The press agent for
The Show-Off at Cohan's Grand over-
looked a good local bet recently
when he was writing about Raymond
Walburn, of the cast. Mr. Walburn
played in the old College stock here 15
years ago and is most pleasantly re-
membered by hundreds of Chicagoans.
He was a character actor and each week
donned a white wig to simulate senility.
Ralph Kettering thinks he is now just
about old enough to play juvenile parts.

EXPERIENCE
Is forever explaining, but
a wise man may avoid
many unpleasant experi-
ences by reading and re-
cording the experiences of
others.
The news in this issue
of The Billboard is
largely the experience of
others, successful and other-
wise. You may profit by
reading it.
The subscription blank
on another page is your
opportunity.

MUSICAL MUSINGS

By THE MUSE

(Communications to 25-27 Opera Place, Cincinnati, O.)

Frank Metcalf writes from Mobile, Ala., that he is teaching a large band class this winter.

Bernie Foyer has placed a Foyer-Jess orchestra at the New Piccadilly, New York's newest supper club. It opened February 3.

The Kentucky Night Owl Orchestra of Louisville has enjoyed successful bookings in its dance and theater work. It is a seven-piece organization directed by J. Selligman.

The Larium Novelty Orchestra has been receiving letters from persons who enjoyed its program broadcast from Larium, Mich., recently. Tony Rolando is director and Bob Murphy is manager.

Frank Van writes from Vienna that business is good and that he and his band will remain there until March 1. He intends to organize several more bands in Austria before returning to this country.

Don Harter's Synopators are playing in Louisville, Ky., where they also are broadcasting. After early dates in Owenton, Frankfort and Bowling Green, Ky., they will be at the Cottillon Ballroom at Des Moines, Ia., indefinitely.

Albert Plotz, trombone player with Eddie Mitchell's Recording Orchestra, of Columbus, O., suffered a broken shoulder in an automobile accident January 20 and would be glad to hear from friends at 605 South Park street, that city.

J. H. Thoma, owner and manager of the Ambassador Orchestra, which toured the Eastern States and completed a successful engagement at the Supper Club in New York, has signed with a Broadway producer for his orchestra to tour in vaudeville. The act will be known as The Ambassadors and will enlist the services of two dancers and a singer.

At the expiration of his contract with the La Vida restaurant in New Orleans March 31 Anthony Parenta will join the Paul Whitehead Orchestra as saxophone and clarinet player. Parenta was a member of the Cafe Gruenwald Orchestra for seven years and later was with the Little Club in the Crescent City.

While playing at Albany, Ga., with the Nell O'Brien Minstrels, Ed. Leahy met an old friend, Fred Pachill, clarinet player, at the Liberty Theater, other members of which orchestra are: Walter Sheets, leader, violin; "Shorty" Cranford, violin; Chas. Foss, flute; Jimmy Downs, trumpet; A. Markett, drums; J. Houghstien, cello, and Arthur Trueman, bass.

"Smiling" Billy Corthay writes that his California Naval Band is "brezing along nicely" at the Palaise Royal Ballrooms in Prescott, Ariz., after a six weeks' engagement at Phoenix. The roster: Seth Soderberg, Wallace Van Treese, William Hevly, Leroy Barter, Harland Pomeroy, William Koverik, Archie Long and Corthay.

Jack Shepard, manager of the Alabamians Orchestra, writes that while en route thru Virginia two of the members were stricken with diphtheria, necessitating the cancellation of several engagements. Arrangements were made, however, with Arthur Richardson and Thomas Snodgrass, formerly with Watson's Bek Hops and "Whitney" Kaufman's Pennsylvania Screamers, to join at Pineville, Ky. The members are Sam Gobbe, Marion Kelley, John Schultz, Herbert Towne, John Anderson, Tom Byers, Richardson, Snodgrass and Shepard.

Coy Barkley's Orchestra, at the new ballroom at Ocean Park, Los Angeles, is eliciting much favorable comment. The personnel reads: Coy Barkley, owner, manager and leader, saxes, or percussions; Bud Minter, piano, celeste, vocalist and arranger; Victor Lattue, banjo, violin and clarinet; "Buz" Gift, violin and sax.; Pat Nehls, saxes, clarinet and vocalist; Harold Tucker, trombone, sax, and novelty man, and Clyde Wilcox, percussions, drums and marimbaphones. Bud Minter also plays novelty choruses on the calliope.

The Indian City Blue Boys, a seven-piece jazz band, are meeting with success in Southern Minnesota, playing their own compositions, *Indian City Blues* and *Smile*. They have been in demand by local radio broadcasting stations. The personnel of the orchestra follows: Vic Wagner, formerly in vaudeville and composer of the numbers, banjo and manager; Lowell Fynskov, piano and female impersonator; Jack Bailey, trombone and entertainer; Norman Larson, sax, and clarinet; C. D. (Swede) Paul, drums; Fay Williamson, sax, and clarinet, and Joe Brozik, sax.

INSTRUCTIVE ENTERTAINING BOOKS
Illustrated Catalogue Free.
COLLINS CO., 197 Fulton Street, Brooklyn, N. Y.

THE BOOK SPOTLIGHT
By Gordon Whyte

(Communications to Our New York Offices)

FRANCIS WILSON'S LIFE

FRANCIS WILSON'S LIFE OF HIMSELF. Published by Houghton Mifflin Company, 2 Park street, Boston, Mass. \$5.

The record of a full life in the theater is to be found in *Francis Wilson's Life of Himself*, a life full enough to include success there and honor in his profession and as champion of its cause on the battleground of economic warfare. It may easily be, in the days to come, that the fame of *Francis Wilson* will be associated as closely in the mind of the world with his championing of the actor's cause as with *Ermite*, and I take it from the book that this would not displease Mr. Wilson.

There is no reason why it should. If ever a class of workers needed a leader it was in those days when *Francis Wilson* and a few far-seeing men formed the Actors' Equity Association. Thru this leadership the player has assumed a commanding position in the American theater and the story of his progress to that goal is one of the best in this book. It is a story which all who took part in it may well be proud of, and of these not the least was *Francis Wilson*.

Mr. Wilson traces the story of his life from the time he was a kid, playing in ramshackle playhouses in the vicinity of Philadelphia, thru the period of song and dance, when as one-half of Mackin and Wilson he rose to the top of minstrelsy, only to put this aside that he might properly learn the fundamentals of the actor's art. To deliberately leave a field of the profession where he was getting a large salary and join a stock company in a minor capacity so that he might become an actor in the truest sense of the word was characteristic of *Francis Wilson*. His courage and wisdom peer out thru many pages of his book. He never lacked for either. And this action of his, foolish as it might have seemed at the time, was just about the wisest course he could have pursued, as afterwards proved. For it was the solid grounding he received in the old stock companies that allowed *Francis Wilson* to take full advantage of his opportunities when they came his way.

Come they did in the fullness of time, culminating in the production of *Ermite* at the Casino, when Mr. Wilson created his Immortal Cadeaux. The piece ran on and on and from the Casino went forth the erstwhile Cadeaux to form his own comic opera company and star at the head of it.

This company of *Francis Wilson's* is green in the memory of all those who knew it. It represented the best in musical productions, played by an eminently capable company of ladies and gentlemen. It was one of the reasons for the added dignity the player has assumed in the world outside the theater.

I can hardly devote the space necessary to even the briefest survey of Mr. Wilson's theatrical career. High spots are his memorable fight with the "Syndicate", his successful graduation from the lyric stage to the dramatic and, lastly, his leadership of Equity. The whole forms a record of which Mr. Wilson may well be happy in looking back on.

For all his busy stage life *Francis Wilson* found time to form charming associations with men of the theatrical and literary world. He tells of many pleasant moments with Edwin Booth, Joseph Jefferson, James Whiteomb Riley, Eugene Field and others. He met Walt Whitman and devotes a most readable chapter to him. All thru the book the reader will find page after page of interesting reminiscences.

Mr. Wilson is a clear, chatty writer. He makes his reader feel at home with him and he can tell a story wonderfully well. Also, from the fruits of his knowledge he has something to offer to the beginner in his own profession. To such the chapter he devotes to philosophizing on his art should be most valuable. I am quite confident that *Francis Wilson's Life of Himself* will take an honored place on the dramatic bookshelf. And Mr. Wilson is bibliophile enough to have realized the value of an index to a work such as this and has included a very full one. Since the work will have distinct value for reference purposes, he should be thanked for that. I am of the opinion that anyone interested in the stage will miss a very valuable and entertaining book if they neglect reading *Francis Wilson's Life of Himself*.

THEATRICAL MUTUAL ASSN.

By DAVID L. DONALDSON, Grand Sec'y-Treas.
899 Main Street Buffalo, N. Y.

Office of the Grand Secretary-Treasurer

We have had quite a creditable showing for the past few weeks and thank all those who have sent in items for our column.

It is with regret that we learn, at this late date, that Henry Phunkett, a member of Boston Lodge, passed away in this city January 30. He was with Dave Marlan's show at the Gayety Theater. We knew nothing of his presence here until reading his death notice in *The Billboard*. Therefore, we again, thru these columns, request all road members when playing or going thru Buffalo to let this office know and we will make arrangements to see you while here.

We are showing an increase in membership and things look as tho we are on the ascent. Everybody keep up the good work and it won't be long until we will be at the top.

Contributors this week are: Brothers W. Mulvihill and Edward Otto, New York.

New York Lodge No. 1

New York Lodge held a public installation of officers. The rites were conducted by Brother R. Webster, of Brooklyn Lodge No. 30, assisted by Brother Al Ruland, of this lodge. Many visiting members attended and the speakers of the evening were Brother William Duerrler, of Newark Lodge; Brother William Schmidt, secretary of the Long Island Lodge, Brooklyn; Brother William E. Monroe, past president of the New York Lodge and president of the Theatrical Protective Union of New York, and Brother Richardson Webster, past president of the Brooklyn Lodge. Brother Terr, president of Long Island Lodge, and Brother Frank Giovanni, vice-president of Bronx Lodge, also attended. The officers installed were: President, J. C. McDowell; vice-president, Joe Bender; past

president, Walter Mulvihill; financial secretary, William T. Butler; secretary-treasurer, Edward W. Otto; sergeant-at-arms, Tom Boylan; marshal, J. Lilly; chaplain, Fred Greene; outer guard, W. Bradley; trustees, Al Ruland, James Hovey; physiciens, Drs. S. Nelson Irwin, Melvin Wolk and Bull Winkle.

A general committee was appointed to arrange all social affairs as follows: James Hovey, Thomas Boylan, Jules Stoney, James J. Farley, Patrick Savage, William Stone, Louis Fleisch, Paul Schmidt, H. Harrison, Frank Rogers, Harry Dignan, Fred Greene, John Lossecoo, Charles Higgins, J. A. Casey, P. Downey, C. W. Helmerle, George Krant, J. Lilly, Walter Mulvihill, J. C. Vermilyea and H. Oterson, chairman.

Brothers R. Webster, Brooklyn Lodge, and Edward W. Otto, of New York Lodge, were the installing officers for Bronx Lodge No. 38.

Brother Otto, of New York Lodge, assisted by Brother J. C. Vermilyea, installed the officers of Brooklyn Lodge No. 30.

Brother John Lilly, of New York Lodge, assisted in installing the officers of Long Island Lodge No. 67.

At the last meeting Brother Joe Bender, vice-president, and Brother Thomas Boylan, sergeant-at-arms, were presented with silver tea sets and Brother Downey with a box of silverware for their good work on the Benefit Committee.

Jersey City Lodge No. 24

Jersey City Lodge No. 24 January 25 installed the following officers for 1925: Past president, Owen S. Kennedy; President, Al D. Wylie; vice-president, Thos. J. Lane; recording secretary, Walter C. Smith; financial secretary, Henry Lachman; treasurer, William W. Baxter;

(Continued on page 46)

Stage Employees and Projectionists

By G. V. WALES

(Communications to New York Office)

The 13th anniversary banquet given by Local No. 236, Birmingham, Ala., was held at Greenwoods, one of the best places in town in regard to cuisine, last week. A reception was held prior to the big feed at the Tutwiler Hotel, where members from not only the local there attended but many were present from the near vicinity. Headliners from the shows playing Birmingham were on hand to make the evening an enjoyable one.

Those who attended to the details of the affair and who acted as the committee in charge were Harry Rensford, chairman; R. A. Root, toastmaster; M. L. Ireland, projectionist, and J. T. Emerson and Earl Walker. The last two named presented some funny stuff that was a big surprise.

During the repast the following officers were announced for this year: J. T. Emerson, president; F. J. Emerson, vice-president; C. L. Gaston, business agent; W. B. Tate, sergeant-at-arms; F. L. Delaney, chairman; Carl Jones and A. Jackson, trustees; J. E. Mankin, recording secretary, and W. B. Herring, financial secretary and treasurer.

Shortly after the food had been served a one-minute meditation was observed for the following deceased brothers: Julius Amberson, Howard Norville, W. H. Culpepper and J. P. Johnson.

During the evening a surprise program was sprung on the guests. Members of the local who have picked up clever bits of humor and satire during their long experience backstage got up and performed admirably for their brothers in labor. The night was a merry one and it was with great regret that the members finally withdrew.

Representative Crickmore, who is working on the Pacific Coast, wired the New York office that all is quiet in his territory, whereupon he was sent to Portland, Ore., to take up questions that have arisen with that local.

The general secretary-treasurer at New York made the following announcement: "At this season many of our local unions are installing new officers, and for the benefit of those coming into the direction of the affairs of their locals it is desired to call attention to the importance of promptly filling with the general secretary-treasurer the names and permanent addresses of all the local officers and of the filling with the same officer the telegraphic addresses of the president and corresponding secretary."

The Billboard will publish the names of all of the newly elected officers of the various locals if they will send the information to the New York office, 1493 Broadway.

The Kankakee (Ill.) Local No. 425 held its election and installation of officers at headquarters January 4. The following were elected: F. Ed Shumaker, president; S. J. Hart, vice-president; Curtiss A. Bernier, secretary, unanimously re-elected for his eighth term, and R. H. Arthur, guard; Perry Powers, retiring president, was appointed a member of the executive board. The members were entertained at Jordan's Restaurant after the installation and a good time was reported by all present.

Vice-President Elliot and Representative Tinney are in Columbus, O., dickering with Keith Theater officials in regard to a new contract, now that this vaudeville house has changed to three a day and pictures. The house formerly played straight vaudeville and did not require the long hours necessary under the present program. The Columbus local submitted what it considered a just arrangement for the extra work, but was not able to arrive at what it considered a satisfactory agreement.

Representative Dillon is at present in Gloucester, Mass., which is in the jurisdiction of the Salem local, straightening out a disagreement over the personnel of the Union Hill theater. He will proceed from there to Springfield, Mass., to untangle several suburban movie houses and then go on to Westerly, R. I., where application for a local charter has been made.

Representative Raulo has been assigned to visit Local No. 293 at New Orleans, La., after finishing his Florida trip. There is a controversy with the outlying moving picture houses around the Crescent City concerning the unionizing of operators.

Due to differences of interpretations of the contracts between the local and theater managers at Piqua, O., Representative Brown has been rushed to that town to get the matter straightened out. The Piqua Amusement Company is the leader in the dispute.



ACTORS' EQUITY ASSOCIATION

JOHN EMERSON, *President* ~ ETHEL BARRYMORE, *Vice President* ~ GRANT MITCHELL, *Second Vice President*
 PAUL N. TURNER, *Counsel* ~ FRANK GILLMORE, *Executive Sec.-Treas.* ~ GRANT STEWART, *Rec. Sec.*

CHICAGO Office - Capitol Bldg. NEW YORK SAN FRANCISCO Office - 369 Pine St.
 KANSAS CITY Office - Gayety Theater Bldg. 115 WEST 47TH STREET LOS ANGELES Office - 6412 Hollywood Blvd.
 TELEPHONE BRYANT 2141-2

Actors Desire Citizens' Jury for Plays
THE actors in every musical comedy or legitimate production on a New York stage would terminate the run of any play deemed immoral or contrary to public policy by the Citizens' Play Jury.

If the city administration is really desirous of arresting the influx of allegedly immoral plays without giving them the publicity which has previously proved of such box-office value, it can do so by touching the button which will start the machinery built up and presented to the city by the committee opposed to political censorship.

All that has to be done upon receipt of complaints against any particular play is to put the names of the voluntary jurors, and a long list of names has been provided, into a jury wheel and to inform the first 12 drawn that they will be expected to sit in judgment on a certain play that evening or the next.

The verdict of this jury will be carried out by the actors instantaneously, with or without the manager's consent, since every actor on the New York stage has signed a contract in which Clause 22 of the rules reads as follows:

"Should the Citizens' Jury provided for in New York decide adversely to the continuance of a production because salacious or against public morals, the actor shall forthwith terminate his employment without notice, payment or penalty."

The actors, therefore, have done everything which could be expected of them to prevent the continuance of really offensive plays.

Suggestions have been made that this association should serve as a censor, but it is expected not much will come of the idea. The method that has been provided seems so simple that it is a matter of surprise to many that the city officials, whether the Police Department, the Legal Department or the Department controlled by the Commissioner of Licenses, should not have made it effective long before this.

Mr. Belasco Swings to Equity

It is a source of great gratification to the Actors' Equity Association that David Belasco, who hitherto has been one of the most determined opponents of Equity, has reversed his views and announced himself as one of the association's strong supporters. In a recent interview Mr. Belasco declared:

"For the last year Equity has been doing splendid work for the actor and the theater and I always look on myself as an actor still. I was opposed to Equity in its infancy because I believed that a movement was under way to establish a closed shop for the stage.

"Equity has shown itself to be a friend of the manager, the actor and the public as well. I am with it heart and soul.

"If it decides that radio injury to the theater it should be encouraged to remedy that condition. The time when all who love the theater should rally to its aid is at a time when competition menaces it. Equity can command me."

Absent-Minded Deputy

It is not well for a deputy to be absent-minded. One of our best known people, who occupies that honorable position, was informed a few weeks ago that four members in his company were not paid up. Nothing happened for three weeks, and when our representative again interviewed the deputy a blank look came over his face and he said: "Those members gave me their dues four weeks ago and I forgot to turn the money in. I will send you a check together with the assessments tomorrow."

Incidentally, our members were not altogether free of blame as they should have asked why they did not receive their paid-up cards.

More Insurance on New Building

The council of the A. E. A. at its last meeting passed a motion to the effect that the insurance which it carries should be increased from \$55,000 to \$80,000 on its new office building.

During the alterations on the new building fire-proof halls, doors, etc., were added so that it now conforms to all the necessary regulations.

Stage Women's Great Work

The Stage Women's War Relief is appealing for funds to enable it to continue the great work it began nearly eight years ago of providing entertainment for ill and disabled veterans in various hospitals of the country.

In a letter to the executive secretary of the Actors' Equity Association Rachel Crothers, president of the Stage Women's War Relief, quotes from a letter written by Dr. G. A. Smith, superintendent and medical director of the Central Islip Hospital, Long Island, as to the value of the work.

"I hope nothing will prevent you from continuing your entertainments," Dr. Smith wrote, "for the reason that they

are not only a great pleasure to the patients but are a means of treatment. Amusement and diversion are the best remedies for a disturbed mind."

An explanation of the aims and needs of the Stage Women's War Relief, as contained in a general letter issued by Miss Crothers, read:

"Do you know that the war work in your profession has never stopped?"

"Do you know that the Stage Women's War Relief is still giving entertainments to our ex-service men in the hospitals?"

"Do you know that the need for this is greater now than ever before?"

"As the war gets further away these men are more and more forgotten—their suffering and loneliness increases.

"The relief and diversion which these entertainments bring cannot be over-estimated and the gratitude and enjoyment of the men is touching beyond words.

"Physicians in charge of the mental cases tell us the effect of this diversion has immeasurable curative value, quieting the men and arousing their interest as nothing else does.

"In the tuberculosis hospitals the men look forward to the S. W. W. R. shows as the brightest spots in their long, dreary weeks.

"This work is surely the peculiar privilege and duty of the theater and it is to the everlasting honor of the theater that it is still going on.

"You will be proud to know that these shows are so good that they have a glorious reputation not only among the eager audiences but the officers and doctors in charge.

"The entertainers, principally vaudeville artists, give their services for a very low figure—each receiving exactly the same amount—and they give with the same enthusiasm and the same inspired generosity with which they gave during the World War.

"We are making a wide appeal now—strictly within the theater—believing that your pride in your organization will want you to help keep it going.

"For eight years the entertainment de-

partment of the Stage Women's War Relief has been going steadily on and our men need us more now than they did in the beginning.

"It was easy enough when the war was on to raise money for our heroes—now the heroes are lying in narrow beds, lonely, embittered, largely forgotten.

"What we are doing for them is very, very little in return for what they did for us.

"What will you give to help carry on this work?"

The council at its meeting February 10 expressed itself as deeply sympathetic and very grateful for the work which the Stage Women's War Relief has already done and is still doing for disabled soldiers.

Lots in a Name

An actor who has been a paid-up member of the association for many years recently changed his Christian name. A few months afterward he was rehearsing in a new play. Our representative, scanning the cast, reported that this particular actor was not a member of the association. He protested volubly that he was.

Our representative returned to the office and went back to the rehearsal surer than ever that no such name was on our books. Then the light commenced to dawn and the member recalled that he had forgotten to notify the association of his rechristening. Of course the representative had no way of knowing that the old name and the new one both referred to one and the same person.

A Nation's Drama Seeks Its Level

Sophia Clough in her book, *Matilda, Goddess of the English*, says: "A nation always sooner or later produces the drama it is mentally equal to and deserves."

Equity Pushes the Button

This letter sent from the office explains the stand of the Equity Association: "Like everyone else interested in the theater we are deeply concerned about the character of some of the recent pro-

ductions. In the long run such suggestive, not to say salacious, material must work to our detriment. Apparently some of the managers are only interested in what they put on at the moment and do not stop to consider the future of the theater as an institution.

"As you know, we have been greatly interested in the formation of a joint committee opposed to political censorship. The title is perhaps a little misleading, but the main object of the committee was to get together a citizens' jury which would pass on all plays against which complaints had been received. We saw Mayor Hylan on the subject. We also interviewed Commissioner Gleason and his successor and they were all enthusiastic about the proposition. The machinery was duly installed and all the commissioner had to do was to touch a button, but for some reason or other he never did it.

"The stand of Equity on this subject must be made clear. We have no wish as an organization to dictate to authors or managers as to what they shall or shall not write. We think such a stand, if we took it, would not only lay us open to the severest criticism but would also be to the detriment of the drama. In other words, we cannot consistently propose political censorship and at the same time become censors ourselves.

ACTORS' EQUITY ASSOCIATION.

New Candidates

Regular Members—Alice Bawdish, Uncas Ann Daniel, Clarence Da Silva, Boyd J. Gilmour, William R. Haig, Phebe Brune, Mrs. Wm. H. Jasper, Jack Boise-Kearney, Judith Vossell Lloyd, Paisley Noon, Barry O'Neill.

Members Without Vote (Junior Members)—Olive Caldwell, Frank Carrington, Leland Chandler, E. B. Dewing Bender, Olga Elsler, Cora Frye, Hildegard Halliday, Odette Laudner, Paul Messink, Alma O'Neill.

Chicago Office

Members Without Vote (Junior Members)—Charlie Chase, Grace Moy, Allan Walker.

Kansas City Office

Regular Member—Kathryn Cady.

Los Angeles

Member Without Vote (Junior Member)—Mrs. Thomas Holding.

which 600 persons were gathered recently when a film became ignited, was destroyed by the flames. No one was injured.

The National and Broadway, Richmond (Va.) movie theaters, have been sold to the Theaters' Corporation, better known as Wells, Wilmer & Vincent, for approximately \$550,000.

Lublner & Trinz, who have been operating the Windsor Theater, Chicago, for several months, have bought the leasehold and building for a reported \$145,000.

Walter F. Davis, manager of the Metropolitan Theater, Winnipeg, Can., postedcard from Mobile, Ala., February 14: "Plenty of sea food, sea breeze and Southern hospitality here."

Herman Lieber, son of Herman P. Lieber, interested in the Circle Theater, Indianapolis, has been chosen director of the 1925 Jordan River Revue, annual Indiana University musical extravaganza.

The Elite Theater, DeLancey, O., has been closed until recently as a result of fire in the projection booth, where 6,000 feet of film was burned and the machine damaged.

Grace Mohler, for the past year organist at the Apollo Theater, Indianapolis, Ind., and previous to that an organist in Dallas, Tex., has taken over the work of organist at the Eagles Theater, Wabash, Ind.

The Majestic and Princess theaters, Plymouth, Wis., have been purchased by a corporation now being formed in Milwaukee, Wis., and will be managed by Jack Anton, former owner of the Princess.

The J. C. Penney Company has declined to grant a request upon the part of the Strand Theater management for an extension of time after March 1 to permit the completion of the new theater under

DROP CURTAINS

That please your purse and your public. FREE SCENERY STUDIOS, INC., 723 7th Ave., New York.

THEATRICAL NOTES

Cranfil Cox has purchased the Crystal Theater, Gilmer, Tex.

The Petit Theater, Hominy, Ok., was robbed recently.

The Empire Theater at Blackwell, Ok., is being remodeled.

Manager F. E. Russ, of the Majestic Theater, Somerville, Tex., has completed remodeling his house.

L. S. Carter has taken over the motion picture theater at 1336 Hoyt avenue, Indianapolis, Ind.

Hugh Wallo, owner of the Ozark Theater, Berryville, Ark., has leased the Majestic Theater at Green Forest, Ark., and will operate both houses.

J. T. Conner, general sales manager for Metro-Goldwyn, recently was in Dallas, Tex., conferring with Branch Manager Bickell and his staff of salesmen.

Alterations to the stage of the Strand Theater, Niagara Falls, N. Y., now under way, will amount to \$25,000, and will result in added facilities for the accommodation of vaudeville acts requiring complicated equipment.

Walter E. Parks, of Richmond, Ky., has accepted the management of the Grand Theater, Lancaster, Ky., operated by Haselden Brothers.

Sale of the Elm Theater, Portland, Me., to the State Theater Company was made by William Wolf, who built the house for motion pictures several years ago.

W. F. Jones, of Archer City, Tex., has purchased the Queen Theater at Olney, Tex., from Manager Richardson, who is retiring from the theater field.

Thieves recently entered the Crescent Theater, Terre Haute, Ind., in the heart of the down-town business district, and escaped with the safe.

M. L. Levine, owner of the Ideal and Majestic theaters, Corsicana, Tex., has purchased the Palace, Grand and Gem theaters in that city, and installed T. B. Noble as general manager.

A. V. Wade, who has taken over the Greenhill Theater, Galveston, Tex., closed it for improvements. A cooling system and a \$10,000 Bartola Orchestral will be added.

The Galnes Theater, Pineville, Ky., in

H & M PROFESSIONAL TRUNKS

New 1925 Models Now on Display

Showroom and Slightly Used Taylor, Hartman, Indestructo and Bal Trunks always on hand.

WE DO REPAIRING. WRITE FOR CATALOG.

SAMUEL NATHANS, Inc., 568 Seventh Avenue, between 40th and 41st Streets, New York City

SOLE AGENTS FOR H & M TRUNKS IN THE EAST.

\$6.60

\$7.70

\$8.80

\$9.90

J. Glassberg Short Vamp Shoes

ORIGINAL STYLES

SALE

Over 4,000 Pairs, Latest Models, in all Leathers, Gold, Silver Brogades. Selling regularly at \$10.75 to \$17.75.

225 W. 42d St., New York

On Mail Orders add 25c Postage. Catalog B Free.

BALLET SLIPPERS

Hand Made.

BOX TOE. \$4.75

Black Kid, Pink Satin, Black Satin.

SOFT TOE. \$3.75

Black or White Kid.

Phonetic Key

1. He is met there at my.
(hi: iz met ðeə æt maɪ)
2. Who would throw water on father?
(hu: wʊd θrəʊ wɔ:tə ɒn fɑ:ðə)
3. Bird above.
(bɜ:d əbʌv)
4. Yes, the singer's thin whisker shows
(jes, ðə sɪŋəz θɪn hwɪskə ʃəʊz
θru: ðə ru:ʒə.
θa: ðə ju:z)

Complete copies of the Phonetic Key will be sent to any address upon request. Write Mr. Daggett, 202 West 74th street, New York City.

CANDIDA

Marchbanks (See Transcription)

1
Is it like this for her here always? A woman, with a great soul, craving for reality, truth, freedom and being fed on metaphors, sermons, stale perorations, mere rhetoric. Do you think a woman's soul can live on your talent for preaching?

2
It's the gift of the gab, nothing more and nothing less. What has your knack of lying talking to do with the truth any more than playing the organ has? I've never been in your church but I've been to your political meetings, and I've seen you do what's called rousing the meetings to enthusiasm; that is, you excited them until they behaved exactly as if they were drunk. And their wives looked on and saw clearly enough what fools they were. Oh, it's an old story; you'll find it in the Bible. I imagine King David, in his fits of enthusiasm, was very like you. "But his wife despised him in her heart."

3
Let me alone. Don't touch me. Stop, Morell, if you strike me I'll kill myself; I won't bear it. Let me go. Take your hand away.

4
I'm not afraid of you; it's you who are afraid of me.

5
Yes it does. You think because I shrink from being brutally handled—because I can do nothing but cry with rage when I am met with violence—because I can't lift a heavy trunk down from the top of a cab like you—because I can't fight you for your wife as a navy would, all that makes you think that I'm afraid of you? But you're wrong. If I haven't got what you call British pluck I haven't British cowardice either; I'm not afraid of a clergyman's ideas. I'll fight your ideas. I'll rescue her from her slavery to them. I'll pit my own ideas against them. You are driving me out of the house because you don't let her choose between your ideas and mine. You are afraid to let me see her again. Let me alone, I say. I'm going.

6
You shall—you must. If you give any explanation but the true one you are a liar and a coward. Tell her what I said, and how you were strong and manly and shook me as a terrier shakes a rat, and how I shrank and was terrified, and how you called me a snivelling little whelp and put me out of the house. If you don't tell her, I will; I'll write it to her.

7
Because she will understand me, and know that I understand her. If you keep back one word of it from her—if you are not ready to lay the truth at her feet as I am—then you will know to the end of your days that she really belongs to me and not to you. Good-by.

8
Either the truth or a lie you must tell her, if I go.

9
I know—to lie. It will be useless. Good-by, Mr. Clergyman.

10
I want to stay, of course, unless the reverend gentleman, your husband, has anything to advise to the contrary.

11
Come and lay the table. I am the happiest of men.

(End of Act I)

Richard Bird, whose speech is transcribed in the part of Marchbanks in *Candida*, is a young English actor whose native whereabouts were in the vicinity of Liverpool. His early dramatic experience was in the Liverpool Repertory Theater, and later experience came in London. The transcriptions on this page are necessarily limited to pronunciation, with only a slight attempt to represent the interpretation of the lines by means of stress marks—the "emphasis" on the thought words—and in the "breath groups" when they are represented. But on the whole we are dealing with the pronunciation used by the speaker, and this leaves out of account the quality of his voice and the personal equation in his art as a reader. There is an animation and gusto to Mr. Bird's reading, an interesting range of voice and a splendidly embodied inwardness of feeling that gives his acting unusual force. You would speak of the force of Mr. Bird's work in the sense of his vigor in genuine thought and feeling, rather than of its elegance in the sense of conventional reserve and formality, for it is in unconventional parts where Mr. Bird finds the range of expression that is especially his. His individuality catches at the universality of things, and it lives inwardly with the generosity and intensity and sympathy of vital youth. This was the boyish appeal

THE SPOKEN WORD

CONDUCTED BY WINDSOR P. DAGGETT

of his Babe in *Haroc*, and this is the poetic appeal in his *Marchbanks in Candida*. This true "deepening of impressions" that comes to Mr. Bird in his acting was nowhere more in evidence than in his dressing room. Here he read his lines so quietly that the sound would not go out of the room, but the smoldering brightness of the inward fire made the reading before an audience of one quite as inspired and moving as it is before an audience of 2,000.

Mr. Bird's (ou) sounds differ slightly from what is usually heard in this country. They are nice sounds and they shade from the standard sound too little to be called dialectal. All that needs to be said is that they are a little higher (on the tongue) and a little more forward than Katharine Cornell's, for instance, or Walter Hampden's. But they are not the affectedly forward sounds that one hears in the Anglican circles of England. A refined (ou) sound is perhaps the best description of Mr. Bird's pronunciation.

An English woman who visited me last summer did not like American (ou) sounds as she heard them in careless speech, and probably somewhat generally in her travels in this country. In her habitual speech she spoke stand-

ard English very true to "non-regional" form, but in view of the lazy (ou) sounds she heard in America she said: "I have deliberately brought my (ou) sounds 'forward' to avoid acquiring this other extreme."

This remark can be taken for what it is worth, but it shows that there are nice shades of difference to the sounds of English which discriminating ears are sensitive to. The shading either verges onto vulgar speech or onto refined speech that bears the stamp of unquestionable good breeding.

Mr. Bird gives some attention to standard English, for he asked me if I noticed anything off-color in his (ar) sounds. He said that these had given him trouble. I presume that some trace of Lancashire, or North of England, dialect had given a 'back' (a) to these sounds. Whatever the difficulty, Mr. Bird has corrected it.

The "your" (jə) of Mr. Bird often becomes (jə), due both to rapid speech and to the full-toned heartiness of his delivery. His trilled (r) is very delicate, in many ordinary passages hardly distinguishable from the untrilled (r).

RICHARD BIRD AS MARCHBANKS

("CANDIDA", END OF ACT I)

1
iz it laik 'ðis fə 'hə: hɪə—'ə lweɪz? ə 'wʊmən, wɪð ə 'ɡreɪt 'səʊl,
'kæɪvɪŋ fɜ: rɪ'ælɪtɪ, 'tʌu:θ, 'faɪndəm, ənd bɪɪŋ 'fed ɒn 'metəfə, 'sə:mənz,
'steɪl pəʊ'retɪfɪz, 'mɪə 'rɪtəɪk. ðə ju: θɪŋk ə 'wʊmənz 'səʊl kən 'lɪv ɒn ju:
'tələnt fə 'preɪtʃɪŋ?

2
ɪts ðə 'ɡɪft əv ðə 'ɡæb, 'nəθɪŋ 'mɔ:—ɒn 'nəθɪŋ 'les. hʌwət hæz 'jə:
'næk əv 'faɪn 'tɔ:kɪŋ tə du wɪð ðə 'tʌu:θ, 'emɪ mɔ: ðən 'pleɪnɪ dɪ
'dʒən 'hæz? aɪv 'nevə bɪn ɪn jə: 'tʃɔ:tʃ; bət aɪv bɪn tə 'səm əv jə:
pə'lɪtɪkəl 'mɪ:tɪŋz; ɒn aɪv 'sɪn ju: 'du: hwɔts 'kɔ:ld 'rəʊzɪŋ ðə 'mɪ:tɪŋz
tʌv ɪn θʊ:zɪzəm; 'dæt 'ɪz, ju: ɪk'sæɪtɪd ðəm ɒn'tɪl ðer bɪ'hæɪvɪd ɪz 'zækəlɪ
əz ɪf ðer wə: 'dɪʌŋk, ənd ðə: 'waɪz 'lekt 'ɒn ɒn 'sə: 'kɪləɪ r'naf hwət
'fɪ:z ðer 'wɔ:; 'ov, ɪts ɒn 'əʊld 'stɔ:ri: ju:l 'faɪnd ɪt ɪn ðə 'baɪbl. aɪ
'mædʒɪn 'kɪŋ 'deɪvɪd, ɪn hɪz 'fɪts əv ɪn θʊ:zɪzəm, wəz 'veri 'laɪk ju:;
'bət hɪz wəɪf dɪs'pəɪzɪd hɪm ɪn hɪ: 'hɑ:t."

3
'let mɪ ə'ləʊn. 'dɔʊnt 'tʌtʃ mɪ. 'stɔp. mɔ:rel, ɪf ju: 'stɔ:ɪk mɪ, aɪl
'kɪl mɪ'self. aɪ 'wʊnt 'bɪə-ɪt. 'let mɪ'gəʊ. 'teɪk ju: 'hænd ə'weɪ.

4
aɪm nɔt ə'fæɪd əv 'ju: ɪts 'ju: hɪ: ə-ə'fæɪd əv 'mɪ:.

5
'jes ɪt 'dæz. 'ju: θɪŋk bɪ'kɔ:z aɪ 'ʃɔ:ŋk frəm 'bɪɪŋ 'brɔ:təɪl 'hændlɪ
—bɪ'kɔ:z aɪ kən 'du: 'nəθɪŋ bət 'kraɪ wɪð 'reɪdɪz hwən aɪ ɒm 'met wɪð
'vaɪəlns—bɪ'kɔ:z aɪ 'dɔʊnt 'lɪft ə 'heɪvɪ 'tɪŋk 'dʌʊn frəm ðə tɔp əv ə
'kæb laik ju:—bɪ'kɔ:z aɪ 'kɔ:nt 'fæɪt ju: fə ju: 'wəɪf əz ə 'nævɪ 'wɔ:d; 'ɔ:l
'dæt meɪks ju: 'θɪŋk ðət aɪm ə'fɪreɪd əv ju:, bət ju: 'rɔ:ŋ. ɪf aɪ 'hævnt
ɡɔt hwət ju: 'kɔ:l 'brɪtɪʃ 'plæk, aɪ 'hævnt 'brɪtɪʃ 'kævədɪs 'aɪdə; aɪm
nɔt ə'fæɪd əv ə 'kɔ:lɔ:ndəmənz aɪ'dɪəz. aɪl 'fæɪt jə:z-aɪ'dɪəz. aɪl 'reskju
'hə: frəm hɪ: 'sleɪvəɪ tʌv ðəm; aɪl 'pɪt mɪ 'əʊn aɪ'dɪəz ə'ɡenst 'əm. 'ju:ɔ:
'dɪəvɪŋ mɪ 'aʊt əv ðə 'hæʊs bɪ'kɔ:z ju: 'deənt 'let hɪ: 'fɪ:z bɪ'wɪn
jə:z-aɪ'dɪəz ɒn 'mɪn. jə:z-aɪ'fæɪd tə let mɪ 'sɪ: hɪ: ə'ɡen. let mɪ ə'ləʊn,
aɪ 'seɪ. aɪm 'gəʊvɪŋ.

6
ju: 'ʃæl—ju: 'mæst. ɪf ju: ɡɪv 'emɪ ɛksplə'neɪʃn bət ðə 'tru: 'wæn,
jə:z-aɪ'ləʊnd ənd ə 'kævəd. 'tel ə 'hwət 'ar 'sed ənd hæv 'ju: wə: 'stɔ:ɪŋ
ɒn 'mænɪ, ɒn 'ʃek ɪm əz ə 'terp 'feɪks ə 'ræɪ; ənd hæv aɪ 'ʃɔ:ŋk ənd
wəz 'terfæɪd; ənd hæv ju: 'kɔ:ld mɪ ə 'snɪvɪlɪŋ lɪtl 'hælp ɒn pʊt mɪ
'aʊt əv ðə 'hæʊs, ɪf 'ju: dɔʊnt 'tel ə, 'ar 'wɪl: aɪl 'raɪt ɪt tʌv hɪ:.

7
bɪ'kɔ:z 'fɪ: wɪl əndə'stænd mɪ ənd 'nəʊ ðət aɪ əndə'stænd 'hə:; ɪf
ju: 'kɪp 'bæk 'wæn 'wə:ɪd əv ɪt 'frəm hɪ:—ɪf jə: 'nɔt 'ædɪ tə 'let ðə
'tʌu:θ əv hɪ: 'fɪt əz 'aɪ 'em—'en ju: l 'nəʊ tə ðə 'end əv jə: 'deɪz ðət
fɪ 'rɪəl bɪ'lɔ:z tə 'mɪ: ənd 'nɔt tə 'ju:; ɡʊd 'baɪ.

8
'aɪdə ðə 'tʌu:θ ɔ:-ə 'laɪ ju: 'mæst 'tel hɪ:; ɪf aɪ 'gəʊ.

9
aɪ 'nəʊ - ə 'laɪ. ɪt wɪl bɪ 'ju:sls. ɡʊd'baɪ, 'mɪstə 'kle:dzɪmən.

10
aɪ 'wɔnt tə 'steɪ, əv 'kæəs, ɒn'les ðə 'revərənd 'dʒentlmən, ju:
'hæʃbən, hæz 'emɪŋ tʌv əd'vaɪz tə ðə 'kɔntrəɪ.

11
'kəm ɒn 'let ðə 'teɪbl, aɪm ðə 'hæpɪst əv 'men.
("Candida", end of Act I)

The delightful part of talking with Mr. Bird about speech was that he knew what he said or what he didn't say. At least he could hear himself accurately, and if any question arose regarding his pronunciation in a certain line he would say: "If I was speaking carefully, I would say it this way, but I might say it thus and so once in a while." This remark established Mr. Bird in our confidence as an educated speaker.

The emotional repression in the speech of *What Price Glory* is part of its eloquence. It gives weight to the mixture of military discipline and human nature that enters into each character, and it gives combustibility to the situations when the clash of personality comes man to man. What is most deep-seated in the voices of William Boyd as Sergeant Quirt and Louis Wolheim as Captain Flagg is the long stifled, constantly accumulating bitterness of heart that comes from personal rivalry on the one hand and the rigor of war and military discipline on the other.

Mr. Boyd, the lingo of the play, makes a lasting impression by the deeply suppressed feeling that he controls by his will. The whole part is stamped on his face and in his voice at his first entrance. I was glad to have a front seat to get the full benefit of those first few moments on the stage. The firm mouth of the sergeant has lips that close like the edges of a knife. The unflinching, irreconcilable gaze of the eye would be vicious if there were not such keenness of intellect and penetrating purpose behind it. The masked setness of the skin drawn over the worn muscles of the face completes the picture of privation and endurance. Such is the muscular texture of Mr. Boyd's whole body, and from this strong, well-governed physique of man and soldier comes the held-in, held-down, but irreconcilable voice of the underdog. The voice comes from the lips like a wire of steel that goes straight to its object, where its point can be felt to penetrate with its warning of ulterior purpose and threat. What is nice in this quality of repression is that the voice is not villainous or brutally ugly. It is highly intelligent, positively human and it rings with the sincerity of high justice, justice at least in the everyday things between man and man.

The Captain Flagg of Louis Wolheim is more of a brute in his physical make-up, but not so much so in his feelings for his fellowmen. There is more fightingdog and growl in his voice, less of the superior intelligence, but with the animal qualities put aside there is a note of sympathy and humanness that is never entirely lost. At times it is uppermost in the weariness of fighting and driving to the death. And even in hate the hatred is a superimposed thing inflicted on men who have some time been where bells have knoled to church.

This is the feeling that *What Price Glory* puts over. It brings out some interesting voices, for the voices have been selected to bring out the ruggedness of the fundamentally masculine nature aroused to its full strength. The strong fiber of the voices resonated in bodies that are equally strong has a ring of sincerity and true-to-color straightforwardness that makes cuss words and coarse expressions pale in significance.

What Price Glory without repression of emotion would be bombast and not art. With this repression that the actors give it, it is deeply human, and beneath the laughter is a sense of horror and harrowing reality.

Clyde North does some excellent work in the part of Lieutenant Moore. His voice, which is naturally strong and firm in texture, is able to unloose a tremendous amount of subconscious suffering. He can reach those depths of soul that tears and prating cannot relieve or quite express. The big waves of torture that never quite come to the surface roll and beat against the man inside. Mr. North's voice can "get me" in about two seconds, and his repression and control in "suggesting" his emotion can keep me on the rack as long as he has lines to speak or breathing muscles to shake his sides and loosen his struggling tone. Brian Donlevy, Fuller Mellish, Jr., and George Tobias are all good in their respective parts, and Leyla Georgie as Charmaine is sweet voiced and amusingly docile as the daughter of Cognac Pete.

The Seventh Avenue Stock Company's New York was quite sparkling during its presentation of *The Gold Diggers*. There was an excellent cast of women, with Anne Morrison as the center of attention in the part of Jerry Lamar. There must be something unusual in Miss Morrison for I remember her distinctly as far back as *The Bat*, and when I knew that she was joining the Seventh Avenue Stock as leading woman I made a point of being on hand her opening week, for having kept up my acquaintance with Miss Morrison thru *The Wild Westcotts* and *Pigs* I am more and more convinced that she is quite worth cultivating. She played in *The Gold Diggers* with the same sense of humor and liveliness that she put into *Pigs* (with Patterson McNutt as co-author). She is spontaneous, wholesome, and unaffected, and there is an unstudied refreshment about her acting that is entirely winsome. LaMarr is not a part to bring out all the refinements what Miss Morrison will give to other characters, but it gave her a favorable introduction to the Seventh Avenue audi-

(Continued on page 44)



(Communications to 1493 Broadway, New York, N. Y.)

The Shopper

A Spanish Costume, a Dainty Hair Wreath and a Strapless Brassiere

PLEASE REMEMBER

The services of The Shopper are free to our readers. The following descriptions are not advertisements. They are simply The Shopper's reports on the smart things displayed by reliable shops.

When ordering do not send personal checks. The shops refuse to accept them, but welcome money orders. A money order simplifies things for our bookkeeper, as all she has to do is endorse it and send it to the shop.

The Shopper acknowledges all letters promptly. When you do not receive a reply within a reasonable length of time you may conclude that The Shopper's acknowledgment has missed you somewhere along the route, has been returned to her and is advertised in *The Billboard's* Let-List.

Please enclose a stamp with your letter for reply.

A bandeau-brassiere, without shoulder straps, is of unusual interest to the aerial performer, equestrienne, dancer or gymnast. First of all, however, we wish to state that the bandeau-brassiere, which covers the breast only, giving adequate support despite the absence of shoulder straps, is for the smaller woman only. A special strapless brassiere for the larger woman is discussed in another paragraph, this column.

The bandeau-brassiere, while supporting the bust firmly, leaves the diaphragm free. The snug fit of the bandeau is assured by a special elastic inset which fits across the back. In appearance the bandeau is dainty. It may be had in imitation fillet lace, with a dainty embellishment, for \$1.50; in imitation Irish, with ribbon decoration, at \$2.75; in fiber jersey silk, with fillet lace edging, \$2.50. An exceptionally beautiful model is of imitation Duchess lace, with ribbon bow, at \$3.75.

The strapless brassiere for the larger woman is made of novelty silk and mercerized fabric at \$2.25; of fine quality Skinner washable satin, with silk elastic and real fillet lace, at \$5. It fits firmly down about the waist and hooks up the side. It is not anchored to a corset clasp and "stays put." No straps to fall over the shoulders or to tuck inside the corset.

We saw a lovely woman of the New York stage wearing the hair wreath illustrated and were so charmed with its soft luminosity that we made a round of the shops until we found its duplicate. It is classic in design, the leaves being fashioned from a silver cloth, flecked with a crystal-like silver tinsel. It is very light weight and graceful, possessing the added advantage of harmonizing with a gown of any color. The price is \$1.95. This style has a double row of leaves. The same type of wreath with a single row of leaves is \$1.25. When ordering, please include postage.

The Taylor Trunk Company is now distributing a new catalog, with illustrations and descriptions, of its "Circus Special", as well as a full line of wardrobe trunks, built for one or two. Information regarding special trays which may be ordered is included. The famous "Circus Special" is quoted at \$31 for the 24-inch style and \$33 for the 28-inch style. Discounts are offered at this season of the year to make buying tempting to the circus folk. A copy of the catalog may be had from *The Shopper*.

If you wish to look fetchingly youthful your wish will be gratified when you don one of the new gumpe skirt ensembles. Two reasons for the popularity of this ensemble are that it is strikingly picturesque and very reasonably priced. At one shop a gumpe skirt of fine wool crepe with pleated skirt set on a mannish vestee, with pockets and buttons, which is continued into shoulder straps, may be had in powder blue, red, rosewood, tan, navy and black, at \$6.95. A peasant blouse designed especially to wear with the gumpe skirt, made of fine crepe de chine in red, white, gold and powder blue, charmingly embroidered in contrasting colors, is offered at \$5.95. The gumpe ensemble comes in sizes



A description of the Spanish costume will be found under the heading of *Stage Style Revue*, on this page, while the hair wreath and strapless brassiere are described in *The Shopper* column, this page.



The Beauty Box

A great many women who prefer to keep their hair bobbed manage to keep within the demands of the mode for the evening coiffure by wearing a clever hair-piece, which conceals the bob and is pinned on in a jiffy. This hair piece has proved a boon to stars of the stage and screen who are called upon to play varying roles to which the bob would be an incongruity. This special hair piece may be had in any shade, your own hair

up to 38 only. Please include postage when ordering.

There are two establishments in New York offering a service which should prove a boon to the actress who wishes to display to the community far from New York the newest styles in millinery and gowns.

One of these establishments specializes in made-to-order hats, copied from style illustrations, in any desired material and made to fit exactly the individual head size.

The other establishment cuts patterns from which you or your dressmaker may duplicate any gown that strikes your fancy—Parisian or American, as illustrated in the fashion magazines.

In order to get quotations for either service, cut from a magazine illustrations of a coveted hat or gown, mention the kind of fabric desired in the case of the hat, as well as your head size and gown size. Send this information to *The Shopper* who will see that quotations are sent you. In this connection, kindly give your route well in advance, as an estimate of this kind cannot be sent by return mail.

If you are hard of hearing, *The Shopper* has for you a story of a wonderful little device which may be worn invisibly, under the hair.

matched, except gray and white, for \$10. Gray and white are each \$5 additional.

The woman who values a natural-looking makeup for the street carries about with her a small compact jar of Scotch Bloom rouge, a cream rouge, emulating an American Beauty rose in shade and fragrance. It will prove a pleasing change from the usual type of artificial-looking rouge, as well as beneficial to the lips at this time of year, when March winds begin to blow. It costs but 50 cents a jar.

The fastidious woman who keeps her nails daintily polished will undoubtedly want to send for a most convenient little box with a sifter top, filled with a rose-scented powder which imparts to the nails a shell-pink luster. Six cents in stamps will bring to you a miniature box of the nail polish and a sample of cuticle remover. This introductory offer is for one month only.

Now that spring is approaching, many women, bobbed or unbobbed, will consider having the hair waved permanently. If you have no favorite beauty parlor in mind we shall be happy to refer you to a beauty salon in midtown which specializes in a permanent marcel wave for \$10—to the profession. This price should be a special inducement to the profession in and about New York City.

A maker of high-grade henna and dye offers to send samples of his preparations to those in need of a hair coloring which is long enduring in effect. Its maker claims that it is harmless. Retail at \$1.50, but a request will bring a sample.

One's appearance when wearing décolletage is often marred by the

Stage Style Revue

JUDITH ANDERSON IN "THE DOVE"

Our artist was so charmed with Judith Anderson in *The Dove*, at the Empire Theater, New York, that she sketched from memory her impression, bringing out adroitly much of the airy grace with which this gifted actress wears a Spanish costume. It also refutes the claim that the Spanish costume must be a blaze of color to be successful, for this costume is of white taffeta. A full face tunic is posed over the dress of white taffeta and cut-out lattice work lends a novel touch at décolletage and hem. The mantilla matches the tunic.

TEDDY GERARD IN "THE RAT"

Teddy Gerard, in *The Rat*, at the Coloual Theater, New York, wears beige so effectively that one ceases to wonder why the fashion creators have used it so lavishly in making up the ensemble suit or trotteur frock.

In one scene Miss Gerard wears an ensemble suit consisting of a full-length coat and frock of beige. The coat is of cloth, with collar, cuffs and wide hem band of matching fox, while the frock of simple lines is of satin, trimmed down the front seam with two rows of tiny satin-covered buttons. The simple V neck with lapels is relieved at each side with a jabot of chiffon.

In another scene Miss Gerard wears a trotteur frock of beige-colored kasha, a coat style, buttoning down the front, with fitted sleeves, flaring slightly above the wrist to show wristlets of gold leather. Pipings of the gold leather on each hip simulate three pockets within pockets of varying size. A choker of the gold leather lends a novel touch, and a smart little hat of beige felt is set off with a band of the gold leather.

PATRICIA COLLINGE AND AURIOL LEE

Patricia Collinge and Auriole Lee, appearing in *The Dark Angel*, at the Longacre Theater, New York, are unhampered by the dark theme of the play in their gown selections. Miss Collinge wears an unusual-looking gown of white chiffon, cut on coat lines. It is posed over a pleated slip and bound down the front, about the hem, sleeves and lapel collars with a band of jade satin. A wide band of satin in a floral embroidery design elaborates the hem line.

Miss Lee, wearing printed crepe de chine, reminds one of a Parisian mannequin. A front apron of tri-tiered arrangement contradicts a plain back, which is relieved by an odd cape which commences at each shoulder and ties at the back with long ends. The sleeves are long and close fitted and the neckline is slightly rounded. With this frock Miss Lee wears emerald novelty jewelry and green metal slippers.

Style Notes

The foregoing frocks, worn on the New York stage, are all expressive of the short silhouette decreed by Paris. *Women's Wear*, a leading fashion authority, prints a wireless from its Paris bureau, reporting that the short silhouette is re-emphasized in the latest Paris openings, the exhibits of which will soon find their way to America to serve as models.

It reports also that the waistline is approaching normal; circular lines are more generally recognized, and that pleats, panels, godets and yokes create interest in the new silhouette.

Metal lames and brocades are largely used for evening gowns, says the same authority, adding that elaborate sleeves will distinguish the afternoon frock.

The vogue for elaborate separate sleeves is so great in New York that the shops seem to make no attempt to carry gowns with long sleeves for afternoon wear.

After the short-sleeved or sleeveless frock has been purchased Milady hastens to the neckwear department and buys a pair of separate sleeves, ready made, to wear with the gown. These are usually of georgette, tucked and shirred, with an elastic top which holds the sleeve firmly to the upper arm. The price ranges from \$2.95 up. The colors are periwinkle blue, red, white, navy, tan and black.

The tucked and shirred material may also be purchased for \$3.95 a yard, in black, navy, tan and red. It is wise to purchase the prepared sleeving by the yard if your upper arm is stout.

Stiff collar and cuff sets of cretonne print, gingham, diamond and stripe designs lend enhancement to the dark tailored dress. These sets are selling in the stores for 79 cents a set and a Windsor tie to match is offered at 47 cents.

If you decide to ask *The Shopper* to purchase the sleeves or collar and cuff set please include postage and mention size of collar.

Uncared for appearance of arms or neck. To insure beauty a good whiteners is as necessary to the arms and neck as is a good powder to the face. A dependable whiteners for general or theatrical use is prepared by Mme. Rubinstein. It adheres to the skin until washed off and will not rub off on a man's black evening coat, after the embarrassing manner of old powders. The price is \$1.25.

Ranch to Movies Unintentionally

Ruby Blaine, Proposed as Entrant in Beauty Contest Without Knowledge, Was Routed Into the Movies by Fate

Those "wags" who believe in the good old copy-book maxims, "Hitch Your Wagon to a Star; Work, Work, Work, and If You Don't at First Succeed Try and Try Again" (and we are one of them), are asked to consider the strange case of beautiful Ruby Blaine, who unintentionally made her debut in the motion picture world as a flapper in the film *The Sixth Commandment*, and within a short time found herself among the featured players, associated with stars, in *The Spitfire* and most recently in *The Midnight Girl*, starring Lila Lee.

This "unintentional" young person, who is singularly reticent, admitted after much questioning that after her debut in the films she decided to stop roping bronchos on her father's ranch and to hitch her wagon to a star instead—the star of fame.

When asked how she made her unintentional debut in the movies Miss Blaine appealed to the third person present to tell the interviewer all about it. "Well," said the third person, Ruby was born on a ranch in the Pueblo Mountains of Colorado. She attended the little red school house and found recreation in riding and roping with the cowboys on her father's ranch.

"Of course, everybody on the ranch thought Ruby was beautiful—as did everybody who ever saw her. When the National Beauty Contest was held at Madison Square Garden, at the time of the memorable Democratic Convention, one of Ruby's admiring friends sent a photograph of Ruby to the contest promoters. The result was that Ruby was nominated as one of the participating beauties. She traveled to the Garden, won the contest and was crowned Miss New York, queen of the Metropolitan Beauty Brigade.

"The inevitable motion picture offer that is linked with winners of beauty contests brought about her debut in the film *The Sixth Commandment*. She screened so well that she was cast for other small parts in the movies."

Altho homesick for the ranch, its loyal comrades, athletic exploits and invigorating rides along mountain trails on a spirited mount, Ruby Blaine steered herself against "babyishness" and decided to remain in New York. She found a substitute for the mountain rides by taking daily horseback rides in Central Park with an adoring little white spitz dog pattering along in wake of the mount.

There is something compellingly vital and vivid in Miss Blaine's beauty, something symbolic of the Golden West itself. The mountain air has kissed her complexion the lovely golden-and-rose-touched hue so coveted by the fashionable woman as suggesting an extended sojourn at Deauville or Palm Beach. Her hair is a sunny auburn and her eyes are violet blue, set just the requisite distance apart for beauty. Her features, while finely chiseled, have a characteristic strength which denotes forebears of the thinking type. And her forebears are of that very type. They were among the independent thinkers who came over on the Mayflower. James G. Blaine, erst-

RUBY BLAINE



A New Beauty of the Films

Ruby Blaine, one of the featured players in "The Midnight Girl", a Chadwick Pictures Corporation release, came from a ranch in the Pueblo Mountains of Colorado, won a beauty prize in a national contest, posed for Howard Chandler Christy magazine covers and passed successfully a screen test. She is the new type of athletic femininity—slender, agile and beautifully poised—all these beauty attributes, she claims, being the outgrowth of good health gleaned in open spaces.

while candidate for the presidency, is her great-grandfather. Altho the Blaines have always been interested in politics, Ruby Blaine is not slightly interested in the feminist movement. She hasn't even voted—an omission undoubtedly due to the fact that she hasn't reached voting age.

Asked what her plans for the future were, Ruby Blaine, who prefers listening to talking, looked thoughtful for a long time and then in a voice which like her face is eloquent of the great outdoor life replied:

"To take all parts as they come, giving my best to each until I have proved definitely what I ought to do. Then perhaps I shall specialize in a certain type of role."

"Whatever small success I have had before the camera is due in a large measure to the kindness of the experienced players of the films with whom I have associated," she added. "Without their assistance I should not have made progress. They have helped me so willingly in the past that I am sure they will continue to help me find the type of roles for which I am best adapted."

Asked if she could offer suggestions to other girls less fortunate in their efforts to enter the motion picture field she replied:

"Most aspirants for motion picture fame start out with a preconceived idea of what they want to do—the type of role they want to play—and do not hesitate to talk about it. In most cases the preconceived idea is wrong. Many a player has turned down a part because of that preconceived idea instead of taking what bits were offered and making the best of them."

"After you have attained stardom what do you plan to do?" was asked.

"Return to the ranch during vacations and store up health, the foundation of beauty and success," said Miss Blaine. "There is no substitute for the great outdoors—not even fame!"

ELITA MILLER LENZ.

Bill To Kill Blue Sunday in Pennsylvania

Pittsburgh, Pa., Feb. 20.—Representative Voltz has introduced a bill into the Legislature which, if passed, will permit municipalities to decide at the next general election whether Sunday sports and amusement will be permitted. The bill is intended to kill the blue laws now in force in this State.

Rob Theater Safe

St. Joseph, Mich., Feb. 20.—Thieves lugged an enormous safe from the Caldwell Theater a mile away on the Lake Shore drive and robbed it of \$600.

Garters



Pierot

Something Snappy

PIEROT GARTERS—1 1/2-in. Silk Button. Hand-Painted Face—Quilted silk collar, fine grade silk and elastic to garter—each pair neatly carried and boxed. Selling rapidly in Gift Shops, Premium Stores, Billie G. Co., Bangor, Me., Dept. Stores, Nov. Shops, I.T.S. NEW. Sample Pair, \$1.00. Write for Quantity Prices. PHILADELPHIA BADGE CO., Manufacturers. 942 Market Street, Philadelphia, U. S. A. Write us about our Princess Chic Heads.

Dramatic Notes

(Continued from page 25) is said that Katherine Cornell will play the leading part in it.

Arthur Byron is once more staging a play. This time it is *The Mud Turtle*, which Kilbourn Gordon is producing.

Melville Burke, who staged *Episode*, has been engaged by the Shuberts to stage two more plays during the spring.

Charles Horan has closed *The Devil Within* after trying it out and will re-write and recast it before it is shown to Broadway.

Loggerheads, which is making a fine impression at the Cherry Lane Playhouse, New York, is to be brought to Broadway to play special matinee performances.

Broadway has it that David Belasco will present an amplified version of *Madame Butterfly* next season with Lenore Ulric in the title role. This piece is a one-act play in its original form.

It now seems a certainty that the author of *The Dark Angel* is Michael Arlen. Guessing the identity of the author kept the wiseacres busy for a day or two.

Walter Hampden will bring his engagement in *Othello*, at the Shubert Theater, New York, to a close on February 28. He will appear in the role again next season.

Franklin Bigelow, whose play, *The Crucible*, is being done at the Triangle Theater, New York, has another completed, called *The White Wind*. It will also be done at this theater.

Benjamin Harrison Orkow, who wrote *Milare's Progress*, has turned out another opus and one of the Broadway managers is said to be favorably inclined towards it.

David Warfield will not play this season. Early next season he will be seen in *Alias Santa Claus*, a play by Willard Mack. At least that is the plan at present.

Jane Cowl, having concluded her New York engagement in *The Depths*, has taken to the road, but will return to play the Subway Circuit. She will tour until late in the spring.

Gertrude Bryan is now being featured in *The Way of the World* at the Princess Theater, New York. This play of Congreve's is doing very well since it moved uptown from Greenwich Village.

Henry Herbert has joined the cast of *Seduction*. He has the leading male role and will be seen in the play when it comes to Broadway. That will be in the early summer, in all probability.

Paul Harvey has been engaged to appear in *Wings of Chance*, which Adolph Klauber is to produce. Others in the cast are Betty Linley and Bernice Vert. Ira Hards is directing the play.

The next production that Mulligan & Trebitsch will make, now that *Night Hawk* is out of the way, is *Fast Workers*, by Roland Oliver. The cast is now being assembled and rehearsals are due to start shortly.

James Crane has recovered from the illness which caused the postponement of *The Heart Thief*. He is leaving for the South and will stay there for the rest of the season. In the autumn he will play *The Heart Thief* again.

Guthrie McClintic will not produce that play of Lewis Beach's which he was supposed to do this season. The story goes that author and manager could not agree as to casting, so Mr. Beach has taken his piece to another manager.

Virginia Pemberton, Leslie Austen and Catherine Dale Owen will be seen in the forthcoming production of *The Toss of a Coin*. This play is by Arthur Previn and Edwin Maxwell and will be presented by Hast Productions, Inc.

Beatrice Terry has been added to the cast of *Bachelor's Brides*. Others in the company are Geoffrey Kerr, Otola Nesmith and Ben Johnson. Miss Terry was last seen on Broadway in *Children of the Moon*, in which play she did notable work.

There was a story around Broadway that *Seduction*, which it seems is stirring up the natives of Baltimore, would come into the Belasco Theater, New York. Now the producers say "tain't so," as any one who saw the crowds flocking into *The Harcm* might have guessed.

BIRCH-MARKS, MOLES, SCARS Removed Painlessly. Write for free information. AKERI METHODS, 277 W. 83rd St., N. Y. City.

Youth-Ami Skin Peel

A New Scientific Discovery which painlessly and harmlessly replaces the old skin with a new and removes all Surface Elements, Pimples, Blackheads, Discolorations, Tan, Eczema, Acne, Large Pores, etc. A non-acid, invisible liquid. Produces a healthy new skin, beautiful as a baby's. Results astounding. Booklet "The Magic of a New Skin" free in plain sealed envelope. Youth-Ami Laboratories, Dept. BKB30 E., 20th St., New York.

FOR THE STAGE - STEIN'S ABSOLUTELY GUARANTEED MAKE-UP FOR THE BOUDOIR

THE STRAPLESS BRASSIERE

A genuine convenience to the Actress, Dancer, Aerial Performer and Gymnast. No shoulder straps to slide out of place or mar the derolletage. Full information concerning the FINLIN STRAPLESS BRASSIERE for Slim and Stout Figures may be had from THE SHOP-PER, care of The Bill-board, 1493 Broadway, N. Y. City.

RUMMAGE SALE

Society Ladies' Furs and Gowns

Beautiful Fur Coats and Wraps, as low as \$25

SOME COSTING AS HIGH AS \$500 WHEN NEW—AT FRAG-TICALLY YOUR OWN PRICE.

Gowns, \$5.00 and up

Hundreds of Beautiful Gowns and Dresses designed by the foremost modistes of New York and Paris. But slightly used.

808 Sixth Ave., NEW YORK CITY.

(Entire Building), 45th-46th Streets.

KEEP YOUR BEAUTY

Our amazing beauty "Keep Your Beauty" is distributed free. Every woman who reads this wonderful leaflet gets a 3 in 1 bag of soap. The soap she washes with is a selling marvel.

3 in 1

3 ARTICLES FOR THE PRICE OF 1
1 ARTICLE TO TAKE THE PLACE OF 3

Agents—Canvassers

MEN and WOMEN

The fastest money you ever saw! The quickest sales you ever made! 3 in 1 is a wizard for cleaning up on sight. There is nothing like it. It is the

Only One in the World

A mechanical masterpiece! Unsurpassed quality! Outwears all others! Sanitary and desirable! Handy and practical! Saves time and money! Protects health! Preserves beauty! Is a nurse in the home! Is the doctor's assistant!

Absolutely Big Money in this Proposition

Greatest Money Harvest Ever Offered to Agents

No delivery or collection. You take orders only. Most unique selling plan in existence furnished you free.

3 in 1

HOT WATER BOTTLE ICE BAG FOUNTAIN SYRINGE

Don't let this proposition grow cold. There is no time like this time. Territory going fast. Write at once.

When You Take Hold of 3 in 1 You Stop Building An Castle. You Can Go Right Out And Buy An Old Thing You Want. Your Money Chance—His Money Chance—Her Money Chance.

LOBL MANUFACTURING CO.

DEPT. 21 MIDDLEBORO, MASS.

Every Woman Can Have Beautiful Eyebrows

COLOURA darkens eyebrows and lashes; not acted by tears, perspiration or creams; lasts for weeks; harmless and simple to apply. Sent \$1.10, prepaid. Treatment at our shops. See SPIRO'S HAIR SHOPS (Est. Over 40 Years), 26 W. 38th St., and 34 W. 46th St., N. Y. C.

Baljon Cold and Cleansing Cream

A California product for members of the profession everywhere who desire a cream which is especially useful as a skin cleanser and massage and massage on retiring.

Its continued use is recommended to bring back the charm of youth to faded beauty.

Send \$1 for regular size jar, mailed prepaid on receipt of silver, stamps or money order.

Overnight size, 25c, prepaid.

BALJON CO., Cosmetic Chemists,

72 Second St., San Francisco, Calif.



Communications to 1493 Broadway, N. Y.)

The building recently purchased by the United Scenic Artists' Association for a permanent New York headquarters is being sought by real estate interests who are willing to pay a price for it that will net the association a profit of more than \$30,000. This would be quite a handsome gift, particularly in view of the fact that it is only six months after the property was bought.

But the Scenic Artists' Association apparently is not interested in real estate speculation. Its only aim is to promote the welfare of its members, and it considers it more important to have headquarters located in a good section of the theatrical district than to take advantage of the opportunity to fatten its treasury and then inconvenience its members thru having to take quarters in a less-desirable part of the city.

The scenic equipment for *Natja*, the Tschalkowsky operetta presented by the Whitneys in New York last week, was supplied by the Triangle Studios and the Robert Law Studios. The Triangle shops contributed the first act, representing the reception room in the winter palace in St. Petersburg. It is not an elaborate affair like the similar settings in *The Student Prince* and *The Love Song*, but it serves very nicely. In fact, it serves even better because it is not obtrusive and does not put a strain on the eyes. The second and third act setting, a scene on the banks of the Dnieper in Crimea, was nicely designed by Law. It is a history fact that when Catherine II visited this spot she was deceived into believing there was a city on a distant hill, whereas the supposed city was actually built of scenery. Law has reproduced the effect in a very clever manner.

Livingston Platt has been commissioned by the Actors' Theater to design the settings for the pantomime, *Pierrot the Prodigal*, in which Laurette Taylor will appear for a series of special matinees at the 48th Street Theater, New York, early in March. Platt recently completed the settings for two other Broadway dramatic shows, *The Dark Angel* and *She Had To Know*. The Oden Waller Studios painted the scenery.

Cleon Throckmorton and his associate, Michael Carr, of the Provincetown Studios in Greenwich Village, are among the busiest scenic craftsmen in New York these days, and the fact that they are turning out large quantities of work does not have any effect on the quality of their output, according to the complimentary reports of several eye-witnesses.

Bernard McDonald is responsible for the scenery in the new Florenz Ziegfeld production, *Louis the 14th*.

Vincent DeVita has closed with the stock company at the Circle Theater, Dallas, Tex.

Walter Sherwood is leaving the Mafestle Theater, London, Ont., and Charles B. Nicholas, who recently closed at the Grand Opera House, Toronto, will succeed him.

Charles Cadwallader, formerly art director at the Long Island studios of the Famous Players film corporation and now connected with a new company, called the Hollywood Studios, in Los Angeles, states in a letter to President Charles E. Lessing of the United Scenic Artists that he is enjoying life and his work on the West Coast and will remain there indefinitely.

Herb Ward is doing the scenery for *Sam Shannou's Sinners*, a new revue being organized in New York on the co-operative plan for a tour of the Erlanger houses.

P. Dodd Ackerman has provided settings for an untitled play—unless an interrogation point can be called a title—being presented by Richard Herndon for special matinees at the Cort Theater, New York.

Norman Bel-Geddes' settings for *The Comic Supplement*, which had a brief career of two weeks out of town, will see Broadway after all. Ziegfeld announces that he is going to incorporate them into his next edition of the *Follies*, opening next week at the New Amsterdam Theater. This puts at rest the accusation reported to have been made by Ziegfeld that *The Comic Supplement* was closed because its scenery was not satisfactory.

Every circus and carnival of any size ought to have a scenic artist traveling with it all the time. He could be useful not only in arranging effective settings for the various exhibitions, but also in keeping up an attractive appearance for the show's front and for the grounds in general. It should not be hard for scenic artists to convince outdoor show owners of the many advantages of their having a scenic craftsman around.

REFLECTIONS OF DOROTHEA

I count this thing to be grandly true: That a noble deed is a step toward God, Lifting the soul from the common clod To a purer air and a broader view. —John Gilbert Holland.

HOW OFTEN we are thrilled by the beautiful lines of some inspirational poem that is all too soon forgotten. If we are to profit by the thought expressed we must practice it or lose the joy of which the lines are only a suggestion. Could we but realize the power and the value of the little word of cheer so lightly spoken, could we but see the flame of hope that springs from the flickering spark in the saddened heart at the sight of a friendly smile, life would outshine the dreams of poets. Truth, sometimes, is stranger than fiction. I think the little story I am about to relate will interest you because it is true in every detail and strikingly illustrates how little will often suffice to feed a hungry heart.

It was several months ago that I first met him, a kindly, sensitive gentleman of the old school. He had been moderately successful in life and felt keenly the blow that adverse fate had just dealt him in his old age. Only a short time before, following a great disappointment, he had planned to spend the remainder of his years in South America. Then, with the sinking of the ship, practically all his worldly possessions were swept away by another cruel stroke of fate. Saddened and alone, he had returned to the States, but to him it seemed the world had quite forgotten his existence. Oddly enough, he had long been a reader of "Reflections" and one hopeful day he asked if he might call to see me.

He went away with a new hope in his heart. He thought he had a plan that would set him on his feet again and he would try. Occasionally he called but, tho he kept a stout heart, I gleaned that the road was rough. Because of his

By way of greeting, Connie DeBower sent me a basket of beautiful deep red posies.

Predictions of an early spring are already in the air and a couple of youngsters in the neighborhood told me they were saving their pennies to buy marbles. Maybe so, maybe so!

Always glad to hear from my readers. Address me at 600 West 180th Street, New York City.

Dorothea Antel

The Spoken Word

(Continued from page 41)

ence, which is fortunate in its leading woman.

Betty Lawrence is a charming ingenue. She is extremely pretty and wellbred in her manner and speech so that the part of Violet gave her opportunity to dress in her prettiest gowns and be as dainty and lovely as she really is. There is nothing affected or put on in Miss Lawrence's acting which is the admirable thing about it. Mary Johns as the Topsy from Missouri was entirely up to standard in regional dialect and characterization in general. Rhoda Davies gave a rather elegant performance of the part of Eleanor with her walking stick and "accents" in London English and Paris French. Florence Pendleton in the small part of Cissie Gray again made a distinct impression by her good acting and excellent voice. She lifted the part into importance and contributed a good scene among the gold diggers who are still young.

The part of Mabel, made famous by Johanna Howland, is not easy to cast in stock, but Kathryn Givney of the Seventh

HARD WORDS

- CARAVANSERAI (kav'vansera). Eastern quadrangular inn, with great inner court, where caravans put up.
- CELLINI (tʃel'ini). Benvenuto (ben'venuto). It, engraver and sculptor (1500-71). Historical character dramatized in *The Firebrand*, played by Joseph Schildkraut.
- COUDRAY (kudrai). Marquis de la Falaise de la Coudray (mar'ki de la fak'z de la kudrai). Husband of Gloria Swanson.
- GILLARS (gila'z). Mildred. American actress.
- GOURAUD (gu'ro). French general.
- KANT (kant). Immanuel. Famous philosopher, b. in Prussia 1724. In German (kant).
- NAVY (navi). Laborer employed in excavating. Abbr. of navigator. A term used in England.
- VINCI ('vintʃi). Leonardo da (lio'nado da). It. artist (1452-1519). Famous painting, *The Supper*.
- WOLHEIM ('wo:lham). Louis. American actor in *What Price Glory*.

(For Key, see Spoken Word)

sensitive nature he believed his old acquaintances were not interested in his adversity. Then I did not hear from him for a long time and I wondered if he had surrendered.

A few weeks ago my nurse handed the phone to me and I recognized the voice on the line. The old gentleman was explaining that he was about to go on a long journey and wanted to say good-by. I told him I had missed his calls and he burst out, "oh, do you really mean to say you thought of me?" I assured him that I did.

Seated at my bedside a little later he explained that he had been fighting a losing battle and had finally decided to end it all by leaping from a balcony 14 stories above the sidewalk. He had made such little preparations as he thought necessary when it occurred to him to say good-by to me. And so there is no brief obituary to mark the end of this story for, with a song in his heart and a new view of life, the hero is carrying on to almost certain success.

It was a great pleasure to read the many communications from my readers last week. There was one from Lillian Krause, who is having a delightful time in California with the Percival Vivian Players, and another from Jack McLain Malady, who sent greetings from down in Dixie. The South was further represented by Mrs. G. W. Morgan, who sent me a bouquet of artificial sweet peas that would deceive even a bee by their appearance.

Out in Portland, Ore., the Hoot Owls sometimes roll their eyes in my direction, according to Frank Sardam, who watches the roost. I'm going to try listening in on my radio for their "Hoo! Hoo!"

Florence Fair and her mother spent a few delightful hours with me and we played cards, something I had not done in a long time. Florence will soon appear on Broadway in a new production.

James Doyle will retire from the east of *Badges* to direct a stock company in Richmond, Va., when that production goes to Chicago in March.

Avenue Company handled the part with real skill. Miss Givney's versatility is quite surprising. She has a big voice when she chooses to use it, and, altho she hasn't the vocal contortions that Miss Howland uses to advantage, she has a keen sense of broad comedy and hunches of horse sense that comes out with more or less of a wallop. She is large enough to make Mabel an imposing figure and with her voice loosening up to its full bigness she put Mabel over with blunt frankness and legitimate good taste as well. This was especially appreciated after seeing Miss Givney in the deeply emotional part of Agnes Fanning in *Lacombes* the week before.

Mr. Litel is not a stereotyped leading man, and there is always some impressive change in his character from week to week. This is especially noticeable in the age of his characters, so much so that I am a little curious to see him with his makeup off to tell whether he is 25 or 40. He has an excellent voice which keeps its natural quality in stock with remarkable success. Except for a few words his speech would be quite satisfying as a demonstration of better speech in stock. We might begin with the word "world", which Mr. Litel seems never to get right. He gets rid of "inverted r-sounds" pretty well in his speech generally, but when it comes to "world" he insists on "sounding the r" and talking Irish. With Miss Morrison, Betty Lawrence, Mr. Litel, Miss Givney, Helen Ray and Mark Kent in the company the Seventh Avenue is pretty well set to speak good English, when the part permits, if they will just watch out. If Mr. Litel will start on the word "world" he will soon puzzle out the other words.

Madelon Davidson gave a recital of *Enter Madame* at the School of Spoken Word in New York February 15. Miss Davidson is an actress of considerable experience and a writer as well. Her talents are well suited to the artistic temperament and the complications that arise therefrom in the play by Glida



(Communications to 1493 Broadway, N. Y.)

Anyone whose work with costumes necessitates complete and accurate detail will find a lot of valuable information in a new book entitled *Costume and Fashion*, by Herbert Norris, published by E. P. Dutton & Company. In a foreword Norris says:

"From an artistic standpoint it is disastrous that, with a few outstanding exceptions, the theatrical profession knows little about historical costume and, worse still, cares less! How many actors wear the toga correctly? What actresses look as if born and brought up in the period of their parts? Invariably some details jar. If this book helps to foster a closer approach to accuracy in the stage representation of costumes of long ago I shall be amply repaid for the labor of its composition. Anachronism is always ugly."

Norris devotes a whole chapter to the history of silk from the earliest times to A. D. 1600. He also describes every detail of each article of clothing from the earliest skin garments to the Norman Conquest of England, and the book contains many illustrations in color and black and white to give the impression of how the costume looked when worn. Diagrams illustrating the cut of certain specific garments are included for practical purposes.

Milla Davenport did the costumes for *Different*, the Eugene O'Neill play now being presented at the Provincetown Theater, New York.

Arlington-Mahler is at work on the costumes for *Sam Shannou's Sinners*, a new musical revue being produced in New York for the road.

Schneider-Anderson, of New York, recently supplied Julian Eltinge, who is at present touring in the South, with a new wardrobe consisting of 42 gowns. The celebrated female impersonator makes changes at each performance and is creating a sensation everywhere with the variety and splendor of his gowns.

James Reynolds is designing the costumes for the operatic version of Justin Huntly McCarthy's romantic play, *If I Were King*, which Russell Janney, of New York, is planning to produce.

Charles LeMaire, the rising Broadway theatrical designer, last week discussed his craft before the women of the Theater Club at their regular weekly meeting in the Hotel Astor.

Madame Kahn, well-known New York creator and importer, has returned from an extended stay abroad.

The costumes designed by John Held for *The Comic Supplement* will be used in the next seasonal edition of the *Ziegfeld Follies*, scheduled to open this week.

Mme. Preisner did the costumes and the Brooks Uniform Company supplied the uniforms for *Natja*, the new operetta presented in New York last week by the Whitneys. Both did an excellent job.

The interesting and profusely illustrated catalog of the Macdonald-Dawn Company, costumers, of Toronto, contains a list of "Seasonable Suggestions", giving ideas for suitable costumes for various kinds of parties. "Paddy and Colleen" is suggested for March masquerades. Overalls, jumpers, gingham and bonnets, which may be rented for very reasonable charges, are suggested for "Barn Dances" and "Hard-Times Parties". And New Year's masquerades, the Macdonald-Dawn Company states, will be fittingly observed by the wearing of the kilt. The company adds that it has a wide range of tartans on hand.

If a costumer wants to be up to date he should include in his stock of costumes or designs the dress worn by all stage and screen characters who have achieved nationwide fame, not only the old standbys like Peter Pan, Charlie Chaplin, Ben Hur, Topsy, and so forth, but also the popular characters in current productions that have had long runs, such as Abie's Irish Rose, Sally, Tondelova, Rose-Marie, Harold Lloyd and others.

Then there are the widely known cartoon characters, including Mutt and Jeff, Jiggs and Maggie, the Katzenbachs, etc.

Parties or masquerades could be given a special timely interest if costumed after these and other contemporary characters.

Varesi and Dolly Byrne. In the part of Lisa she has a voice of rare musical quality and charm and a range of voice that easily covers the emotional gamut of the part. It is a voice teeming with human sympathy and sensitiveness and its flexibility enables it to express the finer shades of meaning delicately and subtly. This same subtlety enabled it to give equally distinctive characterization to Flora and Bice.

While Miss Davidson has a distinctly

(Continued on page 46)

THE ANNUAL NATIONAL LITTLE THEATER TOURNAMENT

Hear ye, hear ye, all ye little theaters!
The third annual little theater tournament and David Belasco cup match is scheduled to be held in New York during the week of May 4, at a Broadway theater to be announced in due time, under the auspices of the Manhattan Little Theater Club, Inc., 226 West 47th street, New York. Walter Hartwig is general manager of the tournament and Grace Marren is treasurer. The advisory board is made up of Mrs. Arthur Aldis, William A. Brady, Gustav Blum, Walter Prichard Eaton, Bassett Jones, Mrs. Alfred Hayman, Bennett Kilpack, Alonzo Klaw, Mrs. Annie Nathan Meyer, J. Kenyon Nicholson, Miss Henrietta Prentiss, Mrs. Ots Skinner, Thomas Wood Stevens, Dorothy Stockbridge, Woodman Thompson, S. Marion Tucker, Manvel Whittemore and Sue Ann Wilson.

Four one-act plays will be produced each evening by four different little theater groups for five evenings, until 20 presentations have been shown. Five judges will witness these productions and select four out of the 20 plays shown as the best plays presented, judged according to a standard set as follows:

Fifty per cent for presentation, meaning interpretation of "how well the idea of the play is gotten over"; 25 per cent for acting, 15 per cent for setting and 10 per cent for selection of play.

The four presentations so chosen will be awarded prizes as hereinafter set forth, and these four productions must be played again on Saturday afternoon and evening. At the Saturday afternoon performance the judges will decide on the best play of the four, according to the same standards set forth above. The play so selected will be awarded the David Belasco cup at the Saturday evening performance. The cup is held by the winning group until the next tournament, when it is again competed for. The prizes will be:

I. Samuel French Award No. 1.—For the best presentation of an original, unpublished play, \$200, with the understanding that this play will be printed, published and distributed by Samuel French, Inc., who will control the rights of the play as the author's agent, guaranteeing the author a royalty of 50 per cent of the income derived therefrom.

II. Samuel French Award No. 2.—A second award of \$100 under the same conditions as Award No. 1, for the next best presentation.

III. An award of \$100 for the next best presentation of a published or unpublished play.

IV. An award of \$100 for the next best presentation of a published or unpublished play.

The David Belasco cup will be awarded to the best presentation of the above four plays.

The contest is open to all little theater non-professional groups. This is to be interpreted to mean that no professional actors shall be employed in the presentations.

Further particulars regarding rules, etc., may be had from Mr. Hartwig.

PLAY-WRITING CONTEST ALSO BEING HELD

The New York Morning Telegraph announces a play-writing contest for the amateur playwright. Full particulars may be had from the Contest Editor, Morning Telegraph, 522 Eighth avenue, New York. Entries are now in order.

EMERY F. TOBIN



Many successful amateur dramatic productions have been presented in Ketchikan, Alaska, during the past four years under Mr. Tobin's direction, including "Clarence," "Only 38," "The Trusting Place" and "The Florist Shop." The plays have drawn as many as 1,200 people out of a population of 5,000. Mr. Tobin formerly was a newspaper reporter in Quincy, Mass.

LITTLE THEATERS BY ELITA MILLER LENZ

(Communications to 1493 Broadway, New York, N. Y.)

CINCINNATI TO HAVE LITTLE THEATER TOURNAMENT

A play contest or little theater tournament will be held in Cincinnati, under the auspices of the Drama League of Cincinnati this spring. This year's tournament has been inspired by the success of last year's event and will be open to all amateur play-producing groups in Cincinnati and its environs. It is planned to hold a similar event in fall, with the object of interesting school, social center and playground groups.

THE PLAYERS' CLUB, COLUMBUS, OHIO

A reviewer of *The Columbus Dispatch*, who witnessed the February bill of the Players' Club in Columbus, writes as follows:

"At the little Playhouse last night we saw a bill of one-act plays, the most creditable performance of the sort that we have seen since the days when Leonard Latham was a guiding spirit in the Columbus Drama League. This time it was the Players' Club which made the favorable impression. Thanks to a large and decidedly co-operative organization and to the professional direction of Stokes McCune, the club is now doing a real service to its membership. We were never less bored at an amateur performance. As a matter of fact, the whole bill is genuinely diverting."

The plays given were *Spurious Versank*, by Laura Fullerton Gilbert, a member of the Players, *The Monkey's Paw*, by W. W. Jacobs and Louis N. Parker, and *Helena's Husband*, by Philip Moeller.

Mrs. Gilbert, loyal to the community spirit, placed the locale of her play "in Columbus, when it was wet," the theme being two lovers on a housetop during the 1913 flood. The authoress was paid warm tribute by a pleased audience.

THE MONTICELLO PLAYERS ANNOUNCE CONTEST PLAY

P. P. Van Cleave Smith, business manager of the Monticello Players of New York City, is now touring with a stock company and writes as follows:

"The Monticello Players, founded last spring, are considering entering the New York Little Theater Contest by presenting *The Riot in Lichen*, by L. Bottomley. The cause for our desire for the publication of this note is not only for publicity but as a means of letting other small theater groups know what we are doing, so they will not prepare the same play."

PLAYHOUSE TO ATTRACT UNIVERSITY DIVISION?

In the campaign to locate the southern division of the University of California in Pasadena, the educational value of the Pasadena Community Playhouse is set forth as one of the good reasons why the proposed site at Pasadena should be adopted.

The new Community Playhouse of the Pasadena Community Players is half completed and present indications are that it will be ready for a grand opening shortly after April 1. As added features have been deemed necessary to the successful completion of the structure, plans are being considered to raise more money to finance the project.

The play committee of the Pasadena Playhouse is now busy reading the 85 original plays which have been received as a result of the plan H. O. Stochhan devised to interest the professional dramatists of America in providing a vehicle for the opening of the new theater. Of the success that this plan has achieved, Monroe Lathrop, dramatic editor of *The Los Angeles Express*, recently wrote:

"Never have so many playwrights of prominence tossed their plays into a contest hopper as have responded to offers recently made by the Pasadena Community Players to consider their work. More than 50 authors have submitted plays. The following are among those who have responded to the appeal from Pasadena: John Hunter Booth, Louis Joseph Vance, Grayville Fortescue, Mrs. Rida Johnson Young, T. Wigney Percyval, Clayton Hamilton, Victor Mapes, Mrs. Mary P. Hamlin, Percy Mackaye, Edith Ellis, Lee Wilson Dodd, John Stapleton, Mrs. Annie Nathan Meyer, David Carb, Miriam Michelson, Mrs. Lillian Trimble Bradle, Charles T. Dazey, Willard Robertson, Margaret Turnbull, Laurence Eyre, Mrs. Ludwig Lewishon, Clara Lipman, Kate Jordan, Grace Livingston Furness, Fanny Cannon, Margorie Chase Surdez, Charlton Andrews and Florence Pierce Reed."

At least a dozen of the plays received have been found worth producing; and three are being considered for the honor of first presentation at the opening of the new Community Playhouse. Considering that all have been rejected of Broadway—nearly duckings as it were—this is regarded as a fine showing. A final decision will probably be made in the next few weeks.

A HUSTLING YOUNG ORGANIZER

Harold W. Gammans, teacher of English, who organized and managed the project known as the Community Theater of New London, Conn., is now directing the Little Theater of the Central High School at Scranton, Pa. The Central High School was reconstructed last year at a cost of more than \$1,000,000, and the enlarged and remodeled auditorium seating 1,700, is said to be one of the best equipped in the country.

Since Mr. Gammans' connection with the organization at Scranton High, the stage has been equipped with two sets of scenery from the Lee-Lash Studios at a cost of about \$2,500 and many improvements have been made in the lighting. The Central auditorium has brought such attractions as the San Carlos Grand Opera and Anna Pavlova to its following. It also had presented many plays with student casts, the most recent being a new play of the life of Lincoln, entitled *Spirit of Ann Rutledge*, a romantic drama. The play was given at the high school auditorium in the afternoon and repeated at the Century Club to an overflow audience. Between the third and fourth acts, members of the cast put on a tableau of Lincoln as a feature of the *Coeur de Lion* Tournel. The night before Lincoln's birthday the third and fourth acts of the play were broadcast by station WQAN.

THE CAROLINA PLAYMAKERS RETURN FROM THE SOUTH

Prof. Frederick H. Koch, head of the department of Dramatic Literature at the University of North Carolina and director of the Carolina Playmakers, advises that his group of players has just returned from the first Southern tour, which was a wonderful experience and a great success in every way.

"We are now getting ready a new production," says Prof. Koch. "This time it will not be our own plays, but—just by way of change—George Kelly's very amusing comedy, *The Torch Bearers*. After this we have a new bill of folk plays, our State Dramatic Institute, the State contest, the Western tour and a Forest Theater production ahead of us. It is a strenuous but happy program we have outlined for ourselves."

We have been following the progress of the Carolina Playmakers' tour thru the medium of newspaper clippings, all of which are enthusiastically in praise of the players. *The Savannah (Ga.) Morning News*, *The Atlanta Journal* and *The Charleston (S. C.) News and Courier* devote a great deal of space to the plays and players, particularly the Savannah paper, which devoted more than a column. Professor Koch is praised for his admirable direction, and George V. Denny, the young manager of the Playmakers, scored a success with a dual role in *Gains and Gains, Jr.* Other players receiving honorable mention were Frances Gray, Aubrey Shackell, Alca Leavitt, Margaret Jones, Ray Haffner and P. L. Elmore.

CLAYTON HAMILTON SEES CHANGES IN ACTING

Clayton Hamilton, dramatic critic, author and editor, spoke before an audience at the Little Theater of Indianapolis, Ind., Monday evening, February 9. Quoting from *The Indianapolis Star*: "It might be said that the evolution of acting has been the descent from one joint to another," Mr. Hamilton declared. "In Greek drama, the actor gestured from the shoulder; in Shakespearean plays the gesture was from the elbow, while the modern play is enacted with gestures from the wrist," he said in illustrating differences between the theater of today and the theater as it was a century and a half ago, when Richard Sheridan's *The Rivals* was first produced.

"Mr. Hamilton explained why the construction and lighting of the stage in Sheridan's day made it necessary for the actors to gesture violently and talk loudly in order that they might be seen and heard in the spacious theaters, and how these conditions had been changed in the modern theater."

JUNIOR LEAGUE FOLLIES AT ATLANTA, GEORGIA

When the debutantes of the Junior League decided to present their own musical extravaganza, the *Junior League Follies* of 1925, they called in as their director no less a personage than Ned Wayburn.

Mr. Wayburn, accompanied by Max Olney, who was left behind to keep things going after Mr. Wayburn had finished rehearsals, is said to have put the girls to work in the usual Wayburn manner, after recovering from the surprise of finding so much "beauty and individual charm in Atlanta's social buds." He rehearsed them from 10 a. m. to 11 p. m., with an hour for lunch and two hours for dinner. There were 36 beauties, and two of them are said to have dropped

out from exhaustion. At any rate, the *Junior League Follies* held the boards at the Atlanta Theater during the week of February 16, and came thru with flying colors.

LITTLE THEATER PRESENTS "STOP THIEF"

Stop Thief, Carlyle Moore's three-act comedy, was selected as the February offering of the Little Theater of Gainesville, Tex., with the following cast: Madge Carr, Una Minnick, James Cluney, A. Morton Smith, Joan Carr, Marie Crudginton, Caroline Carr, Olga Cochran, Mrs. Carr, Mrs. E. I. McGee, Mr. Carr, E. I. McGee, Mr. Jamison, B. F. Mitchell, Dr. Willoughby, Bernard H. Myllas, Jack Doogan, James R. Ford, Nell, Edith Johnson, Rev. Mr. Spelman, William T. Johnson, Detective, Arthur Lee Joyner, Police Sergeant, Theodore B. Crumly.

The latest addition to the Little Theater's equipment is a portable switchboard constructed by Director John J. Lindsay and E. I. McGee.

Little Theater Brevities

Theater Arts, a little theater of Detroit, recently gave its second performance at McClellister Hall. The plays were Alice Gerstenberg's *Seaweed* and Essex Dane's *Cul-de-sac*.

Arts and Crafts Playhouse, another little theater of Detroit, recently gave *You Never Can See the Waiter's Face*, by Irvin S. Cobb, dramatized by William P. Holliday, a member of the group; *Murder Will Out*, by C. C. Winingham, also a member of the Playhouse, and *Friendship*, by Eugene Walter.

The Little Theater of Dallas, Tex., gave John Masefield's *The Tragedy of Nan* as one of its January bills, and Booth Tarkington's *Seventeen* during the week of January 16.

The Community Players of Manitoba, Can., are presenting a trio of one-act plays this week.

The Little Theater of Minneapolis, Minn., offered St. John Irvine's *The Ship* during the week of February 9, attracting audiences which packed the theater to the doors.

The Pasadena (Calif.) Community Players presented Booth Tarkington's *The Intimate Strangers* for 11 performances, beginning February 5. The players were Harry Ashe, Samuel S. Hinds, Margaret R. Clarke, Lurline Tuttle, Douglass Montgomery, R. W. Seay, Mary Wilder and Antha Miller.

The Actor's Playshop of the Boston Little Theater Players gave three one-act plays at the Roxbury School Center of the High School of Practical Arts, Boston, January 29. The offerings were *Doings of the Dooleys*, *A Girl of the People*, and *Stage Struck*. Raymond Gilbert is director of the Playshop.

The Playhouse of Cleveland, O., opened February 11 for a run of 14 performances in Shaw's *The Doctor's Dilemma*.

MINSTRELS PLAYS Complete Catalogue Free. BANNER PLAY BUREAU, 1061 Market Street, San Francisco, California.

SCENERY That pleases your purse and your public. FREED SCENERY STUDIOS, INC., 723 7th Ave., New York.

STAGE CAREER AGENCY 1493 BROADWAY, NEW YORK CITY. Combining Training and Engagement

MAKE-UP BOOK AND STAGE GUIDE By CHARLES TOWNSEND and FELIX FANTUS. Contains "Full" instructions as to Wigs, Beards, various Features, Age, Condition, Character Make-up, Progress of Make-up, Expression, Gestulation, Vocal Exercises, Voice Culture, Breathing Exercises, Organization, Duties of Manager, Prompter, Business Manager, Orchestra, Rehearsals, Contracts, Full List of Theatrical Managers and Agents, with Addresses, etc., with Practical Hints to Actors and Actresses, both Professional and Amateur. Complete. 150 pages. \$1.00 Postpaid. THE COLLINS CO., 197 Fulton St., Brooklyn, N. Y.

PLAYS PLAYS We have the newest and most attractive, as well as the largest assortment of plays in the world. Send four cents for our new list.

SAMUEL FRENCH (Incorporated 1898) "Oldest play publishers in the world" 25 West 45th Street, NEW YORK CITY.

PLAYS For the Little Theatre, in Book and Booklet Form. All publishers. "Crystal Gazer" (2 males, 1 female), 25c. "Crystal Gazer" and 17 other 2-character plays, \$1.00. "Foot Hills of Fame", a farce (1 male, 6 females), 30c. "Ani-sisters of Widdly Maloney" (22 people), 50c. Many Irish plays, 25c and 35c each.

WERNER BOOK SHOP, 11 East 14th Street, New York.

PLAYS PLAYS For the Little Theatre, in Book and Booklet Form. All publishers. "Crystal Gazer" (2 males, 1 female), 25c. "Crystal Gazer" and 17 other 2-character plays, \$1.00. "Foot Hills of Fame", a farce (1 male, 6 females), 30c. "Ani-sisters of Widdly Maloney" (22 people), 50c. Many Irish plays, 25c and 35c each.

WERNER BOOK SHOP, 11 East 14th Street, New York.

PLAYS PLAYS For the Little Theatre, in Book and Booklet Form. All publishers. "Crystal Gazer" (2 males, 1 female), 25c. "Crystal Gazer" and 17 other 2-character plays, \$1.00. "Foot Hills of Fame", a farce (1 male, 6 females), 30c. "Ani-sisters of Widdly Maloney" (22 people), 50c. Many Irish plays, 25c and 35c each.

WERNER BOOK SHOP, 11 East 14th Street, New York.

PLAYS PLAYS For the Little Theatre, in Book and Booklet Form. All publishers. "Crystal Gazer" (2 males, 1 female), 25c. "Crystal Gazer" and 17 other 2-character plays, \$1.00. "Foot Hills of Fame", a farce (1 male, 6 females), 30c. "Ani-sisters of Widdly Maloney" (22 people), 50c. Many Irish plays, 25c and 35c each.

WERNER BOOK SHOP, 11 East 14th Street, New York.

PLAYS PLAYS For the Little Theatre, in Book and Booklet Form. All publishers. "Crystal Gazer" (2 males, 1 female), 25c. "Crystal Gazer" and 17 other 2-character plays, \$1.00. "Foot Hills of Fame", a farce (1 male, 6 females), 30c. "Ani-sisters of Widdly Maloney" (22 people), 50c. Many Irish plays, 25c and 35c each.

WERNER BOOK SHOP, 11 East 14th Street, New York.

PLAYS PLAYS For the Little Theatre, in Book and Booklet Form. All publishers. "Crystal Gazer" (2 males, 1 female), 25c. "Crystal Gazer" and 17 other 2-character plays, \$1.00. "Foot Hills of Fame", a farce (1 male, 6 females), 30c. "Ani-sisters of Widdly Maloney" (22 people), 50c. Many Irish plays, 25c and 35c each.

WERNER BOOK SHOP, 11 East 14th Street, New York.

PLAYS PLAYS For the Little Theatre, in Book and Booklet Form. All publishers. "Crystal Gazer" (2 males, 1 female), 25c. "Crystal Gazer" and 17 other 2-character plays, \$1.00. "Foot Hills of Fame", a farce (1 male, 6 females), 30c. "Ani-sisters of Widdly Maloney" (22 people), 50c. Many Irish plays, 25c and 35c each.

WERNER BOOK SHOP, 11 East 14th Street, New York.

COSTUMES FOR HIRE SEND LIST OF REQUIREMENTS FOR ESTIMATE 1435 B'WAY BROOKLYN NEW YORK

FOR OBVIOUS REASONS
The Billboard
DOES NOT NECESSARILY
INDORSE THE VIEWS
EXPRESSED IN THIS
DEPARTMENT,
NOR TAKE EXCEPTION
TO THEM EITHER

~ BE BRIEF ~
BE AS COURTEOUS AS YOU CAN, BUT BE BRIEF
OPEN LETTERS
IF YOU ARE A MEMBER OF THE PROFESSION, YOU CAN
SAY YOUR SAY HERE

VOLTAIRE ~
SAID TO HELECTIUS:
"I DISAGREE WITH
EVERYTHING YOU SAY
SIR, BUT WILL DEFEND
TO THE DEATH,
YOUR RIGHT TO
SAY IT."

Extra Tax on Tent Shows in Texas
Somerville, Tex., Feb. 16, 1925.

Editor The Billboard:
Sir—Just a line to say that I am still doing business in Texas and cannot complain, altho there are plenty of shows here. A special meeting has been called in Austin and the Legislature will no doubt put an extra tax on all tent shows.
(Signed) DAD ZELNO.

Takes Issue With "Tom" Show Article
Yakima, Wash., Feb. 9, 1925.

Editor The Billboard:
Sir—Relative to the article headed "Uncle Tom Takes a Vacation" in your issue of February 7, three of the principal statements were incorrect. First, C. F. Ackerman did not pass away at Indianapolis; secondly, Tom Aiton had not been with Mr. Ackerman several seasons—only one, and thirdly, the Stetson Show, which was owned by Mr. Ackerman, played practically the same time this season as it has played the past eight seasons. I ought to know, having been with it for that length of time.

Now for the big-city show. There are no more popular-priced houses in the big cities, and if there were the real showmen like Andrew Downie, George Peck, John Stowe, Leon Washburn and many other

oldtimers would no doubt have the so-called big-city shows.

(Signed) JACK BRENNAN.

The Spoken Word

(Continued from page 44)

feminine type of beauty, she has a lower register in her voice and a good punch in her reading for the men's parts. This is especially true of her Gerald who wears of adapting himself to the caprices of the opera singer.

Miss Davidson's besetting sin is to let her naturally volatile temperament run away with her. The activity of her mind and her rapid response to feeling is too quick for the thinking process of an audience. They realize that the performance is fine, but it has flashed before their minds in such haste that they have had no time to drink it in and fully enjoy the real flavor of a speech or situation. This also reacts on the artist who has no time to deepen her own impressions and take advantage of a pause to full measure. The upshot of it all

is that haste makes waste. This inflammable sensitiveness of Miss Davidson is a part of her talent, when properly controlled, but it needs to be checked and given the steady hand of artistic conscience.

Theatrical Mutual Assn.

(Continued from page 39)

chaplain, Richard A. Wolff; physician, Dr. J. E. Hurley; marshal, Louis C. Mahoney; sergeant-at-arms, Wm. Lyons; outer guard, E. A. Grant; trustees, M. A. Donnell, T. M. Brandle and Ed. A. Grant.

Boston Lodge No. 2

Boston Lodge No. 2 at its February meeting considered the advisability of holding a benefit at a future date. The committee on arranging a social hour for the April meeting are to report as to speakers, etc., at the March meeting. It is with sorrow that we report the death of our Brother Henry Plunkett.

AUSTRALIA

114 Castlereagh Street, Sydney
By MARTIN C. BRENNAN

SYDNEY, Jan. 7.—Henry Hayward, premier entrepreneur of the Dominion, has regained possession of an original Stradivarius violin, valued at £3,000, which, it is said, he loaned Zacharewitsch, foreign violinist, during his recent concert tour of Australia and New Zealand, and for which, it is alleged, Zacharewitsch attempted to return a copy instrument. The original violin, it is claimed, was recovered by the police at Auckland, who accosted Zacharewitsch on complaint of Hayward when he arrived on the S. S. Niagara. Hayward, it is claimed, detected the copy instrument immediately upon its delivery to him thru a representative. Zacharewitsch is now en route to America.

James Stewart, English comedian, whose family name is J. W. Bain and who may play America shortly, has left these shores after playing the Fuller Circuit for a year at a good salary and, it is alleged, his absence is regretted by numerous creditors.

Phil Coleman and Lydia Alexandra, who feature the *Good-Luck Girl*, arrived last week from Honolulu, after playing the Hawaii Theater for four weeks. They will subsequently be joined by David Heenan, formerly connected with the Hawaii Theater, who will act as manager for the show. Coleman is putting over some good publicity with a view to securing the attention of managers for a £3,000 per week offering. It is something new in this country for a man to come on spec. and spend a lot of money in preliminary publicity to catch an engagement. Coleman looks like doing it, as he has good stuff out.

Pierce and Roslyn, American pot-pourri act, left on the return to San Francisco last week. They had plenty of ability, but seemingly strained too hard for applause.

Gene Morgan, another American who played Williamson Time and left with Pierce and Roslyn, made good here.

A rumor emanating from Muriel Starr, that Hugh J. Ward was terminating his agreement with the Fullers is ridiculous, according to W. J. Douglas, general manager for Ward.

The Four Ortons, who have been a big

hit at the Tivoli here, leave tomorrow for Melbourne.

Oswald Williams, English magician, is a feature act on the Williamson Circuit. Coming on the heels of so many American master magicians, he fails to impress by his personality, but furnishes quite a lot of new business and is doing nicely. The Haydl Kadjar Arabs leave on their return for America shortly. Their novelty was a drawing card, but their work not up to the standard of previous athletic-cum-acrobatic combinations.

Stanley Grant, in the Australian entertainment coterie for many years, is trying to induce certain showmen to consider the possibility of a big American minstrel combination for this country. Such an aggregation, white or colored, should infuse fresh impetus into theatrical business here.

The new Prince Edward Theater looks like creating a local long-distance record for a single attraction with *The Ten Commandments*, which has been running since the house opened nearly two months ago.

Sir Harry Lauder, now in India, is due here early in March. E. J. Carroll will again be responsible for the Australasian tour of the Scottish knight.

Among the passengers leaving for San Francisco this week is Allen Doone, well-known actor, who for many years played this country with occasional visits elsewhere. To many Mr. Doone's return to America comes as something in the nature of a surprise and it has been suggested that he will secure new plays or other novelties in view of a future visit to this country.

It is said that prior to the opening of Fred Bluett's *Radios* in Newcastle much

PATENTS RECENTLY GRANTED ON INVENTIONS IN THE AMUSEMENT FIELD

(Compiled by Munn & Co., Patent and Trade Mark Attorneys of New York, Washington, Chicago, San Francisco and Los Angeles)

1,524,725. PNEUMATICALLY OPERATING MUSICAL INSTRUMENT. Marie Amelie Balthasar, Namur, Belgium. Filed June 3, 1922. Serial No. 565,612. 3 Claims. (Cl. 85-69.)

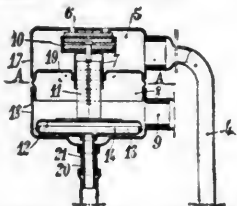

In a pneumatically operating musical instrument, a metal plate forming a valve seat, a plurality of apertures with flanged edges provided on the said seat, a valve, a valve stem, a tube forming a guide from the said stem and forming at the same time a second valve seat having a single aperture, a plate for supporting the said tube, means for moving the tube relatively to the said plate, a diaphragm acting on the valve stem, a diaphragm chamber, an axial tube forming an extension of the said chamber, and means for supporting the axial tube.

1,523,282. THEATRICAL AMUSEMENT, EDUCATIONAL AND ADVERTISING DEVICE. William F. Powers, Englewood, N. J. Filed March 25, 1921. Serial No. 455,395. 10 Claims. (Cl. 16-10.)

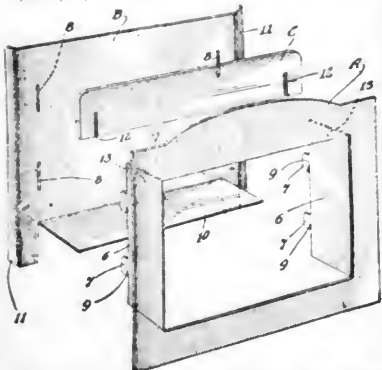

A miniature knock-down theatrical stage setting, comprising a front member and a back member separable therefrom and means for connecting the same to form, when set up, a stage setting, the front member providing the stage arch and opening and having vertical flaps originally occupying said opening at least in part and designed to be folded back on lines constituting the side edges of the stage opening to free said opening from obstruction and form side walls for the stage setting.

The Best Speech in America Is Heard on the Stage

The best English is taught at the Daggett School. Make an appointment for class lessons or private instruction. Voice, pronunciation, freedom of expression, creative speech.

Hear the Spoken Word records with exercises for daily practice. Important lessons in a nutshell. Records demonstrated at the school, or representative will call in New York City at your request.



Windsor P. Daggett

School of the Spoken Word

Endicott 2012
2128 Broadway - NEW YORK
(Between 74th and 75th Streets)

of the advertising carried a line: "The Radios at the So-and-So Theater. Come and listen-in." Many would-be patrons took the entertainment to be a radio show, and business suffered.

Sir Benjamin Fuller is due here next month, after an extended tour abroad.

Lionel Walsh, who recently was suffering from overwork, is much benefited due to a rest in the Memorial Hospital, Adelaide. The show is now at Broken Hill.

W. Newton Carroll is forming a No. 2 company to play drama at several N. S. W. towns.

George Cross wired to Sydney friends that the Adelaide opening of the William Anderson Company was most auspicious.

Harrington Reynolds, it is said, will probably put in a company at Katoomba, N. S. W., presenting popular comedies.

Seymour Hicks has had a most successful New Zealand premiere in *The Man in Dress Clothes*, which opened in Dunedin.

Carlton Chase, American, playing the Baron in the *Mother Goose* pantomime, is off the bill owing to a severe attack of laryngitis and his absence is severely felt.

Amy Rochelle is appearing at the Enmore Theater, N. S. W., (Szarka Bros.) this week and receiving the highest salary ever paid an Australian artist here in a picture theater. The salary runs into three figures.

Claude High, who went to America recently as the representative of Tours, Limited, an enterprise which is producing and exhibiting New Zealand Films, has returned to Wellington and reports that in America the films of New Zealand were most favorably received.

Theo. Trezise, who arrived in Sydney last week, has been engaged by Humphrey Bishop to organize, produce and act in a new musical comedy company preparatory to its setting out on a world tour.

The Fiske Jubilee Singers are at present around the Waikato District, N. Z.

The Savoy Havana Band finished a successful season in Auckland last week.

The widespread effects of the seamen's strike are being particularly felt by performers and others who intend going to New Zealand during the past fortnight. Included among the theatrical fraternity is John Fuller, who, having arranged to leave last Friday, has postponed his visit indefinitely.

Frank Marden, on the vaudeville side of Union Theaters, Ltd., is back at his office in the film house, Sydney.

Here C. McIntyre, general manager of Universal Films, returned from Brisbane New Year's Day, thoroughly satisfied with the way things are going in the Northern State.

Miss Racey, of the Brisbane office of Fox Films, is at present on a holiday visit to Sydney. In point of service Miss Racey is probably one of the oldest of the Fox folk in this country, she being originally associated with the firm when "Bill" Howe opened the Fox branch at Brisbane.

Jack Emsworth, well-known advance agent ahead of the Littlejohns Company in India, speaks of returning to Australia shortly.

The Six Brown Brothers will bring their saxophone clown band to the Tivoli, Sydney, in the near future. The American act is now a big hit in Melbourne.

"Jim" Douglas, father of W. J., of that ilk, is back at his post at the Fuller Theater, Sydney, after a month of inconsistent health.

Gus T. Raglus, ball-bouncing marvel, has been secured by Hugh Huxham, of the *Serenaders*, for a two-weeks' season at Manly, commencing last Monday.

Jimmy Norton, dapper little English light comedian, left for New Zealand last Friday after spending three years in the country. He will play Suva and Honolulu en route to America, where he played for several years.

Long Tack Sam, master Chinese showman who brought wonderful business to the Tivoli last year, is returning from China with a new act and new ideas. He opens in Melbourne and is expected in Sydney next week.

The Hadji Kader Arabs will have a remarkably short season at the Sydney Tivoli for an act of such importance. They depart January 13 and, if original arrangements are adhered to, are now making their last appearance in Australia before returning to American contracts. Harry Weldon and Hilda Glyder make a welcome reappearance at the Sydney Tivoli January 14 in place of the Arabs. The brilliance of the much-copied English comedian was just beginning to get its worthy recognition from Sydney audiences when he left for N. Z. His return season will be short, however.

Phillip Lytton, dramatic manager, opens shortly in one of Melbourne's leading theaters. He will present, among other productions, *Cappy Riels*, the screen version of which was shown here some time ago.

Scott Alexander, English actor and producer, who was rehearsing for a Harrington Reynolds show in Brisbane, informs that the proposition fell thru. Since his arrival in this country Mr. Alexander has had a run of bad luck.

Walter Baker, hero of dramas in the days of Bland Holt, was among the audience at the Palace one evening last week and thoroughly enjoyed *So This is London*.

Thurston Hall will follow *So This is London* with a movie thriller, *The Broken Wing*.

The Martels, unique eccentric dancers, are at the Lyric Wintergarden, Sydney.

MAGIC AND MAGICIANS

(Communications to 1493 Broadway, New York, N. Y.)

More Protest Against Expose Of Pocket and Other Tricks

Not a few magicians who make their living partly with the aid of the small tricks have raised their voice in protest against the practice of exposing them by brother wand wielders and others who can get along without the less important ones. While giving away of the tricks is not new, it is plain that the practice is increasing and to an alarming degree.

Earl M. (Mystic) Thompson, for one, writes that he followed one of the leading magic acts into town, only to find that his predecessor had sold a book for 25 cents which exposed a handkerchief and egg effect in which a performer lays a number of eggs from a cloth or handkerchief. As it happens, Mystic Thompson has quite an illusion built around that particular little trick. He spent time and money perfecting it and loses out when coming into a place that otherwise would be "easy picking."

The *Billboard* refrains from mentioning the big act that Thompson writes about. He asks what is to prevent him from working a few dates ahead of the attraction and giving away a few large illusions, the workings of which he happens to know perfectly, from the smallest to the largest in the routine. Then, adds Thompson, a sample of the humiliation he suffered might be handed out to the one who caused his. Not so long ago a musical comedy show that played Asheville, N. C., did a comedy expose of two versions of the rising cards, the egg and hanky trick and the multiplying billiard balls. Also, Thompson was unfortunate in feeling the effects of the expose of the escape from a milk can in 1912 at Walter Valley, Miss.

Another complaint comes from Harry Stillwell, who does comedy as well as magic, yet he strongly refrains from exposing anything for the sake of a laugh, as has been done by magicians and shows he had to follow in various towns. Mystery, says Stillwell, is the things that counts most in any magical act, and anything that tends to take away the mystery or illusion reacts against all magicians. Yet he has found magicians who actually gave away good tricks in order to get a few laughs, forgetting that he is hurting the entire business by it.

Stillwell reminds those who expose that he has a lot of money tied up in his act, not counting the many hours of practice to perfect himself in the art, and that it is a serious matter to spend valuable time learning a trick only to find that some careless magician but recently revealed it in the same theater for which he is engaged.

A communication from "Mystic Bozo", illusionist, is to the effect that there are at least two well-known magicians who have made money in the past and are now occasionally giving away and exposing the smaller tricks. He writes that it is only a question of time when the larger illusions will be going the same way as the pocket tricks.

EDITOR'S NOTE—The recent article in *The Saturday Evening Post*, by Marian Spitzer, has caused much discussion in magical circles. In justice to Harry Houdini, however, he probably made the most effective complaint. Miss Spitzer formerly worked in the Special Promotion Department of the Keith-Albee Circuit and Houdini registered his displeasure with the circuit which called Miss Spitzer in to confront Houdini. She stated that she got some of her information from books in the library written by Houdini. But the famous escape artist reminded her that those books had been written for professional brother magicians and not the lay people. He concluded his tirade against her by saying that she should not attempt to be an authority on magic until she was earning \$2,500 a week doing such work, as himself, for instance.

Hilliar Visits Dante's Show

William J. Hilliar, internationally known mystic and founder of the Magic and Magicians' department in *The Billboard*, and now publicity director of the Zeldman & Pollie Shows, accompanied by Henry J. Pollie, recently motored from Spartanburg to Greenville, S. C., as guests

of Dante, the magician. After the performance Hilliar and Pollie remained in the magician's dressing room until after 5 a.m. swapping yarns and talking magic. It was Hilliar who, while first editor of *The Sphinx*, gave Harry Jansen (Dante) his first lesson in magic, and Hilliar writes that he is mighty proud of his pupil.

Hilliar states: "Dante has developed into the ideal magician—in fact, the ease with which he accomplished his 'marvels' is almost uncanny. Effects that other magicians have presented laboriously Dante puts over with grace that would have brought admiration from the late lamented Alexander Herrmann. Whether introducing some of the Thurston or Kellar effects, or entertaining his audience with novelties of his own, Dante is equally at home. Mr. Whitmore, manager of the theater at Greenville, said to me: 'He is some magician, Hilliar; the best that ever played here, and when I get my new theater ready I want Dante to be my opening attraction.'"

"Not a single hitch occurred during the two hours and a half that Dante was on the stage, and his whole performance was a blend of mystery, mirth, showmanship and delightful entertainment. It is no wonder that Thurston has selected Dante as his ultimate successor, for his personal magnetism, his profound knowledge of real magic, subterfuge and misdirection, plus a charming appearance and personality stamps him, in my opinion, as the great magician of the future."

Kelly Wins Praise in Kenton

George Marquis Kelly, who played two nights recently in Kenton, O., won considerable praise at the hands of his audiences and in the local press. His efforts were new in point of presentation to the patrons. Notable among his tricks was the newspaper test in which 10 newspapers were given to the audience and then one of them was chosen by lot as was also the page and column of text. A previously examined and washed slate sat on the edge of the stage and immediately the paper, page, column and same words began appearing on the slate. Messages written by the audience and retained in their pockets were read, while Evelyn, "England's mistress of mystery", gave proof of her psychic ability. The rest of the program included everything from mystifying card tricks to the concluding Chinese torture cell in which Evelyn was placed and 12 swords run thru it under the eyes of a committee of 12.

Magic and Magicians

After investigating "Margery", Boston medium, for more than a year, *The Scientific American's* Committee on Psychic Phenomena rendered a verdict last week to the effect that the most famous medium since Palladino has failed to produce any evidence of supernatural phenomena.

Trying for the \$2,500 prize offered by the above-mentioned publication, "Margery", who in private life is known as Mrs. Le Roi G. Crandon, wife of a Boston physician, gave scores of sittings to the five investigators who formed the committee. She puzzled them far more than any of the mediums who preceded her in effort to win the award, but, according to the investigators, she was unable to show anything supernatural under conditions excluding fraud. The case in particular is now marked "closed", and the committee will proceed to examine other aspirants for the prize money and the stamp of the committee attesting genuineness.

Four of the committee voted to veto "Margery's" claim, while the fifth, Howard Carrington, went on record as believing her genuine. Three of the others, Dr. Walter Franklin Prince, Daniel F. Constock and Dr. William McDougall, concurred in the opinion that "Margery" failed to give positive evidence of any unusual gifts. Harry Houdini, the fifth of the investigators, had already pronounced the medium as a fraud and alleged that he had proof of quackery. Judges Prince, Constock and McDougall, altho they express their disbelief, deny that Houdini exposed anything.

Of all the mediums that came under the notice of the committee "Margery" was the most promising at first. Her efforts were enthusiastically received by

the committee. As long as she controlled the situation the effects produced were remarkable. That she was from private life and not connected with others in hiring out her talents was another thing in her favor, in the opinion of the committee. At the time there was a presumption against those who earned their living by producing phenomena. Malcolm Bird, secretary of the committee, who has since resigned as one of the editors of *The Scientific American* to take up other work he long had under consideration, wrote of "Margery's" work early in the investigation and commented on her personality and charm. First published accounts of her work said that, without being caught cheating in any manner, she had caused the spontaneous appearances of many lights, had wafted window poles thru the arms and legs of the investigators, wrecked cabinets, thrummed invisible string instruments and played the piano with invisible fingers. "Margery", wrote Bird, "seems to make progress toward rock-ribbed demonstration."

The statement given out at the conclusion of the investigation last week declares: "We have shared in the labors of the committee, which has devoted a large amount of time and careful observation to this case, affording every facility for the production of phenomena. We have observed phenomena, the method of production of which we cannot in every case claim to have discovered. But we have observed no phenomena of which we cannot assert that they could not have been produced by normal means, altho we have looked for such phenomena patiently and with open minds. It is obvious that we cannot prove that the 'medium' never has produced and never can or will produce supernatural phenomena. But in our opinion we have afforded the medium ample opportunities for the demonstration to us of such phenomena and no such demonstration has hitherto been made."

"Therefore we report that, in our judgment, the 'medium' is not entitled to the award of the prize."

Craig Under New Bureau

Chas. H. Craig, working under the auspices of the Columbia Lyceum Bureau, of St. Joseph, Mo., still has a number of dates to fill in Nebraska, Kansas, Missouri and Iowa.

His program will be about the same, consisting of sleight-of-hand deceptions, a ventriloquist argument, a bit of fun for the kiddies, rag pictures, a series of weird illusions, "The Menace of Fake Spiritualism" and "Where?"—An Amazing Climax. Craig states that he is drawing nice crowds.

"Phenomena's" Record Run

Phenomena, "the man with X-ray eyes", writes, calling attention to the unusual record he set during the season of 1923-1924 in Cleveland, O. During that season he played 57 weeks in 30 different theaters, 27 weeks being return engagements. In all he gave 57 matinees for ladies only, 20 Saturday and 50 Sunday matinees, and 399 night performances. To this he added 110 extra night performances, making a record total of 636 performances, and, Phenomena adds, he is not thru with Cleveland, and is extending engagements there well into 1925.

Magic Notes

Word from Detroit has it that Francis Scott and Petti, formerly F. Scott and Company, have developed several originals to their turn and are booked for a number of weeks in that city. The Great Blackstone played there recently and the Scotts "caught" a couple of his performances.

George Schulte, author of *Words for Wizards*, was a caller at the H. C. Evans Magic Shop, Chicago, last week. Other recent visitors were La Tour, comedy magic act now playing in Chicago; Dr. Tarbell; Zazzell, gypsy mental telepathist; Bob Tysal, psychic expert; W. C. Turtle, magician and member I. B. M.; Mr. Powers, production manager for Fred Stone; John Olms, watch wizard, and Bert Earles. Mr. Earles was on his way from the Magic Shop to dig up European tricks and novelties.

33 Tricks 10c
Amaze and Mystify your friends! Easy to learn. No skill needed. This new book tells how. Sent prepaid, including latest 1925 Catalog of Magician's Supplies and Imported Novelties, for only 10c. Write today!
LYLE DOUGLAS
1616 Commerce St., Dallas, Tex.

Master Magicians
Permanent address cards of size listed below will be printed at the rate of \$2 each insertion. Accepted for 26 or 32 weeks only.
Mystic Clayton
Beyond All Questions
AMERICA'S MASTER MENTALIST,
Care The Billboard, 209 Putnam Bldg., New York.
LAURANT
"THE MAN OF MANY MYSTERIES."
Retail Management, Permanent address, 10322 South Wood Street, Chicago, Ill.

EVANS' MAGIC SHOP
THE RUNAWAY QUEEN and THE BASHFUL QUEEN
Two Tricks of 3 cards each, with Queen in center. In one Queen disappears—in other Queen turns back to spectators. Two good Tricks for 50c, postpaid. Made with Bicycle cards.
321 West Madison Street. CHICAGO.

25 "EASY" LESSONS IN HYPNOTISM 25c
Complete Course Guaranteed.
COLLINS CO., 197 Fulton St., Brooklyn, N. Y.

125 Card Tricks Explained and Illustrated 25c
COLLINS CO., 197 Fulton St., Brooklyn, New York.

MAGIC TRICK CARDS
That are absolutely guaranteed. Free samples. Write me today. C. D. BLANKENSHIP, Adrian, Mich. Va.

SECRETS OF VENTRILOQUISM
Including Sure-Fire Matter Book, 25c.
COLLINS CO., 197 Fulton St., Brooklyn, N. Y.

THEATRE DRAPES
That please your purse and your public. FREE SCENERY STUDIOS, INC., 723 7th Ave., New York.

HOW TO READ PEOPLE'S MINDS!
Illustrated Book, 25c.
COLLINS CO., 197 Fulton Street, Brooklyn, N. Y.

B. L. GILBERT 11135 South Irving Ave., Chicago, Ill. Phone, B-7.
6322 Magic, Rag Pictures, Crystals, Escapes, Feather Flowers, Blue Prints, etc. All Catalogs and 7 line Optical Delusions, 25c.

MAGIC MYSTERY
Illustrated Catalog, 10c.
COLLINS CO., 197 Fulton Street, Brooklyn, N. Y.

BAILEY MAGIC CO.
New Catalogue No. 33 for stamp.
580 Massachusetts Avenue, Cambridge, "39" Mass.

MAGICIAN AND HINDU COSTUMES
Jeweled Turbans, beautifully decorated, \$25.00, satins and broadsides. Wild Man for Pit Show, complete, Silk Lace Spanish Shawls, \$10.00; Embroidered, \$35.00; Chinese Mandarin Coats, Embroidered, \$20.00; Skirts, \$7.50; Large Black Satin Panels, Gold Embroidered, \$12.00; Satin Mandarin Hats \$2.00, \$3.50.
STANLEY, 306 West 22d St., New York.

Magic and Illusions
Buy from the Manufacturers. Lowest prices. Bargains in Used Apparatus. LIST FREE.
R. S. SCHLOSSER MAGIC CO.
857-959 Sixth Avenue, New York, N. Y.

FELSMAN'S MAGIC
Magic Tricks for the pocket, parlor and stage. Largest assortment in the world. Immense stock and immediate shipments. Large (wonderfully illustrated) Professional Catalog, 25c. Book of Card Tricks, 25c. Thurston's Book of Pocket Tricks, 25c. Book of Coin Tricks, 30c, postpaid.
ARTHUR P. FELSMAN
Windsor-Clifton Hotel Lobby,
Monroe and Wabash, Dept. 12, CHICAGO, ILL.

MAGIC
TRICKS, BOOKS AND SUPPLIES
Feature Acts in Mind Reading and Spiritualism. Large stock. Best quality. Prompt shipment. Large illustrated Professional Catalog, 20c.
THE OLD RELIABLE
CHICAGO MAGIC CO.
Dept. D, 140 S. Dearborn St., CHICAGO, ILL.

BE A MAGICIAN
Give shows. Earn big money either on stage or at home. Send 10c for our large catalogue of all the latest Tricks, Wisla, Handkerchiefs, Mail Bag, Strait-Jacket, Milk Can, Mind-Reading, etc.
FREE—Large Die Box with 25 order.
OAKS MAGICAL CO.
Dept. 546, OSHKOSH, WIS.

MINDREADING
Crystal Gazing and Bible Reading, as done by well-known engineers taught in my book. Price, \$2. C. DRAKE, Box 255, Station A, Boston, Mass.
ENTERTAIN WITH MAGIC—Send \$1.00 for Combination DeLani and Wizard Deck. A wonder. Or send 25c for 8 exclusive secrets. Trick Book and List free. Used? Magic wanted. LINDHORST MAGIC SHOP, 1339 1/2 S. Broadway, St. Louis, Missouri.

!! ONE DOLLAR !!
Buy the newest and best little trick ever invented! Any person write a question in ordinary note tablet with carbon paper beneath. But, instead of carbon duplicate of what is actually written, the carbon copy proves to be a DIRECT ANSWER to the person's real question. A REAL SHOCK PRODUCER! EASY! DONE ANYWHERE.
OUR NEW CATALOG NO. 6 IS JUST LEAVING PRESS! A whirlwind of mystical enlightenment. Price, 50c. Or, send a dollar bill for "Secret Answer" and catalog combined.
TRAYER MAGICAL MFG. CO., 334 S. San Pedro St., Los Angeles, California.

How come—nothing from "Zip" Lee? He seems to be troubled with "no-writts"

Low Green, burnt cork artiste, now in tabloid, is said to be itching to make the 11:45. Low doubles in the band.

"Doc" Whitham and "Chet" Mills are now broadcasting from Station WFBL, Syracuse, N. Y.

Wonder if "Uncle" Joe Hatfield is hibernating at Hot Springs, Ark.? He and IH Tom Long sent out many a show from that town—imaginary ones.

Jack Hayes of the Lassies White Minstrels continues to put on those nifty dancing numbers and slings a nasty cynabal in the band.

With Rody Jordan, "Slim" Vermont, Nat McElroy, Ben McAtee and "Hank" White, Pop Coburn is well fixed for black-face comies of the desirable kind.

The Chesterfield Minstrels are now playing a territory thru Texas that hasn't had a minstrel show in nigh onto 40 years. That's trail blazing!

Al J. Palmer, formerly with Al G. Field's Minstrels, was one of the entertainers at the teachers' frolic at Oklahoma City February 13.

We can see Bert Swor's feet slipping since his visit to the Welch Minstrels at Philly. Minstrelsy is calling its own. Will it be your own "op'ry", Bert?

Master Tommy LeZear, who sings *You're in Love With Some One* in Neil O'Brien's troupe, is a youngster for whom there is great promise.

A man blacking up to impersonate a Negro and leaving his dialect in the dressing room is like using a typewriter without a ribbon. Neither one creates an impression. Use dialect, men!

Olin Landick, formerly of J. R. Van Arnam's Minstrels, played the Temple Theater, Syracuse, N. Y., February 5-8. "Doc" Whitham, who has been with Olin on several minstrel shows, visited him and reports he is going big in vaudeville.

"Spike" Connors, noted for versatile accomplishments in the amusement world, sends a description of a minstrel program put on recently at the National Soldiers' Home in Virginia. The cast consisted chiefly of home employees and played to a capacity in the home theater.

Billy W. Burke, old-time minstrel, called at *The Billboard* offices while passing thru Cincinnati from Oakdale, Tenn., to New York. Billy, who was at the Actors' Fund Home in Bernardsville, N. J., for two months last year, fears he may have to undergo an operation for an ear affliction.

A few remembrances by "Doc" Whitham: When "Happy" Allen sang baritone with IH Henry's Quartet? When "Mickey" Guy showed Dodgeville, N. Y.? When Joe Wilkerstine was with Ringling Bros. Circus? When "Doc" Whitham, Leahy Brothers, Frank Guth, Art Crawford, Fred De Artoe and Tom Gaffy showed Liverpool, N. Y.?

Artemus Calloway of Birmingham wrote the act *Pressing Business*, a feature in which Sugarfoot Gaffney and

DOUG. FLEMING



This photograph in black and white is of the clever Doug Fleming, appearing this season in tabloid with Saunders & Fleming's "Some Show" Company, a 16-piece attraction, in which Doug, does his character delineations under the billing of "The Minstrel Fashion Plate". Doug is well known in minstrelsy.

MINSTRELSY By EDWARD J. GALLAGHER

(Communications to 25-27 Opera Place, Cincinnati, O.)

Billy Henderson are the stars on the Neil O'Brien offering, and Birmingham papers pronounced it one of the superior things of the program when the merry band of minstrels played the Jefferson Theater there recently.

Morris Nelson writes from the J. A. Coburn show that while playing in Valdosta, Ga., the boys were royally entertained by J. P. Ulmer with a bird supper after the night performance. The feast was served on the stage of the Strand Theater, the menu including quail, rabbit and Georgia's favorite dish, possum and sweet potatoes. "A good time was had by all."

"There must be a charm in the minstrel life which contains the nectar of eternal youth if one is to judge by 'Hank' Brown and his minstrels," says *The News of Wheeling, W. Va.*, adding that all principals of the show have had from 35 to 55 years in the game. Brown at 71 heads his own company of 25, and included in the roster is his son, who is 51, but looks only half that age.

"Doc" Sampson and Joe Lowe, in a call at *The Billboard* offices a few days ago, reported that their quartet venture failed to materialize and so they decided to frame a two-act. Lately they have been breaking it in around Cincinnati neighborhood theaters. The team claims to have originated a song title, viz.: *Flat Tire Mamma—I'm Going To Give You the Air*. They have the melody completed and will be using their own verses in putting over the idea.

In a call at *The Billboard's* home in Cincinnati recently Arthur Crawford spoke interestingly of his early days in minstrelsy, and, reminiscing, inquires whether or not James L. Finnigan, of the Lassies White show, remembers 22 years ago when, while leading the band and orchestra with the San Francisco Minstrels, Island Pond, Vt., somebody poured a pitcher of water into Crawford's big horn when he was on a side street playing Milt Hall's *Cotton Blossoms* smooch?

"Some time ago," writes Frank H. Carr of Washington, N. C., "in reading the obituary of Frank E. McNish, there was a pretty fair description of his ex-

perience in the minstrel field, but with all the comment I have not seen where they have identified him with Johnny Ray. In 1879 I saw them together as McNish and Ray, doing a song and dance act at the Tivoli Theater, New Haven, Conn. McNish also was doing his *Silence and Fun* act. I boarded at the same house with McNish. This is something for the writers of memories of 49 years ago."

Dan Quinlan, premier interlocutor and producer of many of the best minstrel creations in years gone by, now appearing with McIntyre and Heath on the Keith Time, advises that the new production in which these two eminent comedians will make their final bow to the American public is to be in no sense a minstrel production but an entirely original and unique type of show which the team will term "an evening's entertainment without a wasted moment." According to Quinlan, this in itself will make it original. At the proper time, he adds, details as to the character of the show will be given to the press.

Following is the roster of the band and orchestra with the John H. Van Arnam Minstrels: Glenn Beckley, director and trumpet; Patrick Pouliot, piano and horn; Del Paciulli, violin and sax; Bliss Williamson, piano, clarinet and sax; Bert Guthrie, banjo, accordion and trumpet; Francis Muto, flute and piccolo; Fred Dupile, trumpet and oboe; Fritz Gattelle, horn; Carl Babcock, trombone; George Collison, trombone and viola; Tom Feeley, baritone and cello; Bill Conklin, tuba; Harry Eynon, sousaphone, bassoon and string bass; "Stifffoot" Clifton, bass drum and cymbals; Harry Richards, snare drum and traps. The band is receiving favorable mention all along the route.

Charles E. Darling, old-time minstrel agent, now living in North Adams, Mass., recalls the following array of song and dance teams that worked in blackface in the yesterdays of minstrelsy: Bryant and Williams, Gallagher and West, Sheffer and Sharin, Foster and Hughes, Wade and Leclade, Boyd and Sarsfield, Niles and Evans, Thatcher and Hume, Hurley and Marr, Rice and Barton, Chase and Davis, Canfield and Booker, Lavender and Price, Pell and Lewis, Keating and

Flynn, Sullivan and Smith, Whitney and West, Beach and Gould, Cummings and Hunt, Patton and Reen, Comstock and Eggleston, Mullen and Lebar, Flynn and Lacey, Conway and Mack, Brassell and Gardner, Coffey and Burke, Markham and Goldie, Morrissey Brothers, Blackman Brothers, Phillips Brothers, Parke Brothers, Whippet Twins, Higgin Brothers, Elliot Brothers, Hennessey Brothers, Delmanning Brothers and the Carey Brothers.

Charles W. Seymour of Pawluska, Ok., sends this beautiful blurb for Lassies White's select troupers: "I met the show in Tulsa and made a three-day visit on the show. The boys are all in high spirits and full of pep. It's just the sort of stuff that makes the show go over with a bang from the first curtain. There is not a dull moment in the entire performance. Tulsa's audiences took the show on with open arms and at Bartlesville, which is one of Lassies' strongholds, the crowd simply went into convulsions over the many funny lines and scenes. Boss, White, Dan Holt and all the end men are registering bigger than ever, and the singing is of the highest type. Carl Denton is simply knocking 'em dead in his part. It is one of the best balanced minstrel companies I have witnessed, and I never missed one that was in any way possible to reach by running, riding or walking."

Jack Shears, formerly known as Johnny Howard, writing from Weedsport, N. Y., comments thusly: "My old friend, Cal Cohen, also IH Tom Long, have mentioned quite a few of the oldtimers now passed on and some who are still on the boards. But I wish to mention some whom they have omitted. Who remember these good oldtimers: Baldwin and Daley, the Hottentots; Gordon and Lick, musical artistes; Topack and Steele, Matthews and Bulger, Pilles and Cusick, Burke Brothers, Barton and Van Loer, E. M. Carroll, Dancing John Drew, Swift and Chase, musicians; McAvoy and May, Ranch and Kennedy, Bobby Gaylor, Hamlin and Hamlin, Bryant and Saville, musical act; Vidoc and Haines. All of whom I knew in days gone by when I worked under the name of Johnny Howard and worked on the bill with some of the above. And who remembers the National Trio—Frank D. Byran, Nellie Forrester and Gilbert Moulton (some comedy act, believe me!) of 35 years ago? It does one good to read of the good oldtimers, and *The Billboard* is the only place where one can find this good news together with the latest general news."

50 "COMIC" STUMP SPEECHES. 25c LECTURES AND SERMONS. COLLINS CO., 197 Fulton Street, Brooklyn, N. Y.

MINSTREL SHOW GUIDE 350 End Men's Jokes, 25 Songs, 2 complete Sketches, 3 Monologues, 4 Stump Speeches, besides complete instructions on Stage and Program Arrangements, Rehearsals and "Make-Up", from start to finish, 25c. THE COLLINS CO., 197 Fulton Street, Brooklyn, New York.

NEW THEATERS

Work will start soon on a theater building at Paragould, Ark.

The Babylon Theater, Amityville, N. Y., which opened recently, will be devoted to pictures and vaudeville.

The newest suburban theater to open its doors in Portland, Ore., is the State, at 21st and Hoyt streets, which opened recently. A fine pipe organ is a feature.

Preliminary plans have been filed for a 20-story theater and office building to be erected at Broad and Locust streets, Philadelphia, by the Equitable Realty & Holding Company.

A theater with a seating capacity of 1,500 is to be built in Mt. Lebanon, suburb of Pittsburgh, Pa., at an estimated cost of \$330,000. It is intended that the house be completed by July 15.

The United Triangle Corporation has purchased a site in Port Chester, near Liberty Square, New York, for a \$600,000 theater, work on which will start in the near future.

The R. F. Clary Company has under construction a theater and store building at 24th and Ames streets, Omaha, Neb. The theater, a modern fireproof building, will have a seating capacity of 800 and is to open April 1.

The Tivoli, the Tri-State Amusement Company's newest theater in Sioux City, Ia., opened February 14. It is strictly modern in theater architecture and equipment.

Within the next few weeks the theater in North Main street, South Bend, Ind., will be finished and preparations will be made for the opening. The seating capacity will be 1,500. The Mishawaka Theater Corporation is the owner.

Jacob Markum, owner of the Tuxedo and Belmont theaters, Indianapolis, Ind., announces that he will build a theater at Roosevelt avenue and Sheldon street, that city, with a seating capacity of

1,000 and to be ready for opening in April.

With the recent incorporation of the Zaring Realty Company it was learned that work will start soon on the construction of a 1,000-seat photoplay theater at Fall Creek boulevard and Central avenue, Indianapolis, Ind. The theater will be Egyptian architecture.

The first pile was driven February 16 for the \$1,000,000 Loew-Saenger Theater and office building in Canal street, New Orleans, by the Glover Contracting Company. It is expected that the theater will be ready for occupancy by Thanksgiving.

A campaign which will give Birmingham, Ala., one of the best equipped little theaters in the country, is to be conducted in the next few months. Tentative arrangements call for the erection of a theater with a seating capacity of 500.

London's newest motion picture theater, the Capitol, will seat 2,000 persons and will house two ballrooms and a huge restaurant. The theater, situated in the Haymarket, is built on the first floor above the street and will have an orchestra of 50 pieces.

London, England, is to have another theater which will be built in the Shaftesbury avenue neighborhood and will be opened by the end of this year. The enterprise is being undertaken by Frank Curzon who is the lessee and manager of the Playhouse and Wyndham's theater. The seating capacity will equal that of any of the existing London theaters.

Andrew Karzas, operator of the Trainor and Woodlawn theaters, Chicago, is to erect what it is claimed will be the largest cinema theater in that city on the site of the Woodlawn Theater and adjoining property at a cost of \$4,000,000. The structure, to be six stories high, will contain 5,000 seats, with stores, offices and apartments above.

Minstrel Costumes Send 6 cents stamps for 1925 "Minstrel Suggestions." Our FREE SERVICE DEPT. helps you stage your own show. Hooker-Howe Costume Co., Haverhill, Mass.

LATEST Greatest and Only Complete Collection of Real Minstrel Comedy Material in the World. MACK'S MINSTRELSY Price \$1.00 It is the most valuable collection of Minstrel Comedy Material ever presented to the Minstrel profession. This great book contains: 20 complete Minstrel First-Paris for 2 and 4 end men, a great Mixed Minstrel and a positive applause winner, Female Minstrel, 7 breezy Minstrel Second-Paris and Finest 6 rib-tickling Minstrel Monologues and Recitations, hundreds of Cross-Fire Jokes and Gags for Interlocutor and End Men, also a practical Minstrel Guide for producing an up-to-date Minstrel performance. The price of MACK'S MINSTRELSY is ONLY ONE DOLLAR, and your dollar will be cheerfully refunded if this great book of Minstrel Comedy is not entirely satisfactory. WM. McNALLY 81 East 125th St., NEW YORK COSTUMES FOR HIRE SEND LIST OF REQUIREMENTS FOR ESTIMATE BROOKS 1435 B'WAY NEW YORK

Picked Up by the Page

GEORGE WASHINGTON, ABRAHAM LINCOLN and FRED DOUGLASS, what a great triumvirate, and whose birthday we celebrate in February. Mr. Douglass is ours, and should be better known and more recognized by the nation at large, because of his relation to the immortal LINCOLN. His place in history is slowly but surely being fixed thru the medium of the press and the joint celebrations of the natal days that come close together.

PAUL ROBINSON, now doing the *Emperor Jones* at the 52d Street Theater, read the emancipation proclamation as part of the big general program conducted by a number of organizations before the Lincoln monument at Union Square.

The Congregational Church in Harlem was the scene of a LINCOLN-DOUGLASS celebration. ALTA BROWN, soprano, was the vocal feature of the bill, and the young Washington artist who has made a reputation in the West Indies and South America again added to her laurels. Counselor JOHN C. HAWKINS, ex-member of the State Legislature, and FRED R. MOORE, publisher of *The New York Age*, were the speakers of the occasion. Andrew Strickland, tenor, and Marie Jackson Stewart completed a most remarkable program that was prepared by P. W. BEAN.

The Lincoln Theater emphasized the week by presenting the Abraham Lincoln feature picture, and the people of Harlem cried, prayed and applauded over the filmed history of the great martyr. The vaudeville bill presented with it included JIM and JACK, dancing boys who have just returned from London with a dance offering both as to routine and costuming that is as original as has been presented in a long time. *Leonard Harper's Revue* (reviewed in detail in the Burlesque department of this issue) was the big act. FORD and PRICE, an unusually good white wire act, provided the novelty.

JOHN W. COOPER, ventriloquist, was the surprise feature at an affair tendered the REV. CLAYTON POWELL, pastor of the largest Baptist Church in New York, the occasion being his wife's birthday anniversary.

FRANCIS WILSON and EDNA LEWIS Thomas are starting a curtain raiser for the *Emperor Jones*, entitled *Dracany Boy*, a 27-minute dramatic tabloid at the 52d Street Theater. Reviewers speak highly of the piece and the artists. Wilson wrote the piece.

LOUIS SCHOELLER, FRANCIS CORRIE and NATHANIEL SACK are members of an otherwise white cast of 16 artists in *Cape Smoke*, a drama that opened at the Martin Beck Theater February 16.

COLELAND AND JONES left New York with contacts for six weeks of vaudeville dates that will take them to Quebec and back.

Illness has been upsetting the engagements of the *Harrod Jubilee Singers*, but the misfortunes seem to have subsided and they are again filling dates in and around town. G. H. BARNETT, who formerly conducted his own quartet, has joined the Harrods as basso. MISS WALTON, contralto, registered a few high notes when she heard of the Brown & Stevens bank failure, but she feels less anxious about a substantial reserve that she had on deposit there since she has heard from the meeting of depositors in Philadelphia.

The DOUGLASS THEATRE management has undergone a change. Mr. Hubs, former manager, has gone into the printing business, specializing in theatrical work, and IRVING ROTHENBERG has assumed charge of the house. His first week's program included *Gallopina Hoofs*, a lathé serial, in which LEON WILLIAMS has an important part. There are other Negroes in the cast, and a number used in a grand-stand scene.

The Miletoux film, *The House Behind the Cedars*, was the feature offering February 15-16. It is a wonderful story on the subject of *Passing* with ANDREW BISHOP, SHILZIE HOWARD and LAWRENCE CHENAULT in the "fat" parts.

February 22 the Douglass Theater installed an 18-piece orchestra with a view of making music a prominent part of its program.

While the Holtkamp Minstrels were in the second week at the Lafayette Theater, PROF. ARTHUR WRIGHT, bandmaster, was equipped with the credentials of a deacon. The professor is one of those fellows who insists upon knowing a town that he plays. He almost walked the Page to death seeing churches, business houses of the Race, homes of distinguished people and otherwise adding to his store of information. He is a good mixer, too, and has little time for the commonplace.

LEWIS FRED SIMPSON has contracted to present the Monarch Band at the Palace Theater, White Plains, N. Y., the week of April 23, under the auspices of Briarcliffe Lodge 345, I. B. P. O. E. W.

Yes, the worm has turned. We were once a mendicant group, but it is different today. We are slowly picking up our share of the burden of community interest. A colored orphanage at Riverdale, the St. Philip Episcopal Church and a number of individuals have donated to the funds for St. John the Divine Cathedral, the world's masterpiece of theological construction. The performers have been the forerunners of this, for they have long been donating service and money to every known charity or benefit. WASHINGTON'S birthday ETHEL WA-

J.A. JACKSON'S PAGE
IN THE INTEREST OF THE
COLORED ACTOR, SHOWMAN AND MUSICIAN
• OF AMERICA •

SERVICE LEADING TO ACHIEVEMENT

(Communications to 1493 Broadway, New York, N. Y.)

TERS, the Comries Inn Club group and the Cotton Club Show with others appeared in a performance for the joint benefit of the Katie Ferguson Home for Working Girls, St. Benedict's Day Nursery and the Hope Day Nursery.

TIM OWSLEY, stage manager of the Georgia Minstrels, has taken a vital interest in the fight for better schooling in Indianapolis. Tim had a vigorous letter published in Indianapolis papers while home for a week from the show. He has some very fine daughters in school in his home town.

Dear Old Africa is the name of a new number by E. V. R. GARDNER and W. ASTOR MORGAN. It is published by Mr. Gardner at Newton, N. J., with band and orchestra arrangements and promises to become a classic.

Evelyn Ellis, Allie Hughes, Margaret Hubbard Brown and Lionel Monagas.

It seems that the threatened lawsuit between Mr. Levy and John T. Gibson, owner of the Dunbar Theater, has been sidetracked, and that they with Mr. MacEntee are all working in close harmony. The press agent of the theater, however, neglected to make the harmonious arrangement known to the show world. How long the man will continue is not certain. It is known that Mr. Gibson spent considerable for a long distance call to the Lafayette Theater, New York, trying to prevail upon Mr. Holtkamp to place his minstrel show in the house for an early date, so it is apparent that the entente cordiale is not an enduring thing.

Entertain Unfortunates

Drake and Walker and their *Bombay Gals* played the State Theater, Poughkeepsie, N. Y., week of February 2 and

A Picture Distributor

Some time since an announcement was made to the effect that the Guaranty Pictures Company had taken over the distribution of the Reel films. Since then

ETHEL WATERS AND EARL DANCER



A clever team that has concluded a tour of the Ophelia Circuit, featuring Miss Waters, the first colored woman to be featured over that time. They are now started at the Everglades, a Broadway club. Miss Waters, if plans now in process are concluded, will soon be presented with an otherwise all-white company at an important New York theater.

while there the company journeyed by sleigh to Mattawan, presenting a breakfast matinee to the inmates there, some of whom had not witnessed a show in 11 years. The trip was made out of respect for Nathan Bevans, well-known composer.

Incidentally, the show received a very strongly worded comment in a Poughkeepsie paper, the initial paragraph of which reads:

"The old town sure has been getting its excitement on 100 per cent lots since the eclipse on Saturday. That of the sun was followed by another eclipse last night when Drake and Walker's *Bombay Gals* eclipsed all preceding colored shows at the State. Never have local musical comedy patrons and musical fans ever been given a more rousing treat."

Such comments as these are what has prompted like Weber and other New York agents who are on the lookout for sure-fire things to make inquiries about this attraction. The show went into the Standard Theater, Philadelphia, for the week of February 9, after which it jumped to the Howard Theater, Washington.

No Longer Confused

According to local papers and programs that come from Philadelphia, the confusion that prevailed in theatrical circles there seems to have subsided for the time being. Robert Levy and his erstwhile Manhattan Players opened at the Dunbar Theater, February 9, as the Lafayette Players, in *The Acquittal*, with George MacEntee programed as stage director. *Experience* was presented last week by the same company.

The cast includes H. L. Pryor, Robert W. Brown, Jack Carter, Neil Lawrence, Harry Washington, Richard N. Gregg, Fred Ardson, James Norman, Ruth Carr,

the Page had two interviews with the young man who is promoting the new concern, a Mr. Luby, a broadminded fellow with high ideals and a director of the dramatic club at the Jacob Schiff center. He has had much contact with our people in the West Indies, where he toured in a business way for a time.

Recognizing the limited field offered by the theaters catering to the Race, Mr. Luby has begun the development of a business thru the medium of local organizations in the different cities that desire to promote Race interests thru the medium of good films portraying Negro artists in stories that have to do with our people. The films offered are of the inspirational type that may be presented by churches, schools and societies. At the same time the story and the mechanical work is such as to make them well worth considering by theaters catering to either the general public or to Negro audiences.

Many of the films offered under the Reel trade mark are by Race authors. The films now seem to be in the hands of one who is marketing them with an intelligence that is not only intended to sell pictures but to develop a genuine interest in Race films by the people who should be most concerned, viz., the oft-mentioned "better element".

Mrs. Downs in Cuba

Mrs. Marie Downs, owner of the Lincoln Theater, New York, sailed February 7 on the S. S. Zapara for Havana, Cuba, accompanied by Mrs. Lola Somers. They will remain in the Cuban capital, the native home of Mrs. Downs, until March 7 and then return to the States.

The trip, which is the first the busy woman who heads three large corporations has taken since the death of her

Action for Bettering Performers' Affairs

Comedy Club Meeting Results in Step To Eliminate Bad Element From Race

"I used to sport, I used to fight and I used to think pleasure more important than business. Time was when I was both indifferent to the future and to my associates, and when I change for the better it's time for every colored performer to try to be an angel." Thus spoke "Bojangles" Bill Robinson, the highest salaried single Negro artiste in vaudeville, to more than 100 performers gathered at a midnight meeting at the Comedy Club in New York February 16.

His wife sat just back of him while for 40 minutes Bill hammered into the folks the need of improving the deportment of the group if it is to retain its place on the American stage. In very forceful language the celebrated dancer described conditions that need improving, named performers who have blemished the whole group and mentioned incidents that have reflected unfavorably upon all, high and low salaried alike. The assembly was about equally divided between men and women. Many standard acts were there.

It was an epoch-making event in that it is the first concerted effort on the part of colored performers playing on mixed bills to take into their own hands the matter of disciplining those whose conduct is harmful to the Race.

For nearly three hours these folks listened to speeches and seriously considered ways and means to punish offenders who seem to be beyond redemption, and to lend an advising hand to the less thoughtful and the youthful ones in the profession.

The Page was invited to follow Mr. Robinson and for the first time he verbally presented the arguments for decency that have so often been used in *The Billboard* and that to a great extent helped to crystallize sentiment with the profession to the point of leading up to this meeting.

The club had for the occasion as its guests the officers of the Egilic (college) Club of New York. Attorney Ellis Rivers, president of that organization, addressed the body and disclosed a very keen insight into the problems that confront the actors. Dr. Peter Murray, whose wife is on the concert platform, so interested his auditors that he was promptly elected surgeon to the club. They, with Chester Booth, a dentist, who also made a few remarks, and William Iams were made honorary members of the Comedy Club.

The club, after speeches by William Kinney, its secretary, and Sam Tolson, the manager, elected the latter chairman of a vigilance committee with power to select 10 members to associate with him in seeking information as to the merits of reports against performers, to caution the delinquent ones and to co-operate with managers, agents and other organizations in disciplinary measures. J. A. Jackson was first selected as chairman of this committee by unanimous vote, but declined, explaining that it would be better that such matters be strictly within the hands of the performers themselves. Upon his promise to accept the post of advisory member, his explanation was accepted, the action rescinded, and Mr. Tolson elected.

Among the matters placed before the committee was the failure to respect homes at which performers stop thruout the country.

The practice of surreptitiously using the telephone in people's homes and failing to arrange payment for long-distance calls.

The foul practice of ogling women in front of theatres at which they are playing.

Too much familiarity with women of other acts and attaches of theaters.

Quarreling with stage hands and other employees.

The lack of respect for the women of their own acts.

Failure to accord due courtesy to other acts, both white and colored.

The elimination of jealousies and of invidious comparisons of the different acts and performers.

Unkind expressions in the offices of agents.

Social intrusions upon the company of white artistes with whom they work.

Violations of the liquor law and theater regulations.

Carelessness in the type of company one mingles with in the different cities, which often helps to discredit a company and injures the business of the theater.

The making of improper proposals in public places.

Inviting women other than one's legitimate associates to places of amusement after the show.

After determining to conduct a "Blue Monday" night's entertainment at each week on lines similar to the "Glow Nights" of the N. V. A., the meeting adjourned.

Leonard Rubin acted as presiding officer and handled the executive gavel well.

husband a year ago, is being signalled by a number of social affairs arranged by her relatives, the great Agrimonte family, who are prominent in business and politics in Havana. They are stopping at the Seville-Biltmore Hotel there.

Minstrel and Tent Show Talk

"Slim" Thomas and his wife leave Houston, Miss., where they have been wintering, for North Little Rock, Ark., in time to report March 10 for rehearsals of the Shufflin' Sam From Alabama show, Bruno and Keyno, a new team, have been contracted for this season.

Nay Notes

Belisha Nay, of the Nay Bros.' Show, rejoined the show at Ada, Ok., after an absence of a few weeks at the bedside of her mother in St. Louis. Roberta Roundtree, who was out of the cast for a time because of illness, is improving and will have rejoined by the time this appears in print. If nothing untoward happens, Mrs. Charles Hooper joined her husband on the show at Ada.

While playing Guthrie, where the show orchestra played for a dance, the members were accorded the privilege of visiting Dr. H. W. Conrad's sanitarium, a remarkable institution that is treating patients of both races from all over the country.

The house season closes for the show about April 1, when the show will take up a 10-week route into the Northwest, playing under canvas, after which it will fill a number of fair dates. Seems that the Creole Steppers threaten to become an all-year-round institution.

Prince Oskazuma writes from Miami, Fla., that the tourist season is at its height there and that the Lincoln and Lyric theaters are doing nice business. Leigh Whipper brought the Oh, Baby, Minstrels into town February 15 for an indefinite stay. A damaged ear delayed their arrival for a few days. The Jenkins Orphanage Band is working the streets with good results, financially speaking. Two dance halls with good bands are getting a big play. The I. B. P. O. E. W. local lodge is \$1,000 richer for having presented a carnival under its auspices.

Walter Wardell, tuba player, closed with the Sunbeams From Dixie Company and has signed to go with Prof. Rigger's band when the Robbins Bros.' Circus season opens.

Sponny Bowen, of the Mosella, Bowen and Coleman Trio, informs that the bunch will be with the Sparks Circus when its season opens.

Vernon Hughes, xylophonist, is playing in and around St. Joseph, Mo., with Prof. Odan's eight-piece orchestra.

February 16 the Harvey Minstrels returned to the States at Sault Ste. Marie, Mich. Irvin Richardson, stage manager, has rejoined the show after a brief absence occasioned by the death of his mother in Kansas City. The show received some good press notices in Ontario.

Animal Acts Busy

Frank Wilson has resumed the ownership of the trained pony, mule, dog, donkey and cat act that he had at fair last season. H. D. Collins is handling the bookings. The act was a feature of the Elks' indoor Bazaar at Oswego, N. Y. last week. At the close of that engagement Wilson moved to Buffalo, where he opened at the Palace Theater, with four weeks of split-week dates to follow, for Jack Berman's office. Beginning August 1 the act has six weeks of fair dates booked thru the Spellman office.

Frank Moss and his trained bears were on the bill for the Elks' affair at Oswego. Two Negro novelty acts on one program for a white fraternal organization in a town that has very few Negro citizens augurs well for the improved conditions that prevail with Negroes with meritorious acts.

"Log Cabin Life"

Tim O'Donnell, of the Pat Casey office, is playing *Log Cabin Life*, a new act owned and produced by Aaron Thompson. The act opened at Keith's Rivoli Theater, Brunswick, N. J., where *The Daily Home News* published the following comment upon it:

"The *Log Cabin* Band is a lively musical combination with some good dancers. The ghost number is out of the ordinary, and there are some other specialties of high class."

Ruth Green, a balladist; Babe Aldrich, blues singer; Evelyn Riley, soubrette singer and dancer; Frank Robinson, novelty flute player; Horace George, comedian, and Paul Sullivan, jazz and Russian knee drop dancer, are the specialty people in the act. Aaron Thompson, C. Boone, S. Yarwood, Robert Cloud, A. Golden, O. Howard, A. Thompson and Frank Robinson are in the band, with which the flutist also works.

A Bank Failure

The Brown and Stevens Bank of Philadelphia has gone into the hands of a receiver, appointed by the State banking commissioner. The assets are reported to be \$1,000,000 with liabilities set at a like figure. There are deposits of \$750,000 belonging to 6,000 people, among them many professionals with whom the bank had long been popular

due to its long-time ownership of the Lafayette Players and a circuit of theaters. Frozen assets in the form of paper on the Dunbar Theater, Philadelphia, and the Douglass Theater, Baltimore, are reported to have contributed to the failure. Grand Chancellor Collier of the Knights of Pythias and other influential parties are at work to effect a reorganization of the institution, one of the partners of which is a member of the State Legislature of Pennsylvania.

REVIEW

Macon, Ga.

DOUGLASS THEATER

(Reviewed Monday evening, February 9)
T. O. B. A. Vaudeville

An unusually large audience attended the evening show due to the parade around town of the Hopi Indians featured for the week.

Ridley and Ridley, man and woman, opened "in two" with a song and then went into some chatter that hit despite the age. Ridley sang *Then I'll Go With You* to applause and the lady rendered *I Love My Man*. More talk followed and an eccentric dance by the couple closed the act, but not with the effect that Andrew Ridley got with his former wife, Ethel Ridley, the record star. Fifteen minutes.

Williams and Williams (the Bird), man and woman, both Maconites, opened under cork in half stage in a domestic turn and drifted into *Going South*, a song

hit with the folks. The man then rendered *A Man Never Knows* and registered an encore. The lady came on with *What'll I Do*, refusing an encore. Somewhere talk and the act got away, after 12 fast minutes, with *Under the Slip Slip Sippy Moon*, doing a sensational dance to an encore. This act is very clever and has the best routine seen here by this reviewer.

The Hopi Indians, seven in number, opened before a special drop and were introduced by their manager. They presented native dances to approval. The dances were a dance of thanksgiving, buffalo dance (prayer for snow), the eagle dance, snake dance and the victory war dance. An Indian soloed in his native tongue and an English song proved a treat to the audience. Twenty minutes.

The screen offerings helped to make the program a very good one.

BILLY CHAMBERS.

Busy on the Coast

James and Jacqueline, who went to the Pacific Coast over the Bert Levey Time, seem to have a monopoly upon dates in the Far West. The act has sent in additional dates that indicate that it will be busy in the Mohave Valley until the latter part of March. James informs that Bert Chadwick, who has been working in and around Los Angeles for some months, is going to Australia, but that he and his partner long for the East and will soon be headed for New York.

Here and There Among the Folks

James Ross, wire artiste, broke his winter rest to play a week at the Lincoln Theater, Houston, Tex.

Finley and Stevens are doing the houses in and around Washington, D. C., booked out of the S. H. Dudley office.

Seals and Mitchell with their *Melody Land Girls* are playing the Dudley chain of theaters on the eastern end of the T. O. B. A. Circuit.

Jackson and Taylor are keeping busy with their original act in New England theaters with bookings arranged out of Boston.

Citizens of Tuxedo Park, St. Louis, Mo., are opposing the proposed creation of a \$40,000 theater in the district that is intended for Negro patronage.

Norma and Naomi, of the *Brazilian Nuts*, are more than musical artists. They show a marvelous sense of the artistic in the selection of valentines for their friends.

Charles Lynch, outdoor announcer and novelty worker, is wintering in Hopkinsville, Ky., where he is acting as the representative of a Chicago clothing concern until the summer season opens.

Young Rastus Brown, a dancing boy, joined the *Rivoli's Wild Company* in Baltimore February 9. He closed with the Holtkamp Minstrels in Washington, D. C., the week previous.

Prince Mysteria writes to tell of the new Alpha Hotel, a 100-room house beautifully furnished, yet of moderate charges, that is now open to the profession in Grand Boulevard, Chicago.

Scott and Whaley, who have been favorites in England for some years, and who just concluded a tour of Australia, have been contracted for a tour of the Keith Time. Alf. Wilson is handling their U. S. bookings.

The *Harford Daily Times* has added its praises to those of other New England papers for Masten's *Shake Your Feet* Company with Joe Russell, now playing the Poli Time. Virgie Richardson's work is highly praised in the paper.

Prof. P. G. Lowery, former leader of the side show band on the Ringling-Barnum Circus and who retired some time since to conduct several Cleveland (O.) bands, among them a ladies' organization, is preparing to take the woman's band on tour for a series of fair dates this year.

J. Finley Wilson, grand exalted ruler of the colored Elks, is a member of the Presidential Inaugural Committee by virtue of appointment by Chairman Galiber. The colored people of Washington have had the Elks' hall held at mammoth convention hall sanctioned as their

part of the social phases of the inauguration. Dr. James R. Fletcher, who has made a great reputation in connection with the Lincoln-Howard dances, is in charge of the details.

"Diamond-Tooth" Billy Arnte will head a company of 15 people under the direction of Hugh W. Hill, a Birmingham outdoor agent and investor. The show will be presented in white and colored parks and is being assembled in Birmingham.

H. P. B. Johnson, concert promoter and race harmony propagandist, has been confined for some weeks in Muskogee, Ok., where he was obliged to undergo an operation for appendicitis. He is recovering and will soon be able to resume his local-talent concert promotions.

Ravella Hughes has deserted the musical comedy element of the business and taken up dramatic work with the Lafayette Players, group No. 2, headed by Evelyn Preer. Her initial appearance was at the Liberty Theater, Chattanooga, week of February 16.

Maude Cuney Hare, author- pianist, and William H. Richardson, baritone, have been making successful joint appearances in New England. They are scheduled to appear at the Syracuse University early in March. Ernest Driggs, New York concert agent, has contracted to handle their bookings for 1925-26.

During the stay of the Whitney and Tutt Company in Louisville, Ky., where it played the Lincoln Theater to good business, Charles Hawkins, Wilbur White and Joseph Purnell, members of the show, were raised to the degree of Master Mason. Salem T. Whitney also gave considerable impetus to the local corner of Deacons.

The George Wintz *Shuffle Along* closed February 18 at Youngstown, O., according to word from Al. Watts, stage manager of the company. The show had a stormy time since the opening, and Messrs. Wintz and Shafer were unable to get it going in the old-time way after they took charge of the business at Cleveland.

Princess Wee Wee just joined the Whitman Sisters' "Gang" and, according to reports from Nashville, Tenn., where the show did turnaway business the week of February 9, she was a great favorite with the patrons. She previously confined her work to circuses and museums. Last season she was with the Ringling-Barnum Circus.

Father Quinn's Troupe, as a versatile quartet that John W. Cooper, the ventriloquist, has assembled, is being kept busy by the worthy priest sponsoring their activities. They have a wide range of dates booked for schools, Knights of

Columbus, church and soldier organizations. April 23 Cooper will do the lead part in a dramatic production called *Nothing But Truth* that is to be presented by the dramatic club of the church of St. Peter Clavier at the Academy of Music, Brooklyn.

Maharajah, mystic, is operating a store show in Brooklyn pending the opening of the summer season, when he will take the road for the first summer season in years with about 20 people in a company that will tour with one of the large combinations. Prior to the Brooklyn opening he donated an evening's performance to the Bordertown Industrial School near Trenton, N. J.

During the second week of February Detroit took on the aspect of a theatrical center. The *Seven-Eleven* Company was at the Gayety Theater, the Ida Anderson dramatic players at the Koppin Theater, *Follow Me* at the Palace, and Sheffell's Revue, the Gonzell White Company and several vaudeville acts were in town, and this made quite an impression on Gratiot avenue and St. Antoine street. The Sheffell troupe is headed East.

Bob Russell, who operated his tabloid company under the handicap of illness for some time, took a turn for the worse at St. Louis, Mo., where Charles Turpin, generous theater owner, placed him under the care of a specialist. Meanwhile his show continued to Memphis, where it opened on schedule at the Palace Theater under the direction of Josephine Russell, who has long since demonstrated that she can manage a show.

Greenlee and Drayton and Eddie Green, the burlesque comic, are the featured people in the new Hollywood Club revue, the Broadway cabaret that has been reopened with no traces of the fire that obliged its temporary closing. One of the features of the show is a new strut number called *Mobile Buck*, by Lukie Johnson and Alonzo Govern. It is one of those Charleston things and holds great promise.

George McClennon and Maude DeForest, with Harry Steppie in burlesque, seem to have become the hit of the show if we are to judge by the reviews that have been coming in. Ill Tom Long has just sent a bunch of Dayton papers that confirm what has been said in Eastern papers. Tom is at the National Military Home and would like to hear from the folks whom he enjoyed meeting so much while in Hot Springs.

Billy Carnell's *Dancing Dandies* was closed after the first performance at the Palace Theater, Lake Charles, La., according to a letter from J. A. B. Taylor, stage manager of the theater, who declared the show to be weak, in need of a leading man, whose leading woman was too ill to appear, and the material of which was entirely intolerable. "The show was not only weak but filled with snuff, and Mr. Mancuso would not stand for it," says Taylor.

Alfred Pizarro and his Tasmanians have closed on the Pantages Time in Chicago and will go west over the Western Vaudeville Managers' Association Circuit. During the idle week in Chicago the little fellow has been buzzing with the Lafayette Players at the Grand Theater; Leo Salkin, owner of the Sunset Cabaret, and his performers; "Boots" Marshall and the bunch at the Plantation, and the 7-11 folks, who were drawing big at the Star and Garter Theater. If showfolk are in town Pizarro will find them, and he is not selfish in mentioning others in his letters.

Sidney Easton, the comic with *Talk of the Town* burlesque company, closes a letter with the apology: "Must be brief this time as I am busy arranging a list of stopping places in Buffalo for the information of the *Seven-Eleven* Company that follows me into the city." That's what we call a fine display of commendable fellowship. We are proud of Syd's thoughtfulness. Incidentally that *Seven-Eleven* show grossed \$12,000 and \$14,000 respectively for the weeks at the Olympic and Star and Garter theaters in Chicago. Syd by his lonely has earned a lot of publicity and made friends on the show.

Acts and Managers

communicate with THEATRE OWNERS' BOOKING ASSOCIATION for all matters theatrical (Colored). Offices, 412 Volunteer Building, Chattanooga, Tenn.

Colored Musicians and Performers

Of all kinds wanted. For "SHUFFLIN' SAM" CO State all quick first letter. Rehearsals start March 10. Address HARRY HUNT, P. O. Box 161, North Little Rock, Arkansas.

JOIN NOW— VIRGINIA MINSTRELS

All people engaged. CAN USE a few more Colored Musicians and Performers, Comedians, Trombone, Clarinet, Alto and vocal Cook. State salary. All address N. D. DOBBS, Manager, Box 766, Houston, Tex.

SOMETHING REALLY NEW The Harlem Rounders
A COLORED PRODUCTION BY MEN WHO KNOW HOW TO DO IT.
A Revue with Music, by and under Personal Direction of ROSAMOND JOHNSON.
Production Staged by FRANK MONTGOMERY.
Under the supervision of B. L. BURTT, of the Lafayette Staff.
With a Remarkable Assemblage of Negro Talent, Including

ABIE MITCHELL.	J. ROSAMOND JOHNSON'S BAND	BILLY HIGGINS.
DANCING DEMONS.	FLORENCE McCLAIN.	GULFPORNT AND BROWN.
SOUTHERN FOUR.	BROWN AND PEAT.	ELOISE BENNETT.
WILLIAMS AND BROWN.	KITTY BROWN.	

And New York's Fastest Singing and Dancing Chorus.
See either one of the regular performances, or make the Friday Night Midnight Show. Running now at the LAFAYETTE THEATER, New York City, 131st Street and Seventh Avenue.

31ST YEAR

The Billboard

"Old Billyboy"

The largest circulation of any theatrical paper in the world.
Published every week

By The Billboard Publishing Company,
A. C. HARTMANN.....Editor
E. W. EVANS.....Bus. Mgr.
I. M. McHENRY.....Gen. Mgr.

F. G. KOHL,
President.
W. H. DONALDSON,
Chairman of the Board.

Main Offices and Printing Works:

THE BILLBOARD BUILDING,

25-27 Opera Place,

Cincinnati, Ohio. U. S. A.
Phone, Main 5304.

Cable and Telegraph Address, "Billyboy", Cincinnati.

NEW YORK OFFICES

Phone, Lackawanna 7180-1.
1493 Broadway.

CHICAGO OFFICES

Phone, Central 8480.
Crilly Building, Monroe and Dearborn Streets.

PHILADELPHIA OFFICES

Phone, Tlca 3525.
908 W. Sterner Street.

ST. LOUIS OFFICES

Phone, Olive 1733.
2088 Railway Exchange Bldg., Locust Street,
between Sixth and Seventh.

BOSTON OFFICES

Phone, Beach 0651.
521 Colonial Bldg., 100 Boylston Street.

KANSAS CITY OFFICES

Phone, Delaware 2084.
424 Chambers Bldg., 12th and Walnut Streets.

LOS ANGELES OFFICES

Phone, Vandike 4260.
Room 734, Loew's State Bldg., Broadway and
Seventh Street.

LONDON, ENGLAND

Phone, Regent 1775.
18 Charing Cross Road, W. C. 2.
Cable and Telegraph Address, "Showworld".

SPECIAL REPRESENTATIVES:

Baltimore, Md., 151 Wallis Ave.
Denver, Col., 520-21 Symes Bldg.
Detroit, 507 Detroit Savings Bank Bldg.
New Orleans, La., 2632 Dumaine St.
Omaha, Neb., 216 Brandeis Theater Bldg.
San Francisco, Calif., 511 Charleston Bldg.,
251 Kearny St.
Sydney, Australia, 114 Castlereagh Street.
Washington, D. C., 1724 Newton St., N. W.

ADVERTISING RATES — Fifty cents per
line, agate measurement. Whole page, \$350;
half page, \$175; quarter page, \$87.50. No display
advertisement measuring less than four lines
accepted.

Last advertising form goes to press 12 M.
Monday.No telegraphed advertisements accepted unless
remittance is telegraphed or mailed so as
to reach publication office before Monday noon.

SUBSCRIPTION, PAYABLE IN ADVANCE.

	U. S. & Can.	Foreign.
One Year	\$3.00	\$4.00
Six Months	1.75	2.25
Three Months	1.00	1.25

Remittances should be made by post-office
or express money order or registered letter, ad-
dressed or made payable to The Billboard Pub-
lishing Co., Cincinnati, Ohio.The editor cannot undertake to return un-
solicited manuscripts. Correspondents should
keep copy.If you find a misstatement or error in any
copy of The Billboard, please notify the editor.
The Billboard reserves the right to edit all
advertising copy.

Vol. XXXVI. FEB. 28. No. 9

Editorial Comment

NOW is the time for all good theatrical producers to come to the aid of their party.

Now is the time for that Committee of the Theater to get these producers and all other interests of the theater together and take steps to forestall the dark angel that is hovering over the American stage—legal censorship.

Are these theatrical interests going to permit a bunch of people with no practical knowledge of the show busi-

ness to promulgate legislation that will restrict and hinder that business?

Do the people of the theater want it said of them that they couldn't or wouldn't do their own cleaning and so it had to be done for them?

Not if they are wise. But unless they do something about it right away that's just what will happen.

Despite frequent warnings and plenty of opportunities, the producers of filthy plays have refused to take heed. So there could be only one outcome. With the morals of our youth endangered and the clean ideals of everyone outraged by the increasing number and boldness of salacious and degrading productions, action from the civic authorities has long been inevitable. Perhaps now that communities throuout the country are rising up and taking the situation into their own hands the producers will come to their senses. The regrettable thing is that when they

the production run off as presented in New York or dressed according to the requirements of the local authorities.

Of course the audience clamored for the Broadway style. It is only natural that patrons who have paid a good price to see a show should side with the producer when he offers to show them a little more nudity than they expected.

But suppose Carroll had asked his question in a disinterested public forum composed of intelligent people, who had not paid \$4.40 or more for their seats to see something that they had been led to believe would be daring—suppose he had tried that. There is no doubt that the response would have been quite different—and more reliable as far as voicing the sentiment of the general public is concerned.

Carroll ought to go out and learn some of the sentiments of the thousands who purposely stay away from his show

tact with it. As to acting, that is another thing.

At least two of the most prominent critics in New York admit their ignorance about the art and technique of acting. And they are not entirely to blame for knowing so little about it.

In the days when Hazlitt, Lewes and Lamb wrote so intelligently about the art of the actor, even up to the time of William Winter, it was possible for the man sitting in the audience to acquire a knowledge of what constitutes good acting. In the course of a season he would see the same parts played in the same standard plays by several different players. In that way he could weigh one against the other, determine how one actor did one scene better than another, and in the course of time weave fabric of judgment based on comparison against a standard.

Today the critic sees players in different parts continually and seldom has the advantage of seeing a particular part played by two or more different actors. How can he then acquire a knowledge of what the art of acting is?

There is one way. He might profitably spend his summers with a stock company, where he could study the tricks of the trade and learn more in a month about acting than he could in 10 years from an aisle seat. At any rate, if he did this, he might adopt a more sympathetic attitude toward the player and be willing to substitute intelligent analysis of the manner in which he played his part for a smart phrase. He might even learn to tell a good actor in a bad part from a bad actor in a good part. And that would help some!

COURTESY IN THE THEATER

THE insulting treatment that the public is forced to suffer at many box offices has been commented upon time and again. But theater managers have failed to do anything about it. Now the same ill treatment is becoming more noticeable on the inside of many playhouses.

Producers of shows spend hundreds, even thousands, of dollars in securing effects that will please the eyes and ears of their patrons for a moment. But many of them do not give even a passing thought to creating a happy disposition in these same patrons by seeing that they are treated courteously from the time they step up to the treasurer's window until they are on their way home.

A pleasing theatrical effect may be forgotten 10 minutes later, but the memory of discourteous treatment lingers long enough to do a great deal of harm.

There is a big difference between sending patrons home from the theater with a satisfied feeling that they have been not only entertained but also made welcome and comfortable, and sending them away with the bitter recollection that they not only had to pay a good price for their seats but also had to suffer indignities in the bargain.

The invariable attitude of attaches in the legitimate houses is one that gives patrons the impression that the theater is doing them a favor in admitting them at all. Patrons must meekly accept a curt reply from the box-office man, a growl from the doorman, an imperious command from host or hostess, and a "six rows down and four seats in" from a gum-chewing usher.

Now compare this situation in the legitimate houses with the way things are done in the motion picture theaters. Take the Rialto, Rivoli or Capitol in New York, for instance. A "thank you" and a smile greet each patron from the box office to the head of the aisle, and at that point a solicitous usher, with manners befitting a royal court attendant, escorts the patrons to satisfactory seats. Everything that these ushers can do for patrons in the way of ministering to their comfort and convenience is done with cheerful willingness. Patrons are made to feel as welcome as in their own home. They are made to feel of some importance.

That's the way to build patronage. Of course, the movie houses must depend on the weekly attendance of the same, or practically the same, group of patrons, while the legitimate houses, especially in the big cities and where outstanding hits are playing, get the same people only a few times each season.

But it shouldn't be the matter of attendance that governs the treatment of patrons of the theater. From a common-sense standpoint, and out of pride and respect for the business that gives theater attaches their employment, it should be seen to that playgoers and the public in general are treated in such a way that they too can respect and take pride in their places of entertainment.

finally do come to their senses it may be too late.

If the theatrical industry were organized, if that Committee of the Theater were completed and ready to function, the stage could take care of this problem at home. It would not need any outside assistance. Indeed, it should not have to tolerate it!

Think of the ignominy and shame of having to admit that total outsiders had to step in and do for the theater what it refused to do—or was incapable of doing—for itself. What a commentary on this grand institution of ours, the American Theater!

Earl Carroll, more for the sake of publicity than anything else, keeps trying to justify the nudity in his revue by declaring that he is giving the public what it wants. To prove his point last week he made a speech from the stage on the opening night of his revue in Philadelphia in which he asked the audience whether it would rather have

because it is offensive to them. Also, he would learn something of interest if he could hear some of the comments on his revue made by patrons after leaving the theater. It would give him a much better line on what the public wants.

"The public" is composed mostly of people whom Carroll cannot reach from the stages of theaters where his revue is playing.

IT IS pretty generally held by Broadway players that there is no longer any real dramatic criticism to be found in the New York dailies. There is continual lament among them that the criticism which dealt analytically with the play and acting has been replaced almost entirely by clever, facile and personal writing.

It is admitted that the critics do better with criticism of the play than with the playing. After all they are writers themselves and know good writing from bad when they come in con-

WE BELIEVE Equity actors who are working should make it a habit to keep paid well up in their organization. It pays. It shows consideration.

Recently a company stranded in a Mid-Western State. Equity had demanded a cash bond and got it in the face of vigorous protests from the manager. When the company "went to pieces" two weeks' salary was coming to each actor. There was no money to pay the salaries, hotel bills or transportation. But back in Equity's strong box reposed the cash bond. That did the work by telegraph and not an actor suffered either apprehension or hardship.

This is but one of numerous instances and the same story applies to all. When an Equity actor is working there is no better investment than to pay his dues in his organization for a whole year if possible. It gives him a feeling of independence and of having done his bit.

There are few, if any, veteran actors today but have been left broke and hungry in strange towns at some time or other. Once that was one of the hazards that was accepted as a matter of course. Times have changed. Equity actors say that hotel managers look at them nowadays with an entirely changed viewpoint. This is significant. Hotel men, these actors say, all know about Equity. They know that Equity cares for its own when they get caught in the crash on the road. Hotel men are business men and this sounds sensible to them. Hotel men are also organized and know what organization means. Equity is an organization that appeals to them because it works, these actors further declare.

When the actor works he should see that he is paid ahead in the organization that protects him.

There has been much friendly controversy over the origin of traveling carnivals. Some of the pioneers in that field will give you their versions in the Spring Number of *The Billboard*.

Another feature of that big issue will be a Circus Index showing at a glance what cities and towns had shows of more than two cars in size during the past five years.

A LONDON LETTER

By "COCKRAIGNE"

A. A. Annual Meeting

LONDON, Feb. 6.—Sunday night's meeting at the Kingsway Theater provided no unusual features, but several interesting discussions arose around the proposed alteration of rules. These discussions were so protracted that the real business of the meeting, the presentation and explanation of the balance sheet, secretary's report, etc., had to be curtailed.

The balance sheet bears out my previous contention that the A. A. is being allowed to die, for the total subscriptions for 1924 are disclosed as amounting to about \$8,150, which on a basis of an individual subscription of about \$6 per annum would seem to mean that the average actual and working membership declined to something like 1,300 for 1924. When one realizes that since the middle of last year the Stage Guild has been established and is drawing many artists to itself by extravagant promises, overt and covert, the plight of the A. A. by the end of 1925 is only a matter for speculation.

Among other items of income are the following: Employment agency, \$263; entrance fees, \$153; recovered loans, \$123, and a few minor accounts of this kind which with one big item of income make up a total of \$3,515.

The big item, which represented more than one-half of the total year's income, is called "Donations". It is not otherwise itemized, which, when one realizes that the sum of \$20,252 is involved, seems rather curious. Donations from whom? For what purpose? Is the A. A. a trade union or a charity?

If the A. A. is to keep alive it must do so by virtue of its own usefulness, morale and vitality. If it is to be a mere salary-paying organization dependent upon the generosity of well-meaning and non-comprehending patrons, the sooner the latter give their cash to more deserving organizations the better.

W. Vincent Carlyle, a consistent and ardent worker in the A. A. cause, was obviously disconcerted by the possible reception of the balance sheet, the adoption of which he had to propose. He explained that this big sum of donations was from organizations, prominent men and London actor-managers who wanted to see the A. A. go on, and he half apologized for the anonymity into which these gifts have been plunged. It is generally known, too, that Equity came down with a handsome gift, no less than \$5,000. In spite of all this, however, the general fund balance carried to next accounting amounts only to some \$843, and with the death levy and protection fund balances, the total of all A. A. funds is published as less than \$2,500.

Rules—and After

The other business on the annual meeting agenda was no less promising. Several rules were up for alteration, but only a comparatively slight change, making the end of the year mid-summer instead of midwinter, was effected. This is a change for the better since a summertime annual meeting gives many more provincial artists a chance to get into closer touch with what should be one of the important events of the year.

A much more important alteration, which had received the sanction of the council, was turned down. This rule aimed at the admission of actor-managers to active participation in the affairs of the A. A. and to election to council.

The pros and cons of this question were sharply debated, but in the end the status quo name was retained.

Last, too, was the motion that the managing body similar to that of Equity and the British V. A. F., a real executive capable of carrying on the activities of the association with more facility and speed, should replace the present clumsy administration. The rejection of this rule means that the post of president will not be created. Arthur Bourchier's name has been mentioned frequently in connection with the possible office and it seems a thousand pities that the A. A. cannot have a really distinguished and widely honored figure-head. But the meeting has crushed the possibility of offering this honor to Bourchier or to Sybil Thorne-dike, who would have been a universally popular nominee.

Bitter feeling has centered around the fact that several paid officials of the association also are members of the council. It is freely argued in many quarters that the council should consist of honorary members solely. As Jessica Black pointed out in proposing the end of the present condition of affairs, there are nine paid officials of the A. A. on the council. Ada Barrar went so far as to say that the council was packed by organizers past, present and future, but Fisher White challenged this. Anyhow the "backlash" may rest snugly at 79 St. Martin's Lane, for the motion to keep paid servants of the A. A. off the governing body was defeated.

Points From the Report

Alfred Lugg, general secretary, read this report:

The creation of the new body (Stage Guild) has naturally had its effect on the association. Our total membership now stands at 3,440.

During 1924 bogus management has again appeared to be on the increase. Many artists have been saved from

going abroad on inequitable contracts or with unsound companies.

The A. A. has pressed during the year for the licensing of managers and now many managers who were bitterly opposed to such legislation have come round to the A. A. point of view.

The federal council is not considered effective. This the A. A. secretary considers is due mainly to a dispute between the N. A. T. E. and the Electrical Trades Union. (The financial statement shows that the federation policy demanded that the A. A. pay \$2,500 to a central fund.

The Liverpool branch is closed down. Friendliest relations exist between Equity and the association, which accepted \$5,000 from the A. E. A. and also welcomed the latter's offer to mediate between A. A. and Guild.

Following failures to get recognition of the theater, and the claims of actors and actresses only to appear in the pageants at Wembley, the association will bring further pressure to bear in that direction this year.

One hundred guineas was paid into court and an apology tendered to the A. A. by *The Evening Standard* and Mervyn McPherson, publicity man of the Stage Guild, in respect of the defamatory libel.

First-Nighting

Anthony Prinsep has decided to adopt a policy which, altho it not new, is never likely to be either popular or paying in the long run; he will charge double prices for the seats at the Globe for the first night of the next production.

The first-night fetish has always left me untroubled for I prefer my wine long in the bin, my venison well hung and my play smooth-running.

Curiously enough there are many who apparently prefer the excitement and misplays which are the common lot of first-nights. A strange taste. But I have known people pay to go see a man

play a fiddle (and play it remarkably badly) with his feet, who would never have passed a dime across to hear Kreisler.

Evidently Prinsep finds a lot of people endowed with that particular mental quality among the patrons of his shows.

Well, so long as they and their atrocious first-night manners and conversation are not in the stalls when I visit the Globe I shall not complain if he quintuples his admission prices.

They're With Dean

By a strange the intelligible turn of Fate's wheel Basil Dean has done very well in Kudos out of his more or less enforced resignation from the joint directorship of Drury Lane. In fact it must be said that "nothing so became him in his job as his leaving of it". He is quite the hero of the popular press and theatrical journalists are joined with theatrical fans of all sorts to laud Basil and blame Sir Alfred.

There is a great popular feeling that Butt has scotched the chances of a new theatrical regime, for the success of the present Shakespeare revival, despite Butt's lack of interest in it and showmanship to foster it, is a real thing and there are sentimental, literary and common-sense arguments flying about for the retention of works of this kind in Old Drury. Dean's courage and determination have served him in good stead and it should not be a surprise to hear at any moment that considerable and almost undeniable advances have been made to him by certain influential people, and that Basil Dean will shortly be engaged once more in a task similar to his Drury Lane direction, but with his hands free to get ahead with it.

Meanwhile *Spring Cleaning*, Frederick Lonsdale's ball comedy at the Saint Martin's, is doing capacity business most of the time. So great is the demand that already an extra matinee has been arranged each week.

Brevities

C. B. Cochran's big revue, which Noel Coward is writing, will be tried out first at Manchester. C. B. has great ideas of the Midlands city as a producing center. Two ballets with English subjects are, I believe, to form a part of the revue, and for the choreography of these Massine is to be responsible.

The touring rights of Noel Coward's highly successful *The Vortex* are taken up by Bannister Howard, who has engaged Kate Cutler to play the part of the dancing mother.

FROM LONDON TOWN

The Vaudeville Field

Billboard Office, 18 Charing Cross Road, W. C. 2

By "WESTCENT"

The Royal Performance

LONDON, Feb. 6.—Harry Marlow, general secretary of the V. A. F. F., deserves much credit for being able to stage this Royal show again. Truth to tell, he has been rather unfortunate in these ventures, not thru any misdoing of his own, but thru the fault and thoughtlessness of some of the artistes engaged. The royal show held at the London Coliseum in 1923 nearly put the finish on this kind of royal recognition, and that thru the burlesque on Shakespeare staged by Billy Merson. He travestied the play scene from *Hamlet*, with the King and Queen

"boozed". This got right up the royal nose and left a very bad taste in court circles. When, after months of angling, Marlow got a promise from Buckingham Palace that their majesties would attend another show, it was suggested by the Palace officials that there should be a full-dress rehearsal so that nothing should get by which might give the slightest offense. Apart from this lapse as regards Merson the program was very dull, the outstanding and only laughing success being the Griffith Brothers with their "poro" horse act. Bands predominated with the Sonora Band, the Marimba Band and London Ronald's Symphony Orchestra. The show before, at the London Hippodrome, also ran foul of the royal time schedule, as it was to have finished at 10:45, but ran till 11:20, thus upsetting the police and Buckingham Palace service arrangements. Gillespie made earnest and pathetic appeals to all and sundry in the program to run to time, but some of the artistes overran most badly, seemingly not caring what happened to their colleagues in the show or whether they killed any chance of a repeat show in after years. The first Royal Command at the Palace Theater in July, 1911, also had its upsets. It was held on a Monday night, but on the preceding Sunday a full-dress show was given "as at night", and the State Chamberlain and Palace officials and all concerned were present to an invitation house. The hits of the show were Harry Tate, in *Motoring*; Pipifax and Paulo, and George Robey in a single act. Maurice Volny, now of the stage department in the Stoll Tour, directed the program, and it ran within five minutes of schedule. Charles Aldrich also was in this show, likewise Cissie Loftus. It had been said that the Queen objected to male impersonators; nevertheless, our one and only Vesta Tilley (*Lady de France*) appeared and received a remarkable reception from all parts of the house. It was, however, noted by all and sundry that her turn seemed to be the cue given by the Queen for a very keen scrutiny of the audience and the house decorations, and that their attention to the stage or their giving of applause to the act was noticeable by its absence, and

the court followed suit. The show was to have finished with eccentric dances given by Freddy Farren and Ida Crispi, with their famous exit rolled up in the stage carpet as a laughing curtain. At the rehearsal the stage officials insisted that this part be cut out, but rather than that, Freddy cut himself right out of the performance. That's how apprehensive are the state officials. The curious thing about all this, tho, was that Freddy and Ida gave their full show, with carpet exit, 15 days after, before the King and Queen at Lord Derby's house party at Liverpool. Funny, isn't it?

Future of British Vaudeville

The cinema. Yes, siree; we must follow the example of America and cultivate the cinema as the only possible salvation for British vaude, artistes. Gillespie, Gulliver, Payne, Broadhead and the other tours seem by their continued neglect of vaudeville to have quit. There is the dawn on a new era in the knowledge that one of the biggest circuits of pictures here, the Provincial Cinematograph Theaters, is preparing to operate most of its houses with vaude acts. Some assert the circuit will be able to give work in 70 cinema houses. The P. C. T. people are actively doing effective propaganda work by injecting vaude acts on Friday nights into many houses, and the audiences are asking for more. So far they have tried this Friday night stunt in about 17 houses, thus finding work for more than 50 acts, and they have about six houses playing full weeks. They are using the V. A. F. Award contract, but the question has arisen as to the V. A. F.'s attitude toward "split-weeks." This has never been allowed in this country and the V. A. F. says it will put up a big fight against any such innovation here. The P. C. T. heads say they don't want to upset any settled conditions here, but that business is business. Accordingly the V. A. F. laid its cards on the table and told the artistes that this matter lies with themselves entirely and that if the performers just study the question there will be no necessity for any fight or upset. The cure lies in the insistence of

the V. A. F., that every act playing vaudeville in the cinema must change the act midweek so as to satisfy the repeat audience. It tells cinema men thru its official journal that they should put this condition on their contract and that they should insist that artistes obey the rule. The V. A. F. welcomes the new territory and warns all artistes to prepare for the change and that it is they who must alter as they are the newcomers to the cinema world. Further, that the artistes should be tolerant and go out of their way to overcome any shortcomings as regard stage or other inconvenience and that as the music hall managers don't care what becomes of them they should realize they can only seek their vaude, salvation in cinema. The V. A. F. points the moral that America has shown the way to vaudeville prosperity with a picture and vaudeville program and as the pictures here, many years ago, showed the way to cut into the music hall audiences that vaude managers will find that they will have to follow the cinema lead as regards catering for the millions who will prefer this kind of entertainment. Some performers have started to adapt themselves to the idea and the other night we witnessed three single acts, two men and a woman, surmount a curious obstacle. The stage in front of the screen was only two feet, nine inches deep. The acts had to dress in the manager's room and walk thru the audience to the orchestra pit. Then for their turn, to climb in front full view of the audience, a sort of monkey ladder to get to the stage, do their act and then retire backward down the same ladder as gracefully as possible. And they did it effectively and well. One was an acrobatic step dancer—and he went to it like a hero and put over a corking show. It only shows one that where there is a will there is a way, and the V. A. F. quotes this item and applauds the artiste for rising superior to the occasion. Anyway it's bound to wake up the ex-vaude, managers, otherwise their occupation and audience will have left them.

The B. B. C. and Chappell's

Chappell's, the music publishers, thru William Boosey, don't like the B. B. C., which they look upon as a deadly menace to the concert platform. But the irony of the thing is that without Chappell's and their famous pianos B. B. C. would suffer as regards the tone of their broadcasting. A contract recently was signed whereby Chappell's will supply the 21 B. B. C.'s broadcasting stations with one of their "grand" pianos. So Chappell's Queens Hall concert artistes cannot sing for the B. B. C., yet the B. B. C. must have Chappell's "grand" pianos. The this singing section of Chappell's has been on the outs with the B. B. C., the technical department of the piano side has been experimenting with the Marconi House people for advice on the problem of reproduction. The fact that Chappell's have had great experience with the making of gramophone records helped them immensely in this new venture as some of the problems were identical with those overcome with their gramophone troubles. It is sometimes thought that there is a trick in preparing pianos for this class of work, but Chappell's assert that their pianos for broadcasting and recording are identical with those of their make used in concert halls and musical colleges thru England. The secret lies in the class of timber used, the length of time it has been stored, the process of drying and the sealing of the instrument—that is, the determination of the length of the string and the weight and tension of the string.

Theatrical Notes

(Continued from page 40)

way before giving up the present one in Sturgis, Mich. The action may leave the city without a theater for several months until the New Strand or the Capitol can be completed.

Alex. A. Aarons and Vinton Freedley, producers of *Lady Be Good*, are negotiating for the lease of one of the four theaters to be erected on the site of the old ear-barn block between 50th and 51st streets, New York.

W. E. Pickett, a salesman from the Dallas (Tex.) branch of Famous Players-Lasky Corporation, has been appointed branch manager of the San Antonio office, succeeding George Blackburn, who resigned.

The New Orleans commission council has refused a permit to L. H. Yarritt for the erection of a cinema theater at Philip and Baronne streets, in which \$65,000 would be invested, claiming that the zoning laws of the city would be violated thereby.

The Genesee Theatrical Enterprises, Inc., of Olean, N. Y., has leased the Majestic Theater, Rochester, N. Y. It is understood the new operator plans to enlarge the theater and make other improvements in the property.

It is reported that negotiations are under way at Dallas, Tex., whereby Albert E. Fair will purchase the Chrel Theater in that city. C. N. Hilton, president of the Beaux Arts Amusement Company, which owns the Chrel, has not discussed the sale, but admits such a deal is now pending. The possible sale will not make any change in the policy of the house whereby road shows of Broadway successes will be offered.

MOTION PICTURES

EDITED BY ARTHUR W. EDDY COMMUNICATIONS TO NEW YORK OFFICE

No Change in Warners' Policy Is Contemplated

Head of Producing and Distributing Firm Denies Report of Withdrawal From M. P. P. D. A.

New York, Feb. 21.—There is no truth in the rumor to the effect that Warner Brothers are to withdraw from the M. P. P. D. A. according to a statement made by Harry M. Warner, president of the company. Prior to leaving New York on his return to the Coast Mr. Warner said thru the company press department: "Please state emphatically for me that Warner Brothers have made no alterations with any distributing company, nor are we considering making any connection with any other company."

In connection with the Hays group the statement makes the following reference: "There is a number of things now functioning under the Hays organization that should be and can be remedied for the benefit of all parties concerned, and these we will assist upon. In plain language we want everyone to make a living and we insist on being let alone to make a living for ourselves without anyone telling us what to do or how to do it. This is the policy to which we are dedicated and that is the policy we shall carry on. We shall remain in the Hays organization, but that does not preclude us from the privilege of thinking for ourselves."

Regarding producer ownership of theaters, the statement has this to say: "Right here I want to say something about Warner Brothers building their own theaters, about which there has been considerable talk and comment. Let us make it plain that we do not intend to have anything to do with any theater building plan that will interfere in the slightest with any exhibitor making a living."

"Ben Hur" on Coast

Hollywood, Calif., Feb. 21.—Ben Hur, which Fred Nido started in Rome, Italy, for Metro-Goldwyn, is being completed at the company's Hollywood studios. Players whose work in the picture is not finished include Raymond Navarro, May McAvoy, Kathleen Key, Carmel Myers and Claire McDowell. Frank Currier, who completed his work while production was going on at Rome, is now working in Joseph von Sternberg's *Ishtar*.

The Metro-Goldwyn press department is going to some trouble to make it clear that unsettled conditions in Italy had nothing to do with the return of the *Ben Hur* contingent. Nido is quoted as stating that "it is quite untrue that our difficulties in taking this picture were due to either the Italian labor question or the presence of the Fascists. The Fascists, aside from causing us any difficulty, rendered us every possible aid, and the Crown Prince of Italy was present at the taking of some of our scenes."

Embarrassing Patrons

New York, Feb. 21.—The Astor Theater, now playing *The Lost World*, is following the "quick sale" program gag to embarrass its patrons. At the door you are handed a coupon which the average person, in the hurry of entrance, accepts, assuming that it is free. However, a voice conveys the information that the price is 25 cents for a program which not only furnishes some fairly interesting reading but is calculated to bring other customers into the show. Rather than appear a dud, most people dig deep and produce the necessary "two bits". Admittedly the practice is legitimate, but it is leaving a bad taste in many mouths.

Metro-Goldwyn Dividend

New York, Feb. 21.—Announcement has been made that the board of directors of Metro-Goldwyn Pictures Corporation has declared a quarterly dividend of one and three-quarters per cent on the preferred stock of the company, payable March 14 to stockholders on record at the close of business February 28, this year.

Wants Religious Movies

Des Moines, Ia., Feb. 21.—Religious movies, as well as religious songs and plays, should replace the accepted Sunday evening sermon, according to Carl E. Seashore, dean of the graduate school and professor of practical psychology of the Iowa University at Grinnell.

MARTHA MADISON



Color actress, who pleased in *Bebe Daniels' "Miss Bluebeard"*, and who has been working in *"The Necessary Evil"*, First National production, being made at New York. Miss Madison also is appearing in *"My Son"*, the play at the Imperial Theater, New York.

Wage Super-Feature Battle on Broadway

New York, Feb. 21.—The battle of the super-feature is now in full swing in Broadway picture houses. Sunday night *Quo Vadis* made its bow at the Apollo in West 42d street, joining the other new-comers, *The Lost World*, playing at the Astor, and *The Man Without a Country*, Central Theater attraction. Veteran productions on the street this week are *Romola* at the Cohan, *The Iron Horse* at the Lyric and *The Ten Commandments* at the Criterion—a total of six super-features participating in the engagement.

February 23 will note the departure of *The Ten Commandments* from the Criterion screen to make room for *The Miracle of the Waters*. The house will be dark on the previous day and Monday night there will be a special invitation showing under the auspices of the American committee of the Societe Francaise d'Editions de Romans Filmes, the screening starting at 8:30 o'clock. It is said that the picture was permitted to displace the elaborate De Mille production owing to a desire to co-operate with the French government in appreciation of favors rendered American producers working in France. When *The Ten Commandments* retires it will have run for 62 consecutive weeks on Broadway.

Box-office receipts were hoisted upward last week by Lincoln's Birthday Thursday. The feature of the seven-day period was the showing of *Charley's Aunt* at the Colony, the picture breaking the house record for the first and second days as well as the entire week. More than \$50,000 was the take. In shattering the house record it was necessary to exceed *Boyz*, Fairbanks' *Thief of Bagdad*.

Principal flops of the week were *Pampered Youth*, playing at the Rialto, and *Chu Chin Chow*, seen at the Piccadilly. At the former house the feature drew less than \$15,000 and the Piccadilly box office got less than \$14,000.

Crowds flocked to the Capitol to see *The Great Divide*, which topped business along the street with nearly \$62,000. The reviews were both pro and con. Apparently the familiar title and the normal popularity of the house saved the day or, more accurately, the week. At the Astor matinee business was especially gratifying. *The Lost World*, securing about \$15,415 for its initial week. Newspaper notices were almost unanimously favorable. *The Man Without a Country*, entertaining at the Central, opened Wednesday and had a take of just under \$7,000. This week business was reported as showing a substantial improvement. Press observations were complimentary for the most part.

At the Strand Milton Sills' *As Men Desire*, receiving fair press recommendations, registered an unusually big week, with the finish showing \$33,460. *Comin' Thru*, the Tommy Melghan picture displayed at the Rivoli, drew less than \$24,000. The general tone of the criticisms was unfavorable or lukewarm.

15 Film Censor Bills In State Legislatures

Observers Believe There Is Little Chance of Abolishing New York State Board

New York, Feb. 21.—Approximately 15 motion picture censorship measures have been submitted to State Legislatures now in session thruout the country. The situation in New York State, which is the focus of theatrical interest, has developed very discouragingly for the anti-censorship contingent. Observers at Albany report that, altho Governor Smith urged the abolition of the law in his annual message to the assembly, the chances are that he will not strongly work to carry out his recommendation. Rather than try to push his plan thru in the face of the Republican threat to introduce a measure similar to the Davison "Padlock" Bill, he is expected to appoint two Democrats to the present board and let the matter go at that.

In Oklahoma it is reported that the censorship bill is showing surprising strength. The act provides for the appointment of three censors. As originally drafted, the measure charges a fee for each film reviewed, the money to pay the upkeep of the censorship board.

Kansas City women are mobilizing to fight against the proposed legislation to abolish the board of motion picture review. In addition to 44 parent-teacher circles in the city, the clubs affiliated with the Council of Clubs, an organization representative of hundreds of Kansas City women, will co-operate in the movement against the measure.

The Oregon Legislature has under consideration House Bill 469, which provides for the appointment of three censors at a salary of \$2,400 annually each. They, in turn, would name viewers whose compensation could not exceed \$1,000 each per year. A dollar per reel would be charged provided the reels do not exceed 1,000 feet in length. Fines ranging from \$500 to \$1,500 or imprisonment of from one month to one year would be imposed upon persons showing unapproved films.

Indiana exhibitors are facing another "blue Sunday" bill, under the provisions of which it might be possible to close on Sundays some of the movie houses and theaters now operating. From Rhode Island comes a report that the introduction of a measure legalizing Sunday motion pictures is expected to receive Republican support in the Legislature. Altho Sunday movies are not displayed in Providence and Pawtucket, the two largest cities of the State, many of the smaller places have this form of entertainment.

At present there are motion picture censorship laws in New York, Kansas, Pennsylvania, Maryland, Virginia and Ohio.

Sees Movies as Text Book

New York, Feb. 21.—Thomas Edison prophesies in an interview in the current issues of *Collier's* that in 10 years movies will succeed text books as a medium of teaching. The inventor states: "I believe that in the next 10 years visual education, the imparting of exact information thru the motion picture camera, will be a matter of course in all our schools. The printed lesson will be largely supplemental, not paramount."

Expect 1,500 Delegates

Milwaukee, Feb. 20.—Indications are that 1,500 persons will attend the annual convention of the M. P. T. O. A. here May 11-13. Two large halls in the Municipal Auditorium and several smaller halls and exhibition spaces have been engaged. National headquarters will be located in the Gold Room of the Wisconsin Hotel.

Gloria Recovers

New York, Feb. 21.—After undergoing an operation, necessitated by a fall from a horse during the filming of the final scene of *Mme. Sans-Gene* in France, Gloria Swanson is improved. She was due to arrive February 18. Her two children, called on the France that day, but her husband, Marquis de la Falaise de la Courdray, remained.

Fewer Chicago Movies

At present there are 324 motion picture houses in Chicago, according to trade journal figuring. Their total seating capacity is 249,900. The figures show a decrease, as in 1921 there were 385.

New Films on Broadway

Week of March 1

- Capitol—*Lady of the Night*, Metro-Goldwyn, starring Norma Shearer.
- Rialto—*Confession*, Paramount, with Lois Wilson and Raymond M. Kell.
- Rivoli—*The Thundering Herd*, Paramount, featuring Jack Holt and Lewis Wilson.
- Strand—Indefinite.
- Piccadilly—*On Thin Ice*, Warner Brothers, featuring Edith Roberts and Tom Moore.
- Central—*Men Without a Country*, Fox, with Edward Hearn and Pauline Starke.
- Broadway—Indefinite.
- Cameo—Indefinite.
- Colony—*Charley's Aunt*, Producers' Distributing Corporation, featuring Syd Chaplin.
- Astor—*The Lost World*, First National, with Wallace Berry, Lewis Stone, Lloyd Hughes and Bonnie Low.
- Apollo—*Quo Vadis*, First National, starring Emil Jannings.
- Criterion—*Miracle of the Waters*, Societe Francaise de Romans Filmes.

Film Exploitation

A box-office kink was registered in behalf of *Good* recently when it ran at the State Theater, New Bedford, Mass. by the use of a perambulating book, three feet by five, suitably inscribed. Phil Kahn supplemented this feat by running a crossword puzzle, including good publicity for the film, in three New Bedford newspapers.

Local interest was concentrated on *Sandra* when it played at the Palace Theater, San Antonio, Tex., recently, thru the appearance of a masked dancer in the prolog. Announcement was made that she was a San Antonio girl and the mask was not removed until the last night of the run when the largest crowd of the week assembled to learn who she was.

Exploitation for *Peter Pan* was obtained for the American Theater, Bellingham, Wash., prior to the screening of the picture thru an essay contest on Peter, each theme being exactly 100 words in length. Twenty storekeepers were each given five words on cards and participants in the contest had to inspect their windows, list the words and use them exclusively in writing their essays.

In connection with a visit of *The Snob* at the Grand Opera House, Canton, O., a man appeared on the streets wearing full dress, an innershirt, opera hat, white gloves and carrying a cane. The words "The Snob" were printed in heavy black letters on his shirt bosom, underneath being the caption "At Grand Tomorrow". A small electric light bulb, worn as a shirt stud, furnished the necessary illumination.

When *Excuse Me* recently held forth at the Madison Theater, Peoria, Ill., a well-dressed man made it a practice to bump into people on the street, inevitably saying "Excuse Me" and handing them a card on which the forthcoming engagement of this Metro-Goldwyn picture was announced.

At the Palace Theater, Hartford, Conn., a Marion Davies doll was given as first prize for the best 100-word opinion of *Jonice Meredith*, submitted by any patron of the house. Boy and girl scouts held a parade on the day of the opening and attended a special performance.

Especially elaborate paintings of scenes in *The Man Without a Country*, are being displayed in the lobby of the Central Theater, New York, where the picture is being shown for an indefinite period.

B. P. Schulberg Plans

New York, Feb. 21.—Eighteen releases are planned by Schulberg productions for next season. Announcement is made of 14 of the titles, which are as follows: *Shenandoah*, *Parisian Love*, *Homes and Women*, *Exclusive Rights*, *Low Tuler's Wives*, *The Aristocrat*, *The Worst Woman*, *Open That Door*, *The Romance of a Million Dollars*, *Shoppers*, *Eden's Fruits*, *The Girl Who Wouldn't Work*, *Dancing Days* and *The Other Woman's Story*. Gasnier, James P. Hogan and Frank O'Connor will handle the direction of these productions, in addition to a fourth director who will soon be affiliated with the organization.

Universal Signs Hunter

Gleni Hunter, who starred in the recently closed *Merton of the Movies*, has been engaged by the Universal Studios in the East to star in *Once a Peddler*, by Hugh McNair Kehlar.

REVIEWS

By EDDY

"The Lost World"

First National

The brontosaurus, allosaurus, pterodactyl, trachodon and other monster creatures with unpronounceable names pass in fascinating review in *The Lost World*, First National's extraordinary film. What matters if the story is partly commonplace when a picture parades reincarnations of prehistoric animals? To watch them do their stuffs and especially thru trick photography, observe the brontosaurus ramble thru the streets of London, is decidedly worth the price of admission alone. *The Lost World* will capture the focus of any audience and give it something to talk about.

The story is poor and is poorly handled but you must consider the fact that *The Lost World* is obviously intended as a display of photographic skill. Professor Challenger is jeered at when he returns to London with a tale of prehistoric dinosaurs existing in the 20th century. With a band of intrepid people, including Paula White, who is searching for her father, he returns to the untraveled land in South America. They succeed in reaching the plateau on which roam out-of-date creatures of immense proportions, but one of the animals playfully destroys their tree-bridge, thus removing their avenue of retreat. While stranded they witness battles between various monsters, the effects being impressively realistic, and also locate the skeleton of Paula's father.

More praise for the camera man is necessitated by the scenes in which an erupting volcano drives the mammoth beasts into a panic which jeopardizes the lives of the scientists. The party escapes from the plateau when Paula's pet monkey climbs to their assistance with a rope ladder. A wounded brontosaurus is brought back to London as a means of verification of the party's unbelievable story but he escapes just as he is about to be exhibited and, crashing down a few buildings and part of London Bridge, goes off swimming in the Thames.

Wallace Beery as the irritable professor who heads the party, Lewis Stone as Sir John Roxton, the disappointed lover, and Bessie Love, the girl of the story, are all satisfactory. As much cannot be said of Lloyd Hughes. It isn't altogether his fault as he is the victim of circumstances which have him make love coolly under hot situations and do other absurd things. Bull Montana is ludicrous but not convincing as the ape-man. Others in the cast are: Arthur Hoyt, Margaret McWade, Finch Smith, Jules Cowles, George Bunny, Charles Welsley and Alma Bennett. Earl Hudson directed the film, which is 9,824 feet in length.

"The Top of the World"

Paramount

Another of Paramount's "famous forty," *The Top of the World*, isn't anything exceptional, but it is tolerably good entertainment. Under the influence of the splendid work of James Kirkwood and Anna Q. Nilsson the picture contrives to get beyond the conventional story of South Africa and fades out after a weakly dramatic flood scene. Audiences that stick it out during the first part of the tale will enjoy the latter half.

Under George Melford's direction the picture serves notice that Sylvia Ingleton runs away to South Africa to marry a former sweetheart, her action being prompted by the disagreeable attitude of her foster-mother and the prospects of marriage with a wealthy English fop. At her destination she finds that Guy Bangor has lost his hold on life and has become a drunkard and dope fiend. She is sheltered by his cousin, Burke Bangor, who induces her to marry him on a business partnership basis.

After marrying Burke she is again brought into association with Guy when he becomes ill and takes up his residence at the sugar plantation. One night her husband is called to a neighboring farm and Guy, with a creepy-appearing doctor, Sam Kieff, steals his cousin's savings. When Sylvia discovers the theft she follows him to a village where he is making a "killing" at the gambling tables. Her husband finds her in Guy's hotel room and accuses her of eloping with him but she convinces Burke of her true purpose.

They return to the plantation. Guy, back with his ill-gotten gains, tries to persuade the girl to go away with him. Outside Burke is working with his kaffirs to save the farm from a flood, which is roaring down the valley. He enters the house and misconstrues the scene between Sylvia and Guy. His wife begs him not to kill his cousin and so, by way of disposing of the matter, he puts both Guy and Sylvia on a horse and sends them out into the storm. Verifying her love, the girl struggles back to Burke and altho their property is swept away by the flood they manage to come thru alive and discover happiness at the top of the world.

By the dual role of Burke and Guy, James Kirkwood is earnest and convincing, there being nothing lacking in his interpretation. Anna Q. Nilsson registers

THE ARCUS TICKET CO.
 348 N. ASHLAND AVE., CHICAGO, ILL.
ROLL RESERVED (COUPON) FOLDED
FOOTBALL TICKETS CARNIVAL
DIAGRAM AND ADVANCE SALE RACKS
28 YEARS EXPERIENCE AT YOUR SERVICE
BEST FOR THE LEAST MONEY - QUICKEST DELIVERY - CORRECTNESS GUARANTEED

effectively as Sylvia. Sheldon Lewis is ever a vicious heavy on the screen and he has no trouble in making the doctor the sort of a man you'd appreciate kicking. Other players are: Raymond Hatton, Charles A. Post, Joseph Kilgour, Mary Mersch, Mabel Van Buren, Frank Jonasson and Lorhner Johnston. Footage, 7,167.

"Man Without a Country"

Fox

A series of poignant episodes concerning the life of Lieutenant Nolan, after he had gained something of immortality by damning the United States at his court-martial, is the content of *The Man Without a Country*. Fox's version of the often-told story of Dr. Edward Everett Hale is a striking piece of cinema. One of the best pictures which that company has turned out in a long, long period, it is enhanced by an intensely interesting theme, expert acting except in one instance and competent direction by Rowland Lee.

Prefacing the opening of the main story are several scenes indicating the unsettled conditions existing in the country during the post-Revolution days. They are not essential to the tale but are at least entertaining. The action really gets under way when Aaron Burr, former Vice-President and dreamer of an empire in the West, meets young Philip Nolan, recently promoted to lieutenant in the U. S. Army. The officer, impetuous and headstrong, falls a victim to Burr's vivid prophecy of a great nation and decides to join the enterprise. Just as he is about to tender his resignation an order arrives from the President providing for the arrest of persons affiliated with the movement. Brought into a court-martial he loses his temper and cries: "Damn the United States. I wish I may never hear of the United States again." This severely shocks the patriotic old officers and consequently the verdict is that his expressed desire will be enforced.

Leaving behind his mother and his sweetheart, Anne Bissell, Nolan is taken on board the U. S. naval vessel *Essex* and never again touches foot on the soil he later comes to love with all his heart. The remainder of the picture is devoted to illustrations of his suffering because of the edict which prevents him hearing anything about his country. His courage is exemplified in an effective storm scene and again in an engagement with pirates, the battle shots containing splendid detail work. Comedy relief comes from an old sailor who serves Nolan.

Ever faithful, the exile's sweetheart devotes her life to efforts to free him and finally, when old age has visited them, secures the long-sought pardon from Abraham Lincoln. A special messenger brings the news to Nolan as his ship is at anchor in a foreign port. But he is not destined to have another earthly meeting with his lover. As the vessel sails into an American harbor he dies and Anne, waiting on the wharf, also passes away. Their spirits are united.

Edward Hearn makes the screen Lieutenant Nolan remarkably sincere and human. As his sweetheart Pauline Starke scores another triumph, playing the role disconcertingly. Lucy Beaumont, cast as Nolan's mother, is the only weak member of the company. She is a typical "sob picture" mother. Other players are: Richard Tully, Eric McCall, Edward Coven, Wilfred Lucas, Francis Powers, Harvey Clark (who is clever as the comic sailor), William Walling, Edward Piel, Edward Martindel, William Conklin, Albert Hart, Emmett King, George Billings, Pauline Neff and Fred Becker.

"The Monster"

Metro-Goldwyn

On the legitimate Crane Wilbur's *The Monster* was a hurr-raiser, but on the screen it appears as a jazzy melodrama, with thrills subordinated to laughs. Metro-Goldwyn's interpretation is a splendid evening's entertainment. There is only a lone bit of acting of serious character in the production, that being effectively earned by Lon Chaney, cast as the maniac who rules the sanitarium. Altho the part does not keep Chaney's face on the screen very long, it serves to substantiate his reputation.

Roband West's direction is about 99 per cent lokum. It includes the usual comic country store with its comic clerk who has qualified for scolding thru a correspondence school course, the village sheik with his mail-order evening clothes and the spooky house with its sliding

panels and weird happenings. The only new prop in the drama is an electric chair which is used with telling comedy rather than tragedy, except at the conclusion of the film.

If you are interested in the plot, be informed that a group of maniacs, headed by Dr. Ziska, overpowers the superintendent and attaches of a sanitarium. The alleged surgeon desires to experiment on the human body and so starts a collection of unfortunate victims. Betty Watson and the town sheik fall into the madman's trap and the correspondence school marvel suffers a similar fate. Their experiences in the sanitarium are weird, as might be expected. Matters end when the two young chaps, distinctly comedy types, gain supremacy of the situation just when the doc is about to carve Betty. Dr. Ziska has a bad ending in the electric chair when his faithful servant, also cucks, switches on the current while under the impression that someone else is occupying the unpopular seat. The graduate detective's heroism wins him the girl.

The only women in the cast, Gertrude Olmsted, does all that is expected of her. Johnny Arthur is sufficiently snappy as the sleuth with a diploma, and Hallam Cooley fills the bill as his opponent in love and fellow-sufferer in the spooky house. The cast also includes Charles A. Sellon, Walter James, Knut Erickson, George Austin, Edward McQuade and Ethel Wales.

The Monster, despite its menacing name, is a good picture for any house.

"The Man in Blue"

Universal-Jewel

Herbert Rawlinson portrays a cop, apparently the social star of the force in Little Italy. In *The Man in Blue*, made by Universal-Jewel, he devotes most of his duties to entertaining kiddies and talking to Tita Sartori, flower girl. Also he smiles, displaying those engaging dimples, and looks fairly handsome, but that's all.

The Man in Blue may have been intended as a box-office attraction, but it was a case of inaccurate figuring. The plot is incoherent and meaningless for several reels. About the most complimentary thing I can say in connection with the film is that the scenes are laid with considerable attention to detail and that some of the players are real Italian types.

Tita's father meets with a fatal "accident", planned by the district Italian political boss, who then takes the girl to his home with a view of making her his spouse. One day she escapes, but returns when she gets the impression that the big-hearted Irish policeman whom she loves is married. But, as a matter of fact, Tom Conlin is not married, as his wife died, leaving him two children.

The wicked boss arranges a banquet to precede his wedding, but things are upset when a young chap, said to be feeble-minded, but nevertheless loves Tita, learns of the schedule. He opens a fight. The girl flees to a nearby restaurant and seeks the protection of an old friend of her late father. The villain pursues, flanked by his henchmen, properly known as thugs. What follows mingles up the restaurant, kills the boss and unites Tita and Tom.

Repetition of scenes in which Tita escapes from the boss's house by sliding down a bed spread assists in the monotony. Tom Conlin gives the idea that his desire to marry the girl is not solely because of love, but because he wants a mother for his two little tots. There are a number of positively unnecessary scenes which ought to be clipped. None of the characters are clearly delineated.

Madge Bellamy appears as Tita and others in the cast are Niek de Ruiz, Andre de Berger, Cesar Gravina, Harry Mann, Jackie Morgan, Dorothy Brock, D. J. Mitsoras, Carrie Clark Ward, C. P. Roark, Albert Frisco and Martha Mattox. The picture is based on Gerald Beaumont's story, *The Flower of Napoli*. Direction of the film, which has a footage of 5,334, is by Edward Laemmle.

"Her Husband's Secret"

First National

A moderately good picture is *Her Husband's Secret*, which Frank Lloyd directed for First National. At times it shows symptoms of lagging, but nevertheless it manages to keep its head above water, which is quiet to a monotonous degree. High-caliber photography, including superb night shots, greatly enhance the interest of the film. *Her Husband's Secret* has a fair amount of that mysterious atmosphere known as "box-office appeal".

The story, adapted from May Edging-

ton's *Saturday Evening Post* tale called *Judgment*, tells of Leon Kent's break with his wife and his subsequent leaving home when he discovers her talking with a wealthy banker and widower, Ross Brewster, who sympathizes with her. In dissolving his home ties Kent takes his little son. Twenty-five years elapse. Judy, daughter of the banker, returns home from a vacation with the news that she is engaged. Her fiancé, Elliott Owen, arrives the next day for "inspection." Brewster recognizes him as a crooked broker. Owen, informing him that he has already married Judy, demands his assistance in getting out of a fraudulent investment jam. Furthermore, he advises the banker he is the long-missing son of Mrs. Kent.

Brewster proposes that the young man save his mother and Judy pain by jumping off the cliffs and into the Atlantic Ocean. The plan does not appeal to Owen. Judy comes along and springs the news that she is soon to become a mother. When she leaves Owen tries the recommended course in suicide, but is not killed. Brewster, admiring the boy's real mettle and new-born consideration for other people, helps him to keep out of jail and permits him to retain Judy as his wife.

Like the other reviewers nearby, I was irritated to find that Owen was completely repaired after his leap from the cliff. Under anything but movie circumstances the fall was sufficiently long and hard to kill a hard-boiled army mule, not to mention a mere man. But picture etiquette demands a living hero at the finale of every production. I also wonder why Judy waits until her father and Owen are in conference on the lawn before informing her husband that he is destined to become a father. When they were alone previously, the time would have been more appropriate, methinks.

Judy Brewster is played by Patsy Ruth Miller and Antonio Moreno plays Elliott Owen. The following also do well: Ruth Clifford, David Torrence, Walter McGrall, Phyllis Haver, Pauline Neff, Margaret Fleiding, Edwards Davis, Frank Coffyn, Fred Warren, Frankie Darro, Lou Salter, Harry Lonsdale and Frances Teague.

The picture measures 6,151 feet.

"The Cloud Rider"

F. B. O.

Genuinely dare-devil airplane stunts keep *The Cloud Rider*, F. B. O. production starring Al Wilson, above the average film which comes under this classification. The acting is hardly good enough to win praise but the film is entertaining without paying any attention to that phase.

Solely for the purpose of staging thrills the story opens with the villain's sweetheart, supposed to be in love with Bruce Torrence, champion aviator, stealing a ride in his plane. Her life becomes endangered when the skyship loses a wheel. Al chases after her in another airplane, transfers onto her ship in a hair-raising scene and then puts on a substitute wheel.

The main theme of the drama relates to the activities of drugsmugglers and the efforts of Al Wilson, who is a Secret Service man, in locating them. Against his instructions Blythe Wingate hides in his machine and figures in the wreck which follows. Together they chance upon the smugglers' headquarters and are captured. The villain takes the girl away in his airplane and Al, escaping, pursues him until the anticipated arrest is made.

Shots in high altitudes were not faked, according to the F. B. O. publicity department. Playing opposite Wilson is Virginia Lee Corbin. She is attractive but has a tendency to make her part too childish. Other players are: Harry Von Meter, Helen Ferguson, Frank Rice, Melbourne MacDowell and Brinsley Shaw. *The Cloud Rider*, is a good program picture. Bruce Mitchell directed it.

"Quo Vadis"

First National

Quo Vadis, as produced by Unione Cinematografica Italiana for distribution by First National, is much more than a series of bewildering mob scenes and imposing sets. It retells graphically and with unforgettable power the tale of Nero, his persecution of the Christians and his death. But without the superb characterization of Emil Jannings the film would probably rate a place beside the average foreign-made spectacle. All the principals are excellently suited to their roles.

Jannings portrays Nero as sensual, childish, brutal and utterly detestable in other ways. Especially is he vain of his ability to sing and this vanity is exploited by Petronius, cynic and court jester of fashion who knows that flattery is a poignant mistress of the emperor. Andree Haby is suave and understanding as Petronius, who philosophically orders his own death with his sweetheart when disaster impends.

Nero is the fawning center of a licentious court. Vinicius, one of his generals in special favor at the opening of the story, becomes enamored of a beautiful hostage, Lucia, and this accounts for the principal love theme of the spectacle. The

(Continued on page 56)

Film Shorts

Victor Hugh Halperin has completed direction of *School for Wives*, starring Conway Tearle. The picture, made at Tec-Art Studios, New York, will be released thru Vitagraph.

The company, which has been making *White Mice*, screen version of Richard Harding Davis' story, has gone to Havana to shoot exteriors. E. H. Griffith holding the megaphone. Featured in the cast are Jacqueline Logan and David Powell. The players have been working at Fort Lee. Included in the cast is George Neville, famous as the broad-mouthed village constable in *Way Down East*.

Helen Holmes will return to the serial game in a series of J. P. McGowan features to be made at the California Studios, Hollywood.

Ralph Spence will write the scripts for Chadwick's next series of George Walsh pictures and will edit and title them.

Edward Burns will occupy the leading male role in *The Manicure Girl*, which Frank Tuttle will direct for Paramount at its Long Island studios. Bebe Daniels is the star.

Under Rex Ingram's direction *Mare Nostrum* is being filmed in France and Spain for Metro-Goldwyn. Except for the leading players, Antonio Moreno and Alice Terry, the cast is composed of foreign players.

Century is producing a burlesque on *Uncle Tom's Cabin* which will be known as *Uncle Tom's Gal*. Edna Marian is the star and will be supported by Larry Richardson and Les Bates. William Watson is the director.

Rin-Tin-Tin's next picture will be *Below the Line*, a Warner Brothers production.

Great Nissen, who successfully appeared in the stage version of *Beggar on Horseback*, will have a leading role in a Paramount picture, *In the Name of Love*, which will be filmed at Hollywood.

Henry King is to make two specials for Ritz-Carlton Pictures. He will start production upon completion of a film he is now making for Robert Kane, which will be released thru Paramount.

King Baggott has been assigned the job of directing Virginia Valli's next starring vehicle, *Peacock Feathers*, adapted from Temple Bailey's novel.

She Wolves, to be made for Fox, will have Alma Rubens in the lead, assisted by Jack Mulhall. It was known on the legitimate stage as *The Man in Evening Clothes*.

Mac Marsh will head the cast of *In the Garden of Charity*, which J. Stuart Blackton will produce. Other players will be Earl Schenck, Ivor McFadden, Thomas Mills, Laska Winters and Ben Hendricks.

Metro-Goldwyn has purchased *In His Arms*, Lynn Starling's dramatic success. Roy Del Ruth, comedy director, and John Patrick, who played recently in *The Dark Swan*, have new Warner Brothers contracts.

Proud Flesh, King Vidor production for Metro-Goldwyn, is nearing completion at Culver City. Featured in the cast are: Eleanor Boardman, Harrison Ford and Pat O'Malley.

Another new B. P. Schulberg contract possessor is Alysie Mills, who will have a feature role in the production of Zona Gale's novel, *Faint Perfume*, which will be started soon by Gasnier.

Future Sawyer-Lubin productions will be made at the Universal Studios at Fort Lee. Work has been completed on that concern's latest picture, *Heart of a Temptress*, starring Barbara LaMar and Conway Tearle.

Warner brothers stopped off in Chicago long enough to get the signature of Lowell Sherman, who was playing there in *High Stakes* on one of their contracts. He will report at the company's Coast studios at the close of the present theatrical season and will start work in his first picture early in June. Sherman will be starred in several novels which Warner Brothers have just purchased.

Roland V. Lee's next directorial job for Fox will be *Havoc*, which is to be filmed at the Coast.

A picture to be released as *Abie's Imported Bride* is in production at the Kolnic studio, Philadelphia, for Masterpiece Film Attractions, Roy Kolnic directing.

Flornore Vidor, Betty Bronson and Adolphe Menjou have been assigned to the principal roles in a forthcoming Para-



ROLL TICKETS

Five Thousand,	-	-	-	-	\$3.50
Ten Thousand,	-	-	-	-	6.00
Fifteen Thousand,	-	-	-	-	7.00
Twenty-Five Thousand,	-	-	-	-	9.00
Fifty Thousand,	-	-	-	-	12.50
One Hundred Thousand,	-	-	-	-	18.00

THE BIG TICKET AT THE SMALL PRICE

Your own Special Ticket, any color, accurately numbered, every roll guaranteed. Coupon Tickets for Prize Drawings, 5,000, 25,000. Prompt shipments. Cash with order. Get the Samples. Send diagram for Reserved Seat Coupon Tickets. State how many sets desired. Serial or dated. All tickets must conform to Government regulations and bear established price of admission and tax paid.

National Ticket Co., - Shamokin, Pa.

mount picture, *Are Parents People?* Mal St. Claire will hold the megaphone.

Shirley Mason will appear in Sam Rork's new production entitled *The Talkers*.

Richard Dix's next story will be *The Shock Punch*, to be made by Paul Sloane for Paramount. Frances Howard will play opposite him.

Charlie Chaplin has retitled his new Alaskan comedy *The Lucky Strike*.

No subtitles are used after the first 1,000 feet of *Men and Women*, William de Mille's latest Paramount cinema, starring Richard Dix, which will be released in March.

Fred Thompson has started production on his new P. B. O. picture, *That Devil Quezado*, being filmed at Hollywood. He took an enforced vacation recently due to a broken leg, the fracture being sustained in leaping to the back of a stage-coach wheelhorse.

Actual camera work on Harold Lloyd's newest picture will be completed either late in April or early May. It has been in production since October 15.

Under a F. B. O. contract Dick Talmadge has commenced work on *Yellow Faces*, his supporting cast including: Kathryn McGuire, Charles Clary, Herbert Prior, Frank Elliott, Arthur Rankin, Macella Daly and Eve Morris. Art Rosson is the director.

The Iron Horse broke into political company the other night when it was viewed by the Utah State Legislature at a special session.

Clara Kimball Young's next screen vehicle is *Lying Wives*, now under construction. With Miss Young are playing: Madge Kennedy, Richard Bennett, Edna Murphy and Niles Welch.

Baby Peggy is seeing New York in company with mother and father, making the Algonquin her headquarters.

Gloria Swanson and Rod La Rocque will soon start operations in *The Coast of Folly*, which will be filmed at the Paramount Long Island studio.

Children of the Whirlwind, to be made at Whitman Bennett studio at Yonkers, will feature Lionel Barrymore, Johnnie Walker and Marguerite de la Motte.

Pola Negri, who is now working in Sidney Olcott's *The Charming* at the Paramount West Coast studios, has booked passage on the *Leviathan*, which sails March 21. She will be in Europe three weeks, devoting part of her visit to her homeland, Poland.

Richard Arlen is Jesse L. Lasky's most recent "discovery." He plays a role in *The Lady of Lyons*, soon to go into production for Paramount. Statement is made by the Famous Players-Lasky publicity department that he resembles Ronald Colman.

D. W. Griffith's final picture for United Artists will be *Poppy*, which is being made at the Paramount Long Island studio. The featured players are Carol Dempster and W. C. Fields.

A change in the plans of St. Regis Pictures provides that its next film will be *Headlines*, instead of *The Million-Dollar Doll*. Production will start at the Tec-Art Studio, New York, March 2.

Irving Cummings' next film for First National is entitled *Just a Woman*. It will be produced at Hollywood.

News Notes for Exhibitors

C. C. Griffin, formerly president of the M. P. T. O., of Northern California, has consolidated his Piedmont house with the Golden State Theater and Realty Corporation, which operates 20 theaters.

Two ward motion picture houses at Buffalo, N. Y., recently were closed temporarily until the roofs had been cleared of snow. The houses affected by the order, issued by the fire prevention bureau, were the Burnet Park and Kernan's theaters.

"Test matinees" have been introduced at the Liberty Theater, Kansas City, Mo., by Jack Stebbins, who has devoted the redecorated mezzanine balcony to this purpose. This innovation is proving a great success.

Freda Levine, manager's secretary of the M. P. T. O., of Michigan since its organization, has resigned after a service of five years.

P. M. Honecy, former owner of the Moon Theater, Tecumseh, Neb., is to engage in the real estate business in Florida, where he will locate permanently.

Jacob Richman, proprietor of the Pearl Theater, Pittsburgh, and the Best Theater, Millvale, Pa., is now operating Fred Barth's Elite Theater on the North Side in Pittsburgh. The retiring owner has been in the picture business for 15 years.

Dr. J. Victor Wilson, recently manager of the Robbins houses at Water-

town, N. Y., is in Europe on a vacation and will visit his old home in Denmark. Prior to leaving this country he was tendered a dinner at Watertown and presented with a cane and umbrella.

A price-slashing battle is in progress in Providence, R. I., among the movie houses, exhibitors stressing their low admission fees thru newspaper space.

At Springfield, Mass., the Broadway Theater is selling two tickets for the price of one between 4 and 4:30 p.m. daily, except Saturday and Sunday.

Fred DeCrotteau has resigned as manager of the Strand Theater, Dover, N. H. He formerly was located at South Berwick.

The Strand Theater at Charlotte, N. C., is planning the production of a film, *What You Should Know About Charlotte*.

Stevenson Theaters, Inc., of North Carolina have organized as follows: President, W. D. Burwell, Henderson; vice-president, Roy P. Rosser, Raleigh; secretary, treasurer and general manager, S. S. Stevenson. George E. Stevenson is resident manager of the corporation's new Cameo Theater at Rocky Mount.

V. A. Peterson, formerly of the Mission, Georgetown, Wash., is now operating the Ruston Theater in Tacoma.

The Franklin Theater at Oakland, Calif., now under the management of Eugene L. Perry for Ackerman & Harris, has been redecorated. The projection room has been enlarged and new equipment installed. A \$25,000 organ has been placed in the house.

The Rosemary Theater is the newest movie house at Ocean Park, near Los Angeles.

REVIEWS

(Continued from page 55)

emperor also takes notice of the girl but his empress obstructs his plans.

Soon afterwards events transpire which lead to Nero's downfall. Desiring inspiration to write an epic which will outglory Homer's tale of the destruction of Troy, he secretly has started a conflagration which destroys Rome. When the mob demands that he turn over to it the responsible party he accuses the worshippers of Christ of the crime and they are seized to await torture and death. Later, before thousands of Roman citizenry, they are killed by lions in the Circus Maximus. Other martyrs are fastened to the rear of chariots and are dragged to their death during a race, while still others are made human torches. Some of the scenes are almost revolting in their realism. Nero's day is fast drawing to a close. Citizens in provinces outside of the Eternal City rise in revolt and an army marches upon Rome. Vinicius heads one unit of angered citizens and Nero is forced to flee for his life. Overtaken in the country he musters up enough courage, with the urging of a hermit, to take his own life, thus dying with some semblance of the bravery that becomes an emperor of Rome.

Lillian Hall Davis, a very good-looking young lady, is Lygia, and effectively so. Others in the cast are: Elena di Sangro, Elza Brink, Rina de Linuoro, Alphons Fryland, Bruto, Castellani, Gino Viotti and R. Van Niel.

Just what *Quo Vadis* will do to the box office is something of a gamble, but the betting is in favor of a happy attitude.

TABLOID REVIEWS OF SHORT SUBJECTS

"Sleeping Sickness"

Universal comedy with Hal Roach. The only thing new about the picture is the idea of ascribing a man's sleepiness to the disease named in the title. As a matter of fact he had been playing poker all night. Most of the film is devoted to his snooze in a runaway baby carriage. Real laughs are very, very infrequent.

"Great Guns"

Educational comedy, with Bobby Vernon. Bobby, as an artist, encounters considerable comic hard luck, including a gunman. All ends satisfactorily when his girl doctors one of his artistic attempts, sells it and then separates Bobby from the gunman. Not a bad comedy.

SHERIFF STOPS SHOW; MANAGER JAILED

Vero, Fla., Feb. 21.—Blue laws were enforced here February 15 when Sheriff Merritt and deputies raided the new Vero Theater and arrested manager William Atkin, Operator H. L. Motz and Ticket-Seller William Frick and lodged them in jail at Fort Pierce for operating a picture show on Sunday. The arrests were made and show closed at the middle of the picture.

Spokane Houses Are Bought

Spokane, Wash., Feb. 14.—T. H. Neal, brother of R. E. Neal, recently of Neal & Allender, has purchased an interest in the Casino and Class A moving picture houses here. The Neal Brothers now succeed the Neal & Allender management at those houses. Jack Allender is giving all his time to the Ritz, Majestic and Lyric theaters, in which he has full ownership. The five theaters were previously operated as a string in this city.

To Vote on Sunday Movies

Auburn, N. Y., Feb. 21.—A petition containing 172 names urging that Sunday movies be permitted in Waterloo has been presented to the Village Board. The proposition will be submitted to a vote March 17.

The Only Ku-Klux Klan Picture Extant, "THE TOLL OF JUSTICE" is open for booking. Address PHIL MILLER, St. Albans, West Virginia.

ST. LOUIS CALCIUM LIGHT CO.

CALCIUM LIGHT furnished in tanks for Arcetrol and Moving Picture Machines. Orders to any part of United States filled promptly. Calcium Burners, Rubbed Tubing, Condensing Lenses, Lime Pencils, Gelatin Colors. Roll Tickets for sale. 316 Elm St., St. Louis, Mo.

ROLL MACHINE FOLDED. RESERVED SEAT

TICKETS

Prices Right. On-time Delivery

REES TICKET CO.

10 Harney Street, OMAHA, NEB.

REBUILT MACHINES

They Are Like New.

POWERS—SIMPLEX—MOTIOPH

Some real bargains you cannot afford to overlook. Write for our GENUINE complete list of Machines and Supplies. MONARCH THEATRE SUPPLY CO., Dept. 5, Memphis, Tennessee.

MOTION PICTURE CAMERAS

NEW OR USED

Free Big Catalog, 48 pages, check full of Bargains. Big rebuilt Camera List. Wire or write.

BASS CAMERA CO.

Dearborn and Washington, Chicago, Ill.

GO INTO THE MOVING PICTURE BUSINESS

Small Capital Starts You

Our Catalog FREE. Show us how to earn \$25 to \$50 per day.

on our easy payment plan. Begin now and get your share. We sell everything. Write today.

Atlas Moving Picture Co. Dept. 37 538 S. Dearborn St., Chicago

Dependable "MOTSCO" Reliable

POWERS—SIMPLEX—MOTIOPH

100 GUARANTEED REBUILT MACHINES

Mazda Equipments, Used Opera Chairs, Transmitters, Compensars, Screens. Everything for the theatre. Bargain Bulletin now ready.

MOTSCO, 724 South Wabash Avenue, Chicago.

GO INTO THE MOVING PICTURE BUSINESS

EARN BIG MONEY.

NO EXPERIENCE

Professional Machine and Complete Outfit on Easy Payment.

Monarch Theatre Supply Co. 724 So. Wabash Ave., Dept. A. T., Chicago, Ill.

FEATURE FILMS FOR SALE

"Broken Shadows", 5 reels, \$10.00; "Her Greatest Performance", 5 reels, \$10.00; "Her Story", 5 reels, \$10.00; "Price Woman Pays", 6 reels, \$10.00; "The Typewriter", 5 reels, \$10.00; "Whither Thou Goest", 5 reels, \$10.00; "Sins, Where Do You Live?", 5 reels, \$10.00; "Wasted Lives", 6 reels, \$10.00. Also two-reel Comedies, \$7.50 each. Single reel "Stars at Home", \$5.00 each. All films shipped on receipt of \$5.00 deposit, balance C. O. D. Two first-class Simplex Machines for sale, complete, guaranteed in perfect order, \$100.00. Will ship on receipt of \$50.00 balance C. O. D. CHAS. STERN, Room 707, 720 7th Ave., New York, N. Y.

"Benshi", Film Interpreter. Is Jap. Exhibitor's Problem

Tokio, Japan, Feb. 20.—Among problems which confront Japanese exhibitors is that of the "benshi", who frequently can make or break a picture. He is an interpreter who gives a skeleton explanation of the plot while the picture is being screened. Without him a Japanese movie house resembles a deserted village, for the movie fans demand a vocal description in addition to the film. If the benshi likes the picture his enthusiasm generally makes it popular, but if he doesn't it's curtains for the film. As a general rule these interpreters are temperamental and insist upon due recognition of their talents as actors.

LYCEUM ~ CHAUTAUQUA ~ FESTIVAL
THE PLATFORM
 SPEAKERS ~ ENTERTAINERS ~ MUSICAL ARTISTS
 CONDUCTED BY AL FLUDE

(Communications to 35 S. Dearborn St., Chicago, Ill.)

Geneseo Chautauqua

Will Celebrate Its 20th Anniversary This Season

For each of the past 19 years Geneseo, Ill., has looked forward to the coming chautauqua season, and during most of those years the committee came out with the balance on the right side of the ledger. Last summer Geneseo was stricken with floods and there was a deficit. It looked for a time as if "finis" would be written at the bottom of the page. But the better sentiment prevailed. R. F. Goslop went there with his old-time helpfulness, and the Colt-Alber Company did its share, so this year Geneseo will celebrate its 20th anniversary with a splendid program.

Among the speakers will be Senator Ferris, of Michigan, and ex-Senator Magnus Johnson, of Minnesota. Emory Farnell will entertain, and the musical programs will be rendered by the Jugoslavians, the Singing Hussars, the Marinaphone Sextet, the Little American Opera Company and the Metropolitan Novelty Orchestra. Carlos Inskeep and his company will furnish the play. There will be other speakers, and the people of Geneseo feel that they will have one of the best programs in the history of their chautauqua.

I am glad that Geneseo is able to continue the good work. It is impossible to compute the good that has been done and the inspiration which has been given by the programs for the past 19 years. Recently it was my privilege to speak six times before students of Geneseo schools. They are among the most inspiring and intelligent I have met. They never missed a point, and were as ready with their enthusiasm as they were quick in understanding.

To take from these young people all the inspiration which comes with a chautauqua would be a calamity. There is no other entertainment feature which can take its place. Those years of chautauquas in Geneseo have been worth vastly more to that community than they have cost. There is no enterprise in a community except the schools which deserves to be made permanent more than the chautauquas.

It is a treat to go over the old programs of Geneseo and read the names of those who have brought inspiration and a determination to do better and bigger things to the young people of that community in years past. Adam Bede, Gov. Hoch, Adrian Newsom and McNutt were there in 1902. Father Cleary, whose presence was like a benediction; Senator Jas. E. Watson, of Indiana; Gabriel Maguire and the famous Chicago Male Quartet were there in 1910. Who could forget them? 1911 was rich in entertainment and art, with Smith Damon, the Cavenys, Laurant, Charlie Taggart, Wm. McCormick and his wonderful dog, Bronte. There was a program to catch the young folks. I mention only a few as it would be impossible to speak of all the great platform people who have taken part in the programs at Geneseo.

The 1912 program of inspiration had William E. Bennett, Bryan, Cook, Tahan, Flowers and Gillian for spics. Any boy or girl would be bigger and better for having listened to them. And in 1913 they enjoyed Booker T. Washington and his great message. They still talk of that event with enthusiasm in Geneseo. Then Mother Lake, Fletcher, Cope and Amsbury. They repeated some of the old favorites. What a feast it was.

Dr. John Wesley Hill, Dr. L. G. Herbert, Mand Willis and the Preachers' Quartet, in 1914, will not be forgotten. 1915 brought Dr. Hulbert, Kessinger, the Sadlers, the Apollos, the Dixies, La Pollette and the Forest Players—memories that will never be forgotten by the young folks of that time.

Senator Kenyon, Judge Bale, Miss MacLaren and Preston Bradley came in 1917, and Gov. Lowden, Roy Smith, Dr. A. W. Evans and the Boston Symphony Sextet were there in 1918. Money could not buy the inspiration brought to Geneseo by these programs if invested in any other way.

And so the story of the programs reads right down to 1925. It is a story of sacrifice by committees—sometimes unappreciated—but of wonderful inspiration and opportunity for the growing generation of Geneseo.

It is hoped that the 20 years which are now closing will have built a strong foundation for a good that will be perpetuated for generations.

Geneseo is a vastly better city on account of the self-sacrifice of those who have borne the burden of its chautauqua.

The Redpath Chautauqua will be held at Carlisle, Ky., opening July 3.

People of the Platform

"Army" Ambrose

I have received a great many clippings in regard to the work of "Army" Ambrose, the scientific demonstrator, who is lecturing for Redpath. That we may all know him a little better, I am reproducing a good writeup of his program which appeared recently in *The Advocate*, of Greenville, O.:

"Army" Ambrose made a very decided hit not only with the amazing feats he performed but by his witty line of chatter that kept the audience in a roar most of the time.

"Ambrose did some amazing feats with electrical current, such as passing hundreds of volts thru his body, lighting an alcohol torch with electricity from his finger tips, from the toes of his shoes and lastly from the tip of his tongue.

"He created home-made lightning and made a spark 18 inches long. He welded nails together while holding the instruments in his bare hands, and made an arc light in the same manner by placing sticks of carbon in the plecters he held in his bare hands. He blew soap bubbles with a gas that exploded with a bang when touched with a flame. He then performed the seemingly impossible feat of lighting a fire with water by pouring water past an alcohol torch, the water being so heavily charged with electricity that the flame was created despite the natural antipathy of flame and water. He then lighted the torch by touching it with the glass.

"He gave some sage advice to parents, counseling them to permit their boys to experiment with things and try to make things, saying that 'a boy with an old battery and a few wires is going to be too busy to think of shooting craps in a boxcar.'

"Ambrose also riddled, in a few well-chosen words, the idea that science and religion are antagonistic to each other and proved to the satisfaction of a well-pleased audience that they are closely related and that science is absolute corroboration of the truth of religion. If he should come this way again he will have an overflow crowd."

Dr. Henry Black Burns

Most of us know of Dr. Henry Black Burns, the Scotch lecturer. It would be well for us to know him better, for he is becoming one of the worth-while speakers. I have received the following little sketch in regard to him, sent by



Last spring Fred High lectured at Savanna, Ill., for the Men's Club, and while there he gathered the facts about the wonderful band of 225 boys which has made civic history in that little city. He published a story in *The Billboard* and furnished the facts for *The Rotarian*, both of which publications were largely circulated in Savanna, and these stories pleased the boys, their parents and the townspeople in general, so that the other day when Fred returned for another talk he was met at the station by more than a boys' band and a special delegation from the Rotary Club, Business Men's Organization and the Men's Club. He was escorted to the high school, where more than 100 women gathered to hear his special address to the school and to personally meet him. When the train pulled in at Savanna, and the boys' band began to play, one passenger said: "Gee, judging from the reception that is being given here one would imagine that President Coolidge is expected." Fred says: "It was just another case of Making Service Pay."

I note many favorable newspaper comments in regard to the work of Frederick Eugene Powell, magician, with the Swarthmore Chautauquas this winter. *The Beaver* (Pa.) *Times* says of him: "The choicest problems in the realm of mystery were offered and proved again that the hand is quicker than the eye. Mr. Powell brings to the platform those qualities that make of magic a beautiful

Praise for Bell Ringers

One of the six pages of an attractively worded and illustrated folder just released by the White Entertainment Bureau of Boston on the Royal Holland Bell Ringers contains endorsements from committees in New England, where the attraction recently terminated a three-months' tour, which the White people declare to be the strongest ever received by them. The sextet, better known to platformists as the P. H. Brouwer Family, offers a versatile program of rare and artistic novelties interspersed with folk songs and dances of the Netherlands. Hand bells, cymbal harp, chimes, rattles and the ocarina are among the harmony producing instruments played by the Brouwers, who appear in native dress during the course of their performance.

The Royal Holland Bell Ringers are now making their home in Cincinnati. In September they begin a 35-week route of the East, New England and Eastern Canada for the White Bureau, opening and closing in Pittsburgh, Pa.

one who is not in any way interested except in passing the information on to other committee-men:

"Dr. Henry Black Burns is known as the speaker who does not fear the truth. Born of Scotch parents on a Pennsylvania farm, and reared in a home where books were his everyday friends, Henry Black Burns received an early training which fitted him well for the work he has chosen in later life. He worked as a farm hand, lumber jack and school teacher to gain the professional education on which he has set his heart.

"These stern days built into the young lad's life the hatred of sham and the deep, quick, human sympathy which characterizes the man of today. His years on the platform have developed and ripened his powers as a public speaker. His return dating thru various bureaus is probably not exceeded by any lecturer now on the platform.

"A St. Louis manager wrote to Dr. Burns as follows: 'Twelve years is a long time to "last" in a circumscribed territory. You have done it. You have "made good." From numerous satisfied committees in various localities there are similar comments.

"Dr. Burns has studied crime and the criminal tendency for years. He brings to his lecture platform a trained mind and the result of first-hand observation. He is not a "reformer" with a panacea for all social ills."

and dignified entertainment as well as a puzzling exhibition of cleverness. He delighted a large audience."

In Ohio I followed A. B. Powell, the lecturer, and it was interesting to note the real enthusiasm with which committees mentioned his work. Powell is one of those all-round platformists who is able to make good on the platform and also do that more difficult thing of booking others. His conscientious representation causes him to be as welcome in a community the second year as he is the first—and that is the real test of a representative. A lecturer who can book is a real builder. He gives to the platform not only the riches of his oratory but of opportunity for others.

From *The Franklin* (Ind.) *Star*: "Franklin is assured a chautauqua during 1925. This decision was reached at a meeting of the board of directors. Not only are Johnson County people given assurance that there will be a chautauqua, but they are assured that the program this season will be the premier program of all chautauquas that have gone before. A tentative program was presented to the directors by J. Oscar Hall, Bloomington, Ill., representing the Lear Chautauqua Company, of that city. "The time set for the annual chautauqua is August 2 to 9. This is approximately the same date as that of 1924. The talent as a whole will be mostly

(Continued on page 58)

The Editor Hits the Trail

What a difference between communities. There is as much difference as there is between individuals. What causes the difference? Two towns 50 miles apart and with the same kind of country surrounding them will be as different as day is from night. In no other way do you become so well aware of those differences as when speaking before high school pupils day after day. Last week I spoke before a high school in a town of 2,000 population. The faces of the pupils were mediocre. The young people were ill-behaved, noisy, rude and without any of those graces which are so eloquent of good home training. The superintendent impressed me as a man of fine character and a good instructor. He simply had poor raw material with which to work. The audience that night was fine but small. It was a selected audience. It represented only a few of the rare spirits of the community. But that crowd of students was so depressing that it was several days before I could overcome the depression in myself.

At Victoria, Ill., where one would not have expected so much, I was greeted with an audience of pupils who fairly radiated intelligence and to whom it was a genuine joy to talk. Fine instructors in both cases. Perhaps Dr. Wiggan might solve the problem and give the answer. I cannot. I used to think that the lyceum and the chautauqua had much to do with this difference—that the fine audiences—especially in the schools—were the result of that platform courtesying which those institutions bring. There is, of course, much in that. The lyceum and the chautauqua do bring a fine training in the courtesy and the etiquette of the public audience. But they do not account for all of it by any means. There is simply a fundamental difference in these communities. I will assert that it will be demonstrated that the young people of Victoria will amount to 50 per cent more in the future than the young people of that other community. The best of schools cannot bring genuine character to inbred mediocrity. Mediocrity may be alleviated by instruction and example, but not cured. Even fine schools will not put brains behind faces marked with the bluish of poor breeding.

At Thompson, Ia., a suburb of Des Moines, Prof. "Van" greeted me. I had given the commencement address for his schools at Runnels last year. "Van" is a real school man. Thompson is not a lyceum town now, but it will be under his guidance. While the school man cannot put brains in a block of wood, he is, if of the proper caliber, the most powerful influence for good in any community. Runnels lost a real power for right living and thinking when "Van" left.

At Albany, Ill., the people have the real lyceum spirit. Every seat in the hall was sold and the audience was just about one jump ahead of me all the way. There was as fine a lot of high school pupils to address in the afternoon as I had met, but crowded into a school which was pitiful in its inadequacy. Yet there was perfect discipline and instructors who would do credit to a city ten times as large. Undoubtedly the people of Albany are proud of their young folks. They should be. But their pride should take the practical trend of giving them a school building of which they need not be ashamed. It is the poorest school equipment I have seen this year. If I visit Albany again I sincerely hope that I shall see a school building worthy of the town. Albany has a beautiful community hall and the whole town is up to the minute in everything but its school house.

Recently I spoke before an audience in the Parish House of the Northside Universalist Church of Chicago, of which Dr. Allison is pastor. The course is the result of the hard work of Mrs. Hazel Folsom Allison. It was a most enjoyable group. A hundred such courses might be run in Chicago.

For 13 years Prof. Geo. F. Close has been at the head of the schools of Woodhull, Ill. The entire town shows the effects of his splendid work. I was surprised to see that not a bit of advertising was up in regard to the course, but found later that every seat was sold. Prof. Close has made the lyceum power for good in his community. Simply by his energy and determination to put it over and his conviction that the platform is one of the essential elements of culture in any community.

News Notes

(Continued from page 57)

new, so far as a local audience is concerned, but whose numbers are individually well known on the platform.

Comes news of the purchase by Mr. Rupe, of the Acme Chautauquas, of Des Moines, Ia., of the Midland Chautauquas, heretofore conducted so capably by Mr. Trimble.

Dr. Winfield Scott Hall, nationally known hygienist, addressed more than 3,000 persons at several meetings in one day recently in Hamilton, O., speaking upon Life Problems.

It is said that Captain Donald B. MacMillen is not only a great explorer but a great speaker—the best since the time of Dr. Nansen.

The Columbus Entertainers are Beatrice Baughman, saxophonist, pianist and reader, and Miriam Hoover, violinist and pianist.

Frank Preston Johnson is lecturing upon community problems, teaching how to bridge the gulf between the average country community and the town in its midst—how to bring all factions together in a strong and united pull for community betterment.

Senora Isabel de Palencia, of Madrid, Spain, is lecturing in this country on the subject: Spanish Regional Costumes; the story of the Mantilla and the Spanish Shawl.

Dr. H. H. Lumkin, of Madison, Wis., who spent five years in Alaska, is lecturing in Wisconsin upon Alaska, using illustrations.

Prof. David Vaughan, of Boston, lectured recently at Warren, R. I., and the person who set the item in regard to the lecture in The Providence Tribune said that his subject was The Challenge of the New Day.

Arthur Newton Pack, of Princeton, N. J., is giving illustrated lectures dealing with the bird life of British Columbia. During the past summer Mr. Pack made an expedition under the auspices of the American Nature Association to and among the beautiful fjords along the Coast of British Columbia.

This ought to be an interesting lecture for the woman clubs, The Quest of the Slim Silhouette, by Mrs. Mary Brown-Lewers.

Mme. Metzthin, widow of an American diplomat in China, is lecturing in America on her experiences in that country. She speaks in eulogistic terms of the people of that country, the admitting that they have much to learn from the West in the way of sanitation.

The Smith-Spring-Holmes Company recently played before an audience at the State Teachers' College at Hattiesburg, Miss., and the local paper is enthusiastic in its praises of the entire program.

Albert Osborn, who is lecturing in this country on India, was born in that country, his parents having been missionaries. It is stated that he is a fine speaker, and

is able to picture conditions in that country in a vivid manner that will at once hold the attention of his listeners and also give much information. One of his bits of description was presented by The Statesville (N. C.) Sentinel after a recent lecture as follows: "Among the many interesting things he related was their reverence for snakes. Twenty thousand were killed in a year by snakes, said the speaker. "One day I was asked to call at the home of one of my students who had been detained from school because of sickness. When I arrived at the door I was asked to go in. I did so, and sat on the floor to win the confidence of my Hindu friend. While I sat there I saw something moving. Believing it to be a rat hole, I asked a trifle nervously: "Is that a rat hole?" "No," came the reply. "It is a snake hole." Immediately I arose and never sat down again, and gradually moved away as I talked to the boy's father. Finally a snake emerged out of the hole. It was one of India's deadliest snakes, the cobra. When I was about to kill it the old man begged of me to spare its life, as it was his god. Later I heard that he had worshipped that reptile for many years. At first it killed two of his children. Today it is domesticated and receives its food at the hand of the old man at regular hours."

Prof. H. D. Fish, of the University of Pittsburgh, has been lecturing before the high schools of Pennsylvania upon the subject of Evolution and Heredity. I quote below a report from The Meyersville (Pa.) Republican as a very striking example of the fact that a truly educational lecture may be made of intense interest, and it also discounts the argument that people do not want lectures upon their courses. The employment of entertainments of various characters upon the courses to the exclusion of the lecturers has given to the University Extensions a great opportunity to work upon new and educational lines, where, indeed, they should be the strongest. As long as bureaus and university extensions follow the rut—that is what appears to be the line of least resistance—entertainments will predominate, and the lyceum will come more and more into competition with the movies, the theaters and the vaudeville. The more they follow these lines the more difficult it will be to secure the guarantee. It is time a new trail was blazed. Strictly educational courses, with free admission to all high school pupils, with the courses financed by the progressive people of the community with the sole desire to do genuine good to their communities, will always have a field free from competition and will command the respect of all elements of the community. Such a plan needs careful study and promotion at the hands of representatives who are broadminded and eager to serve. The article from The Republican is as follows: "To say that the audience which assembled in the High School auditorium on Thursday evening of last week to hear the lecture of Professor H. D. Fish, of the University of Pittsburgh, was delighted would be to tell but a small fraction of the story. From the standpoint of instruction it probably was the greatest lecture ever given in Meyersdale. Without a single person leaving the hall until after the lecture was finished, the audience remained until 10:30 o'clock, and then seemed reluctant to leave. Many persons came to Dr. Fish after the lecture was over to ply him with questions to which they long have desired answers. "Dr. Fish had been announced to speak on the subject Heredity. He stated at the beginning of the address that he had enlarged his subject to that of Evolution and Heredity. These two vast subjects were discussed in a truly remarkable and complete manner. Some said after the meeting was over that the speaker had presented the main substance of a college course in science in one lecture. The fact that several times the subject matter of the address was illustrated with a series of wonderfully enlightening stereopticon pictures, and that Professor Fish is an exceptionally pleasing speaker, kept the audience intensely interested throughout. In fact, it is not often that a speaker is heard who can present the main facts of science so succinctly and concretely. "Pictures were shown that illustrated how the solar system, the world and continents have come into existence by a process of development. The periods of the evolution of animal life were described and portrayed. It was shown that the main points of the Darwinian theory of evolution are true, and admit of no denial whatsoever. Then Mendel's laws of heredity were clearly expounded and profusely illustrated. No one present failed to catch a pretty definite idea of the characteristics that are hereditary, and of the certainty that these traits or deformities will be transmitted. "Dr. Fish drew the applause of the crowd when he explained that since science is what we know and religion is what we believe there cannot possibly be any conflict between science and religion.

The subject matter was handled thruout in a reverent manner."

Prof. G. W. Fyer, of Vanderbilt University, has been selected by the National Industrial Council as its official lecturer, and he is addressing Chambers of Commerce thruout the country upon modern phases of business.

Helen Gaston Fish, presenting lectures on Interior Decoration before many of the women's clubs of New York State, is receiving many fine newspaper notices.

Dr. John A. W. Haas, president of Muhlenberg College of Allentown, Pa., is lecturing on The Newer Ideals of Justice, presenting his subject in a series of addresses under the headings: Is Justice Only Punitive? Shall We Have Punishment or Correction? What Is Economic Justice? Can Might Be Combined With Right?

Dr. Ephraim Hareubeni, famous botanist, is lecturing in the East concerning the flowers of the Bible. He was employed by the British during the World War, and also spent several years in Palestine collecting flowers. He carries with him a wonderful collection of flowers which he places on display at points where he is to lecture.

Dr. Henry Knight Miller, editor of Psychology, is lecturing in the East, giving a series of four lectures on consecutive evenings. He has planned a trans-continental tour and will appear in the principal cities from New York to San Francisco. The subjects of his four lectures are: Fear and Worry, The Great Destroyer; The Blue Bird of Happiness, Sources of Power, Gold Everywhere.

Princess Cantacuzene, Countess Speransky (nee Julia Dent Grant), granddaughter of President Ulysses S. Grant, is devoting considerable time at present to the platform, presenting a lecture entitled My Life Here and There. While the title is hardly happily chosen it is said that the Princess is able to give a wonderfully interesting address from the wealth of her many experiences.

Dr. Russell H. Conwell has recently been delivering lectures in Tampa and other Florida points. The American people are to be congratulated on the fact that the veteran lecturer is still able to give that masterpiece, Acres of Diamonds, to thousands of delighted listeners. For almost 50 years this has been one of the headline lectures of the platform.

When Geoffrey F. Morgan reached Colo., Ia., in the course of his present tour he found he was already well known in the town by reason of the fact that the high school had produced one of his musical comedies, A Royal Cutup, only a year ago. The youngsters reported a highly successful performance. Mr. Morgan has recently completed a new song for high school use which will shortly be off the press.

S. K. Ratcliffe, editor of The Manchester Guardian of Manchester, England, is in America lecturing in some of the Eastern University Extension courses. His subject is Present-Day Conditions in Great Britain.

Dr. George Herman Derry of Schenectady, N. Y., a well-known student of political economy, is to lecture in Nashville, Tenn., for the St. Cecilia Alumni on True Americanism and the Hundred Percenters. It is safe to say he is not being endorsed by the K. Ks.

Jaek Miner of Kingsville, Ont., a noted bird lover, is lecturing in the U. S. on The Saving of the Birds. At Syracuse, N. Y., they are arranging for a "bird sanctuary", and have engaged Mr. Miner to give them his lecture and his advice.

The Loar Independent Chautauqua Company will furnish the program next summer for an independent chautauqua at Manchester, O. The Signal, of that city, says: "The Sunday program will be distinctively religious, with all churches and choirs having a part in it. A united effort will make this a restful social home-coming affair. The same program will be given at Maysville, going direct from here to that city."

There is no more vital question for platform discussion today than the immediate future of Asia, and the utterances of those who are truly qualified to speak upon the subject, both by experience and study, are of genuine value. Miss Marguerite Harrison is lecturing upon Asia for the Asiatics. She says: "Since the close of the war there has been a great nationalist movement whereby the Asiatics are adopting

(Continued on page 65)

Easy to Play Easy to Pay BUESCHER True-Tone Saxophone. Bennie Krueger Director Bennie Krueger and His Orchestra. Free Saxophone Book. BUESCHER BAND INSTRUMENT CO. 507 BUESCHER BLOCK ELKHART, INDIANA

32 CLEVER SONGS, 20c. Songs You Like To Sing. Novelty Songs for Banquets, Entertainments, Lodges and all Social Occasions. Collins Co., 197 Fulton Street, Brooklyn, N. Y.

WILLIAM STERLING BATTIS. Giving complete programs of Original Character Sketches of Just Plain Folks "as is". Address 168 North Michigan Blvd., Chicago.

53 CLEVER SPEECHES, 20c. Humorous Stories, "Self-Starters", for Speeches, Toasts, Fraternal Speeches, Loyal Sentiments, Beautiful Funeral Orations, Ways To Insure Success of Banquets, Entertainments, etc. Clever pocket size booklet, only 20c, postpaid. THE COLLINS CO., 197 Fulton St., Brooklyn, N. Y.

Callie J. Stillson CHARACTERIST AND VERBAL CARTOONIST. Giving complete programs of Original Character Sketches of Just Plain Folks "as is". Address 168 North Michigan Blvd., Chicago.

"The High Cost of Ignorance" A Thought-Provoking Lecture by MRS. TAYLOR Z. MARSHALL. It is high time that the American people took stock of themselves to determine where they stand morally, intellectually and culturally. Mrs. Marshall has done a great thing in fearlessly presenting this problem. Available for special engagements and for Lyceum of 1925. Address BILLBOARD PLATFORM SERVICE, Crilly Building, Chicago.

RALPH BINGHAM "The American Entertainer" Available for Independent Chautauquas, 1925. REDPATH BUREAU Chicago

STAGE YOUR OWN SHOW Minstrel or Musical. Our Guide Books and Free Service Dept will show you how. We can supply everything you need. Send for 1925 "Minstrel Suggestions", "Minstrel Menu" FREE. HOOKE HOWE COSTUME CO., Haverhill, Mass.

49 "ORIGINAL" RECITATIONS, 50c. Speeches and Dialogue, Serious, Comic and Pathetic in French, German, Yankee, Irish, Negro Dialects. Adapted for the Platform and Stage by Rodolph Hutchinson. In one volume, 155 pages, 50c, postpaid. COLLINS CO., 197 Fulton Street, Brooklyn, N. Y.

COSTUMES FOR HIRE BROOKS 1435 B'WAY NEW YORK

QUICK DELIVERIES AT FAIR PRICES OF COSTUMES TIGHTS, HOSE, SPANGLES, WIGS, ETC. COMPLETE LINE OF LEIGHNER'S AND STEIN'S MAKE UP. We Make and Rent Costumes of All Descriptions. CHICAGO COSTUME WORKS, Inc., 116-120 NORTH FRANKLIN STREET, CHICAGO, ILLINOIS. Phone, State 6700.



TRADE DIRECTORY

A Buyers' and Sellers' Guide and Reference List for Show World Enterprises and Allied Interests

RATES AND CONDITIONS

Your name and address, if not exceeding ONE LINE in length, will be published, properly classified, in this Directory, at the rate of \$20.00 in advance, per year (52 issues), provided the ad is of an acceptable nature.

COMBINATION OFFER

One year's subscription to The Bill-

board and one line name and address inserted in 52 issues, properly classified, for \$23.00.

RATES FOR TWO-LINE NAME AND ADDRESS

If a name and address is too long to insert in one line there will be a charge of \$15.00 made for a whole or part of the second line used, or \$35.00 a year. The Billboard and two-line name and address, under one heading, \$38.00 a year.

BEADS

(For Concessions)

Mission Factory Co., 519 N. Halsted, Chicago.
National Bead Co., 14 W. 37th, New York City.
Oriental Mfg. Co., 891 Broad St., Prov., R. I.

BIRDS, ANIMALS AND PETS

Bartels, 45 Cortland St., New York City.
Alligator Farm, West Palm Beach, Fla.
Buffalo Canary Plant, 11 Niagara, Buffalo, N.Y.
Max Geisler Bird Co., 50 Cooper Sq., N. Y. C.
Wm. J. Mackensen, Yardley, Pa.
Overbrook Kitten Exch., 262 W. 39th St., N.Y.C.
Ansel W. Robinson, 1196 Market, San Francisco.

BIRD CAGES

Edge & Clarke, 224 E. 34th st., N. Y. C.

CIGAR LIGHTERS AND MOIST-ENERS

Drake Mfg. Co., 290 E. Water, Milwaukee, Wis.

CIGARETTES

Liggett & Myers Tobacco Company, 212 Fifth Ave., New York City.

CIRCUS & JUGGLING APPARATUS

Edw. Van Wyck, 2643 Colerain, Cincinnati.

CIRCUS SEATS FOR RENT

Arena Seating Co., 125 Market st., Newark, N.J.

CIRCUS WAGONS

Beggs Wagon Co., Kansas City, Mo.

COAL IN CARLOAD LOTS THRU SALESMEN

Washington Coal Co., 965 Coal Exch. Bldg., Chgo.

The Advantage of the Trade Directory

PERHAPS every day, every week or every month you want to buy certain goods, but do not know the dealers and address. That is the purpose of the Trade Directory. To furnish information on "where to buy" merchandise that is used or sold in the Show World. It's a buyer's guide with this important advantage. You ought to have your name and address under a heading in the Directory.

What may be printed here in reference to the Directory cannot demonstrate the value of this department so much as for you to run your eyes over the names of firms and the goods they sell. You can start here at any time.

THE BILLBOARD PUB. CO., Cincinnati, Ohio:

If my name and address can be set in one line under (name heading).....Insert it 52 times in *The Billboard* Trade Directory for \$20. If it cannot be set in one line, write me about rate.

BURNT CORK

Chicago Costume Wks., 116 N. Franklin, Chgo.

BURNT LEATHER NOVELTIES

Anchor Leather Nov. Co., 105 Bleeker, N.Y.C.

CALLIOPES

Tangley Mfg. Co., Muscatine, Ia.

CAMERAS FOR ONE-MINUTE PHOTOS

Chicago Ferrotpe Co., Chicago, Ill.

CANDY FOR WHEELMEN

E. Greenfield's Sons, 95 Lorimer st., Brooklyn.

CANES

Chas. Berg, 69 Beckman st., N. Y.

CARNIVAL GOODS AND CONCESSIONAIRE'S SUPPLIES

Advance Spec. Co., 307 W. Poplar, Columbus, O.
Advance Whip & Novelty Co., Westfield, Mass.
Am. Nov. Sup. Co., 434 Carroll, Elmira, N. Y.
Jas. Bell Co., 34 Green st., Newark, N. J. and 2092 E. 4th st., Cleveland, O.
Geo. W. Bink, 1442 Brush st., Detroit, Mich.
Carnival Supply Co., Inc., Bridgeport, Conn.
Karl Guggenheim, Inc., 45 W. 17th st., N. Y.
Midway Nov. Co., 302-04 W. 8, K. C., Mo.
Singer Bros., 536 Broadway, New York City.

CAROUSELS

M. C. Illinois & Sons, Coney Island, New York.

CARS (R. R.)

Houston B. R. Car Co., Box 223, Houston, Tex.

CARVING SETS AND CUTLERY

Kettle Cutlery Co., 368 6th ave., New York.

CHEWING GUM MANUFACTURERS

The Helmet Gum Shop, Cincinnati, O.
Texas Gum Co., Temple, Tex.
Toledo Chewing Gum Company, Toledo, O.

COFFEE URNS AND STEAM TABLES

H. A. Carter, 16 E. Marshall, Richmond, Va.
Talbot Mfg. Co., 1213-17 Chestnut, St. Louis, Mo.

COIN OPERATED MACHINES

Exhibit Supply Co., 4222 W. Lake st., Chicago.
Hance Mfg. Co., Westerville, Ohio.
Yu-Chu Co., 329 Broad st., Newark, N. J.

CONFETTI AND SERPENTINES

Kindel & Graham, 782-84 Mission, San Francisco

CORNET AND TROMBONE MUTES

Carl J. Magin, 301 E. Wash. st., Belleville, Ill.

COSTUMES

Chicago Costume Wks., 116 N. Franklin, Chicago
Harrelson Costume Co., 1327 Main, K. C., Mo.
Schmidt Costume & Wig Shop, 320 N. Clark, Chi.
Stanley Costume Studios, 306 W. 22d, N. Y.

COSTUMES (Minstrel)

Chicago Costume Wks., 116 N. Franklin, Chicago
Hooker-Howe Costume Co., Haverhill, Mass.

COSTUMES (To Rent)

Brooks Costume Rental Co., 1437 B'dway, N. Y.
Hooker-Howe Costume Co., Haverhill, Mass.
Kampmann Costm Wks., S. High, Columbus, O.
John D. Keller, 94 Market st., Newark, N. J.
E. Monday Co., 147 East 34th st., New York.

COW BELLS

The Seiss Mfg. Co., Alexia ave., Toledo, O.

COWBOY AND WESTERN GOODS

Harrelson Costume Co., 1327 Main, K. C., Mo.

CRISPETTE MACHINES

Long Eskins Co., 1976 High st., Springfield, O.

CUPID DOLLS

Cadillac Cupid Doll & Statuary Works, 1362 Gratiot ave., Detroit, Mich.

DART WHEELS AND DARTS

Apex Mfg. Co., Norristown, Pa.

DECORATIONS AND BOOTHS

M. E. Gordon, 6 North Franklin st., Chicago.

DECORATORS

F. A. W. Dean Decorating Co., Alliance, O.
Southern Awning & Decorating Co., 18 Tryon St., Charlotte, N. C.

DINNER SETS

National Mfg. & Prod. Co., 150 N. Wabash, Chi.
Salem China Co., Salem, Ohio.

DOLLS AND TEDDY BEARS

Fair Trading Co., Inc., 307 6th ave., N. Y. C.
Kindel & Graham 782-84 Mission, San Francisco

DOLLS

Arancee Doll Co., 417 Lafayette st., New York.
E. C. Brown Co., 440 W. Court St., Cin., O.
Capitol City Doll Co., 125 W. Reno, Okla.
homa City, Ok.
Dallas Doll Mfg. Co., 22194, Main, Dallas, Tex.
Italian Art Co., 805 S. Vandeventer, St. Louis, Mo.
Karr & Auerbach, 415 Market St., Phila., Pa.
L. B. P. & Co., 1431 Walnut st., Kansas City.

DOLLS—DOLL LAMPS

California Dolls, Timeo Drosses, Phemas, etc.
PACINI & BERNI, 1424 W. Grand Ave., Chicago.

Wm. Rainwater, 2034 Westlake, Seattle, Wash.
A. N. Rice Lamp Co., 1837 Madison St., K. O.
D. Vezzani Stat. Co., 309 3d st., Portland, Ore.

DOLL HAIR SUPPLIES

Rosen & Jacoby, 195 Chrystie St., New York.

DOLL LAMPS

Kindel & Graham 782-84 Mission, San Francisco
Wm. Rainwater, 2034 Westlake, Seattle, Wash.

DOUGHNUT MACHINES

Talbot Mfg. Co., 1213-17 Chestnut, St. Louis, Mo.

DRINK CONCENTRATES

Beardley Spec. Co., 217 18th, Rock Island, Ill.

DRUMS (Band and Orchestra)

Acme Drummers' Supply Co., 219 N. May, Chi.
Wilson Bros. Mfg. Co., 222 North st., Chicago.

ELASTIC VEILS FOR DOLLS

Jobbing & Salea Co., Inc., 640 Broadway, N.Y.C.

ELECTRIC BULBS ALL KINDS

Charles R. Ahlett, 199 Fulton st., New York.

ELECTRICAL STAGE EFFECTS

Chas. Newton, 244 W. 14th st., N. Y. C.

ESMOND BLANKETS

Deesauer, F. & Co., Adams & Market st., Chgo.
Oriental Nov. Co., 28 Opera Pl., Cincinnati, O.

FAIR AND BAZAAR MERCHANDISE

Doulton, Wm. P., & Co., 32 Bank Pl., Utica, N.Y.

FAIR TICKETS, ADV. & SUPPLIES

The Fair Pub. Co., Norwalk, Ohio.

FAVORS, BEEFSTEAK APRONS AND NOISE MAKERS

U. S. Favor Corp., 40 West 34th st., New York.

FEATHER FLOWERS

DeWitt Sisters, E. Prairie, Battle Creek, Mich.

FELT RUGS

Eastern Mills, 425 Broadway, Everett, 49, Mass.

FIREWORKS

Amer. Fireworks Co., 739 R. E. T. Bldg., Phila.
N. R. Barnaba Fireworks Mfg. Co., New Rochelle, N. Y.
Columbus Imperial Fireworks Co., Columbus, O.
Gordon Fireworks Co., 190 N. State st., Chicago.
Illa. Fireworks Display Co., Danville, Ill.
Liberty Fireworks Co., Franklin Park, Ill.
Macroy Fireworks Co., 1111 Capitol Bldg., Chi.
Martin's Fireworks, 201 Ave. "E", Ft. Dodge, Ia.
Pain's Manhattan B's Fireworks, 18 Pk. Pl., N. Y.
Potts Fireworks Display Co., Franklin Park, Ill.
Schenectady Fireworks Co., Schenectady, N. Y.
Texas Fireworks Co., Dallas, Texas.
Thearle-Duffield Fireworks Co., Chicago, Ill.
The Tapp Fireworks Co., Inc., Tippecanoe City, O.
Unexcelled Mfg. Co., 22 Park Pl., N. Y. City.
Vitalo Fireworks Mfg. Co., P. O. Box 194, New Castle, Pa.
Weigand Fireworks Co., Franklin Park, Ill.

FLAGS

American Flag Co., Dover, N. J.

FLAGS AND DECORATIONS

Metropolitan Flag & Dec. Co., 713 S. 59th, Phila, Pa

FLAGS AND FESTOONING

Annie & Co., Fulton, cor. William st., N. Y.
U. S. Favor Corp., 49 West 34th st., New York.

FLAGS FOR RENT

Anderson Tent-Awn. Mfrs., Anderson, Ind.

FLOODLIGHT PROJECTORS

Charles R. Ahlett, 199 Fulton St., New York.
Cabill Bros., 519 W. 45th st., New York City.

FLOOR LAMPS

A. N. Rice Lamp Co., 1837 Madison st., K. C.

GAMES

H. C. Evans & Co., 1529 W. Adams, Chicago.

GASOLINE BURNERS

H. A. Carter, 16 E. Marshall, Richmond, Va.
Talbot Mfg. Co., 1213-17 Chestnut, St. Louis, Mo.
Waxham Light & Heat Co., 350 W. 42d, N.Y.C.

(Continued on page 60)

DIRECTORY

(Continued from page 59)

GASOLINE ENGINES

Cushman Motor Works, Lincoln, Nebraska.
GASOLINE LANTERNS, STOVES AND MANTLES
Warham Light & Heat Co., 550 W. 42d, N.Y.C.

GELATINE SHEETS—COLORED
H. Channon Mfg. Co., 223 W. Erie st., Chicago.

GIANT PALM TREES FOR DESERT SCENES, CONVENTIONS, HALLS, ETC.
Amelia Grain, 819 Spring Garden st., Phila.

GOLD LEAF
Hestings & Co., 517 Filbert, Philadelphia, Pa.

GUM MACHINES (Ball Gum)
Ad-Lee Novelty Co., 825 So. Wabash, Chicago.

HAMBURGER TRUNKS, STOVES, GRIDDLES
Talbot Mfg. Co., 1213-17 Chestnut, St. Louis, Mo.

HINDU BOOKS
Hindu Publ. Co., 907 Buena ave., Chicago.

HORSE PLUMES
H. Schaemke, 10414 89th, Richmond Hill, N. Y.

ICE CREAM CONES
Alco Cone Co., 124 N. Front, Memphis, Tenn.

ICE CREAM CONES AND WAFERS
Columbia Cone Co., 61 Palm, Newark, N. J.

INDIANS AND INDIAN COSTUMES
W. H. Barten, Gordon, Neb.

INSURANCE (Accident and Health)
A. J. Ruch, Jefferson Bldg., Peoria, Ill.

JEWELRY
Singer Bros., 536 Broadway, New York.

JOKE BOOK AND MINSTREL SPECIALTIES
Dick Ubert, 521 W. 159th st., New York.

LAMP SHADES
Phoenix Lamp Shade Co., 45 E. 20th st., N. Y.

LAMPS
Artistic Metal Prod. Co., Newark, N. J.

LAWYERS
F. L. Boyd, 17 N. Lonsdale st., Chicago.

LIGHTING PLANTS
J. Frankel, 134 S. Clinton St., Chicago, Ill.

MAGIC BOOKS
Adams Press, 19 Park Pl., N. Y. C.

MAGIC GOODS
Chicago Magic Co., 140 S. Dearborn st., Chicago.

MAGIC PLAYING CARDS
Aladdin Spec. Co., 102 N. Wells, Chicago.

MAKEUP
Chicago Costume Wks., 116 N. Franklin, Chicago.

MARABOU & OSTRICH TRIMMINGS
Amer. Marabou Co., 67 5th ave., N. Y. City.

MEDICINE FOR STREETMEN
Amer. Pharnacal Co., 1551 Donaldson, Cin'ti, O.

MINDREADING APPARATUS
Nelson Enterprises, 1297 Fair, Columbus, Ohio.

MINSTREL PUBLICATIONS
Hooker-Howe Costume Co., Haverhill, Mass.

MINTS FOR VENDING MACHINES
Radio Mint Co., 1652 Central ave., Cin'ti, O.

MUSIC COMPOSED & ARRANGED
Arthur Bros., 5100 Banger, Detroit, Mich.

MUSIC PRINTING
The Otto Zimmerman & Son Co., Inc., Cin., O.

MUSICAL BELLS & SPECIALTIES
R. H. Mayland, 54 Willoughby, Brooklyn, N. Y.

MUSICAL GLASSES
A. Brauneiss, 5512 109th st., Richmond Hill, N. Y.

MUSICAL HARPS
Lindeman Harp Co., 4140 Kedzie Ave., Chicago.

MUSICAL INSTRUMENTS (Automatic and Hand Played)
Bettoney & Mayer, Inc., 218 Tremont, Boston.

MUSICAL SAWS
Paul Goward, Box 601, Worcester, Mass.

NEEDLE BOOKS AND NEEDLES
Fifth Ave. Notion Co., 501 5th, Pittsburg, Pa.

NEEDLE BOOKS AND SELF-THREADING NEEDLES
Kindel & Graham, 782-84 Mission, San Francisco.

NOISE MAKERS
The Seiss Mfg. Co., Toledo, O.

NOVELTIES AND SOUVENIRS
Toy World Novelty Co., 32 Union Sq., N. Y. C.

ORANGEADE
Geiger Co., 6535 N. Maplewood Ave., Chicago.

ORANGE DRINK MACHINE
Lebros Mfg. Co., 656 Broadway, New York City.

ORGANS AND CARDBOARD MUSIC
B. A. B. Organ Co., 340 Water St., New York.

ORGANS AND ORCHESTRIONS
Johannes S. Gebhardt Co., Tacony, Phila., Pa.

ORGAN AND ORCHESTRION REPAIR SHOPS
H. Frank, 3711 E. Ravenswood Ave., Chicago.

ORIENTAL NOVELTIES
Shanghai Trad. Co., 22 Waverly pl., San Francisco.

PADDLE WHEELS
Bay State Novelty Co., Westfield, Mass.

PAPER CARNIVAL HATS
U. S. Favor Corp., 40 West 34th St., New York.

PAPER CUPS (LILY) AND DISHES
Public Service Cup Co., Bush Terminal, B'klyn.

PAPER CUP VENDING MACHINES
Dixie Drinking Cup Co., Inc., 220 W. 19th, N.Y.C.

PAPIER MACHE INSTRUMENTS
U. S. Favor Corp., 40 West 34th St., New York.

PARASOLS
Kindel & Graham, 782-84 Mission, San Francisco.

PEANUT ROASTERS
Holcomb & Hoke Mfg. Co., 912 Van Buren, Indianapolis, Ind.

PEARL SUPPLIES FOR WIRE WORKERS
N. E. Pearl Co., 174 Longfellow, Provi., E. I.

PENNANTS AND PILLOWS
American Pennant Co., 66 Hanover St., Boston.

PERFUMES & TOILET ARTICLES
C. H. Selick, Inc., 56 Leonard St., New York.

PHOTO ENG. AND HALFTONES
Central Eng. Co., 137 W. 4th, Cincinnati, O.

PHOTOGRAPH REPRODUCTIONS
J. J. Becker, Jr., 211 S. Elsie, Davenport, Ia.

PILLOW TOPS
Muir Art Co., 116 W. Illinois, Chicago.

PLAYGROUND APPARATUS
Everwear Manufacturing Co., Springfield, Ohio.

POCKETBOOKS FOR MEN (7-in-1 All-Leather)
A. Rosenthal & Son, 804 Wash., Boston, Mass.

POPPING CORN (The Grain)
Bradshaw Co., 31 Jay St., New York City.

POPCORN FOR POPPING
Bennett Popcorn Co., Schaller, Iowa.

POPCORN MACHINES
Dunbar & Co., 2654 W. Lake St., Chicago.

POPCORN SPECIALTIES MFRS.
Wright Popcorn Co., 355 6th St., San Francisco.

POSTCARDS
Gross & Onard, Sta. D, Box 132, N. Y. City.

PREMIUM GOODS
Singer Bros., 536 Broadway, New York.

PUSH CARDS
Peerless Sales Co., 1160 E. 55th St., Chicago.

RAINCOATS
Goodyear Rubber Mfg. Co., 34 E. 9th, N. Y. C.

RHINESTONES and JEWEL PROPS.
Chicago Costume Wks., 116 N. Franklin, Chicago.

ROLL AND RESERVED SEAT TICKETS
Boss Ticket Co., 10 Harney St., Omaha, Neb.

ROLLER SKATES
Chicago Roller Skate Co., 4458 W. Lake, Chicago.

RUBBER STAMPS (And Accessories)
Hess Stamp Co., 33 E. Gay St., Columbus, O.

RUGS AND TAPESTRIES

J. Landowne, Co., Inc., 404 4th Ave., New York

SALESBOARD ASSORTMENTS AND SALESBOARDS

Fair Trading Co., 307 Sixth Ave., New York.
Hecht, Cohen & Co., 201 W. Madison, Chicago.

SALESBOARD & CARD MFRS.

U. S. Printing & Nov. Co., 195 Chrystie, N.Y.C.

SCENERY

New York Studios, 328 W. 39th, New York City

SCHELL'S SCENIC STUDIO

581-583-585 South High Street, Columbus, Ohio

Williams, 21st & Chelton, Germantown, Phila.

SCENERY (That Carries in Trunks)

M. R. Denny, 5761 Cherokee Ave., Tampa, Fla.

SCENERY TO RENT

Amelia Grain, 819 Spring Garden St., Phila.

SCENIC ARTISTS AND STUDIOS

Freud Scenic Studios, Inc., 723 7th Av., N.Y.C.
Lee Lash Studios, 42nd St. & B'way, N. Y. C.

SERIAL PAPER PADDLES

Schulman Printing Co., 30 W. 8th, New York.

Smith Printing Co., 1331 Vine St., Cincinnati, O.

SHOOTING GALLERIES (LONG RANGE) & SUPPLIES

H. C. Evans & Co., 1529 W. Adams, Chicago.

SHOW AND POSTER PRINTERS AND LITHOGRAPHERS

E. W. Allen & Co., Atlanta, Ga.

Dallas Show Print (Boht. Williams), Dallas, Tex.

JORDAN SHOW PRINT

229 Institute Place, CHICAGO, ILL

Type and Engraved Posters, Etc.

Planet, Chatham, Ont., Can.

SIG-KNIT-RING SCARFS

Toulson Yarn Co., Inc., Bridgeport, Conn.

SIGN PAINTERS' BRUSHES

Dick Blick Co., Box 437-B, Galesburg, Ill.

SIGNS, PARAFFINED CARDBOARD

The Harrison Co., Union City, Ind.

SILVERWARE

Continental Mfg. Co., 369 6th Ave., New York.

Karr & Auerbach, 415 Market St., Phila., Pa.

Kindel & Graham, 782-84 Mission, San Francisco

SLOT MACHINES

Automatic Coin Machine Supply Co., 542 W. Jackson Blvd., Chicago.

Ohio Nov. Co., 40 Stone Block, Warren, O.

Sicking Mfg. Co., 1922 Freeman Ave., Cin'ti.

SLUM GIVEAWAY

Rayless Bros. & Co., 704 W. Main, Louisville.

Premium Nov. Co., Box 842, Providence, R. I.

SNAKE DEALERS

SNAKE KING, Brownville, Texas.

SOAPS FOR MEDICINE MEN

Columbia Laboratories, 18 Col. Hts., Brooklyn.

Indianapolis Soap Co., Indianapolis, Ind.

Geo. A. Schmidt Co., 236 W. North Ave., Chi.

SPANGLES AND TRIMMINGS

Arthur B. Alberts, 457 Broadway, New York.

J. Baum, 527 South St., Philadelphia, Pa.

Chicago Costume Wks., 116 N. Franklin, Chicago

STAGE APPARATUS AND TRICK BICYCLE

Tom Simmons, 409 W. 42d, New York City.

STAGE CLOG SHOES

Chicago Costume Wks., 116 N. Franklin, Chicago

Hooker-Howe Costume Co., Haverhill, Mass.

STAGE HARDWARE

J. H. Channon Mfg. Co., 223-233 W. Erie, Chicago

STAGE LIGHTING APPLIANCES

Frederick Bohling, 502 W. 44th St., N. Y. C.

Display Stage Light Co., 334 W. 44th, N. Y. C.

Chas. Newton, 244 W. 14th St., New York City

Universal Electric Stage Lighting Co., Kilgill Bros., 321 W. 50th St., New York.

STREETMEN'S SUPPLIES

M. Gerber, 505 Market St., Philadelphia, Pa.

Singer Bros., 536 Broadway, New York.

SUPPORTERS FOR ACROBATS AND DANCERS

M. Fox, 796 8th Ave., New York City.

SWAGGER STICKS FOR LADIES

Cat. Swagger Stick Co., 1931 E. 68th, Los Angeles

Frankford Mfg. Co., 906 Filbert St., Phila., Pa.

SWEATERS FOR COWBOYS

Sol Pudlin, 1212 Broadway, New York City.

TATTOOING SUPPLIES

Percy Waters, 1050 Randolph, Detroit, Mich.

TAXIDERMIST

Taxidermist Studio, 11 Niagara, Buffalo, N. Y.

TENTS

American Tent-Awn. Co., Minneapolis, Minn.
Anchor Supply Co., Water St., Evansville, Ind.
Clifton Manufacturing Co., Waco, Texas.

TENTS TO RENT

M. Magee & Son, Inc., 138 Fulton St., N. Y. C.

THEATER TICKETS

(Roll and Reserved Seat Coupon)

Ansell Ticket Co., 730-40 N. Franklin st., Chicago

Trimount Press, 115 Albany St., Boston, Mass.

THEATRICAL COSTUME SUPPLIES

Chicago Costume Wks., 116 N. Franklin, Chicago

Dazio's Theatrical Emp., 142 W. 44th, N. Y.

THEATRICAL GROUND CLOTHS, SAND BAGS AND TARP-AULINS

Ernest Chandler, 252 Pearl St., New York City.

Chas. A. Salisbury, 61 Ann St., New York.

TICKET PRINTERS

Ansell Ticket Co., 730 N. Franklin, Chicago

Elliott Ticket Co., 101 Varick St., New York

Trimount Press, 115 Albany St., Boston, Mass.

World Ticket & Sup. Co., 1609 B'way, N. Y. C.

TIGHTS

Arthur B. Alberts, 457 Broadway, New York

Chicago Costume Wks., 116 N. Franklin, Chicago

TINSEL MANUFACTURERS

National Tinsel Mfg. Co., Manitowoc, Wis.

TOUPEES

W. Solomon, 101 W. 41st St., New York.

TRIMMED BASKETS

H. Bayeradorfer & Co., 1129 Arch, Phila., Pa.

TRUNKS

(Professional and Wardrobe)

Newton Trunk Co., see W. W. Winship & Sons, Inc.

Second-Hand Trunk Co., 50 E. 59th St., N. Y.

W. W. Winship & Sons, Inc., Utica, N. Y.

TURNSTILES

H. V. Bright, Prospect Bldg., Cleveland, O.

Damon-Chapman Co., 234 Mill, Rochester, N. Y.

Percy Mfg. Co., Inc., 101 Park Ave., N. Y. C.

UKELELES

J. J. Thome, 646 Springfield Ave., Newark, N. J.

UMBRELLAS

Frankford Mfg. Co., 906 Filbert St., Phila., Pa.

Issacsohn Umbrella Co., 114 Court, Brooklyn.

UNBREAKABLE COMBS

Ohio Comb & Novelty Co., Orrville, O.

UNIFORMS

Brooks Uniform Co., 1437 Broadway, N. Y. C.

Fechheimer Bros. Co., Cincinnati, O.

De Moulins Bros. & Co., Dept. 10, Greenville, Ill.

G. Loforte, 215 Grand St., New York City.

Smith-Gray, 729-731 Broadway, New York City.

VASES

Otto Goetz, 43 Murray St., New York.

VENDING MACHINES

Caille Bros. Co., 6210 2nd Blvd., Detroit, Mich.

VENTRILOQUIAL FIGURES

Theo. Mack & Son, 67 W. Ohio St., Chicago.

VIOLINS

Aug. Gemunder & Sons, 125 W. 42nd St., N. Y.

VIOLIN TONE PRODUCER

E. J. & J. Virzi, 503 5th Ave., New York.

WAFFLE IRONS

The Wafeldog Corporation, Washington, D. C.

WAFFLE MACHINES (Sugar Puff)

Talbot Mfg. Co., 1213-17 Chestnut, St. Louis, Mo.

WAFFLE OVENS

Long-Eakins Co., 1976 High, Springfield, O.

WAGONS

Wm. Frech & Co., Maple Shade, N. J.

WATCHES

Leon Hirsch Corp., 37-39 Maiden Lane, N. Y. C.

WIGS

A. M. Busch & Co., 228 S. 11th St., Philadelphia

Chicago Costume Wks., 116 N. Franklin, Chicago

of all descriptions and Theatrical Make-Up.

THE KETTLE CO., 32 W. Washington, Chicago

Alex. Marks, 662-B 8th Ave., New York, N. Y.

G. Shindhelm & Son, 144 W. 40th, New York.

Zander Bros., Inc., 113 W. 48th, New York.

WIRE WORKERS' SUPPLIES

Juergens Jewelry Co., 235 Eddy, Providence, R.I.

XYLOPHONES, MARIMBAS, BELLS AND NOVELTIES

E. R. Street, 28 Brook St., Hartford, Conn.

AT LIBERTY AND WANT SITUATION ADVERTISEMENTS

AT LIBERTY BANDS AND ORCHESTRAS
5c WORD. CASH (First Line Large Black Type)
2c WORD. CASH (First Line and Name Black Type)
1c WORD. CASH (Small Type) (No Ad Less Than 25c)
Figure at One Rate Only—See Note Below.

At Liberty—Sloppy Seven Orchestra after June 1. Experienced in dance program. Now looking for the summer. Pre-ferred summer resort or excursion line. JOHN A. MOSLEY, Hartlage, Illinois.

Beckley's Concert Band After March 7. Just closing 26 weeks' engagement. All essentials. Reliable managers only. GLENN BECKLEY, Richmond, Ohio.

Open for Summer—Six-Piece Dance band of real quality. Pop, rhythm, snappy appearance, up-to-date program. Fourth successful year. Recommendations. Write THE IMPs, Cedar Falls, Iowa. mar7

AT LIBERTY ON TWO WEEKS' NOTICE. A well organized organization of eight men. We do not offer you work but will consider any real offers. If you haven't a real proposition kindly send stamps. BOX 138, care Billboard, 1493 Broadway, New York City. feb28

AT LIBERTY—RED HOT BRASS TEAM. PLAY sweet stuff and lots of jazz with latest style. Correct rhythm and plenty of it. Can be featured alone or together. Teamed together two years. Ages 21. Neat with lots of personality. Do not misrepresent. We do not. Location only. State best salary and all details in next wire. Address wire R. M. BRASS TEAM, care of Western Union, Tampa, Fla.

AT LIBERTY—DRAPER'S SNAPPY 7-PIECE Orchestra. Singing and doubling. Past two seasons, 23-24 at Cleveland Beach. Would close for coming season for park, resort or hotel. Write or wire. HARRY DRAPER, 2339 E. 8th St., Cleveland, Ohio.

BARRINGER'S ORCHESTRA AFTER JUNE 15. Four to seven pieces. All players double and sing. BARRINGER'S ORCHESTRA, 1347 No. Edward St., Kalamazoo, Mich. mar7

COLLEGE DANCE ORCHESTRA AVAILABLE after June 3. Seven pieces or any combination desired. Singing, novelties and musical pop. Only first-class engagement considered. Address MANAGER, Collegiate Entertainers, 467 Park Place, Springfield, Ohio.

EIGHT-PIECE ORCHESTRA WANTS SUMMER engagements, park or resort. Free June 1. Young experienced musicians, together over year. Double fifteen instruments. Nonunion. Write KARL H. BLANCH, Saxton, Pa.

ILLINOIS RHYTHM KINGS—UNIVERSITY OF Illinois dance orchestra open for summer booking June 10. Last summer at Daytona Beach Casino, Florida. Eight men playing 18 instruments, four sax, three violins, three clarinets, bass clarinet, two cornets, melophone, piano, banjo, drums and bass. College songs, novelties and costumes. Write, "DING" JOHNSON, 810 So. Third St., Champaign, Ill. mar7

RED HOT DOMINO ENTERTAINERS—SEVEN men, now booking for 1925 season, park, lake or hotel. Young, union; tuxedos and costume. Write BURNETT ELY, 2065 North Meridian, Indianapolis, Indiana. feb28

SAX TEAM—YOUNG, EXPERIENCED, READ anything, fake, improvise, good tone. We double eight instruments. Open for real summer engagement. ARNOLD, 7 Brookside Ave., Jamaica Plain, Boston, Mass. feb28

THE ARABIAN KNIGHTS' ORCHESTRAS of Chicago are now accepting bookings for summer resort work. We entertain as well as play. All young, double and reliable. Write JACK REED, 13912 Chippewa Ave., Chicago.

20TH CENTURY BOYS—ORIGINAL 5 KINGS. Open February 22. Doubling saxophones, xylophones, high-class singer. Red hot combination. Experienced hotel. Readers; improviser; play standard concert feature solos; dinner sessions. Specialize new modern syncopated for dancing. Will travel anywhere. All reliable managers wire, phone, write. PAUL GOSS, Hotel Hermitage, Nashville, Tenn. feb28

AT LIBERTY—Hendricks & Dark Wonders of Sensation of Chicago, a feature orchestra. Price reasonable. Best of references. Managers of summer resort dance halls, write. Now working in Southern States. CHAS. T. RANDOLPH, 110 1/2 N. 10th St., Springfield, Illinois.

ORIGINAL BROADWAY ENTERTAINERS, hot jazz band. Six young, neat-appearing and entertaining men for hotel, cafe or vaudeville; cafe preferable; also summer resorts. Will travel anywhere. All offers considered. Booking agents write. JACK SHAMAN, 11 East State Street, Trenton, N. J. mar7

TONY CARRIER'S RAMBLER ORCHESTRA at Liberty for 1925 summer season. Address 207 Ashley Blvd., New Bedford, Massachusetts.

AT LIBERTY BILLPOSTERS

5c WORD. CASH (First Line Large Black Type)
2c WORD. CASH (First Line and Name Black Type)
1c WORD. CASH (Small Type) (No Ad Less Than 25c)
Figure at One Rate Only—See Note Below.

BILLPOSTER AT LIBERTY—15 YEARS' EXPERIENCE on 5 A. boards. Address JAMES WOODWARD, Box 464, Ames, Iowa. feb28

CLASSIFIED ADVERTISEMENTS

A Market Place for Buyer and Seller, and Want Ad Department
FORMS CLOSE THURSDAY, 5 P.M.
FOR THE FOLLOWING WEEK'S ISSUE.

RATES PER WORD

SET IN 5/8-PT. TYPE WITHOUT DISPLAY. NO CUTS. NO BORERS.
WE DO NOT PLACE CHARGES FOR ADS IN THE CLASSIFIED COLUMNS UPON OUR BOOKS. NO BILLS RENDERED.

CASH MUST ACCOMPANY THE COPY.

NO AD ACCEPTED FOR LESS THAN 25 CENTS.
COUNT EVERY WORD AND COMBINED INITIALS, ALSO NUMBERS IN COPY, AND FIGURE COST AT ONE RATE ONLY.

Table with 3 columns: Ad Type, First Line Attractive, Small First Line. Includes categories like Arts, Songs and Parodies, Medical Apparatus, Musical Instruments, etc.

Table with 3 columns: Ad Type, First Line Attractive, Small First Line. Includes categories like Information Wanted, Medical Apparatus, Musical Instruments, etc.

MOVING PICTURE CLASSIFIED ADVERTISING RATES.

Table with 3 columns: Ad Type, First Line Attractive, Small First Line. Includes categories like Calcium Lights, Films for Sale, etc.

Table with 3 columns: Ad Type, First Line Attractive, Small First Line. Includes categories like Moving Picture Accessories for Sale, Theaters for Sale, etc.

AT LIBERTY CLASSIFIED ADVERTISING RATES, OPEN ONLY TO PROFESSIONAL PEOPLE.

Table with 2 columns: Ad Type, Per Word. Includes categories like At Liberty (Set in Small Type), At Liberty (Display First Line and Name in Black Type), etc.

Advertisements sent by telegraph will not be inserted unless money is wired with copy. Mail addressed to initials care General Delivery will not be delivered. We reserve the right to reject any advertisement and revise copy. "Till forbid" orders are without time limit and subject to change in rate without notice. THE BILLBOARD PUB. CO., 25-27 Opera Place, Box 872, Cincinnati, Ohio.

AT LIBERTY—Billposting Agent. Open for circus, minstrel or repertoire. Can run into. Answer by mail, state all. GEO. REID, 2416 Fourth St., Chester, Pennsylvania.

AT LIBERTY CIRCUS AND CARNIVAL

5c WORD. CASH (First Line Large Black Type)
2c WORD. CASH (First Line and Name Black Type)
1c WORD. CASH (Small Type) (No Ad Less Than 25c)
Figure at One Rate Only—See Note Below.

At Liberty for Circus, Fairs, side shows. Strong man, just back from South America. Hate big attractions, among others lifting auto with four persons, and other good acts. Write J. WILLIAMS, 3610 S. Harrison St., Ft. Wayne, Ind.

At Liberty—Handcuff Escape King and Fire Eater. Go anywhere. State all in first letter. M. MATHIS, Kenton, Tenn.

CIRCUS BAND LEADER—SOBER AND RELIABLE. Age 27. State salary. J. HAROLD JOHNSON, Argonne Rooms, Sioux Falls, South Dakota. feb28

I HAVE A GOOD THREE-ABREAST CARNIVAL. Would like to go with a carnival. JOHN DAVIS, R. F. D. 2, Box 69, Monroe, Nebraska.

IMPALEMENT AND MINDING ACT. MAKE openings and clown. Prefer small circus. WM. (SLIM) DEWEY, 3703 Fourth Ave., Detroit, Michigan.

RETIRED CIRCUS WOMAN OF 35 WISHES to join Palace. Will work on small percentage for chance to learn business. Business proposition only. MADAME GONZA, Billboard Office, New York City.

AT LIBERTY—6 to 8 Circus Acts, tumbling and acrobatic, comedy slack wire, acrobatic dancing (trill), balancing trapeze, flying trapeze, clown acts, contortions (trill), black-face buck and wing dancers and comedy plays. WILL G. MORRIS THORPE, 830 Linton St., Jeffersonville, Ind. feb28

CIRCUS SIDE-SHOW ACTS at Liberty season 1925. Punch and Judy, magic, ventiloquist, lecture, hallyho and openings. KING COLE, 400 South Halsted Street, Chicago, Illinois. mar21

JOHN KLUMP, ventiloquist and magician, featuring comic cartoon drawings, open for date with first-class carnival. Good salary and all of selling privileges. No put-up or take-down man; performer only. Join near. No banners. 5026 N. Amber St., Philadelphia, Pa. mar7

OVERLAND CIRCUSES—I have Dog and Pony Act for big show, plus-foot Animal Slide Show, nice Front Truck for moving same, to place on real show. What have you to offer? DE VAUL, Nedrow, N. Y. mar7

WOULD LIKE to hear from Staley, Bergen, Dolans Shows, care Billboard. KLUMP, 2028 N. Amber St., Philadelphia, Pa. mar7

NOTE—Count All Words, Also Combined Initials and Numbers in Copy. Figure Total at One Rate Only. IN ANSWERING CLASSIFIED ADS, PLEASE MENTION THE BILLBOARD.

YOUNG MAN, good nature, with the Reporter company. Anything considered offers opportunity to acquire knowledge of drama art. Just necessary living expenses. Write outlining answers. HEINER, 1 Court St., Hudson, New York. mar11

AT LIBERTY M. P. OPERATORS

5c WORD. CASH (First Line Large Black Type)
2c WORD. CASH (First Line and Name Black Type)
1c WORD. CASH (Small Type) (No Ad Less Than 25c)
Figure at One Rate Only—See Note Below.

OPERATOR—DESIRES POSITION. EXPERIENCED in Simplex and Power's machines and electrical equipment. Married. State salary. THOMPSON, 672 Gladstone Avenue, Detroit, Michigan.

PICTURE OPERATOR WANTS JOB—SEVEN years' experience. Willing worker and will devote time to manager's interest. Best of reference. But will have to give present employer at least two weeks' notice. H. A. GARRETT, care Pullman Theatre Co., Chaffee, Missouri.

A-1 PROJECTIONIST at Liberty. Long experience. Handle any equipment and produce results. Dependable, no bad habits, nonunion. Salary reasonable. Available immediately. GLENN SMITH, Girard, Kansas. feb28

AT LIBERTY—Soldier Discharged February 25, 1925. Experienced Operator; any equipment. References. Go anywhere. Write or wire. OPERATOR'S SERVICE CLUB, Ft. D. A., Russell, W. Va. mar7

AT LIBERTY—Up-To-Date Projectionist. Locate anywhere; permanent. Any equipment and to end. Fourteen years' experience. References. Name salary. PROJECTIONIST, 2119-A College Ave., St. Louis, Missouri.

AT LIBERTY—Projectionist-Manager. Six years' experience. Good all-around man. Handle any phase of theatrical work, from management on down. Union, steady, reliable, married. A-1 references. Two weeks' notice. State all; don't misrepresent. G. J. ROBERTS, 1927 Spruce St., Murphysboro, Illinois.

EXPERT OPERATOR desires position. Handle any equipment. OPERATOR, 756 Ketcham St., Indianapolis, Indiana. feb28

MOTION PICTURE OPERATOR, 29, single, nonunion, will join. Thoroughly experienced in projection and electricity. Perfect screening guaranteed. Steady, references. FINKEL, 5225 Arch Street, Philadelphia, Pennsylvania. mar7

AT LIBERTY MUSICIANS

5c WORD. CASH (First Line Large Black Type)
2c WORD. CASH (First Line and Name Black Type)
1c WORD. CASH (Small Type) (No Ad Less Than 25c)
Figure at One Rate Only—See Note Below.

At Liberty—A-1 Violinist, Experienced theatre, hotel and concert musician, leader or side man. VIOLINIST, 504 North Elm St., Champaign, Ill. feb28

A-1 Leader (Violin) A. F. of M. First-class theatre, vaudeville and pictures preferred. Excellent library. 10 years' experience. Kindly state particulars. W. D. WALKERMAN, 46 Park St., Buffalo, N. Y.

A-1 Lady Violinist—Real Musician, experienced. Must give two weeks' notice. RUBY GENOLIN, 1121 N. New Jersey, Indianapolis, Ind. feb28

A-1 Violinist at Liberty—Experienced in vaudeville and pictures. WM. HORVATH, 21 Basket Ave., Braintree, Pa.

Accordion Player—Stage or orchestra. Address ACCORDION PLAYER, 6033 Saginaw St., Detroit, Mich. mar11

Alto Saxophone Doubling Bb soprano Clarinet. Pop, appearance, 23 years old, tone reader, experienced vaudeville or dance as straight sax man. Group or locate. Union. Wire SAXOPHONIST, 1528 Kenmore Blvd., or write Box 888, Kenmore, Ohio.

At Liberty—A-1 Trumpet, double Eb Sax. Experienced pictures and vaudeville. Address MUSICIAN, General Delivery, Huntington, W. Va.

At Liberty—Alto Sax., Doubling Clarinet, Baritone Sax. Legit. and honkum. C-BOX 758, care Billboard, Cincinnati.

At Liberty—Experienced drummer, bell and xylophone. Dance or motion-picture house. A. E. of M. Single, sober and reliable. Write or w/p. C. J. MILLER, 308 East Chalmers, Champaign, Ill.

At Liberty—Theatre Organist. Have had some experience on two Manual and Pedal Organs. Will accept a low salary job in order to gain more actual experience. Union. Please state all, addressing EDWIN WALKER, 1048 Clark St., Stevens Point, Wisconsin.

At Liberty—Trumpet. Union Troupe or locate. THOS. GARDNER, care Billboard, Chicago.

At Liberty—Clarinet. Experienced vaudeville and pictures. Union. G. E. WAGNER, 718 Maume St., Wheeling, West Virginia. mar7

At Liberty—Organist for Im-mediate engagement. Give pictures properly, play feature songs. Live in Liberty. CARL STEFFEY, 737 West Linn St., Shelbyville, Ind.

(Continued on Page 62)

At Liberty—Violinist.

Schooled and experienced musician. Pleasing tone. Age 26. Union. VIOLINIST, 1329 North...

At Liberty—Organist and Orchestra Pianist

Organ preferred. Fifteen years' experience in pictures. Splendid Library (organ) late of Howard Theatre, Atlanta (organ) and French...

At Liberty—Drummer and Pianist

Women, experienced in best music and with best references. Pianist can direct. Drummer plays xylophone. BOX 4260, Takoma Park, District of Columbia.

Band and Orchestra Conductor

or conservatory trained. Twenty years' experience. Best of references. Desires position with municipal, college or school band. Will come for trial. Address S. KOOYMAN, Mar 7

Cellist — Double Trombone.

Prefer combination house. Experienced. Union. CELLIST, 3900 Huntington Ave., Newport News, Va.

Cellist for Vaudeville or Legitimate House

Young, neat, reliable, union, working now but desires change. Address CELLIST, Box 267, Sumbury Pennsylvania.

Clarinetist — Experienced.

wishes theatre or other steady position. Union. "CLARINETIST", Box 439, Gadsden, Alabama. mar21

Competent Violin Leader or Side Man

with large library for perfect picture cello or horn. Prefer position with good orchestra where good music is appreciated. Can furnish other good musicians if necessary. Union. Wire ARTHUR SELLS, 4436 Noble St., Bellaire, Ohio.

Competent Violin Leader

Wishes position in reliable picture house or hotel. Large library for perfect picture cello. Can furnish fine Cellist, Pianist and Drummer with tymp. Prefer permanent engagement where good music is appreciated. Union. Wire CHAS. L. McKEE, 8016 Crumb Ave., Cleveland, Ohio.

Dance Drummer — Plenty Experience

reliable, go anywhere, photo. CAL HOLDEN, Milford, Iowa.

Drummer, Circus and Carnival

experience. Either drum, reliable, read spots. DICK BLANCHARD, 521 Wabash, Kansas City, Mo.

Drummer—Tymp, Bells, Xylophone

for theatre; union. Wife good or orchestra pianist, doubles organ, with large library. Joint or separate. South preferred. Two weeks' notice required. Write or wire PERCUSSION, Billboard, New York City.

Experienced Lady Clarinetist

for coming season. Sax, if necessary. Sight reader. Troupe or locate. Address BEATRICE COBB, care Billboard, Cincinnati.

Experienced Clarinet for Pictures or Vaudeville

CLARINET, 69 East Seventh Ave., Columbus, Ohio.

Flutist—A-1, Experienced All Lines

reliable. Address ED TONAR, 1612 Topeka Ave., Topeka, Kansas. feb28

French Horn—Experienced in Pictures and Bands

C-BOX 747, care Billboard, Cincinnati, Ohio. feb28

Leader (Violin) or Sideman

Long experience, pictures, vaudeville, etc. Large library; union. LEADER, 1 Walnut St., Hudson Falls, New York. feb28

Organist—Absolutely A-1, Reliable Union

Library, married, congenial, can correctly picture only. Don't care present State salary. PAUL JONES, Lees Summit, Missouri.

Organist — Expert, Reliable.

Long experience playing pictures; desires change but has large library; best references. LEON YACKLY, Box 212, Carlisle, Pa. mar21

Organist at Liberty—18 Years' Experience

picture work, also orchestra and accompaniment. References given. A. F. of M. C-BOX 749, care Billboard, Cincinnati.

Trombone for Real Band—Recording Experience

plenty. Use so-called "tub tone". Read, fake, improvise, break choruses. Wire JIMMIE FRESHOUR, 196 Lee St., Tampa, Florida.

Trumpet Player on 2 Weeks' Notice

picture or vaudeville orchestra; experienced; reliable; age, 30. C-BOX 753, care Billboard, Cincinnati. mar7

Trumpet — Hot, Legitimate.

double saxophones and arranger. Nothing less than \$70.00 considered. Recognized recording orchestra preferred. Address C-BOX 754, Billboard, Cincinnati.

Trombonist at Liberty—Had Experience

with vaudeville and dance bands. Young and reliable; troupe or locate. Can furnish red hot dance pianist. Please allow time for mail to be forwarded. Where are you, Joe? NEILL H. HARTLEY, Quaker City, Ohio.

Trumpet — Experienced Pictures

vaudeville and road shows. At Liberty on two weeks' notice. Union, sober, reliable. For season or permanently. C-BOX 756, care Billboard, Cincinnati, Ohio.

Violinist Desires Position in Town

of six or eight thousand. Anything considered. CARL MCGOWAN, Lexington, Mo.

Young Sax Player — Doubles

Clarinet, Alto and Sop. horns. 22, neat, personality, dependable, tuxedo, nonunion, but will join; vaudeville experience. Want steady job where reading and execution is appreciated. Travel or locate. Write at once. MUSICIAN, 317 N. Warman Ave., Indianapolis.

A-1 CLARINETIST FOR BAND AND ORCHESTRA

CLARINETIST, 54 Second St., Piquette, Ohio.

A-1 LADY PHOTOFLAYER-PICTURE ORGANIST

Good library; experienced in cello movies; union; reliable. BOX 383, Marion, Ky.

A-1 ALTO SAX—THEATRE, VAUDEVILLE

and picture experience. Need cello. Address E. BURKE, 1217 Neosho, Emporia, Kansas. mar7

AT LIBERTY—A-1 EXPERIENCED VIOLINIST

and leader. Experienced in pictures, vaudeville and symphony work. Carry \$2,500 library. Member A. F. of M. Address C-BOX 726, care Billboard, Cincinnati, Ohio. feb28

AT LIBERTY IN TWO WEEKS. EIGHT YEARS' BAND

and orchestra experience, doubling clarinet and violin; good singer; union; read and fake. Write or wire best offer. Traveling or permanent. ANDY ANDERSON, P. O. Box 166, Cambridge, Ill. feb28

AT LIBERTY—CORNETIST FOR FACTORY

or municipal band. CLARENCE A. SHOUP, Eminton, Pa. feb28

BANDMASTER—A-1 CORNETIST. UNION.

Library. Young man. Will travel. Circus, carnival, good shows write. JOSEPH CARUSO, 1153 Oak St., San Francisco, California.

BANDMASTER—WISHES LOCATION WITH EITHER AMATEUR

or professional band. Authority on brass and reeds. Instructor of harmony and counterpoint. Only salaried positions considered. Prefer either Michigan or Wisconsin, but will consider other States. Address EMPRESARIO, care Billboard, New York. mar7

BASSONIST AT LIBERTY—ROUTINED PICTURES

theatre or concert band. 25 years' experience. 12 years' British Army Band training. Would consider good industrial organization. What have you to offer? Union. Address W. J. SPARLING, care E. Young 175-21 Jamaica Ave., Jamaica, L. I., New York. mar21

CIRCUS FRENCH HORN OPEN FOR ENGAGEMENT

for coming season. Write. MUSICIAN, 18 Elm St., Webster, Mass. mar7

LONG RUN MUSICAL PLAY RECORDS

Number of consecutive performances up to and including Saturday, Feb. 21.

IN NEW YORK

Table with columns: PLAY, STAR, THEATER, OPENING NO. OF DATE, PERFS. Lists various plays and their performance counts.

IN CHICAGO

Table with columns: Artists and Models, STAR, THEATER, DATE, PERFS. Lists plays and performance counts.

IN BOSTON

Table with columns: PLAY, STAR, THEATER, DATE, PERFS. Lists plays and performance counts.

IN PHILADELPHIA

Table with columns: PLAY, STAR, THEATER, DATE, PERFS. Lists plays and performance counts.

A-1 TROMBONIST WITH MUSICAL SHOW AT Liberty April 1. I do not insist present. C-BOX 751, care Billboard, Cincinnati.

A-1 CLARINETIST—BAND AND ORCHESTRA experience, double Alto Sax, desires permanent location. Address C. BURNAP, 628 Washington, Emporia, Kansas. mar7

AT LIBERTY—HOT TROMBONE. DOUBLING euphonium with plenty rhythm. Feature plenty humor and pretty solos. Play any trombone part on records. Have personality; tone; know harmony; fake everything, but don't read. State your highest and all particulars. No road work. Address C. P. TROMBONE, Gen. Del., Lakeland, Fla.

AT LIBERTY, ABOUT APRIL 1. DRUMMER—Carnival, rep. or dramatic. Prefer carnival and share in band. Double B. & O. Good outfit traps. Reliable and sober. Read or fake. References. Reliable parties only write. DRUMMER, Real Art Theatre, Puxbo, Mo.

AT LIBERTY—VIOLIN, PIANO, DRUMS AND Cello. Cello doubling clarinet. Will consider summer resort, hotel or picture house. HAYDEN JONES, 305 Richmond Ave., Morgantown, West Virginia.

A-1 BANJOIST—UNION. YOUNG. NEAT and reliable. Would like to join dance orchestra, hotel or summer resort preferred. Will be at Liberty March 15. Address ERMAR PICKENS, 1409 1/2 Second Street, Ft. Madison, Iowa.

CELLIST—ABSOLUTELY COMPETENT IN every line; nice broad tone; can double banjo or second saxophone; desires a permanent engagement. Address S. HOUSTON, Gen. Del., Dayton, Fla.

CLARINET-PIANO—JOINT OR SEPARATE. Long orchestra experience. Address MUSICIAN, 4121 So. 23d, Onisia, Neb.

CONCERT-THEATRE ORGANIST INVITES correspondence from theatre managers desiring the services of a first-class, experienced picture player and soloist of unquestioned ability. Musician of international reputation. Good, modern instrument essential. Exceptionally fine library. Union man. Wire or write full particulars. ORGANIST, Room 224, Princess Hotel, Atlantic City, New Jersey.

DANCE DRUMMER TO LOCATE AT ONCE IN West. Gold outfit; read and fake; union; age, 21; neat; pep; personality. State best offer. FRANCIS CLESTER, Chillicothe, Ohio. feb28

DRUMMER—UNION. AGE, 26. MARRIED. British Army band, also pictures, concert and dance experience. State salary, particulars. GEORGE PEARSON, 2216 Dover Ave., N. E., Canton, Ohio. feb28

LADY CORNETIST—VAUDEVILLE AND Chautauqua experience. Desires looking with good band or orchestra. Available for immediate engagement. Age, 29. MUSICIAN, 325 W. Crawford St., Findlay, Ohio.

EXPERIENCED ORGANIST DESIRES POSITION

at once. Large library of music. Pictures, carefully. Address LOUISE H. DEAGAN, care Gen. Del., Atlanta, Ga. mar7

FLUTE AND PICCOLO AT LIBERTY—DOUBLES

also saxophone. Union. Experienced. C. CASTEL, 1322 Buchanan Ave., St. Joseph, Missouri.

FLUTE AND PICCOLO—EXPERIENCED. DESIRES POSITION

in concert, orchestra or band. Location or traveling. FLUSTIT, 1335 Cypress St., Pueblo, Colorado.

FUTE PICCOLO WOULD LIKE TO LOCATE WITH SHRINE BAND

and references; union. C-BOX 700, care Billboard, Cincinnati. feb28

HOT TRUMPET AT LIBERTY—READ, HARMONIZE

or fake. Any amount of hot stuff. Wire or write at once. Specialize in "low down". Can hit the top ones. Also furnish equally hot trombone. We do not carry records, but make up our stuff. LES COOK, 615 Washington St., Pittca, New York.

LEGITIMATE STYLE VIOLINIST—TALENTED, SCHOOLED

experienced. Young; sober; reliable; union. Prefer side with real piano leader. Anywhere if permanent. Wire, write. A. H. FRY, Independence, Mo. mar7

ORCHESTRA PIANIST—EXPERIENCED ALL LINES

45; good appearance, etc. Play pipe organ, teach piano and vocal. State particulars. F. J. LAPIERRE, Pianist, Gen. Del., Little Rock, Ark. feb28

ORGANIST—A-1. WANTS TO SECURE PERMANENT POSITION

on any good organ. Can give pictures correctly and good pianist for vaudeville. Am married. State salary and hours. ORGANIST, Terminal Hotel, Wilson, North Carolina.

TRAP DRUMMER AT LIBERTY—CAN DELIVER THE GOODS

Union man; single; age, 29; theater dance experience; xylophones; references furnished. DRUMMER, Celania's Cafe, Ottumwa, Iowa.

TRAP DRUMMER—PLAYS BELLS, XYLOPHONE, TYMP

Really play and complete line traps. One thousand-dollar outfit. Wife, or orchestral pianist. Sight reader. Play anything. Prefer small combination picture house. Reasonable expense for this ad. Union. Reliable. Must give two weeks' notice. Very reasonably joint. C-BOX 755, care Billboard, Cincinnati.

TRUMPET AT LIBERTY—THOROUGHLY CAPABLE

and experienced. Will locate or travel. Address TRUMPET PLAYER, 137 West 64th St., New York City.

TRUMPET AT LIBERTY FEBRUARY 21. BY ONLY

Union. 8 1/2 years' vaudeville and pictures. State salary, particulars. TRUMPET, 32 E. State, Gloversville, N. Y. feb29

TRUMPET—EXPERIENCED ROAD OR PICTURES

Address TRUMPETER, 3443 West-hampton Ave., Richmond, Va. feb29

TRUMPET—EXPERIENCED. WISHING THEATER POSITION

in or near New York City. Pictures and vaudeville preferred. ENSLE, care Billboard, New York.

VIOLINIST-LEADER, GENERAL BUSINESS, EXCELLENT LARGE LIBRARY

Union. Married. family. Small place preferred if permanent. Years of experience. Pictures special study. Absolutely reliable. VIOLINIST, Tribune Apts., Tipton, Indiana. feb28

VIOLINIST-LEADER OR SIDE FOR PICTURE HOUSE ANYWHERE

Fine tone, wide experience, good library. BOX 148, care Billboard, 1183 Broadway, New York City.

VIOLINIST AND STRING BASS AT LIBERTY.

E. GASKELL BUNTYN, Memphis, Tenn. x

A-1 ORGANIST OR PIANIST DESIRES TO MAKE CHANGE

Long experience in pictures or vaudeville. Like to locate in New Mexico, Arizona or Colorado. Good health; union. Address ORGANIST, 1807 N. 5th St., Terre Haute, Indiana.

AT LIBERTY—A-1 Baritone Player. Prefer engagement with concert band

Address D. CARRA-FIELD, 822 Bowen Ave., Chicago, Illinois. mar14

AT LIBERTY—Musical Director, moving picture theatre and concert band

wishes to locate permanently. Best references. Address MUSICAL DIRECTOR, 434 E. 43d St., Chicago. mar21

A-1 Eb SAX, doubling "Hot" and Legitimate

Clarinet, desires connection with good dance orchestra. Formerly at Merry Gardens and other Chicago "high spots". Collegiate type. Am also capable manager, director and teacher. Write today! full particulars first letter, please, and state best offer. Those who write before please answer; best mail. A. T. N., care Billboard, Chicago.

CELLIST WISHES STEADY ENGAGEMENT. REAL MUSICAL TONE

experience, young, reliable. Notice required South, west Double Sax. Salary your best. Address C-BOX 724, Billboard, Cincinnati. feb28

COMPETENT VIOLINIST-LEADER OR SIDE MAN

with good library and twenty years' experience in all lines. Desires permanent theatre engagement. Address J. MARTIN, 451 East 14th St., New York City. mar7

MUSICIANS AT LIBERTY—Violinist, leader, side

big tone, age thirty. Experienced pictures, vaudeville, dance. Fast reader; reliable. Good library. Double other instruments. Address VIOLINIST, C-Box 724, Billboard, Cincinnati. feb28

TROMBONIST—Experienced; vaudeville, theatre and band

Age, 21; union. Address TROMBONIST, 1220-50 E. 47th St., Chicago, Illinois.

TRUMPET AT LIBERTY—Locate or travel. Trumper

absolutely reliable. I also have for sale some good band music; to junk. Books are in fine shape. A big bargain. Write for list and price. Address F. C. WILLIAMS, General Delivery, Penitentiary, Ind.

VIOLINIST AND CELLIST, both experienced and competent

professional musicians, seek work; music, clerical or anything; Canada only. COOPER, 31 St. Mark, Montreal, Canada. mar14

YOUNG LEGITIMATE TROMBONE WANTS TO LOCATE

Experience in H. and O.; soloist in both. Last place the Army Band, Washington, D. C. Stale music or stalling. Correspondence limited. MELVIN M. SHOOT, Juanita, North Dakota. mar7

NOTE—Cancel All Words. Also Combined Initials and Numbers in Copy. Figure Total at One Rate Only. IN ANSWERING CLASSIFIED ADS, PLEASE MENTION THE BILLBOARD.

YOUNG VIOLINIST, age 25 would like to locate in a town where there is a good opening for a teacher of Violin and Saxophone and playing in theatre at night. Address VIOLINIST, 716 Bristow Street, Belleville, Illinois. feb28

AT LIBERTY
PARKS AND FAIRS
5c WORD, CASH (First Line Large Black Type)
2c WORD, CASH (First Line and Name Black Type)
1c WORD, CASH (Small Type) (No Ad Less Than 25c)
Figure at One Rate Only—See Note Below.

Park Manager Invites Offers.
Promoter of publicity, picnics, celebrations, fireworks, exhibitions and excursions. RACE MACKLIN, P. O. Box Delivery, Indianapolis, Indiana.

The Original Rube Perkins.
Lady and gentleman. Three real feature acts. Parks, celebrations. Holton, Kansas. June 13

AT LIBERTY FOR PARKS AND FAIRS—TWO feature acts. Reliable Weaver's Act Supreme. Beautiful white Arabian horse, dogs and people presenting famous scenes in staturary. High-class dog and pony act. Now booking. Cortland, New York. mar7

AT LIBERTY—TWO DE VIERTEL BROS. original gnomish killers. Three feature acts. Reliable agents and secretaries write. 413 North Seventh Street, Manitowoc, Wis. feb28

BONETTE BROTHERS, FAMOUS AERONAUTS.
Have open time for parks, fairs and celebrations. Three big feature attractions. Send for description and prices. Permanent address Bradford, N. H. mar7

GROTH BROS.—FOUR BIG FEATURE FREE acts and a balloon for fairs and celebrations. We furnish entire program. Write for literature. Charter Oak, Iowa. sept3

TWO EXCELLENT ACTS FOR INDOOR CIRCUSES, parks and fairs. Lady and gentleman. Finest of wardrobe. LASERE AND LASERE, Carey, Ohio. mar7

GAYLOR BROS.—Four free acts; fairs, celebrations: two acrobatic frolics, European band-head balancers, Chinese novelty equilibrist. Comedy troupe of four 2018 15th St., Detroit, Michigan. June 27

STEPHENS AND MELVIN COMBINATION—Three high-class acts, tight and slick wire, contortion, hand balancing and juggling. One lady, two men secretaries and managers in Ohio, New York, Pennsylvania, Michigan, Indiana and Ontario. Write care The Billboard, Cincinnati, Ohio. mar7

AT LIBERTY
PIANO PLAYERS
5c WORD, CASH (First Line Large Black Type)
2c WORD, CASH (First Line and Name Black Type)
1c WORD, CASH (Small Type) (No Ad Less Than 25c)
Figure at One Rate Only—See Note Below.

A-1 Pianist-Leader — Perfect
Young; large library; go anywhere; state all. AL. MORTON, Lawrence, Kansas.

Pianist—Experienced, Vaudeville, pictures, dance or concert. Available after April 5. A. F. of M. MUSICIAN, 3 Glenwood Ave., Dayton, Ohio.

AT LIBERTY—MALE PIANO PLAYER FOR med. shows. No wires. Address PIANIST, 1 Stacer Ave., R. R. 2, Evansville, Indiana.

AT LIBERTY—PIANIST AND DRUMMER.
Young married couple desires position in restaurant or dance orchestra. Union. Plenty experience. State salary. Address MUSICIANS, 1420 Pine Ave., Mattson, Illinois.

AT LIBERTY—PIANIST AND VIOLINIST.
double sax, experienced and reliable; library for pictures, etc.; cue perfectly; references; latest popular music. M. CLARK, Gales, Tenn. mar7

AT LIBERTY—PIANIST, SIGHT READER,
for traveling vaudeville show. Experienced and reliable. Can join on wire. A. L. CRAIG, 211 W. 22d St., New York City.

AVAILABLE—EXPERIENCED YOUNG MALE pianist. Union; leader; double stage; quartet; hotel, dance, vaudeville. Travel, locate. "RUD" HARMON, 311 42d St., Newport News, Virginia.

PIANIST—READ, FAKE, IMPROVISE. Double cornet some. Play comedy in acts. Can sing some. Location preferred. Age 28; male; white; also black-face, rube. C. W. HODGKINS, 111 W. Neptune St., West Lynn, Mass.

PIANIST—28. UNION. THOROLY EXPERIENCED dance, ballad or vaudeville act. Lead or side. Head, lute, transpore, arranger. Locate or troupe. Absolutely first class. HARRY LUDWIG, Hotel Hermitage, Nashville, Tennessee. feb28

AT LIBERTY—Most excellent Orchestra Pianist.
Hotel, pictures, vaudeville. Address J. MATZEK, 101 1st St., Milwaukee, Wisconsin. mar7

PIANIST—Well experienced in all lines. Nice piano library. Pictures, vaudeville. Nearby preferred. Union. State salary and particulars. JOHN OTTO, 55 Bonner St., Dayton, Ohio.

AT LIBERTY
VAUDEVILLE ARTISTS
5c WORD, CASH (First Line Large Black Type)
2c WORD, CASH (First Line and Name Black Type)
1c WORD, CASH (Small Type) (No Ad Less Than 25c)
Figure at One Rate Only—See Note Below.

Baritone Singer — Quartette,
vaudeville or lab. show. Sober and reliable; light 10 ft.; weight, 180. Wire, write. R. L. KIMBLE, 23 N. Oxford Street, Indianapolis, Indiana.

Classy Female Impersonator
Playing vaudeville. EMIL WALTER, General Delivery, Birmingham, Ala.

AT LIBERTY—ALL AROUND MAN. CAN dance, sing, whistle, acrobat and ventriloquist. Will join standard act, show or partner. HARRY POSNACK, 318 Thurford Ave., Brooklyn, N. Y.

AT LIBERTY, for med. change for week, Black, some dancing, good singer, all acts. Good hustler. Real oddities. Ticket JIM LELAND, 2414-A N. Broadway, St. Louis, Missouri.

AT LIBERTY—Versatile Singing and Dancing Comedian. Change for a week Blackface, Irish, etc.; Alto Horn in band. HARRY B. WESLEY, Gen. Del., Memphis, Tennessee.

AT LIBERTY—Young Male Pianist for musical talk, vaudeville or repertoire. Can double stage. Neat appearance on and off. GORDON KEITH, 188 Mitchell, South Dakota.

Acts Written — Stamp for terms. J. R. LAYDEN, 256 West 44th Street, New York City.

A Good Act Brings Fame and fortune. No artist ever achieved success with poor material. It will pay you to get in touch with us. CARSON AND D'ARVILLE, Vaudeville's Leading Authors, 560 West 179th, New York City.

"COMEDY CHATTER" PUBLISHED NEW weekly, 50c; Monologues, \$1.00; 150 Snuff-Box Gags, 50c. Special material reasonable. Sample and price list, 10c. GUSTUS SMITH, Box 224, Essex Street, Boston, Mass. mar14

AGENTS AND SOLICITORS WANTED
7c WORD, CASH. NO ADV. LESS THAN 25c.
9c WORD, CASH. ATTRACTIVE FIRST LINE.
Figure at One Rate Only—See Note Below.

Advertisers — 25 Words, 50 magazines, \$2.00. World-wide circulation. Proof furnished. JOHN R SERVICE, 1827 Fullerton, Detroit.

Agents, Crew Managers, Sheet writers make \$50 daily with our \$1.85 "Cash Deposit Coupons". Samples free. SOHRE, Box 1356, Richmond, Va. mar7

Agents, Demonstrators — New figure Chas. Chaplin, 15 inches high, does funny stunts, dances, more fun than Cine. Just what the kids want. Trial order, 6 for \$1.10; doz. \$2; gross, \$18.50 W. PFEIFFER, Apt. 701, Havana, Cuba.

Agents—Latest Rage, 300,000 quickly sold. Nickel, gold types. Plain or fraternal emblemized handy holder for safety razor. Popular prices. Liberal proposition. Write today. LADIS L. BUCHEK, 95 Munson St., Astoria, Long Island, N. Y. mar14

Agents — Monogram Automobiles, 15 million prospects, \$1.40 profit every \$1.50 sale. Will be made \$29.50 first day. Free samples. WORCESTER MONOGRAM CO., 1718, Worcester, Mass. x

Agents To Sell "Little Wonder Check Protector", vest-pocket size. Perforates amount in figures through written amount on dollar line of check. A money maker for live agents, 200% profit. Exclusive territory. Details, 50c. Sample and terms, 50c. PIQUA CHECK PROTECTOR CO., Piqua, O. x

Big Money Selling New Household Cleaning Set. Washes and dries windows. Sweeps, scrubs, mops. All complete, only \$2.95. Over half profit. Write HARPER BRUSH WORKS, 329 Grimes St., Fairfield, Iowa. feb28

Canvassers, Fair and Medicine men. Excellent proposition. WEIL'S INDIAN TEA, 211 West 30th St., New York.

Card Signs for Every Business. Big profits for agents. Sample, 10c. SIGNS, 819 St. Louis, New Orleans. mar7

Cash in on X-Word Craze. Fascinating new Crossword Game. Copyrighted. 400% profit. Act quick. Sample, 25c (incl. postpaid). BOX 190, Sioux Falls, South Dakota. mar7

Earn Big Money Fast Applying Gold Initials to Autos. Every owner buys. \$1.35 profit on \$1.50 sales. Extra orders and samples free. Write quick. LITHOGRAM CO., Dept. 19, East Orange, N. J. x

Enormous Profits for Dealers handling our second hand clothing line. We also start men and women in this business. Experience unnecessary. AMERICAN JOBBING HOUSE, Dept. 10, 2036 Grand Ave., Chicago. feb29

Ku Klux Klan Agents Koining money selling Klan jewelry. Dime brings lucky Kluxer Pocketpiece and Katalog. BOX 524-B, Omaha, Nebraska. mar19

Large Manufacturer Wants agents to sell shirts direct to wearer. Exclusive patterns easily sold. No capital required. Whole or spare time. Experience unnecessary. KALENDER SPORTSWEAR CO., 5438 Broadway, New York. mar24

Marvel Foot Remedies — Big profits. Fast sellers. Send for price list. ANCO LABORATORY, Canton, Ohio.

Nationally Known Manufacturer wants men and women representatives everywhere. Make \$5 to \$25 daily selling our famous Jural Household necessities. No experience necessary. WILLIAMS CO., 110 Pine, Montclair, N. J. x

Superior Rubber Weld. The only rubber weld on the market. Sample can, 50c. No stamps accepted. Agents wanted. R. W. SMITH COMPANY, 1874 E. 20th, Cleveland, Ohio. mar28

The Agents and Buyers' Guide tells where to buy everything. Copy, 50 cents. WILSON, Box 74, Madison Square Station, New York.

Wonderful Invention Eliminates Needles for Phonographs. Preserves records. Abolishes scratching. Day's supply in pocket. \$20 daily. Sample on approval if requested. EVERPLAY, Desk C2, McClurg Bldg., Chicago. feb29

AGENTS—A REAL LINE OF HOUSEHOLD Specialties that will sell and repeat. New articles, novel devices and new methods of selling; also a splendid Easter proposition. Catalogue free. REX SPECIALTY CO., Est. 15 years, 511 N. 10th St., Philadelphia, Pa. x

LONG RUN DRAMATIC PLAY RECORDS

Number of consecutive performances up to and including Saturday, Feb. 21. IN NEW YORK

Table with columns: PLAY, STAR, THEATER, OPENING NO. OF DATE, PERFS. Lists various plays like 'Able's Irish Rose', 'Ariadne', 'Badges', etc. with their respective theaters and performance counts.

IN CHICAGO

Table listing plays in Chicago such as 'Applesauce', 'Big Mogul', 'High Stakes', etc., with theater names and performance counts.

IN BOSTON

Table listing plays in Boston such as 'Beggar on Horseback', 'New Browns', 'Peter Pan', etc., with theater names and performance counts.

IN PHILADELPHIA

Table listing plays in Philadelphia such as 'Fandance', 'Grounds for Deceit', 'Moon Music', etc., with theater names and performance counts.

CLASSIFIED COMMERCIAL ADVERTISEMENTS. A large rectangular box with decorative borders containing the text 'CLASSIFIED COMMERCIAL ADVERTISEMENTS'.

ACTS, SONGS AND PARODIES
5c WORD, CASH. NO ADV. LESS THAN 25c.
9c WORD, CASH. ATTRACTIVE FIRST LINE.
Figure at One Rate Only—See Note Below.

Acts of Every Description —
Written to fit you with pep and punch. Vaudeville acts, minstrel, productions written and staged. LEWIS AND BELMORE, Box 189, Times Square Station, New York City.

NOTE—Count All Words. Also Combined Initials and Numbers in Copy. Figure Total at One Rate Only. IN ANSWERING CLASSIFIED ADS, PLEASE MENTION THE BILLBOARD.

AUTHORS' SCRIPTS DUPLICATED. 50-LINE page, 100 copies, \$1.00. Extra hundreds, 50c. VIN SULLIVAN, 225 West 23d St., New York. mar7

"DORA'S VINDICATION", ALSO "THE WIZARD and the Woman", two brand-new plays with strong plot and sure-fire comedy which can't be beat. Also other sensational Sure-Fire Melodramas, cast 3-3, 4-2 and 3-2. Great for "one nighters", stock or tent shows. New catalogue for stamp. WOODARD PLAY CO., East Toledo, Ohio.

INTRODUCING GREAT MONOLOGUES FULL of laughs. Worth \$10.00; price, \$1.00. J. NEUMANN, 1715-A Iowa Ave., St. Louis, Mo.

MUSIC ARRANGED FOR ANY COMBINATION under guarantee of absolute satisfaction. Copyrights secured. Submit scripts for estimate and free advice. WALTER W. NEWCOMER, 1054 Broadway, New York. feb28

SHORT-CAST DRAMAS, FARCES AND MUSICAL TALKS; Comic Songs, Monologues, Vaudeville Acts; Hit Book, \$3.50. BANNER, 2061 Market Street, San Francisco, California. april

(Continued on Page 64)

AGENTS- ACTORS, SALESMEN-ASK YOUR... suggest for "Pep-Ling-Ton", the delicious... table tonic, send 10c for samples. PEP-... GIVING PRODUCTS CO., 51 Crawford Ave., Newark, New Jersey.

AGENTS-ANN PENNINGTON GARTERS FOR... rolled stockings. Hides the roll. Wonderful... flash. Millions will be sold. Every girl and... woman wants them. Rush your order and get... started. Sample pair, one dollar; dozen pairs... \$6.00; wonderful assorted colors. Satisfaction... guaranteed. F. J. LOESCH, Distributor, 20 W. 34th St., New York City. feb28

AGENTS-BANKRUPT STOCK, HOSIERY... Shoes, cheap. Bargain list for stamp. CAR-... RIGAN JOBBING HOUSE, 359 N. Sherman Drive, Indianapolis.

AGENTS-BE INDEPENDENT. MAKE BIG... profits with our Soap, Toilet Articles and Household Necessities. Get free sample case offer. HO-RO-CO, 2704 Dodier, St. Louis, Missouri. feb28

AGENTS-BEST SELLERS, JEM RUBBER... Repair for tires and tubes. Supercedes vul-... canization at a saving of over 800 per cent. Put it on cold. It vulcanizes itself in two... minutes and is guaranteed to last the life of the... tire or tube. Sells to every auto owner and... accessory dealer. For particulars how to... make big money and free sample address... AMAZON RUBBER CO., Dept. 706, Philadelphia, Pennsylvania. feb28

AGENTS-JUST OUT. POWDERED SUBSTI-... tute for gasoline, non-explosive. Eight-... ounce package makes eight gallons fluid. Re-... tails 25c; 100 per cent profit. Big repeater;... exclusive territory. 25 cents brings sample... terms, etc. LIBERTY SALES COMPANY, 665 Newark Avenue, Jersey City, New Jersey. x

AGENTS-LATEST RAGE, 300,000 QUICKLY... sold. Nickel, gold types. Plain or Praterial... Embossed Handy Holder Safety Razor. Popu-... lar prices. Liberal proposition. Write today. LADIS L. BUECK, 35 Munson St., Astoria, Long Island, New York. mar14

AGENTS-MAKE \$100 WEEKLY. FREE SAM-... ples. Genuine Gold Window Letters. No expe-... rience. METALLIC CO., 412 North Clark, Chicago. x

AGENTS MAKE 500% PROFIT HANDLING... Auto Monograms, New Pictures, Window Let-... ters, Transfer Flags, Novelty Signs. Catalog... free. HINTON CO., 1133 N. Wells St., Chi-... cago. x

AGENTS-MAKE \$90.00 WEEK FULL TIME;... \$25.00 to \$40.00 week spare time. Establish... permanent business of your own. All-Wool... Men's Suits, \$24.75; Boys' Suits, \$9.75. Direct... from factory to consumer. Liberal commission... paid in advance. We deliver and collect. Old... house, established 1882. Guarantee absolute... satisfaction or money back, quick. Write to-... day for free sample outfit and full particulars. JOHN G. LONGWORTH & SONS, 1301 W. Congress St., Dept. 54-CU, Chicago. x

AGENTS-MEN AND WOMEN. 35 MILLION... women are anxiously waiting to buy the... 3-in-1 Hot Water Bottle-Icebag-Fountain Sy-... ringe Combination. Commission daily. No... delivering. Write for startling money-making... plan. LOBL MANUFACTURING CORPORA-... TION, Middleboro, Massachusetts. feb28

AGENTS-QUIVERA GOLD BEAUTY CLAY... Direct from beauty clay deposits. Sure hit. Agents, write for prices. Sample bottle to... agents, 50 cents. M. STEVENS WAGNER, Clements, Kansas. mar7

AGENTS-SELL EMBLEM BELTS TO LODGE... members. An article of merit, but not of... excessive price. Write EMBLEM BELT CO., Dept. T, Ashland, Ohio.

AGENTS-SELL MEN'S SUITS, TOPCOATS... and Raincoats. Make \$15.00 to \$25.00 daily. We... undersell stores. Free selling outfit starts... you in business. HENRY W. HIGH CO., 306 So. Franklin, Dept. 560, Chicago. x

AGENTS-SELL OUR BLEACHING CREAM TO... the colored trade. Big hit; placing wide-... awake persons on easy street. PRIMAL... CHEMICAL CO., Indianapolis, Ind. feb28

AGENTS-SELL OUR USEFUL, ATTRACTIVE... Household Specialties. Housekeepers want... and are glad to buy. Steady sellers, larger... profits. CENTRAL MFG. CO., Dept. C, Lynn, Massachusetts.

AGENTS-SEND FOR CATALOG TOILET... Requisites, Food Extracts, Hoses, Kitchen... Tools, Soaps, Perfumes, Face, Dental, Beauty... and Parade Cream, Toilet Combinations, Photographs, Enlargements, Pillow Tops, Frames, Medallions, Sweet Pictures, on credit. JAS. C. BAILEY, Desk G, Chicago. x

AGENTS-SOMETHING NEW. WITH WAL-... ton-Duplex you sell two shirts for price of one. Make \$15.00-\$25.00 daily. We deliver... Write for your opportunity. WALTON-DU-... PLEX CO., 1-3 Brooks Bldg., Chicago. mar7

AGENTS-TWO FAST SELLERS, BIG PROF-... its. Samples, 10c. MODERN SPECIALTY CO., 315 So. Broadway, St. Louis, Mo. feb28

BUILD SPLENDID BUSINESS MAKING... Chipped Glass Number and Name Plates. Particulars free. SIMPLEX CO., Dept. 97, 1133 Broadway, New York. mar7

DEMONSTRATORS-DARNERS, FITS ALL... Sewing Machines, \$10.00 and up sets. Good... sellers. Sample, 25c. A. COLBERT, Box 518, Ocean Park, California. mar11

EARN \$10 DAILY SILVERING MIRRORS... Plating, Refinishing Metalware, Headlights, Chandeliers, Stoves, Tableware, Bedsteads (out-... fits furnished) ROBERTSON-DECIE LABORA-... TORIES, 1133 Broadway, New York. feb28

FORTUNE MAKER-THREAD-CUTTING... Thimble. Everyone buys. 25c seller; \$7.50 gross; prepaid. Sample, 15c. AUTOMOTE MFG. CO., 3773 Montebello, Calago. mar21x

ENORMOUS PROFIT-RIDS FOWLS OF ALL... insects and disease. FISHER, Weatherford, Texas. mar21

FREE BOOK-START YOUR OWN LITTLE... Mail Order Business. Beginners' outfit fur-... nished. PIER, 873 Cortland St., New York. x

GET OUR FREE SAMPLE CASE-TOILET... Articles, Perfumes and Specialties. Wonder-... fully profitable. LA DERMA CO., Dept. RK, St. Louis. feb28

GUARANTEED PRODUCTS USED BY EVERY... body and repeats. 150-200%. VETERAN'S... PRODUCTS, 78 Watts, New York. feb28

HAVE YOU SEEN THE NEW BEEGEE LINE!... Get our 1925 catalogue and stop worrying... about what to sell. You'll be satisfied with... what you make. B. & G. RUBBER CO., Dept. 708, Pittsburgh, Pennsylvania. feb28

HOW TO GIVE AWAY ARTICLE OF VALUE... and still make profits. You'll be flooded... with mail. Illustrated instructions, 10c. HULET, 4 Stapleton, New York. x

KNOCKOUT DOLLAR SELLER-HEMSTITCH-... ing and Picot Edging Attachment, new in-... vented, fits any sewing machine. Sample, 50c... postpaid. Wonderful discounts to agents. EL... PASO SEWING MACHINE CO., Phoenix Hotel Bldg., El Paso, Texas. mar7

MAKE \$75.00 A WEEK AND UP SELLING... our fine made-to-measure, all-wool Suits, direct to wearer. All one price, \$31.50. Big-... gest values. Commissions in advance. We... deliver and collect. 6th swatch samples fur-... nished. Write today. W. Z. GIBSON, INC., Dept. B-43, 191 W. Harrison St., Chicago, Ill. feb28x

MARVELOUS NEW INVENTION-400% PROF-... it. Johnson's Liquid Quik Mend. Trem-... endous demand. Plan unique; act quick. Over... hundred other fast-selling specialties. J. E. JOHNSON & CO., Dept. 62, 321 W. Chicago Ave., Chicago, Illinois. feb28x

MONEY MAKERS-100% TO 150% PROFIT... Write for free samples. LIGHTNING... PRODUCTS CORPORATION, 1773 Greenleaf Ave., Chicago. x

NEW WONDERFUL SELLER-98c PROFIT... every dollar sale. Deliver on spot. License... unnecessary. Sample free. MISSION FAC-... TORY L. 519 North Halsted St., Chicago, Ill. feb28

PROFITS LARGE, REPEAT BUSINESS... great. Super-Clean Wonder Cleaner sells on... eight. Write HOFMAN PRODUCTS CO., Box 840-A, Cincinnati, Ohio.

RELIEF-DE-ODOR FOR FROSTBITE, OF-... fensive foot and body odors, valuable external... remedy. \$1.00 package makes fifty 50c bottles;... labels free. H. STEPHENS, Ogemaw, Ark. mar14

SELL UNION-LABEL, ALL-WOOL, MADE-TO-... Measure Suits direct to wearer for \$24.50. SCOTT SYSTEM, INC., Whole. Tailors, 99F Bedford Street, Boston.

SELF-THREADING NEEDLES, NEEDLE... Books, Machine Needles-Find sales in every... home. Fine side lines, easily carried, big... profits. Sample and catalogue free. LEE... BROTHERS, 143 East 23d St., New York. mar7

SELL \$1 NECESSITIES, 98c PROFIT. SAM-... ples, particulars, 8c. MOYE MFG., 1234-B Clay, Paducah, Kentucky. x

SELL UNION LABEL, ALL-WOOL, MADE-TO... Measure Men's Clothing direct to wearer for \$24.50. SCOTT SYSTEM, Boston. feb28

TAILORING SALESMEN - \$100-\$150 WEEK... selling union, hand-tailored, made-to-measure... Suits and Overcoats, \$23.50-\$29.50. Liberal... commissions advanced. WOOD & CO., 651 So. Wells, Chicago. x

THE TOPSY-TURVY CARDS, SAMPLE, 15c;... lists free. CAESAR SUPPLIES, 18 West D-laware Place, Chicago. x

WE START YOU WITHOUT A DOLLAR-... Soaps, Extracts, Perfumes, Toilet Goods. Experience unnecessary. CARNATION CO., Dept. 235, St. Louis. feb28

\$10 DAILY SILVERING MIRRORS, PLATING... and refinishing lamps, reflectors, autos, beds, chandeliers by new method. Outfits furnished. Write GUNMETAL CO., Ave. G, Decatur, Ill. feb28

300% PROFIT-FAST SELLER, HOUSEHOLD... Necessities. Repeater. Free sample. "MAGIC... DISTRIBUTING CO., 301 Gladstone, Kansas City, Missouri. x

\$50.00 DAILY OPERATING FIRE SALES;... Salvaged Clothing. Representatives wanted. Exclusive territories. Particulars free. HEAD... QUARTERS, Dept. BB, 1698 So. Halsted, Chi-... cago. x

\$50.00 DAILY SALVAGE FIRE SALES. EX-... clusive territories. District Managers wanted. BB, 1698 So. Halsted, Chicago. x

\$125.00 WEEKLY SELLING FINEST, MOST... complete line of Men's \$12.50 Suits; Boys'... Two-Pants Suits, \$10.95. Guaranteed union, made to measure. Four latest patterns. Also... Topcoats, Vests, Caps, Riding Brooches. Big... commissions advanced. Free attractive outfit. DOUBLE SERVICE MANUFACTURERS, 1327-35-A Washington, Chicago. x

ANIMALS, BIRDS AND PETS... 6c WORD, CASH. NO ADV. LESS THAN 25c. 8c WORD, CASH. ATTRACTIVE FIRST LINE. Figure at One Rate Only-See Note Below.

Midget Horses. Beauties for... sale, \$50 to \$75. ARDETH BEDE, 76 W. 49th, New York. x

NOTE-Count All Words, Also Combined Initials and Numbers in Copy. Figure Total at One Rate Only. IN ANSWERING CLASSIFIED ADS, PLEASE MENTION THE BILLBOARD.

Wanted-Kicking Mules, Edu-... cated ponies, wrestling bear. GUS FRAMER, General Delivery, Elizabeth, New Jersey.

4 Rhesus Monkeys for Sale-... Healthy. ADAM TESKA, 412 Iryan Ave., Peoria, Illinois.

A GIRL CAN WORK WITH FLINT'S POR-... cupines. Cleanly, vegetarians, inoffensive, in-... expensive. FLINT'S, North Waterford, Me. feb28

BACKSOMERSAULT AND RIDING MONK... rhesus; first \$10.00 takes her. E. WALSETH, Camp Dennison, Ohio.

CANARIES, \$12.00 DOZEN; PARRAKEETS... yellow or green, \$6.00 pair; six pairs for \$30.00. Parrots, also Cages, every description. We supply carnivals, dealers, small stores and homes. Prompt, safe shipments. Ask your... banker about us. Largest bird and dog store in Missouri or south. NATIONAL PET SHOPS, St. Louis, Missouri. feb28

DEEP SEA WONDERS FOR PIT SHOWS... Stuffed and Mounted Fish Specimens and Al-... ligators, a wonderful attraction, \$10, \$20 and \$30.00; assorted collection. JOS. FLEISCH-... MAN, 1105 Franklin, Tampa, Florida. feb28

FIVE FOX TERRIER PUPS, EASY TRAINED;... one large Male Rhesus Monkey; Tattooing... complete; Glass Blowing, complete; Electric... Chair or Fixtures, Buddha, complete; 6 Swords... and Ladder, 2 Tents, like new, and other show... articles, cheap. CURLEY SMILEY, Chillicothe, Ohio.

FOR SALE-9 TRICK DOGS, PRICE FIFTEEN... to thirty dollars each. Sell together or... separate. SAM STRICKLIN, 616 Fifth Street, North West, Canton, Ohio.

FOR SALE OR TRADE-ONE BLACK BEAR... female, three years old, good wrestler, very... gentle; one Pinto Donkey, year old, does three... tricks, will make feature clown mule; one... Cane Wagon, large enough for two lions, ex-... cellent condition. Want to buy Monks, also... one male Cub Lion. For information write... REUBEN RAYS TRAINED ANIMAL SHOW... AND COMBINED CIRCUS, care Billboard, San Francisco, California.

FREAK TWO-LEGGED DOG, BORN WITH-... out front feet, well developed, smart and... active, for sale. JOHN NORMAN, Bizen, Mississippi.

MONKEYS - RHESUS AND RINGTAILS... grand lot, bargain prices, overstocked, bot-... tle hurry. NATIONAL PET SHOPS, St. Louis, Missouri.

MONKEYS-ACCLIMATED, GIANT RHESUS... males and females; Digital Baboons, Spiders, Ringtails, Jays, Racoons, Foxes, Squirrels, Caves, Hares, Giant Pigeons, Doves, Pheasants, Pea Fowls, Fancy Poultry, Goats, Ponies, Donkeys. We buy and sell everything. DE-... TROIT BIRD STORE, Detroit, Michigan.

ONE AIREDALE-BROOD MATRON, OLIVER... POWELL, Freedom, Pennsylvania.

PARROTS ON HAND AT ALL TIMES. PAN-... AMERICAN BIRD CO., Laredo, Tex. feb28

PUPPIES, FANCY PIGEONS, PERSIAN KIT-... tens, Monkeys, Birds, Pets and supplies every... description. We ship everywhere safely... promptly. Reference any bank. Write NA-... TIONAL PET SHOPS, St. Louis, Missouri.

WANT PERFORMING DOGS, FULL PAR-... ticulars to CHAS. SMITH, 36 Wilson St., Brooklyn, New York. mar7

WANTED-ANIMALS FOR ZOO, STATE ALL... first letter. FRANK FUNK, Winchester, Indiana. mar14

ATTORNEY AT LAW... 6c WORD, CASH. NO ADV. LESS THAN 25c. 8c WORD, CASH. ATTRACTIVE FIRST LINE. Figure at One Rate Only-See Note Below.

Edward Voelcker, Lawyer... Garrick Theatre Building, Chicago. apr1

ATTRACTIONS WANTED... 7c WORD, CASH. NO ADV. LESS THAN 25c. 9c WORD, CASH. ATTRACTIVE FIRST LINE. Figure at One Rate Only-See Note Below.

Concessions and Rides Wanted... for Tulsa's Ideal Park. Large concrete swim-... ming pool now in park. Riverside Park, Tulsa, Oklahoma. For information write J. A. CLINE, Route 2, Tulsa, Oklahoma.

If You Have a Good Act for... carnival show write T. W. MCCONNELL, 2527 Admiral Court, Tulsa, Oklahoma.

WANTED TO HEAR FROM ALL SWIMMING... and diving act, booking season. WELCOME PARK, Ada, Ohio, Wm. S. Fink, Owner.

BOOKS... 6c WORD, CASH. NO ADV. LESS THAN 25c. 8c WORD, CASH. ATTRACTIVE FIRST LINE. Figure at One Rate Only-See Note Below.

CURIOUS BOOKS, UNIQUE NOVELTIES... Stunning Pictures. Samples, 10c, prepaid. LIND, 214 West 34th Street, New York. feb28

HEADQUARTERS FOR USED BOOKS, 50 AS-... sorted, trial \$3.00. BSH, 1698 So. Halsted St., Chicago. x

RARE ENGLISH BOOKS-NEW CATALOGUE... 15 cents. LUCIEN PROUVE, Allee des Sources, Livry-Gargan (S. and O.), France

BUSINESS OPPORTUNITIES... 6c WORD, CASH. NO ADV. LESS THAN 25c. 8c WORD, CASH. ATTRACTIVE FIRST LINE. Figure at One Rate Only-See Note Below.

COLUMBIA LABORATORIES, SOAP SPECIAL-... ists, 18 Columbia Heights, Brooklyn, N. Y. Our principal business is manufacturing Medi-... cated Soaps for large advertisers. A field with... enormous possibilities and colossal achieve-... ments. We put out some stock brands at... about cost, any of which will serve as an... excellent medium for a tryout. Take any of... these goods; make them your own; start... your selling campaign. Leave the manufac-... turing to us. feb28

EIGHT COLLECTION LETTERS THAT WILL... collect any account without friction. Get... the dough and worth dollars for three dimes. Agents, write. H. MCKNIGHT AGENCY, Box 255, Louisville, Kentucky. mar21

FOR A DOLLAR BILL 100 LETTERHEADS... or Billboards or Statements and 100 Envelopes... 100 Cards, 50c, prepaid. CROWN MAIL... ORDER PRINT, Sta. A, Columbus, O. mar11

HOW I SOLD 400,000 NAMES. THIS GREAT... scheme and list of 123 names of buyers for... \$1.00. ERNEST L. MORRIS, 805-A Market St., St. Louis, Missouri.

INCH DISPLAY ADVERTISEMENT, 166... magazines, year, \$50. WOOD'S POPULAR... SERVICES, Atlantic City.

MANUFACTURER DESIRES CONTRACT... Work, such as assembling, metal stamping... or any light manufacturing. Able to give ex-... ceptional service and prices. Address BOX 143, care Billboard, 1133 Broadway, New York.

PATENTS-WRITE FOR OUR FREE GUIDE... Books and "Record of Invention Blank" be-... fore disclosing inventions. Send model or sketch... of your invention for our free examination and... instructions. VICTOR J. EVANS & CO., 9th and G, Washington, D. C. mar7

START A MAIL ORDER BUSINESS, WHOLE-... sale lists and sample circulars free. Printing... and Linotype Composition. ENTERPRISE... PRESS, Corfu, New York. x

SEIZED AND SOLD FOR TAXES-\$45 FOR 5... Acres, beautiful lake front; \$50 for 10 Acres, mixed... hunting camp site; \$95 for 50 Acres, mixed... farming, good market; \$315 for 160 Acres... wheat and dairy farm, Manitoba; \$378 for... claim near mines that have paid millions... Lots from 1/2 acre to 2 square miles, suitable... for hunting, fishing, farming, mining, lumber-... ing, summer cottages, camp sites, etc. All... offered at ten cents on the dollar of their... value. \$5 and \$10 down and easy monthly... payments. Send for illustrated list describing... the above and hundreds of properties seized... and sold for taxes. Send no money. Send for... list today so you will have first choice. TAX... SALE SERVICE, 72 Queen Street, West, Dis-... trict 18, S. Toronto, Ontario, Canada. feb28x

START A MAIL ORDER BUSINESS, WHOLE-... sale lists and sample circulars free. Printing... and Linotype Composition. ENTERPRISE... PRESS, Corfu, New York. feb28x

START A PROFITABLE BUSINESS FOR LESS... than \$10.00. Send for free particulars. ROBERT SCHLEETER, 527 S. George St., York, Pennsylvania. mar21

24 WORDS, 355 RURAL WEEKLIES, \$14.20... ADMAYER, 4112-B Hartford, St. Louis, Mo. feb28

CARTOONS... 5c WORD, CASH. NO ADV. LESS THAN 25c. 7c WORD, CASH. ATTRACTIVE FIRST LINE. Figure at One Rate Only-See Note Below.

BALDA'S TRICK DRAWINGS-STUNTS WITH... pep and reputation. Chalk-Talk Crayons, Perforated Fake Sheets, Rag Pictures, Big... list free. BALDA ART SERVICE, Oshkosh, Wisconsin. feb28

CHALK-TALKERS' PICTURE STUNTS - 32... Trick Drawings, Evolutions, Smoke, Rag and Novelty Pictures, \$1.00. H. BJORKLUND'S... CHALK-TALK SERVICE, 1919 Lincoln St., N. E., Minneapolis, Minnesota. feb28

CHALK-TALKING IS EASY AND PROFIT-... able. Particulars, TRUMAN'S STUDIO, Box 792, Perryville, Ohio. feb28

INSTRUCTIONS FOR STAGE CARTOONING... and Chalk Talking, with 23 trick cartoon... stunts, for \$1.00. Particulars free. BALDA... ART SERVICE, Studio, Oshkosh, Wis. feb28

THEATRICAL SCENE PAINTING TAUGHT... by mail. Practical, low-priced correspond-... ence courses. We sell lithographed, Colored... Scenery Models. Send stamps for literature. ENKEBOLL ART ACADEMY, Omaha, Neb. x

CONCESSIONS WANTED... 7c WORD, CASH. NO ADV. LESS THAN 25c. 9c WORD, CASH. ATTRACTIVE FIRST LINE. Figure at One Rate Only-See Note Below.

DALLAS CELEBRATION CO., EAST ST... Louis, Ill., wants Concessions, or will sell... all to reliable party. Playing one to three-... day stands. mar11

COSTUMES, WARDROBES... AND UNIFORMS... 5c WORD, CASH. NO ADV. LESS THAN 25c. 7c WORD, CASH. ATTRACTIVE FIRST LINE. Figure at One Rate Only-See Note Below.

Chorus Costumes - In Very... good condition, in sets from 1 to 16. Satin... and Silk, \$1.50 per costume, \$2.50 per cos-... tume, \$1.00 per costume, \$5.00 per costume... Mention color when ordering. These are all... bargains. NORMAN'S INC., Costumers De-... Luxe, 1061 Market St., San Francisco, Calif. mar11

A TINY LOT OF IMPORTED SILVER AND Gold Cloth, 500 yard. Send stamp for sample. Chorus Costumes, in sets of 1, 8, 10, 15, 20, 25, 30, 35, 40, 45, 50, 55, 60, 65, 70, 75, 80, 85, 90, 95, 100, 105, 110, 115, 120, 125, 130, 135, 140, 145, 150, 155, 160, 165, 170, 175, 180, 185, 190, 195, 200, 205, 210, 215, 220, 225, 230, 235, 240, 245, 250, 255, 260, 265, 270, 275, 280, 285, 290, 295, 300, 305, 310, 315, 320, 325, 330, 335, 340, 345, 350, 355, 360, 365, 370, 375, 380, 385, 390, 395, 400, 405, 410, 415, 420, 425, 430, 435, 440, 445, 450, 455, 460, 465, 470, 475, 480, 485, 490, 495, 500, 505, 510, 515, 520, 525, 530, 535, 540, 545, 550, 555, 560, 565, 570, 575, 580, 585, 590, 595, 600, 605, 610, 615, 620, 625, 630, 635, 640, 645, 650, 655, 660, 665, 670, 675, 680, 685, 690, 695, 700, 705, 710, 715, 720, 725, 730, 735, 740, 745, 750, 755, 760, 765, 770, 775, 780, 785, 790, 795, 800, 805, 810, 815, 820, 825, 830, 835, 840, 845, 850, 855, 860, 865, 870, 875, 880, 885, 890, 895, 900, 905, 910, 915, 920, 925, 930, 935, 940, 945, 950, 955, 960, 965, 970, 975, 980, 985, 990, 995, 1000. STANLEY, 306 West 224 Street, New York.

A-1 STAGE WARDROBE. LOWEST PRICES. Specialize in Evening Gowns, Wraps, Tailored, Jeweled, etc. up-to-the-minute. Models, Afternoon, Dancing and Street Dresses and Chorus Sets. House of class, dash, reliability and prompt service. Over 10 years at former address. C. CONLEY, 401 West 30th St., New York City.

A LOT OF TRUNKS FOR SALE. \$5.00 UP. 100 pair Shoes, Miller's, Azzimotti, lot including trunk, 500 pair; Chorus Dresses, sets of 10, 15, 20, 25, 30, 35, 40, 45, 50, 55, 60, 65, 70, 75, 80, 85, 90, 95, 100, 105, 110, 115, 120, 125, 130, 135, 140, 145, 150, 155, 160, 165, 170, 175, 180, 185, 190, 195, 200, 205, 210, 215, 220, 225, 230, 235, 240, 245, 250, 255, 260, 265, 270, 275, 280, 285, 290, 295, 300, 305, 310, 315, 320, 325, 330, 335, 340, 345, 350, 355, 360, 365, 370, 375, 380, 385, 390, 395, 400, 405, 410, 415, 420, 425, 430, 435, 440, 445, 450, 455, 460, 465, 470, 475, 480, 485, 490, 495, 500, 505, 510, 515, 520, 525, 530, 535, 540, 545, 550, 555, 560, 565, 570, 575, 580, 585, 590, 595, 600, 605, 610, 615, 620, 625, 630, 635, 640, 645, 650, 655, 660, 665, 670, 675, 680, 685, 690, 695, 700, 705, 710, 715, 720, 725, 730, 735, 740, 745, 750, 755, 760, 765, 770, 775, 780, 785, 790, 795, 800, 805, 810, 815, 820, 825, 830, 835, 840, 845, 850, 855, 860, 865, 870, 875, 880, 885, 890, 895, 900, 905, 910, 915, 920, 925, 930, 935, 940, 945, 950, 955, 960, 965, 970, 975, 980, 985, 990, 995, 1000. STANLEY, 306 West 224 Street, New York.

CHORUS COSTUMES—SATEEN DRESSES, SIX colors, six blue, six orange, \$25 takes all; sateen Pink Satin, with hats, six, \$12; Sateen Dresses, bloomers and hats, six, \$11; Grass Hat Dresses, with bloomers, \$5; Satin Sateen, \$5. All new, no seconds. GERTRUDE LEHMAN, 13 West Court St., Cincinnati, D.

EVENING GOWNS, SLIGHTLY WORN, \$8, \$10, \$12. Deposit, balance C. O. D. Satisfactions guaranteed. All sizes, colors. GENE SMITH, 798 W. Springfield, Boston, Massachusetts.

GENUINE SIOUX INDIAN COSTUMES AND head work at prices you can afford to buy. All heads put on with sinew. If the Sioux Indian makes it we have it. Squaw Buckskin Beaded Dresses, \$75.00 to \$125.00. Squaw Leggings, \$10.00. Beaded Belts, \$5.00; Bone Bracelets, \$15.00. Beaded Moccasins, \$1.25 to \$1.75. Buckskin Beaded War Shirts, \$50.00. Buckskin Beaded Leggings, \$22.50; War Bonnets, \$15.00 to \$25.00; Indian Pipes, \$2.00 to \$10.00; Beaded Tobacco Bags, \$0.50; War Clubs, \$1.25; Bow, with 3 steel-point arrows, \$1.75; Beaded Vests, \$35.00; Porcupine Head Dresses, \$5.00. Complete costumes for men, women and children. Why pay more? Terms, cash with order. Satisfaction guaranteed. LYON CURIO STORE, Clinton, Nebraska.

MINSTREL SUITS, FLASHY, COMPLETE. \$5.00, Tuxedo suits, new, latest, \$25.00. Clown Suits, \$2.00; Band Coats, \$3.50; Big Band Clown Suits, \$5.00; Hussar Coats, pearl, silver buttons, \$4.00; Prince Alberts, \$4.00; Doorman Coats, \$4.00. Stamp for list. WALLACE, 1831 N. Halsted, Chicago.

UNIFORM COATS, \$6.00; CAPS, \$1.00; TUXEDO COATS, nearly new, all sizes, \$6.00. JANDORE, 229 W. 97th St., New York City.

EXCHANGE OR SWAP 7c WORD, CASH. NO ADV. LESS THAN 25c. 5c WORD, CASH. ATTRACTIVE FIRST LINE. Figure at One Rate Only—See Note Below.

Bus — Will Accomodate 25 passengers, all upholstered in solid leather, will make fine living or office car, will trade for a good automobile. Ford truck and take difference in cash. Car has no run over six thousand miles and in perfect condition and a fine flash. EDGAR WHITE, Clarksburg, DeKalb Co., Indiana.

TRADE OR SELL—TALBOT TRUNK POP-UP Machine. Want Kottontally Duffin, Concession Foods or Tops. HAROLD ROBBINS, Miami, Florida. feb28

WE TRADE AND SELL. GET OUR LIST. We buy Truck, Motor, Boat, make list offer. McCADDON COMPANY, Zanesville, Ohio.

WILL TRADE CLOTHING FOR PRINTING. BB, 1908 So. Halsted St., Chicago.

\$200.00 JOB PRINTING PRESS TO EXCHANGE for small Electric Light Plant or Movie Camera. ALVIN WARFEL, Cadiz, Ohio. x

FORMULAS 7c WORD, CASH. NO ADV. LESS THAN 25c. 5c WORD, CASH. ATTRACTIVE FIRST LINE. Figure at One Rate Only—See Note Below.

Big Money in Formulas — 10, 000 selected manufacturing formulas. One great book. SOUTHERN TRADING COMPANY, Dept. 28, Flushing, N. Y. feb28

Eyebrow Lotion, Cosmetics, Shoe and Shoe Polishes, Silvering Mirrors. 21 guaranteed formulas for \$1. M. H. ELSBURY, 1113 Madison St., Chicago. feb28

Goody Goody Chewing Candy. Concession people, stand operators. Greatest of all carnival candies. First time this great formula ever sold. Send \$1.00 for formula and instructions. D. C. PLACE, Council Bluffs, Ia.

Medicine Men and Agents — Make and sell your own medicine. Herb Tonic Formula, Two dollars; Snake-Bit Linctus, one dollar. Cash for two dollars and fifty cents. MARLOW MEDICINE CO., 506 E. 10th St., Chattanooga, Tenn.

Superfluous Hair Remover — Eucalyptus Salve (for catarrh, colds, etc.) and 23 other money-making formulas. All for \$4. Address E. WALSAN, Kansas City, Mo., Station C, General Delivery. mar14

ARTICLE COSTS 50c TO MAKE, SELLS FOR \$3.00; reprinter. Sell the year around. Sample, 25c. MITCHELL-AMES CO., Elmhurst, Illinois.

MEXICAN TAMALES SELL YEAR ROUND. Instructions, complete, \$1.00. H. STEPHENS, Dugmaw, Arkansas. mar14

CHOO-CHOO. THE MOST DAINTIEST, TASTI-est and delicious Confection ever Imagined! Formula and complete directions, 50c. GEORGE KNOLL, Box 562, Kankakee, Illinois.

STOP RHEUMATISM, QUICK; GUARANTEED. 25c bottle. Particulars, stamp. Bank reference. PROF. WALLIE BARNES, 2824 Muncie, Indiana.

YOU CAN RECEIVE 25 LETTERS A DAY each containing \$1.00; legitimate. Working plan and formula, \$1 bill. W. M. GREIN, 822 E. Douglas, Wichita, Kansas. feb28

YOUR FAVORITE BEVERAGES AND OTHER reliable Formulas. Free information. THE FORMULA CO., Sales Dept., 122 West Howe, Seattle, Washington. apr18

\$1.00 BUYS GUARANTEED WORKING FOR- mulars, Lemon Antising Cream, Quick Roll- ing Massage, Spawite Cold Cream. No Junk. UNIVERSAL LABORATORIES, Dallas, Texas.

24 GUARANTEED FORMULAS FOR A SELF- addressed envelope and silver dime. YAR- RINGTON, Box 360B, La Crosse, Wis. feb28

FOR RENT, LEASE OR SALE 7c WORD, CASH. NO ADV. LESS THAN 25c. 5c WORD, CASH. ATTRACTIVE FIRST LINE. Figure at One Rate Only—See Note Below.

For Rent—Picture-Vaudeville Theatre, fully equipped except machines. BOX 917, Billings, Montana. mar7

For Sale—Complete Shooting Gallery, guns, etc. Address Y. KOMATSU, Route 5, Box 222, Tampa, Fla.

Jennings and Mills O. K. 5c Counter Mint Venders. For quick sale, \$15.00 each. One-third deposit. ADVANCE SALES COMPANY, 1438 Schofield Building, Cleveland, Ohio. feb28

Mills Liberty Bells, \$40. Mills Standard Scale, \$30. UNIVERSAL COMPANY, Yonkers and Central, Yonkers, New York. mar7

Mills O. K. 5c Counter Mint Venders, late models. PEERLESS, 2106 Central Ave., Minneapolis, Minn. mar7

Notice to Users of Slot Ma- chines—New and used Mills, 5c and 25c mint venders, for sale at bargain prices. Terms to responsible users. Reduced prices on mints also. ATTRACTO MINT DIST. SYSTEM, 1023 Cottage Grove Ave., Chicago, Ill. x

Portable 12-Unit Balloon Racer in A-1 condition, Chester Pollard's make; also 20 unit Get 'Em Racer (climbing contest); can be used as a fast grand stand. Will sell cheap for cash. PRUDENT AMUSE- MENT SHOWS, 124 Cedar Ave., Paterson, N. Y. mar1

A "CITIZENS" PLAY JURY IN the past four years there have been six crusades against profanity, obscenity and "immorality" in the theater. But, except for the brief "trials" when "the devil was sick", licentiousness has increased. Traditionally the recourse has been to indictment by the Grand Jury and trial by a petit jury. It is possible that the method could be made to work, and work better than any other, but the outstanding fact is that as at present employed it defeats its own ends. The mere threat of an indictment crowds the theater. Since the present outcry across the play attacked, the re- ported to be as bad artistically as morally, has had crowded houses. When a jury convicts, the fine is generally a small portion of the profits of public scandal. Under such circumstances there is danger that ex- asperated moralists will demand a "political" censorship—the utility of which has been sufficiently demonstrated in the comparatively simple matter of the movies. An alternative method would be a jury selected by lot from a panel of citizens capable of intelligent judgment in matters of art and morals. This was urged two years ago, and it had the backing of the most promi- nent groups of actors, authors, churchmen and professional purists. That it was not put into effect is said to have been due to opposition on the part of managers, who preferred the methods of laissez-faire tem- pered only by the police court. What is certain is that it attempted to operate thru the wrong channel. Commissioners of Licenses having given it no support. Both legally and practically, it now appears, the proper agent of the public is the Commissioner of Police. Mr. Enright is already showing his zeal by proceeding with such means as he finds at hand. District Attorney Banton has expressed entire willingness to give the "citizens" jury a fair trial, and is hopeful that it will be the means of staving off a political censorship. Especially promising is the attitude of the Actors' Equity Association. Feeling keenly that decency in the theater is essential to the best interests of the profession, to its honor and its dignity, it has for some time included a clause in Equity contracts providing that if the citizens' jury finds against a production, even by a vote of 9 to 3, actors and managers are alike bound to bow to it. Important as insuring speedy and effective action, the citizens' jury is especially worthy of a trial as promising that the judgments shall be rendered on the basis of intelligence, both in matters of morals and in matters of art. At least two of the plays now on view have caused a sharp division of opinion. Advanced lovers of the drama find them highly interesting and significant, and no more immoral than nature is. Others find them objectionable in the extreme. In such cases a petit jury could scarcely be counted on to render a fair judgment. Even the more way- wise "citizens" would doubtless be divided. But they would be far more likely to give due weight to questions of truth to nature and to art— which are themselves of high importance to public morals. —NEW YORK TIMES.

FOR SALE—NEW GOODS 7c WORD, CASH. NO ADV. LESS THAN 25c. 5c WORD, CASH. ATTRACTIVE FIRST LINE. Figure at One Rate Only—See Note Below.

INDIAN HUNTING BOWS, \$2.50; INDIAN Bows, Butterflies, Minerals, Archery. Cata- logue, thousand articles, 10c. INDIANCRAFT B. B. COMPANY, 466 Connecticut, Buffalo, New York. x

FOR SALE—SECOND-HAND GOODS 5c WORD, CASH. NO ADV. LESS THAN 25c. 5c WORD, CASH. ATTRACTIVE FIRST LINE. Figure at One Rate Only—See Note Below.

Arcade Outfit for Sale—Also odd machines. B. MADORSKY, 689 Howard Ave., Brooklyn, N. Y. feb28

Balloon Racer for Sale—Ches- ter Pollard's Balloon Racer, 11 units. Good condition, \$150.00. FRED THORPE, 170 Beach 30th St., Rockaway Beach, L. I.

For Sale — Circle Swing, Im- mediate, now at Kennwood Park, Pa. ROOM 1508, 2 Rector St., New York City. mar7

For Sale—Two Portable Skat- ing rinks, 40x90, complete. Can be seen at Princeton, Ind., until April 15. Address BERT WOODS, Ft. Branch, Indiana.

Portable Three-Abreast Mer- ry-go-round, complete with Fordson tractor and Wurlitzer Band Organ. Bargain for cash. C-BOX 759, care Billboard, Cincinnati.

40x60 Tent, 8x10 Con. Tent (new), Also Balloon Filler, new light cage wagon, bargains. KEYSTONE SHOW EQUIP- MENT CO., Oxford, Pa.

ANCHOR CONCESSION TENT WITH FRAME. 14x16, \$75.00. Like new. E. WALSETH, Camp Dennison, Ohio.

CONCESSION TENT, FLANDERS FIELD. Street Piano, Mermaid, Pits, large Reptile Banner. HOPPER, Corning, New York.

DEAGAN UNA-FONS FOR SALE. WIRE DUCHEMIN, 612 East Washington, Indian- apolis, Indiana.

FOLDING CHAIRS — 15,000 IN STOCK, strongest made, \$1.00 each up. OAKWOOD CHAIR CO., Philadelphia, Pa. feb28

FOR SALE — BALLOON RACER, 15 UNIT. \$175; Walking Charlie, \$175. Both used two seasons; Chester Pollard. V. SPANNAGEL, Ocean View, Virginia.

FOR SALE—COMPLETE DRAMATIC TENT 10x14, six-foot round top, two thirty-foot middles, sidewalls, extension caves, marquee, seven sections blue, seven high; two hundred seats, electric switch box, wires, lights, piano, scenery. Very reasonable. McCALL BROS., Hhuca, Michigan.

FOR SALE—DEAGAN XYLOPHONES, \$70. IN trunk, and \$72; Marimba, \$52, in trunk. Address LOWELL TAFT, Jamestown, N. D.

FOR SALE—EIGHTY BY ONE SEVENTY, ten-ft. walls, six hundred dollars. Sixty-five by one twenty-five, ten-ft. walls, four hundred dollars; sixty by one fifteen, ten-ft. walls, three hundred dollars. ANDERSON TENT AND AWNING CO., Anderson, Indiana.

FOR SALE—ONE FULL-SIZED CAROUSEL, IN perfect condition. Will be sold at a reason- able figure to a quick buyer. At present located in Philadelphia with full equipment. Apply to SUMMERFIELD & ROMM, 907 S. Exchange Build- ing, Philadelphia, or 312 Dunam Building, 1193 Broadway, New York City. mar7

FOR SALE—SLOT MACHINES, CHEAP. A. PAGLINGKI, 85 Baxter St., New York. mar14

FOR SALE — TENT, 20x30, TOP ONLY; white, 10x11, beaded frame, black. Will trade for Pit Show Stuff FOUNTAIN SQUARE P. O. BOX 8, Indianapolis, Indiana.

FOR SALE—TWELVE-INCH GLOBE LIGHT, twelve dollars; 1 Frank 5-legged Dog, thirty dollars. Address J. LAMONT, 603 N. Dearborn St., Chicago.

FOR SALE — 9 MARIONETTE FIGURES, dressed and strung. C. L. SMITH, Apt. 16, 1518 Payne Ave., Cleveland, Ohio.

FOR SALE — 100 LENGTHS OF CIRCUS Seats, used one week at 1914 Cavalry Armory, Philadelphia, Pa. Better, high, as good as new, also 50 lengths of Star 12". Sell all or as many as you want. WELSH BROTHERS, 1207 West Thompson St., Philadelphia, Pennsylvania. mar7

\$95.00 ITALIAN SOPRANO PIANO ACCOR- dion, fine condition, 60 basses, cost \$300; also 1,000 other Musical Instruments. WELL'S CURIOSITY SHOP, 20 S. Second St., Phila- delphia, Pennsylvania.

FOR SALE — 30-FOOT SEAMLESS STEEL Tubing uprights for single or double net. Solid uprights, aluminum painted; also 14-foot Nickel-Plated Ring Uprights. Can be seen at RUGGIO GYM, 542 S. Wells St., Chicago.

FOUR SKEEBALL ALLEYS FOR SALE, PER- fect condition. Former owner willing to set same up anywhere. NELSON & MAASS, 32 Prince St., New York.

FULL STAGE VENTRILOQUIAL PRODUCTION for sale. Reasonable for quick sale. Address C-BOX 757, care Billboard, Cincinnati.

IDEAL CARD VENDERS, 33, WITH IM- proved slots, \$5.00; 50 metal and 25 oak, new last October, \$6.00 each. C. A. BERG, 871 N. La Salle, Chicago.

INDUCTION MIND READING APPARATUS, packed in suit case, first \$20.00; "Trunk of Magic", \$25.00; Seeing Thru a Woman, new illusion for pit show, \$50.00; Levitation, \$25.00. F. N. LAMB, 829 Michigan Ave., Detroit, Mich.

LORD'S PRAYER ON PINHEAD, NEW, \$2.50; Old Newspaper, dated 1800, describing death and funeral of Washington, slaves for sale, etc., good condition, \$2.50; Smallest Bible, \$2.00 each. Wonderful Curio. SEIDMAN, Room 1503, 110 West 40th Street, New York.

MILLS F. O. K. FRONT MINT VENDERS, \$100.00 each, used two weeks, five-cent play; also have a few Oval Glass Venders, price \$5.00 each. Mills make, five-cent play, all are in good order. NOVELTY SALES CO., Box 27, Waverly Station, Baltimore, Md. feb28

MIRRORSCOPE, RING GAME, HUCKLEY- huck, Drop Picture Machine, Palms-Graf, Wheels, Mind Reading, Snake Banners, Trunk, 10x25x23; Illusions, Amusements, Great Sets, Special Tickets. SHOWMAN'S EXCHANGE, Reading, Pennsylvania.

NICKEL MINT VENDERS (MILLS), ELEVEN, perfect, \$17.50 if sold at once. L. NELSON, 92 Prince St., New York. mar7

PERCENTAGE TARGET, GAME OF SKILL, moving combinations. Shoot for cash or mer- chandise. Nothing like it before. BOX 1187, New Orleans, Louisiana.

\$120.00 BASS DRUM, SIZE 34 INCHES, GOOD heads, slightly used, bought government. We have all sizes and makes, also 1,000 other musical instruments of different kind. Write for list. WELL'S CURIOSITY SHOP, 20 S. Second St., Philadelphia, Pennsylvania.

POPCORN POPPERS, ALL KINDS, CHEAP. NORTHSIDE CO., 1306 Fifth, Des Moines, Iowa. apr18

REBUILT IRON BELLS, BRONZE OR ALU- minum finish, \$25; remodeled, \$32.50. TOTEM NOVELTY CO., Aurora, Illinois. mar21

RADIO OUTFIT, COMPLETE, TWENTY-FIVE dollars; Corona Folding Typewriter and Case, twenty dollars. A-1 condition. POSTER ADV. CO., Red Hill, Pennsylvania.

SACRIFICE JOBS SHOES, COATS, HATS, Rubbers, Novelties, etc. Lists free. BB, 1608 So. Halsted, Chicago.

SLOT MACHINES, NEW AND SECOND-HAND, bought, sold, leased, repaired and exchanged. Write for illustrative and descriptive list. We have for immediate delivery Mills or Jennings O. K. Gum Venders, all in 5c or 25c play. Also Brownies, Eagles, Nationals, Judges, oval and all styles and makes too numerous to mention. Send in your old operator Bells and let us make them into money-getting 2 bet machines with our improved coin detector and saw set slides. Our construction is fool proof and makes for long-distance operation with our unusual parts. We do machine repair work of all kinds. Ad- dress P. O. BOX 173, North Side Station, Pittsburgh, Pennsylvania. feb28x

UP-TO-DATE ARCADES FOR SALE. WILL set up anywhere. Annual charges. NELSON & MAASS, 32 Prince St., New York. mar7

(Continued on Page 66)

NOTE—Count All Words. Also Combined Initials and Numbers in Copy. Figure Total at One Rate Only. IN ANSWERING CLASSIFIED ADS, PLEASE MENTION THE BILLBOARD.

\$6.50 HEAVY KHAKI USED CANVAS COVERS. 9x15 feet, from United States Government...

SLOT MACHINES—ONE DIME AND TWO nickel Cooper O. K. Venders, used two weeks...

STEREOPTICON ADVERTISING OUTFITS. complete, with slides, \$25. GRONBERG MANUFACTURING CO., 1510 Jackson, Chicago, Ill., Makers.

STYLE 125 WURLITZER ORGAN. IN GOOD condition, with 10 rolls music, for sale at a bargain. Cost \$900.00, sell for \$400.00. R. W. CROSBY, Dover, Ohio.

UNA-FONS WANTED. WIRE. STATE ALL. CONCERT MUSIC CO., 642 East Washington, Indianapolis, Indiana.

\$40.00 JAP CELLO AND BOW, ONE STRING. with take apart stand and seat attached. Cost \$100. Fine condition and tone. Great for musical act. WELL'S CURIOSITY SHOP, 20 S. Second St., Philadelphia, Pennsylvania.

WILL SELL MILLS O. K. MINT VENDER, 5c. 10c. 2c. play. MAX ABESHOUSE, 94 Grand Ave., New Haven, Connecticut.

2 MILLS O. K. COUNTER MINT VENDERS. round glass, in extra fine condition, filled with checks and ready to start working. These machines for operating purposes, just as good as new. For quick sale, \$100.00 for the 2. F. O. B. Norfolk. S. S. DIGGS, 501 W. 31st St., Norfolk, Virginia.

10 H. P. GAS ENGINE ON WHEELS, COST \$490.00, will sacrifice \$130.00. L. & F., 165 Walnut St., Bloomfield, New Jersey.

15 H. P. CUSHMAN ENGINE AND WATER Tank, used 8 months in a park, price \$398.00. CHAS. HOFFMANN, 933 22d St., Milwaukee, Wisconsin.

300 PAIR BARNEY & BERRY FIBER ROLLER. Skates, sell all or part, all sizes; 1 Deagan Una-Fon, 8-octave, \$150.00, without battery. R. W. CROSBY, Dover, Ohio.

\$50.00 SET 15 CHROMATIC MUSICAL BOTTLES in G. and C. take down standing rack, played with thumbs and padded. Fiber Trunk to hold outfit. Great bargain. WELL'S CURIOSITY SHOP, 20 S. Second St., Philadelphia, Pennsylvania.

FURNISHED ROOMS

3c WORD, CASH. NO ADV. LESS THAN 25c. 6c WORD, CASH. ATTRACTIVE FIRST LINE. Figure at One Rate Only—See Note Below.

RICTON'S ROOMING HOUSES, CINCINNATI, Ohio, 14 houses. For rooms call Canal 1099-K.

HELP WANTED

6c WORD, CASH. NO ADV. LESS THAN 25c. 8c WORD, CASH. ATTRACTIVE FIRST LINE. Figure at One Rate Only—See Note Below.

Catcher Wanted or Young Man to learn catching in Casting Act. Address C-BOX 742, Billboard, Cincinnati. mar14

Girl Wanted for Teeth and trapeze. A. BALIOT, 1819 Terrace, New York. feb28

Wanted for 10-in-1 — Man for openings, also tattooed man with own banner. State lowest. Write: A. ANDREWS, 130 Niagara St., Buffalo, New York.

Wanted — Girls for Illusion. Crystal Gazer, Mind Reading act, Oriental dances, novelty acts. Twenty weeks' traveling. MAHARAJAH, 17 East 131st Street, New York City.

Wanted — Men and Women To earn money at home in spare time. No soliciting or peddling. Pays big money. Write immediately. OPPORTUNITY PUBLISHING CO., Station "A", Columbus, Ohio.

ADVANCE AGENT FOR MOVING PICTURE, middle-aged lady or gentleman. Must be well educated and highly refined. Splendid proposition for person of initiative ability. Private company. Travel Virginia. A. J. VAUGHAN, Abingdon, Virginia.

FAT PEOPLE—FAT PEOPLE—WANT TO hear from Fat People at all times. Year round work. KARN BROS., care Rubin & Cherry Shows, Montgomery, Ala. mar7

LADIES—SELL RICH-LOOKING IMPORTED Pearl Necklaces, imitation diamond chain, value \$5; sample, C. O. D. \$1. LA VAL PEARLS, 90 William, New York. x

MEN WANTING FOREST RANGER POSITIONS; \$1,500-\$2,400 year. Write for free particulars of exams. MOKANE, A-33, Denver, Col. feb28

WANTED—COLORED BAND LEADER AND Plantation Show and Merry-Go-Round. 13 weeks' travel by truck. C. F. HOGANS, 75 Chestnut St., Hamilton, Ohio.

WANTED—FAST-STEPPING YOUNG COMedian, sing, dance and handle small vaudeville show; also three young, good-looking girls. Must sing, dance and do bits (no chorus work); Pianist that doubles stage. Wardrobe? Yes. Photo for consideration; will return. Long season. State lowest. Opens in April. J. L. LASANE, 802 So. First St., Louisville, Ky.

WANTED—MAGICIAN TO TAKE OVER COMPLETE Illusion Show. I furnish illusions, banners and outfit. Man, wife and little girl. Rajah Rabod, write. MYSTIC ELTON, Miller Bros.' Shows, Savannah, Georgia. feb28

WANTED—MARRIED MAN, NO CHILDREN, that understands wagon picture show racket. Must be good operator; Power's G-B Bliss Light. Will turn over real 2-wagon outfit. You 40, me 60. State all first letter and reference. REED SHOW, Patroon, Texas.

WANTED—ORGANIZED SHOW, OR WILL take partner with capital. I have outfit. MANAGER TENT SHOW, Mobile, Alabama.

WANTED—VAUDEVILLE ACTS, ALSO CLEVER Principals to work in acts. JOHN H. BENTLEY AGENCY, 177 North State, Chicago. mar21

HELP WANTED—MUSICIANS

6c WORD, CASH. NO ADV. LESS THAN 25c. 8c WORD, CASH. ATTRACTIVE FIRST LINE. Figure at One Rate Only—See Note Below.

Drummer Wanted Immediately. Must be experienced. Have tympani, bells and complete line of traps. DALTON THEATRE, Pulaski, Va.

Musicians Wanted All Instruments, Zeelman & Polie Show concert band, opening Spartanburg, South Carolina, early in April. Address CAPT. MILLER, bandmaster, Elks' Club, New Orleans, La. mar7

Wanted Cornet, Clarinet and

Trombone for big comedy band act, playing the Keith Time. Tall, thin man, over six-foot tall answer, staling instrument you play. Can also use Midget, Dwarf or very short man that plays brass. Music easy. Act always working. Salary, \$40.00 after joining. Send photo. State age and height. Address CHARLES AHEARN, care Hughes and Manwaring, 1562 Broadway, New York City, N. Y.

WANTED—VIOLIN-LEADER WITH A GOOD, large library. Must be capable, cue pictures, play vaudeville. Good engagement for right party. Union. MAJESTIC THEATRE, La Salle, Illinois.

WANTED—VIOLINIST THAT CAN OPEN panditorium. No boozier. BEN BRUICK, West Point, Iowa. feb28

INSTRUCTIONS AND PLANS

6c WORD, CASH. NO ADV. LESS THAN 25c. 8c WORD, CASH. ATTRACTIVE FIRST LINE. Figure at One Rate Only—See Note Below.

Advertisements under this head must be confined to instruction and Plans only, either printed, written or in book form. No ads accepted that offer articles for sale.

\$Money\$ Writing Show Cards. Instructions, \$1.00. "SERVICE", 40 Richmond Ave., Worcester, Mass.

Makeup Book — Complete Instructions on makeup. Text with colored illustration. You can learn this wonderful art. Price, 50c, prepaid. F. W. NACK, 36 S. State St., Chicago.

Tumbling Easily Learned — Complete course, \$1.00. Satisfaction guaranteed. WALLACE POWER, 821 W North St., Kalamazoo, Michigan.

HARMONY CORRESPONDENCE INSTRUCTION, 25c lesson. "Songwriter", 10c. UNIVERSAL MUSICAL SERVICE, 2545 Cooper Avenue, Brooklyn, New York. mar7

TEN FANCY STEPS OF "CLOG DANCE" taught by amazing new chart system. These lessons taught privately in New York City for \$20.00. Printed copy of lessons for \$1.00. Free circular. JAMES MOORE, 8 East Third St., New York City.

\$1,000 A WEEK PROFIT PROMOTING AUTO Shows without capital. Complete plan by successful promoter, 25c; worth \$5.00. "HANSER", 627 1/2 Main, Tell City, Indiana. apr1

A PUBLIC DEFENDER

EVERY person accused of violating the criminal laws should be duly prosecuted and defended. No accused person should have less than efficient prosecution on the one hand or more than just defense on the other. But the practice in our criminal courts is out of balance in this respect. The prosecution is provided for. The accused hires his defenders according to his resources. If he be without money or friends, a defender is appointed. The result is that the worst criminal often escapes thru the manipulations, tricks and delays made possible by expert legal tacticians, while lesser offenders are inadequately defended.

Judge Buckner, at present presiding over one of the divisions of the criminal court, is disposed to name a public defender instead of calling for volunteers for each case where the accused is unable to employ an attorney. But an unpaid defender could not be relied on except temporarily.

In justice—and no more than justice—to all, there should be a public defender, chosen at the same time and in the same way the public prosecutor is chosen. He would be the paid agent of the State, just as the prosecutor is. When a special prosecutor is employed he works under the direction of the prosecuting attorney, or should be required so to work. And if special defenders were employed on behalf of the accused, they should be compelled to work under the direction of the public defender. In all cases the special attorneys should be paid by the State and their fees fixed by the courts.

Of course, such a policy would displease many lawyers. But lawyers, who are primarily responsible for our laws, our courts and our system of procedure, have not made a very good job of the thing—except for themselves.

MAGICAL APPARATUS

FOR SALE. (Nearly New and Cut Priced) 6c WORD, CASH. NO ADV. LESS THAN 25c. 8c WORD, CASH. ATTRACTIVE FIRST LINE. Figure at One Rate Only—See Note Below.

Laurice Magical Shop, 799 Broadway, Brooklyn, New York. mar7

CHESTER MAGIC SHOP — ANYTHING IN Magic, Books, Illusions, Secrets, Roll Paper for hats, etc. Blueprints are cheap. Bargain list for stamp. Cuttings for heralds and letter heads; samples for 10c; none free. We buy used goods. 403 North State, Chicago.

FOR SALE—MAGIC. A WELL-SELECTED lot of magic of highest quality, used 45 times, cost \$300.00, all in trunk, for \$200.00. Will sell separate. Have no junk; taking other business. Dime brings list. ROBERT D. BURRIS, 333 Hickory St., Hammond, Indiana.

ILLUSIONS AND MAGIC AT REDUCED prices. Send stamp for new list. EASTWOOD, 243 Front, Portsmouth, Ohio.

MAGIC AT GIVEAWAY PRICES. STAMP FOR list. LOHREY, Garfield Street, Dayton, O. feb28

PLAY LODGES, CLUBS OR VAUDEVILLE with our Magic, Mind Reading, Crystal Gazing, Spiritualistic and Escape Acts. Easy work; big returns. We teach you how. Six cents brings catalog; none free. Low prices; prompt service. GEO. A. RICE, Auburn, N. Y. feb28

SUIT CASE OF MAGIC. CONTAINS ABOUT 15 tricks, sucker die box, slide stand, etc. First \$15.00. MISS M. MCGILLVARY, 5792 Iroquois, Detroit, Michigan.

TWO GOOD ILLUSIONS SUITABLE FOR SIDE Show, \$35.00 each. ALI HASSAN, 1331 So. Fourth St., Marietta, Ohio.

MUSICAL INSTRUMENTS AND ACCESSORIES

FOR SALE—WANTED TO BUY. 6c WORD, CASH. NO ADV. LESS THAN 25c. 8c WORD, CASH. ATTRACTIVE FIRST LINE. Figure at One Rate Only—See Note Below.

Band Organs — Big Bargains. TANGLEY CO., Muscatine, Iowa. mar11

Conn C Soprano Saxophone. Straight model, quadruple gold plated with velvet-lined case, just like new, or will trade for E-flat alto saxophone. JESSE HALLER, Coshocton, Ohio. feb28

For Sale—Band Organs. Two fine factory rebuilt instruments with all new music. For carnival, hall or can be mounted on truck for advertising purposes. Also Hardy-Gurdy phono. Positive no junk. Bargain. J. S. GEBHARDT ORGAN CO., Tacony, Philadelphia, Pennsylvania. mar14

Free — New Musical Instrument to bonafide professionals. No red tape. Particulars. ADVERTISER, 418 W. 38th, New York. mar7

BAND AND ORCHESTRA INSTRUMENTS—Kansas City's original "Professional House" sells, repairs and exchanges all makes of instruments. All latest popular music and Fischer, Schirmer, Barnhouse, Fillmore, King Agnew and other standard editions. Send all your orders for music to one house—if we have not got it we will get it for you. Exchange your old instrument for music, write us for details. Distributors in Kansas City for complete Buscher line, also Ludwig Drums, Vega Banjos, Deagan Bells and Marimbas and other lines. Used and rebuilt instruments for sale: Buscher Alto Saxophone, silver, gold bell, in case, a bargain at \$90.00; Conn C Melody, silver, gold bell, case, a fine Sax., \$95.00; Conn Curved B-Flat Soprano, silver, gold bell, in case, a snap at \$80.00; Harwood Trumpet, silver, in case, \$25.00; H. S. A. Trombone, brass, nearly new, no case, \$21.00. Send for bargain bulletin of used and rebuilt instruments. Free subscription to Musical Booster Magazine to all who send permanent address; also free catalog of band and orchestra instruments. We cater to professional musicians all over the country. Deal with the "Professional House." CRAWFORD-RUTAN CO., 1017 Grand Ave., Kansas City, Missouri. mar7

BARGAINS IN HIGH-GRADE NEW AND Used Saxophones and Band Instruments. Your old instruments taken as part payment on a new one. J. T. FRENCH, 227 1/2 Erie Street, Toledo, Ohio. feb28

BETONEY BOEHM PICCOLO, ORCHESTRA 410, wood, \$25.00. Trade for Band Piccolo. D. NEWMAN, Huntington, West Virginia.

CLARINET—B FLAT, SPECIAL OFFER, CUNdy Bettyony, seventeen keys, six rings, grenadilla wood, complete, with case, \$100.00. HENTON KNECHT, 110 South 17th Street, Philadelphia, Pennsylvania.

DEAGAN XYLOPHONE, THREE OCTAVES, first-class, \$10.00; Ludwig #15 Snare Drum, good, \$20.00. GLENN BECKLEY, Richmond, Ohio.

FOR SALE — BASS AND SNARE DRUM, Pedal and Traps. LYNN HUGHES, Sandusky, Ohio. mar14

FOR SALE—COLUMBUS PIANO IN HINGED box, good condition, one hundred dollars. Sixty by ninety Khaki Top Processium for same, some patches, but good for season, price, one hundred fifty dollars. No poles or side wall. Half down, balance C. O. D. LESLIE E. KELL, Warren, Arkansas. feb28

FOR SALE — IVERS AND POND PARLOR Grand Piano, new, blue for theatre or concert hall, price \$500.00. Will stand any kind of playing or inspection. RAY D. CARTER, 623 W. Nevada St., Marshalltown, Iowa.

FOR SALE—2 BERNI 46-KEY ORGANS, IN good repair; also 100 pair of Skates. BOX 212, Devon, Connecticut.

LEEDY BASS DRUM, IN CASE, TWENTY-five dollars; Snare, ten; Deagan Three-Octave Song Bells, fifty dollars, like new. OZRO McFARLAND, Gen. Del., Ottumwa, Iowa.

MARIMBA, DEAGAN, 3/2 OCTAVES, WITH case, practically new, bargain. HARRY EIGHER, 1408 Union Cent. Bldg., Cincinnati, O.

REGULATION BAND COATS, \$3.50; CAPS, \$1.00; 1 set Boys' Band Coats, red, \$25.00; 1 set Blue, \$25.00; Minstrel Suits, flashy, complete, \$5.00. Stamp for list. WALLACE, 1534 N. Halsted, Chicago.

TENOR BANJO, BRAND NEW, BACON, SILVER bell, style 2, geared pegs and plush case. Outfit cost \$210.00 two weeks ago. Will accept \$170. L. LOKEN, JEWELER, Box 777, Cromwell, Oklahoma.

TYMPANI, LUDWIG MAKE, 25 AND 23 IN., good as new, \$85. C. O. D. F. J. BISSONETTE, Belle Theatre, Escanaba, Michigan.

\$150.00 BUYS NEW WOOD WHISTLE COZATT Air Calliope, complete with motor and blower. SAM V. DAY, Marshalltown, Iowa.

\$70 DEAGAN XYLOPHONE AND CASE, LIKE new, \$75; Leedy Bells, 2 1/2 octaves, 1 1/2 in. har, good condition, \$12. DRUMMER, 215 1/2 E. 4th St., Waterloo, Iowa.

\$400.00 BUYS NEW 36-WHISTLE SELF-CONTAINED True Tone Air Calliope, complete. SAM V. DAY, Marshalltown, Iowa.

NOTE—Count All Words. Also Combined Initials and Numbers in Copy. Figure Total at One Rate Only. IN ANSWERING CLASSIFIED ADS, PLEASE MENTION THE BILLBOARD.

PARTNERS WANTED FOR ACTS

(NO INVESTMENT) 5c WORD. CASH. NO ADV. LESS THAN 25c. 7c WORD. CASH. ATTRACTIVE FIRST LINE. Figure at One Rate Only—See Note Below.

Wanted Partner — Experienced picture show man to join me in opening a picture show in Memphis. I have about four thousand dollars to invest. W. D., 1501 Netherwood, Memphis, Tenn.

LADY DOING JIU JITSU WRESTLING ACT would like to join act or partner. Some stage experience. 5 ft., 5 in. height. JESSIE AARONS, Billboard, New York.

LADY THAT CAN SING AND TALK FOR vaudeville. Send photo, MILT WILLIAMS, General Delivery, Brooklyn, New York.

PARTNER WANTED—HAVE SOME ANIMALS and illusions. Want help to enlarge show. Have two trucks. FOUNTAIN SQUARE P. O. BOX No. 8, Indianapolis, Indiana.

PERSONAL

6c WORD. CASH. NO ADV. LESS THAN 25c. 8c WORD. CASH. ATTRACTIVE FIRST LINE. Figure at One Rate Only—See Note Below.

Buffalo, Cleveland, Detroit representation. Information. Mail addresses. Management business, personal affairs. Tell us your legitimate wants. GENERAL SERVICE BUREAU, 554 Bramson Bldg., Buffalo, New York.

Correspondence—Choice Line printed personal stationery. Very low in price. Special rates to clubs. Address PIONEER PRESS, Plantsville, Conn.

INFORMATION WANTED REGARDING HARVEY K. MARR and W. E. (Billy) Senior. Matter of interest and importance. Will persons who know where these men are located or with what show connected please write H. C. DIEHL, Greenville, Illinois.

PRIVILEGES FOR SALE

6c WORD. CASH. NO ADV. LESS THAN 25c. 8c WORD. CASH. ATTRACTIVE FIRST LINE. Figure at One Rate Only—See Note Below.

POP. SODA AND SOFT DRINK: CANDY Kitchen with Crispette and Floss Machine Outlets, complete, with long lease in fine parking seven-day park. Owner retiring and will sell at a sacrifice. Address CANDY KITCHEN, The Billboard, 1493 Broadway, New York.

SALESMEN WANTED

7c WORD. CASH. NO ADV. LESS THAN 25c. 8c WORD. CASH. ATTRACTIVE FIRST LINE. Figure at One Rate Only—See Note Below.

DISTRIBUTORS—AMAZING NEW INVENTION selling 2c. Seals 3.50 envelopes hour. Tremendous demand. Exclusive territories available. RED-E. CO., Dept. Q1, Colonial Bldg., Boston, Massachusetts. feb28

DISTRIBUTORS — FORTUNE RIGHT MEN. Sensational new Auto Number Frame retails \$3 only. Spreading like wild fire. Exclusive territory now. PROMANCO, 652 Trinity Bldg., Boston.

DISTRIBUTORS—WONDERFUL PRICING SYSTEM for all stores. Absolute protection. Immediate repeat sales. Possibilities \$100,000 yearly. Write MANUFACTURER, Dept. 4, 100 Boylston, Boston, Massachusetts.

DISTRIBUTORS — SCREW-HOLDING SCREW Driver. Handiest tool ever invented. Unlimited market; exclusive territories; big repeat earnings. Write COBURN TOOL, 739 Z Boylston, Boston, Massachusetts. feb28

SALESMEN—NEVER A DULL MOMENT WITH A Wetmore, the unique little pocket knife that uses discarded safety razor blades. Write at once for extraordinary offer in our direct-import campaign, covering office buildings, etc. Sharpest handiest knife a man ever owned. WETMORE KNIFE, INCORP., Milwaukee, Wisconsin.

WANTED TO HEAR FROM GOOD STOCK Salesmen. Stock insured against loss. Good commission. T. G. SORTOR, St. Joseph, Mo.

SCENERY AND BANNERS

6c WORD. CASH. NO ADV. LESS THAN 25c. 8c WORD. CASH. ATTRACTIVE FIRST LINE. Figure at One Rate Only—See Note Below.

USED SCENERY BARGAINS. STATE SIZES wanted. KINGSLEY STUDIO, Alton, Ill. feb28

ARTISTIC, MODERN SCENERY, DYE DROPS. Banners at greatly reduced prices if you order now. Send dimensions for prices and catalogue. ENKEBOLL SCENIC CO., Omaha Nebraska. feb28

SCHOOLS

(DRAMATIC, MUSICAL AND DANCING) 4c WORD. CASH. NO ADV. LESS THAN 25c. 6c WORD. CASH. ATTRACTIVE FIRST LINE. NOTICE!

No advertising copy accepted for insertion under "Schools" that refers to instructions by mail or any training or coaching taught by mail. No ads of acts or plays written. The copy must be strictly confined to Schools or Studios and refer to Dramatic Art, Music and Dancing taught in the Studio. Figure at One Rate Only—See Note Below.

VOICE SPECIALIST—J. BURLINGTON RIGG, vocal record artist, toured world. Pupils trained for light opera, concert, vaudeville, church, lyceum, chautauqua. 606, 64 E. Van Buren St., Chicago. mar14

READ THIS CAREFULLY—Do you want to win success on the stage, also wealth and fame? The Harvey Thomas method is the surest way. Every style of dancing taught—Soft Shoe, Buck and Wing, Boogie, Waltz-Clog, Spanish, Jigging, Triple-Rattle, Spitta, Acrobatic, etc. Beginners trained until ready for the stage. Bookings by my agency and affiliations. We give no diplomas, but issue contracts instead. Special Home Mail Course Study. Soft Shoe, Buck and Wing, Waltz-Clog, \$2.00 each; three for \$5.00. Send money order, stamps, cash or check. HARVEY THOMAS DANCING SCHOOL, 34 Floor, 59 W. Van Buren St., Chicago. oct7-1925

2ND-HAND SHOW PROPERTY FOR SALE

6c WORD. CASH. NO ADV. LESS THAN 25c. 8c WORD. CASH. ATTRACTIVE FIRST LINE. Figure at One Rate Only—See Note Below.

For Sale — Mechanical City. Two banners and motor and 1,000 tickets; all in good working order. Will sell cheap for cash, \$200.00. Reason for selling, have gone into real estate business. H. E. BULMER, Box 752, Glace Bay, Cape Breton, Canada.

CRISPETTE MACHINE, COMPLETE, GOOD condition, \$200.00; set of Trap Drums, with extra pedals, complete, \$50.00; lot of Small Magic, Laughing Mirrors, newest novelty for mechanical shows and arcades. Three styles, fat, slim and upside down. Especially framed for shipping size, 15"x18", all new. 3 for \$20.00 or \$8.00 each while they last. RAY SHOW PROPERTY EXCHANGE, 1330 South Broadway, St. Louis, Missouri.

DEVIL'S BOWLING ALLEY, COMPLETE. W. R. SNEHEN, West Frankfort, Illinois.

ELECTRICAL EFFECTS—CLOUDS, WAVES, Ripples, Waterfalls, Fire, Flowers. SPOTLIGHT NEWTON, 214 West 14th Street, New York. mar2

FOR SALE—A LOT OF UNCLE TOM PAPER, cheap. A. B. CAIN, Ontario, Indiana.

IF YOU DON'T STOP RUNNING AROUND, fox-trot hit, 15 cents copy. LOESCHER MUSIC CO., 2633 Gov. Nichols St., New Orleans, Louisiana.

ROOSEVELT MUSICAL ASSOCIATION—MUSIC for all occasions. CLARENCE BROWN, 158 Lefferts Place, Brooklyn, New York. mar14

TATTOOING SUPPLIES

(Designs, Machines, Formulas) 6c WORD. CASH. NO ADV. LESS THAN 25c. 8c WORD. CASH. ATTRACTIVE FIRST LINE. Figure at One Rate Only—See Note Below.

PAIR BEST MACHINES, FIVE DOLLARS. WAGNER, 209 Bowery, New York. mar14

SEE WATERS NEW PRICE LIST FREE. Buy from manufacturer. Nuf sed. WATERS, Manufacturer, 1630 Randolph, Detroit. feb28

TATTOOING SUPPLIES, ILLUSTRATED catalogue free. WM. FOWKES, 8430 John R., Detroit, Michigan. mar28

FOURTEEN LATEST TATTOO DESIGNS, 25c. ZEIS, Box 162, Saint Paul, Minn. feb28

TENTS FOR SALE

(SECOND-HAND) 6c WORD. CASH. NO ADV. LESS THAN 25c. 8c WORD. CASH. ATTRACTIVE FIRST LINE. Figure at One Rate Only—See Note Below.

SLIGHTLY USED TENTS—EIGHT 25x48, khaki. Other sizes up to 80x150. ILLINOIS VALLEY AWNING AND TENT CO., Peoria, Illinois. mar14

The National Music Study Movement in America. THANKS are due, without doubt, to somebody for the rich openings which certain vocal and instrumental teachers of Europe have of late found in America; for the lucrative positions, that is to say, which they have secured in the recently established music schools of the country. Obviously, also, plenty of thanks are owed in turn to every master of the voice, the violin and the piano who, forsaking a career in his own land, expends his strength furthering social experiments in another, and who withdraws the renown of his presence and the benefit of his talent away from France, Italy, Poland, Czechoslovakia, Rumania or wherever else in order to bestow them upon the United States. But to risk a one-sided view of the situation, there can unquestionably be pointed out persons—yes, a number of them can be called by name—who have industriously labored the past 20 years to get a music education movement going on American soil and who really have made possible the fine jobs into which the visitors have stepped. Does anyone ask who they are? Let him look for some of them in classrooms of universities, and for others on the platforms of public and private lecture halls. For the professor of music and the touring music lecturer may be regarded as chief among those who have prepared the way for the specialized pedagogue of today. The professor, giving a course in appreciation of the classics to large groups of students and lessors in harmony and counterpoint to small ones, and the lecturer, talking to popular or intimate gatherings on the operas of Wagner, on the orchestral works of the impressionists, or on the quartets and trios of the chamber-music writers, have instilled such artistic desires in the community as only heavily endowed, magnificently equipped and brilliantly staffed conservatories could satisfy. Necessarily, the men and women who have been called to posts of honor and profit in the new institutions will entertain feelings of profound regard for the wealthy benefactors and sustainers from whose bounty they directly draw their stipends. At the same time they may be expected, in all justice, to cherish a warm feeling in their hearts for the professor, perhaps, emeritus, or for the lecturer, his labors possibly but a memory, who helped set the whole splendid idea of national music study in motion. —CHRISTIAN SCIENCE MONITOR.

FOR SALE—SHOW PROPERTY. PUSH POLE Tents, 70, with a 30-foot middle; one 60x10-foot Tent with a few patches, one fifty-foot Tent, Concession Tent, 10x15; all used tents. 40 Canvas Bench Seats, for five people, fair condition; one Marquee, fifteen lengths Seats, seven high; Stringers, Jacks, good shape; Ropes, twelve American Machine Lanterns, one Stage Proscenium. Stored near Buffalo, N. Y. Those that mean business write, strictly cash. If interested write MGR. JIM WELCH, Welch's Show, 18 South Division St., Buffalo, N. Y.

FOR SALE—2 BOX BALL ALLEYS, \$150.00 each, and 20 Arcade Machines, J. DEMARCO, 5053 Newport Ave., Ocean Beach, Calif. mar14

TANGLEY SELF-PLAYER CALLOPE, mounted on one-ton Ford truck, circus style, excellent condition, big dash. Address ARTHUR BROWN, care Billboard, Cincinnati.

TENT, 40x70, KHAKI, PUSH POLE, ROUND ends, top same as new, used 6 weeks, side wall 10 ft., marquee, express poles, complete, a dandy outfit, \$250 gets it. DR. F. L. GRANGER, Hawk Point, Missouri.

VENTRILOQUIST FIGURES OF EVERY DESCRIPTION. SHAW, Victoria, Mo. mar14

WAX FIGURES OF EVERY DESCRIPTION. SHAW, Victoria, Missouri. mar14

SONGS FOR SALE

5c WORD. CASH. NO ADV. LESS THAN 25c. 7c WORD. CASH. ATTRACTIVE FIRST LINE. Figure at One Rate Only—See Note Below.

Exclusive Songs, Parodies on latest hits. 6 for \$5. Send stamp for list. EMJAYDEE MUSIC CO., 1213 Superior Ave., Cleveland, O.

THEATRES FOR SALE

7c WORD. CASH. NO ADV. LESS THAN 25c. 9c WORD. CASH. ATTRACTIVE FIRST LINE. Figure at One Rate Only—See Note Below.

Sealed Bids Are Called for on lease of Shuler Auditorium, moving pictures and road shows, Raton, New Mexico, for period of two years, option of lessee for three additional years. Certified check for \$500.00 must accompany bids. The right to reject any and all bids is reserved. Bids must be in hands of City Clerk not later than 12 o'clock, noon, March 5, 1925. CITY OF RATON, Raton, New Mexico. feb28

THEATRICAL PRINTING

6c WORD. CASH. NO ADV. LESS THAN 25c. 8c WORD. CASH. ATTRACTIVE FIRST LINE. Figure at One Rate Only—See Note Below.

Cards, 500 Printed for \$1.00 and a Card Case Free. 1,000 for \$1.90. Neatly printed on good quality white Bristol. Four lines composition or less. Cash with copy. ST. LOUIS CARD SPECIALTY CO., P. O. Box 1514, St. Louis, Mo. feb28x

Curtiss, Continental, Ohio. mar21

Foster, Chicago, Catalogs, Advertising. Commercial Printing, 4342 N. Robey. feb28

BOND LETTERHEADS AND ENVELOPES, 250 of each, for \$2.25, postpaid. FRANK KENYON, Greene, New York. mar7x

ATTRACTIVE PRINTING—250 LETTERHEADS and Envelopes, neatly printed, \$2.50; 500, \$4.50, postpaid. COLE BROS., 400 South Halsted, Chicago. feb28

BOOKING, ENGAGEMENT, BAGGAGE, HOTEL Contracts; Passes, Calls, Route Cards, Daily Reports, Agent's Reports. Postpaid, 1c each. BOX 1155, Tampa, Florida. apr18

BUSINESS PROGRESS—NEW MAIL-ORDER and local business plans each month. Trial 3 months' subscription, including other money-making business chances, 25c. 734 Cherry St., Kansas City, Missouri.

LETTERHEADS, ENVELOPES, 50 EACH, \$1, postpaid. STANLEY BENT, Hopkinton, Ia. mar7

LOOK!—250 COLORED BOND LETTERHEADS or Envelopes, \$1.00, postpaid. Pink, blue, goldenrod, canary. Samples, 2c. BLANCHARD PRINT SHOP, Hopkinton, Iowa.

PACKWOOD PRINTING COMPANY, WYACONDA, Missouri. mar7

10,000 4 1/2 x 6 TONIGHTERS, 20 WORDS, SPECIAL, \$7.75. KING PRINTERS, Warren, Ill. feb28

20 LB. BOND LETTERHEADS OR ENVELOPES, 500, \$2.99; 1,000, \$4.98. Samples free. HELLE PRINTERS, 1153 Gladwin, Detroit, Michigan.

500 FINE BOND LETTERHEADS, \$2.75; 500 Envelopes, Acts and Sharing Contracts, Reports, Complimentaries. TODD CO., 17-19 E. Second St., Cincinnati, Ohio.

WANTED PARTNER

(CAPITAL INVESTED) 6c WORD. CASH. NO ADV. LESS THAN 25c. 8c WORD. CASH. ATTRACTIVE FIRST LINE. Figure at One Rate Only—See Note Below.

Partner Wanted With \$500 To Invest in Traveling Motorized Picture and Animal Show, with concessions. J. F. WATSON, Star Shows, care Billboard, Cincinnati, O.

Wanted Partner With \$2,000 to enlarge show—buy one or two railroad cars. I have new tent outfit. C-BOX 740, Billboard, Cincinnati.

FIVE HUNDRED DOLLARS CASH SECURES third interest in the big paying concessions, booked on reliable carnival. Prefer man or woman, capable of running "Dorno" game. Address, quick, WILLIAM WELCH, 1501 North Clark St., Chicago, Illinois.

PARTNER WANTED TO GO THRU SOUTH America with a show. Want man with investment to know all. CARL DRAKMA, 1915 S. Michigan Ave., Chicago.

WANTED TO BUY, LEASE OR RENT 5c WORD. CASH. NO ADV. LESS THAN 25c. 7c WORD. CASH. ATTRACTIVE FIRST LINE. Figure at One Rate Only—See Note Below.

Location Wanted for Up-to-date Penny Arcade. L. NELSON, 92 Prince St., New York. mar7

Want to Buy—Mills, 5 and 25c plays. State condition and price. PEERLESS, 2106 Central Ave., Minneapolis, Minnesota. mar7

Wanted—Skeeball Alley. Describe fully with price. T. M. WHITE, Dunn, N. C. mar14

Wanted—Wax Figures, Relics, etc., for world museum. Want figures showing wounds for war museum, relics and guns of all periods, in fact any relics that will cause attention. Pay cash. HARR, Nora Springs, Ia.

Wanted at Once—Set of Leedy or Ludwig Pedal Tramps, tuning device attached, with trunks. A-1 condition, good as new, cheap for cash. Pay your own way. Write or wire, EDDIE ELLIOTT, 192 Fort St., Winnipeg, Canada.

ARCADE MACHINES OF ALL KINDS wanted for cash. B. LEVY, 105 Fulton St., Brooklyn, New York. feb28

DIAMOND DYE SCENERY FOR TENT OR theatre. Two-Piece Canvas Benches, Marquee. Must be A-1 condition and cheap. GEO. D. BAKER, Coronado Hotel, Columbus, Ohio.

DICE MACHINES WANTED. TOTEM NOVELTY CO., Aurora, Illinois. mar21

NEED CASH! BEST PRICES FOR THEATRE and Road Show Machines, Films and Equipment. Spot cash; immediate attention. GROBARICK, Trenton, New Jersey.

SLOT MACHINES WANTED TO BUY. 5c, 10c, 25c play. Mills O. K. Vendors. State condition and price. MAX ABESHOUSE, 94 Grand Ave., New Haven, Connecticut. mar14

WANTED—JOB LOTS, EVERY DESCRIPTION. BB, 1808 So. Halsted, Chicago.

WANTED—PORCELAIN SLOT SCALES AND Waxed Fortune Tellers. LOUIS BRENNAN, 514 Maple St., Rockford, Illinois. feb28

WANTED—SMALL HAND CRANK ORGANS for export any condition. State lowest prices. MUZZIO ORGAN WORKS, 237 Hamilton Ave., Glen Rock, New Jersey. mar28

NOTE—Count All Words, Also Combined Initials and Numbers in Copy. Figure Total at One Rate Only. IN ANSWERING CLASSIFIED ADS, PLEASE MENTION THE BILLBOARD.

(Continued on Page 68)

WANTED—8x10 CONCESSION TOP AND TWO dozen Dolls for ball game. Must be cheap. Have for sale or trade Tenor Banjo and B Flat Clarinet with case. JACK DURHAM, Harrodsburg, Kentucky.

WANTED AT ONCE—GOOD SECOND-HANDED Hecklan Bassoon, also Oboe. Both must be 410. Instruments must be sent on trial. FRANK SOMMER, 417 1/2 S. Robberson Ave., Springfield, Missouri.

WANTED TO BUY—MINIATURE RAILROAD. No junk; price low. JOHN ROCKWOOD, 706 Fifth Ave., Lyons, Iowa.

WHIP WANTED FOR CASH. 802 JAMAICA Ave., Brooklyn, New York. feb28

REMARKABLE BARGAINS—FIVE THOUSAND reels Westerns, Dramas, two-reelers and single reels. Send for list and make your own price. Re-wind examination. Satisfaction guaranteed. INTERSTATE FILM SERVICE, 732 S. Wabash Ave., Chicago. mar1

SMALL CHOICE LOT 2, 3, 4, 5-REEL FEATURES. Positively nearly new. Extra good plays. Plenty new paper. \$7.50 per reel. 20% deposit, balance C. O. D., with examination. Better hurry. AMER FILM, 1119 Fair, Columbus, Ohio.

THERE IS ONLY ONE 5-REEL PASSION Play, Life of Christ, and the best of all editions that critics will buy and that is being handled by us; beware of others. All kinds of other wonderful productions. Ask those who know the home of no misrepresentations. WESTERN FEATURE FILMS, 738 S. Wabash Ave., Chicago, Illinois.

30 REELS GOOD FILM: RUN IN THIS TERRITORY. Would cost more than 150 dollars from exchange. 1 Four-Reel Subject, cost 75 dollars. First money order for 75 dollars takes all. L. HULL, Jewett, Texas.

FOR SALE OR TRADE—FILMS 7c WORD, CASH. NO ADV. LESS THAN 25c. 9c WORD, CASH. ATTRACTIVE FIRST LINE. Figure at One Rate Only—See Note Below.

Want To Swap Films—Write JAMES PROUD, Thomas, W. Va.

2ND-HAND M. P. ACCESSORIES FOR SALE 7c WORD, CASH. NO ADV. LESS THAN 25c. 9c WORD, CASH. ATTRACTIVE FIRST LINE. Figure at One Rate Only—See Note Below.

Absolutely Guaranteed Rebuilt Projectors, Powers, Simplex, Motiograph, Edison, Royal, Monarch. Also Acme, DeVry, Holmes, American Suitcase Portable Machines. All theatre supplies and equipment. Get our prices first. MONARCH THEATRE SUPPLY CO., Memphis, Tenn. feb28

Bargain Sale—\$20,000 Stock Theatre equipment. New and used. Anything you want at big savings. WESTERN MOTION PICTURE COMPANY, Danville, Illinois. mar14

Bliss Light for Projection. Best grade Pastils. 821 Spring Street, Peoria, Illinois. apr4

Dependable "Motsco" Reliable. Power's, Simplex, Motiograph, Holmes, Acme, DeVry, American and Cosmograph machines. Over 100 guaranteed rebuilt machines, chairs, transmitters, compensators, Mazda equipment. New bargain bulletin is now ready. You'll be surprised. MONARCH THEATRE SUPPLY CO., 724 Wabash, Chicago. feb28

Moving Pictures and Machines for sale. 601 Munfort Court, Kansas City, Missouri. mar7

Opera Chairs—420 Veneered 18-in.; 800 veneered 19-in. CHAS TAYLOR, 4535 Newberry, St. Louis, Mo.

Films Rented and Sold. Moving Picture projectors sold at lowest prices. Movie Cameras, \$40.00; Tripod, \$20.00; new Motor-Driven Suit Case Projector, \$75.00. Write for bargain price list K. BAY, 324 Fifth Ave., New York. feb28

FOR SALE—COMPLETE PICTURE EQUIPMENT. Booth, chairs, machine, curtain, signs; everything. P. F. DONOVAN, Lyric Theatre, Deposit, New York.

FOR SALE—COMPLETE THEATRE OUTFIT. Including Duplex 45-Note Wurlitzer Piano, 350 seats, two Power's machines, GA and GII; fancy hand work arches, fit front any theatre, and transformer. TOM MORRIS, Eleven Ten Fourth Ave., Huntington, W. Va. mar7

HALF-PRICE SALE—MACHINES, FILMS. Mazda, Arc Light and Coleman Light Equipment. Lamp Houses, Incandescent, Arc Lamps, Calcium Jars, Auto Electric Generators for road shows. State your wants. Bargain list free. NATIONAL EQUIPMENT CO., 190 West Michigan Street, Duluth, Minnesota.

SACRIFICING COMPLETE ROAD SHOW OUTFIT. Picture machine, films, accessories, dirt cheap. GROBARICK, Trenton, New Jersey.

SERIALS—PERFECT CONDITION. PAPER complete. Bargains. H. B. JOHNSTON, 523 S. Dearborn St., Chicago, Ill. feb28x

SUITCASE, PORTABLE, AND THEATRE MACHINES, selling out, Sacrificing prices. GROBARICK, Trenton, New Jersey.

1,500 REELS, CONSISTING OF FIVE AND six-reel Westerns and Dramas, two-reel Comedies and Westerns, one-reel novelties and Comedies. All in excellent condition; accessories on all. Attractive price. DELUXE FEATURE FILM EXCHANGE, 2020 Stout St., Denver, Colorado. feb28

M. P. ACCESSORIES FOR SALE—NEW 8c WORD, CASH. ATTRACTIVE FIRST LINE. 10c WORD, CASH. ATTRACTIVE FIRST LINE. Figure at One Rate Only—See Note Below.

MOVING PICTURE MACHINES, SCREENS. Portable Projectors, Stereopticons, Spot Lights, Booths, Opera Chairs and everything required for motion. MOVIE SUPPLY CO., 814 S. Wabash Ave., Chicago, Illinois. mar7x

NOTE—Count All Words. Also Combined Initials and Numbers in Copy. Figure Total at One Rate Only. IN ANSWERING CLASSIFIED ADS, PLEASE MENTION THE BILLBOARD.

Income Tax Department

Conducted by M. L. Seidman, C. P. A., of Seidman & Seidman, Certified Public Accountants

This is the 11th of a series of articles on how to prepare income tax returns that will appear regularly in these columns. Mr. Seidman is chairman of the Committee of Tax Consultants of the Committee of American Business Men. He is a well-known tax expert and has written numerous articles on taxation. Mr. Seidman will answer all questions on the subject directed to him by our readers. Such questions should be addressed to this publication, attention of the Tax Editor. To receive attention all communications should be signed by the writer. Mr. Seidman's answer, however, when published will not reveal the identity of the inquirer.

Preference is again being given to the answer of readers' questions, as most of these questions present situations of general interest that are undoubtedly confronting many readers. Mention might again be made, in this connection, that space requirements do not make it possible to publish every question received and the answer thereto. In many cases the questions are along the same lines or have already been answered in previous articles. The policy followed, therefore, is to publish only those questions that contain a novel feature or are of general interest. In every case, however, a direct communication is sent to the inquirer, giving the answer to his question.

QUESTIONS AND ANSWERS

Stock Losses

Q. My losses on the Stock Exchange for the year 1924 exceed my income for that year. Under these circumstances, of course, I pay no tax. The question is whether I am allowed to carry forward to my 1925 tax return the excess of losses in 1924. P. A. E.

A. In order to deduct a net loss, the loss must result from the operations of a trade or business. If your business is that of trading in stocks, you can deduct the excess of your losses in 1924 on your 1925 return; otherwise you cannot.

Sale of Business

Q. I sold my interest in my business for \$6,000. The profit was \$3,000; the balance was cost of merchandise. I took long-deferred notes to close the transaction. Should I state the entire \$6,000 as income in making out my return, or should I only state \$3,000, the actual cost of the merchandise? Also, shall I include in the return the notes as a whole, or wait until due and paid? R. E. T.

A. Only the profit, namely \$3,000, need be returned by you for income tax purposes. Unless the notes have no fair market value, you cannot wait until the notes are collected. If they have a fair market value, you need consider them only at that value and adjust your profit accordingly.

Investment Loss

Q. About four years ago I invested \$6,300 in a concern which has since gone into the hands of a receiver. Please advise me whether I am entitled under the law to deduct this from my income when filing my income tax report. O. W. Z.

A. The loss on your investment can be deducted, and your deduction should be taken in the year in which the investment becomes worthless.

Incorporating a Partnership Business

Q. In 1925 some friends and myself formed a partnership for the purpose of

buying and selling unimproved real estate. In 1917 we decided to incorporate and the new corporation took over the assets of the partnership. In making up our balance sheets we have added yearly to the original cost price of each parcel the taxes and interest paid on the mortgage as representing a fair increase in the value of the land, so that in May, 1917, when the corporation took over the assets, each parcel stood on the books at a substantial advance over cost price. Having sold a number of parcels in 1921, the question has arisen whether in computing the profits to the corporation it is proper to base the same on the original cost of the property to the partnership or on the cost as shown on the books of the partnership in 1917, when the corporation took over the properties of the partnership. C. E. S.

A. The basis for determining gain or loss to the corporation is the value of the property at the time it was turned into the corporation in 1917. If the books of the partnership at that time reflected fair value the book figures should be used. The original cost of the property to the partnership has no bearing on the case, as under the 1917 law, incorporating a partnership business was a transaction in which gain or loss might be recognized.

Personal Expenditures

Q. I would like to know if deductions are permitted and how to determine the amount of deduction in each case, of the following articles: (1) cigars, cigarettes, smoking tobacco, theater tickets, watches, rings and eyeglasses, (2) I understand that deduction of 1925 State tax from federal tax is permissible. Is this correct? (3) Are union (trade) dues deductible? C. W. P.

A. (1) The amounts expended for items you mention are not deductible as they are purely personal expenses. (2) State taxes are deductible on the federal tax return. (3) Dues paid a union are likewise deductible.

Exemption for Support of Parents

Q. My two brothers and myself each contribute \$20 per month which we send monthly to our parents in Scotland who are up in years and unable to earn their living. We are anxious to know if we are allowed exemption individually or whether the exemption only goes to one. D. J.

A. Only the one who is the chief support of the dependent can deduct the exemption. In your case it is apparent that you and your two brothers are equal contributors. Under the circumstances none of you could claim the exemption. It would be necessary for one of you to make more than 50% of the total contribution for that one to be entitled to the exemption.

Straus Bonds

Q. I hold a Straus bond which has a tax-free provision in it up to 4%; that is, the Straus Company pays 2% at the source and refunds the other 2% to me. How shall I treat this in my return? J. A.

A. The 2% refunded to you should be reported by you as additional interest. You can take as a credit against the tax due by you the 2% that has already been paid at the source for you.

News Notes

(Continued from page 58)

enough of the Western culture as a measure of self-defense and as a protection to their own culture. They are united in their efforts to get rid of the foreigners and have their own continent to themselves. It is the hope of the Japanese today to become the head of a great Asiatic federation and they hope to absorb the other nations in that part of the world rather than conquer by military force, said Mrs. Harrison. However, strong influences are at work to prevent absolute union. These are Russian and British.

Alton Packard writes: "Dear Al Fhda—Your article in *The Billboard* condemning 'Cheap John' methods in the lyceum is good and much appreciated by me. Do it some more! We need some fault finding in our business. Secure to me your position on *The Billboard* should enable you to wield a completely independent pen, and to say what's what. I am reading you regularly. Give us good stuff."

The above is all very true. I am absolutely free on *The Billboard* to tell the truth as I see it, but I am not free to wield a censorious pen merely for the sake of getting applause. If what I write is constructive, then I am satisfied, regardless of the result to me. But we have a lot of hard-working bureau men in this country, all of them trying to give value received, some of them handicapped by lack of funds, some by lack of knowledge. I do not want to hurt a single one of those good fellows if I can help it. I never put a piece of hard criticism in *The Billboard* but what it hurts me first. But sometimes I have to cut. I want to work for the bigger, better and more abundant lyceum of the future.

CLASSIFIED MOVING PICTURE ADVERTISEMENTS

FILMS FOR SALE—NEW 6c WORD, CASH. NO ADV. LESS THAN 25c. 10c WORD, CASH. ATTRACTIVE FIRST LINE. Figure at One Rate Only—See Note Below.

LIFE OF CHRIST OR PASSION PLAY, tinted and toned, new prints, full line advertising, \$200.00. INTERSTATE FILM SERVICE, 732 So. Wabash Ave., Chicago. mar14

FILMS FOR SALE—2D-HAND 7c WORD, CASH. NO ADV. LESS THAN 25c. 9c WORD, CASH. ATTRACTIVE FIRST LINE. Figure at One Rate Only—See Note Below.

Dependable "Motsco" Reliable. Selected subjects of highest quality. New lists now ready. MOTSCO, 724 Wabash, Chicago. feb28

Best of All Editions and Wonder productions of the original five-reel Passion Play, Life of Christ, Uncle Tom's Cabin, Joseph and His Brothers, Dante's Inferno, Jesse James, Custer's Last Fight, Fingert of Justice and many other big specials. WESTERN FEATURE FILMS, 738 S. Wabash Ave., Chicago, Ill.

Dependable "Motsco" Reliable. The film you want is on our new list. MOTSCO, 724 Wabash, Chicago. feb28

Slashing New Year Sale—Best film money can buy. Wonderful assortment of Super-Special Features, Westerns, Comedies, Weeklies and Educationals. All the Famous Movie Stars. Prices, rock-bottom. Posters free. Your money's worth guaranteed. Genuine list free. MONARCH FILMS, Memphis, Tenn. feb28

The Reward of the Public approval is our edition of the five-reel Passion Play—it's a wonder—beware of others. WESTERN FEATURE FILMS, 738 S. Wabash Ave., Chicago.

Westerns, Comedies, Big Star, Mabel, Mabel Normand, \$70. Pale in Blue, Tom Mix, \$60. Lists available. ECONOMY CO., 814 Cornhill, Philadelphia, Pa.

BARGAINS—FEATURES, COMEDIES, WESTERNS. Send for list. REGENT FILM CO., 1237 Vine St., Philadelphia, Pa. feb28

IT'S OUR EDITION OF THE FIVE-REEL Passion Play that the world is talking about; beware of others. WESTERN FEATURE FILMS, 738 S. Wabash Ave., Chicago.

EXTRA GOOD CONDITION FEATURE AND Short Subject Films for sale. Send for list. SOUTHERN FILM BROKERS, Broker's Building, Birmingham, Alabama. mar7

FILM EXCHANGE GIVING UP BUSINESS. Great bargains Westerns, Northwesterns, Dramas, Short Subjects. A. J. HEPNER, Pres., 124 Coronas St., Denver, Colorado.

FILM FOR SALE—BIGGEST STOCK IN THE South. \$5 per reel up. Film for toy machines and home projectors, \$2.50 per reel. Send for list. INDEPENDENT FILM EXCHANGE, 303 West Commerce St., San Antonio, Texas. mar14

FOR RENT—PASSION PLAY, FIVE REELS: Uncle Tom's Cabin, five reels. C. J. MURPHY, Elyria, Ohio. feb28

HERE IS ANOTHER ONE OF MY BIG BARGAINS—West of the Rio Grande, 5 reels; Blood and Thunder, Western, \$42.00. A full line of advertising free. Two-reel Comedies, \$8.00; also Pathe's five-reel wonder production of the Life of Christ. Brand-new prints, at big bargain prices. Satisfaction guaranteed. E. ABRAMSON, 2711 Augusta St., Chicago, Ill.

ONLY THOSE WHO ARE DISGUSTED WITH junk need apply for our lists. WESTERN FEATURE FILMS, 738 S. Wabash Ave., Chicago, Illinois.

PATHE'S FIVE-REEL PASSION PLAY, brand-new print, \$189.00. Act quickly. Other big bargains. Bargains is my middle name. Satisfaction guaranteed. E. ABRAMSON, 2711 Augusta St., Chicago, Illinois.

\$10 BUYS TEN REELS. WORTH \$50. CASH with order. LOUIS SILVERMAN, 1012 Forbes St., Pittsburgh, Pennsylvania.



Managers and artists are respectfully requested to contribute their dates to this department. Routes must reach The Billboard not later than Friday of each week to insure publication.

When no date is given the week of February 23-28 is to be supplied.

Aaron & Kelly (Capitol) New Britain, Conn.
Ages Five (Pantages) Tacoma, Wash., March 27.
Agnones (Wehlita) Wichita Falls, Tex., 26-28.

Bordne & Carroll (Orpheum) Lima, O.; (Regent) Jackson, Mich., March 2-7.
Bowers, Walters & Crocker (Golden Gate) San Francisco; (Orpheum) Los Angeles March 2-7.

Cervo & Moro (Keith) Jersey City, N. J.
Chamberlain & Earle (Victoria) Wheeling, W. Va.
Chapman, Stanley (Lincoln Hipp.) Chicago 26-28.

CHAS. ALTHOFF
Address EDW. S. KELLER.
Palace Theatre Bldg., New York.

Althoff Sisters (Pantages) San Diego, Calif.; (Hoyt) Long Beach March 2-7.
Anne (Majestic) Dallas, Tex.
Angton & Nite (Orpheum) Oklahoma City, Ok., 26-28.

Send us your route for publication in this list to reach Cincinnati Office by Friday. Cards mailed upon request.

Table with columns: NAME, WEEK, THEATER, CITY, STATE. The table is mostly empty, intended for user input.

Bald, Syrell & Lorraine (Palace) Chicago.
Babcock & Dully (Earle) Philadelphia.
Baker, Bert, & Co. (Keith) Columbus, O.

Buckley & Calvert (51st St.) New York.
Buckler, Edna, & Co. (Edgemoor) Chester, Pa.
Budd, Ruth (Orpheum) Kansas City.

Clayton, Fletcher, Revue (105th St.) Cleveland.
Cleveland & Dowry (Strand) Shenandoah, Pa.
Clifford & Bailey (State) Buffalo.

Burns & Bows (Proctor) Albany, N. Y.
Burr, Henry (Orpheum) Omaha.
Berk & Sam (Majestic) San Antonio, Tex.

LORA CAROL & RING
Presenting Comedy-Singing-Violin in "FUNATICS".
Carol, Lora, & Ring (Empire) Providence; (Cassidy) Boston March 2-7.

Cook, Mortimer & Harvey (Emery) Providence, R. I., 26-28.
Cook & O'Brien (Forsyth) Atlanta Ga.
Cook, Phil (Valley) Langford, Pa.

Coyne & French (Hennepin) Minneapolis; (Orpheum) Omaha March 2-7.
Crafts & Sherman (Palace) Peoria, Ill., 26-28.

Daine & Rubin (Keith) Asheville, N. C.
Dale, Billy, & Co. (Palace) Cincinnati.
D'Alroy, Marceline (Nixon) Philadelphia.
Dana & Mack (Pantages) Tacoma, Wash.; (Pantages) Portland, Ore., March 2-7.

Diamond & Brennan (Victoria) Wheeling, W. Va.
Diamonds, Four (Temple) Detroit.
Diaz, Powers (Maryland) Baltimore.
Digenotes, The (Grand) Clarkburg, W. Va.

Earl, Bert, & Girls (Palace) Manchester, N. H.
Eary & Eary (Gates) Brooklyn 26-28.
East & Humke (Jefferson) New York.

Falar & Green (Palace) Watertown, Conn.
Fagan, Noodin (Pantages) Weymouth, Can.; (Pantages) Saskatoon March 2-7.
Fagan's, Raymond, Band (Pantages) Hamilton, Can.; (Keith) Ottawa March 2-7.

Fearless Flyers (K. K. K. Circus) Clarksburg, W. Va.
 Peely & Valentine (Prietors) Newark, N. J.
 Fenner & Roberts (Delaney St.) New York 26-28.
 Fenton & Fields (Regent) New York
 Ferguson, Dave (Golden Gate) San Francisco; (Orpheum) Oakland March 2-7.
 Fern & Marie (Keith) Asheville, N. C.
 Fisher-Patman Trio (Palace) Brooklyn 26-28.
 Fifty Miles From Broadway (State) Newark, N. J.
 Pink Mules (Palace) Cleveland
 Finley & Hill (Greedy Sq.) New York 26-28.
 Fisher & Gilmore (Keith) Boston.
 Fishler, Walter (Englewood) Chicago 26-28.
 Fitzgerald, Lillian (Palace) Chicago; (Orpheum) St. Louis March 2-7.
 Fitzgibbon, Bert (Palace) Cleveland
 Fitzgibbon & Mahoney (Pantages) San Francisco March 2-7.
 Fletcher Bros. & Ruth (Palace) St. Paul 26-28; (Seventh St.) Minneapolis March 1-7.
 Flemings, The (Fifth Ave.) New York
 Fleeson & Greenwood (Palace) Cleveland.
 Flippin, J. C. (Maryland) Baltimore.
 Foley & LaTour (Majestic) Paterson, N. J.
 Follis & Leroy (Pantages) Seattle; (Pantages) Vancouver, Can., March 2-7.
 Folsom, Bobby (Earle) Philadelphia.
 Ford & Price (State) New York.
 Ford, Mabel (Cross Keys) Philadelphia.
 Ford, Senator (Orpheum) Fresno, Calif.; (Orpheum) Los Angeles March 2-7.
 Fortunello & Cirilino (Irving) Carlsdale, Pa.
 Four Flushing (Harris) Pittsburgh.
 Four of Us (Keith) Dayton, O.
 Fox & Allyn (Rialto) St. Louis 26-28.
 Fox, Will, & Co. (Lincoln Sq.) New York 26-28.
 Foy, Chas., Revue (Palace) Brooklyn 26-28.
 Frabry, A. & E. (Victoria) St. Louisville, O.
 France & Lapell (Imperial) Montreal.
 Francis Ann, Revue (Palace) Cincinnati.
 Frank & Barron (104th St.) Cleveland.
 Frawley & Louise (Orpheum) Denver; (Hennepin) Minneapolis March 2-7.
 Fred's Pigs (Main St.) Kansas City.
 Freda & Anthony (Empire) Lawrence, Mass.
 Friedland, R. Rhoda (Shea) Buffalo.
 Friedland, A., & Co. (Albee) Providence, R. I.
 Frisco, Sig. (Orpheum) Los Angeles.
 Frish, Hector & Toelin (Regent) Springfield, O.
 26-28; (Ames) O. City, Pa., Feb. 2-4; (Orpheum) Franklin 5-7.
 Frost & Morrison (Crescent) New Orleans.
 Frozler (Majestic) Springfield, Ill., 26-28.
 Fulton & Rny (Englewood) Chicago 26-28.
 Furman & Evans (Keith) Asheville, N. C.

G

Gaffney & Walton (Pantages) Vancouver, Can.
 Gaines Bros. (Palace) 16th Bank, N. J.
 Galatti & Kolin (Valley) Launford, Pa.
 Gallier Sisters (Victory) Holyoke, Mass.
 Galvin, Wallace (Grand) Montgomery, Ala.
 Garry & Bald (Palace) Pittsfield, Mass.
 Gascolines, Royal (Hipp.) New York
 Gates & Kane (Electric) Joplin, Mo., 26-28.
 Gaston, William, & Co. (Bushwick) Brooklyn.
 Gahan & Gerritson (Orpheum) Oklahoma City, Ok., 26-28.
 Gelger, John (Colonial) Lancaster, Pa.
 Genaro Girls (Lyric) Mobile, Ala.
 George, Col. Jack (Forsyth) Atlanta, Ga.
 George, Edwin (Keith) Washington.
 Ghezzi Bros. (Majestic) Chicago.
 Gibson & Price (Metropolitan) Brooklyn
 Gibson Sisters (Pantages) Tacoma, Wash., March 2-7.
 Gieseler Sisters (Temple) Rochester, N. Y.
 Gilbert & May (Palace) Pittsfield, Mass.
 Gilber, Jimmy, & Co. (Loew) Montreal.
 Giffey & Lang (Columbia) Far Rockaway, N. Y.
 Girton Girls (Pantages) Spokane March 2-7.
 Glason, Billy (Majestic) Dallas, Tex.; (Majestic) Houston March 1-7.
 Goff & Bobby (Boston) Boston
 Golden Girls (Belmont St.) New York 26-28.
 Goldie & Betty (Hoyt) Birmingham, Ala.
 Goldie & Eddie (Pantages) Kansas City; (Pantages) Memphis March 2-7.
 Goldie, Jack (Towers) Camden, N. J.
 Golfers, Three (Majestic) Harrisburg, Pa.
 Gordon & Healy (Orpheum) Madison, Wis., 26-28.
 Gordon & King (Pantages) Minneapolis March 2-7.
 Gordon & Knowlton (Orpheum) Omaha.
 Gordon & Rea (Edgmont) Chester, Pa.
 Gordon & Spain (Hipp.) Taft, Calif., March 5-7; (Hipp.) Fresno 8-10.
 Gordon, Vera, & Co. (Earle) Washington.
 Gornley & Caffrey (Loew) London, Can., 26-28.
 Gould & Adams (State) Memphis, Tenn.
 Gould, Rita (Colonial) Allentown, Pa.
 Gould, Venita (Keith) Indianapolis.
 Graf, Victor (Palace) New Haven, Conn.
 Granece, Jean, & Co. (Keith) Indianapolis.
 Grant & Boyer (Hoyt) Brooklyn 26-28.
 Gray & Arbes (Rialto) Chicago.
 Gray, Bee Ho (Palace) Jacksonville, Fla.
 Gray Family (Victoria) Stouhenville, O.
 Grazer & Lawler (Loew) Montreal.
 Green & LaFell (Orpheum) Joliet, Ill., 26-28.
 Green, C. T. (Greenpoint) Brooklyn.
 Green, Harry, & Co. (Jefferson) New York
 Green, Page & Green (Forsyth) Atlanta, Ga.
 Green, Gene (Palace) New Orleans, La.
 Gresham, Lillian, & Co. (Majestic) Little Rock, Ark., 26-28.
 Griffon, Joe (Rialto) Amsterdam, N. Y.
 Gulan & Marguerite (Majestic) Springfield, Ill., 26-28.
 Gypsy Wanderers (Rialto) Amsterdam, N. Y.

H

Hale, J. & W. (State) Washington.
 Haley & Rock (Temple) Rochester, N. Y.
 Hall, B. Swede, & Co. (Avon) Watertown, N. Y.
 Hall, Bob (Orpheum) St. Louis.
 Hallen, Billy (Keith) Lowell, Mass.
 Halperin, Nan (Orpheum) Seattle; (Orpheum) Portland March 2-7.
 Hamel Sisters & Strause (Pantages) Minneapolis March 2-7.
 Hamilton, Dixie (Palace) Cincinnati.
 Hamilton Sisters (Shea) Buffalo.
 Hanev Review (Earle) Washington.
 Haneford, Poodles (Victory) Holyoke, Mass.
 Hanson & Burton Sisters (Sheridan Sq.) Pittsburgh.
 Hare & Hare (Majestic) Johnstown, Pa.
 Harmon & Sans (Keystone) Philadelphia.
 Harper, Mabel, & Co. (Avenue B) New York 26-28.
 Harris & Holly (Orpheum) Sioux City, Ia., 26-28.
 Harris & Vaughn (State) Nanticoke, Pa.
 Harris, Marion (Palace) Milwaukee; (Hennepin) Minneapolis March 2-7.
 Harris, Val, & Co. (Majestic) Houston, Tex.

Harrison, The (Fair) Bradentown, Fla.; (Fair) Miami March 9-14.
 Hart & Helene (Colonial) Lancaster, Pa.
 Hart, Roberts & O'Neill (Orpheum) Oklahoma City, Ok., 26-28.
 Hartley & Patterson (Allegheny) Philadelphia.
 Hashi & Osai (Palace) Manchester, N. H.
 Havel, A. & M. (Rivera) Brooklyn.
 Hawthorn & Cook (Keith) Ottawa, Can.
 Hayes & Hillard (Grand) St. Louis.
 Hayes, Brent (Avon) Watertown, N. Y.
 Hayes, Grace (Majestic) Dallas, Tex.
 Hayes, Rich (Orpheum) Sioux City, Ia., 26-28.
 Haynes & Beck (Proctor) Youkets, N. Y.
 Haynes, Mary (Albee) Providence, R. I.
 Healy & Cross (Bushwick) Brooklyn.
 Healy Sisters (Miller) Milwaukee.
 Hearn, Sam (Sheridan Sq.) Pittsburgh.
 Heath, R., Revue (Polk) Wilkes-Barre, Pa.
 Heather, Jesse (Orpheum) St. Louis; (State-Lake) Chicago March 2-7.
 Hecker & Pals (Keith) Boston.
 Hecker, Jack, Trio (Davis) Pittsburgh.
 Hecker, Fred, & Co. (Binghamton) Binghamton, N. Y.
 Heller & Riley (Orpheum) Omaha.
 Henderson, Dick (Orpheum) Vancouver, Can.; (Orpheum) Seattle March 2-7.
 Heulere, Herschel (Albee) Brooklyn.
 Henry & Moore (Orpheum) Los Angeles.
 Herbert & Bolt Trio (Palace) Chicago.
 Herbert's Dogs (Hennepin) Minneapolis; (Orpheum) Winnipeg, Can., March 2-7.
 Heruan, Al (Triness) Montreal.
 Hewitt & Hall (Keith) Utica, N. Y.
 Heut, Ernest (Galaxy) Cincinnati.
 Hickey Bros. (Keith) Columbus, O.
 Hillum, B. S. (Shea) Buffalo.
 Hines, Harry (Orpheum) Denver; (Hennepin) Minneapolis March 2-7.
 Hodge & Lowell (Chateau) Chicago 26-28.
 Holburn, R. (Academy) Norfolk, Va.
 Holman, Harry (Orpheum) St. Louis.
 Holmes & Lawrence (Keith) Lowell, Mass.
 Holt & Leonard (Lyric) Birmingham, Ala.
 Honeymoon Cruise (Fordham) New York.
 Honeymooners, The (Garrick) Norristown, Pa.
 Hopper, Edna W. (Pantages) Portland, Ore.
 Houdini (Davis) Pittsburgh.
 Howard & Bennett (Keith) Indianapolis.
 Howard & Hobson (Franklin) New York.
 Howard & Luckie (Victory) Holyoke, Mass.
 Howard Girls (Olympia) Lynn, Mass., 26-28; (Lowdown Sq.) Boston March 2-7.
 Howard, Joe, Revue (Orpheum) Oakland, Calif.; (Orpheum) Fresno March 5-7.
 Howard's Animals (Orpheum) Oakland, Calif.; (Orpheum) Los Angeles March 2-7.
 Hughes & Burke (Pantages) Seattle; (Pantages) Vancouver, Can., March 2-7.
 Hughes & Pam (Capitol) New Britain, Conn.
 Hughes, Gareth, & Co. (Colonial) Allentown, Pa.
 Huling, Ray, & Co. (Earle) Washington.
 Humby, Jack & Art (Victoria) New York 26-28.
 Hurst & Vogt (Hill St.) Los Angeles.
 Hyams & Evans (Pantages) Tacoma, Wash., March 2-7.
 Hyman, Officer (Orpheum) Boston.
 Hymer, John B. (Palace) Chicago.

I

Ibach's Band (Opera House) Galveston, Tex., 19-21.
 Ideal Co. (Keith) Toledo, O.
 Imhoff, Roger, & Co. (Empress) Grand Rapids, Mich.
 In China (York) York, Pa.
 Inspiration (Irving) Carlsdale, Pa.
 Iola Princess, Show (Rex) Beaver, Mo.; (Grand) Macon March 2-7.
 Iramanette & Violette (Strand) Shenandoah, Pa.
 Irwin, May, & Co. (Riverside) New York.
 Ishakawa Bros. (Grand) St. Louis.
 Ivy, Mlle., & Co. (State) Newark, N. J.

J

Jahl & George (Harris) Pittsburgh.
 Jackson & Mack (Crescent) New Orleans.
 Janis, Ed, Revue (National) Louisville, Ky.
 Janis & Chaplow (Pantages) Portland, Ore.
 Jardon, Dorothy (Proctor) Troy, N. Y.
 Jarrow (American) New York 26-28.
 Jarvis Revue (Pantages) Pueblo, Col.; (World) Omaha March 2-7.
 Jean & Jacques (Boulevard) New York 26-28.
 Jennings, Amy, & Co. (125th St.) New York.
 Jennings & Mack (Seventh St.) Minneapolis.
 Jessell, George (Hennepin) Minneapolis.
 Jones & Jacqueline (Hipp.) Bakersfield, Calif., March 1; (Hipp.) Fresno 4-7.
 Johnstone, J., & Co. (Capitol) Hartford, Conn.
 Johnson, Harry (Palace) Milwaukee.
 Jones, Gattison & Co. (Orpheum) Winnipeg, Can.; (Orpheum) Vancouver March 2-7.
 Josefsson, Johannes, & Co. (Keith) Washington.
 Joy Bros. Co. (Keith) Asheville, N. C.
 Joyce's, J. Horses (Shea) Buffalo.
 Joyner & Foster (Pantages) Hamilton, Can.
 Joyson, Jean (Maryland) Baltimore.
 Juliet (Orpheum) St. Louis; (Palace) Milwaukee March 2-7.
 Juggeland (Orpheum) Denver; (Orpheum) St. Louis March 2-7.

K

Kahne, Harry (Keith) Portland, Me.
 Kandy Krooks (Grand) Oshkosh, Wis., 26-28.
 Kane & Homan (Colonial) Lancaster, Pa.
 Kane (Hoyt) Long Beach, Calif.; (Pantages) Salt Lake City March 2-7.
 Karavaff (Hill St.) Los Angeles.
 Karle & Sister (Pantages) Portland, Ore.
 Kate & Wiley (Pantages) Tacoma, Wash.; (Pantages) Portland, Ore., March 2-7.
 Kavanagh, Stan (Orpheum) Vancouver, Can.; (Orpheum) Seattle March 2-7.
 Keating, Chas., & Co. (Boston) Boston.
 Keefe, Zena (Broadway) New York.
 Keely, Frankie, & Co. (State) Chicago 26-28.
 Keely-Laird Co. (Majestic) Malden, Mass., 26-28; (Quincy) Quincy March 2-4; (Franklin Park) Dorchester 5-7.
 Kelso Bros. Revue (Opera House) Philadelphia 26-28; (Wm. Penn) Philadelphia March 2-4; (Tower) Camden, N. J., 5-7.
 Keller Sisters & Lynch (Orpheum) Tulsa, Ok., 26-28.
 Kellogg, Chas. (Orpheum) San Francisco; (Orpheum) Los Angeles March 2-7.
 Kelly & Hoghorn (Lyric) Birmingham, Ala.
 Kelly Smuers (Pantages) Spokane; (Pantages) Seattle March 2-7.
 Kelly & Pollock (Boston) Boston.
 Kelly & Brown (American) New York 26-28.
 Kelly, Walter C. (Opera House) Galveston, Tex., 19-21.
 Kelton, Pert (Keith) Lowell, Mass.
 Kennedy & Kramer (Colonial) Lancaster, Pa.
 Kennedy, Harold (Pantages) Pueblo, Col.; (World) Omaha March 2-7.

Kennedy & Martin (Pantages) Denver; (Pantages) Pueblo March 5-7.
 Kennedy & Nelson (Avenue B) New York 26-28.
 Kennedy, W. J., & Co. (Broadway) Philadelphia.
 Kenny & Hollis (Avon) Watertown, N. Y.
 Kerenski, Vera (Majestic) Little Rock, Ark., 26-28.
 Kerr & Ensign (Orpheum) Boston.
 Kessler, Harry (Seventh St.) Minneapolis.
 Ketch & Wilma (Delancey St.) New York 26-28.
 Keyes, Nelson (Hennepin) Minneapolis.
 Keyhole Kameos (Colonial) Lancaster, Pa.
 Kharum (Orpheum) Seattle; (Orpheum) Portland March 2-7.
 Kikutas Japs (State-Lake) Chicago; (Orpheum) Kansas City March 2-7.
 Kimberly & Page (Orpheum) Portland, Ore.; (Orpheum) San Francisco March 2-7.
 King & Hearty (Hoyt) Woonsocket, R. I.
 King & Irwin (World) Omaha; (Pantages) Kansas City March 2-7.
 Kinney, Hubert, Revue (Miller) Milwaukee.
 Kirby & Duval (Grand) Montgomery, Ala.
 Kirkland, Paul (Keith) Philadelphia.
 Kismet Sisters (York) York, Pa.
 Kio Taki & Yokio (Proctor) Albany, N. Y.
 Klass & Brilliant (Washington St.) Boston.
 Klop, Mel (Orpheum) Evansville, Ind., 26-28; (Central Bk) Chicago March 2-4.
 Klein Bros. (Orpheum) Omaha.
 Kleks, Los (Pantages) Memphis, Tenn.
 Knick Knacks (Edgmont) Chester, Pa.
 Koban Japs (American) New York 26-28.
 Kramer, Berdie (Rialto) Chicago.
 Kramer Bros. (Polk) Scranton, Pa.
 Kuma Four (Pantages) Minneapolis; (Pantages) Regina, Can., March 2-7.
 Kyle, Howard, & Co. (Orpheum) Omaha; (State-Lake) Chicago March 2-7.

L

LaBernaia & Co. (Orpheum) Joliet, Ill., 26-28.
 La Cross, Joan (Keystone) Philadelphia.
 LaDent, J., & Co. (Towers) Camden, N. J.
 LaFleur & Portia (Maryland) Baltimore.
 LaFrance & Co. (Yonge St.) Toronto.
 LaMarr, Leona (Pantages) Denver; (Pantages) Pueblo March 5-7.
 LaMonte, Lestra & Hazel (Lyric) Birmingham, Ala., 26-28.
 LaTocha, Phil (Pantages) Spokane March 2-7.
 LaTour, Jack (Wm. Penn) Philadelphia.
 LaV & Woodard (Orpheum) New York.
 Lamberti (World) Omaha; (Pantages) Kansas City March 2-7.
 Lamsy, The (Princess) Montreal.
 Land of Fantasy (Hipp.) New York.
 Landfield, Sidney (Majestic) San Antonio, Tex.
 Lane & Harper (Majestic) Milwaukee.
 Lang & Volk (Empress) Grand Rapids, Mich.
 Langford & Fredericks (Pantages) San Francisco; (Pantages) Los Angeles March 2-7.
 Langton, H. & H. (Pantages) Pueblo, Col.; (World) Omaha March 2-7.
 Latell & Volas (State) New York.
 Laug & Haly (Calvin) Northampton, Mass.
 Lawton & Walsh (Hipp.) Pittsville, Pa.
 Lazar & Dale (Kiddie) Chicago 26-28.
 Lea, Emille (Orpheum) Seattle; (Orpheum) Portland March 2-7.
 Ledova (Keith) Philadelphia.
 Lee & Romalae (Sheridan St.) Pittsburgh.
 Lee & Cranston (Proctor) Youkers, N. Y.
 Leipsig (Aldine) Wilmington, Del.
 Lemire & Balston (Pantages) Vancouver, Can.
 Lemora Sleepers (Pantages) Edmonton, Can.; (Pantages) Calgary March 2-4.
 Leo & Gladys (Lyric) St. Louis, Ill., March 1-4; (Orpheum) Hannibal, Mo., 7-8.
 Leonard, Benny, & Co. (Maryland) Baltimore.
 Leonard, Eddie, & Co. (Keith) Cincinnati.
 Leonard & Wilson (Pantages) San Francisco; (Pantages) Los Angeles March 2-7.
 LeMoine & Young (Wm. Penn) Philadelphia.
 LeRoy & Lytton (125th St.) New York.
 LeRoy, Talma & Bosco (State-Lake) Chicago.
 Lester, Fred (Majestic) Chicago.
 Let's Dance (Palace) Chicago.
 Levin & Doris (Rivoli) New Brunswick, N. J.
 Levsthan Orch. (Orpheum) Omaha.
 Levy, Bert (Columbia) Davenport, Ia., 26-28.
 Lewis, Helen, & Co. (Bijou) Bangor, Me., March 2-4; (Music Hall) Lewiston 5-7.
 Lewis, Sid (Pantages) Spokane March 2-7.
 Lewis & Body (Strand) Washington.
 Lewis, Ted, & Band (Orpheum) San Francisco.
 Lewis, May (Palace) Waterbury, Conn.
 Leonard (Empire) Hazleton, Pa.
 Liddell & Gibson (Majestic) San Antonio, Tex.
 Lindsay, Fred, Co. (Pantages) Spokane; (Pantages) Seattle March 2-7.
 Little Mads, Three (Columbia) Far Rockaway, N. Y.
 Little Revue (Grand) St. Louis.
 Livingstons, The (Key-tone) Philadelphia.
 Lloyd & Bruce (Maryland) Baltimore.
 Lloyd, Arthur (Loew) Montreal.
 Lloyd & Rosalie (Strand) Washington.
 Lloyd, Herbert, Co. (World) Omaha; (Pantages) Kansas City March 2-7.
 Lockett & Page (Hill St.) Los Angeles.
 Loftus, Ceelia (Albee) Brooklyn.
 Loda, Grille & Senna (Pantages) Vancouver, Can.
 Lomas Co. (Pantages) Regina, Can.; (Pantages) Saskatoon March 2-4.
 Loner Girls (Orpheum) Sioux City, Ia., 26-28.
 Lorraine & Mingo (Keith) Toledo, O.
 Lorraine & Hitz (Broadway) New York.
 Lorraine Sisters (Orpheum) Portland, Ore.; (Orpheum) San Francisco March 2-7.
 Loster, J. & B. (Victory) Holyoke, Mass.
 Lou, Betty (Keystone) Philadelphia.
 Love, Montague (Riverside) New York.
 Love Nest (Main St.) Kansas City.
 Loyal, Sylvia (Palace) Milwaukee.
 Lucas & Iuez (Strand) Shenandoah, Pa.
 Lucy & Pals (Avenue B) New York 26-28.
 Lumars, The (State) Buffalo.
 Luster Bros. (Orpheum) Fresno, Calif.; (Orpheum) San Francisco March 2-7.
 Lydell, Mery Co. (Lyric) Richmond, Va.
 Lynn & Howland (125th St.) New York.
 Lyons, Geo. (Rivera) Brooklyn.
 Lyons, Jimmy (Crescent) New Orleans.
 Lyons & Pant (Opera House) Galveston, Tex., 19-21.

M

Mack & LaRue (Keith) Washington.
 Mack & Munus (Keith) New Orleans.
 Mack & Watson (Sullivan St.) Boston.
 Mack & Correl (Pantages) Spokane March 2-7.
 Mack & Brantley (Pantages) Pueblo, Col.; (World) Omaha March 2-7.
 Mack & Williams (Pantages) San Diego, Calif.; (Hoyt) Long Beach March 2-7.
 Mahon & Chalel (Seventh St.) Minneapolis; (Majestic) Milwaukee March 1-7.
 Mahoney & Talbot (Binghamton) Binghamton, N. Y.

Major Revue (Garrick) Norristown, Pa.
 Maker & Redford (Golden Gate) San Francisco; (Hill St.) Los Angeles March 2-7.
 Mall, Paul (Loew) Richmond Hill, N. Y., 26-28.
 Mallen & Cuse (Keith) Toledo, O.
 Manley & Johnson (Cross Keys) Philadelphia.
 Manning & Glass (Orpheum) Oakland, Calif.; (Golden Gate) San Francisco March 2-7.
 Manning & Ball (Lyceum) Columbus, O.; (Hoyt) Dayton March 2-7.
 Mandell's Manikins (Majestic) Houston, Tex.; (Majestic) San Antonio March 2-7.
 Marcus & Booth (Orpheum) Ogden, Utah; (Pantages) Denver March 2-7.
 Marce, Madame, & Pals (Cortland) Cortland, N. Y., 26-28; (Opera House) Plattshurz March 2-4.
 Marks & Ethel (Pantages) Hamilton, Can.
 Marks, Joe, & Co. (Keith) Portland, Me.
 Marshall, Lee, Revue (Lincoln Hipp.) Chicago 26-28.
 Marshall & Shannon (Baldwin) Royal Oak, Mich., 26-28; (Savoy) Flint March 4.
 Martels, Two (Pantages) Spokane; (Pantages) Seattle March 2-7.
 Martin, Oscar, & Co. (Rialto) Racine, Wis., 26-28.
 Mason & Koeler (81st St.) New York.
 Mason & Zadora (Scollay Sq.) Boston.
 Masters & Grayce (Pantages) San Francisco March 2-7.
 Mastley & Stone (Palace) South Bend, Ind., 26-28.
 Mayer, Lattie, Co. (Pantages) Pueblo, Col.; (World) Omaha March 2-7.
 Maxine & Bobby (Pantages) Memphis, Tenn.
 McBanis, The (Pantages) Salt Lake City; (Orpheum) Ogden March 2-7.
 McCane, Mabel (Orpheum) Oakland, Calif.; (Orpheum) Fresno March 5-7.
 McCarthy & Stenard (Majestic) Paterson, N. J.
 McCoof & Reilly (Poll) Worcester, Mass.
 McCrunk & Wallace (Keith) Toledo, O.
 McDermott, Billy (Edgmont) Chester, Pa.
 McDonald, Trio (Crescent) New Orleans.
 McFarland & Palace (Grand) Clarksburg, W. Va.
 McGood, Chas., & Co. (State) Newark, N. J.
 McGrath & Deeds (American) New York 26-28.
 McIntyre, The (Irving) Carlsdale, Pa.
 McKay & Ardine (Orpheum) Tulsa, Ok., 26-28.
 McKay, Neil (Temple) Detroit.
 McLaughlin & Carson (Keith) Indianapolis.
 McLaughlin & Evans (Keith) Syracuse, N. Y.
 McLeod, Tex (Orpheum) Des Moines, Ia., 26-28.
 McMahon, Jack & Claire (Palace) Detroit (Cinderella) Detroit March 1-4; Council Bluffs, Ia., 6-7.
 McNeil & Clegg (Orpheum) Los Angeles; (Hill St.) Los Angeles March 2-7.
 McRee & Motz (Rialto) Amsterdam, N. Y.
 McWaters & Tyson (Palace) Jacksonville, Fla.
 Meahan & Shannon (York) York, Pa.
 Meahan, Harry (Victory) Holyoke, Mass.
 Mecher & Shannon (Polk) Wilkes-Barre, Pa.
 Meekins, Dugs (125th St.) New York.
 Melody & Steps (Keith) Ottawa, Can.
 Melroy Sisters (Keith) Lansing, Pa., 26-28.
 Memories (Alhambra) New York 26-28.
 Mendezas, The (Orpheum) Portland, Ore.; (Orpheum) San Francisco March 2-7.
 Meredith & Snoozer (Empress) Grand Rapids, Mich.
 Merediths, The (Keith) Philadelphia.
 Merle & Friends (Lyric) Hammond, Va.
 Merriam, Billy & Eva (Rex) Beaver, Mo.; (Grand) Macon March 2-7.
 Merritt & Coghlin (Calvin) Northampton, Mass.
 Meroff, Ben, & Band (Palace) Milwaukee.
 Meyers & Hausford (State) New York.
 Micahua (Keith) Rochester, N. Y.; (Riverside) New York March 2-7.
 Miller, P. & M. (Pantages) Vancouver, Can.
 Miller & Feas (State) Buffalo.
 Miller, Geraldine, Trio (Loew) Richmond Hill, N. Y., 26-28.
 Milo (Bijou) Birmingham, Ala.
 Mills & Kumbal (Majestic) Houston, Tex.
 Minstral Memories (Keuse) Charleston, W. Va.
 Mitchell, Al, Band (Bushwick) Brooklyn.
 Monroe Bros. (Majestic) Springfield, Ill., 26-28.
 Montana (Shea) Toronto.
 Moore, Al, & Band (Palace) Chicago.
 Moore & Freed (Orpheum) Tulsa, Ok., 26-28.
 Moore, H., & Co. (Poll) Bridgeport, Conn.
 Moore & Megley Show (Palace) Rockford, Ill., 26-28.
 Moore's, Patty, Revue (Keith) Washington.
 Morales Bros. & Baisy (Main St.) Ashory Park, N. J., 26-28; (Palace) Red Bank March 5-7.
 Morrell, Clark, & Co. (Davis) Pittsburgh.
 Moroto, Cellus (Golden Gate) San Francisco, Calif.; (Orpheum) Fresno March 1-7.
 Morgan, Woolley Co. (Capitol) New Britain, Conn.
 Morgan, J. & B. (Orpheum) Oakland, Calif.; (Crescent) Los Angeles March 2-7.
 Morning Glories (State) Nanticoke, Pa.
 Moro & Yaco (Hoyt) Long Beach, Calif.; (Pantages) Salt Lake City March 2-7.
 Morris, Wm. (Palace) Milwaukee.
 Morris, Lily (Keith) Boston.
 Morrison & Coghlan (Majestic) Bloomington, Ill., 26-28.
 Morrison's Band (Hoyt) Long Beach, Calif.; (Pantages) Salt Lake City March 2-7.
 Morro Castle Orch. (Orpheum) New Orleans.
 Morton, Lillian (Palace) Brooklyn.
 Morton, Jewel Co. (Lyric) Mobile, Ala.
 Morton, Jas. C. (Bijou) Birmingham, Ala.
 Mortons, Four (Proctor) Albany, N. Y.
 Moss & Frye (Boston) Boston.
 Movie Masque (Pantages) Portland, Ore.
 Mower, Millicent (10th St.) Cleveland
 Mullen & Francis (Keuse) Charleston W. Va.
 Murrain & Leo (Pantages) San Francisco; (Pantages) Los Angeles March 2-7.
 Murdoch & Mayo (Wichita) Wichita Falls, Tex., 26-28.
 Murdoch & Kennedy Sisters (Orpheum) Madison, Wis., 26-28.
 Murriel & Phyllis (Pantages) Spokane March 2-7.
 Murphy, Bob (Avenue B) New York 26-28.
 Murphy, Senator (Colonial) Erie, Pa.
 Murphy, Johnny (Hamilton) New York.
 Murray & Neal (Academy) Norfolk, Va.
 Murray & Allen (Hoyt) St. Louis 26-28.
 Myra, Mildred, Co. (Pantages) San Francisco; (Pantages) Los Angeles March 2-7.

N

Nash & O'Donnell (Palace) Springfield, Mass.
 Nardo, Cliff (Hoyt) Long Beach, Calif.; (Pantages) Salt Lake City March 2-7.
 Nazarro, Nat, & Buck & Bubbles (State) Cleveland.
 Neff, John (Rivoli) New Brunswick, N. J.
 Nelson, Alma, & Co. (Keith) Syracuse, N. Y.
 Nelson, Bob (Grand) Oshkosh, Wis., 26-28.
 Nelsons, Juggling (Pantages) Denver; (Pantages) Pueblo March 5-7.
 Nevada, Lloyd, & Co. (81st St.) New York.

Newhoff & Phelps (Flatbush) Brooklyn, N. Y.
Newman, W. & Co. (Poli) Scranton, Pa.
Nelson, Dorothy (Franklin) New York

Ricardo, Irene (Palace) New York.
Ritz Seneaders (Strand) Greensburg, Pa.
Rohlfins, A. (Proctor) Troy, N. Y.

Stinbach, Bruno (Orpheum) Oakland, Calif.; (Orpheum) Los Angeles March 2-7.
Stonard, Nellie (Temple) Syracuse, N. Y.

Wilbert, Raymond (Pantages) Tacoma, Wash.; (Pantages) Portland, Ore., March 2-7.
Willard, Clarence (Regent) New York

O'Brien & Josephine (Pantages) Salt Lake City; (Orpheum) Ogden March 2-7.
O'Brien Sisters Co. (Globe) Philadelphia.
O'Connor & Wilson (Capitol) New London, Conn.

Ross & Edwards (Pantages) Denver; (Pantages) Pueblo March 5-7.
Rosa, Lew, & Co. (Palace) Pittsfield, Mass.

Taketas, Three (Lincoln Hipp) Chicago 26-28.
Tango Shoes (Boulevard) New York 26-28.
Taylor & Markley (Palace) Waterbury, Conn.

Yarmark (Loew) Richmond Hill, N. Y., 26-28.
Yates & Carson (State) New York.
Yeoman, George (Pantages) San Diego, Calif.

Oxford Four (Palace) Pittsfield, Mass.

Sale, Chic (Orpheum) Madison, Wis., 26-28.
Salle & Rolles (Lyric) Birmingham, Ala.

Uls & Clark (Orpheum) Ogden, Utah; (Pantages) Denver March 2-7.

CONCERT AND OPERA
(ROUTES FOR THIS COLUMN SHOULD REACH THE CINCINNATI OFFICE BY SATURDAY MORNING TO INSURE PUBLICATION)

Pazzana (Keith) Cincinnati.
Page, Jim & Betty (Lincoln Sq.) New York 26-28.
Palmer, Gaston (Hipp) Pittsfield, Pa.

Sanna & Dean (Hamilton) New York.
Sanna & Weber (Strand) Greensburg, Pa.

Vadie Dancers (Pantages) Denver; (Pantages) Pueblo March 5-7.
Valentine & Bell (Keith) Ottawa, Can.

Wagner & Lela (Grand St. Louis.
Waidman, Harry, & Co. (Majestic) Dallas, Tex.

Quinn, Vic, & Orch. (Crescent) New Orleans.
Radio Robot (Majestic) Harrisburg, Pa.

Singer Sisters (Majestic) Johnstown, Pa.
Singer's Midgets (Temple) Detroit.

Wagner & Lela (Grand St. Louis.
Waidman, Harry, & Co. (Majestic) Dallas, Tex.

Wagner & Lela (Grand St. Louis.
Waidman, Harry, & Co. (Majestic) Dallas, Tex.

Radio Robot (Majestic) Harrisburg, Pa.
Raker, Loren (Orpheum) Portland, Ore.; (Orpheum) San Francisco March 2-7.

Singer Sisters (Majestic) Johnstown, Pa.
Singer's Midgets (Temple) Detroit.

Wagner & Lela (Grand St. Louis.
Waidman, Harry, & Co. (Majestic) Dallas, Tex.

Wagner & Lela (Grand St. Louis.
Waidman, Harry, & Co. (Majestic) Dallas, Tex.

Radio Robot (Majestic) Harrisburg, Pa.
Raker, Loren (Orpheum) Portland, Ore.; (Orpheum) San Francisco March 2-7.

Singer Sisters (Majestic) Johnstown, Pa.
Singer's Midgets (Temple) Detroit.

Wagner & Lela (Grand St. Louis.
Waidman, Harry, & Co. (Majestic) Dallas, Tex.

Wagner & Lela (Grand St. Louis.
Waidman, Harry, & Co. (Majestic) Dallas, Tex.

DRAMATIC & MUSICAL

(ROUTES FOR THIS COLUMN SHOULD REACH THE CINCINNATI OFFICE BY SATURDAY MORNING TO INSURE PUBLICATION)
Able's Irish Rose (Republic) New York May 22, 1922, Indef.

Aren't We All? (with Cyril Maude) (Blackstone) Chicago Feb. 22, indef.
 Arland: (Garrick) New York Feb. 23, indef.
 Armstrong, Rufus, Musical Comedy Co.: Memphis, Tenn., 23-28.
 Artists & Models: (Shubert) Kansas City, Mo., 22-28.
 Artists and Models of 1921: (Casino) New York Oct. 15, indef.
 Badges: (Broadhurst) New York Dec. 3, indef.
 Barrymore, Ethel: (American) St. Louis 23-28.
 Be Yourself: Brooklyn, N. Y., 23-28; Newark, N. J., March 1-7.
 Beggars on Horseback: (Wilbur) Boston Feb. 9, indef.
 Best People: (Broad) Philadelphia 23-March 7.
 Betty Lee: (44th St.) New York Dec. 25, indef.
 Blossom Time: (Chestnut St.) Philadelphia Feb. 2, indef.
 Blossom Time: (Auditorium) Chicago Feb. 22, indef.
 Blossom Time (No. 2): (Orpheum) Duluth, Minn., 23-28.
 Blue Bird: (Frolie) New York Dec. 29, indef.
 Boston Opera Co. Artists: Fred Myers, mgr.: (Auditorium) Des Moines, Ia., 23-28; (Rialto) Omaha, Neb., March 7-13.
 Bowers, Frederick, in What'll I Do?: Uniontown, Pa., 25.
 Bridge, Al: Players: (Garden) Kansas City, Mo., indef.
 Bringing Up Father (E. J. Carpenter's): Baker, Ore., 25; Welser, Id., 26; Boise 27-28; Nampa March 2; Twin Falls 3; Buhl 4; Burley 5; Pocatello 6-7.
 Cape Smoke: (Martin Beck's) New York Feb. 16, indef.
 Carroll's, Earl: Vanities: (Forrest) Philadelphia 16-28.
 Charlotte's Revue of 1924: (Garrick) Chicago Feb. 1, indef.
 Charm-Souris: (19th St.) New York Jan. 11, indef.
 China Rose: (Wallack's) New York Feb. 23, indef.
 Chocolate Dandies, B. C. Whitney, mgr.: (Metropolitan) Minneapolis 22-28; (Metropolitan) St. Paul March 1-7.
 Dancing Mothers: (Maxine Elliott) New York Aug. 11, indef.
 Dark Angel, The: (Longacre) New York Feb. 10, indef.
 Desire Under the Elms: (Earl Carroll) New York Nov. 10, indef.
 Diffent: (Provincetown) New York Feb. 9, indef.
 Dixie to Broadway: (Lyric) Philadelphia Jan. 19, indef.
 Dove, The: (Empire) New York Feb. 11, indef.
 Dream Girl, The, with Fay Bainter: (Studebaker) Chicago Feb. 2, indef.
 Rose-Marie: (Murat) Indianapolis, Ind., 23-28.
 Saint Joan, with Julia Arthur, B. C. Whitney, mgr.: (Ford) Baltimore 23-28; (Broad) Newark, N. J., March 2-7.
 Sakura, with Walker Whiteside: (Hanna) Cleveland 23-28.
 Sally, Irene & Mary: (Walnut) Philadelphia 23-March 7.
 Seventh Heaven: Bradenton, Fla., 25; Tampa 26-27; Sarasota 28; Lakeland March 2; Orlando 3; Sanford 4; Ocala 5; Gainesville 6; Brunswick, Ga., 7.
 Seventh Heaven: (Hartman) Columbus, O., 23-28; (Victoria) Dayton March 1-7.
 Seventh Heaven: (Mason) Los Angeles 23-March 7.
 She Had to Know, with Grace George: (Times Square) New York Feb. 2, indef.
 Show-Off, The: (Cohan's Grand) Chicago Jan. 4, indef.
 Show-Off, The: (Playhouse) New York Feb. 5, indef.
 Silas Green From New Orleans: Ocala, Fla., 25; Leesburg 26; Hollywood 27; Hawthorne 28; Gainesville March 2.
 Silenus, with H. B. Warner: (National) New York Nov. 12, indef.
 Simon Called Peter: (Plymouth) Boston Feb. 16, indef.
 Simon Called Peter: (Shubert) Cincinnati 23-28, Sitting Pretty: (Toek) Buffalo 23-28; (Royal Alexandra) Toronto March 2-7.
 Skinner, Ots: (New Columbia) San Francisco 23-March 7.
 Sky High: (Poll) Washington 23-28.
 Small Timers, The: (Punch & Judy) New York Jan. 27, indef.
 Stepping Stones, with Fred Stone: (Illinois) Chicago Feb. 16, indef.
 Student Prince, The: (Jolson) New York Dec. 2, indef.
 Student Prince, The: (Great Northern) Chicago Feb. 22, indef.
 Swan, The: (Hollis) Boston Feb. 16, indef.
 Sweet Little Devil: (Shubert) Philadelphia Feb. 2, indef.
 Ten Nights in a Barroom, Billy Blythe, mgr.: Ft. Wayne, Ind., 25; Logansport 26; La Fayette 27-28; Crawfordsville March 1-2; Terre Haute 3-4; Sullivan 5-6.
 They Know What They Wanted: (Klaw) New York Nov. 24, indef.
 Thurston, Magician: (Grand) Cincinnati 23-28, Topsy and Eva, with Duncan Sisters: (Harris) New York Dec. 23, indef.
 Two by Two: (Stolwy) New York Feb. 23, indef.
 Uncle Josh Sprucey, A. J. Wok mgr.: Clarksburg, W. Va., 26; Lou Chere 27; Stillwater, Minn., 28; Anoka March 1; St. Cloud 2; Little Falls 3; Staples 4.
 Virgin of Bethulia, The: (Ambassador) New York Feb. 23, indef.
 Vixen's Musical Comedy Co.: (Regent) Toronto, Can., Feb. 23, indef.
 Way of the World: (Princess) New York Nov. 17, indef.
 What Price Glory: (Plymouth) New York Sept. 5, indef.
 White Cargo: (Daily) New York Nov. 5, indef.
 White Cargo: (Cort) Chicago Oct. 5, indef.
 White Cargo: (Selwyn) Boston Jan. 19, indef.
 White Cargo: Springfield, Mo., 26-28; Barksdale, Ok., March 4; Wichita, Kan., 6-7.
 White Collars: (Cort) New York Feb. 23, indef.
 White's, George, Scandals: (Selwyn) Chicago Jan. 25, indef.
 Wild Hink: The: (Equity-14th St.) New York Feb. 21, indef.
 Wild's, George, Models of 1925: Burlington, S. C., 25; Bennettsville 26; Haullet, N. C., 27; Wilmington 28.
 Youngest, The: (Gaiety) New York Dec. 22, indef.
 Zigzag Folies, with Will Rogers: (New Amsterdam) New York Oct. 30, indef.

My Girl: (Vanderbilt) New York Nov. 21, indef.
 My Sout: (Nora Bayes) New York Sept. 17, indef.
 Najja: (Knickerbocker) New York Feb. 16, indef.
 Nervous Wreck: (Canton, O.), 25; Youngstown 26-28; Toledo March 2-4; Indianapolis, Ind., 5-7.
 New Broome, with Frank Craven: (New Park) Boston Feb. 2, indef.
 Night Hawk: (Bijou) New York Feb. 21, indef.
 No, No, Nanette: (Ohio) Cleveland 22-28.
 No, No, Nanette: (Sam H. Harris) Chicago May 4, indef.
 Nocturne (Spec. mat.): (Punch & Judy) New York Feb. 16, indef.
 O'Hara, Fiske, in The Big Mogul: (Central) Chicago Jan. 11, indef.
 Old Homestead, Herman Lewis, mgr.: Ridgway, Pa., 25; Erie 26-28.
 Old English, with George Arliss: (Ritz) New York Dec. 23, indef.
 Parasites, with Françoise Larrigue: (Princess) Chicago Jan. 18, indef.
 Passing Show: (Tulane) New Orleans, La., 23-28.
 Passing Show: (Alvin) Pittsburgh 23-28.
 Palace: (Greenwich Village) New York Dec. 29, indef.
 Peter Pan, with Marilyn Miller: (Tremont) Boston 16-28.
 Pigs: (Little) New York Sept. 1, indef.
 Piker, The, with Lionel Barrymore: (Hitting) New York Jan. 15, indef.
 Plain Jane, with Joe Laurie, Jr.: (Garrick) Philadelphia Feb. 15-28.
 Potters, The: (Royal Alexandra) Toronto, Can., 23-28; Detroit, Mich., March 2-11.
 Puzzles of 1925, with Essie Janis: (Fulton) New York Feb. 2, indef.
 Quarantine: (Henry Miller's) New York Dec. 16, indef.
 Rain (No. 2): Charleston, S. C., 25; Augusta, Ga., 26; Greenville, S. C., 27; Asheville, N. C., 28; Charlotte March 2; Bennettsville, S. C., 3; Florence 4; Wilmington, N. C., 5; Wilson 6; Rocky Mount 7.
 Rat, The: (Colonial) New York Feb. 10, indef.
 Ritz Revue, Hossard Short: (Apollo) Chicago Feb. 15, indef.
 Rivals, The: Ft. Wayne, Ind., 25; South Bend 26; Grand Rapids, Mich., 27-28; Kalamazoo March 2; Jackson 3; Lansing 4; (Lyceum) Rochester, N. Y., 5-7.
 Robson, May: (Metropolitan) Seattle, Wash., 23-28; Vancouver, Can., March 2-4; Everett, Wash., 5; Tacoma 6-7.
 Rose-Marie: (Imperial) New York Sept. 2, indef.
 Rose-Marie: (Woods) Chicago Feb. 8, indef.
 Rose-Marie: (Murat) Indianapolis, Ind., 23-28.
 Saint Joan, with Julia Arthur, B. C. Whitney, mgr.: (Ford) Baltimore 23-28; (Broad) Newark, N. J., March 2-7.
 Sakura, with Walker Whiteside: (Hanna) Cleveland 23-28.
 Sally, Irene & Mary: (Walnut) Philadelphia 23-March 7.
 Seventh Heaven: Bradenton, Fla., 25; Tampa 26-27; Sarasota 28; Lakeland March 2; Orlando 3; Sanford 4; Ocala 5; Gainesville 6; Brunswick, Ga., 7.
 Seventh Heaven: (Hartman) Columbus, O., 23-28; (Victoria) Dayton March 1-7.
 Seventh Heaven: (Mason) Los Angeles 23-March 7.
 She Had to Know, with Grace George: (Times Square) New York Feb. 2, indef.
 Show-Off, The: (Cohan's Grand) Chicago Jan. 4, indef.
 Show-Off, The: (Playhouse) New York Feb. 5, indef.
 Silas Green From New Orleans: Ocala, Fla., 25; Leesburg 26; Hollywood 27; Hawthorne 28; Gainesville March 2.
 Silenus, with H. B. Warner: (National) New York Nov. 12, indef.
 Simon Called Peter: (Plymouth) Boston Feb. 16, indef.
 Simon Called Peter: (Shubert) Cincinnati 23-28, Sitting Pretty: (Toek) Buffalo 23-28; (Royal Alexandra) Toronto March 2-7.
 Skinner, Ots: (New Columbia) San Francisco 23-March 7.
 Sky High: (Poll) Washington 23-28.
 Small Timers, The: (Punch & Judy) New York Jan. 27, indef.
 Stepping Stones, with Fred Stone: (Illinois) Chicago Feb. 16, indef.
 Student Prince, The: (Jolson) New York Dec. 2, indef.
 Student Prince, The: (Great Northern) Chicago Feb. 22, indef.
 Swan, The: (Hollis) Boston Feb. 16, indef.
 Sweet Little Devil: (Shubert) Philadelphia Feb. 2, indef.
 Ten Nights in a Barroom, Billy Blythe, mgr.: Ft. Wayne, Ind., 25; Logansport 26; La Fayette 27-28; Crawfordsville March 1-2; Terre Haute 3-4; Sullivan 5-6.
 They Know What They Wanted: (Klaw) New York Nov. 24, indef.
 Thurston, Magician: (Grand) Cincinnati 23-28, Topsy and Eva, with Duncan Sisters: (Harris) New York Dec. 23, indef.
 Two by Two: (Stolwy) New York Feb. 23, indef.
 Uncle Josh Sprucey, A. J. Wok mgr.: Clarksburg, W. Va., 26; Lou Chere 27; Stillwater, Minn., 28; Anoka March 1; St. Cloud 2; Little Falls 3; Staples 4.
 Virgin of Bethulia, The: (Ambassador) New York Feb. 23, indef.
 Vixen's Musical Comedy Co.: (Regent) Toronto, Can., Feb. 23, indef.
 Way of the World: (Princess) New York Nov. 17, indef.
 What Price Glory: (Plymouth) New York Sept. 5, indef.
 White Cargo: (Daily) New York Nov. 5, indef.
 White Cargo: (Cort) Chicago Oct. 5, indef.
 White Cargo: (Selwyn) Boston Jan. 19, indef.
 White Cargo: Springfield, Mo., 26-28; Barksdale, Ok., March 4; Wichita, Kan., 6-7.
 White Collars: (Cort) New York Feb. 23, indef.
 White's, George, Scandals: (Selwyn) Chicago Jan. 25, indef.
 Wild Hink: The: (Equity-14th St.) New York Feb. 21, indef.
 Wild's, George, Models of 1925: Burlington, S. C., 25; Bennettsville 26; Haullet, N. C., 27; Wilmington 28.
 Youngest, The: (Gaiety) New York Dec. 22, indef.
 Zigzag Folies, with Will Rogers: (New Amsterdam) New York Oct. 30, indef.

BANDS AND ORCHESTRAS
 (ROUTES FOR THIS COLUMN SHOULD REACH THE CINCINNATI OFFICE BY SATURDAY MORNING TO INSURE PUBLICATION. PERMANENT ADDRESSES WILL NOT BE PUBLISHED FREE OF CHARGE.)
 Allen's, Jean: McGhee, Ark., indef.
 Alvarez, Billy, Havana Ramblers: (Toklo Dancing Club) Havana, Cuba, indef.
 Bachman's Million-Dollar Band: Tampa, Fla., indef.
 Balls, Edgar A.: (Lake Lola Park) Orlando, Fla., indef.
 Bernard's, Willie J.: Enfield Center, N. H., indef.
 Bobbitt's, Forest O., Collegians: (Winter Garden) Van Wert, O., indef.
 Butler's, Mel: (Davenport Hotel) Spokane, Wash., indef.
 Castor's, Robert, Seven Aces: (Palace) Bedford, Ind., indef.
 Chicago Miami Orch., Frank J. Novak, dir.: Miami, Fla., indef.
 Chicago Harmony Kings, Geo. R. Reardon, mgr.: (Empire) Los Angeles, Calif., 26-28; (Lauro) Watts March 1-4; Compton 5-7.
 Cohn's, Albert, Feature Band: Orange, N. J., indef.
 Craven's, C., Golden Gate: (Brown Hotel) Des Moines, Ia., indef.
 Dexter's, Fred, Orch.: (Wisconsin Roof Garden) Milwaukee, until April 19.
 Elbers, Leo, Circle Orch.: (Wisconsin Theater Roof) Milwaukee, Wis., indef.
 Ellis, Gertrude, Harmony Queens: (San Juan Hotel) Orlando, Fla., until April 1.
 Emerson's, Wayne K., Ft. Steuben Hotel Orch.: Steubenville, O., until May 15.
 Emerson's, Wayne K., Victoria Theater Orch.: Steubenville, O., until May 30.
 Erb's, Original Ace: (Gingham Cafe) Chicago, Ill., indef.
 Evans, Merle: Sarasota, Fla., Dec. 15, indef.
 Finnerhut's, John F.: Lakeland, Fla., indef.
 Fischer's, Chas. L., Orch.: (Eastman Hotel) Hot Springs, Ark., until May 1.
 Ficus, Leo, Orch.: (Pershing Palace) Chicago, Ill., indef.
 Fink's, orchestra: (Roseland Ball Room) Milwaukee, Wis., until May 10.
 French Co. Band (F. Sturchio's): North Baltimore, O., indef.
 Gates' Metropolitan Band: (Winter Gardens) La Crosse, Wis., indef.
 Gault's, George, Orch.: Baltimore, Md., indef.
 Golden Gate, John Cohan, mgr.: Fort Myers, Fla., 23-28.
 Golden's, Neil, Singing Orch.: (Toledo Winter Garden) Toledo, O., indef.
 Gralla's, Rocco: Tarpon Springs, Fla., indef.
 Hall's, Fred, Orch.: (Club Madrid) New York City, indef.
 Harbort's, Lou, Orch., J. G. Milburn, bus mgr.: Dunwoody, W. Va., 25; Covington, Va., 26; Lexington 27.
 Harter's, Don, Synopators: (Ball Room) Gary, Ind., indef.
 Hayworth's, Herb, Orch.: (Hanna Restaurant) Cleveland, O., until Apr. 1.
 Johnson's, Rosamond: (Lafayette) New York, indef.
 Kibbler's, Gordon, Black & White Pennsylvanians: (Tri-City Club) St. Petersburg, Fla., Dec. 31, indef.
 Karm & Andrew's Orch.: (Follies Bergere) Atlantic City, N. J., indef.
 Lawn's Sun Dodgers: (Travelers Inn) Springfield, Ill., indef.
 Lee's, Honor F.: Monett, Mo., indef.
 Lone Star Ten, Jack G. Van's: (Ansley Grill) Atlanta, Ga., indef.
 Louisiana Pool Wonders, Jack G. Van's: (Sam Houston) Houston, Tex., until June 1.
 Lyman's, Glenn L., Orch.: Cedar Rapids, Ia., indef.
 Metcorder Bros' Radio Jazz Band & Orch., A. T. McGruder, dir.: (Union Masonic Hall) Chicago, Ill., indef.
 McKown's, Joe, Musicians: (Hipp.) Fresno, Calif., March 4.
 Maynard's, Southland, Sorenaders: (Whittle Springs) Knoxville, Tenn., until Apr. 1.
 Meredith's, Jack, Orch.: (Franklin Springs Club) Franklin Springs, N. Y., indef.
 Miami Linky Seven Orch., O. G. Ireland, mgr.: (Nonticus Hotel) Miami Beach, Fla., until Apr. 10.
 Mills, Peck, Orch., Floyd Mills, mgr.: Washington, D. C., 25-26; Washington, Pa., 27; Pittsburgh 28.
 Moore's, Ray, Music Masters: (Arkeen Dancing Academy) Casper, Wyo., indef.
 Munnings, Angelo: Miami Beach, Fla., until April 18.
 Neale's, Carl: Elizabeth City, N. C., indef.
 Nelson's, C. H., Orch.: (Great Southern Hotel) Gulfport, Miss., until June 1.
 Nelson's, Emma, Chl. Girls: (Hotel Martin) Sioux City, Ia., indef.
 Norton's, Al, Canadian Roamers, J. E. Gibbs, dir.: (Far East Restaurant) Cleveland, O., indef.
 Norton's, Al, Collegians, Michael Lottah, dir.: (Palmetto) Toledo, O., indef.
 Original Kentucky Kernel Orch., Inc., Jos. E. Hiffman, mgr.: (Roseland Gardens) Lexington, Ky., Nov. 10-March 10.
 Original Blue Melody Jugs' Orch., Eddie Elliott, mgr.: (Alhambra Dance Garden) Winnipeg, Can., until May 1.
 Paris, Frank, Band: Greenville, S. C., indef.
 Pryor's, Arthur: (Royal Palm Park) Miami, Fla., indef.
 Riley's, Jim, Texas Hotel Orch.: Ft. Worth, Tex., until May 1.
 Rogers, W.H., Orch.: Lowell, Mass., indef.
 Sacco's Peacock Band: Cairo, Ill., indef.
 Seeger's, Hucers, Maitre, Howard Frank, dir.: Tampa, Fla., indef.
 Seely's, W. A., Orch.: (Wood's Restaurant) Syracuse, N. Y., until Apr. 1.
 Smith's, LeRoy: (Connie's Inn) New York, indef.
 Smith's, Don, Com. Roof Garden Orch.: (Oak Hill Hotel) Coral Springs, Ill., until June 15.
 Southern Synopators, Jack G. Van's: (Jefferson) Dallas, Tex., indef.
 Spindler's, Harry, Original Orch.: (Hotel Seltzman) Lakewood, N. J., indef.
 Sturchio's, Frank: Findlay, O., indef.
 Thornton's, Harold, Entertainers: (Strand) Tampa, N. Y., 23-28.
 Turners, The: (Hilford, Va. Tenn., 23-28.
 Turner's, J. C., Orch.: (Half Links) St. Augustine, Fla., until April 1.
 Twentieth Century Boys, Paul H. Goss, Mgr.: (Hotel Hermitage) Nashville, Tenn., Jan. 1, indef.
 Vanue Band (F. Sturchio's): Vanue, O., indef.

Zabel's, Sol, Orch.: (Rose Tree Cafe) Philadelphia, Pa., indef.
 Zabel's, Sol, Orch.: (Maze Cafe) Philadelphia, Pa., indef.

BURLESQUE
COLUMBIA CIRCUIT
 Bathing Beauties: (Empire) Newark, N. J., 23-28; (Miner's Bronx) New York March 2-7.
 Best Show in Town: (Gaiety) Rochester, N. Y., 23-28; (Avon) Watertown March 2-4; (Colonial) Utica 5-7.
 Broadway by Night: (Gaiety) Montreal 23-28; (Empire) Lewiston, Me., March 2-4; (Jefferson) Portland 5-7.
 Come Along: (Gaiety) Kansas City 23-28; (Gaiety) Omaha March 2-7.
 Cooper, Jimmy, Show: (Columbia) Cleveland 23-28; (Empire) Toledo, O., March 2-7.
 Dady, Lena: (Palace) Baltimore 23-28; (Gaiety) Washington March 2-7.
 East Steppers: (Empire) Brooklyn 23-28; (Casino) Philadelphia March 2-7.
 Follies of the Day: (Capitol) Albany, N. Y., 23-28; (Gaiety) Boston March 2-7.
 Gerard's, Harry, Show: (Lyceum) Columbus, O., 23-28; (Lyric) Dayton March 2-7.
 Golden Crooks: (Lyric) Bridgeport, Conn., 26-28; (Hurlig & Seamon) New York March 2-7.
 Good Little Devils: (Grand) Canton, O., 26-28; (Columbia) Cleveland March 2-7.
 Go To It: (Hurlig & Seamon) New York 23-28; Stamford, Conn., March 2; Holyoke, Mass., 3; (State) Springfield 4-7.
 Haggis-Lewis: (Gaiety) Detroit 23-28; (Empire) Toronto March 2-7.
 Happy Moments: (Olympic) Chicago 23-28; (Star & Garter) Chicago March 2-7.
 Happy Hop: (Empire) Providence 23-28; (Casino) Boston March 2-7.
 Hollywood Follies: (Gaiety) Pittsburgh 23-28; Wheeling, W. Va., March 2-3; Steubenville, O., 4; (Grand) Canton 5-7.
 Let's Go: (Gaiety) Omaha 23-28; open week March 2-7.
 Marions', Dave, Show: (Olympic) Cincinnati 23-28; (Gaiety) St. Louis March 2-7.
 Monkey Shines: (Casino) Brooklyn 23-28; (Orpheum) Paterson, N. J., March 2-7.
 Nitties of 1921: (Gaiety) Buffalo 23-28; (Gaiety) Rochester, N. Y., March 2-7.
 Peck-a-Boo: (Star & Garter) Chicago 23-28; (Gaiety) Detroit March 2-7.
 Reed's, Brokers: (Star) Springfield, Mass., 25-28; (Empire) Providence March 2-7.
 Red Pepper Revue: (Gaiety) Boston 23-28; (Grand) Worcester, Mass., March 2-7.
 Rumm'n' Wild: (Casino) Philadelphia 23-28; (Palace) Baltimore March 2-7.
 S.K. Stocking Revue: (Casino) Boston 23-28; (Columbia) New York March 2-7.
 Stoppe, Harry: (Gaiety) St. Louis 23-28; (Gaiety) Kansas City March 2-7.
 Stop On It: (Gaiety) Washington 23-28; (Gaiety) Pittsburgh March 2-7.
 Stop This Way: (Miner's Bronx) New York 23-28; (Casino) Brooklyn March 2-7.
 Stop and Go: (Columbia) New York 23-28; (Empire) Brooklyn March 2-7.
 Seven-Eleven: (Empire) Toronto 23-28; (Gaiety) Buffalo March 2-7.
 Take a Look: (Orpheum) Paterson, N. J., 23-28; (Empire) Newark, N. J., March 2-7.
 Talk of the Town: (Colonial) Utica, N. Y., 26-28; (Gaiety) Montreal March 2-7.
 Town Scandals: (Empire) Toledo, O., 23-28; (Lyceum) Columbus March 2-7.
 Watson, Shading Billy: (Lyric) Dayton, O., 23-28; (Olympic) Cincinnati March 2-7.
 Williams, Mollie, Show: Open week 23-28; (Lyric) Chicago March 2-7.
 Wine Woman and Son: (Grand) Worcester, Mass., 23-28; New London, Conn., March 2; Middletown 3; Meriden 4; (Lyric) Bridgeport 5-7.

MUTUAL CIRCUIT
 Band Box Revue: (Gaiety) Scranton, Pa., 23-28; (Gaiety) Wilkes-Barre, Pa., March 2-7.
 Bashful Babies: (Hudson) Union Hill, N. J., 23-28; (Gaiety) Brooklyn March 2-7.
 Beau's Paraders: (Prospect) New York 23-28; (Hudson) Union Hill, N. J., March 2-7.
 Bobbed-Hair Bandits: (Olympic) New York 23-28; (Star) Brooklyn March 2-7.
 Cuddle Up: (National) Chicago 23-28; (Caddis) Detroit March 2-7.
 French Follies: (Grand) Buffalo 23-28; (Corinthian) Rochester, N. Y., March 2-7.
 Gargles: (Star) Brooklyn 23-28; (Lyric) Newark, N. J., March 2-7.
 Girls From the Follies: (Corinthian) Rochester, N. Y., 23-28; Geneva March 2; Elmira 3; Johnston 4; Schenectady 5-7.
 Hello Jake Girls: (Garrick) St. Louis 23-28; (Mutual) Kansas City March 2-7.
 Harry's, The: (Empress) Cincinnati 23-28; (Gaiety) Louisville March 2-7.
 Kinky Kids: (Royal) Akron, O., 23-28; (Empire) Cleveland March 2-7.
 Kelly, Lew, Show: (Columbia, Pa., 25; Uniontown 27; (Academy) Pittsburgh March 2-7.
 Kidding Kitties: (Caddis) Detroit 23-28; (Park) Erie, Pa., March 2-4; (International) Niagara Falls, N. Y., 5-7.
 Luff, Thelma: (Harle) Newark, N. J., 23-28; (Gaiety) Scranton, Pa., March 2-7.
 London Gaiety Girls: (Garrick) Des Moines, Ia., 23-28; (Palace) Minneapolis March 2-7.
 Love Makers: (Prosper) Philadelphia 23-28; (Olympic) New York March 2-7.
 Mads From Merryland: (Palace) Minneapolis 23-28; (Empress) St. Paul March 2-7.
 Make It Poppy: Schenectady, N. Y., 26-28; (Howard) Boston March 2-7.
 Merry Makers: (Mutual) Washington 23-28; (Park) Pa., March 2; Lancaster 3; Columbia 4; Uniontown 6.
 Miss New York Jr.: (Empress) Milwaukee 23-28; (National) Chicago March 2-7.
 Moonlight Maids: (Gaiety) Louisville 23-28; (Broadway) Indianapolis March 2-7.
 Natchez Nights: (Broadway) Indianapolis 23-28; (Garrick) St. Louis March 2-7.
 Reeves' Beauty Show: (Gaiety) Wilkes-Barre, Pa., 23-28; Allentown March 2; Sunbury 3; Wilkesport 4; Lancaster 5; Reading 6-7.
 Red Hot: Williamsport, Pa., 25; Lancaster 26; Reading 27-28; (Gaiety) Philadelphia March 2-7.
 Round the Town: Open week 23-28; (Prospect) New York March 2-7.
 Sadies and Kisses: (Mutual) Kansas City 23-28; (Garrick) Des Moines, Ia., March 2-7.
 Soap It Up: (Howard) Boston 23-28; open week March 2-7.
 Speed Girls: (International) Niagara Falls, N. Y., 26-28; (Garden) Buffalo March 2-7.
 Speedy Steppers: (Empress) St. Paul 23-28; (Empress) Milwaukee March 2-7.
 Step Along: (Gaiety) Baltimore 23-28; (Mutual) Washington March 2-7.

Lively Girls: (Gayety) Brooklyn 23-28; (Lorado) Philadelphia March 2-7; (Lorado) Philadelphia 23-28; (Gayety) Baltimore March 2-7; (Royal) Akron, O., March 2-7; (Empress) Cincinnati March 2-7.

TABLOIDS

(ROUTES FOR THIS COLUMN SHOULD REACH THE CINCINNATI OFFICE BY SATURDAY MORNING TO INSURE PUBLICATION)

Adde's, Leo Olympians: (Wilson) Wilson, N. C., 23-28; All Stars Revue, Billy McCoy mgr.: (Orpheum) Altoona, Pa., 23-28; Aron's, Frank, Pretty Girls: (Peoples) Beaumont, Tex., indef.; Austin, Mildred, Musical Comedy Co.: (Ada Meade) Lexington, Ky., indef.; Pinks of Paradise Revue, Dalton Bros., mgrs.: (Dalton's Broadway) Los Angeles Calif., indef.; Erley's Eddie, Smiles & Chuckle Revue: (Temple) Bay City, Mich., Dec. 23, indef.; Booth's, Thelma, American Beauties: (Strand) Salisbury, N. C., 23-28; Boggs's Revue, Larry Hall, mgr.: Milwaukee, Wis., indef.; Brent & Chalmers' American Beauty Girls: (Majestic) Cleveland, O., 23-28; Bridge, Lou, Players: (Tootle) St. Joseph, Mo., indef.; Broadway Masqueraders, Eddie Ford, mgr.: (Gayety) West Toronto, Ont., Can., indef.; Broadway Flappers, Eddie Ford, mgr.: (Lafayette) Toronto, Ont., Can., indef.; Brown's, Mary, Tropical Maids, with Doc Paul: (Orpheum) Paducah, Ky., indef.; Bulter's Follies of 1925: (Columbia) Asbland, Ky., indef.; Burns & Paden's Cute Little Devils, Chas. V. Turner, mgr.: (Strand) Shamokin, Pa., 23-28; Buzzin' Around, Golden & Long, mgrs.: (Globe) Philadelphia, 23-28; Checker Girls, Mack Ingalls, bus, mgr.: (Victoria) Lansford, Pa., 23-28; (Victoria) Shamokin March 2-7; Dale City Revue, Lew Williams, mgr.: (Premier) Brooklyn, N. Y., 23-28; Danleison, Conn., March 2-4; Rockville 5-7; Star, Roy, Musical Show: (Palace Hipp.) Seattle, Wash., indef.; Clark Sisters Revue, John Clark, mgr.: (Elks) Grand Bellairs, O., 23-28; (Manas) Wexford, W. Va., March 2-4; (Pastime) Martins Ferry, O., 5-7; Clifford's, George, Pop & Ginger Revue: (Havana Park) Havana, Cuba, indef.; Columbia Musical Comedy Co., A. L. Konrad, mgr.: (Zaza) Denver, Col., indef.; Desmond's N. Y. Roof Garden Revue: (Majestic) Duquoin, Ia., 23-28; Downard's, Verg, Roseland Maids: (Victoria) Wilmington, 23-28; Dreamland Follies, Bob Deming, mgr.: (Grand) Cedar Rapids, Ia., indef.; Evans, Ray, Liberty Belles: (Lexington) Lexington, N. C., 23-28; Fads and Fancies, Art Owens, mgr.: (Bijou) Wausau, Wis., indef.; Fearless Eye Revue, Dalton Bros., mgrs.: (Dalton's Follies) Los Angeles, Calif., indef.; Holly Town Maids, Arthur Higgins, mgr.: (Lyric) Ft. Dodge, Ia., Jan. 25, indef.; Frenchie's, Dan, Holly Dells, H. A. Postum, mgr.: (Lyric) Ft. Worth, Tex., indef.; Frisco Frolics, Maurice J. Cash, mgr.: (Booster) Monroe, Mich., 23-28; (Majestic) Cleveland, O., March 1-7; Gove's, Bob, Stepping Stairs, W. J. Lytle, mgr.: (Grand) San Antonio, Tex., indef.; Harling & Klinging Co. (Elks) Port Arthur, Tex., indef.; Harris, Teddy, Jazz Revue, T. Teeters, mgr.: (Hippodrome) Dallas, Tex., indef.; Harris, Honey, & His Honey Girls: (Pearl) San Antonio, Tex., indef.; Harrison's, Arthur, Lyric Revue: (Orpheum) Hartford City, Ind., 23-28; Herbert & Sanderson's Revue: (Miles) Detroit, Mich., 23-28; He Jinks Revue, Dalton Bros., mgrs.: (Eureka) Los Angeles, Calif., indef.; High Speed Co.: Okmulgee, Ok., 23-28; His and His of Broadway, Chas. Bengas, mgr.: (Royalton) Royaltown, Ill., 26-28; (Montgomery) St. Louis, Mo., March 1; Hoochy Mr. Gene, Cobb, mgr.: (Pastime) Martins Ferry, O., 26-28; (Strand) Galton, W. Va., March 2-7; Host, Hal, & Gang: (Liberty) New Castle, Pa., 23-28; (Elks) Grand Bellairs, O., March 2-7; Humphreys, Bert, Dancing Buddies: (Broadway) Richmond, Va., 23-28; Hurry a Big Town Revue, Ralph Smith, mgr.: (Orpheum) Lima, O., 23-28; (Strand) Fremont March 1-7; Hurley's Jolly Follies, Frank Maloy, mgr.: (Orpheum) Huntington, W. Va., 23-28; (Marlowe) Ironton, O., March 2-7; Jazzy Mania Revue, Billy Edge, mgr.: (Hipp.) Parkersburg, W. Va., 23-28; Johnson's Musical Revue: (Star) Louisville, Ky., indef.; Johnson's Frolics: (Kerrigan) New Albany, Ind., indef.; Jones, Follies Co., Tommy Somers, mgr.: (Casino) Ottawa, Ont., Can., indef.; Kirkland's, Henry, Radio Revue: (Gem) Little Rock, Ark., indef.; League of Non-sense, Frank Smith, mgr.: (Star) McKeesport, Pa., 23-28; (Strand) E. Liverpool, O., March 2-7; Leger's, Billy, Musical Revue: (Band Box) Springfield, O., 23-28; Lewis, Ross, Radio Buddies: (Opera House) Warren, O., 23-28; (Columbia) Alliance March 2-7; Mack's, Lew, Musical Comedy Co.: (Capitol) Lansing, Mich., indef.; Maryland Beauties, Ed (Pop) Lowry, mgr.: (Fairmont) Baltimore, Md., indef.; Norton's, Frank, Co.: (Playhouse) Victoria, B. C., Can., March 2, indef.; N. Ch. Girl, Chas. E. Emery, mgr.: (Orpheum) Elkhart, Ind., 23-28; Musical Merry Makers, Frank Milton, mgr.: (Rivoli) Denver, Colo., indef.; Naughty Baby Revue, Art Kavanaugh, mgr.: (Dreamland) Chester, S. C., 23-28; Oh, Daddy, J. L. Davis, mgr.: (Majestic) Dubuque, Ia., indef.; Ontario Rotary Stock: (Park, Crystal and Madison Theaters) Toronto, Ont., Can.; Orpheum Players, Harris & Proy, mgrs.: (Rex) Ottumwa, Ia., indef.; Palm Garden Revue, Art Lewis, mgr.: (State) Akron, O., 23-28; Pinks, Pele, Show: (Jefferson) Dallas, Tex., Sep. 21, indef.

Peck's Bad Boy, Chas. W. Bonner, mgr.: (Strand) E. Liverpool, O., 23-28; (Opera House) Warren March 2-7; Phelps & Poland's Jolly Jollifiers: (Strand) Port Arthur, Tex., indef.; Rainbow Girls, Harry Ike Evans, mgr.: (Rialto) Waterloo, Ia., indef.; Rarick's, Guy, Musical Revue: (Capitol) Lansing, Mich., 23-March 7; Rendon, Billy, Musical Comedy Co.: (Hippodrome) Louisville, Ky., indef.; Sanford's Butterly Maids: (Gayety) Picher, Ok., indef.; Seattle's, Jack, Nifty Revue: (Variety) Calgary, Alta., Can., indef.; Selby's, Art A., Main Street Follies: (Strand) Ft. Worth, Tex., indef.; Society Girls, Tom Harmon, mgr.: (Orpheum) Franklin, Pa., 23-28; (Evans) Morgantown, W. Va., March 2-7; Soladar's, Chas., Brinker Girls: (Imperial) New Kensington, Pa., 23-28; (Lyric) Brad-dock March 2-7; Some Show, Alex. Saunders, mgr.: (Grand) Washington, Ind., 23-28; (Grand) Blooming- ton March 2-7; Song Box Revue, Bill Lober, mgr.: (Lyric) Brad-dock, Pa., 23-28; (Liberty) New Castle March 2-7; Step Lively Co., Eastwood Harrison, mgr.: (Lyric) Butler, Pa., 23-28; Sunshine Girls, Dick Hyland, mgr.: (Sunshine) Taft, Calif., indef.; Whiz Bang Revue, Marshall Walker, mgr.: (Plaza) Brownsville, Pa., 23-28; (Dixie) Uniontown March 1-7; Wilson Musical Comedy Co., J. P. Price, mgr.: (Palace) Oklahoma City, Ok., indef.; Wilson's, Billy, Dixie Harlings: (Alhambra) Brockbridge, Tex., 23-28.

MINSTRELS

(ROUTES FOR THIS COLUMN SHOULD REACH THE CINCINNATI OFFICE BY SATURDAY MORNING TO INSURE PUBLICATION)

Husky's Colored, Doc Gardner, mgr.: Poteau, Ok., 26-28; Ft. Smith, Ark., March 2-7; Colored's, J. A. Culpeper, Va., 25; Front Royal 25; Harrisonburg 27; Winchester 28; Stanton March 2; Clifton Forge 3; Covington 4; Hinton, W. Va., 5; Mt. Hope 6; Field, Al. G.; Winston-Salem, N. C., 25; Greensboro 26; Spartanburg, S. C., 27; Greenville 28; Charleston March 2; Savannah, Ga., 3; Waycross 4; Jacksonville, Fla., 5-7; Harvey's, Greater, F. A. McLain, mgr.: Iron Mountain, Mich., 25; Escanaba 26; Menominee 27; Appleton, W. S., 28; Green Bay March 2; Shioogran 3; Manitowoc 4; New London 5; Antigo 6; Wausau 7; White's, Lasses, Spauth & Co., mgrs.: Junction City, Kan., 25; Topeka 26; Atchison 27; Sedalia, Mo., March 2; Jefferson City 3; Moberly 4; Hannibal 5; Quincy, Ill., 6; Keokuk, Ia., 7.

STOCK & REPERTOIRE

(ROUTES FOR THIS COLUMN SHOULD REACH THE CINCINNATI OFFICE BY SATURDAY MORNING TO INSURE PUBLICATION)

Alhambra Players: (Alhambra) Brooklyn, N. Y., indef.; Auditorium Players: (Auditorium) Lynn, Mass., indef.; Auditorium Players: (Auditorium) Maiden, Mass., indef.; Avalon Players, Kelley Masters, mgr.: (Temple) Lewiston, Id., Dec. 20, indef.; Balnbridge Players: (Shubert) Minneapolis, Minn., indef.; Baker Stock Co.: (Baker) Portland, Ore., indef.; Baldwin Players: (Palace) Houston, Tex., indef.; Bayonne Players: (Opera House) Bayonne, N. J., indef.; Berkell Players, Chas. Berkell, mgr.: (Waterloo) Waterloo, Ia., Nov. 30, indef.; Boney Stock Co.: (Yorkville) New York, indef.; Bond, Harry, Players: (Hudson) Schenectady, N. Y., indef.; Bonstelle Stock Co.: (Bonstelle Playhouse) Detroit, Mich., indef.; Boston Stock Co.: (St. James) Boston, Mass., indef.; Brockton Players, Casey & Hayden, mgrs.: (City) Brockton, Mass., Sept. 1, indef.; Calumet Players: (Calumet) South Chicago, Ill., indef.; Carroll, F. James, Players: (Majestic) Hall-fax, N. S., Can., indef.; Cataract Players: (Cataract) Niagara Falls, N. Y., indef.; Chase-Lister Co.: Ottumwa, Ia., 23-28; Chicago Stock Co., Chas. H. Roskam, mgr.: (Gem) Willimantic, Conn., 23-28; (Empress) Danbury March 2-7; Cloninger, Ralph, Stock Co.: (Wilkes) Salt Lake City, Utah, indef.; Colonial Players: (Colonial) San Diego, Calif., indef.; Copley Repertory Co.: (Copley) Boston, Mass., indef.; Desmond, Mae, Players: (Desmond) Philadelphia, Pa., indef.; Duffy, Henry, Players: (Alcazar) San Fran-cisco, Calif., indef.; Empire Players: (Empire) Salem, Mass., indef.; Empress Players: (Empress) Butte, Mont., indef.; Empress Players: (Empress) Vancouver, B. C., Can., indef.; Fulton Stock Co.: (Fulton) Oakland, Calif., indef.; Garrick Players: (Garrick) Wilmington, Del., indef.; Gifford Players: (Hippodrome) Peoria, Ill., indef.; Glaser, Vaughan, Players: (Uptown) Toronto, Can., indef.; Gloucester Stock Co.: (Fulton Hill) Gloucester, Mass., indef.; Gordiner Players, Clyde H. Gordiner, mgr.: (Orpheum) Duluth, Minn., indef.; Harder & Hall Stock Co.: (Palace) Port Rich-mond, S. I., N. Y., indef.; Harrington, Guy, Players: (Stone O. H.) Big-hampton, N. Y., indef.; Hastings, Jane, Stock Co., Adam W. Friend, mgr.: (Burnside Post O. H.) Mt. Carmel, Pa., indef.; James, Stanley, Players: (Star) Pawtucket, R. I., indef.; Kramer, Charles, Players: (Victory) Charle-ston, S. C., indef.; Kramer, Ella, Stock Co.: (Arcade) Cunnells-ville, Pa., indef.; Lafayette Players No. 1, Andrew Bishop, mgr.: (Grand) Chicago, indef.; LaVerne, Dorothy Players: (Lyceum) St. Joseph, Mo., indef.

Loehr, Raymond, Players: (Wainut) Louisville Ky., indef.; Levy's, Robert, Lafayette Players: (Dunbar) Philadelphia, Pa., indef.; Lewis-Worth Players: (Lyceum) Memphis, Tenn., indef.; Lowell Players: (Opera House) Lowell Mass., indef.; Luttringer, Al, Players: (Park) Manchester, N. H., indef.; Lyric Players: (Lyric) Atlanta, Ga., indef.; Majestic Stock Co.: (Majestic) Los Angeles, Calif., indef.; Majestic Players: (Majestic) London, Ont., Can., indef.; Majestic Players: (Majestic) Utica, N. Y., indef.; Matthews, Cameron English Players: (Comedy) Toronto, Ont., Can., Jan. 1, indef.; Maylon Players: (Auditorium) Spokane, Wash., indef.; Metropolis Players: (Metropolis) New York, indef.; Mission Players: (Mission) Long Beach, Calif., indef.; Montank Players (Montank) Brooklyn, N. Y., indef.; Morocco Stock Co.: (Morocco) Los Angeles, Calif., indef.; Myrtle-Harder Co.: Norwich, N. Y., 23-28; National Art Players: (Lyceum) Paterson, N. J., indef.; New Bedford Players: New Bedford, Mass., indef.; Orpheum Players: (Orpheum) Racine, Wis., indef.; Park Players: (Park) Miami, Fla., indef.; Permanent Players: (Winnipeg) Winnipeg, Man., Can., indef.; Permanent Players: (Regina) Regina, Sask., Can., indef.; Plainfield Players: Plainfield, N. J., indef.; Playhouse Players: (Playhouse) Los Angeles, Calif., indef.; Poli Players: (Poli) Waterbury, Conn., indef.; Poli Players: (Hyperion) New Haven, Conn., indef.; Princess Players: (Princess) Wichita, Kan., indef.; Proctor Players: Elizabeth, N. J., indef.; Proctor Players: (Proctor's 23d St.) New York City, indef.; Rialto Players (Rialto) Hoboken, N. J., indef.; Rialto Players: (Rialto) Tampa, Fla., indef.; Ritz Players: (Ritz) Ft. Worth, Tex., indef.; Ross, Earl, Stock Co.: (Majestic) Waukegan, Ill., indef.; Saenger Players: (St. Charles) New Orleans, La., indef.; Savor Players: (Savoy) San Diego, Calif., indef.; Seventh Avenue Players: (Loew's Seventh Ave.) New York, indef.; Sherman Stock Co.: (Hippodrome) Terre Haute, Ind., indef.; Somerville Players: (Somerville) Somerville, Mass., indef.; St. John Players: (Opera House) St. John, N. B., Can., indef.; Strand Players: (Strand) San Francisco, Calif., indef.; Strand Players: (Strand) Ft. Wayne, Ind., indef.; Temple Theater Stock Co.: Hamilton, Ont., Can., indef.; Temple Theater Stock Co.: Hammond, Ind., indef.; Temple Players, Clint Dodson, mgr.: (Temple) Miami, Fla., indef.; Toledo Players: Toledo, O., indef.; Trent Players: (Trent) Trenton, N. J., indef.; Wallace, Earle, Players, direction Oliver Eck-hardt: (Walker) Santa Ana, Calif., indef.; (Mission) Glendora, Calif., indef.; (Scenic) Whittier, Calif., indef.; (United) Anaheim, Calif., indef.; Walker, Stuart, Players: (Cox) Cincinnati May 5, indef.; Warburton Players: (Warburton) Yonkers, N. Y., indef.; Wilkes Players: (Denham) Denver, Col., indef.; Woodward Players: (Majestic) Detroit, Mich., indef.; Woodward Players: (Empress) St. Louis, Mo., indef.

MISCELLANEOUS

(ROUTES FOR THIS COLUMN SHOULD REACH THE CINCINNATI OFFICE BY SATURDAY MORNING TO INSURE PUBLICATION)

Argus, Magician: Cave City, Ky., 25; Louis-ville 26-28; Birdie McDonald, Magician: Boyle, Miss., 25; Springfield, Tenn., 27; Bon-Homme Bros. Comedy Co.: Winona, Mo., 23-28; Bragg's Vaudeville Circus, No. 1, Geo. M. Bragg, mgr.: Sherbrooke, Que., Can., 23-28; Magog March 2-7; Bragg's Vaudeville Circus No. 2, Dorothy Klay-ton, mgr.: Newcastle, N. B., Can., 23-28; St. Johns March 2-7; Columbia Vaudeville Co., with Galvan: Lex-ington, Ky., 25; Carlisle 26-28; Maysville March 2-3; Hazard 4-6; Craig, Chas. H., Magician, Columbia Lyceum Bureau, mgrs.: Hooper, Neb., 25; Earlham, Ia., 26; Altoona 27; Worth, Mo., 28; Dante, Magician, Felix Hiel, bus, mgr.: Meridian, Miss., 25; Hattiesburg 26; Laurel 27; Gulfport 28; (Tulane) New Orleans, La., March 1-7; Delmar, the Wizard, C. L. Delmar, mgr.: (Grand) St. Paul, N. C., 26-27; (Opera House) Maxton 28-March 1; Hathaway, Magician: (Palace) New Britain, Conn., 26-28; Heart of America Trio, Willis Edwards, mgr.: Palestine, Tex., 25; Marshall 26; Winona 27; Canton 28-March 3; K. C. Four, Al Hickerson, mgr.: Demorest, Ga., 26; Dawson 27; Cummings 28-March 1; Lucy, Thos, Elmore, Humorist: Cotulla, Tex., 25; Dilley 26; Pearsall 27; Kenedy March 2; Yorktown 3; Round Rock 4; Georgetown 5; Killeen 6; Copperas Cove 7; Newman, the Great, Fergus Falls, Minn., 22-28; Valley City, N. D., March 1-7; Newwood, Hypnotist: (Clinton) Clinton, Ia., 23-28; Oldfield, Clark, Co. & Royal Hawaiians, H. A. Wilson, mgr.: Cleburne, Tex., 25-26; Brock- enridge 27-28; Brownwood March 2-3; Cole- man 4; Winters 5; Abilene 6-7; Paka, Lucy, Co.: Cuero, Tex., 26-28; (Grand) Yoakum March 2-4; Shiner 5; Schulenburg 6-8; Reno, Great, & Co.: Reading, Pa., 23-28; Smith, Mysterious, Co., A. P. Smith, mgr.: Ell-wood City, Pa., 23-28; Butler March 2-7; Turtle, Wm. C., Magician: Chicago, Ill., 23-28.

CARNIVAL COMPANIES

(ROUTES FOR THIS COLUMN SHOULD REACH THE CINCINNATI OFFICE BY SATURDAY MORNING TO INSURE PUBLICATION)

Broughton's, Leon, Motorized Carnival: Gobert, Tex., 23-28; Bonham March 2-7; Clark, Billie, Broadway Shows: Ft. Myers, Fla., 23-28; Cronin Shows, J. L. Cronin, mgr.: Daytona, Fla., 23-28; Delmar Quality Shows, C. J. Keppler, mgr.: Kirbyville, Tex., 23-28; Dixieland Shows, J. W. Hildreth, mgr.: Helena, Ark., 28-March 7; Hall, Dor, Outdoor Amusement Co.: Comstock, Tex., 23-28; Kline, Abner K., Shows: San Bernardino, Calif., 23-March 1; Monumental Shows: Jacksonville, Fla., 23-28; Nail, C. W., Shows: Monroe, La., 23-28; Thomas, Kid, Amusement Co.: Wortham, Tex., 23-28.

ADDITIONAL ROUTES ON PAGE 119

ALL-AMERICAN SHOWS

Now booking Shows, Rides, Help, Agents and Colored Performers. Opening in April Address NIP BUTTS, Manager, Box 195 Hobart, Oklahoma.

ANDERSON-SRADER SHOWS

Can place one or two more Shows. Will furnish outfit for good money-getting Shows. CAN PLACE few Concessions exclusive: Candy Floss, Novelties, Dart Gallery Perfume Candy Race Track, High Striker and one or two Ball Games. Address BOX 411, Great Falls, Montana.

BARLOW'S BIG CITY SHOWS

OPEN APRIL 11, GRANITE CITY, ILL. WANT Showmen for Athletic, Ten-in-One, Minstrel, Juggleland, Bottles, 2 Platform Shows. CAN PLACE Concessions, Waffles, \$40; Grind, \$25. Nonexclusive. No grit tolerated, Corn Game, et. open, \$100 weekly. Palmsbury, Sth. ex. This is a 17-car show. Address HARRIS BARLOW, Manager, Box 16, Granite City, Illinois.

CLARK'S GREATER SHOWS

Now booking Shows, Rides and Concessions. Season 1925. CLARK'S GREATER SHOWS, Phoenix, Ariz.

GOLD MEDAL SHOWS

Now booking Rides, Shows and Concessions. HARRY E. HULLIK, Mgr., Box 73, Packers Station, Kansas City, Kansas.

McMAHON SHOWS

WANT Manager and Attraction for Pitt Show. Dennis write, Manager for Athletic. WILL BOOK any Shows of merit. All concessions open except Cook House and Juice. Experienced Men for Rides. McMAHON SHOWS, Marysville, Kansas.

MACY'S EXPOSITION SHOWS

WANT Rides, Concessions, Shows, Free Acts. Open April 6. Guarantee ten or more Fairs. Address care Billboard, Cincinnati, Ohio.

MAD CODY FLEMING SHOWS

Booking Shows, Rides and Concessions for 1925. 24 Central Avenue, Cincinnati, Ohio.

GEORGE W. MATHIS

Booking Shows and Concessions exclusively. 3762 Ludlow Avenue, Cincinnati, Ohio.

SMITH SOUTHERN SHOWS

Now booking Shows, Rides, Concessions, Colored Musicians. Box 158, Catlettsburg, Kentucky.

STRAYER AMUSEMENT CO.

Booking Shows, Rides and Concessions season 1925. Hotel Warren, Williamsport, Indiana.

SUNSHINE EXPOSITION SHOWS

WANT Shows and Concessions. Opening Millen, Ga., April 4, 1925. P. O. BOX 225, Millen, Georgia.

SUCCESS One of the secrets of success lies in the ability to anticipate the movement of thought and life and then to meet the demands thus created. For those in the show business The Billboard is a help. Are you making use of the advantage it offers? The subscription blank on another page is your opportunity.



HIPPODROME CIRCUS

RAILROAD — OVERLAND



BY CHAS. WIRTH

SIDE SHOW MENAGERIE

PIT SHOWS — PRIVILEGES



(Communications to 25-27 Opera Place, Cincinnati, O.)

L. C. Gillette Signs With Main Circus

Clown Alley Will Be Directed by Arthur Borella—Spec. To Be One of Features

Louisville, Ky., Feb. 20.—L. C. Gillette, well-known circus agent, has signed with the Walter L. Main Circus for the coming season. He was agent for the Sparks Circus 11 years, and one season assistant manager, and also was with the late J. Augustus Jones and Elmer Jones for eight years.

Clown alley will be directed by Arthur Borella, widely known jockey. He appeared at the recent Shrine Circus in Wichita, Kan., and, after playing the balance of his vaudeville dates, will come here. Equestrian Director Grover McCabe has completed his program, which promises to be one of the strongest ever offered by a circus of this size. All the old-time circus features, including the leaps, will be seen, as well as several new features. Two wild animal numbers will be presented in a steel arena.

The idea of "singing 'em in and singing 'em out" will not be followed by the Walter L. Main Circus, but the spectacle that will open the show will be one of the important features. Nearly 150 people will take part in it. Ray Glaum will assist Mr. McCabe in producing the entry.

The mechanical department is putting on the finishing touches. Every week from one to three wagons are sent from the blacksmith and woodworking shop to the paint department. George Hubers is superintendent of the blacksmithing department, with "Red" Hoover in charge of the No. 2 forge. Hardly a week has passed this winter without an addition to the menagerie, the latest to arrive being a shipment of polar bears.

Tommy Poplin, electrician, has reached winter quarters, and is superintending the building of a wagon to carry the electric light plant, which will be two 18 K. W. Westinghouse generators, operated by Olds engines. Poplin has been wintering at Raleigh, N. C. Charles (Hook-rope) Rodimer, boss hostler, is expected here about March 10, at which time the draft horses wintering on a farm 10 miles from Louisville will be brought into quarters and conditioned for the road.

Sarasota Briefs

Sarasota, Fla., Feb. 20.—Merle Evans' new composition, entitled *Sarasota*, has been changed to *Symphonia*, dedicated to Mr. Charles Ringling, according to Joe Simon, librarian for Evans' Concert Band. Karl King composed a *Sarasota* number a few years ago. Peggy Mitchell, who was a recent visitor here, is vacationing at Bradentown, her home, and will be back with the big show this season.

Soldier Bolln, Eph Allen, Dan Deltose and John Likont cannot resist the temptation to troupe even during the winter. They are at present with the Frank McIntyre Show. They will be with the big show with Ollie Webb in the cookhouse.

Carl Hathaway is indeed busy these days, working on the festival to be held here early next month. Chas. Kannaly is busy at the Ringling Bros.' offices. "Chuck" Langford is wintering at Marianna, Fla. During the trouting season he can be found at the candy stands with the big show. He also is captain of the R-B baseball team, which was undefeated last season.

Mr. Charles Ringling was awarded the prize for the best name for the carnival week. It will be known as the Sarasota Orange Blossom Festival. Mr. and Mrs. Charles Jordan and son and Clyde Ingalls are guests of Mr. and Mrs. Charles Ringling on board their palatial yacht, *Symphonia*, for a 10-day fishing and hunting trip.

R. B. Dean Makes Change

Has Been Engaged as Press Agent for Hagenbeck-Wallace Circus

Raymond B. Dean, who efficiently handled the press for the Gentry Bros.-Patterson Circus the past two seasons, will look after the press back with the Hagenbeck-Wallace Circus this year. He has been putting in the winter at Milford Center and Niles, O.

Ed Whitham, brother of Doc, who recently was discharged from the U. S. Marines, says he will return to clown alley this season.

Seils-Sterling Circus

Will Open Season in Sheboygan, Wis., Week of May 4

The Seils-Sterling Circus will open its season in Sheboygan, Wis., May 4, and continue there until the 9th, under auspices of the Industrial Exposition Association, the contract having been closed by General Agent Albert Sigbee. This will be the sixth annual tour of the show under the Lindeman brothers' banner. Billy Lindeman and Sigbee are getting out new paper. G. H. Lindeman (late Nelson), assistant manager, is at the quarters and animal barns every day, and work under his guidance is progressing nicely. Capt. Sharpley has the two four-pony drills working in fine shape, and is now breaking in a bear act and some riding goats, dogs and monkeys. Arthur Heller will have the band and Crazy Mack will play the callopie. Albert Lindeman, manager of the side show, will have a good line of attractions, including the Impalement Alberts; Colo. fire king; Paul Marks, magic; Madame King, mindreading, and Earl Collins' Punch and Judy show. Others with the show will be Frank Koss, Harry Martin, Mr. and Mrs.

Moon Bros.' Circus Activities

Ada, Ok., Feb. 20.—Work is progressing rapidly at the winter quarters of the Moon Bros.' Circus. A. B. Campbell is in charge of the mechanical department with a force of 10 men. So far six cages have been turned over to the paint shop. The old dens will be gone over in a short time and made ready for the road. Construction of the new band truck will start in a few days, and it will be one of the largest and most beautifully designed trucks with a motorized circus. The management recently purchased a new Tangley callopie mounted on an auto, enclosed in an aluminum body.

Charles Yeargin, who will have charge of the candy stands, arrived last week, and with a number of the boys is building a new outfit. John Landes, musician, reports that he and Betsy will come here March 1. Two band boys, Moss, from Cheyenne, Wyo., and Hurley, from Bennington, Vt., are on their way to Ada. Equestrian Director Wilson recently lost three dogs in his prize spitz group, but he has an ample supply in six half-grown pups. Two steel arenas are now in use, one in the barn and the other outside. Stokes is working the Orange Bros.' Circus animals inside and LeBlair for the

Robbins Bros.' Circus

Will Start Season at Perry, Ia., April 25—Granger Quarters Scene of Activity

Granger, Ia., Feb. 20.—The Robbins Bros.' Circus will commence its season at Perry, Ia., April 25, and then fill an engagement at Des Moines.

With the completion of the new season den the last of the new parade wagons has left the shop. The parade equipment has been completely changed from that which left Lancaster, Mo., a year ago. Not one old wagon will be used. The new tableaux and cages, together with the new callopie wagons, are marvels of beauty. Owner Fred Buehmann has sold to the Taylor Circus, of Omaha, Neb., two stock cars and a new big top which he had in reserve last season. The canvas of the Robbins show is being made by the Baker & Lockwood Manufacturing Company, and will be new from cookhouse to big top. Bert Emerson is working the new ring stock and is doing nicely. The Davenporters are at the State Fair grounds, where they are breaking new bar-back stock. Stiek Davenport now has eight head of ring stock, but will probably only carry six head with the show.

Bert Rickman promises a big surprise in the new wardrobe. Mrs. Rickman having designed it. The new steel ears are about ready, and it is expected the equipment will be here before March 15. Two dozen monkeys arrived from Louis Ruhe last week and John Schulz, boss animal man, is looking after them. The new seat lumber is being assembled for use. The new blues are 18 high, with the reserves 14. The long side has eight double sections.

Charles Nelson, the Swede, wires he will report March 15, and Jack King will be here by that time. J. E. Shaw is here at the farm, and "Shorty" Murray, with two assistants, is building the new grand stand. Diamond, who has charge of the carpenter shop, has been transferred to his favorite—covers and tarps. George Johnson has the harness about ready and is working at this time on spec. trappings. John Schulz has entertained the boys all winter with his big radio outfit.

The new quarters of the Robbins show are enjoyed by the help, and the new cookhouse is one of the largest and best ever used in circus business. This building was completed the past summer. On the second floor is the dormitory. This is amplified with bath tubs and showers for the boys. The colored boys are all quartered in the second story of the paint shop. They also have bath tubs and showers and every convenience available. Earl Sinnott, superintendent, is being complimented by visitors at the farm upon his wonderful showing.

Neumann Gets Contract

Chicago, Feb. 20.—Edward P. Neumann of the Neumann Tent & Awning Company, reported today that his house will paint all banners this season for the Ringling-Barnum Circus and that his artists are now painting pictures on the wagons in the show's winter quarters at Bridgport, Conn. Mr. Neumann said he closed a number of large contracts with shows during the meetings here this week at the Auditorium Hotel.

Sayvillia Bros. have signed contracts to appear at the Police Circus in St. Louis. They are now filling vaudeville engagements around Chicago.

"Billyboy" Links Family

In a recent issue of *The Billboard* a notice was published in the circus department to the effect that George C. Franklyn was endeavoring to locate his father, Martin Franklyn, whom he had never seen, and the item brought results, informs Mrs. George Franklyn, who states: "The notice came to the attention of Jesse M. Franks, who wrote to the now grown up young man, whom she once held in her lap, when the team of Franks and Franks was playing vaudeville. It was thru her efforts that the father was found. Mr. and Mrs. Franklyn arrived in Boston to fill a week's engagement at the Bowdoin Square Theater with the Felix Morales Troupe, and found that the father was to play with a burlesque show at the old Howard Hotel the same week. Both were registered at the same hotel."



Pictured above is the Kilian Family in the days of 1905. Reading from left to right: Rose, Rosalind, Mabel, Otto and Ruth Kilian.

A. C. Miller, Orval Sterling, Mr. and Mrs. George LaVine, George Klauk, Mr. and Mrs. Art Heller, Albert and Mrs. Sigbee, Ivy Birge, Floyd Luce and wife, Birge Bros. (Harold and Martin), Gilda Nacks, Eddie Farr and Cleve Sharpley. Late visitors to the quarters were Buhl Gabbert and wife, Bobby Franks and Doc Engles, reports Fred Worthing for the show.

Emil A. Arp Will Play Chicago Lots This Season

Emil A. Arp's Great American Circus, a one-ring outfit, which has played in Eastern Iowa since 1916, will this season play Chicago lots. Manager Arp plans to play the lots on the South Side under auspices and may show at some stands on the West Side. He will use a 60-foot top with a 30-foot middle and operate the show as a circus-bazaar combination. Week stands will be made under auspices of the smaller fraternal orders and churches, he says. He plans to add a small pit or side show to his organization. Ed (Buffalo) Schroeder, who has been with the show as general agent since it was organized, will be back with the show as will Larry Ingledon, who formerly had the side show. James Parnell, former landmaster, is now conducting a general store in McGregor, Ia. A. (Jolly) Duffy, former side-show announcer, was best heard of touring Iowa with a magic and escape offering.

Howard Barry to West Coast

Howard Y. Barry, who was connected with the Golden Bros.' Circus the past season, stopped over in Cincinnati for a few hours February 17 on his way from Philadelphia, his home, to the West Coast. He gave *The Billboard* a call.

Moon Show in the open. The writer, Harry Shell, will have the band on the Moon show.

Walsh Bros.' Shows

Cottondale, Fla., Feb. 20.—Walsh Bros.' Combined Shows, in quarters here, are making preparations to open early next month. The outfit is adding three additional trucks and several lengths of seats, and Manager O. E. Walsh is sparing no expense in having one of the best motorized shows of its size on tour. A new big top and side-show top is expected most any day. Eight trucks will be used in transporting the show and one for the advance. Sig Sautelle will be connected with the organization in an official capacity; Mrs. O. E. Walsh will be in the wagon, as usual, and Mrs. George Washburn will be featured in the program. The latter is now rehearsing a new act. George Washburn will have the dressing room and play the callopie, and Jos Woolley will be chief mechanic. "Slim" Talley will again have the canvas, Ray Sanders the side-show top and George Ross the light plant. Wm. X. Reno, the writer, will again have the lanterns and look after the press. The outfit played Florida, Alabama, Mississippi, Arkansas, Missouri and Illinois territory, some of which will be repeated and a little of the Eastern country taken in.

Tallent Signs as 24-Hour Man With Sells-Floto Show

H. M. Tallent, of Chicago, who has been absent from the white tops for several seasons, has signed contracts with E. M. Harvey as 24-hour man with the Sells-Floto Circus the coming season.

'Al G. Barnes' Circus

New Stables and Training Barns Completed by Frank Rooney—All Departments Busy

Palms, Calif., Feb. 20.—All departments are now busily engaged at the quarters of the Al G. Barnes Circus here preparing for the coming season's tour. Frank Rooney has completed the new stables and training barns. Mr. Barnes' Circus city covers five acres of actual training quarters. General Manager Charles G. Cook has returned from Honolulu, and General Agent J. B. Austin has left for the East. Mrs. James Young, who sustained a broken arm a short time ago, is again on the lot. Mrs. Leon Blondin, who underwent a major operation during the holidays, has recovered and will be with the show this year. Mr. Blondin also will be with Mr. Barnes in charge of the elephants. Max Sable, Austin King and Carl Bruce are putting the new bronks and menage horses, imported by Mr. Barnes, thru their paces.

Mr. Barnes has received word from Mr. Buck, who is in Africa, that the shipment of giraffes, rhinos and other wild animals is en route to California. The widow of James Morrow, who was with the Barnes show for many years, will

have charge of the wardrobe department. Two specs. will be featured this season, with new costumes, settings and music. Bert Nelson has been taken in hand by Louis Roth, animal trainer, and is now training wild animals.

Charles C. Charles will have the two groups of seals and sea lions, and will introduce leopard seals, which recently arrived from Alaska. Boh McKane is seen daily riding in a cart drawn by Lotus, the five-ton hippopotamus. This is one of the features at Mr. Barnes' Zoo. Klendhart's Midgets have returned from a 10-week engagement at Grauman's Egyptian Theater, where they were featured with the film *Romalo*. Mr. and Mrs. Stonehouse, in charge of the ranch, have returned from Oakland, where they visited for three weeks.

George Tipton, who will again have charge of the cookhouse, has arrived at the quarters. The writer, Rex de Rosselli, has been very busy working on the new spectacles, and John Backman, equestrian director, has been rehearsing a number of acts.

Col. Joe C. Miller Returns to 101 Ranch

Marland, Ok., Feb. 20.—Col. Joe C. Miller has returned here after a visit of several days to New York in connection with the sailing for Germany of a group of Indians. He also attended to some business for Miller Bros.' 101 Ranch Real Wild West and Great Far East Show.

Al Curtis is hard at work getting in readiness the dining car he will operate with the show. "Grandpa" Fred Branch is with him. "Doc" Oyer has arrived and is greatly pleased with the work that has been done for the side show. California Frank Hatley, Manie Francis and Rene Hatley were recent visitors at the ranch.

Bronco busting, or at least attempts at it, is not confined entirely to professionals on Sundays at Miller Bros.' 101 Ranch. Many young men from Marland and Ponca City come to the ranch on the Sabbaths when the weather is good and try their ability at this dangerous and difficult sport. Fully 1,500 spectators from neighboring towns were at the ranch last Sunday to watch the fun. As usual, after the Wild West features, there was a free exhibition of stunts by the elephants.

The newest addition to the diversified activities of the Miller brothers was the completion last Saturday of the oil refinery they have built on the ranch. The oil comes from the Miller brothers' own oil wells on the ranch and the products of the refinery will be sold to the public as well as used in the operation of the ranch. A filling station has been installed at the store for the convenience of the almost countless automobile tourists that pass the ranch every day. A half holiday marked the opening of the refinery. Music was furnished by an amateur band gotten up among the cowboys. George Miller filled the tank of his touring car with the first distillation of gasoline and then drove several times around the refinery amid the cheers of the spectators.

A license has been granted the John Robinson Circus to show in Concessville, Pa., May 6, following a two-day stand at Pittsburgh.



Here is show Will Lea, clowning his way from Alaska to Jerusalem via the South Sea Islands, Australasia, Asia and Africa. Mr. Lea is the father of the clever dancer, Emilie Lea. This picture was snapped in Fiji. The men holding Mr. Lea were the only two of many natives who, after witnessing his convoluted and acrobatics, did not take to their heels fearing that he was a "man devil". In the memory of the oldest inhabitant, Mr. Lea was the first performer in his line to perform in the Fiji Islands.

Special Sale on Black Tents

- No. 5875—Size 20x60, Round End Front, Gable End Back, 8-Oz. Black Duck; used 2 months. Price \$325.00
- No. 5936—Size 22x85, Square Hip Roof Tent, 8-Oz. Black Duck; used 1 month. Price 315.00
- No. 5801—Size 16 1/2 x 13 Ft., Gable End Black Tent, for a Frame; 8-Oz. Black Duck; used 3 weeks. Price 50.00
- No. 4661—Size 30x50, Hip Roof Front, Gable End Back, 8-Oz. Black Duck; used 6 months. Price 250.00

Large stock of New and Used TENTS and BANNERS of all styles and sizes. Ask us about our low prices. Quality and workmanship the best. Telephone, Haymarket 0444.

U. S. TENT AND AWNING CO.

701-709 No. Sangamon St., Chicago, Illinois
Circus and Carnival Tent and Banner Headquarters.

REBUILT SHOW CARS

Various Types in Stock
Ready for Immediate Shipment.

SOUTHERN IRON & EQUIPMENT CO.

(Est. 1889)

Atlanta, Ga.

DOWNIE BROS., Inc.

640-42-44 Sanpedro Street, LOS ANGELES, CALIF.

Show-TENTS-Concession

Special Fall Prices. Let us know your wants. Show Tent Department in charge of LOU B. BERG.

TENTS FOR RENT. TELEPHONE TR. 7101. SEATS FOR RENT.

FOR SALE—BARGAINS—TENTS

Two Stable Tents, 28x42 ft., 6-ft. walls, 10-oz. double filling; side walls 8-oz. double filling. Four Sleeping Tents, 18x30, 5-ft. walls, 10-oz. double filling; side walls 8-oz. double filling. All in good condition, used parts of two summers. One Sleeping Tent not used. Inquire of P. RICHARDSON, Purchasing Agent, D. & M. Ry., East Tawas, Mich.

Feb. Feature
MINER'S CLOWN WHITE
30c

Theatrical
MAKE-UP
Send for Catalogue
Est. Henry C. Miner Inc
124 W. N. St.
Miner's

FOR SALE—A PAIR OF SPOTTED MULES

A real pair, for Circus or Advertising Team. If interested, will send you photos and description. JOHN E. ROBBINS, R. R. 6, Greensburg, Ind.

R. R. CARS

BOUGHT, SOLD, LEASED AND REPAIRED. Including turning steel-tired wheels. ALSO CARS STORED UNDER COVER OR OUT IN THE OPEN.

VENICE TRANSPORTATION CO.
1120 Title Guaranty Bldg., St. Louis, Mo.
Shops: Cara Terminal R. R., East St. Louis, Ill.

WALTER F. DRIVER, Pres.

44 YEARS REPUTATION BACK OF EVERY TENT

GOSS' SHOW CANVAS

CARNIVAL TENTS

FLAGS Waterproof Covers

SEND FOR NEW CATALOG AND SECOND HAND LIST

The J. C. GOSS CO. DETROIT MICH.

The Arms-Yager Railway Car Co.

410 N. Michigan Ave. SUITE 1382, CHICAGO.
Are prepared to furnish showmen and theatrical managers 60-ft. BAGGAGE CARS, equipped to run in high speed trains on all railroads. Write for rates. W. A. YAGER, President.

THOMSON TENT CO.

PIT. TOPS, CONCESSION TENTS, MARQUEE, SIDE-SHOW TENTS, 305 East Second Street, Cincinnati, Ohio.

CHAS. G. DRIVER, Sec'y & Treas

DRIVER BROTHERS, Inc.

500-504 SOUTH GREEN STREET. CHICAGO, ILLINOIS.
3 Long Distance Phones, 3: Haymarket 0221, Montee 6183, Montee 2675

Before The Rush

SAVE MONEY BUY NOW SAVE MONEY

1925—TENTS—BANNERS—1925 CIRCUS and CARNIVAL TENTS

THE BEST ARTISTS SEE OUR BANNERS THEY PLEASE

The **DEAGAN UNA-FON**

The Bally-Hoo Musical Instrument Supreme. Played same as piano, but with one-fifth the weight, one-tenth the size, yet fifty times the volume.

Write for Catalogue F. illustrating and describing the LATEST MODELS.

J. C. DEAGAN, INC., Deagan Bldg., 1780 Bertram Ave., CHICAGO.

WRITE FOR PRICES

on

Your 1925 Requirements

SHOW OR CARNIVAL TENTS. CONCESSION TENTS, MARQUEES. Anything Made of Canvas.

CARNIE-GOUDIE MFG. CO.
KANSAS CITY, MO.

WANTED

For Al. G. Barnes Side Show

Feature Side Show Attractions. Act quick. Address M. F. CHAMBERLAIN, Manager Side Show, care Barnes Circus, Palms, California.

CALL CALL CALL

All people engaged for the MIGHTY HAAG SHOWS report at the FAIR GARDENS, MARLBOROUGH, MASS., not later than TUESDAY, MARCH 10. Performers report to ABE JOHNSON, Equestrian Director. Musicians to BEN FOWLER, Band Master. All others to ERNEST HAAG, CAN BLAIR, Clarinet, Trombone and Cornet Player. Billposters report March 5. Kindly acknowledge call by wire or letter. E. HAAG.

ORTON BROS. SHOWS

Want a Producing Clown who can do announcing. Band Men, one Cornet and one Slide Trombone. Cook, a good camp cook. One Billposter. This is a wagon show. Address ORTON BROS.' SHOWS, Adel, Iowa.

WANTED FIRST-CLASS CIRCUS OPERATOR. LITTLE THEATRE, for Theater. Steady position. Must have habits and full of pep. No lowest salary and all particulars. Address TOM MULLROW, Manager Bennett Theatre, Logan, West Virginia.



(Communications to 25-27 Opera Place, Cincinnati, O.)

Dinkey Moore will be with King Bros.' Walter L. Main Circus this season. It will be his third year with the Kings.

Bert Bowers and Jerry Mugivan have been registered at the Congress Hotel, Chicago, the past several weeks.

Gallagher and Colscott, blacksmiths, will be connected with the John Robinson Circus.

J. H. Henley in his travels thru the South has visited the Rose Kilian, Davis Bros. and M. L. Clark & Son's shows and the Mighty Haag show quarters.

Clyde Smith, now driving thru Florida, expects to be with the Gentry-Patterson Circus this season. States that he met Paul Kramer and Tom Hurley taking subscriptions in Georgia and Alabama.

A. H. Knight reports that the M. L. Clark & Son's Shows, now in Florida, are headed for Tampa. Two performances are given daily and business has been good, he adds.

F. Walker sends word that the wagons which are being built at Miller Bros.' 101 Ranch, Marland, Ok., are attracting attention; also that August (Dutch) Christ is at the quarters.

George (Punch) Irving has been busy this winter giving entertainments for lodges, clubs and fairs in New England. He is anxious for the start of the tented season.

The Tom Atkinson Circus recently played a 10-day engagement in Mexcala, Mexico, and business was so good that three shows a day were given, reports Prince Elmer.

Mr. and Mrs. Wm. J. Irwin, who do juggling on the wire and head balancing on the swinging perch, are visiting St. Louis for five weeks, following which they will return to Steelville, Mo.

Roland Douglas pens that he and Harry Johnson, both formerly on the advance of the Ringling-Barnum Circus, will not troupe this season. They are partners in an advertising business in Detroit.

Wvatt Davies, who will again be with the Christy Bros.' Circus, dancing in the spec, and clowning, states that he has been taking dancing lessons this winter in New Orleans.

Claire Illington, female impersonator, writes that he spent a pleasant season under the George W. Christy banner last season. He did an Oriental dance in the spec, and iron-jaw and swinging-ladder numbers.

Horace Laird reports that his clown band recently made quite a hit at Towers Theater, Camden, N. J. Johnny Buffington, trap drummer, joined the act at the Broadway Theater, Philadelphia, replacing Harry Gouty.

J. Dudley Bradbury, who has been breaking his seven-rhesus-monkey act for some time, has booked the animal turn for the Police Circus in St. Louis April 12 to 26. The animals are the sacred rhesus monks from India and are quite intelligent.

Thomas H. Dean, who was with the Hagenbeck-Wallace Circus some years ago, is one of the feature comedians with the Ben Strasser Motion Picture Productions in Cincinnati. Some of his friends from Dayton, O., his home town, paid him a visit last week.

Buck Leahy, well-known ring gymnast, was slightly injured at Portland, Me., when a hook broke while he was performing with the Pop Gallagher Indoor Circus. He is recovering rapidly and expects to rejoin the show at Hartford, Conn.

"Kid" Cotman, steam calliope player with Golden Bros.' Circus last season, is busy in the winter quarters of Christy Bros.' Circus at Beaumont, Tex., re-wiring and retubing the two steam and two air calliopes. He is assisted by Fireman Joe Bailey Phipps. Cotman will be with Christy's Lee Bros.' Show this year.

Gene Milton, now with Short's Ritz Revue in Chicago, was a visitor at The Billboard offices there February 19. Gene promises a real surprise when he opens his pit show with Miller Bros.' 101 Ranch Shows the coming spring. He has engaged Al Salvail to handle the inside of the show, where Mrs. Salvail will do her mind-reading act.

A school for young women who wish to learn circus riding has been opened at Peru, Ind., the home of two circuses controlled by the American Circus Corporation. A number of Peru girls enrolled and, as the season approaches, others

Yes We Have BARGAINS

Lots of 'em. Here's a complete outfit consisting of 50x105 Baker-Built Top, almost like new, with 9-foot wall, proscenium, marquee, stage, scenery complete, wiring complete, etc. And \$1,250.00 takes it all. Ask for full details.

The Bargain Book's full of money savers. Write for it now.



Baker-Lockwood Mfg. Co.,

Incorporated

Seventh and Wyandotte, Kansas City, Mo.

AMERICA'S BIG TENT HOUSE

NOTICE! NOTICE! NOTICE!

MEMBERS OF THE INTERNATIONAL ALLIANCE OF BILL POSTERS AND BILLERS OF U. S. AND CANADA ARE AT LIBERTY TO SIGN WITH

ROBBINS BROS. CIRCUS AL. G. BARNES CIRCUS
GENTRY BROS.-JAS. PATTERSON CIRCUS

In addition to the Circuses previously announced.
JOHN JILSON, Int'l Pres.; WM. MCCARTHY, Int'l Sec'y.; GEO ABERNATHY, Int'l Treas.

desirous of a career in the sawdust ring are expected to apply for admission to the school.

A very interesting article on the training of horses appeared in *The Bridgeport (Conn.) Herald*, issue dated February 15. The subject of the story was Jorgen M. Christensen, now head horse trainer for the Ringling Bros. and Barnum & Bailey Combined Shows. In all the years he has handled horses Christensen thinks there is none more beautiful than the Polish stallion.

O. E. Dops, clown policeman, after four years off the road, will be with Robbins Bros.' Circus this season, informs Kenneth Waite, who adds that Jack Penton, for the past four seasons with the Walter L. Main Circus, will have the banners on the show. Chester Sherman and Jim Keating will be with it, making their 10th year in the employ of Fred Buchanan, and Lawrence Cross also will be found in clown alley. Frank Boyle and Frank Cosgrove will be additional fumakers. Waite will be producing clown.

Allen Wirth will do publicity ahead of the Moon Bros.' Circus, with A. B. Campbell on the advance. He reports that David Mastin has arrived at the quarters of the Orange and Moon Bros.' shows in Ada, Ok., likewise Capt. Cunningham, who is looking after "Tex", the elephant that tore up things recently at the quarters. Peggy Waddell, in addition to playing a role in the spec, of the Orange Show, will perform on the swinging ladder and perch. Colorado Sandy and Montana Earl, cowboys, put on some real bronk riding for the many visitors on Sundays. Wirth intends to open a press office in Long Beach, Calif., in the fall.

A correspondent writes that Gollmar Bros.' Circus, now at Mobile, Ala., will open the season next month and will play Tennessee, Kentucky, West Virginia and Pennsylvania. A shipment of new wardrobe and band coats has been received. He also reports that Al Hicks has signed as general agent for Elmer Jones' three-car circus, that the Cole Bros. and Cooper Bros.' circuses will be consolidated this season, and the best features of the two shows retained and a parade given. After opening near Little Rock, Ark., in March the show will be seen over its old route in Tennessee, Kentucky, West Virginia and Pennsylvania.

Abe Goldstein, clown policeman, who will be with the Sparks Circus this season, is playing some Florida fair dates. Says that he had a wonderful engagement at the South Florida Fair, Tampa. This week he is at the Fort Myers Fair, following which he will go to Cuba for a few days. The closing night of the Tampa Fair Leon LaMarr, who has the Wild West show with the Johnny J. Jones Exposition, gave the showfolk a dinner party, those present including Harry Greer, Bill Mossman, Jack Keek, Harry Stevens and Goldstein. Dave Nemo and wife have joined LaMarr's show until the opening of the Sparks Circus "Blackie" Crawford Blackwell, formerly with the Howe Show, is in the garage business in Tampa and doing well.

WITH AUSTRALIAN CIRCUSES

By Martin C. Brennan

Sydney, Jan. 7.—Perry's Circus is now touring New Zealand, opening at Wellington. It had the bad luck to experience inclement weather, which closed the show the last three nights it was booked.

Worley's Circus played Towed Head (N. S. W.) for three nights last week to fair business. It will play thru Queensland and should do well in view of the great rains experienced up that way.

Moneygetters in New Zealand this season are Dave Meekin's boys, a very fine show and a credit to the showgrounds; Dan, the giant dog; the Glass-Blowing Westwoods and the Bonless Westwoods. The New Zealand shows have finished until after the New Year, Invercargill being the last one.

Will Lea, globe-trotting clown, is now in New Zealand, and most likely will be back in Australia next week, after an absence of nearly 30 years. Now known as "The Man Who Never Grows Old", Lea will be remembered by oldtimers as the male in the amazing strong act of The Lucifers, which was a big feature with the *Matsa* (J. C. W.) pantomime.

Col. Bob Love, veteran circus man, will celebrate his 75th birthday anniversary January 12. For more than 60 years this warrior has been identified in the amusement world, has traveled in many countries, and, for one of his years, has a most prolific memory.

St. Leon's Circus and Buckjumpers opened in Auckland Boxing Day, Jimmy Matheson goes in advance of this combination.

Billy the pig, managed by Joe Gardiner, is getting the big money at White City, Perth, Jimmy, the small thoroughbred race horse, also is an attraction at White City. Business there is good with most of the freak side shows.

Byron Baunberg has severed his connection with Joe Gardiner, of Billy the pig fame, and is working on his own.

Mrs. Martin Wirth, a sister of Phil and George Wirth, arrived in Melbourne Boxing Day. They immediately left for Port Enry, where the circus was playing. Mrs. Wirth was accompanied by her daughter, Stella, and her son-in-law, Phil St. Leon. They will return to America early in February.

The carnival at Petrie Bight, Brisbane, is doing fair business.

Wirth Bros.' Circus is still playing the Victorian towns to good returns. The show will be in Sydney late in March.

Joe Morris, veteran clown and animal impersonator, is prominent in the *Mother Goose* pantomime at the Majestic, Newtown.

The Westwood Bros. will leave Auckland by the S. S. Maheno January 16. They will play the Hobart Regatta February 3.

Bro. Bob, popular carnival worker, who has been in Brisbane for some time, expects to be back in Sydney next week.

Phil Levarto, well-known juggler, has joined Lloyd's Circus and will go on tour with the show. The combination will be at Lake Cargellico next Saturday.

Picked Up on the Way

By FLETCHER SMITH

La Petite from Beaumont, Tex., to Macon, Ga. I came by way of New Orleans, Atlanta, and finally down the Central of Georgia. The publication in *The Billboard* that I had changed my base was the cause of an avalanche of mail at the Macon Hotel. Found a real bunch of oldtimers here and work progressing satisfactorily at the winter quarters of the Sparks show, on my way to the quarters run across the minstrel car of the *Florida Blossoms* that is owned by Oscar Rogers, who was part owner and assistant manager of the Sun Bros.' Show for many years. He will open in about two weeks for his 16th annual tour.

Rogers has purchased a splendid residence here and is the proud daddy of a four-year-old daughter. Mrs. Rogers, who has been suffering from the flu, is convalescing. Oscar will not be long with the show this season, leaving it all to Mose Forrest and "Brownie" Rogers, who will assist in the management. He tells me that after this year he is going to retire.

Jake Pusey, long hostler of the Sparks Circus, was called upon to tell the story of his life before the Civic Club of Macon, and was the subject of a two-column story in a recent Sunday issue of *The Macon Sunday Telegraph*. Jake bears up nobly under the publicity thrust upon him, and is down at the quarters daily just the same as if he was not some pumpkin with the feature writers. An oldtimer at the Sparks quarters is George (Pop) McCoy, who is building wagons with just as much skill as he did with the Gentry show for more than 15 years. Mike Carey is another oldtimer who is there with the brush, and the Sparks pa-

rade will surely be a flashy affair. Charlie W. Connors is at work on the train and is rebuilding the elephant car. John Castle has a new monkey act working to perfection, and George Singleton is figuring out a new wrinkle to raise all of the center poles at one time. George still owns many lots in Houston, Tex., on which he expects to erect bungalows.

Eddie Jackson seems to be the most popular man in the city with the theatrical folk. St. Valentine's Day he was swamped with mail from friends. He blames it all on Louis Rosignol, of the Macon Hotel, which is housing most of the Sparks bunch. Last Sunday George Wintz and his company arrived, and there was quite a reunion between oldtimers. Dave Durrett is here with his bride, the young daughter of Ernest Haag, and will probably not be on the road the coming season. Dave owns plenty of property in Macon.

The recent story in *The Billboard* about "Tom" shows brought many responses. From C. G. Phillips I learn that he is going to put out a tent Tom show in partnership with Tom Aiton. The show will be framed and owned at Cortland, O. C. G. has given up his railroad affiliations and is ready to embark once more in the show business. Harry Opel is another heard from. He is putting in the winter at Toledo, O. He will open this spring with his magic show as usual and play the small towns in the East. He used to be with the Brownlee & Reed show. I mentioned Dot Huntington, and a letter from her states that she is living at Blissfield, Mich., with her daughter, Bernice, who is married and has two children. From East Point, Ga., came a letter from Will Delavoie, of the old team of Delavoie and Fitz, the originators of the trick house. He is now going by the name of Lambert, and is putting on the market his ball-throwing novelties.

I knew you couldn't keep Andrew Downie down. He was bound to put something out the coming season. Have it on good authority that he will have a five-car show and is framing it now.

Garry Vanderhilt is much in evidence at the quarters of the Sparks show, and has with him this winter his wife, who in her time was one of the greatest somersault riders. Miss Polly has grown to be a big girl and is in school in Macon. The rendezvous of the Sparks show bunch and visiting show and stage folk is the Hotel Macon. The shows that are "put up" and "taken down" there each night would put most of the real ones out of business, which reminds of the old saw: "Yeah, your idea is all right, but where is your show?"

Pacific Northwest Will Have Its Quota of Shows

Don Carlos', Henry Bros.', Day's, Yager Bros.' and Adams' Outfits Preparing for Season's Tour

The Pacific Northwest will have its quota of small shows the coming season. In Portland, Ore., three shows are wintering within two blocks of the Sellwood street car barns. Don Carlos' Dog & Pony Show, with about 20 head of exceptionally fine-looking ponies, is rehearsing daily. A fine illustrated half-page writeup of the Carlos monkeys appeared in a recent Sunday edition of *The Oregonian*.

Henry Bros.' Circus is quartered in the same block and is looking forward to an early opening. The big lion act was featured at the recent Astoria (Ore.) Indoor Circus. The dog acts have appeared in some of the uptown store windows the past month and proved splendid publicity medium for the merchants. The Henry boys are frequently appearing in suburban vaudeville houses with their acrobatic acts. Manager Henry recently purchased a young bear from the city park bureau.

"Happy" Day's Novelty Animal Show occupies quarters adjacent to Henry Brothers'. New animal acts are in course of preparation, and illusions calling for the use of animals are being built. The show will go out under canvas the latter part of March.

Yager Bros.' Golden West Show is being prepared and, as usual, will make practically the same territory covered the past five years. Two new trucks will be added to replace discarded equipment. This organization probably will be the first in the field. Last year it opened the latter part of February and was favored with good weather.

Frank Adams is wintering his circus under his big top at Cape Horn, Wash., near Portland. He and his son, Albert, recently visited the Portland colony of showmen, reports Walter Adrian.

I. A. B. P. & B., Local No. 59

Denver, Col., Feb. 20.—After spending a year on the Pacific Coast Bro Burkhardt has transferred back into Local No. 59, I. A. B. P. & B. Bro. Payne was here for two weeks with *The Ten Commandments* film and reported that he will be back on the John Robinson Circus brigade. Local No. 59 is now in its new quarters at 1113 18th street, where road members are always welcome.

Gaston With Miller's Show

Albert Gaston, veteran clown, has signed with the George Miller Dog & Pony Circus, of Eaton Rapids, Mich., for the coming season. He will play indoor circus dates until the opening the early part of May.



Communications to 25-27 Opera Place, Cincinnati, O.)

All contest committees send in your dates!

The heads of each contest are duly proud of the winners' honors they award.

First, seconds, thirds, etc., are worth being really contested for.

Mrs. M. F.—Write *The Denver* (Col.) Post, which possibly can give you the information desired.

The regular season for contests will soon be on, starting in the "warmer" States.

W. W. Dillingham—What's this we hear of you probably again taking to the road this spring? Fact, or rumor?

Bert Shepard, "Australian Whip King", is having a successful tour of the Orpheum Circuit.

We understand that Bee Ho Gray is wintering on his farm in Missouri and will be seen at contests and fairs the coming season.

Tommy Douglass—Where, when and what? Frank Maish—Inquiries as to your whereabouts. Bob Anderson—Let us have the news as to your plans regarding contests this season.

Cowboy contest managements and cowboy and cowgirl contestants, keep your names before the public! News of your self and "doings" in this "column" will be read with interest all over the world.

Contest managers, if you want new faces in your arena get busy and let the folks all over know about your events, including prizes, dates, etc. The earlier the better.

Cowboy and cowgirl contestants, and those who have stunts to book in the nature of contracted exhibitions, should get busy now and let all contest managers know what you have.

An effort will be made by the Houston Ad Club to get Will Rogers to attend the convention of the Associated World Advertising Clubs in that city in May. And why not? Has he not leaped to the front ranks of American ad writers in the past few weeks?

Dick Halliday writes to the effect that Las Vegas is preparing for an exceptionally big "doings" at her 11th annual Cowboys' Roubion in July. Also that his new equestrian and shooting act is coming along nicely. He wonders what has become of Tex. Smith.

It might be explanatory to several writers to advise that the reason their stunts were not used was that they were straight-out advertising, not news for our readers. What a person "wants" or has to "sell" or "contract" is not news.

Monroe Veach, of Trenton, Mo., has just completed a special nine-inch tree saddle for Pat Clancy, four-year-old son of Fog Horn Clancy. Pat says he will loan the saddle to anyone except Bud Hampton, C. B. Irwin or Fog Horn, who also weighs more than 200 pounds.

Every day and in every way it is becoming more evident that those who are staying serious thought to the future and welfare of cowboy contests are beginning to realize that the sooner all in the business pull together the better it will be for all.

One of the contest folks writes: "Why the high entrance fees at some rodeos? The contestant who touts the management into making the entrance fees high evidently is doing it to exclude as much competition as possible, and likely will be the loudest grumbler if he fails to win."

A party of 17 Indians, including Chief Crooping Bear, said to be 35 years old, and three cowboys, Montana Earl Brumbe, Paul Sutherland and Joe Orr, sailed from New York on the S. S. Deutschland February 17 for Germany, to appear with a circus, they being sent over by Miller Brothers.

It probably will be a pleasure to some cowboys to be called upon the carpet by Col. Joe Miller the coming season, as they will get to see the inside of that \$50,000 private car. But there will be no harsh words from Col. Joe in any case, as he has a way of making kindness hurt the offender.

Hear that Mr. and Mrs. Johnny Roberts are wintering at St. Louis, also that Johnny is affiliated with an oil and gasoline concern, that he is getting quite "hipper," and tells friends that as soon as any of the other bulldozers beat his record of 3 4-5, made with the K. of C. show in Brooklyn, he opines that he is "only" enough to lower it.

Blue Gentry steps "out in front" with the following letter, from Oklahoma: "I

Spring Special

number of

The Billboard

Was especially instituted as a service number to the outdoor show world to book shows, acts and attractions, secure rides, rent privileges, sell show paraphernalia and equipment or fill any want in the great outdoor field.

ISSUED **MARCH 17** DATED **MARCH 21**

If you have used space in previous Spring Special Numbers you know that there is no element of experiment in letting it represent you. And if your advertisement does not appear in the 1925 Spring Special you are missing an opportunity of keeping your message before the entire amusement field, as this number is their constant reference for many months to come.

REMEMBER, THE EDITION WILL NUMBER

105,000 COPIES

AND CIRCULATE COMPREHENSIVELY OVER THE ENTIRE AMUSEMENT WORLD.

ACT QUICK!

If you delay it may mean the loss of preferred position. Many special reservations have already been made, and they are coming in by each mail.

Special Reservation Section Closes
March 2

SEND YOUR COPY BY RETURN MAIL.

The Billboard Pub. Co.

1493 Broadway, New York City

CINCINNATI CHICAGO ST. LOUIS BOSTON
PHILADELPHIA SAN FRANCISCO KANSAS CITY

have noticed several times in *The Billboard* about holding an official real championship rodeo somewhere every year. I'm for it. I believe I can rope and tie down a bunch of steers, anywhere, quicker than any other left-handed steer roper and will enter such a competition."

The fact that one contestant wins at one place and loses at another does not necessarily make him "bad". Neither does it make him the "best in the world". New ones are constantly coming to the front, and some of the old heads are still good. Also the public likes to see the newcomer contesting with the well-known hand who has already established a reputation. But, it takes ability, as well as reputation, to get over these days.

Jim Eskew will again this season have the Wild West show with the Rubin & Cherry Shows. And Jim is to have one of the best attractions of its kind with any carnival, with a crackerjack outfit and carrying 30 head of horses, mules, steers and buffalo and 20 people, according to report from the shows' headquarters at Montgomery, Ala. Eskew last year was working up some innovations and props, and it is quite probable that he will include some of them in his program this season.

After finishing a very successful engagement at the South Florida Fair, at Tampa Joe Greer and his personnel were last week all set for a two weeks' restup before going north to join the Ringling-Barnum Circus, with which Greer is to put on a feature jumping horse number in the big show program, he furnishing 10 horses and riders for the display. For the past five years Joe Greer has specialized in jumpers and he has collected and trained a wonderful array of equine talent. A list provided Rowdy states that the collection includes three horses that jump over automobiles, one that jumps over three horses, seven that make six-foot high jumps and three that jump seven feet high.

Dame rumor is again busy with the report that Guy Weadick will take one of the largest real Western shows across to England that ever was on tour. Reports say that negotiations are under way for Weadick to cross the pond as soon as the Calgary Stampede is over. At the time we go to press nothing definite upon the subject has been received from Guy, who is at present traveling thru the Northwestern States on a publicity campaign in the interests of Calgary's 1925 Stampede, which, it is claimed, will be the greatest Frontier Day Celebration ever staged there, as the event will celebrate the 50th anniversary by the Mounted Police of the founding of Calgary.

General Pisano, with his crackerjack shooting act—combined with a film introduction and singing by the talented Charlotte Cochrane—was on the bill at the Palace Theater, Cincinnati, last week and, naturally, this well-known quarksman paid *The Billboard* a couple of visits and stressed his hope that at some time all prominent shooters of the country get together in competition at one of the big annually held Wild West sports contests. Among other amusing "stories" he gave an imitation of Guy Weadick telling of being "gypped" in a barber shop while in vaude, in France, and how afterward the tonsorial artist "challenged him to a duel"—says Guy's account of the incident is a veritable scream. Pisano is at the Palace Theater, New York, this week.

Joe McManus writes from Billings, Mont., that Caroline Lockhart had gone to Prescott, Ariz., to attend the roundup and to purchase some "long-horns" to be used at the Cody Stampede in July. He also informed that Arlie Orser, bronk rider, was to be taken to the St. Vincent Hospital February 10 for an operation and that friends wishing to write him may address him to 204 South 27th street, Billings, Mont., and that Johnny Wintz, who suffered injuries at the Midland Empire Fair, is around again and looking forward to a good year; also that E. Collins is figuring on a trip to Europe and Ches. Phelps is getting his bucking horse string ready for the season. Joe says: "Let's hear from Bill Smith, who with the McDowell Brothers is wintering somewhere in the South."

Fog Horn Clancy writes: "I arrived in Houston, Tex., February 12, and booked my picture *North of 36 Rodeo* for 10 days—but I was never superstitious. Met Chief Corrells at Hempstead—on his way to join Texas Kid's Wild West Show at Navasota. Visited Brenham, Beese Lockett's home town, and met a world of his friends. It is hard to realize the great number of cattle that froze to death in the vicinity of Houston during the big freeze in December. Expect to play in the vicinity of Houston in about three weeks and then tour the Rio Grande Valley. I understand that there will be a rodeo staged here in May, during the World Advertising Club's convention, but haven't learned any of the particulars as yet. Looks like a wonderful rodeo season ahead, and I like the old saying, 'Will be with them and for them!'"

CIRCUS STEWARD WANTED

Experienced man only. Leon Hines, wire. Address GENTRY BROS.-JAS. PATTERSON CIRCUS, Paola, Kansas.

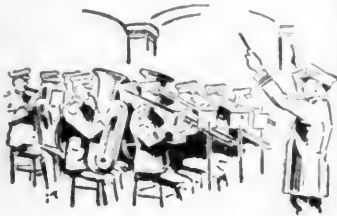

FAIRS AND EXPOSITIONS

Together With Their Musical Features
Grand-Stand Acts, Midway Shows
and Concessions
BY NAT S. GREEN



(Communications to 25-27 Opera Place, Cincinnati, O.)

Attendance Small at the Mid-Winter Meeting of International Assn. of Fairs

Some 30 Fair Officials Present---Valuable Suggestions Contained in Papers Read by Members---Bookings of Platform Acts Unusually Heavy

Chicago, Feb. 19.—The International Association of Fairs and Expositions held its annual mid-winter meeting in the Auditorium Hotel yesterday. There were present Edgar F. Edwards, president, of Rochester, N. Y., who occupied the chair; Frank D. Fuller, vice-president, of Memphis, Tenn., and Ralph T. Hemphill, secretary-treasurer, of Oklahoma City, Ok., and some 25 or 30 other fair officials.

Routine business was transacted and informal discussion had in the forenoon. In the afternoon Charles Nash, secretary and manager of the Eastern States Exposition, Springfield, Mass., read a paper on *Fair Accounting*. After he had finished several of the secretaries plied him with questions, and he was later congratulated on the valuable data contained in the paper. A. R. Corey, of Des Moines, Ia., followed up Mr. Nash's talk, speaking on the budgeting system of the Iowa State Fair. Ralph Hemphill, of Oklahoma City, was then, at the suggestion of Don V. Moore, secretary of the Interstate Fair, Sioux City, Ia., called upon to explain, by chart, a system which he (Hemphill) had followed and later to show, by chart also, what percentages 10 fairs from various locations devoted to entertainment, purses, etc.

The next speaker was Thomas H. Canfield, manager of the Minnesota State Fair, whose interesting subject was *Maintenance and Repairs*. Ray P. Speer, publicity manager of the Minnesota State Fair, then offered some sound and attractive ideas on *Advertising and Publicity*, and after J. C. Simpson, president of the World Amusement Service Association and former secretary of the Eastern States Exposition, Springfield, Mass., made a brief impromptu talk, paying tribute to the members, etc., the meeting was adjourned.

It was announced that the School in Fair Management has been indefinitely postponed, as stated in a recent issue of *The Billboard*, and the subject will probably not come up before the meeting next December.

No register of the secretaries in attendance was kept, but among the fair men noticed, besides those mentioned above, were J. E. Fahey, Louisville, Ky.; R. M. Striplin, Atlanta, Ga., and Jacksonville, Fla.; E. R. Montgomery, Grand Forks, N. D.; Elroy S. Thompson, Brockton, Mass.; W. H. Stratton, Dallas; E. J. Keist, Dallas, publisher of *The Times-Herald* of Dallas; Henry J. Lund, Minneapolis; M. E. (Pat) Bacon, Davenport, Ia.; Dick White, Milwaukee, Wis.; B. M. Davison, Springfield, Ill.; A. A. Jackson, Dallas, Tex.; C. E. Cameron and John Mullin, Des Moines; Herman Roe, Minneapolis; Lee Warner, Minneapolis; Sam Crabbe, Fargo, N. D.; John White, Huron, S. D.; A. B. Alexander, Milwaukee; Edward Watts, Muskogee, Ok.; Joel Bixby, Muskogee; Ralph Gaylor, Sioux City, Ia.; Henry Shull, Sioux City, Ia.; W. F. Sanger, Minnesota; A. W. Prehn, Wausau, Wis.

Among the general agents, managers and others who visited the fair secretaries were A. H. Barkley, Harry Sanger, W. S. Cherry, George Coleman, C. W. Cracraft, Jimmy Simpson, R. L. Lohmar, L. S. Hogan, Ralph V. Ray, Barney Gerety, Fred Beckman, Harry G. Melville, John M. Sheesley, Lester M. Brophy, Gene DeKreko, M. T. Clark, Beverly White and W. David Cohn.

Among those who had display rooms in the hotel were Thearle-Duffield Fireworks Company, Gordon Fireworks Company, Potts Fireworks Company, Western Vaudeville Managers' Association, Robinson Attractions and Ernie Young.

Agents Sign Many Contracts
It is claimed that more contracts for platform engagements were signed by the fair booking agencies at the meeting of fair secretaries yesterday than at any previous February meeting. Fred Barnes, of the World Amusement Service Association, reported contracts for acts signed with fairs as follows: Aberdeen (S. D.) Fair, Devils Lake (N. D.) Fair, North Dakota State Fair, Grand Forks; Fargo (N. D.) Fair, North Dakota State Fair (N. D.) Fair, Iowa State Fair, Des Moines; Minnesota State Fair, Hamline; Texas State Fair, Dallas; Oklahoma State Fair, Oklahoma City; Proo Fair, Muskogee, Ok.; Arkansas State Fair, Little Rock; Texas-Oklahoma Fair, Wichita

Falls, Tex.; Louisiana State Fair, Shreveport.

Sam J. Levy, of the same booking office, reported the signing of the Wisconsin State Fair, Milwaukee; Fond du Lac (Wis.) Fair and the Western Michigan Fair, Grand Rapids.

Edward F. Carruthers, also of the same office, announced Eastern fairs signed as follows: Massachusetts State Fair, Springfield; Allentown (Pa.) Fair, Ye Grande Old Fair, York, Pa.; Rutland

Income of \$3,000,000 From Sesqui Expected

Adequate Entertainment a Requisite of Success, Director General Declares

Philadelphia, Feb. 19.—Colonel Collier, director general of the Sesqui-Centennial Exposition, has announced that an income of \$3,000,000 is expected from the exposition.

The sum of \$5,000,000 will be ample for an exposition of international scope, Colonel Collier states, and all expenses can be defrayed thru a \$2,000,000 city appropriation and the sale of concessions and space for industrial exhibits.

Speaking of the entertainment side of the exposition Colonel Collier said:

"We must have adequate entertainment at the exposition. The entertainment must be dignified, but we must make things attractive for both children and grownups, for grownups still retain their love of a circus. Unless we look after the matter of proper entertain-



Waiting for the start of an automobile race at the South Florida Fair, Tampa, with crowds thronging the grand stand and sidelines. The South Florida Fair is without doubt the greatest winter fair in America.

(Vt.) Fair, New Hampshire State Fair, Rochester; Maine State Fair, Bangor.

Ethel Robinson, of the Robinson Attractions, did not make her bookings public, neither did J. C. McCaffery, of the fair booking office of the Western Vaudeville Managers' Association.

Appropriation Refused For Idaho State Fair

Spokane, Wash., Feb. 19.—After passing a bill creating a new Idaho State Fair to be held at the capital, Boise, the legislature of that State, in its last hurried hours, refused to appropriate the funds to establish the exposition. Spirited debate in which the "cow counties" led in defense of the proposed fair ended with the house voting 22 to 26 to refuse the appropriation at this time. The sudden tendency to economy was unexpected by champions of the bill, who now declare they will force it thru at the next session.

Representative McBirney told the house that the fair for two years would cost only 50 cents per taxpayer. The great advertising advantage to the State in addition to the inestimable value of a fair to the farmers was brought out in striking fashion by Representative Smith.

Grella at Tarpon Springs

Rocca Grella and his band are at Tarpon Springs, Fla., booked there for ten weeks by the Chamber of Commerce. Grella has a 20-piece band and two singers, and is said to be making quite a hit.

During the coming season Grella's band will be heard at many fairs. It will also furnish the music for the two-day Water Carnival and Illuminated Fleet at Tarpon Springs March 4 and 5.

ment I think we would cut our attendance 50 per cent.

"Under the present plans there will be few permanent buildings erected," the director general said. "The others can be built of steel and stucco, of the factory type, giving plenty of light and ventilation. The steel would be bolted instead of riveted and thus complete sawdust would be allowed."

Transportation played an important part in his selection of League Island Park as a site for the exposition, Colonel Collier told the executive committee, as the success of any such enterprise depended absolutely on transportation facilities at the exposition grounds.

Altho he would not commit himself definitely to an exposition with an international aspect, the director general said that such would be his recommendation to the executive committee.

C. N. E. Officers Banquet

Toronto, Feb. 19.—Several hundred representative men turned out for the annual banquet tendered by the president and directors of the Canadian National Exhibition to the live-stock breeders and exhibitors the night of Tuesday, February 19. Speakers from many parts of the Dominion addressed the gathering and all joined in declaring the Canadian National Exhibition to be one of the big features of Canadian life.

Fair Under One Director

The system of managing the New York State Fair under the supervision of a group of commissioners will be permanently abolished if a bill introduced in the New York State Legislature becomes a law. This bill would place the fair in charge of one director after January 1, 1926.

Calgary's 1925 Exhibition Promises To Be Greatest

50th Anniversary of Founding of Calgary To Be Fittingly Celebrated---Record Attendance Expected

A big year is ahead for the Calgary Exhibition and Stampede.

The exhibition has long been one of Canada's leading fairs, especially since the addition of the Stampede and Frontier Day Celebration, originated by Guy Weadick. This year will see an added celebration, marking the 50th anniversary of the founding of Calgary by the famous law and order organization, the Mounted Police.

Plans are going forward for large exhibits in the agricultural, live-stock and industrial departments. There is unusual activity, too, in the arrangements for entertainment and amusement features. Entries for the races are numerous. The Stampede will enlist hundreds of cowboys, cowgirls, Indians, wild cattle and wilder bucking horses, ropers and riders, and the contests for thousands of dollars in cash prizes will, as usual, attract the best riders. The Prince of Wales is offering a handsome trophy for the best bucking-horse rider.

The reunion of oldtimers and pioneers of the Canadian Northwest will be an interesting feature. Then there will be a big jubilee program presented by old-time Westerners, mounted policemen, cowboys, cowgirls and Indians to commemorate the founding of Calgary by the Riders of the Scarlet and Gold 50 years ago.

Every feature of this year's program has been enlarged and many new features have been added. The attendance in 1923 was 132,000. In 1924 it increased to 167,000. This year Calgary is aiming at a 200,000 attendance record. If hustle and earnest effort combined with a wonderful show will do it the goal will be reached.

E. L. Richardson is still the efficient exhibition manager, and Guy Weadick will again handle the Frontier Day Celebration and Stampede.

Exceptionally strong committees are in charge of the various departments, and Calgaryans as a whole headed by their noted cowboy mayor, George H. Webster, are getting behind the big jubilee celebration to a man.

With the lineup of capable executives at the head of things and the solid endorsement and co-operation of the Calgary citizens, visitors to Calgary this year are assured of a wonderful display. Everyone in Calgary wears the attire of the cowboy during "Stampede Week". Ranch chuck wagons camp on the main streets, and Indians, hundreds of the real long-haired blanket kind, come to town and pitch their gaudily painted tepees, race their ponies, meet the oldtimers and in general have a genuine old-fashioned frontier time. Already attractive literature is being issued regarding this big event; already hotels are receiving requests for reservations, and from every viewpoint Calgary will again this year show the exhibition world that it has the right idea in drawing people to its city and exhibition and showing them a combination that will educate, amuse, thrill and enthrall them in a historical manner, and at the same time it is keeping green the memory of the frontier days in that section, and giving credit to those sturdy pioneers who paved the way to make the Canadian Northwest the great inland empire it is today. All presented in a manner that raises Calgary's efforts above that of a mere show.

Hancock County Fair On Its Own Grounds

Carthage, Ill., Feb. 20.—Dates for the Hancock County Fair at Carthage this year are September 1, 2, 3 and 4—the first week in September, as usual.

The fair will, for the first time, be held on its own grounds, which are the same location as heretofore, but the grounds have been recently purchased and the title is now in the Fair Association. Heretofore the grounds have been leased by the association. Co-operation of Carthage people recently made possible the purchase of the 40 acres, besides adding the fairgrounds and 80 acres to the fair and more than 80 acres besides adjoining the fairgrounds.

This ownership of the grounds, and consequent assurance of a permanent home for the fair, enables the manage-

(Continued on page 83)

First Move To Make Tampa Fair State Fair

State Legislature To Be Asked for Appropriation To Pay Premiums--Exhibitors and Directors Meet

Tampa, Fla., Feb. 18.—What is regarded as the first move to make the South Florida Fair a State fair was taken last Wednesday night at a meeting of exhibitors and officers of the fair, when it was agreed to ask the next State Legislature for an appropriation to pay the premiums for the 1926 exposition. The action was taken at the annual banquet of exhibitors and directors at the Tampa Bay Hotel.

Governor John W. Martin and Mrs. Martin were guests at the banquet and congratulated the fair directors and exhibitors who had made the wonderful growth of the exposition possible.

The resolution to ask the State for assistance followed an address by Dr. L. A. Rize, who spoke in behalf of the directors. Dr. Rize explained the method by which the fair is financed, pointing out the fact that the officials and directors are "gambling" every year on the fair because all the revenue brought in was put back into the enterprise.

"In erecting new buildings and offering the premiums we do," Dr. Rize said, "the fair directors are running the risk of falling short each year a sum near \$5,000. If it should rain thru the fair and we should fail to receive the gate receipts we would be up against a real problem of financing."

He also pointed out the growth and value of the fair, and how it has become in reality a State fair rather than a section fair, and in some respects an international exposition. The situation, however, he termed as unfair to jeopardize the directors in a financial way year after year. The value of the institution, he said, warranted the aid of the State.

P. M. Childers, of Brevard County, presented a motion that the next Legislature be asked for a sufficient sum to pay the premiums offered. W. A. Manning, of Manatee County, amended the motion by asking that a committee be appointed to draft proper resolutions. Upon second of J. W. Geary, of Highlands County, the resolution passed unanimously. It was pointed out that the State had made such an appropriation from 1905 to 1909 and therefore had precedent to guide its action.

When the banquet had been served Mr. Brorein welcomed the exhibitors and thanked Governor Martin for his visit. He called upon those present from outside Florida to stand, and about 20 men representing Georgia, Tennessee, Ohio, Indiana, Michigan, Missouri, New York, Iowa and other States arose.

Then followed a discussion of the fair in which some 30 or 40 exhibitors, county agents and home demonstration agents participated. "Co-operation" was the predominant theme of the remarks made, and many suggestions for improving the exposition were made.

The value of the fair as an advertising medium was also discussed. W. A. Manning, who is secretary of the Chamber of Commerce at Bradenton, urged that the publicity men of Florida devote more time to educational opportunity offered in the fair displays, saying that it is far more effective than the letter-writing method used by them.

ELECTED LIEUT.-GOVERNOR



Last or West, North or South, fair men are first-class political timber. Here's one from New England. H. K. Farnsworth, one of the best known fair men in Vermont, and secretary-manager of the Champlain Valley Fair, is now Lieutenant-Governor of his State, and we venture the prediction that he will make a good one.



CAPT. LATLIP'S ATTRACTIIONS

NOW BOOKING FOR SEASON 1925.

THREE RIDES—Up-to-date Jumping-Horse Merry-Go-Round, new 5 Ell Ferris Wheel and brand new Merry Mix-Up. Four good Free Acts, presenting LADY MARION, Queen of All Lady Net High Divers; BABY BETA, the Child Wonder, in Her High Swinging Ladder Act, Double Trapeze. And the FOUR LATLIPS ACROBATIC ACT.

Would like to hear from Fairs, Fall Festivals, Old Home Weeks, or any good, live Committee intending to hold any Celebration. These Attractions are all guaranteed and will be backed up with a deposit that all contracts will be fulfilled.

WILL BOOK good legitimate Concessions. All open except Cook House. Address MR. JOE GALLER, Manager, Care of W. Va. Permanent Address, 209 Elm St., Charleston, W. Va.

THE LATLIP FAMILY.

Georgia State Fair Officials Installed

Savannah, Ga., Feb. 19.—With a great deal of enthusiasm members of the executive committee of the Georgia State Agricultural Society, at a meeting held here a few days ago, planned elaborately on making the 1925 Georgia State Fair the most extensive and important of any ever held by the organization.

Each of the members who represent the various congressional districts of Georgia entered fully and freely into the discussion and one after another pledged themselves to fully advertise the fair, which will be staged here October 26-31, inclusive, and to this end a promise was made by A. W. Morehouse, president of the Savannah Fair, Inc., to post and distribute advertising placards in conspicuous places and distribute advertising matter which will appeal to the populace and fully acquaint Georgians with the fact that Savannah this fall will offer the finest attractions available.

Judge Peter W. Meldrim, who was elected as president of the society at the midsummer meeting last year, was duly installed in office today and immediately assumed the direction of affairs. J. H. Mills, of Jenkinsburg, the outgoing president, opened the meeting, which was held in Judge Meldrim's chambers in the court house beginning at 10 o'clock this morning. Those present were Mr. Mills, Judge Meldrim, George Gilmore, Sandersville, general vice-president; J. L. Moore, Aragon, seventh district vice-president; A. Whitaker Conyers, fifth district vice-

president; James W. Horton, Athens, eighth district vice-president; W. D. Hammock, Coleman, third district vice-president; S. D. Truitt, Sparta, 10th district vice-president; J. T. Woodall, Woodland, fourth district vice-president; W. E. Harvin, Edison, second district vice-president; A. E. Gibson, Edison, secretary; A. W. Morehouse, president, and W. A. Johnson, vice-president of the Savannah Fair, Inc.

Mills B. Lane, of Savannah, was elected as first district vice-president, and B. M. Gaddis, of Valdosta, was elected as 11th district vice-president in place of J. G. Stanley, deceased.

The financial report submitted showed the society to be in excellent condition. The summer or annual meeting of the organization will be held at Athens on Wednesday, August 12.

Berney Smuckler New Manager of Georgia State Fair

Savannah, Ga., Feb. 19.—At an executive committee meeting Monday the Savannah Fair, Inc., elected Berney Smuckler of Laurel, Miss., as manager of the Georgia State Fair. His duties begin March 15 and continue until December 31. Mrs. Smuckler was engaged as assistant manager.

Dates of the Tri-State Exposition and Georgia State Fair combined are October 26 to 31, inclusive.

The Smucklers have been identified with the operation of fairs at Laurel and Meridian, Miss., in recent years.

FAIR NOTES AND COMMENT

Winter meetings are about over.

Now for the application of the ideas gathered!

How many successful free fairs are there in the U. S.?

"I just go to the secretary and say, 'I'll give you so much a foot for your space; take it or leave it,'" remarked a concessionaire at a recent winter meeting.

Probably when he goes into a shoe store he sets his own price on a pair of shoes. And does the clerk let him get away with it?????

Don't miss *The Billboard's* Spring Special—out in three weeks. "Bill" Hirsch's special article is one of the many good things in that issue and one of the best.

The South Florida Fair at Tampa is keeping pace with the wonderful development of the West Coast of Florida in other lines. It has made steady progress under the wise administration of W. G. Brorein and P. T. Strider and their associates, and is destined for still greater development.

We hesitate to record Col. Ed R. Salter as sojourning in the hospital. Chances are by the time this is in print he'll be on his merry way, cane "everything, parading the beach and feasting his optics on visions of loveliness. And maybe the "visions" will not be indifferent to the colonel's charms either, for when one is 34 and handsome—

Yep, the blue birds are warbling; fishin' worms are wriggling toward the surface, and it won't be long until the honk, honk of geese bound northward will be heard. Spring is just around the corner. We don't need any patent medicine to develop vim, vigor and vitality—just a dash of the vernal spirit will do the trick.

Britt M. Preston, the new manager of the Kalamazoo County Fair, Kalamazoo, Mich., has outlined an ambitious program for the 1925 fair. He announces that the association is spending \$7,000 for free acts, \$5,000 for fireworks, and will have a \$6,000 horse-racing card. Mr. Preston hopes to have 25,000 school kiddies on the grounds the first day of the fair. On that day all children will be admitted free.

There seems to be an epidemic of "State fairitis". Idaho wants a State fair and is going after one, Pennsylvania

is determined to have one even if it has to be conducted independent of the State, a bill has been introduced in the California Legislature to establish a second California State Fair at Riverside, and the first move has been made toward making the fair at Tampa, Fla., a State fair.

All of which is very good if the creation of these State fairs will increase their benefits to the public. In some cases such would undoubtedly be the result.

President Harry White of the Pennsylvania State Association of County Fairs was, we believe, the first to suggest a State school in fair management to be patterned after the school sponsored by the International Association of Fairs and Expositions. He also suggested a concession bureau.

Ohio's concession law has been in operation for two years and seems to be functioning fairly well, although there are still many problems that have to be worked out. There ought to be some common-sense plan, workable in all States, whereby the gyping concessionaire and the gyping fair secretary could be eliminated. There is much to be said on both sides, and any plan that does not give a square deal to all concerned should be discarded.

The De Land Daily News, De Land, Fla., issued a daily miniature edition during the Volusia County Fair which made quite a hit.

Dates of the Dade County Fair, Miami, Fla., have been changed from March 16-21 to March 9-14. This was done to avoid conflict with the Miami Musical Festival, scheduled for the former dates.

As these notes are being written Col. Ed R. Salter is reported to be rapidly recovering from his illness and expects soon to leave the Gordon Keller Hospital, Tampa, Fla. Col. Salter fell ill just after the Johnny J. Jones Shows had pulled into Tampa for the South Florida Fair, and this was the first in many years that he was not "out and among 'em", as an editorial in *The Tampa Tribune* had it.

The Seils-Sterling Circus will furnish 17 displays and acts in front of the grand stand and on the free attraction platform at the Adams County Fair, Friendship, Wis., and also at the Waupaca County Fair, Weyauwega, Wis.

A budget of \$225,000 for expenses incident to the Indiana State Fair and work of the State Board of Agriculture (Continued on page 82)

South Texas Fair Circuit Sets Dates

Annual Two-Day Meeting of Circuit Held in Kenedy, Tex.---
Next Meeting Place
San Marcos

Kenedy, Tex., Feb. 19.—Fifteen fair dates, starting from August 21 and extending until November 5, were set here Tuesday at the closing of a two-day session of the South Texas Fair Circuit.

The following dates were agreed upon: Fredericksburg, August 21, 22 and 23; Boerne, September 4, 5 and 6; San Marcos, September 8, 9, 10 and 11; Seguin, September 16, 17, 18 and 19; New Braunfels, September 21, 22, 26 and 27; Flatonia, September 22, 23, 24, 25 and 26; Lagrange, September 28, 29, 30 and October 1, 2 and 3; Victoria, September 29, 30, October 1 and 2; Austin, October 1 to 8, inclusive; Gonzales, October 6, 7, 8, 9 and 10; Alice, October 6, 7, 8, 9 and 10; Lockhart, October 12, 13, 14, 15, 16 and 17; Kenedy, October 20, 21, 22 and 23; Beville, October 26, 27, 28, 29 and 30, and Floresville, November 2, 3, 4 and 5.

No bookings were made, although representatives of several different shows and booking agencies attended the meetings.

George Kempen was re-elected secretary of the association. Sam Fore, Jr., of Floresville, was named president, succeeding A. B. Rogers, of San Marcos.

The next convention, the date of which has not been set, will be held in San Marcos.

The meeting went on record as opposing any advance or discriminatory license against carnivals "for the reason that the latter are absolutely essential for the success of the fairs, besides being a popular form of amusement as attested by the attendance, and afford the person of moderate means an opportunity to give amusement for the entire family. We oppose House Bill No. 447."

The bill referred to is one calculated to deal a deathblow to carnivals with Texas bookings, it was explained.

Robert Burns, president of the Karnes County Fair Association, delivered the address of welcome to the assembled delegates. J. W. Anderson, chairman of the concessions at the Texas State Fair at (Continued on page 120)

VICTOR'S FAMOUS BAND

MISS GERTRUDE VAN DEINSE (Soloist)
NOW BOOKING FAIRS, PARKS AND CELEBRATIONS

20 Musicians, 4 Instrumental Soloists, 1 Specialty Instrumentalist, 1 Lady Vocalist.
For further particulars and terms, address
JAMES F. VICTOR,
Care N. Y. A. Club, 229 West 45th Street,
New York City.

GRELLA AND HIS BAND

20 first-class Musicians and four Instrumental Soloists, Soprano and Tenor Soloists. This Band has played three winter seasons in Fort Myers, Fla., one winter in Jacksonville, and now playing daily concerts here. Booked by the Chamber of Commerce until April 15. Now booking Parks, Fairs, Chautauquas and Expositions for this coming season. Address **ROCCO** Springs, Fla. Home address, Box 208, Lexington, Ky.

WANTED

Free Acts, Fireworks, Shows and Rides
Sept. 15, 16, 17 and 18.
MIAMI COUNTY AGRICULTURAL ASSN., CONVERSE, IND.

New Titusville Fair

Sept. 15, 16, 17 and 18, 1925
DAY AND NIGHT
Wanted—Independent Rides and Shows.
R. P. FOWLER, Secy., Titusville, Pa.

PARKS-PIERS-BEACHES

THEIR AMUSEMENTS AND PRIVILEGES WITH ITEMS OF INTEREST TO MUSICIANS

BY NAT S. GREEN

(Communications to 25-27 Opera Place, Cincinnati, O.)

Special Division of N. A. A. P. Formed

Manufacturers and Engineers' Division Will Consider Highly Specialized Questions

New York, Feb. 20.—At the office of R. S. Uzzell Corporation recently the organization committee of the Manufacturers and Engineers' Division of the National Association of Amusement Parks met to organize this special division of the association for the consideration and co-operation of the highly specialized questions that vitally interest the manufacturers and engineers and are of only minor importance to the park managers of the country and therefore not of such a universal interest that they should take up the time of the national association convention. It was therefore decided to have a special meeting of all the manufacturers and engineers catering to amusement parks on the Monday in December previous to the opening of the national convention on the following day.

At the preliminary meeting of this division in Chicago H. G. Traver was elected chairman and R. S. Uzzell secretary and treasurer for the present year. The organization committee is headed by George P. Smith, general manager of the Philadelphia Toboggan Company; the credit committee by M. Goldberg, of the Skee Ball Company; the contract committee by Wm. H. Dentzel, of Philadelphia; the program committee by Fred W. Pearce, of Detroit; the committee on safety of operation and design by Frank W. Darling, of the L. A. Thompson Scenic Railway Company, and the committee on ethical procedure by George P. Smith, of Philadelphia.

The organization committee, which has so recently met at the office of R. S. Uzzell, consists of George P. Smith, chairman; Trubenbach, Strauss, D. A. Bond, E. J. Kilpatrick, of London and Chicago; Wm. H. Dentzel, H. G. Traver and R. S. Uzzell.

They drafted a constitution for this division and a set of by-laws and decided to classify the park men and concession operators of the country into four classes and pass the information around among the manufacturers so that each is fully informed as to the credit standing of customers, with special emphasis on those who attempt to dishonor their obligations. It is the province of the contract committee to compile the information as to the laws in each State pertaining to the best method of securing deferred payments on personal property.

The meeting was called to order at 11 o'clock and held a continual session until half past one, when E. J. Kilpatrick, who was here only a few days from London, invited the committee to lunch with him at the Commodore Hotel and to hold the afternoon session of the committee in his rooms at the Commodore. The hospitality of "Kil" was hugely enjoyed and appreciated and he was able to take to the English members of the national association the latest information concerning the work of the new division.

The committee wishes to emphasize the fact that this division of the national association is not opposed to the national association in any way, but is a part of it and is co-operating with the national association and has made its constitution, by-laws and procedure subject to the approval of the board of directors of the National Association of Amusement Parks.

All manufacturers and engineers who join this new division and pay \$25 per year are entitled to the information on credits, contracts and the information on safety of operation and design, and it is hoped that all of the manufacturers and engineers who have not already done so will send in their application for membership at once to the secretary's office at 1493 Broadway, New York City.

Park Planned at Canandaigua

Canandaigua, N. Y., Feb. 20.—William Maur, of Rochester, widely known concessionaire, has purchased from Marion I. Case nine acres of land at the foot of Canandaigua Lake which he intends to turn into an up-to-date amusement park. More than \$30,000 is said to have been involved in the deal and Mr. Maur indicates that he will spend half as much again in development of this property.

Tentative plans call for the erection of a modern dance hall, the grading of the beach with bathing permissions to persons using the free camp site nearby and the illumination of the beach at night.

Crystal Beach Park

George H. Blanchat, manager of Crystal Beach Park, Vermilion, O., advises that several new amusement features will be installed this year. One of the principal improvements will be Crystal Gardens dance hall, work on which has already been started. The hall will accommodate 2,000 couples, it is announced.

Mr. Blanchat states that a ferris wheel, caterpillar and coaster are to be installed. The park now has a miniature railroad, pony track, carousel, Custer coaster, dodgem, jr.; aeroplane swings and roller rink. There also is a bathing beach and two large bathing pavilions. The park has plenty of shade and parking space for several thousand autos.

The management has decided that the admission charge of 10 cents will be discontinued and the park made a free-gate park. A number of picnics have been booked.

Crystal Beach Park is located on the main lake driveway 38 miles from Cleveland.

Broad Ripple Park

Indianapolis, Feb. 20.—The prospects for a banner season were never more bright than they are for Broad Ripple Park for 1925, according to R. M. Edwards, director of promotions.

The park is undergoing a complete remodeling, and, contrary to the former policy, the park will be inclosed and a 10-cent gate admission will be charged. Free attractions of real merit will be booked each week. Already some of the best talent in the business has been engaged, and the management expects to offer several sensational outdoor acts and bands.

Much work has been done on landscaping, additional ground has been secured and a number of new rides will be constructed immediately. A new filtration plant for the pool is rapidly nearing completion, which will change the water in the pool every 24 hours.

The personnel of the park remains practically the same as in previous years. Women and children will be especially

"Hillside" Now "Riviera"

Park at Belleville, N. J., Under New Management—Is To Be Improved

Belleville, N. J., Feb. 19.—Hillside Park, on Washington avenue near the Belleville-Nutley line, has now become Riviera Park. Thomas W. Crowley, the leading spirit in the park's management since the death of William H. Thaller five years ago, has retired from the management and it is planned to spend about \$50,000 on the resort before the spring opening.

The new officers of the company which owns the park are: President, Daniel Spieler; vice-president, Thomas W. Crowley; secretary, Daniel Kugel; treasurer and general manager, Leon S. Harkavy. Mr. Crowley said that he expected to give part of his time to the enterprise for a "little while," but that he is gradually withdrawing.

The new name will bring with it a change in policy and in the kind of entertainment offered to patrons. A new archway will be built to take the place of the present Washington avenue entrance, a new midway is now being planned, a new "scooter" will be erected and the old dance hall thoroughly overhauled and improved. About 6,000 lights will be installed, a new automobile entrance made and parking space for 1,000 cars provided.

Hillside Park long has been a landmark. Twenty-five years ago it was the scene of the championship bicycle races and when these moved to a larger and newer arena it was used for several years for football games, track meets and other events of the sort. It then became a pleasure park.

Mr. Harkavy states that several other improvements will be made, among them the installation of a swimming pool. If conditions permit work will be started on the pool this year; otherwise it will be deferred until 1926.

"Our picnic grove is being made so attractive that the old-time family picnic is sure to be revived because of the comforts and facilities that are being provided for our patrons," Mr. Harkavy states.

Basile's Band has been engaged to furnish music at the park for the season of 1925.

Capitol Beach

Undergoing Extensive Improvement—New Aeroplane Swing and Ferris Wheel Installed

Lincoln, Neb., Feb. 20.—Capitol Beach, the leading outdoor pleasure resort of Nebraska, is making extensive improvements preparatory to opening the 1925 season.

To provide a continuous supply of fresh water in Capitol Beach Lake, a cement and steel dam has been installed in Oak Creek just north of the beach. This dam is one of the first of its kind ever installed in the United States. It is a Swiss needle dam type of construction and is arranged so that in flooded conditions 50 feet of the center of the dam can immediately be let down and all water can go over without any going into the intake in the lake.

A large cement spillway has been built at the east end of the lake to take water from the lake and in this way the installation of these improvements guarantees pure, sweet water at all times and keeps it at the level required. This will make it possible for the use of sail boats and small passenger boats, and also for stocking the lake with fish.

Among the other improvements, the Uzzell Corporation has installed one of the latest aeroplane swings, and one of the giant ferris wheels manufactured by the C. W. Parker Amusement Company will be ready for operation at the opening of the season.

A system of cement walks is being built and extensive improvements being made at the saltwater bathing pool; hundreds of shrubs and trees are being planted to beautify the grounds and additional parking space for automobiles is being provided.

The management proposes to continue the plan of giving free vaudeville shows afternoons and evenings, and band concerts are being arranged at various dates throughout the summer with some of the large bands of the country.

Picnics are fine for a park—but a park must possess something more than a picnic ground to be successful.

PICNIC TIME IS JUST 'ROUND THE CORNER

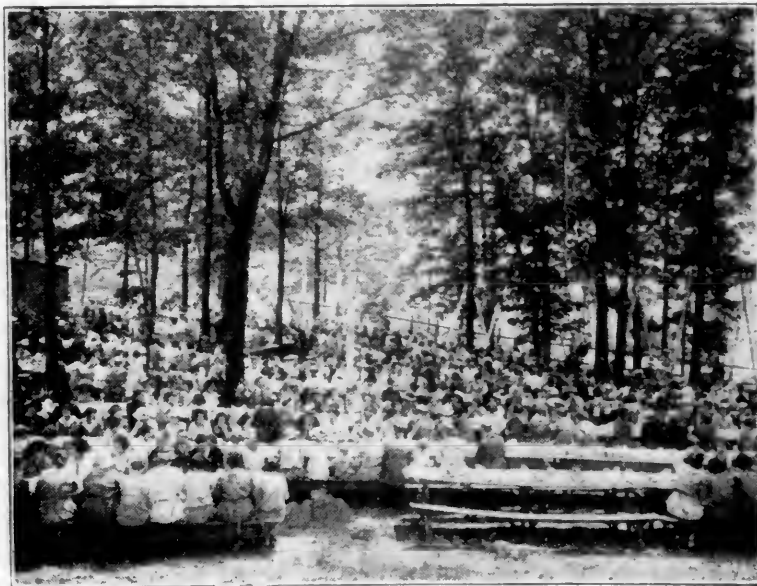

Picnic time is on the way—the time that gladdens the hearts of park men. Occasionally you'll find a park man who claims that picnickers do not spend money at the park. But you'll notice that pretty nearly every park makes a bid for picnics, indicating, we should say, that picnics pay. The accompanying picture shows a picnic at a popular Waterbury (Conn.) park that was attended by more than 750 persons.

\$100,000 Pavilion for Watkins Glen

Watkins, N. Y., Feb. 19.—Work on a new \$100,000 pavilion at Watkins Glen will be begun late this spring, according to an announcement made at the meeting of the State Finger Lakes Park Commission at Ithaca Tuesday. The money was appropriated by the 1923 legislature and plans for the pavilion have been completed. Bids will be advertised within a few days and it is expected that all bids will be received by April 6, with work starting shortly thereafter.

The pavilion is to be located in the mountain park section of the glen. Work on it will be rushed as speedily as possible because of the way the park has been overtaxed the past few years.

Traver Building Coaster At Revere Beach, Mass.

Boston, Feb. 20.—The Traver Engineering Company is building at Revere Beach, on the site of one of the first L. A. Thompson scenic railways, what is said to be the longest roller coaster in this part of the country. The new ride will be known as the Cyclone and will be about 90 feet at the highest point. The site on which it is being erected occupies a stretch of land with about 500 feet beach frontage. The coaster will have "aeroplane dips" at the curves. Not only will it be the longest ride at the beach, but also the fastest, the outstanding feature of it being its absolute safety.

Nothing has been found that will beat the rides for profit.

catered to, as in the past, and additional playground apparatus will be constructed and competent people placed in charge.

New Pavilion at Paw Paw Lake

Hartford, Mich., Feb. 20.—The popularity of Paw Paw Lake as a summer resort and amusement place will be increased this year thru the erection of a new dance pavilion by Richard Mack.

Invents Safety Device

Chas. H. Watkins has invented an automatic car stop for use on roller coasters and other pleasure railway devices.

Park Paragraphs

It's old stuff—but 'tis well to remember that politeness pays very tangible dividends.

Ed J. Fenton will manage Island Park, Brattleboro, Vt., this year. He also is manager of the Auditorium Theater, Brattleboro.

An appropriation of \$578,679 for the Ocean Beach Highway from Kelso, Wash., to the sea has been agreed upon by the Washington State Legislature.

Like the tariff, the free gate or pay gate is a local proposition, governed by local conditions. What's one man's profit is another man's loss.

The work of transforming Coney Island, Cincinnati, O., is progressing, and the

(Continued on page 82)

The Optimist

A magazine for Ride Men. Every Ride Man ought to read the magazine published for the benefit of Riding Device men. Also contains information valuable to

PARK MEN

A cent well spent will bring you a sample copy.

Eli Bridge Co.,

Opp. Wabash Sta., Jacksonville, Ill.



KIDDIE FERRIS WHEELS

KIDDIE RIDES

Six different devices. Order from the originators. **PINTO BROS.,** 2944 W. 8th St., Coney Island, N. Y.

85% OF THE SALE IS PROFIT

Selling Orange Drinks made from the fresh fruit with **FAZIO'S ORIGINAL ORANGE MILLS.** Now being displayed in nearly all Beaches. Write for details.

JAMES FAZIO & SON, Mfrs., 195 Canal Street, New York, N. Y.

WANTED

Used Balloon Racer

Must be Caster Pettard make, 1923 or 1921 model. State lowest cash price first letter. **B. LANG,** Carana Hotel, Montreal, Quebec.

DODGEM JUNIOR

(PATENTED)

THE CENTER OF ATTRACTIONS

Most popular amusement buy of the year. **DOUBLE CAPACITY.** Each car seats two people side by side comfortably. Fulfills the common desire to drive an automobile with added thrills and enjoyment. Order now for early delivery.

DODGEM CORPORATION

706 Bay State Building, Lawrence, Mass.

SPILLMAN ENGINEERING CORPORATION

Manufacturers of the

LATEST RIDE (OVER THE JUMPS)

Grossed \$10,760.75 at six fair dates. Portable 2 and 3-Abreast Carouselles, 44 ft., 50 ft. and 60-ft. Special Park Carouselles. Write for Catalog. **North Tonawanda, N. Y.**

SKEE BALL

The International Game of Skill that Charms the Crowds of Enthusiasts, and what is more important—**HOLDS THEM.** Easy To Operate—A Speedy Money Maker. Write for Catalog.

SKEE BALL CO., Coney Island, New York

MILLER & BAKER, Inc.

AMUSEMENT PARK ENGINEERS

MILLER PATENT COASTERS AND DEVICES

Special Designs and Structures.

Suite 3041, Grand Central Terminal, **NEW YORK, N. Y.** Agents for Dayton Fun House and Riding Device Mfg. Co. Devices.

Cash In With Whirl-O-Ball



C. N. Andrews took in \$935.65 last month

New Automatic "Loop-the-Loop" Game

for all amusement places, soft drink parlors, shooting galleries, etc. Runs itself—automatic nickel collector and scoring device. Thrilling sport! Everybody plays—men, women and children! Your receipts clear profit. Each Whirl-O-Ball Game is 3 1/2 x 20 ft., and has an earning capacity of \$5 an hour. You can put 2 to 12 Games in any ordinary room or tent. Take in \$15 to \$50 per day. Moderate investment required. Write now for catalog. **BRIANT SPECIALTY CO.,** 704 Consolidated Bldg., Indianapolis, Ind.

GAMES

I have moved to larger quarters. Plenty new games. New address. **WM. ROTT,** 40 E. 9th St., New York

Dentzel 50 Ft. 3 Abreast

Jumping Horses and Animals, practically new, wonderful decorations, complete with motor, organ and lights. A real park machine. Address **F. G. L.,** Olympic Park, Irvington, New Jersey.

FOR SALE

Whip, in first-class running condition, including lease, at reasonable terms, at Lake Compounce, Bristol, Conn. Address **E. BROWN,** Florida Arcade, St. Petersburg, Florida.

FOR SALE

One brand new 10-Seat Ferris Wheel, \$1,000 in cash, or \$1,800 on time. Not an Ell. One Tent, size 10x25 ft., 7-ft. wall, 19-oz. khaki, without frame, \$10.00. One Knife Rack, complete with frame, without tent, \$35.00. Two Paddle Wheels, complete, \$5.00 each. Real bargain. Ferris Wheel Seats, in rough, \$10.00 each. **MAUL & MOORE,** 26 Turrill Ave., Lapeer, Michigan.

WORLD'S GREATEST RIDES

BOBS COASTER. Most thrilling Coaster ever built anywhere. Now building for 1925 in Detroit, Boston, Los Angeles and elsewhere. doubles receipts of ordinary Coasters.

CATERPILLAR. We built 75 during 1923 and 1924. Earned its cost in three weeks. Kenwood Park. Two at Coney Island got over \$10,000 each in one season. Greatest small ride ever produced.

SEAPLANE. The standard ride in nearly every park. Cheap to buy. Low operating cost. Lasts a lifetime. 214 now operating in parks and 131 in portable use all over the world.

Prompt deliveries. Some bargains in used machines.

JAZZ R. R. The latest novelty. Funniest ride ever built. The climax of 23 years ride building. See it in operation at factory.

TUMBLE BUG. Not portable, but can be moved. Circular ride, with big coaster thrills. Made a splendid record in eight parks in 1924. Many orders being booked for 1925.

MERRY MIX-UP. Best portable ride ever produced. Built of steel. Easily shifted. Loads on one wagon. 30 built in 1924. Order now for 1925.

TRAVER ENGINEERING CO., Beaver Falls, Penna., U. S. A.



Over Fifty Years of Exclusive Carrousell Building

(Established 1867)

DENTZEL CARROUSELS

Mechanically and Artistically Perfect.

WM. H. DENTZEL,

3641 Germantown Ave., Philadelphia, Pa.

THE GLIDER

THE RIDE THAT THRILLS

Made with 24, 32, 36 or 48 seats. Send for catalog. **MISSOURI AMUSEMENT AND CONSTRUCTION COMPANY,** Builders of Portable and Stationary Riding Devices, 1202 South Sixth Street, St. Joseph, Missouri.

WE ONLY SELL GAMES AND DEVICES THAT HAVE PROVED THEY WILL MAKE MONEY FOR YOU.

BALLOON RACER (Game of Skill, Portable, 152 in operation)	\$1,650.00
CONY (RABBIT) RACE (Game of Skill), 64 in operation	2,000.00
FOOT-BALL GAME (Penny Arcade Slot Machine), 42 in operation	375.00
WALKING CHARLIE (Ball Game), 121 in operation	500.00
PARK YOUR OWN CAR (Game), 8 in operation	450.00
THE BOMBER (New Game of Skill Last Season), 5 in operation	750.00
GALLOP AWAY (Portable Ride), 38 Units in operation, Per Unit	150.00
MECHANICAL ADVERTISING BOOK, 291 in operation	210.00

Write for Catalogue. **CHESTER POLLARD AMUSEMENT CO., Inc.,** 1416 Broadway, New York City

CONCESSIONS and RIDES WANTED

NEW JERSEY'S IDEAL PARK. ONE MILLION PEOPLE TO DRAW FROM.

Now Booking Acts for Season 1925

DREAMLAND PARK CO.

FRELINGHUYSEN AVENUE, NEWARK, NEW JERSEY

THE CONY RACE

Quick, reliable game. Steadily increasing its admirers each season. The more you play the better you like it.



PATENTED

Send for Catalogue.

Inventor and Manufacturer.

M. HIGUCHI

52 Second Ave., College Point, New York.

Telephone: Flushing 3698.

MANGELS' CHAIR-O-PLANE

Has many superior points over all others. A fine clean-cut machine built of steel in a thorough manner for safe and sane operation. Easy to transport, set up and operate. Brilliantly illuminated and highly decorated. Suitable for Parks and Carnivals. Gasoline engine or electric motor optional.

W. F. MANGELS CO., Coney Island, N. Y.

Wanted Man With Park Experience

Amusement Park in the West wants a man experienced in advertising, working up excursions, engaging free acts and other attractions. We have a good opening for a live wire who can show us that he has and can still create new ideas in the way of attracting business to a park. Address at once, stating all in your first letter. **GEORGE F. FORSYTHE,** Gregson, Montana.

CONCESSIONS TO LET ON PUT IN BAY ISLAND

LARGEST SUMMER RESORT ON LAKE ERIE, FOR SEASON 1925.

Daily steamers from Detroit, Toledo, Cleveland and Sandusky. Buildings for Concessions, Amusements and legitimate Games (Wheels not allowed) on the main thoroughfare. Prospects for coming season are good. You can do business here seven days a week. When writing for Concessions, state size of building wanted. Price for same is \$10 per Foot Frontage, with Building; \$8.00 per Foot for Vacant Lot Frontage. The above prices are for entire season. Season opens about June 15 and closes after Labor Day.

D. ROSENFELD, Put in Bay Island, Ohio.

WAFELDOG

GET IN LINE FOR 1925 PROFITS

WAFELDOG CORPORATION, Washington, D. C.

SHOWMEN—CONCESSIONERS!

READ THIS AND GET BUSY

Midway Amusement Park, Florida's \$2,000,000 Playground, now under construction, anticipates opening its gates October 1, this year.

A PERMANENT PROPOSITION, OPERATING 12 MONTHS, 365 DAYS IN THE YEAR---You know what that means to you.

... EXCLUSIVES GIVEN ...

1,000,000 people to draw from in the winter---500,000 in the summer.

Everybody has money to spend or they would not be here.

If this sounds good*to you, act quick---write or wire what you have or want.

A. J. BODKIN, Park Manager
MIDWAY AMUSEMENT PARK, INC.
St. Petersburg, Florida

SAVIN ROCK PARK NEW HAVEN, CONN.

Greatest Amusement Park in Southern New England
CONCESSION MEN—Fine opportunity for you on our new Midway. Would like to hear from versatile Entertainer who can do Punch, Magic, etc.
Frederick E. Levere, Pres.

SAVIN ROCK PARK CO., INC.
New Haven, Conn.

OLCOTT BEACH AMUSEMENT PARK. OLCOTT, NEW YORK

World's largest Dancing Casino on Lakeside, Olcott Beach Hotel, 100 rooms. Picnic Grounds, Baseball Park, Bathing Beach. Free Gate.

On Lake Ontario, vicinity of Buffalo, Lockport, Niagara Falls, The Tonawandas and suburbs.

Can use few more up-to-date Riding Devices and legitimate Concessions.

A. L. GILLIG, Gen. Mgr., 189 Commonwealth Ave., Buffalo, N. Y.

Merry-Go-Round Concession WANTED

Have Mangels Three-Abreast, all jumpers. Entirely renovated, ready for season 1925. Address MERRY-GO-ROUND, care The Billboard, 1493 Broadway, New York City.

WANTED

On percentage for 1925 season. Ferris Wheel Merry-Go-Round, Skee-Ball Alleys, Penny Arcade, Shooting Gallery, Restaurant and Juice.

NELA BEACH AMUSEMENT CO., Altoona, Pa.

Park Paragraphs

(Continued from page 80)

popular up-river resort will present a fresh and inviting appearance when it opens in the spring.

Watch the kiddie rides this year. They're sure coming into their own. Many parks have installed special kiddie playgrounds, equipped with miniature rides as well as slides, swings, sand piles, etc., and they have "caught on" wonderfully.

Mike G. Helm, owner of Electric Park, Kansas City, Mo., is still enjoying himself in Florida, but plans for the 1925 park season are not being neglected. There is activity in K. C., and before long the resort out in the south end will become a scene of activity.

The Zoo, Cincinnati, O., remains one of the most consistently high-class amusement resorts of the country, combining in just the right proportions education and amusement. Its officials are well-seasoned business men who know the game theory, and their success is well deserved.

The Arlington Beach Amusement Park, Washington, D. C., has changed hands. L. D. Schaffer has leased the park for 10 years and expects to make many improvements. The staff, it is announced, will be as follows: L. D. Schaffer, owner; Jesse Thomas, general manager; C. Neeson, assistant manager; W. J. Brett, superintendent of grounds and buildings.

Every detail of a modern amusement park will be provided at the rejuvenated Neptune Beach, La Salle, N. Y., mention of which was made in last week's issue. There will be sandy playgrounds for children, band stands, decorative landscape work, modern commodious bath houses and many other features. Hundreds of tons of new white sand will be provided for the bathing beach. An elaborate and artistic dance hall will be erected at a cost of \$35,000, and Philadelphia interests are negotiating for the installation of a roller coaster.

Angelo A. Scalzo is president and treasurer of the LaSalle Amusement Corporation, which owns the park. Thomas A. Russell is vice-president. Joseph Peanessa, a nephew of Mr. Scalzo, will manage the park.

Fair Notes and Comment

(Continued from page 79)

for 1925 was approved by the board at its annual meeting.

The Southern Ohio Horsemen's Promotion Association has taken a lease on all stables and the track at the Carthage, O., fairgrounds, and announces that it is the intention to resoil the track and build additional stable room.

This year's Southwest American Livestock Show at Oklahoma City, March 1 to 7, is expected to eclipse those of all previous years. California Frank and his Wild West show are to give performances each afternoon and night of the show.

After a meeting of officials of the West Texas Fair, Abilene, last week, it was announced that \$25,000 worth of additional stock will be sold, the proceeds to be used for improvements in Fair Park.

Many Texas fair associations are evincing a tendency to expand—not sporadically but steadily and sanely.

WANTED—Merry-Go-Round

And other Kiddie Rides, for Kensington Park, on percentage basis. No competition. Seven days a week. Beautiful park. Large Swimming Pool and Dance Pavilion. All-year proposition. Will rent Concessions separately or the entire Park to one party. Address KENSINGTON PARK, Box 504, Georgetown, S. C.

FOR SALE

FERRIS WHEEL, 16 cars; WHIP, 11 cars, complete with motors. Good condition. Price reasonable for quick sale. Address W. E. MCGINNIS, 55 Wilson Rd., Nahant, Massachusetts.

CANDY FLOSS MACHINES

Ten different models of new Machines. All kinds of used Machines. Hand Power. All Electric and Combination Machines. Good used Machines at less than half what new ones cost. Mrs. of Automatic Fishponds, Merchandise Wheels, Cork Guns, Etc.

AUTOMATIC FISH POND CO.
Western Ave. & Langdon St., TOLEDO, OHIO

JOYLAND PARK
PORT JERVIS, N. Y.
Opens May 16, closes after Labor Day. A few legitimate Concessions of all kinds. Penny Arcade, Kentucky Derby, Corn Game, Ice Cream Concession open. WANTED—Whip and other Rides. This park operates 7 days a week and has a free gate.

BELVEDERE BEACH AMUSEMENT PARK
THE BRIGHT SPOT
Want one more Ride on percentage. What have you? Have opening for Corn Game, two good Grind Stores, Fun House, Photo Gallery or any good Merchandise Games. Address P. LICARI, INC., Owners, Keansburg, N. J.; R. O. Williams, Mgr.

FOR RENT

ON THE

BOARDWALK AT KEANSBURG, N. J.

Fastest growing Beach on the Jersey Coast. Four Steamers plying between New York City and Keansburg daily. Numerous Excursions.

- | | |
|---|--------------------------------------|
| DANCE HALL | LIFE-SAVING DE-VICE PRIVILEGE |
| ROLLER SKATING | POPCICLE STAND |
| AUTOMATIC ROWLING ALLEY | HOME-MADE CANDY |
| Spaces for All Kinds of Rides, such as: | POP CORN |
| DOOGEM | ORANGEADE |
| FUN HOUSE | MILK SHAKES |
| MINIATURE RAILWAY | CIDER |
| SWINGS | ICE CREAM AND SODAS |
| CUSTER CARS | FRANKFURTER STAND |
| FERRIS WHEEL | WAFEL-DOG |
| SKOOTER | LUNCH ROOM |
| TOROGGAN SLIDE | RESTAURANT |
| LOTTO OR CORN GAME | DRUG STORE |
| RALLON RACER | DRY GOODS STORE |
| CAT GAME | SHINE PRIVILEGE |
| UMBRELLA AND CHAIR PRIVILEGE | BARBER SHOP |
| | BEAUTY PARLOR |
| | PENNY ARCADE |

Apply J. L. SCULTHROP, Mgr.,
New Point Comfort Beach Co.,
Keansburg, N. J.

"Think of skidding in an automobile, then sliding down a hill backwards, then you will realize the thrill of

"THE REVERSER"

(Patented)

Incorporate it in that new Coaster, or install it in the old Ride.

Engineering and Building by

THE L. A. THOMPSON SCENIC RY. CO.
T. D. HOOPER, JR., Merchantsville, E. N. J.
Send for Circular describing new Patent.

PARK TO LEASE

An excellently located 16-acre Park, one mile from city. On trolley line, and space for parking 500 autos. Concerts every Sunday draw from 5,000 to 7,000 people. Will lease as a whole including Soft Drinks and Dance Floor, which have already been leased for this year. Will include them in lease for next year. Address FRID O. STRINE, Chairman Park Committee, Eagles' Home, York, Pa.

FOR SALE—LARGE CIRCLE SWING

Complete, Good condition. Bargain. Immediate delivery. Apply A. PATRONO, 915 Royal St., New Orleans, Louisiana.

FOR SALE, MECHANICAL CITY

Portable, first-class condition. LARGEST AND FLASHIEST IN THE WORLD. Bargain for showmen. Further information, J. JOHNSON, 2799 W. 34th St., Coney Island, New York.

FREE BOOKLET FOR INVENTORS

IF YOUR INVENTION is new and useful it is patentable. Send me your sketch. Z. H. POLACHEK, 70 Wall St., New York. Reg. Patent Att., Engineer.

LOCATION WANTED

For up-to-date Penny Arcade, L. NELSON, 92 Prince Street, New York City.

GAMES OF SKILL

Ball Game, Grind Store, Stock Store. DIAMOND MFG. CO., Malta, Ohio.

Hancock County Fair
On its Own Grounds
(Continued from page 78)

ment to put on bigger and better fairs than ever before. Already 10 big free acts have been contracted for this year, and a wonderful fireworks display for each night of the fair is also arranged for. In the speed ring, in the farm and home exhibits and in the live stock and all other departments of the fair there will be many more and much finer exhibits than ever before.

Ellis E. Cox, who has been secretary for the last eight years, has been re-elected.

FAIRS AND FUN
IN ENGLAND

By "TURNSTILE"

The Judgment of Paris

London, Feb. 6.—As I mentioned last week the plans for British representation at the forthcoming Paris Exhibition are crystallizing. A. M. Samuel, the capable minister in charge of overseas trade, is actively arranging a worthy display of national and international interest. The artistic side of British exhibits is being more developed than usual in foreign centers, and among the famous artists who are participating in this aspect of our appearance in Paris are Dr. R. Amberg Bell, Maurice Greiffenhagen and Henry Wilson. We are fortunate in having secured a central site, the greatest of exhibition assets, and that fact, combined with the attraction of two totally original-looking restaurants, should be largely responsible for giving the cosmopolitan crowds which will flock to the Gay City next spring a pleasant impression of France's ally.

In another way also Great Britain is making a showing in the French capital next spring. I have already referred to the big engineering contract given to a Swanson firm for the steel-work structure of the giant switch-work to be erected at the exhibition. Now again English engineering is finding favor in the Paris Exhibition thru the medium of Sir Owen Williams, who was responsible for the Amusements Park at Wembley. His scheme, which is likely to be a feature, provides for an amusement building for all weathers which is to cover two acres and which will rise in four decks. In this erection a sort of intensive entertaining will go on, for besides accommodating all sorts of games and shows, old and new, it will even enclose this great scenic railway. This last inspired effort will run from the top deck to the bottom and up to and beyond the roof, where one, at least, of the cities of the world will be seen in literally a moment of time.

Wembley Side Shows and Games

Following on the many complaints about the Amusements Park at Wembley last summer, and the comparative fiasco of the whole outfit there, a more detailed and interesting revelation of affairs was made during the first statutory meeting of the creditors and shareholders of Side Shows and Games (Wembley), Ltd.—a meeting which took place at the end of last week. It will be remembered that a compulsory winding-up order was made against this company at the end of July, and the unpleasant necessity for this action is clear now that the figures are publicly disclosed.

The necessary land with a frontage of 500 feet for the erection and operation of side shows and games was arranged by contracts between the new company, Wembley Amusements, Ltd., and Amusements Construction Company, Ltd. The nominal capital of side shows and games was \$50,000, and the issued capital subscribed in cash \$49,000, and the business of erecting the shows went forward more or less merrily. But the bad luck that dogged the fortunes of the Amusements Park soon began to show its teeth, and, quite early in the season, a receiver was appointed over all the side shows and games. The amusements moreover failed to catch on as they do in the less competitive atmosphere of the smaller exhibition, the weather was so consistently bad as to drive potential patrons under cover, and the original estimate of a probable attendance of 20,000,000 people had not at the end of the season been reached by a long chalk. Last and most important reason for its failure, the company put forward the fact of the excessive rental of the site. The balance of \$75,000 in the appointed receiver's hands at the end of the season was totally insufficient. It was stated, to meet the amusements' committee's claim, and the shareholders' prospects are nil.

All of which again points the moral. And that is that the show game can only be properly played by showmen. The people who were responsible for last year's conduct of Wembley, for the fixing of stiff rentals, for the fatal folly of allowing a catering monopoly, for the absurdly optimistic calculations of probable returns on which their initial arrangements were based, and so on thru the innumerable blunders which gave such substantial ground for complaint and ill-feeling, lacked the great essential—proper showmanship. I have pointed this out so often before that I feel I ought to apologize for mentioning it again.

Out and About

A. V. George has secured a five-year

FOR RINKS—A NEW TONE

(10-TUNE ROLLS, ONLY \$3.50)



The
Calliophone
PROMOUCED BY KA-LI-A-PHONE

Muscatine TANGLEY COMPANY Iowa

Here They Are! Souvenir Pins!!

Gold finish, to retail at 20c. A CLEVER ad for your rink with a liberal profit to you. Everybody wants one. Order yours NOW!

Rubber Tire Wheels on "CHICAGO" Skates

for TILE or CEMENT

Noiseless! A New Sensation!

Write for particulars

CHICAGO ROLLER SKATE CO.
4453 W. Lake St., Chicago, Ill.



lease of the great revolving tower at Yarmouth together with the exhibition premises beneath for the sum of \$2,125 per annum. This observation tower is a great north beach attraction.

The recognition of the value of Hull Fair by the municipality is shown by the motion to vote \$4,000 to improve the roads on the fairground. It was decided to leave the matter in abeyance for the present year only owing to other heavy expenditure, but every effort is being made locally to improve the fairground and to encourage show initiative in the district.

Skogness council has recently decided to allow no mechanical organs or music of that description on the foreshore this year nor will fortune telling or gambling games be permitted. The committee has drawn up a list of approved attractions and even automatic machines have to pass the surveyor. To avoid having to resell pitches it has been decided that lessees will have to deposit full rentals immediately the auctions are over. In short Skogness is putting its entertainment house in strict business order.

Morecombe council has decided to spend \$10,000 on military band during the coming season. The Entertainment Proprietors and Managers' Association has protested strongly against what it calls a useless expenditure, but this criticism seems to "Turnstile" as unjustified as it is futile. The fact is that anything that makes the English seaside resort attractive must be good for the show game as a whole. There was a time, true, when the military band could scarcely be called an enlivening influence, but recent developments, particularly the fine work accomplished at Knibber Hall under the direction of Colonel Summer-ville, has resulted in a very different state of affairs. Not only has the work of executants and conductors been enormously improved, but the quality of music both as regards the actual work-played and more suitable methods of scoring has put the English military band on an entirely different footing during the last few years.

A glance at the Hotel Directory in this issue may save considerable time and inconvenience.

EXHIBITIONAL AVIATION
BALLOON ASCENSIONS AND PARACHUTE DROPS

(Communications to 25-27 Opera Place, Cincinnati, O.)

Lillian Boyer, aerial acrobatic performer, will again be seen at fairs and celebrations this year, working as usual with her partner, Billy Block, aviator. They are booking independently. Miss Boyer was seen last week around the Auditorium Hotel, Chicago, during the fair men's meeting.

The start of the race for the second Gordon Bennett cup for balloons will take place from Brussels June 7. Entries will close April 1. A solid-silver cup valued at 12,500 francs, donated by the Aero Club of Belgium, will replace the original trophy given by the late James Gordon Bennett, which became the property of the Belgian Ernest De Myster, thru his successive victories in 1922, 1923 and 1924. A cash prize of 12,500 francs also will be allotted to the winner of the race.

The complete list of officials governing the conduct of the national elimination balloon race to start at St. Joseph, Mo., May 1 follows: Carl H. Wolfley, chairman; Harry Block, vice-chairman, both of St. Joseph; Major A. B. Lambert, St. Louis, referee; Major Howard F. Wehrle, Kansas City, starter; Ernest Lawhon, St. Joseph, alternate starter; Oris D. Porter, Indianapolis, chief timer; Scott Willard, St. Joseph, alternate timer; Charles H. Hellum, St. Joseph, chairman of judges; R. D. Lewis, St. Joseph, chairman of scores.

R. William Langley, press agent for the Page Aerial Pageant, had a story recently in *The Times Herald* at Dallas, Tex., where he is employed during the winter, describing the new "baby" plane used by the Page outfit. It has a wing spread of only 20 feet, being small enough to land in the street, but will attain a speed of 90 miles an hour, according to the article. A photograph of the plane shows Earl Barnes as the pilot. Barnes

is well known in commercial flying circles. It is announced that quantity production of the baby planes will be reached and that they will be put on the market at a price around \$1,000.

J. M. Stewart, general manager of the Stewart Aerial Attraction Company, South Bend, Ind., refuses to be convinced of the accuracy of the claim of "Dare-Devil" Jack Hoyt in a letter to *The Billboard* of January 10, that Hoyt all last season made four or five parachute jumps, using only a 60-foot bag, and at the Brockton (Mass.) Fair did six and seven chute jumps, two ascensions a day, from a 60-foot bag. Mr. Stewart writes: "Some time ago I read an item in *The Billboard* by a man named Hoyt, and he made quite a spread about questioning the kind of material 'those Western balloon men make their balloons of,' and that if double and triple drops off a 40-by-60-foot balloon was such a wonderful feat then he must be a marvel, etc. When Wm. O. (Wild Bill) Armstrong, who has been with this outfit for the past four years—is now 46 years of age and going strong—was reading that account he jumped straight up, saying that if the Easterners could strap a bag around that kind of stuff they could easily break doubles and triples off tissue-paper balloons and make singles off little toy balloons. I agree positively with Armstrong, and may I say that if that stuff of Hoyt's is not inflammable to get in touch immediately with the U. S. Army Air Service officials, as they will arrange big business for anything like that in the lighter-than-air division since helium gas costs lots of money to produce. I still maintain that no matter who does it a double or triple drop made off a 60-by-40 balloon is a feat that no one need feel ashamed of. I am open for argument from all comers and shall gladly defend this feat of the late Monte La May, making a triple off a 60-foot bag."

RINKS & SKATERS

(Communications to 25-27 Opera Place, Cincinnati, O.)

Word comes that the skating team of Koehler and Roberts is meeting with success on the Pacific Coast. The act was the headliner at the Yorst Theater in Santa Ana, Calif., recently. They are playing north to Spokane and east to Lubith, with solid bookings between. They plan to enlarge the act next season.

A Los Angeles rink will introduce ice skating in that city. The building is being rushed to completion and has an ice surface of 130 by 240 feet.

The newly opened Norwood (O.) Ice Rink is rapidly enlarging its patronage. Practically all of the noon-day luncheon clubs of Cincinnati had a skating party at the rink February 9. It was the first of a series of large Monday night parties arranged by Manager F. A. Minard.

The Skating Club of Elmira, N. Y., has given pleasure to many skaters during the past week at the former Billy Sunday tabernacle site by flooding the land. The space has been enlarged and overhead lights arranged. Leo Campbell is president of the club.

Frank and Lillian Vernon are entertaining with a skating novelty with their Hippodrome Circus, at present making a tour of Tennessee. They are their own managers and have a strong bill, including the Bernard Brothers and the Aerial Cowdens.

In connection with the proposed formation of a company to construct and operate an artificial ice arena at Niagara Falls, N. Y., a meeting was held in that city recently at the Imperial Hotel. Roy D. Schooley, of Pittsburgh, Pa., president of the U. S. Amateur Hockey Association, presented interesting data as to the financial success of similar ventures in other cities.

February 17 marked the beginning of the Cleveland (O.) amateur champion roller skating races at Luna Park Roller Rink. *The Cleveland Press* is conducting these races and will award loving cups to the winners, lady and gentleman. Amateur races will be held on Tuesday nights and winners will be eligible to race in the finals March 10.

The first race was won by Steve Novotny, who did one mile in 3:16; the second by Mrs. Eleanor Krahn, 3:26, and the final race was won by Jimmie Ross, whose time for a mile was 2:57 3-5.

Manager Peter J. Shea, of Washington Gardens, Washington, Pa., is putting a lot of pep in roller skating in that section. He recently organized a city roller hockey league, consisting of high school, legion, college and several business house teams, in addition to a State hockey league, including nearby towns, to play games on an average of two a week for the balance of the season. Roller hockey is new to Washingtonians, but from the amount of enthusiasm they are displaying the game will be well supported. The Gardens is an ideal place to stage contests, as it is big and has a gallery that will accommodate 1,000 people.

RICHARDSON SKATES

SUCCESS in the rink business doesn't just happen—it shows real sound judgment on the part of the rink owner or manager. Buy Richardson Skates and be assured of the best equipment—KNOW that your judgment of the best skates is correct.

THE FIRST BEST SKATE—THE BEST SKATE TODAY.

WRITE FOR CATALOG TODAY.

Richardson Ball Bearing Skate Co.
3312-18 Ravenswood Ave., CHICAGO



DO YOU KNOW?

We have sold eleven of our Rinks to one manager. There is a reason. Get you one. Write for Catalog. TRAMMILL PORTABLE RINK CO., 18th and College, Kansas City, Missouri.

PROFESSOR A. MORRIS

ENGLAND'S PREMIER ROLLER SKATER. Triple Gold Medalist. And Partner, MISS WYATT. Open to consider good offers from America for Skating Instructors' positions. Communicate Hotland Park Rink London, England.

LOWE'S PORTABLE RINK FLOORS

Our product is built up to a standard, not down to a price. Address all communications to Department L. BAKER-LOCKWOOD MFG. CO., INC., 7th and Wyandotte Sts., Kansas City, Missouri.

LIST OF CONVENTIONS CONCLAVES AND ASSEMBLIES

Compiled by Means of The Billboard's Unequaled Facilities and of Special Interest to Novelty Manufacturers and Dealers, Streetmen, Fair Followers, Etc.

ALABAMA

Alabama City—Order of Red Men. May 26. Wm. Smith, Montgomery, Ala. Birmingham—Medical Assn. of Ala. Apr. 21-24. Dr. D. L. Dannon, 519 Dexter ave., Montgomery. Birmingham—State Elks' Assn. May —. E. D. Warneck, Ensley, Ala. Birmingham—S. E. Retail Hardware & Impl. Assn. May 12-14. W. Harlen, 701 Grand Theater Bldg., Atlanta, Ga. Mobile—State Bankers' Assn. May —. H. T. Bartlett, Amer. Tr. & Sav. Bk., Birmingham. Mobile—State Fed. of Labor. May 18. I. Bowen, 910 Farley Bldg., Birmingham. Mobile—United Com'l Travelers. May 29-30. W. H. Roach, Box 545, Anniston, Ala. Mobile—Rotary Clubs, Dist. No. 26. March 16-18. L. D. Dix, 302 Van Antwerp Bldg. Mobile—State Education Assn. Apr. 2-4. H. G. Dowling, 415 First Nat'l Bank, Montgomery. Mobile—State Dental Assn. Apr. —. W. A. Wood. Troy—Knights Templar. Apr. 22. George A. Beachamp, Montgomery, Ala. Tusculum—State Fed. Rural Letter Carriers. May 30. Foster D. Duncan, Honoraville, Ala.

ARIZONA

Bisbee—State Medical Assn. Apr. 16-18. Dr. D. F. Harbridge, Goodrich Bldg., Phoenix. Globe—State Firemen's Assn. May 10-12. W. Nemeck, Douglas, Ariz. Phoenix—Knights of Pythias. Apr. 13. J. D. Loper, Box 1381. Phoenix—Rotary Clubs. March 11-13. Max Allen, care Western Union. Prescott—Order of Odd Fellows. Apr. —. A. H. Hargrave, 365 N. Third ave., Phoenix.

ARKANSAS

El Dorado—Knights Templar. May 12. F. Hempstead, 209 Exch. Bk. Bldg., Little Rock. Ft. Smith—Rotary Clubs, Dist. No. 15. Apr. 16-17. R. Talbot, 408 S. Main st., Tulsa, Ok. Hot Springs—Electric Light Assn. Apr. 21-24. S. J. Ballinger, Public Service Assn., San Antonio, Tex. Hot Springs—Royal Neighbors. May —. Mrs. Alice Gilliland, Rock Island, Ill. Little Rock—State Assn. Lumber Dirs. Apr. —. L. P. Biggs, 816 Southern Tr. Bldg. Little Rock—State Medical Soc. May —. Dr. W. R. Barthurst, Boyle Bldg. Little Rock—State Eclectic Med. Assn. May 12-13. Dr. S. G. Royce, 718 1/2 Main st. Little Rock—Knights of Pythias. May 19. C. H. Russell, 220 1/2 Center st. Pine Bluff—State Elks' Assn. May 16. A. Parke, Box 699, Little Rock.

CALIFORNIA

Fresno—Knights of Columbus. May —. C. F. Lenz, Security Bldg., Los Angeles. Glendale—Junior Order. March 17-18. M. G. McClinton, 1201 Caballo ave., Burlingame, Calif. Long Beach—State Clothiers' Assn. March 10-12. L. D. Middough, Long Beach, Calif. Los Angeles—Air Brake Assn. May 26-29. F. M. Nellis, 105 Broadway, New York City. Palo Alto—Companions of Forest of Amer. May 20. Agnes D. Bremer, 509 Grant Bldg., San Francisco. Palo Alto—Foresters of Amer. May 22. J. B. Rebold, 104 Gallaghan Bldg., San Francisco. Riverside—Southern Calif. Medical Soc. Apr. 3-4. Dr. C. T. Sturgeon, 1136 W. Sixth st., Los Angeles. San Francisco—State Retail Hdw. Assn. March 11-13. LeRoy Smith, 112 Market st. San Francisco—State Bottlers' Protec. Assn. March 12-13. C. D. Lightbody, 57 Post st. San Francisco—Order of DeMolay. March 16-18. E. S. Sorfret, Fed. Res. Bk. Bldg., Kansas City, Mo. San Francisco—P. E. O. Sisterhood of Calif. Apr. —. Miss J. P. McEwen, 2733 Pierce st. San Francisco—The Macabees. Apr. 14. S. W. Hall, 801 First Nat'l Bk. Bldg., Oakland, Calif. San Francisco—R. & S. M. R. A. M. & Knights Templar. Apr. 20-21. T. A. Davis, Masonic Temple. San Francisco—Pacific Coast Bowling Congress. Apr. 26-May 9. V. B. Hayes, Crocker Bldg. San Francisco—Order of Odd Fellows. May 12. H. D. Richardson, Seventh and Market sts. San Francisco—Hobekah State Assembly. May 12. Ada E. Madison, Seventh and Market sts. San Francisco—Veteran Odd Fellows' Assn. May 12. M. H. Ludlow, 1. O. O. F. Bldg. San Jose—United Com'l Travelers. May 7-9. H. C. Eagles, Box 337. San Francisco—Companions of Forest. May 19-20. M. Boehm, DeYoung Bldg. Santa Ana—Modern Woodmen of Amer. May —. E. A. Owsal, Chico, Calif. Santa Cruz—Pythian Sisters. May 18. Mrs. L. Holmes, 478 19th st., Oakland, Calif. Stockton—Order Sons of Herman. May 11-13. H. J. Kertz, 1514 Seventh ave., San Francisco. Yosemite—State Medical Assn. May 18-21. Dr. E. W. Pope, Balboa Bldg., San Francisco.

COLORADO

Colorado Springs—Rotary Clubs, Dist. No. 7. Apr. 16-17. R. E. Tope, Grand Junction, Col. Denver—Rocky Mountain Retail Clothiers' Assn. March 2-4. Geo. F. Cottrell, 621 16th st.

CONNECTICUT

Ansonia—Daughters of Amer. Revolution. March 25-26. Mrs. F. S. Stevens, 1482 Franston ave., Bridgeport, Conn. Bridgeport—State Medical Soc. May 20-21. Dr. C. W. Comfort, 27 Elm st., New Haven. Danbury—Knights Templar. May 5. Ell C. B. Wadsworth, Meriden, Conn. East Hartford—Sons of Veterans. Apr. —. I. T. Jenks, Box 1233, New Haven, Conn. Hartford—State Dental Assn. Apr. 30-May 2. Dr. S. E. Armstrong, 185 Church st., New Haven. New Haven—N. E. Order of Protection. Apr. 8. H. C. Kendall, Room 916, Chamber of Com. Bldg. New Haven—American Oriental Soc. Apr. 14-19. Dr. C. J. Ogden, 925 W. 114th st., New York City. New London—Rebekah State Assembly. Apr. 15. Mrs. M. E. Johnson, 26 Alford st., Torrington, Conn. New Haven—Order of Odd Fellows. May 20. W. S. Hutchinson, Box 1989. New Haven—Order of Red Men. May 6. W. Saunders, 79 Woodside ave., Waterbury, Conn. Waterbury—Foresters of Amer. May 13. T. O'Loughlin, 3 Neary Bldg., Naugatuck, Conn.

DELAWARE

Wilmington—Order United Workmen. Apr. 14. C. R. Pretzman, 800 Wash. st. Wilmington—Ladies of Golden Eagle. Apr. —. Mrs. J. Palmer, 1800 Delaware ave.

DISTRICT OF COLUMBIA

Washington—Gen. Sec. of War 1812. Apr. 26. Mrs. J. Weisman, 2214 Battery st., Little Rock, Ark. Washington—Hobekah State Assembly. May 5. Mrs. E. Ohlander, 3107 24th st., N. E. Washington—Colonial Dames of America, Nat'l Soc. May —. Mrs. B. Wendell, 358 Marlboro st., Boston. Washington—Chamber of Commerce of U. S. May —. D. A. Skinner, Mills Bldg. Washington—Congress of Amer. Physicians. May 3-6. W. R. Steiner, 646 Asylum ave., Hartford, Conn. Washington—Woodmen of Amer. May 6. O. V. Bowman, 748 Quebec st., N. W. Washington—Knights Templar. May 11. J. C. Keiper, Masonic Temple. Washington—Tobacco Merchants' Assn. of U. S. May 14-15. C. Dushkind, 5 Beckman st., New York City.

FLORIDA

Daytona—State Fed. of Labor. April 6-7. W. P. Mooly, Box 490, Miami, Fla. Deland—Pythian Sisters. Apr. 22-23. Marie Mauty, Box 333, Leesburg, Fla. Gainesville—State Bar Assn. March 19. H. Elmer, 712 Graham Bldg., Jacksonville. Jacksonville—P. & A. Masons. Apr. 21-23. W. P. Webster, Masonic Temple. Jacksonville—R. & S. R. A. Masons. May 18-20. W. P. Webster, Masonic Temple. Lakeland—State Baraca Philanthropic Union. May 13-16. Mrs. A. T. Race, Winterhaven, Fla. Lakeland—State Elks' Assn. Apr. 27-29. P. M. Henderson, Box 871. Miami—Order Eastern Star. Apr. 1-3. Mrs. M. H. Carter, Holly Hill, Fla. Miami—Laudry Owners' Assn. Apr. 6-8. C. B. Ross, Model Laundry, Charlotte, N. C. Miami—Southern Bakers' Assn. Apr. 6-9. A. Anderson, Box 5. Miami—State Golf Assn. Tournament. Apr. 8-11. Wm. Harrison, Box 858. Orlando—Amer. Assn. of Engineers. May —. C. E. Drayer, 63 Adams st., Chicago. St. Augustine—American Legion of Fla. Apr. 1-6. C. H. Rowton, Palatka. St. Petersburg—State Medical Assn. May —. G. E. Henson, 201 St. James Bldg., Jacksonville. Tampa—Knights of Columbus. May —. C. R. Munde, 3191 Knight st., Jacksonville. Tampa—United Com'l Travelers. May —. Gus A. Willa, Pensacola, Fla. Tampa—Knights Templar. March 18-19. W. P. Webster, 215 Masonic Temple, Jacksonville. Tampa—State Hotel Assn. First week in April. H. C. Thomason, 227 W. Forsyth st., Jacksonville. Tampa—Rebekah State Assembly. Apr. 21-22. Mrs. Josie Morrow, 1111 E. Seventh st., Jacksonville. West Palm Beach—State Engineering Soc. March 9. J. R. Benton, Gainesville, Fla. West Palm Beach—Rotary Clubs, Dist. No. 39. March 19-20. W. R. Lanier, West Point, Ga. West Palm Beach—State Bankers' Assn. Apr. 10-11. W. O. Boozor, Box 1139, Jacksonville. West Palm Beach—In. Spanish War Veterans. May —. J. W. Gooding, 619 Jessamine st.

GEORGIA

Athens—Knights Templar. May 13-14. C. S. Wood, 10 E. Taylor st., Savannah. Atlanta—S. E. Wholesale Jobbers' Assn. March 9-14. V. Shepard, City Auditorium. Atlanta—American Soc. of Orthodontists. Apr. 14-17. Dr. W. H. Ellis, 397 Delaware ave., Buffalo, N. Y. Atlanta—State Eclectic Med. Assn. Apr. 24-25. Dr. J. H. Powell, Atlanta Nat'l Bank Bldg. Atlanta—State Medical Assn. May 6-8. Dr. A. H. Burns, 65 Forrest ave. Atlanta—Nat'l Service Star Legion. May 18-23. Mrs. B. W. Maxwell, 16th and Millerville road, Indianapolis, Ind. Atlanta—Odd Fellows' Encampment. May 27-28. T. H. Robertson, Gainesville, Ga. Atlanta—Rebekah State Assembly. May 27-28. Mrs. M. C. Strickland, 332 Luckie st. Augusta—State Sunday School Assn. Apr. 7-9. M. A. Wood, 1022 Pierce ave., Macon. Brunswick—Knights of Pythias. May 20. W. H. Leopold, Box 1632, Savannah, Ga. Macon—State Educational Assn. Apr. 15-18. K. T. Alfriend, Box 395, Fuzughy, Ga. Macon—R. & S. M. & R. A. Masons. Apr. 28-29. E. A. McEllan, 614 Mulberry st. Macon—State Funeral Directors' Assn. May 26-28. Walter Harlan, Atlanta. Savannah—Sheet Metal Contractors' Assn. March 10-11. Savannah—S. E. Regional Shippers' Adv. Board. March 10-11. E. B. Gaines. Waycross—State Travelers Protective Assn. Apr. 16-17. A. Ehrlich, Box 585, Savannah.

IDAHO

Boise—Knights Templar. May 22. L. W. Ensign. Pocatello—Rotary Clubs. Apr. 16-17. C. E. Dinwiddie, Idaho Falls, Id. Nampa—Woodmen of Amer. May 6. D. L. Lewis, Malad, Id.

ILLINOIS

Belleville—Rotary Clubs. March 24. J. L. McConaughy, Galveston, Ill. Champaign—Retail Merchants' Assn. May 19-21. F. A. Tiesler, 523 Murphy Bldg., E. St. Louis. Chicago—American Ry. Engineering Assn. March 10-12. E. H. Fritch, 431 S. Dearborn st. Chicago—Fashion Art League of Amer. Approx. March 15. Anna Z. MacMichael, 15 E. Washington st. Chicago—State Gas Assn. March 18-19. R. V. Prather, Mine Workers Bldg., Springfield.

Chicago—Alpha Omega Alpha Frat. March 10. Dr. Wm. W. Root, Slatterville Springs, N. Y. Chicago—State Elec. Railways' Assn. March 18-19. R. V. Prather, Mine Workers Bldg., Springfield. Chicago—Sigma Delta Kappa. Apr. —. W. M. Sojley, 1208 W. Ottawa st., Lansing, Mich. Chicago—Nat'l Lumber Mfrs' Assn. Apr. —. Wilson Compton, Transportation Bldg., Washington, D. C. Chicago—Internat'l Ry. Supplymen's Assn. March 26-29. F. S. Wilcoxon, 460 McCormick Bldg. Chicago—American Booksellers' Assn. May 11. B. M. Walker, 9 Park pl., New York City. Chicago—Nat'l Fire Protection Assn. May 12-14. F. H. Wentworth, 40 Central st., Boston. Chicago—Master Boiler Makers' Assn. May 19-22. H. D. Vought, 20 Cortland st., New York City. Chicago—Internat'l Ry. Fuel Assn. May 26-29. J. B. Hutchinson, 6000 Michigan ave. Chicago—Nat'l Assn. Box Mfrs. Apr. 8-10. C. V. Hodges, 824 Rush st. Chicago—Western Cannery's Assn. Apr. 13-14. J. A. Lee, 12 Grand ave. Chicago—American Ry. Assn. Safety Section. May —. J. C. Caviston, 30 Vesey st., New York City. Chicago—State Homeopathic Medical Assn. May —. Dr. L. G. Bridges, 1121 Wilson ave. Chicago—Order of Ladies of Vikings. May —. Mrs. A. Bergwall, 1735 Waveland ave. Chicago—Internat'l Ry. Supply Men's Assn. May —. F. S. Wilcoxon, 460 McCormick Bldg. Chicago—Nat'l Piano Mfrs' Assn. of America. May —. H. W. Hill, 130 W. 42d st., New York City. Danville—Royal Arcanum. May 20. J. Kiley, 105 W. Monroe st., Chicago. Galesburg—United Com'l Travelers. May 14-16. J. H. Foster, 326 W. Madison st., Chicago. Joliet—Daughters of Amer. Revolution. March 24-25. Mrs. F. J. Bowman, 207 Eighth ave., Sterling, Ill. Moline—Rotary Clubs. Apr. 30-May 1. E. P. Nutting. Peoria—State Dental Soc. May 12-14. A. E. Converse, Leland Office Bldg., Springfield. Peoria—State Gideons' Assn. May 16-17. W. A. Hurek, 8024 St. Lawrence ave., Chicago. Quincy—State Medical Soc. May 19-21. Dr. H. M. Camp, Monmouth, Ill. Rock Island—State Fed. Parent-Teachers' Assn. Apr. 21-23. Mrs. W. Drennan, 812 N. College st., Decatur. Springfield—Knights of Columbus. May 12-13. W. D. Rose, Rose-Wells Bldg. Co. Springfield—Foresters of Amer. May 17-19. M. J. Donna, Box 1, Braidwood, Ill.

INDIANA

Anderson—United Com'l Travelers. May 15-16. A. A. Dicks, 1603 Chestnut st., Terre Haute, Ind. Auburn—Monster Horseboers' Assn. Apr. 8-9. R. W. Merchant, Brookston, Ind. Evansville—Tribe of Ben Hur. May —. M. E. Artman, 103 N. 10th st., Decatur, Ind. Ft. Wayne—State Travelers' Protective Assn. Ind. —. C. M. Zink, 407 Ind. Pythian Bldg., Indianapolis. Indianapolis—Auto Trade Assn. March 27. John Orman, 338 N. Delaware st. Indianapolis—State Egg & Poultry Assn. March 10-11. W. N. Locks, 123 N. New Jersey st. Indianapolis—Order Eastern Star. Apr. 21-22. Mrs. Nettie Ransford, 509 N. Illinois st. Indianapolis—Cath. Knights of Amer. May 12. H. Siemer, 211 N. Seventh st., St. Louis. Indianapolis—Knights Templar. May 13-14. Wm. H. Swintz, Masonic Temple. Indianapolis—Rebekah State Assembly. May 18-19. Mrs. M. Lovick, 1. O. O. F. Bldg. Indianapolis—State Dental Assn. May 19-20. C. L. Byers, 2138 N. Illinois st. Indianapolis—Order of Odd Fellows. May 20-21. G. P. Bornwasser, 1208 1/2 O. O. F. Bldg. La Fayette—Nat'l Assn. Stationary Engrs. May —. W. E. Knowles, care Gas & Electric Co. Madison—State Haymakers' Assn. May 10. G. C. Exline, 609 E. Main st., Jacksonville, Ind. West Baden—State Assn. Stationary Engineers. March 9-11. J. A. LaMure, Hammond, Ind.

IOWA

Burlington—State Sunday School Assn. May 5-7. W. Hatton, 443 Youngerman Bldg., Des Moines. Des Moines—State Retail Shoe Dirs.' Assn. March 10-12. Ira L. Welch, Griswold, Ia. Des Moines—State Aberdeen Angus Assn. March 18-19. E. T. Davis, Box 250, Iowa City. Des Moines—Independent Telephone Assn. Apr. —. C. C. Doring, 409 Royal Union Bldg. Des Moines—Central Div. Iowa Teachers' Assn. Apr. 9-11. Des Moines—State Dental Soc. May 5-7. E. B. Smith, 613 E. Court st., Iowa City. Des Moines—Order United Workmen. May 12. W. H. Stowell, 2160 Grand ave. Des Moines—State Medical Soc. May 13-15. Dr. T. B. Throckmorton, Bankers' Tr. Bldg. Dubuque—State Fed. of Labor. May 1. J. B. Wiley, 160 W. Eighth st., Des Moines. Dubuque—American Legion of Ia. May 25-27. G. W. MacIsaac, 611 Park Bldg., Des Moines. Dubuque—Knights of Columbus. May 27-28. J. McCormick, Box 21, Cedar Rapids, Ia. Dubuque—Fed. Business & Prof. Women's Clubs. May 22-23. Alice Wykoff, Waterloo, Ia. Ft. Dodge—Rotary Clubs, Dist. No. 11. March 23-24. C. H. Boardman, Rotary Club, Marshalltown, Ia. Waterloo—State Travelers' Protective Assn. May —. L. C. Stein, Box 363, Ottumwa.

KANSAS

Eldorado—Daughters of Amer. Revolution. March 26. Miss A. J. Morse, 1227 Lawrence st., Emporia, Kan. Hutchinson—State Dental Assn. Apr. 20-22. C. K. Weaver, Clay Center, Kan. Kansas City—Order Eastern Star. May 11. Mrs. D. Bennett, Guaranty State Life Bldg., Topeka. Topeka—Knights Templars. May 12-13. A. K. Wilson, Masonic Temple, Topeka. Salina—State Sunday School Assn. May 5-8. F. G. Richards, 112 W. Seventh st., Topeka. Salina—G. A. R. Encampment. May 12-11. C. H. King, Memorial Hall, Topeka. Topeka—State Assn. Stationary Engrs. Apr. 6-8. J. M. Vansant, 730 Horne st. Topeka—Ind. Telephone Assn. Apr. 7-9. L. M. Krause, 112 E. Seventh st. Topeka—State Medical Soc. May 5-7. Dr. J. F. Hassel, 804 Elks' Bldg., Kansas City. Topeka—State Bankers' Assn. May 20-22. W. W. Bowman, Room 201, Kansas Hotel. Wichita—American Assn. Petroleum Geologists. March 27-29. Chas. E. Decker, Chanawana ave., Norman, Ok. Wichita—State Pharm. Assn. Apr. 21-23. J. W. Kelley, 918 Kansas ave., Topeka.

KENTUCKY

Ashland—Knights Templars. May 20-21. E. C. Sellers, Box 45, Covington, Ky. Bowling Green—Travelers' Protec. Assn. May 15-17. Edward L. Kerley, Liberty Hotel, Glasgow, Ky. Henderson—State Fed. Women's Clubs. May —. Mrs. J. E. Warren, Mayfield. Lexington—Knights of Columbus. May 12. G. A. Burkley, 305 Columbia Bldg., Louisville. Louisville—Rotary Clubs, Dist. No. 23. March 24-25. J. E. Riddell, care Riddell Furniture Co. Louisville—State Educational Assn. Apr. 22-25. R. E. Williams, 320 Starks Bldg. Louisville—State Negro Educ. Assn. Apr. —. A. S. Wilson, 2518 Magazine st. Louisville—State Dental Soc. Apr. 6-8. Dr. W. M. Ittandall, 1035 Second st. Louisville—American Water Works' Assn. Apr. 27-May 3. W. M. Niesley, 170 Broadway, New York City. Louisville—R. A. R. Encampment. May —. John Barr, Lebanon, Ky. Louisville—Odd Fellows' Encampment. May 13. C. E. Cooke, 806 Tr. Bldg., Lexington. Winchester—Order of Red Men. May 12-13. A. Crader, 2740 W. Main st., Louisville.

LOUISIANA

Alexandria—State Homestead League. Apr. —. E. A. Wagner, 625 Commerce st., New Orleans. Baton Rouge—Knights of Pythias. Apr. 19-22. John D. Brown, Box 7, Gray, La. Lake Charles—Knights Templar. Apr. 20. J. B. Parker, Masonic Temple, New Orleans. Monroe—Order Eastern Star. May 7-8. Miss P. B. Nelson, 1620 Denbiston st., New Orleans. New Orleans—Butcher Assn. March 10-12. C. V. Rainwater, 232 Candler Bldg., Atlanta, Ga. New Orleans—Southern Pine Assn. March 24-25. H. C. Berckes, Interstate Bank Bldg. New Orleans—State Dental Soc. March 6-7. Dr. F. J. Wolfe, 609 Machecha Bldg. New Orleans—American Cotton Mfrs' Assn. Apr. —. W. D. Adams, 701 Com'l Bk. Bldg., Charlotte, N. C. New Orleans—State Assn. of Optometrists. Apr. —. Dr. Thomas Forrest, Hammond, La. New Orleans—King's Daughters & Sons. Apr. 6. Mrs. A. P. Hres, 7425 Macardy st. New Orleans—State Medical Soc. Apr. 21-23. Dr. P. T. Talbot, 1551 Canal st. New Orleans—Amer. Feed Mfrs' Assn. May —. L. F. Brown, 53 W. Jackson Blvd., Chicago. New Orleans—State Pharmaceutical Assn. May 12-13. G. W. McDuff, 317 Chestnut st. New Orleans—Southern Cypress Assn. May 19. E. W. McKay, 507 Varonoleit st. New Orleans—Itce Millers' Assn. May 28. F. B. Wise, 600 Audubon Bldg. New Orleans—Sunday School Assn. May 5-7. Van Carter, 829 M. B. Bldg. Shreveport—United Com'l Travelers. May —. M. Frank, Box 313. Shreveport—Odd Fellows' Encampment. March 9. Will A. Stedley, Crowley, La. Shreveport—Rebekah State Assembly. March 10. Mrs. P. Walmesley, 1532 Maple al.

MAINE

Portland—N. E. Order of Protection. Apr. 1. Forest E. Ludden, Auburn, Me. Portland—F. & A. M., R. A. M., R. & S. M., & K. T. Masons. May 5-7. C. B. Davis, Masonic Temple. Portland—Order of Good Templars. May 13. G. E. Fildes, 18 High st., Waterville, Me. Portland—Pythian Sisters. May 20. Mrs. E. Carter, 357 Maine st., S. Portland. Portland—Order Eastern Star. May 26. M. M. DeShon, 26 Oriand ave.

MARYLAND

Baltimore—Odd Fellows' Encampment. March 17. W. A. Jones, 1. O. O. F. Temple. Baltimore—American Chemical Soc. Apr. 6-11. Dr. Chas. L. Parsons, 1709 G st., N. W., Washington, D. C. Baltimore—Order of Odd Fellows. Apr. 29. W. A. Jones, 1. O. O. F. Temple. Baltimore—Royal Arcanum. Apr. 28. Chas. Hogenbort, 18 W. Saratoga st. Baltimore—Junior Order. Apr. 21-22. C. S. Davis, 100 N. Pine st. Baltimore—Order of Red Men. Apr. 22. Dr. J. C. Littleton, 110 N. Penn st. Baltimore—Order Eastern Star. Apr. 27-29. Wm. F. Boyd, 206 W. Belvedere ave. Baltimore—Rebekah State Assembly. Apr. 7. W. A. Jones, 1. O. O. F. Temple. Baltimore—Daughters of Revolution. May —. Mrs. Wm. L. Cunningham, 2351 Gd. Concourse, New York City. Baltimore—Knights Templars. May 13. G. A. Elda, Masonic Temple. Baltimore—Assn. Harvard Clubs. May 21-23. N. Perelles, Jr., 102 Wisconsin st., Milwaukee, Wis. Baltimore—State Dental Assn. May 1-6. Dr. N. H. McDonald, 201 Morris Bldg. Chambers—Order Sons of Amer. Apr. 28-29. Chas. H. Davis, 6053 Kingsswing ave., Philadelphia, Pa. Frederick—Knights of Pythias. Apr. 11. G. W. Ward, 121 N. Gay st., Baltimore.

MASSACHUSETTS

Boston—Auto Dirs' Assn. March 7-11. Chester I. Campbell, 329 Park St. Bldg. Boston—Daughters of Amer. Revolution. March 11-14. Miss N. H. Harris, 37 Saunders st. Boston—N. E. Assn. Boiler Mfrs. March 11. H. H. Lynch, 99 Summer st.

Boston—N. E. O. P. Grand Lodge, March 11. Mass. J. A. Hinkley, 101 Tremont st.
 Boston—Women's Relief Corp., Apr. —, Mary E. Elliott, 657 Washington st.
 Boston—Sons of Veterans, Apr. 7-8. H. F. Weiler, 88 Tremont st.
 Boston—State Humane Soc., Apr. 14. C. P. Curtis, 71 Ames Bldg.
 Boston—Ray State Checker Clubs, Apr. 19. E. W. MacDonald, 985 Washington st.
 Boston—Sons of Amer. Revolution, Apr. 19. H. S. Kimball, 3 Ashburton Place.
 Boston—Royal Arcanum, Apr. 23-24. Wm. L. Kell, 101 Tremont st.
 Boston—Order Fullered Workmen, Apr. 28. C. C. Fearing, 12 Walnut st.
 Boston—Laundry and Am. Assn., Apr. 24. W. E. Hallahan, 705 Colonial Bldg.
 Boston—Rotary Clubs, Apr. 21-22. D. F. Sullivan, 155 S. Main st., Fall River, Mass.
 Boston—Old Fellows' Encampment, March 5. G. H. Fuller, 170 Newbury st.
 Boston—Knights of Pythias, May 5-6. G. E. Howe, 15 Ashburton pl.
 Boston—Pythian Sisters, May 6-7. Mrs. H. P. Young, 48 Waverley st., Waverley, Mass.
 Boston—Hebeke State Assembly, May 6-7. Mrs. S. A. Barry, 9a Monument sq., Charlestown, Mass.
 Boston—State Assn. Master Plumbers, May 6-7. G. A. Stewart, 330 Bridge st., Lowell.
 Boston—Knights of Columbus, May 12. W. C. Front, Barristers' Hall, Boston.
 Boston—Order of Protection, May 12. D. M. Frye, 52 Chaucery st.
 Boston—New England Railroad Club, May 12. W. E. Cade, Jr., 883 Atlantic ave.
 Boston—Assn. Ptg. House Craftsmen, May 17. H. B. Perry, 91 Allyn st., Hartford, Conn.
 Boston—State Dental Soc., May 4-8. Dr. W. A. Ryder, 175 Newbury st.
 Haverhill—Sons & Daughters of Liberty, May 13. Miss A. F. Towne, 314 Pearl st., Cambridge.
 Springfield—Rotary Clubs, Apr. 13-14. G. H. Conner, 100 North st.
 Springfield—N. E. Coal Dirs.' Assn., March 25-26. W. A. Clark, 141 Milk st., Boston.
 Springfield—State Dental Soc., Apr. —, H. W. Alden, 160 Main st., Northampton, Mass.
 Springfield—State Ice Dirs.' Assn., Apr. 9-10. G. R. Votter, 224 State st., Boston.
 Springfield—Eastern Ari Assn., Apr. 23-25. P. E. Mathewson, Dickinson High School, Jersey City, N. J.
 Springfield—Order Eastern Star, May 14-15. Mrs. C. A. Cushing, 21 College ave., W. Somerville, Mass.
 Swampscott—Sons of Amer. Revolution, Nat'l Soc., May 20. E. H. Steele, 188 St. James place, Buffalo, N. Y.
 Worcester—State Retail Jewelers' Assn., March 24-25. Louis S. Smith, 258 Cabot st., Beverly, Mass.

MICHIGAN

Battle Creek—Tri-State Medical Assn., Apr. 14. Dr. C. W. Haywood, 405 Haynes Bldg., Elkhart, Ind.
 Bay City—Old Fellows' Encampment, May 19-19. E. Hoyt, 11 Eldred st., Battle Creek.
 Detroit—Carbonated Beverage Mfrs.' Assn., March 16-17. Chas. E. Spencer, Plainwell, Mich.
 Detroit—Nat'l Sanitary Supply Assn., Apr. 13-15. W. G. Hutchins, 111 E. Columbia st., Ft. Wayne, Ind.
 Detroit—R. & S. Masters, May 18. Chas. A. Conner, Coldwater, Mich.
 Grand Rapids—State Dental Soc., Apr. 13-15. Wm. R. Davis, 1004 Genesee Bank Bldg., Flint, Mich.
 Grand Rapids—State Assn. Ret. Plumbing Dirs., Assn., March 26-27. W. A. Decker, 12 Oakes st., S. W.
 Grand Rapids—White Shrine of Jerusalem, May 7. Mrs. C. C. Hannon, 3145 Florney st., Chicago.
 Grand Rapids—F. & A. Masons, May 26-27. L. B. Wisor, Masonic Temple.
 Ironwood—Knights of Columbus, May —, Wm. E. Sturn, 19 E. Front st., Monroe, Mich.
 Muskegon—Retail Grocers' Assn., Third week in Apr. Paul Geson, Wyoming Park, Grand Rapids, Mich.
 Saginaw—Woodmen of America, May 5. W. H. Korn, 1104 E. 8th st., Traverse City, Mich.

MINNESOTA

Duluth—Bro. American Yeomen, Apr. —, G. Young, 433 Andrus Bldg., Minneapolis.
 Hibbing—Rotary Clubs, Apr. —, E. C. Ekstrom, Hibbing.
 Mankato—Woodmen of Amer., May —, Edward F. Burns, Minneapolis.
 Mankato—Knights Templars, May 20-21. J. F. Schell, St. Paul.
 Minneapolis—State Sunday School Assn., March 23-25. J. K. Craig, 405 Y. M. C. A. Bldg.
 Minneapolis—Retail Jewelers' Assn., Apr. —, E. M. Schwenke, New Richmond, Minn.
 Minneapolis—Internat'l Sunshine Soc., May —, Mrs. N. C. Furman, 8432 107th st., Richmond Hill, N. Y.
 Minneapolis—Order Ry. Conductors, May 4-8. E. P. Curtis, Cedar Rapids, Ia.
 St. Paul—Order Eastern Star, May 13. Mrs. M. P. Taylor, 3208 Aldrich ave., South Minneapolis.

MISSISSIPPI

Biloxi—State Sunday School Assn., Apr. 21-23. W. P. Long, Box 123, Jackson.
 Biloxi—State Medical Assn., May 12-14. Dr. L. M. Dye, Clarkdale, Miss.
 Columbus—Old Fellows' Encampment, May 19. Arthur Allen, Pascagoula, Miss.
 Columbus—State Congress of Mothers & Parent Teachers' Assn., April 11-16. Mrs. Harry G. Matthews, 502 Todd st., Jackson.
 Columbus—Hebeke State Assembly, May 18. Mrs. Jennie Stralner, West Point, Miss.
 Columbus—Lodge of Old Fellows, May 19. W. S. P. Doty, Grenada, Miss.
 Jackson—Order Eastern Star, May 12. Mrs. M. Eaton, 105 MeLeod st., Hattiesburg, Miss.
 Jackson—State Bankers' Assn., May 12-13. Geo. R. Power, Box 314.
 Jackson—State Teachers' Assn., Apr. 30-May 2. W. N. Taylor, Old Capitol, Jackson.
 Laurel—Knights Templar, Apr. —, E. L. Fausette, Meridian, Miss.
 Meridian—Junior Order, Apr. 28. W. D. Hawkins, Box 592.
 Natchez—In. Daughters of Confederacy, May 4-8. Miss C. G. Hill, Laurel, Miss.

MISSOURI

Chillicothe—Woodmen of Amer., May 6. F. L. Lunderman, 303 Ohio st., Sedalia, Mo.
 Columbia—Royal Daughters of Amer., March 17-20. Mrs. A. M. Shepherd, 306 S. Fifth st.

Hermann—Order of Eagles, May 20-21. S. R. Griffin, 100 E. Commercial st., Springfield.
 Joplin—G. A. R. Encampment, May —, W. F. Henry, Temple Bldg., St. Louis.
 Kansas City—American Florists' Soc., March 23-26. J. Young, 43 W. 18th st., New York City.
 Kansas City—Music Supervisors, March 29-Apr. 4. Grace Wilson, Topeka, Kan.
 Kansas City—Tri-State Poster Adv. Assn., Apr. —, R. H. Hinkinson, 111 E. Eighth st., Topeka, Kan.
 Kansas City—State Telephone Assn., Apr. 7-9. R. W. Hedrick, Cen. Tr. Bldg., Jefferson City.
 Kansas City—Bro. American Yeomen, Apr. 8. B. Wolf, 311 Title Guaranty Bldg., St. Louis.
 Kansas City—Associated Traffic Clubs of Amer., Apr. 15-16. B. L. Kirkwood, 277 Broadway, New York City.
 Kansas City—Western Physiotherapy Assn., Apr. 16-17. Dr. C. W. Fassett, 115 E. 31st st.
 Kansas City—Kiwanis Clubs, May —, W. D. Myers, Forrester's Nave Box Co.
 Kansas City—Laundry Owners' Assn., May —, R. C. Nicholson, 301 Statter Hotel, St. Louis.
 Kansas City—Nat'l Assn. of Harpists, May 3-5. A. Hills, 315 W. 7th st., New York City.
 Kansas City—Hrs. of Ry. Clerks, May 4. G. S. Lewis, Second Nat'l Bldg., Cincinnati, O.
 Kansas City—State Medical Assn., May 4-6. Dr. E. J. Goodwin, 901 Mo. Theater Bldg., St. Louis.
 Kansas City—State Dental Soc., May 11-13. Dr. H. C. Pollock, 721 Metropolitan Bldg., St. Louis.
 Kansas City—Amer. Farm Congress, Last week in May. E. V. Rhum, 909 Continental Bldg.
 Kansas City—Amer. Ice Assn., Freight Claim Div., May 25-28. Lewis Pitcher, 431 S. Dearborn st., Chicago.
 Kansas City—Nat'l Assn. Public School Business Officials, May 19-22. J. A. Mount, State House, Trenton, N. J.
 Sedalia—Rotary Clubs, March 20-27. Guy Dealbody.
 St. Louis—Royal Arcanum of Mo., March 17. J. G. McWhiskey, 516 Fullerton Bldg., St. Louis.
 St. Louis—American Zinc Inst., Apr. 27-28. Stephen S. Tuttle, 27 Cedar st., New York City.
 St. Louis—American Inst. Electrical Engrs., Apr. 13-17. E. L. Hutchinson, 33 W. 39th st., New York City.
 St. Louis—N. E. Mo. Lumbermen's Assn., March 24-26. O. R. Butts, 527 Farish st., Moberly, Mo.
 St. Louis—Southern Ill. Retail Lumber Burs., March 24-26. H. L. Ziegler, Carni, Ill.
 St. Louis—Order of Old Fellows, May 19-21. B. Wolfe, 3745 Lindell Blvd.
 St. Louis—Hebeke State Assembly, May 19-21. Mrs. O. M. Parker, 1132 Blackstone ave.
 St. Louis—Knights of Columbus, May 12. J. T. Nugent, 3549 Olive st.
 Springfield—Knights Templars, May 19-20. H. V. Denslow, 311 Leouast st., St. Louis.

MONTANA

Hillings—Interstate Bottlers' Assn., March 2-3. R. P. Wise, Box 983.
 Great Falls—State Stock Growers' Assn., Apr. 15. E. A. Phillips, Helena.

NEBRASKA

Grand Island—Polled Hereford Breeders' Assn., March 19. Roy C. Radford, Newark, Neb.
 Grand Island—Order United Workmen, May 12. H. R. Rousay.
 Hastings—Knights of Columbus, May —, E. G. Zimmerman, 716 S. 18th st., Lincoln, Neb.
 Lincoln—Knights of Pythias, May 12. W. H. Love, Pythian Temple.
 Lincoln—Pythian Sisters, May 12. Miss B. Hastings, Box 268, Central City, Neb.
 Lincoln—En. Commercial Travelers, May 15. A. W. Hawkins, 2880 Gauman ave., Omaha.
 Loup City—P. E. O. Sisterhood, Third week in May. Mrs. V. J. Cameron, 216 N. 32d ave., Omaha.
 Omaha—Royal Neighbors of Amer., March 17-18. Henrietta Owen.
 Omaha—Rotary Clubs, Apr. 2-3. V. Hedge, 414 First Nat'l Bldg., Lincoln.
 Omaha—Royal Arcanum, Apr. 2-8. S. P. Hostwick, 723 Peters Tr. Bldg.
 Omaha—Knights Templar, Apr. 23. F. E. White, Masonic Temple.
 Omaha—Altrusa Club, Apr. 23-21. Mrs. P. E. Garnett, 909 Inter-Southern Bldg., Louisville, Ky.
 Omaha—G. A. R. Encampment, May 5-7. Harmon Bross, State House, Lincoln.
 Omaha—Woodmen of America, May 6. G. E. Morrillan, S. Omaha.
 Omaha—Order Eastern Star, May 12. Miss R. M. Owens, Masonic Temple.
 Omaha—State Dental Soc., May 18-21. Dr. H. E. King, 541 Peters Tr. Bldg.
 Omaha—Nat'l Elec. Light Assn., Midwest Section, May 20-22. Horace M. Davis, Lincoln.

NEW HAMPSHIRE

Concord—G. A. R. Dept. Encampment, Apr. 9-10. Frank Bixbee, State House, Concord.
 Manchester—State Med. Soc., May 19-20. D. E. Sullivan, 7 N. State st., Concord.
 Plymouth—Old Fellows' Encampment, May 13. H. A. Currier, Franklin, N. H.
 Portsmouth—Knights of Pythias, May 12. C. M. Carson, 7 Masonic Temple, Dover, N. H.
 Portsmouth—Pythian Sisters, May 11-12. Lena G. Davis, 123 Church st., Laconia, N. H.

NEW JERSEY

Atlantic City—Nat'l-American Wholesale Lumber Assn., March 18. W. W. Schupper, 41 E. 42d st., New York City.
 Atlantic City—Penna. Library Club, March 27-28. Mrs. J. K. Leibster, 17th & Spring Garden sts., Philadelphia, Pa.
 Atlantic City—Radio District Conv., Apr. 14-16. J. W. Horte, 892 E. Schuller st., Philadelphia, Pa.
 Atlantic City—Mfrs. Assn. of N. J., May 1-2. W. C. Billman, 175 W. State st., Trenton.
 Atlantic City—State Fed. Women's Clubs, May 6-9. Mrs. E. M. Waterman, Mahwah, N. J.
 Atlantic City—Degree of Pocahontas, May 16. Mrs. L. W. Thompson, New Egypt, N. J.
 Atlantic City—American Medical Assn., May 25-29. Dr. O. West, 535 Dearborn st., Chicago.
 Atlantic City—American Radium Soc., May 25-29. E. C. Ernst, 412 Humboldt Bldg., St. Louis.
 Atlantic City—Historical Soc. of N. A., May 25-29. Dr. M. J. Sanborn, 811 College ave., Appleton, Wis.
 Atlantic City—Bankers' Assn. of Md., May 13-14. Chas. Hawn, Merchants' Nat'l Bank, Baltimore.

Atlantic City—Tal. Collars of Lebanon, May 21. John M. Wright, Box 413, Trenton.
 Jersey City—Order of Golden Scepter, May 12. Miss M. Ballinger, 1553 N. Park ave., Philadelphia, Pa.
 Newark—State Dental Soc., Apr. 8-11. Dr. F. K. Heazleton, 233 E. Hanover st., Trenton.
 Phillipsburg—Knights of Malta, May 2. H. Peters, 2017 Eder ave., Easton, Pa.
 Rutherford—Letter Carriers' Assn., May 30. Clarence F. Stinson, Bayonne, N. J.
 Trenton—R. & S. Masters, Apr. 21. H. A. Putnam, 17 Wilkinson Pl.
 Trenton—Woodmen of Amer., May —, P. J. Ross, 910 E. 10th st., Paterson, N. J.
 Trenton—Forgers of Amer., May 26. W. L. J. Jones, 275 Grove st., Jersey City.
 Vineland—Old Fellows' Encampment, May 5. Frank R. Jummel, Box 390, Trenton, N. J.

NEW MEXICO

Albuquerque—Knights of Columbus, May 10. T. J. McAffrey, Box 1006.
 Albany—Order of B'nai B'rith, May 11. Max Levy, 2907 Broadway, New York City.
 Albany—State Dental Soc., May 13-15. A. P. Burkhardt, 57 E. Genesee st., Auburn.
 Brooklyn—Royal Arcanum, May 18-20. D. A. Brown, 215 Montague st.
 Buffalo—State Optometric Assn., May 25-27. W. R. Prouty, 350 Fulton st., Brooklyn.
 Buffalo—Knights of Columbus, May 26-27. E. M. Coyle, 372 Willow st., Lockport, N. Y.
 Buffalo—American Bowling Congress, March 5-9. A. L. Langtry, 175 Second st., Milwaukee.
 Buffalo—Bro. American Yeomen, Apr. 8. J. A. Porter, 818 Niagara st.
 Geneva—Old Fellows' Encampment, May 24-27. Harry Walker, 31 Union sq., New York City.

NEW YORK

New York—Camp Directors' Assn. of Amer., March 13-14. Laura Mattoon, Wolfboro, N. H.
 New York—Order Free Sons of Israel, March 25. R. J. Clark, 3109 Broadway.
 New York—Nat'l Paper Trade Assn., Apr. —, W. C. Ridgeway, 41 Park Row.
 New York—The Associated Press, Apr. 21. M. E. Sime, 383 Madison ave.
 New York—Nat'l City Planning Conf., Apr. 25. F. Shurtleff, 130 E. 25th st.
 New York—Chamber of Commerce of N. Y., May 7. J. D. Taudy, 65 Liberty st.
 New York—Nat'l Board Fire Underwriters, May 28. S. Balladr, 75 Williams st.
 New York—American Gurnsey Cattle Club, May 13. Karl B. Musser, Peterboro, N. H.
 Niagara Falls—Amer. Fed. of Musicians, May 11-16. W. F. Kernwood, 233 Halsey st., Newark, N. J.
 Niagara Falls—American Electrochemical Soc., Apr. 23-25. Dr. C. G. Fink, Columbia Univ., New York City.
 Rochester—Nat'l Paper Box Mfrs.' Assn., May —, P. S. Records, 112 N. Broad st., Philadelphia, Pa.
 Rochester—State Assn. of Mfg. Retail Bakers', May —, R. Zuk, 379 Wells ave., Bronx, New York City.
 Rochester—Fed. Women's Clubs, May 23-25. Mrs. John Knight, Arcade, N. Y.
 Saratoga Springs—Sons & Daughters of Liberty, May 5-6. Mrs. L. McClure, 171 Hillside ave., Jamaica, N. Y.
 Syracuse—Delta Epsilon, Apr. —, P. C. Pack, 1010 Union Trust Bldg., Chicago.
 Syracuse—State Med. Soc., May 12. Edward Livingston, 17 W. 23d st., New York.
 Utica—Hebeke State Assembly, May 19-21. Miss A. E. Rogers, 3011 Albany Crescent, New York City.

NORTH CAROLINA

Charlotte—Bakers' Assn., May 27-28. J. H. Woodruff, Box 1190, Washington, D. C.
 Fayetteville—Travelers Protec. Assn., Apr. —, D. C. Crutchfield, Winston-Salem.
 Greensboro—Order Sons of America, May 19. Fred C. Slink, Lexington, N. C.
 Greensboro—Order of Old Fellows, May 19-21. J. B. Berry, Box 363, Raleigh, N. C.
 Greensboro—Rebekah State Assembly, May 19-21. Miss P. E. Beck, 39 Brookstown ave., Winston-Salem.
 High Point—Order of Red Men, May 6. W. B. Goodwin, Box 226, Elizabeth City, N. C.
 Pinehurst—State Fed. Women's Clubs, May 5-9. Mrs. F. R. Perdue, Raleigh.
 Pinehurst—State Dental Soc., May 11-13. Dr. E. B. Howle, Box 281, Raleigh.
 Pinehurst—Medical Soc. of N. C., Apr. 28-30. Dr. L. B. McBrayer, Box 17, Southern Pines, N. C.
 Raleigh—Royal Arcanum, Apr. —, George R. Wootton, Hickory, N. C.
 Raleigh—Footry Assn. of N. C., Apr. 19. John L. Colby, Jr., Box 406.
 Raleigh—Rotary Clubs, March 26-27. M. Eugene Newsom, Durham, N. C.
 Raleigh—En. Commercial Travelers, May 21-23. A. H. Snider, Salisbury, N. C.
 Winston-Salem—Sons & Daughters of Liberty, May 28-29. A. W. Cole, 615 E. Davis st., Burlington, N. C.
 Winston-Salem—State Retail Jewelers' Assn., March 10-11. Wm. G. Frasier, Durham, N. C.

NORTH DAKOTA

Bismarck—Farmers Grain Dirs.' Assn. of N. D., March 21-26. P. A. Lee, Box 422, Grand Forks.
 Bismarck—State Nurses' Assn., Apr. 27-29. Esther H. Teichmann, 811 Avenue C.
 Bismarck—Knights of Columbus, May 29-30. S. W. Callahan, Box 537, Williston, N. D.
 Devils Lake—Order United Workmen, May 27. E. J. Moore, Fargo, N. D.
 Fargo—State Dental Assn., May 5-7. Dr. C. D. Price, 539 deLondre Bldg.
 Jamestown—State Retail Merchants' Assn., May 19-21. W. D. Powell, 723 8th st., S. Fargo.
 Mandan—Knights Templars, May 26-27. W. L. Stockwell, Box 578, Fargo.

OHIO

Cincinnati—Nat'l Council of Education Feb. 26-28. Adelaide S. Baylor, 200 N. J. ave., Washington, D. C.
 Cincinnati—Nat'l Elec. Assn., Dept. of Supts., Feb. 23-28. S. D. Shankland, 1201 16th st., N. W., Washington, D. C.
 Cincinnati—Ohio Valley Furniture Dirs.' Assn., March 2-6. G. H. Bricker, 175 South High st., Columbus.
 Cincinnati—American Soc. Civil Engrs., Apr. 22-24. J. H. Dunlap, 33 W. 39th st., New York City.
 Cincinnati—Wholesale Dry Goods Assn., May 19-22. Newman H. Johnson, Richmond, Va.
 Cincinnati—Linen Supply Assn. of Amer., May 19-22. F. H. Hartless, 601 N. Parkside ave., Chicago.

Cincinnati—Appalachian Logging Congress, Apr. 20-22. T. Sutherland, 807 Holston Bk. Bldg., Knoxville, Tenn.
 Cincinnati—Loyal Legion, Apr. 15-16.
 Cincinnati—Drama League of America, Last week in May.
 Cincinnati—Retail Shoe Dealers of Ohio Valley, March 2-4. Mrs. H. F. Hageman, 175 S. High st., Columbus.
 Cleveland—State Egg & Poultry Assn., March 1. W. A. Rurdick, 606 Broadway.
 Cleveland—Bro. of American Yeomen, Apr. 8. Dr. W. D. Edgar, Diehl Bldg., Defiance, O.
 Cleveland—Nat'l Women Bowlers' Assn., Apr. —, Olive Foster, 3553 Magnolia ave., Chicago.
 Cleveland—Nat'l Heating & Vent. Assn., Apr. 15-16. A. W. Williams, 52 W. Gay st., Columbus.
 Cleveland—Nat'l Metal Trades' Assn., Apr. 23-25. H. D. Sayre, People's Gas Bldg., Chicago.
 Cleveland—American Fed. of Arts, May 13-16. Miss L. Muehlen, 1741 N. Y. ave., Washington, D. C.
 Cleveland—Bro. of Railroad Trainmen, May 12. A. E. King, 820 W. Superior ave.
 Cleveland—Soc. of Indust. Engrs., May 6-8. Geo. C. Bond, 198 S. Dearborn st., Chicago.
 Columbus—Order of Red Men, May 12-13. Thos. J. Irwin, Box 143, Martins Ferry, O.
 Columbus—State Haymakers' Assn., May 11. Edw. C. Richardson, Room B, H. & S. Bk., Newark.
 Columbus—State Medical Assn., May 5-7. Dr. D. K. Martin, 131 E. State st.
 Columbus—Degree of Pocahontas, May 12. Ella M. Browning, 221 E. 5th st., Urichville, O.
 Columbus—State Eclectic Med. Assn., May 12-13. Dr. J. F. Wunst, 5th & Garfield sts., Dayton.
 Columbus—Woodmen of the World, May 12. C. Greiner, 381 Linwood ave.
 Columbus—Order of Amaranth, May 13. H. W. Gordon, 452 Kildahl place.
 Columbus—Royal Arcanum, May 13. C. H. Sawyer, Lancaster, O.
 Columbus—State Fed. Music Clubs, Apr. 20-24. Mrs. E. Kelly, Western College, Oxford, O.
 Dayton—Assn. Adv. Clubs, Dist. No. 5, March 9-10. A. W. Neally, 711 Sav. & Tr. Bldg.
 Marion—Daughters of Amer. Revolution of Ohio, March 10-13. Mrs. Claude H. Thompson, 2835 Burnet ave., Cincinnati.
 Middletown—Knights of Columbus, May —, J. P. Duffy, 143 E. 11th st., Columbus, O.
 Toledo—Rebekah State Assembly, May 13. Mrs. E. M. Bell, 75 Maynard ave., Columbus.

OKLAHOMA

Cushing—R. & S. Masters, Apr. 21. W. E. Caruth.
 Enid—Rotary Clubs, Dist. No. 12. Apr. 13-14. Art Stephenson.
 McAlester—Junior Order, March 3. C. Briggs, Box 166, Wilburton, Ok.
 Muskogee—State Retail Jewelers' Assn., Third week in April. Carol Roundtree, Shawnee, Ok.
 Norman—Old Fellows' Encampment, May 18-19. H. A. Herwig, Box 704, Guthrie, Ok.
 Oklahoma City—State Utilities Assn., March 10-12. E. F. McKay.
 Oklahoma City—Assn. of Optometrists, Apr. —, Dr. E. B. Alexander, Box 336, Duncan, Ok.
 Oklahoma City—State Dental Soc., Apr. —, Dr. A. B. Walker, Norman, Ok.
 Oklahoma City—State Sunday School Assn., Apr. 11-16. J. S. Peter, 1328 E. Eighth st.
 Oklahoma City—State Pharm. Assn., May 12. H. S. Shufeldt, Wynnewood, Ok.
 Oklahoma City—Knights Templars, May 19-20. G. W. Spencer, Masonic Temple.
 Okmulgee—Pythian Sisters, May 12. Delphine Jones, 221 Prisco st., Tulsa, Ok.
 Oklahoma City—State Veterinary Medical Assn., March 2-3.
 Oklahoma City—Phi Gamma Delta Frat., March 7.
 Oklahoma City—State Retail Clothiers' Assn., March 16-17.
 Oklahoma City—Eighty-Niners' Reunion, April 29.
 Ponca City—Soc. of Ok. Indians, May 18-24. J. G. Sanders.
 Tulsa—State Med. Assn., May —, Dr. C. A. Thompson, 508 Com. Nat'l. Bk. Bldg., Muskogee.
 Tulsa—Knights of Columbus, May 4-6. A. R. Russell, 515 S. 3rd st., Muskogee, Ok.
 Tulsa—State Bankers' Assn., May 26-27. E. P. Gunn, 907 Colcord Bldg., Oklahoma City.

OREGON

Ashland—Old Fellows' Encampment, May 19. E. E. Sharon, 10th & salmon sts., Portland.
 Ashland—Rebekah State Assembly, May 19. Mrs. Ora Casper, 402 Hayer st., Dallas, Ore.
 Portland—B. A. Masons, Apr. 13. Jas. F. Robinson, 719 Corbett Bldg.
 Portland—R. & S. Masters, Apr. 14. J. H. Richmond, 115 E. 33d st.
 Portland—Rotary Clubs, Apr. 23-24. M. M. Higley, 317 S. Howard st., Spokane, Wash.
 Portland—Foresters of America, May 17. P. F. Schweber, Court House, Astoria, Ore.
 Salem—State Jewelers' Assn., May 11-12. F. M. French, Box 217, Albany, Ore.
 Salem—Bro. of American Yeomen, Apr. 8. Soren Sorenson, Astoria, Ore.

PENNSYLVANIA

Altoona—Ladies of Oriental Shrine, Apr. 27-30. Mrs. J. R. Summers, 85 Maryland ave., Wheeling, W. Va.
 Bethlehem—Ass. Adv. Clubs, May 11-12. P. V. Barrett, Scranton, Pa.
 Gettysburg—Bro. of America, May 12. J. Kohl, 2410 Frankford ave., Philadelphia.
 Harrisburg—State Fed. of Labor, May 12-15. J. E. Kelly, 430 North st.
 Harrisburg—Knights Templars, May 25-27. A. H. Thomas, Masonic Temple, Philadelphia.
 Lancaster—Rotary Clubs, Apr. 3-4. Eugene Andes.
 Philadelphia—Lumbermen's Exchange, March 5. J. H. Lank, 301 Crozier Bldg.
 Philadelphia—State Trade Secretaries Assn., March 27-28. F. Rees, 2005 Finance Bldg.
 Philadelphia—Nat'l Assn. Hosiery Assn., Apr. 3. J. N. McCallough, 331 W. Fourth ave., New York City.
 Philadelphia—Eastern Com'l Teachers' Assn., Apr. 9-11. F. A. Tibbets, Dickinson High School, Jersey City, N. J.
 Philadelphia—American Philosophical Soc., Apr. 23-25. A. W. Goodspeed, Univ. of Pennsylvania.
 Philadelphia—Relay Race Carnival, Apr. 24-25. Wm. W. Orton, 4301 Walnut st.
 Philadelphia—Amer. Academy Political Science, May 15-16. Dr. J. P. Leichtenberger, 30th & Woodland ave.
 Philadelphia—Needwork Guild of America, Apr. 30-May 2. Miss R. Berder, 133 S. 12th st.

Reading—State Dental Soc. May 5-7. A. C. Hargrave, 211 Highland Bldg., Pittsburgh.
 Pittsburgh—Theta Chi Frat. Apr. 16-18. F. W. Ladue, 110 E. 42d st., New York City.
 Scranton—Knights of Golden Eagle, May 12. L. L. Gallagher, 814 N. Broad st., Philadelphia.
 Scranton—Ladies of Golden Eagle, May 12-14. Mrs. E. F. Logan, 814 N. Broad st., Philadelphia.
 Scranton—Order of Americans, May 5-6. Geo. W. Shaffer, 101 W. Douglas st., Reading, Pa.
 Williamsport—Knights of Malta, May 12. J. H. Hoffman, 405 Elmer Bldg., Harrisburg.
 Williamsport—Rotary Clubs, Apr. 7-8. R. W. Scott.

RHODE ISLAND

Newport—Knights of Columbus, May 12. W. P. Nolan, 201 Admiral st., Providence.
 Providence—Woodmen of Amer., May —. Geo. J. Vignault, Box 132, Pawtucket, R. I.
 Providence—Knights of Pythias, May 19. C. H. Snow, 345 Butler Ex.
 Providence—Order of Amer., May 28. F. H. Bellin, 209 Indust. Tr. Bldg.
 Providence—Auto. Dirs., Assn., Apr. 7. R. P. Lord, 617 Indust. Tr. Bldg.
 Providence—Rebekah State Assembly, Apr. 9. Mrs. C. A. Aldrich, 43 Violet st.
 Providence—N. E. Order of Protection, Apr. 15. R. W. Syddall, 53 Lupine st., Pawtucket, R. I.
 Providence—Royal Arcanum, Apr. 23. Chas. M. Bishop, 107 Westminster st.
 Providence—Sons of Veterans, Apr. 21. E. B. Wright, 47 Wash. st.
 Providence—Order of Odd Fellows, May 5. K. H. Wilson, 86 Weybosset st.

SOUTH CAROLINA

Charleston—Lodge of Masons, March 11. O. Frank Hart, Columbia, S. C.
 Charleston—State Sunday School Assn, Apr. 11. L. C. Palmer, Montgomery Tr. Co. Bldg., Spartanburg.
 Charleston—Order of Odd Fellows, May 12. S. F. Killingsworth, Columbia, S. C.
 Columbia—Junior Order, Apr. 21-22. E. J. Hisey, Box 794, Charleston, S. C.
 Greenville—State Elks Assn, May —. H. E. Cochran, Box 163, Anderson.
 Spartanburg—State Medical Assn, Apr. 21-23. Dr. E. A. Hines, Seneca, S. C.
 Spartanburg—R. A. Masons, Apr. 11. O. F. Hart, Columbia, S. C.

SOUTH DAKOTA

Huron—Order United Workmen, May 26. Henry Nell, Aberdeen, S. D.
 Sioux Falls—Sunday School Assn, May 19-21. Jay B. Allen.

TENNESSEE

Chattanooga—G. A. R. Encampment, May 16. B. F. Bushor, R. D. 3, Knoxville, Tenn.
 Cleveland—Un. Daughters of Confederacy, May 18. Mrs. M. A. Martin, 1419 Goodbar ave., Memphis.
 Jackson—State Fed. of Labor, May 4-6. W. C. Birthwright, Labor Temple, Nashville.
 Knoxville—State Dental Soc., May 5-7. Dr. Jas. B. Jones, Murfreesboro.
 Knoxville—Daughters of Amer., May 14-15. Mrs. G. Bateman, 1011 W. Sharpe ave., Nashville.
 Lenoir City—Order of Red Men, May 19. C. R. Jackson, 820 18th ave., S., Nashville.
 Memphis—Western Arts Assn, May 5-8. R. T. Fell, Dayton & Baymiller sts., Cincinnati, O.
 Memphis—Un. Commercial Travelers, May 21-23. J. D. Hardin, 530 Pine st., Chattanooga.
 Memphis—Rotary Clubs, March 24-25. L. S. Akers, 225 Madison ave.
 Morristown—State Retail Jewelers Assn, Apr. 15-16. E. H. Murray, Pulaski, Tenn.
 Nashville—Royal Arcanum of Tenn, March 17. W. H. Gray, 910 Fatherland st.
 Nashville—State Medical Assn, Apr. 14-16. J. F. Gallagher, 420 Jackson Bldg.
 Nashville—Knights Templars, May —. S. M. Cain, Masonic Temple.

TEXAS

Amarillo—Panhandle Hardware & Impl. Assn, May —. C. L. Thompson, Canyon, Tex.
 Austin—State Medical Assn, May 5-7. Dr. H. Taylor, 207 W. 11th st., Ft. Worth.
 Austin—Retail Merchants Assn, May 15-20. A. Grasso, 112 W. Commerce st., San Antonio.
 Austin—Nat'l Congress of Parents & Teachers, Apr. 27-May 2. Mrs. A. C. Watkins, 1201 16th st., N. W., Washington, D. C.
 Austin—State Automotive Dirs. Assn, Apr. —. W. A. Williamson, Box 326, San Antonio.
 Beaumont—Lumbermen's Assn. of Texas, Apr. 1-3. J. C. Doane, 608 Carter Bldg., Houston.
 Beaumont—Knights Templar, May 5-7. J. C. Kald, Box 211, Houston, Tex.
 Brownwood—Knights of Pythias, May 12. H. Miller, Box 314, Weatherford, Tex.
 Dallas—Un. Confederate Veterans, May 19-22. J. P. Barnard, 207 W. Chestnut st., Louisville, Ky.
 Dallas—American Hardware Mfrs. Assn., Apr. 23-24. F. D. Mitchell, 1819 Broadway, New York City.
 Dallas—State Cotton Ginners Assn, Apr. 11-12. C. B. Hunt, 3116 Commerce st.
 Denison—Order of Eagles, May 19-20. Wm. T. Souter, 122 Main ave., San Antonio.
 El Paso—Rotary Clubs, Dist. No. 13, Apr. 13-14. L. W. Dawley, Box 592, Paris, Tex.
 Ft. Worth—State Hereford Assn, March 10-12. John P. Lee, San Angelo, Tex.
 Ft. Worth—Royal Neighbors of Amer, March 17-18. Alma Beyer, 2413 Wash. ave., Houston, Tex.
 Galveston—Order of Red Men, May 26-27. R. E. Tompkins, Box 118, Hempstead, Tex.
 Houston—Woodmen of Amer., May —. C. Gallagher, 405 W. Hunt St., McKinney, Tex.
 Houston—Ass. Adv. Clubs, May 10-14. Jesse H. Neal, 353 Madison ave., New York City.
 Houston—State Bankers Assn, May 26-28. W. A. Philpot, Jr., Box 1447, Dallas.
 Houston—E. S. Good Roads Assn, Apr. 21-22. J. A. Bountree, 3200 Cliff rd., Birmingham, Ala.
 Mineral Wells—W. Tex. Chamber of Commerce, May 14-15. P. A. Whaley, Stamford, Tex.
 Navasota—Daughters of Republic, Apr. 21-22. Mrs. M. K. Cloud, 1601 Riverside Drive, Austin, Tex.
 San Antonio—Cattle Raisers Assn, March 17-19. E. B. Spiller, Stock Yards, Ft. Worth.
 San Antonio—State Pioneers, Apr. 29. Miss E. Bell, 404 W. Laurel st.
 San Antonio—Sheet Metal Contractors Assn, April 23-24. Geo. Duinzig, care Duinzig Sheet Metal Works.
 San Antonio—American By Development Assn, May 13-15. H. M. Madison, care S. A. & A. P. B. E.

San Antonio—State Nurses Assn, May 6-9. Miss A. Taylor, Woodlawn 172.
 San Antonio—State Dental Assn, May 19-21. Mr. Kyle, care St. Anthony Hotel.
 San Antonio—Woodmen of the World, April 7-9. John J. Wahl.
 Tyler—In Commercial Travelers, May 14-16. W. P. Gilbert, Drawer 43, Waco, Tex.
 Tyler—State Press Assn, May 20-23. Samuel P. Harben, Richardson, Texas.
 Waco—State Assn. of Carpenters, May 13. R. E. Roberts, Box 1313, Dallas.
 Wichita Falls—Order of Odd Fellows, March 16. E. Q. Vestal, 312 N. Texas Bldg., Dallas.

UTAH

Park City—Knights Templars, May 12. H. G. Blumenthal, 474 W. Center st., Provo, Utah.
 Salt Lake City—Order of Odd Fellows, May 19. W. N. Gandy, care I. J. O. F. Temple.
 Salt Lake City—Rebekah State Assembly, May 19. Mrs. C. I. Almont, 543 4th st.

VERMONT

Bellows Falls—N. E. Order of Protection, Apr. 28. C. A. Spier, Barre, Vt.
 Brattleboro—Knights Templars, May 23-26. H. H. Rose, Burlington, Vt.
 Burlington—State Dental Soc., March 18-20. Carter R. Woods, Rutland, Vt.
 Essex Junction—Knights of Pythias, May 27. F. A. Whitaker, Bellows Falls, Vt.

VIRGINIA

Danville—Order of Red Men, May 20-21. A. M. Tennis, Box 485, Hampton, Va.
 Norfolk—Order of Odd Fellows, May 11-13. T. W. Davis, Jr., 401 Lyric Bldg., Richmond.
 Norfolk—North Carolina Pine Assn, March 29. J. M. Gibbs, 1203 Nat'l Bk. of Commerce.
 Norfolk—Rebekah State Assembly, May 12-13. Mrs. O. L. Hinch, 1114 16th st., Lynchburg.
 Richmond—State Wholesale Grocers Assn, Apr. —. W. P. Johnson, 304 Broadway Nat'l Bk. Bldg.
 Richmond—Nat'l League of Women Voters, Apr. 15-22. Eliz. J. Hauser, Girard, O.
 Richmond—Order Fraternal Americans, Apr. 21-22. J. R. Mansfield, 106 N. Pitt st., Alexandria, Va.
 Richmond—American Psychiatric Assn, May 12-15. Dr. E. D. Bond, 4401 Market st., Philadelphia, Pa.
 South Norfolk—Daughters of Amer., May 19. Mrs. M. Daywalt, 2928 Baulbridge st., Richmond.
 Skyland—Nat'l Conference on State Parks, May 25-28.

WASHINGTON

Seattle—Order United Workmen, Apr. 8-10. J. H. Honer, 1409 Ninth ave.
 Spokane—Sunday School Assn, May 19-20. E. C. Knapp, 426 Peyton Bldg.
 Spokane—Order of Red Men, May 19-20. H. R. Isherwood, 1174 Arcade Bldg., St. Louis.
 Spokane—Inland Empire Teachers Assn, Apr. 8-10. Supr. J. A. Burke, Garfield School.
 Tacoma—State Bottlers Assn, March 5-6. F. L. Schuller, Ellensburg, Wash.
 Wenatchee—Woods of Amer., May 5.

WEST VIRGINIA

Charleston—Rotary Clubs, Apr. 21-22. Roy Hunte, Morgantown, W. Va.
 Huntington—Order of Red Men, May 12. T. H. Clay.
 Martinsburg—Knights Templars, May 29-31. Henry F. Smith, Box 336, Fairmont, W. Va.
 Wheeling—Shield of Honor, Apr. 23. F. W. Doyle, 2242 Chauncy st.

WISCONSIN

Eau Claire—State Ret. Jewelers Assn, May —. A. M. Anderson, Neenah, Wis.
 Green Bay—Bro. of American Yeomen, Apr. S. C. A. Willis, 620 Fifth st., Eau Claire, Wis.

Lorain—Rotary Clubs, Dist. No. 10, Apr. 28-29. P. F. Hunter, 11 Tinney Bldg., Madison, Wis.
 Madison—Travelers Protec. Assn, Apr. —. C. W. Constatine.
 Milwaukee—Royal Arcanum, Apr. 29. C. D. Simonds, 85 Oneida st.
 Milwaukee—American Rot. Bakers Assn, May —. J. M. Hartley, 10 S. LaSalle st., Chicago.
 Milwaukee—American Soc. Mechanical Engrs, May 18-23. C. W. Rice, 29 W. 39th st., New York City.
 Milwaukee—M. P. Theater Owners of Amer., May 12-14. S. S. Cohen, Fitzgerald Bldg., New York City.
 Milwaukee—State Assn. Stationary Engrs, May 18-22. F. W. Horn, 256 29th st.
 Milwaukee—Sunday School Assn, Apr. 22-25. Dr. C. Manshardt, 308 N. Michigan ave., Chicago, Ill.
 Milwaukee—Amer. Soc. Refrigerating Engrs, May 18-23. Wm. H. Ross, 35 Warren st., New York City.
 Milwaukee—Nat'l Assn. Purchasing Agents, May 25-30. W. L. Chandler, 19 Park place, New York City.
 Stevens Point—Knights of Columbus, May 25-27. E. J. Carrigan, 1309 Majestic Bldg., Milwaukee.

WYOMING

Greybull—Bro. of American Yeomen, Apr. 9. Homer Loucke, Sheridan, Wyo.

CANADA

Charlottetown, P. E. I.—Orange Lodge of P. E. I. March 11. W. W. Muttart, Box 67, Summerside.
 Edmonton, Alta.—Orange Lodge of Alta, March 31-19. W. L. Hall, 1610 15th ave., W., Calgary.
 Hamilton, Ont.—Canadian Fraternal Assn, May —. W. F. Montague, Drawer 349, Hamilton.
 London, Ont.—Royal Arcanum, Apr. 15. C. H. Canfield, 49-B Metcalfe st., Ottawa.
 London, Ont.—Rotary Clubs, March 19-20. P. H. King, 906 Majestic Bldg., Detroit, Mich.
 Montreal, Que.—Boot & Shoe Workers Union, May 18-25. C. L. Baine, 246 Summer st., Boston, Mass.
 Moose Jaw, Sask.—Order Eastern Star, May 13-14. Mrs. V. M. Reilly, 1548 Garnet st., Regina.
 North Bay, Ont.—Orange Lodge of Ontario, West, March 11. W. M. Fitzgerald, 39 Browning ave., Toronto.
 Ottawa, Ont.—Orange Lodge of Ontario, East, March 18. D. J. Sutherland 147 Flora st.
 Ottawa, Ont.—Canadian Inst. of Mining, March 4-6. G. C. MacKenzie, 604 Drummond Bldg., Montreal, Que.
 Quebec, Que.—Rotary Clubs, March 28. E. R. Weeks, 75 Collier st., Binghamton, N. Y.
 Revelstoke, B. C.—Order of Odd Fellows, May 10. F. D. Dayer, 1323 Douglas st., Victoria.
 Saskatoon, Sask.—Rotary Clubs, Apr. 20-21. J. W. Davidson, 713 Herald Bldg., Calgary, Alta.
 St. John, N. B.—Orange Lodge of N. B., Apr. 15-16. W. H. Sullis, 232 Britain st.
 Toronto, Ont.—Canadian Home Circle, March 15. M. Foster, Confed. Life Bldg.
 Toronto, Ont.—Educational Assn, Apr. 13-16. W. M. Morris, 1214 Lansdowne ave.
 Vancouver, B. C.—Orange Lodge of B. C., May 26. Wm. Lee, 55 Queen st., E. Toronto, Ont.
 Winnipeg, Man.—Orange Lodge of Man, March 11. S. B. Meredith, Box 1048.
 Winnipeg, Man.—Order United Workmen, March 18-19. G. Clark, 205 McIntyre Bldg.
 Winnipeg, Man.—Order of Odd Fellows, March 11. B. D. Deering, I. O. O. F. Temple.
 Winnipeg, Man.—Rebekah Assn., March 11. Mrs. A. Coyle, 122 Ruby st.
 Yarmouth, N. S.—Rotary Clubs, Apr. 28-29. Karl W. Baker.

United Lyceum Bureau, 8 E. Broad st., Columbus, O.; Robt. E. Ferrante, mgr.
 Western Lyceum Bureau, 801 Blackhawk Bank Bldg., Waterloo, Ia.; W. I. Atkinson, mgr.
 White Entertainment Bureau, 100 Boylston st., Boston, Mass.; K. M. White, pres.-mgr.
 White, J. S., Lyceum Agency, Railway Exchange Bldg., Kansas City, Mo.; J. S. White, pres.; Moreland Brown, mgr.

UNIVERSITY EXTENSION LYCEUM

University of Kansas, Extension Division, Lawrence, Kan.; H. G. Ingram, director.
 University of Minnesota, Extension Division, Minneapolis, Minn.; L. J. Seymour, secy.
 University of Wisconsin, Extension Division, Madison, Wis.; R. B. Duncan, secy.
 University of North Dakota, Extension Division, Grand Forks, N.D.; A. H. Yoder, secy.

INDEPENDENT CHAUTAUQUA BUREAUS

Coit-Alber Independent Chautauqua Company, 830 Orchestra Bldg., Chicago, Ill.; O. B. Stephenson, secy.-treas.
 Co-Operative Chautauquas, 705 S. Center st., Bloomington, Ill.; James H. Shaw, pres.; A. P. Laughlin, vice-pres.; Ruth H. Shaw, secy.
 Loar Independent Co-Operative Chautauquas, Bloomington, Ill.; Jas. L. Loar, mgr.

CIRCUIT CHAUTAUQUAS

Aime Chautauqua System, Hubbell Bldg., Des Moines, Ia.; W. S. Rupe & Helen H. Sloan, mgrs.
 Cadmean Chautauqua Assn., 310 Crawford Bldg., Topeka, Kan.; C. Benj. Franklin, pres.; E. W. Carson, gen. mgr., Champaign, Ill.; Ralph W. Scuire, dir.
 Central Community Chautauqua System, 28 W. North st., Indianapolis, Ind.; Loring J. Whiteside, pres.; Harry Z. Freeman, gen. mgr.
 Civic Chautauqua Festival Assn., 28 W. North st., Indianapolis, Ind.; Harry Z. Freeman, gen. mgr.
 Community Chautauqua Inc., Church and Grove streets, New Haven, Conn.; Loring J. Whiteside, gen. mgr.; Cary H. Turner, asst. gen. mgr.
 Dominion Chautauquas, 410 Burns Bldg., Calgary, Alberta, Canada; J. M. Erickson, mgr.
 Ellison-White Chautauqua System, 333 E. 10th st., North Portland, Ore.; J. R. Ellison, gen. mgr.
 Ellison-White South Sea Chautauquas, Box 459, Auckland, New Zealand; M. E. Paget, mgr.
 International Chautauquas, Bloomington, Ill.; Jas. L. Loar, mgr.
 Midland Chautauqua Circuit, 911-12 624 S. Michigan ave., Chicago; Nelson Trimble & Robt. L. Myers, mgrs.
 Mutual Chautauqua System, 632 McCormick Bldg., Chicago; Frank A. Morgan, pres.; Glen MacCaddam, sales mgr.
 Radcliffe Chautauqua System, 905-907 Sixteenth st., N. W., Washington, D. C.; W. L. Radcliffe, gen. mgr.
 Redpath Chautauquas, Kimball Bldg., Chicago, Ill.; Harry P. Harrison, mgr.
 Redpath-Vawter Chautauquas, Cedar Rapids, Ia.; Keith Vawter, mgr.
 Redpath Chautauqua System, White Plains, N. Y.; C. A. Peffer, pres.
 Redpath Chautauquas, 55 S. Sixth st., Columbus, O.; W. V. Harrison, mgr.
 Redpath Horner Chautauqua, 3000 Troost st., Kansas City, Mo.; Chas. E. Horner, pres.
 Southern Chautauqua Assn., 514 Temple Court, Chattanooga, Tenn.
 Standard Chautauqua System, 328 S. 12th st., Lincoln, Neb.
 Swarthmore Chautauqua Assn., Swarthmore, Pa.; Paul M. Pearson, director.
 Toledo Chautauqua System, 807 National Bank Bldg., Toledo, O.; G. S. Chance, mgr.
 Travers Chautauquas, 327 Good Block, Des Moines, Ia.; Frank C. Travers, pres.
 United Chautauqua System, 321-327 Good Block, Des Moines, Ia.; Frank C. Travers, pres.; Ray D. Newton, gen. mgr.
 Western Welfare Chautauqua, Pierce City, Mo.; F. M. Price, pres. & gen. mgr.
 White & Myers Chautauqua System, Railway Exchange Bldg., Kansas City, Mo.; J. S. White, pres.; Moreland Brown, mgr.

TALENT AGENCIES AND ORGANIZERS OF LYCEUM COMPANIES

Ballantine Bureau, 909-10 Lyon & Healy Bldg., Chicago, Ill.; Saida Ballantine, mgr.
 Booth, C. E., Music Bureau, 1302 Auditorium Tower, Chicago, Ill.; C. E. Booth, mgr.
 Boston Lyceum School, 418-19-20 Pierce Bldg., Copley Square, Boston, Mass.; Harry Raymond Pierce, director.
 Bureau of Fine Arts, 425 Fine Arts Bldg., Chicago, Ill.; Jessie B. Hall.
 Chicago Musical Bureau, 904 Kimball Bldg., Chicago, Ill.; O. E. Todd, mgr.
 Ewyn Concert Bureau, J. R. Ellison, pres.; Oliver O. Young, vice-pres.; C. H. White, secy.-treas., 645 Everett st., Portland, Ore.
 Hewitt Bureau, 410 S. Michigan Blvd., Chicago, Ill.; Paul L. Armstrong and Jack Tobo, mgrs.
 Hineshaw Conservatory, 910 Kimball Hall, Chicago, Ill.; Marvin Hineshaw, director.
 Horner Institute of Fine Arts, 300 Troost ave., Kansas City, Mo.; Charles F. Horner, pres.; Karl Rosenber, director.
 International Entertainment Assn., 330 St. Peter st., New Orleans, La.
 Inter-Slate Conservatory, Dodge City, Kan.; Carl Albert Jesse, director.
 Lenco's International Musical Bureau, 28 Nichols st., Newark, N. J.; Anthony M. Lenco, pres.
 Lyceum Arts Conservatory, 1160 N. Dearborn st., Chicago, Ill.; Elias Day, director.
 Mears, Neil F., 1525 N. La Salle ave., Chicago, Ill.
 Miami Civic Bureau, 19 E. 4th st., Dayton, O.; J. R. Frew, mgr.
 Rea, Maude N., Bureau, 1525 Kimball Bldg., Chicago, Maude N. Rea, mgr.; John B. Miller and Ben Q. Tufts, directors.
 Runner, Louis O., 5527 W. Lake st., Chicago, Ill.
 Star Service, 5527 Lake St., Chicago, Ill.; G. G. Fisher, mgr.
 University School of Music and Other Fine Arts, Lincoln, Neb.; Adrian M. Newena, pres.; Thurlow Licence, director of music and company organizer.
 Whitney Studios of Platform Art, Suite 10, 58 Fenway, Boston, Mass.; Edwin M. Whitney, director.

HOME TALENT PRODUCERS

Adams Harrington, Inc., Elks Bldg., Fostoria, O. Harrington Adams, pres. & gen. mgr.
 (Continued on page 91)

Lyceum and Chautauqua Bureaus

In the United States and Canada

LYCEUM BUREAUS

Abbott Lyceum Bureau, Williamston, Mich.; C. Lawrence Abbott, mgr.
 Aime Lyceum Bureau, Hubbell Bldg., Des Moines, Ia.; W. S. Rupe, G. S. Chance, Helen H. Sloan, mgrs.
 Affiliated Lyceum and Chautauqua Assn., Inc., 2443 Prospect ave., Cleveland, O.; L. J. Alber, pres.; C. H. White, vice-pres.; T. A. Burke, secy.
 Alkabeth Lyceum System, Inc. Healy Bldg., Atlanta, Ga.; S. Russell Bridges, pres.; Howard L. Bridges, secy.-treas.
 Allen Lyceum Bureau, Lima, O.; Mrs. Sorensen, pres. and mgr.
 American Lyceum & Entertainment Bureau, 13 Park Row, New York, N. Y.; D. W. Robertson, mgr.
 Antrim Entertainment Bureau, 1001 Chestnut st., Philadelphia, Pa.; C. D. Antrim, pres. and mgr.; Chas. M. Sipple, secy.
 Brown Lyceum Bureau, Musical Art Bldg., Olive and Boyle sts., St. Louis, Mo.; Walter H. Brown, mgr.
 Cadmean Lyceum Assn., 310 Crawford Bldg., Topeka, Kan.; O. Benj. Franklin, pres.; E. W. Carson, gen. mgr.; Champaign, Ill.; Ralph W. Scuire, dir.
 Chicago Circuit Lyceum Bureau, 850 Orchestra Bldg., Chicago, Ill.; K. A. Migliario, mgr.; O. B. Stephenson, secy.-treas.
 Coit-Lyceum Bureau, 2443 Prospect ave., Cleveland, O.; L. J. Alber, pres.; T. A. Burke, gen. mgr.
 Coit-Alber Lyceum Bureau, 80 Boylston st., Boston, Mass.; Elbert A. Wickes, mgr.
 Coit-Nelson Lyceum Bureau, 722 Highland Bldg., Pittsburgh, Pa.; I. M. Nelson, mgr.
 Columbia Lyceum Bureau, Schloss Bldg., 1184 S. 8th st., St. Joseph, Mo.; J. A. Dillinger, gen. mgr.; Della Nash, secy.
 Continental Lyceum Bureau, 508-11 Walker Bldg., Louisville, Ky.; C. W. Hesson, gen. mgr.
 Dennis Lyceum Bureau, Wabash, Ind.; Leroy Dennis, mgr.
 Dixie Lyceum Bureau, 510 Wilson Bldg., Dallas, Tex.; M. C. Turner, mgr.
 Ellison-White Lyceum Bureau, 333 E. 10th st., North Portland, Ore.; C. H. White, gen. mgr.; Walter Ricks, bureau mgr.
 Emerson Lyceum Bureau, 860 Orchestra Bldg., Chicago, Ill.; O. B. Stephenson, mgr.

Emmerich Lecture Bureau, Inc., 1450 Broadway, New York, N. Y.
 Forrence Entertainment Bureau, Peru, N. Y.; V. H. Forrence, mgr.
 Feakins, Wm. B., Inc., Times Bldg., New York City, Wm. B. Feakins, pres.; Albert T. Perkins, secy.-treas.
 Gavin Lyceum Circuit, Quitman, Miss.; R. S. Gavin, pres.; D. W. Gavin, secy.
 Hoover, Florence Jennie, 800 Orchestra Bldg., Chicago, Ill.
 Interstate Platform Service, 911-12 624 S. Michigan ave., Chicago, Ill.; Robert L. Myers, mgr.; Nelson Trimble, associate mgr.
 Kuedick, Lee, Lyceum Bureau, 437 Fifth ave., New York, N. Y.; W. O. Glass, booking mgr.
 Leigh Lecture Bureau, 152 W. 78th St., New York, N. Y.; W. Colston Leigh, mgr.
 McDonald-Bryan Bureau, Inc., Asheville, N. C.; Solon H. Bryan, pres.; Marvin A. McDonald, vice-pres. and mgr.
 Minor Community Service, Baker-Deweller Bldg., Los Angeles, Cal.; Harry R. Minor, mgr.
 Mutual Lyceum Bureau, 632 McCormick Bldg., Chicago; Frank A. Morgan, pres.; Glen MacCaddam, sales mgr.
 National Lyceum System, Woodward Bldg., Washington, D. C.; Harry W. Brimer, pres.-mgr.
 Paramount Music & Lyceum Bureau, 1400 Broadway, New York City; Palmer Kellogg, mgr.
 Players, The, 162 Tremont st., Boston, Mass.; George W. Whipple, mgr.; George W. Britt, assoc. mgr.
 Pond Lyceum Bureau, 50 E. 42nd st., New York, N. Y.; Jas. B. Pond, Jr., mgr.
 Redpath Lyceum Bureaus: Kimball Hall, Chicago, Ill.; Harry P. Harrison, Boston, Mass.; White Plains, N. Y.; C. A. Peffer, 643 Wash Bldg., Pittsburgh, Pa.; George S. Bord, 55 E. Sixth st., Columbus, O.; W. V. Harrison; Kansas City, Mo.; Chas. F. Horner; 826 Electric Bldg., Denver, Col.; Arthur Oberfelder; Commerce Bldg., Rochester, N. Y.; G. Le-Roy Collins; Baker-Deweller Bldg., Los Angeles, Calif.; L. B. Crofty.
 Royal Lyceum Bureau, 303 E. Washington st., Syracuse, N. Y.; I. E. Parmenter, mgr.
 Star Lyceum Bureau, Tribune Bldg., New York, N. Y.; Thornton Webster and Frederick D. Walker directors.

ARMORIES, AUDITORIUMS AND CONVENTION HALLS SUITABLE FOR INDOOR EVENTS

Alabama - Gadsden-Armory, A. C. Herzberg, mgr. Montgomery-City Auditorium, W. A. Gunter, mgr. Tuscaloosa-Elks' Home, Herman Burchfield, mgr.

Arizona - Phoenix-Shrine Auditorium, H. B. St. Claire, mgr. Phoenix-Armory, Adj. Gen. Ingalls, mgr. Tucson-State Armory Bldg., Sgt. G. W. Myers, mgr.

California - Alameda-Neptune Beach Pavilion, R. C. Strebrow, mgr. Eureka-Auditorium, City Ry. Dept., mgr. Fresno-Civic Auditorium. Long Beach-Municipal Auditorium, S. F. Du Bois, mgr. Nevada-The Frolic, Robert Robinson, mgr. Oakland-Civic Auditorium. Pasadena-Armory, Capt. W. R. Jackson, mgr. Pomona-American Legion Hall, Howard C. Gates, mgr. Sacramento-Armory, Gen. J. J. Rorree, mgr. San Bernardino-Municipal Auditorium, Leo A. Strome, mgr. San Diego-Balboa Park Auditorium, Mrs. F. W. Haman, mgr. San Francisco-Exposition Auditorium, J. P. Donahue, mgr. Stockton-Civic Auditorium. Stockton-State Armory.

Colorado - Boulder-Armory, Frank Wolcott, mgr. Colorado Springs-City Auditorium, A. M. Wilson, mgr. Pueblo-Municipal Auditorium, Robert Ryan, mgr. Pueblo-City Auditorium, John M. Jackson, mgr.

Connecticut - Bridgeport-Colonial Hall, Daniel Quilty, mgr. Bridgeport-State Armory, Lieut. Richardson, mgr. Danbury-Hull's Armory, T. Clark Hall, mgr. Derby-Gould Armory, Charles Hart, mgr. E. Hartford-Comstock Hall, Lewis B. Comstock, mgr. Hartford-State Armory, George M. Cole, mgr. Hartford-Foot Guard Hall, Henry S. Ellis, mgr. Middletown-State Armory. Norwich-State Armory, Capt. W. R. Deason, mgr. Stamford-Elks' Auditorium. Waterbury-State Armory, Major James Hurley, mgr. Waterbury-Buckingham Hall, J. Sweeney, mgr. Waterbury-Temple Hall, Lymman Rich, mgr.

District of Columbia - Washington-Washington Auditorium, Louis J. Fosse, gen. mgr.

Florida - Jacksonville-Armory, Major William LeFills, mgr. Miami-Elmer Pler, Fred W. Maxwell, mgr. Tampa-Tampa Bay Casino (leased to Shriners, Egypt Temple).

Georgia - Albany-Municipal Auditorium, D. W. Broonan, mgr. Albany-Armory, D. W. Broonan, mgr. Athens-Moss Auditorium, W. L. Moss, mgr. Atlanta-Auditorium-Armory, R. A. Gordon, mgr. Macon-City Hall Auditorium. Rome-City Auditorium, O. C. Lam, mgr. Savannah-Volunteer Guards' Armory, Henry M. Buckley, mgr. Savannah-Municipal Auditorium, Louis Garfinkel, mgr.

Illinois - Bloomington-Coliseum, Fred Wolkan, Jr., mgr. Cairo-Armory Hall, Wilbur Thistlewood, mgr. Cairo-K. M. K. O. Hall, Bill Winter, mgr. Chicago-Armory, 122 E. Chicago ave., Lieut. Martin, mgr. Chicago-Broadway Armory, 5875 Broadway, Captain Baehus, mgr. Chicago-7th Inf. Armory, 31st and Wentworth, Captain Houston, mgr. Chicago-1st Reg. Armory, 16th and Michigan, Capt. Jas. P. Tyrrell, mgr. Chicago-Coliseum, 15th and Wabash ave., Chas. R. Hall, mgr. Chicago-Dexter Pavilion, 42d and Halsted, Union Stock Yards. Chicago-Municipal Pier, Henry J. Kramer, bus. mgr., 601 City Hall Sq. Bldg. Chicago-132d Inf. Armory, 2635 W. Madison St., Major Fred W. Leas, mgr. Danville-Armory, John D. Cole, mgr. Galesburg-Armory, Capt. R. W. Hinchliff, mgr. Keawee-Armory, Capt. E. B. Still, mgr. La Salle-Auditorium Ballroom, Wm. Jasper, mgr. Oregon-Coliseum, Carl M. Stroek, mgr. Peoria-Armory. Peotium-Fletcher's Hall, Harry W. Hall, mgr. Quincy-5th Inf. Armory, O. Irwin, mgr. Rock Island-American Legion Bldg., George L. Booth, mgr. Springfield-State Arsenal, General Black, mgr. Waukegan-Armory, Capt. Bradford West, mgr.

Indiana - Elkhart-Armory, James Morris, mgr. Elwood-Armory, Eric E. Cox, mgr. Evansville-Coliseum, Sam R. Bell, mgr. Huntington-Coliseum. Indianapolis-Cadle Tabernacle, E. H. Cadle, mgr. Indianapolis-Tomlinson Hall, Board of Works, City of Indianapolis, mgr. Kokomo-Armory, Capt. Fred Gover, mgr. Peru-Community Bldg., C. C. Hoag, mgr. Richmond-Coliseum, Herb Williams, mgr. Terre Haute-K. of C. Auditorium, W. H. Durner, mgr.

Iowa - Albia-Urban Auditorium, Happy Hi Hibbard, mgr. Clinton-Coliseum, Dr. Thos. B. Charlton, mgr. Council Bluffs-Auditorium, Geo. F. Hamilton, mgr. Council Bluffs-Dodge Light Guard Armory, Robt. Wallace Co., mgr. Davenport-Coliseum, G. G. Peterson, mgr. Iowa Moines-Coliseum, Alex. Fitzhugh, mgr. Dubuque-Armory, Kendall Burch, mgr. Ft. Dodge-Exposition Bldg., H. S. Stanbery, mgr. Ft. Dodge-Armory, Chamber of Commerce, mgr. Iowa City-Armory, Col. M. C. Mumma, mgr. Iowa City-Auditorium, Homer R. Dill, mgr. Keokuk-Battery A Armory, Mr. Dickinson, mgr. Mason City-Armory, Howard O'Leary, mgr. Muscatine-Armory, Bower & Brummer, mgr. Okaloosa-Armory, C. A. Stoddard, mgr. Sioux City-Auditorium, Geo. W. Dyer, mgr.

Kansas - Atchison-Memorial Hall, Claude Warner, mgr.

Coffeeville-Armory, Capt. Larry Lang, mgr. Hutchinson-Convention Hall, R. A. Campbell, custodian. Hutchinson-Armory, Guy C. Itzroad, mgr. Leavenworth-Sales Pavilion, E. M. Sichel, mgr. Independence-Memorial Hall Auditorium, R. R. Bittman, chairman. Parsons-Municipal Bldg. Topeka-Auditorium, Robt. McGiffert, mgr. Wichita-Forum, E. M. Stanton, mgr. Hopkinsville-Auditorium, H. L. McPherson, mgr. Louisville-Armory. Louisiana - New Orleans-Washington Artillery Hall. New Orleans-Labor Temple. Plaquemine-Hippodrome, G. A. Hagle, mgr. Shreveport-Coliseum, State Fair Grounds, W. R. Hirsch, mgr.

Maine - Auburn-Anbura Hall, J. Wilson, mgr. Bangor-The Auditorium, W. A. Hennessy, mgr. Bangor-Bowldrome, Chas. W. Morse, mgr. Bath-Armory Hall, Hiram T. Stevens, mgr. Waterville-Armory, Capt. I. E. Thomas, mgr.

Maryland - Annapolis-State Armory, Capt. D. J. Murphy, mgr. Baltimore-104th Medical Regt. Armory, Col. Fred H. Vluip, mgr. Baltimore-Moose Hall. Frederick-Armory, Major Elmer F. Munschower, mgr.

Massachusetts - Attleboro-Armory, Dr. J. A. Reese, mgr. Boston-Mechanics' Bldg., on Huntington ave., F. W. Easterbrook, supt. Boston-State Armory, on Howard St. Boston-Paul Revere Hall. Boston-Horticultural Hall. Cambridge-Cambridge Armory, Col. John F. Osborn, mgr. Chelsea-Armory, on Broadway, American Legion, mgr. Clinton-State Armory, Peter F. Connelly, mgr. East Boston-Music Hall. East Boston-Masonic Bldg., Samuel Susan, mgr. Fall River-Armory, John Cullen, mgr. Gardner-Town Hall, H. F. Holden, mgr. Gloucester-Armory, Merritt Alderman, mgr. Greenfield-State Armory, F. W. Pratt, custodian. Greenfield-Washington Hall, Chas. S. Barrett, mgr. Haverhill-Armory. Leominster-Auditorium, City Hall, R. L. Carter, mgr. Lowell-Memorial Auditorium, Collin H. MacKenzie, mgr. Malden-Auditorium, Wm. Niedner, mgr. New Bedford-Armory, Harold Winslow, mgr. Plymouth-Armory, Capt. Andrew Carr, mgr. Southbridge-Hippodrome, A. A. Blanchard, mgr. Springfield-U. S. Armory, Capt. Paul J. Norton, mgr. Springfield-Municipal Auditorium, H. L. Bonham, mgr. Worcester-Mechanics' Hall, C. H. Briggs, mgr.

Michigan - Alpena-Memorial Hall, Ed Saether, mgr. Bay City-National Guard Armory. Detroit-Light Guard Armory. East Saginaw-Auditorium, F. P. Walter, mgr. Grand Rapids-Coliseum, Geo. B. Zindel, mgr. Grand Rapids-Grand Rapids Armory, J. D. English, mgr. Kalamazoo-New Armory, Arthur H. Fitzgerald, mgr. Saginaw-Armory. Minnesota - Aitkin-Armory, Capt. J. A. Peturbury, mgr. Bemidji-New Armory, Wilbur S. Leach, mgr. Duluth-New Armory, Guy Eaton, mgr. Hibbing-Coliseum, Laurence Brown, mgr. Mankato-Richards Hall, J. B. Richards, mgr. Mankato-Mankato Armory, Capt. W. A. Sanborn, mgr. Minneapolis-Auditorium, Richard Horgan, mgr. Minneapolis-National Guard Armory. Rochester-Armory, Capt. R. M. Green, mgr. St. Cloud-Armory, Frank E. Lee, mgr. St. Paul-Auditorium, W. D. Bugge, mgr. Winona-National Guard Armory, Arthur J. Frey, mgr.

Mississippi - Jackson-Municipal Auditorium, Mabel L. Stire, mgr. Natchez-Memorial Hall, Miss Beatrice G. Perault, custodian. Missouri - Kansas City-Convention Hall, Louis W. Shouse, mgr. Kansas City-American Royal Live Stock Expo Bldg., F. H. Servatius, mgr. Kansas City-The Armory, Capt. Jerry F. Dugan, mgr. Springfield-Convention Hall, Mrs. H. L. McLaughlin, mgr. St. Louis-Coliseum, T. P. Bates, mgr. St. Louis-Armory. St. Joseph-Auditorium, H. G. Getchell, mgr. Sedalia-Coliseum, State Fair Grounds, W. D. Smith, secy. Sedalia-Convention Hall, F. F. Combs, mgr.

Montana - Great Falls-Live Stock Pavilion, L. E. Jones, mgr.

Nebraska - Grand Island-Liederkrantz Auditorium, C. Niemann, mgr. Grand Island-Columbian Hall, George Bauman, mgr. Hastings-Armory, Capt. L. E. Jones, mgr. Lincoln-City Auditorium (municipal owned). Omaha-Municipal Auditorium, Chas. A. Franke, mgr.

New Hampshire - Dover-Armory. Charlestown-Town Hall, Harry Eaton, mgr. Concord-Auditorium, D. J. Adams, mgr. Endfield Center-Town Hall, Willie J. Bernard, mgr. R. F. D. 3, Canaan, N. H. Grafton-Allen's Hall, Willie J. Bernard, mgr. R. F. D. 3, Canaan, N. H. Keene-Armory, F. E. Howe, mgr. Laconia-Armory, Capt. C. O. Anstin, mgr. Manchester-LeChateau. Portsmouth-Armory. Portsmouth-Freeman's Hall, Geo. Paras, mgr. West Springfield-Town Hall, Willie J. Bernard, mgr. R. F. D. 3, Canaan, N. H.

Willnot-Town Hall, Willie J. Bernard, mgr. R. F. D. 3, Canaan, N. H.

New Jersey - Asbury Park-Co. D Armory. Atlantic City-The Viola, Ward H. Kentner, mgr. Bridgeton-Armory, Reuben M. Husted, mgr. Elizabeth-Armory, Col. Wm. B. Martin, mgr. Gloucester City-City Hall Auditorium. New Brunswick-National Guard Armory. Passaic-Kanter's Auditorium, A. Kanter, mgr. Trenton-2d Regt. Armory, Major Stark. Trenton-Knights of Columbus Bldg., Thomas Major, secy.

New Mexico - Albuquerque-Armory, Sgt. Harry Claggett, mgr.

New York - Albany-10th Inf. Armory, Col. Chas. E. Walsh, mgr. Amsterdam-State Armory, Capt. Thomas F. Brown, mgr. Auburn-State Armory, Chas. M. Nevius, mgr. Auburn-Auditorium, Jas. A. Hennessy, mgr. Brooklyn-23d Regt. Armory. Buffalo-174th Regt. Armory. Buffalo-166th Field Art. N. G. Armory, Edward E. Holden, mgr. Colosse-Armory, Thos. J. Cowdry, mgr. Elmira-Armory, Capt. Rife, mgr. Gloversville-Armory, John Trumble, mgr. Hornell-Armory, Lieut. F. J. Piers, mgr. Jamestown-Armory, Capt. Brown, mgr. Middletown-Armory, Major J. A. Karschen, mgr. Mohawk-Armory, Capt. C. A. Carroll, mgr. Newburg-Armory, O. J. Cathcart, mgr. Newburg-Columbus Hall, James Grady, mgr. New York-Madison Square Garden. New York-71st Regt. Armory, Lieut. James E. Eben, mgr. New York-Grand Central Palace. New York-Roosevelt-25th Inf. Armory. Niagara Falls-Armory, Major Max H. E. E. Odenburg-Armory, C. A. Briggs, mgr. Utica-Armory, Van Simmons, mgr. Oneonta-Municipal Hall, Major C. C. Miller, mgr. Oneonta-Armory, Capt. Louis M. Baker, mgr. Oswego-State Armory, Fred T. Gallagher, mgr. Port Richmond, S. I., Staten Island-Coliseum, David Kandelberger, mgr. Poughkeepsie-Armory, Col. W. L. Burnett, mgr. Rochester-Convention Hall, W. E. Fannigan, mgr. Rochester-108th Inf. Armory, A. T. Smith, mgr. Saratoga Springs-Convention Hall, Comm. of Public Works, mgr. Saratoga Springs-Armory, Lieut. James H. How, mgr. Schenectady-State Armory. Syracuse-Armory. Tonawanda-Co. K Armory. Troy-Armory. Utica-State Inf. Armory, Major Thomas T. Dedell, mgr. Watertown-State Armory, Capt. Ned S. Howell, mgr.

North Carolina - Charlotte-City Auditorium. Raleigh-City Auditorium, Mayor of City mgr. Wilmington-Municipal Auditorium, James H. Cowan, mgr.

North Dakota - Fargo-Auditorium, W. P. Chestnut, mgr. Grand Forks-City Auditorium, C. J. Evanson, mgr. Ohio - Akron-Rose Hall, H. E. Mill St., Harry Armstrong, mgr. Akron-Music Hall, F. W. Schumacher, mgr. Akron-Auditorium-Armory, W. W. Price, mgr. Canton-City Auditorium, Director of Public Service, mgr. Cincinnati-Armory, Capt. Thompson, mgr. Cincinnati-Music Hall, John Graham, mgr. Cleveland-Public Auditorium, Lincoln G. Dickey, mgr. Dayton-Memorial Hall, Joseph Hirsch, mgr. Gallon-Armory, Capt. Fred B. Cleland, mgr. Hamilton-Moose Auditorium, Wm. J. Walsh, mgr. Lancaster-Armory, Ralph Melrose, mgr. Lima-Memorial Hall, G. R. Christia, mgr. Mansfield-The Coliseum, R. F. Cox, mgr. Portsmouth-Auditorium, C. M. Searl, mgr. Springfield-Memorial Hall. Toledo-Terminal Auditorium, Hugo V. Buelow, mgr. Toledo-The Coliseum, J. S. Bralley, mgr. Toledo-The Armory, Major E. W. Rydman, mgr. Warren-Armory Bldg. of 145th Inf., Lieut. Weltzel, mgr.

Oklahoma - Ardmore-Convention Hall. Enid-Convention Hall, Herbert G. Creekmore, mgr. Oklahoma City-Oklahoma Coliseum, W. R. Martineau, secy. Shawnee-Convention Hall. Tulsa-Convention Hall, J. F. Prothero, mgr. Tulsa-Nat'l Guard Armory, Major James A. Bell, mgr.

Oregon - Portland-Public Auditorium, Hsl M. White, mgr. Salem-Armory, Capt. Paul Hendricks, mgr.

Pennsylvania - Bethlehem-Coliseum, James Elliott, mgr. Butler-State Armory, Capt. James F. Leetch, mgr. Greensburg-Armory, Capt. Robt. Herbert, mgr. Harrisburg-Rendezvous Hallroom, Edw. I. Fishman, mgr. Harrisburg-Chestnut St Auditorium, D. F. Miller, mgr. Lancaster-Hiemenz Auditorium, John Hiemenz, mgr. Meadville-State Armory, Capt. Fred'k L. Pond, mgr. Milton-Regiment Armory, Capt. L. A. Gebett, mgr. Philadelphia-Commercial Museum, Dr. Wm. F. Wilson, mgr. Philadelphia-La Lu Temple, 1337 Spring Garden. Philadelphia-10th Field Artillery Armory. Philadelphia-3d Regt. Armory. Philadelphia-Olympic Arena, Leo Rains, mgr. Philadelphia-Moose Hall, Joseph McCann, mgr. Philadelphia-Second Regt. Armory. Philadelphia-First Regt. Armory.

Pittsburg-18th Regt. Armory. Pittsburg-Penn Armory. Pittsburg-Motor Square Garden. Pittsburg-Syria Mosque, J. W. Barber, secy. Plymouth-Armory, N. Kosenbender, mgr. Pottstown-Armory, W. E. Schuyler, mgr. Reading-Bach's Dancing Academy, 134-36 N. 5th St., Arthur H. Bach, mgr. Reading-Reading Armory, Capt. J. D. Eisenbrown, mgr. Shamokin-Moose Hall, Fred Frenk, mgr. Sharon-Armory, Capt. Thos. Price, mgr. Warren-Armory, Capt. Chas. G. Pearson, mgr. Wilkes-Barre-9th Regt. Armory, W. M. Speece, mgr. York-State Armory, Capt. Jos. E. Rice, mgr.

Rhode Island - Providence-Infantry Hall, Loula J. Bernhardt, mgr.

South Carolina - Spartanburg-Hampton Guard's Armory. South Dakota - Deadwood-Auditorium, owned by city. Hot Springs-Auditorium, E. L. Delaney, mgr. Mitchell-Corn Palace Auditorium, W. H. King, mgr. Sioux Falls-Auditorium, Geo. W. Burnside, mgr. Sioux Falls-Coliseum, Geo. W. Burnside, mgr.

Tennessee - Chattanooga-Soldiers & Sailors' Memorial Auditorium. Johnson City-Municipal Auditorium, W. B. Ellison, mgr. Memphis-Municipal Auditorium, Chas. A. McHenry, mgr. Nashville-Ryman Auditorium, Mrs. L. O. Nag, mgr.

Texas - Amarillo-Auditorium, city manager in charge. Amarillo-Texas National Guard Armory, Col. John B. Golding, mgr. Beaumont-Fair Park Auditorium, Geo. J. Hoark, mgr. Dallas-Coliseum at Fair Grounds. Ed Ft. Worth-Coliseum Bldg., Fair Grounds, Ed H. Henry, mgr. Galveston-City Auditorium, F. M. Owens, mgr. Houston-City Auditorium, John P. Morgan, mgr. Houston-Main Street Auditorium, A. E. Everts, mgr. San Antonio-Beethoven Hall, Mr. Altman, mgr. Waco-Cotton Palace Coliseum, S. N. Mayfield, mgr. Waco-Auditorium, C. J. Doerr, mgr.

Utah - Salt Lake City-Auditorium, J. Ernst Gillespie, mgr. Danville-Armory in Municipal Bldg. Newport News-American Legion Hall, Nelson Overton, mgr. Richmond-City Auditorium, Director of Public Safety, mgr. Richmond-Coliseum, Edw. Cowardin, mgr. Roanoke-Market Auditorium, R. E. Coleman, mgr.

Virginia - Everett-Armory, Major A. B. Cutter, mgr. Tacoma-Armory, Col. H. P. Winsler, mgr. Tacoma-Auditorium, E. M. Wesley, mgr. Yakima-Armory, Capt. W. E. Hoyer, mgr.

West Virginia - Huntington-City Hall Auditorium. Wheeling-City Auditorium.

Wisconsin - Appleton-Armory, Capt. F. W. Hoffman, mgr. Ashland-Armory, T. Thorsen, mgr. Eau Claire-Municipal Auditorium, Fred Radtke, mgr. Fond du Lac-Armory E, Chas. Froehling, Jr., mgr. La Crosse-Trades & Labor Temple, F. O. Wells, mgr. Marinette-Bay Shore Park Pavilion, Wm. Hasenau, mgr. Waukesha-Antheum, A. L. Steinert, mgr. Wausau-Rothschild Auditorium, Frank R. Whitney, mgr.

Wyoming - Casper-Moose Auditorium, O. N. Shogren, mgr.

Canada - Carman, Man.-Memorial Hall, A. Malcolmson, mgr. Chatham, N. B.-Dominion Armory, Capt. A. Duncan, mgr. Chatham, Ont.-The Armories, Col. Neil Smith, mgr. Estevan, Sask.-Town Hall, A. B. Stuart, mgr. Fredericton, N. B.-Armory, Col. H. M. Campbell, mgr. Inverness, N. S.-Labor Temple, Michael Ryan, mgr. Kamloops, B. C.-Kamloops Drill Hall, Col. J. R. Vicars, mgr. Lloydminster, Alta.-Town Hall, A. S. Pollard, mgr. Montreal, Que.-Armories. Montreal, Que.-Mount Royal Arena, Oscar Benoit, mgr. Oshawa, Ont.-Armories, Major F. C. Chappell, prop. Ottawa, Ont.-Canadian Government House. Peterborough, Ont.-The Armories, Col. A. W. McPherson, mgr. Prince Rupert, B. C.-Auditorium, L. J. Marren, mgr. Prince Rupert, B. C.-Exhibition Hall, J. Venable, mgr. Quebec, Que.-Convention Hall, B. A. Neale, mgr. Red Deer, Alta.-Armory. St. John, N. B.-Armory. Swift Current, Sask.-City Hall, Auditorium. Three Rivers, Que.-Market Hall. Toronto, Ont.-Massey Music Hall, Norman M. Withrow, mgr. Toronto, Ont.-Royal Coliseum. Toronto, Ont.-Palais Royale, J. W. Connell. Vancouver, B. C.-Manufacturers' Bldg., W. S. Nelson, mgr. Victoria, B. C.-The Armories, Col. F. Robertson, mgr. Winnipeg, Man.-Auditorium, Board of Trade. Winnipeg, Man.-Amphitheater, Billy Holmes, prop. Woodstock, N. B.-Armory. Woodstock, Ont.-Arena, Hy Sneath, mgr. Woodstock, Ont.-Armories, Col. F. Burgess.

RUBY FREE To introduce our imported Mexican BLUE-FLASH-GEM, the only low priced gem exactly matching genuine diamonds, with same blue-white brilliancy and rainbow fire, guaranteed 20 years, we'll send free this beautiful, flashing Ruby red Mexican Ruby. Just clip out this ad, mail with your name, address and 10c to partly cover handling cost and we'll mail FREE, with catalog of gems and special half price offer. Write today. Mexican Gem Importing Co., Dept. N85 Mesilla Park, N. Mex.

Where They Are Wintering

CIRCUSES AND WILD WEST SHOWS

App's, Emil, Great American Circus, Emil App, office address, 6324 Loomis Blvd., Chicago, Ill.

Atkinson's, Thomas Atkinson, mgr.: 237 27th St., San Francisco, Calif.

Atterbury's Trained Animal Circus, R. L. Atterbury, mgr.: Dakota City, Neb.

Barnes, Al G., Circus, Al G. Barnes, prop.: Barnes Circus City, Palms, Calif.

Buckskin Ben's Wild West: Cambridge City, Ind.

Campbell Bros. & Lucky Bill Shows, A. B. Campbell, mgr.: 922 E. 8th St., Ada, Ok.

Christy Bros., Wild Assembl Shows, Geo. W. Christy, mgr.: Beaumont, Tex.

Cole Bros. Shows, E. H. Jones, mgr.: Little Rock, Ark. (State Fairgrounds).

Cooper Bros. Shows, E. H. Jones, mgr.: Little Rock, Ark. (State Fairgrounds).

Dakota Max Wild West & Circus, Max T. Sanders, mgr.: Fairgrounds, Savannah, Ga. (office address, 1620 Hotel).

Country Bros.-James Patterson Circus, James Patterson, prop.: Paola, Kan.

Gollmar, Bros., Circus, C. J. Monahan, mgr.: Monroe Park, Mobile, Ala.

Great Bonham Shows, E. E. Bonham, mgr.: Fair grounds, Ladysmith, Wis.; offices, Lodi, Wis.

Great Keystone Show, Sam Dock, mgr.: Republic, Ia.

Hagenbeck-Wallace Circus, Dan Odum, mgr.: Peru, Ind.; offices, 709 Crilly Bldg., Chicago, Ill.

Hall Bros.' Trained Wild Animal Shows, Frank E. Hall, prop. and mgr.: 313 Queen St., Whiteawa, Wis.

Hatfield's Animal Show, Fred Hatfield, mgr.: 414 W. 18th St., Ada, Ok.

Horney's, C. R., Circus, Will Z. Smith, mgr.: 3003 Rowena, Los Angeles, Calif.

Ketrow Bros.' Circus, Wm. Ketrow, mgr.: Anderson, Ind.

LaMar Society Circus, James Cochran & Leslie Martin, mgrs.: 441 Wooster ave., Akron, O.

LaRoy's Overland Show, H. LaRoy, mgr.: 509 W. Town St., Columbus, O.

Leasia's, Frank W., One-Ring Circus, Frank W. Leasia, mgr.: Hamilton, Ore.; offices, 320 Burlington st., Portland, Ore.

Lee Bros.' Circus, G. W. Christy, prop.: Beaumont, Tex.

Lind Bros.' Motorized Circus: Fairbury, Neb.

Linger Bros.' Show, Harry & Paul Linger, mgrs.: Virgilia, Va.

Lowery Bros. Shows, George B. Lowry, mgr.: Shenandoah, Pa.

Lucky Dorsey Shows, Geo. P. Dorsey, mgr.: Dale, Ind.; offices, 54 S. Clover st., Poughkeepsie, N. Y.

Main, Walter L., Circus, King Bros., mgrs.: North Jackson st. and River Road, Louisville, Ky.

Mighty Hooge Trained Wild Animal Shows, Col. Wm. Hoogewoning, mgr.: 1303 E. Main St., Ottumwa, Ia.

Mighty Hoag Shows: Marianna, Fla.

Miller Bros.' 101 Ranch Wild West Show, Miller Bros., mgrs.: Marland, Okla.

Miller & Ayres Shows, A. Miller, mgr.: Sheboygan, Wis.

Miller's Dog & Pony Circus, Geo. A. Miller, mgr.: 921 Chester st., Eaton Rapids, Mich.

Miller's Society Circus, Obert Miller, mgr.: Smith Center, Kan.

Morgan's Nickel Plate Shows, W. E. Morgan, mgr.: Caldwell ave., Oakwood, Knoxville, Tenn.

Old Dominion Show, E. Keller Iseninger, mgr.: Funkstown, Md.

Orange Bros.' Circus: Ada, Ok.

Orton Bros.' Circus, Sarah B. Orton, prop.: Adel, Ia.

Penny's Wild West, Bill Penny, mgr.: 1831 Sherman st., Denver, Colo.

Perry Bros.' Shows, A. O. Perry, mgr.: Bassett, Neb.

Ringling Bros.-Barnum & Bailey Combined Shows, Ringling Bros., props.: Bridgeport, Conn.; general offices, 221 Institute Place, Chicago, Ill.

Robins Bros.' Circus, Fred Buchanan, prop.: Granger, Iowa.

Robinson, John, Circus, Sam Dill, mgr.: West Baden, Ind.; offices, 709 Crilly Bldg., Chicago, Ill.

Rodgers & Harris Circus: Jacksonville, Fla.

Rotax Bros.' Shows, Glenn Davis, mgr.: Metuchen, N. J.; office address, 351 E. 135th st., New York City.

Schulz Society Circus & Wild Animal Show: Round House, Fremont, O.

Sells-Sterling Circus: Fair Grounds, Plymouth, Wis.; general office, 504 South 14th st., Sheboygan, Wis.

Sells-Floto Circus, Zack Terrell, mgr.: Peru, Ind.; offices, 709 Crilly Bldg., Chicago, Ill.

Sparks' World-Famous Shows, Charles Sparks, prop.: Central City Park, Macon, Ga.

Taylor's Animal Circus, F. J. Taylor, prop.: Omaha, Neb. (Address care Taylor Grain Co.)

Texas Ranch Wild West & Animal Show, Geo. W. Christy, prop.: Beaumont, Tex.

Texas Bill's Wild West Show, Clyde E. Anderson, mgr.: 307 N. Vermont ave., Atlantic City, N. J.

Wilson-Arling Show, Billy Lindeman, mgr.: Fairgrounds, Plymouth, Wis.; office, 504 S. 14th St., Sheboygan, Wis.

CARNIVAL COMPANIES

All-American Amusement Co., B. E. Gardner, mgr.: Care General Delivery, Philadelphia, Pa.

All-American Shows, Nip Butts, mgr.: Hobart, Ok.

Al-Canadian Shows, J. W. Conklin, mgr.: Vancouver, B. C., Can.

American Expo Shows, Inc., M. J. Lapp, mgr.: Poughkeepsie, N. Y.; offices, 19 Hickory st., Ellenville, N. Y.

Anderson-Strader Shows: Great Falls, Mont. (Box 411).

Barkoot Shows, K. G. Barkoot, mgr.: DeFance, O.

Barkow's Big City Shows, Harold Barlow, mgr.: Granite City, Ill.

Beasley-Boucher Carnival Co., R. C. Beasley, mgr.: Navasota, Tex.

Bernard, Expo Shows, Felice Bernard, mgr.: Salt Lake City, Utah (address Gen. Del.).

Bernard Greater Shows, Wm. Glick, mgr.: Maryland Ship Yards, Baltimore, Md.; office address, Continental Hotel, New York City.

Blue Ribbon Consolidated Shows, C. L. Dingman, mgr.: St. Paul, Minn. (Box 91); office address, Spaulding Hotel, St. Paul.

Brown & Dyer Shows, Al J. Demberger, gen. mgr.: Poughkeepsie, N. Y. (Box 688).

Browning Amusement Co., W. F. Browning, mgr.: 810 S. 21st st., Salem, Ore.

Bruce Greater Shows, J. H. Bruce, mgr.: Scotland Neck, N. C.

Brundage Shows, Seth W. Brundage, mgr.: (Fair Grounds) Peoria, Ill. (R. R. No. 7).

Butler Midway Co., R. B. Butler, mgr.: 712 Commerce st., Wellburg, W. Va.

California Shows, Inc., H. F. Hall & Sam Anderson, props.: Northampton, Mass.; offices, 28 W. 15th st., New York City, and 35 Concord ave., Belmont, Mass.

Casadian Victory Shows, Maurice Nelsa, gen. mgr.: Offices, Room 61 Yonge St. Arcade, Toronto, Ont., Can.

Capital Outdoor Shows, Phil Isser, mgr.: Syracuse, N. Y.

Centanni Greater Shows, Mike Centanni & Mike Buck, mgrs.: 88 Fairmount Ave., Newark, N. J.

Chnesberg Shows, J. P. Chnesberg, mgr.: 101 Fourth St., Garden City, Kan.

Clark's Greater Shows, A. S. Clark, mgr.: 710 E. Jefferson st., Phoenix, Ariz.

Clinton Expo Shows, T. L. Snodgrass, mgr.: Gould, Ark.

Coman Bros.' Shows, Thomas & Richard Coleman, mgrs.: Portland, Conn.; offices, 520 High st., Middletown, Conn.

Copping, Harry, Shows, Harry Copping, mgr.: Reynoldsville, Pa.

Corenson's Shows, Sam Corenson, mgr.: 825 Sunset Blvd., Los Angeles, Calif.

Corey Greater Shows, E. S. Corey, mgr.: Harrisburg, Pa. (Address General Delivery.)

Cote Wolverine Shows, Elmer F. Cote, mgr.: 11728 Broad St., Detroit, Mich.

Cotton Belt Shows, W. H. Haines, mgr.: Pilot Point, Tex. (Box 293).

Crane Amusement Co., R. F. Searight, mgr.: 311 S. Grand ave., Eldorado Springs, Mo.

Cronin Shows, J. L. Cronin, mgr.: New Orleans, La.; offices, Chillicothe, O.

Crouse United Shows, Inc., J. F. Crouse, gen. mgr.: Altamont, N. Y.; office address, 17 Tremont Ave., Binghamton, N. Y.

Daglow Amusement Co., L. G. Daglow, mgr.: Pittsburgh, Pa. (Lock Box 245).

Dalziel Amusement Co., J. A. Dalziel, mgr.: Sarnia, Ont., Can. (Box 10).

DeKreko Bros.' Shows, Jean DeKreko, mgr.: 2520 Cottage Grove ave., Chicago, Ill.

Dixieland Show, J. W. Hildreth, mgr.: Helena, Ark.

Dohys, George L., Shows, Inc., George L. Dohys, pres.: (Fair Grounds) York, Pa.; direct mail to Port Richmond, N. Y.

Dodson's World's Fair Shows, C. G. Dodson, mgr.: Pleasure Pier, Port Arthur, Tex.

Dreamland Expo Shows, Dave Rose, mgr.: offices, 1493 Broadway, room 303, New York, N. Y.

Dykman-Joyce Shows: Augusta, Ga.

Eastern States Attractions, Roy Belanger, mgr.: North Adams, Mass. (Berkshire Hotel).

Ehring Amusement Enterprises, Frederick Ehring, mgr.: 152 Musgrove st., Clinton, S. C.

Electric City Shows, Ernest A. Wanmer, mgr.: 159 Clinton St., Schenectady, N. Y.

Ellman Amusement Co., Chas. Ellman, mgr.: 1218 Kneeland ave., Milwaukee, Wis.

Enterprise Shows, H. H. Dreihelbels, mgr.: Box 221, Warren, Ill.

Evans, Ed A., Shows, Ed A. Evans, mgr.: Boone, Ia.

Farrell's United Shows: Hudson Heights, N. J.

Fields Greater Shows, J. C. Fields, mgr.: Stevens Point, Wis.

Fleming, Mad Cody, Shows, Mad Cody Fleming, mgr.: 26 Central ave., Cincinnati, O.

Foley & Burk Shows: office address, 603 Humboldt Bank Bldg., San Francisco, Calif.

Fox Bros.' Attractions: Carson, Me.

Francis, John, Shows, John Francis, gen. mgr.: Ft. Worth, Tex. (Box 414).

G. F. & A. Fair Shows, Thos. P. Littlejohn, mgr.: Valdosta, Ga. (Box 611).

Gerard's Greater Shows, Chas. Gerard, mgr.: office address, 1493 Broadway, Room 414, New York, N. Y.

Gold Medal Shows, Harry E. Billicek, mgr.: 6th & Kaw River, Kansas City, Kan.

Golden Rule Show, L. W. Leesman, mgr.: 702 Walnut st., Texarkana, Ark.

Great White Way Shows, C. M. Nigro, mgr.: Gen. Del., Nitro, W. Va.

Great Pacific Shows, Billie C. Martin, owner-mgr.: Madisonville, Ky.

Greater Sheesley Shows, John M. Sheesley, mgr.: Alexandria, Va.; office address, Hotel Raleigh, Washington, D. C.

Gray Shows, Roy Gray, mgr.: 317 Crawford St., Houston, Tex.

Hazelman's United Shows, Dirk & Hazelman, owners: 123 Green st., Philadelphia, Pa.

Happlyland Shows, Guy Y. Averill, mgr.: 2432 Michigan ave., Detroit, Mich.

Harding, C. R., Shows, C. R. Harding, mgr.: 1343 Hutton St., Des Moines, Ia.

Heller's Acme Shows, Harry Heller, mgr.: 84 Fair st., Paterson, N. J.

Heth Shows, L. J. Heth, mgr.: North Birmingham, Ala.

Herman's Mighty Expo., Howard Herman, mgr.: Williamsport, Pa.; office address, Altoona, Pa. (Box 568).

Home Celebration Shows, Edward Oliver, pres.: office address, 305 Ouray Bldg., Washington, D. C.

Imperial Expo Shows, W. J. (Doc) Ralston, mgr.: Barcherton, O.

International Amusement Co., A. R. Lavelle, mgr.: Lyneate St., Bechtel, Mich.; offices, 297 Detroit Savings Bank Bldg.

Islar Greater Shows, Louis Islar, mgr.: Chapman, Kan.

Jones' Greater Shows, A. H. Jones, mgr.: Danville, Ky.

Johns, Johnny J., Expo., Johnny J. Jones, prop.: Orlando, Fla.

Joyland Expo. of Rides, Joe Steinberg & Joe Zottler, mgrs.: Oklahoma City, Ok. (Address Victoria Hotel).

Kelle Grady Shows: Birmingham, Ala. (Box 1464).

Kennedy, Con T., Shows: Gretna, La.

Ketchum's 29th Century Shows, K. F. Ketchum, mgr.: 131 E. 16th st., Paterson, N. J.

Keystone Expo Shows, Mechanic & Gruberg, mgrs.: 1827 E. Cambria St., Philadelphia, Pa.

Kline, Abner K., Shows, Abner K. Kline, mgr.: Lodi, Calif.

Knickelbocker Shows, Maurice B. Lagg, mgr.: offices, care Museum, 1731 E. 9th st., Cleveland, O.

Krause Amusement, Leroy Krause, mgr.: Lansdale, Pa.

Krause Greater Shows, George H. Krause, prop.: Milton, Pa.

Lachman Expo Shows: Omaha, Neb.

Lang's, Frank E., Northern Exposition Shows: St. Paul Minn. (Box 18).

Lapp's, M. J., Greater Shows, M. J. Lapp, mgr.: 19 Hickory St., Ellenville, N. Y.

Lalip's, Capt., Rides, Capt. Lathip, mgr.: 209 Elm St., Charleston, W. Va.

Lavoie Attractions, A. R. Lavoie, mgr.: Ly-caste St., Detroit, Mich.; offices, 507 Detroit Savings Bank Bldg.

Leggette, C. R., Shows: Lock Box 167, McGehee, Ark.

Levitt-Brown-Huggins Shows: Seattle, Wash.

Lippa Amusement Co., Leo Lippa, mgr.: Box 263, Alpena, Mich.; general offices, Hotel Normandie Hotel, Detroit, Mich.; branch office, American Bond & Mortgage Bldg., Room 1508, Chicago, Ill.

Litts Amusement Co.: Cairo, Ill.

Loos, J. George, Shows, J. George Loos, mgr.: Ft. Worth, Tex.

Lottridge, Harry, Amusements, Harry Lottridge, mgr.: Sarnia, Ont., Can. (Box 215).

McCaslin's Peerless Shows, John T. McCaslin, mgr.: Govans, Md.; offices, 123 E. Baltimore st., Baltimore, Md.

McClellan Shows, J. T. McClellan, mgr.: Excelsior Springs, Mo.

McKellar, Jas. I., Shows: Appleby, Tex.

McMahon Shows, T. W. McMahon, mgr.: Marysville, Kan.

Macgregor's, Donald, Shows, Donald Macgregor, mgr.: Armstrong's Tractor Bldg., Sweetwater, Tex.

Macy's Expo Shows, Mrs. Leona Macy, mgr.: 541 S. 17th st., Reading, Pa.

Maple Leaf Shows, W. J. Malcolm, mgr.: St. Catharines, Ont., Can. (Box 438).

May & Dempsey Shows, E. C. May & Wm. Dempsey, mgrs.: address, Apt. 32, 3507 Lincoln ave., Detroit, Mich.

Max's Expo Shows, Max Goldstein, mgr.: 1053 Dunbar ave., Forest Park, Ill.

Metro Bros.' Shows, Chas. Metro, mgr.: Boston, Mass. (Address care The Billboard, Boston).

Michaels Bros.' Expo. (Colored) Shows: 552 Lenox ave., New York City.

Miller Bros.' Shows, Morris Miller, mgr.: (Fair Grounds) Savannah, Ga.

Mimic World Shows: Gen. Del., Beaumont, Tex.

Miner's Model Shows: 161 Chamber st., Philadelphia, N. J.

Monarch Greater Shows, Irvin D. Baxter, mgr.: Allentown, Pa.

Morasia Circus & Bazaar Co.: 55 Rock st., Shamokin, Pa.

Morris & Castle Shows, Milton M. Morris & John R. Castle, mgrs.: Fair grounds, Shreveport, La.

Mountain Lake Shows, W. O. Newman, mgr.: 1122-24 7th ave., rear, Huntington, W. Va.

Muholland Shows, A. J. Muholland, mgr.: 317 N. Edwards st., Kalamazoo, Mich.

Murphy, D. D. Shows, L. M. Brophy, mgr.: 407 Walnut st., St. Louis, Mo.

Murphy Bros. Shows: 12 W. Stockton ave. (Apt. 12), North Side, Pittsburgh, Pa.

Naill Shows, C. W. Naill, mgr.: 6th & Olive sts., Monroe, La.

Narder Bros. Shows, Nat Narder, mgr.: Hog Island, Philadelphia, Pa.

National Amusement Co., Henry Oldham, mgr.: Enid, Ok. (Box 504).

Northern Expo Shows, Frank E. Lang, mgr.: St. Paul, Minn. (Box 18).

Northwestern Shows, E. L. Flack, mgr.: 36 E. Woodbridge st., Detroit, Mich.

Old Alken Amusement Co., W. H. McGhee, mgr.: 619 W. Superior St., Cleveland, O.

Pago, J. J., Shows: Metter, Ga. (care of J. D. Bird Motor Co.).

Palmer's United Attractions, Alonzo Palmer, prop.: 150-205 Talbot St., St. Thomas, Ont., Can.

Payne's, Herb, Expo Shows: 209 Stair Bldg., Toronto, Ont., Can.

Pearson, C. E., Shows, Capt. C. E. Pearson, mgr.: Ramsey, Ill. (Lock Box 48).

Pilbeam Amusement Co., F. E. Pilbeam, mgr.: 3433 Michigan ave., Detroit, Mich.

Prairie State Amusement Co., Hal Graham, owner: Edinham, Ill. (Address General Delivery).

Princess Olga Shows, F. W. Wadsworth, mgr.: 324-A East 3d st., Jacksonville, Fla.

Quality Greater Shows, Edward Oliver, pres.: office address, 306 Ouray Bldg., Washington, D. C.

Queen City Shows, H. Imhoff, mgr.: 21 N. Douglas St., Oklahoma City, Ok.

Reles, Nat, Shows, James F. Murphy, gen. mgr.: Jeffersonville, Ind. (P. O. Box 323).

Reithoffer Shows, J. Reithoffer, mgr.: Huguesville, Pa.; offices, 1611 N. 18th St., Philadelphia, Pa.

Rice & Dorman Shows, George F. Dorman, mgr.: Medina & Vera Cruz Sts., San Antonio, Tex.; mail address, Box 233, Sta. A., San Antonio.

Rice & Quick Shows, W. L. Quick, mgr.: Durant, Ok. (Box 522).

Riley Shows, Matthew J. Riley, mgr.: Brighton, N. J.; office address, Box 161, Elizabeth, N. J.

Rose's Imperial Shows, Rose T. Wade, mgr.: 149 Conestog St., Adrian, Mich.

Royal Expo Shows, H. H. Tapp, mgr.: San Antonio, Tex.

Royal American Shows, S. J. Sedlmayr, mgr.: 1911 Broadway, Kansas City, Mo.

Rubin & Cherry Shows, Rubin Gruberg, mgr.: Montgomery, Ala.

Sandy's Amusement Shows, Sandy Tamargo, mgr.: 1714 East st., North Side, Pittsburgh, Pa.

Savage Amusement Co., Walter Savidge, mgr.: Wayne, Neb.

Scott Greater Shows, C. D. Scott, mgr.: Newnan, Ga.

Scott Greater Shows, George T. Scott, mgr.: Anadarko, Ok.

Smith, Orie L., Shows, Orie L. Smith, mgr.: 775 Canal st., Syracuse, N. Y.

Smith's Southern Shows, Steve Smith, mgr.: Gattletown, Ky.

Smith's Greater United Shows, K. I. Smith, mgr.: 114 S. Clay St., Salisbury, N. C.

Snapp Bros' Shows, Ivan & Wm. Snapp, mgrs.: Fresno & D streets, Fresno, Calif.

Southern Tier Shows, James E. Strates, mgr.: Elmira, N. Y. (Box 464).

Spencer Shows, Sam E. Spencer, mgr.: Brookville, Pa.

Strayer Amusement Co., J. R. Strayer, mgr.: Hotel Warren, Williamsport, Ind., or 64 Third st., Milwaukee, Wis.

Stewart Amusement Co., Wm. S. Wichter, mgr.: Brighton Bldg., New St., Bethlehem, Pa.

Sunshine Expo Shows, H. V. Rogers, mgr.: Bessemer, Ala. (Box 275).

Toffel-Gonnelly Amusements, Inc., John A. Toffel, mgr.: 1728 North Mason Ave., Chicago, Ill.; office address, 703 Hoars St., Chicago.

Traver Chautauque Corp., Inc., Geo. W. Traver, mgr.: 1409th St., N. Y.; offices 1547 Broadway, New York, N. Y.

Tribune & Michaels (Colored) Shows: 552 Lenox ave., New York City.

Vasey Amusement Co., Frank B. Vasey, mgr.: 27 Collins Ave., Miami Beach, Fla.

Veal, Stella, Circus-Expo., George W. Johnson, mgr.: Cold Spring Park (Fair Grounds), Rochester, N. Y.

Venus Amusement Shows, Cliff LaBell, mgr.: Hammond, Ind.; mail address, The Billboard, Chicago.

Vernon, C. A., Shows, C. A. Vernon, mgr.: 3212 Harrisburg Blvd., Houston, Tex.

Wade Shows, W. G. Wade, mgr.: 5811 Cass ave., Detroit, Mich.

Wallace, John E., Attractions: office address, 307 6th ave., New York, N. Y.

Weer Amusement Co., J. C. Weer, mgr.: South Bend, Ind.

West Shows, Frank West, mgr.: Greensboro, N. C.

Williams, S. B., Shows: Weatherford, Tex.

Wise Shows, David A. Wise, mgr.: 1819 Fourth ave., Bessemer, Ala.

Wunderland Expo Shows, C. H. Barlow, mgr.: 310 Wyoming Ave., Scranton, Pa.

World at Home Shows, Inc., Irv. J. Polack, mgr.: 954 Liberty Ave., Pittsburgh, Pa.

World of Fun Shows, H. DeBlaker, mgr.: 102 Arch st., Paterson, N. J.

Wolf Greater Shows, Wm. Wolf, mgr.: 432 Wabasha st., St. Paul, Minn.

Wolfe, T. A., Shows, T. A. Wolfe, mgr.: Atlanta, Ga.

Wortham, John T., Shows, John T. Wortham, mgr.: Paris, Tex.

Wortham, C. A., World's Best Shows, Beckmann & Grety, props.: 127 E. Loughborough st., St. Louis, Mo.

Wright Bros.' Shows, Inc.: general offices, 824 N. Broad st., Philadelphia, Pa.

Zeldman & Polie Shows, James Simpson, mgr.: Camp Wardsworth, Spartanburg, S. C.

Zelger United Shows, C. F. Zelger, mgr.: Kansas City, Mo.; office address, Coates House, Kansas City.

MISCELLANEOUS TENT SHOWS

Acker's Vaudeville Show, E. H. Acker, mgr.: New Milford, Conn. (Box 906).

Adams, James, Floating Theater, Elizabeth City, N. C.

Alabama Minstrels, Chas. E. Bowen, mgr.: Waco, Tex. (Box 900).

Almond's, Jethro, Show: Albermarle, N. C.

Amazo, W. J. Carter, mgr.: 216 N. Robey st., Chicago, Ill.

America Show Boat, Wm. Reynolds, mgr.: Point Pleasant, W. Va.

Barker's Dixie Entertainers, F. H. Barker, prop.: 417 Rhodenster St., Danville, Va.

Big Comedy Show, Dr. L. Simpson, mgr.: 519 Park Ave., Poplar Bluff, Mo.

Blackburn Dog & Pony Show, H. B. Blackburn, mgr.: 706 Center st., Milwaukee, Wis.

Blondin, Leo, Show: Oklahoma City, Ok.

Buller's Trained Animal Shows, Ltd., Robert W. Buller, mgr.: Friday Harbor, Wash.; mail address, Victoria, B. C., Can.

Byers, Wm., Educated Horse Show: Union, Ore.

Byers, F. C., Animal Show, W. M. Byers, mgr.: 28 W. Swan st., Columbus, O.

Call-Farker-Racifix Shows, Inc., S. G. Davidson, mgr.: Sumner, Iowa.

Cole's Circus Side-Show, H. R. Cole, mgr.: 400 S. Halsted st., Chicago, Ill.

Couchman Bros.' Trained Animal Shows, K. Couchman, mgr.: 28 Elm st., Ilon, N. Y.

Dalton's, Carl M., Tent Dramatic Show, Carl M. Dalton, mgr.: 123-125 S. 7th St., La Crosse, Wis.

Dandy Dixie Shows, G. W. Gregory, mgr.: Brodnax, Va. (P. O. Box 68).

Dar's Guy Novelty Animal Show: Salem, Ore.

Dion's Freak Animal Shows, Joseph Dion, mgr.: St. Jean, Que., Can.

Dorsey Bros.' Overland Truck Show: 54 S. Clover st., Poughkeepsie, N. Y.

Edwards, Jack, Show: Care Merrimac House, Friend st., Boston, Mass.

Elmer's Circus Side Show, Prince Elmer, mgr.: 237 27th St., San Francisco, Calif.

Engesser's, George E., Shows: Let Ole De Le, Hippomane Shows, Art Glass, mgr.: San Antonio, Tex.; The Fighting Swede, Al Engesser, mgr.: St. Peter, Minn. Office, Coates House, Kansas City, Mo.

Eques-Curriculum, D. M. Bristol, mgr.: 141 Milk st., room 403, Boston, Mass.

Everton's Model Show, M. T. Everton, mgr.: 112 S. Minn. St., Shawnee, Ok.

Folker Bros.' Circus Side-Show, E. M. Folker, mgr.: R. F. D. 3, Shelby, Mich.

Frantz Free Show, Jerry Frantz, mgr.: Slatons-ton, Pa.; office, Walnutport, Pa.

Gallagher's Trained Dog Show, W. P. Gallagher, mgr.: 453 S. Eighth st., Charleston, Ia.

Gold Players, Lloyd T. Gauld, mgr.: Orleans, Mich. (R. F. D. 1).

Gray's Dog & Pony Circus, Henry Gray, mgr.: Cortland, N. Y. (R. D. 1).

Hibbard's United Animal Show, C. A. Hibbard, mgr.: 28 11th ave., West, Albia, Ia.

Hill's Novelty Show, Donald D. Hill, mgr.: Sylvania, O.

Hoskins-Blondin Show, Lee Bloudin, mgr.: 1016 N. Olive st., Oklahoma City, Ok.

Huddleston Family Show, Frank Huddleston, mgr.: Lucasville, O.

Hulburd's Animal Show, Dr. B. Hulburd, mgr.: Nashville, Tenn. (R. F. D. 3, Box 227A).

Hull's Independent Shows, Len Hull, mgr.: Georse, Mich.; mail address, Thordale, Ont., Can. (Route 4).

Irving Bros.' Show, Tom Irving, mgr.: 215 Slocum ave., Syracuse, N. Y.

Jolly Dixie's Congress of Fat People, H. L. Wilson, mgr.: 429 Northeastern ave., Joliet, Ill.

Joe Right Shows, John H. Rudolph, mgr.: Dig-gins, Mo.

Kell's Comedians, Leslie E. Kell, mgr.: Warren, Ark.; offices, Springfield, Mo. (Route 11, Box 386).

Kelly's, Kitty, Killee Vanderle Show, J. R. Gollenstein, mgr.: Huntington, Ind. Home address, 3824 Broadway, Gary, Ind.

King Bros' Show, Jack W. King, mgr.: Washington, D. C. (Box 1534).

(Continued on page 118)

LITTLE THEATERS

ALABAMA

Birmingham—Little Theater of Birmingham, 214 Highland ave., Bernard Scold, dir. Mobile—Mobile Little Theater, Seims—Selma Drama League Players.

ALASKA

Ketchikan—Ketchikan High School Players, Lantry F. Tobin, dir.

ARIZONA

Phoenix—Arizona Club, Luhrs Bldg., 9 W. Jefferson st., Walter Ben Hare.

CALIFORNIA

Berkley—Campus Little Theater. Berkeley—University English Club Players. Berkeley—Greek Theater. Carmel-by-the-Sea—Little Theater Arts & Crafts Club. Fruitvale—The St. Elizabeth Players, 1530 34th ave.

Los Angeles—The Potboiler Players, 930 S. Grand ave., Samund Russell. Los Angeles—Los Angeles High School Players' Assn.

Los Angeles—Los Angeles Theater Guild, 315 N. Hancock st., Frank Castello, secy. Monterey—Football Players.

Pomona—Community Playhouse Assn., 80-85 North Fair Oaks Ave. Pomona—Ganesha Players, 146 E. Third st., Smith Russell, secy.

Redlands—Redlands Community Players. San Diego—San Diego Players. San Francisco—Players' Club.

San Jose—DeMolay Players, 148 N. 3d st.; Ernest Alonk, secy.

San Francisco—The Harrington Players, Century Hall, 1335 Franklin st. Santa Ana—Santa Ana Players.

Santa Barbara—Santa Barbara Com. Arts Assn. Santa Monica—Dramatic Club, Santa Monica Day Women's Clubs, 1216 Fourth st.

Whittier—Community Players, care of Y. M. C. A., Miss Marian H. Weed, secy.

COLORADO

Boulder—University of Colorado Little Theater, 120 Grand View, G. F. Reynolds, dir.

Colorado Springs—Colorado Springs Drama League. Denver—Denver Community Players, Inc., 1420 Marion st., Mrs. Clara W. Springer, secy.

Denver—South High Dramatic Club, South Pearl & Colorado aves., Christine C. Buck, secy.

CONNECTICUT

Bridgport—Little Theater League, 25 Laurel st., Julia Farnam, secy.

Bristol—Little Theater, Memorial High School, R. S. Newell, dir.

Bristol—Bristol Community Players, 249 Main st., Greenwich—Fairfield Players.

Hartford—Little Theater Guild of Hartford, 55 Sterling st., Esther Gross, secy.

Litchfield—The Litchfield Players, Miss Inga Wisterberg, secy.

New Haven—The Playcraftsmen of Yale University, 1847 Yale Station, Richard C. Lowabie, secy.

Westport—Little Theater Players, Charles Fable, treasurer.

DELAWARE

Wilmington—Air Castle Players, Victoria Hertz, secy.

Wilmington—Wilmington Drama League.

DISTRICT OF COLUMBIA

Washington—The Arta Club.

Washington—Ram Head Players, Wardman Park Inn.

Washington—The Departmental Players, 2200 14th st., N. W., John J. Campbell, bus. mgr.

FLORIDA

Deland—Green Room Players, Stetson Univ., Irving C. Storer, dir.

Jacksonville—Jacksonville Community Players. Palatka—Palatka Community Service.

Pensacola—Little Theater, 24 E. Romana st., B. W. Sims, dir.

Tampa—Community Players, 2810 Jefferson, Earl Stumpf, dir.

GEORGIA

Atlanta—Little Theater, Women's Club.

Savannah—Town Theater, Martin T. Price, mgr.

ILLINOIS

Bloomington—Bloomington Community Players, Ethel Gunn, secy.

Champaign—Illinois Theater Guild, Ill. Union Bldg., Paul Wilson, dir.

Chicago—Hull House Players.

Chicago—College Players, 822 Buena ave., Fritz Beck, secy.

Chicago—Studio Players, 826 N. Clark st.; Phyllis Idell, dir.

Chicago—The Art Club, care Mrs. John A. Carpenter, 710 Rush st.

Chicago—The Boys' Dramatic Club, care Bertha Lee, dir., 431 Fine Arts Bldg.

Chicago—Coffer-Miller Players, 631 Fine Arts Bldg., 410 S. Michigan Blvd.

Chicago—Children's Civic Theater of Chicago, 410 S. Michigan ave., Bertha L. Hos, dir.

Chicago—Rosary College Dramatic Club, 5454 Everett ave., Midwest North, secy.

Chicago—Athletic Little Theater (Colored) School, 413 E. 50th st., Alfred M. Eigon, managing dir.

Deerfield—Deerfield Little Theater.

Evansville—Campus Players, Northwestern Univ., Alex. Dean, secy.

Galesburg—Knock College, C. L. Menser, secy.

Lake Forest—Lake Forest Playhouse.

INDIANA

Indianapolis—Little Theater Soc. of Ind., 126 E. 14th st., Lillian F. Hamilton, exec. secy.

Indianapolis—Little Theater Soc., care Clarence M. Weesner, the John Herron Art Institute.

Indianapolis—Little Theater Soc., care Mrs. Wm. O. Bates, 756 Middle Drive.

Iowa—Masque Players, State College, Box 425, Sta. A, Nancy E. Elliot, secy.

Rhoads—Community Players.

Cedar Rapids—Coe College Little Theater.

Des Moines—Little Theater Association.

Dubuque—St. John Players, 13th & White sts., Frances Mullin.

Grinnell—Play Production Class, Grinnell College, W. H. Trumbauer, dir.

Iowa City—The University Theater, University of Iowa, Hall of Natural Science, Miss Dorothy McClellan, secy.

Knoxville—Knoxville Players, Laryl Cook Macy Mason City—Drama Shop Players, 229 Second St., N. E., F. K. Tressel, secy.

Mystic—Mystic Dramatic Club, Paul E. Hunter, secy.

Newton—Little Theater Assn., 709 N. Second ave., E. N. R. Moore.

KANSAS

Lawrence—University of Kansas Little Theater.

Manhattan—Purple Masque Players, State Agricultural College, Earl G. McDonald, dir.

Pittsburg—Theat Alpha Pi, State Teachers' College, Prof. J. R. Peisma, secy.

KENTUCKY

Barbourville—National Theater, J. L. Hoffin, secy.

Lexington—Campus Playhouse, University of Kentucky, Box 545, Prof. W. R. Sutherland, dir.

Louisville—University of Louisville Players, 119 W. Broadway, Virginia Jarvia, secy.

Louisville—Dramatic Club of Nazareth College, Louisville—Players' Club.

Louisville—N. M. H. A. Players, Second and Jacob sts., Louis M. Roth, pres.

LOUISIANA

Baton Rouge—Little Theater Guild.

Lafayette—Community Service of Lafayette Parish, H. B. Skinner, dir.

Morgan City—Teche Players, 508 Everett st., Frank I. Froinska, secy.

New Orleans—Dramatic Club, Tulane University.

New Orleans—Dramatic Class of the New Orleans Conservatory of Music and Dramatic Art.

New Orleans—Jerusalem Temple.

New Orleans—Dramatic Society, Young Women's Hebrew Association.

New Orleans—Jed Wood's Studio of Stage Crafts, 530 St. Peter st.

New Orleans—Jefferson College Players.

New Orleans—LeFollet Theater du Vieux Carre, 230 St. Peter st., Arthur Maitland, dir.

Shreveport—Shreveport Little Theater, Opal Parten, secy.

MAINE

Lewiston—The English 4 A Players, Bates College, Att. Prof. A. Craig Baird.

Ogunquit—Ogunquit Village Studio.

MARYLAND

Baltimore—Baltimore Children's Theater, Lyric Theater, Mt. Royal ave., Frederick R. Huber, secy.

Baltimore—Vagabond Players.

Baltimore—All Univ. Dramatic Club, Johns Hopkins Univ., Albert G. Lanzetta, Jr., secy.

Frostburg—State Normal School, Leo st., Thelma Harvey, secy.

MASSACHUSETTS

Amherst—Rolerster Dramatic Soc., 53 Pleasant st., Edw. F. Ingraham, secy.

Boston—Actors' Play Shop, 8 Blackwood st., Raymond Gilbert, secy.

Boston—Theater Guild of Boston, 417 Pierce Bldg., John Patterson, secy.

Boston—Children's Theater, care Emerson College of Oratory.

Boston—Elizabeth Peabody Playhouse.

Boston—Boston Stage Soc., 36 Jay St.

Boston—Waban Neighborhood Club, Harry L. Tilton, mgr.

Boston—The Outdoor Players, Pierce Bldg.

Boston—Actors' Play Shop, 8 Blackwood st., Raymond Gilbert, dir.

Cambridge—Larchwood Players, Bungalow Theater, Larch road.

Deerfield—Dramatic Society of Deerfield Academy.

Framingham—The Wardrobe Club, Mrs. O. Fuller, 31 Warren road.

Glendale—Little Theater Players, care of Harvard St. High School, Mrs. M. L. Green.

Glochester—School of Little Theater, Rocky Neck st., Stuart Guthrie, secy.

Holyoke—English 95 Playshop, Mt. Holyoke College, Chas. W. Audin, secy.

Jamaica Plain—Football Club.

Lawrence—St. John Dramatic Soc., P. O. Box 22, W. Ridings, secy.

New Bedford—The Cannon Players' Studio, 85 Court st., Mr. McEwen, dir.

Northampton—McCallum Theater.

Northampton—Northampton Players.

Northampton—Senior Dramatic Soc., Smith College.

Pittsfield—Town Players.

Plymouth—Plymouth Theater.

South Middleboro—The Cape Players, Henrietta C. Wilbur, secy.

Tuff's College—Pen, Paint and Pretzels Dramatic Society of Tuff's College.

Williamstown—Cap & Bells, Inc., Robert W. Post, secy.

MICHIGAN

Detroit—Community Players of Detroit, 285 E. Ferry ave., J. A. Eckel, secy.

Detroit—International Players, 1502 Pennsylvania ave., Frank Carraro.

Detroit—Dramatic Class of Northeastern H. S., Jos. Woslosky, secy.

Detroit—Theater Arts' Assn., 10620 Foley ave., Albert Redding, dir.

Detroit—Detroit New Century Club, Harriette G. Locke, chairman.

Detroit—Circle Theater & Vaudeville House, 2915 Hastings st., Harry Green, secy.

Detroit—Temple Beth El Arts Soc., Frank V. Martin, secy.

Detroit—Theater Arts Club, 711 Lake Shore road, Mrs. G. W. Zancu, secy.

Hillsdale—Dept. of Dramatic Art, Hillsdale College, Prof. Sawyer Falk.

Petersburg—Little Theater, Lillian Mortimer, dir.

Pontiac—Pontiac Little Theater.

Saginaw—Little Theater, Hoyt Library Bldg., Harry G. Miller, secy.

Ypsilanti—Ypsilanti Players, 133 Rear North Huron st.

MINNESOTA

Duluth—Duluth College Club & A. A. U. W., Mrs. S. Shepard, dir.

Minneapolis—MacPhail Little Theater Co., L. L. Lalle at 18th, Jack DeVere.

Minneapolis—St. Stephen's Players, 1819 Lyndale ave., South, Suite 222, A. H. Fanst, dir.

Minneapolis—Univ. Dramatic Club, Univ. of Minn., 18 Music Bldg., A. M. Dingwall, secy.

Minneapolis—Studio Players, 624 New York Life Bldg.

Minneapolis—Burlat Playhouse, 3306 Columbus ave., Dean Jensen.

Montevideo—Montevideo Dramatic Club, Agnes E. Holstad, secy.

Owatonna—Dramatic Students High School.

MISSOURI

Boonville—Kemper Dramatic Club (Kemper Military School), L. Logan Smith, dir.

Columbia—The Masquera, State University of Missouri.

Springfield—The Pill Box Little Theater, 874 Boulevard, Joseph P. Peck, dir.

St. Louis—St. Louis Artists' Guild, 812 Union Blvd., Miss Grace F. Gooding, secy.

MONTANA

Bozeman—Bozeman's Woman's Club, 605 S. 9th st., Mrs. E. Powers, secy.

Missoula—Missoula University Masquers Red Lodge—Mask and Frolic Club.

NEBRASKA

Lincoln—Carroll's Little Theater, Neb. State Bank Bldg., Harvey H. Carroll, dir.

Peterboro—Outdoor Players, Marie W. Laughton, dir.

NEW HAMPSHIRE

Jersey City—Little Theater, Y. W. C. A., 43 Belmont ave., E. Fuller, secy.

Newark—Catholic Young Women's Club School; Franklin Croese, secy.

Orange—Drama Guild of the Oranges, 211 Prospect st., J. J. Hayes, secy.

Princeton—Princeton Theater Intime, R. McClenahan, secy.

Summit—The Playhouse Assn., Tulip st., Mary Budean, secy.

Trenton—Trenton Group Players.

NEW JERSEY

Atlantic City—Boardwalk Players, Strephechase Pier Park, George V. Hobart, dir.

Bayonne—Bayonne Theater Guild, 98 W. 10th st., Mary E. Gormley, secy.

Hightstown—Hightstown Players, Wilson Hall, G. W. Marque Maier, secy.

Jersey City—Little Theater, Y. W. C. A., 43 Belmont ave., E. Fuller, secy.

Newark—Catholic Young Women's Club School; Franklin Croese, secy.

Orange—Drama Guild of the Oranges, 211 Prospect st., J. J. Hayes, secy.

Princeton—Princeton Theater Intime, R. McClenahan, secy.

Summit—The Playhouse Assn., Tulip st., Mary Budean, secy.

Trenton—Trenton Group Players.

NEW MEXICO

Santa Fe—Santa Fe Community Players.

NEW YORK

Albany—St. Patrick's Players, Central & Laka aves.

Alfred—Wee Playhouse.

Astoria, L. I.—Precious Blood Players, 393 Broadway; D. F. Barraca, secy.

Astoria, L. I.—Astoria Little Theater, 497 Graham ave., Miss A. Peterson, secy.

Auburn—Auburn Amateur Dramatic Club.

Batavia—Crosby Players, Denio Apartments; Harry D. Crosby, secy.

Bay Ridge—Ovington Players, Bay Ridge High School.

Brooklyn—Mission Relief Players, 45 Foxall st., Joseph P. Bretano.

Brooklyn—St. Francis & St. Mary Missionary Players, 45 Foxall st.

Brooklyn—Little Theater Committee, 126 St. Felix st., Judge F. E. Crane, secy.

Brooklyn—Institute Players, 30 Lafayette ave., Chas. D. Atkins, secy.

Brooklyn—Bensonhurst Theater Guild, 60 Bay 31st st., Bernard Katz, dir.

Brooklyn—Clark Street Players.

Brooklyn—Shaw Players, 120 Jackson st., Jos. Bascetta, pres.

Brooklyn—The McLaughlin Players, 419 Flushing ave., Mary G. Burch, secy.

Brooklyn—Arme Players, Arme Hall, 7th ave. & 8th st.

Brooklyn—The Thespians, 149 Amherst st., Herbert G. Bliven, secy.

Brooklyn—Brooklyn Drama League, 1172 President st., George Lieb, dir.

Brooklyn—Court Players, 1728 Madison st., W. B. Kasparoff.

Buffalo—The Buffalo Players, Inc., 20 Irving Place, Maison de Forest, secy.

Buffalo—Dramatic Society of the Canisius College.

Buffalo—D'Youville Players.

Buffalo—Junior Class of Buffalo Seminary, Mrs. Alida White.

Buffalo—Two-in-One Players of Buffalo, 1539 Broadway, Ed Sommer.

Dunkirk—The St. George Dramatic Club, Mark Heigan, secy-treas.

Elmhurst (L. I.)—Elmhurst Jackson Heights Players.

Elmira—Elmira Community Service, 413 E. Water st., Z. Nesbit, secy.

Flushing, L. I.—League Players, League Bldg., Sarah C. Palmer, secy.

Forest Hills, L. I.—Garden Players, 11 Greenway Terrace, Helen Hoff, secy.

Glen Morris—Richmond Hill State Dramatic Society, 10772 111th st., Ed Mackert.

Gouverneur—Gouverneur Players, care Howard Collins.

Hamburg—Hamburg Women's Club, Mrs. H. P. Himmeyer, dir.

Ithaca—Cornell Dramatic Club, Goldwin Smith Hall, LeVerne Baldwin, secy.

Montclair—Montclair Players.

New York—Children's Dramatic League, Hotel Astor, Elsie Oppenheimer, secy.

New York—Stuyvesant Players, Inc., 216 E. Tremont ave.

New York—Civic Club, Drama Group, 14 W. 12th st.

New York—Dramatic Dept., Community Service, 215 Fourth ave., George Junkin, secy.

New York—Children's Theater, Fifth ave. & 104th st., Clare T. Major, secy.

New York—Inter-Theater Arts, Inc., 42 Commerce st.

New York—Playwrights' Soc., 158 W. 45th st., Fred Wall, secy.

New York—Thomas E. Crosby, 380 Park ave.

New York—The Proscenium Players, 200 Fifth ave., Room 1411, R. R. Gilbert, dir.

New York—"The Snarks", care The N. Y. Comedy Club, 210 East 68th st., Mrs. Danforth.

New York—Washington Square College Players, 100 Washington Square, Thos. H. Mullen.

New York—The Senior Players, Evander Childs High School, 184th st. & Creston ave.

New York—Marionette Theater Studio, 27 W. 8th st., Florence Koeller, secy.

New York City—138 E. 27th St.—Bramhall Players.

New York City—Cooper Players of Cooper Union Inst.

New York City—785 Madison Ave.—Cutler Comedy Club of Cutler School.

New York City—Dramatic Association of Hunter College.

New York—Lenox Hill Players, 12 Park ave.

SPECIAL LIST

Of Clubs, Societies and Unions, Dramatic Producing Managers, Magicians' Societies and Clubs, Motion Picture Producers and Distributors and Others

CLUBS, SOCIETIES, ORGANIZATIONS AND UNIONS

CHICAGO ASSOCIATIONS

Actors' Equity Assn., 1032-33 Capitol Bldg. Chicago Civic Opera Co., Auditorium Theater. Civic Music Assn. of Chicago, 410 S. Mich. ave. Drama League of America, 59 E. Van Buren st. National Assn. of Amusement Parks, A. R. Hodge, secy., care Riverview Park Co., Chicago, Ill. National Vaudeville Artists, Woods Theater Bldg. Poster Adv. Assn., Inc., 307 S. Green st. Showmen's League of America, 177 North Clark st.

CLUBS

Apollo Musical Club, 243 S. Wabash ave. Chicago Mendelssohn Club, 243 S. Wabash ave. Chicago Musicians' Club, 175 W. Washington st. Opera Club, 18 W. Walton place.

TRADE UNIONS

Chicago Fed. of Musicians, Local No. 10, A. F. of M., 175 W. Washington st. Musicians' Prot. Union, 3934 S. State st.

CINCINNATI, O. ASSOCIATIONS

Moving Picture Mach. Operators, Room 11, 106 E. 4th st. Musicians' Headquarters, Local No. 1, A. F. of M., Mercer and Walnut sts.

NEW YORK ASSOCIATIONS

Actors' Fund of America, Broadway & 47th st. Actors' Equity Assn., 45 W. 47th st. American Artists' Federation, Room 515, 245 W. 47th st. American Dramatists, 2 E. 23d st. American Federation of Musicians, 110 W. 40th st. American Guild of Organists, 29 Vesey st. American Society of Composers, Authors and Publishers, 56 W. 45th st. Associated Actors and Artists of America, 45 W. 47th st. Authors' League of America, Inc., 2 E. 23d st. Catholic Actors' Guild of America, 220 W. 42d st. Cercle des Annales, Inc., 9 E. 54th st. Chorus Equity Assn., 229 W. 61st st. Columbia Burlesque Assn., Columbia Theater Bldg. Drama Society, 131 E. 15th st. Grand Opera Choir Alliance, 103 W. 46th st. International Theatrical Assn., 1540 Broadway. Jewish Pub. Service for Theat. Enterprise, 132 W. 43d st. Motion Picture Directors' Assn., 234 W. 55th st. Motion Picture Producers and Distributors of America, 409 Fifth ave. M. P. Theater Owners of America, 25 W. 43d st. Music Pub. Prot. Assn., 56 W. 45th st. Music League of America, 250 W. 57th st. Mutual Burlesque Assn., Power's Bldg., cor. Seventh ave. and West 48th st. National Bureau for Advancement of Music, 45 W. 45th st. New York Drama League, Inc., 29 W. 47th st. National Assn. of Broadcasters, 1265 Broadway. National Assn. of Harpists, Inc., 315 W. 79th st.

National Vaudeville Artists, 229 W. 46th st. Photoplay League of America, 221 W. 57th st. Professional Women's League, 56 W. 53d. Theatrical Press Representatives of America, Inc., 214 W. 42d st. Vaudeville Managers' Prot. Assn., 701 7th av. Amateurs Comedy Club, 150 E. 36th st. Authors' Club, Carnegie Hall. Burlesque Club, 245 W. 48th st. Film Players' Club, 161 W. 44th st. Friars' Club, 110 W. 48th st. Ganutt Club, 61 W. 50th st. Green Room Club, 19 W. 48th st. Hebrew Actors' Club, 31 E. 7th st. Kiwanis Club of New York, 54 W. 33rd st. The Lambs, 128 W. 44th st. The Players, 16 Gramercy Park. MacDowell Club of New York, 65 E. 56th st. Metropolitan Opera Club, 139 W. 39th st. National Travel Club, 7 W. 6th st. The Newspaper Club, 133 W. 41st st. Rehearsal Club, 47 W. 53d st. Rotary Club of New York, Hotel McAlpin. Travel Club of America, 342 Madison ave. Treasurers' Club of America, 123 W. 48th st. Twelfth Night Club, 47 W. 44th st.

TRADE UNIONS

Ass. Musicians of Greater New York, Local No. 902, A. F. of M., 958 8th ave. Hebrew Actors' Union, No. 1, 31 E. 7th st. Internat'l All. of Theatrical Stage Employees and Moving Picture Operators, 110 W. 40th st. Motion Picture Operators, 101 W. 45th, N. W. 507, 6th ave. Mutual Mutual Prot. Union, 210 E. 86th st. Musical Union New York Federation, 1253 Lexington ave. Theatrical Prot. Union, No. 1, 307 W. 54th st. United Scenic Artists' Assn., 394 W. 47th st.

PHILADELPHIA, PA ASSOCIATIONS

Footlight Club, 1306 Arch st.

TRADE UNIONS

Internat'l Alliance Theatrl., Local 8, 1720 Delaware st. Moving Picture Mach. Optra. Union, Loc. 307, 1527 7th. Musicians' Protective Assn., Loc. Union A. F. of M., 115 N. 19th.

KANSAS CITY, MO. TRADE UNIONS

Moving Picture Operators' Union, 1017 Washington st., Musicians' Club Bldg.

SAN FRANCISCO, CALIF. TRADE UNIONS

Moving Picture Operators, 109 Jones. Musicians' Union Local 4, 68 Haight. Theatrical Stage Employees' Local 15, 68 Haight.

ST. LOUIS, MO. CLUBS

Musicians' Club, 3535 Pine. Phoenix Musical Club, 1712 S. 3rd.

NEW YORK PRODUCING MANAGERS

Actors' Theater, 137 W. 48th st. Ames, Winthrop, Little Theater. Belasco, David, Belasco Theater. Bohemians, Inc., 229 W. 42d st. Brady, Wm. A., care The Playhouse. Broadhurst, George, Broadhurst Theater. Carlton, Carl, 1672 Broadway. Carroll, Earl, Earl Carroll Theater. Choos, George, 110 W. 47th st. Comstock & Gest, 104 W. 39th st. Cort, John, Cort Theater. Dillingham, Charles, Globe Theater. Dramatists' Theater, Inc., 220 W. 42d st. Erlanger, A. L., New Amsterdam Theater. Frazer, H. H., 1441 Broadway. Frohman, Charles, Inc., Empire Theater Bldg. Gatta, George M., 1482 Broadway. Gest, Morris, 104 W. 39th st. Golden, John, Hudson Theater Bldg. Goodman, Philip, 559 Fifth ave. Gordon, Kilbourn, 226 W. 47th st. Hammerstein, Arthur, 229 W. 42d st. Hampden, Walter, National Theater. Harris, Sam H., 227 W. 43th st. Harris, William, Jr., Hudson Theater. Herndon, Richard G., 123 W. 48th st. Hopkins, Arthur, Plymouth Theater. Independent Theater, Inc., 220 W. 42d st. Janney, Russell, 1482 Broadway. Klauber, Adolph, 110 W. 42d st. Klaw, Marc, Klaw Theater. Kugel, Lee, 1437 Broadway. Kusel, Daniel, 755 Seventh ave. Lewis and Gordon, Times Bldg. McClintic, Guthrie, 23 W. 43d st. McLaughlin, Robert, 229 W. 42d st. Marciu, Max, 220 W. 48th st. Miller, Gilbert, 1430 Broadway. Miller, Henry, Henry Miller Theater. Mindlin and Goldreyer, 227 W. 45th st. Morosco, Oliver, 526 Street Theater. Nichols, Anne, 206 W. 46th st. Pemberton, Brock, 227 W. 45th st. Players Co., Inc., 52 E. 78th st. Sanger and Jordan, Times Bldg. Savage, Henry W., 226 W. 42d st. Schwab and Kusel, 755 Seventh ave. Schwab, Lawrence, 755 Seventh ave. Selwyn & Co., Selwyn Theater. Shea, Joseph E., 1583 Broadway. Shesgreen and Reed, 229 W. 47th st. Shubert, Lee & J., Shubert Theater. Stewart & French, 110 W. 47th st. Theater Guild, 65 W. 35th st. Tully, Richard, Walton, 1482 Broadway. Tyler, George C., 214 W. 42d st. Wagenhals & Kemper, 1531 Broadway. Wagner, Charles L., 511 Fifth ave. Wallach, Samuel, 220 W. 45th st. Weber, Joe, 146 Broadway. Weber, L. Lawrence, 229 W. 48th st. Werba, Louis R., 214 W. 42d st. Woods, A. H., Eltinge Theater. Ziegfeld, Florenz, New Amsterdam Theater Bldg.

MAGICIANS' SOCIETIES AND CLUBS

Baltimore, Md.: Felician Troway Assembly (No. 6, S. A. M.), R. W. Test, secy., 1204 Munsey Bldg. Boston, Mass.: Assembly (No. 9, S. A. M.), Arthur W. Baird, pres., 175 Mass. ave., care Caines. Buffalo, N. Y.: Society of Magicians, J. P. Orson, secy., 51 Eureka Place. Canton, O.: Magic Crafters, George L. Hewitt, secy., 209 Hartford ave., S. E. Chicago, Ill.: Assembly (No. 3, S. A. M.), Arthur P. Felman, pres., Windsor-Clifton Hotel. Cincinnati, O.: Magicians' Club, George Stock, pres., 1326 Sycamore st. Cincinnati, O.: Queen City Mystic (No. 11, S. A. M.), L. P. Guest, secy., 1511 Vine st. Houston, Tex.: The Houston Mystic Circle, Robert Blau, secy., 810 Keystone Bldg. Indianapolis, Ind.: Indiana Magicians' Fraternity, E. E. Wood Nichols, secy., 406 S. Meridian st. Milwaukee, Wis.: Magicians' Club, 2314 Villet st., Elmer A. Wilson, secy. Minneapolis, Minn.: Mystic Circle, John E. Tyler, secy., 305 James ave., N. Nashville, Tenn.: Society Magique, T. J. Crawford, secy., 810 Broadway. Newark, N. J.: Magicians, J. McKnight, pres., 136 Fleming ave. New York: Knights of Magic, J. J. McMannus, 2474 Davidson ave., Bronx. New York: Society of American Magicians (Parent Assembly), Harry Houdini, pres., 278 W. 113th st.; Richard Van Dien, secy., 230 Union st., Jersey City, N. J. New Orleans, La.: Magicians' Club, G. E. Pearce, secy., 339 Carondelet st. Omaha, Neb.: Assembly (No. 7, S. A. M.), A. A. Schrempf, secy., 5156 Pine st. Portland, Ore.: Portland Magical Soc., E. J. Ludeman, secy., 296 Nantilla st. Providence, R. I.: R. I. Soc. of Magicians, No. 2, N. C. A.; B. C. Tillinghast, secy., 64 Nolia st. Rochester, N. Y.: Council of Sorcerers, Ken Drexel, secy., 71 Aberdeen st. San Francisco, Calif.: Golden Gate Assembly (No. 2, S. A. M.), Dr. Alexander Schwartz, secy., 1163 Flood Bldg. St. Louis, Mo.: Assembly (No. 9, S. A. M.), R. G. Williams, secy., 4220 McRee ave. Syracuse, N. Y.: Central City Assembly, No. 14, S. A. M.; C. R. Glover, secy., 4314 E. Salina st. Toledo, O.: Magicians' Club, V. D. Barbour, secy., 2421 Scottwood ave. Toronto, Ont., Can.: The Order of the Genii, M. Sumner, 96 Bowood ave. Wichita, Kan.: Magicians' Club, A. Loring Campbell, secy., 2201 W. Douglas ave. World Wide Magicians' Soc., James McKnight, pres., 136 Fleming ave., Newark, N. J.; Euclide A. Laramee, secy., 151 Mechanic st., Lakewood, N. H.

CANADA

Winnipeg, Man.: International Brotherhood of Magicians, Len Vintus, pres., 156 Edmonton st.

AUSTRALIA

Adelaide: South Australian Branch A. S. M. V. Treloar, secy., care Dalgety & Co. Fitzroy, Melbourne: Victorian Branch A. S. M. M. Hamilton, secy., 149 Gertrude st. North Perth, W. A.: West Australian Branch A. S. M. R. J. Sanderson, secy., 9 Woodville st. Sydney, N. S. W.: Society of the Sphinx, G. L. G. Reese, secy., 62 Pitt st. Sydney, New South Wales: Australian Society of Magicians, H. F. Cohen, secy., Box 964, G. P. O.

ENGLAND

Birmingham: British Magical Society, Fred Walker, secy., 44 Park Hill, Moseley, Birmingham, Eng. London: Magicians' Club, Harry Houdini, pres.; Will Goldston, first vice-pres., 14 Green st., Leicester sq. Plymouth: English Magicians, C. H. Tickell, 11 Frederick st., West.

MOTION PICTURE PRODUCERS AND DISTRIBUTORS

Associated Exhibitors, Inc., 35 W. 45th st., New York. Arrow Film Corp., 220 W. 42d st., New York. Anderson Pictures Corp., 723 Seventh ave., New York. Associated First National Pictures Corp., 383 Madison ave., New York. C. B. C. Film Sales Corp., 1600 Broadway, New York. Equity Pictures Corp., 723 Seventh ave., New York. Education Films Corp., 370 Seventh ave., New York. Famous Players-Lasky Corp., 406 Fifth ave., New York. Film Booking Offices of America, 728 Seventh ave., New York. Grand-Asher Distr. Corp., 15 W. 45th st., New York. Go-dwyn-Cosmopolitan Pictures Corp., 469 Fifth ave., New York.

Griffith, D. W., Inc., 1472 Broadway, New York. Hodkinson, W. W., Corp., 409 Fifth ave., New York. Independent Pictures Corp., 1540 Broadway, New York. Mastodon Films, Inc., 135 W. 44th st., New York. Metro Pictures Corp., 1540 Broadway, New York. Preferred Pictures Corp., 1650 Broadway, New York. Principal Pictures Corp., 1640 Broadway, New York. Pathe, Inc., 35 W. 45th st., New York. Seiznick Pictures Corp., 729 Seventh ave., New York. Truett Pictures Corp., 1542 Broadway, New York. Universal Pictures Corp., 1600 Broadway, New York. United Artists' Corp., 729 Seventh ave., New York. Vitagraph Corp., East Fifteenth st., Brooklyn. Weber-North Pictures Corp., 1600 Broadway, New York.

AMERICAN FEDERATION OF MUSICIANS

Joe. N. Weber, pres., 110-112 W. Fortieth st., New York City.

INTERNAT'L ASSN. BILLPOSTERS AND BILLERS OF UNITED STATES AND CANADA

Wm. McArthur, Internat'l. Secy., 821 Longacre Bldg., New York City.

COLORED SOCIETIES, ORGANIZATIONS AND UNIONS

Colored Vaudeville Benevolent Assn., 424 Lenox ave. MARYLAND Colored Actors' Union, 1223 Seventh st., N W

VAUDEVILLE AGENTS

NEW YORK A Amalgamated Vaude. Agency, 1441 Broadway. Anderson & Weber, 220 W. 48th. Argana, Andy, 774 Union ave., Bronx, New York. Ashland, Wilfred, 1650 Broadway. Associated Theaters, 214 W. 42d. B Aserwitz, Samuel, 160 W. 46th. Baker, Bob, 160 W. 46th. Beck, Arthur F., 135 W. 44th. Becker, Herman, 148 W. 46th. Benedict, Phil P., 1402 Broadway. Bentham, M. S., 1564 Broadway. Bernstein, David, 1540 Broadway. Bierbauer, Charles, 1607 Broadway. Binkoff, Harry L., 472 2d ave. Bloch, A. L., 502 W. 179th. Bloch & Barmore, 145 W. 45th. Bloom, Cella, 1564 Broadway. Blum, John J., 233 W. 51st. Bradley, Lillian, 1579 Broadway. Brecher, Leo, 628 Mad. ave. Reed, Charles S., 1564 Broadway. Brennan, George H., 1402 Broadway. Brill, Sol, 1540 Broadway. Broadway Varieties Co., 2834 Broadway. Brooks, Morris & Freeman, 1493 Broadway. Brown, Miss G. F., 1564 Broadway. Buckley & Sullivan, Inc., 1607 Broadway. Burke, Bernard, 1581 Broadway. Burke, Billie, 1495 Broadway. Bush, Phil, 1493 Broadway. C Cantor, Lew, 160 W. 46th. Carpenter, E. J., 1402 Broadway. Casey, Pat, Dramatic Agency, Inc., 701 7th. Choos, Geo., 110 W. 47th. Cohn, David, 1493 Broadway. Collins, H. D., 1493 Broadway. Connors, Jack, 1628 Broadway. Consolidated Theatrical Enterprises, Inc., 1888 Broadway. Cooper, Irving M., 1607 Broadway. Cornell, Charles, 1520 Broadway. Cornell, John, 1520 Broadway. Cosby, Vivian, 160 W. 45th st. D Dandy, Ned, 148 W. 46th. Davis, Al, 1547 Broadway. Davis, Frank, 245 W. 47th st. Davidson, Edward, 1493 Broadway. Dow, A. & B., 1547 Broadway. Driscoll, Dave, 509 Astor Bldg. DuFua, Bruce, 1493 Broadway. Dupree, Geo., 1547 Broadway. Durand, Paul, 1562 Broadway. E Eckl, Jos., 1493 Broadway. Edwards, Gus, 1531 Broadway. Ehrlich-Cutty Productions, 140 W. 42d st. Eichenr, Manny, 1545 Broadway. Elliott, Wm., 104 W. 39th. Evans, Frank, Inc., 1564 Broadway. F Follow, Sam, 160 W. 46th. Farnum, Ralph G., 1564 Broadway. Fernberg, A., 160 W. 46th. Feldman, N. S., Inc, 1493 Broadway. Fitzgerald H. J., 220 W. 48th. Fitzpatrick & O'Donnell, 160 W. 46th. Flynn, Jack D., 1564 Broadway. Ford, Max, 1674 Broadway. Fox, William, 126 W. 46th. Friedman, John E., 218 Romax Bldg. G Garren, Jos, 160 W. 46th. Gerber, Alex, 1607 Broadway. Golden, M., 160 W. 46th st. Golden, Lew, 1564 Broadway. Grady, Billy, 1564 Broadway. Graus, Matt, Agency, New York Theater Bldg. Griesman, Sam, 1493 Broadway. Grossman, Al, 180 W. 46th. Green, Howard, Jr., 110 W. 47th.

H Hall, Syd, 148 W. 46th st. Haliatt, Loula, 1493 Broadway. Hart, Joe, 137 W. 48th. Hart, Max, 1540 Broadway. Harvey, Charles J., 1402 Broadway. Hastings, Ben, 160 W. 45th. Hathaway, O. S., 1476 Broadway. Henry, Jack, 1607 Broadway. Herman, Al, 245 W. 47th. Hirschfeld, M., 1441 Broadway. Hockey, Milton, 110 W. 47th. Hogarty, John E., 200 W. 52d. Horn, J. E., 1493 Broadway. Hughes, Geo., Inc., 1562 Broadway. I International Variety & Theatrical Agency, Inc., 218 W. 43d. J Jackel, John C., Inc., 1581 Broadway. Jacobs, Miss Jenie, 1674 Broadway. Jermson, Rush, 701 Seventh ave. Johnson & Lowenstein, Inc., 219 Strand Theater Bldg., 1579 Broadway. Jones, Bert, 405 Loew's Annex, 160 W. 46th st. Jordan, Jack, 414 Loew's Annex, 160 W. 46th st. K Kamm, Philip, 1493 Broadway. Keeney, Frank A., 1493 Broadway. Keith, E. F., Vaudeville Exchange, 1564 Broadway. Keller, Edward S., 1564 Broadway. Kenny, Samuel J., 1564 Broadway. Kessler, Aaron, 245 W. 47th. King, Miss Frances R., 1564 Broadway. L Lambert, Clay, 1402 Broadway. Lamy, Adolph (So. Amer. specialist), 1482 Broadway. Lawrence, Joe, 220 W. 42d. Le Maire, Rufus R., Inc., 1493 Broadway. Leo, Joe, 1493 Broadway. Levine, Herman, 245 W. 47th st. Lewis & Gordon Producing Co., Inc., Times Building. Lewis, Jack, 1583 Broadway. Linder, Jack J., 1493 Broadway. Loeb, Jack B., 1531 Broadway. Loew, Marons, 1540 Broadway. Lozand, Miss Oily, 1547 Broadway. Lowe, Maxim P., 140 W. 42d. Lowenstein, Max J., 1579 Broadway. Lyons, Arthur S., Theatrical Enterprises, Inc., 245 W. 47th. M MacGregor, E. J., 1482 Broadway. Maddock, O. B., 137 W. 48th. Mandel & Rose, 160 W. 46th. Mann, Joe, 1658 Broadway. Marinelli, H. B., Ltd., 245 W. 47th. Marlon, Dava, 1583 Broadway. Markus, Fally, Vaudeville Agency, Strand Theater Bldg., 1547 Broadway. Maxwell, Joe, Inc., 700 W. 179th. Maynard, C. G., 214 W. 42d. McCarthy, J. J., 1476 Broadway. McClellan Vaudeville Agency, 145 W. 45th. McGuire, B. C., Co., 245 W. 55th. McGiey, Macklin M., 245 W. 47th. Melville, Frank, Inc., 220 W. 43d. Michaels, Joe, 160 W. 46th. Miller, Harry, Co., 1476 Broadway. Moore Gregory Co., 245 W. 47th. Mosser, Geo., 217 W. 45th. Morris, Joe, 701 7th ave. Morris, Phil, 245 W. 47th. Morris, Wm., 1493 Broadway. Morris & Fell, 1579 Broadway. Moss, B. S., Theatrical Enterprises, Inc., 1564 Broadway. N Madel, E. K., 232 West 46th. Newman, Dave, 708 Jackson ave. New York Theatrical Exchange, 1493 Broadway. North, Mayar B., 140 W. 46th. O O'Neal, James, 160 W. 46th st. Orphanum Circuit Co., 1564 Broadway.

Paige, Amos, 245 West 47th.
Pantages Vaudeville Circuit, 1493 Broadway.
Pearson, Arthur, 229 W. 42d.

Herman, Sam, 119 N. Clark st.
Hewitt Bureau, 410 S. Michigan Blvd.
Horwitz, Arthur J., 177 N. State st.

International Entertainment Assn., Fred Wood, mgr.: 539 St. Peter St.
PHILADELPHIA, PA.
Collins & Phillips, 1395 Arch.

OKIO
Canton—Food Show, in Auditorium. Week of March 9.
Cincinnati—Women's World Home Expo., in Music Hall, March 18-25.

Rath, Fred, 180 W. 46th.
Rapp & Golder, 1564 Broadway.
Reid-Dunbar, L., 225 W. 46th.

Jackson, Billy, Agency, 177 N. State st.
Jacobs, Wm., 54 W. Randolph st.
Johnstone, O. H., 36 W. Randolph st.

PHILADELPHIA, PA.
Collins & Phillips, 1395 Arch.
Consolidated Booking Offices, Market & Juniper sts.

OKLAHOMA
Oklahoma City—Home-Coming Celebration, ausp. Citran Club, April 22.
Oklahoma City—Auto Show. Week of March 23.

Randers, Paly, 1547 Broadway.
Sauber, Harry, 148 W. 46th.
Schenck, Nick M., 1540 Broadway.

Keith, B. F., Vaudeville Exchange, 100 M. State st.
Keough, L., 54 W. Randolph.
Kingston Vaudeville Booking Assn., 108 M. LaSalle st.

PITTSBURG
McLaughlin, J. S., Fulton Bldg.
ST. LOUIS, MO.
Belmont, Sidney, Amusement Service, Odeon Bldg.

PENNSYLVANIA
Brownsville—Elks' Indoor Circus, March 7-14. T. F. Cox, chairman committee.
Pittsburgh—Firemen's Circus at Motor Square Garden. Week of March 9.

Shaw, M. A., 1540 Broadway.
Shaw, P. F., 214 W. 42nd.
Shively Vaudeville Agency, Inc., 1493 Broadway.

Levey, Bert, Circuit, 54 W. Randolph st.
Loew, Marcus, Western Booking Agency, Suite 604 Woods Theater Bldg.

ST. LOUIS, MO.
Belmont, Sidney, Amusement Service, Odeon Bldg.
Dane, Oscar, Gayety Theater Bldg.

TENNESSEE
Memphis—Mrs. & Merchants' Expo., in Auditorium, March 9-11.
TEXAS
San Antonio—Fiesta San Jacinto, Apr. 20-23.

Tennia, C. O., 1476 Broadway.
Thalheimer, A., 160 W. 46th.
Thatcher, James, 755 7th ave.

Orpheum Circuit, 190 N. State st.
Pantages Vaudeville Agency, 36 S. State st.
Patlin, J., 22 Quincy st.

TORONTO, CAN.
Canadian Booking Offices, 3 Dundas st., West.
Ontario Booking Office, 36 Yonge st., West.

WASHINGTON
Vancouver—Centennial Celebration, July 4-Aug. 4.
WISCONSIN
Watertown—State Firemen's Convention & Tournament & Mid-West Fire Apparatus & Equipment Expo., June 15-20.

Vincent, Walter, 1451 Broadway.
Vogel, Wm., Production, Inc., 130 W. 46th.
Walker, Harry, 1674 Broadway.

Schallmaier Bros., 35 W. Randolph st.
Seluster, Milton, 36 W. Randolph st.
Shapiro, Seymour, 38 W. Randolph st.

ALABAMA
Birmingham—Food Expo, March 4-14, B. C. Apperson, secy.

CANADA
London, Ont.—Joy Week, ausp. War Veterans, March 23-28. L. E. Granger, dir., 192 Brant ave., Brantford, Ont.

Webster, Harry, 1564 Broadway.
Weber, Herman W., 1364 Broadway.
Weber, Ike, 701 7th ave.

United Fairs Booking Assn., 624 S. Michigan ave.
Van, Edward, 159 N. State st.
Webster Vaudeville Circuit, 30 W. Randolph st.

FLORIDA
Sarasota—Orange Blossom Festival, March 3-7. Address Harry E. Crandell, care Chamber of Commerce.

FLORIDA
Bradentown—Manate Co. Fair Assn., Feb. 21-27. G. A. Spencer.
Fort Myers—Lee Co. Fair Assn., Feb. 23-28. J. M. Horing.

Wells, Wm. K., 701 7th ave.
West, Roland, Producing Co., 236 W. 55th.
White, George H., 229 W. 43rd.

Young, Ernie, 159 N. State st.
Zimmerman, Wm., 106 N. LaSalle st.
BALTIMORE, MD.
McCaslin, John T., Vaudeville Agency, 123 E. Baltimore st.

IDAHO
Lewiston—Water Carnival, aus. D. O. K. K. July 2-4.
ILLINOIS
Chicago—Woman's World's Fair, in American Expo. Palace, April 18-25.

FLORIDA
Sarasota—Orange Blossom Festival, March 3-7. Address Harry E. Crandell, care Chamber of Commerce.

Wilbur & Vincent Theater Co., 1451 Broadway.
Wilkin, Charles S., Inc., 1573 Broadway.
Wilton, Alf. T., 1564 Broadway.

Webster Vaudeville Circuit, 30 W. Randolph st.
Western Vaudeville Managers' Assn., 190 N. State st.
Weyerson, Edw., 22 Quincy st.

INDIANA
Indianapolis—Home Complete Expo, April 6-11. J. Frank Cantwell, dir.

INDIANA
Indianapolis—Home Complete Expo, April 6-11. J. Frank Cantwell, dir.

Wirth & Hensid, Inc., 1579 Broadway.
Wolfe, Georgia, 137 W. 48th.
Yates, Irving, 160 W. 46th.
CHICAGO
A
Arme Amusement Exchange, 33 W. Randolph st.

Hub Amusement Co., 230 Tremont St.
Keith, B. F., Vaudeville Exchange, 164 Tremont St.
Quigley, John J., 184 Boylston St.

MASSACHUSETTS
Boston—Auto Show, March 7-14. Chester I. Campbell, mgr., 329 Park Sq. Bldg.

MASSACHUSETTS
Boston—Auto Show, March 7-14. Chester I. Campbell, mgr., 329 Park Sq. Bldg.

COMING EVENTS

FAIR DATES

CALIFORNIA
San Bernardino—National Orange Show, Feb. 19-March 1. R. H. Mack, 215 Chamber of Commerce Bldg.

Lyceum and Chautauqua Bureau

(Continued from page 86)
Barrow Productions, E. G. Barrow, mgr.: Crestwood, Ky.
Bord-Prinz Co., 326 W. Madison st., Chicago, Ill.

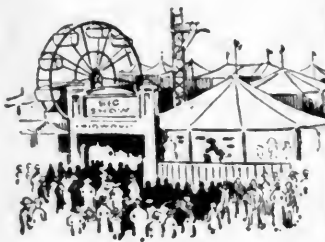

TENTED ENTERTAINMENT ~ RIDING DEVICES
CARNIVALS
 BANDS ~ FREE ACTS ~ CONCESSIONS
 BY CHAS. C. FOLTZ (BLUE)



(Communications to 25-27 Opera Place, Cincinnati, O.)

SHOWMEN'S LEAGUE PARTY SUCCESS FROM ALL ANGLES

Affair Given for Benefit of Cemetery Fund Yields Gratifying Financial Results and Is Greatly Enjoyed by Heavy Attendance

CHICAGO, Feb. 19.—The Showmen's League of America has large club rooms at 155 North Clark street, but they were none too large for the crowd that turned out last night for the party given for the benefit of the League's Cemetery Fund. The affair was a great financial success and jollity reigned supreme.

Members and their friends and acquaintances began to arrive as early as 6:30 p.m., and by nine all available space in the three rooms was well occupied. A half hour or so later the crowd grew to such proportions that one had to do some angling to get about, and this held true the biggest part of the night. Particularly was this the case on the second and fourth floors, the dancing taking place on the fourth. The attendance mark was around 450, and it was in the "wee sma' hours" when the last people left the club rooms.

The rooms were decorated for the occasion, and everybody was there with the glad hand. The music for the occasion was furnished by Henshel's Orchestra and was splendid. There were four pieces, Norman Henshel playing drums; Fred Miller, saxophone; Frank Desort, violin, and Sam Rosenthal, piano. Around midnight a treat in the way of a musical specialty was offered by Master Jerome, who proved to be a "wiz" on the xylophone. He played four selections and each went better than its preceding one. Master Jerome literally "brought down the house". His cleverness speaks well for Zipperstein & Johnson's Drum and Xylophone Studios, where the youngster, 11 years of age, received his musical training.

A prize endurance waltz was another feature of the evening, the honors being carried off by Louis Keller and Mrs. John Harris. Mrs. Harris received a beautiful bouquet.

D. Meehan was a lucky one, getting a fine top, donated by the Neumann Tent Company.

Coffee, sandwiches, cake, logansbury, etc., were served on all three floors, starting about 10 o'clock. Mrs. Baba Delgarian superintended the lunch arrangements. Charles McCurrren was at the door, Thomas Rankine was kept busy on the second floor, and Colonel Owens was here, there and everywhere, bending every effort to see that everything went off smoothly. Edward J. Neumann, was chairman of tickets and Sam J. Levy was general chairman of the affair.

Mrs. Thomas Rankine raised a nice sum of money thru the sale of carnations donated by Louis Hoeckner.

Among those present were: C. W. McCurrren, Mr. and Mrs. G. Ashkena, Sam Gluskin, Louis Levy, Mr. and Mrs. Thomas B. Vollmer, Hermann J. A. Ernst, Zebbie Fisher, Louis Leonard, Lewis Weisberg, L. L. Hall, Henry T. Curtin, Budd F. Menzel, Geo. A. Wright and family, Ed. L. Brannan, Jean D-Kreko, Edw. P. Neumann, Sam Frankenstein, R. E. Gump, E. E. Lindley, James Connery, J. Fred Temple, Fred Hollman, Tom Rankine, Mrs. J. Donahue, Mary Donahue, Mr. and Mrs. Murphy, Chas. G. Driver, Mrs. R. E. Scott, L. Ireland, Harry Liss, Col. Owens, A. C. Hartmann, Frank Perka, A. Milo Bennett, Al Hoek, Mr. and Mrs. Ed. A. Hoek and Evelyn Hoek, Asher B. Samuels, William Gelder, Conn Samuels, Ella Gelder, Mrs. H. E. Miller, Mrs. Gertrude Bert, Charlie Martin, Harry Coddington, Mr. and Mrs. W. O. Brown, Mr. and Mrs. A. Hodgini, Mr. and Mrs. H. M. Shoub, Mrs. H. S. Rose, Mae Davis, Hattie Martin, Julian Rogers, Mrs. Dan Odum, Gladys Gourdin, H. Snyder, Aida Snyder, Dorothy Kilfedder, C. J. McGloutson, B. M. Pederson, Ida Grehs, I. M. Seltz, Cecil Lowande, Irene Bonnett, Alma DePuy, John Harper, R. L. Duncan, L. J. Moser, Flo Hoeckner, S. Simonson, Ed. Kublozowski, Mary Bonafice, Mary Angell, E. Angell, N. Henchel, Mr. and Mrs. H. J. Tolley, R. W. Poignant, Ed. Beneke, J. Kural, Mr. and Mrs. F. Pokoeney, Lee Hall, Mrs. I. L. Peysner, Mrs. George Witter, G. D. Witter, M. Lightstone, Wm. H. Elliott, F. M. Barnes, Mr. and Mrs. E. Delgarian, L. C. Beckwith, A. L. Rossman, Al Goldstein, P. J. Stanton, S. Skolnik, Mr. and Mrs. J. L. Nichols, Frank C. Lob, Mrs. Ayres, Herman Siemen, W. S. Freed, W. D. Johnson, Mr. and Mrs. H. W. Kaplan, Mr. and Mrs. F. D. Weatherington, L. Kehos, Mrs. A. Latto, Mr. and Mrs. H. J. Garnel, Harry Gordon, E. J. Phillips, Mrs. H. Noethan, Mrs. M. L. Callahan, Mr. and Mrs. B. J. Levy, R. O. Henrie, W. B. Willis, Hazel Harrison, Nene Spiraon, Mr. and Mrs.

"Blacky" Murray, Mr. and Mrs. Joe Williams, M. L. Callahan, H. Byron, Mr. and Mrs. Tex Sherman, Erma H. Addis, Rose Addis, Celia Addis, J. H. Bolton, H. C. Hayes, G. E. Kolin, Mr. and Mrs. G. W. Anderson, Violet Olson, Chas. G. Patterson, Marie Kane, Ida Wagner, Winifred O'Malley, Mrs. F. Hansen, M. G. Fellman, A. J. Ziv, Mrs. Ed. Still, Mrs. Caroline Maxwell, Lillie Rhode, Mrs. Mattie Crosby, Genevieve Hill, Frank Reynolds, Cleora Miller, Gertrude O'Brien, Mr. and Mrs. A. L. Miller, Mr. and Mrs. L. Sorkin, Loraine Rhode, Albert R. Heselbarth, Mr. and Mrs. L. H. Weisberg, Margaret Rake, Agnes Foley, Anna Rake, June Eberhart, William Glickman, Mr. Miller, Pearl Hall, Mr. and Mrs. Tom Rankine, Mr. and Mrs. H. B. Danville, Mrs. H. T. Curtin, Mrs. W. H. (Bill) Rice, Mrs. Geo. Rollo, M. Bruns, Dorothy Rahbock, Mrs. Paul Young, Jeanne Severdloff, Jerry Rosen, Mrs. Frank Perlson, Mrs. S. M. Brewer, Lillian Doerr-Starr, Mrs. A. E. Doerr, A. E. Doerr, Geo. F. Starr, Mrs. C. Pagan, Mrs. W. F. Kelly, Rae Wojtecki, Bessie Planowski, Helen Wojtecki, Chas. G. Kilpatrick, Elsie Cloutier, Selma Quandt, M. Peterson, Helen Reilly, J. Holly, H. C. Zander, Eddie Young, Milton Edstrand, Leslie Byrnes, Mrs. Byrnes, Edward Gall, P. B. Curtin, W. F. Kelly, Louis Keller, Wm. Brill, Jos. Mark, William Murdo, Minnie Murdo, John M. Sheesley, H. Kurren, J. D. Bollow, Mr. and Mrs. Ray C. Quandt, M. Backus, Harry E. Wright, Theresa Triana, Lucille Triana, Minnie Triana, Harry Binder, Al Lewis, Mrs. Fred Kressmann, Mr. and Mrs. E. C. Talbot, Ruth Lassch, Esther Talbot, R. F. Potts, Robt. Demling, Della Barnes, A. D. Alliger, Miss Danier, Walter F. Driver, Harry Greenberg, D. Meehan, Kenneth Grigsby, Mrs. Drives, Mr. and Mrs. Jas. Chase, Mrs. B. Beshel, John W. Harris, E. H. Boomgarn, Fred Beckmann, B. S. Gerety, C. R. Fisher, Mike Smith, Harold V. Olson, H. D. Bisehoff, Mr. and Mrs. J. J. Russell, Marie Francis, Mrs. J. Drucker, E. O. Cates, Mrs. C. B. Cates, Mrs. Anna Cates, Eileen Cates, H. A. Ackley, Lillian Moyer, R. S. Whalon, C. J. Skinner, W. D. Cohn, Gertrude M. Drake, John L. Weber, Mrs. J. Foster, Pauline Cohan, E. M. Keller, John A. Pollitt, J. C. McCaffery, Frank Davis, Mr. and Mrs. M. B. Decker, E. Courtenanche, Jack Stanley, James Casey, Pat Wade, John A. Gillard, Mrs. F. M. Barnes, Ralph T. Hemphill, Henry J. Lund, Ray P.

(Continued on page 95)

Savidge Amusement Co.

To Open May 11 at Wayne, Neb.

Kansas City, Mo., Feb. 19.—The local office of *The Billboard* is advised that the Walter Savidge Amusement Co. will inaugurate its coming season at Wayne, Neb., May 11 and that Mr. Savidge will take the road this year with one of the largest outfits he has ever presented, as customary featuring the Walter Savidge Players (dramatic company), playing seven royalty bills.

Clarke B. Felgar, assistant manager, will report at Wayne in a short time to co-operate with Mr. Savidge in getting things lined up for the opening and the publicity campaign started.

Henry J. Pollie in Cincy

Henry J. Pollie passed thru Cincinnati last week while on a business trip in the interest of the Zeldman & Pollie Shows and spent a few minutes at *The Billboard*. The show was being represented at the "doings" in Chicago by Manager Jimmy Simpson. Mr. Pollie spoke in a very optimistic vein relative to prospects as he had found them for outdoor showdom in 1925 and informed that his engagement bookings for the season were fast reaching a degree of completeness.

FRED M. BARNES



Mr. Barnes is the new president of the Showmen's League of America.

Shore's Greater Shows Slated To Open April 25

Boston, Feb. 13.—Shore's Greater Shows, wintering at Levere, Mass., will be one of the first carnivals to take the road in this vicinity for the coming season. They open April 25 at a promising spot in Greater Boston, with other spots in this territory to follow. Business with this carnival was not very good last season except in certain spots, but the management is quite confident that 1925 will be a "red letter" season.

General Manager Abe Shore advises that the show is being enlarged in many ways. Besides the usual number of rides, among which will be a whip, merry-go-round and chairplane, there will be several shows, probably including a Wild West and an animal show. About 20 concessions will be carried.

Col. Fisk Out and Around

Col. I. N. Fisk is at this writing again able to be out and around in Cincinnati, in fact, is almost his old jovial self again after about six weeks of confinement at his home, during the early part of which it was thought he would be compelled to undergo an operation for kidney trouble. Colonel visited *The Billboard* February 19 and stated that three small stones had passed from his kidneys and that there was a possibility that at least one still remained, but X-ray photos (incidentally, difficult to secure because of Mr. Fisk's large proportions) had so far failed to reveal this condition. For the coming season this veteran showman, now about half thru his 60th year of life, intends to continue with the promotion and production of special events as he has during the past several years exclusively.

Morgan Gets Shrine Club Carnival at Corsicana, Tex.

Corsicana, Tex., Feb. 19.—At a recent meeting of the Navarra County Shrine Club a proposition from J. Doug. Morgan was accepted whereby the club will stage its second annual Spring Carnival here the week of March 16. Mr. Morgan insured the club that only high-class amusements will be included in the attractions he will present in connection with the event, consisting of two riding devices, three shows, featuring a big dramatic performance, also a colored minstrel show and a Wild West and some concessions.

Murphy on Business Trip

Edward Murphy, general representative of Sandy's Amusement Shows of Pittsburgh, Pa., passed thru Cincinnati early last week while on a business trip west as far as Indianapolis. Because of close train connections Mr. Murphy did not have time to pay *The Billboard* a visit, but 'phoned that the show will have a nice outfit, with 3 rides, 9 shows and about 35 concessions, and will play in Pennsylvania, West Virginia, Ohio and Indiana the coming season.

Showmen's Legislative Committee To Continue

Members Discuss Various Subjects and Decide To Operate About the Same as Last Year, Plus Improvements

Chicago, Feb. 19.—The Showmen's Legislative Committee met Sunday, Monday and Tuesday at the Auditorium Hotel and, altho few members were in attendance, they were all men of prominence in the carnival world and business was disposed of with decision and harmony. In a nutshell, the committee is to function along the same lines as it did last year with almost no changes in policy or supervision, according to M. T. Clark, authorized spokesman for the meeting, which was a closed one.

The committee met first Sunday afternoon, but so few members were present that adjournment was had until Monday. At the Monday meeting those who were present Harry Gerety, Fred Beckmann, Harry G. McVilvie, chairman of the executive committee; Thomas J. Johnson, commissioner and general counsel; John M. Sheesley, Lester M. Brophy, Jean D-Kreko, Jimmy Simpson, M. T. Clark, secretary of the committee and who also represented the S. W. Brundage Shows, W. S. Curry, representing the Rubin & Cherry Shows, and R. L. Lohmar, representing the Morris & Castle Shows.

According to Mr. Clark it was decided to continue the policies already in force and to take advantage of any mistakes in the past, stop leaks and generally improve the organization wherever improvement seemed practicable. Mr. Clark said the committee will bend every effort to give the public clean shows and will cooperate with all fair officials, city officials, civic bodies and other responsible organizations to this end. He said the committee will work with State fair organizations and the international organization of fairs toward giving the best in entertainment.

Mr. Clark said the entire committee members present worked in harmony thruout the proceedings, that there was an entire absence of radicalism and that businesslike and common-sense ideas were at the front. He added that Mr. Johnson's authority and prerogatives as commissioner and counsel remain the same as last year and which were agreed upon at the December meeting of the committee. Mr. Clark said in substance that the committee would continue to function along businesslike and conservative lines and seek to make itself a still greater aid and agency in advancing the interests of clean shows and the development of clean and better entertainment in the outdoor world in general.

The matter of salaries and expense of the committee, Mr. Clark said, remain the same as at the December meeting in answer to a reporter's question Mr. Clark stated that the matter of an attempt to organize another outdoor showmen's organization, variously reported to be seeking to supplant, amalgamate with or take over the Showmen's Legislative Committee, was not even discussed at the meeting.

Different members of the committee, after the meeting closed, expressed themselves to *The Billboard* as being well satisfied with the deliberations and conclusions arrived at.

Mrs. R. E. Russell III

Mrs. Rosalie Russell, wife of R. E. Russell, passes representative last season with the Great White Way Shows, is confined in St. Joseph's Hospital, Pittsburgh, Pa., where she underwent a serious operation. Following her discharge from the institution, Mrs. Russell will return to the home of her husband's parents, Mr. and Mrs. W. E. Russell, at Demarest, O., where she will remain for several months. Mr. Russell, who is at present editor of *The Daily News* at Cincinnati, Pa., will be connected with Smith's Greater United Shows the coming season in an executive capacity.

Lee Manchell to Florida

Lee Manchell, a member of the O'Brien Brothers' special event promoting and producing staff, last week journeyed from Toledo, O., where he had just concluded his work in connection with the Knight of Columbus' Circuit to Florida to lend his aid in the production of some specially arranged affairs in that State. Manchell had a few hours between trains at Cincinnati and availed himself of the opportunity to call on *The Billboard*.

ATTENTION!—Candy Users—ATTENTION!

For the coming season the Ireland Candy Company has prepared a wonderful new line of attractive and novel Flash Boxes in which are packed Chocolates of the highest quality.

It is merchandise that means repeat business---and that is what both the traveling and permanent concessionaires want.

Ireland's Chocolates are recognized as the best in the country---with prices always right---and service and promptness unexcelled. Send for 1925 Price List Today.

Eastern Representatives:
SINGER BROS.
536-38 Broadway,
NEW YORK, N. Y.

FACTORY
IRELAND CANDY COMPANY
501-3-5 North Main Street, ST. LOUIS, MO.

Northern Representatives:
H. SILBERMAN & SONS,
328 Third Street,
MILWAUKEE, WIS.

BAND ORGAN BARGAIN

ATTENTION, MR. PARK OWNER!

If interested in a big attraction to draw crowds and entertain, write for details on Style 165 Mammoth Band Organ we are now rebuilding like new. Just the instrument you want. Write or wire immediately. *This is your big chance!*

THE RUDOLPH WURLITZER MFG. CO., N. TONAWANDA, N. Y.

MAKE MONEY THIS SUMMER WITH KOMPACT SODA AND LUNCH OUTFITS

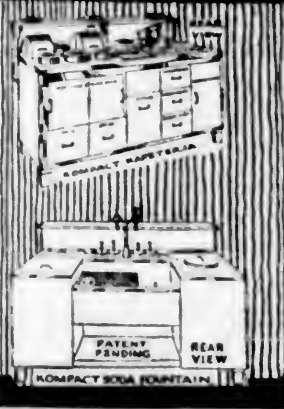

For Parks, Rinks, Beaches, Dance Pavilions, Chautauquas, Theatre Lobbies, Excursion Boats, Carnivals, Etc.

KOMPACT SODA FOUNTAIN and KOMPACT KAFETERIA are just what you want to make a good profit, along with plenty of legitimate money. Fountain occupies 2 1/2 x 3 1/2 feet; Kafeteria, 3 1/2 x 6 ft. Sell from the Fountain, Ice Cream, Draft Soda, Bottled Drinks, Candy, Sandwiches, etc. From the Kafeteria, Hot and Cold Lunch. Fountain has a "Silent Salesman Display Case" front and can be used with either city or well water. Both units can be moved to new locations. Operated by one man. Sold together or separately, and cost is so moderate that they soon pay for themselves. Big profit this summer for Kompact operators who have good amusement location or who have auto road stands. Investigate! WRITE FOR ILLUSTRATED LITERATURE.

KOMPACT PRODUCT CORP., MFRS.,
247 Park Ave., NEW YORK
Canadian Distributors: NAT'L DRUG & CHEM. CO. OF CANADA, LTD., Montreal, Canada.

EVANS' LATEST! The Pony Track! TOP MONEY EVERYWHERE



Price. **\$75.00**
15-horse machine, mounted on 36x36 food-up board.
IMMEDIATE SHIPMENTS.

COMPLETE LINE OF SUPPLIES FOR BAZAARS, INDOOR CIRCUS, ETC. Send for Our 96-Page Catalog of New and Money-Making Ideas.
H. C. EVANS & CO. Show Rooms, 321 West Madison St., CHICAGO
Office and Factory, 1528 W. Adams St.

NEW SUPER-JUMBO BURNER for Cook-House Men



Power, service and satisfaction heretofore unknown. Top measures 6 inches across. No packing--self-cleaning. Has double the heat of any other burner or reduces low for slow cooking. Try this burner and we promise you will be surprised and delighted. Price, \$6.50. Write for circulars of everything to outfit the Cook-house. Hamburger Trucks, Storage-Box Stoves, Griddles, Tents, Orangeade Powder and Glassware, Snow Machines, Hamburger Press, Steamers, Wazmers, Tamale Machines and Kettles, Tents, Umbrellas and a long list of useful items. Ask for anything you need.

TALBOT MFG. CO., 1213-17 Chestnut St., St. Louis, Mo.

Milk Bottles For Ball Games

Best made, biggest money-getter in the Concession Field.

\$20.00 For 18 Bottles

Buy your bottles now from the manufacturer. Bottles sent on receipt of money order.
DAVE ROSE, Room 303, 1493 Broadway, New York City.

Showmen's League Annual Election

Much Interest Manifested in the Proceedings
—Fred M. Barnes Elected President
and A. J. Ziv Secretary

Chicago, Feb. 19.—The annual election of the Showmen's League of America Tuesday showed a general interest in the membership of the league. The regular ticket had no opposition except an independent ticket carrying names for the Board of Governors only. Still this ticket served to arouse a considerable degree of interest. It put quite a lot of ginger in the voters working for the regular ticket. It is perhaps but fair to say that Fred M. Barnes, the new president, was the outstanding figure in point of interest all during the day, altho Mr. Barnes was busy with the fair secretaries at the Auditorium Hotel. This was but natural, as Mr. Barnes in the capacity of first vice-president for the past year has been the essence of promptness, unselfishness and fidelity in presiding over the league, aiding it in manifold ways, stimulating interest as only he knows how to do, prodding things up when they lagged, promoting enthusiasm in all movements of the league, stiffening the grip of committees when they needed him and raising money for the league with something like a sixth sense for finding it. A presiding officer of rare ability, a sound and quick parliamentarian, coolheaded and with the wit that keeps people in a good humor, Mr. Barnes brings to the office of president a group of ripe qualities that the league can use with profit.

When Mr. Barnes is unavoidably absent from any meeting, it should be added, the second and third vice-presidents, Edward A. Hock and Sam J. Levy, respectively, have all the qualifications needed—and more—to run things the way the chairman would do if he was there. During Mr. Barnes' absence last fall at the fairs Mr. Hock was the first man on the job each meeting night as presiding officer and the last man to leave after the meeting closed. He watched every detail with precision and the business of the league moved like clockwork while he was at the helm. Nobody needs to say anything about what Sam Levy can do. Ever since this writer has been a member of the league Sam Levy has been doing something useful for the organization and doing it always in a big way. It should be added that Mr. Browning is in Florida and it is not known just when he will return. Therefore the reference to Mr. Hock and Mr. Levy is emphasized as above.

It is not known just what policies Mr. Barnes has in mind for the league's consideration, but those who know his fertile and businesslike mind are looking for "something different", that is something striking, original and practical. It is safe to say he will be heard from and soon.

The new officers are: President, Fred M. Barnes; first vice-president, Charles G. Browning; second vice-president, Edward A. Hock; third vice-president, Sam J. Levy; treasurer, Edward P. Neumann, and secretary, A. J. Ziv.

Honorary vice-presidents: Edward C. Talbot, Edward F. Carruthers, Fred L. Clarke, Jerry Mugivan, Walter McGinley. Members of the Board of Governors: C. R. Fisher, Bert Earles, Joe Rogers, J. C. Simpson, Fred Beckman, Charles G. Kilpatrick, Milt Morris, Walter D. Hildreth, W. C. Fleming, M. H. Barnes, C. F. Eckhardt, Charles McCurren, Baba Delgarian, Rubin Gruberg, W. O. Brown, W. D. Cohn, Dr. Max Thorek, John M. Sheesley, J. C. McCaffery, Lou Keller, S. H. Ansell, W. H. Rice, James Campbell, Al Hock, Frank Perison, Leon A. Boreznak, Harry G. Melville, A. H. Barkley, Felice Bernard, Tom Rankine, Ed Ballard, Harry Coddington, Dan Odum and Col. Fred J. Owens.

Don't Miss This Big WATCH BARGAIN

The Cheapest Standard American Watch in the U. S.

Now Only **\$2.95**



No. 196B—Gent's 16 Size, Thin Model Gold-Plated Double Hunting Case, beautifully engraved in assorted designs, fitted completely with a reliable AMERICAN-MADE jeweled movement. An excellent time-keeper, fully guaranteed, stem wind and stem set. The biggest watch value on the market today. Our price while this lot lasts:

Each, **\$2.95**
In Lots of 10 or More, Each, **\$2.85**

Sample, Post-paid, \$3.25. The above also furnished in ladies' or boys' 6 size at the same prices.

HERE IS ANOTHER SPECIAL



No. 1897B—The biggest value in Wrist Watches. White platinum finish case, stamped "Warranted 25 Years", engraved bezel and slides; blue sapphire in winding stem. Movement is a 6-jewel Swiss, silver-engraved dial, with silk ribbon and box. Price Complete, Only **\$3.95**

No. 1891B—10 1/2-Line, Tonneau Shape White Platinoid Finish Ladies' Wrist Watch, 6-jewel Swiss movement, silver-finish dial, silk ribbon Broochlet and Box. Price Complete **\$2.85**

Samples, 25c Extra. See our prices before buying elsewhere. It means money in your pocket. Orders shipped same day received. Samples, 25c extra. Deposit required on all C. O. D. orders. Catalog free.

JOSEPH HAGN COMPANY,
The House of Service.
Capt. B. 223-225 W. Madison St., Chicago, Ill.

TENTS

FOR CIRCUS AND Sideshow.
Write for Circular and Prices.
ENDICOTT-HAMMOND CO.
Phone, Whitahall 7298, New York.
153 Chambers Street.

FOR SALE

Two Freak Animal Shows. New Tents. Banners all new. Twenty Live Freaks and Stuffed One. Best show on the road. Must sell. A bargain. Terms to the right party. Apply BOX 8, Welaka, Fla.

FOR SALE GLOT MACHINES OF ALL KINDS FOR SALE CHEAP.
Address SICKING MFG. CO., 1931 Truman Ave., Cincinnati, Ohio.



This Ring Sold for \$125.00

So one of our Salesmen wrote us

We offer it here for \$3.98

Our Catalogue price \$12.00

No. 1049 To interest live Billboard Salesmen in

The Marvelous Mexican Blu-flash Gem

Is the latest gem sensation. It positively matches the finest Genuine Diamond side-by-side in perfect cut, blue-white brilliancy (guaranteed 20 years), and dazzling rainbow fire. Experts need utmost experience to detect any difference. You risk nothing in dealing with us. Wear our gem 3 days side-by-side with the finest diamond and if you can detect any difference whatever, send it back for cheerful refund.

The ring shown above is a massive Flat Belcher Gem's Ring, made from a fitted tube of solid gold and set with 2-carat selected, extra brilliant Mexican Blu-Flash Gem, set with fire and flash. Our catalogue price is \$12.00. To interest Billboard salesmen, we offer a limited number at only

\$3.98
(Order as No. 1049.)

Never before offered at any such price as this. It is exactly the same quality of ring as sold by one of our salesmen in Kansas for \$125.00. SEND NO MONEY. Not over three of these rings to a customer at this price. State size. You run no risk. Use coupon below.

OTHER MONEY-MAKING NEW DESIGNS

All set with our most brilliant rainbow fire Mexican Blu-Flash Gem.



No. 1018—Massive 8-Frang Tooth Belcher Ring. Fitted solid gold tube mounting, set with 2-Ct. gem. \$8.00. For **\$3.28**



No. 1103—Sterling Silver, in our new Platino finish, basket setting, engraved; 1-Ct. Gem. \$8.00 for **\$3.46**



No. 1203—Solid White Gold Solitaire, basket design, finely engraved, with 1-Ct. Gem. \$15.00 for **\$6.94**



No. 1122—Gem's Heavy Fancy Ring, sterling silver, with our new Platino finish, black inlaid shanks, mounted with 1 3/4-Ct. Gem. \$12.00 for **\$4.98**

Don't Delay CLIP OUT COUPON NOW. Order one or more rings above offered at reduced prices quoted. No duty or custom charges to anywhere in U. S. or possessions. No deposit. Above all, get our catalogue and proposition; use coupon attached. IT COSTS NOTHING TO INVESTIGATE.

We are headquarters for Mexican Resurrection Plants. Write for prices.

MEXICAN GEM IMPORTING CO., Dept. NK, Mesilla Park, New Mexico
Dealers in Gems for more than 19 years. Reference: First National Bank, Las Cruces, New Mexico.

Use This Opportunity Coupon

(To investigate, check and mail this coupon today for our Catalogue and Agents' Proposition. To order at reduced prices from this ad order by number only. SEND NO MONEY. On arrival deposit price with postoffice. If not pleased, return in three days for refund. State size of Ring wanted, or enclose narrow paper strip exactly meeting above lines.)

MEXICAN GEM IMPORTING COMPANY, Dept. NK, Mesilla Park, New Mexico.

Send quick your Catalogue and Agents' Proposition. []

Mail quick Rings Nos. at reduced prices quoted as offered in your

Billboard advertisement. Size.....

NAME.....
ADDRESS.....

WANTED; LEGITIMATE CONCESSIONS FOR

Sarasota Orange Blossom Festival

March 3 to 7, inclusive. Free on the Streets—Street Dances, Fireworks and Parades. Something doing every minute. Write or wire

HARRY E. CRANDELL, care Chamber of Commerce, Sarasota, Fla.

Auspicious Opening

Abner Kline Shows Make Initial Bow at San Bernardino Orange Show

San Bernardino, Calif., Feb. 19.—The Abner K. Kline Shows enjoyed a most auspicious opening here today at the 15th annual National Orange Show. The significance of securing this prominent event of the Pacific Coast for the show's initial engagement, the volume of attendance and the very favorably commented-on appearance of the grand array of amusements constructed and assembled for the above show title is exceedingly gratifying to Manager Abner K. Kline and attaches of his organization.

The people came in droves to the Orange Show, the gate admissions numbering in the neighborhood of 20,000. From a majority standpoint they first visited the new \$150,000 building which is elaborately decorated—the greatest scenic display of its kind the writer has ever witnessed. They heard the presentation speech of Governor Richardson of California, who verbally delivered the new building to the orange show directors in a masterful way and stressed the greatness of the citrus industry. Then they came to the midway, and the assemblage on the pleasure zone kept getting greater until it was a seething mass of humanity, and they saw one of the most pretentious looking collections of amusements ever assembled for this particular event.

The midway is laid out in horseshoe formation. Near the entrance is centered the kiddies' playground, known as Fairyland, presenting seven miniature Parker rides, with varied colored lighting effects and attendants spotlessly dressed. These "kiddie" rides consist of carry-us-all, Ferris wheel, seaplanes, chair-o-plane, ocean wave, circle swing and rockaby. C. W. Parker is here supervising the opening of this unique feature. Conspicuously placed thruout the center of the midway are the large riding devices, all under the management of Mr. Kline and consisting of Parker three-abreast carry-us-all, seaplanes and Ferris wheel—all new and a great flash.

The shows are all under new canvas and presented back of new banners or freshly painted carved wagon fronts. The ballyhoo shows are well wardobed and the grind shows neatly dressed up. Following is a list of these attractions (a complete roster of the personnel will be provided in a later "letter"): Old Frontier, Billy Kirby, manager; Cowboy Elliott on the front, and a coterie of Wild West sports entertainers, featuring Magdalena Bill, with "Don Fulano", wonder horse, as an added attraction. Monkey Speedway, Elmer Kline, manager. Darktown Follies, with Billy Tucker, manager; Frank Hüllinger, talker, and performance given by 17 people, inclusive of a six-piece orchestra and band. Bill Evans, of freak animal note, presents "Cleo", the double-bodied child. Prince Maho, the horse-like man—upside-down marvel. Mason's Jungleland, with a 70-foot panel and banner front. Mrs. Abner K. Kline's Penny Arcade. Mysterious India, an illusion show. W. S. Ferdna, manager. Glass Show. Silodrome, with a straight wall and presenting three intrepid riders. The Google and Spark Plug Fun House. Copeland's Circus Side Show, with a 100-foot banner line and 10 living attractions. Hollywood Follies, in an up-to-date manner presenting Tanagra with six singing and dancing specialties under management of Charles W. Donnelly. Milt Runkle's Law and Outlaw Show, under a 40x100-foot top. Sky Clark's War Exhibit, House in a Log, showing three rooms complete (parlor, bedroom with bath and kitchen) hollowed out of a monster redwood tree and mounted on a motor truck—this attraction is causing a world of comment. Pony track, with 25 neatly groomed Shetland ponies. "Casey Jones", which consists of a miniature locomotive (from pilot to tender), mounted on a truck, the handwork of two ex-service men—another interesting exhibit. The show is well supplied with music, with the big band under leadership of John Mitchell, the minstrel show band, and there are three Tangley calliphones scattered among the bally shows. Also the Prince Maho Show has a three-tube radio set constantly "tuned in" on band concerts and other music.

Of the executive staff Abner K. Kline is manager, W. B. Wedge secretary and treasurer, Al (Big Hat) Fisher general representative, G. E. Crowder and C. H. Bryant special agents, H. E. Simpson superintendent of concessions, Ed A. Marshall bill superintendent and electrician, Bill Kitchen trainmaster, John Mitchell musical director, and the writer, C. H. Bryant, is also in charge of publicity.

There were many visitors of note at the opening, among them Governor Richardson and his staff, who made a tour of the show's attractions, personally conducted by Manager Kline. After this date (February 19-March 1) the show will travel on its own special train of 15 cars.

Buys Bankrupt Stock

New York, Feb. 19.—J. Kaufman & Sons have bought a bankrupt stock of horse blankets which they are selling to the show trade at a low quantity price probably never before equaled.

Specials for Sheet Writers

Best Values Offered in Ready-To-Wear Spectacles for Premium Trade

Prices Radically Reduced

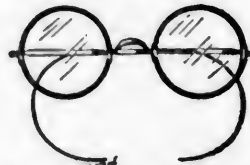

F2729—Shell-Rim Spectacles, Shell frame, gold filled riding bow, large deep curved lenses, furnished in all focused numbers from 6 1/2 to 315.

DOZEN, \$9.50

NOTE—Leatherette Covered Cases for above Spectacles, with plush lining, Dozen, \$1.75. Same style of Case, with flannel lining, Dozen, \$1.35.



F2730—Shell Frame Spectacles, Dark, skull-fit, heavy weight shell frame, fitted with deep curved lenses, focused from 8 to 315.

DOZEN, \$9.00

NOTE—High-grade composition Cases for above Spectacles, in envelope, snap-down shape, Dozen, \$1.75.

Write for Big Free Catalog

We handle the biggest variety of goods for Sheet Writers, Premium Users, Solicitors, Shows, Carnivals, Bazaars and other dealers in America. If in the market for new novelties and other money-making merchandise get our catalog.

LEVIN BROTHERS
Terre Haute, Indiana

DOG-IN-A-BUN

TRADE MARK
DOG-GONE GOOD

FRANKFURTER BAKED IN A ROLL

Get into line with this proved steady money maker. Find a location and forget your worries. Demonstrate to public view this new, delicious HOT DOG SANDWICH, which is getting sensational sales and earnings everywhere—North, South, East and West. Costs 2c, sells 10c. Both prepared flour and recipe furnished. Big sales, up to \$100.00 daily. Owners reporting great success.

TALBOT MFG. CO.

1215-17 Chestnut Street, ST. LOUIS, MO.

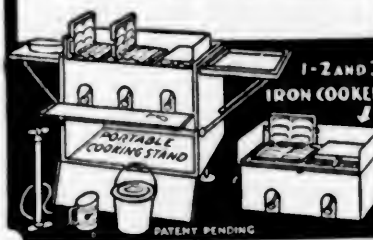

AMERICAN EAGLE BUCKLES

"THE ORIGINAL EMBLEM" WITH THE "RED", "WHITE" AND "BLUE" ENAMEL COLORS.

With Rubber BELTS, \$15.00 gross

With Leather BELTS, \$24.00 gross

Complete line of Genuine Cowhide Leather BELTS

RUBBER BELTS, \$12.00 gross

With Toller or Lorer Buckles, Colors: Black, Brown, Grey, Smooth and Walnut. One-third deposit on all orders, balance shipped C. O. D. Write for our new Catalogue.

PITT BELT MFG. CO.,

705 5th Avenue, PITTSBURGH, PA.

OUTDOOR AMUSEMENT COMPANY

New looking 1925 season. WANT Cook House, and all Wheels open. Would like to hear from a few legitimate Grind Stores. We own our rides. All former concessionaires write. Address: J. F. McCARTHY, Manager, Frankford Ave., Philadelphia, Pennsylvania.

Advertise in The Billboard—You'll be satisfied with results.

CAILLE VICTORY MINT VENDER

WILL NOT CLOG IN THE COIN TOP

Increase Your Profits
At same time furnish amusement for your customers

IN USE EVERYWHERE

The only perfect coin-controlled construction
Immediately becomes a favorite with the public

Most attractive vender ever designed

WRITE TODAY For Full Information

Manufactured Only by **THE CAILLE BROTHERS CO.**



CAILLE VICTORY COUNTER VENDER.

Automatically shares the profits with purchasers of
Caille Quality Mints

ALWAYS WORKING

The result of thirty years' experience

FULLY GUARANTEED

PATENTED COIN TOP
Thick, thin, bent or mutilated coins quickly removed

No Clogs Possible—Easy To Operate

6241 Second Boulevard, DETROIT, MICH.

The "TELERAY" Electric Flower Basket

WAS MADE FAMOUS BY INCREASED SALES.
Electric bulbs inside the flowers give a most beautiful transparent effect not obtainable in any other electric flower basket. WONDERFUL PREMIUM ON SALEBOARDS and a fast seller at Bazaars, etc. Teleray bulbs burn almost indefinitely. The Basket shown at right, 6 lights, 23 inches high.

	Each.	Dozen.
4-LIGHT BASKETS. 19 inches High.....	\$3.00	\$33.00
5-LIGHT BASKETS. 22 inches High.....	3.25	36.00
6-LIGHT BASKETS. 23 inches High.....	3.75	42.00

Sample sent at individual prices shown above.



SHOWING ROSE DETACHED

	Each	Sample
MAZDA LIGHT BASKET. No. 7-M-9—3-Light Basket. 23 inches High.....	\$3.75	\$4.00

CALIFORNIA DAHLIAS
Unstemmed, Assorted Colors,\$30.00 per 1,000
Simple Assortment of 100, \$3.50.
Cutlets on Long Wire Stem, with Natural Preserved Grass, 60.00 per 1,000

25% cash required on C. O. D. orders. Samples All cash. Write for Illustrated Catalog.
OSCAR LEISTNER Manufacturers, Estab. 1900. **323-325 W. Randolph St., Chicago, Ill.**

Barlow's Big City Shows Busy at Winter Quarters

St. Louis, Feb. 19.—The local *Billboard* representative journeyed to Granite City, Ill., and visited with Harold Barlow, of Barlow's Big City Shows, at the winter quarters there.

A crew of men is working on new wagons and fronts, and getting things in shape for the show's opening, which will be April 11, on the streets between the cities of Venice and Madison, Ill., at what is considered a wonderful carnival location. It will play there eight days. The show has been enlarged, Mr. Barlow stated that it will go out with 12 shows, 6 rides, a new calliope for street advertising and a special line of advertising paper. For the first few weeks it is booked thru Southern Illinois. Most of the new fronts will be paneled and carved, and all new tops have been bought, the writer was informed. The flat, box and sleeping cars recently purchased from James Patterson are expected in a few days, and workmen will repaint them with the show's title and thoroughly overhaul them. Louis LaPage and Harry Kackley, special agents, are busy with promotions.

Mich. Outdoor Showmen's Assn.

Detroit, Feb. 18.—Last week the Michigan Outdoor Showmen's Association celebrated the first anniversary of its organization. The rapid strides and healthy growth of this organization is largely due to the spirit and enthusiasm of each member in putting forth his support in helping the organization in everything it has set out to do.

Final plans and arrangements for the barbecue and dance to be held March 14 at the Detroit Labor Temple hall were discussed and acted upon and committees were named. More than 300 tickets were distributed among the members and judging from present indications this event is assured of being a grand success. Attendance at last week's regular meeting was small, due to the fact that a large number of the members were busily engaged with indoor doings in Detroit and vicinity. H. A. Ackley, who at one time operated a carnival of his own in Michigan, made an address as a member, expressing his views and complimenting the organization on the wonderful progress and good work it has accomplished in the year passed. Mr. Ackley was here on business for a few days, representing the Traver Engineering Company. President Leo Lipka presided at the meeting. He is very active on the ticket sale for the barbecue and dance and if he maintains his enthusiasm as displayed heretofore on the recent banquet and ball he will undoubtedly be awarded the prize which Second Vice-president Louis Rosenthal will present to the one selling the most tickets.

Miniature Adding Machine

New York, Feb. 19.—I. Gancher, who has been selling to the show trade for years, has put on the market an adding machine designed especially for showmen's use. It is light and may be carried in the ticket seller's pocket.

Showmen's League Party Success From All Angles

(Continued from page 92)

Speer, E. R. Montgomery, R. L. Lohmar, J. C. Simpson, A. H. Barkley, Tommy Thomas, Jack C. Sampson, Mrs. Lottie Bennett, Mrs. Laura Stromquist, Thos. Cantfield, Thos. Hislop, Rube Liebman, R. E. Buckam, S. W. Carruthers, S. Raymond, A. L. Putnam, A. P. Alexander, J. P. Malone, John Seripsma, Elroy S. Thompson, W. A. Kelly, J. R. Campbell, Mr. and Mrs. C. R. Roger, Mr. and Mrs. W. F. Palmer, C. O. Patton, D. V. Moore, R. N. Gayner, Henry Thull, George Weber, Lillian L. Blbe, Saldo Deka, B. B. Sawyer, J. Collins and John Wendler.

BEANO or CORN GAME

The Fastest and Best of All.
Cards made of heavy leatherette bound material. Complete, with numbers, wooden blocks, tally sheets and instructions.

33-PLAYER LAYOUT.....\$ 5.00
70-PLAYER LAYOUT..... 10.00

HEADQUARTERS
For all kinds of Games, Lamps, Aluminum, Silverware, Dolls, Vases, Candy, Baskets, Stuffed Toys, Paddle Wheels, Dart Wheels, Electric Appliances, Pictures, Pillow Tops, Pennants, Noctules, Balloons, Games, etc. Send today for our new Catalog No. 124.

SLACK MFG. CO.
128 W. Lake St., Chicago, Illinois

OPERATORS

TWO PROVEN PENNY GETTERS
Run Anywhere—Steady Repeaters
MADE TO MAKE YOU MONEY

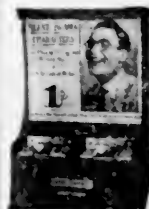

Ideal Post Card Vender

A great little machine to install in School Stores, Billiard Halls, Restaurants, etc. We publish about fifty series of Postcards for the Ideal. You just change the cards and display sign regularly and get the pennies all the time. Sells one to three thousand cards weekly. Send for descriptive circular of Ideal, Postcards and operators' prices.

Duoscope Picture Machine

A steady money getter for operators in School Stores, Resorts, Arcades, etc. The Duoscope is the smallest picture machine made using our genuine photo views of art models and comedy pictures. Holds two sets of views. Requires no electricity. Operates by hand. One-cent or five-cent play. Send for descriptive circular of Duoscope, Views and operators' prices.



ASK US HOW YOU CAN START IN BUSINESS.
World's Largest Makers of Coin-In-Slot Amusement Machines and Supplies.
EXHIBIT SUPPLY CO.
4222-30 West Lake Street, CHICAGO, ILL.

Capitol Outdoor Shows, Inc.

CAN PLACE AT ONCE TEN-IN-ONE, PLATFORM SHOWS, INDIAN VILLAGE, ETC.
Have Good Proposition for a Metrodrome. WANTED—Legitimate Concessions.
We own our own Rides and own Light Plant. Those with us in previous years write. WANT Ride Help. Show opens latter part of April, then the choice Canadian Fairs, which start in August. Fraternal and Civic Organizations write, and representative will call. WANT A-1 Free Attraction for entire season, including Fairs.
PHIL ISSER, General Manager, 1520 Broadway, Room 2, Loew's Theatre Bldg., New York City.

COOK HOUSE MEN ATTENTION!!
We are the headquarters for Gasoline Stoves, Jumbo Burners, Steam Tables, Tanks, Pump, Hollow Wire Gasoline Lanterns, Little Wonder System Lamps, Mantles, Torches, Waffle Irons, Coffee Urns, Griddles, Juice Jars, Juice Powders, Circus Lemonade Glasses, and Special Equipment to order. Order from this ad, wiring one-fourth deposit, or write for complete catalogue. We make immediate shipments.
WAXHAM LIGHT & HEAT CO.
Dept. 15, 550 West 42d Street, NEW YORK CITY

Advertise in The Billboard—You'll Be Satisfied With Results.



FAMOUS NOS-NIVEL PEARLS

Guaranteed Indestructible, with Rhinestone clasp.

24-Inch. \$4.00 Per Dozen
30-Inch. \$5.50 Per Dozen

Beautiful Heart-shaped Plush Boxes, \$4.00 per Dozen.
20% deposit must accompany C. O. D. orders.
Have you our 1925 Jewelry and Novelty Catalog?
HARRY L. LEVINSON & CO
168 N. Michigan Ave., Chicago.

WANTED—CONCESSION.
In Show, Carnival, starting from St. Louis. Have own equipment. Write B. KRESTEFF, P. O. Box 345, Granite City, Illinois.

NICKEL PLATED TRAYS



A SENSATIONAL ITEM

Size, 11x9 inches. Hand-painted glass bottoms, with 3/8-in. non-rusting nickel-plated edge. Polished handles and ornamental corners. Assorted designs. Each in box.

Per Dozen, \$13.50
Per Gross, 150.00
Sample, Prepaid, \$1.50.

25% Deposit Required. No Personal Checks Accepted.

OPTICAN BROTHERS
"ARE RELIABLE"
St. Joseph, Missouri

MIDWAY CONFAB

• BY DEBONAIR DAB •

(Communications to 25-27 Opera Place, Cincinnati, O.)

Winter sure seems to be "flying". The Spring Number will again be a whopper.

The Showmen's League benefit party last week was a grand, gala occasion.

That sale of the Con T. Kennedy show property was finally consummated.

Report has it that T. A. Wolfe will have some outstanding feature attractions.

Only two editions between this one and the BIG one—the Spring Special, dated March 21.

Deb's thanks to Harry Dickinson, of pit show and dog and pony circus note, for his sending of a fine pictorial folio of scenes in and around Havana, Cuba.

getting together a girl revue to play indoor events.

Word from the headquarters of the Corey Greater Shows was that Dare-Devil Oliver, high diver, had been signed for the coming season; also that Will Smith, of Winslow, Ill., had signed his chair-o-plane and two concessions.

Carl S. Elder, known to many carnival folks, and who has been operating a restaurant at Paducah, Ky., this winter, advised that he just signed as cook with the Belle Barchus Stock Company, opening early in May.

Fred Zindra and wife left Chicago February 18 for Atlanta, Ga., to ship the Zindra Circus Side Show paraphernalia from there to Jeffersonville, Ind. The attraction will be a feature with the Nat Reiss Shows this season.

Before getting right down to hard-pain special agent work for the coming season of the John T. Wortham Shows Roy E. Ludington has been spending his time between relatives at Durant, Ok., and winter quarters at Paris, Tex.

"Paddy" Gold, the past two seasons with Gordon's Freak Animal Show with the George L. Dobyns Shows, probably will be with that caravan this year. However, since a baby daughter arrived in "Paddy's" family recently the Mrs. will not "troupe" the coming season.

CULVER AND VALLEY



The photo reproduced above was "snapped" about a year ago in Santo Domingo City, D. R., and shows two well-known Eastern showmen, Cal. Culver, the giant, and Capt. Jack Valley, of water show fame, who because of illness postponed his intended return trip to South America this winter.

That the coming season will be better than last year seems assured—but it might be best to not indulge in too luxurious living during the spring and early summer months at least.

Capt. H. Snider, years ago with small circuses and later with an animal show with Billie Clark's Broadway Shows, is planning on launching a medicine show in Alabama for the coming season.

Now and then you find persons so busy trying to attend to other people's business that they fail in putting over their own—their figure on "bluffing it thru" for their "porkchops".

Send Deb your "confab" squibs that will be currently good in forthcoming big special edition now, so that they may be prepared before the rush of work on that issue starts.

Bob Warner, who with his animals has been booked with the W. G. Wade Shows, recently opened a museum in Hamtramck, Mich., until the shows open, and the place is reported to be doing fair business.

Chas. Lorenzo, who is to again have his concessions with Miller Bros' Shows, arrived at winter quarters recently from Atlanta after a motor trip over some miserable roads—caused by heavy rains.

The W. G. Wade Shows have all their rides ready to "spring", other preparations are progressing nicely, and the management expects an early opening on lots in Detroit.

Jolly Dixie and Her Congress of Fat People, under management of H. L. Wilson, are slated to spend their eighth season with the L. J. Heth Shows. The personnel was scheduled to leave Chicago for Birmingham, Ala., February 22.

John Farley inoed from Boston that he has five new 10x20 concessions and thinks he will be with Al Shaw's Shows the coming season. Until the season opens he is

W. H. BLUEDORN



Mr. Bluedorn, who is well known to outdoor showfolks east of the Mississippi River, is now contracting and staging indoor affairs.

Last week again found a large amusement organization exhibiting under the management of Abner K. Kline. For about two years it was thought he would not be able to again pick up the managerial reins because of an accident and illness.

Thanks, Harry K. Long, for the "clipping". It is very handy for Deb. to know of such instances even if probably best (sometimes) not to comment in print on them—which, as you will notice, does not allude to the one you sent.

Albert Kreutz, who has been street-selling in Cincinnati and environs this winter, left last week for Akron, O. Albert has sold his merry-widow swings and highstriker and is thinking of operating only his long-range shooting gallery, which he has stored the past eight years, the coming season.

"Mother" Flanagan, of cook-house note, and her assistants, have been industriously preparing for the coming season on "Mother's" farm in West Virginia. Mrs. Midge Florka has been her guest. "John" has his two-ton truck ready to move at a moment's notice, and Al Woods, the grid die man, is awaiting the signal to start.

Since closing his season with the Miller-Via Shows Ken Hudson has been playing his "Echoes of Hawaii" troupe in picture houses in Georgia, with J. W. Keown as

ELI POWER UNIT

16 HORSE POWER Our four-cylinder heavy duty type engine, with our special gear reduction, makes the ELI POWER UNIT standard, reliable power for riding, driving, of all kinds. Write us about your engine troubles and let us tell you about the most reliable, economical power on the market.

BUILT BY
ELI BRIDGE COMPANY
N. West Street, Jacksonville, Ill.

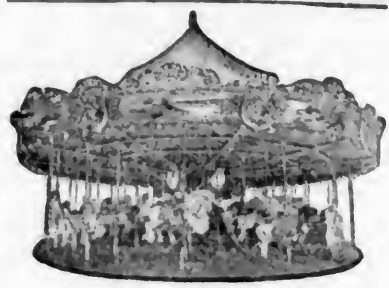

"IDEAL" THREE-ABREAST.
"LITTLE BEAUTY" TWO-ABREAST.
NO. 1 SPECIAL THREE-ABREAST.
STANDARD THREE-ABREAST.
STANDARD TWO-ABREAST.
PORTABLE AND PARK CARROUSELS.
Write for Catalog and Prices.

ALLAN HERSHELL CO., INC.
NORTH TONAWANDA, N. Y., U. S. A.

THE NEW CHAIRPLANE



The Latest Invention. The Most Sensational Ride Out for Parks, Fairs and Carnivals. Portable and stationary. Write today and let us tell you all about it.

SMITH & SMITH, Springfield, Erie Co., New York.



Horses, Figures, Kiddie Rides, Flying Swings, Etc.
M. C. ILLIONS & SONS, Inc.
Write for Illustrated Circular and Prices.
2789 Ocean Parkway, CONEY ISLAND, N. Y.

HEADQUARTERS FOR BAND ORGANS

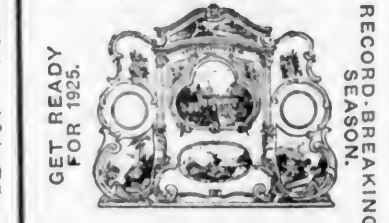

Get our new Improved Organ. Different sizes for all purposes. Our Organs are guaranteed. Let us figure on your repair work. Prices reasonable. Our motto is true to time, perfect for hand effect. Write for catalogue and about your requirements. **ARTIZAN FACTORIES, INC.**, North Tonawanda, N. Y., U. S. A.

FUTURE PHOTOS

NEW HOROSCOPES
Macle Wand and Buddha Papers.
Send for samples
105, LEDOUX,
169 Wilson Ave., Brooklyn, N. Y.

GUERRINI COMPANY

17 Petronilli and C. Platano, Proprietors
HIGH-GRADE ACCORDIONS.
Gold Medal P. P. I. E.
277-279 Columbus Avenue,
San Francisco.

End your correspondence to advertisers by mentioning The Billboard.

ARMY BLANKETS NEW AND PERFECT



Parcel Post, 10c Each.
Order now and save money. Color, Light Gray, with fancy striped borders. Send Cash, Check or Money Order.
QUARTERMASTER'S SUPPLY CO.,
423-B Market Street, Philadelphia, Pa.
BEAUTIFUL ILLUSTRATED CATALOGUE FREE.

\$125 Made in One Day

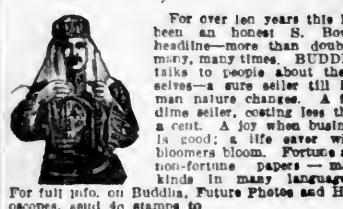

For over ten years this has been an honest S. Bower headline—more than doubled many, many times. BUDDHA talks to people about themselves—a sure seller till human nature changes. A fast dime seller, costing less than a cent. A joy when business is good; a life saver when bloomers bloom. Fortune and non-fortune papers—many kinds in many languages. For full info. on Buddha, Future Photos and Horoscopes, send 4c stamps to

S. BOWER
Bower Bldg., 430 W. 18th Street, New York.

LITTLE WONDER LIGHTS



Lanterns, Tanks, Pumps, Hollow Wire, Jumbo Butters, 2, 3 and 4-Burner Pressure Stores, Folding Camp Stoves, Ovens, Griddles, Mantles, etc. Write for catalog and prices. Deposit required on all orders.

Little Wonder Light Co.
5th and Walnut Streets,
TERRE HAUTE, IND.

FAIRS PARKS Carnivals

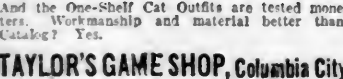

Taylor-Made Ball Games
And the One-Shelf Cat Outfits are tested money getters. Workmanship and material better than ever. Catalog? Yes.

TAYLOR'S GAME SHOP, Columbia City, Ind.

FOR SALE Large Floor Machines

Centaurs, Ellipses, Singles, Twins, Triplets, Roulettes, 5c and 25c play, Jack Pot. All Castile Bron. make. T. J. NERTNEY, Ottawa, Illinois.

CHOCOLATE BARS Plain and Almond. Best Premiums and Concessions on earth for Salesboards. Send 10c for samples and prices. **HELMET CHOCOLATE CO., Cincinnati, O.**

If you see it in The Billboard, tell them so.

Bargains for Outdoor Showmen

Two used 4-track Monkey Speedways, with Cars, \$800.00 each, or can furnish with patent reversible Cars at \$35.00 each extra. Also some used Hanners for above at \$6.00 each. One rebuilt Two-Abreast Parker Carry-All, one rebuilt Three-Abreast Parker Carry-All, one Parker Wheel, used 3 months. Several other bargains in rebuilt Rides and Carnival Equipment. Write for what you want. I likely have it.

C. W. PARKER

World's Largest Manufacturer of Amusement Devices, LEAVENWORTH, KANSAS.

PERFUME SALESBOARDS

100-Hole Board, with 100 Bottles Perfume, containing of 2 large 4-oz. Bottles for lucky numbers, and 1 large extra fancy 4-oz. Bottle for last sale. COMPLETE OUTFIT..... \$2.75

Salesboards free with orders. No blanks on boards. Every sale gets a bottle.

FOR TRUST PLAN WORKERS. Perfume put up in 24-vial box, 48c. Also in 30-vial boxes, 59c. 3 assorted colors and odors. Brings in \$2.40.

Unlabeled Vial Perfume, \$1.75 Gross.

Perfume Sachet, \$1.75 Gross.

Give-Away Perfume Vials, \$1.75 Gross.

Big Flashy Toilet Set, consisting of 3 Bars Soap, Box Face Powder, Can Talcum Powder, Bottle Perfume, Bottle Shampoo, Doz. \$5.50

Mammoth Big Flashy 18-oz. Size Lilies, Jockey Club Perfume, Eau de Cologne or Hair Tonic... Doz. \$6.50

Big Jar Cold Cream, Sells for 30c each... Doz. \$1.00

Big Jar Vanishing Cream, Sells for 30c Each. Guaranteed Shaving Cream, Sells for 25c... Doz. \$1.00

Big 4-oz., 6-in. High, Gold Plate Cap, Beautiful Sprinkler Top Bottles Eau De Cologne, Lilies or Jockey Club Perfume, Ribbon Cord Tied, Dozen, \$3.00; Big Flashy 8-oz. Size, Dozen... \$5.50

TERMS: We ship by American Express. Full cash on \$10.00 order. Over \$10.00, one-half cash, balance C. O. D. WRITE FOR OUR 1925 CATALOG.

NATIONAL SOAP AND PERFUME CO.

20 East Lake St., Dept. B 4, CHICAGO, ILL.

Genuine Mexican Resurrection Plant



Awake. Best of All Money-Making Novelty or Premium Article.

SOMETHING DIFFERENT. Greatest novelty of the vegetable kingdom. Looks dead, but placed in water bursts into beautiful, living, fern-like plant in a few minutes. Brings up and revives at will. Lasts for years. Easy to ship. Light weight, low cost. Retail 10c to 50c each. We are the world's largest collectors, carry large stocks and ship orders day received. Terms cash only; no C. O. Ds. For large, selected, clean plants we quote ideas.

LOWEST WHOLESALE PRICES
Sample 10c, 10c; 15 for 50c; 100 for \$2.50.
500 F. O. B. here, \$7.50; 1,000 for \$13.00;
5,000 for \$60.00; 10,000 for \$117.50.

A Few Slightly Smaller Plants at \$10.00 per 1,000.

MEXICAN DIAMOND IMPORTING COMPANY
Dept. K2, LAS CRUCES, NEW MEXICO
(See our separate adv. of Mexican Blu-Flash Gems.)

Free Catalog

Fully Illustrated
Write for Copy. We have just what you want!
Midway Novelty Co. 326 West 14th St. Kansas City, Mo.

Novelties

NEW CARROUSEL FOR SALE

Have \$1,000.00 deposit on an Allan Hershell Carrousel that has never left the factory. Two or three-abreast optional. This deposit contract can be bought at a very liberal discount. Address: J. W. LINTON, care Wm. Bauer, 316 Exchange Bank Bldg., St. Paul, Minnesota.

HAIR SQUATS

1 color of Hair, 5 colors of B. S., 1 Barrel of 150 for \$18.00. Half cash, balance C. O. D.
JONES STATUARY CO.
800 Main Street, Kansas City, Mo.

advance agent. Ken advised that his winter trouping has been successful, also that he had not yet decided what show his troupe will be with the coming outdoor season.

A letter from the Abner K. Kline Shows stated that they were "all set" for their season's opening at the National Orange Show at San Bernardino, Calif., for 10 days, starting February 19. Incidentally Mr. Kline sent out catchy invitation cards (in cute little envelopes) requesting the recipients' attendance at the opening.

Show agents have been experiencing some delays in securing railroad contracts in advance over several lines, including the New York Central (Big Four) and Illinois Central, said by a Big Four official to be caused over his line by the current "form" not yet being arranged, which probably would be consummated by March 1.

John (Johnny) Polle, son of Henry J. Polle, will have a dandy penny arcade the coming season with the Zeldman & Polle Shows, the attraction being purchased last week in the vicinity of Cincinnati. "Johnny" virtually "grew up" in show business, and the Z. & P. personnel will again welcome his being in their midst.

Mr. and Mrs. Harry E. Crandell, having returned a couple of weeks ago to their home at Umatilla, Fla., from their motor trip thru the State, Harry was called to Sarasota by Frank B. McIntyre to help the Chamber of Commerce put over the big festival scheduled there for March 3-7, under the guidance of Messrs. Charles Ringling, Samuel Gumpertz and Carl Hathaway.

In its comment on the midway of a State Fair being awarded to a carnival company a newspaper in the city where it was awarded stated in part: "Offered to bring the largest carnival ever shown at the fairground, and offered to pay the fair board a flat rate of \$7,500. This is \$2,500 more than has ever been received for such a concession."

A special attraction frameup is being arranged by Gerard's Greater Shows for two people who sprang strongly into the limelight of publicity, Jack Robinson, "living skeleton", who has appeared about seven years at Coney Island, N. Y., and his wife, Baby Bunny, well-known fat lady. Contract was signed with them about two weeks ago thru R. C. (Bob) Crosley, general agent for the Gerard organization.

In answer to an "information wanted" ad in the classified section, issue of January 17, of T. J. Kirby, who resides at Columbus, Tex., M. O. Smith wired *The Billboard* from Stuart, Fla., early last week that T. J. Kirby, a well-known concessionaire of West Texas, had been killed in an automobile accident near West Palm Beach, Fla., February 15. The wire also requested the address of Kirby's father, which was provided.

George M. Stevens (Mechano) says he has been putting in a nice winter at Cleveland, and was last week in his third week's showing with his mechanical man act at Zimmerman's Dancing Academy. Stevens says two other "mechanical men", George Lewis and "Butch" Moore, both of Cleveland and both of whom he tutored in the work when he was at T. A. Wolfe's World Museum, that city, in 1917, are getting along nicely.

Don and Carrie Stewart, wintering at Columbus, O., advise that they had a poor season last year, but intend taking another "hitch" at the road, starting out about the middle of April. They say that among showfolks they meet occasionally at Columbus are Dode, Flisk, of circus note; George Nolan, cook-house concessionaire; Silver Cloud, medicine showman, and "Arizona Jack" Bell and wife. They wonder if Kitty Brown is still in show business.

Mr. and Mrs. Pat Beggs, who have been wintering at their home near Orlando, Fla., will this season be with Carl J. Lauther's Circus Side Show on the Rubin & Cherry Shows. They will present their telepathic act, formerly in vaudeville and also with the Con T. Kennedy, James Patterson, Wortham No. 1 and the Johnny J. Jones organizations, under their title of "Marvelous Mirrorings of Minds". Mrs. Beggs is professionally known as "Vada, the Mystic".

No one is infallible when it comes to making errors—even a "know-it-all". To the best of the writer's knowledge there is now not a "know-it-all" in the employment of *The Billboard*. In case any of us make an error or thru a spirit of confidence in the reliability of someone announcing something as fact cause an erroneous statement to appear in print, we are always only too glad to correct it in print—provided we afterward find the facts or they are furnished us by someone who is really in the know.

In *The Greensboro* (N. C.) *Daily News* of recent date appeared a three-column-wide cut of three of the young lions with West's World's Wonder Shows in winter quarters at Greensboro. The paper reporter had a long and excellent story along with it, and in commenting on the picture taking stated regarding the fourth

(Continued on page 98)

4 RIDES--W. G. WADE SHOWS--6 SHOWS

Open at Detroit April 25th

Can place one or two more shows, which do not conflict with those already booked. Splendid opening for Motordrome, Mechanical Walk-Thru and Single Platform Shows. Can use a few more strong attractions in Ten-in-One. Can also place one Kiddie Ride. CONCESSIONS---String Game, Hoop-La, Cut Flowers and Novelties are among the Grind Stores which we have open, which we will sell exclusive. Also have several choice Wheels open. On account of changes made will sell exclusive Cookhouse and exclusive Juice, except Root Beer Barrel. Mr. Pierce wishes to hear from Ball Game Agents. Man and Wife preferred. Address all communications to 5811 Cass Avenue, Detroit, Mich.

Wanted for the BERNARDI EXPOSITION SHOWS

Can place Five or Ten-in-One, Snake Show, Hawaiian Show, Illusion Show or any show of merit. Have complete outfits for same. Can place Merry-Mix-Up or any Novelty Ride. This show has a real circuit of fairs and celebrations. All Concessions Open. Will sell exclusive on Cook House, Palmistry and Corn Game. All others open. Wanted—Reliable Men to handle Crazy House and Seaplane. Have Traver Seaplane for sale. Show opens here April 6.

FELICE BERNARDI, Box 1053, Salt Lake City, Utah.

SILVER KING VENDING MACHINES

INCREASE PROFITS \$10 to \$20 Daily

Have you one in your store doing this for you? If not, order one today. All element of chance removed. A standard 5c package of confection vended with each 5c played. Own your own machine and you will not have to divide the profits with another man. Ninety days' free service guaranteed. Price, \$125.00. Give this machine ten days' trial and if not satisfied with the results we will refund purchase price less the handling cost and our regular rental fee. You keep all the money the machine takes in during trial period. Machine filled with checks ready to set up on your counter and collect the nickels. We can also supply other makes of machines—Jennings, Mills, etc. Have a few rebuilt, refinished, re-ricketed machines in excellent running order. \$85.00 Each. Wire us or mail us \$25.00 and a machine will go forward the day order is received, balance of the purchase price billed C. O. D. Can supply MINTS, standard 5c size packages, \$15.00 per Half Case of 1,000 Packages. Also special short lengths to fill front vendors same price; full Case, 2,000 packages, \$26.00, if ordered with machine. 5c TRADE CHECKS, \$2.50 per 100, \$18.00 per 1,000.

SILVER KING NOVELTY CO., 604 Williams Building, INDIANAPOLIS, IND.

\$20.00 SPECIAL \$20.00

25 Inch Diameter Wheel

Painted on both sides in any combination you desire. The outside rim is 1 1/2 inches thick. Hub and spokes are made of solid hard aluminum casting. Runs free on hardened ball bearings. Encased in rust-proof container and cannot fall out. Heavy steel, nickel-plated, polished pins are used. Aluminum indicator. Holder beautifully painted, clear and easy to read from a distance. Wheel is accurately balanced. Satisfaction guaranteed. Prompt delivery. \$20.00 EACH.

E. A. HOCK COMPANY
171-173-175-177 NORTH WELLS STREET, CHICAGO, ILLINOIS.

Attention, Salesboard Operators!

Tried and Proven and Bringing About Wonderful Returns, Namely, Our

Sectional Bridge Lamp and Floor Lamp Assortment No. 11

2500—5c Tiny Hole Board—3 Bridge Lamps— \$39.85
3 Floor Lamps; 6 Lamps; Complete at

Merchandise Boards with Circulars, \$1.50 a Dozen, \$10.00 per Hundred. To bring about best results, place them with office workers, stenographers, shipping clerks, janitors, porters, etc. Full amount or 25% with order. No merchandise shipped without deposit. Send for our free circular of live wire assortments.

THE HARTCRAFT COMPANY,
68 E. S. Water Street, Dept. B, CHICAGO, ILL

POOLE & SCHNECK SHOWS

Spring Opening, Port Arthur, Texas. Two Weeks, March 2 to 14. Opening for Shows and Concessions. Wheels, \$35. Grind Concessions, \$30. Ball Games, \$25. Nolan, bring Vick. Frog Boy, also come on.

Homer E. Moore Shows

CONCESSIONS. ALL WHEELS AND GRIND STORES OPEN.
Wheels, \$10.00; Grind, \$20.00. Sell exclusive Cook House and Juice. Exclusive on American Palmistry. Open April 25 near Pittsburgh.
HOMER E. MOORE SHOWS, 2337 Carson St., S. S., Pittsburgh, Pennsylvania.

IT HELPS YOU, THE PAPER AND ADVERTISERS, TO MENTION THE BILLBOARD.

The biggest flash of color you ever saw



SEND FOR CIRCULAR AND PRE-WAR PRICES

MUIR'S PILLOWS

for CARNIVALS and BAZAARS

ROUND AND SQUARE

There is no article of carnival merchandise which shows the value and flash for the money like these beautiful pillows

Grind Stores These Pillows Will Attract the Crowd and Get the Play.

Patriotic Designs for American Legion Events. Lodge Designs for Fraternal Order Bazaars.

MUIR ART CO.

116-122 W. Illinois St., - CHICAGO, ILL.

A KINGERY MOVABLE STAND

Gets the

Barbecue Business

Whether you locate in a city or along a highway, you can make BIG MONEY satisfying the public's demand for barbecued meats. From 70% to 100% clear profit on every sale. With our new movable barbecue stand you suffer no loss if you find you can do more business in a new locality. Here's your chance to get into a good paying business on very little capital. Complete Barbecue Machine only \$200. Terms can be arranged.

Send for full particulars. No obligation.

The

Kingery Mfg. Co.,
Room 302 Kingery Bldg.,
CINCINNATI, O.

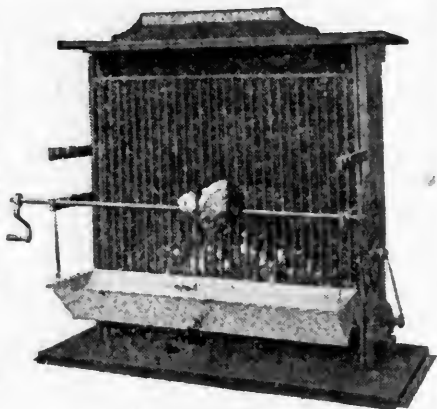

MIDWAY CONFAB

(Continued from page 97)

of the cubs—not in the photo: "One of them was so determined not to get mixed up in such foolishness as having his photograph taken that he bluffed his way out of it."

Chas. J. Walpert, concessionaire, last season with the John T. Wortham Shows, wrote from Beaumont, Tex., that while he and Herbert Sucher were en route to Houston they had picked up a fellow who claimed to be a "trouper" and wanted to go to Beaumont, and that when he and Sucher came from a restaurant, where they lunched, they found that his (Walpert's) automobile had vanished and along with it all his changes of clothing and Sucher's. Walpert says the auto's license read: "Texas, 484,333."

There's a loud ring of sincerity of purpose in the following quotation, a newspaper clipping sent by Milton M. Owens, an ex-service man, of Corbin, Ky.—alho there was no title of paper or specifying what individual was quoted accompanying it:

"I'm a miner," he said. "I'm going to Floyd Collins because he'd do the same for me. We learn that about each other, we guys who dig like this for a living. I didn't come here to spread myself in the papers. You leave my name out, see? When a man's in a tight fix it's up to his buddies to get him out. Soft pedal the glory, see?"

"As he squared his husky shoulders they spoke an argument more convincing than his words."

"Sailor Ralph", after closing his tattooing parlor at Pensacola, Fla., where he gathered some fine specimens for his Deep Sea Show, returned to Nashville, Tenn., for a restup before joining the Kellie Grady Shows at Birmingham, Ala., with which his wife, Madam Wonder, will have her palmistry concession. "Sailor's" partner this winter, George Wright, had his fingers mashed about three weeks ago and went to his home in St. Augustine, Fla., but will not troupe the coming season because of his mother's poor health. "Sailor" informs that "Fat" Price will also be with Kellie Grady and is rebuilding his covehouse at Nashville, and that Tommy Robinson will be with same caravan, with his new cigaret gallery, he now having a barber shop in Nashville. He also informs that Reeding & Son have their two rides in a fine shape and expect to open around the first of April, playing four or five weeks on lots in the Tennessee capital city.

An article in *The Houston (Tex.) Chronicle* bearing an Austin date line of February 14 was interesting. The first paragraph read thus (tent show folks might especially note the latter half of it): "A graduated occupation tax on theatrical, dramatic and moving picture shows is proposed in a bill introduced in the House by Representative Covey, of Goree. It would not increase the present tax on moving pictures and shows presented in regular theaters, but increases the present tax on tent shows and other such exhibitions that move from place to place." Here's the second paragraph: "The bill provides a minimum annual tax of \$5 in all cities and towns of 1,000 inhabitants and less. This is gradually increased until the tax reaches a maximum of \$75 in all cities and towns of 40,000 or over. In each case the population shall be determined by the last preceding Federal census." The third paragraph states fact—should the bill go thru: "This bill seriously affects traveling circuses and tented exhibitions, for it provides that when such a show moves from one place to another a new tax shall be paid. Each time it shows in another place the \$75 tax is required under the terms of the bill."

Following is the way the first paragraph of comment on some local city council proceedings, etc., appeared in *The Frederick (Ok.) Leader* of February 11: "R. B. Walker, C. B. Groover and Fred Brown, representing the theater interests of Frederick, appeared before the city



\$80.00

EACH

In Lots of 5 or more,

\$75.00

Practically new. Only used one to three weeks.

GUARANTEED

Why pay more? These are the latest side venders. MINTS, \$13.00 a 1,000.

Home Novelty & Sales Co.

2210 8th Ave., ALTOONA, PA.

Look Here Mr. Showman

PORTABLE GAS MACHINE COMPLETE PRICE \$60.00

Why pay all your money out for light, when a gallon of Gasoline in our 6,000 candle-power IMPROVED PORTABLE GAS MACHINE WILL LIGHT UP YOUR TENT?



EACH WINDHORST SUPPLY COMPANY 1426 Chestnut Street, St. Louis, Mo.

SALES BOARD OPERATORS AND JOBBERS

We have De-Luxe and Ma Jong 2,000-hole Boards in 5c and 10c sales, very attractive in color. Are closing them out at \$1.50 each, or \$15.00 dozen. Order a sample by return mail.

E. & R. NOVELTY CO. 405 Manhattan Bldg., Duluth, Minn.

C. F. Zeiger United Shows

WANT WHIP, MERRY MIX-UP, MUSICAL COMEDY. Will furnish complete outfits for money-getting Shows. All Concessions open except Cook House and Palmist. MY FAIRS START BOTTINEAU, N. D. JUNE 16. HAVE SIX BIG FAIRS IN NORTH DAKOTA THAT HAVE NEVER HAD A WHIP, MIX-UP OR MUSICAL COMEDY. C. F. ZEIGER, Coatee House, Kansas City, Mo.

YOU CAN GET \$\$\$ VERY EASY WITH "MOOREMADE" PRODUCTS

New 1925 Games, Rides and many more Money-making Amusements and Novelties. Stamp for particulars. "MOOREMADE" PRO. WKS., 20 Years in Business in Lapeer, Michigan.

European Bonds AND MONEY \$1.00 Brings Big Output. 100 Pieces BIRNBAUM BROS., 70 Wall Street, New York.

MINER'S MODEL SHOWS Now booking Shows and Concessions for 1925. Season opens April 18. Address all mail to R. H. MINER, Owner and Manager, 161 Chamber St., Phillipsburg, New Jersey.

MUSICIANS WANTED

All Instruments. Opening March 29. Write or wire JEAN ALLEN, Hand Makers, Leggett Shows, Box 167, Maesee, Ark. Pay your own wires.

H. R. WILLIAMS—I have a new Ford car here for you. Write as per letters. Get them all once. Everything all right. BERNICE SHEPHERD, 1330 13th Avenue, North, Birmingham, Alabama.

Wanted for The John Francis Shows

Season 1925, opening Ft. Worth, Texas, under the Dokays, Monday, March 16, running until late November, playing the cream of the Texas and Oklahoma oil centers. Sixteen Fairs and Celebrations now booked. Athletic Show, Musical Comedy or Tab., Fat People for Fat Show, Attractions for Pit Shows. Can place three Talkers and Managers, Concession Agents, Help on all Rides. Good proposition for Motordrome or Motordrome Riders. Can use one good Feature Show. Furnish wagon front. Also any good Platform Shows. This show carries eight rides, fifteen shows. Everything loads on wagons. JOHN FRANCIS, Box 414, Ft. Worth, Texas.

WANTED John T. Wortham Shows

OPENING IN PARIS, TEX., MARCH 21 TO 28, INC. WANT Help for all Rides, Man to handle Whip and Man to handle Sea-plane. Help in all departments. Pullers and Chalkers for train, Freaks and Fat People for Circus Side Show, Minstrel Show People, Talkers and Grinders. CONCESSIONS—Have opening for Devil's Bowling Alley, Cigarette Shooting Gallery, Country Store, Pitch-THI-You-Win, Hoop-La, Mit Camp (white), legitimate Grind Shows. CAN USE two good Agents for Corn Game, two men or man and wife. Trainmen address BLACKIE RIELY, care Wortham Shows, Paris, Tex. Minstrel People address JESS SHOATS, 34 Chartres St., Houston, Tex. All others address JOHN T. WORTHAM, Paris, Tex. HAVE FOR SALE good set of Wild West Banners. Will furnish Top and front for good Athletic Show.

CARNIVAL MEN AND CONCESSIONAIRES WE HAVE SOMETHING NEW FOR YOU. Write for information.

410 N. 23d St.



Telephone, Bomont 841

ZEBBIE FISHER CO.

LARGEST CONCESSION SUPPLY HOUSE IN THE WEST

Catering to Concessionaires exclusively. Write for Prices and Catalogue.

60 EAST LAKE STREET, - - CHICAGO, ILL.

Another Eclipse Expected
 WITH THE
SPRING NUMBER
 OF
The Billboard
 ISSUED MARCH 17
 DATED MARCH 21

Packed and jammed with data of vast interest to everybody in the amusement profession, those of the outdoor fields in particular.

Illustrations in abundance. A cover in four brilliant colors. Appropriate lists of all kinds including, FOR THE FIRST TIME IN ANY PUBLICATION, A TABULATED CIRCUS INDEX, showing at a glance what cities and towns throuout the United States and Canada had railroad circuses of more than two cars, as well as the dates, in the past five years—a list that will be of inestimable value to circus owners, managers and agents in particular.

Then there will be the usual Circus and Carnival Rosters and last, but by no means least, a number of special articles by writers who KNOW their respective fields, among them being

FRED W. PEARCE

Mr. Pearce is a widely known builder and operator of roller coasters and other park rides and is thoroughly conversant with conditions in amusement parks throuout the United States. His long experience qualifies him to speak with authority. His subject should be of great interest to park men.

ROBERT E. HICKEY

Former general press representative of the John Robinson Circus, Mr. Hickey is returning to that institution after a year's contract with the World Amusement Service Association, Inc. Previous to his circus connection he was publicity promoter for seven years with J. Alex Sloan. He has also been connected with many daily newspapers and the Associated Press.

AL FLUDE

Mr. Flude, editor of The Platform Department of THE BILLBOARD, is one of the best authorities in the chautauqua branch of the entertainment world. His article will deal with the chautauqua.

JOS. C. MILLER

The name of "Colonel" Miller in the Wild West world is a household word. He and his partners are returning to the fold the coming season with the famous "101 Ranch" after an absence of some years. Because of this an article from him should be all the more interesting.

MRS. FRANK W. GASKILL, JEAN DEKREKO, GEO. F. DORMAN, FRED P. SHIELDS, HAROLD BUSHEA, W. H. RICE
 and other pioneers will give their versions of the origin of traveling carnivals—a symposium.

JAMES F. DONALSON

They his long connection with amusement enterprises, particularly circuses, as press representative, and many years devoted to the daily newspaper field as news writer, reviewer, columnist, and editor. Mr. Donalson has been able to study hardy the connecting links between amusements and the dailies, and it is on this subject that he will contribute an article.

ROBERT F. DEMOREST

Mr. Demorest, owner and manager of the Democrat Stock Company, has been in the show business some 23 years. With cleanliness as his motto, he has established a very good reputation in the south, both in houses and under canvas.

BARRY GRAY

Mr. Gray has spent about 35 years in the show business, entering it as a singing comedian in 1883. Before retiring from the road some years ago to enter a commercial field he was connected with circus side shows, where he had a prominent part; in fact, he did many of the side-shows for approximately 31 years in Louisville and with circuses and other shows.

W. R. HIRSCH

Mr. Hirsch is one of the best informed as well as most popular fair secretaries in the country. He has been successfully guiding the destinies of the State Fair of Louisiana for many years, first serving as president, then president-secretary, and for the past 10 years or more as secretary.

THE EDITION WILL BE
105,000 COPIES

But you are apt to be too late if you do not

Make Your Reservation Early

council at its regular meeting Tuesday evening, asking that the street carnivals which have been making Frederick a more regular stopping place lately be made to pay a higher license fee than the one which is now in force. The show operators endeavored to show that the ratio was too great between the amount of money that these companies took out of the city and the amount they leave with Frederick in payment of their licenses.

Doesn't it seem strange that representatives of local theaters specifically made the request, taking pains to "endeavor" to make a comparison as to how much "money these companies took out of the city"? This writer does not know what companies were alluded to or how many persons were with them respectively, but he sure would like to see which side (debit or credit) their ledgers balanced on at the close of their engagements at Frederick. Anyway all their actors and construction crews paid out cash in Frederick for eating while the shows were exhibiting there, also the performances presented weren't shipped in from some other city by express.

In face of the fact that last season was one of the worst in years for collective outdoor amusement organizations (because of unemployment and conditions, etc.), and the fact that very few (notably so) shows closed the season with a profit, yet at frequent intervals, one knowing facts could pick up a newspaper and get "sickened" with reading some "knocker's" spoutings of how much "money they take out of town". With but comparatively few exceptions (all carnival companies included) the shows left MORE money in the towns than they received as receipts during their summer "still" engagements (there was much borrowing to meet expenses), and there were not a dozen which went into their fair and celebration dates ahead of the game. The money showfolks spend, however, is scattered about town with grocers, meat markets, hotels, restaurants, confectioneries, clothing, lumber, hardware, paint and other dealers, and truckmen and for teams, etc.

It is well known among showmen that too many of a town's citizenry judge the attractions are taking in a "barrel of money" when they see the midways crowded with people—they don't figure that it doesn't cost a penny to enjoy themselves on the midways unless they patronize the pay attractions.

But right there is the foundation for the "knocking": Large crowds gather on the grounds at night from their year-round haunts and places where they MUST PAY for everything they see, which naturally, tho not consistently (the townspeople are capable of choosing for themselves), draws "fire" from "want-all-the-receipts" oppositionists.

John Francis Shows

Fort Worth, Tex., Feb. 18.—The work of making ready for the spring opening of the John Francis Shows is showing well-marked signs of nearing completion. The fire last week, while destroying Mr. Francis' private car, did not interfere with the general winter-quarters work, as the warehouses burned were aside from the buildings housing the show property. "Chicago Dutch", assisted by Wm. Jones, has most of the painting done. Mapei Williams has the fine midway restaurant and two nice soft drink and lunch stands all completed. E. Z. Wilson and Assistant W. H. Borho have Mr. Wilson's Fun Show completed, constructed from original ideas of E. Z. Vincent Book said that if the whip didn't "fit the cable he would be in bad shape," as he has built an entirely new ride around the cable. Doc Bushnell has the circus side show in A-1 shape. The new front is 110 feet. Thirty-three men are now at work in quarters, and ideal weather permits all shows and rides to be set up on the spacious grounds about the buildings, which makes the work faster and easier. New canvas and other show property are arriving almost daily, and Mr. Francis states that everything will be complete for the opening early in March, with the most complete organization he ever opened with.

At this writing Mr. Francis is attending the meetings in Chicago. He will stop in Kansas City and St. Louis on his return trip. New arrivals this week are Mrs. V. J. Yearout, Mrs. E. Z. Wilson, Mr. and Mrs. J. Boon, Bert Barber, Mr. and Mrs. Clarence Lutz and Earl Mason. General Agent Rodocker is in and out of the city and reports every thing as far as the booking is concerned much ahead of his expectations.

V. J. YEAROUT (for the Show).



A REGULAR GOLD MINE THE NEW GUM-VENDING Bowling Alley

A ball of gum and a shot at the 10-pins all for 1c. Located in all States. Operators, Parks, Arcades, write for prices and circular.

Gaiter Novelty Co. 143 East 23d Street, NEW YORK.

WANTED FOR THE WALLACE BROS. SHOWS

OPENING

YOUNGSTOWN, O., APRIL 23, 1925

All Legitimate Concessions Open.

WANTED---Side-Show Attractions for Ten-in-One, one high-class Platform Show and one more real Ballyhoo Show that does not conflict.

EXCEPTIONAL PROPOSITION FOR A-NO. 1 MERRY-GO-ROUND AND FERRIS WHEEL.

JAS. P. SULLIVAN

26 W. Federal St.,

Youngstown, Ohio.

TENTH SEASON
TRAVER CHAUTAUQUA CORPORATION, Inc.
 FORMERLY
TRAVER EXPOSITION SHOWS
 (SUCCESSFUL THRU CLEANLINESS)

7 RIDES

UNIFORMED BAND

← WANT →

SHOWS

Ten-in-One, Animal or any clean, intelligent Shows that are capable of handling big business, as we play territory that is closed to ordinary Carnivals.

CONCESSIONS

Have excellent openings for a few first-class concessions that must work for not more than ten cents at one time. No concessions considered unless they have clean appearance.

FREE ACTS

Need few more first-class Free Attractions to play our long list of conservative Fairs. State all in first letter.

TRAVER CHAUTAUQUA CORP., Inc. - - - 1547 Broadway, NEW YORK.

GOOD NEWS FROM PHILLY

The Pitchmen's Delight



BB. 2/01—The Latest Novelty Wrist Watch. Engraved back and bezel. Adjustable ribbon bracelet. One on a card. Gross..... \$8.00
 BB. 2/03—White Gold-Like Wrist Watch. Engraved back and bezel. Adjustable grosgrain ribbon bracelet. Each in a plush-lined box. Gross..... \$12.00

BB. 2/02—Still another style of the sensational Watches as described above, this with a leather strap bracelet. Each in plush-lined case. Gross..... \$9.50
 Samples, 25c Each.

THE BIG HIT OF THE YEAR.

BB. 2/32—Beautiful Serving Trays. Polished metal frame and handles. Splendid hand-painted designs, beautiful assortment. Glass panel. Size 13x19. Dozen..... \$16.50
 Sample, Each \$2.00.

BB. 2/33—Four-Piece Shell Toothpick and Manicure Set. Knife. Gross..... \$4.25

HALF MONEY IN ADVANCE.

M. GERBER,
 Underselling Streetmen's Supply House,
 505 Market Street, PHILADELPHIA, PA.

Eli Wheel WANTED Chain Swing

Also a few Concessions open. Cock House, Juice, 4-Ball, Fish Pond, Country Store, Cigarettes, Baskets, Swagger Sticks and Ball Games sold. Others open. Get our prices. WANT Man for Circle Swing. Open April 18. Territory in Ohio, Indiana, Illinois and Missouri. No girl shows or grift. No two-week stands. We advertise like a 20-car Show.
MAD CODY FLEMING SHOWS, 20 Central Avenue, Cincinnati, Ohio.

WILL BUY, SPOT CASH

Riding Devices, Merry-Go-Round, Whip, Eli Wheel, Caterpillar. Give full Particulars. BOX 146, Billboard, 1493 Broadway, New York City.

HERMAN'S MIGHTY EXPOSITION WANTS

Fill Ferris Wheel. Will pay half transportation to join. Motor-drome, Grind Show, Secretary, State salary. WANT Concessions. Will give N. String Game, Hoop-La, Fish Pond, High Striker, Cigarette Gallery, Candy Flies, Pop Corn. WANT Following Wheels, price \$50.00, which includes all: Ferris, Lamps, Alarm, Clocks, Silver, Fruit Candy and Birds. One Bill Game, Arkansas bids or Cats. Help in all departments. No grift. Will positively play 16 Fairs. Show opens April 18. Will be at General Forbes Hotel, Pittsburgh, Pa., March 4. Address: **HOWARD HERMAN, Box 566, Altoona, Pa.**

Advertise in The Billboard—You'll Be Satisfied With Results.

Doc Hall Amusement Co.

Pete Cole Buys Half Interest in Organization—Title Is Changed

Sabinal, Tex., Feb. 18.—Sonora, Tex., was the best spot played this winter by the Doc Hall Outdoor Amusement Co. The show had the good will of leading citizens of the town and several of the business men tried to get Mr. Hall to sign a contract for their Fourth of July Celebration, but this offer had to be declined, as the show will be up in Nebraska for that date.

Several notable changes were made last week, the most important being the purchase of a half interest by Pete Cole, the well-known showman. The show will hereafter be known and advertised as the Doc Hall and Pete Cole Shows. Mr. Hall will have charge of the advance and Mr. Cole will be manager and legal adjuster. The writer remains as secretary.

J. H. Criner, Sr., left at Sonora with his concessions and will have a small show of his own working towards Louisiana, where he has lumber interests.

The show is now in the Rio Grande Valley, but starts west next week, headed to New Mexico and Colorado. Several new arrivals were on the midway here, but the writer has not yet learned their names. This is the second week in the Valley. The gross receipts of the show have not come up to expectations. Although every one of the natives seems to be working they do not spend as freely as in the western part of the State.

Monday "Honest" Ed Street's Show played here and friendly visits between the members of the two companies during the day were in order.

GRACE HUFFER (for the Show).

Rubin & Cherry Shows

Montgomery, Ala., Feb. 18.—An augmented force of workmen is forging ahead with coming-season preparations

Wanted--Merry-Go-Round and Ferris Wheel

For 24 weeks. Terms, 60-40. Few Concessions open. Will book Bingo, 50-50 or flat. Grind Stores, \$20 flat. Show opens April 25.

J. V. MORASCA, Mgr., Morasca Circus and Bazaar, 55 S. Rock St., Shamokin, Pa.

at the winter quarters of the Rubin & Cherry Shows and there is no doubting that the building, rebuilding and painting will be completed long before the opening date late in March.

The new front for the combined Trained Wild Animal Show and Royal Hippodrome will be 120 feet long and probably the most massive, elaborate and brilliantly designed show front ever constructed, and Designer Fred Lewis is exceedingly proud of it. At this attraction Rhoda Royal's elephant "Muggins", menage horses, trained ponies, dogs, etc., will exhibit along with the many lions, bears and other wild animals already here.

Mr. and Mrs. Gruberg are vacationing at Hot Springs, Ark., for two weeks or more before assuming the arduous duties of directing the tour of the big caravan, after which they will return here to complete arrangements for the formal opening. Before leaving Mr. Gruberg was awarded contracts for this year's Alabama State Fair, November 2-8. The shows closed last season with this big fair and will do so again in 1925. This will make a total of 20 prominent fairs already booked this season, possibly an unprecedented record for any one carnival organization.

Mr. Gruberg has ordered new tons and other canvas needs for every attraction on the midway—a policy he has followed the past several years. Felix Blei, ahead of Dante, the magician, was a recent visitor and spent Sunday with Jack Cullen, manager of the Minstrel Show. Secretary-Treasurer Frank S. Reed, assisted by Arthur Arlington, is literally swamped with work at the down-town office. Jim Eskew, who will again have the big Wild West, has his stock on pasture at the fairgrounds and his performers are beginning to arrive. Cash Wiltsie is the steward in charge of the dining room at winter quarters. He is loud in his praise of his new dining car which he will manage this summer. Cliff Wilson is building a brand-new Fun Show of new design and elaborately decorated with gold and silver leaf. He will also manage the Crystal Maze and Laughland. Cliff and Mrs. Wilson have as their guests Mr. and Mrs. Fred Meier of Cincinnati. (Mr. Meier is an old trouper of the Ben Wallace days.) Emil Ritter writes that the Royal Performing Midgets are a big hit in Havana. They will have a brand-new outfit ready for them on their return and this attraction, as in former seasons, will be one of the greatest attractions along the midway. A. F. (Doc) Collins reports that Mrs. Collins has purchased some beautiful costumes and stage settings for the Style Show and Fashion Revue which they will have under their management. The Water Show has been completed and several new diving beauties have been signed. Artie Wells' monster alligator writes promise of being a sensation on the Canadian tour—is 12 feet in length and weighs about 800 pounds. Several of the Pullmans have been returned from the car shops, where they were repainted and put in splendid condition. The new wagons will be completed within a couple of weeks. WALTER D. NEALAND (Publicity Director).

as additional advertising, Ralph Barr will again operate a line of concessions, Thomas E. McNew will be back on the show in an executive capacity. Only a week will be played by the show in the city of Detroit, to be followed by a tour to Ontario to fulfill its celebration and of Northern Ohio, Michigan and then in-fair dates.

John T. Wortham Shows

Paris, Tex., Feb. 17.—Plenty of warm sunshine the past few days has seemed a stimulant to crews working in the winter quarters of the John T. Wortham Shows and the work is going forward rapidly. Several new fronts are now ready to receive their prime coats of paint. The fences of all the riding devices also are in the paint shop. The carousel and the Big Eli have been painted along with the other rides under the careful supervision of the Millers. W. B. Spencer, having put the finishing touches on the double wagon front for the tantalizer, is starting his crew on building an elaborate band wagon for the show, with the calliope purchased by Mr. Wortham last fall installed in the rear. Vester Crawley, who lost his foot in a train accident last summer, has his new artificial foot and walks around the quarters with the snap of a soldier. He has completed work on the Jasser, the big fun house. John T. Wortham is on the job early and late and can be seen at most any nook or corner of the quarters at most any time with the company's popular manager, Eddie Brown, who arrived in quarters recently.

Among the visitors recently was John Hanley and Abbie Woodyard of Bonham, Tex. Both stated they would again be "with it". People under contract continue to arrive and Paris is now harboring quite a little colony of showfolks—in fact, anyone attending the weekly dances given by Mr. Wortham would think there is a multitude of them. The party and dance last Saturday night was held at the Wortham and Jones residence on Clarksville street and a most enjoyable time was had by all. A delightful course of refreshments was served, including a real cup of coffee of the Jones cook house brew. A real old-fashioned dance was also included. L. Glen Jones was principal "caller" for all square dances and quadrilles. The next dance, according to Mr. Wortham, will be held at the coliseum at the quarters, which mammoth building has hardwood floors and will make an ideal place. ROY E. LUDINGTON (for the Show).

Greater Sheesley Shows

Alexandria, Va., Feb. 19.—The Greater Sheesley Shows' winter quarters and workshops here are taking on increased airs of activity. An augmented force of mechanics and painters is now on the job, being housed in the show train. A "dining room" has been installed on the second floor of one of the warehouses and healthy inroads upon the food supply are made thrice daily.

G. A. (Dolly) Lyons and wife (Shirley Francis) have returned signed contracts to assume management of the Water Circus and Peacock Alley, and these two attractions will be featured next season under the supervision of these well known and experienced showfolks. Both shows will be enlarged as to personnel, and much new equipment will be provided by Capt. John M. Sheesley.

Joe Norton, scenic artist, of Mobile, Ala., will arrive next week for his annual task of decorating and embellishing many show fronts, wagons and scenic drops. G. Lawrence MacDonald has an imposing crew welding brushes, and it is being predicted that this aggregation will never have been turned out so tastily and completely so far as the art department is concerned as for the coming season.

"Doc" Murray reports the gathering of much satisfactory material for his presentation of the big circus side show. William Stehle will manage one of the other shows and has had several conferences with Mr. Sheesley regarding ideas to be adopted. With the booking of a number of large fairs and promising spring dates General Representative A. H. Barkley and Assistant C. W. Craft are covering much ground in the task of routing for 1925. The Chicago meeting of the Showmen's Legislative Committee this week is being attended by Mr. Sheesley, Mr. Barkley, Mr. Craft and Special Agent A. J. Link.

Among visitors during the week were Frank West of West's World's Wonder Shows and Kenny E. Moore, of the Norfolk Tent and Awning Co., who conferred with Sam Kaplan regarding needs for the attractions to be presented by the latter. Joseph S. (Dad) Brown, custodian of the Sheesley Shows many seasons, writes from Valdosta, Ga., that he is restively waiting for the band to play. Walter Convera has installed a radio at quarters, an attraction rivaled only by the progress of his twin sons, who seem to thrive in a show atmosphere. CLAUDE R. ELIAS (Press Representative).



PEARLS PRICED TO PEP UP YOUR PROFITS

24-inch... \$3.00 Doz. Chokers, \$3.00 to \$12.00 Dozen. 30-inch... 3.50 Doz. M & O Pearl-Parl 36-inch... 4.50 Doz. Necklaces, \$12.00 Dozen. 60-inch... 6.00 Doz. 72-inch... 7.00 Doz. 4-Strand Bracelets, \$6.00 Dozen. With Earrings, \$3.00 Doz. More.

OUR LEADER: 3-Strand Necklaces, \$10.00 Doz. Boxes, \$2.00 to \$4.50 Doz. Terms: C. O. D. 10% with order.

STAR BEAD CO., 15 W. 38th St., N. Y. C.

Rock Bottom Prices



FETCHING FLASHING

B-100 - POLYCHROME BRIDGE, 50 inches high. A beauty. Assorted shades. Assorted colors. \$7.50 Each. 12 to a Case.

T-56 - POLYCHROME TABLE, 19 inches high. Assorted colored shades. One light. \$3.75 Each. 12 to a Case.

V-72 - JAPANESE VASE LAMP, 22 inches high. The real thing. Assorted shades and colors. Two lights. 6 to a Case. \$9.25.

Sample assortment, one of each, sent for \$21.00. Only one set to a customer. 25% with order, balance C. O. D.

The H. M. Manufacturing Co., New Haven, Conn. Austin, Nichols & Co., New Haven, Conn. Conn. and R. I. Jobbers TERRITORY OPEN FOR LIVE JOBBERS

30-In. OPALESCENT PEARLS, Doz. \$3.50

Carry it in your pocket and easily make \$15 a day. One gross beautiful Scarf Pins, 102 different LATEST NEW YORK STYLES and DESIGNS.

set with Diamonds, Pearls or Rubies, for \$15 only. Pins sell ON SIGHT for 50c and 75c each. Many agents make \$30 a day. FREE with each order, one gross Pin Protectors and a Velvet Board—all for \$15 only. Sample half-gross order of Assorted Pins, \$8.00.

Full Line for Streetmen, Pitchmen and Concessionaires.

25% deposit, balance C. O. D.

H. SHAPIRO, 81 Bowery, NEW YORK

Wanted, Side Show Attraction

Open the last week in April. Any good Act to feature, Mind Reader, Fat Man, Woman, Sword Swallower, Strong Man, Midgets with outfit. Wanted to hear from Cha. Hanson, also Elmer Larsen. Address PRINCE BUDDHA, 5218 Third Ave., Detroit, Michigan.

FOR SALE CHEAP

Best one-wagon Fun House on the road. Only one on 20-car show. Cash or terms. P. O. BOX 8729, Miami, Florida.

WANTED

FOR MILLER'S DOG AND PONY CIRCUS. Bandmen, Cornet, Trombone, Baritone, Bass and Drums. Will West People for Concert. Concessionaire drive Ford truck. Show opens May 11. Must claim write B. YATES, 417 W. Water St. Kalamazoo, Mich. All others address GEO. A. MILLER, 921 Chester St. Easton Rapids, Michigan. Want to book good Side Show.

90-FT. ROUND TOP

100x220 ft.; both 10-ft. wall. Poles and Stakes. 8 lengths 7-ler Blues, new; 7 lengths 10-ler Blues, new. Price right. BEAR, VAN, Northville, N. Y.

Wanted General Agent

For two-car gilly show. Flat salary, with transportation. Must put up paper. Give all details first letter. Harry Buckley and Whity Campbell, write. Some choice Concessions open yet, including Houses. Opening April 11. QUEEN CITY SHOWS, Victoria Hotel, Oklahoma City, Oklahoma.

Kirchen's Electric Baskets



24 Inches High

Made of Feed Beautiful 2 Tone Finish

8 Light MAZDA ELECTRIC FLOWER Basket, \$3.75 Each in Doz. Lots

SAMPLE, \$4.00. BULBS INCLUDED.

9 Light Electric Basket, \$4.00 Each in Doz. Lots

SAMPLE, \$4.25. BULBS INCLUDED.

SEND FOR WHOLESALE PRICE LIST and Illustrated Circular.

25% Deposit Required on C. O. D. Orders.

KIRCHEN BROS., Manufacturers 221 W. Randolph St., CHICAGO, ILL.

MR. PARK MANAGER—MR. FAIR SECRETARY!

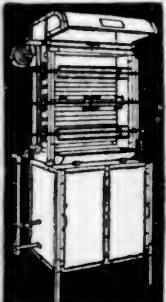

ROTISSERIE RANGES

Have been main attractions and great profit producers at Eastern Resorts and Fairs for a number of years. You cannot afford to overlook the opportunity they offer. If you have not witnessed them in operation and the great patronage they draw, just ask any recent visitor at the Eastern Parks, Beaches, Resorts or Fairs. Write us for information.

TALBOT MFG. CO., Western Factory Distributors, 1213-17 Chestnut St., ST. LOUIS, MO.

WANTED FOR TOM ATKINSON'S SHOW

Calliope Player and Acts suitable for one-ring show. This is a truck show. Address TOM ATKINSON, Yuma, Arizona.

Gerard's Greater Shows

New York, Feb. 17.—At this writing Manager Chas. Gerard and R. C. Crosby, general agent of Gerard's Greater Shows, are attending the fair men's meeting at Albany, N. Y., and they have assurances of bringing back several contracts to add to those already secured. They also will spend a few days at winter quarters in Torrington, Conn., in looking over the work in progress there.

Mrs. Gerard recently staged a small party at her apartment on Riverside Drive and quite a few show people were there. Among the guests were R. C. (Bob) Crosby, Mr. and Mrs. Polack, Mr. and Mrs. Paka, Harry Brown, Mr. and Mrs. Chas. Wilson and the writer. There was a nice dinner served and a card party and dancing by radio music. Mrs. Gerard's pet monkey "Patsie" was on the entertainment program. The writer, special agent, will leave the latter part of this month for the opening town to get things lined up and start working on promotions. CONNIE GILBIE (for the Show).

Happyland Show

To Open in Detroit May 1

Detroit, Feb. 19.—The Happyland Shows, which were organized last year, under the management of G. Y. Averill, will again take to the road this season. It was not until a few weeks ago that Mr. Averill decided to take out the show. J. F. Reid, assistant manager last season, has purchased a half interest in the show and will immediately assume the duties of manager, permitting Mr. Averill to remain in Detroit to give his undivided attention to other business interests. The show is scheduled to open in Detroit May 1. A 10-piece band will be carried this year, as well as an air calliope to be used in advance

WILLIAM GLICK, Gen. Manager.

M. B. DUKE GOLDEN, Gen. Rep.

RALPH SMITH, Treas.

BERNARDI GREATER SHOWS, INC.

"AMERICA'S BEST"

25—DOUBLE-LENGTH RAILROAD CARS WITH PULLMAN ACCOMMODATIONS FOR ALL—25

We Have Contracted the Following State and County Fairs

Maryland State Fair, Week Sept. 7 (Labor Day), Timonium, Baltimore, Md.

Penn. State Fair, Week Sept. 21, Allentown, Pa.

Fayetteville Fair, Week Oct. 19, Fayetteville, N. C.

New Jersey State Fair, Week Sept. 28, Trenton, N. J.

Goldsboro Fair, Week Oct. 26, Goldsboro, N. C.

Va. State Fair, Week Oct. 5, Richmond, Va.

Clinton Fair, Week Nov. 2, Clinton, N. C.

Concord County Fair, Week Oct. 12, Concord, N. C.

Peedee Fair, Week Nov. 9, Florence, S. C.

We have THREE FAIRS under negotiation for the last three weeks in August, which makes THIRTEEN FAIRS FOR THE 1925 SEASON.

WE CAN PLACE THREE MORE SHOWS. WILL FURNISH OUTFIT AND FINANCE ANY GOOD ATTRACTION OF MERIT. CONCESSIONS: CAN PLACE WHEELS, GRIND STORES AND AMERICAN PALMISTRY. WE HAVE EXCLUSIVE CONCESSIONS AT EIGHT FAIRS. ALSO SPACE FOR ALL OUR CONCESSIONS WHERE WE DO NOT HAVE EXCLUSIVE. HELP WANTED: PORTER FOR TRAIN, EXPERIENCED TRAINMASTER, ALSO RIDE HELP. WRITE OR WIRE WILLIAM GLICK, Continental Hotel, New York City. Winter Quarters, Baltimore, Md. RALPH SMITH, at Emerson Hotel, Baltimore. Show opens 1925 season at Baltimore, April 18.

Morris & Castle Shows

Shreveport, La., Feb. 18.—Work goes on steadily at the winter quarters of the Morris & Castle Shows. With each day either something new is finished or started.

Messrs. Morris and Castle take pride in showing visitors around the quarters. "Red" James, partner of Paul Hunter, of San Antonio, Tex., drove over with Johnny Bejano, and while here purchased Mr. Bejano's fun show called the "Love Nest". Bejano also was on hand to see the work started on the pretentious 112-foot banner front for his No. 1 side show. "Plain" Dave Morris unexpectedly dropped in from Chicago, where he has been headquartering for the past two months. Jake Newman, formerly Ben Austin's partner when they a couple of years ago owned and operated the Gentry Bros. Circus, was a visitor last week and highly praised the physical equipment of the show. Tannehill and Little are building all stands and a finely equipped "cafeteria" for this show for the coming season. Sammy Shafer is building a couple of concessions for Messrs. Tannehill and Little. Phil Little, accompanied by his wife, dropped in for a few days' visit from Dallas, Tex. A letter from Mrs. Al Armer stated that Al was getting along very nicely, that he was out of bed, but still confined to the house, but that by the opening date they both will be among "those present", with their mindreading act in Mr. Bejano's main show. Mrs. Armer also advised that little Paul Bejano had to have his tonsils removed and is getting along nicely after this painful operation. Mr. and Mrs. Chas. (Red) Bell entertained with a delightful spaghetti dinner for Pete Thompson and Al C. Beck last week. Joe Davis has returned from the oil fields around Wortham, Tex., and will soon be around work on the Chas. Jameson Glass House, of which he will be superintendent. The baggage horses arrived here from the pasture and are being clipped and shod this week. They look in fine shape. Dallas Drake, who is re-engaged with Harry Calvert, will soon resign his position at a picture show to get busy at winter quarters. JOE S. SCHOLIBO (Director of Publicity).

MILLER'S MIDWAY SHOWS

SEASON OPENS MARCH 21, KENNER, LA.

WANT Whip and Merry Mix-Up. WANT capable people to take charge of Pit Show. Have new 20x30 Top and Front. Must have two or three live Pits. WANT Boxers and Wrestler; take charge of Athletic Show. Will furnish Top and Front for Pit Hawaiian Show. Have 20x30 Top and Front for Snake Show. Will furnish Top and Front for any money-getting Show. WANT Colored Musicians and Performers for Minstrel Show. Concessions all open except Cook House. WILL SELL ex. on Corn Game and Novelty. Show now playing lots in New Orleans, La. CAN PLACE General Agent that is capable of putting show in good spots. Address all mail to

F. W. MILLER, General Delivery, New Orleans, La.

METROPOLITAN SHOWS

WANT Merry-Go-Round, Ell Wheel and Merry Mix-up. WANT capable people for Athletic Show. Have complete new outfit for same. WANT organized Musical Comedy Show or organized Minstrel Show on percentage only. Will furnish outfit for Five-in-One (except banners) to capable showman. Have 20x20 Top for single Pit Show, Big Snake or good Platform Attraction. Concessions: Everything open. Let me know what you want. Will sell the exclusive privileges on Corn Game, Cook House and Juice and American Palmistry to the right parties. Would like to hear from my old people and all those that were with me before. Address A. M. NASSER, Manager, 2201 Stone Avenue, Norwood, Ohio.

Zeidman & Pollie Shows

Spartanburg, S. C., Feb. 18.—Contracts have just been signed by General Manager Jimmie Simpson with Capt. S. L. Miller and his band to furnish the featured music for the Zeidman & Pollie Shows this season.

S. A. Kerr has signed as electrician and Art Gardner has been engaged as trainmaster.

Work is now going on day and night at the winter quarters at Camp Wadsworth, and a large force of men is busily engaged in getting everything ready for what many predict will be the biggest season in recent years for the collective tented amusement business.

"Arizona" (or the "Cliff Dwellers") will, in the candid opinion of the writer, be the greatest historical and educational feature ever seen with a carnival company, and this is written with a full realization of what the statement means. It will tend to lift the Z. & P. organization entirely out of the beaten track, and the possibilities of the exhibit from a public standpoint are unlimited. T. W. (Slim) Kelly just drove in from Florida and is stopping at the Franklin Hotel. The writer entertained the American Legion last week, and Ingram Chambers brought down from the quarters his "monk and babe" as an extra added attraction, and a great time was "had by all".

During Mr. Simpson's absence in Chicago William Zeidman has been a busy man, getting to the quarters every morning at 7 o'clock, laying out the day's work and then returning to the downtown office to look after the volume of mail.

General Representative Henry J. Pollie has practically completed the lineup of fairs and is busy now arranging the still dates for the coming season. Mr. Simpson is expected back early next week. WILLIAM J. HILLIAR (Publicity Director).

Ogilby Busy on Sunshine Shows' Dates

F. N. Ogilby, general agent of the Sunshine Exposition Shows, of which H. V. Rogers is general manager, advises that during the past few weeks he has been busy securing engagements, including fairs, for that organization, among the meetings attended being that of the fair men at Nashville, Tenn. Mr. Ogilby informs that the company will carry 8 shows, 4 rides and about 30 concessions the coming season.

Morasca Circus and Bazaar Co.

Watkins, N. Y., Feb. 18.—When the Morasca Circus and Bazaar, located in Shamokin, Pa., takes to the road the latter part of April nothing will have been left undone to make it clean, bright and up to date.

Manager J. V. Morasca has been busy the past month directing operations at winter quarters and making arrangements for the enlarging and improving of his show. Contracts have been closed for the addition of a whip, merry-go-round and ferris wheel, and the purchase of a chairplane.

The outdoor free attractions will again be carried. From indications at this writing the show will carry about 8 shows, also about 25 concessions. Shamokin will be the opening spot. Mr. Morasca predicts that 1925 will be one of the most prosperous years in the history of outdoor amusements. JIM KELLY (for the Show).

K. G. Barkoot Shows

To Open at Defiance, O., in April

Detroit, Feb. 18.—Preparations for the opening of the K. G. Barkoot Shows at Defiance, O., week of April 20 will soon start in earnest. Mr. Barkoot, owner and manager, has been busy all winter with indoor doings in this vicinity. From now on he will devote his attention to organizing his staff of executives, etc., for the coming season. The local Billboard representative is advised that in addition to the tented shows five rides, merry-go-round, ferris wheel, chairplane, whip and kiddie ride will be carried this season.

The cars are now being painted and undergoing repairs at winter quarters in Defiance.

Cooper in Chicago

Chicago, Feb. 20.—Les Cooper, with the John Francis Shows, passed through Chicago this week on his way to winter quarters at Fort Worth, Tex.

1925 SPECIAL ASK FOR OUR VALUE GUIDE CATALOG

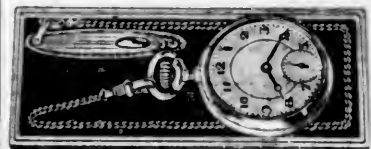

No. B-168—Combination consists of gold-plated Watch, Waldemar Chain and Knife. Put up in attractive display leatherette box. Price, Each, Postage Paid..... \$1.95

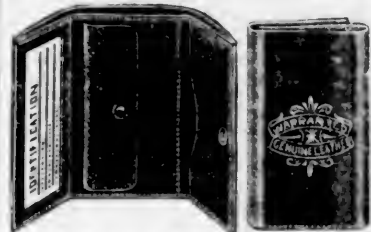

No. B-169—Genuine Leather Billbook. \$2.05 Postage Paid, per Dozen.....

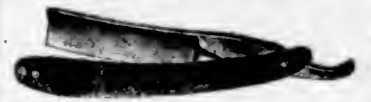

No. B-170—American-Made Straight Razor Assorted. Special while they last. Postage Paid, per Dozen..... \$3.00

We guarantee you better service and lower prices than any wholesale house in U. S. We carry a complete line of Watches, Silverware, Hollow Ware, Jewelry, etc. We specialize in Carnival Supplies, Street Men's, Auctioneers', etc. All we ask is a trial order.

25% with order, balance C. O. D.

ELIAS SHAHEN COMPANY
Importers and Wholesalers
337-339 W. Madison St., CHICAGO, ILL.

The Simplex Typewriter

A West Virginia customer writes: "I would not part with the Simplex for five times what I paid for it." A Connecticut customer writes: "My little girl is well pleased with the Simplex." Agents wanted. Only \$2.95, sent C. O. D. Hurry your order. We thank you, Yankee Novelty Co., Tilton, N. H.

GLOTH AMUSEMENT CO. WANT

ORGANIZED PLANT SHOW. Have good proposition. All Concessions open. Have for sale 13 good Wagons, 3 Seaplanes which can be changed into Merry Mix-Up. Shows and Concessions address GLOTH AMUSEMENT CO., Lake Helen, Fla. Wagons and Seaplanes address MAX GLOTH, 614 Penn Ave., Pittsburgh, Pa.

FOR SALE—CONDORMAN FERRIS WHEEL

In A-1 condition. Bargain for quick sale. Cash only. \$800. P. O. B. car. 1011N ST. AUBIN, 624 South Smith, St. Paul, Minnesota.

HARRIS SHOW BAND AT LIBERTY FOR CARNIVAL

Ten or more pieces. Flashy uniforms and real musicians. "HAL" H. V. HARRIS, Band Master, General Delivery, Tulsa, Oklahoma

YOU SAVE 33 1/3 %

Special Rush Service for Showmen
Strictly Guaranteed First Quality

Electric Bulbs

MADE IN UNITED STATES UNDER LICENSE OF GENERAL ELECTRIC CO.'S LAMP PATENTS.

Compare Our Prices With Your Local Dealer.

STANDARD LIGHTS \$1
Clear, 10, 15, 25, 40, 50 Watt, 5 Bulbs to Carton
Per Carton.

NITROGEN LAMPS, GAS-FILLED

75 watt 40 cts.
100 watt 45 cts.
200 watt 70 cts.

All other sizes at cut prices. Every lamp tested, absolutely guaranteed against breakage or mechanical defects.

DELIVERY FREE ANYWHERE—110 to 125 VOLTS.

Send Check or Money Order.

CHAS. EMORY CO.
1215 Filbert St., Philadelphia, Pa.



TRADE SHOWS AND INDOOR EXPOSITIONS

INDOOR CIRCUSES, INDUSTRIAL EXPOSITIONS, MUSEUMS, ARCADES, BAZAARS, DEPARTMENT STORE AMUSEMENTS, STORE-ROOM SHOWS, RADIO SHOWS



(Communications to 25-27 Opera Place, Cincinnati, O.)

Shrine Fashion Show

Melba Temple of Springfield, Mass., To Have Noted Beauties, Singers and Actors on Program

Springfield, Mass., Feb. 21.—Plans are under way by Melba Temple of Shriners for a fashion show and exposition on a scale of unparalleled magnitude, to be held in the Auditorium from April 2 to 7, inclusive. Merchants have welcomed the opportunity of thus drawing attention of buyers to spring wares, and are getting together elaborate exhibits. Noted beauties will be brought here to act as models and will parade on a specially constructed and brilliantly lighted runway, upon which they will display more than \$100,000 worth of the latest of Dame Fashion's gowns. Besides these dress parades there will be a series of feature acts taken from such theatrical attractions as the *Ziegfeld Follies*, while singers from the Chicago Opera Company will appear for the entertainment of lovers of music. Charles A. Frazer, potentate of Melba Temple, is general chairman of the fashion show.

Legion Circus-Auto Show

Wilmington, N. C., Feb. 21.—The American Legion Indoor Circus and Auto Show will be staged in the Auditorium the week of March 2. All automobile space has been sold. Leading merchants will give four style revues.

A radio show will be a new feature. The Legion has 300 members at work boosting the event. The post boasts a 20-piece band, which will do its bit. Inasmuch as Wilmington had no fair last fall the prospect for success is particularly bright.

The circus program will consist of about five acts. Vaudeville will be included in the entertainment, and Charles H. West's Carolinians, an orchestra of seven pieces, will furnish music.

Navarro Spring Carnival

Corsicana, Tex., Feb. 21.—A proposition from J. Doug Morgan has been accepted for shows which will be presented in connection with the annual Spring Carnival here under the auspices of the Navarro County Shrine Club, March 16-21.

Morgan will bring to Corsicana three shows, two riding devices, a jazz band and concessions, all of which will be under canvas. They will include a dramatic company, vaudeville, Wild West show and Negro minstrel troupe. The company will come by special train.

Wheeling Auto Show in Exposition Building

Wheeling, W. Va., Feb. 21.—Spectacular features are planned by Wheeling auto dealers for their show the coming week at the exposition building on the State fair grounds. The outstanding novelty will be a bonfire of used cars that are unable to pass the censors' test for entries in the show. The rejected machines will be parked inside the quarter stretch on the grounds, and some time during the week will be set afire. Motion picture companies will film the stunt.

Progress Exposition To Be Huge Tent Show

Jacksonville, Fla., Feb. 21.—Governor John W. Martin will be the central figure at the Progress Exposition when the huge tent show opens March 6. The governor has promised to lead the grand street parade that will precede the opening, make a speech and view the exhibits. About 150 exhibit spaces have been sold, and a minimum crowd of at least 16,000 is looked for.

Indoor Circus Aids Girls

Ann Arbor, Mich., Feb. 21.—Sufficient proceeds were realized from an indoor circus in the Armory by the Washington Club, an organization of local school girls, to finance the annual trip by the members to the national capital. The girls sold tickets for the Saturday matinee. The other shows during the week were under the auspices of Companies I and K, of the Michigan National Guard.

Ann Arbor Auto Show

Ann Arbor, Mich., Feb. 21.—March 11 to 14, inclusive, are the dates announced for the Automobile Dealers' Association show.

Detroit Shrine Circus in State Fair Coliseum

Detroit, Feb. 21.—The indoor circus of Moslein Temple of Shriners closed tonight, and was without doubt the best ever presented by this organization. As an acknowledgment of friendly and courteous relations, the Shriners designated February 19 as Knights of Columbus Day.

State Fair officials were greatly interested in the crowds drawn, regarding them as proof that Detroit has found the fair coliseum easy of access. The auditorium has 10,000 comfortable seats, and the State of Michigan has just installed a heating system to make the building available for winter events.

Among the acts at the circus were the Hagenbeck-Wallace performing bears; Hagenbeck-Wallace mixed group of lions, tigers and panthers, worked by Pete Taylor; the original Nelson Family, Orrin Davenport troupe, Art Adair clown band, Hagenbeck-Wallace troupe of performing elephants, the Five Avalons, Silbon Sisters, Mlle. Victoria, Hamilton Sisters, Thomas Trio, Siegrist Sisters, Lester Bell and Griffith, Mme. Ella Bradna, the Picchianini troupe, the original Siegrist and Silbon troupe, the Charles Siegrist troupe, Corill Brothers, West and Solts, 12 Liberty Horses and a contingent of clowns.

Cincinnati Shrine Circus Books 18 Acts

The Poodles Hanneford Act Will Be the Feature

The Poodles Hanneford act will be the feature of 18 acts at the third annual Shrine Circus at Music Hall, Cincinnati, March 30 to April 4. John G. Robinson, director of the show and owner of Robinson's elephants, promises a two-hour program. The Shrine Band, directed by Henry Fillmore, again will provide the music for each of the 11 performances.

Industries Fair at Portland, Ore., a Hit

Portland, Ore., Feb. 21.—Thousands of persons viewed the Oregon manufacturers' exhibits last week, 60 concerns putting on elaborate displays. Dan C. Freeman, manager of the Associated Industries of Oregon, was in charge. There were several manufacturing demonstrations both by machinery and by hand. School children competed in essay contests for which prizes were awarded from \$25 down for articles on "What I Saw and Learned at the Oregon Products Fair."

Yacht Club Holds Circus

Port Huron, Mich., Feb. 21.—A midwinter circus, under the direction of Phil Sher and the auspices of the Port Huron Yacht Club, opened a seven-day engagement in the Armory today. Among the acts billed to appear were Clifford and Clifford, novelty iron jaw and halancing; Mlle. Berzac's comedy circus; Ralph and May, European jugglers; Mlle. Sherie, "the woman in bronze"; Aerial Clarks, and others.

Record Crowds Saw Pittsburgh Food Show

Pittsburgh, Pa., Feb. 21.—Herbert Sanders, chairman of the food show, held this week at Motor Square Garden, under auspices of the Retail Grocers' Association, declares it justified the claim of "America's greatest food show", and eclipsed any previous show held here. Attendance was the largest ever.

Pittsburgh Firemen's Benefit

Pittsburgh, Pa., Feb. 21.—Pittsburgh firemen will stage an indoor circus in Motor Square Garden, March 10 to 14, as a benefit for their insurance fund.

Chambers' Circus Has Philadelphia Engagement

Philadelphia, Feb. 21.—The R. M. Chambers Circus Company will stage its initial Philadelphia performance at the Adelphi Academy commencing March 2. There will be 24 acts on the program, according to Jack Hoyt, speaking for the show, who says the talent will include the Flying Fords, Mack, May and Roy; the Rollaway Trio, the Clinton Sisters, Marvelous Elden, in feats defying the law of gravitation; Hagen and Allen, hand balancers; A. G. Lowonde, bounding rope; R. M. Chambers' horses, performing ponies and bucking mule, Elmer Perdue and his five merry-makers, furnishing clown capers, and Jack Hoyt's All-American band.

The first two weeks will be played under the auspices of the Order of Beavers. Besides R. M. Chambers and Harry Bestum, general directors, the circus roster includes: Harry Emerson, general representative; Charles Lewis, assistant representative; Jack Hoyt, musical director; Newman Ward, electrician; Jacob Barnes, doorman; John Shumway, chief usher; Alec Schnorr, boss candy-butcher; Chas. B. Kelly, reserved seat tickets; Geo. W. Frank, boss property man; Jimmy Brown, boss hostler; Frenchy Jones, assistant hostler.

Valparaiso Beckons To 5,000 Indiana Elks

Valparaiso, Ind., Feb. 21.—Indiana Elks, 5,000 strong, will make Valparaiso their mecca August 19 and 20, when the B. P. O. E. of this city will throw open their new \$250,000 temple to Hoosier members of the antiered order. Work is being rushed to complete the structure for the convention, which will constitute the highest Elks' celebration ever held in this district.

Peoria Dog Show

Peoria, Ill., Feb. 21.—It has been decided to hold the Peoria Dog Show in the new Armory, the Shrine Temple having proved too small last year. The dates set for the occasion, April 11-12, include a Sunday, on the supposition many people can visit the show that day who could not otherwise attend, except at night, when there is always a crowd.

Governor Opened Show

Hartford, Conn., Feb. 21.—The annual auto show opened in the Armory for a week, under the auspices of the Hartford Auto Club, being the 18th show of the kind in Hartford. The event was officially opened by Governor John B. Trumbull. Band concerts, with Charles B. Beach, baritone soloist, were a feature.

K. of C. Indoor Circus

Auburn, N. Y., Feb. 21.—Plans are well under way for the K. of C. Indoor Circus and Winter Frolic, to be held soon at Oswego. The Oswego All-Girl Revue, a swinging ladder act, which made a sensation last year, will be a feature act.

Marlow Furnishes Acts

Shreve, O., Feb. 21.—The Marlow Amusement Company of Canton will furnish the attractions at the Merchants' Exposition, sponsored by the local Legion, February 26, 27 and 28. Lorenze, the "mechanical man", who just terminated an engagement at the Cleveland auto show, will be the feature act.

Revue at Akron Style Show

Akron, O., Feb. 21.—The Akron food show had 5,000 in attendance the opening night, and the attendance all week was beyond expectations. Besides a style show Bert Marshall and his Minstrel Revue were featured.

Dutton Signs Big Contracts

James Dutton has contracted to put on a big circus for the Lakewood Elks, Cleveland, O., week of July 6. Two large tents are to be used for the affair, one a 150-foot round top with two 50-foot middle pieces and one 80-foot round top with two 40-foot middle pieces for auto show. There will be 30 high-class circus acts, including the Duttons' all-star combination. Following the Elks' Circus Dutton has contracted his show for Sum-

(Continued on page 103)

WANTED—A-1 Contest and Program Man, Concessions and Circus Acts

Consolidated Odd Fellows of Cicero

Week Commencing April 11th to 18th, inc.

INDOOR CIRCUS

2 SATURDAYS — 1 SUNDAY

WANTED—A-1 Contest and Program Man. Wonderful proposition for capable people. WANTED—Circus and Animal Acts of all kinds. CONCESSIONS OF ALL KINDS OPEN. Concession Agents wanted. Also Freaks, etc. First Indoor Circus in five years. Attendance expected, 100,000. Wire or write at once. FRED L. CIZEK, General Manager, Odd Fellows' Temple, 5500 W. 25th St., Cicero, Ill.

One Tube Radio Sets



\$62.50 Dozen Sample Set, \$5.50
THESE PRICES ARE FOR A LIMITED TIME ONLY
Beautifully finished with Black Fabricoid, giving a fine leather finish. Size, 10x8x5 inches.
The "DALCOPHONE" Receives Up To 1,000 Miles. Live Premium Users and Salesboard Operators write for sample set. Look it over, then rush us your order while the price holds.
All sales are made with a money-back guarantee if set is not as represented and illustrated. Half cash with quantity orders, full cash for samples.

EM-KAY RADIO CO.
148 Chambers St., NEW YORK

Wanted--Masonic Circus and Bazaar--Wanted

Shows, Rides and Concessions.
7 BIG DAYS. The First in Savannah This Year. 7 BIG NIGHTS.
MARCH 14 TO 21.
Write or wire M. T. SANDERS, Office, 24 E. President St., Savannah, Ga.

DIRECT SALES & SERVICE CO.

CARNIVAL, BAZAAR AND PREMIUM SUPPLIES

Send for Circular
24-26 W. Washington Street, Near State Street, CHICAGO



OUTDOOR CELEBRATIONS



(Communications to 25-27 Opera Place, Cincinnati, O.)

Ringling Lithographs To Glorify Sarasota

Billing All Over Country Will Advertise Orange Blossom Festival, Annual Event

Sarasota, Fla., Feb. 21.—Coincident with putting the final touch on preliminaries for the week of festivities opening March 3 comes the statement from Mr. Charles Ringling that all the Ringling Circus lithographs that go on billboards all over the country will hereafter tell the nation of Sarasota's Orange Blossom Festival, which is to be an annual event, typical of spring. Thus the city will receive advertising the value of which is almost beyond comparison.

The general committee offered a prize of \$10 for the best name selected for the carnival, and the name chosen was that proposed by Mr. Ringling, who, however, declined to accept the money. The name is regarded as an excellent one, symbolic of the festival period, the section represented, and one of the chief products, besides linking the sentiment of spring with orange blossoms and suggesting Sarasota as the bride of spring, a pageant being a part of the program, in which the bride is to be chosen by popular vote.

At the meeting of the committee Thursday it was reported that at least 10 floats will participate in the merchants' parade Tuesday night, March 3, and even more in the King de Sots' parade on Friday night. All costumes, trappings for horses and decorative material for floats will be supplied by Mr. Charles Ringling, and most of them will be new, having been made the past winter to be used by the circus the coming season. They have been shipped from Bridgeport, Conn., and should arrive early the coming week.

Bushman's Million-Dollar Band, now playing at Tampa, will be a feature one evening during the festival, and the Oldsmar band will spend the entire week in Sarasota. Harry E. Prettymann, assuring the committee he would be glad to lend the services of the organization without charge. Arrangements also were completed for the concessions and everything that tends toward clean enjoyment will be here.

Water sports will be an important feature, while there will be fireworks displays of an elaborate character under the personal supervision of Charles Duffield, head of the Duffield Fireworks Company of Chicago. This arrangement was made possible thru the personal friendship of John and Charles Ringling and Mr. Duffield, who has for that reason decided to give his personal attention to the celebration, and will make the trip to Sarasota so it may have the best in fireworks. It is planned to set the various pieces off from barges in the bay, with different features each evening, and something carrying the name of the festival in floral pieces will be produced.

President Coolidge Will Speak at Norse Centennial

Minneapolis, Feb. 21.—President Coolidge will speak June 8 at the celebration in St. Paul and Minneapolis of the Norse-American Centennial. Acceptance of the invitation extended the President several weeks ago by the Minnesota Congressional delegation and officers of the committee was announced by Dr. Gisle Nothne, head of the department of Scandinavian languages and literature of the University of Minnesota, after a further conference on the matter with the Executive. The celebration, which will mark the one hundredth anniversary of the landing of the first Norwegian settlers in America in 1825, will be held June 6 to 9, at the Minnesota State Fairgrounds, between St. Paul and Minneapolis.

King of Spain Invited To Ponce De Leon Festival

St. Augustine, Fla., Feb. 21.—There went forward this week from the city of St. Augustine a formal invitation to King Alfonso, Queen Victoria and other members of the royal family of Spain to attend the Ponce de Leon celebration here April 2, 3 and 4. Printed on heavy linen paper, rolled like a scroll of olden times and tied with the American and Spanish colors, these invitations are interesting documents.

Hoosier Citizens Plan Century Celebration

La Fayette, Ind., Feb. 21.—Plans are under way for the observance of the La Fayette-Tippacanoe County joint centennial celebration, which will take place in the fall of 1925.

Bridgeport Civic Show On Ringling Circus Lot

Bridgeport, Conn., Feb. 21.—The Chamber of Commerce has given preliminary endorsement of a plan to hold an outdoor tent show, displaying Bridgeport products and merchandise, on the Ringling Circus lot during the second week of June. Chamber officials and members will conduct the show without the aid of outside promoters. In this regard it will be "All Bridgeport" and will not be for profit. A special committee of members has approved the plan and will ask the sanction of the directors of the civic body at once. The matter has been under advisement for several weeks, and originated with Secretary Robert A. Crosby, of the Chamber. A similar plan, which had been considered by the United Commercial Travelers of Bridgeport, was voted down at a meeting when it was found the civic organization had already commenced preparations. All Bridgeport will be asked to aid in making the tent show a gigantic success. It will be modeled after a big show in Schenectady by the General Electric Company.

Reunion of Kin of Daniel Boone Proposed

Lexington, Ky., Feb. 21.—Celebration of the 150th anniversary of the naming of Lexington and a homecoming in this city of the 2,000 members of the recently organized Boone Family is proposed in a letter to Mayor Yancey and the City Commissioners by C. Frank Dunn, secretary of the Lexington Automobile Club.

Wenatchee's Festival

Spokane, Wash., Feb. 21.—The sixth annual Apple Blossom Festival will be held this year at Wenatchee. As the show is now established in the spring circuit in this State, and has gained a standing thruout the Northwest, the Chamber of Commerce will back the enterprise heavily. Ward Jessup is chairman of the Business Men's Committee in charge.

Will Have Fall Festival

Mexico, Mo., Feb. 21.—Plans were formulated this week by the Chamber of Commerce to hold a fall festival in Mexico this year. The event will last several days, and an effort is being made to make it one of the largest ever held in this section.

Fort Valley, Ga., Boosts Peach Blossom Festival

Fort Valley, Ga., Feb. 21.—The fourth annual Peach Blossom Festival is to be held here March 19 and 20. A large number of people from outside cities and towns will attend, it is expected.

OUT IN THE OPEN

By Fred G. Walker

Communications to The Billboard, 1493 Broadway, N.Y.

No field is overcrowded for the man who can think for himself and is not afraid of hard work.

Dr. Maurice William recently sold, thru Joseph Malady and Abraham Lehman, attorneys, a plot 40x120 on West 31st street and Boardwalk, Coney Island, to John Palmieri, who owns adjoining parcels, making 180x135x120 feet. Mr. Palmieri plans to erect a 12-story hotel, restaurant and bathing pavilion to cost \$3,000,000.

Charles W. Kenyon, well-known cook-house operator, who has been doing publicity work in Harrisburg, Pa., during the winter months, writes that he has booked his midway cafe with Miner's Model Exposition of Rides for the coming season. Mrs. Kenyon, one of the few lady magicians, has been presenting her act at numerous affairs and has carried off honors with her deftness.

Frank W. Moore, representing Tex Austin, Inc., returned recently from London and Paris, and announces that he has given up the idea of promoting another exhibition abroad for awhile at least. Things in Europe at this particular time are not too bright, according to Mr. Moore. Leon Britton, well known in rodeo circles, accompanied Mr. Moore on the return trip.

Frank Haggerty, general representative the World at Home Shows, passed thru

New York last week en route up-State on business. Frank reports everything moving along swimmingly with Mr. Polack's organization.

It was a real gathering at Albany, N. Y., for the 31th annual meeting of the New York State Association of Agricultural Societies last week. While there was missing the clashing arguments for clean fairs of last year nevertheless Commissioner Norgord told the boys plentifully and plainly that clean midways were what was wanted, also what was liable to happen if they did not furnish the same.

We were disappointed in not having personally heard the views of Hon. Francis D. Gallatin, president of the Park Board of Greater New York and president of the Outdoor Showmen's Association, but the banquet was lengthy and caused others also to be passed over. Mr. Gallatin could have told much of interest.

Among the recent showfolks to arrive in Detroit was Charles Lambert, concessionaire, who has been out of the game for the past two years. Charles announces that he will become associated with John C. Ranches and Lew Stockton this season.

Duke Mills, manager of side-show attractions on the John Robinson Circus, announces that after February 25 he will

be at the winter quarters of the show in West Baden, Ind. Duke has surrounded himself with a fine set of attractions for the coming season and will break the glad news of their names soon.

Mrs. Oscar Lowande has returned to her farm at Reading, Pa., after a most pleasant visit thru the East, during which she visited Mr. and Mrs. A. C. Hoyt (Mrs. Hoyt was formerly a member of Oscar Lowande's Brazilian Riders). The "white lights" of Broadway have given Mrs. Lowande visions of a season under the white tops, she says.

We err occasionally and are always glad to correct:

Last issue this "column" stated that it was John A. Reddan who was appointed supervisor of publicity for the Trenton Inter-State Fair when we should have told you John's name is Frank.

George F. Melghan, general agent of the Ringling-Barnum Circus; Ed Arlington, owner of the Broadway-Caridge and other hostilities, and Clint W. Finney, general agent of the 101 Ranch Shows, hobnobbed recently at an evening of battles at Madison Square Garden. We were unable to get close enough to the trio to get an earful, but from our viewpoint there was something more interesting in the wind than the fighters.

Dutton Signs Big Contracts

(Continued from page 102)

mit Beach Park, Akron, O., for three consecutive weeks. The show also plays the Police Circus at St. Louis for two weeks beginning April 13 under the Sidney Belmont management. Other bookings include John G. Robinson's Shrine circuses at Louisville, Cincinnati and Columbus. Dutton has also booked 15 weeks of fairs.

Detroit Grotto's Plans

Production Starting June 27—Will Include Elaborate Fireworks and Many Feature Acts

Detroit, Feb. 21.—The "Awakening", Shauckian Grotto's annual fireworks display, will be staged for two weeks, starting June 27, on the fairgrounds. Earl Newberry, general manager, and Maxwell Kane, business manager, were in Chicago during the fair meeting negotiating for suitable attractions. A ballet of 200 girls and a score or more of feature acts will be interspersed in the production.

Household Exposition at Arena Gardens, Detroit

Detroit, Feb. 21.—The third annual Household Exposition at the Arena Gardens, under the direction of the Retail Grocers' Association, closed February 20, the members being well satisfied with results achieved during the eight days.

CORN GAME

R-I-G-H-T the game that never fails to get a play, made RIGHT, sold RIGHT. 35 card games \$5.00—70 card games \$10.00. BARNES MFG. CO., 1356 N. La Salle St., Chicago.

YOU CAN'T BEAT THESE PRICES

SPECIAL

3-STRAND NECKLACE \$10 doz.
Sterling Clasp, Wonderful Lustre

24-Inch Indestructible Pearls, \$3.25 Doz.
30-Inch Indestructible Pearls, 3.85 Doz.
60-Inch Indestructible Pearls, 5.75 Doz.

Complete Assortment of above Numbers, \$2.25, including postage. No catalog.

BOXES, \$1.75 Doz.

20% Deposit With All Orders, Balance C. O. D.

KOBE IMPORT CO.,
736 Broadway, New York City

EAGLES' INDOOR CIRCUS

DENVER AUDITORIUM, APRIL 6 TO 11, INCLUSIVE.

Concessions open. NO Xs. CAN USE Circus Acts that do two or more. Also good Clown Acts that do walk around. Wire

WESTERN AMUSEMENT ENTERPRISE CORPORATION, 329 Foster Bldg., Denver, Colo.

Wanted for Moose Fair and Bazaar

WEEK MARCH 16 TO 21

Vandeville Performers who do two or more acts. Concessions of all kinds. Palmistry. W. D. TYRE, Secy., Moose Home, Elkins, West Virginia.

HIGH-CLASS ACTS WANTED

For Shrine Celebration, Thursday night, March 10, 1925. Write at once what you have and price. Address SAM SCHLUP, Chairman Shrine Committee, Cambridge, Ohio.

WANTED CARNIVAL

15 to 25-act show, week of July 4, Legion Celebration. Address CLARENCE KAISER, Prairie du Chien, Wisconsin.

COSTUMES FOR HIRE

SEND LIST OF REQUIREMENTS FOR ESTIMATE

BROOKS

1435 B'WAY NEW YORK

SINGER BROS.
SPRING 1925
SPECIAL BULLETIN
 JUST OUT
It's Free to Dealers
 WRITE FOR IT.
 Also ask for Booklet "B" on Salesboards. Also ask for Circular "C" on Candy.
SINGER BROTHERS
 536-538 Broadway, New York

PIPES FOR PITCHMEN
 BY GASOLINE BILL BAKER

(Communications to 25-27 Opera Place, Cincinnati, O.)

Money "talks"—when you get any "muzzle it"!
 To the party who wrote from Ludlow, Pa.—Send the cut or the original photo.
 A. E. Albany—The article has been on the market some time, but this scribe has no address up to this writing.

are far-reaching!" Quite right, W. C. (you sprang a "deep" one!
 H. D. Reid and wife recently returned to Cincinnati from Portageville, Mo., where H. D. was employed at local business institution. Reid was a caller at *The Billboard* and stated that he will again be with Lew Conn's Entertainers for the coming outdoor season.

Smile—even if it hurts a little. It's sunshine that warms the hearts of people, not the clouds.

Heard a fellow say last week that he was "victim of Fortune", that he had passed his opportunity so many years ago he didn't think he could live long enough for it (Fortune) to catch up with him. Probably in his younger days he "flirted" too impressively with "Miss Fortune".

Your "feet itching"? Salve 'em with the condoleance of "within but a few weeks, my 'friends'!"
 H. C. Nolan has been hibernating at Nashville, Tenn. Says he has something to "whisper" to Harry Carson.

George Williams wrote from Nashville, Tenn.: "H. C. Nolan and I are here, working aquarels. L. Dille is not with us, he being in Columbus, O. We expect to migrate north soon, as the section is not very prosperous at present. We have with us Florence Adkins and Betty Green, still on coples, but doing good."

Dr. Redjacket, wintering in Cincy, says he will sure enough be again active in med. business the coming season with a new line to handle.

Billy Rimmer pipes that he is still "writing 'em" in Georgia and Alabama, and adds: "Have had plenty of company this winter around Macon, but most of the boys have stepped out. Will again have paper with the Mighty Haag Show (back home) this year. Would like pipes from F. W. Stires and 'Red' Cunningham."

Jack W. Vierling "shot" from Akron: "Early spring weather (at least) is sure here. A number of boys are working."

A few weeks ago some notes came from a med. show, signed by the manager, but with this request: "Say that Miss _____ sent it in." Bill hears that some folks with the show have been wondering "why it wasn't used". In answer, Bill cannot state that someone else sent it when it is really sent by the party making the above-mentioned request—it wouldn't be consistent, as "Miss _____" could have sent it in the first place.

With periodical warmer weather in the North the past couple of weeks, quite a number of the boys left their city hibernations to make out-of-town trips.

From Dr. Arthur Jerome, recently: "Am in Northern Missouri, with one of the best shows I have ever carried, and business is very satisfactory. The roster includes Grant DeVell, Hazel Deering, Henry LeMar, Luva Duvel, Marie Christensen, Clifford Stotwell and myself. My wife and I spent two weeks, around Christmas, with relatives and friends at San Antonio, Tex., and had a very enjoyable vacation."

Joe (Jelly) Brown and C. (Kid) Deal shot from Eastern Texas recently: "Say! Who's the 'bird' that has been giving 15 and 20 per cent to work pens out here? We won't pay but 10. Business has been fair."

F. A. Coury, who conducts auction sales at San Antonio, Tex., winters, informs that there have been quite a number of the boys there lately, including some pen workers and a couple of vegetable knife men, also James A. Powell, the noted whiststone man, of Chicago, who was assisted by Kenneth E. Allen, probably the youngest whiststone worker in the country—they had two locations, one on Houston street and the other on Alamo Plaza.

LIE CONTEST
 The fellow who never blames his poor business on anything except "the men who have been ahead of me."—DOC BURKE. (Doc says: "This surely will win the 'pertaters'").

Rex Evans, of subs. note, was in Cincinnati last week, en route to Indianapolis. Says he might join J. W. Farrington and Harry Carson on their intended motor trip to the Pacific Coast—thus making the "old trio" again.

The article was sent to that department, Walter. Look at the heading to that page—it's included. Incidentally, there was no letter in that envelope to forward—this scribe deduced that you wanted to be enlightened on the correct address.

Walter C. Dodge says this sign was standing along a highway in South Carolina: "Loafers, Scalawags and Bums Don't Like (naming the town)". Dodge comments: "Sometimes these sentiments

You Surely Can Find Profitable Sellers Here.

Finger Nail Files, Gross.....\$1.75, \$1.00, \$2.50
 Sachet Packet, Gross.....1.35, 1.50, 2.15
 Court Plaster (3 Pieces), Gross.....1.50
 Potato Peeler, Imported, Gross.....2.00
 Tooth Peels (Collapsible), Gross.....3.10
 Basketball Score, Gross.....2.10
 Perfume Vials, Gross.....\$2.15, 2.50
 "Close Back" Collar Buttons, Gross.....1.35
 4-Place Collar Button Sets, Gross.....3.00
 Round Shoe Laces (Pairs), Gross.....\$1.65, 1.99
 Flat Shoe Laces (Pairs), Gross.....3.00, 3.25

Deposit required on all C. O. D. orders. No free samples. We ship promptly. Postage is extra on all goods listed. Send for price list.

CHARLES UFERT,
 133 West 15th Street, NEW YORK

LAYS FLAT on Home or Street
RADIO
 WILL FIT ANY SATTY BLADE
 63 West Chicago Avenue, Chicago, Illinois.

A MONEY GETTER!
 Try it and see! Pitchmen, Demonstrators, Radio Stropper holds and sharpens all Safety Blades. Sample Stropper and Home, 35c. Stropper, \$3.00 Gross; Home, \$3.50 Gross. 25% on C. O. D. **RADIO STROPPER CO.,** Chicago, Illinois.

THE DUPLEX Package
 Send 25c for Sample and Special Package Price.
 J. S. MEAD, Mfr., 4 W. Canal St., Cincinnati, O.

European Bonds AND BIG SELLERS!
 MONEY. Circulars Free!
 \$1.00 Brings Big Outfit. BONDS, MONEY COINS
HIRSCH & CO., 70 Wall St., New York.

MAGAZINE MEN
 Experienced in the trade field. Low turn-in. TRADE PUBLISHER CIR. CO., 1513 Madison Ave., N. Y. C.

TIES YOU DON'T HAVE TO PUSH
 100% Pure Fibre Silk. No Mixed Cotton. Clear, Bright Colors. Fast Selling Patterns. Our Ties are used by some of the Largest Operators in the Country.
ONCE A CUSTOMER, ALWAYS A CUSTOMER. TRY US AND BE CONVINCED.
 Gross \$30.00 SAMPLE DOZEN, \$3.00, \$5.00 deposit required on each gross ordered. No checks accepted. We have few seconds, 6 Dozen for \$9.00. No less sold.
GOVERNMENT SQUARE KNITTING MILLS, Government Square, Cincinnati, Ohio

SHARPENS KNIVES IN A JIFFY
 Big money made on Knife Sharpeners. Here they are:
LARGE SIZE, 10 Sharpening Discs.....\$27.00 Gross, \$23.50 Dozen
SMALL SIZE, 2 Sharpening Discs.....3.00 Gross, .50 Dozen
 Send 50c for two samples, one of each size. Shipped C. O. D. on a deposit of at least \$2.00 on each gross lot ordered.
JUMBO RED, Black Tip, Fitted with No. 8 Solid Gold Pen Point.....Dozen, \$15.00; Gross, \$168.00
JUMBO RED, Red All Over, No. 6 Special Solid Gold Pen Point.....Dozen, \$11.00; Gross, \$120.00
JUMBO RED, Red All Over, Fitted with No. 6 Gold-Plated Pen Point.....Dozen, \$6.00; Gross, 66.00
SILVERTONE, ALL METAL, GOLD-PLATED, PEN POINT.....20.00
BLACK PEN, with Red Top, Gold-Plated Pen Point, Gross.....20.00

All American-made Pens. All clean stock, coming from the factory daily.
 407-409 BROADWAY. **KELLEY, THE SPECIALTY KING.** NOTE MY NEW ADDRESS: NEW YORK.

UNBREAKABLE WRIST WATCH
 WHITE GOLD FINISH



WRISTLET WATCH
 With box and black silk ribbon. Just like cut.
\$11.00 Gross
 25% deposit, Sample 15c. 3,000 Gross sold in 3 days. The Wonder Item for Street-men and Pitchmen.
NADEL BROS.
 147 Park Row, New York.

ELECTRIC BELTS
 For PITCHMEN, MED. WORKERS and HUSTLERS
 Prices from \$2.75 Doz. to \$55.00 Doz.
 500% profit. Get complete NET Price List of money-makers. Sample Demonstrator for \$1.00.
THE ELECTRIC APPLIANCE CO.,
 Inc. 1801, Burlington, Kansas.



NOTICE: Due to fire at 21 Ann St., please note new address.
 All Orders Shipped Same Day
 Hard rubber, clip attached, lever Self-Filling Pens. Colored tops and bottoms.
\$20.00 Per Gross
Chas. J. MacNally
 110 Nassau St., NEW YORK CITY



TIES
LOUIS TAMCHIN, proprietor of the Comb House of America, is back in business, selling direct to Pitchmen, Streetmen and Agents. Boys, I am ready to work faithfully with you again.
Jumbo Brand Ties
 No. 200—FIBER SILK, in stripes and colors. DOZEN.....\$2.15
 No. 305—SILK CUT FOUR-IN-HAND. Wonderful numbers, made in stripes, figures and solids. Best buy in the world, 3 1/2 in. width. DOZEN.....\$3.00
 No. 400—SWISS FLAT BIAS EFFECT STRIPES, in the latest colors and designs. Also Heathers and Plain. Packed 6 to Box. DOZEN.....\$4.00
 All of the above Ties are guaranteed full length, 43 to 45 inches. 25% deposit, balance C. O. D. Send \$9.75 for Sample Assortment of one dozen
LOUIS TAMCHIN
 7-9 Waverly Place NEW YORK CITY



METAL ORIENTAL CIGARETTE CASES
 Wonderful Profits. Costs But a few Cents. Beautiful, Inexpensive, Durable.
 No. 583—Black Lacquer Finish. Hand-some Oriental Design. Dozen.....\$1.80
 No. 582—Rich Gold Finish, with beautiful Decorations. A very elegant case. Dozen.....\$2.40
 Come one dozen to package. Include 20c extra for mailing.
THE YAMATOYA CO., Inc.
 Importers Tea Sets, Vases, Parasols, Gift Ware, Variety Store Merchandise, Novelties, Etc., 327 East 2d Street, LOS ANGELES, CALIF.



The Best Seller in New York City
"ATTENTION" STREET SALESMEN MAKE MONEY
 Patent Nov. 25, 1924. Attractive bright colors packed one to an envelope and one gross to a carton.
 Write for lowest prices. Sample 25c, postpaid.
 Manufactured by **NATIONAL TOY AEROPLANE CO.,** 611-621 Broadway, New York, N. Y.



AGENTS, SALESMEN, DEMONSTRATORS
 Big profits selling new, marvelous RAY-O-LITE Cigar Lighters and Gas Lighters. Earn \$15.00 to \$25.00 daily. Fast sellers.
Rapid Mfg. Co.
 799 Broadway, NEW YORK



WHY HESITATE ANY LONGER?
 Agents, Demonstrators, Distributors! **SUPREME-NO-CEMENT WHITE RUBBER TUBE AND TIRE PATCH** will get the money for you. The Patch that vulcanizes itself to the tube. Takes a moment to demonstrate. For particulars, exclusive territory and low prices write **SUPREME PATCH MFG. CO.,** 135 Winder Street, Detroit, Mich.



PAPERMEN
 Write for our 1st Trade, Outdoor, House-to-House and Show Publications. Our Men covering all cities, towns and other shows. Address nearest office to you. **THE PUBLISHERS' ASSOCIATION,** Main Office: 139 North Clark St., Chicago. Eastern Office: 1493 Broadway, New York City.
More "Inside" Information (?)
 The Mail Dealers and Agents' Directory tells you where to buy over 1,000 different articles from "hot hands". Original "source of supply". Most complete, up to date, published. 150 pages, handy pocket size. \$1.00, postpaid. **THE COLLINS CO.,** 197 Fulton St., Brooklyn, N. Y.

J. J. Brennan, Chicago, Ill.



WRITES:
"In 12 hours I sold 46 sets."
Profit, \$66.70

You, Too, Can Make Big Money with Harper

NOT A CENT OF MONEY REQUIRED TO START.

We make it easy so you can make money quick. Our agents easily average \$7.50 to \$30.00 a day from the start. You get territory you want with protection.

HARPER'S TEN USE SET washes and dries windows, scrubs, mops, cleans walls and ceilings, sweeps and does five other things that sell housewives on sight. Complete set costs less than brooms.

Over 100% Profit

Martin Buckley, New York City, writes: "Yesterday I sold 25 sets." Profit, \$38.25.
Wm. H. Buran, Pa., writes: "I sold 36 sets in seven hours." Profit, \$52.20.
Don't wait. Start today and send coupon for full particulars.

(Cut on dotted line and mail at once.)

HARPER BRUSH WORKS,
106 3rd Street, Fairfield, Iowa.

Please send me full particulars concerning your proposition and how I can start without investing a cent.

Name

Address

City

State

Brazel Specials



INFLATED TOYS OF ALL SORTS, \$10.50 Gross.
TUMBLING CLOWNS, \$4.75 Gross.
FLYING BIRDS, Long Fancy Sticks, \$4.50 Gross.
ST. PATRICK'S NOVELTIES:
Green Carnations, \$2.50 per Gross.
Silk Flags, \$1.00 Gross.
Shamrocks, \$1.00 Gross.
Green Gas Balloons, \$4.00 per Gross.
Crepe Paper Hats, \$4.75 Gross.
Catalog free.

BRAZEL NOVELTY MFG. CO., 1700 Ella St., CINCINNATI, O.

EARN BIG MONEY Selling Shirts

DIRECT TO CONSUMERS AT WHOLESALE PRICES.
Write for samples, Dept. B.
THE SENECA CO., 145 West 45th St., New York

RUGS AGENTS CONcessionAIRES PREMIUM MEN

Buy direct. Save two profits.
No. 614—Service Felt Rug, 31x51. Dozen... \$12.00
No. 615—Pioneer Stryrna Rug, 26x52. Dozen... 30.00
No. 616—Mottled Axminster, 27x54. Dozen... 30.00
Compare these three Specials with Rugs costing double. Terms—20% cash with order, balance C. O. D. Write for samples at above Factory Prices.

MAISELY-PAYNE MFG. CO., 20-3 Sudbury St., Boston, Massachusetts.

AGENTS 300% PROFIT
Genuine Gold Leaf Letters

Guaranteed to never tarnish. Anyone can put them on Store and Office Windows. Enormous demand. Large profits. Paul Clark says: "Impossible day \$23.70." R. L. Reel made \$620 in two months. Write today for free sample and liberal offer to general agents.

Metallio Letter Co., 439 N. Clark, Chicago.

GO INTO BUSINESS for Yourself

Establish and operate a "New System" Specialty Candy Factory in your community. We furnish every thing. Money making opportunity unlimited. If three men or women, buy Candy Booklet Free. Write for it today. Don't put it off!

W. HAYLER BAGSDALE, Brewer 42 EAST ORANGE, N. J.

GREATEST SENSATION! 11-Piece Toilet Goods Assortment selling like blazes at \$2.00, with \$1.25 Dressmaker's Shears FREE to each customer. Winner for fifteen years. **DAVIS PRODUCTS CO.,** Dept. 94, Chicago.

ville. Capt. says he participates in all the clay-bird shooting tournaments he can get to, and is "just as good as ever".

There are but two issues (after this one) before the Spring Special. It's going to be a mighty big one, and we want the Pipes well represented. Toward this end, Bill would greatly appreciate the knights sending in pipes for that number now so that he can get them ready nights in advance (he has to help out in other branches of the Spring and Fall specials, and likes to keep from getting "swamped" with "eleventh-hour" work). Be sure to mark them "Spring Special", so they will not get in one of the two issues preceding the big one. And here's thanks to all who help "Your Uncle Dudley" get as much of pipes ready as possible during the coming week.

From Dewitt Snarks, in "Ol' Kaintuck": "The sun is shining these days in ol' Kentucky, and I will not tarry long here but will soon be north of the Ohio River again. The court days and tobacco sales proved good in both Tennessee and Kentucky. Met several of the boys and all seemed to be doing well. 'Whitey' Clark is in this State and fixing the town boys up with garters. 'Slim' Fessler is dishing out his share of belts and whiststones. Some of the spots are burned up, some fellows using jam methods and are rather hostile, but when a different worker explains he is working legitimately it makes a difference with the natives. Would like pipes from Doyle, of peeler fame, and the 'Accordion Artist Soap King'."

Dr. Ed. F. Weise, after closing his outdoor show in September went home to Lake View, O., where (at Sassafras Point) he enjoyed hunting, etc., and built a store and another house and started the erection of a modern dance hall. He got sort of lonesome for the road, however, so "got the bunch together" and opened again January 5. Says business has been fine. The roster includes Ralph and Marie Ray, Sid Householder, the Carsons, Johnny Murry, and Doc and the Mrs. Will play houses until May, then go home for vacation. Incidentally, Doc and Mrs. Weise celebrated the 30th anniversary of their marriage February 10. Their son, "Bud", now 15 years of age, is attending school at Lake View. (DeForrest, Doc, is doing vaudeville dates in the South, with Master Bob, in "Western" specialties).

From Dr. Chief Street, of the Washaw Indian Medicine Company: "Well, here we are in Hot Springs, Ark. Arrived here February 1, just two weeks after leaving Tampa, Fla. Had the worst road thru Georgia, Eastern Alabama and Mississippi that it was ever my pleasure (?) to drive over. But the new 'six' (coach) made it without a tow-in. Mud in some places was knee deep. Several of the med. workers here, Dr. T. A. Smith and wife are here again this winter and have Dr. Less Williamson and his son, Buster, with them—stopping at the Goddard Hotel, as usual. Dr. Cal Hicks and wife have a beautiful 5-room cottage here for the winter, sharing it with Mr. and Mrs. Carl Beard. Haven't been up to arrange for work yet, but they all (Continued on page 106)

SOME THERMOMETER!

18 INCHES WIDE, 30 INCHES LONG.

JUMBO THERMOMETER BAROMETER AND EIGHT DAY CLOCK

This is the biggest thing in advertising. It's not only big in feet and inches, but in dollars and cents. Scores of men are making big successes by selling advertising space on the "Jumbo".

\$100.00 FOR A DAY AND A HALF WORK

Display space in public places and on prominent corners is easily secured for the "JUMBO" Thermometer. The fourteen advertising spaces go like hot cakes—some of our men sell out the board in a day and a half or less.

Write Us Today and Let Us Send You Full Details. CAN MAKE IMMEDIATE SHIPMENTS.

THE CHANEY MFG. CO., BOX B, SPRINGFIELD, OHIO.

Matchless for Profits!

Demonstrators, Agents, Salesmen

Here is a **Big Money-maker!**
New, Marvellous

POCKET CIGAR LIGHTER

Sells on a Moment's Demonstration. Newest thing in specialty field. Goes strong wherever you go. Big profit and repeat sales. A sure-fire, surprising sensation. We show you how to make big money selling to consumer and dealers. Includes 30c in stamps for sample, with selling plans.

B. MASTERLITE MFG. CO., 110 East 23d St., New York City

TUMBLING CLOWN
Will tumble and roll forever. Nothing to get out of order. A wonderful ten-cent seller.

Per Gross **\$5.00**
Sample Dozen 75 Cents



Just received Famous Combination Tooth Pick, Ear Spoon and Manicure Knife. Fast seller. **\$4.00**
Sample, 10 cents. Gross



Our Famous Peerless 5-in-1 tool. Big seller. Packed each in box with illustrated circular and instruction sheet. **\$16.00**

PENS We are Headquarters for Self-Filling Fountain Pens and all Demonstrating Articles. Write for catalog.

BERK BROS., 543 Broadway, New York

Write for Canadian prices on these items to **BERK BROS., Ltd.,** 220 Bay Street, Toronto, Canada

A BIG ALL-YEAR MONEY MAKER

Make Photo Postal Cards, Genuine Black and White Plates, and Tintypes with a Daydark Camera. No dark room. Finished on the spot. No waiting. Easy to operate and learn. Big profits. The Daydark Camera originated the Modern Camera and was the first to offer the Operator a High-Class One-Minute Camera. Daydark supremacy began then and has been maintained.

In buying a Camera consider that you must choose the Daydark or something you hope will do as well and remember that the Daydark, the standard by which all are judged, costs no more. The Daydark Camera Line includes Six Models, from \$11.00 up.

Full line of supplies. Black Back Cards, 2 1/2 x 3 1/4, \$12.00 per 1,000. Mounts for same, \$4.00 per 1,000. 1 1/2 x 2 1/4, \$8.00 per 1,000. Mounts for same, \$2.70 per 1,000. Newly designed Mounts and Folders just out. Write to us for Illustrated Catalogue. It's Free.

DAYDARK SPECIALTY COMPANY, 2821 Benton Street, ST. LOUIS, MO.



SALESMEN DEMONSTRATORS

Send today for our BIG SPECIAL OFFER on **TIME SAVER NO-CEMENT SELF-VULCANIZING PATCH.** Best known and most reliable Patch made. Repairs inner tubes, rubber boots, hot-water bags, etc. Sells to auto owners, dealers, garages, oil stations and homes. We have full line of **TIME SAVER PRODUCTS**—all big sellers. Select your territory now before it is too late. Write today for FREE particulars.

THE TIME SAVER COMPANY
760 The Arcade, Cleveland, Ohio

\$100 PAID WEEKLY

Here's a world beater—a repeater that makes \$100 weekly for any live specialty salesman who will call on car owners, garages, bus lines, general stores, etc. Quickest Tire Changer on the market. Contracts and expands demountable rims.

ONE-MINUTE TIRE CHANGER

Simple, sure, speedy. Sells on sight. Makes wonderful demonstration. Nothing else in its class. Traced right, too. 5-year guarantee. Big sales records this spring. Exclusive territory. We help you start. Write at once for details.

R-M MFG. CO., Dept. 50, 14 Riegel St., Dayton, Ohio



For BIGGER PROFITS

Pen and Pencil Set. Gold finished, fancy chased, self-filling Fountain Pen with Pencil, with attractive display box. \$35.00 Gross Set. Sample, 40c. \$3.25 per Doz. Sets.

Hard rubber clip attached, lever self-filling Pen, colored tops and bottoms, \$20.00 Gross, \$2.00 Doz.

25% deposit, balance C. O. D.

ACE IMPORT CORP., 137 East 14th St., New York.



AGENTS WE START YOU WITHOUT A DOLLAR

Famous Carnation Products—Creams, Soaps, Extracts, Perfumes, Toilet Goods, Household Necessities. Widely known line, 200 items, 100% profit, repeat orders enormous. We give agents big commissions. Experience unnecessary. Write today Carnation Co., 148, St. Louis, Mo.

Sell Foxes

A permanent lifetime proposition for you in a substantial, unlimited industry.

Big Pay Jobs for Producing Salesmen

Our men have made from \$200 to \$1,000 a month and more. Our national magazine ads produce live leads for you. **WRITE TODAY** for full particulars and our FREE selling outfit of photos and profit charts on

Windswept Glass Boxes

Customers need have no previous fox experience or own any land—we ranch foxes for them—they reap the animal increase and pelt profits. A yielding investment for their dollars now. A steady income for the man who intends to retire. **Field unlimited—sell prospects with \$5 or \$5,000.** Many selling plans—full or part ownership, whole or time payment. Costs nothing to get full particulars. **WRITE TODAY.**

Windswept Caricis
3754 Windswept Building
HENDERSON, Jefferson Co., NEW YORK



HERE IS A KNOCKOUT!

The biggest and newest flash out. Sterling silver finish, hand engraved engine turned. Fancy Egyptian mounting, with a beautiful Mexican in. gem. 1K. with a blue-white glitz: you cannot tell from the genuine. \$1.25 per Doz.; \$12.00 Gross. Stick Pins, \$2.75 to \$3.50 Gross. Stick for our new catalog and monthly circular.

KING LEON, 19 South Wells St., Chicago, Ill.



A WINNER

Your own label on the famous **"HAPPY HOME MAKER"** Shampoo, the lightest and whitest shampoo on the market. Combines all features desired in a shampoo. Establish your own private business with this fast selling item.

"HAPPY HOME MAKER" Shampoo makes a big flash, quick sales and repeats 90%. Sell under our label if you prefer. Write or wire for prices. Sample, 10c.

GEO. A. SCHMIOT & CO., Dept. 2, 238 W. North Ave., Chicago, Ill.



AGENTS!! THE BETSEY ROSS, 6 to 20.

E. C. SPUEHLER, 315 N. 21st St., St. Louis, Mo.

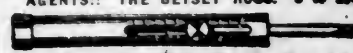

KEEN EDGE IMPROVED SHARPENER

SHARPENS KNIVES IN A JIFFY

A high-class sharpener supplied with written guarantee.

Enormous profits on each sale.

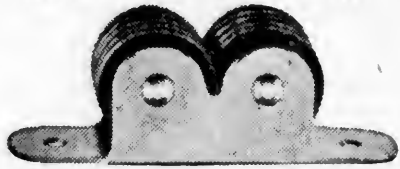

Smaller Size Two Wheel Sharpener.

Retails for 25c. 50c Doz. \$5 Gr. Plus Postage.

Send 25c for Sample of IMPROVED SHARPENER and Price on Gross Lots.

KEEN EDGE KNIFE SHARPENER CO., Inc.

127 University Place.

New York City.

"AIR-O" LINK LEATHER BELTS

GOING BIG

For Street and Premium Men in Gross Lots. Price, \$2.50 Per Dozen.

Less Quantities, \$3.00 Per Dozen. Sample, 35c.

One-third cash with order, balance C. O. D. ST. LOUIS, MO.



WRIGHT SPECIALTY MFG. CO., 908 1/2 Souard Street.

We Want 1000 Live Agents To Sell E. Z. EST ORANGE DERINDER

Makes the eating of all citrus fruit a pleasure. Removing the rind in a quick, sanitary manner without breaking the meat. Every person a prospect. Send 25c for sample. E. Z. EST MFG. CO., 219 Bushnell Bldg., Springfield, Ohio.

SALESMEN, AGENTS, DISTRIBUTORS!!

Fastest Money Maker in the United States!!!

100% profit. Costs you \$2.50; sells for \$5.00. Every demonstration a sale. No competition. Quality product. Write fully. Address S. E., care Billboard, Crilly Bldg., Chicago, Ill.

EASY-FILL CAP-GAUGE BIG MONEY

Can be made selling the Easy Fill Cap and Gasoline Gauge. Every Ford Car is a prospect, and there are over five million of them. Ask any Ford owner the trouble he has with his filler cap. Then show him the Easy Fill Cap that opens like a trap door, can not be lost, tells him instantly the gallons of gasoline in the tank and never leaks. Takes only one minute to install.

Agents and Salesmen everywhere say it is the biggest money getter they ever sold. Sells on sight. Send \$1.00 for sample and our 100% or better profit proposition.

EASY-FILL CAP CO., Dept. F. 931 Lawrence Avenue., CHICAGO, ILL.

TELEGRAPH ORDERS FILLED 7-IN-1 STYLE BILL FOLDS

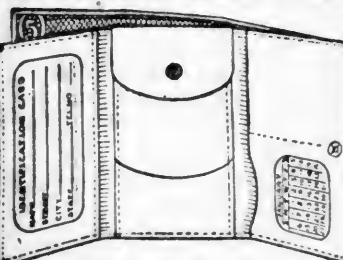

KING'S LINE used by Pitch Men, Sheet Writers, Sales Board and Premium firms. Sample assorted dozen sent C. O. D. at gross prices, to start you. Get started with KING. Leave your forwarding address at our office.

King Razor & Leather Goods Mfg. Co. B. B. Street, Indiana, Pa.



RUGS At Factory Prices

WE WANT representatives in every district. YOU MAKE BIG PROFITS.

Sample Outfit Free.

Men or women. Our Rugs sell on sight. Every house a prospect. Every sale brings repeat orders. Write today for particulars. MAISLEY-PAYNE MFG. CO., 648 Sudbury St., Boston, Massachusetts.

AGENTS

The Monogram business, with Decolomania Transfers, shows real profit. Easy to apply. No license needed. Catalogs and particulars for the asking. Motorists' Accessories Co., Mansfield, Ohio

AGENTS—SALESMEN

Big Money Monogramming Cars. Make \$20.00 to \$25.00 Daily.

Automobile owners want initials on their cars. You apply them while waiting, charging 25c per letter, three letters on each side of the car, six initials letters in all for which you charge the car owner \$1.50, and you make \$1.44 profit. They could not get finer work if they paid \$5.00; then again, no sign painter could give them as nice a job as you could do without experience in 15 minutes. You can sell to individual auto owners, or you can sell to garages and supply stores complete display outfits, like the one illustrated, at big profits. 400 Transfer Monogram Letters in three of our most popular styles, with eight Borders to match and complete working outfit only \$5.00. Send money order or certified check. Outfits sent C. O. D. upon receipt of \$1 deposit.

World Monogram Co., Inc. Dept. 1. NEWARK, N. J.



RUBBER BELTS PEDAL PADS and KEY KASES BELTS



First Quality Belts. Prompt shipment. Belts with Polished Clamo Buckles, \$12.00 Gross. Belts with Polished Roller Buckles, 12.00 Gross. Belts with Eagle or Island Gold Buckles, 18.00 Gross. Key Kases, Brown or Black, 12.00 Gross. Ford Pedal Pads, \$2.65 per Doz. Sets. Belts can be supplied in one inch and 1 1/2 inch width. In plain stitched, ribbed or wairus style in either black, brown or gray colors. Terms: One-fourth cash with order, balance C. O. D. F. O. B. Galion, O. Orders for one-half gross accepted. We ship same day orders are received. Service for patronage. Let us show you our quality and service. NATIONAL MAILING CO., Box 131, Galion, O.

Buy Direct From Manufacturer

with the reputation of best quality goods for lowest prices. A trial order will convince you. New Creations in SILK KNITTED TIES. The Latest Designs and Shades. Nos. 1000, 1100, 1200, 1300, 1400, 1500, 1600, 1700, 1800, 1900, 2000, 2100, 2200, 2300, 2400, 2500, 2600, 2700, 2800, 2900, 3000, 3100, 3200, 3300, 3400, 3500, 3600, 3700, 3800, 3900, 4000, 4100, 4200, 4300, 4400, 4500, 4600, 4700, 4800, 4900, 5000, 5100, 5200, 5300, 5400, 5500, 5600, 5700, 5800, 5900, 6000, 6100, 6200, 6300, 6400, 6500, 6600, 6700, 6800, 6900, 7000, 7100, 7200, 7300, 7400, 7500, 7600, 7700, 7800, 7900, 8000, 8100, 8200, 8300, 8400, 8500, 8600, 8700, 8800, 8900, 9000, 9100, 9200, 9300, 9400, 9500, 9600, 9700, 9800, 9900, 10000. \$1.25 per Dozen. 10% reduction in Gross Lots. 25% deposit, balance C. O. D. R. & P. KNITTING MILLS, 271 Congress Ave., New Haven, Conn.

PIPES

(Continued from page 105)

say it is 'pretty hard'. We will be here four or five weeks, then back to good old Kansas City to get ready for the spring rush".

From our Boston office—Just had a visit from F. L. Stone, real old-time pitcher (he's been at it 30 years), who is now manufacturing cheap "wipes" and a 6-in-1 tool (can opener, etc.), and numbers many of the boys among his customers. Here's proof positive of the fact that totting a tripe and keister "sticks with you." Stone has made plenty of money pitching flexible razor hones and other items, so much so he has about a dozen houses, owns an interest in the handkerchief factory, is part owner of about four cafeterias, owns three automobiles (one a "speed wagon" that he travels in), so has plenty of interests around Boston to keep him to home, but he says every year he picks up the tripe and goes out again—he can't stay home, tho he's "retired" about 40 times from the road. He'll be out again this year, doing the big fair up this way and working the towns, once the snow leaves the ground.

From Doc William H. Burns: "First, I have not run into a purveyor of fountain pens lately, so am shoving this to Bill with a pencil. Since my last pipe I have been to St. Louis, purchased a ton truck, made it into a 'home on wheels' and am living in it—believe me it's comfort, with a capital 'C'. Leroy Easter and myself are still telling 'em how it happened. Met Lindstrum in St. Louis, also Hanley with combs, Millis with sharpeners and Doc Sage. On leaving St. Louis we went to Southeastern Missouri, crossed Illinois and are now in Indiana. There are two men who have a large store in Johnson City, Ill., who are glad to have pitchers work on their corner. They say that every time one comes there they do additional business. But they are a couple of live-wire business men, who appreciate advertising, a little unusual entertainment on their streets for the townfolks and believe in a 'live and let live' principle. They are not like the would-be penny-grabbing local merchants (of the vintage of '76) that we met up with in a certain town recently—where a Business Men's Association put out the propaganda that we had taken in 'lots' of money on our last visit there, and had since 'had it stopped'. (More along this line later). We will go a little further south, then

Headquarters for White Stones

"Our Latest Season's Creation"



You can do a big business with our honest goods, honest prices and prompt service.

J. ROSENSON & CO.

295 W. Madison St., Chicago, Ill., U. S. A.

SALES BOARD ASSORTMENTS

That Are New and Different for JOBBERS AND OPERATORS

Illustrated Catalogue and Price List FREE Upon Request.

COMPARISON PROVES YOU'LL DO BETTER AT GELLMAN BROS., 118 No. 4th St., MINNEAPOLIS, MINN.

KNIT TIES

SPECIAL PRICES

To Agents and House-to-House Canvassers

Buy direct from the Manufacturer and save the middleman's profit. NARROW TIES FOR LADIES Are in great demand this year. Send for samples of LADIES' KRINKLED TIES. Beautiful patterns, from \$3.00 to \$4.50 Dozen. PURE SILK FIBRE KNITTED TIES. \$24.00 to \$48.00 Gross. Beautiful patterns, well finished and full length. FANCY FIBRE SILK BOWS. \$12.00 Gross. SPORT BELTS. \$36.00 Gross. Send \$3.00 for Sample Dozen Assorted Styles. ACME TIE CO. P. O. Box 921, St. Louis, Mo.

HOUSE DRESSES

\$10 Per Dozen



Assorted styles. No two alike. Made of fine Percale, Gingham, Chambray, etc. All sizes. All popular colors. Value \$15 to \$24 a dozen. Retail from \$1.50 to \$3. You can easily sell a dozen every day.

1 Doz. Assorted Dresses \$10.00
1/2 " " " \$5.25
1/4 " " " \$2.75

Sent Postpaid. WRITE FOR FREE CATALOG.

ECONOMY SALES COMPANY, Dept. 102, 104 Hanover Street, Boston, Mass

Large Profits Easy Sales

Handling "VAPO" Vaporizers

To Distributors and Agents selling the "VAPO" Vaporizer—a unique, automatic, patented device that gives greatly increased motor power, reduces gas consumption 25% to 40% (guaranteed) and WILL remove carbon by a simple operation. Installed on any motor without expense in a few minutes—no holes to drill. Money back guarantee. Very attractive sales proposition. Write for details and samples.

"VAPO" Specialty Company Philadelphia, Pa. 450 North 12th St.

AGENTS—SALESMEN

You can make \$20 to \$25 daily selling our

PHOTO MEDALLION

Send for our new Catalog and Request Price List. MEDALLION NOVELTY CO., 208 Bowery, New York City.

\$20 PROFIT daily selling Needlebooks. Cost 3c-5c each. Sells 25c; value 50c. 3 Samples, 25c. Self-Threading, \$2.75 per 100 Packs (1,000 Needles). Catalog free. NEEDLEBOOK SPECIALTY CO., 661 Broadway, New York.

DAY "I SAW IT IN THE BILLBOARD."

BALLOON MEN, CLEAN UP!

Double your sales. Don't have any more poor days. Make every day a big one. Here's how you do it. Have your BALLOONS printed with name of Celebration or Fair or Park you are going to work. Your name and ad printed on a No. 70 and shipped same day. \$21.00 per 1,000. No. 90—Heavy, five colors, pure gum Gas Balloons. Fifteen different assorted pictures on both sides. Gross, \$4.00. No. 70—Patriotic. Gross, \$3.60. Balloons, Gross, \$3.00. Balloon Sticks, Gross, 25c. No personal checks accepted. 25% with order, balance C. O. D.

YALE RUBBER CO. 15 East 17th Street, NEW YORK CITY.

\$15.00 A DAY SELLING 3 IN 1 FILTER

Stop Splish. Strain Water. Prevents Dish Breaking. By our plan the "Bureka" Filter sells itself. Beginners make as high as \$10.00 a day. Experienced salesmen make thousands annually selling this long-established well-known device. You can't go wrong. Learn about it today. Positive money-back guarantee. J. B. SEED FILTER & MFG. CO., INC. (Established 1862). C. P. Shias, Pres. 73 Franklin Street, NEW YORK CITY.

IWEMAKEM FELT RUGS

The kind that sell. Write for particulars. LAETUS MILLS Box 1356, Boston, Mass.

PEDDLERS—DEMONSTRATORS

Needle Packages at Special Prices

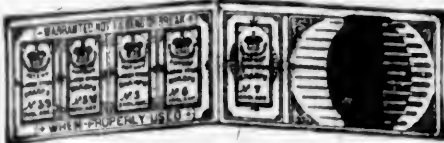

All contain 5 Papers Needles and Patch of Darning Needles.

No.	Per Gr.
B701—Army & Navy	\$6.00
B702—Reindeer	6.00
B703—Home	7.50
B704—Agee	6.00
B705—Marvel	6.00
B706—Polly Prim. All Cloth Stuck.	9.00

Sample set of one of each by mail, prepaid, for 75c.

We carry big stock of Watches, Clocks, Jewelry, Brads, Cutlery, Novelties, Notions, Carnival Goods, Peddle Wheels, Tickets, etc. Catalog free. No goods shipped C. O. D. without cash deposit.

SHRYOCK-TODD NOTION CO.

824 No. 8th Street,

St. Louis, Missouri

back westward. We are, virtually, but killing time until spring."

A. J. Haas wants us to ask Chas. Lindner if he remembers the time the "roadster" tipped over into a ditch one cold January morning about two years ago up in Minnesota?

During a cold spell in New York State recently, Billy Ahern turned loose this bit of wit: "Will exchange a pair of non-leakable trijods for a pair of earmuffs—must be fur-lined."

In a Western city a baby was recently born with an extra finger. A squib in *The Laurel* (Neb.) *Advocate* commented that this seemed to be an attempt of Nature to produce the ideal jazz-band pianist.

C. S. (Kid) Deal "unlimbered" from Lubbock, Tex.: "Bill" asked in a recent issue, "Who is in El Paso this winter?" so Joe Brown and I are going down there to find out—so by the time this appears in Pipes, will have the ol' crippled foot on Jimmie O'Brien's rail. Maybe the others hittin' El Paso don't have time to pipe in—we'll find out. The country around here might be better, as there has been no rain here for six months. Wonder where Jas. E. Miller got those whiststones he used in Memphis last year?"

Among the paper frat, boys seen at the recent auto show in Kansas City: Joe Bickett, Kabler Brothers, Masonhoff, Harry Raiston, "Izzy" Kemp, Richardson, Dick Hall, A. J. Haas, Jack Clements, Rowdy Dowdy, Wilson, Davis, Beltram, "Whitey" Thomset, Bob Sheppard, Mickey Humphreys, Chris Miller, Peterson and others. One of the boys says: "Where are M. T. Hagan and Guy T. Crippen? Haven't read a pipe of or from either of them for a long time, also House and C. R. Johnson."

Dr. Frank A. Latham piped from Portland, Ore.: "Am passing thru Portland, en route eastward. Dr. Jay Van Cleave is still doing business 'at the same old stand' here. The boys out this way are getting ready for what they think will be one of the best years ever. Dr. Travis is around Tacoma, working; so is Dr. Bonnar. Dr. Thompson is here, and old Dr. Blanchard is working with him. Dr. Haley is over in Salem. Seattle put the 'ten-a-day' reader on all the dental places on the ground floor and pitching in office. As for me, I am hitting it back to what some show people call the 'Death Trail'—Eastern Oregon, Southern Idaho and Utah."

From the Babetta Show—The roster of the company now includes Madam Anivo (Mrs. Millette—a registered nurse), proprietor; Miss Babetta, manager, lecturer and novelty aerialist; Una Pelham, late of the Pelham Stock Company, soubrette and specialties; Paul LaBounty, black-face comedian and fire-eating specialties; Jack Moran, pianist and song and dance specialties—not forgetting "Troupier", the show's canine "mascot". The show has been doing a nice business playing halls in good-sized towns in Pennsylvania. (Continued on page 108)

AGENTS MAKE GOOD PROFITS

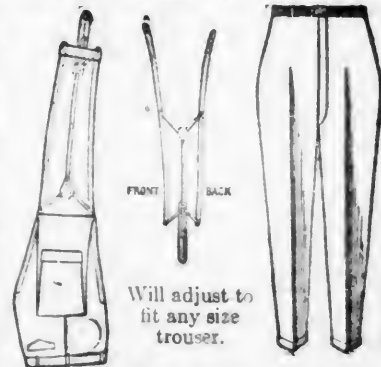

Will adjust to fit any size trouser.

Every Man Wants the Universal Creaser

Is the only invention in the market that will make a crease in a pair of trousers that no hot iron can duplicate. It will entirely eliminate baggy knees.

AGENTS, GET BUSY. Send for sample pair and agents' price. Price for one pair:

- Straight Steel.....\$2.00
- Straight Aluminum.....\$2.00
- Straight Aluminum, Black Lacquered.....\$2.00
- Collapsible Aluminum, Black Lacquered.....\$2.25
- Collapsible Aluminum.....\$2.25

Also add postage.

Money Refunded If Not Satisfactory

UNIVERSAL TROUSER CREASER COMPANY

97-99 Nassau Street, NEW YORK.

AGENTS Some Seller at \$2.00 Looks Like \$5.00 Worth Gives You \$1.10 Profit!



You should see our Nifty Nine Package. Our Representatives introduce our products with a first sale of beautiful combination sets of Toilet Articles, Soaps, etc., at half store prices. No fancy talk—they sell on sight. Make twenty to thirty sales a day with \$1.10 profit on each.

Easy to Average \$100.00 a Week. Could you ask more? line establishing a permanent business for yourself? Another plan calls for no deliveries—no investment—no delays. You bank immediate profits. Also a winning plan, a premium to each sale. Write today for illustrated circulars explaining our unique plans. Act NOW. E. M. DAVIS CO. Dept. 9542 CHICAGO

NEW NUMBERS



\$15 Gr. \$1.50 Dz. Onyx stone set ring is even better looking than illustration. Ring on right side comes in ladies' and men's, with blue sapphires on sides. Very Heavy All rings same price. GET INTO THE MAIL ORDER BUSINESS. We sell you 16-page Jewelry Catalogs, with your name imprinted on cover. We supply you with merchandise, etc. Write for information.

H. REISMAN & CO. 551 W. Lake St., Dept. B, Chicago.

Agents \$15 a Day

Sell new insured hosiery for men, women and children. Guaranteed. Must wear and give satisfaction or new hose free. All styles and colors. Finest line of silk hose you ever saw.

We Pay You Daily on all orders you take. We make all deliveries and collections. After you have sold a certain amount of goods, we furnish you with cash to travel in. Write for sworn proof of \$14.55 a day or \$2 an hour for spare time. Any man or woman can make big money every day. Samples furnished to workers. WILKNIT HOSIERY CO., Dept. 1210 Greenfield, Ohio

SHEETWRITERS MAGAZINE MEN

Get out of the rut. Our magazine sold anywhere. Not a farm or home town. \$2 a copy, complete working outfit. Write today and get into the soft money. CIRCULATION MANAGER, Box 446, Denver, Colorado.

MAKE MONEY Sell Custom-Made Shirts

Direct from our factory to wearer. Easily sold. Full satisfaction guaranteed or money back. No capital or experience required. Large steady income. Write for full samples. SAMUEL HORN, 125 Second Ave., New York City.

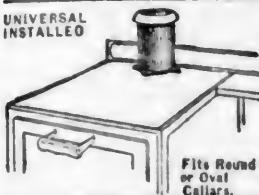

WE WANT 100 LIVE AGENTS TO SELL UNIVERSAL GAS RANGE FLUES

Your earnings begin at once. Pay yourself \$300.00 a month. 12 to 20 orders per year from \$15.00 to \$25.00 a day. No monthly rent pipe to the chimney is needed. Saves kitchen walls and ceilings from grease and smoke. Saves decoration expense. One sample order Black Japan, \$2.00; one sample order Enamel Trim Collar, \$2.25; one dozen Black Japan Finish, at 90c each, \$10.80 dozen; White, Grey or Blue Enamel Trim Collars, at \$1.15 each, \$13.80 dozen. Your profit, \$1.10 per sale. Write for quantity prices.

UNIVERSAL HEATER MFG. CO., 1000 North Vandeventer Avenue, St. Louis, Mo.



ST. PATRICK'S DAY FAVORS

- No. 10—Plain Silk Shamrocks.....\$0.90
- No. 25—Red Celluloid Rose on Shamrock.....1.75
- No. 800—Yel. and Green Rose on Sham.....1.75
- No. 80—R. W. and B. Streamer Rose on Shamrock.....2.25
- No. 40—Miniature Clay Pipe on Shamrock.....1.75
- No. 50—Miniature Irish Hat on Shamrock.....1.75
- No. 100—Miniature China Kewpie on Sham.....1.75
- No. 70—Silk Amer. Flag Bow on Shamrock.....2.50
- No. 15—Amer. Flag Shield on Shamrock.....2.50
- No. 500—Miniature Cell. Kewpie on Sham.....2.50
- No. 20—Glit. Harp on Shamrock.....1.75
- No. 000—Assorted Shamrocks.....2.25
- No. 12—1/2 in. Silk Irish Flag on Stick......60
- No. 12—1/2 in. Silk Irish Flag on Pin......75
- 50—Ligne Celluloid Buttons, "Erin Go Brack".....1.25
- Green Tissue Paper Caranations, with Wire Stem.....Grass, \$1.00; Grass, 1.75
- No. 5019—Papier Mache Shilleleahs.....4.00
- Dozen, 35c; Grass.....4.00
- Im. Potato Candy Box.....Doz., \$0.80; Grass, 9.00
- No. 1391—Green Wire Snakes, Doz., 80c; Gr., 9.00
- No. 4692—Flex. Wood Snakes, Doz., 65c; Gr., 7.50
- No. 6291—Satin Heart Boxes, Doz., 40c; Gr., 4.75
- No. 6292—Satin Heart Boxes, Doz., 75c; Gr., 8.50
- No. 4116P—Assorted Crisp Paper Hats.....4.50
- No. 5439P—Assort. Paper Hats, Doz., 80c; Gr., 9.00
- No. 1788P—Shamrock Emblem Squawker Balleens.....Doz., 30c; Gr., 3.50
- No. 671P—Shamrock Emblem Valve Balleens.....Doz., 30c; Gr., 3.50

25% deposit required on all C. O. D. orders. ED. HAHN, "HE TREATS YOU RIGHT" 222 West Madison Street, CHICAGO, ILL.

Make \$24 Daily



YOU CAN DO IT TOO. And Make Only 12 Sales Daily. BELLS FOR \$3.50. With 200 Letters. Size, 15x19 In. Just out! Territory going fast. Every merchant buys one or more. Write today for General Agent proposition, stating territory wanted. Sample, prepaid, \$1.00. DAVENPORT-TAYLOR MFG. CO., 418 Orleans Street, Chicago.

AMENZ means \$20 a day

Liberal advance commissions of 30% for you selling guaranteed made-to-measure and ready-to-wear AMENZ Shirts. We deliver C. O. D. to customer. Write for FREE sales outfit. Menzin Shirt Company, Dept. 26, 470 East Tremont Ave., NEW YORK CITY.

MAGAZINE MEN

We are open for a few good clean producers on various trade publications, clothing, grace, cloaks and suits, grocery, bakery, heating, machine shop, laundry, tobacco, printers, etc., etc. Write for particulars. TRADE PERIODICAL SERVICE CO., 1400 Broadway, New York City.

SIGNS, BANNERS, CARDS

Easily Painted with the aid of Letter Patterns. Simply draw around a letter pattern and fill in. Made in a large variety of styles and sizes at surprisingly reasonable prices. Send stamp for free samples. J. F. RAHN, 62433 Green View Avenue, Chicago.

Silk Knitted Ties

Are Fast Sellers Easy to Make \$15.00 A DAY

Selling our regular 35c, 50c, 75c and \$1.00 styles for the price of \$2.00, \$2.50, \$3.00 and \$3.50 per Dozen. These Ties go like wildfire. You can undersell everybody with big profits for you.

THE POPULAR SELLER—Silk Joe Brod Ties, \$1.50 per Doz.

LATEST STYLES in Sport Rows, per Doz., \$1.00, \$1.25, \$1.50 and \$2.00.

PRINCE OF WALES FAVORITE CRAVAT. Price \$2.50 per Dozen. 25% deposit with all orders.

American Cravat Exchange, 621-A Broadway, New York City, N. Y.

ONE MILLION 84 1/2% German Government Treasury Notes—With Interest coupons attached. Rush your order as there is only a limited supply—Kaufman State Bank, 112-114 N. LaSalle St., Chicago. Price List Mailed Free!

MEDICINE MEN YOU WILL FIND

A. T. F. SPECIFIC, for Coughs, Colds, Pneumonia, Influenza, Bronchitis, Asthma, Pleurisy, Hoarseness, Winter Coughs, Backache, Shingles, Rheumatism and all trouble, to be an excellent seller. Thousands of people have used it; it builds up the tissues. A. T. F. SPECIFIC is a nerve tonic for the system; gives you an appetite. Keep it in the house for the children; it will help keep Croup, Influenza away; also choking pain between the shoulders and lungs. Also for Actors, Actresses, or any one who is exposed to all kinds of weather. Actresses and Showmen have taken it for years, and it has kept them on their feet when all others failed. A. T. F. SPECIFIC never fails to bring the roses to the cheeks. Now is the time for medicine men to get busy. Thousands of bottles await your orders at THE BAERNE CHEMICAL COMPANY, 610 West Seventh St., Cincinnati, Ohio.

MEN'S SILK SOX (Slightly Imperfect) \$1.50 Per Dozen

Sell fast 4 pairs for \$1.00. One dozen assorted. Samples sent prepaid for \$1.75. 25% cash with all C. O. D. orders. LONG LIFE HOSIERY CO., 325 South Main St., Los Angeles, Calif.

CROSSWORD PLAYING CARDS

Something new. A complete deck of 52 cards, with full directions for playing. More interesting than the newspaper crossword puzzles. Sent to any address for 75c. Send money order only. Agents wanted. Address WALTER J. WHITE, Box 876, City Hall Station, New York, N. Y.

OLD DR. BROWN'S BOOK OF SECRETS! Contains 2,000 Rare, Valuable, Tested, Tried Recipes for Mixers, Farmers, Mechanics, Manufacturers, Business Men, Medical and Household use. Interest Tables, Measurement Tables, Ready Reckoner, Weights, etc. Fully illustrated. 400 pages. Only \$1.00, postpaid. THE COLLINS CO., 197 Fulton St., Brooklyn, N. Y.

Reduced Prices

- IMPORTED STRAIGHT RAZORS. Great bargains. Each in box. \$30.00
- Sample Order \$3.00.
- Army & Navy Needle Books.....\$4.00
- Comb Cleaner, Metal.....3.00
- Electrical White Stone Pins.....3.00
- Snag Links, Best Quality.....5.50
- Leather Key Case, 6 Hooks.....6.00
- Square Aluminum Pencil Sharpeners.....4.50
- Pocket Combs, Leather Cases.....9.00
- Blaisdell Gilt Clutch Pencils.....9.00
- Assorted White Stone Rings.....10.00
- Steel Nail Files.....2.00
- Teeth Paste, 2c Seller.....6.00
- Samples of above 10c each with order.
- Artists' and Models' Picture Rings.....24.00
- Gilsh Combination Locks, Nickel.....18.00
- Fountain Pen, Gilt, Lever Filler.....20.00
- Fountain Pen, Gilt, Coin Filler.....13.00
- Gillette Style Razor, Nickel Box.....24.00
- Pen & Pencil Set, Gold Pln., with Box.....45.00
- Gillette Blades, 10 to Pkg., 10 Pkgs.....2.00
- 30-in. Opal Pearls, Per Dozen.....4.00
- 60-in. Opal Pearls, Per Dozen.....6.00
- 3-Strand Pearl, Colored Stones, Dozen.....11.00
- Send 15c extra for postage for samples.
- 25% deposit, bal. C. O. D. Send for circular.
- SPIEGEL CO., 153 Canal Street, New York.

DON'T GAMBLE

Take no chances with old stuff. Here are two new items. Be the first one to handle them. The Mysterious Pictures, appear and disappear. The one you like. Assorted Great Lots \$6.75. We don't sell less than 6 Dozen, \$4.00.



The Crying Nigger, with morbid eyes and tongue, like cut, each in a box. Great. \$33.00; Doz., \$2.90. 25% deposit, balance C. O. D. ACE IMPORT CO., 137 East 14th Street, NEW YORK.

PIPES

(Continued from page 107)

vania. Miss Babetta is probably the youngest woman manager and lecturer in the medicine show business, and she is also a very energetic business woman—in addition to her aerial specialties, she also does advance work.

A pipe from the N. P. S. P. A.—A short time ago there was announced in the "Pipes" an invitation for all members of pitchdom to compete in a "lie" contest. This announcement did not state what reward or trophy would be given to the winner, but if there are any prizes, gold medals, loving cups or crowns of victory, these tokens denoting the champion "falsifier" will have to be equally divided among nearly all pitchmen, as nearly all have been guilty of telling the same "great lie".

It has been repeated thousands of times by thousands of pitchmen—simply this: "The pitchmen will never be able to form an association." If Ananias were living today he would have to take the dust of the pitchmen who have told that so long and so frequently. It would be a sad outlook for the famous "pre-variator", if he had any thought of competing.

In a sense of fair play and justice it must be admitted that the pitchmen who have been guilty of broadcasting this "falseness" had sufficient and adequate reasons to cause them to believe they were telling the truth. The predominant reason for telling this would be the fact that until recently all the praiseworthy endeavors, made at frequent intervals in the period embracing the past 50 years, to organize pitchmen into an association, resulted in dismal failures. Failures of this kind have been so numerous that even a suggestion of organization was greeted by the rank and file of pitchdom with the old discouraging "lie", "It can't be done!"

The latest attempt at organization has been made by the pitchmen of Los Angeles, who have formed the National Pitchmen's and Salesmen's Protective Association. There is no doubt but what the majority of pitchmen, as they read in "Pipes" of the activities of this association, immediately conclude that it is another "mirage", a "rainbow" or a "dream", and decide that it will be a failure because of the failures in the past and then resume telling the old time-worn "lie"—"It can't be done."

Are these conclusions and decisions fair? Is it possible to render an honest decision or a just conclusion upon the success or the failure of this association unless there is first a clear understanding and an intelligent knowledge of the facts and figures? It would not be consistent with good judgment.

The N. P. S. P. A. can, by substantial and authenticated records and impressive statements (which are compounded of facts) prove that the plain and undeniable truth is that "It has been done", and "done well!"

This association is now reaping the harvest of great efforts, which in this case is success, and this success is built upon such a solid foundation that it will be a success of continuity and permanence. Nothing great is easy. Success is great, and to attain it was not easy—it was won by hard work, persistent plugging, energy, enthusiasm, study, personal service, individual cooperation and financial sacrifice.

It is now the business of every pitchman to think about this great achievement, the successful formation of this association. It is of more vital importance than the price of "gummy", or the "reader" in "Punkville". The march to success was made with an upgrade constantly under foot, and now that it has been reached, there is a clear road, with a down-hill slope ahead. This association now invites all pitchdom to join with it in the march down the easy road to Opportunity and Progress.

If every pitchman, wholesaler and jobber who reads this would write a letter to this association and write a letter to two other pitchmen, urging them to communicate with this association, the problem of "Co-Operation, Unity and Defense" would soon be solved and the success of this association would become a national success, from which all of pitchdom would derive a direct benefit. If these benefits are wanted now there must be action—now—as all believe in the old adage, "Do not put off till tomorrow what you can do today." Write today for the success of tomorrow. The address is P. O. Box 324, Station C, Los Angeles, Calif.

Widow of Composer of "Rosary" To Appear at Copyright Bill Hearing

(Continued from page 6)

far as his particular concern was affected, they could get along with bargaining with the composers as well as the artists.

MEDICINE SHOWMEN

STREETMEN, AGENTS!

Get Our 1925 Prices. Private Brand Goods Our Specialty. Write us your requirements today. THE SEYLER MEDICINE COMPANY, 1645 Central Avenue, Cincinnati, Ohio.

GOLDEN OPPORTUNITY

In this little ad for live ladies and gentlemen wishing to make \$100.00 per week in high-class work. Particulars free. Write ALLEN WIRTH, Ada, Okla.

(But the mechanical men had already agreed to stick together.)

Arthur D. Garnatze, for the Columbia Phonograph Company, charged that the industry was on the verge of a gigantic trust being formed that would control the music industry and be so wonderfully organized that neither the Federal Trade Commission nor Department of Justice would be able to break it up. It would be the biggest thing of its kind yet known to man. E. C. Mills, chairman of the advisory board of the American Society of Composers, Authors and Publishers, would be head of the trust, according to Attorney Garnatze. As E. C. Mills was not present at the time but preparing for a trip to the West Indies, he has sent a radio message to the committee stating that the charges were absurd and that he would not be a party to any sort of an illegal combine.

G. W. Case, Jr., for the Brunswick company, voiced the opinion that the legislation might better be not in favor of the publisher, but so that the composer might be protected from them. George T. Bettys, for the Aeolian company, wanted the compulsory license clause extended to piano rolls, because they were now paying more than two cents a roll in royalties to the publishers. His concern, he said, had been manufacturing piano records at a loss for years, but upon being questioned about it explained that they also made pianos and other rolls did not fit their pianos. But they did make money on the pianos.

For the film producers, tomorrow, will appear, among others, Arthur Weil, Gabriel Hess and two more attorneys, some of them experts on copyright matters. Their particular side is expected to be altogether different from any yet heard.

Tribute Paid Edyth Totten

(Continued from page 6)

raptured while starring in *The Power Behind the Throne*. Mrs. Sam Carter-Waddell, with Burdet Soule at the piano, presented the Carter-Waddell Dancers, four separate and distinct groups of personally attractive, intellectual, refined, talented and able feminine dancers. The first ensemble in a waltz group included Louise Robinson, Florence Krillberge, Lorraine Deutsch, Josephine White, Lillian Koeckler, Mary Hoffman and Isabel Froment, costumed to a la seminary. The second ensemble a la ballet included Tatiana Polloff as premiere danseuse, Steuart Mackall as premier danseur and the Cochran Twins. The third ensemble in nifty dancing costumes included Mary Jane Reese, Lorraine Deutsch, Lillian Koeckler, Josephine White, Regina Beck, Miriam Levy, Florence Krillberge and Estelle Levy. The fourth ensemble in Spanish costumes included Wayeno, Tatiana Polloff, Cochran Twins and Mitzi Bergere.

Drama Comedy Medals were presented to members, viz.: Mrs. Blanche Bobrow, Mrs. H. R. Buckye, Marie Cordes, Mrs. Minnie Cohen, Mrs. George Cozine, Mrs. W. A. Dibbs, Mrs. H. Gross, Mrs. Kurt Gloeckner, Mrs. Elizabeth Gubitz, Mrs. Anton Hilbert, Mrs. Laurel Holzman, Mrs. Louis Heim, Mrs. Harold Haber, Mrs. Joseph Josephs, Mrs. Paul H. Junghans, Mrs. J. N. Little, Mrs. Selig Mayers, Mrs. F. J. Oakes, Mrs. A. J. Pennell, Mrs. Belle Rosenthal, Mrs. Florence Thoades, Mrs. Lucy Singer, Mrs. W. P. Schimpf, Anna Schmidt, A. Maria Schaefer, Mrs. J. Seligman, Mrs. Mae Taylor and Mrs. R. J. Walsh.

Taking the assemblage collectively, it was a gathering of congenial folks closely identified with the stage, and one of the best conducted affairs of its kind. When any woman can induce the masculine element of Broadway theatricals to dress in time for a high-noon banquet on Sunday she has really achieved wonders. More power to Edyth Totten and her Drama Comedy.

Stricter Censorship

Lansing, Mich., Feb. 20.—Stricter censorship of the movies was urged in a resolution adopted by the Michigan State Farm Bureau at its seventh annual meeting here. The bureau is in favor of the tightening of censorship in order to make the motion pictures "cleaner morally".

Cleveland House Will Reopen

Cleveland, O., Feb. 21.—The Colonial Theater here, which has been dark for almost six months, is to reopen this week. Announcement to this effect has just been made by the playhouse management. The theater's entertainment program will comprise vaudeville and moving pictures and four separate shows will be given daily.

Sign Advertis Fair

Jackson, Miss., Feb. 20.—More than 250,000 persons who heard Billy Sunday, world-renowned evangelist, during his five-week revival in the Municipal Auditorium received an invitation to "come back to the State Fair October 19-24" by way of a huge sign suspended over the stage. The sign, hung there by order of Mabel Stire, secretary of the fair and custodian of the big auditorium, also serves as an invitation to hundreds of others who attend State conventions in the structure.

Prospects for the 1925 fair are excellent, according to Miss Stire. A record-breaking attendance of poultry fanciers is expected as the result of the decision of the State Poultry Federation to hold its annual session here during fair week in order to take advantage of the splendid poultry show that will be assembled here at that time. Five hundred members are looked for by the federation.

State Fair of Alabama

The announcement has been made by Mort L. Bixler, manager of the State Fair of Alabama, that the budget of expenses this year will be increased in all the departments of the fair. The advertising efforts will be made much more effective thru a greater expenditure and covering a wider territory.

The attendance last year was 117,000 and the mark set for this year is 150,000, says Mr. Bixler. The dates have been set for October 2 to 8, inclusive, and Rubin & Cherry Shows will furnish the midway attractions.

The State fair last year attained a gratifying success due to the co-operation and backing of the State officials, the Alabama Farm Bureau and the U. S. Extension workers.

Arkansas State Fair May Get Appropriation

Little Rock, Ark., Feb. 19.—By a bill introduced in the Arkansas State Legislature last week the State fair would receive an apportionment of \$12,400 for each of the two fiscal years ending in 1926 and 1927. This is the first time the fair has received help by legislation. In substance the measure also provides that no exhibitor shall be paid in premiums unless he be a resident of Arkansas. If this bill passes the money appropriated will be available for premiums for the fair next fall.

Less Live Stock in Pa.

Pittsburgh, Pa., Feb. 20.—County fair managers of Pennsylvania will have \$6,379,000 less live stock to choose from for their exhibits next fall, according to figures recently compiled.

With the exception of cattle, other than dairy cows and sheep, the number of horses, dairy cows and swine was less January 1 than a year ago. Total value of live stock is estimated at \$150,705,000 as against \$157,054,000 a year ago.

Average values of individual animals as compared with a year ago are: Horses, \$94, as compared with \$110; dairy cows, \$61, as compared with \$62; other cattle, \$31.10, compared with \$30.60; sheep, \$8.90, compared with \$7.80, and swine, \$16, compared with \$14.

Winnebago County Fair

Pecatonica, Ill., Feb. 19.—Plans for the development of all departments of the Winnebago County Fair for 1925 were discussed at the annual meeting of the association held here February 10.

Receipts for the fair last year were reported as having been \$18,000.

Among the improvements planned for this year is the erection of a large building for the display of stock. An extensive celebration will be staged at the fairgrounds July 4, with horse races, vaudeville acts and other features.

New Fair at Dayton, Wash.

Dayton, Wash., Feb. 19.—The second annual Columbia County Fair will be staged here next fall, with R. E. Eager, E. S. Hubbard and Franz Romaine in charge. The county farm bureau has announced. This fair is one of a score of new county expositions started with fine results last fall. All thru Eastern Washington at these secondary fairs are springing up at present, a tendency being encouraged by the larger sectional fairs of the Pacific Northwest.

AGENTS—It's New, Just Out AMAZING MONEY MAKER



MARVO cleans hands instantly without water. Work like magic. Removes dirt, grease, ink, paint. Rub on—wipes off—that's all! Put up in sanitary tubes—easy to carry as a lead pencil. No grit, lye, acid. As smooth as butter. Harmless to skin. Hurts nothing but dirt. Every demonstration a sale at big profits. Big business. Needed by all autoists for use on the road after tire or engine trouble—all mechanics, painters, printers, factory workers, housewives—anyone with dirty hands. Sales guaranteed. Exclusive territory pays \$100 weekly. Write or wire for amazing details.

SECURITY MFG. CO., Dept. 6, TOLEDO, O.

PARISIAN MODEL RINGS



Made of radio silver, set with a 1-Kl. Montana Diamond, through which a picture of a Parisian Model can be seen. 25% deposit with order, balance C. O. D. \$3.50 PER DOZ. Sample, 50c. American Bead & Jewelry Co., 32 Union Square, NEW YORK, N. Y.

INSIDE INFORMATION

AGENTS, PEDDLERS, CANVASSERS, Etc. YOU "NEED NO LICENSE"

To sell goods in any town, city or State. AGENT'S PROTECTOR OR LAW BOOK "proves it". If trouble comes, show your Law Book of "Absolute Proof" with court decisions rendered by State, Federal and Supreme Court Judges, and be released with apologies. "Guaranteed" Copy on hand for form \$1.00. Postpaid. THE COLLINS CO., 197 Fulton St., Brooklyn, New York.

MAILED FREE

Our new 100-page Catalog (No. 137), full of JEWELRY, SALESGOARD, PREMIUM and OPTICAL BARGAINS

ALBERT MARTIN & CO. 123 West Madison Street, CHICAGO, ILL. Formerly Manager of Morrison & Co.

MAKE MONEY SELL MADISON SHIRTS

Direct from our factory to wearer. Easily sold. Over one million satisfied wearers. No capital or experience required. Largest steady income. Many earn \$100 to \$150 weekly. Territory now being allotted. Write For Free Samples. Madison Factories, 560 B'way, N.Y.

\$69.50 in ONE DAY!

\$69.50 in one day for J. R. Head! \$945 in one month for R. A. Trenton! \$16,800 in three years for W. J. McCarty! These records show what some of my representatives earn taking orders for DODGE All-Weather Topcoats and Raincoats. You can do the same in your community. No capital or experience needed. Big profits at once and a chance to get a Dodge Touring Car FREE! Write for details today. The Comer Mfg. Co., Dayton, Ohio. Dept. C.446. Free DODGE Touring Car

COIN MACHINE OPERATORS

here is

One grand opportunity to clean up in a legitimate game. The J. & O. NERVE AND EYE TESTER gets the money. Is strictly legitimate. Vends nothing but amusement and plenty of it. Excellent territories still open.

J. & O. LABORATORY

565 W. Washington Blvd., CHICAGO, ILL.

AGENTS

"TAKE ME HOME PACKAGE" contains merchandise valued at \$3.00, and sells handsily at a bargain price, \$1.50. Send 50c for sample package today and price in quantity less. N. Y. STATE TRADING GOODS CO., 53 East Houston Street, New York.

\$1.75 AT THE BARGAIN COUNTER. GERMAN MILLION THOUSAND NOTES, 1923 Issue, 10 pieces. Best seller on the Market. Ask for Descriptive Circular. KAUFMAN STATE BANK, Dept. G. H., CHICAGO, ILL.

VETERAN'S SERVICE MAGAZINE

78 Watts Street, New York. Service men, come in on the holiday clean-up. Only monthly publication. New things. Special hot edition going strong. 6c each. Sells 25c. Agents wanted everywhere.

"SMALLEST BIBLE ON EARTH"

About size of postage stamp. Contains 200 pages New Testament, each in small printed envelope marked 2c. Sample, 25c. Dozen, \$1.00; Gross, \$10.00. THE COLLINS CO., 197 Fulton St., Brooklyn, N. Y.

MEDICINE MEN: Indian Herbs and Package, \$1.20 Doz. 50c. Rubbing Oil, 75c Doz. 50c. Salve, 75c Doz. 25c. Corn Cure, 60c Doz. 25c. Skin-Shampoo Soap, 50c Doz. Guaranteed "repeaters". CHAS. FINLEY (Druggist), 4151 Olive, St. Louis, Mo.

MAGAZINE MEN

Order your two-pay receipts from us free. 425 Temple Court Building, Minneapolis, Minnesota.

Advertise in The Billboard—You'll be satisfied with results.

SOMETHING NEW THE "KARRYALL" Folding Shopping Bag

None better made. Fast seller. Large profits. \$9.50 per Dozen. Send 85c, stamps or coin, for sample. We gladly refund your money if not satisfied.

THE KARRYALL BAG SHOP, Marshall Ave., Mansfield, Ohio.

MANUFACTURERS

OF AMERICA'S FINEST

FELT RUGS

Agents Write Today EASTERN MILLS, Everett, Mass.



Here's Some Showfolks That Will Make Money Watch Them

We wait! Don't experiment. Buy the "Best by Test". Our new 1925 Models are the result of 11 years' experience, and our 15-year guarantee backed by \$125,000 factory, equipment and assets, which spells "certific" for years to come. The following shipments have "recently" been made, with over \$30,000 worth of orders on hand awaiting deliveries. These fellows are the ones you know advertising and only selected the "TANGLEY CALLIAPHONE" after careful investigation of everything on the market. "There's a reason." We have built 50% of all Calliaphones ever sold.

- D. W. Fisher (2), Jackson, Mich.
- Big A Amusement Co., Dallas, Tex.
- C. W. Parker (3), Leavenworth, Kan.
- G. S. Hurst, Canton, Miss.
- Dixie Co., Spartanburg, S. C.
- North Western Shows, Detroit.
- D. L. Doyle, Beaumont, Tex.
- C. J. Berner, Rochester, Minn.
- Morris-Miller, Savannah, Ga.
- C. B. Edwards, New Albany, Miss.
- Greenan Co., Detroit.
- Eli Bridge, Jacksonville.
- Umberhan & Wirtz, Green Bay.
- T. Loyd, Cumberland, Md.
- Sherwin Cramer, Hawthorne, Cal.
- Ferne Hawkins, Cuto, Cuba.
- R. Jackson, Sault Ste. Marie.
- Morris Updegrave, Tower City, Pa.
- John F. Longdon, Barton, Md.
- Howard Family Shows, Do, Miss.
- Harry O'Neill, Scranton, Pa.
- W. S. Billings, Tenaha, Okla.
- Riverside Park, Indianapolis.
- Norwood Rink, Norwood.
- Alfred C. Locke, Beverly, Mass.
- Casino, Hartford, Conn.
- F. C. Wadbyburn, Sask. Can.
- Luna Park, Cleveland.
- C. H. Cudney, Pleasanton, Tex.
- Abner Kline, San Bernardino.

TANGLEY CO.
Muscatine, Iowa

Trade in Your Old Models or Organs

ORDER NOW FOR PROMPT DELIVERIES
Our capacity is one instrument daily. Cash or terms.



ADDITIONAL OUTDOOR NEWS

S. L. A. Starts Year With New Officers

Large Attendance Hears Annual Reports and Greets the Incoming Officials

Chicago, Feb. 21.—Not in months has a regular meeting of the Showmen's League of America had so large and attentive a crowd as it had last night when the annual meeting of the old year blended into the first meeting of the new. The meeting was opened by Acting President Fred M. Barnes, elected president at the annual election last Tuesday. Reports on the election were read and filed. Mr. Barnes asked if there were any objections to the report, and, hearing none, declared all of the new chair officers and members of the Board of Governors duly elected. A motion made by a member for a recount of the vote was lost.

Secretary Sam J. Levy then read his annual report, a document clear, succinct and comprehensive in all of its details. Mr. Levy made a few suggestions to his successor that he thought might be helpful in the conduct of the secretary's office. Mr. Barnes then declared the meeting adjourned. After this it was the new president, Fred M. Barnes, who opened the first meeting on the new league year.

Reports of chairmen of committees on the league party Wednesday night were called for. Edward P. Neumann, chair-

man of tickets, reported that he had received in cash the sum of \$1,050 and that money was coming in daily. Edward A. Hook, chairman of concessions, reported that his department took in \$465.80, and \$100 from the sale of flowers was reported. President Barnes offered the opinion that when all of the money is in from tickets and other sources the total should approach \$2,500, which will go to the Cemetery Fund.

Mr. Neumann asked that *The Billboard* say he has been unable to acknowledge the receipt of money for tickets from anybody as yet, owing to the pressure of work in getting the tickets in the mail, but that thanks will be extended to every purchaser as soon as he and his assistants can get around to it. Mr. Neumann also asks that everybody owing for tickets kindly send the money in so the whole matter can be closed up.

President Barnes asked all of the boys who will soon go out into the field in their work to bear a message to all of the outdoor showmen, a message of good will from the league, asking them to always visit the league—their league—when in the city, and assuring them that the league is for all of its members and not merely for a few.

The new chair officers are: Fred M. Barnes, president; Charles G. Browning, first vice-president; Edward A. Hook, second vice-president; Sam J. Levy, third vice-president; Edward P. Neumann, treasurer, and A. J. Ziv, secretary.

The names of the newly-elected members of the Board of Governors appear in another story in this issue of *The Billboard*.

Thanks were extended to the ladies of the auxiliary for services rendered at the party Wednesday night.

At the meeting of the Board of Governors last night, the matter of increasing the personnel of the active showmen on the board came up for discussion. It was finally decided to add 16 honorary members to the body, the following being chosen: John T. Wortham, Johnny J. Jones, George L. Dobyns, Alex. Sloan, Walter F. Driver, Louis Hoekner, W. S. Cherry, Harry G. Traver, Leo. Lipka, John G. Robinson, Larry Boyd, Andrew Downie, F. J. Frink, Charles H. Duffield, W. H. Donaldson and Norman Shields.

Texas Kid Shows

Hearne, Tex., Feb. 18.—The Texas Kid Shows had a very good week at Navasota, Tex. They are playing here under auspices and prospects are promising. Had an exceptional good week at Hempstead, which town was played thru the efforts of General Agent Joe Cantrelle.

"Slim" Haynes has rejoined with a 20x20 cook house. Al Hansen joined with five concessions. "Happy Jack" Brown is foreman of the White Show. Mr. Russell has the White Show. Lenny Davis the 20-in-1, Jack Nichols in charge of the new merry mixup, and Chas. Duckworth still operates the Ferris wheel. Mr. and Mrs. Louis Selzer joined with "Bingo", claimed to be the largest hand turtle in captivity. Mr. and Mrs. V. B. Thomas and sister, Clarice, have returned from a spring shopping trip. Fred Calkling will probably join here with his big-snake show and three concessions. Mayther Lewis has returned Texas Kid has ordered a new cage for immediate delivery. Hoke Dalinger is still train-master. Jack Cantrelle has purchased new tops for his three concessions, which are in charge of Mr. and Mrs. J. E. Brown. Mrs. Bill Nettles has returned, bringing with her little Ralph, born Christmas. Dan Whitefield has a new 20-foot glass concession. Doc Slaton is still here with his spitz dogs. John Lipsco has the novelties. Slim Walker and wife have a new blanket store. Mr. and Mrs. Reallinger and son have three nice concessions. Mrs. Ruby Brown has all the ball games with the show. The cowboys with the show include Sherry Creed, Bo-Bo Dorsey, Bill Sawyer, Chief Carrels and Charlie Brown. Mrs. Texas Kid has returned from San Marcos Academy, visiting her two sons in school there. Mrs. Chas. Duckworth is ticket agent on the merry mixup. Mrs. Nichols has been suffering with the grippe the past week. For the coming regular season the lineup will include 4 rides, 7 shows and about 40 concessions. All of which is according to an executive of the above shows.

Shadowgraphs

By CHAS. ADDRESS

New York, Feb. 21.—Am I having a good time? Well, I should say yes. I cannot give the time to write "Shadowgraphs" that the occasion deserves, for every minute seems to be booked for this and that. Notwithstanding the fact that it has been 17 years since my last visit here, I find so many friends from the long ago as well as of today in the realms of amusement, including circus, magic, vaudeville, that it would be impossible to mention them all in the way I should like to.

Harry and Mildred Rouclere, the mentalists, came over from their home, the Rouclere Hotel in Ridgewood, N. Y., purposely to entertain Mrs. Adelaide Herrmann and myself, and what a delightful day we had. Had lunch at the N. Y. A. Club. Went to the Metropolitan Opera theatre. Then to Guffanti's Italian restaurant for dinner and then to the Hippodrome, where we enjoyed a wonderful show. Clinton E. Lake, altho still a young man, has set a managerial stride that might be well for some older ones to follow.

By the time you are reading this I will be gone from dear old New York, but I shall take with me many fond memories. I must not close until I return sincere thanks to Harry and Mildred Rouclere for the loyal way they treated me, and I know Madame Herrmann joins in this attestation; to Nellie Revell, for the kind words she wrote about me in *The New York Evening Mail and Telegram*; to Ollie Webb; to Frank Ducrot (Ducrow), the big, congenial, affable magic purveyor; to Maurice (marvelous), magician; also little Al Flosso and many other magicians I have met here; also John Barton, an old comradetrouper of mine. I also had a delightful visit with Harvey Watkins.

I must say a word before closing about the wonderful *Billboard* office in this little old New York. I thought I established a big office in Chicago when I was local manager of the branch there, but gee whiz, it's not in it, and then too I have felt so at home here, for Miss M. Henry, Mr. Walker, and in fact the entire office force, have treated me so splendidly that it makes another real reason why I dislike to leave here, but best of friends must part. So au revoir—more soon.

Ladies' Auxiliary, Showmen's League, Holds Election

Chicago, Feb. 21.—The Ladies' Auxiliary of the Showmen's League of America held its annual election of officers Tuesday. Much interest was centered in the event and the officers and members of the Executive Committee chosen in the balloting were as follows:

OFFICERS—Mrs. Edward A. Hook, chairman; Mrs. W. O. Brown, 1st vice-chairman; Mrs. Geo. B. Ho, 2d vice-chairman; Mrs. Louis Hoekner, 3d vice-chairman; Mrs. Babo, Bulgarian, secretary; Mrs. Edward P. Neumann, treasurer. EXECUTIVE COMMITTEE—Mrs. Tom Rankine, Mrs. Joseph Harris, Mrs. Henry T. Belden, Mrs. J. M. Sheesley, Evelyn Hock, Mrs. H. Nothman, Mrs. Al Latta, Mrs. H. J. Gamet, Mrs. James Campbell, Mrs. Dick Collins, Mrs. Harry McKay, Mrs. Ed. Hill, Mrs. Charles Linker, Mrs. I. L. Poyser, Mrs. Rose Adelslein Zindra, Mrs. C. E. Eckert, Mrs. Arthur Board, Mrs. Con. T. Kennedy, Mrs. W. H. Donaldson, Mrs. Rubin Gruber, Mrs. J. T. Wortham, Mrs. W. H. Rice, Mrs. Sam Gushkin, Mrs. William Glick, Mrs. Fred Bennett.

"No Intention Closing Our Chicago Office"—Mugivan

A trade paper (not *The Billboard*) in its last issue carried a story that the Chicago office of the American Circus Corporation will be abandoned after the engagement of the Sells-Floto Circus in that city. When brought to the attention of Jerry Mugivan, he wired *The Billboard* from Peru, Ind., February 21, as follows: "No intention closing our Chicago office."

Our Chicago office, in answer to another story in the same paper that a new rule of checking up on expenditures of agents would be adopted by the American Circus Corporation, said: "Circus people say the story is pure fabrication."

ST. PATRICK SUGGESTIONS

- 150 Shamrocks for \$1.00
- 150 Green Jumping Frogs for 1.00
- 150 Green Crocodile Crickets for 1.00
- 100 St. Patrick Silk Flag Pins for 2.50
- 100 Green Carnations for 2.50
- 100 Shamrocks, with Hats, for 2.50
- 100 Green Balloons, with Harps, large size and best quality, for 3.50
- 100 St. Patrick Paper Hats, beautiful assortment and designs. Special, for 5.75
- 1000 St. Patrick Novelties, assortment, for 7.00
- 100 St. Patrick Cigar Fans for 3.50
- 100 St. Patrick Flexible Snakes for 6.25
- 100 Green Roosters (Noise Makers) for 7.50

SAUNDERS MERCHANDISE & NOVELTY CO.
620 St. Clair, West, Cleveland, O.
Terms: 25% deposit with order, balance C. O. D.

BUY YOUR CEDAR CHESTS WHERE YOU SAVE MONEY

Prices and merchandise guaranteed. Your money cheerfully refunded if not satisfied.

CEDAR CHESTS—Copper Trimmed

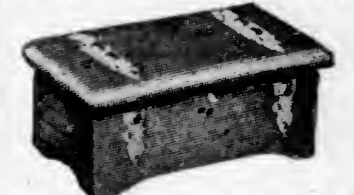

- With Candy Filler, 1-lb. Size. Dozen \$12.00
- 2-lb. Size. Dozen 13.50
- 3-lb. Size. Dozen 16.50
- 5-lb. Size. Dozen 17.50

Send for list and prices of other items. Orders shipped promptly upon receipt of 25% deposit. Include postage for parcel post shipments. Goods positively not shipped without deposit.

SAMUEL FISHER
54 West Lake Street, CHICAGO.

BEST PRICES

- No. ART PHOTO RINGS
- 621 Asst. Photos. Per Dozen \$ 1.75
- 940 With Selected Art Models. Dozen. 2.25
- 2668 White Stone Searf Pins, with Pictures Similar to Rings. Dozen 2.00

- 35 Gillette Type Razor Blades, Gross. \$ 1.50
- 30 Gillette Type Razors, in Boxes. Gr. 21.00
- 391 Bracelet Watches for Streetmen. Gr. 9.00

- No. STREETMEN'S ITEMS Gross.
- 130 Fun Mirrors \$ 5.00
- A142 Ear Pick, Knife Combination 4.50
- 5 "Cutwell" Pencil Sharpeners 7.00
- 540 Same Shape as Above, Good Grade. 5.00
- M14 Mysterious Writing Pads 3.75
- M13 Mysterious Writing Pads, Small size 2.25
- 1900 Imported Pocket Cigar Lighters. 6.00

M. L. KAHN & CO.,
711-713 Arch Street, Phila., Pa.

Get this Ring FREE

NO. 1 \$5.00 NO. 2 \$6.25

We want you to wear a marvelous imported Mexican Gemstone without a single drop of expense to you! These beautiful Gems positively match genuine diamonds—same perfect cut, same dazzling play of rainbow fire, stand intense acid test of side-by-side comparison with genuine diamonds. Noted experts positively need their experience to detect any difference whatever. Wear it among your friends, let them admire its marvelous beauty and compare it even with exquisite stones selling for \$500 a carat. Watch them become enthusiastic and envious.

Here are the two rings included in our free offer to you: No. 1—Ladies' 1 ct. Solitaire, fine 14k gold. No. 2—Gents' 1 1/2 ct. heavy 14k gold. Total Value, \$500. Let us water Gemstone to you and wear one OUR FREE OFFER enable you to own and wear one one cent and at the same time make a lot of money if you wish. PAY US NOTHING—simply write today, enclosing a strip of paper that meets around ring finger to show size. Say which ring you want. We only give one ring FREE. MEXICAN GEM IMPORTING CO., Dept. N 650 Madison Park, N. Y. C.

FOR SALE Five Flat Cars. Will go to any service. 12 first-class Show Wagons, 1 Saver and Straight Wall Motorcar, three Machines. Address E. B. REED, General Delivery, Eldorado, Kansas.

TAYLOR'S CIRCUS TRUNKS

Do not fail to see our new, improved Circus Trunk. Stronger than ever, at the same old price. Write for catalog.

TAYLOR'S
210 W. 44th St. NEW YORK
28 E. Randolph St. CHICAGO

WANTED

Circus Acts, Side Shows and Concessions

For week beginning March 30, at Charleston, W. Va. Also Concessions for Huntington, W. Va., week beginning March 16. Address HARRY LA PEARL, 348 3d Avenue, Huntington, W. Va.

Buck Weaver Wants LIVE AGENTS

J. Rodgers O'Henry, Wally Johnson and others who have worked for me, wire quick. Care Rubin & Cherry Shows, Montgomery, Alabama.

Wanted—Partner—Wanted

With Two-Across, to play Missouri, Kansas, Nebraska dates. I have No. 3 and Aero Sailing. Fair. Societies wanting two or more independent riders, let me hear from you. Melale, wife, Gen. Myers, let me hear from you. W. A. GIBBS, Erie, Kan.

FOR SALE

Buy Wheel, good as new, numbered 120 on one side, on the reverse; 1000 Serial Paper Paddles, in book form, two numbers on a ticket, 60 tickets in a set; one set of small Pool Balls, used on Holly River. What am I offered? CHAS. ABRAMS, Box 100, Daytona Beach, Florida.

Ladies' Aux., H. of A. S. C. Holds Anniversary Luncheon

Kansas City, Mo., Feb. 20.—The fifth annual "birthday" luncheon of the Ladies' Auxiliary of the Heart of America Showman's Club took place last night in one of the private dining rooms of the Coates House. From 8 o'clock until the actual luncheon was announced the ladies assembled in their clubrooms and played cards, then adjourned to the banquet hall.

The table presented a beautiful sight. On one end was a huge basket of bright red carnations, furnished by the Auxiliary, and on the other another big basket of white carnations entwined with red sweet peas, sent with the compliments of the men's club. At each place was a lovely "lady", attached to the flowers with red and white ribbons, a red "cracker" which when pulled developed a paper hat and small red basket containing salted peanuts.

The menu consisted of bouillon, olives and celery and crackers, chicken a la king and julienne potatoes, head lettuce with thousand-island dressing, ice cream and petit cakes, and coffee. President Viola Fairly sat at the head of the table and Mrs. C. W. Parker acted as toastmistress. Mrs. Parker gave prayer prior to the dinner, also called on each lady present to tell a story, anecdote or personal experience, this being the course decided on instead of prepared speeches. Mrs. Helen Brainerd Smith was first and she was pleasingly humorous. Gertrude Parker spoke on membership. Mrs. J. H. Johnson, the new treasurer, spoke on co-operation. Mrs. George Engesser was delightful in her pleasantries. Mrs. Hattie Howk said that she had been heard so much when she was president she thought the others should be heard from. Mrs. Fairly spoke of her pleasure in being honored in the presidency and of her intention to fill the chair to the best of her ability. Mrs. Nell Duncan, acting secretary, spoke on helping the new president and Bertha McMahon on this her first luncheon.

Mrs. Parker then gave a toast to those not present, to those not able to come and to all the past presidents, who were all around the table; Gertrude Parker, serving two terms; Hattie Howk, two terms; Helen Brainerd Smith, one term. Mrs. Parker told of some of the early experiences of the Parker Shows and got many a laugh over some of the incidents she related.

Before the party broke up it was voted to send one of the baskets of flowers to Mrs. Clara Zeiger, who was ill and not able to attend, and the other basket to Louise Jane Campbell, also sick. As "goodnights" began to be exchanged Mrs. Parker had Gertrude Parker distribute to all the ladies a handsome red heart, made of wood and manufactured in the C. W. Parker factory in Leavenworth, with the inscription on the face, "Presented by Mrs. Parker to the L. A. S. C.," and accompanied by the following for which there had not been time enough to have inscribed on the heart: "A heart of wood I give to you, five years of memories it bears for you."

The following ladies were present, all of whom voted the evening "perfect" and their luncheon the premier entertainment of the winter season: Mrs. P. W. Deem, Mrs. J. W. Brizendine, Mrs. L. W. Lindell, Mrs. Helen Brainerd Smith, Mrs. A. T. Brainerd, Mrs. C. W. Parker, Mrs. Charles McMahon, Marie McLaughlin, Mrs. H. H. Duncan, Alice Grubs, Mrs. Noble C. Fairly, Hattie Howk, Mrs. George Engesser, Mrs. G. C. Loomis, Mrs. J. H. Johnson, Mrs. P. E. Pocock, Mrs. J. M. Sullivan, Mrs. Sam Wallas, Mrs. Ellis White, Gertrude Parker and Irene Shelley.

CIRCUS ADVERTISING

J. W. Nedrow, manager of the Nedrow Poster Advertising Company, Massillon, O., writing to Charles Bernard of Savannah, Ga., says: "I follow your articles in The Billboard and find them interesting, especially the one a few weeks ago on billing the circus. The first show that is game enough to discard most of all the old billing ideas and take up new schemes all the way thru will not only save money but make money. H. M. Harvey tried it out a few years ago. With more than 13,000 towns having poster panels now, one or two 24-boards would, by using the local plant owner's boards, better bill the average town of from 100 to 1,000 than the 500 to 1,000 sheets they now use on daubs. A first-class mailing system and mail matter properly handled, more newspaper advertisements, less pictorial printing and dates properly placed would get the shows more business in the end. The more improved highways the less daubs. The first daub west of here on the Lincoln Highway is at East Union, 20 miles out. There are only two daubs between here and Wooster and none between here and Canton. Two good press agents, a mailing bureau and 10 good all-round billers can bill a show like it should be billed. The day is not far distant when they will be billed with less paper than they are now using."

Nedrow was manager of a Hagenbeck-Wallace advertising car under Mr. Harvey eight to 10 years ago, states Mr. Bernard. His comment on circus advertising is sound logic and with the rapid transformation of public highways into clean, civic beauty exemplifies the "daubs" on buildings, fences and all kinds of private property are doomed to

Johnny J. Jones Exposition Shows WANT

To join April 20, Family Circus Acts suitable for week-stand shows, giving several a day. Dobbins Family of Acrobats, write. Good Clown Number that can entertain while people are getting seated, or anything suitable for biggest trained wild animal circus ever traveling with carnival, such as high school horses, pony or other domestic animals. Girls for high-class Novelty Acts. Other useful Carnival People address WINTER QUARTERS, City Beautiful, Orlando, Florida, but not in care of show now en route.

NEUMANN TENT & AWNING CO. 16 N. May St., near Madison St., CHICAGO. Phone Haymarket 2715. CIRCUS and TENTS and BANNERS

WE HAVE THE BEST ARTISTS PAINTING OUR BANNERS, TENTS AND CIRCUS STATS FOR RENT, SECOND-HAND TENTS, SEATS AND BANNERS. WE MAKE HORSE AND TRAILING MATS, TRAPPEZ NETS, CONCESSION TENTS, PLESH OR CANVAS SHIELD COVERS. AGENTS TANGLEY CALLOPES, WURLITZER BAND ORGANS, MIYESSNER BABY UPRIGHT PIANOS. WATERPROOFING IN 1 AND 5-GALLON CANS, OR 50-GAL. BBLs.

discard, adds Bernard, who expects to live to see new ideas for circus advertising come into general use.

Col. W. W. Downing Injured

Veteran Showman in Need of Assistance

"In a humble room of the Corona Hotel at Buffalo, N. Y., lies Col. W. W. Downing, that old veteran and gladiator, who in his time has given away a fortune to help others—to allay suffering and want. He is alone there—without funds. My 'widow's mite' has gone on to him. Friends, follow suit! Send him money and good cheer. The dear old fellow slipped on an icy pavement and was seriously injured. Let's live the Golden Rule for him." So writes Doc Waddell, well-known press agent, who gives his paramount business as "Scattering Sunshine".

Stewart Amusement Co.

Bethlehem, Pa., Feb. 20.—The Stewart Amusement Company will again take to the road this season as a three-car show. Al Breen, show carpenter, is now working in winter quarters on a new 10-in-1 show and two new banner lines. He also has two men painting the merry-go-round and the trucks, and says he will have everything ready for the opening date April 18 in Bethlehem. It is Mr. Wachter's plan to play two different locations in this city. The show will play some of the old territory that it played last year. JOE WENDELL (for the Show).

Loos Shows Get Southwest Texas Fair Circuit

Ft. Worth, Tex., Feb. 21.—The J. George Loos Shows have secured 20 fair dates and celebrations, including the Southwest Texas Fair Circuit, comprising Flatonia, San Marcos, New Braunfels, Seguin, Lockhart, Austin, Kennedy, Beeville and Floresville, besides Cherrystone

(Kan.) Reunion, Marshall (Mo.) Fair, Lamar (Mo.) Free Fair, Missouri State Fair, Columbus (Kan.) Reunion, and the Southwestern Exposition and Fat Stock Show at Fort Worth, starting March 7, the opening stand. This is the 10th year for the show to play the Southwest Texas fairs and the Fat Stock Show at Fort Worth, each time so far to increased business.

Coleman Bros.' Shows

Middletown, Conn., Feb. 19.—The opening date for Coleman Bros.' Shows will be April 30, in this city, for nine days. Michael Cahal has been engaged for the free exhibitions, with high trapeze and cloud swing. The lineup of attractions will include a merry-go-round, Ferris wheel, aerial swings and merry mixup, and five shows. Joe Gengler has new acts for his circus attraction this year, among the features being "Teddy", his wrestling and boxing bear. FRANK A. GRIPPO (for the Show).

Latlip's Expo. of Rides

Charleston, W. Va., Feb. 19.—Capt. Latlip's Exposition of Rides will open its season at Dunbar, W. Va., the week of April 15. Joe Galler, of Corco, W. Va., has purchased a half interest in the organization, he having sold out his picture show at that place. Mr. Galler will handle the back of the show and Mr. Latlip will take charge of the advance and booking of his free acts at special events. Work is moving right along at the winter quarters on the Big Four fairgrounds, and Fred Latlip, who has taken charge of activities there, states that he is sure of everything being in readiness at least two weeks before the opening date. Messrs. Latlip and Galler have made frequent trips, looking over the territory in this section of the country and report that they have a very promising route picked out. The captain was busy of late, assisting Harry La-Pearl stage a big indoor Circus here.

HEADQUARTERS ABBA TEMPLE SHRINE CIRCUS 9 BIG NIGHTS DEC 4-13 LOCATION CONYER NEW STS. 9th and CARL FREE



VOTE FOR MISS MOBILE
BOOST THE BABY SHOW
SHRINE CIRCUS

Noble A. E. Weary, manager of Abba Temple Shrine, Madisonville, Ky., and ad. exec. director with the Bob Martin Circus Company, The picture shows the type of headquarters and publicity this promoter gets across under fraternal auspices.

under auspices of the Police Pension Fund, which affair proved a gratifying success. Lady Marion (Mrs. Capt. Latlip), Baby Ruth and Virginia Latlip will take part in the show, but will not take part in any of the performances until next season. The lineup is being enlarged and will include a merry mix-up and two kiddie rides. ROY REX (for the Show).

DOLLS CLOCKS ALUMINUM INDIAN BLANKETS etc. We carry a complete line of Merchandise for Carnivals and Bazaars. Deposit required with all C. O. D. orders. ORIENTAL NOVELTY CO., 28 W. Third St., Cincinnati, Ohio.

DUTCH SHOES Our Dutch Shoes are exact miniature reproductions of the Old Holland wooden shoes, their size being 1 1/2 inches. Sold in tremendously large quantities last year as souvenirs, favors, and were also used widely by many firms who hand-painted or decorated them. The name of your town or bank can be burned on free of charge if desired. We will send you a sample dozen for \$2.25, postpaid, or a dozen for \$12.00, postpaid. Send for a sample dozen of these original Dutch Wooden Shoes and you will be sure to come back for more. One firm sold over 100 gross last year. Our General Catalogue, listing over a 1000 and different numbers, will be sent you upon request. Ask for it today. BRADFORD & CO., INC., St. Joseph, Michigan



High-Class Dolls, Doll Lamps and Parlor Lamps AT THE RIGHT PRICES C. F. ECKHART & CO. PORT WASHINGTON, WIS.

WANTED GOLLMAR BROS. CIRCUS Performers and Concert People doing two or more acts. Knight Family, Grant Family write. Clowns, Will and Domestic Animal Trainers. Henry Coffey Newman, write. Hawaiian Singers, Dancers, Whirling Danish Dancers and Gun Spinners to double Tom Tom and Flare let, and any other good big or side-show people. Good wardrobe essential. Ticket Sellers and Candy Butchers. John Mullens, write. Picture and Hamburg pretzels for sale. FOR ADVANCE BILL POSTERS and Lithographers, all-round men. Billposter's address HENRY W. LINK, General Agent. All others, C. J. DONOHAN, Box 1958, Mobile, Ala.

ORIENTAL RUGS AND Genuine French Tapestries A quick money maker for Concessionaires and Specialty Salesmen. Prices, \$9.00 a Dozen and up. Order a sample Tapestry, \$1.00, and a Silk Rug, \$3.00. Money positively refunded if not satisfactory. 25% with order. Balance C. O. D. FRANCO-AMERICAN RUG & TAPESTRY CO., 32 Union Square, New York, N. Y.

LADIES' SILK HOSE (Sub-Standards) PREPAID \$1.75 PER DOZ. Any size. Assorted colors. No samples. No C. O. Ds. FULL CASH WITH ALL ORDERS. LONG-LIFE HOSIERY CO., 325 South Main Street, Los Angeles, Calif.

WANTED BALL GAME AGENTS I want two or three experienced Agents for Ball Throwing Games. GED W. LA MANCA, Gainesville, Fla., this week.

WANT TO BOOK Cook House and Juice with some good, reliable show WANT Cook House Help, Horse fighters, save stamps 8 B. DOWDY, Sanford, N. C.

WANTED TO BOOK real Cook House with good Carnival of not less than ten cars. Address WGN 267, Coalinga, Oklahoma.

COLLINS ENTRAPPED

AND A TRIP THRU THE WONDER CAVES OF KENTUCKY

Greatest Walk-Thru Show of the Age
NOW READY

Opened last night in storeroom. Newark, Ohio, to \$67 house: whole city will see it before week is over. See the cave. Collins himself after death, under the rock in the hole, the tunnel, soldiers, father and friends, workmen digging like mad to recover, funeral services, etc., and also greatest pictures ever taken of nearby cave formations. Whole nation waiting for this great exhibition. 6x10-ft. beautiful banner showing cave with man trapped under the 7-ton boulder, a banner that will bring them in and an exhibition that will set the town talking. Show complete. 25 viewing boxes, 25 pictures, banner, full directions, etc., all guaranteed ready to set up, for ONLY \$100.00. Wire or mail \$25 and exhibition will go out at once, remainder collect. Order now or write for information.

CHAS. T. BUELL & CO., Box 306, Newark, Ohio.

CUSHMAN Light Weight Engines



10 H. P. and 15 H. P.
Double Cylinder

Standard, Reliable Power for Amusement
Devices of All Kinds.

Cushman 1 1/2 H. P.

Easy-Starting — Smooth-
Running — Throttle Governed.

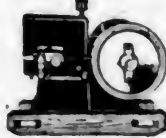

Service on the road and quick delivery of
repairs assured anywhere in America from our
factory or one of our branches.

Write us concerning your engine problems.

**OPERATORS—Send in your Cushman
Engines for overhauling or exchange.**

CUSHMAN MOTOR WORKS

815 N. 21st Street Lincoln, Neb.

Texas Fair Men Oppose Bill To Raise Tent Show Licenses

Southwest Association Adopts Resolution Favoring
Carnivals—Opponents of Measure
To Appear Before House
Committee

Fort Worth, Tex., Feb. 21.—A new bill is about to be brought up in the Legislature at Austin raising the license fees on outdoor shows and carnivals. At the Southwest Texas Fair meeting at Kenedy, Tex., the following resolution was adopted against same: "We, the Southwest Texas Fair Association, oppose any advance or discriminatory license against carnivals, for the reason the latter are absolutely essential for the success of our fairs, besides being a popular form of amusement, as indicated by the attendance, and afford the persons of moderate means an opportunity to give amusement for their entire families. We oppose House Bill No. 447."

Secretaries of various fairs in the State also wired their respective members of the Legislature accordingly.

A. B. Rogers, president, and George P. Kempen, secretary of the fair circuit, and Walter F. Stanley, representing the J. George Loos Shows, immediately went to Austin to appear before the House Committee in an effort to oppose the bill and present the fair and carnival side of the matter. More than 75 members were present at Kenedy in behalf of their circuit.

Among the carnival men at Kenedy were George F. Dorman and W. K. Havis, of the Rice & Dorman Shows; J. A. Schneck, of the Poole & Schneck Shows; Raymond Spencer, of the C. A. Vernon Shows; and Roy Gray, of the Gray Shows; also Fred Kressman and Charles Watmif, representing the World Amusement Service Association and the Western Vaudeville Managers' Association, respectively. James Anderson, of the State Fair of Texas, at Dallas, also was in attendance and gave valuable talks.

Clarence A. Wortham's World's Best Shows

Finishing touches to Clarence A. Wortham's World's Best Shows, at their winter quarters at St. Louis, are being added as the staff members and attaches for the coming season start to drift in.

Benny Sturges, trainmaster, has arrived and he and his crew will have the train in shipshape. Earl Strout, band master, and wife (Alice Melville) are expected in St. Louis soon to complete what they promise will be one of the best equipped musical comedy shows ever with an open-air institution. It will be a real show in that 22 young women gathered from the musical comedy field will make up the company. Mrs. Strout was highly successful with her show last year. Jack Kenyon and wife, who had the cookhouse last season, soon will end their tour to and thru California and return for the coming season. Sam Feinberg, one of the oldest attaches of the shows (in point of continuous service), also is expected back. He is now in Rochester, N. Y. Bennie Pugh, concessionaire, will join soon for his first season with the show. John L. Karnes, widely known as "Judge", returns to the show from California as executive secretary. Tony Ybanez, an old hand around the show, will put in another year as treasurer.

Harry Sanger, general agent, spent two weeks in St. Louis just before the convention of secretaries of fairs at Chicago. Then he went to the convention, where he met Messrs. Beckmann and Gerety, owners and operators of this organization. The show will open its season on a larger scale than ever before, as special attention has been paid to building equipment as compact as possible. BEVERLY WHITE (Press Representative).

West's Shows Get Gastonia (N. C.) Fair

A telegraphic communication from R. A. Josselyn, general representative of West's World's Wonder Shows, states that the midway contract for this year's Gastonia (N. C.) Fair had been awarded to that organization; also that this date completed the fair bookings contemplated by the show for next fall, bringing the total to 12 attractive engagements.

WE BUY, SELL, RENT, LEASE COIN OPERATED MACHINES OF ALL KINDS

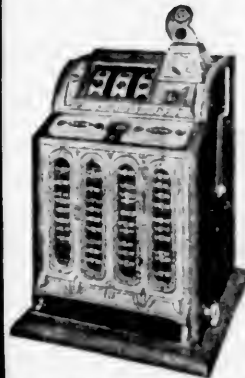

PRICES

New O. K. Front Mint Vendor, 5c.....	\$120.00
New O. K. Mint Vendor, 5c.....	110.00
New O. K. Mint Vendor, 10c.....	125.00
New O. K. Mint Vendor, 25c.....	130.00
New O. K. Mint Vendor, 50c.....	140.00

**OPERATORS BELL,
\$10.00 Less on Each of Above Machines.**

REBUILT MACHINES.

O. K. Mint Vendor, 5c.....	\$70.00
O. K. Mint Vendor, 25c.....	90.00

REBUILT OPERATORS BELL.

5c Machine.....	\$60.00
25c Machine.....	75.00

SECOND-HAND.

Dewey, 6-Way.....	\$75.00
20th Century, 6-Way.....	75.00
Owl, 5-Way.....	45.00

O. D. Jennings' Machines at Same Prices as Above.

WE REPAIR AND REFINISH ALL MAKES OF COIN OPERATED MACHINES.

MINTS.

1,000.....	\$14.00
2,000.....	\$25.00

ATKINSON NOVELTY CO., 4440 Cottage Grove Ave., CHICAGO, ILL.

ATTENTION! HIGH-CLASS SIDE SHOW ATTRACTIONS

Want the best obtainable, those who can command the very highest salaries. No salary too large. Want especially Midgets, Far People, Giants, Skeleton Dudes and other top-notch People. Please note again, salary is no object for the proper attractions. The best of accommodations and long engagement offered. Address by letter and enclose photos.

T. A. WOLFE SHOWS, Atlanta, Georgia.

EIGHTH SEASON GERARD'S GREATER SHOWS EIGHTH SEASON

The show that leads all others to the opening stand. Opens early in April for a long season of real celebrations, and choice fairs. Cookhouse and Juice open. Palmistry and All Stock Wheels open. All Grind Stores open. Want one more Show to Feature. Will furnish outfit to reliable showmen. Have opening for Kiddie Rides. Want experienced Carnival Electrician. One more Free Act. Everybody address

CHARLES GERARD, Manager,

Room 414, Putnam Bldg., 1493 Broadway, N. Y. City.

Buckskin Ben's Famous Wild West Shows

BOOKED SEASON 1925 WITH DODSON'S WORLD'S FAIR SHOWS

- Can use a small Dog and Pony Act.
 - Can place Cowboys and Cowgirls if you can trick ride and trick rope.
 - Can place good Rope Spinner and Whip Act. State lowest and all in first letter.
- We pay all after joining. Address all mail

BUCKSKIN BEN

Cambridge City, Ind., until March 15; then Port Arthur, Texas.

MONKEY ACTORS FOR SALE

NINE TRAINED RHESUS MONKS FOR SALE. Knife and Fork, Globe Walker, High Dive, Somersault, Tight Wire, Bicycle (partly broken), Two Mothers with Babies, One Mother, to have baby in March. Wonderful breeders. Smart, young, sound, healthy, acclimated Monks. No rough or disease. Guaranteed. I have had these Monks for five years, playing Big Time Fairs. Anyone looking for a one-in-a-lifetime buy for cash, come and see this act or write. Plans for Loop-the-Loop and my Frame-up goes with the above.

CLIFF WILSON, Rubin & Cherry Shows, Montgomery, Alabama.

ALL ABOARD WESTERN CANADA AND 14 BIG STATE FAIRS

WANTED—FUN HOUSE HELP.
FOR JAZZER—Capable, sober Man who understands engines and can show speed on front.
FOR GLASS HOUSE—Capable, sober, grinding Ticker—Her who will work.
FOR CROSS WORD PUZZLE SHOW—Manager single. Your own terms if you can show speed.
Playing 10 Biggest Fairs, starting in June.
WILL BUY A ROLL-A-RAUER FOR CASH.

Central States Shows WANT

Metry-Go-Round, Shows and Concessions, to join at once. No grift. Florence Fun Fest and Water Carnival, Fort Pierce, Fla., Feb. 23 to 28; Red Men's Bow Wow and Industrial Fair, Miami, Fla., March 3 to 11. Key West to follow. Write or wire. J. T. PINFOLD.

FOR SALE

MOTOR TRUCK BODY AND TRAILER.
Large enclosed Auto Truck Body in A-1 condition. Size, 21 ft. long, 7 ft. 5 in. wide, 8 ft. 2 in. high. Inside measurements. Detroit reversible 8-ton Trailer equipped with an enclosed body. Size, 18 ft. long, 7 ft. 5 in. wide, 8 ft. 2 in. high. Must be sold at once. Will sell together or separately. CITIZENS' MOTOR CAR CO., 3048 Colerain Ave., Cincinnati, Ohio.

Highest Offer Buys

48 State Flasher, complete, carefully crated and guaranteed. **THE EARL F. REBMAN CANDY COMPANY, 113 W. Kline St., Lancaster, Pa.**

GENUINE GERMAN 5,000,000 MARKS
61st Bond, 25c; \$2.50 per 12; \$17.50 per 100.
DAVID WEISS, Box 3049, Memphis, Tennessee.

Ringling Brothers Not Changing Winter Quarters

"There is no truth whatever in report of changing winter quarters from Bridgeport."

The above statement was contained in a telegram from Mr. Charles Ringling to *The Billboard* late Monday afternoon, in answer to a message which we sent him, stating that Eastern daily newspapers on Monday published a story to the effect that the Ringling Brothers had purchased the extensive Hanover Farms tract, situated in Burlington County, N. J., between Browns Mills and Whiting, for winter quarters. The dailies further stated that this was the former property of the Lpton Estate of Boston, and was sold to the Hanover Farms Company a few weeks ago; also that the farms are on the Trenton division of the Pennsylvania Railroad, about 35 miles from Camden, N. J.

S. W. Brundage Shows

From present indications the S. W. Brundage Shows will leave their winter quarters at Peoria, Ill., this spring as well prepared and as solidly organized as ever in the past. There is much activity at the winter quarters at the fair grounds and the people engaged are beginning to come in and get themselves and their attractions toned up for the 25th annual opening of the show.

Assistant Manager Denny E. Howard has been on the job all winter, his activity and energy being responsible for much that will continue to improve this already well-established carnival organization. Considerable work is under way, new equipment, rebuilding, painting, etc., with Homer Heffrich in charge as chief mechanic. John Aughee promises some innovative novelties in the Circus Side Show. Arch Johnstone will again have the Society Circus, but with added features this year. The Band Box Revue, under management of Harry K. Fields, will be the biggest show of its kind offered with the Brundage troupe. Some new stage paraphernalia is being built for it, also a flashy wagon front. For the Water Show, a new set of double-decked banners will make up part of the equipment. Jolly Emma and her Congress of Fat Folks will provide a novelty. Ada J. Meyers will have one of the best Minstrel Shows in the carnival field.

Cross-Word Puzzle will be one of the mechanical attractions. There will be two other mechanical shows, yet to be named. Bert Brundage is here, and with a crew is getting his rides in shipshape. Chas. Cohen, Ferris wheel operator, has given his ride close inspection. The caterpillar will have a few mechanical changes. Elsworth McAtee will have the three-abreast carry-all and his new organ in good shape. C. S. Brooks will again have the hand. Jack London, who will be trainmaster, is at present in the yards of the M. K. & T., at Denison, Tex. Roy Hewett will be chief electrician. The decorating will be in charge of Bob McAtee, while H. O. Harris will be in the office to care for finance and books, taking part of the work off of Denny Howard, who has been appointed assistant manager. Bob and Lila Taylor will not be "with it" this season, they preferring to stay on their Texas ranch.

FRANK P. DARR (for the Show).

Imperial Exposition Shows

Barberton, O., Feb. 20.—The Imperial Exposition Shows have things progressing at their winter quarters here. Mr. Engring advises that he will repaint his merry-go-round and have it in readiness for the opening before he ships it to quarters. Just received a communication from Driver Bros. that the firm had just completed the new front for the Athletic Show, of which J. L. King will have complete charge. He has two wrestlers and himself. This show will be completely overhauled. The top is at the Wagner Tent & Awning Mfg. Co., Cleveland, being repaired, and there will be a complete new ring (portable), an idea of Manager Doc Ralston.

The merry mixup that was booked with the show was destroyed when the barn that it was stored in, close to Sharon, Pa., burned to the ground, but if things work out as the management feels that they will, the show will open with three rides. The shows contracted are: J. S. Cochran, with his circus side show, with all attractions on elevated stages. He will have the assistance of Lester Martin with magic and Punch and Judy. LaMar and LaMar, with their Luba show, which has quite a reputation as a pit show throughout this part of the country. The Down in Dixie Minstrels will be one of the feature attractions, and one of the best 10-people shows traveling this section. With the musical comedy, this will give the total of 5 shows and 3 rides, and with 25 concessions the show will present quite an attractive appearance at the opening. The concessions contracted to date are: Eugene McGruder's cook house, Strabely & Strabely, corn game; C. E. Beabout, pitch-till-you-win; B. E. Ralston, *Ad-a-Ball* game; Mrs. L. M. Ralston, devil's bowling alley. Ira Wallace will pilot the show over the route, which will be Eastern and Southeastern Ohio, Western West Virginia and a few spots in Western Pennsylvania. As Mr. Wallace has had quite a number of years' experience in this line and is well acquainted with this territory, the manage-

Ladies' Wrist Watches

No. B-3002 Small, 10 1/2" LIGNE, 10 1/2" SIX, JEWEL

No. B-3022 Same as above, in Tonneau Shape only with Jewel Movement. Each only \$2.85

KURZON-SAIKIN CO.,
Headquarters for Watches, Jewelry and Premium Specialties.
333-5 WEST MADISON STREET, CHICAGO, ILLINOIS

ment looks forward to a very prosperous season. All of which is according to an executive of the above shows.

C. A. Vernon Shows

Houston, Tex., Feb. 19.—Three more weeks and the flag will be run up on the C. A. Vernon Shows for the start of the 1925 season. General Agent Spencer will take the show thru Texas, Oklahoma and Kansas, with a lineup of Nebraska Gals for the fall. The show opens in Houston under auspices, with a lineup of eight shows, four riding devices and about 30 concessions. The working staff has been engaged the past five weeks getting the show ready, and it will leave the barn in fine shape. Mr. Vernon has surrounded himself with an able office staff, which includes Bob Howell and W. J. Wood as second men and promoters.

Recent visitors noted were: Jim Campbell, who will be with the show; Roland Smith, concessionaire; Chas. Watnuff; Guy Dodson, of Dodson's World's Fair shows, who was in the city buying wheels for his show wagons; Roy Gray, of the Gray Shows; Harry Poole, of the Poole & Schneck Shows, playing Goose Creek; Mr. and Mrs. Baker, well-known concessionaires, and Mr. Jackson, of the Jackson & Black Shows, which are wintering here.

The weather is like spring, the grass being green and peach trees in bloom, and every day sees a party of folks headed for Galveston for fishing and other sports offered in the Gulf City.

CHAS. TONNINGS
(Press Representative).

Miller Bros.' Shows

Savannah, Ga., Feb. 19.—The winter quarters' routine is at its height with Miller Bros.' Shows at the Tri-State Fairgrounds. Art Gardner, superintendent of winter quarters, is producing to the degree of perfection desired. "Slim" Sourby, scenic artist, has completed the "effects" on four of the carved-wagon fronts. General Manager Morris Miller is expected to arrive from Cuba this week. Cablegram communications from Havana report good business with Miller Bros.' Shows contingent there. Clay M. Greene, director of the advance, is now in New England, contracting with fair secretaries.

Visitors to winter quarters recently included: Henry J. Polle, of the Zeidman & Polle Shows; W. C. Fleming, of the Johnny J. Jones' Exposition; Felix Blei, in advance of "Dante", the magician; Mr. and Mrs. Bernie Smucker, of Meridian, Miss.; Col. V. O. Bliss and Andrew Aprea, of the Savannah Board of Trade, who interviewed department heads of the show—Mr. Aprea is the energetic director of Savannah's live-wire organization, and also is connected with several associations which are prominent in the social and business life of Savannah.

NORMAN D. BROWN (Sec'y and Treas.).

Park Men Getting Ready To Make This a Big Year

An amusement park can't run while ice and snow cover the ground, but winter time is an ideal time for planning, and just now park men from Montreal to the Gulf are busy with plans which they hope will insure them a successful 1925 season.

Letters coming to the desk of the park editor from park managers, ride manufacturers and others interested in outdoor amusements indicate almost unprecedented activity as regards amusement parks. New projects are being launched, some of them on exceedingly large scale; improvements are either under way or being planned at many of the older resorts that will amount almost to a rebuilding of the parks in question, and there is scarcely a park of any consequence that is not installing one or more new rides or other features.

Model Shows

The Model Shows had a very bad break with the weather at Ashburn, Ga., week ending February 14. Business that Monday night was good, but a "norther" came Tuesday and the balance of the week was cold, warming up a bit for Saturday. The show will stay in South Georgia a few more weeks, then go to Newnan, to be absorbed into Scott's Greater Shows, wintering there, for the coming season.

C. D. Scott visited the show at Ashburn and informed the writer that preparatory work on the paraphernalia at New-

nan is progressing nicely, with a crew of carpenters and painters hard at work daily. Among new faces with Scott's Shows will be Bert Briggs, who will have the Dog and Pony Show, and who is breaking in new acts at winter quarters. Mr. and Mrs. M. L. Dell also are at Newnan looking after their interests. Robert Sickels, general agent, has been attending fair men's meetings, including those held at Nashville, Tenn., and Macon, Ga., and reports success with his bookings.

Sam Hawkins, Mrs. W. A. (Curly) Poss, Harry Garrett, J. A. Bailey and George S. Palmer joined the Model Show at Ashburn. Harry Harris and wife left the show recently and the writer is now handling the Minstrel Show. Manager F. H. Bee, Jr., has of late been doing the advance work and George R. Schaw is doing second-agent work. "Slim" Smith is still loading the cars and selling candy in the Plant Show. The lineup includes 4 shows, 1 ride and 12 concessions. Music is furnished by Cy Elliott's Band of 10 pieces.

R. L. DAVIS (for the Shows).

Augusta "Pickups"

By WM. C. MURRAY

Augusta, Ga., Feb. 19.—Everything is shaping up nicely for the Eagles' Festival here, February 28-March 7, and report is that the advance ticket sale is very promising.

A. E. (Andy) Logsdon was a visitor for a few days among showfolk friends here. The writer understands that "Andy" has signed with one of the large carnival companies as contracting agent for the coming season.

Elmore Yates also was in town a few days and left on a trip north. He will be on the advance staff of the Zeidman & Polle Shows.

Dick Dykman, owner and manager of the show bearing his name, wintering in this city, has been here a few days looking after progress of work in quarters and attending to other business interests in Augusta.

Johnny Wallace is active around his winter quarters, and his circus side show, which will be at the Eagles' Festival, will have several new features.

Central States Shows

The Central States Shows have been playing all winter so far in Eastern Florida and getting along very satisfactorily. Fort Pierce is the stand for week ending February 22. The writer has been with the company the past ten weeks, with the Minstrel Show handling the front, with "Rucker" and "Old Folks" and a coterie of other entertainers putting on performances. In a recent issue of *The Billboard* names of concessionaires were given. Following are the shows and rides, in addition to the plant show: "Pop" Erby (the "German Oak") has the Athletic Show, with Murphy, boxer, and Tex Trueman, wrestler. Ralph and Almee Pearson have their Show Beautiful and Prof. Alexander his Flea Circus, and Roy, the Ossified Boy, is a very interesting attraction. Mr. Woods has the Eli Wheel and M. Clark the merry mixup.

CIRLY NORMAN (for the Show).

December Shows

Employment Gain

(Continued from page 5)

tember and October was genuine despite a slight setback shown in November.

Showmen all over the country are intensely interested in the state of employment since the patronage of theaters and amusements of all sorts is greatly dependent upon conditions in the industrial world.

The amusement business learns with interest that December of last year has been equaled in its bright increase only three times since 1911, when the Department of Labor began its surveys.

The total earnings for December, based on reports from 8,170 establishments in 52 industries, and covering more than 2,000,000 employees, were \$68,299,677. The same establishments in November reported total pay rolls of \$65,175,417.

I. A. Adopts New

Road Show Ruling

(Continued from page 5)

while playing a single engagement. He refused to accede to the demand.

A compromise was effected by Mr. Gantvoort agreeing to play two special matinees at Daly's Theater this week, thereby establishing a consecutive engagement in New York without the con-

templated week's layoff. Hence *Hell's Bells* will be presented Tuesday and Thursday afternoons at Daly's during the regular tenancy of that house by *White Cargo*.

Mr. Gantvoort is highly indignant at what he terms an unfair ruling on the part of the stage-hardys' union, in that a producer is forced to engage a full road crew every time he moves from one New York theater to another without playing consecutively.

The Earl Carroll office faced the same situation last week when a suitable theater was not available for *White Cargo*. It was planned to move the play from Daly's to a downtown theater after a layoff of one week, but because of the union's ruling this was abandoned and the play will move into the Comedy Theater Monday without losing a performance. Meanwhile the Theater Guild's production of *Professional* plays the Comedy Theater this week only.

Will Hays Returns East

Los Angeles, Feb. 23.—Declaring that the outlook for the motion picture industry is better than ever, Will H. Hays, president of the Motion Picture Producers and Distributors of America, left for New York yesterday after two weeks of meetings with heads of producing and distributing organizations.

Hays expressed special satisfaction with the progress made in the elimination of harmful and unworthy elements in the movies.

Chorus Girls Hurt in Crash

Four young women, members of *The Passing Show*, which closed an engagement at the Shubert Theater, Cincinnati, Saturday night, were cut and bruised when an automobile in which they were riding crashed into a tow line of a wrecking car on Reading Road, near Cincinnati, early Sunday morning.

Anna Cluin, of Atlanta, received injuries on her face which may disfigure her for life, according to the attending physician, who said that it required several stitches to sew up a deep tear in her cheek. Allice Diana, Brooklyn, another chorus girl, received bruises and cuts. The names of the other two young women could not be learned. The four left for Pittsburgh Sunday to join their show.

Two Weeks for Milwaukee?

Milwaukee, Wis., Feb. 22.—Two-week runs for the better productions next season at Milwaukee were predicted by Sherman Brown, manager of the Davidson Theater, upon his return from a visit to New York. Mr. Brown declared that the nemesis of business at the Davidson this year has been a dearth of suitable shows rather than difficulty in attracting patronage, and substantiated his claims by submitting record box-office figures for several feature productions presented during the past few weeks.

"There are sufficient excellent productions playing Broadway at this time to assure an abundance of good material on the road next fall," Mr. Brown declared. "With conditions in general showing every tendency toward improvement I feel confident that next season will be prosperous."

Sherman Brown is the dean of Wisconsin theatrical managers, having been lessee of the Davidson for the past 40 years, and his views on things theatrical bear considerable weight in local showdom.

Winn in Fairbanks' Film

Jack L. Winn has gone back into pictures, having completed his season ahead of *The Ten Commandments*. He is in Los Angeles, working for Douglas Fairbanks in the latter's new picture, *Don Q.* Winn, who expects to go to Spain in May, reports business in Los Angeles as all right for the good shows, and, as for the others—well, he says the people won't stand for being "gypped" any more.

Improve Milwaukee Theater

Milwaukee, Wis., Feb. 23.—Redecoration and improvement of the Palace-Orpheum Theater at a cost in excess of \$100,000 is nearing completion, without interruption to regular business. The work was begun several months ago with the erection of a large electric sign and will be completed when the mammoth new ventilation system is put into operation.

At present the theater front and lobby are resplendent in tasteful art work executed under the supervision of James A. Higley, manager of the house. Particular pride is taken by the management in the ladies' retiring room on the mezzanine floor, which is hung with richly colored draperies. The program of improvements also calls for the redecoration and remodeling of the dressing rooms, in which further conveniences for artistes playing the Orpheum are to be arranged.

The \$40,000 suburban show house, the Society Theater, Vancover, Wash., at 23d and Main streets, was opened recently. The building is of concrete and stucco construction and represents the latest in suburban theaters. It was built by William Peiers, former Minnesota showman.

BROWN & DYER SHOWS WANTS

WANT Freak Animal Show.
 WANT Complete 10-in-1 Show.
 WANT Water Show Complete.
 WANT Fat Girl Show.
 WANT Working World.

WANT Mirror Maze.
 WANT Penny Arcade.
 WANT Wild West Show. Have two Wagon Fronts, Canopy and Side Wall.
 WANT Party to Handle Rocky Road to Dublin, who has Donkeys and Cars.

PLANTATION PEOPLE who were with me last year, write, or any other show of merit. Bob Sherwood, write.

NEW ENGLAND FAIRS BOOKED Plattsburg, N. Y., Week Aug 31; Rutland, Vt., Week Sept. 7; Burlington, Vt., Week Sept. 15; Rochester, N. H., Week Sept. 22; Brockton, Mass., Week Sept. 28; Danbury, Conn., Week Oct. 5.

BROWN & DYER SHOWS, Poughkeepsie, N. Y., P. O. Box 888.

Play Jury Plan Accepted By N. Y. District Attorney

(Continued from page 5)

would first be received by himself or Police Commissioner Ehrlich. No complaints will be given serious attention if they are of a frivolous nature. There will be no person on the panel of 300 who is connected with the theater in an official or financial way, and no person who is connected in any way with any reform movements.

Upon receipt of a complaint deemed worthy of investigation the district attorney's office will immediately notify the police commissioner, who will have the names of the 300 citizens in a box in his office. Then a representative of the district attorney and a representative of the play complained against will together draw 12 names from the box. Each representative will have two peremptory challenges. If these challenges are exercised additional names will be drawn from the box to fill the vacancies. The 12 citizens named will then be notified and will forthwith review the play. They will report their findings on two points of view as follows:

First, whether any part of the play is objectionable from the standpoint of public morals. If so, the management of the show will be given one week to adjust it in accordance with the report of the jury. After the adjustment the jury will again review the play, and if, on the second viewing, the play is still objectionable, the show must be closed immediately.

Second, whether the whole play is objectionable from the standpoint of public morals. If, after a visit, the jury decides this is so, there will be no second visit. The play must be closed immediately.

The vote of the jury necessary to close a play is 9 to 3.

All players who are members of the Actors' Equity Association will be compelled under their contracts to retire from a play declared by the citizens' jury unfit to be allowed to continue.

No member of the jury will be asked to serve twice and no records will be kept so that no precedents can be established. Each case is to be tried on its own merits.

William A. Brady, who earlier in the week, after a conference with the district attorney, agreed to withdraw his play, *A Good Bad Woman*, reversed his decision yesterday when he learned that David Belasco, who also had a session with the district attorney, would rewrite his two shows, *The Haven* and *Ladies of the Evening*, and keep them on. Brady, however, finally fulfilled his promise and closed his play tonight, although the action probably was necessitated by the fact that upon his original announcement to close the play the Shuberts immediately arranged another booking for the Comedy Theater beginning Monday.

Kenneth Macgowan's conference with the district attorney over the Provincetown Players' production of the Eugene O'Neill play, *Desire Under the Elms*, did not have a very happy outcome. The district attorney insisted that no revision of the play could be made that would make it respectable enough to bring it within the provisions of the Penal Law, while Macgowan and his associates contended the play is a great work of art, teaches a moral lesson and does not offend decency.

Incidentally the theater-ticket speculators have been profiting by the crusade against dirty plays. For the last two or three nights the curb brokers have been asking as high as \$10, \$12 and \$15 for seats to the Brady show.

New York, Feb. 23.—*Desire Under the Elms* is to be the first production to be tried by the Citizens' Play Jury. The district attorney, who gave the drama until Wednesday to close or face prosecution, now states that the play may be allowed a chance before the new tribunal. This course is welcomed by the producers, who announced they would risk indictment rather than withdraw the play.

New York Fairs' Record Meeting

(Continued from page 5)
 to financial success. Along these lines Mr. Norgard spoke as follows:
 "The small local and county fairs in particular are advantageously placed for effective visiting and enjoyable entertain-

"HARLICH'S KICKLESS SALES BOARDS"

We use them with all our assortments because they are the best on the market.

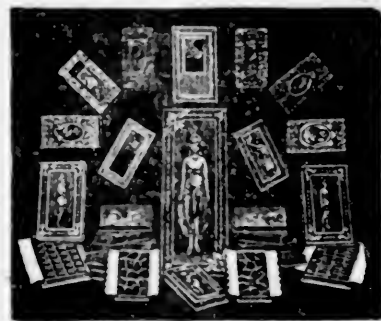

29 BOXES HEGONE'S WELL-KNOWN HIGH-GRADE CHOCOLATES and Cherries, including a \$5.00 box for last sale and a 600-hole Baby Midget Sales-board. **\$5.95**

WHEN SOLD BRINGS IN \$30.00.
 Complete, each in carton, No. BB 42 \$5.95
 12 Lots 5.90

39 Larger Box Assortment and an 800-Hole Baby Midget Salesboard. When sold brings in \$40.00.

No. BB 900—Sample \$8.25
 12 Lots, each 8.10

NET NO DISCOUNT **GOLD DIGGER BOARD** 4,000 Holes, 5c or 10c Sales Each, \$7.50, 10 lots \$6.00

NET NO DISCOUNT **SLOT MACHINE BOARD** \$7.20
 3,000 Holes brings in \$300 at 10c, or \$150 at 5c sale. State which you want. Sample, each \$9.00. In 10 Lots, each

25¢ WITH ORDER, BALANCE, C. O. D.

Assortments, as well as merchandise without boards at prices that defy competition, are listed in our just out No. 27-1925 Spring and Summer Catalogue. If you have no copy send for one.

HECHT, COHEN & CO., 201-203-205 W. Madison St., CHICAGO, ILL.

ment. Providing attractive, clean entertainment for a fair is of exceeding importance, but a most difficult matter.

Fundamental to Financial Success

"Real entertainment is absolutely necessary to a successful fair. Say what you may of the fine stock and educational features, it is the sensational aeroplane performer, the merry-go-round and the elephant that make advertising and bring the crowd. The fair run on modern lines and costs must have them or they fail immediately.

"True as this may be, we have also passed thru a period of 'bad shows' until we have arrived where the public demands 'clean entertainment'. The good, high-class people have been aroused so that the fair that fails to meet their standards and demands is now in danger of serious consequences.

"Local entertainment can be provided here and there for the smaller fairs, especially if paid the amount we pay for other attractions. The 'outdoor' acts now available are clean and unusually entertaining. Emphasis might wisely be placed on these rather than on the old-type shows."

The Banquet

Forty members of the State Association of Union Agricultural Societies joined forces with the county societies and their guests in the banquet and additional room was necessarily provided for the seating of the extra large number assembled to enjoy the splendid menu and program of entertainers furnished thru the courtesy of Wirth & Handl, John C. Jekel, Frank Melville, Louis E. Walters, James F. Victor, Will Robbins and the World Amusement Service Association. President William E. Pearson, chairman, introduced the speakers of the evening, among whom were Hon. Florence E. S. Knapp, Secretary of State; Hon. Seymour Lowman, Lieutenant Governor, and the Hon. Berne A. Parke, Commissioner of Farms and Markets; all in well-hosen words, depleted their individual flens of fatidom and were most cordially received. Those attending included Hon. Rhoda Fox Graves, Mrs. Sara E. Lamb, secretary to Mrs. Knapp; E. P. Cooke, Wilson Messer, J. Maxwell Knapp, Frank S. Hall, Florence Buel, Hon. Francis D. Gallatin, president of the Outdoor Show-

men's Association; W. H. Gocher, Clarence R. Sperry, Leslie C. Sperry, Frank M. Smith, T. L. Quair, B. G. Johnson, Ellis W. Bentley, Theodore L. Rogers, Ezra R. Dickinson, Frank T. Carroll, John W. Gates, Hon. H. A. Bartholomew, George A. Ferris, George L. Thompson, John G. Downs, Robert Seaman, Havelock C. Karer, George M. Hewlett, Henry Rigney, Oscar Kahler, M. B. Heller, Francis X. Disney, Gilbert T. Seelye, F. J. DeBischop, E. P. Boyson, W. M. Bates, R. C. France, Morgan C. Beard, Clyde E. Shults, A. W. Robinson, L. F. Wheatley, Hovey E. Copeland, Cassius Congdon, C. L. Lathrop, Dr. A. A. Lyker, J. J. Flanagan, P. A. Paquette, Charles P. Zeh, James R. Robinson, R. G. Robinson, W. P. Biggs, Samuel W. McCleary, Fred B. King, Elmer F. Botsford, Mrs. Elmer F. Botsford, Peter G. Ten Eyck, John D. White, Albert E. Brown, John A. Wert, George W. Harrison, William E. McDonough, R. H. Wheeler, A. H. Carlton, M. W. Sheehan, John H. Hayes, W. H. Cole, F. G. Jacobs, Herbert Bogardus, H. S. Olmsted, J. H. Pelton, John H. Hubbard, William H. Golding, Ward L. Snyder, William Snyder, E. J. Roberts, Hon. Fred B. Parker, Mrs. Fred B. Parker, C. F. Wood, Robert E. Bradley, Daniel Larkin, Kenneth H. Fake, Stareton Osterhout, A. C. Miller, W. P. Hawley, Samuel Kaufman, William A. Dardess, D. H. Whipple, E. E. Cole, A. Miner Wellman, H. C. Payton, John M. Farr, John W. Thompson, William W. Campbell, F. E. Pease, John H. Walton, David Miller, J. K. Williamson, Charles Lebrecht, Frank M. Butler, Charles H. Johnson, Charles Sheehan, Harold G. Dobson, Charles M. Watkins, H. L. Woodruff, Samuel J. Barnes, J. H. Underwood, I. Seymour Purdy, Mrs. Alexander Diver, John H. Quakenbush, T. R. VanHousen, Emma B. Glosser, John C. Pratt, Charles C. Poynter, David L. Lloyd, J. F. Williams, Dr. S. F. Bullis, Fred M. Nielson, Edgar Rowe, Edward W. Morey, C. M. Harding, Lewis H. Robinson, Louis M. Bull, Jr.; C. D. Townsend, David E. Wilber, Lewis F. Rose, W. G. Dodds, Frank W. Hobart, J. C. Newton, J. W. Watson, W. S. Green, S. C. Shaver, Horace P. Murphy, Francis H. Parker, T. J. Horri-gan, W. J. Kilmer, George S. Deine, Mortimer Y. Ferris, C. H. Naylor, Arthur R. Maytum, Mrs. C. H. Naylor, Lottie V. Rowe, Lee H. Starr, Alan C. Madden,

John Orfmann, George E. Martin, Charles P. Burhaus, R. J. Bolton, N. G. Westbrook, LeRoy P. Hollis, H. L. Wallace, Fred J. Hayes, Hon. Oscar W. Ehrhorn, Francis S. Elgar, E. P. Murdock, Frank J. Potter, William S. Doyle, Fred A. Davis, M. J. Pangburn, Joseph Snyder, Frank Stanton, E. G. Crannell, Earl Barkhuff, J. W. Cowen, E. Conning Davis, L. N. Vedder, W. Schenck Martin, Edgar Leonhardt, Seelye Hodge, J. F. Snow, G. C. Cannon, W. L. VanEpps, T. R. Staley, Charles H. Fisher, James B. Bunyan, William Bronner, Fred R. Uter, H. E. Keller, Frank L. Asher, F. Cokingham, Benson R. Frost, F. E. Chase, Clarence L. Fisher, M. M. Lyman, R. A. Catchpole, L. H. Ellsworth, William Kennedy, Ray M. Colby, William Phelps, Bert Lord, Harry A. Willard, P. A. Graves, B. A. Dodds, Henry D. Williams, Mrs. J. H. Quakenbush, Alexander Diver, George B. Sample, Mrs. George B. Sample, W. S. Klumey, G. E. Little, Mrs. G. R. Little, Henry M. Robie, Frank H. Stowell, Everett Cokendall, J. Willard Huff, Harry G. Horton, B. Roger Wales, James S. Truman, Mrs. Ray M. Colby, Ben L. Botsford.

Representatives of Shows and Attractions

A. T. Wright and Grover W. Campbell, of the Brown & Dyer Shows; Irving J. Polack, owner World at Home Shows; H. N. "Pop" Endy, of the Endy Shows; George W. Traver, of the Traver Chautauqua Corporation; Otis L. Smith and T. J. Singleton, of the Otis L. Smith Shows; Charles Gerard and Bob Crosby, of the Gerard Greater Shows; William Glick, manager Bernardi Greater Shows; George L. Dobyns, manager George L. Dobyns Shows; Mike Zeigler, manager of the Monarch Exposition Shows; Edward K. Johnson, general agent Narder Brothers' Shows; A. F. Crouse, manager, and Merrick R. Nutting agent, Crouse United Shows; Harry Heller, manager Heller Acme Shows; Clay M. Greene, general agent Miller Brothers' Shows; J. B. Kuhlman and Milton J. Lapp, owners of the Lapp Greater Shows; Larry Boyd and Max Linderman, of the Boyd & Linderman Shows; Jack W. King, manager of King Brothers' Wild West attractions; Dave Rose, manager of the Dreamland Exposition Shows; Henry Meyerhoff, of the Meyerhoff Amusements; Frank Wirth, George Hamid, Ernest Anderson, Barney Demarest, Helen McLaughlin and Henry L. Rapp, of the Wirth & Hamid offices; Felix Reich, Clarence D. Parker, Fred C. Murray and Mrs. Charles Van Norman, of the World Amusement Service Association; Louis E. Walters, Boston, Mass.; John C. Jekel, Frank Melville, New York attraction agents; John Grieves and J. E. Stowell, of the Shenectady Fireworks Co.; George B. Jackson, representing the Pain Fireworks Co.; James F. Victor, manager of Victor's Bands; Chester A. Clock, of Victor's Famous Concert Band; Alfredo A. Swartz, tight rope aerialist; Arthur C. Holden, of Palsades Amusement Park, well known high diver.

Entertainers included Mae Drisko, Gertrude Van Diense, Charles E. Colley, Lillian Semmett, Hattie Dolman and the inimitable Will Robbins, now associated with the New York offices of Frank Melville.

Andrew Donaldson and William Bretwitz were present, representing the show and fair department of the Donaldson Litho Co., of Newport, Ky.

It was declared that the meeting was the largest attended of any ever held by the association. **FRED G. WALKER.**

GENTS' ART PHOTO RINGS

Sell Big—Quick Turnover—Big Money
 RINGS: Latest assorted Art Photos, attractive finish, engraved shank, set with attractive Brilliant. Samples, 25c Each. Stock limited.
Per Doz., \$2.50 25% Cash, Bal. Per Gr., \$25.00
 ADVERTISING PREMIUM CO.
 159 North State St., Chicago, Ill.

SALESMEN!

FOR MAGAZINE CAMPAIGN Best paying proposition ever made. Exceptional premium. Opportunity for permanent connection.
FRED COX, Inc., Erie, Pa.

DEATHS IN THE PROFESSION

BARRETT—Francis, music critic of *The Morning Post* of London, Eng., for the past 34 years, died in London recently. The deceased was educated at Dulwich College and Durham University, and studied music under Manuel Garcia, Carrodus, Edward Howell and his father, Dr. W. A. Barrett, who preceded his son as critic on *The Post*, holding this office for 25 years.

BERGER—Dot, 24, wife of Willie Berger, booker for the W. V. M. A., died at the Michael Reese Hospital, Chicago, Ill., February 14, one week after giving birth to a seven-pound baby girl. The deceased formerly appeared in vaudeville with her sister under the name of the Berger Sisters. Her husband and daughter survive.

BOOM—Maurice, 72, one of the pioneers of the vaudeville and outdoor booking agencies, died of pneumonia February 17 at his home in New York City. The deceased was a loyal member of his fraternity. He devoted 50 years of his life to the outdoor show business and at the time of his death was employed by the World Amusement Service Association in its New York City office. Funeral services were conducted from Cook's Funeral Parlors, New York, February 19.

BOSSI—Marco Enrico, noted composer and organist, who wrote the nuptial music and presided at the organ at the marriage of the King and Queen of Italy in 1896, died at sea February 20 after a brief illness. Signor Bossi joined the pianoforte class at the Musical Lyceum, Bologna, as a boy of 10. Eleven years later he had become organist and choir-master at Como and a short time later was appointed instructor in organ harmony at the Royal Conservatory, Naples, Italy, and at the Marcellio Lyceum at Venice. From 1916 to 1923 he directed the affairs of the Academy of Santa Cecilia at Rome. Signor Bossi won considerable fame as a composer, his best known numbers being *Glavanna d'Arco*, the *Canticum Cantatorium* and *Paradiso Perduto*. He was quite a figure at the Italian Court and recently played his *Canticum Cantatorium* before Premier Mussolini.

BRACKEN—Clio Hinton, 56, sculptor and widow of William Barrie Bracken, died of pneumonia at her studio in New York City February 12. The deceased was born in Rhinebeck, N. Y., the daughter of Howard Hinton, editor of *The Home Journal*, and was the first wife of James Gibbons Huneker, author and music critic, whom she married in 1892 and divorced in 1893. She is survived by three children.

BULLOCK—Mrs. William, 67, mother of Mrs. D. F. Coffey, known professionally as Myrtille Vetteson, passed away at her home in Valparaiso, Ind., January 31.

CLARK—Mrs. Queen, wife of Charles Clark, who was the owner and manager of the Clark Company, died February 13 at Christopher Hospital, Christopher, Ill., after a short illness.

CLAYTON—Frederick, 48, actor, a member of the Ella Kramer Company, died suddenly February 19 at Connellsville, Pa., of heart disease. The deceased was a resident of Illinois and had been on the stage nearly all his life. He was a member of the Ella Kramer Company for four years. Surviving him are his widow, Estelle Clayton, and a daughter, Virginia, three years old. Funeral services were held February 20 in the chapel of Funeral Director W. A. McNamany, followed by interment in Hill Grove Cemetery, Connellsville.

CRANDELL—Tony, for many years connected with various circuses and of late interested in theaters at Pasadena, Calif., died there recently. He is survived by his widow and father. The deceased was a life member of Lodge No. 672, B. P. O. E., and of the International Alliance of Theatrical Stage Employees, Lodge No. 33. Funeral services were held at the chapel of Bergien & Cabot. The Elks' Lodge was in charge of the services, both at the chapel and at the grave. Burial was in Mountain View Cemetery.

DAVIDSON—Charles, 69, father of Florence Davidson, a popular member of the staff of the Randwick Theater, Sydney, Australia, died there recently.

DAVIES—Mrs. Elizabeth, 34, wife of Harry Davies, Jr., died at Bristol General Hospital, London, Eng., of pneumonia. Interment was at Avonview Cemetery near Bristol. The deceased is survived by her husband and two daughters.

DeCAULDWELL—Lavinia Mallory, one of the famous Mallory Sisters, well known in musical comedy and concert circles, died in New York City February 11. The deceased was born in Alexandria, Va., but for years had been a resident of New York. Mrs. DeCauldwell was at one time a member of the Negro Grand Opera Company, under which she appeared in *Vendetta*. Just prior to her death she became a member of the choir, as leading soprano, of Mount Zion Baptist Church, and Rev. Brown, of that church, conducted the funeral services. Three sisters, Mrs. Marie Woodby, Mrs. Louise Brown and Mrs. Rebecca Adley; a brother, George Mallory, and her husband, William G. DeCauldwell, survive.

de LUCIA—Fernando, famous Italian tenor, died February 22 at Naples, Italy.

DIVE—James, 68, died at Glebe, Sydney, Australia, January 1. He had been a resident of Glebe for 35 years and was greatly esteemed in the commercial life of that city. He is survived by four daughters and two sons, among the latter being Percy Dive, secretary of Australasian Films, Ltd.

DOUGLAS—Franklin M., 61, died of heart trouble at his home in Elkhart, Ind., February 14. The deceased was for many years with the original Sells Bros. Circus as 24-hour man, where sprang a friendship with Peter Sells that lasted until the latter's death. He was also connected with several of the leading circuses, his last professional engagement being on the staff of Howe's Great London Shows in 1920, when he retired from the "white tops". He then entered the employ of the Buescher Band Instrument Company, at his home town of Elkhart, as a saxophone tester, being chief tester at the time of his last illness. Besides his widow he is survived by three brothers and one sister, also one son and four daughters, one of whom, Mrs. Pat Beggs, is known in vaudeville and outdoor circles as Vada, the Mystic, "the Original California Mind-Reading Girl". Interment was in the family plot at Columbia City, Ind.

DREW—Dorothy, 48, wife of Albert E. Johnston, of the vaudeville act known as the Musical Johnstons, died in New York City February 20 after an illness of six months.

ELLIS—Mrs. Winifred, 50, wife of the late George Ellis, theatrical producer, playwright and actor, died February 20 at her home in Woodcliff, N. J., of heart disease. The deceased, who was born in Ireland, is survived by four sisters, three of whom are now in Ireland, and two brothers. Funeral services were held February 23 and burial was in Grove Church Cemetery, North Bergen, N. J.

ELLISTON—Thomas Roy, four-year-old son of Mrs. Florence Elliston, died suddenly February 11 at Belleville, Ill. The mother is a well-known dancer and was for some time the partner of R. Stewart, known in vaudeville as Stewart and Derry.

FISHER—Charles J., 53, superintendent of Marcus Loew's theaters in Manhattan, New York, died February 20 at his home in Brooklyn, N. Y.

FRIEDLANDER—Robert (Pop), 56, died February 13 in New York City. For 20 years the deceased was a familiar figure in booking office circles of Chicago. He probably knew as many showmen as any agent of his day, and during all of his Chicago residence he was identified with vaudeville booking. He operated the Continental Booking Exchange for a number of years. A daughter, Mrs. Gertrude Westfall, of Chicago; a son, Albert Friedlander, of New York, and two brothers survive. Funeral services were held February 16 at Chicago. Interment following in Waldheim Cemetery.

GRANT—James P., 87, father of Grant Gardner, who is well known in theatrical circles, died at Greenlawn, N. Y., February 15.

HELD—Prof. Frederick, 79, who in his day was a master of the opera and of music in general, at one time basso of German Court and long Denver (Col.) favorite teacher of voice, died in that city February 14 at the J. K. Mullen Home for the Aged. Professor Held, whose rich basso voice won him the plaudits and acclaim of the German nobility 50 years ago, passed away suddenly, and the end came amid surroundings exactly opposite of those he had known in his heyday when he was a member of the German Court opera. Forty years ago he went to Denver and in the early days of that city was the foremost local teacher of the voice. Many singers who since have attained national reputations were trained by him there. Funeral services were held February 17 at the funeral parlors of W. P. Horan. Interment was in Mount Olivet Cemetery.

HILL—Dr. J. P., 62, father of J. Paxton Hill, of the John J. Williams Stock Company, died February 14 at Christiansburg, Va., of heart failure. The deceased had been retired for about five years. He is survived by a daughter, Mrs. Clara Carter, and two sons, J. Paxton Hill and Lawrence Y. Hill, musical director and camera expert, respectively, with Hal Roach Pictures, Los Angeles, Calif.

HOLDEN—Thomas, 46, son of the late Mr. and Mrs. Thos. Holden, well-known Lancashire roundabout proprietors, and husband of Julia Relf, died in Buchill Hospital, Glasgow, Scotland, of pneumonia January 21. He is survived by his widow and four sons.

HOLLISTER—Albert J., 53, president and treasurer of the Lyceum Theater Corporation, Rochester, N. Y., died at his home in that city February 16. The deceased was also a past president of the Rochester Theatrical Men's Association.

HOLTKAMP—Mayme, sister of L. B. Holtkamp, owner of the Georgia Smart Set Minstrels, and of H. J. Holtkamp, secretary of the show, died recently at Quincy, Ill. The deceased's brothers left the show temporarily in charge of Prof.

A. A. Wright, bandmaster, until J. Martin Free joined the show as business manager, to attend the funeral.

JENNEN—Ferdinand, who was the proprietor of the first moving picture house in Little Rock, Ark., and one of the first men to exploit this form of amusement in the South, died at Dallas, Tex., recently. The deceased was born in Paris, France, and upon his arrival in this country entered the photography business. He owned the old Happy Hollow Studio at Hot Springs, Ark., about 20 years ago and at one time traveled with a moving picture outfit advertising that city.

IN LOVING MEMORY OF MY DARLING HUSBAND
HARRY KERSHAW
Who passed away February 20, 1924.
With broken heart I watched you.
I saw you pass away.
Although I dearly loved you,
I could not make you stay.
You're not forgotten, Harry, dear.
Your memory will never fade.
My thoughts will always linger
In Oak Grove, where you are laid.
His wife, **FANNIE KERSHAW**.

KIERMAN—Mrs. Katherine, whose death was published in our issue of February 14, was the mother of the former Kerwin (not Klerman) Sisters, Minnie, Eulalie (Mrs. Gertrude Weber), the late Katherine (Mrs. H. S. Griffith), Ethel (Mrs. Tom Atkinson) and Mrs. Harry Melville.

KIRBY—T. J., Jr., widely known concessionaire of Texas, was killed in an automobile accident February 15 near West Palm Beach, Fla., according to recent reports to *The Billboard*.

LAYTON—Mrs. Julia Mason, mother of J. Turner Layton, of the team of Layton and Johnstone, now the rage of London, Eng., died February 8 after a short illness. J. Turner Layton, her son, is the author of many popular song numbers, and for years the names Creamer and Layton adorned the title pages of many of the best sellers.

LE VEY—Mrs. Minnie, wife of Henry Allen Le Vey, died recently at her home in New York City after an extended illness. The deceased was an officer of the Woman's Forum, Fortia and Century Theater clubs, and a member of the International Sunshine Society and Women's Press Club.

McCABE—Harry, 44, motion picture actor, died at the Clara Barton Hospital, Los Angeles, Calif., following two operations. The deceased was one of the original stars of the Seelig Company and had been working with numerous companies in and about Los Angeles for the past eight years. He is survived by his widow, Evelyn McKibben, a non-professional, to whom he had been married only three days, and his father and mother, who reside in Chicago, Ill.

McDONOUGH—Stephen, well known in the outdoor show world, and who had charge of one of the advance cars of the Ringling Bros.-Barnum & Bailey Circus for several seasons, died at the National Military Hospital, Marion, Ind., February 17. Burial was at New Castle, Pa.

McGEE—Mrs. Theresa, mother of Walter Duharry, manager of the Savoy Theater, Flint, Mich., passed away February 16 at her son's residence in Flint. The body was sent to the family home-stead at Kensington, O., for burial February 19.

McKAY—Mrs., 32, wife of Jock McKay, Scottish comedian, died at Dalby, Australia, recently. Before her marriage the deceased was one of the Tourbillion Troupe of cyclists, famous in England and America for many years. Three sons, aged nine, seven and four years, now in England, also survive.

McNULTY—Anson, 33, at one time a member of the Selwyn companies and later with various West Coast stock companies, died at Los Angeles, Calif., February 14 following a prolonged illness.

McPHERSON—Eleanor D., wife of Quinton McPherson, well-known vaudeville actor, died suddenly at Wellington, New Zealand, January 18.

MILLER—Fred W., died suddenly at Kansas City, Mo., recently. The deceased was well known in show business, having been on the privilege car of Gussey & Ronsey on the Great Latham Shows, and was also with the Wortham Shows.

MORTON—Martha, one of the first successful American women playwrights, died at her New York home February 18. Her first production, offered in 1888, was *Helen*, in which Clara Morris appeared. Two years later she wrote *The Merchant*, which won a prize offered by *The New York World*. Among her other plays were *A Bachelor's Romance*, *Her Lord and Master*, *The Diplomat* and *The Truth Tellers*.

MYERS—Victor, 20, died at Sydney, Australia, January 12. Born in Bradford, Eng., the deceased went to Australia when a small boy. He toured the various States and New Zealand, presenting a vaudeville act which received considerable recognition in view of the fact that

he was a midget comedian. In the height of his fame he went to London, Eng., where he played for some time on the Moss Tour.

NOBLE—William H., 48, a trainer of show horses and connected with the Brooklyn Riding and Driving Club, died of pneumonia February 19 at his home in Brooklyn, N. Y.

PALMER—Gertrude, 56, died at Sydney, Australia, recently. The deceased, who came from a well-known musical family, was for some time prior to her illness pianist at Betts' Picture Theater.

PETERSEN—Mrs. Elsie (nee Gadbaw), 41, wife of Peter Petersen, leader with Sam Howe's *Love-Makers* Company, died suddenly of heart disease February 14 at Maxlin's Hotel, Union Hill, N. J. The deceased was a pianist, member of Akron Local A. F. of M., and well known in the profession. She was with the Gilmore theaters of Oswego, N. Y., for 16 years and also played in theaters of Chicago and Akron. Funeral services were held in the Chapel of Necker's Undertaking Rooms, Union Hill, February 15, a Lutheran minister officiating. Members of the *Love-Makers* Company and attaches of the Hudson Theater attended in a body to pay their last respects to the deceased. Interment was at Mount Olive Cemetery, Chicago, Ill., February 19.

PIERSON—Edward, infant son of Mr. and Mrs. Hal Pierson, died at the Johnson City Hospital, Johnson City, N. Y., recently. Hal Pierson is a member of the cast of *The Volunteers*, well-known vaudeville act now touring the Middle West. His wife is a non-professional.

PINAUD—Reed, of the original vaudeville team of Jillson and Reed, died in London, Eng., February 10. His wife, Florrie Robins, survives.

QUINLIN—Helen, 22, a talented violinist, died suddenly at her home in New York City February 15.

REYNOLDS—Edward E., 21, manager of the Liberty Theater, Cameron, W. Va., died February 14 at Wheeling, W. Va. The deceased was a prominent man of that city and took an active part in civic affairs. He is survived by his father and a sister. The body was sent to Cameron, where preparations were made for burial.

RHOADS—J. Albert, 65, died recently at the Habneman Hospital, Philadelphia, Pa. The deceased with his brother, H. D'Esta, formed the vaudeville team known as the D'Esta Brothers, pantomimists, 40 years ago. He had retired from the profession about 20 years ago, following a commercial line, and of recent years had been interested in motion picture theaters in Gloucester County, New Jersey. Surviving are his widow, two daughters, a sister and a brother. Burial was at Mt. Ephraim, N. J.

RIVERA—Manuel, 37, musician in the Minneapolis Symphony Orchestra, died February 18 at Birmingham, Ala. The deceased was a violinist of note. He is survived by his widow, a talented singer and musician, and three children.

ROLLES—William J. (Billie), 40, well-known dramatic actor, died in a Chicago (Ill.) hospital February 16. The deceased had been connected with the John and Nellie Kennedy Stock Company for many years and of late had been prominent in vaudeville. Surviving him are two daughters and one brother.

SAWYER—Master, three-year-old son of Mr. Sawyer, Northern representative for Universal Films, died suddenly at Newcastle, Australia, December 13. The lad was playing on the balcony of the Pacific Hotel in that city and fell to the roadway when the railing gave way.

SAW—Henry (Hank), 78, who had spent many years with circuses, died February 19 at Bellefontaine, O. During his active life he had traveled with circuses and was an expert canvasman, and for many years had charge of the erection of the chautauqua tent at Bellefontaine, O.

SLOANE—Alfred Baldwin, 52, musical composer and well-known Broadway playwright, died at Rod Bank, N. J., February 21 of heart disease. The deceased was born at Baltimore, Md., and was educated by private tutors and in the public schools there. He married Miss Anward, of New York, February 15, 1900. He had been a composer of music since 1890, including music of *Jack and the Beanstalk*, *Erskine* Jr., music of many of the late Charles Hoyt's farces; *Sergeant Kibb*, *The Mocking Bird*, *Illhan Russell's Lady Tazle*, *Mama's Papa*, *All Around Chicago*, *The Gingerbread Man*, *Coming Thru the Rye* and many others. He was president of the Composers' Publishing Company and vice-president of the Authors' and Composers' Publishing Company. He was a member of the Episcopal Church, Lambs' Club, Strollers' Club and Green Room Club.

STANCH—Mrs. Rose, mother of "Smoke" Evans, well known in theatrical circles, died recently at Columbus, O. She had many friends in the profession.

TURNER—George F., 65, manager of the Goodwin Theater, Newark, N. J., died February 16 at his home in that city. The deceased had been connected with Newark theatrical enterprises for 28 years, going there as manager of Miner's Theater. He subsequently was manager of Waldman's Opera House and later was interested in the operation of Fox's Palace and the Strand. He was

member of Columbia Lodge, F. and A. M. Surviving him are his widow and a sister. Burial was at Newark February 18.

VALLERIA—Alwina, 76, noted operatic prima donna, a native of Baltimore, Md., died at New France, February 17. The deceased had retired from the operatic stage and largely from public appearance in 1886. In the decade and a half before that she was a widely known figure in the operatic field, notably in England, where the greater part of her career was made. She sang frequently in America, making her debut in New York as Marguerite in Faust in 1891.

VASSILIEVA—Olga, famous Russian dancer, died suddenly at Paris, France, February 21. The deceased had been appearing at the Montmartre Cabaret there.

WALKER—Frank, 22, of Memphis, Tenn., a stunt aviator and acrobat, engaged for carnival work with the Gates Flying Circus, died February 19 at New Orleans, La., when he fell from a plane upon which he was performing stunts into the Mississippi River and was drowned.

WEHR—Johnson, 65, died at the Waterfall Hospital, Sydney, Australia, recently. The deceased was a well-known character actor and had appeared in various productions in Australia for a number of years.

WERHAGEN—Carl, 56, a theater musician in Passaic, N. J., for the past 15 years, died February 8 of heart failure. Deceased had been connected with the Montebank and Playhouse theaters in Passaic and was in the pit at the latter house for the past 19 years. He was a clarinet player, a native of Germany, and before settling down in Passaic had toured with Sousa's Band and circuses.

WHALEN—Mike S., 62, veteran vaudeville actor, died February 13 at his home in Pittsburgh, Pa. The deceased entered the theatrical profession at the age of 15, and continued in it until almost the time of his death. Sixteen years of his career were spent in England. He was a member of the National Vaudeville Artists, Inc. Surviving him are his widow, a former professional; one sister and a brother-in-law. Funeral services were held February 16 in the Holy Innocents' Church, Pittsburgh. Interment was in St. Mary's Cemetery.

WHITE—Edmund C., 75, one of the oldest citizens of Dallas, Tex., and father of Leroy (Lasses) White, famous minstrel, died at his home there February 16 after an illness of four weeks. He is survived by his widow and seven children, Leroy (Lasses) White, W. E. White, R. H. White, Mrs. Jack Reamey, Mrs. Edna Knox, Mrs. Henry Gilchrist and Mrs. Paul Shipman.

WHITE—Harvey T., veteran trouper, and of late with the Blugging Bron-Barnum & Bailey Circus band, died at Glen Lake Sanitarium, Oak Terrace, Minn., February 15. He is survived by his widow, mother and three brothers.



YAGO—Philip, 86, well-known musician, died at his home in Covington, Ky., February 19 after a long illness. The deceased was a cornetist, and had led the band at Mayville, Ky., for a number of years. He is survived by four children, two sons being musicians. One of them, Bill, was a musician on the "Lasses" White Minstrel Show for four seasons, but canceled last fall on account of his father's ill health. Bill was with his father when death came. Another son, Frank, is a well-known musician in Cincinnati, O., and a former trouper. Funeral services were held in Covington February 21, followed by burial at Aberdeen, O.

MARRIAGES

In the Profession

ARTHUR-MAYNARD—Billie (Dude) Arthur, comedian, director and author of a number of plays, and Pauline Maynard were married February 12 at Kenedy, Tex. Both of them recently joined the Lamkin Players, now touring Texas. The bride will be leading lady of the company.

BANISTER-CORRY—Robert G. Banister of Kansas City, Mo., and Geraldine Corry of New York, a member of the cast of Hollywood Follies, were married in Washington, D. C., February 16. The bride will continue with the Columbia Burlesque company until the close of the show.

BULLOCK-DRAKE—Warren J. Bullock, chief comic with the Famous Bullock Family, and Kathryn Drake, of a prominent family of Canton, Ill., were married at Peoria, Ill., January 31.

BURKE-O'HARE—Irisna M. O'Hare, of Boston, Mass., well known in musical circles and on the professional stage, was married February 18 in the sanctuary of St. Aloysius Church, Washington, D. C., to Morton E. Burke, managing editor of The Washington News and a former

member of the staff of The Boston Post. The ceremony was performed by the Rev. William J. Brooks, S. J. The bride is the daughter of John J. O'Hare, foreman of The Boston Post color press department. She was with Raymond Hitchcock's Hitchhik-Koo Company for some time, and Fred Stone also engaged her for his company in Tip-Top, and she went into Jack O'Leary's under the same contract. She also toured with Irene, and was featured in Oh, Pauline.

DURRETT-HAAG—Dave Durrett, circus side show manager, and the younger daughter of Ernest Haag, owner of the Mighty Haag Shows, were wed recently and likely will make their home in Macon, Ga., where Mr. Durrett owns considerable real estate.

FLOURNOY-SCOTT—Peter C. Flournoy, a member of the Neil O'Brien Minstrels, and Minnie Scott, of Pine Bluff, Ark., were married February 18 at New Orleans, La. The bride will accompany her husband with the company for the balance of the season.

GODHARD-DALEY—A. C. Godhard, and Mona Daley were married at St. James Church, Sydney, Australia, recently. The bride for some years was organizing secretary of the Women's Hospital, Crown street, Sydney, and was intimately known to many theatrical and motion picture folk.

LARGE-BESANZONI—Enrique Large, one of the best known and wealthiest men in Brazil, S. A., and Gabriela Besanzoni, famous operatic contralto, recently were married in Brazil.

MORRISSEY-MILLER—Will Morrissey, author, actor and producer, and Midge Miller, former dancer in The Gingham Girl and The Greenwich Village Follies, were married in Chicago February 17. It is said Mr. Morrissey will star his wife in a play he is developing in New York.

PEACOCK-CRISP—Oliver Peacock, vocalist of note, and Stella Amy Crisp were married December 17 at Albany, N. S. W., Australia. Rev. Canon Bevan performing the ceremony.

SMITH-DOSSNBACH—Paul J. Smith, nonprofessional, and Hazel Dossnbach, violin teacher in the Eastman School of Music, were married February 20 at the home of the bride's parents, Rochester, N. Y.

SULLIVAN-MAY—Gardner Sullivan, well-known scenarist and motion picture producer, and Ann May, screen star, were married recently.

SULLY-HUNTINGTON—Granville F. Sully, son of the former sugar magnate, and Kathleen Huntington, a professional dancer, were married recently at the home of Mr. Sully's sister, Mrs. Beth Sully Fairbanks, at Los Angeles, Calif. Douglas Fairbanks, Jr., nephew of the bridegroom, was best man, and the former Mrs. Douglas Fairbanks gave away the bride. The couple are now taking a honeymoon trip on the Finland to New York via the Panama Canal.

TUCKER-HALLWORTH—Frederick C. Tucker, music composer, of Providence, R. I., widely known in New York as the composer of some of the late song hits, and Clara Hallworth, of New Bedford, Mass., a nonprofessional, were married January 31.

TELLEGEN-DILWORTH—News has been received that Lou Tellegen, famous screen and stage star, and Isabel Craven Dilworth, daughter of a wealthy glass manufacturer of Philadelphia, Pa., were married December 17, 1923, but have kept it secret until recently. Miss Dilworth, who is a graduate of the Ward Belmont Girls' School, of Nashville, Tenn., met Mr. Tellegen on a trip to New York, and he secured a place for her in his cast of Don Juan, which afterward led to their marriage.

VANNI-DUNN—Adelmo J. Vanni, nephew of S. Z. Poll, New England theatrical magnate and the picture hooker of the Poll Circuit, was married at Boston, Mass., February 21 to Anna Dunn. After a honeymoon trip the couple will reside at New Haven, Conn.

WEIGEL-HARVEY—Paul Weigel, veteran motion picture actor, married Mrs. Florence Stevens Harvey, a society woman of Los Angeles, San Francisco and New York, February 18, at Pasadena, Calif.

Jeanne Eagles, who achieved phenomenal success as the star in Rain, is reported to have married Ted Coy, the former Yale football star, who was divorced in January.

COMING MARRIAGES

In the Profession

The engagement of Bert Drysdale, operator of the St. Kilda Theater, St. Kilda, Australia, to Dora Webster, of Colac, is announced.

Renee Albert, premier danseuse of The Buayip, pantomime at the Hippodrome, Sydney, Australia, recently announced her engagement to Dr. P. J. Crowe, of Brisbane.

Edward J. Frankfort, professionally known as Edward LaZelle, who did a slack wire and juggling act, but retired

from the stage several years ago, is engaged to Rose Louise Bennett, of the Bennett Sisters, a singing and dancing act.

Dorothy Knapp, a Ziegfeld beauty, is engaged to marry Fehner Christy, nephew of Howard Chandler Christy, the artist, who started Miss Knapp on the road to fame by judging her as winner in a beauty contest. Miss Knapp states that she will continue on the stage after marriage, and it is rumored that the young Mr. Christy will follow her there.

BIRTHS

In the Profession

Mr. and Mrs. Paddy Gold announce the arrival of a seven-pound daughter, christened Janice, February 10, at Utica, N. Y. The father for the past two seasons was with the George L. Dobyns Shows.

According to newspaper reports from Los Angeles, Calif., Lou Tellegen, famous stage and screen star, is the father of an eight-month-old boy, named Rex. Mrs. Tellegen, whose stage name is Nina Romano, made the announcement, stating that Rex was born in Jacksonville, Fla.

Born to Mr. and Mrs. "Snowy" Flynn, at Sydney, Australia, a daughter. The father operates a hotel at Sydney and is well known to showmen. For years he ran several attractions on the fairgrounds there.

Mr. and Mrs. Fred Klimo announce the arrival of a daughter, born at Buckston Private Hospital, Glebe (Sydney), Australia. The father is a well-known acrobatic clown.

To Mr. and Mrs. Owen (Shorty) Batts, an eight-pound boy, at their home in Kansas City, Mo., February 8. The father is with the John Francis Shows, and is well known in the outdoor show world.

A daughter was born to Mrs. Wm. Garrett at Norristown, Pa., February 3. The mother is known in the theatrical world as Babe (Daisy) Lasley, actress, of the old Lasley Trio. The baby has been named Eleanor Lorraine.

A son, weighing six pounds, recently was born to Genevieve Houghton Sully. The father has been playing with the No Other Girl Company, and will shortly return to vaudeville with his wife.

DIVORCES

To Members of the Profession

Marcia Nell Compton McLaughlin, premier danseuse, with Sineopated Tones, now playing in Cleveland, O., has filed suit for divorce in the Superior Court against Eustace Lee McLaughlin, who takes the leading dance part in Plain Jane, alleging infidelity.

Low Gordon, well-known eccentric comedian, was granted a divorce in the Jackson County Circuit Court at Kansas City, Mo., February 17, from Mrs. Midge Gordon, known in the theatrical world as Midge Carroll.

Allen Hauser advises The Billboard that an item regarding his wife, Verne Hauser, instituting divorce proceedings in Las Vegas, Nev., appearing in our issue of February 21, was erroneous.

Minert DeArlo, well-known clown, who for the past four seasons had been connected with the Sparks Circus, was granted a divorce and custody of his two children by Judge Clarence H. Brown, of the Circuit Court, at Saginaw, Mich., February 18.

Lorraine Wallace, animal trainer with the John Robinson Circus, recently filed suit for divorce against Steve Batty, a trainer with the Sparks Circus. The case will be heard in the Los Angeles (Calif.) courts upon Miss Wallace's return at the close of the season. The couple were married in Colombo, Ceylon, B. I., in 1907.

Jeanette Selar, well known in the outdoor show world, playing under the name of Jean St. Clair, and now with a carnival company in Florida, instituted divorce proceedings against Mark Selar, alleging desertion. Mr. Selar is now on the road with his own tabloid show.

Theatrical Notes

Following a special meeting of the holders of the Lansing (Mich.) Theater Company proceedings for liquidation of its affairs were started after it had unsuccessfully endeavored for four years to establish a community theater corporation among local stockholders.

Improvements on the stage of the American Theater, Bellingham, Wash., that, it is said, are designed to provide the best facilities in the State for the production of moving pictures, vaudeville and road shows, are being carried out by the Bellingham Theaters, Inc., at a cost of \$14,000.

L. G. Edel, of Buffalo, N. Y., formerly manager of the Academy of Music, New York, and the Mack-Strand theaters in Syracuse, Buffalo and Detroit, recently assumed the duties of assistant manager of the Lumberg Theater at Niagara Falls taken over by Allas S. Moritz of Buffalo.

Would Ban Chance Games At Penna. County Fairs

Harrisburg, Pa., Feb. 21.—Under provisions of a bill sponsored by Representative Martha G. Thomas, Chester County, now before the general assembly, all games of chance would be banned from the county fairs of Pennsylvania, but horse racing and trials of skill would be permitted.

The bill is backed by the Department of Agriculture. In a statement several weeks ago the Secretary of Agriculture said that inspectors who had visited about 50 fairs last year had found very few shows which might come under the ban, but that games of chance generally prevailed.

Under the Thomas bill the president and secretary would have to certify to the department that the fair association did not "permit immoral, lewd, obscene or indecent shows or exhibitions" or "use or permit the use of any gambling device, instrument, contrivance or practice in the operation of which bets were laid or wagers made, any wheel of fortune or the playing of any game of chance . . . upon the association grounds to get state aid. The bill, however, would not be construed "to prohibit horse racing, or trials of skill, or the giving away of articles for which no consideration is received."

Fairs conforming to the requirements of the act would be entitled to receive aid not exceeding \$2,000 annually, the payment to be based on the total of premiums paid. Where more than one fair is held in a county, the county, as a whole, would be entitled to \$4,000 aid, to be divided among the fairs on the basis of premiums paid. At present each fair receives not to exceed \$1,000 annually. The bill also would increase the total which may be paid for State aid from \$100,000 to \$250,000.

Rumored That Palisades Park May Cease To Exist

New York, Feb. 21.—According to reports, not yet verified, when the lease of the Palisades Amusement Park expires at the close of the season this year it will not be renewed by the owners, who desire, it is understood, to develop it into a residential tract, many fine homes having been built all around it since it was first opened nearly 20 years ago.

Palisades Park, situated directly opposite Grant's tomb and overlooking the Hudson River, lies partly in Chiffside and partly in Fort Lee, N. J. The no official announcement has been made, it has been rumored that Schenck Brothers, the lessees, have secured an option on a tract along the Hackensack River opposite Ridgefield Park, which they will eventually develop into another amusement park. There is a small natural lake on this property.

For a number of years Palisades Park has been one of the most popular amusement parks in the vicinity of New York and has been the recreation resort for theatrical companies, due to the popularity of Nicholas and Joseph Schenck, among the best known amusement purveyors in the country.

S. B. Williams' Shows

Weatherford, Tex., Feb. 20.—Work at the winter quarters of the S. B. Williams Shows is now moving along rapidly. Four men were steadily employed since the show closed, which force has lately been increased to 12, all working hard to be in readiness for the spring opening here under the auspices of the Parker Co. Post, American Legion. From all appearances, this will be one of the flashiest gilly shows on the road this season. Showfolks are coming in rapidly to prepare their equipment, as everything must blend in accord with the show colors, orange and blue. The swing has received an entire rebuilding. Among last season's people at quarters are "Ma" and "Pa" Cottingham, Hergert Muir, Happy Harris and wife, who motored in recently.

HAPPY HARRIS (for the Show).

E. S. Corey Greater Shows

Work at the winter quarters of the E. S. Corey Greater Shows is now in full blast. This year will mark the 16th annual tour of this organization, and Mr. Corey and his manager, P. J. Finnerty, seem to be bending every effort toward having the show beat all its former records. Jack Matthews has added four new concessions. It will be his fourth season with this company. The opening will be early in April, in Central Pennsylvania.

JACK E. TYSON (for the Show)

Was Son of Late Circus Owner

Charles Algernon Robbins, whose death notice appeared in The Billboard, was a son of the late Frank A. Robbins, Sr., and Fannie F. Robbins, of Peoria, who were married at Utica, N. Y., September 14, 1876, by J. W. P. Justice of the Peace. The younger Robbins was born January 11, 1878, at Newport, N. Y., reaching his 47 years old at the time of his death, instead of 48, as stated in the last issue.

W. Hillie
Western, Donna
Wherell, Connie
Whitely, Muriel
White, Mrs. N.

Wilson, Mrs. Russ
Wilson, Mrs. C. T.
Wilson, Mrs.
Whitford, L.
Whitford, L.

Willard, O. C.
Willard, R. L.
Willard, R. L.
Willard, R. L.
Willard, R. L.

Willis, Mr.
Willis, Mr.
Willis, Mr.
Willis, Mr.
Willis, Mr.

Willis, Mr.
Willis, Mr.
Willis, Mr.
Willis, Mr.
Willis, Mr.

Willis, Mr.
Willis, Mr.
Willis, Mr.
Willis, Mr.
Willis, Mr.

Willis, Mr.
Willis, Mr.
Willis, Mr.
Willis, Mr.
Willis, Mr.

Willis, Mr.
Willis, Mr.
Willis, Mr.
Willis, Mr.
Willis, Mr.

Willis, Mr.
Willis, Mr.
Willis, Mr.
Willis, Mr.
Willis, Mr.

Willis, Mr.
Willis, Mr.
Willis, Mr.
Willis, Mr.
Willis, Mr.

Willis, Mr.
Willis, Mr.
Willis, Mr.
Willis, Mr.
Willis, Mr.

GENTLEMEN'S LIST

Abert, Joseph
Abert, Joseph
Abert, Joseph
Abert, Joseph
Abert, Joseph

Abert, Joseph
Abert, Joseph
Abert, Joseph
Abert, Joseph
Abert, Joseph

Abert, Joseph
Abert, Joseph
Abert, Joseph
Abert, Joseph
Abert, Joseph

Abert, Joseph
Abert, Joseph
Abert, Joseph
Abert, Joseph
Abert, Joseph

Abert, Joseph
Abert, Joseph
Abert, Joseph
Abert, Joseph
Abert, Joseph

Abert, Joseph
Abert, Joseph
Abert, Joseph
Abert, Joseph
Abert, Joseph

Abert, Joseph
Abert, Joseph
Abert, Joseph
Abert, Joseph
Abert, Joseph

Abert, Joseph
Abert, Joseph
Abert, Joseph
Abert, Joseph
Abert, Joseph

Abert, Joseph
Abert, Joseph
Abert, Joseph
Abert, Joseph
Abert, Joseph

Abert, Joseph
Abert, Joseph
Abert, Joseph
Abert, Joseph
Abert, Joseph

Abert, Joseph
Abert, Joseph
Abert, Joseph
Abert, Joseph
Abert, Joseph

Additional Routes
(Received Too Late for Classification)

Barton Bros. Circus: New Bedford, Mass., 26-28; Newburyport March 2-4; Waltham 5-7. Bill's Hawaiian Revue: (Bix) Indiana, Pa., 25-26; (Liberty) East Palestine, O., 27-28; (State) Palomont, Pa., March 2-4. Beach, McDonald, Magellan, Ambrosio Lyceum, mgrs: Lake George, N. Y., March 2; Beverly, Mass., 3; Nantucket 4; Woodstock, N. H., Can., 5; Princeton, Me., 7. Carlises, The: Lockport, N. Y., 23-25. Central States Shows: Ft. Pierce, Fla. 23-28. Irving's, J. J., Kalek Knacks: (Strand) Charlotte, N. C., 23-28. Jones, Johnny J., Expo.: Bradenton, Fla., 23-28. Lashay, George: (Palace) Springfield, Mass., 26-28; (Poli) Bridgeport, Conn., March 2-4. Leahy, Buck: (Colonial) Keene, N. H., 24-26; (Marlboro) Marlboro, Mass., March 2-5. McCoy's, Billy: All Aces Revue: (Drumhead) Alton, Ill., 23-28; (Imperial) New Kensington, Pa., March 2-7. Model Shows, F. H. Bee, Jr., mgr.: Oglethorpe, Ga., 23-28. Morrison & Coghlan: (Majestic) Bloomington, Ill., 26-28; (Palace) Peoria March 1-4. Monumental Shows: (Correction) Lake City, Fla., 23-28. Originals in Stepping Out, H. P. Campbell, mgr.: Sunbury, Ont., Can., 25; North Bay, Ont., 26; Orillia 27; Barrie 28; (Grand) Toronto March 2-21. Poole & Schneck Shows: Goose Creek, Tex., 23-28. Reno, Great, & Co.: (Correction) Gilbertsville, Pa., 23-28. Terrell's, Billy: Stock Co.: Fayette, Mo., 23-28; Vandavia March 2-7. Texas Kid Shows: Wallis, Tex., 23-26. Thomas, Joe, Saxotet: (Mark Strand) Brooklyn 23-28; (Stanley) Philadelphia March 2-7. Unwanted Child: Shreveport, La., 25; Texarkana, Ark., 26; Little Rock 27-28; Hot Springs March 2-3; Helena 4; Memphis, Tenn., 5-7.

DIXIELAND SHOWS

SATURDAY, OPENS SATURDAY, MARCH 7.
FEB. 28.

FIRST SHOW IN SIX YEARS—HELENA, ARK.—ON STREETS.

WILL BOOK any Show or Ride that doesn't conflict. Will furnish complete plans for real Hawaiian Show. Concessions, WIRE or COME ON. NO EXCLUSIVE except Cook House. CAN PLACE capable Ball Itack Agents. FOR SALE—Merry-Go-Round Top. Address all communications, J. W. HILDRETH, Gen. Mgr.

Crystal Lake Park, Manchester, N. H.

Three miles from city of 90,000, with additional population of 150,000 within radius of twenty-five miles. Manchester's Best Bathing Beach, with Toboggan Slides and other Water Attractions that draw the crowds. Greatest Music and Kiddies' Playground. Now installing latest loud-speaking Radio Set for free attraction. Big opportunity for Penny Arcade. Have buildings, Shooting Gallery, Ball Games, Walking Charlie, Bowling, High Striker and other games of skill only. No Carnivals play this city and anything new will get the money. WANT Fun House, Over the Falls, Bug House, Mechanical City and any other good attraction. Will build and give long lease to stationary Shows and Rides. CAN PLACE all portable Shows and Rides at my six Fairs at close of Park season. WANT Rides of all kinds. Big opportunity for Kiddie Rides and Miniature Railroad. Owing to limited dancing space last year, I am compelled to build new large Dancing Pavilion. Will consider partner for half interest. Must have capital and ability to manage same. NOTICE, FAIR SECRETARIES, Home Comings, Churches and Any Other Committees through New England and New York State—can furnish you any time from one to three up-to-date Riding Devices, selected Shows and Concessions. Eddy Walsh, write, JOHN KILONIS, Owner and Manager, 344 North Kedzie Ave., Chicago, Ill. After April 15, Crystal Park, Manchester, N. H.

FEATURE FREAKS WANTED
SUMMER SEASON 1925, ROCKAWAY BEACH

CAN USE Pinhead, good Midget, Sword Swallower. Others write. Talkers. State particulars, salary and send photos. Returned if requested. M. KRAUT, Room 302, 215 Montague St., Brooklyn, N. Y.

K. F. KETCHUM WANTS
FOR HIS TWO CARNIVAL ORGANIZATIONS

Shows of all kinds. Rides that do not conflict. Corn Game, Julec, Palmistry, Hoop-La, High Striker, Dart Game, String Game, Glass Store, Pitch-Till-You-Win, Grand Stores of all kinds. Following Wheels open: Candy, Fruit, Floor Lamps, Silver, Aluminum, Dolls, Paramount Bells, Leather Goods, Clocks and Birds. Address 131 East 16th Street, Paterson, N. J. Phone, Lambert 3792 J.

run for three months. Easter Sunday is not very far distant and then the outdoor season will make a strong demand for a portion of the spoils. Business at the theaters continues good.

Jolly and George Westcott, who are now entertaining the populace of Carter, Ok., write that business has been very pleasing to them both. It looks as tho the outdoor show world has lost two of its celebrities.

Dave Taylor, who is to make several dives into the Pacific ocean from an airplane, succeeded in drawing a large crowd to the Venice beach last Sunday. His work was not only daring but had an artistic touch. It is the first time this stunt has been tried on this Coast.

Mme. Leonja Ogradaka, Polish singer, is spending several weeks here and is being extensively entertained by Polish citizens. Arrangements are being made to have one of the operas given at the Metropolitan in New York last year produced and sung by her before her stay here comes to an end.

Tim Buckley, veteran animal trainer, is busy at the Al. G. Barnes winter quarters, breaking some white tomcats.

Warren Eccles, of Long Beach and the Sunland Amusement Corporation of that city, was a visitor and states that they expect to create much activity the coming summer. They are to build several small riding devices for the local resorts and then will fill their many contracts for the 1926 season.

Beginning March 1, and for two Sundays following concerts will be given by the Philharmonic Orchestra in the Coliseum. These will be of the popular kind and prices will range from 10 cents to \$1.

The Paul Whiteman Jazz Orchestra arrived in Los Angeles February 13 and was met at the train by all the musicians not actually engaged in the theaters. A real reception was given the jazz king.

The Pacific Coast Showmen's Association has set the date of its annual ball for March 16, and this time it will be taken to the Cinderella Roof. Two orchestras will furnish the music so that the dancing numbers will be almost continuous. Entertainment of the lighter kind will intersperse the dancing. The entrance will resemble the marquee of a circus and the whole dance will be built on a novelty idea.

On Sunday, February 8, a big vaudeville show was put on for 400 men, women and children at the Tuberculosis Sanitarium. It was arranged under the auspices of the Los Angeles Elks No. 99, and the following artists volunteered their work: Berney Pollock, Tony Smith, Inez Kenna, Bill Martin, Dorothy Farrell, Ruby Miller, assisted by his office boy, Al Wager; Henry King, Majestic Singing Trio, Albert and Rozella. Mrs. Bert Melville acted as musical director and won the praise of all participants on the bill for her clever work.

The Annual Orange Show will open its gates February 19, and run until March 1. The exhibits will all be under

roof this year, but the midway shows will still be on the outside.

The Billboard Thought and Pleasure Club turned its regular semi-monthly meeting into a valentine party February 14 at the residence of Will J. Farley in Venice. Doing things just the opposite, the dinner and discussion were held first, after which they all danced and then listened to an hour's entertainment given by The Times' Lost Angels Radio Entertainers. On the program were Eastcake Barnes, the One-Eyed Fiddler; Hatch Graham, Charlie Wellman, Louis Klein, the bald-headed sheik from Sawtooth; the Seminole Bill Hatch, and all the others. Adjournment at 3 a.m.

John S. Berger—Los Angeles is ready for another exposition and all eyes are set upon your ability to pull it. The Coliseum is built and the coming spring is most auspicious for such a celebration.

Mark Hanna, who has left the outdoor field to become the manager of the big Palace Ball Room at the entrance of the Ocean Park Pier, is meeting with splendid success. His efforts here brought to this palace of pleasure many of the parties that are constantly given on the bay shores.

Creatore is again at the head of the Metropolitan Theater Orchestra here and, as usual, increasing the business many fold. A great favorite on this Coast, Creatore's work is receiving plenty of publicity and the Metropolitan plenty of business.

Buell Gets Art Pictures

Newark, O., Feb. 22.—Charles T. Buell has returned here from Cave City, Ky., where he spent a week with his cameramen at Sand Cave, containing the body of Floyd Collins. They brought back some wonderful views of the cave formations in that part of the country, as well as views of Collins, the tunnel, soldiers, workmen, his relatives and friends; also several views of the funeral services of the trapped man.

Johnny J. Jones Gets Augusta Exchange Date

The following telegram was received by The Billboard from W. T. Buck, chairman of the Exchange Club, Augusta, Ga., last Sunday: "Zeldman & Pollie do not play the Fall Festival under auspices of the Exchange Club. We have the Johnny J. Jones show contracted and will not change. Please explain."

Ollie B. Chappell in Hospital

Ollie B. Chappell, who has been with the Knight Troupe for the past three years, was taken ill February 4 and rushed to the hospital at Quincy, Fla., where she underwent an operation a few days later. Dr. Massey states that she will not be able to return to the act before the latter part of April. The Knights are with the M. L. Clark & Son's Shows.

A glance at the Hotel Directory in this issue may save considerable time and inconvenience.

Assortment No. 229
\$6.75 \$6.75

LIST OF PREMIUMS
1 GOLD-PLATED GILLETTE SAFETY RAZOR.
2 FANCY CIGARETTE HOLDERS.
2 POCKET KNIVES.
2 COMBINATION PENCILS AND CIGARETTE HOLDERS.
2 SCARF PINS.
2 REDMANOL CIGAR HOLDERS.
2 BELT BUCKLES.
1 LARGE POCKET FLASK. Reserved for Last Sale.
Complete with a 700-Hale 5c Salesboard.
Price, \$6.75 Each
SATISFACTION GUARANTEED OR MONEY REFUNDED—NO QUESTIONS ASKED.
Cash in full, or 25% with order, balance C. O. D. Send Money Order or Certified Check to avoid delay.
WRITE FOR OUR ILLUSTRATED CATALOG.
Fastest selling Salesboards on earth.
Est. 1907. MOE LEVIN & CO. Est. 1907.
180 No. Wabash Ave., CHICAGO, ILL.

Venice Pier Ocean Park Pier Santa Monica Pier
LOS ANGELES
WILL J. FARLEY
Loew State Bldg., Los Angeles
Long Beach Pier Redondo Beach Seal Beach

Los Angeles, Feb. 17.—The opening of the remodeled Mason Opera House, the Los Angeles Horse Show, Paul Whiteman's Orchestra, the annual visit of the San Carlo Opera Company, the Annual Orange Show and many other events will give the people of this city much to interest them during the rest of the month. Grauman's Egyptian Theater closed the picture *Romola* and, after being dark a week to arrange for the big prolog, it will reopen with the feature *The Iron Horse*, which, under the new policy, will

Our New "Big Idea"
KNIFE DEALS on
SALESBOARDS
Concealed in Cigar Boxes



No. 1146—Boxed-In Knife Deal of 12 Knives—11 big Photo Handle Two-Blade Jacks, with double bolsters and 1 Two-Blade Heavy Office Knife, on 800-hole Board.

Complete, each, 5.25
No. 1147—Boxed-In Knife Deal—12 Knives. Assorted Photo Handles, stags and others. Two-Blade, different sizes, double and single bolster. On 600-hole Board.

Complete, each, 4.50
No. 1148—Boxed-In Knife Deal—12 Knives. ALL PEARL HANDLES. In 2 and 3-blade, nickel silver bolster, nice, clean-cut goods, on 1,000-hole Board.

Complete, each, 8.25
ROHDE-SPENCER COMPANY
Wholesale Only
Watches, Jewelry, Premium Goods
215 W. Madison Street,
CHICAGO, ILL.

SURE NUFF BARBECUE



This is the double Barbecue, using two revolving spits. Bricks can be dismantled and used over again if you care to use them for a week's stand. These come either electrically operated or by hand and will last a natural lifetime. Different from the old way. Just demonstrate to public view the sensational delicious style of cooking and watch the dollars roll in. It draws people like a magnet. Highly nickel-plated tool steel.

I supply all of the iron work, 1/4-h. p. Motor, and reducing unit, or handle for hand power, and with my enlarged drawing and simple instructions a brick mason or any one mechanically inclined can erect this in a very short time. Satisfaction guaranteed.

This stand will deliciously barbecue 60 lbs. of meat at one time. It is a wonderful flash, as it stands approximately 8 ft. in height and 5 ft. in width and it requires domestic coke as fuel, which can be purchased nearly anywhere, and which gives forth a slow intense heat. It comes to you packed in three strong boxes, shipping weight when packed approximately 350 lbs. This little sketch gives a pretty cool idea of how the joint will look when erected.

Specify when ordering motor what current is wanted, A. C. or D. C., or if hand power is desired.

ACT AT ONCE
PRICE, F. O. B. KANSAS CITY, MO.
COMPLETE ELECTRIC POWER, \$125.00. HAND POWER, \$75.00.
Half with order, balance C. O. D.

At Home
ROX FIBER
Office, 118 E. Fifth Street
KANSAS CITY, MO.

VENDING MACHINE SALESMEN
Sensational new plan sells newly invented Combination Gum Machine by hundreds. Six machines in one. New slug-proof device. 2 to \$250 weekly. HURD, Wholesale Dept., Ridge Bldg., Kansas City, Mo.

Salesboard Operators, Campaign Operators, Coin Machine Operators, Concessionaires

WE HAVE EVERYTHING YOU NEED AND OUR PRICES WILL SURPRISE YOU

Salesboards advanced on December 1. We purchased a huge amount of Boards prior to the advance and we are still able to sell at the old prices. Write for prices on Jennings and Mills Coin Machines.

A FEW OF OUR ITEMS:

COIN MACHINES
ALUMINUM WARE
CARNIVAL DOLLS
TOILET SETS
WATCHES
ETC.

SALESBOARDS
AUTO ROBES
MAMA DOLLS
UMBRELLAS
MANICURE ROLLS
ETC.

SALESBOARD ASSORTMENTS
SILVERWARE
BRIDGE LAMPS
CLOCKS, NUMEROUS MAKES
FANCY JEWELRY
ETC.

CAMPAIGN BOOKLETS
RUBBER BALLS
FLOOR LAMPS
MESH BAGS
SMOKER'S SUPPLIES
ETC.

PREMIUMS
NOVELTIES
CUTLERY
BEAD BAGS
BLANKETS
ETC.

Write for our Sales Catalogue. You need it. It will be mailed to you free of charge.

AMUSEMENT NOVELTY SUPPLY CO.,

Phones: 4080-4081

434 CARROLL STREET, ELMIRA, N. Y.

ST. LOUIS

FRANK B. JOERLING

Phone, Olive 1733

2038 Railway Exch. Bldg., Locust St.,
Between Sixth and Seventh

Attractions

St. Louis, Feb. 20.—The American Theater was dark this week and Ethel Barrymore, who was scheduled to be the attraction, does not move in until February 23. She will appear in *The Second Mrs. Tanqueray*.

At the Shubert-Jefferson good houses have seen the *Greenwich Village Follies*, which closes here tomorrow night, to be followed Sunday night by De Wolf Hopper and his Comic Opera Company. *The Mikado* will be presented the first four days of next week and *H. M. S. Pinafore* the last part.

The John McCormack concert which was announced for February 16 at the Coliseum has been postponed until March 24 on account of the tenor's recent illness.

The Woodward Players are offering *The Monster* at the Empress Theater this week, with *The Hotentot* to follow.

The Columbia Theater, which is presenting feature photoplays now, has adopted the policy of showing five vaudeville acts in addition on Saturdays and Sundays. *Marjah*, mindreading act, is an added feature this week.

Showmen's Banquet-Ball

The committee on tickets for the Mississippi Valley Showmen's First Annual Dinner-Dance reported at a meeting yesterday that progress is being made in the sale of tickets for the big event on the evening of March 28 at the American Annex main ballroom. L. S. Hogan, chairman, who just returned from Chicago, advised that a large delegation of Windy City showmen will be on hand for the gala event.

Permanent Flying Field

The St. Louis-Lambert Flying Field at Bridgeton, in St. Louis County, a few miles from this city, has been purchased by Albert Bond Lambert and the St. Louis Aeronautic Corporation for \$68,352. The field is composed of 169 acres and is the spot where the International Air Races were held in October, 1923. Henceforth it will be a permanent center for St. Louis flying activities.

Immense Amphitheater

A group of prominent University City (residential section of St. Louis) business men, headed by Flint Garrison, is planning the erection of an amphitheater in University City, where it is proposed to produce high-class entertainment during the summer months. The syndicate has acquired a large tract of ground on the corner of Olive street road and the Creve-Coeur carline. Garrison, one of the principal promoters of the Annual Fashion Pageant here, advised that improvements totaling \$100,000 will be made on the property and a fund of \$50,000 set aside to underwrite productions. It is claimed that more than likely three forms of entertainment will be presented in the new open-air theater, i. e., several weeks of drama, several weeks of Shakespearean plays adapted to outdoors and several weeks of classical opera. It is also probable that the Fashion Pageant will be held here. Joseph Solari is to be director of the new theater.

Pickups and Visitors

Mort H. Singer, vice-president, and Walter Lloyd, general publicity director of the Orpheum Circuit, were in St. Louis Sunday and visited each of the three local vaudeville houses, Orpheum, Grand Opera House and Rialto.

Frank M. Sutton advises that he will be in the Mound City in March.

L. C. Zelleno, advance agent of Gaskell & Smith's *Shepherd of the Hills* Company, passed thru St. Louis Sunday en route from Washington, Mo., to Panama, Ill. He advised that the show is doing nicely and has six weeks of Canadian bookings to follow its route in Ohio, entering the Dominion at Sarnia, Ont., and coming out at the Canadian Soo. Thus far this season his show has played



Look into this MONEY GETTER!

Let "MUTOSCOPE" Earn 1000% Profit a Year for YOU

"Mutoscope" is the original Penny Moving Picture Machine. Attractive, strongly built, yet light weight. Thousands now in use quickly turn pennies into dollars. Operators everywhere report big earnings. You can get your share. Write today.

INTERNATIONAL MUTOSCOPE REEL CO., 641 Gardner St., UNION HILL, N. J.

MAY & DEMPSEY SHOWS

WE HAVE MERRY-GO-ROUND, ELI FERRIS WHEEL AND MERRY MIX-UP AND THREE SHOWS.

WANTED—Two more Grind Shows, Concessions open: Blankets, Floor Lamps, Fish Pond, Bowling Alley, Clocks, Silver, Pillows, Cedar Chest, Cigarette and Long Range Shooting Gallery, Siring Game, Skillo, Pop-Kim-In Buckets, Novelties, Fruit and Groceries, Spot-the-Spot and American Phrenologist. Will sell exclusive on above mentioned. We pay all after joining. Want to hear from good Acts and Freaks for our shows. Also have good proposition for reliable Ball Game Workers. Address

MAY & DEMPSEY SHOWS, 3507 LINCOLN AVE., Apt. 32, Detroit, Mich.

Wanted—FREAKS—Wanted

ALSO NOVELTY ACTS, FOR SEASON 1925 AT CONEY ISLAND WONDERLAND CIRCUS SIDE SHOW.

CAN USE Fat Lady, Sword Swallower, Midgets, etc. Send Photos. State salary.
DAVE ROSEN, 2869 West 16th Street, Coney Island, New York.

For Sale—Concession Tents For Refreshment Stands

16x16-FT., 4-WAY, 9-OZ. ARMY CANVAS, PRICE.....\$50.00
8x16-FT., 1-WAY, 9-OZ. ARMY CANVAS, PRICE.....40.00
The canvas in these Tents is green and white striped. The Tents are well made and give a very attractive appearance.

JUICE GLASS TANKS, 5 GALLONS, PRICE, \$5.00.

W. M. SNYDER, - - - 200 Third St., W., Ashland, Wis.

In 18 States, viz.: Illinois, Wisconsin, Minnesota, Iowa, Nebraska, Colorado, Utah, Idaho, Oregon, Washington, Montana, Wyoming, Kansas, Oklahoma, Arkansas, Missouri, Indiana and Ohio.

Syd Shaw, for the last six weeks manager of the Hotel St. Louis, has resigned his position and expects to re-enter the show business. He plans on doing a double turn in vaudeville with his wife, Ray Phillips, owner of the Ray Show Property Exchange, who has been ill the last few months, is again in the best of health and able to spend most of his time at his factory. He was a *Billboard* visitor Tuesday.

By Gosh, the celebrated clown, and his *Seidom Fed Minstrels* are still playing the large picture and vaudeville houses in this vicinity. They expect to remain here for another month at least.

The Famous Bullock Family, a feature last season with the S. W. Brundage Shows, arrived in the city last week preparatory to joining the D. D. Murphy Shows. Until the Murphy Shows open here, April 11, the Bullocks will play independent vaudeville dates in Missouri and Southern Illinois. Gus Bullock, manager of the family, while paying a visit to *The Billboard* office, stated that he will have a bigger show this season than ever before.

L. S. Hogan, special agent for the C. A. Wortham World's Best Shows; Ralph V. Ray, superintendent of concessions on the D. D. Murphy Shows, and wife, and Ray Oakes, concessionaire, returned from their auto tour to Chicago Wednesday. They drove to and from the Windy City in Hogan's sport car.

Samuel E. MacMillen, who resigned last week as business manager of the St. Louis Symphony Orchestra, expects to leave for New York tomorrow to look over the field of his future endeavors. MacMillen will manage a new musical organization in the Metropolis. He will return to St. Louis about March 16 to manage the St. Louis Symphony Orchestra's annual spring tour, which he has booked and which the executive council of the Symphony Society asked him to handle before entirely severing his connections here.

Others in the city included Chet Wheeler, Charles Drilleck, Daphne Ballard, George Slocum, Harry Shannon, Artie Leeming, McGushion Twine, Eddie Franklyn, Ben Levine, Thomas Brennan, Feto Laboe, Clara Young, Jessie Gay, Van Brooks, Tom King, A. E. Nelson, Harry Evenson, Billy Barnes, John Wells, Buster West, Charley Lane, Chic Stanley,

Helene Hamilton, Tom Howard, Alice Lawlor, Joe Lyons, Joyce Latelle, June Rose, Edna Haley, Boots Feltman, Art Daily, Lefty Ben Block, Herman Rudick, Frank A. Payne, Edith Bruner, Elsie Calvert, William and Joe Mandell, Irene Delroy, Joe Sacks, Jack Barnes, Florence Brady, Gilbert Wells, Frosini, Betty Burroughs, Walter Pearson, Elsie Leonie, Harry King, George Brown, Lula Pool, Mabel Ball, Romeo Buffano, Doc L. W. Lewis, A. S. Reed, Billy Grove, Bever and Berry, Thelma Hunt, Al Sexton, A. E. Nelson, Prof. C. A. Henry, The Briants, Harry Holbrook, Happy Golden, Pat Murphy, Earl C. Riobe and wife, Mrs. M. E. Ross, Great Lester, Martha Graham, Julia Silvers, Victoria and Dupree, Delima and Marita, Anna Bismarck, William Doc Lang, Jean LaMarr, Gregory Safronic, Marian Dabney, Norman Clark, Harry Taylor, Mystic Karma, Will Lindhorst, Herbert Hackleroad, Mae Beresville, The Vaggies, Barrie Oliver, Billy Weston, Boots Wecker, W. C. Bunyard, Mrs. Stella Rensch, Della Cowell, Elsie Howard, Fred Howard, M. A. Guggenheim and wife, R. E. Flannigan, Okra Tyree, Dan DePrugh and Paul Flannigan.

South Texas Fair Circuit Sets Dates

(Continued from page 79)
Dallas, delivered a rousing talk, urging greater co-operation from residents of this section. Retiring President A. B. Rogers responded to the address of welcome.

J. George Loos, head of the organization bearing his name, and Walter Stanley, an executive of the show, attended the meeting. Others who made their presence known were: F. H. Kressman, special representative of the World Amusement Service Association; George E. Durman and W. G. Havlis, Rice & Jordan Shows; G. R. Spencer, C. A. Vernon Shows; Chas. F. Watmuff and a number of Eastern showmen. In addition to several score persons residing in the territory covered by the circuit.

Kenedy residents showed more than Southern hospitality to the visiting delegates, there being automobile rides, banquets and other gatherings to occupy their time when they were not discussing business of the amusement world.

W. E. Donovan, of Gonzales, was appointed chairman of the dates committee. Assisting him will be R. J. Willman, of Gonzales; George Ward, of San Marcos; Robert Burns, of Kenedy, and H. M. Preau, of Lagrange.

MILLS

5c & 25c

MACHINES

With or without vendors, used a short time, as good as new, at bargain prices. MINTS—Nearly a coronad, at cost.

WINNER MINT CO.

3979 Cottage Grove Ave., CHICAGO, ILL.



TOY BALLOONS!

SHAMROCKS NOVELTIES

etc.
No. 70—Heavy Circus Balloons, Gross \$2.45
No. 70—Heavy Gas Transparent, Gross \$2.25
No. 75—3-Color Panel Prints, Gross \$2.75
No. 15—Silk Shamrocks, Best quality male, 1 Gross to a Box, Gross \$1.90



No. 22—Wire-Covered Shamrocks, with Clay Pipes, Hats, Snokes, Flags, etc., Gross \$2.20
No. 70—Round Green Balloons, Gross \$2.45
No. 15X—Green Paper Shakers, Doz., 45c; Gross \$4.50

Samples of all above, 50c, postage prepaid. Catalog free on request. 25% cash with all orders, balance C. O. D.

M. K. BRODY, 1118-1120 So. Halsted Street, CHICAGO, ILL.



SPECIAL Valet Auto Strop Razor

Complete with Strop.
25c Each
In 100 Lots.
Sample, Postpaid, 40c.
Deposit required with all orders.

Karl Guggenheim, Inc.
45 West 17th Street, NEW YORK CITY

2 New Oncs



No. 441—Men's. No. 374—Ladies'.

GENUINE STERLING SILVER RINGS

The biggest flash of the season, heavy, open in the back. Set with South African imitation gems. Men's ring set with 2K stone and 2 beautiful sapphires on each side. Ladies' ring set with 1K brilliant stone, Egyptian mounting, fancy engraved. Stones have a blue-white glitter. Takes a diamond expert to detect them from the genuine. Each, \$1.85. Sample of both, \$3.50, parcel post prepaid. Half a dozen of each kind, \$19.75. 25% deposit required on all orders. Write for our Catalog and Monthly Circular.

MEXICAN DIAMOND KING, Chicago, 19 South Wells Street.

FOR SALE—In first-class running condition, complete organ and engine, Herschell-Spillman 16-Sweep, 3 Breast Merry-go-Round, galloping horses and animals. Late, up to date. First \$1,100 takes it. Waste no stamps unless you have the cash. C. J. HUBBARD, 321 Indiana Ave., Toledo, O.

THE BABIES IN THE BOTTLE
And lots of other Curiosities for sale. THE NELSON SUPPLY HOUSE, 514 E. 4th St., So. Boston, Mass.

WANTED TO BOOK

With reputable show having a string of pairs, 42-passenger Daugler, the ever Chair-a-plane, the flashiest side on the road. Also No. 12 Fish Wheel. No. 13. Address DICKINSON, 214 East 139th St., New York.

MONEY! MONEY! MONEY!



Will be made by the wise Jobber and Operator who buys these snappy, fast selling and smallest dolls ever turned out.
Platinum finish brilliant white stone rings that experts can't tell from genuine diamonds. BUT WAIT! A beautiful Photo inserted in each ring that makes it the greatest novelty of the day. Hold it to your eye and behold a work of art. Displayed in a handsome velvet pad and 12 Rings, complete, with a 40-hole Miniature Sales-board, for only **\$5.00**

Stores eat them up at \$10.00 each. Order a sample AT ONCE. If C. O. D. include 25% deposit. Money refunded if not satisfactory.
Do you use Trade Boards? We are the originators of the 200-hole Midget Leader Poker-Hand Board. Price, \$28.50 per 100, or \$4.00 per Dozen.
LIPAULT CO.
Dept. B, 1028 Arch Street, Philadelphia

Billboard Callers

NEW YORK OFFICE
Phil Isser, president, and I. Trebish, secretary, the Capital Outdoor Shows, Robert Lusse, Sr., representing Lusse Bros., amusement engineers. Manager Williams, Belvedere Beach, Keansburg, N. J. Louie G. King, general agent of tented attractions. Charles L. Cohn, agent Just Married Company (formerly agent of the Capital Outdoor Shows). Giuseppe Crisafulli, clarinetist of symphony orchestras. Jack H. Smith, inventor and manager of the Psycho-Aeroplane ride. Sam Wagner, manager World's Circus Side Show, Coney Island. H. D. Johnston, announcer of cowboy sports. H. Ike Friedman, well-known general agent (en route Pensacola, Fla., to Waterbury, Conn.). Emil Gelb, constructor of swimming pools (en route to Woodlawn Park, Trenton, N. J.). Jos. A. McKee, constructing engineer Miller & Baker, amusement builders. H. A. Bauscher, Maple Grove Park, Lancaster, Pa. Mr. and Mrs. Jack Klug, representing King Bros. (Wild West). Clint

for Holtkamp Minstrels). Alonzo Govern and Lukie Johnson, composers. Mahara-jah, the mystic. Gaines Brothers (off with six weeks' bookings). Gladys Peake and Miss Marsh, Canadian showgirls (the latter returning home for the Lenten season). Happy Kimball, comedian. Prof. A. A. Wright, bandmaster of Holtkamp's Minstrels, and Cuban Edards, tight-wire performer of the same company. Aaron Thompson and Paul Sullivan, of the Log Cabin Life Company. Flornoy Miller, co-star of *Running Wild*, playing Brooklyn, and A. W. Jackson, of the same show, a son of J. A. Jackson. Happy Holmes (off to Boston to assemble a tabloid company). Billy B. Jones, singer and writer (in from Washington, where he closed a six months' tour). J. R. B. Whitney, advertising representative of the Negro Press Association. Louis Scholer, of the *Cape Smoke* cast. "Piccolo" Jones, musician.

T. A. Wolfe Shows

Within a few weeks the T. A. Wolfe Shows will inaugurate their new season. Work at the winter quarters at Camp Gordon, Atlanta, Ga., has assumed the brisk home-stretch speed. A squad of

TARGET PRACTICE LITTLE PERFECTION



Write us if in Want of Machines of Sales-boards. Send for Catalog.
REX NOVELTY CO., 2848 Southport Avenue Chicago.

THERE ARE BUT TWO MORE



But two more issues remain before the big Annual Spring Number of The Billboard makes its bow.

Have you placed your order?
The harbinger of the outdoor show season. The tang of sawdust. Can you feel the urge?

LET'S GO!

ORDER BLANK

THE BILLBOARD PUBLISHING CO., Cincinnati, O.:

Please enter my subscription for one year, for which I enclose \$3.00. I understand the Spring Number issue, March 21, will be included in my subscription at no additional cost.

Name

Address

City....., State.....

W. Finney, general representative Miller Bros. 101 Ranch Shows. Mrs. Paul DeVully, well-known horsewoman and trainer. Mrs. Nellie Robbins (formerly Mrs. Charles Robbins). Mrs. H. D. Johnston, wife of the well-known general announcer. J. E. Pool, impersonator of rube characters, a grand-stand attraction. Paul Walker, diminutive comedian, formerly of Lollitop Company. Thomas P. Marrion, of the C. M. Walker Attractions, Rochester, N. Y. John Lowell Russell, formerly well known in things theatrical. King Karlo, well-known attraction and manager of attractions. Victor Lee, late of the Morris & Castle Shows. Barney Demarest, exploiting attractions for Wirth & Hambl. Jimmie Burke, concessionaire. Frank J. Haggerty, general agent the World at Home Shows. Frank Moore, representing Tex Austin, Inc. Andrew Downie (in from Philadelphia). J. J. McCarthy, manager of attractions, Grand View Park, Singac. N. J. J. W. Bayley and wife (Billy), well known in showboat circles. Francis P. Loubet, director of symphony orchestras. Irving J. Polack, manager World at Home Shows.
Callers at J. A. Jackson's desk: Martin Free (in from Chicago to become agent

painters was added to the working lists in order to have wagons, show fronts, the cars and all equipment in bright colors by the first of March.
The figures for the proposed new Wax Exhibition arrived at Camp Gordon recently. This attraction will be housed in a modernly arranged tented theater, with a ballyhoo of moving and seemingly alive wax figures.

A prominent visitor to winter quarters was Hon. William Stackhouse, of Marion, S. C. Other visitors were E. C. Buchanan, of Moscow, O.; A. F. Dirrell, of Springfield, O.; Mrs. Valt Hacker, of Waukegan, Ill. and W. E. Sullivan and family, of Roodhouse, Ill., who stopped while on a trip to Florida.

Mr. Wolfe was under the weather for a week, but at this writing he is up energetically attending business in connection with the coming season for his large amusement organization. The writer is at his home, Columbus, O., for the present. He has added a well-known city editor and Indiana newspaper man to the publicity department, and will also have as an assistant a lady story writer.
DOC WADDELL
("Just Broadcasting").

RO-CO-CO
THE SUPER-NOVELTY KNIFE
WRITE FOR ILLUSTRATED PRICE LIST
Whitsett & Company, Inc.
212-26 N. Sheldon St. CHICAGO, ILL.

SLOT Machines
Very Best Profits Obtained This is the **BANNER**
1925 Model MINT VENDERS AND OPERATORS BELL MACHINES.
10-50-100-250-500 Styles.
New Improved 1925 Model. Write or wire.
BANNER SPECIALTY CO.,
608 Arch Street, PHILADELPHIA, PA.

RAINCOAT MEN
You have been wanting something new in RAIN-COATS. We have just what you need.
YELLOW SLICKERS
College Yellow Oil Skins. Large Patch Pockets. Corduroy Collar, with Strap.
\$33.00 Dozen
SAMPLE COAT, \$3.00
GAS MASK RAINCOATS, \$1.65 Each
In Dozen or Gross Lots.
25% deposit with order, balance C. O. D.
BLUE LABEL RAINCOAT CO.,
51 East Broadway, New York

Perfect Indestructible Pearls
THREE-STRAND NECKLACE
Best Quality Guaranteed Indestructible. Complete with assorted colored crystal cut with Birthstone
\$12.00 PER DOZEN
24-in. Indestructible Pearls, \$3.50 per Doz.
30-in. Indestructible Pearls, \$4.00 per Doz.
4-Strand Bracelets, \$7.50 per Doz.
All of above have sterling silver rhinestone clasps. Samples of above four numbers, \$2.50, postage prepaid 25% with order, bal. C. O. D. Catalog free on request.
M. K. BRODY
1118-1120 So. Halsted Street, Chicago, Ill.

Want---Great Eastern Shows---Want
PLACE Merry-Go-Round, Ferris Wheel and Merry Mix-Up, Jenkins, Dillinger, Dixon and Pop Irish, wire. PLACE Shows with own outfits that don't conflict. Concessions all kinds open. No exclusive. Address all mail and wires Birmingham, Alabama. T. S.—Place General Agent immediately.
It helps you, the paper and advertisers, to mention The Billboard.

UNBREAKABLE
WRITE FOR CATALOG
UNGER DOLL & TOY CO.,
270-286 Fourth Ave., MILWAUKEE, WIS.

5 Sticks of CHEWING GUM
Full Size - 5 Sticks to the Pack
SPEARMINT, PEPPERMINT, FRUIT FLAVORS.
For Premiums, Concessions and Shows. Packed in Flashy Packs. You can double your money quick.
Also Novelty Packs and New Ideas in GUM, BALLOONS, GIVE-AWAY GUM, etc. We make all kinds. One-third deposit required.

Helmet Gum Shops, Cincinnati, O.
ST. PATRICK DAY NOVELTIES

- | | |
|--|--------------------------------|
| 100 Shamrocks..... | \$1.00, \$2.00, \$3.00, \$5.00 |
| 100 Green Jumping Frogs..... | 2.00 |
| 100 Green Crickets..... | 2.00 |
| 100 Green Bow Badges and Pins..... | 4.50 |
| 100 Green Carnations..... | 2.00 |
| 100 Green Crepe Ties..... | 7.00 |
| 100 Green Pipe Holders..... | 3.75 |
| 100 Green Tin Routers..... | 9.00 |
| 100 Green St. Patrick Hats..... | \$3.50 and 6.50 |
| 100 Green Vaive Balloons..... | 4.00 |
| 100 Green Ladies' Aprons..... | 12.00 |
| 100 Green Wire Snakes..... | 7.00 |
| 100 Green Weed Snakes, Per Dozen..... | 1.50 |
| 100 Green Tin Alligators on Wheels, Per Dozen..... | 2.75 |
| Green Pin Flags, Per Gross..... | 2.00 |
- FREE—ST. PATRICK CIRCULAR—FREE.**
Terms: Half deposit. All goods sold F. O. B. Cleveland. No personal checks accepted. Post-Office or Express Money Order.

NEWMAN MFG. CO.,
1293 West 9th Street, CLEVELAND, O.

Wanted for Luna Park
HOUSTON, TEXAS.
Man with first-class equipment for Marionette and Punch Theater. Must be capable. For long engagement. Season opens April 15. Wire quickly lowest salary. Will rent space to first-class Pony Track Concession. Glass blowers with complete outfit write. FOR SALE—Derby Race, 12 horses, good condition, \$150.
Advertise in The Billboard—You'll be satisfied with results.

THE TIME TO SAVE MONEY IS ALL THE TIME

IT IS EASY WHEN YOU DEAL WITH US

SALESBOARDS

The Factories have made another advance, taking effect Feb. 15. OUR PRICES ARE STILL THE SAME. Single boards and up at December Factory List. 20% Quantity rebate on orders for \$75.

ASK US FOR LIST TODAY.

Some Boards To Close Out at Half of List Prices.

ASIATIC PEARLS

BIGGEST VALUE FOR THE MONEY

- 24-INCH STRINGS, \$3.75 DOZEN
- 30-INCH STRINGS, \$4.75 DOZEN
- 36-INCH STRINGS, \$5.50 DOZEN
- 60-INCH STRINGS, \$7.50 DOZEN

SPECIAL PRICES IN GROSS LOTS. GOOD DISPLAY BOXES, \$1.75 DOZEN.

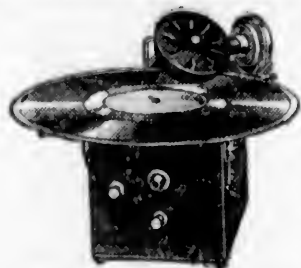

THE CAMERAPHONE

A first-class Phonograph in camera size and style. A sensational success. \$8.00 Each.

FAIR TRADING CO., Inc. - 307 6th Ave. - NEW YORK

Sensational Money Maker For You

THE BIGGEST, MOST ATTRACTIVE QUICK SELLER OF THE YEAR. EVERY MERCHANT BUYS TWO OR MORE. ANDERSON—A NEW MAN—CLEARS \$125 WEEKLY. Olander, Lockwood, Young, Woods, Henry and others clean up \$10 to \$25 daily. WHY? Because we have the fastest selling big money maker on the market. EVERY BUSINESS MAN BUYS ON SIGHT. Auto Dealers and Garages use them for prices, announcements and used car sales. The Real Estate for property listings. Restaurants for bill of fare. Banks, Millinery, Cigar, Barber and Business Stores all use them. NEATEST, MOST ATTRACTIVE CHANGEABLE SIGN MADE. Easy to change. A child can set up any wording in a jiffy. Nothing better as a side line for spare-time salesmen. A FAST SELLER AND BIG MONEY MAKER—GET BUSY. Order a supply at once—better still, order the Bargain Outfit. You don't need any experience to make big quick money. You can't lose. Order today. Don't delay. You can make from \$10 to \$25 the very first day out. Order today!! Start making big money quick.

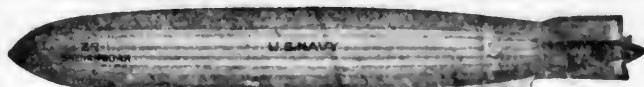

SIX ZR-1 FREE

Retail for **\$7.50** Our Latest Hit Size 13x21 inches

Retail **\$1.25 each** To Introduce You Get 6 FREE with

BARGAIN No. 7

A new, unique attraction of National Interest, complete with a 3-line changeable panel, with 165 letters, etc., and 6 show cards for all lines of business. The biggest and most complete combination sign on the market. Sells like HOT CAKES.

Two Best Places TO EAT HERE AND HEREAFTER

Special Sample Bargain No. 7—To Get You Started

Money back if you want it. Sells for \$26.50. Costs you \$5.00. Profit \$21.50. YOU CAN SELL EASILY IN 4 OR 5 HOURS. We made up this SPECIAL SAMPLE OUTFIT to convince you that JIFFY SIGNS are the fastest sellers of the day. Bargain consists of:

2 JUMBO No. 9, with Letters. Sell for \$2.00 Each.	\$4.00
4 JIFFY No. 33, with Letters. Sell for 1.00 Each.	4.00
2 SILVERINE No. 4, with Letters. Sell for 1.50 Each.	3.00
2 JIFFY No. 48 1/2, with Letters. Sell for 1.50 Each.	3.00
4 JUMBO No. 103, with Letters. Sell for 1.25 Each.	5.00
6 ZR-1, with 6 Showcards and Letters free. Sell for \$1.25 Each.	7.50

COSTS YOU ONLY \$5.00. SELLS FOR \$26.50. PROFIT \$21.50 FOR A FEW HOURS' WORK. Cash with order. No shipments C. O. D.

PEOPLE'S MANUFACTURING CO.
564 W. Randolph St., Dept. BB CHICAGO, ILL.

JUMBO NO. 9
THE BIG LETTER SIGN
MERCHANTS EVERYWHERE
BUY IT ON SIGHT
THE BIGGEST SIGN HIT OF THE YEAR

Jumbo No. 9—12x18 inches. Metal, black enamel faced. Complete with 350 letters. 2 lines. Big value and good seller. Sample, \$1.25.
12, BY EXPRESS...\$9.00

JIFFY NO. 48 1/2
THE BIGGEST SIGN
BARGAIN TODAY
SENSATIONAL HIT

No. 48 1/2—Size, 10x12 inches. A 4-line metal sign, fitted in a polished mahogany wood frame. Complete with 200 letters. Sample, by mail, \$1.00.
12, BY EXPRESS...\$6.00

LET JUMBO
ANNOUNCE YOUR
SPECIAL SALES

Jumbo, No. 103—7x13 inches. Dimpled metal, with 165 large letters. This sign can be read from a long distance. A popular and big seller. One, by Mail, 60 Cents.
12, BY EXPRESS...\$4.00

NEW SILVERINE
THE SIGN THAT
BRINGS YOU
\$20 A DAY

Silverine, No. 4—7x13 inches. Looks like hammered silver. Complete with 200 letters. Most beautiful sign made. Tremendous seller. Sample, by Mail, 60 Cents.
12, BY EXPRESS...\$4.00

JIFFY NO. 33. THE
CHANGEABLE SIGN
HIT OF THE YEAR

Jiffy, No. 33—7x13 inches. 200 letters, etc. An attractive sign for a thousand uses. Everybody buys. Sample, by Mail, 50 Cents.
12, BY EXPRESS...\$3.25

HAMILTON
GUARANTEED SALES
30 to 10000 BOARDS PUSH AND PULL CARDS
BEST SALES BOARD IN AMERICA - BABY OR MIDGET
Wholesale Only.
HAMILTON MANUFACTURING COMPANY
Hamilton Buyers MINNEAPOLIS, MINN. Valuable 32 Page Catalog Free to Buyers

Full 5 CENT Package of Good Chewing Gum for 1 CENT
FRUIT DELICIOUS FRUIT FLAVOR
SPEARMINT NATURAL MINT FLAVOR

Three Delicious Flavors Fruit, Spearmint, Peppermint.
In beautiful, flashy packages, packed five full-size penny sticks to the package, twenty packages to the box, 100 boxes to the case for shipment. Price, 1c a Package, 20c per Box, or \$20.00 per Case, F. O. B. Nashville, Tenn. Terms, Net Cash. We make all kinds Gum for Premiums, Schemes, Concessions and Give-Aways. If interested, write: NATIONAL CHEWING GUM COMPANY, 215 Second Avenue, North, NASHVILLE, TENN.

Indestructible Pearl Necklaces
24-inch, Rose, White or Cream, with Rhinestone Safety Clasp. (Standard Merchandise) Dozen\$3.50
24-inch, A-1 Selected, Perfect Graduation, Rhinestone Double Safety Clasp. Dozen: 6.00
24-inch, Special French, Small Graduation, Perfect, Cream White. Dozen..... 9.00
Leatherette Covered Satin-Lined Boxes. Dozen 2.25
Special Velvet Covered Boxes. Dozen 5.00
All Spangler Necklaces sold under a money-back guarantee.

Spangler
160 N. WELLS ST. CHICAGO ILL.

JULIETTE
Increase Your Sales 100% IMMEDIATELY
10 BIG FLASHES, 90 REAL BALLS PER 1,000 PACKAGES.
An Article of Value in Each Package.
CREAM CARAMEL WRAP CANDY
\$45.00 per 1,000, \$22.50 per 500, \$11.25 for 250.
Deposit of \$10.00 required on each 1,000.
THE DEE CANDY CO.
728 W. Randolph St., Chicago, Ill.

WONDER SWEET SUPREME PRIZE PACKAGE
25 to 30 Banner Prizes to every 250 packages. Prizes include Watches and many other big Banner Numbers.
\$10.50 FOR 250 PACKAGES.
\$20.00 FOR 500 PACKAGES.
\$39.00 FOR 1000 PACKAGES.
25% deposit is required on all orders, balance C. O. D.
Immediate delivery. State how you wish shipped.
WONDER CONCESSION CO., 19 South Wells St., Dept. 305, Chicago.

JUNE 1st WE WILL RELEASE TO OUR TRADE THE GREATEST SALES STIMULATOR EVER MADE. CIRCULAR ON REQUEST.
HAMILTON MFG. CO. 413 South 5th St. MINNEAPOLIS, MINN.

THE END OF CLOSED TERRITORY

Our Concealed Salesman can be used anywhere! When closed it looks like a fine box of cigars, but when opened discloses a salesboard with a stunning 5 color lithographed heading. The headings pay out as follows:

- 1,500 Holes---5c. Takes in \$75. Pays out \$27.50
- 1,500 Holes---10c. Takes in \$150. Pays out \$55.

\$2.50

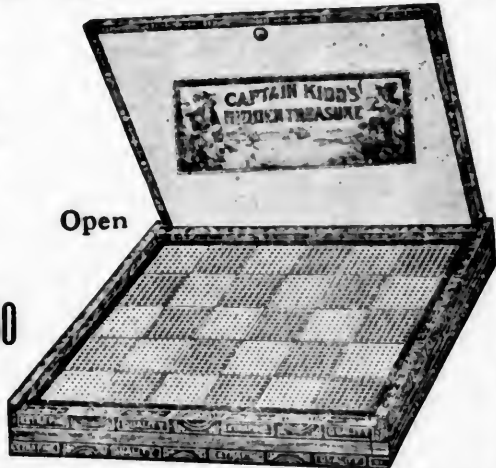

Open

Be the First With This Idea in Your Territory

Get on our mailing list for free descriptive circulars every month. Send us your name. Manufactured by THE FIELD PAPER PRODUCTS COMPANY, Peoria, Ill.

Salesboard Operators



No. 63 Assortment **35 Boxes**
 20-\$.30 Boxes
 10-.60 Boxes
 5-.75 Boxes
 3-.85 Boxes
 2-1.50 Boxes
 1-4.00 Box for last sale
PRICE \$7.50
 600-Hole 5c Salesboard FREE

No. 64 Assortment **55 Boxes**
 25-\$.40 Boxes and Oriental Baskets
 10-.60 Boxes
 8-.75 Boxes
 5-.85 Boxes
 2-1.50 Boxes
 1-2.00 Basket Chocolates and Cherries
 1-3.00 Basket Chocolates and Cherries
 1-4.00 Basket Chocolates and Cherries
 1-7.00 Basket Chocolates and Cherries
 1-10.00 Basket for last sale
PRICE \$19.50
 1,200-Hole 5c Salesboard FREE

Special Discount to Quantity Buyers. Send for Complete Assortment Catalog. One-third Deposit. Balance C. O. D.

WEILLER CANDY COMPANY,
 1209 Clybourn Ave., Chicago, Ill.

SHAMROCKS and ROSES

FOR ST. PATRICK'S DAY



SILK SHAMROCKS — A perfect reproduction of the national emblem of Ireland. Covered with green silk, about 1 1/2 inches wide by 2 inches long. (One gross in box.)
 No. 93N16. Per Gross..... **80c**
 No. 93N15. Better quality. Per Gr... **90c**



CELLULOID ROSE — A splendid reproduction of a genuine Irish rose, green-leaf back, two-layer red rose, glass head center. One gross roses in box.
 No. 3N501. Per Gross **55c**

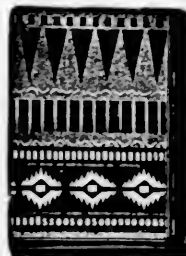

Special Indian Blankets

Getting top money at all indoor shows. Wool mixed, extra large size, wonderful colors. Showmen, compare our new Blankets with what you are using. Samples and prices upon request.

Always in Stock
Big Chief, Esmond and Beacon Blankets

Thousands of new and dependable items in our fall and winter "SHURE WINNER" Catalog, No. 104. Yours for the asking.

N. SHURE CO. MADISON AND FRANKLIN STS. CHICAGO

SCENIC PILLOWS—New York, Coney Island, Washington, D. C., Niagara Falls, Etc.

LARGE SIZE PILLOWS \$9.60 Dozen



SILK-LIKE CENTERS NEW FREE CIRCULAR
 For Carnivals and all kinds of Merchants



BIG HIT SALESBOARDS
 Color Display on Boards
 600 Holes, 8 Pillows... \$ 8.00
 800 Holes, 12 Pillows... 11.50
 1,000 Holes, 12 Pillows... 12.00
 1,000 Holes, 16 Pillows... 15.00
 1,500 Holes, 71 Prizes, 10 Pillows, 36 Pennants, 24 Dolls, Leather Pillow for Last Sale 20.00

ALL KINDS OF LODGE EMBLEMS AND AMERICAN LEGION.
 SPECIAL PULL CARD WITH LEATHER PILLOW. 50 PULLS BRINGS \$9.00 FOR \$2.50.
 For Quick Action Wire Money With Order. Ship Same Day Order Received. 25% Deposit, Bal. C. O. D.
WESTERN ART LEATHER CO., DENVER, COLO.
 P. O. BOX 484 - TABOR OPERA BUILDING.

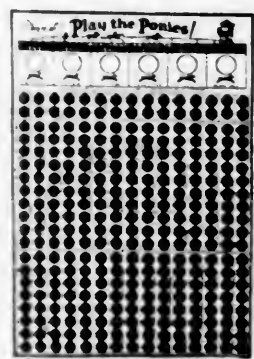

The Sport of Kings **PLAY THE PONIES** The King of Sports
ANOTHER WONDERFUL MONEY GETTER
 That will repeat and repeat and repeat. Made the same as our nationally known "PLACOLOR", and selling like "Hot Dogs" at a circus.

A Most Thrilling and Fascinating Game THAT SELLS TO STOREKEEPERS AT **\$1.00 each, \$10.00 per doz., \$80.00 per 100**
PRICE TO SALESBOARD AGENTS AND JOBBERS
 Sample, \$1.00, \$6.00 per doz., \$40.00 per 100 (Transportation charges prepaid.)
 Terms: Cash with order, or one-third deposit on C. O. D. orders. Originated and Manufactured by
ARTHUR WOOD & CO.
 219 Market St., St. Louis, Mo.



SUPREME PRIZE PACKAGE
 FASHION DAINTIES—a package that beats them all. Candy nut chocolate caramels. Wonderful assortment of prizes and balls. We pay all express charges.
\$45.00 per 1,000. 200 for \$9.00
 Twenty Rolls to Case. Send \$9.00 for sample carton of 200. Remember, we pay all express charges. 25% deposit required.
DELIGHT CANDY CO.
 64 University Place, NEW YORK

RAINCOATS AND APRONS



GAS MASK RAINCOATS— Diagonal gabardine cloth, heavy red rubber lining. **1.90** Each, Doz. Lots
 Sample Coat, \$2.00

GRAYLING ALL-WEATHER COATS— Grey Whipcord cloth, slate plaid, rubber lined. **2.25** Each, Doz. Lots
 Sample Coat, \$2.50

\$3.00 Doz. RUBBERIZED HOUSEHOLD APRONS. 20 different designs, gingham and percale. **\$30.00 Gross**

\$3.50 Doz. DOMESTIC PURE GUM APRONS. Full size. All colors. Can be worn either side. **\$36.00 Gross**

\$4.50 Doz. DE LUXE PURE GUM APRONS. assorted colors, worn either side. Does not absorb oils, grease or acids. **\$48.00 Gross**

\$2.00 Doz. Sample SLEEVE PROTECTORS. Made of pure gum rubber, assorted colors. **\$21.00 Gr**

TERMS: 20% on deposit, balance C. O. D. Remit Money Order or Certified Check.

AGENTS: Write for our complete Catalog and Price List of 35 different styles of Raincoats. DEPT. B.
GOODYEAR CO., Inc., 529 Broadway, New York
 NOTE—No connection with any other firm using similar name.

OPERATE A SEEBURG PIANO

Become independent by operating on commission the greatest little money maker in the musical field. Many slot machine operators and others have 100 or more SEEBURG pianos out on commission. Write for details.
J. P. SEEBURG PIANO COMPANY.
 1510 Dayton Street, CHICAGO, ILLINOIS.

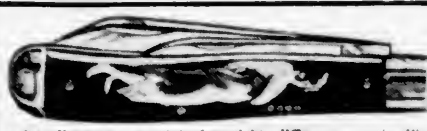

If Your Jobber Cannot Supply You With
"LACKAWANNA PHOTO KNIVES"

write direct to us. Ask for eight different sample Photo Knives priced at \$3.00. Save useless correspondence by sending check or money order for these knives. Money refunded if you wish to return the knives.
LACKAWANNA CUTLERY CO., Ltd., NICHOLSON, PA



SALESBOARD ASSORTMENTS
 30% Discount in Lots of 12 or More. 5% Discount on Single Orders

NO. 75 ASSORTMENT. 29 Boxes Chocolates.	Price, \$6.45	NO. 1 ASSORTMENT. 37 Boxes Chocolates.	Price, \$12.00
20-40c Boxes Choc.		24-40c Boxes Choc.	
8-50c Boxes Choc.		6-50c Boxes Choc.	
2-80c Boxes Choc.		3-75c Boxes Choc.	
8-\$1.00 Boxes Choc.		2-\$1.25 Boxes Choc.	
1-\$3.50 Box Choc.		1-\$2.00 Box Choc.	
600-Hole 5c Board FREE.		800-Hole 5c Board FREE.	

Terms: 25% with order, balance C. O. D. Write for Catalogue.
Theodore Bros. Chocolate Co., Inc., Compton & Park, St. Louis, Mo.

THE
GREATEST
PRODUCTION
OF
WRAPPED
CANDY
IN
THE
UNITED
STATES



THE
LARGEST
CONSUMERS
AND
IMPORTERS
OF
NOVELTIES
IN
THE
WORLD

“FOLLIES OF 1925”

250 PACKAGES
\$11.25

500 PACKAGES
\$22.50

1000 PACKAGES
\$45.00

2500 PACKAGES
\$112.50

\$10.00 Deposit Required on Each Thousand Packages Ordered

A 10c Novelty Candy Package backed
by all the standards that have MADE

THE UNIVERSAL THEATRES CONCESSION CO.

The producer of a greater volume of candy for the Theatrical
Concessionaire than all other concerns in the world put together

FT. WORTH, TEXAS · CHICAGO, ILL. · SAN FRANCISCO, CAL.

Address All Orders and Correspondence to Chicago Head Office

WE IMMEDIATELY TELEGRAPH YOUR ORDER To Our Distributing Depot for Your Territory!

ALL SHIPMENTS ARE THEREFORE MADE INSTANTANEOUSLY!

UNIVERSAL THEATRES CONCESSION COMPANY

RANDOLPH AND JEFFERSON STS., - CHICAGO, ILL.