

# COMMUNICATIONS QUARTERLY

THE JOURNAL OF  
COMMUNICATIONS  
TECHNOLOGY

Spring 1999

\$9.95



U.S. \$9.95



- DEMPHANO: A Practical, Accurate Way to Measure Phase Noise
- The Basics of Speech Processing
- Add an Inexpensive Electro-optical Shaft Encoder to Your Next Project
- How to Make "Stretched" Versions of Loaded Wire Aerials
- Does Polyphase AM Have a Useful Niche in Ham Radio?
- The Half-Square: A Bidirectional Vertical Performer on 2 Meters
- Homebrew a Multi-band, Maximum Power Linear Amplifier
- HBR Fifteen: A "Hot" QRP Project

# Innovative Low Loss Coax Surge Protectors for Broadband Wireless Applications

Specialized Designs for Point to Point, PCS, Cellular,  
WLL, LMDS and Mobile Systems



- Excellent broadband performance from DC thru 3 GHz, compared to the narrowband DC blocked or stub designs. Typical dB loss: 0.1@ 1 GHz; 0.2@ 2 GHz; 0.5@ 3 GHz.
- Innovative impedance compensated thru-line cavity design allows control voltages to pass thru the device, instead of the "wire around" requirement of DC blocked designs. Our design allows "in-circuit" cable sweeps.
- Innovative fast acting gas tube replaceable ARC-PLUG module can be removed and replaced in the field in about one minute with no tools required, and without having to remove the protector from the circuit. The "O" ring sealed knurled knob does the trick!
- The ARC-PLUG module and connectors are "O" ring sealed for complete weatherproofing.

A variety of connector styles are available for stud or bulkhead mounting including type N, 7/16, and others. All of our protector styles include a 1/4x20 stud mounting kit that can be user installed for maximum mounting flexibility.

**Toll free order line (888) 302-8777**

- Model TT3G50, N females, stud mount-----OEM \$30.00 ea.
- Model TT3G50B, N females, bulkhead mount----OEM \$32.00 ea.
- Replaceable ARC-PLUG Cartridge, any model--OEM \$7.00 ea.

Website: [www.alphadeltacom.com](http://www.alphadeltacom.com)

**ALPHA DELTA COMMUNICATIONS, INC.** 

P.O. Box 620, Manchester, KY 40962 • (606) 598-2029 • fax (606) 598-4413  
Alpha Delta - *Compelling You Into the 21st Century*

# COMMUNICATIONS QUARTERLY

THE JOURNAL OF  
COMMUNICATIONS  
TECHNOLOGY

## CONTENTS

Volume 9, Number 2

Spring 1999



page 41

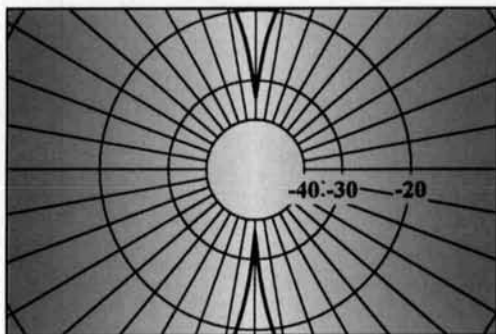

page 65

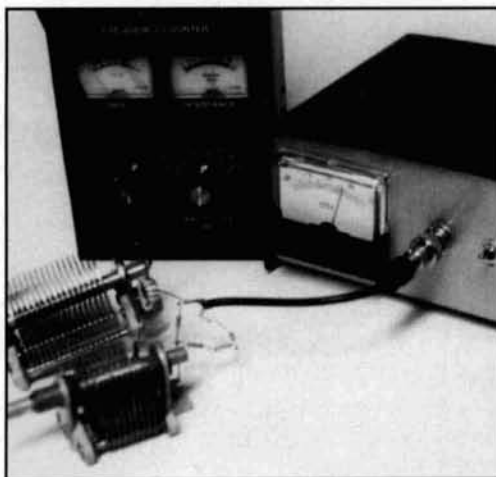

page 81

- 2 **Editorial: Ham Radio + Change = Excitement!**  
*Rick Littlefield, K1BQT*
- 3 **Technical Conversations**
- 9 **"DEMPHANO"**  
*Jacob Makhinson, N6NWP*
- 18 **Science in the News**  
*Douglas Page*
- 21 **The Basics of Speech Processing**  
*Ian Poole, G3YWX*
- 29 **An Electro-optical Shaft Encoder**  
*Parker R. Cope, W2GOM/7*
- 37 **Elevated Radial Wire Systems for Ground-Plane Type Antennas**  
*John (Jack) S. Belrose, VE2CV*
- 41 **Homebrewing an Amplifier Around the Svetlana 4CX400A**  
*Dean D. Battishill, W5LAJ, and W.J. Byron, W7DHD*
- 47 **Polyphase AM**  
*Warren B. Bruene, W5OLY*
- 56 **Quarterly Review**  
*Peter J. Bertini, K1ZJH*
- 59 **Loaded Wire Aerials**  
*F.J.H. Charman, B.E.M., G6CJ*
- 65 **A Bidirectional Vertical Antenna**  
*L.B. Cebik, W4RNL*
- 71 **The Last 100 Years in Communications**  
*Walter J. Schulz, K3OQF/VQ9TD*
- 81 **Transferring Power with the Controlled-Q L Match and a 6-Meter Application**  
*John Pivnichny, N2DCH*
- 89 **HBR Fifteen**  
*M.A. (Mac) Chapman, K16BP*
- 97 **Atmospheric Ozone**  
*Robert R. Brown, NM7M*
- 104 **Tech Notes**  
*Barry L. Ornitz, WA4VZQ*  
*Peter J. Bertini, K1ZJH*

**On the Cover:** In our Spring cover, inspired by M.C. Escher's work "Drawing Hands," Bryan Bergeron, NU1N, shares his impression of amateur radio construction.

## Ham Radio + Change = Excitement!

There were at least 15 people signed in on frequency for the 5:00 o'clock end-of-the-day 75-meter ragchew, but the channel was silent. Eventually, someone said, "Where'd everybody go?"

One by one, the voices returned saying things like: "Oh, I was just checking my e-mail," or "I was just checking the .jggs Dave sent from Johnson Atoll," or "I was just looking something up on a newsgroup."

That's when it hit me. Ham radio today is much as it was 15 or 20 years ago. We have our analog-based SSB, CW, or FM radios, and it's all pretty much the same. My modest little Alinco DX-70 and AL-80B can deliver virtually the same bruising signal as someone else's FT-1000 and ETO amplifier, give or take a couple dB. And, barring severe QRM, we all hear about the same "stuff" when monitoring a frequency. Needless to say, this usually includes a fair amount of static, noise, splatter, and other analog detritus. The truth is, nobody talks much about their radios anymore. Someone could check in with a derelict \$35 HW-12 salvaged from a flea-market scrap pile and no one would be the wiser!

On the other hand, when the topic turns to computers, all hell breaks loose. One guy has a new scanner, another a new high-resolution digital camera, two guys are getting into Linux, and someone else just installed a new motherboard with a dual-channel monster processor. Suddenly, the conversation's downright animated!

Everything you do to a computer seems to make a huge difference. On the other hand, anything you add to a ham radio doesn't seem to make much difference at all. To spunk up your digital life, an exciting new adventure may be as close as your nearest Staples, Circuit City, or Best Buy. To spunk up your radio life, a new adventure could mean spending weeks erecting a monster tower and new beams—only to realize marginal returns.

If anyone working in the amateur radio industry is wondering where all the money has gone, they won't have far to look.

Of course, ham radio won't die. It won't die if CW requirements are eliminated, and it won't die if the 13/20-wpm CW requirement is maintained. It won't die if we increase technical standards, and it won't die if we maintain the same multiple-choice status quo we currently enjoy. But, it probably won't thrive, either.

To put the challenge and spark back into ham radio, small changes must once again make big differences, just as they did when you could throw away your box of crystals and buy a cheap VFO. Or, how about when you could work more DX by using the "Donald Duck" mode, without suffering all that selective fading and heterodynes? What about enjoying local mobile operation more by using 2-meter FM rather than 75 or 40-meter HF? How different was the excitement you experienced as a result of these changing ham radio technologies from the excitement you felt when you experienced the new horizons that opened when you bought your first flatbed scanner or NEC program for your PC?

Come to think of it, right now my modem does a lot of incredible things operating at 28.8 kbt through a squawky phone-line voice channel not much wider than the bandwidth I occupy on 75-meter SSB. Are we missing something here?

Of course, we aren't missing too much. When one member of the 5:00 p.m. round-table wants to send a photo of his new airplane or share a particularly raunchy joke, he can do it via e-mail and attached files. If I want to sell my old Flame-Thrower 2000 amplifier, I can bypass the rigors and malicious QRM of a trader net and reach an international audience of thousands via a swap newsgroup. And we can all share technical information or research obscure topics worldwide! Let's face it, ham radio won't ever catch up with the World Wide Web. Nor should it! We're talking about a goose and a cat—two very different animals.

At the same time, if we want this hobby to be exciting, more fun, alive, and new, as it was in earlier years, it's time to collectively cogitate about the possibilities based on today's technology. For example, wouldn't you enjoy having QRM and static-free digital QSOs on 75 meters, with inaudible digital signals exchanging Fax images when nobody's talking? Changes like this not only could happen, they *should* happen, just as in the past. SSB isn't obsolete yet; but by 2005, it damn well ought to be. Indeed, as long as the new modes give us a tuning knob and a volume control, it will be radio and we will follow! Hopefully, the people who make it happen will spread the word here, in the pages of *Communications Quarterly*.

**Rick Littlefield, K1BQT**

### EDITORIAL STAFF

#### Editor

Terry Littlefield, KA1STC  
**Consulting Technical Editor**  
 Robert Wilson, WA1TKH  
**Senior Technical Editor**  
 Peter Bertini, K1ZJH  
**Managing Editor**  
 Edith Lennon, N2ZRW

### EDITORIAL REVIEW BOARD

L.B. Cebik, W4RNL  
 Forrest Gehrke, K2BT  
 Michael Gruchalla, P.E.  
 Hunter Harris, W1SI  
 Bob Lewis, W2EBS  
 John Marion, W1QM  
 Walter Maxwell, W2DU  
 Jim McCulley, P.E.  
 William Orr, W6SAI

### BUSINESS STAFF

#### Publisher

Richard Ross, K2MGA  
**Advertising Manager**  
 Donald R. Allen, W9CW

#### Sales Assistant

Nicole Tramuta  
**Accounting Department**

#### Sal Del Grosso

#### Ann Marie DeMeo

#### Circulation Manager

#### Catherine Ross

#### Operations Manager

#### Melissa Gilligan

#### Data Processing

#### Jean Sawchuk

#### Customer Service

#### Denise Pyne

### PRODUCTION STAFF

#### Art Director

#### Elizabeth Ryan

#### Associate Art Director

#### Barbara McGowan

#### Electronic Composition Manager

#### Edmond Pesonen

#### Production Manager

#### Dorothy Kehrwyder

#### Production

#### Nicole Tramuta

#### Electronic Composition

#### Pat Le Blanc

#### A publication of

#### CQ Communications, Inc.

#### 25 Newbridge Road

#### Hicksville, NY 11801-USA

**Editorial Offices:** P.O. Box 465, Barrington, NH 03825. Telephone/FAX: (603) 664-2515.  
**Business Offices:** 76 North Broadway, Hicksville, NY 11801. Telephone: (516) 681-2922. FAX: (516) 681-2926.

Communications Quarterly is published four times a year (quarterly) by CQ Communications, Inc. *Communications Quarterly* is the philosophical successor of *Ham Radio Magazine* founded by T.H. "Skip" Tenney, Jr., W1NLB and James R. Fisk, W1HR. Subscription prices (all in U.S. Dollars): Domestic—one year \$33.00; two years \$62.00. Canada/Mexico—one year \$39.00; two years \$74.00. Foreign Air Post—one year \$46.00; two years \$88.00. Contents copyrighted CQ Communications, Inc. 1999. Communications Quarterly does not assume responsibility for unsolicited manuscripts. Allow six weeks for change of address.

Periodical postage paid at Hicksville, NY and additional mailing offices.

**Postmaster:** Please send change of address to Communications Quarterly, CQ Communications, Inc., 25 Newbridge Road, Hicksville, NY 11801. ISSN 1053-9433.

Printed in U.S.A.

# TECHNICAL CONVERSATIONS

## A comment on "Complex Impedance Measurements"

### Dear Editor:

I refer to your article in the Fall 1998 edition of *Communications Quarterly*, "Complex Impedance Measurements" by M.E. Gruchalla.

I had been using the instrument described by D. Strandlund, W8CGD, for many years since the early 1970s. The graphic method of extracting the impedance from the voltage data, used by W8CGD, overcame the need for lengthy calculation, although I became so proficient with the method over the years that I got to know the rough impedance values from the voltage readings without having to draw the intersecting circles. I found the W8CGD method to be very useful when designing matching networks for antennas.

Later, when personal computers with their BASIC language applications became available, I considered that this would be a good way of accurately extracting impedance from the voltage data. Unfortunately, I did not have the mathematical skills to devise the formula, but I managed to get the late Tom Lloyd, G3TML, to investigate the possibilities.

Tom devised the formula and I coded it into the BBC Computer BASIC (which supported inverse trig functions). The results, using GW BASIC, were published in *QEX* in November 1987. This provoked considerable discussion in the following Correspondence columns of *QEX*, including some very constructive corrections by WD8KBW and a suggested simpler formula by WA6OGH that did not use trig functions—very similar to those proposed by M.E. Gruchalla.

Tom's analysis of the non-trig approach was that it was fine, provided there were no errors in the data. Because there are always some errors in the data, a method of identifying them and giving some indication of their magnitude is desirable. The GW BASIC source code enclosed with the *Antenna Compendium* provides this error indication. This code is also available at the RSGB Web site <www.rsgb.org> under *The Antenna Experimenter's Guide* in the books section. Further methods of identifying and reducing errors are described in *Antenna Compendium*, Vol. 5.

I feel that the low signal linearization circuit by M.E. Gruchalla should, on the face of it,

make the instrument useful at much lower excitation levels but I have yet to try it.

**Peter Dodd, G3LDO**  
West Sussex, U.K.

## On "Designing Frequency Synthesizers"

### Dear Editor:

I would like to thank Mr. Helm for the comments in his letter in the Winter 1999 edition of *Communications Quarterly* regarding my article "Designing Frequency Synthesizers." I must agree with him that it would have been nice to address the problem of the spurs generated as a result of the comparison frequency that appear on either side of the main signal. This is a problem that all synthesizer designers face. How to balance the conflicting requirements for the loop filter is not an easy decision to make. However, the thrust of the article was to look at the effects of the phase noise on the performance of the loop, and not those that appear on discrete frequencies. Techniques for reducing these spurs might even be a suitable topic for a future article.

I must, however, disagree with the comment that the noise from the phase detector will not be subject to the multiplication factor  $20 \log N$ , where  $N$  is the division ratio within the loop. This can be explained qualitatively from the fact that the noise from the phase detector is generated at the comparison frequency because the noise from the phase detector results from perturbations at the phase comparison frequency. Even though the resulting noise is applied to the VCO effectively as an "audio" signal, the multiplication factor will still be applied because the same audio voltage will produce a much larger swing at the VCO operational frequency than one operating at the phase comparison frequency. The multiplication effect of phase detector noise is mentioned in a number of publications. It is explained well on page 130 of a book entitled *Phase Noise in Signal Sources* by W.P. Robins, publisher Peter Petergrinus (Institution of Electrical Engineers (UK)). Ulrich Rohde, as mentioned by Mr. Helms, is another excellent source of information on synthesizers.

However I would like to thank Mr. Helm for the comments and interest in the articles. I hope this clarifies the situation.

**Ian Poole, G3YWX**  
Middlesex, England

A full explanation, please

**Dear Editor:**

On page 91 of the Spring 1998 issue of *Communications Quarterly* you state that using 120 volts AC with a 220 volt (sic) neutral raises safety issues. Any safety issue involving high-voltage power supplies immediately gets my attention. Especially since I have built supplies doing the same thing. Notice that almost all buildings in this country are wired that way. I wonder if you have neutral and ground confused.

In any case, you owe your readers a full explanation of the hazards involved.

Thank you.

**Darrell D. McKibbin**  
Ukiah, California

*The senior editor replies:*

**Dear Mr. McKibbin:**

Thank you for your letter concerning W5LAJ's power supply design. I was the tech-

nical editor and draftsman for this manuscript, and it was I who questioned the safety of the design as presented for publication.

First, to clarify matters, I am running a portion of the original schematic to illustrate those concerns (see **Figure 1**).

Please note that the schematic clearly shows the neutral wire being attached to chassis ground. Since the design relies on current flow through the neutral conductor for the 120-volt AC power supply sections, any failure of the neutral conductor between amplifier to breaker box would place deadly voltages between the amplifier cabinet and nearest ground. This failure would probably become painfully evident when the operator happened to remove the last PL-259 going between the exciter and amplifier

In my opinion, any AC-powered device should be grounded back to the fuse box via a dedicated ground wire in the cord and house wiring. To meet these requirements, a three-wire system must be used (Hot-Hot-Neutral and bare GROUND wire) if one attempts simultaneous 120 and 220-volt AC operation

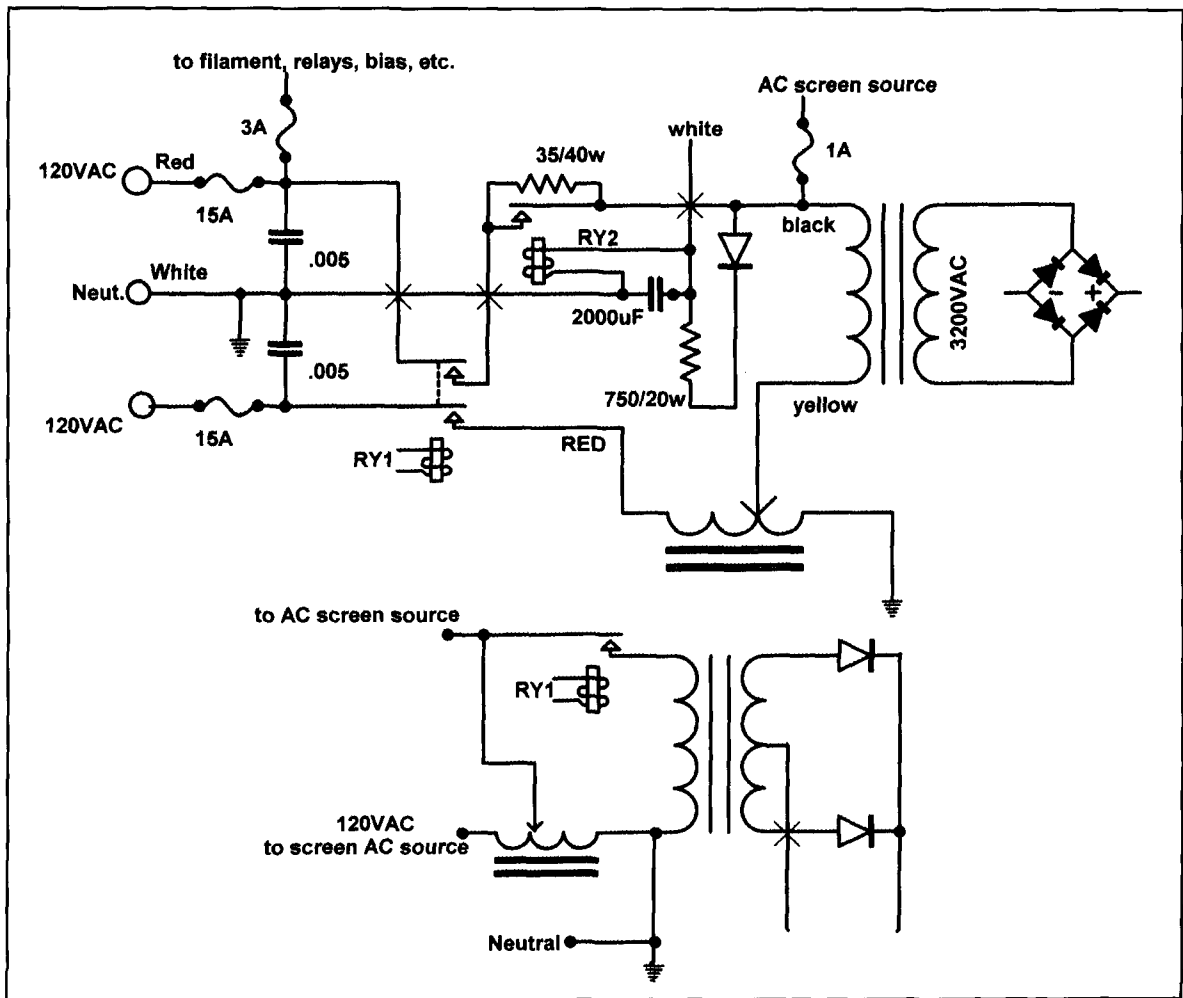

Figure 1. Portion of original W5LAJ schematic highlighting areas of concern.

from a single outlet. The Neutral must only serve as a current carrying conductor, and the ground lead must only serve as a protective ground, and never as current carrying conductor. The Neutral should never be tied to the chassis ground under any circumstances. I am not a practicing electrician, so I would welcome input regarding the use of a four conductor plug and socket for this purpose and whether it would meet the National Electrical Codes. (Sockets and plugs that meet these requirements appear to be reserved for three-phase systems.)

I have also seen too many 220-volt AC homebrew designs using two-wire Romex (using the white and black leads for the hot leads, with a bare ground wire) where the design relied on the bare ground wire for both grounding and 120-volt AC power sections neutral return! This is a doubly deadly combination. Failure of ground return would place deadly voltage levels on the cabinet, and the National Electrical Code is violated by using the ground as a current-carrying device, and no acceptable neutral is in service for the 120-volt AC supplies. Again, the ground wire must only be used for a protective safety ground.

**Peter J. Bertini, K1ZJH**  
Senior Technical Editor

## An interesting comment on amateur radio licensing found online

Well I guess I'll add my 2 cents to a thread full of rhetorical questions. For over two years, I had a Technician class license and really enjoyed it. It's absolutely amazing what you can do and achieve with a Technician class license. There's EME, weak-signal 2-meter, satellite (my personal favorite), repeaters, digital modes—the list is endless. I explored almost all of these, but I always wanted something more. Not because somebody downplayed my license, but for a feeling of personal achievement. Even when I was just a Technician, nothing thrilled me more than to be able to help people.

There has been more than one occasion when I have helped Extra class amateurs with modes they weren't familiar with, particularly satellites and digital modes. Guess what, they were thankful for the help and the class of licenses we held didn't matter, it's just that someone needed help and they got it.

Now that I have upgraded to Tech-Plus, I'm having to turn to some of those who I helped on the HF bands, and I'm getting the help I need.

## Antenna Analysis Software with the User in Mind!

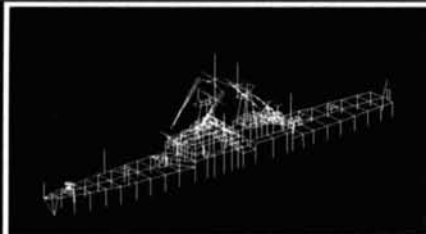

- Easy data entry
- Cut, copy, and paste commands
- Different conductivities for each wire
- Built-in defaults for wire diameter
- Graphical ground plane selection
- Built-in defaults for ground planes
- Transmission lines and networks
- Automatic wire scale, rotate, and translate
- Graphical placement of sources and loads
- 3-D visualization of antenna structure
- Rotate, Zoom and Pan antenna structure
- Tabular data for input impedance
- Polar plots of power gain and electric fields
- Antenna analysis with gain and delta probe
- Comparison of multiple antenna files

# NEW! GNEC-4

☛ Visualize the antenna structure as you design it!

☛ Output your analysis with fantastic plots!

☛ Simplify your design process - Save time and money!

*GNEC-4 includes all of NEC-Win Pro plus the full NEC-4 command set.*

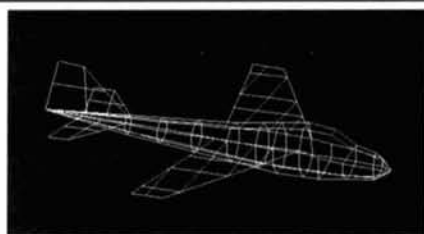

- Arc, Helix, Cylinder, Wires, Surface Patches
- Source/Load/Wire/Current Identification
- Color display of currents on structure
- Numerical Green's Function
- Smith Chart, Polar and Rectangular plots
- 3-D surface plot - antenna displayed in center
- Near Electric and Magnetic fields
- Dialog box input for each command

#### Plotting includes:

Power Gains	Electric Fields
VSWR	Currents
Input Impedance	Axial Ratio
Near Fields	RX Patterns

\*Due to licensing contract, GNEC-4 will only be sold to registered users of NEC-3 or NEC-4

**Nittany Scientific, Inc.**  
1733 West 12600 South, Suite 420  
Riverton, UT 84065  
Phone/Fax: (801) 446-1426  
sales@nittany-scientific.com

nittany scientific inc  
**nsi**

Major credit cards accepted!

Orders shipped via UPS or Airmail within the US or Overseas!

[www.nittany-scientific.com](http://www.nittany-scientific.com)

The people aren't giving me grief because I hold a slow-code class of license, they are just helping me and I'm grateful for the help. One particular local amateur is even going out of his way to help me with my code so I can get it up to a speed where I can pass my General test.

I will never hold anything against someone who has a No-Code ticket, but if you do have one I plead with you to make the most of it. Don't get in the rut of just using it for repeaters and autopatches. The possibilities are endless. It doesn't matter if we hold an Extra ticket or a Novice ticket, we all love amateur radio, each in our way, so let's not bicker the hobby to death. Let's try to keep the hobby going...let's attract new people. Who cares if they don't do CW? They can still add a breath of fresh air and ideas to the hobby.

**Jeff Johns, W4JEF**  
**Birmingham, Alabama**  
 <jeffj@scott.net>

## Taking the Classic Cube one more step

### Dear Editor:

I greatly enjoyed the recent letters to the editor presenting various solutions to the "Classic Cube Problem." It brings to mind a similar but more theoretical problem for a circuit class I took years ago. As I recall, it was given as an

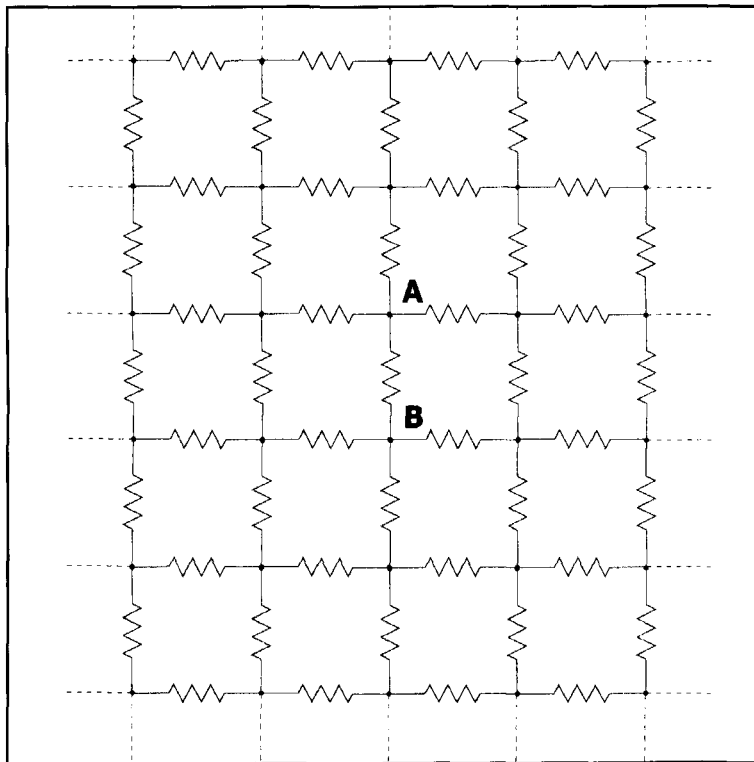

**Figure 1.** Say you have an infinite array of 10-ohm resistors connected as shown. What is the resistance between points A and B?

example of the power of the principle of superposition. This principle can be stated as follows: *In a linear bilateral network with two or more current or voltage sources, the current or voltage of any component is the algebraic sum of the effects produced by each source individually.* In order to calculate the effects of one source at a time, voltage sources are turned off by replacing them with a short circuit, and current sources are turned off by replacing them with an open circuit.

Here's the problem: Suppose there's an infinite array of 10-ohm resistors connected as shown in **Figure 1**. What is the resistance between points A and B?

The solution is much easier than might appear at first glance. First connect the far ends of all those resistors out at infinity to ground. This will have an infinitesimally small effect on our calculation. Next, connect the positive terminal of a 1-amp constant current source point to point A and the negative terminal to ground. By symmetry, the current in the four resistors connected to point A divides evenly so that 1/4 amp flows in each. Finally, rearrange the current source so that the negative terminal is connected to point B and the positive terminal to ground. Again, by symmetry, the current in the four resistors connected to point B is 1/4 amp. By using the principle of superposition, and adding the results of these two tests, we have a total current of 1 amp flowing from point A to point B, and a current of 1/2 amp flowing from point A to point B through the common resistor between them. This produces a voltage across that resistor of 5 volts ( $V = 1/2 \text{ amp} \times 10 \text{ ohms}$ ). We can now quickly calculate the resistance between points A and B as follows:

$$R_{ab} = V_{ab}/I_{ab} = 5 \text{ volts}/1 \text{ amp} = 5 \text{ ohms.}$$

**Jim Taylor**  
**Tempe, Arizona**

## A rebuttal

### Dear Editor:

The title of the letter written by Joe Gagliardi appearing in the Winter 1999 *Communications Quarterly* falls short of the contents. "In defense of the study of elevated radials" offers no defense. It simply calls my comments "overpowering" and "dogmatic." Gagliardi somehow believes my suggestion we measure properly has an effect of "discouraging experimentation" and "curiosity."

In my opinion doing things correctly is what science is all about. Very little useful knowledge is gleaned with flawed data or methods! It takes very little extra time or effort to do things properly, rather than sloppily.

I can't understand why Mr. Gagliardi thinks that proper measurements have a negative



impact on technology. It makes more sense that wild claims based on flawed or improper measurements are at the root of continuing debates. If theorists would simply break out a good old-fashioned field-strength meter and spend less time at the computer modeling things (or measuring totally nebulous parameters like radial current), the articles would become both meaningful and useful.

Gagliardi fails to point out exactly where my response "went wrong," or how it discourages experimentation. His letter simply calls a point-by-point technical response "dogmatic" and other names.

There is nothing "dogmatic" about explaining how measurements should be made. Mr. Gagliardi obviously has either not read my response, doesn't understand what the authors claimed, or can't understand my technical rebuttal to what amounted to poor scientific methods and unfounded technical claims.

**Tom Rauch, W8JI**  
Barnesville, Georgia

The debate goes on

Dear Editor:

I am writing in regards to the Belrose letter to the editor published in *Communications*

*Quarterly*, Winter 1999, pages 5, 6, and 7 regarding the conjugate match.

The impedance at any point in a circuit as determined by dividing the voltage across the circuit at the point by the current at that point always determines the *load* impedance. The direction of current flow is into the *load* impedance. The source impedance at that point cannot be determined by that measurement.

A commonly used example to prove this point is to turn on a 100-watt light bulb. The resistance of the bulb with 120 volts applied is:  $R = V^2/W = 120^2/100 = 144$  ohms. This is definitely *not* equal to the output (source) impedance at the AC receptacle on the wall. This is typically only a fraction of an ohm which is necessary to maintain good voltage regulation. It definitely is not 144 ohms as Belrose spends pages trying to prove.

Also, most hams know that SWR in a coax is determined only by the *load* impedance (and coax loss if significant). the SWR is not determined at all by the source impedance at the input to the coax.

The major error in Belrose's reasoning is his *assumption* that RF power amplifiers are tuned and operated for "maximum available power

(Continued on page 108)

M<sup>2</sup>

SEE THE DIFFERENCE

**NASA USES OUR ANTENNAS FOR THEIR PROJECTS, SHOULDN'T YOU?**

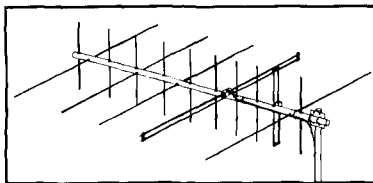

DUAL BAND AND SINGLE BAND YAGIS FOR ANY APPLICATION

CIRCULAR POLARIZED AND CROSS POLARIZED YAGIS FOR SATELLITE AND MOONBOUNCE SYSTEMS

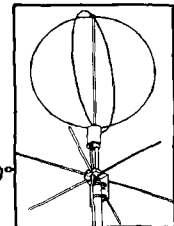
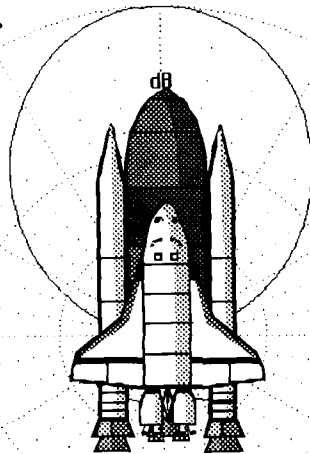
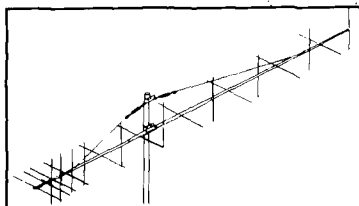

HORIZONTAL / RIGHT HAND CIRCULAR POLARIZED 70CM / 2M EGGBEATERS

6M, 2M, 70CM, 220 MHZ OMNI DIRECTIONAL HORIZONTAL LOOPS

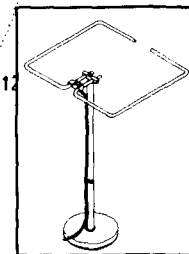

**SEE US A DAYTON BOOTH # 627**

M2 Antenna Systems, Inc. 7560 N. Del Mar Fresno, CA 93711  
559-432-8873 Fax 559-432-3059 E-Mail:m2sales@aol.com



# TECHNICAL BOOKS

the antennas & propagation collection



## Microstrip Antennas

**David M. Pozar and Daniel H. Schaubert**

430 pages of antenna designs, theoretical and practical techniques for microstrip antennas. Covers element types, feed systems, polarization, bandwidth improvement and more.

IE-14 ..... \$80.00



## Antenna Engineering Handbook

**Richard C. Johnson, editor**

The most widely-used reference for antenna engineering from VLF to microwaves, covering all standard antenna types and more. Each chapter written by an expert contributor.

MH-4 ..... \$120.00



## Introduction to Radio Propagation for Fixed and Mobile Communications

**John Doble**

Basic insight into fixed-link and mobile radio propagation effects. Includes data on in-building systems and diversity techniques.

AH-48 ..... \$69.00

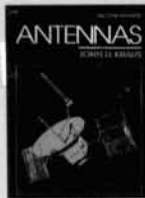

## Antennas

**John Kraus**

A classic text by an important researcher and teacher, required for any antenna design reference library. Has a good combination of strong theory and practical applications.

MH-14 ..... \$89.00



## Radiowave Propagation and Antennas for Personal Communications

**Kazimierz Siwiak**

A thorough review of propagation in mobile environments, antenna types and their performance. Includes a program disk.

AH-7 ..... \$89.00



## Phased Array Antennas

**R.C. Hansen**

Detailed coverage of both practice and theory in the design and analysis of antenna arrays, from sidelobe considerations to superdirectivity and HTS antennas.

JW-28 ..... \$98.00



## The ARRL Antenna Book

**Gerald L. Hall, editor**

A practical guide to the design and construction of antennas for HF through microwave, valuable data for amateur and professional designers and experimenters.

AR-2 ..... \$30.00

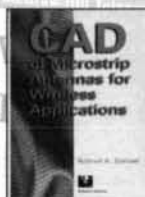

## CAD of Microstrip Antennas for Wireless Applications

**Robert A. Sainati**

Provides understanding of microstrip antennas and supplies the tools for design work. Written for engineers who are not antenna specialists.

AH-59 ..... \$89.00

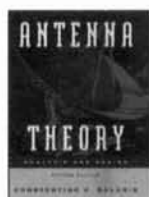

## Antenna Theory: Analysis & Design, Second Edition

**Constantine A. Balanis**

Emphasis on design, with a solid theoretical foundation. Excellent coverage of antenna terminology and performance parameters.

JW-11 ..... \$103.00



## Ionospheric Radio

**Kenneth Davies**

An especially well-written and understandable text on radiowave propagation. A complete summary of all aspects of solar-terrestrial interaction and its effects.

IN-1 ..... \$88.00

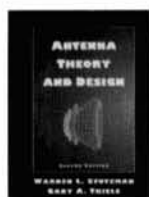

## Antenna Theory and Design, Second Edition

**Warren L. Stutzman and Gary A. Thiele**

New edition covers resonant, broadband and aperture antennas, lines and feeds, arrays, systems and electromagnetic modeling.

JW-29 ..... \$100.00

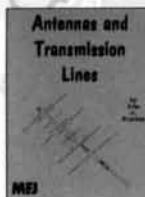

## Antennas and Transmission Lines

**John A. Kuecken**

A handy collection of short, to-the-point chapters with the basic design equations for various antennas, matching, self-impedance, noise and radio range prediction.

MF-2 ..... \$20.00

THE POWER OF INFORMATION

[www.noblepub.com](http://www.noblepub.com)



## Crestone Technical Books

Division of Noble Publishing Corp.

4772 Stone Drive  
Tucker, GA 30084  
Tel: 770-908-2320  
Fax: 770-939-0157

Order today by phone, fax or on the web, using your VISA, Mastercard or American Express!

# "DEMPHANO"

## A device for measuring phase noise

Phase noise, and its effects on receiver performance, has received a great deal of attention in professional and amateur radio literature in the past few years. *The ARRL Handbook* provides a fine treatise on this subject.<sup>1</sup>

While frequency synthesizers are becoming common in all commercial amateur radio transceivers and some home-built equipment, for some stringent high-performance applications requiring high dynamic range, a free-running LC VFO may still be the device of choice.

Defining the phase noise requirements of the VFO is an essential task in the initial receiver design stage. An oscillator with a high level of close-in phase noise may reduce the receiver's ability to separate closely spaced signals. In addition, due to the so-called reciprocal mixing,<sup>1</sup> the noise sidebands of the oscillator can mix with strong off-channel signals causing in-band interference. This interference may overwhelm the weak signal, essentially causing desensitization of the receiver. On the other hand, a high level of far-out phase noise may raise the receiver's noise floor at the receiving frequency causing degradation of the receiver's dynamic range.

The purpose of this article is to provide the designer with a practical method of accurate phase noise measurement. An example illustrates the method for specifying the phase noise requirements for a VFO. A free-running LC VFO has been designed as a part of a portable 20-meter band transceiver. A 12-pole crystal filter described in **Reference 2** provides adjacent-signal rejection of 100 dB at 2.2-kHz offset. From **References 3** and **4**, the maximum acceptable close-in phase noise level at 2.2 kHz offset are:

$$L_c = P - 10\log(BW_{-100}) = -100 - 10\log(4400) = -136 \text{ dBc/Hz} \quad (1)$$

where:

$L_c$  = VFO close-in phase noise spectral noise density in dBc/Hz at offset  $BW_{-100}/2$  Hz

$P$  = crystal filter rejection in dB at offset  $BW_{-100}/2$  Hz  
 $BW_{-100}$  = crystal filter bandwidth in Hz at the specified rejection level

At larger frequency offsets, the phase noise level should be such that the phase-noise-governed dynamic range (PNDR) is equal or better to the spurious-free dynamic range (SFDR).

Assuming the PNDR equals the SFDR at 110 dB in a 2.5-kHz IF noise bandwidth, from **Reference 3** the maximum acceptable far-out phase noise level is:

$$L_f = -\text{SFDR} - 10\log(BW) = -110 - 34 = -144 \text{ dBc/Hz} \quad (2)$$

where:

$L_f$  = VFO far-out phase noise spectral density in dBc/Hz at large frequency offsets (100 kHz)

$BW$  = estimated IF noise bandwidth in Hz

### Block diagram

Phase noise measurement techniques are described in detail in the literature.<sup>5,6,7,8</sup> The scope of this article is limited to the method involving two frequency sources maintaining phase quadrature. As a general phase noise measurement tool it offers the best versatility and measurement accuracy. The block diagram of the measurement system is given in **Figure 1**.

The device under test (DUT) is a free-running LC VCO tuned to 6.144 MHz to match the frequency of the reference oscillator. The reference oscillator is built around a standard 6.144-MHz microprocessor crystal. It is assumed that the phase noise contribution of the reference source is insignificant compared to that of the VFO. One of the two oscillators must have provisions for electronic tuning to accomplish quadrature phase locking. In this example, the DUT is equipped with tuning for convenience; a tunable VXO as a reference

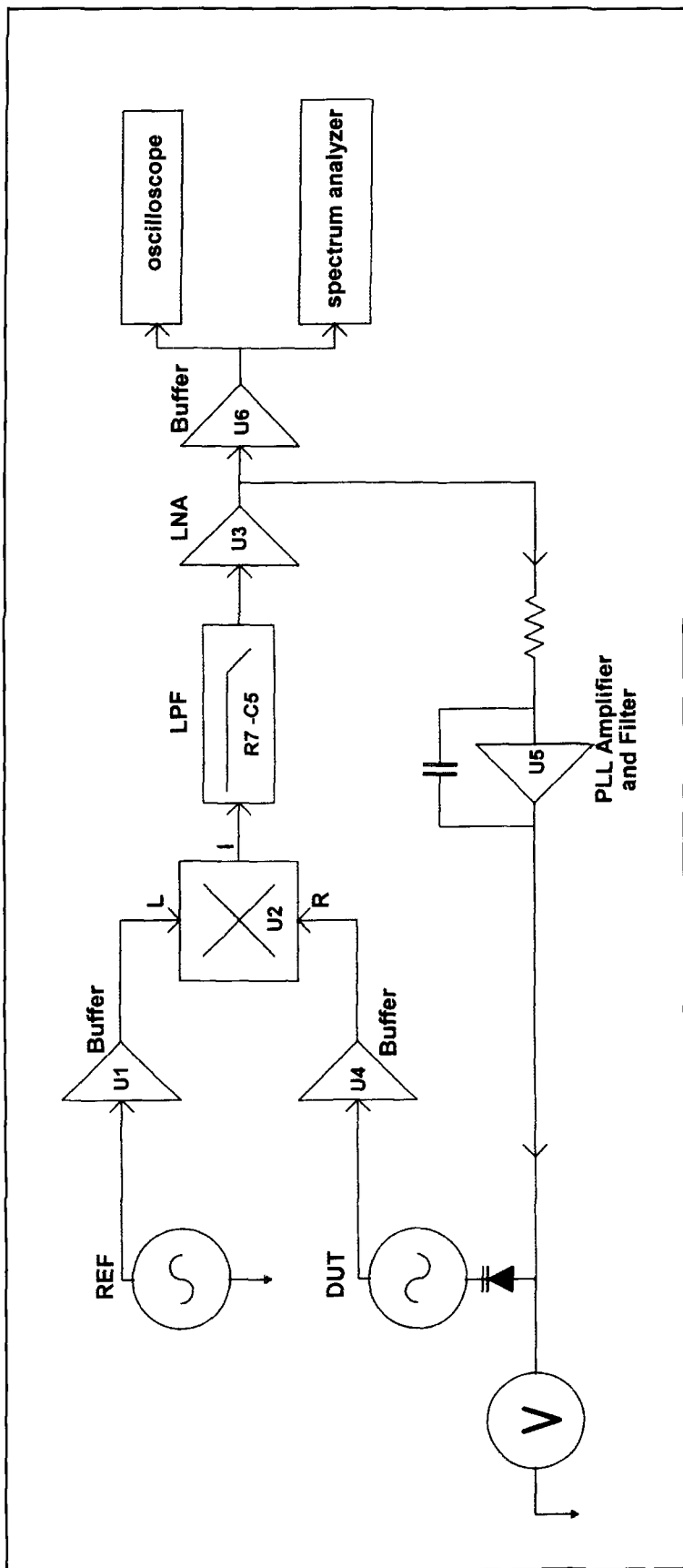

Figure 1. Block diagram.

source may be more appropriate if the DUT is a frequency synthesizer. Buffers U1 and U4 prevent injection locking of the two frequency sources. Mixer U2 serves as a phase detector. To properly use a double-balanced mixer as a phase detector, it is important that a quadrature is established and the mixer is used in its linear range.<sup>8</sup> Low-pass filter R7-C5 removes the conversion products that lie outside of the frequency range of interest: 0 to 100 kHz. The LNA built around U2 ensures that the full dynamic range of the spectrum analyzer is used, and the noise floor of the measurement system is not limited by the noise floor of the spectrum analyzer.

Buffer U6 is required to drive the 50-ohm input of the spectrum analyzer. The oscilloscope serves as a convenient way to monitor the progress of the PLL toward a quadrature lock. U5 is the loop amplifier—it produces the control voltage that causes the VCO to tune until it is at the same frequency as the reference source; the error voltage at the phase detector output returns to the nominal value of zero volts.

## Schematic diagram

The schematic diagram of the measurement system appears in **Figure 2**.

Buffers U1 and U4 have sufficient bandwidth to cover the HF band; measurements over the VHF band are possible if the buffers are replaced with devices with wider bandwidth. Resistors R1 and R12 discourage parasitic oscillations. Resistor R5 and the output impedance of U1 present a 50-ohm termination to the RF port of mixer U2. Resistor R16 and the output impedance of U4 present a 50-ohm termination to the LO port of the mixer.

U2 is a low-distortion high-LO level mixer. It ensures linear operation with signals up to 4 volts p-p at the J1 connector. The crystal oscillator should be able to provide a 8 to 10 volts p-p voltage swing at J2 to ensure that the required +17-dBm drive is applied to the LO port of the mixer. Resistor R6 presents a 50-ohm termination to the IF port of the mixer.

Networks R7-C5 and R23-C19 form a 2-pole low-pass filter to remove undesired frequency conversion products. A simple RC filter was chosen over an LC filter to ensure a flat noise gain response over the frequency band of interest. The -1 dB point of the filter is set to 150 kHz; it limits the phase noise measurement frequency range to 100 kHz.

U3 is a low-noise amplifier. Its noise contribution to the overall system noise can be neglected. The non-inverting configuration was chosen over the inverting configuration to preserve the flatness of the noise gain response. Resistors R10 and R11 set the gain of the

amplifier; R11 is the gain control used during the calibration process.

R17, R20, C18, and U5 comprise the so-called Type 2 second-order loop. Being the most popular loop type, it offers almost infinite DC gain and independent selection of natural frequency of the loop and its damping factor. The proper selection of loop components is important and deserves a few comments. From the PLL theory from **References 5 and 9**:

$$\omega_n = (K_v * K_d / \tau_1)^{1/2} \quad [1] \quad \zeta = (\tau_2 * \omega_n) / 2 \quad [2] \quad (3)$$

where:

$$\tau_1 = R17 * C18 \quad \text{and} \quad \tau_2 = R20 * C18$$

$\omega_n$  is the natural frequency of the loop

$\zeta$  is the damping factor

$K_v$  is the VCO Gain factor (tuning sensitivity) in radians per second per volt

$K_d$  is the phase detector Gain factor in volts per radian

Because the PLL suppresses noise within its loop bandwidth, the -3 dB-point of the closed loop transfer function  $f_{-3\text{dB}}$  should be chosen below the lowest offset frequency to be analyzed.

To accommodate the offset frequency range from 10 Hz to 100 kHz, the  $f_{-3\text{dB}}$  is set to 3.5 Hz. The value of the damping factor is not critical for this application and is set to 0.7. The -3 dB-bandwidth of a Type 2 second-order loop is a function both  $\omega_n$  and  $\zeta$ :<sup>5,9</sup>

$$\omega_{-3\text{dB}} = \omega_n * \{2\zeta^2 + 1 + [(2\zeta^2 + 1)^2 + 1]^{1/2}\}^{1/2}$$

$$\text{for } \zeta = 0.7 \quad \omega_{-3\text{dB}} = 2 * \omega_n \quad (4)$$

Resistors R17 and R20 can be found from **References 1 and 2**:

$$R17 = (K_v * K_d) / (\omega_n^2 * C18);$$

$$R20 = 2\zeta / (\omega_n * C18) \quad (5)$$

where:

C18 is set to 100  $\mu\text{F}$

$$\omega_n = (2\pi/2) * f_{-3\text{dB}} = \pi * 3.5 = 11 \text{ rad/sec}$$

$$\zeta = 0.7$$

$K_d = 0.38 \text{ V/rad}$  - is obtained from Mini-Circuits data sheets

$$K_v = 12 * 10^3 \text{ rad/sec/V}$$

The VCO Gain factor  $K_v$  is obtained by applying a DC voltage to the VCO frequency control terminal and measuring the frequency deviation  $\Delta f$  in Hz per 1 volt of control voltage change  $\Delta V$ .

$$\text{Gain factor } K_v = (2\pi\Delta f) / \Delta V \text{ rad/sec/V} \quad (6)$$

The VCO gain factor is a non-linear function of the control voltage and must be measured

Table 1. Phase noise versus frequency.

Offset from carrier (Hz)	Measured phase noise (dBc/Hz)	SSB phase noise (dBc/Hz)
10	-75*	-81
100	-99	-105
1k	-128	-134
2.2k	-138	-144
10k	-155	-161
100k	-159	-165

\*The noise measurement at 10 Hz is affected by the proximity of the -3-dB point of the loop bandwidth. Because the loop has a suppressing effect on the noise within the loop bandwidth, the actual noise level at 10 Hz is slightly higher.

around the nominal value (around 1 volt DC; the Q of the varactor diodes is too low below 0.7 volts, and the tuning sensitivity is too low above 2 volts DC).

The calculated resistor values are R17 = 390 k and R20 = 1.2 k.

With these loop component values, the acquisition time is very long. The speed of the acquisition can be improved by widening the loop bandwidth. This is a form of so-called aided acquisition<sup>9</sup> and is accomplished by placing a much smaller resistor in parallel with R17.

SW1, a 3-position toggle switch, places R22 in parallel with R17 to achieve a fast phase lock ("LOCK" position). SW1 should be in the middle position during the measurement period ("NORMAL" position). In the third position ("CALIBRATION"), a short is placed across the feedback components R20 and C18. In this mode, the phase lock is broken and a beat signal is produced at J3.

Finally, U6 serves as a buffer. Resistor R27 and the output impedance of U6 form a 50-ohm termination required at the input of the spectrum analyzer.

## Calibration

The system calibration should be performed before every noise measurement to ensure measurement accuracy. The HP3585A spectrum analyzer is used for the phase noise measurement. In its "Noise Level" mode, it measures the rms noise spectral density in the frequency range between 0 and 40 MHz. The noise-level reading indicates the noise spectral density at the marker, normalized to a 1-Hz noise power bandwidth. The spectral noise density at the instrument's noise floor is -147

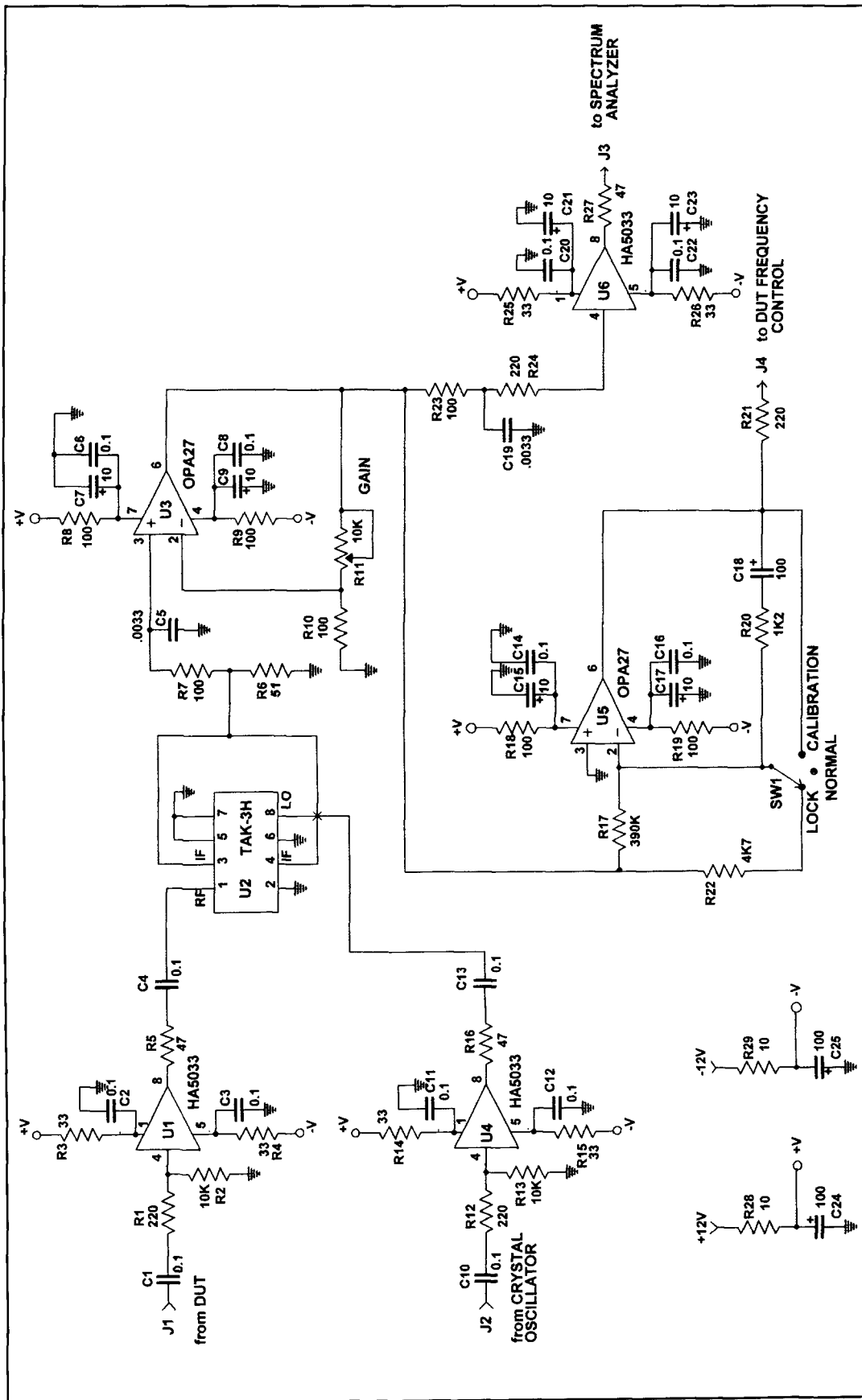

Figure 2. Schematic diagram.

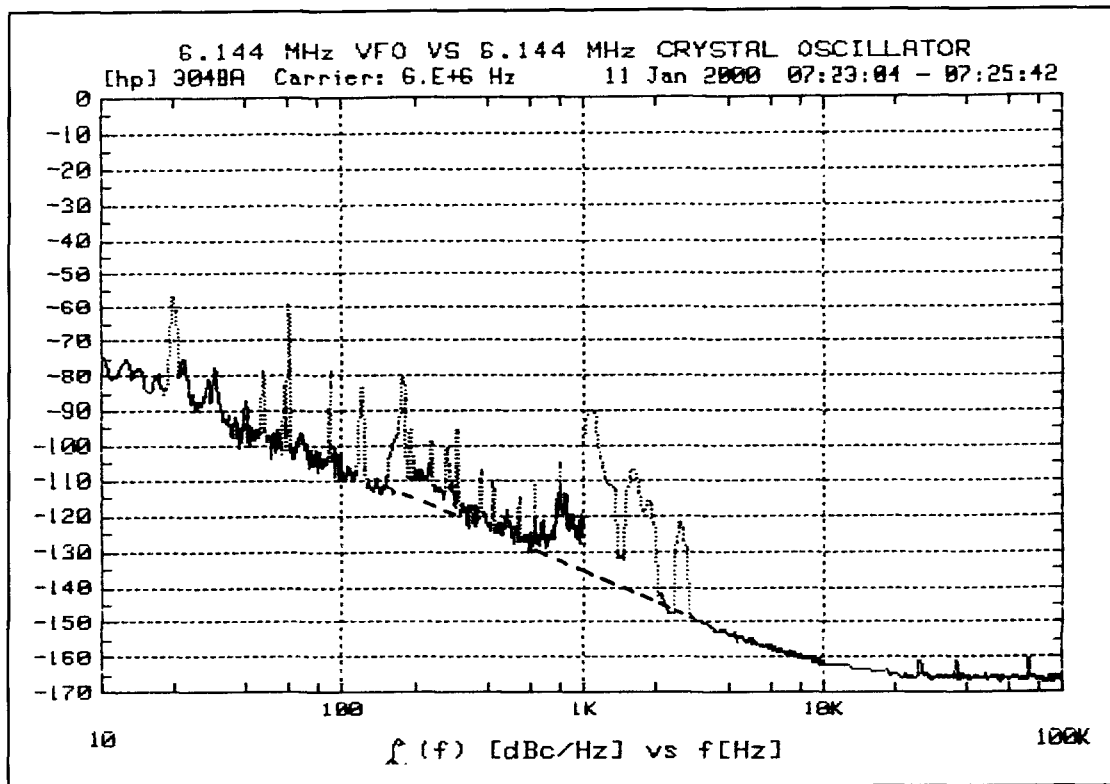

Figure 3. HP3048A phase noise plot.

dBm/1 Hz. Because the phase noise is measured relative to the carrier (dBc/1 Hz), the measurement range can be widened by raising the carrier level. If the carrier level (or the beat signal in our case) is raised to +20 dBm, the measurement range is widened to 167 dB (-167 dBc/1 Hz), which should be sufficient for most practical applications.

The calibration procedure is given below:

1. Apply power to the system and allow sufficient time for the frequency of the VFO to stabilize.
2. Toggle the switch momentarily to the "CALIBRATION" position; verify the presence of a beat frequency at J3 using the oscilloscope.
3. Disconnect J3 from the oscilloscope and connect it to the 50-ohm input of the spectrum analyzer.
4. Vary the VCO frequency to set the beat frequency anywhere between 5 and 50 kHz.
5. Set the analyzer marker to the peak of the signal; set the beat signal level to +20 dBm using the "GAIN" control R11.
6. Activate the "OFFSET" function and press the "ENTER OFFSET" button. The noise measurement floor has been moved down this way from -147 dBc/1 Hz to -167 dBc/1 Hz.
7. Vary the VCO frequency to set the beat frequency to 12 kHz;  $f_{\text{BEAT}} = f_{\text{REF}} - f_{\text{VFO}}$ .

8. Toggle the switch momentarily to the "LOCK" position; the beat signal disappears if lock is established.

9. Monitor the value of the control signal at J4 with a voltmeter. The voltmeter reading should be between 1.0 and 2.0 volts DC, otherwise adjust the VCO frequency slowly to bring the value of the control signal into the desired range. If the lock is broken in the process, re-establish it by toggling the switch again. If the voltmeter is AC powered, disconnect it prior to the measurement.

10. Activate the "NOISE LEVEL" function and the "dB (1 Hz)" reading should appear; it is equivalent to "dBc (1 Hz)."

11. Activate the "RANGE" function and set the value to -25 dBm. The instrument noise floor (after the "OFFSET" procedure) can be verified by disconnecting the signal from the input connector. The system is ready for a phase noise measurement.

## Measurement

The "NOISE LEVEL" function built into the HP3585A spectrum analyzer greatly simplifies the phase noise measurement process. The correction factors associated with equivalent noise bandwidth and detector type are automatically included in the readout.<sup>11</sup> The noise value is measured 100 times and averaged to reduce the

Table 2. The components of the phase noise measurement fixture.

Component	Part Number	Note Number
board	Vector 8007; Digi-Key #V1049-ND	1
connectors J1 - J4	BNC, Receptacle Vertical PC, Amphenol, ARF1066-ND	2
buffers U1,4,6	Harris, HA3-5033-5, DIP	3
amplifiers U3,5	Burr-Brown, OPA27GP-ND, DIP	2
mixer U2	Mini-Circuits, TAK-3H	4
potentiometer R11	Philips, 10k, Multiturn, CT9W103-ND	2
resistors	0.25 watt, 5%	surplus
capacitors, ceramic	Panasonic, type X7R, 5 or 10 %	2
capacitors, electrolytic	AVX, TAP series, tantalum, 16 volts DC 10 % tolerance	3

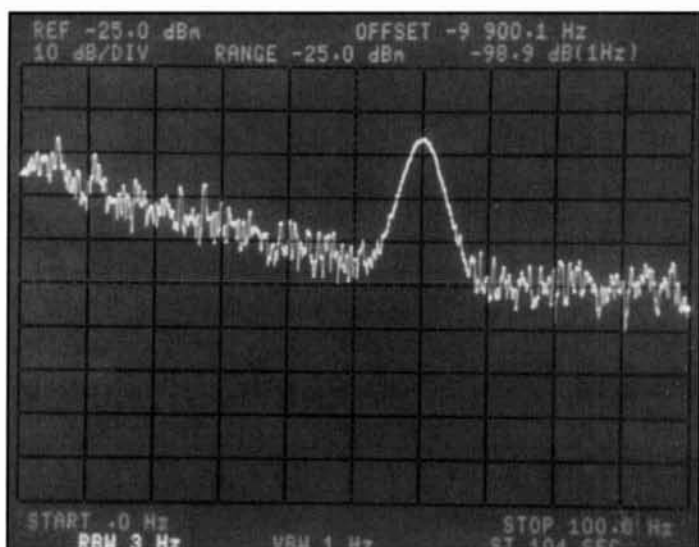

Photo A. Phase noise measurement, 100-Hz sweep. Display marker is at 100 Hz.

variance of the reading. The HP3585A can perform linear sweep only; it does not provide sufficient frequency resolution in a single sweep over 4 decades of desired frequency coverage (from 10 Hz to 100 kHz). Therefore, the desired frequency range is covered in three separate sweeps: 0 to 100 Hz, 0 to 10 kHz, and 0 to 100 kHz.

The measurement procedure is given below:

1. Set the "STOP FREQUENCY" to 100 kHz, "RESOLUTION BW" to 100 Hz, and "VIDEO BW" to 30 Hz. Place the marker at 100 kHz and record the readout in "dB/1 Hz".
2. Set the "STOP FREQUENCY" to 10 kHz, "RESOLUTION BW" to 30 Hz, and "VIDEO BW" to 10 Hz. Record the readout at 1 kHz, 2.2 kHz, and 10 kHz. The noise measurement

at 2.2 kHz is required in order to verify whether the initial close-in phase noise level requirement has been met.

3. Set the "STOP FREQUENCY" to 100 Hz, "RESOLUTION BW" to 3 Hz, and "VIDEO BW" to 1 Hz. Record the readout at 10 Hz and 100 Hz. The 60-Hz leakage should have no effect on the measurement, but if it is excessive, a battery-operated power supply should be considered.

**Table 1** shows the results of the phase noise measurement. The spectrum analyzer measures noise from both noise sidebands, which add linearly at the mixer output. The SSB noise of the original RF signal is obtained by simply subtracting 6 dB from the measured results.<sup>6,7,8,10</sup>

**Photos A, B, and C** show the HP3585A measurements results for three different frequency sweeps.

A phase noise test using the HP3048A Phase Noise Test System was performed to verify the accuracy of the measurement results in **Table 1**. The HP3048 phase noise plot is provided in **Figure 3**. The phase detector method has been used where the 6.144-MHz oscillator served as the reference oscillator. The few breaks in the phase noise curve are due to injection locking. Examination of the HP3048 phase noise plot shows excellent agreement with the measurement results in **Table 1**.

## VFO

The schematic diagram of the VFO is shown in **Figure 4**. Because the VFO was designed for portable operation, the design criteria were simplicity, a minimum number of parts, and low-power consumption.



L1, the tapped tank coil, is wound around an iron-powder toroidal core; the unloaded Q of the coil exceeds 300. C4, C5, C7, and C8 are NPO ceramic capacitors. C6 has a temperature-compensating characteristic to compensate for the positive temperature coefficient of the toroidal core. C2, an air-variable capacitor, tunes the frequency from 6.0 to 6.35 MHz to accommodate a 20-meter transceiver with an 8.0-MHz IF. The loaded Q of the resonator is kept high by using a tapped coil and loose coupling to the gate of Q1 through C8. J310 was selected as the active component because of its very low noise level in the HF frequency range. Resistor R5 is adjusted to set the Q1 drain current equal to 4 mA.

Q2-Q3 is a push-pull buffer. It has excellent linearity and low output impedance. Resistor R6 discourages parasitic oscillations, and resistor R12 sets the output impedance of the buffer equal to 50 ohms.

Two back-to-back varicaps, D1 and D2, and associated circuitry serve as a means of adjusting the VFO frequency to match the frequency of the reference oscillator during the phase noise measurement. Switch SW1 disconnects the adjustment circuit after the measurement is completed.

U1 and associated components provide the VFO with a regulated 9-volt supply. Bias current setting resistor R13 sets the regulator standing current equal to 2 mA. The overall VFO current drain is under 9 mA.

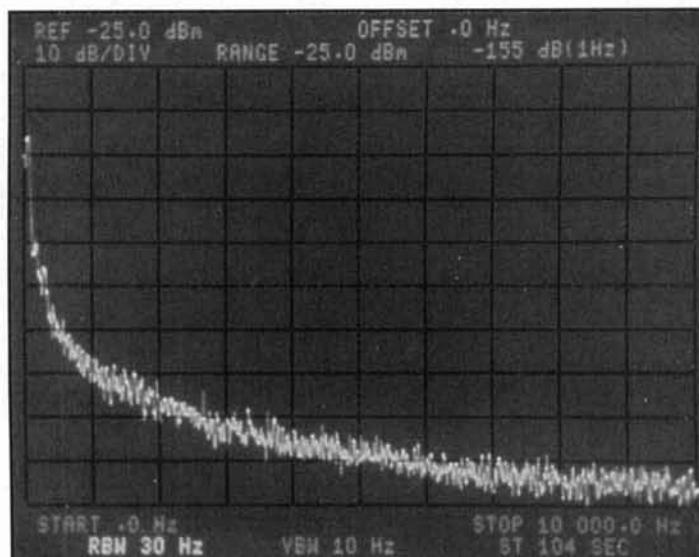

Photo B. Phase noise measurement, 10-kHz sweep. Display is at 10 kHz.

Despite the simplicity, the phase noise of the VFO is quite impressive. The design goals were met with a healthy margin. Several guidelines intended to minimize the phase noise level were implemented in this design:

1. High unloaded Q of the resonator,
2. Light coupling between resonator and FET to avoid saturation and maintain high loaded Q,
3. Low L/C ratio,

Table 3. Details of the VFO components.

Component	Part Number	Note Number
aluminum box	Rolec, 806-0007, 3.1 x 4.7 x 2.4 inches	3
board	Vector, 8007; Digi-Key # V1049-ND	1
BNC connector	BNC, Receptacle Vertical PC, Amphenol, ARF1066-ND	2
toroidal core, L1	T-94-6	5
FET, Q1	J310	3
diodes, D3, D4	1N4148	3
transistor, Q2	2N4401	3
transistor, Q3	2N4403	3
varicaps, D1, D2	NTE612, ECG612	3
voltage regulator, U1	LM317MP	3
RF chokes, L2, L3	Delevan, DN2568-ND, 100 uH	2
resistors	0.25 watt, 5%	surplus
capacitors, ceramic	Panasonic, type X7R, 5 or 10 %	2
tank capacitors	Philips, COG 100 volts, 13xxPH-ND	2
t° comp. capacitor, C6	Philips, N750 100 volts, 1309PH-ND	2
capacitor air-variable, C2	Oren Elliott, N-50, 15 blades-5160	6
trimmer capacitor, C3	Xicon, 2.7-10pF, 242-2710, NPO	7
feed-thru capacitors, C15, C16	1000 pF	surplus
capacitors, electrolytic	AVX, TAP series, tantalum, 16 volts DC, 10% tolerance	3

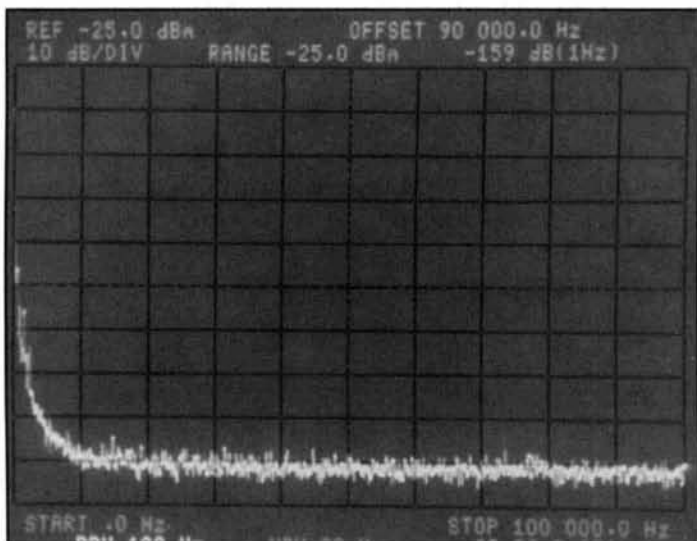

Photo C. Phase noise measurement, 100-kHz sweep. Display marker is at 100 kHz.

4. Active device with a low noise figure and low phase perturbation (J310),
5. Unbypassed source resistor to reduce flicker noise,
6. No gate clamping diode,
7. Energy coupling directly from the resonator (via C9).

More information on minimizing the phase noise can be found in **Reference 5**.

The implementation of the 6.144-MHz crystal oscillator is not critical. Practical examples of crystal oscillators are provided in **References 1 and 12**.

## Construction

### A. Phase noise measurement fixture

The components of the measurement fixture are mounted on Vector 8007 board (perforated, with a solid copper plane on one side). The components are mounted on the copper side, which serves as a ground plane. The ground side of bypassing components is soldered directly to the ground plane.

Input (J1-2) and output (J3-4) terminations are implemented via BNC connectors soldered directly to the board. At this frequency range, there was no need to enclose the board in a metal box, but it should be considered at higher frequency ranges.

**Table 2** serves as a guide for procuring the necessary components.

### B. VFO

The VFO is enclosed in a diecast aluminum box to ensure mechanical rigidity and provide

RF-tight construction. The DC power and the control voltage are delivered via feed-thru capacitors to avoid RF leakage. The air-variable capacitor is attached to one of the side walls of the box with three screws. The VFO output is delivered via a BNC connector attached to another side wall.

The VFO components are mounted on a piece of a Vector board. Layout isn't critical, but the component leads are kept short. The tank coil L1 is built by tightly winding 22 turns of #16 AWG enameled copper wire on a T-94-6 iron-powder toroidal core tapped at three turns and 14 turns from the cold end. The coil is covered with low-loss polystyrene Q dope for enhanced stability. The inductance of the coil is 3.26  $\mu$ H.

SW1 is a wire jumper that is removed after completion of the testing procedure.

The VFO component details are provided in **Table 3**. Dealer information is provided at the end of the article.

## Summary

Commercial equipment that is capable of measuring low levels of phase noise (like the HP3047 or HP3048 Phase Noise Test System) is quite expensive and far beyond the reach of most amateurs.

The measurement method described above offers a much more economical alternative. It presumes access to the HP3585A spectrum analyzer. Although discontinued years ago, this versatile instrument is still quite common and can be found in most well-equipped labs. It can also be found on the surplus equipment market at a price under \$8,000.

In the absence of the HP3585A, any low-frequency spectrum analyzer can be used; however, a different calibration procedure would have to be developed using the rationale described previously. In addition, several correction factors associated with analog spectrum analyzers<sup>6,7,8,10,11</sup> would have to be applied to the readout to ensure measurement accuracy. ■

## REFERENCES

1. *The ARRL Handbook*, ARRL, Newington, Connecticut, 1998, pages 14.4-14.13 and 14.24-14.28.
2. Jacob Makhinson, N6NWP, "Designing and Building High-Performance Crystal Ladder Filters," *QEX*, January 1995, pages 3-17.
3. Peter Chadwick, G3RZP, "Phase Noise Intermodulation and Dynamic Range," *Frequency Dividers and Synthesizers IC Handbook*, Plessey Semiconductors, 1988, page 151.
4. Mohammed Nezami, "Evaluate The Impact of Phase Noise On Receiver Performance: Part 2," *Microwaves and RF*, June 1998, pages 106-108.
5. Ulrich Rohde, KA2WEU/DJ2LR, *Digital PLL Frequency Synthesizers*, Prentice-Hall, Englewood Cliffs, New Jersey, 1983, pages 23-25, 78-82, and 98-106.
6. Dieter Scherer, "The 'Art' of Phase Noise Measurement," RF & Microwave Measurement Symposium Exhibition, Hewlett Packard, May 1983, pages 9-19.
7. "Phase Noise," RF & Microwave Phase Noise Measurement Seminar, Hewlett Packard, pages 52-76.
8. "Phase Noise Characterization of Microwave Oscillators," Product Note 11729B-1, Hewlett Packard, pages 9 and 12.

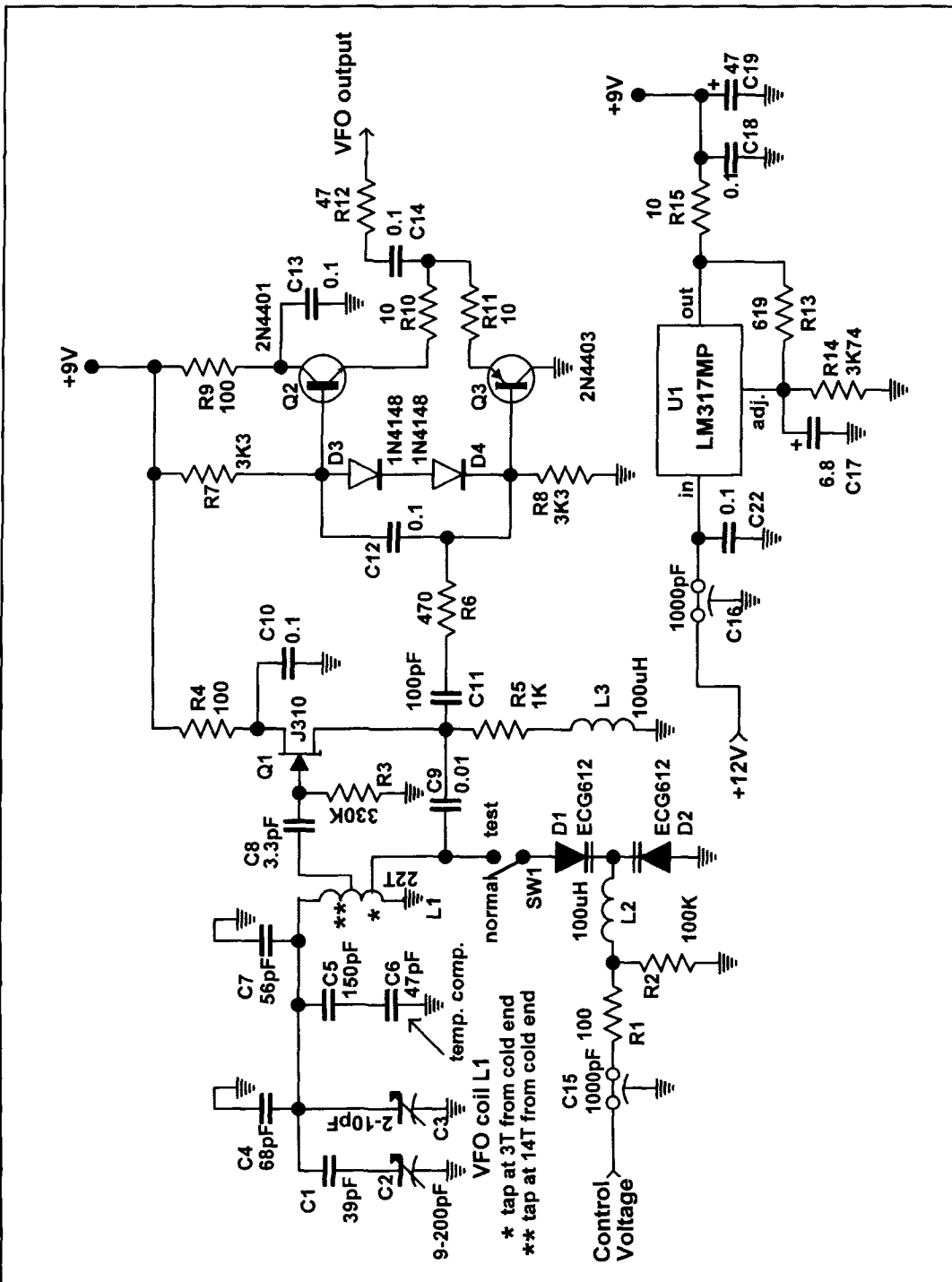

Figure 4. VFO schematic diagram.

9. Floyd Gardner, *Phase-lock Techniques*, New York, John Wiley & Sons, Inc., 1979, pages 8-15 and 70-89.
10. "Crystal Oscillators," Vectron Laboratories, Inc., Norwalk, Connecticut, 1987, pages 74-75.
11. "Measuring Phase Noise With the HP3585A Spectrum Analyzer," Application Note AN 246-2, Hewlett Packard, May 1981, page 15.
12. Wes Hayward, W7ZOI and Doug DeMaw, W1FB, *Solid State Design For the Radio Amateur*, ARRL, Newington, Connecticut, 1977, pages 19-20.

Dealer Information:

1. Vector Electronic Company, telephone: (800) 423-5659; distributor: Digi-Key

2. Digi-Key Corporation, telephone: (800) 344-4539, fax: (218) 681-3380; Internet: <http://www.digkey.com>
3. Allied Electronics, telephone: (800) 433-5700; Internet: <http://www.allied.avnet.com>
4. Mini-Circuits, telephone: (800) 654-7949; fax: (417) 335-5945; Internet: <http://www.minicircuits.com>
5. Amidon Associates, P.O. Box 25867, Santa Ana, California 92799; telephone: (714) 850-4660; fax: (714) 850-1163
6. Oren Elliot Products, Inc., 128 West Vine, P.O. Box 638, Edgerton, Ohio 43517; telephone: (419) 298-2306; fax: (419) 298-3545
7. Mouser Electronics, telephone: (800) 346-6873; fax: (817) 483-0931; Internet: <http://www.mouser.com>

# SCIENCE IN THE NEWS

*A look at "colossal magnetoresistance"  
and the "mobile" family room*

---

## **"Colossal magnetoresistance": Driving at improved data storage**

Japanese researchers may soon have something new for disk drives. A team of scientists in Japan have identified an oxide material that could greatly improve the storage capacity of hard disks and magnetic tapes. The discovery, reported recently in *Nature*, relies on a phenomenon called "colossal magnetoresistance"—a large drop in a material's electrical resistance by more than a factor of 10 in response to an applied magnetic field. The basic cause of the magnetoresistance is the Lorentz Force, which influences the electrons to move in curved paths between collisions.

Magnetoresistance materials have become a mainstream research subject by virtue of their considerable technological importance, although the subject is not well explained within the existing theoretical framework. It is potentially important for its commercial applications in devices such as magnetic sensors, magnetoresistive read heads, magnetoresistive random access memory devices (MRAM), and use as electrodes in solid oxide fuel cells.

Magnetoresistance allows tape recorder or disk drive heads to read data from the magnetic pattern on the tape or disk. It's the result of a particular magnetic property of materials called the "magnetic moment," a tiny magnetic field produced by the electrons orbiting the nucleus of an atom.

Science has been investigating magnetoresistance for over 20 years. Magnetoresistive materials are very special. When exposed to a magnetic field, they exhibit less resistance to electrical current. If a voltmeter is placed across a disk head made of magnetoresistive material, the fluctuations in voltage that the meter shows reflect the magnetic values stored on the disk.

## Advantages of magnetoresistance

Heads designed using MR instead of the current inductive design have distinct advantages. By directly detecting the magnetic field, rather than measuring the change in field as current inductive heads do, MR heads can detect smaller magnetic signals. They don't face the problems of increasingly smaller spacings and thermal noise that currently plague inductive heads as storage densities increase.

In many crystalline materials, magnetic moments are randomly oriented, increasing the electrical resistance of the material. A strong external magnetic field can reduce that resistance by bringing the magnetic moments into alignment. The greater the magnetoresistance of a material, the smaller the magnetic signal to which it can respond—hence the possibility of dramatically increasing storage capacity.

The magnetoresistance of traditional materials is quite small. The passage of current isn't greatly affected by external magnetic fields. However, various materials have been made with extremely large magnetoresistances. "Giant" magnetoresistive materials, multilayers

of ferroelectric and non-magnetic metals, were discovered in 1988. Then, in 1993, when the magnetoresistance of the special kind of perovskite manganese oxide was discovered to be much larger, the name "colossal" magnetoresistance (CMR) was chosen.

Before the Japanese research, the largest resistance drops were seen only when the temperature of the material was very low. This was impractical when used in common, everyday items, such as read/write heads. Scientists had to settle for only a 1 or 2 percent reduction in resistance. However, a team led by Kei-Ichiro Kobayashi at the Joint Research Center for Atom Technology (JRCAT) in Tsukuba, Japan, observed a 10 percent drop in resistance at room temperature in crystals of an iron-molybdenum oxide when the material was placed in a strong magnetic field. This has encouraged experts to predict the finding will eventually accommodate improved magnetic sensors and disk storage.

## Important considerations

To be useful commercially, CMR must address several important considerations, according to Edward Gillman, staff scientist in the Accelerator Division of the Thomas Jefferson National Accelerator Facility, Newport News, Virginia, including the temperature range at which the MR materials operate. For practical applications, the MR materials need to operate near room temperature.

Another consideration is the magnitude of magnetic field at which the materials are responsive. A large MR response to a large magnetic field isn't practical outside the laboratory. A low field MR response will ultimately determine the utility of these materials. The application of the new generation of magnetoresistive oxides in information storage requires a reduction in the applied fields required to achieve significant magnetoresistance.

How difficult is it to incorporate these materials into electronic structures? For near-term applications, these materials need to be integrated into conventional microelectronic devices at low cost, and this is determined by the processing technology needed for these materials.

"Kobayashi's work is an important new development that attempts to address some of these issues," said Gillman. "Most work, including my own, has focused on the CMR manganite films. Clearly this new material represents an important advancement in the field of MR technology."

Because of the relatively high magnetic field required to produce the MR effect, researchers say the material is not yet ready for use in data storage devices.

"It's no good having 99.9 percent resistance suppression if you need a Tesla field to achieve it," said Matthew Rosseinsky, University Lecturer in Inorganic Chemistry at Oxford University. "So the demonstration that the spin-polarized metallic oxide Sr<sub>2</sub>FeMoO<sub>6</sub> displays low-field magnetoresistance at room temperature is significant."

The discovery is part of JRCAT's 10-year Ultimate Technology for Manipulating Atoms and Molecules project, which began in 1992. The two-phase project aims at establishing a generic technology and a fundamental concept for creating new materials and devices by manipulating atoms and molecules either individually or collectively at operator's will.

The six-year first phase operated as a versatile basic research program rather than a rigid project, with some remarkable results, such as creation of semiconductor nanostructures, experimental and theoretical clarification of initial oxidation process of clean silicon surfaces, direct observation of higher order structure of DNA, and discovery of colossal magnetoresistance effects in single crystals of manganese oxide and iron-molybdenum oxide.

## The mobile family room

Saturday mornings just got less complicated for American dads, thanks to Japanese technology. They'll soon be able to drive the kids to soccer and keep an eye on ESPN's Game of the Week at the same time.

Japanese industrial giants Toshiba, Toyota, and Fujitsu have announced the joint establishment of a start-up communications company, Nihon Mobile Broadcasting Corporation (NMBC), for the first time bringing digital satellite broadcasts to automobiles.

The pioneering broadcasts, scheduled to begin in 2001, will first provide vehicles with navigation assistance (map reading and route plotting) via a satellite Global Positioning System, plus CD-quality music, news, and sports. This will be followed by video, Internet, and Intelligent Transport System (ITS) services. ITS will furnish 24-hour local interactive handholding for breakdowns and emergencies, and information on navigation, traffic, park and ride lots, and points of interest, as well as directions to the nearest gas station, garage, and Mexican restaurant. Until now, satellite service has been restricted to stationary customers.

## Entertainment for passengers

The mobile service is, of course, intended more for passengers than drivers. Drivers doing anything other than driving or looking at any-

thing other than the road is inadvisable—if not outright illegal. While designated driver dads will be able to pick up the soccer team and ESPN video feeds all in the same specially equipped family van, the distraction danger surpasses that of cellphones. In fact, the *New England Journal of Medicine* reports that cellular phone users are 4.3 times more likely to have an accident if they're using a cellphone while driving.

The new technology, as yet unnamed, can be adapted for use on the monitors of existing laptop computers, some of which are already configured for mobile video conferencing. The next generation of cellphones is also expected to be capable of displaying video feeds. Heads-up (hands-free, voice-actuated) computer systems currently exist with wearable monitors (made by DisplayTech in Longmont, Colorado) smaller than your thumbnail that flip down in front of your eye from cap visors or telephone operator-type headsets. New mobile terminals are being developed similar to Toshiba's Genio (an Internet-ready Personal Digital Assistant, or PDA), as are Sony Walkman-type units capable of receiving video. With this plethora of devices, the family sport utility vehicle can become a traveling family room, complete with simultaneous offerings of Nintendo, MTV, Jeopardy, and Monday Night Football.

## Two service levels expected

Two types of service levels are expected, similar those offered by cable companies. A basic service will be available for a fixed monthly fee of about \$6.50, to include special CD-quality music channels, news, and weather broadcasts. Those users desiring navigation, educational, entertainment, sports, Internet programming, or pay-per-view features will be charged a premium. The receivers necessary will vary with the services desired. When the service begins, the main receivers will support audio and vehicle navigation services. Development of a full-range mobile terminal will follow, with a total of four kinds of receivers anticipated: vehicle audio, multimedia-based vehicle navigation, mobile radio, and mobile multimedia.

The core of the NMBC system is Toshiba's Radi-Vision (radio and television) technology, which exploits the narrow S-band frequency (2630–2655 MHz) and MPEG-4, an emerging

video compression standard for wireless communications. S-band enables signals to be received in vehicles equipped with a flat, two-inch wide antenna instead of the wok-sized parabolic receiver dishes that cling to eaves troughs and balcony rails and are normally needed to pick up Direct TV satellite signals.

Uninterrupted broadcast can be received on all moving vehicles traveling at speeds up to 190 mph. Reception isn't possible on commercial airplanes, but train passengers can relax with HBO or work themselves into a spending frenzy with one of the Home Shopping channels. Gap-filler booster technology will be necessary to deflect the signals into the shadowed areas between high rises, behind mountains, and into tunnels, assuring stable reception.

The system is designed to support simultaneous transmission of between 30 and 80 channels at data rates of up to 256 K-bits per second. The high-power satellite transponder makes the system resistant to the influence of bad weather.

The bewildering, high-speed evolution in digitization has instigated this fusion of communications and multi-channel broadcasting around the world. Prior to the NMBC announcement, the main focus had been on fixed receivers, which excluded all mobile customers. However, the enormous potential of the mobile market is attracting attention. There's a potential market in everyone's garage. Over 200 million vehicles are registered in the U.S.; Japan has 70 million more. Last year, the World Radio Conference authorized allocation of frequencies for mobile services and advances in such areas as satellite technology, and delivery of audio and multimedia signals via MPEG-4 based technology make mobile services practical.

The new company plans to secure the right to use one of the transponders on a commercial satellite scheduled for launch into geostationary orbit in 2000. Work to set up the necessary terrestrial infrastructure will coincide with the development of the corresponding reception equipment to meet the 2001 start-of-service date. NMBC hopes to have more than 2 million subscriber contracts in hand by 2003 and 10 million by 2010.

Airbags and seatbelts have made vehicles safer. NMBC will make them smarter and more entertaining. All we need now is something to make better drivers! ■

# THE BASICS OF SPEECH PROCESSING

*The nature of speech and ways it can be modified*

Speech processing can be a very powerful tool to ensure that maximum use is made of the available transmitter power. The technique is particularly useful for single sideband (SSB) transmissions where the peak power level of the transmitter is limited, while the average power is determined by the speech or audio being transmitted. Under many circumstances the average power is low, and this means that poor use is made of the transmitter capabilities. In fact with today's technology, SSB that does not use processing could be said to be an outmoded form of communications. Speech processing is also invaluable for AM

transmissions where the carrier level limits the sideband power and hence the audio power levels which can be transmitted.

## Composition and nature of speech

Much of the audio transmitted around the world is in the form of speech. As such, it is useful to understand its nature and composition. Such an understanding gives an idea about the types of sound to expect and the problems associated with transmitting them.

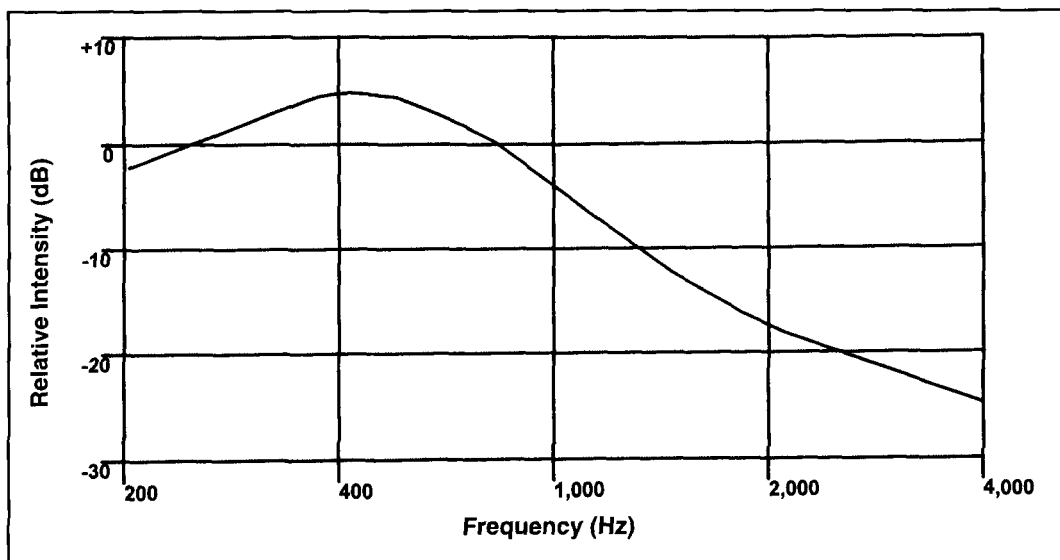

Figure 1. Spectral distribution of typical speech.

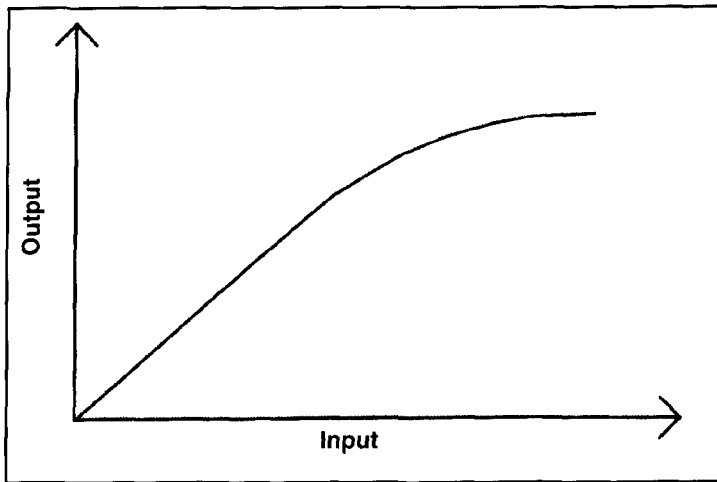

Figure 2. An instantaneous compression.

Human speech is made up of a large variety of sounds. The lungs, windpipe, vocal cords, throat, nose, and mouth cavities all operate together to produce the sounds we hear as speech. Speech is formed as the air passes out from the lungs and its flow is modulated in a number of ways. The cavities which can be changed in shape to change the sound are often called the articulators, for obvious reasons.

There are four main types of modulation used. These are vocal cord, frictional, cavity, and start-stop. Of these, the vocal cord and frictional types of modulation generate many of the base sounds. These are then modified by cavity and start-stop types of modulation.

The vocal cords produce sounds by vibrating in a way that interrupts the flow of air out of the lungs. The way in which they vibrate results in a sound that is rich in harmonics. This sound is then modified by the cavities in the nose, throat, and mouth to give the characteristic "voicing" to speech. Vocal cord modulation has fundamental frequencies of between about 70 and 500 Hz depending on a variety of factors, including age, sex, and so forth.

Frictional modulation is used to generate sounds like "s," "f," "th," and "sh." These sounds are known as fricative sounds. They are formed by creating a small opening possibly between the tongue and the roof of the mouth, for example, and forcing air to flow through this opening. The resulting turbulent air makes a noise as the frequencies produced are randomly generated. Like the vocal cord modulation, the cavities around the mouth and nose alter the frequency content to give the required sound. Generally these sounds have a very large high-frequency content.

Cavity modulation is used to modify sounds made by the vocal cords and by frictional modulation. It is perceived as adding "voicing" to the basic sounds produced. The cavities are used as filters, reinforcing some frequencies and reducing others. These are changed at relatively slow rates as the word or sound progresses. Primarily, the cavities act on the sounds produced by the vocal cords, although they do provide some change to the fricative sounds. They alter the fricative sounds to a lesser degree because these sounds are actually produced in the front of the mouth and it is not possible to exert so much of a change.

The last type of modulation is start-stop. This may be caused either by the vocal cords or the articulators, and it occurs at a rate of less than 10 Hertz. The corresponding sounds aren't perceived as tones but as pauses in the flow of speech. However the range of levels associated with these sounds can often be quite large, as sounds may start with a burst of energy.

When all the types of modulation are used together, it's possible to produce a large variety of sounds. The ear of the English-speaker can distinguish between a total of 39 different sounds. Vowel sounds use the vocal cords to produce the basic sound, and this is modified by the cavities. Explosive sounds like "b," "p," and "v" are formed by combining start-stop modulation with frictional modulation. Many

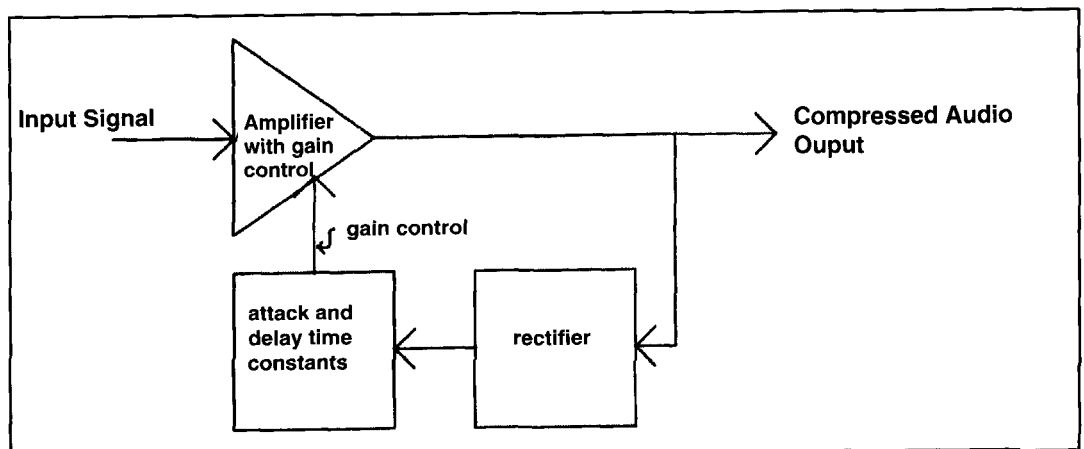

Figure 3. A compressor or VOGAD.



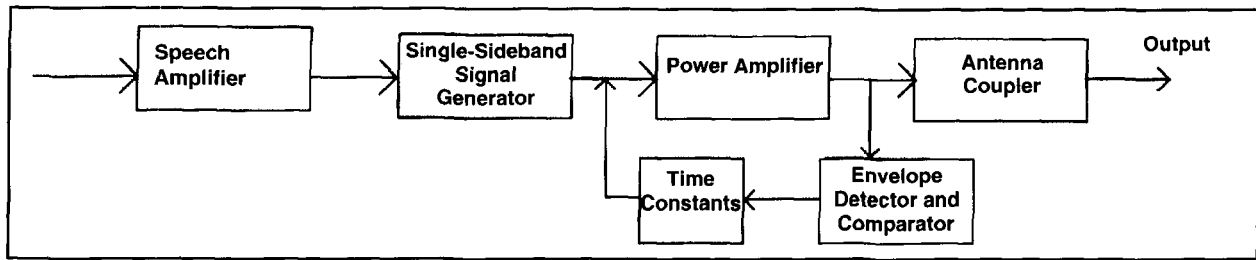

Figure 4. An ALC system.

sounds change during the course of the sound. Sounds like “u,” “q,” and others require the position of the articulators to change as the sound is made.

Not only are a great number of sounds produced, but the levels which are produced vary widely. Different speakers talk at different levels of loudness, and there are enormous variations within one speaker’s speech. Under different circumstances the speaker will change the level at which he or she is talking. They may place different emphasis on different words, and even the sounds themselves have significantly different levels. When all of these factors are combined, the sound level can vary by as much as 35 dB for a given speaker—although for someone speaking into a microphone on a communications link, the dynamic range is more likely to be around 25 dB.

In addition to these level variations, there are other differences to be taken into account. There are differences between the negative and positive peaks of the waveforms. In extreme cases, these can be as high as 7 or 8 dB.

As well as having a wide dynamic range, speech also occupies a wide bandwidth. A fairly typical distribution of the frequencies found in speech is shown in **Figure 1**. Obviously the spectrum will vary from one sound to the next, depending on its formation. Accordingly, the response is averaged over time to remove this effect.

**Figure 1** shows that there is a peak at around 500 Hz which falls slowly below this and somewhat more above this peak. In fact, above 500 Hz the power content falls at around 9 dB per octave. It’s also true that most of the lower frequency constituents are from the vocal cords, while the higher frequencies are from the fricative sounds. In addition, the lower frequencies contribute less to the intelligibility of the signal, adding mainly to the naturalness. It is the frequencies above this, but below about 3 kHz, that are mainly required to carry the intelligibility.

The wide range in level and frequency doesn’t lend itself to making the most use of the modulation or power available in a transmitter. Without any form of processing, efficiencies are very low. If high-quality transmissions are required, then the low levels of effi-

ciency may need to be tolerated. But even the VHF FM stations which carry high-quality transmissions normally use some form of processing to improve the level of modulation. Usually this is much higher on stations that carry popular music than on those that carry classical music.

For shortwave communications transmissions, it is possible to accomplish far more. The main focus for many transmissions is to optimize the intelligibility; fidelity is less important. It’s possible to process the audio signal to contain those constituents that carry the intelligibility and reduce the others.

The main methods used are reducing the bandwidth, reducing the dynamic range, and adding pre-emphasis to change the frequency response and content of the signal. There are a number of ways in which the dynamic range can be reduced. Compression and clipping are two of the processes used.

## Compression

Compression can take a variety of forms, and the term compressor often means slightly different things to different people depending upon the use. However, whatever type of compressor is used, it will consist of an amplifier whose gain is reduced as the input signal increases. In this way, the dynamic range of the output signal is reduced when compared to that at its input. Normally, the gain is only reduced after a certain level has been reached. As the onset of compression is progressive and no information is actually lost, it is possible to put the signal through an expander with an inverse response to return to the original signal. However for many communications purposes, this is not required.

A compressor can take one of two forms. The first is where the gain is adjusted instantaneously, as shown in **Figure 2**. Here the level of gain may vary over the course of the incoming waveform.

The other type of compressor introduces a time constant into the feedback loop, so the gain varies according to the overall level of the waveform, as in **Figure 3**. This type of com-

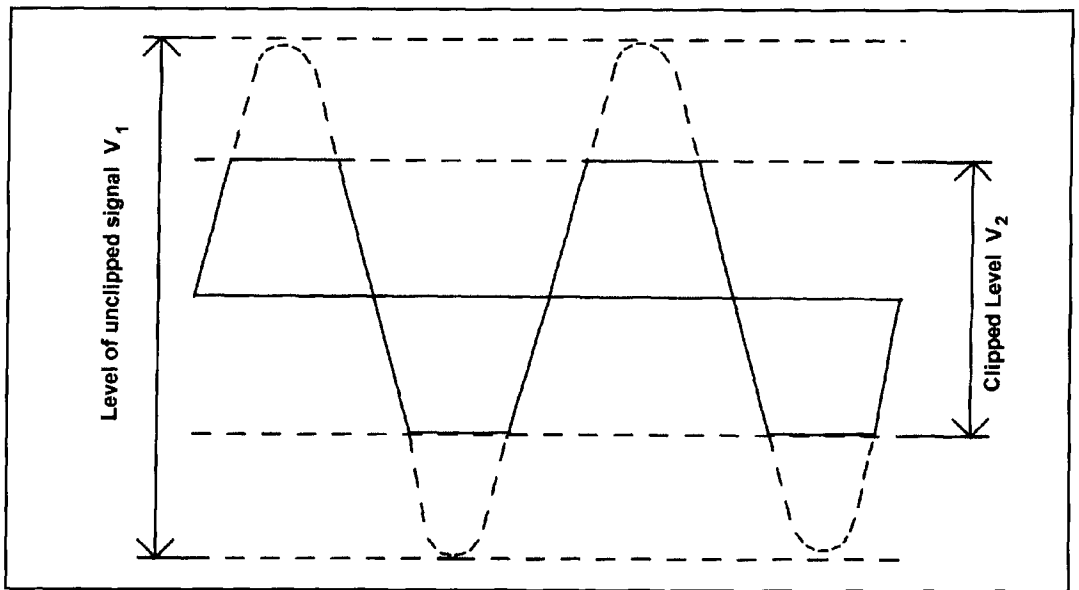

Figure 5. Level of clipping.

pressor is sometimes known as VOGAD (Voice Operated Gain Adjusting Device).

When designing compressors with time constants in the feedback loop, the attack and decay times are of paramount importance. It's necessary to ensure that the attack time is fast. If it is not fast enough, then the first transient peaks will pass through the compressor at a high level and may result in distortion of some of the transmitter stages. This, in turn, will result in distortion and the possibility of splatter on either side of the transmitter frequency.

The decay time is also important. If this time is chosen so the circuit follows the individual syllables of the audio, it is known as a syllabic compressor. Often a longer decay is chosen so the compressor follows the overall level of the speech. Typically an attack time of about 10 mS and a decay time of between 100 and 300 mS is selected.

Compressors provide a certain degree of audio gain, but are often used to maintain a constant level of audio into the input of the transmitter or the next stage in a processing. If higher levels of gain are required, clipping is generally used.

## RF compression

The most common form of RF compression is automatic level control (ALC) circuitry incorporated in most SSB transmitters. Its primary purpose is to ensure that the peak power levels encountered by the output stages do not cause overloading and distortion.

An ALC system uses a circuit that detects/generates a signal proportional to the envelope of the output signal. This is fed back

to earlier stages of the transmitter in such a way that the output level is regulated to within the output capability of the power amplifier. It's normal for the control signal to be fed back to the early RF stages of the transmitter; in this way the level is controlled throughout the set.

A basic ALC system (see **Figure 4**) is not normally active for most of the signal and only reduces the output level on voice peaks. A fast attack time is required to ensure that transient peaks don't overload the amplifier. If the system has a relatively short recovery, then some enhancement of the signal occurs between the signal peaks. If a slow time constant is used, the system will tend to adjust itself to accommodate the prevailing level of peaks; i.e., the general signal level.

In some cases, a dual time constant is used. The first, typically with a time constant of between three and five seconds, adjusts the system to the general level of the audio; the second, with a time constant of between 100 and 300 mS, enables system to follow the syllables, thereby increasing the average audio level. In this way both requirements are met.

## Clipping

Clipping is a process that removes voltages above a given level. As the process is not gradual, as in the case of compression, it is not possible to restore the waveform to its original form by passing it through a circuit with an inverse response.

Although it may be one's view that clipping introduces severe distortion to a waveform, it's surprising what levels of clipping can be introduced. If the effects of harmonic distor-

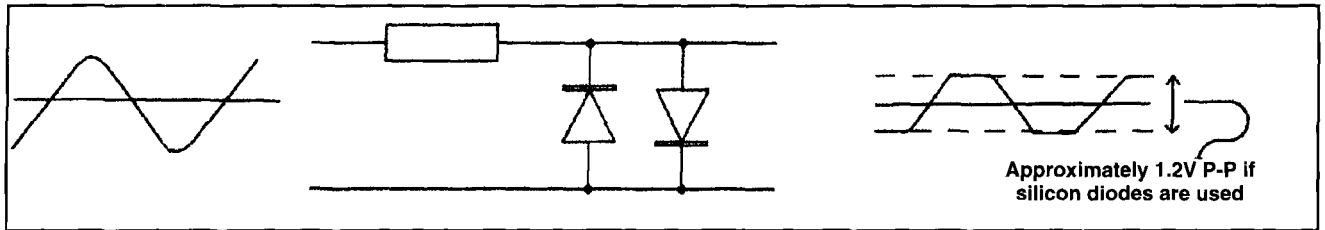

Figure 6. Diodes used for limiting audio level.

tion are removed, the ear can tolerate infinite levels of clipping without loss of intelligibility. Only the character of the sound is changed. This is because the ear detects the frequency content of the sound rather than the amplitude content and, provided this is not unduly disturbed, no significant degradation in intelligibility is incurred.

The level of clipping is often defined. Some clippers even have controls to set the required level of clipping for the conditions encountered. This refers to the reduction in the peak level of the signal by the clipper. If the peak level with no clipping would have been  $V_1$ , and the peak level with clipping would have been  $V_2$ , then the clipping level is  $20 \log_{10} (V_1/V_2)$  as shown in **Figure 5**.

### AF clipping

An audio frequency clipper can be made relatively easily. Audio is taken from the source and normally passed into an amplifier. This can be run to saturation to remove the peaks. An alternative method involves passing the output from the amplifier into a series resistor and then into a pair of parallel diodes wired together as shown in **Figure 6**.

This, strictly speaking, is audio compression because the diodes don't turn on instantly; however, if a low value of series resistor is used, then a fairly sharp cutoff can be obtained. This is often the most popular method of achieving clipping. Still, it's also possible to drive an amplifier into saturation. Here the amplifier reaches both rails and gives a far sharper cut-off (**Figure 7**).

The problem with a clipper of this type is that harmonics are generated as shown in **Figure 8**.

A low-pass filter can filter those components above the maximum required frequency and should always be included at the output of an audio frequency clipper. Those which are less than half the maximum frequency will produce some products that fall inside the required bandwidth and cannot be removed. These introduce new frequencies into the signal and reduce the intelligibility of the signal. This limits the level of clipping that can be applied in an audio clipper to around 15 dB, and this will provide a gain of around 4 or 5 dB. While this is not a hard and fast limit, levels beyond this will increase the level of distortion and start to reduce the benefit of the clipping.

### Post clipping response

The design of post clipping filters and the response of any amplifiers must be taken into consideration. During the clipping process, the signal is squared off. The subsequent filtering required will tend to "re-peak" the waveform as some high frequency components that provide the sharp squaring to the waveform are removed. The effect is that the waveform will increase in amplitude by a factor of 1.3 or 2.1 dB. This fact must be remembered when setting up the transmitter levels because the voice dynamics are very different from a steady tone often used in transmitter settings. If care is not taken, overloading can result.

### RF clipping

To overcome the problem of in-band harmonics, an RF signal can be generated and this can be clipped. In this way, the harmonics will

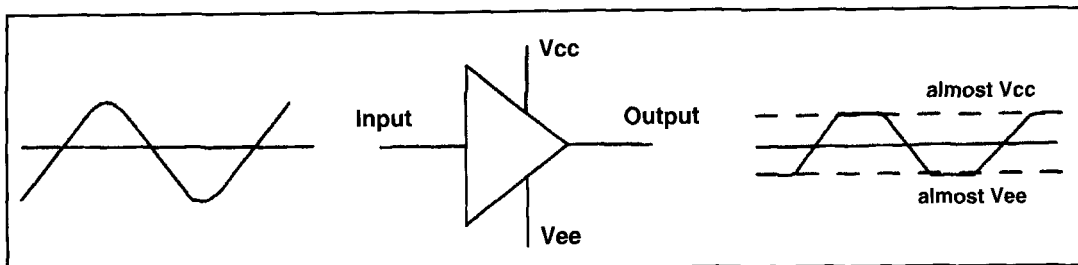

Figure 7. Running an amplifier into saturation gives a sharp cut-off.

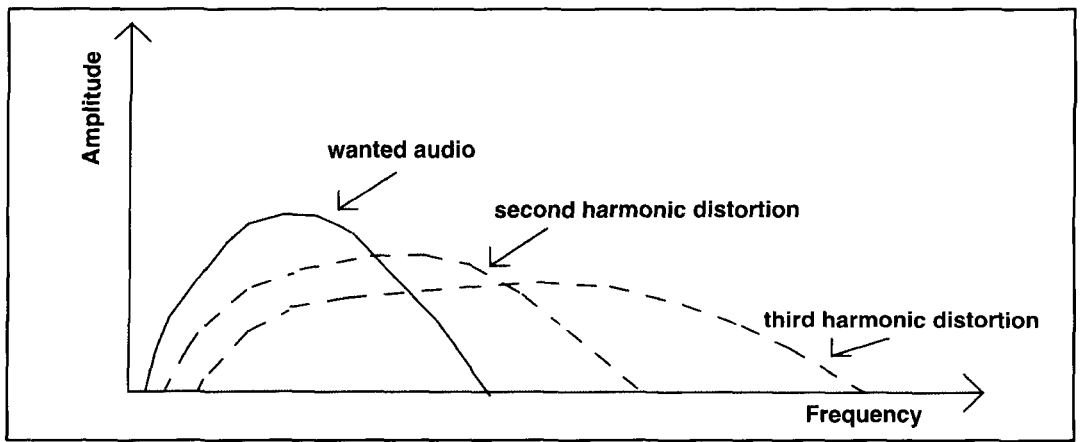

Figure 8. Harmonics generated by an AF clipper.

fall at multiples of the radio frequency signal rather than the AF signal and can be easily filtered out. To prevent problems from intermodulation distortion (IMD), a single sideband signal is generated. Good sideband suppression is required. Once generated, the signal is clipped and passed through a simple filter to remove the RF harmonics (Figure 9). Once this is done, the audio can be regenerated; or, if the system is part of an SSB transmitter, it can be passed on to the next stages of the transmitter.

With this form of clipper (Figure 10), infinite levels of clipping can be used. In view of the increase in the level of clipping, and the reduction in loss of intelligibility due to harmonic distortion, further gain is available. Typically, the maximum level of gain a system like this will provide is around 8 dB. The main degradation is in the naturalness of the sound. Listeners report that the audio sounds harsher and that its nature changes. This is due to the fact that hard clipping will introduce the same effect as the capture effect noticed on FM signals when the strongest tones capture the signal. It has the effect of reducing many of the higher frequency constituents while reinforcing many of the stronger lower frequency tones.

It is also found with RF clippers that the signal may be "re-peaked" when it is band-pass

filtered. Again, the exact level of re-peaking will depend upon the voice constituents and will change accordingly. A good ALC is required to ensure that this does not have any detrimental effects on the quality of the transmitted signal. For this to be achieved, the ALC should be applied to a stage of the transmitter after the clipper and not before it.

### Frequency response

There is plenty that can be achieved by modifying the frequency response of the audio amplifier. Two main aspects can be addressed. The first is to reduce the bandwidth, and the second is to pre-emphasize portions of the used spectrum to obtain the maximum intelligibility.

It's necessary to limit the bandwidth of a signal to ensure that transmission bandwidths are kept to an acceptable value. A balance has been chosen between intelligibility and naturalness on one hand and the use of power and bandwidth on the other. The standard telephone bandwidth of 300 Hz to 3.3 kHz has been chosen as a good compromise for many telecommunications applications. It has been found that there is only a small degradation in intelligibility under good conditions. Reducing this further doesn't degrade intelligibility much more. The

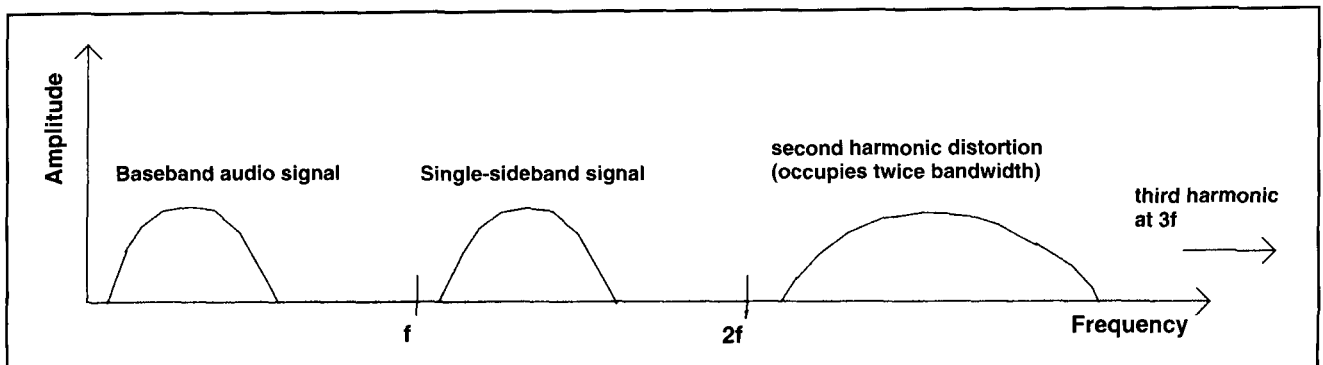

Figure 9. Harmonics generated in an RF clipper.

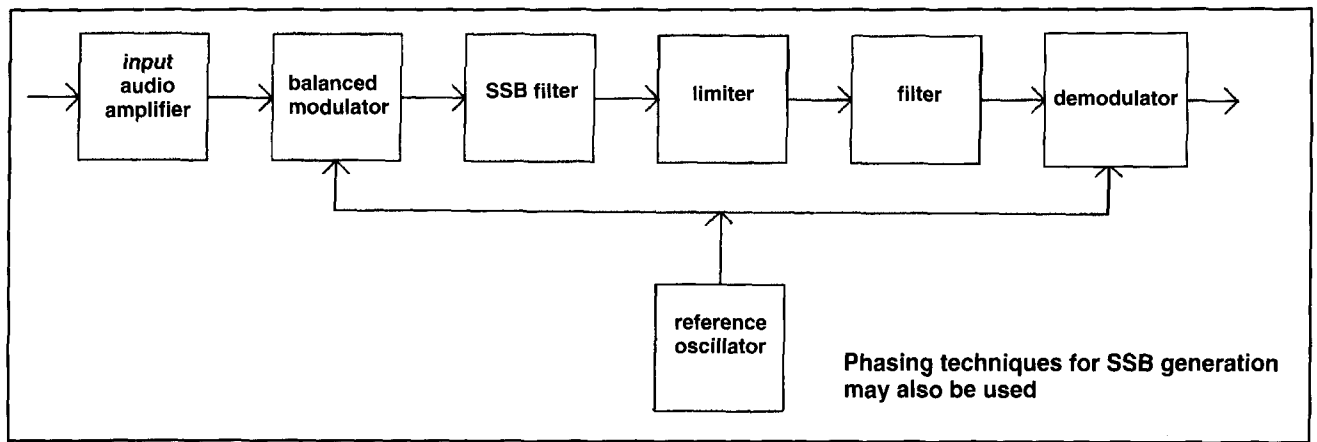

Figure 10. Block diagram of an RF clipper.

reason the telecommunications industry stops at this figure is because the naturalness of the voice and the ability to distinguish between one speaker and the next is reduced, and this is of paramount importance for commercial and domestic requirements. For many radio communications applications, a top limit of 2.7 kHz is adopted and gives good results. The bottom limit of 300 Hz is generally retained.

In addition to reducing the bandwidth required, there are additional benefits in altering the frequency response within the required bandwidth to pre-emphasize the signal. Components below about 600 Hz have a relatively high level and do not contribute as much as some of the higher frequencies to the intelligibility of the signal. By increasing or pre-emphasizing the frequencies above this frequency, some benefits can be gained in terms of increasing the intelligibility of the signal. Used on its own, pre-emphasis increases the peak to average ratio, and this somewhat nullifies its effectiveness.

However, when used in conjunction with a clipper, pre-emphasis can be very beneficial. Without pre-emphasis, the low-frequency components can easily dominate the signal as already mentioned. Typically a single-pole filter may be placed in front of the clipper with a cut-off frequency just above 600 Hz. The inclusion of this pre-emphasis will ensure that the high-frequency components are not unduly attenuated and retain their contribution to the intelligibility of the signal.

## Combining approaches

To obtain the best from signal processing, it's necessary to combine several approaches, as no single method gives the optimum solution (see Figures 11 and 12). While the main form of processing is often the clipping, it's also necessary to use frequency tailoring and filtering along with some form of compression.

To ensure that the audio level reaching the clipper is maintained at a suitable level, a VOGAD or compressor is usually placed before the clipper. This is essential, otherwise the large variations present in audio level will result in significant changes in the degree of clipping.

Pre-emphasis can also be used to good effect. Although it will tend to make the signal sound slightly "toppy," it ensures that intelligibility is retained. It is also useful for AF processors to reduce the level of low frequencies, and hence the level of low frequency harmonic distortion, that will fall within the required audio band and cannot be removed.

As most high-grade processors will use RF clipping, most of the post-clipping filtering will be limited to removing the RF harmonics. Little audio filtering should be required. For AF clippers, a good low-pass filter is required. In many cases, signal sideband transmitters will have internal filtering within the sideband generator, especially if the filter method is used. However, if little or no filtering is present (for example, in an AM transmitter), a sharp filter cut-off around the top audio limit is required.

In both cases, two adjustments are required. The first is to set the level of clipping. This may be chosen according to the prevalent conditions. Where conditions are good, the level of clipping may be reduced to preserve the naturalness of the signal, a higher level of clipping may be chosen when conditions are worse. The second adjustment is more difficult and involves setting the output level of the clipper. This should be adjusted so the ALC just operates on voice peaks.

## Practical aspects

There are a number of practical aspects to keep in mind when using speech processors, otherwise the results of the processing may not lead to the expected improvements and may even degrade the signal.

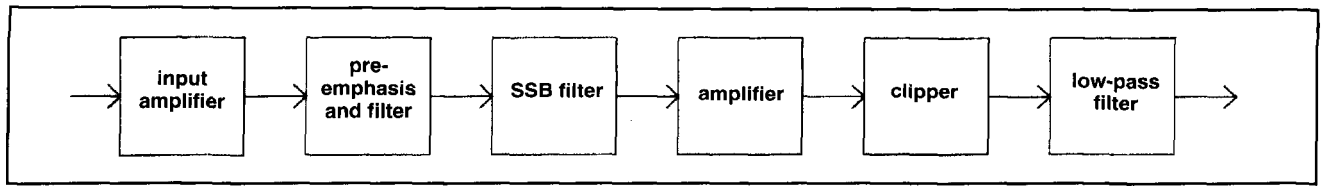

Figure 11. An AF processor combining several techniques.

The first is associated with RF feedback. Often there are significant levels of RF in the vicinity of a transmitter. While these must be reduced to the minimum levels possible for safety, as well as the proper operation of the station, the inclusion of a speech processor may highlight the presence of any RF. The reason for this is that, assuming the same peak audio level, there is additional audio gain equal to the level of clipping. For an audio clipper this may be around 12 dB, and for an RF clipper it may be 20 dB or more. This will increase the susceptibility to RF pickup by this degree.

To ensure that RF feedback does not occur, the filtering into the processor must be optimized to ensure that no RF enters the processor via this route. Additionally, the use of a low-impedance microphone helps. If feedback does occur, it may cause oscillation in the worst case, or it may result in distortion which will significantly degrade the intelligibility of the signal. Not only should the audio input from the microphone be screened and filtered, but the power input should also be filtered, especially if the processor is powered from the transmitter.

There is another problem associated with the increased duty cycle. The inclusion of a processor will markedly increase the duty cycle of the waveform being transmitted. In many cases it will be more akin to a single tone than a typical speech waveform. Most transmitters manufactured today are able to cope with this without any problem. Still, it is a factor that must be taken into account when designing output stages in particular, and when determining the level of heat sinking required for the output devices. This lesson was learned in the late

1960s and early 1970s when a number of transmitters used television line output valves for their final amplifiers. These operated satisfactorily under normal conditions, but when processors were used, their life was considerably shortened.

It's often useful to adjust the level of processing according to the prevailing conditions. If signals are strong, and there's little difficulty in copying, it's often more pleasant to reduce the level of clipping—only moving to the higher levels of processing when conditions deteriorate. The reason for this is that a highly processed signal is not as easy on the ear and many operators prefer less processed signals.

Background noise can sometimes be a problem. With a significant increase in effective audio gain, this noise can often become noticeable during pauses in speech. To overcome this, a noise-canceling microphone is recommended. Additionally, the increase in audio gain can also mean that power supply ripple or buzz may become more noticeable. Accordingly, the supply should be very well smoothed, and care should be taken in the audio input to ensure that there are no hum loops or points where hum may be picked up.

## Summary

Speech processing is an accepted part of today's radio communication scene. Most transceivers today incorporate processing to ensure that efficient use is made of the available power. However, to make the best use of speech processing, it is often necessary to understand a little of the way in which it operates. ■

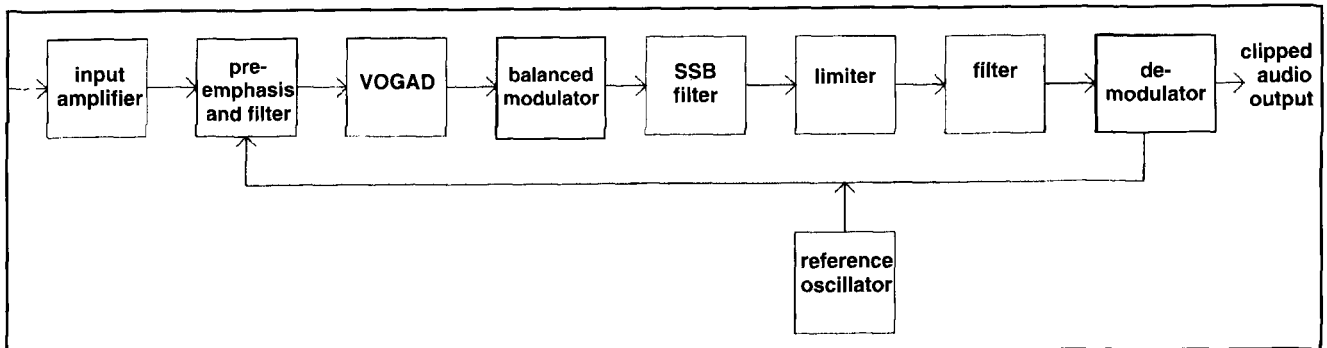

Figure 12. An RF processor combining several techniques.

# AN ELECTRO-OPTICAL SHAFT ENCODER

*Add this inexpensive device to your next project*

An electro-optical shaft encoder generates a digital number in response to the turning of a shaft. This digital number might tune a synthesizer or indicate the position of a matching network, tuning control, or volume control. Another potential application is the calculation of turns of a distance-measuring wheel for digital logging. While tuning a synthesizer may seem like an obvious radio application, digital indication of a shaft position for logging is probably the most common application outside amateur radio.

Encoders come in two flavors: incremental and absolute. The absolute encoder's output is determined by its absolute position, while the incremental encoder indicates how much it has traveled from its arbitrary starting point. When power is removed and then reapplied, the absolute encoder generates a digital number representing its present position. When the power is removed and then reapplied to an incremental encoder, it loses its reference and must restart when power is restored. The disadvantage of an incremental encoder is outweighed by its simplicity.

The incremental encoder encoding disc has only one track and two sensors; the absolute encoding disc has a track for each bit. Six bits of resolution, 1 in 64, requires six tracks with six precisely located sensors. This is a task better left to the pros. Because an incremental disc has only one track and two sensors, its construction is well within the capabilities of the handy tech.

The number of digital steps per revolution of the shaft is determined by the design of the encoder. The shaft encoder is comprised of three parts: 1) an electro-optical encoder that,

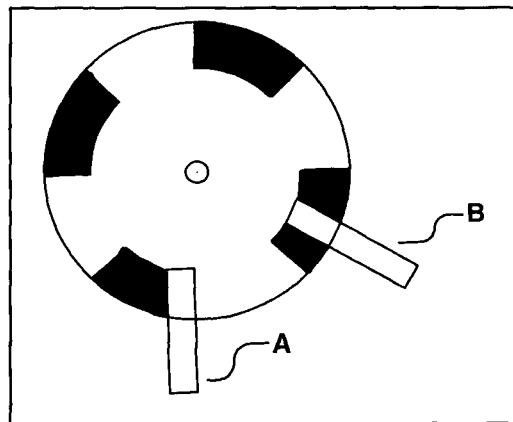

Figure 1. An encoder disc has equal clear and opaque areas.

with rotation, generates two square waves displaced by 90 degrees; 2) a decoder/pulse generator that converts the outputs of the encoder to two pulse trains—one for clockwise rotation of the shaft and one for counterclockwise rotation; and 3) a counter that counts the pulses from the decoder and generates the digital number.

## The encoder

The encoder is made up of an encoding disc and a pair of electro-optical sensors. An encoder disc is shown in **Figure 1**. The electro-optical sensor, a transmissive source/detector assembly (electro-optical interrupter switch) is shown in **Figure 2**. The sensor is equivalent to either a Texas Instruments TIL143 or a Harris H21A1. The sensor contains an infrared emitter diode and an n-p-n phototransistor detector

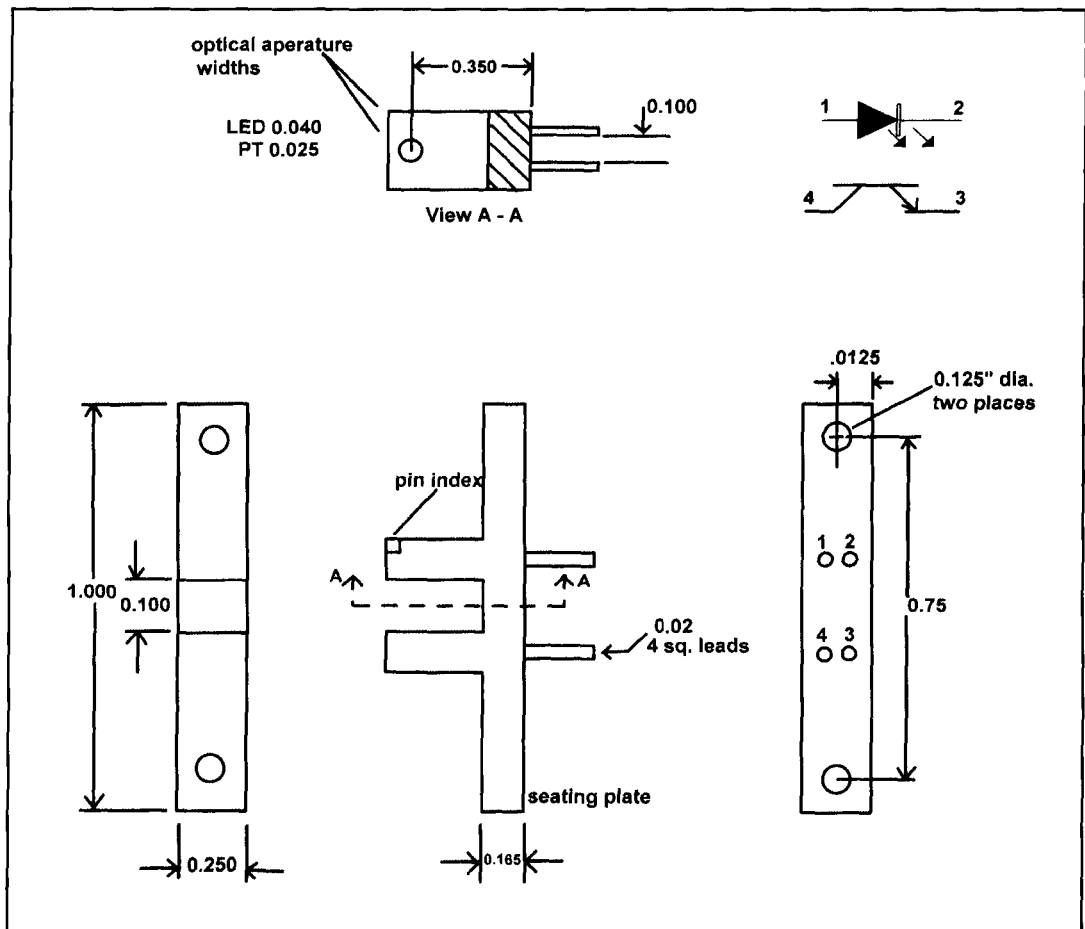

Figure 2. The electro-optical sensor contains a light source and a photo detector.

(PT). The light passing through the clear segment of the disc causes the n-p-n PT to conduct. When an opaque segment blocks the light, the PT is nonconducting.

The center line of the active area of the sensor, the optical aperture, is 0.085 inch inside the top edge. The sensor aperture has an effective diameter of 0.025 inch. The slot through which the disc rotates is 0.100 inch wide, so a disc made with 0.032-inch clear plastic allows wobble room for the disc. Any clear material will work for the disc. Discs can even be cut from clear vinyl report covers. Slots cut in shim stock will also work well. If you intend to make several discs, a photographic negative will also work. The only requirement is that the material both pass and block light.

When a disc is cut from something like Plexiglas™ or Lucite, the cut edges may craze unless the piece is annealed by heating it to about 85°C (185°F) and cooling slowly. The piece can be put in a flat-bottomed pan of hot water (almost boiling) and allowed to cool. A microwave oven will raise the temperature of Plexiglas or Lucite enough for annealing, but polystyrene can't be annealed in a microwave

oven because its dielectric losses are too low. The flame from a cigarette lighter or propane torch can be played around the edges to soften and anneal the plastic, but the temperatures can easily melt the plastic, so don't get too close.

The disc shown in **Figure 1** has eight line pairs. A line pair is made up of one clear area and one opaque area. An appropriate decoder produces a pulse at each transition in the line pair. That is, four pulses are produced for each line pair. An encoder disc with a few line pairs can be hand painted; but when more steps per revolution are desired, more lines are required, and more care is required in the construction of the disc. A disc with 25 line pairs produces 100 pulses per revolution and requires considerable care in construction. As a reference, a clock face with 60 minutes only represents 30 line pairs. The diameter of a circle that can fit  $N$  line pairs of width  $W$  on its circumference is:

$$D = NW/\pi \quad (1)$$

Twenty-five line pairs 0.2 inch wide, opaque areas 0.1 inch wide, and clear areas 0.1 inch wide, will fit on the circumference of a 1.6-inch



diameter circle. When the opaque areas and clear areas are 0.0625 inch (1/16 inch), 25 line pairs will fit around a 1-inch diameter circle. **Figure 2** shows the optical aperture of the sensor to be 0.025 inch. An opaque section width smaller than the optical aperture of the sensor leads to complications better left to encoder manufacturing businesses. Line widths of 0.1 inch allow a considerable margin, and lines can be made with 0.1-inch pc board drafting tape. Of course, masking tape cut 0.1 inch wide will work equally well.

The lines are made by placing short pieces of the 0.1-inch-wide tape radially around the circumference of a 1.6-inch clear plastic circle. Place the 50 pieces of tape radiating out from the 1.6-inch circle but touching at the 1.6-inch diameter. Remove alternating pieces of tape and spray or brush paint over the disc. The color of the paint is immaterial but it must be thick enough to be opaque. When the paint is dry, but still soft, lift off the remaining pieces of tape to reveal clear areas 0.1 inch wide radiating from the periphery of the 1.6-inch circle.

The sensors, shown in **Figure 2**, are fixed to the chassis in such a way as to allow the disc to rotate through their slots. One sensor is mounted over the center of any line, while the other is centered on the edge of any other line. When the disc rotates, the output of the phototransistor detectors (PTs) is basically square waves separated by 90 degrees as shown in **Figure 3**. The sensor's diodes are connected in series and the voltage drop across the two diodes is 2.7 volts. The current in the diodes  $I_f$  should be limited to 20 or 30 mA by a current-limiting resistor whose value is:

$$R = (V^+ - 2.7)/I_f \quad (2)$$

Where R is in ohms,  $V^+$  is the supply voltage, and  $I_f$  is the diode current in amps. When  $V^+$  is 5 volts, R is computed to be 115 ohms. When R is 100 ohms  $\pm$  5 percent 1/4 watt, the diode current will be between 22 and 24 mA.

The sensor's PT collector current is specified as 1 mA when the diode current is 20 mA. From this we can infer a PT collector current approximately 5 percent of the diode current. The maximum current in the diodes is 50 mA in 25°C free-air temperature, but should be derated linearly to 80°C at the rate of 0.91 mA/°C. Twenty milliamps of diode current allows operation in an ambient temperature of about 61°C. Diode current of 30 mA restricts the ambient temperature to about 52°C. Therefore, it's prudent to limit the current to between 20 and 30 mA.

With the diode current of 20 or 30 mA, PT current is expected to be between 1 and 1.5 mA. A resistance of about 5.1 kΩ in the collec-

Table 1. Rotation for various states of sensors A and B.

B	A	transition to:
0	0	A=CCW, B=CW
0	1	B=CCW, A=CW
1	0	B=CCW, A=CW
1	1	A=CCW, B=CW

tor of the PT will guarantee saturation of the PT when a 5-volt supply is used for the decoder. A larger collector resistor is needed when a higher supply voltage is used.

**Figure 3** shows that the direction of rotation is indicated by the transitions of the PTs and the state of the PTs after the transition. **Table 1** shows the rotation for various states of sensors A and B.

### The decoder

The decoder detects the transitions of the A and B PTs and generates a pulse that's multiplexed to the appropriate CCW or CW output, according to the states of A and B PTs after the transition. The decoder schematic is shown in **Figure 4**. The decoder is comprised of a quad ExNOR IC and a dual four-channel multiplexer. The CD4077 and MC14077 are equivalent CMOS ExNORs, and the CD4052 and MC14052 are equivalent CMOS multiplexers. Either the AE unbuffered or BE buffered versions of these ICs can be used. The truth tables for the ICs are given in **Table 2**.

The decoder in **Figure 4** generates a pulse for every transition of the PTs. Because there are two transitions in each PT for a line pair, an encoder disc with 25 line pairs is decoded to produce 100 pulses per revolution.

The decoder and the electro-optical sensors, A1 and A2, are shown in **Figure 4**. A1 generates the "A" waveform and A2 generates the "B" waveform. U1a and U1c each have one input connected to  $V^+$ . From the truth table for

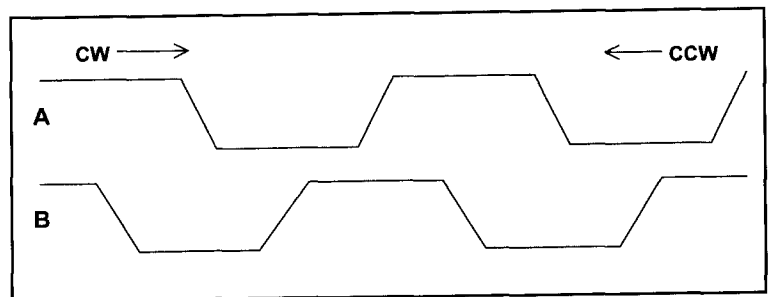

Figure 3. The output of the electro-optical sensors is separated by 90 degrees.

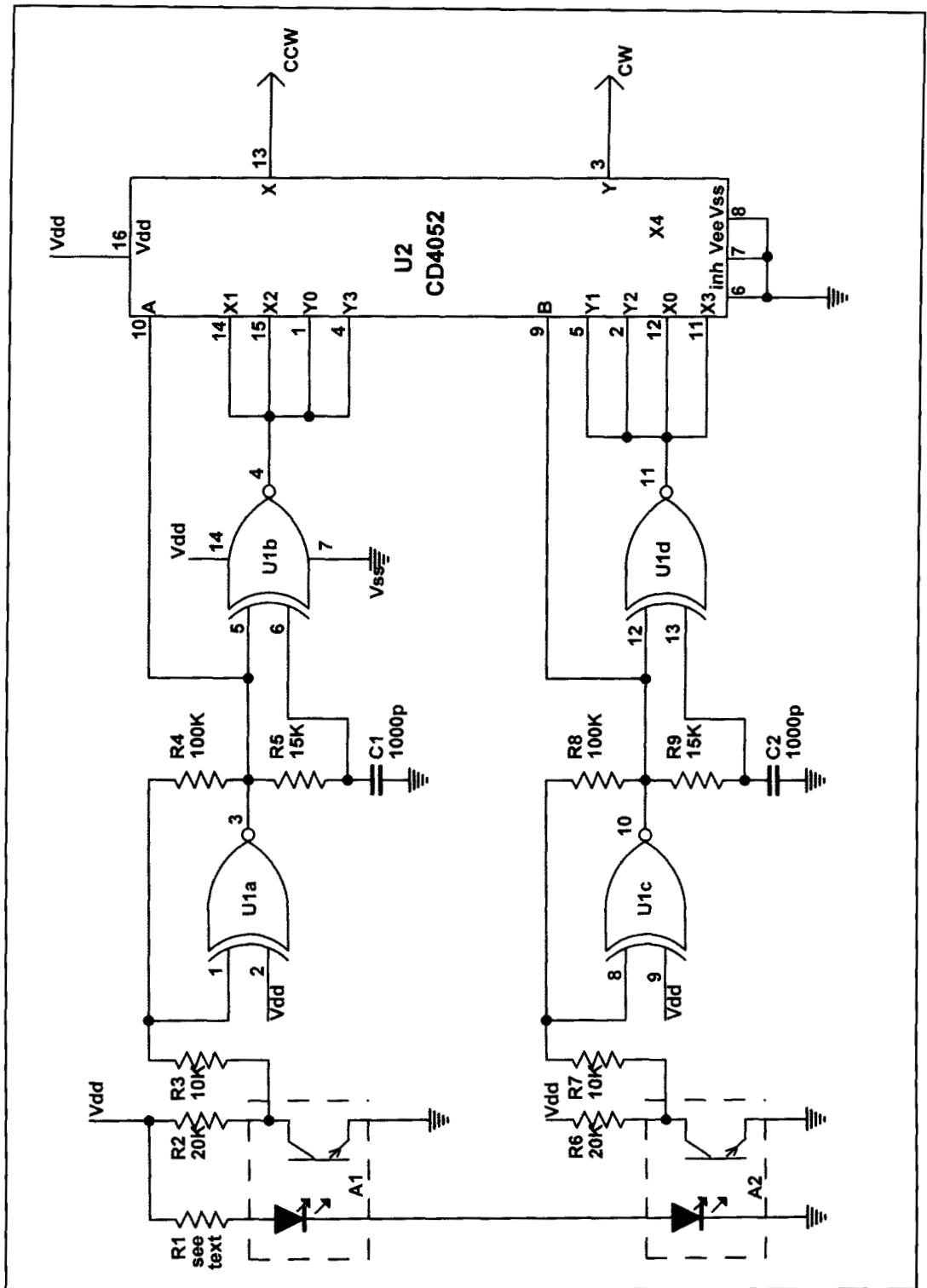

Figure 4. The decoder produces four pulses per line pair.

the ExNOR, it's apparent that when one input is tied high, the gates act as non-inverting buffers. Positive feedback provided by R2 and R3, and R5 and R6 speed the rise and fall times of the outputs and produce some hysteresis. The hysteresis eliminates noise chatter effects

from the PTs at the gate's threshold. The outputs provide the control signals to the multiplexer U2 and also drive the pulse generators U1b and U1d.

Before the transition of A or B, the inputs of U1b and U1d are equal and the outputs are

Table 2. IC truth tables.

ExNOR CD4077			Multiplexer CD4052			
B	A	out	B	A	"on"	channel
0	0	1	0	0	X <sub>0</sub>	Y <sub>0</sub>
1	0	0	0	1	X <sub>1</sub>	Y <sub>1</sub>
0	1	0	1	0	X <sub>2</sub>	Y <sub>2</sub>
1	1	1	1	1	X <sub>3</sub>	Y <sub>3</sub>

1 = high level, 0 = low level

The inhibit, pin 6, and V<sub>EE</sub>, pin 7, of the CD4052 are held low.

high. At the transition, one input changes immediately while the other lags until the capacitor charges. The voltage on the capacitor charges to the gate threshold of about 0.5 V<sup>+</sup> in about 0.7 RC seconds. While the capacitor is charging, the inputs are different and the output is low. Therefore, the low output pulse width is about 0.7 RC or about 100 μs when R is 15 kΩ and C is 1000 pF.

The negative pulses at the outputs of U1a and U1c are multiplexed by U2 to produce the CW or CCW outputs according to the states of A and B. The pulses at the CW output increment (increase) the counter, while the CCW pulses decrement (decrease) the counter.

### The counter

A two-decade counter is shown in **Figure 5**. CW pulses drive the "up clock" input and the CCW pulses drive the "down clock" input of the CD40192 or CD40193. The CD40192 is a binary-coded decimal (BCD) decade up/down counter and the CD40193 is a straight-binary (BIN) counter.

The CD40192 and CD40193 are presettable

up/down counters with dual clocks. The inputs consist of four independent jam lines, a preset, a master reset, and individual clock up and clock down inputs. The outputs are four binary Q outputs (1, 2, 4, 8) plus carry and borrow outputs. The counter is cleared so all outputs are set in a low state by a high on the "reset" line. Reset is accomplished asynchronously with the clock. Each output is individually programmable asynchronously with the clock to the levels on the corresponding jam inputs when the preset control is low. The truth table for both the CD40192 and 40193 is shown **Table 3**.

The counter counts up on the positive clock edge of the "clock up" signal, provided the "count down" line is high. The counter counts down one count on the positive clock edge of the "count down" signal, provided the "count up" line is high. The "carry" and "borrow" outputs are high when the counter is counting up or down. The "carry" signal goes low one-half clock cycle after the counter reaches the its maximum count in the count up mode. The "borrow" signal goes low one-half clock cycle after the counter reaches its minimum count in the count down mode. Any number of counters

Table 3. CD40192/CD40193 truth table.

Clock up	Clock down	Preset enable	Reset	Action
Δ+	1	1	0	Count up
Δ-	1	1	0	No count
1	Δ+	1	0	Count down
1	Δ-	1	0	No count
X	X	0	0	Preset to "jam" inputs
X	X	X	1	Reset to zero

1 = high level, 0 = low level, X = don't care

Δ+ = positive transition, Δ- = negative transition.

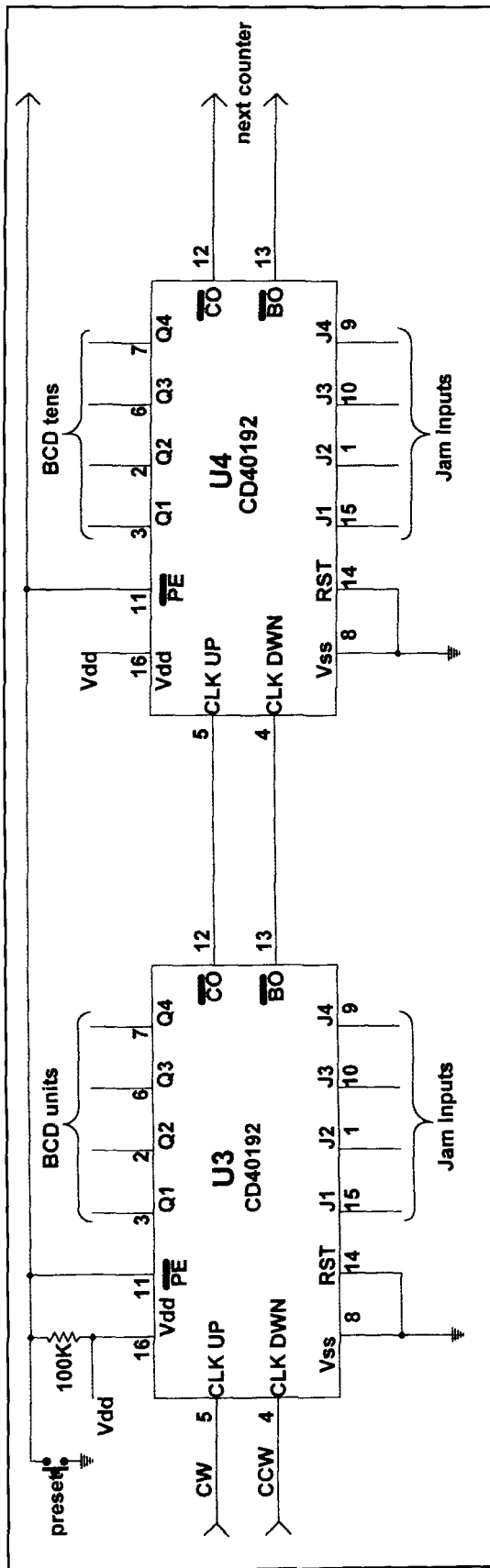

Figure 5. CW pulses are counted up and CCW pulses are counted down.

can be cascaded by tying the “carry” and “borrow” outputs to the respective “count up” and “count down” inputs of the succeeding counter.

While preset capabilities aren’t required for a shaft encoder, they can be useful when it’s desirable to return to a stored count. For example, the count can be stored in 4-bit registers, such as the CD4076. The register’s inputs are provided by the counter’s Q outputs for storage and the register’s outputs are applied to the counter’s jam inputs. When the count is to be recalled, the preset control line is pulsed low and the number stored in the register presets the counter.

Up/down counters like the CD4029 can be used if an up/down detector, such as the one shown in Figure 6, is used to control the up or down mode. The inputs of the CD4029 consist of: a single clock, “not carry in,” “binary/decade,” “up/down,” “preset enable,” and four individual “jam inputs.” A high “preset enable” signal allows information on the “jam inputs” to set the Q outputs to any state asynchronously with the “clock.”

The counter advances one count at the positive transition of the “clock” when the “not carry in” and “preset enable” are low. Advancement in the count is inhibited when the “not carry in” or “preset” are high. The “not carry out” is normally high and goes low when the counter reaches its maximum count in the “up” mode and the minimum count in the “down” mode, provided the “not carry in” is in the low state. The “not carry in” terminal must be connected to V<sub>SS</sub>, low, when not in use.

Binary counting is accomplished when the “binary/decade” input is high; the counter counts in the decade mode when “binary/decade” input is low. The counter counts up when the “up/down” input is high, and down when the “up/down” input is low.

The conversion of separate clock up and clock down lines into a single clock and an up/down control signal is accomplished with the CD4011 quad dual-input NAND gate U5 shown in Figure 6. With negative clock signals from the decoder, either CW or CCW, the output of U5a is a single positive clock pulse train. U5d acts as an inverter. U5b and U5c are connected to form a latch. A CW pulse from the decoder causes the output of U5b to be high until a CCW pulse is received to set the output low.

A shaft encoder’s electronics are simple and with the low 4000 series CMOS prices, cost isn’t much of a consideration, but the mechanics can be demanding depending on the number of counts per revolution and the “feel” of the knob.

The inertia of a heavy flywheel makes the knob less touchy and allows the knob to spin

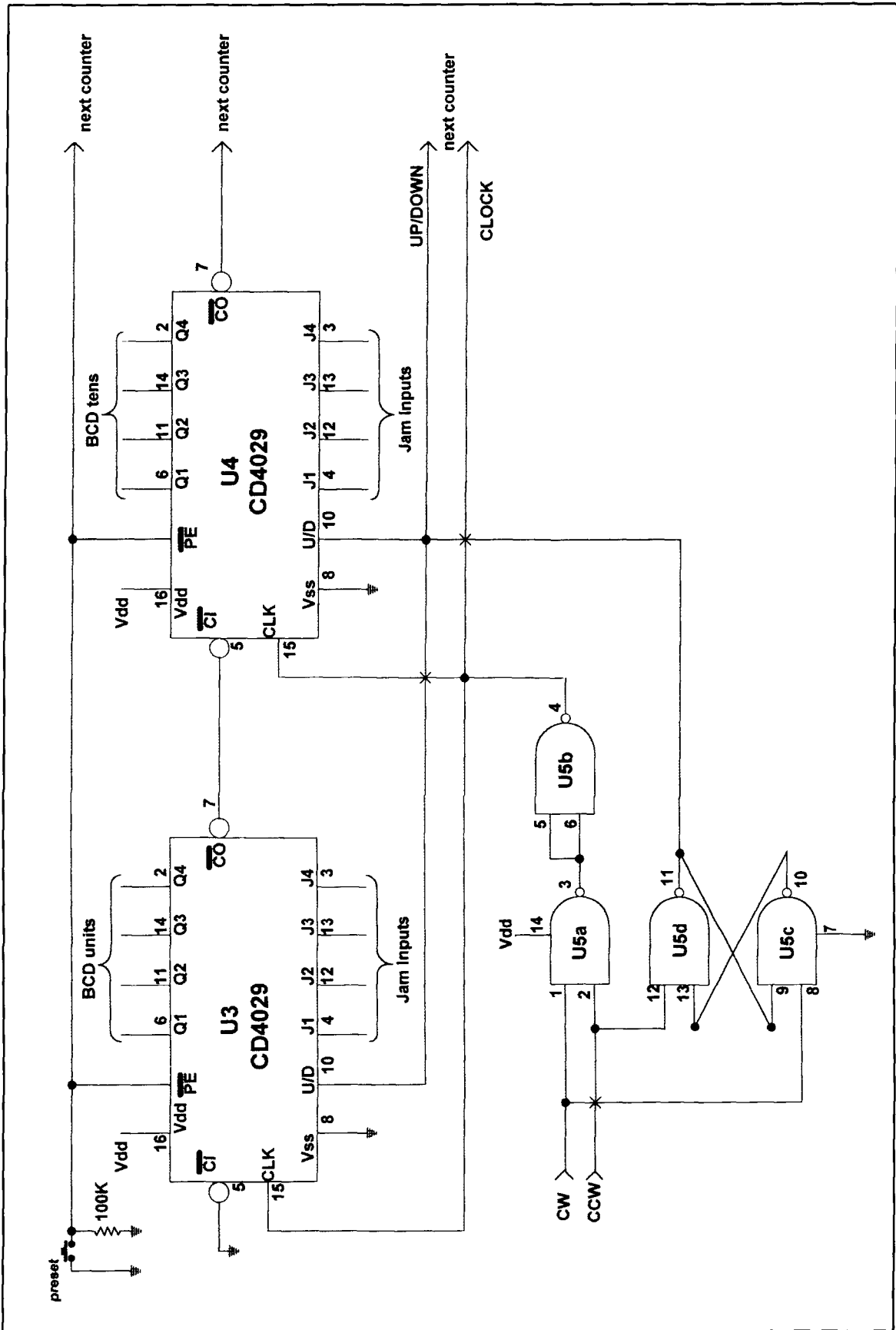

Figure 6. CW or CCW pulses can be detected to control an up/down counter.

with a single turn. Inertia in the knob can be achieved by casting a flywheel from melted used tire-balancing weights. A flywheel weight of three or four ounces will probably be enough. The flywheel can be cast in a mold made of plaster or a small tin can. The flywheel diameter must be a quarter inch or so less than the encoder disc, so there's room for the sensors to fit over the disc.

The flywheel must be balanced with the encoding disc in place on the shaft. The fly-

wheel is balanced by drilling holes or otherwise removing flywheel material at the point that settles to the bottom. The sensitivity of balance depends on the quality of the bearings holding the shaft.

With the design considerations given here, you can design a shaft encoder that performs with the best of them and costs a lot less. A shaft encoder that compliments the project you have in mind is a worthwhile endeavor and won't cost a bundle! ■

## PRODUCT INFORMATION

### **AOR's AR7000B DSP**

#### **Wide-Range Receiver**

AOR's AR7000B wide-range receiver blends a color video display, DSP technology, a triple conversion front end, and computer interface in an all-mode unit.

The receiver's color video display has a panel approximately 2 inches high and 2.5 inches wide (3.1 inches diagonal). It displays: frequencies, modes, volume, squelch, AGC, bandwidth, channel and bank designators, alphanumeric channel label, date, and time. Video information can be exported to an outboard monitor from the composite video output on the rear panel of the AR7000B. The user can select either NTSC or PAL video formats for the output port.

The AR7000B rear panel has a 9-pin RS-232C port for a full-control computer interface, an 8-pin DIN auxiliary connector, BNC antenna connector, constant-level audio output, external speaker jack, and 12-volt DC input coaxial connector. The front panel has a headphone jack and a remote-control receiver window for commands from the standard infrared (IR) remote controller that allows operation of the AR7000B from across a room.

Computer programming and control of the AR7000B is possible with free software available through the AOR Web sites at: <[www.aorusa.com](http://www.aorusa.com)> or <[www.aorja.com](http://www.aorja.com)>.

Front panel controls include power switch, multi-function keypad for direct frequency entry, and 12 secondary functions. Other buttons control volume, operating mode (VFO or memory), keyboard lock, escape command, frequency entry command, and run/break for executing programmed search and scan functions.

Modes received include: WFM, NFM, AM, LSB, USB, and CW. Frequency coverage is from 100 kHz to 2 GHz (cellular frequencies blocked on U.S. version).

For more information contact AOR U.S.A., Inc., 20655 S. Western Avenue, Suite 112, Torrance, CA 90501; Phone: (310) 787-8615.

### **Tektronix DPO**

Tektronix, Inc. has introduced a second family of digital phosphor oscilloscopes (DPO). The TDS3000 family of DPOs are priced starting at \$2,995. These scopes include up to 500-MHz bandwidth, four-channel operation, and a 5-gigasamples per second (GS/s) sample rate.

The Tektronix DPOs display, store, and analyze in real-time, using three dimensions of signal information: amplitude, time, and the distribution of amplitude over time. This provides the intensity-graded display and responsiveness of an analog oscilloscope, combined with the storage and measurement capabilities of a digital storage oscilloscope (DSO).

To learn more about the TDS3000 series of DPOs, visit the Tektronix home page on the web at: <<http://sss.tektronix.com>> or write on company letterhead to: Tektronix Measurement Business Division, P.O. Box 3960, Portland, Oregon 97208-3960.

### **Duplex Adapters from Molex**

SC-ST and SC-SC Duplex Adapters from Molex Fiber Optics feature a metal housing with a choice of zirconia or phosphor bronze alignment sleeves. The adapters can be grounded to the equipment chassis to minimize EMI emission. They are suitable for both single mode and multimode applications in local area network (LAN) and telecommunication market.

The Molex duplex adapters come with a metal clip for snap-mount installations or two mounting holes (without thread) for flange-mount installation. They are compatible with Molex's plastic SC duplex shutters that help prevent dust contamination and laser exposure. These adapters meet IEC and NTT standards.

For more information on the SC-ST and SC-SC Duplex Adapters, contact Molex Fiber Optics, Inc., 5224 Katrine Avenue, Downers Grove, Illinois, 60515, or call toll-free 1-800-A1-FIBER.

# ELEVATED RADIAL WIRE SYSTEMS FOR GROUND-PLANE TYPE ANTENNAS

## *Part 3: A monopole antenna with parasitic wire elements*

---

In Part 2 of this series of articles, I compared predicted field strengths (FS) with results measured for an MF broadcast station which used an antenna system employing elevated radials. Why report on a study of MF broadcast antennas in an article published in a magazine whose readers are interested in amateur radio? I did so because I had measured results and wanted to validate the application of NEC-4D (the EZNEC pro version\*) to predict field strength and gain. I conclude that I have validated NEC-4D, particularly as I have carried out additional studies since publishing the earlier articles.<sup>1,2</sup>

Carrying on in the same theme, I then described a number of phased arrays for a band of interest to VE2CV, the 80-meter band. While the antenna systems described do not represent any particular installation, they are technically correct and could be used by an ambitious radio amateur. They are however, except for one (a twin half-diamond-loop GP

type array), not practically easy to adjust. This is because each of the elements of the antenna systems must be fed with currents having the appropriate phase and amplitude, otherwise the radiation patterns and gain calculated will not be realized in practice.

It is better to have one feed point. VE2CV has experimentally (see **Reference 3**) and numerically modeled twin half-delta-loop GP type antennas. For field-day application, he has used two orthogonal twin half-delta-loop GP type arrays, dimensioned for the 40-meter band. This antenna system certainly worked, but I had no reference antenna for comparison.

Here we consider a monopole antenna, a tower, with parasitic wire elements, active guys, which is a practical antenna from the point of view of space required and simplicity in feeding it (one feed point).

### Introduction

Dipole antenna systems with parasitic elements (e.g. the Yagi antenna) are commonly used for the higher bands: 40 meters and down.

---

\*Available from Roy Lewallen, W7EL, P.O. Box 6685, Beaverton, Oregon 97007 (e-mail <w7el@teleport.com>). Note: EZNEC pro is normally supplied with the NEC-2 and MININEC engines because NEC-4 is not available unless the user is licensed to use NEC-4.

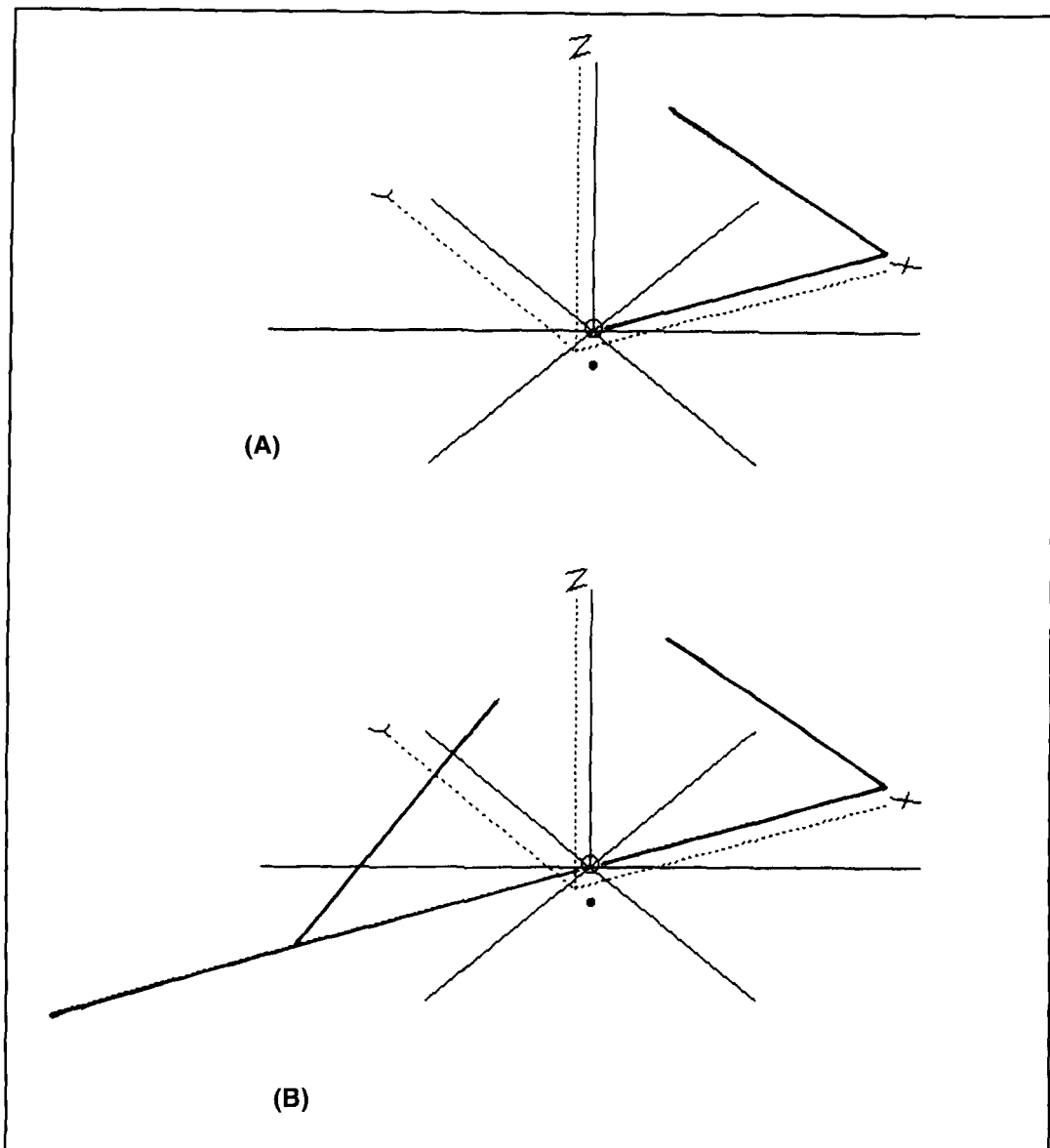

Figure 1. (A) Arrangement where a sloping wire is used as a reflector element. (B) Arrangement where two sloping wires are used.

While a GP type monopole antenna system with parasitic elements can be devised, and such antenna systems are in use for MF broadcasting, they are not very practical, particularly for the lower bands—40 meters and up—because, if lattice towers are used for the antenna elements, the height of a tower is not very easily adjusted to optimize forward gain. Broadcasters use tuned towers. And, multi-tower antenna arrays for the lower bands are not very practical for the radio amateur.

The sloping-reflector arrangement described by Ford,<sup>4</sup> which consists of a wire slung from near the top of a monopole antenna (but insulated from it) at a slope of 45 degrees is revisited here. Ford's reflector/or director, is tuned by inserting a passive reactance in series with the

base of the sloping wire, which is attached to its own ground system. Dimensions for various mast heights were investigated. For an overview of Ford's antenna systems, see Belrose.<sup>5</sup>

I describe here the results of a numerical modeling study for a monopole that comprises a typical lattice tower, with sloping reflector and director elements. If the tower height is 0.249 wavelength (19.9 meters or 65.3 feet) and it is fed against six elevated resonant radials over average ground (height of radials 2.5 meters, length of radials 0.24 wavelength or 19.2 meters), it is a resonant antenna for 3.75 MHz ( $Z_a = 36$  ohms). A grounded tower could be used with shunt or gamma match feed, but since we are concerned here with elevated radials, our model is for this type of antenna.



The parasitically excited director and reflector elements are wire structures, suspended between the top of the tower and wooden posts 1/4 distant on one or both sides of the tower (height 2.5 meters, distance out from the tower 20 meters for 3.75 MHz). The lower ends of these elements are connected to a horizontal resonate radial wire running back toward the tower and in the direction of maximum gain, but are insulated from the tower. For the case where the sloping wire is supposed to act like a reflector, only one radial wire is needed

because this wire, running back toward the tower, is already pointing in the direction of maximum gain. Thus we have simulated a GP type monopole array with parasitic elements.

### Antenna with a reflector

In **Figure 1A**, I have sketched the arrangement where a sloping wire is used as a reflector element. The optimum length of the sloping wire (according to NEC-4D) is 0.263 wavelength (21.04 meters). The length of the radial

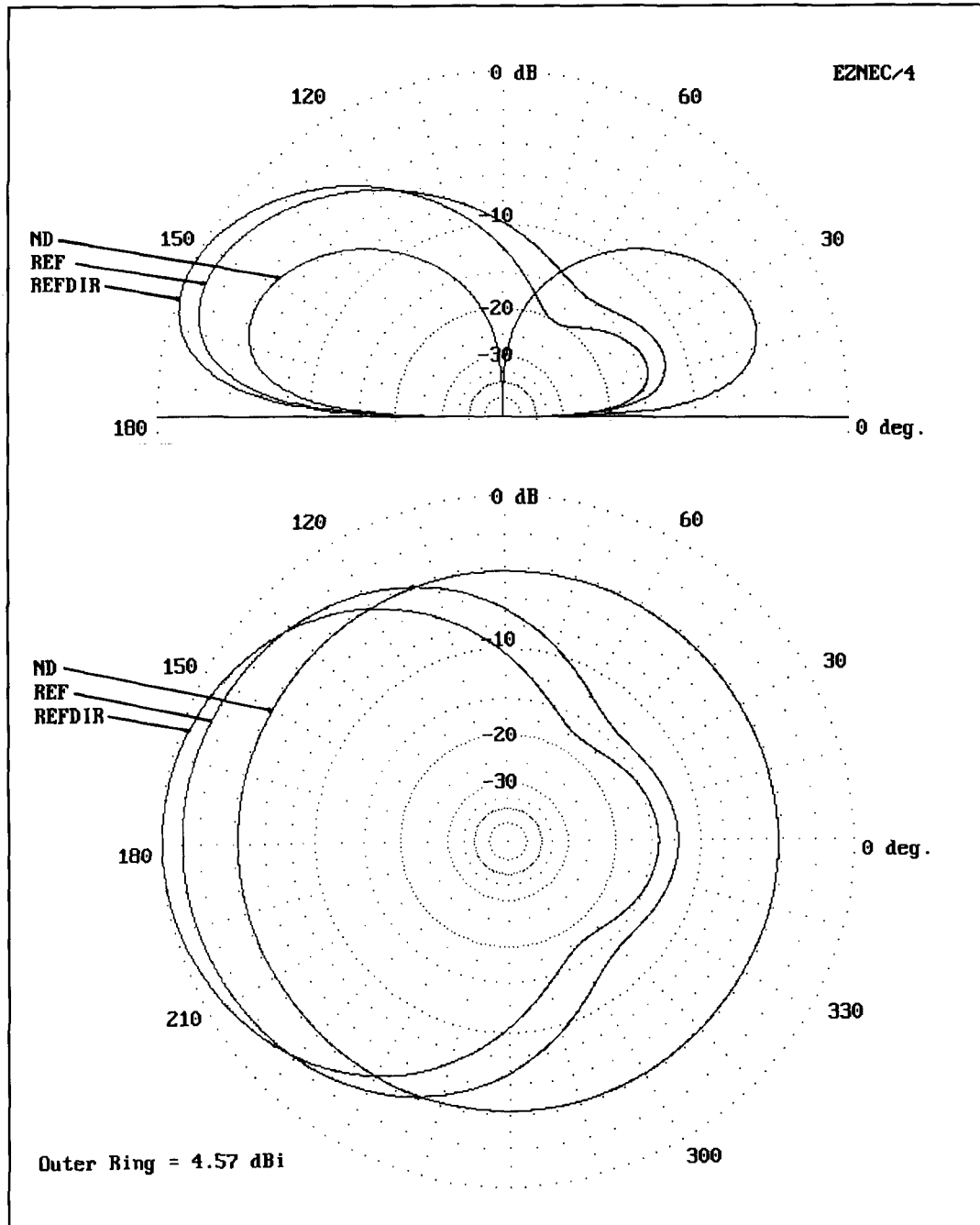

Figure 2. Calculated principle patterns.

(see above) is 0.24 wavelength (19.2 meters). The calculated space wave gain is 3.53 dBi, compared with 0.34 dBi for the tower alone. Thus this two-element array has a gain of 3.2 dB over the ND tower. The calculated antenna system impedance is  $Z_{as} = 47.7 + j 29.6$  ohms (recall that the tower alone was resonant,  $Z_a = 36 + j 0$  ohms). I will discuss and compare the radiation patterns below.

## Antenna with director and reflector

In **Figure 1B**, I have sketched the arrangement where two sloping wires are used: one whose length has been adjusted so it acts like a reflector (as discussed above); the other sloping wire on the opposite side of the tower is shortened, so it acts like a director. This sloping wire is connected to two resonant radials: one running back toward the tower and one running in the direction of maximum gain (to optimize realizable gain). The optimum length for this sloping wire is 0.242 wavelength (19.36 meters). The forward gain is increased by more than 1 dB, to 4.57 dBi. Thus the gain for this three-element array is 4.23 dB over the ND tower. The antenna system impedance is  $Z_{as}$  (calculated) =  $28 + j 27.3$  ohms.

## Radiation patterns compared

In **Figure 2**, I show the calculated principle plane patterns. The curves labeled ND are the non-directional patterns (tower alone). The curves labeled REF are for the arrangement where a sloping wire and radial have been added to form a two-element array, driven element, and reflector. The curves labeled REFDIR are the patterns for a three-element array, a driven element, and a reflector and director.

Clearly this is a simple way to realize significant gain and directivity, and the active guys help support the tower.

## Concluding remarks

While various GP type arrays consisting of driven and parasitic elements can be fabricated (e.g., antenna systems employing separate towers tuned to act like a driven element, with director and reflector elements), the antenna system described here is much easier to fabricate and more practical for backyard installation. In fact, the director and reflector elements of the array described are merely tuned guys.

The two-element array (driven element and reflector) is the one easiest to construct, and an antenna system of this type could be arranged

to change the azimuth of maximum gain. We could install two (perhaps four) reflector elements, with two (or four) remote control connect/disconnect relays located at the junction between the sloping wires and the horizontal radials. Because floating quarter-wavelength wires are not resonant, the unwanted wires required to rotate the beam in other directions will not carry an appreciable current.

The reflector and director elements can be adjusted for maximum forward gain or for an optimum F/B ratio. We have optimized our model for maximum forward gain. When constructing the antenna, make the sloping wires initially longer than I have calculated—to optimize the antenna performance, you'll want to cut off short lengths of wire, rather than having to add lengths of wire.

The reflector/director elements for this model are wire elements. Two parallel conductors spaced by insulated spreaders could be used instead to broaden the bandwidth of the antenna system.

Note: This modeling study has assumed a base insulated tower, height 19.9 meters, height of base 2.5 meters, with elevated radials. But reflector or reflector/director elements could be added to an existing GP type antenna of any reasonable height. Whatever the tower height, the tower (the driven element) must be tuned, and it is necessary to retune when parasitic elements are added.

Have fun constructing, adjusted, and operating this antenna array and, if you do, let me know how it performs.

## Postscript

I carried out a design study for adding a reflector to an MF broadcast tower in New Zealand, which I hoped might be installed as this would provide me with measured data.<sup>6</sup> While this project may go ahead, the broadcaster has not yet decided. If it does, VE2CV will report on the results obtained in a brief note in the "Technical Conversations" column of *Communications Quarterly*. ■

## REFERENCES

1. J.S. Belrose, "MF Broadcast Antennas and Antenna Arrays: A Historic Branch of Antenna Engineering Revisited by Computer Simulation and Measurement," Proceedings of 15th Annual Review of Progress in Applied Computational Electromagnetics, Naval Postgraduate School, Monterey, California, March 15-20, 1999.
2. J.S. Belrose, "Umbrella Top Loaded Antennas: Base Fed, Folded, and with Tuned Insulated Counterpoise," *ibid.*, 1999.
3. J.S. Belrose, "A Half Twin-Delta Loop Array," *Technical Correspondence, QST*, April 1983, pages 39-40.
4. E.T. Ford, "A Directional MF Transmitting Antenna Comprising a Single Guyed Mast and a Sloping Parasitic Reflector," ICAP #3, IEE Conference Publication No. 219, Part 1, 1983, pages 235-239.
5. J.S. Belrose, "An Update on Sloping-Wire Antennas," *Technical Correspondence*, September 1984, page 40.
6. Steven White, private communication, 1998.

Dean D. Battishill, W5LAJ  
7 Crest Way  
Silver City, New Mexico 88061, and  
W.J. Byron, W7DHD  
240 Canyon Drive  
Sedona, Arizona 86336

# HOMEBREWING AN AMPLIFIER AROUND THE SVETLANA 4CX400A

*A multi-band, maximum power linear*

It's always exciting to build a brand-new piece of equipment, especially when the components themselves are new. Such is the case with the amplifier described here. The power tubes are three Svetlana radial-beam power tetrodes, type 4CX400A (see **Photo A**).

This amplifier is designed and built around a tube which bears a special characteristic that allows it to operate at 70 percent efficiency, without producing excessive screen current. All parameters are within (and usually less than) their maximum values.

Considerable improvisation was required during the amplifier's construction. For instance, Svetlana manufactures tube chimneys, but we didn't have access to them. Instead, we wrapped high-voltage transformer insulation around the tubes, using the tubes themselves as mandrels. The insulation was held in position by applying glass tape. The entire chimney was then removed and the procedure was repeated for each tube.

## The design

The amplifier is mostly conventional, but there are *some obvious differences*. The 4CX400A is a high-perveance tetrode possess-



**Photo A.** The Svetlana 4CX400A (courtesy of Svetlana).

ing 400 watts plate dissipation capability when air cooled. It resembles other external anode tubes, particularly those of EIMAC™ and PENTA™ manufacture.

The idea was to build a multi-band, maximum-power linear amplifier. Note that it's not quite "all band," as operation on 160 meters and on 10 meters isn't covered. Part of the reason is technical and part is philosophical; operation on

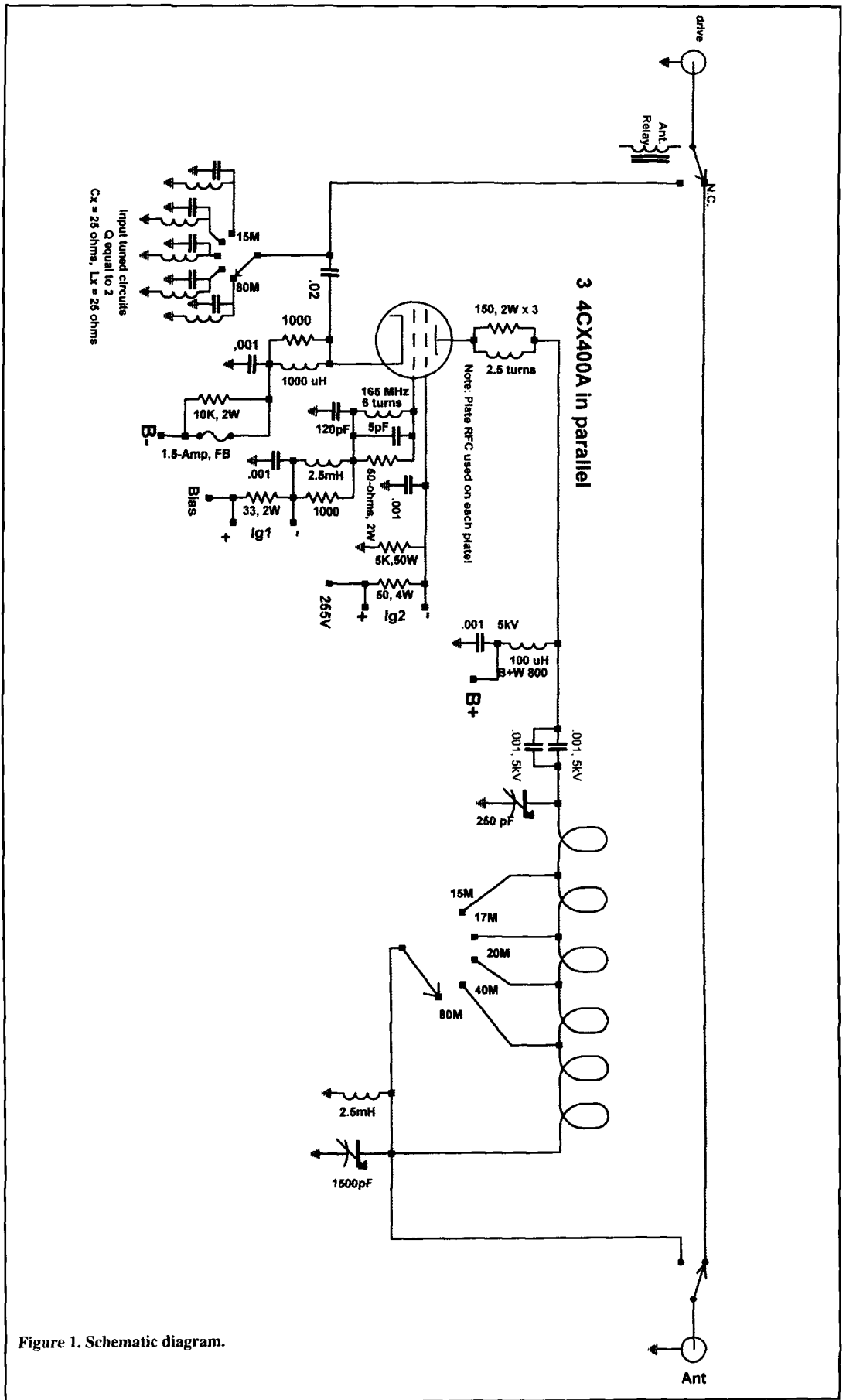

Figure 1. Schematic diagram.

the 160-meter band requires special handling as required by both the tank circuit and the RF plate choke. The frequency range is limited to the region between 80 and 12 meters. It's a subjective choice. Some operators question the need for a kilowatt amplifier on 10 meters, and maybe even 12 meters. The selection of the tube types, the class of operation (AB<sub>1</sub> or AB<sub>2</sub>) and the power level are of concern—and must be among the *prime* considerations.

## Power level and class of operation

The amplifier is of the maximum power variety. A single 4CX400A wouldn't produce the power needed, but two such tubes could produce 1500 watts safely. However, we used *three* tubes, making this a very conservatively designed amplifier (see the schematic in **Figure 1**).

A nominal efficiency of 70 percent can be achieved with these tubes; thus, the amplifier requires about 2150 watts input. Enough capability must be provided to allow comfortable operation at 1500 watts output on RTTY. Three '400As provide 1200 watts of plate dissipation. Only 650 watts are dissipated during operation in class AB<sub>2</sub>. *Everything* about these tubes promotes confidence. They are "loafing" even during the RTTY phase; and, with a power gain of 15 dB, they aren't challenged in that sense, either.

## Plate load resistance

The plate voltage under load is 2700 volts. The plate current at maximum power output is 800 mA, developing a plate resistance of 2150 ohms—the value that must be converted to the nominal 50-ohm load. As is usual practice, the pi-coupler is used. It must be designed for the

```

5 '*****
10 '*      Qo-BASED PI-NETWORK CALCULATIONS BY WSFD      *
20 '*      *
30 '*  CALCULATING PI-NETWORK REACTANCES USING WSFD EQUATIONS BASED *
40 '*      ON ACTUAL CIRCUIT OPERATING Q (Qo).          *
60 '*  FILE NAME: PINET      Edited by W2DU 2-21-89 *
61 '*      *
62 '*  EMENDED 9-8-91, W7DHD (Lines 320+)          *
70 '*      *
80 '*  SEE WSFD'S QST ARTICLE, AUGUST 1983, P23. SEE ALSO CORRECTIONS, *
90 '*      "FEEDBACK," QST, JANUARY 1984.          *
100 *****
110 CLS
120 X1=0:X2=0:XL=0:R1=0:R2=0:Q1=0:Q2=0
130 INPUT "R1";R1
140 INPUT "R2";R2
150 INPUT "Qo";QO
160 IF (R1*R2*QO)<=0 THEN PRINT "NOT A PI NETWORK" : GOTO 310
170 ' SPECIAL CASE WHERE R1 = R2
180 IF R1 = R2 THEN X1 = (2*R1)/QO : X2 = (2*R2)/QO : Q1 = QO/2
190 IF R1 = R2 THEN XL = (R1*QO)/(Q1*Q1+1) : GOTO 290
200 IF ABS((QO*QO+1)-(R1/R2))<.01 THEN PRINT "L NETWORK" : GOTO 310
210 IF ABS((QO*QO+1)-(R2/R1))<.01 THEN PRINT "L NETWORK" : GOTO 310
220 IF R1/R2>QO*QO+1 THEN PRINT "NO SOLUTION" : GOTO 310
230 IF R2/R1>QO*QO+1 THEN PRINT "NO SOLUTION" : GOTO 310
240 Q1=(R1*QO-SQR(R1*R2*QO^2-(R1-R2)^2))/(R1-R2)
250 Q2=QO-Q1
260 X1=R1/Q1
270 X2=R2/Q2
280 XL=(R1*QO)/(Q1*Q1+1)
290 PRINT TAB(3)"R1"TAB(14)"R2"TAB(23)"QO"TAB(33)"Xc1"TAB(45)"Xc2"TAB(57)"XL"
300 M$="###.# ###.# ##.# ###.# ###.# ###.#"
310 PRINT USING M$;R1,R2,QO,X1,X2,XL:PRINT:PRINT
320 INPUT "Enter frequency in Megahertz";F:PRINT:PRINT
330 W = 2*3.14159*F*1000000!
340 C1 = 1/(W*X1): C2 = 1/(W*X2): L = XL/W
341 C1=C1*1E+12:C2=C2*1E+12:L=L*1000000!
342 PRINT" C1,pF C2,pF L,UH"
350 N$="###.# ###.# ###.#"
351 PRINT USING N$;C1,C2,L
352 END

```

Figure 2. Program for BASIC Pi-Network calculations from *Reflections* by Walter Maxwell.

Table 1. Minimum cooling air-flow requirements.

Plate dissipation (watts)	Sea level		10,000 feet	
	Air flow (CFM)	Pressure drop (inches of water)	Air flow (CFM)	Pressure drop (inches of water)
200	5.0	0.10	7.5	0.15
300	6.0	0.15	8.7	0.22
400	8.0	0.20	11.5	0.30

transfer ratio of 2150:50. While "Q" is an option, it must be high enough to reduce most of the harmonic production, but not so high as to produce both heat production in the tank and the attendant difficulty of "touchy" tuning. A Q of 10 is used for most bands, but on a band like 12 meters, a higher Q is unavoidable. This is because *at least* 21 pF of the pi-input capacitance  $C_1$  results from the fixed output capacitance of the three tubes. It would be safe to say that the true value is in the vicinity of 30 pF. The specific values of  $C_1$  and  $C_2$  are calculated for each band.

### The pi-tank

The design of the tank circuit can be obtained from two or three sources. It doesn't matter which is used, the tank circuit and the values of its components must be designed—a "truism" that must be accommodated in the blueprint of *every* amplifier. It's possible to copy another pi-coupler, provided the input and output resistances match those of the proposed amplifier, but this is a construction article and we want to cover every step that's faced during the amplifier's design. Output coupling is one of the most important.

One of the best references available to the amateur designer-operator-builder is *Reflections*, by M. Walter Maxwell, W2DU.

We used his BASIC program #5 (labeled "PINET") from the book (see **Figure 2**). PINET calculates the component values of pi-sections using an "operating Q," designated as  $Q_o$  in the program. These pi-section component values require careful consideration, and the availability of a program that includes the selection of an operating "Q" is almost essential for a good design. Note that, Q is not an option in L-sections. You "take what you get," and it *always* will be the lowest value available from the use of the pi-section, which *does* permit its selection.

Actually, Q plays an integral part in sizing pi-components and *dictates* their values in the HF regions. One of the most useful aspects of a pi-section is that the circuit is *bilateral*. The output tank described here will convert 2150 ohms. We use that quality in fixing the coil taps in the band-switching tank. Here's how it's done:

1. Remove all operating voltages from the amplifier. Then install a temporary non-inductive resistance of 2150 ohms between the plates and the chassis-ground.
2. Connect a noise bridge or other RF measuring device, preset to 50 ohms, to what would be normally the amplifier output.
3. Select the desired band and frequency.
4. Use the BASIC program to compute the values of  $C_1$ ,  $C_2$ , and L.

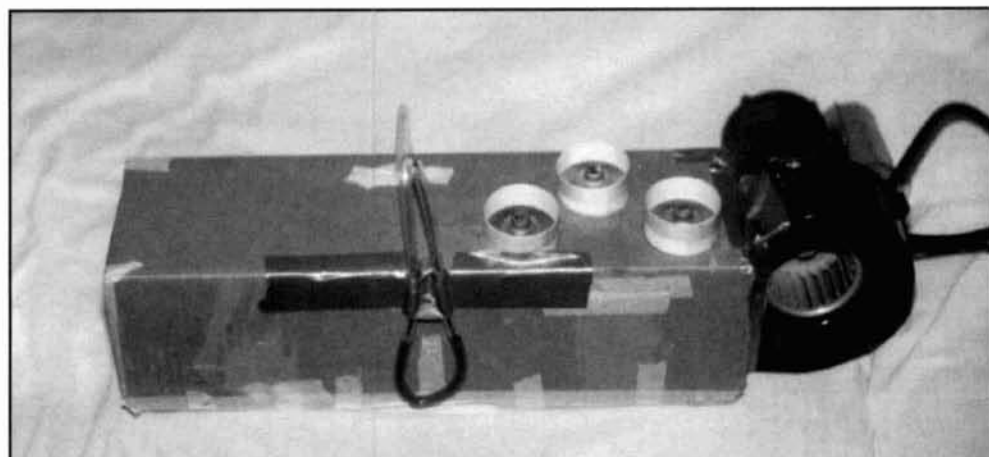

Photo B. Setup for making pressure differential measurements.

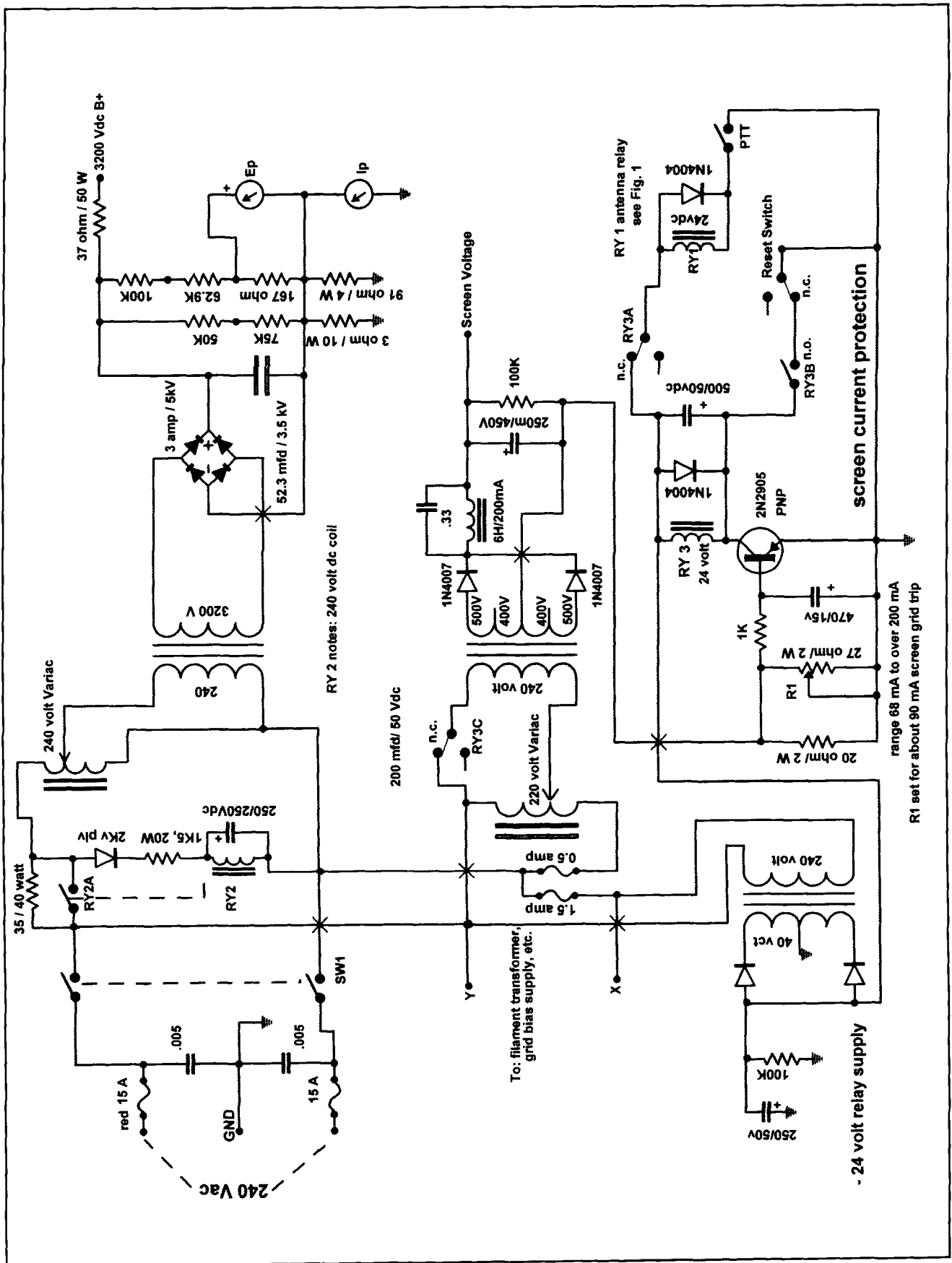

Figure 3. Power supply and protective circuits schematic.<sup>1</sup>

5. Note the C-values and preset the capacitors. A very good guess will suffice.
6. Temporarily connect the band-switch tap to the tank coil (tack solder).
7. Change the temporary position until the bridge at the output is balanced.
8. Make the "temporary" coil connection permanent.
9. Repeat these steps for each band.

The tank and its tapped inductances, as well as the two capacitors, are now "tuned" properly, with due attention to the operating Q and all other characteristics. It will be properly tuned as if it were being used in service, but *without transmitting 1 watt*. And, it will have been done *correctly*. By the way, if you forget to remove the 2150-ohm resistor, your power supply will do it for you!

## Cathode drive

The amplifier is cathode driven, with normal bias and screen voltages applied; however, it "thinks" it's being grid driven. The exciter "knows" that it's being driven in a power-consuming state. With a maximum cathode current of almost 1 ampere, the cathode driving impedance is about 25 ohms. The driver, of course, has been standardized to the usual 50-ohm value.

To accommodate both the cathode drive impedance and that of the exciter, a coupler was provided. The circuit must also be band-switched. Separate tuned circuits were used, employing parallel tuned circuits. The inductances were T-50 toroids paralleled by dipped-mica capacitors. The Qs were near 2. The idea was to afford some selectivity (and simultaneous harmonic attenuation) along with impedance matching. An SWR bridge was used to determine where the 25-ohm tap should be. In the process, a ratio for the full-coil and cathode-tap turns-ratio were determined. No further measurements of this type were made. The same ratio was applied successfully to each of the other circuits.

Both the plate- and cathode-drive circuits are bandswitched. Although both could be activated (with difficulty) by one switch, we used *two switches* requiring two front-panel knobs. The method used to establish the coil-tap positions on the output pi-section was described above, and similar cathode-tap positions were described in the previous paragraph. It's a small imposition for such a beautifully functional amplifier.

## Cooling

To cool the external anode tubes, the design requires centrifugal blowers. This is because

there is a simultaneous need for a large amount of air to be forced through the fins in the anode cooler—not only to overcome the friction of the cooling fins themselves, but also the physical construction of the air-flow path.

This is, of course, a "home-built" amplifier. The blower provided for cooling is a surplus item, rather common among builders. The cooling flow is specified in the data sheet (see **Table 1**) in both CFM and the delta-P across the tube in inches water gauge, or w.g. Most of us couldn't make an accurate flow measurement, but we *can* make quite accurate pressure differential measurements.

This is accomplished by making a trial. Select a cardboard box large enough to accommodate both the blower and the number of tubes; in this case, *three* (see **Photo B**). In the photo, the home-built manometer, constructed of Tygon™ tubing, is visible on the side of the box. Red vegetable dye helps define the liquid levels. With both blower and tubes in place, start the blower and *measure* the distance between the surfaces. The minimum flow required depends upon the actual plate dissipation (**Photo B**). A simple ruler is all you need to measure the difference in inches. In this amplifier, one-quarter inch would suffice; the elevation of Silver City is at 7,000 feet asl. The 10,000-foot reading is, therefore, appropriate.

## The power supply

The power supply used is one built originally for the 4CX1200 (see **Figure 3**).<sup>1</sup> Both the plate and screen voltages are adjustable. Mating connectors for each of the amplifiers are available, allowing it to be used on either amplifier. The screen-supply rectifier uses a "tuned choke" (note the capacitor around the filter choke). This is resonated at 120 Hz, the ripple frequency. Screen voltages must be *steady*. The use of a tuned reactor relieves the operator-builder from having to construct a full-fledged voltage-controlled screen supply. All voltages are available from the supply, including the 24-volts DC required by the relays.

## Acknowledgment

We wish to acknowledge the help and counsel received from Dick Linari, WØYXM. He has been, in this and countless other efforts, a valuable source of knowledge and inspiration. ■

### REFERENCES

1. Dean Battishill, W5LAJ, "The Care and Feeding of the 4CX1600B," *Communications Quarterly*, Spring 1998, page 91.

### BIBLIOGRAPHY

1. M. Walter Maxwell, W2DU, *Reflections*, The American Radio Relay League, Newington, Connecticut



# POLYPHASE AM

## Generation of amplitude modulation in the antenna field

**P**olyphase AM is a unique system for generating and radiating AM, where the carrier and sideband power are radiated from separate elements of the antenna system. The **field strengths** of the carrier and sidebands **add** in the antenna far field, producing the amplitude and modulated signal.

This ingenious scheme was invented by a team of Collins Radio engineers in 1938–39. Their objectives included (1) higher overall transmitter efficiency, (2) higher radiated power with the tubes available at that time, and (3) the elimination of a high-power class B modulation transformer.

The basic concept was tried in the 75-meter phone band at a carrier power of 100 watts. Tests proved that the concept was valid. The system and principles of operation were published in *Electrical Engineering*,<sup>1</sup> the official journal of the AIEE, in July 1939. Then Collins and the Central Broadcasting Company, which owned WHO, Des Moines, Iowa, installed a 1000-watt test transmitter using the station's half-wave vertical antenna with additional elements. (WHO operated on 1000 kHz at that time, with a carrier power of 50 kW.) The engineers performed their tests in the late-night hours. The description of this improved system, called **polyphase broadcasting**, and the results of the tests were published in *The Proceedings of the IRE*<sup>2</sup> in May 1942.

Polyphase broadcasting requires a special antenna system consisting of three co-located, but electrically isolated, antennas. The center vertical tower is fed carrier power only. The other two antennas are fed double sideband suppressed carrier (DSBSC) power. The phase of the audio modulation fed to one pair lags the phase of the other by 90 degrees.

**Figure 1** shows the basic antenna concept. One of the DSBSC antenna pairs is shown in

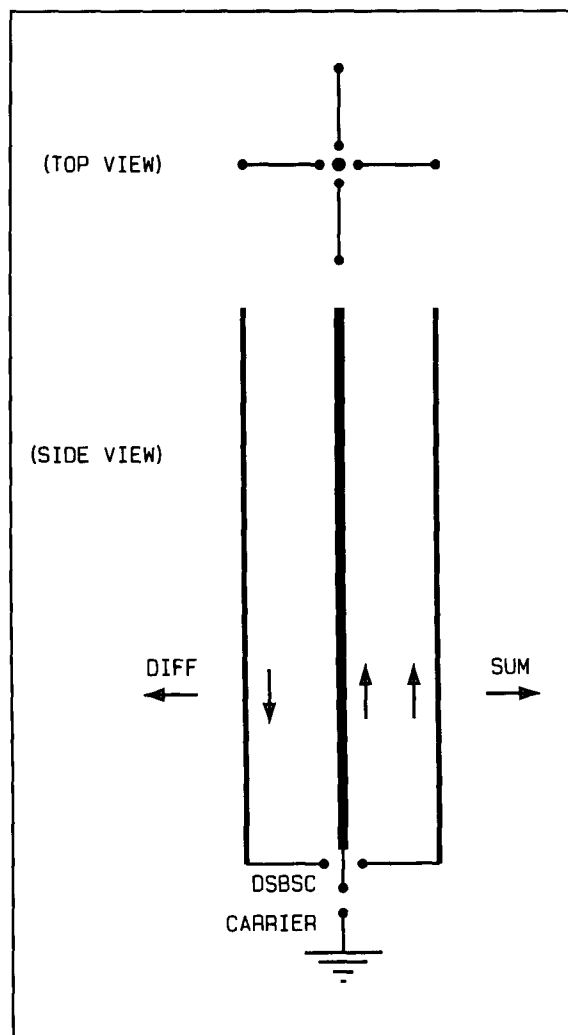

**Figure 1.** Top and side view of carrier and DSBSC antenna system. DSBSC elements are spaced 1/16 wavelength from carrier antenna. No coupling between carrier and DSBSC antennas. Carrier antenna is omnidirectional. DSBSC are bidirectional.

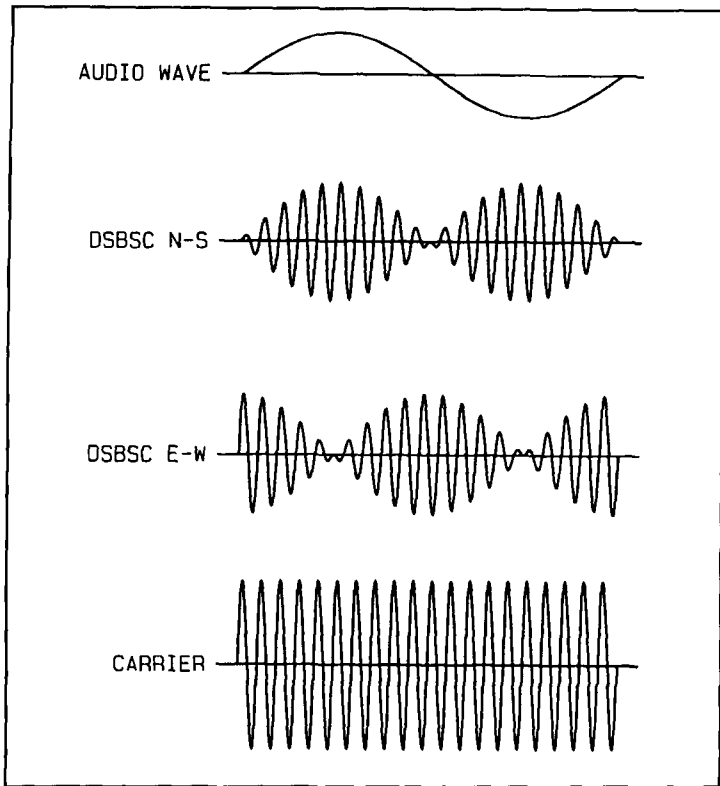

Figure 2. RF waves in three antennas for 100-percent sine wave modulation.

side view; this is the E-W (east-west) pair. Another identical pair was installed on the N-S (north-south) side of the central tower, as illustrated by the top view. Figure 1 also illustrates the antenna terminals (of the carrier and E-W pair) and the relative current phases when positive modulation is to the right (east). Each pair

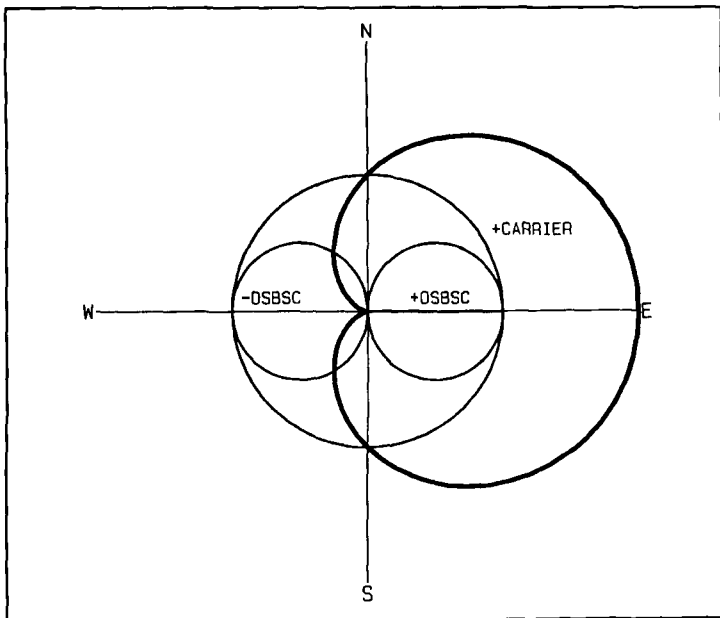

Figure 3. Antenna pattern for sine wave modulation peak East.

is fed in series, so the element currents are equal but opposite in phase.

The two DSBSC pair antennas have no RF coupling to each other or to the central tower. Each DSBSC pair produces a figure-eight radiation pattern with 3-dB gain. The elements of each pair must be close together to produce the desired figure-eight radiation pattern; but placing them too close together reduces their radiation resistance, which increases the Q of the antenna and narrows the bandwidth.

The element pairs were hung from guy wires connected to the top of the central tower. In the WHO installation, the top ends of the sideband pairs slanted inward using part of the guy wires for the top ends of the antenna pairs.

The central tower is fed carrier power only. DSBSC is fed to each of the antennas. The phases of the two suppressed carriers are the same as the other carrier, but the audio of the E-W pair lags the audio of the N-S pair by 90 degrees. Figure 2 illustrates the three RF waves fed to the three antennas for 100-percent sine wave modulation. Note the RF phase reversal when the audio changes polarity.

Figure 3 illustrates the addition of one DSBSC peak combined with the carrier in the field of the antenna to produce a modulation peak to the east. The sum of the carrier and the E-W DSBSC antennas produces a cardioid pattern when the modulation percentage is 100 percent. At this instant, the current in the N-S pair is zero. Figure 4 shows the antenna patterns 45 degrees (of the audio tone) later. The amplitude of each DSBSC antenna pair is 0.707 the amplitude of the carrier when the radiation peak is on a 45-degree diagonal. Note that the cardioid radiation pattern has rotated 45 degrees. Thus, the radiation pattern produced by the combined radiation of the three antennas for 100-percent sine wave modulation is a cardioid pattern that rotates at the modulating frequency. Figure 5 depicts the instantaneous variation of the RF field strength (at a receiver located north of the antenna) as the cardioid rotates.

Note that when a receiver located east of the antenna is receiving the positive peak of the sine wave, a receiver located west of the antenna is receiving the negative peak of the modulating wave. As a result, the total power delivered to the antenna is constant over the entire audio sine-wave cycle. For 1000 watts carrier power, the PEP of each sideband pair is 500 watts and the average power of each is 250 watts for 100-percent sine-wave modulation. Thus, the total average power to all three parts of the antenna system is 1500 watts. The signal as detected by a receiver is the same as would be produced by a conventional trans-

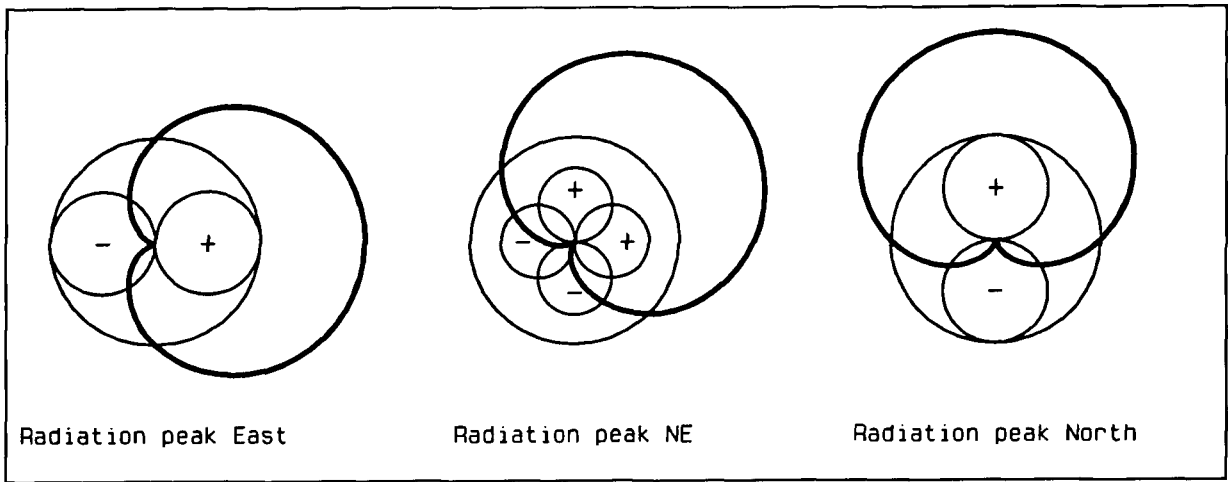

Figure 4. Carrier and DSBSC antenna field strength patterns and their sum, which is a rotating cardioid for 100-percent sine wave modulation. Carrier polarity is + in all directions. Relative polarity of each DSBSC lobe is labeled inside lobe.

mitter with 1000 watts carrier power and 4000 watts PEP!

Figure 6 shows the block diagram of the initial 100-watt transmitter system. Each linear amplifier was capable of delivering 50 watts PEP. The balanced modulators provided enough power to drive the linear amplifiers. The two audio phase-delay networks at the bottom of the diagram are designed to have audio phase delays that differ by 90 degrees across the audio band. This is similar to those used in SSB exciters that use the phasing system of SSB generation.

Each delay network had only three sections, therefore the maximum error was approximately  $\pm 5$  degrees over the broadcast band of 30 to 10,000 Hz. The phase error could have been reduced by using four-section filters or by limiting the audio bandwidth. For SSB, the phase error must be less than 1 degree for acceptable opposite sideband rejection. More phase error can be tolerated for polyphase AM because it affects the percentage modulation at each audio frequency in different directions. The suppressed carriers should be in phase with the carrier. Any phase difference causes amplitude distortion.

The cardioid azimuth radiation pattern only exists for 100-percent modulation with a single tone. For 70-percent modulation, the figure-eight radiation patterns are only 70 percent of the amplitude, as illustrated in Figure 7. When the audio consists of many frequency components, such as speech, each frequency component produces a pattern that rotates at the frequency of that component. Consequently, there are many small "radiation patterns" rotating at different speeds (but all in the same direction). The field strengths of their phasors add in the direction of any receiver to produce the AM

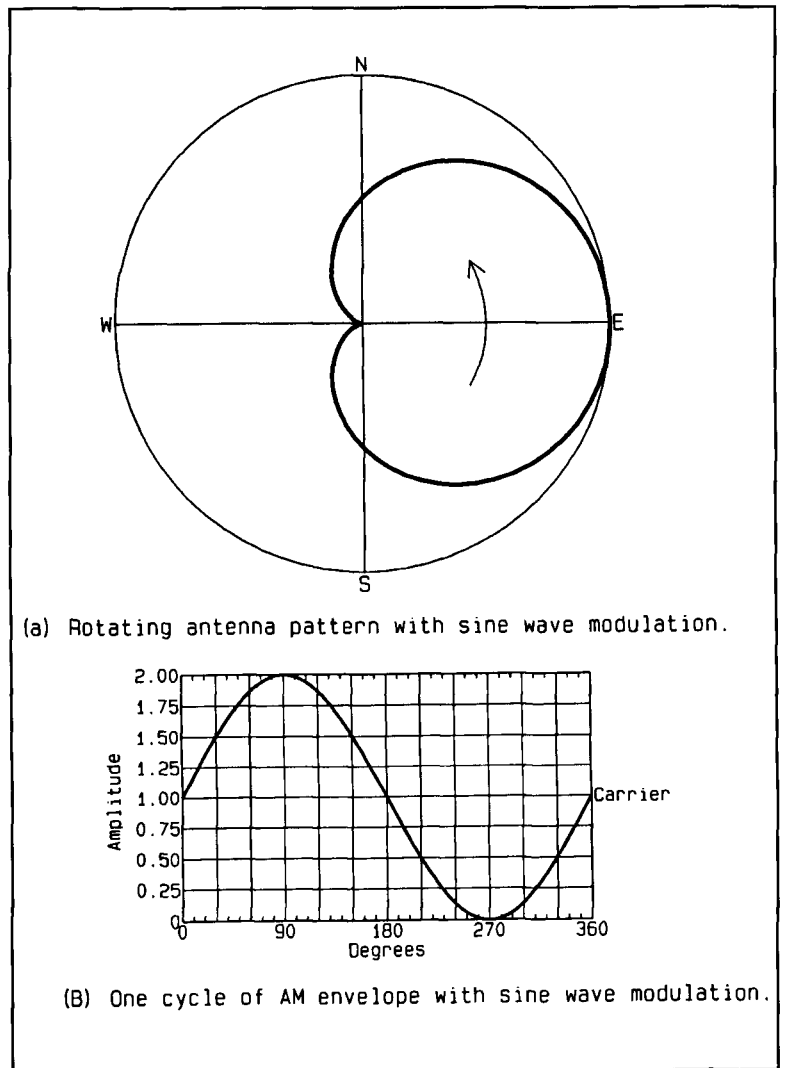

Figure 5. Variation of field strength as cardioid rotates. (A) Rotating antenna pattern with sine wave modulation. (B) One cycle of AM envelope with sine wave modulation.

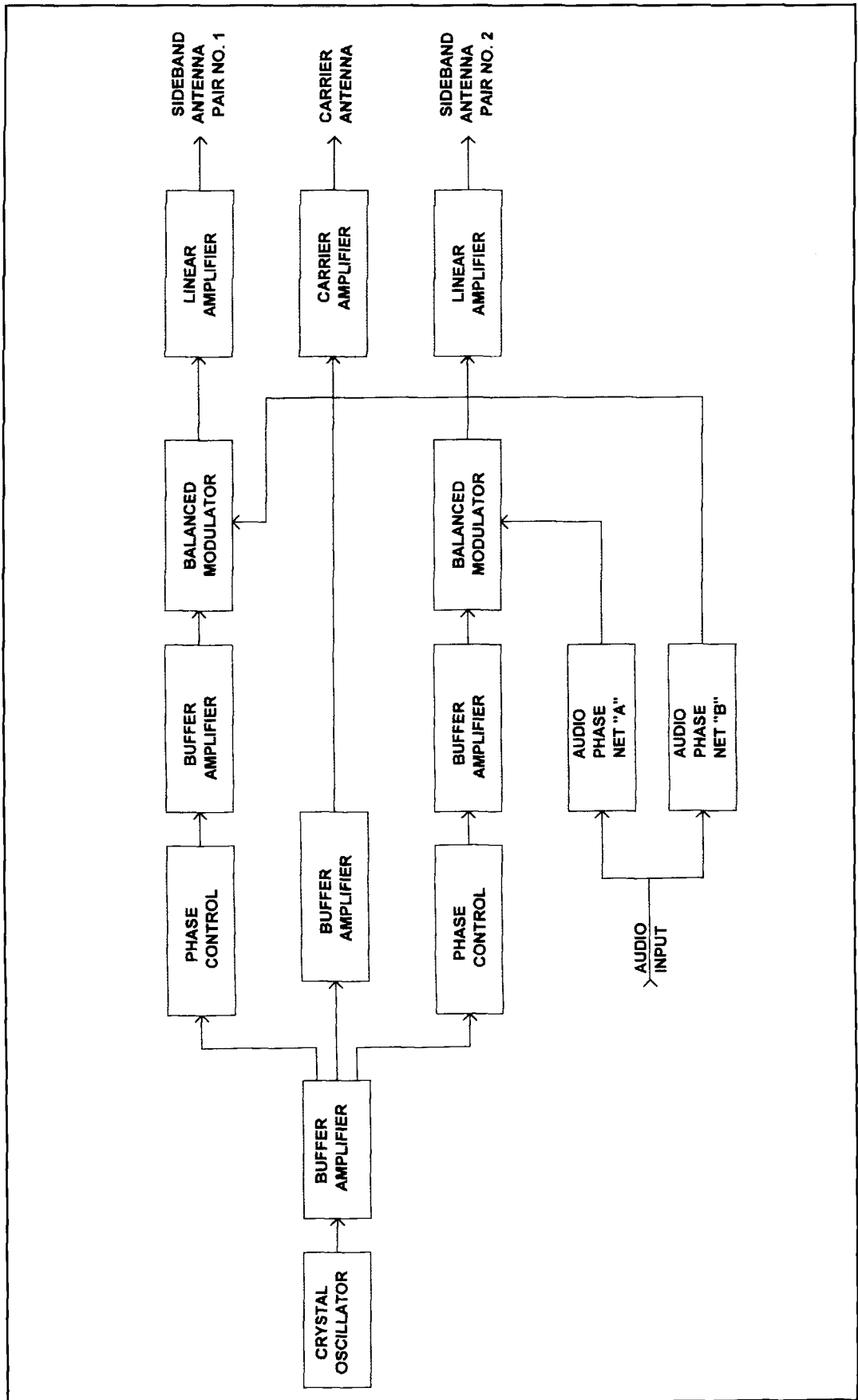

Figure 6. Block diagram of 100-watt proof of concept transmitter.

modulation envelope we are used to seeing on an oscilloscope.

The 1000-watt transmitter installed at WHO was more sophisticated, as shown in **Figure 8**. It generated upper single sideband and lower single sideband signals using the phasing scheme. The two SSB linear amplifiers each had an output of 250 watts PEP. Their RF outputs were combined in passive RF networks to produce the two DSBSC signals needed for the antennas. Note that the suppressed carriers of the two SSB signals were generated in phase quadrature. After combining, the DSBSC signals were still in phase quadrature. Therefore, a 90-degree T-network was used to bring the USB back in phase with the LSB. The RF power to each of the sideband pairs was 500 watts PEP, accomplished using two 250-watt PEP linear amplifiers.

The IRE article<sup>2</sup> didn't show the coupling circuitry between the three RF outputs of **Figure 8** and the antenna. The input impedance to each antenna element had to have been high because each element was a half wavelength long. I suspect that the engineers used inductive coupling to a balanced parallel resonant circuit. Each element of a sideband pair would be connected to the opposite ends of this parallel resonant circuit. The transmitter was installed in the phasing network house located just a few feet from the base of the antenna tower. Therefore, no transmission lines were needed.

## The monitoring system

Because the AM wave is generated in the antenna field, the monitor receiver was located one mile away on a 45-degree diagonal to the sideband antenna pairs. Thus, it picked up equal strength signals from each sideband pair. The demodulated audio wave was returned to the transmitter location by means of a twisted pair transmission line. An oscilloscope was used to observe the wave shape of the demodulated wave. They also installed a measuring system in a truck, which they could drive to different locations around the antenna.

The engineers measured frequency response and distortion across the audio band at 95-percent modulation. They found they could adjust the transmitter to bring the distortion below the error of the measuring equipment at any one audio frequency; but it was best to adjust it for lowest distortion in the middle of the audio band for best performance overall.

## Their conclusions

The team concluded that polyphase broadcasting was capable of high-fidelity operation

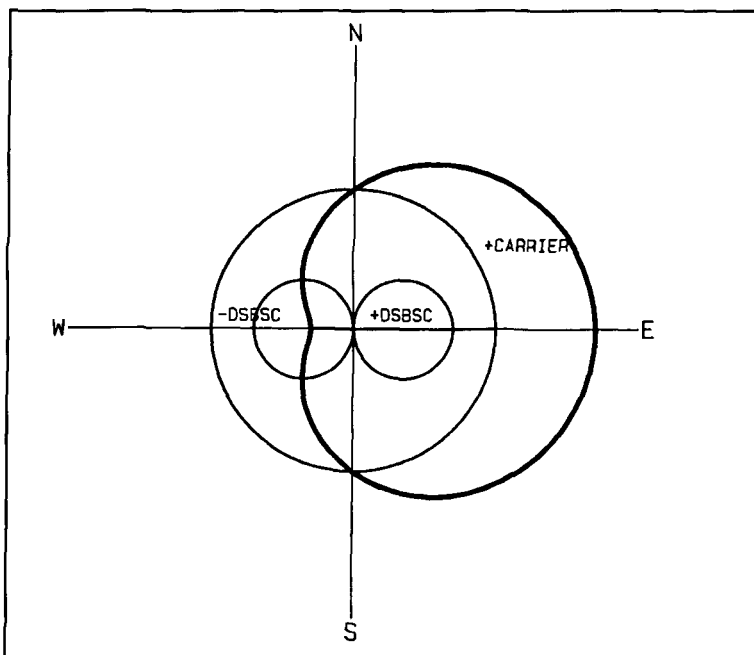

Figure 7. Antenna pattern for 70-percent modulation peak East.

and that the expected gains in tube and power economy could be realized.

## My observations

These tests were made at a time when several other AM modulation systems were in existence or being tested, such as the Doherty system (used by Continental Electronics) and out-phasing modulation (used by RCA). High-level class B modulation was used to some extent at lower powers, but the modulation transformer engineers hadn't quite discovered how to control leakage inductance and stray capacitance at high power levels. The 500-kW transmitter at WLW in Cincinnati, Ohio, used class B plate modulation, but they invented a scheme to do it using just modulation reactors.

The two main disadvantages of the polyphase broadcasting system were that (1) it was inherently omnidirectional and (2) the tuning requirements were rather complex.

Collins Radio abandoned this system and developed a line of class B plate-modulated transmitters. It took Thordarson seven tries before they produced a satisfactory modulation transformer for the 5-KW 21A broadcast transmitter. The Collins 21A was largely responsible for the company selling more broadcast transmitters during the year before World War II than all other transmitter manufacturers combined.

I started working for Collins in November 1939, when this work was going on. I was not privy to any details then, but I knew the principle players involved.

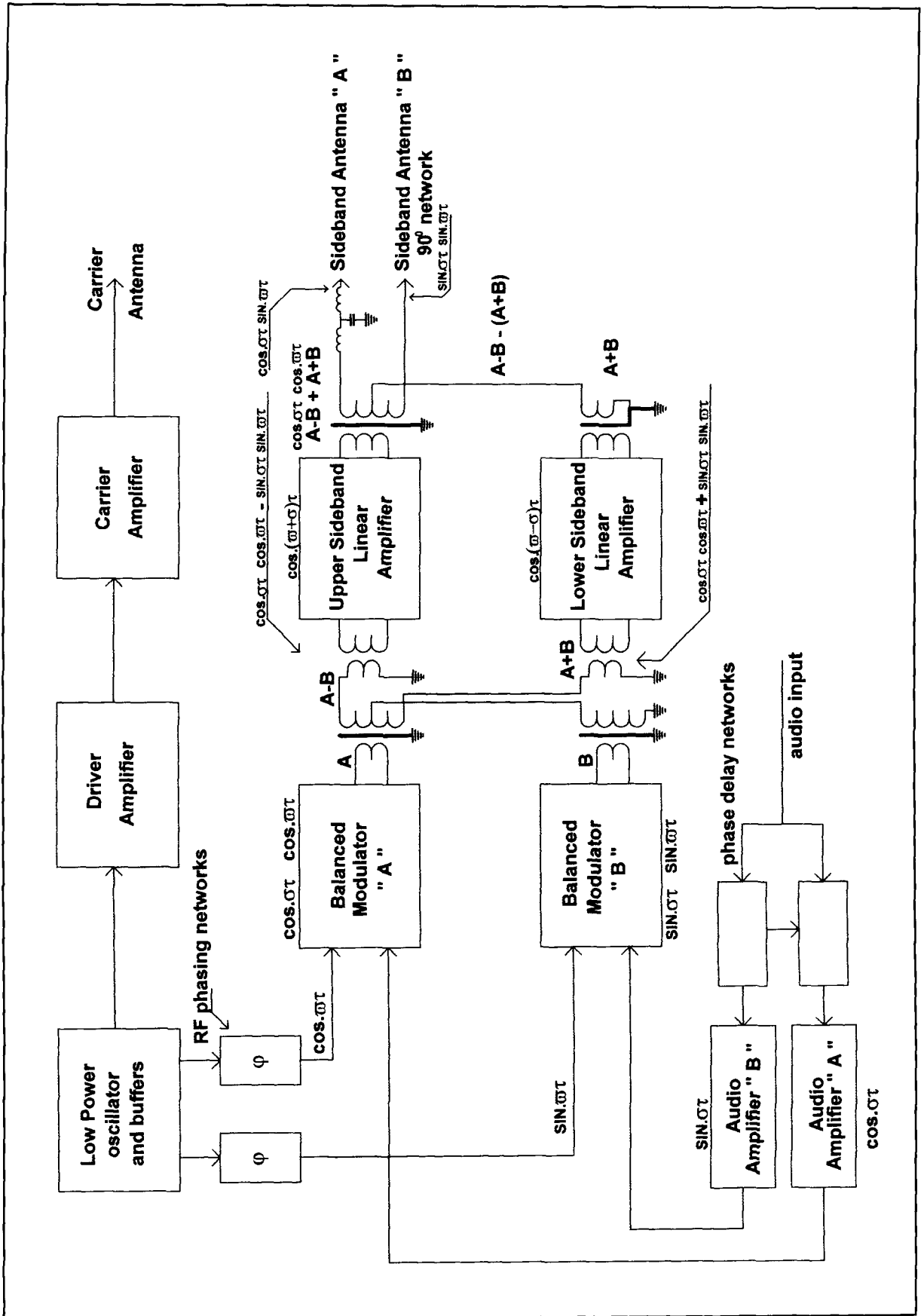

Figure 8. Block diagram of 1000-watt transmitter installed at WHO.

Walt Wirkler probably was the principle transmitter inventor. He had been interested in SSB since the flurry of ham activity in 1935. He had a couple of patents on phasing modulation methods of generating SSB. He was the "absent-minded professor" type, but was very innovative and had a practical mind. John Byrne was a broadcast consultant and was probably responsible for the design of the antenna system. L. Morgan Craft was chief engineer and designed the audio phase-shift networks. Paul Loyet, wrote the article on the testing at WHO and was probably chief engineer at the station. He was not a Collins employee. Art Collins' name was not mentioned in the published papers, but he undoubtedly closely monitored the project and contributed to the development of the system.

Are any of the polyphase AM system concepts worth resurrecting?

The polyphase AM system appears to be a means to overcome the 1500-watt PEP limit on amateur transmitter power for AM emission.<sup>3</sup> The sum of the PEP power to the three antenna inputs would just add to the 1500 watts for a 750-watt carrier power transmitter. Actually, the two DSBSC envelopes do not peak at the same time; therefore, the output of an instrument that added the "instantaneous" powers of the two DSBSC inputs would not be any higher than the PEP of either DSBSC input alone.

I would like to suggest two concepts for testing this idea of generating AM in the antenna field. The basic idea of each is to use a bidirectional antenna system and bipolar modulation (instead of polyphase modulation). This eliminates one of the DSBSC linear amplifiers and the need for generating the two audio signals phased 90 degrees apart. The suppressed carrier of the DSBSC signal would be generated in phase with the carrier. **Figure 9** is block diagram for a simpler bipolar AM transmitter using the technology available back then.

Today we would probably choose to generate the DSBSC signal at a lower power level, as in an SSB transmitter. Audio signal processing or band limiting should be performed on the audio signal and not after the DSBSC generator to keep the sidebands symmetrical.

Ideally, the carrier antenna should have the same figure-eight azimuth and elevation patterns as the one sideband pair, but the radiation polarity must be the same in both directions (the DSBSC antenna radiates opposite phases in opposite directions) and it must be orthogonal to the sideband pair to avoid coupling to it. This antenna would provide 3-dB gain at the

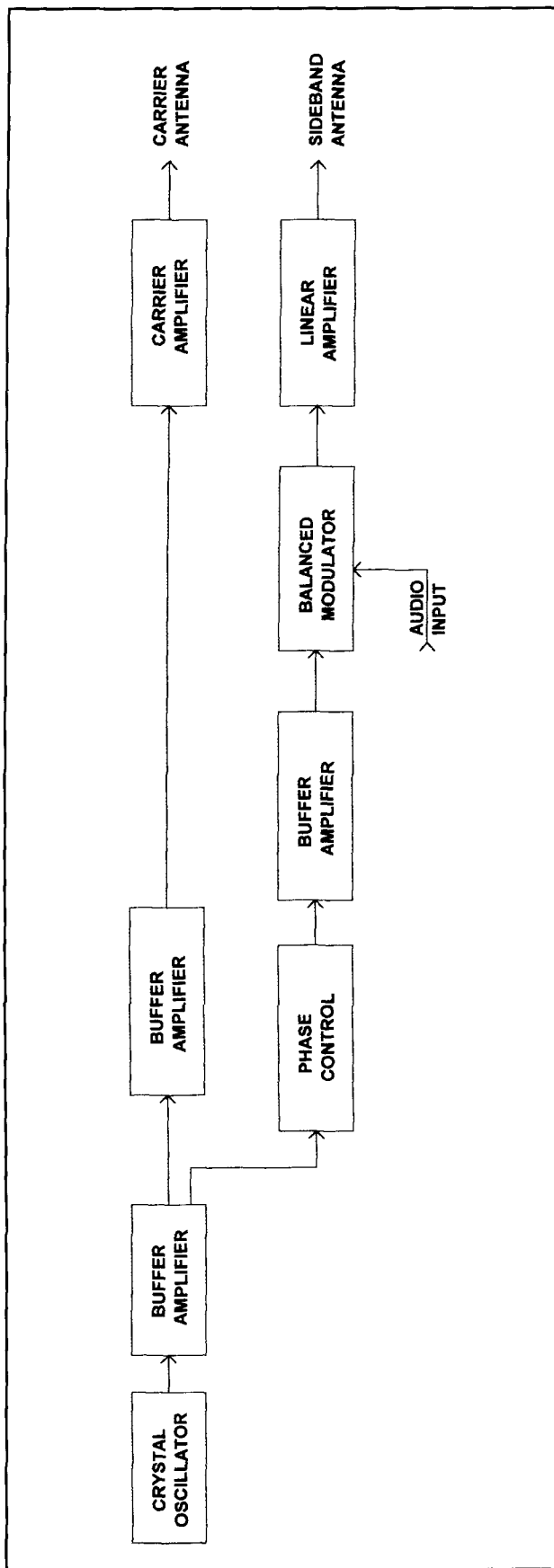
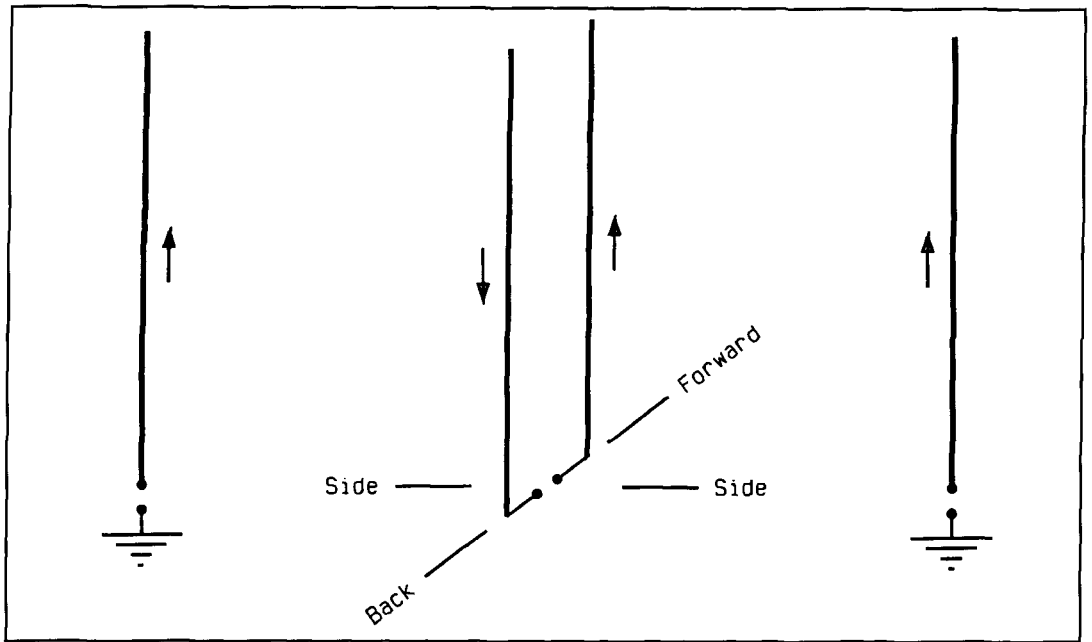

Figure 9. Block diagram of 1000-watt transmitter installed at WHO.



**Figure 10.** Perspective view of carrier and DSBSC antenna elements. DSBSC elements spaced  $1/8$  wavelength apart. Carrier elements spaced  $1/2$  wavelength apart. No coupling between carrier and DSBSC antennas. Both antennas should have identical bidirectional patterns. Carrier antenna radiates same phase in both directions. DSBSC antenna radiates opposite phases in forward and back directions.

peak of the radiation lobe in both the forward and back directions.

One idea is to use a pair of quarter-wave verticals spaced a half-wave apart and fed in phase for the carrier antenna. **Figure 10** shows a view of this antenna configuration. The sideband pair is shown in the center. Another set of elements oriented  $90$  degrees from the first would permit switching direction by  $90$  degrees for omnidirectional coverage. The gain would

only be down  $3$  dB at the crossover points of the azimuth patterns (which would still be the same gain as an omnidirectional system).

**Figure 11** shows the carrier and the DSBSC radiation patterns and their sum by the wider lines. Because it is a biphasic system, the pattern doesn't rotate.

**Figure 12** illustrates the steps for generating the AM wave. The PEP of the sideband linear is the same as the carrier power. The average

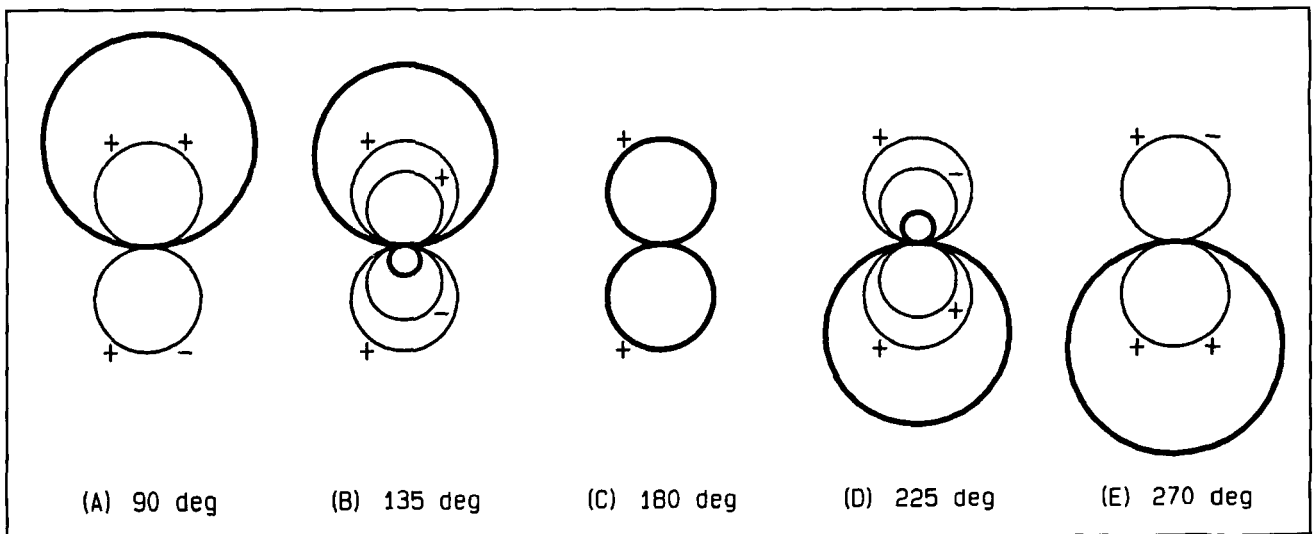

**Figure 11.** Carrier and DSBSC antenna field strength patterns and their sum. Degree labels are at  $45$ -degree steps along audio wave.  $\pm$  to left of center is phase of carrier radiation.  $\pm$  to right of center is phase of DSBSC radiation.



power with 100-percent sine wave modulation is half the carrier power.

A remote monitor receiver may not be necessary if antenna current sensors are placed in the antenna leads so the carrier phases can be adjusted to be the same. Also a peak reading directional wattmeter could be used to assure that 100 percent modulation is not exceeded. Overmodulation of the carrier will not cause splatter on the air, but it will cause distortion in the AM detector of the receiver.

The other idea is to use a horizontally polarized dipole configuration. A W8JK antenna, fed in the middle to make it bidirectional, would be used for the sideband antenna. The carrier antenna would be a dipole located in the middle of the W8JK antenna. It probably should be shortened to  $3/8$  wavelength to be the same length as the W8JK antenna. It should be mounted approximately  $1/2$  wavelength above ground to cancel upward radiation, leaving the vertical radiation patterns approximately the same. This should be practical in the 20-meter band.

Perhaps these two ideas will trigger an even better idea of your own.

Polyphase broadcasting didn't make it to the marketplace, but maybe with new technologies and antenna analysis programs, the concept of generating AM in the antenna field might find a useful niche in amateur radio. ■

#### REFERENCES

1. John F. Byrne, "Polyphase Broadcasting," *Electrical Engineering Transactions*, Volume 58, July 1939.
2. Paul Loyet, "Experimental Polyphase Broadcasting," *Proceedings of the I.R.E.*, May 1942.
3. Tom Hogerty, KC1J, Editor, *The ARRL's FCC Rule Book*, 11th edition, American Radio Relay League, Newington, Connecticut, 1998, page 4-38.

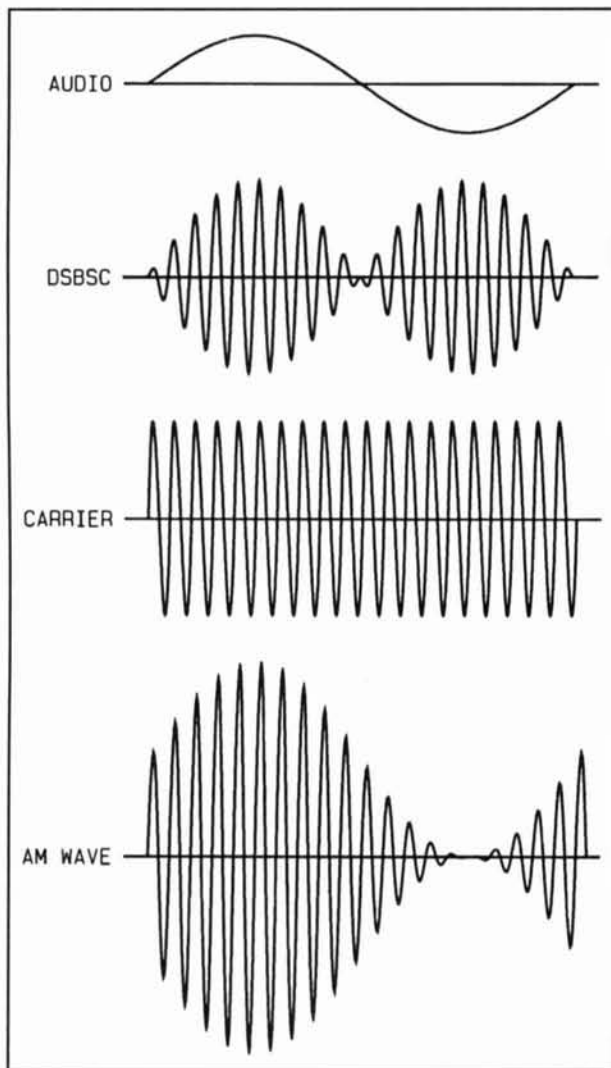

Figure 12. Steps for generating bi-phase AM in the antenna field.

## PRODUCT INFORMATION

### The Kepro BTE-302 Glass Bead Etcher

Kepro Circuit Systems, Inc., introduces the new Kepro Glass Bead Etcher for short-run etching of panels of up to one square foot. The etcher is designed for the etching of printed circuits boards, copper and brass nameplates, or chem milling of thin copper-bearing metals using sodium persulfate as the etchant.

With the BTE-302, glass beads are suspended in the etchant for even exposure of the solution to both vertical surfaces of the panel. Uniform persulfate distribution minimizes resist pattern undercut. Typical etch time is approximately 30 minutes for 1 ounce thick copper foil.

For more information about Kepro's BTE-302 Glass Bead Etcher or other Kepro products, contact Kepro Circuit Systems, Inc., at 3640 Scarlet Oak Boulevard, St. Louis, Missouri

63122-6606, call toll-free 1-800-325-3878, or e-mail to <kepro@worldnet.att.net>. The Kepro website address is <www.kepro.com>



**Peter J. Bertini, K1ZJH**  
Senior Technical Editor  
20 Patsun Road  
Somers, Connecticut 06071  
<comquart@erols.com>

# QUARTERLY REVIEW

*A look at the latest literature*

---

Over the past few months, some interesting literature has found its way into my mailbag. Among the offerings was a set of CD-ROMs, plus a number of interesting books for review. Let's start with the CD set.

## *QST View*

*QST* magazine, the official journal of the American Radio Relay League, has been published monthly since 1915—except for a short period from October 1917 to May 1919. Housing an entire set in your home could easily overrun several bookcases, assuming you could locate copies of those rare early issues. Now, however, the entire collection of *QST* from 1917 through 1994 is available on CD-ROM; this represents nearly 1,000 issues that easily fit on a single shelf! This CD set is an invaluable research tool, covering the history of amateur radio. Within its “pages” you'll find virtually every important technical advance made in radio communications. Every page of every issue has been fully scanned, including ads and covers.

*QST View* is sold in sets of three or four CDs, and each CD-ROM holds from two to five full years of *QST*. Each *QST View* CD set is bundled in a multi-sectioned jewel case for easy storage and CD protection. The earliest set covers from 1915 through 1929 on four CDs. I was able to read through *QST View* sets spanning from 1915 through 1969 for this review. The years 1915 through 1994 are reproduced in 11 sets, each priced at \$39.95 plus shipping.

You'll need a computer with a CD-ROM drive running the Microsoft Windows operating system to install *QST View*. Windows 3.x or 95/98 will do. Included with each CD set is a viewer and index data base for the *QST* vol-

umes included with that set. The viewer need only be loaded once, but as each set is acquired, the associated index database must be installed. A fast computer helps here, typical installation times can vary from five minutes for a Pentium 90 class machine, to as long as 30 minutes for a slower 386-based system.

## Using *QST View*

The viewer search engine provides the user with several powerful options. Each issue may be casually read page by page by entering the year and month. Or, you can search by article name, column, and author's first or last name, or callsign. Searches can be performed for a single issue, a full year of publication, or for the years covered on a single CD. The index for any single issue, year, or the years contained on a particular CD-ROM can also be viewed, permitting rapid searches for specific information. Many of these features were not fully discussed in the enclosed booklet, nor are they intuitive. It took some playing to discover some of them.

The screen display may be zoomed in or out; I found my 17-inch SVGA monitor to be just adequate when trying to view a full page at once. Being able to zoom to a specific area on a page made reading the material much easier. Unfortunately, due to the digitized scanning used to capture the pages, many of the black-and-white photographs and drawings have suffered some loss of gray scale.

You can print a selected page, range of pages, or selected article. Given the nature of the material, a laser or good inkjet printer is preferred. I was very pleased to see that each printed page covered an 8 x 11 1/2-inch sheet of paper! Printed copy was excellent, given the

scanned nature of the material. My printer will do up to 600 dpi, but I found the 300 dpi mode more than adequate.

For more information, or to obtain copies of *QST View*, contact the American Radio Relay League at 225 Main Street, Newington, Connecticut 06111; sales phone: (888) 277-5289; e-mail <pubsales@arrl.org>.

## Radio System Design for Telecommunications

*Radio System Design for Telecommunications*, second edition, by Roger L. Freeman is a handbook for the design and configuration of radiolinks in point-to-point telecommunications services, as well as wireless and cellular systems. It offers practical theory on how radiolinks and wireless systems operate, and has been upgraded and expanded to cover personal communications (PCS) and very small aperture terminal (VSAT) satellite communications networks, meteor burst communications, and established techniques, such as troposcatter and HF 3- to 30-MHz systems.

The use of VSAT systems is fully discussed as a more efficient and cost-effective alternative to leased land-line circuits. This edition also touches on spectrum-efficient code division multiplex (CDMA) technology and its ability to operate in high-interference environments. Discussed in depth are scintillation effects, bandwidth requirements for digital radio networks, penalties for not meeting LOS conditions, analysis of radio interference, coordination contours, jitter accumulation, forward error

correction, advanced digital modulation waveforms, and dispersion on digital paths.

The book is geared toward self study with end-of-chapter reviews and questions. Key formulas are followed by at least one worked example. A glossary of abbreviations and acronyms common to the industry are included.

*Radio System Design for Telecommunications* (ISBN 0471-16260-4) is an invaluable guide for engineers or specialists involved in designing or planning state-of-the-art wireless and radiolinks for the telecommunications industry. It is published by John Wiley & Sons, Inc., 605 Third Avenue, New York, New York 10158-0012.

## Short Wave Listener's Guide

Ian Poole, G3YWX, a regular contributor to *Communications Quarterly*, is a leading writer on radio subjects. His *Short Wave Listener's Guide* is a comprehensive introduction to the fascinating world of short-wave monitoring. Ian begins by explaining the short-wave monitoring hobby, various aspects of the hobby, current technologies, and how it all began. This leads to discussion, in Chapter 2, of various modulation systems and transmission codes encountered on the HF bands.

Chapter 3 delves into the mystery of radio waves, how they propagate, the effects of polarization and ground waves, angles of radiation, skip, and fading. Poole also looks at ionospheric disturbances, sporadic-E, and propagation effects at various frequencies. All of his explanations are made in a clear and easily understandable manner using plain English and avoiding "engineerese" or technical "buzzwords."

Chapter 4 is devoted to receivers. Here Ian discusses the functions of the various receiver controls, touches upon the workings of superhets, talks about DSP (digital signal processing), and explains various receiver parameters like dynamic range, filtering, and sensitivity. Following chapters cover antennas (aerials), and ancillary equipment, including antenna tuners, audio filters, and preselectors. Poole also talks about who one might find on the HF bands, launching into a discussion of amateur radio that touches on band plans, licensing, and QSL information. The remaining chapters deal with the art of shortwave listening and how to set up an effective shortwave monitoring post.

Poole's *Short Wave Listener's Guide* (ISBN 0-7506-2631-3) was an ambitious undertaking, encompassing several topics that easily could be expanded into three or four volumes. It's remarkable that Ian has succeeded in compressing all of this information into one volume without sacrificing accuracy or clarity. Both neophyte and experienced shortwave listeners

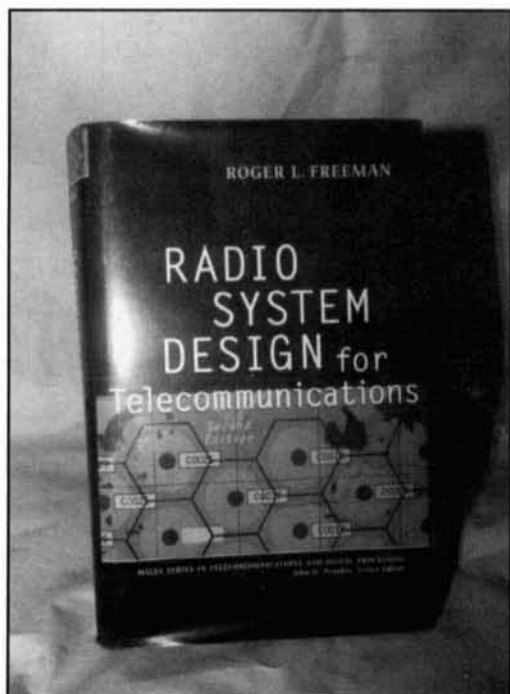

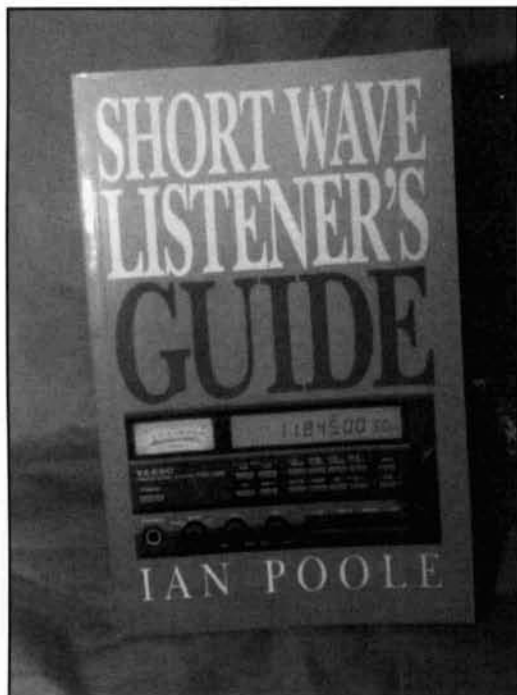

will find the book an enjoyable read and a handy reference. *Short Wave Listener's Guide* is available from Newnes, Linacre House, Jordan Hill, Oxford, England OX2 8DP.

### *Build Your Own Intelligent Amateur Radio Transceiver*

Author Randy Henderson has served as assistant technical editor for the American Radio Relay League and has authored many articles for *The ARRL Handbook*, *QST*, *73*, *QEX*, and *Nuts and Volts* magazines.

Henderson's book, *Build Your Own Intelligent Amateur Radio Transceiver*, centers around the design and construction of a modern microprocessor-controlled HF transceiver. However, this is more than a "cookbook" of circuits and assembly instructions. Indeed, this hardcover book runs over 350 pages and resembles a handbook. The volume is written at the amateur level; complex math or design equations are avoided.

While talking about the construction of his transceiver, Henderson makes light of the difficulties encountered in executing such an ambitious project. The information he presents prepares the average hands-on technician to handle such problems on his own. Practical informa-

tion on the design of audio and RF stages is provided, as well as interstage matching techniques, LC and crystal filters, mixers, and interstage isolation requirements. Randy also discusses oscillator noise, indirect synthesis, and synthesizer problems and solutions.

There is considerable information on implementing microprocessor control of the transceiver. This information goes far beyond simply offering the source code; it covers binary numbers and arithmetic, negative numbers, and microprocessor theory. The 80C31/8051 instruction is explained in detail, as well as the interrupts. There's also an overview of the software and subroutines. Subsequent chapters deal with human engineering, a spectrum analyzer project, and a swept-frequency generator for crystal filter evaluation.

Not only was the transceiver itself an ambitious undertaking, but the amount of additional practical information offered throughout the book makes it a worthy reference for any technical library. Much of what is offered goes well beyond how the topic is discussed in many radio handbooks. And, for modifications and updates, readers can check out Randy's web page at <http://www.flash.net/~randylh/>.

*Build Your Own Intelligent Amateur Radio Transceiver* (ISBN 0-07-028263-3) is published by TAB Books, McGraw-Hill, New York. ■

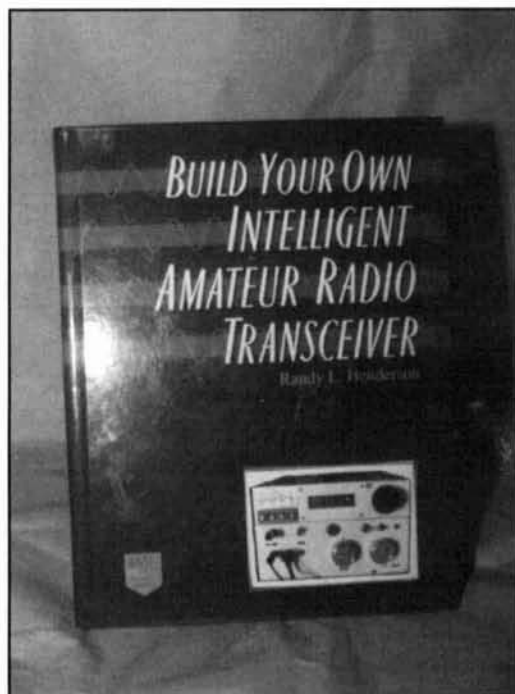

# LOADED WIRE AERIALS

## How to make "stretched" versions

**H**ave you ever heard of a 14 Mc/s dipole which must be made 100 feet long, instead of the usual 33 feet, before it comes to resonance? In this article, it is proposed to show how such "stretched" aerials can be made and some of the ways they may be useful.

### The principle

In order to understand how this seeming magic can be performed, it will be helpful to start with an equivalent circuit. **Figure 1** shows

a half-wave dipole and two ways of representing it as a lumped circuit. The wire has distributed series inductance ( $L$ ) and shunt capacitance ( $C$ ). The field of the capacitance can be considered to terminate on an "earthy" bisecting plane whence it continues symmetrically to the other half of the dipole. The radiation resistance is also represented by resistance ( $R$ ) in series with the inductance. Side (a) has been represented by one single mesh of  $LCR$ , and the network can be variously considered as a closed resonant circuit or as a half section of low-pass filter, with all the damping in the coil. The image impedance of the filter ( $Z_0 = \sqrt{LC}$ )

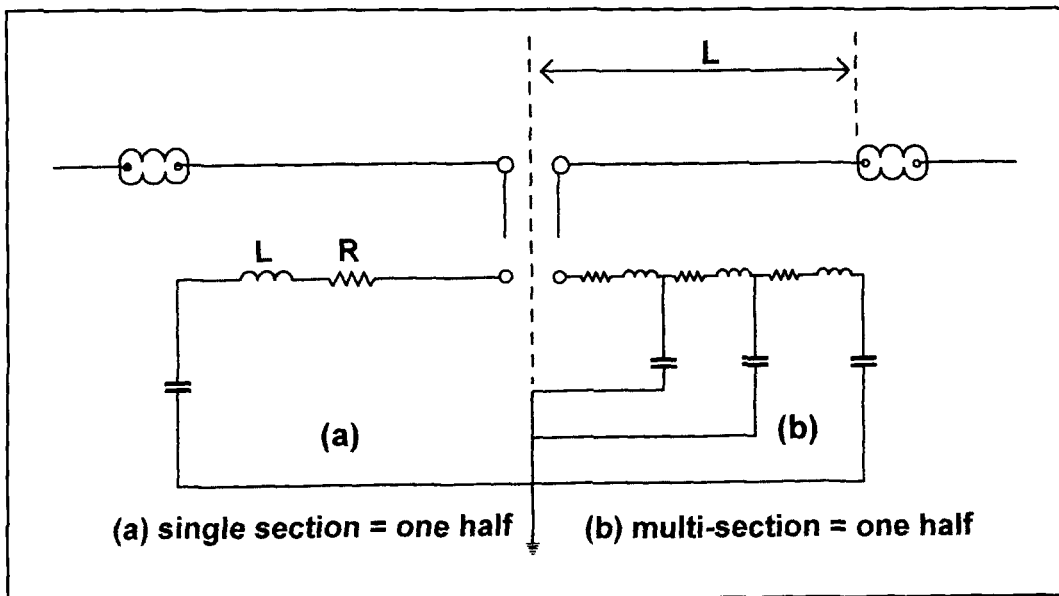

Figure 1. Balanced half-wave dipole and lumped equivalent circuits (A) Single section = one half; (B) Multi-section = one half.

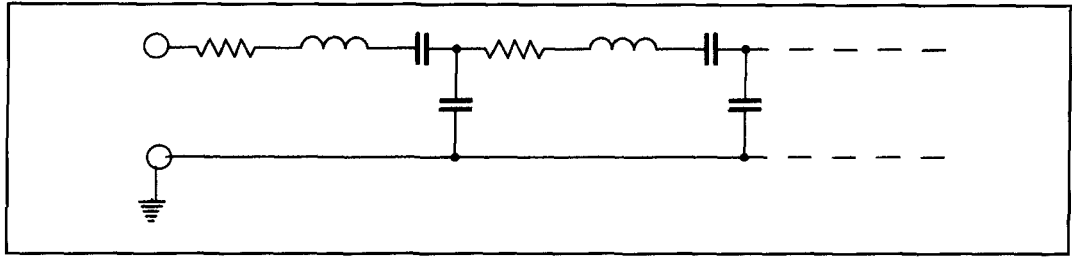

Figure 2. Equivalent aerial sections with series capacitance loading.

corresponds to the characteristic impedance of one half of the aerial.

The single *LCR* is a poor approximation to the aerial, but if the aerial is divided into three or more sections, the representation (b) of the right-hand side is much better and enables reasonable estimates of the “free-end to earth” or “parallel” impedance of the aerial. With many sections the circuit approximates a lossy transmission line. If the quarter wave of an aerial is divided into three sections of electrical length of 30 degrees, the equivalence is fairly good, and, in the aerials to be described, these 30-degree or  $\lambda/12$  sections will be used and treated as “lumped” component sections.

The reactance of the equivalent coil of a 30-degree section in  $Z_0 \tan 30^\circ$  ohms, and for the value of  $Z_0$  for one half of the dipole one can use:

$$Z_0 = 138 \log (4L/D) - 60 \text{ ohms}$$

where  $L$  is the half length of the aerial and  $D$  is the wire diameter. Since the principle is being explained in terms of one half of a balanced aerial, it may be less confusing to consider it as a quarter-wave vertical erected over an earth plane, in which case its radiation resistance (at the base) is 35 ohms.

If the aerial had a uniform current along its length (instead of a standing wave) then its radiation resistance would be 120 ohms per half

wavelength, and hence the value of  $R$  would be 30 ohms per 30-degree section in **Figure 1B**. This is practically independent of  $Z_0$  but the three-section filter has heavy attenuation, and so the total input resistance at resonance is less than 60 ohms—one might say,  $20 + 10 + 5$ , making it 35.

### Series loading

The quarter wave represented by **Figure 1B** requires three 30-degree sections for resonance. Now suppose that in series with each inductance a capacitance (**Figure 2**) of such value is inserted that two-thirds of the inductive reactance is cancelled—namely a capacitive reactance of  $(2/3) Z_0 \tan 30^\circ$ . This is equivalent to reducing the sections from 30 to 10 degrees and clearly it will take nine such sections to reach quarter-wave resonance. The aerial has thus been “stretched” by a factor of 3:1.

What has become of the network? It was originally a low-pass filter: now in **Figure 2** it is one of the known types of high-pass filter, and with the aid of filter theory it is found that the image impedance (mid-series for the feedpoint) has been reduced three times. Further, in the equivalent aerial there are now nine 20-ohm radiating elements and it is therefore to be expected that the radiation resistance of the aerial would rise about three times to, say, 100 ohms.

The characteristic impedance of the aerial

Table 1. 14 Mc/s dipoles; 5 foot 6 inch sections

<i>n</i>	C(pF)	No. of Sections	Dipole Length Ft.	Input Z	Beam-width	Gain
1	-	2 x 1	33	70 ohms	78°	0 dB
2	68	2 x 6	66	200 ohms	56°	1 dB
3	50	2 x 9	99	400 ohms	42°	2.1 dB
4	43	2 x 12	132	550 ohms	32°	3.2 dB

For other bands, change  $C$  and section length proportional to wavelength; e.g., for 21 Mc/s take two-thirds values given, for 28 Mc/s, half.

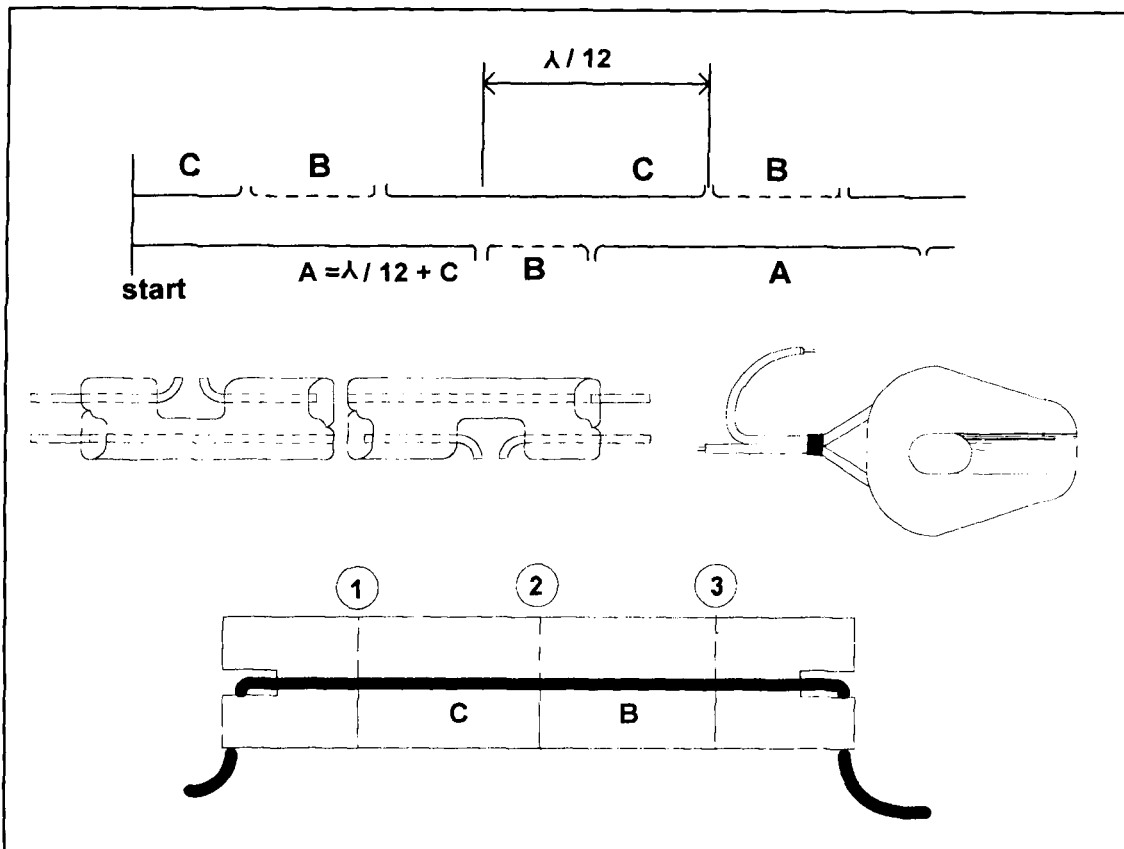

Figure 3. Details of construction from 80-ohm flat twin line. The upper diagram shows how the two conductors are cut to produce overlapping sections of the required length. The lower diagram shows a marking board. The inner diagrams show details of the cuts and the method of holding ends on insulators. Dimensions are given in Table 2.

corresponds in fact to the reactance of the coil of **Figure 1A**, and hence  $Z_0/R$  is the  $Q$  of the aerial. The effect of loading is that  $Z_0$  is lowered and  $R$  is effectively raised, and hence the  $Q$  of the loaded aerial is very low: the aerials to be described have a  $Q$  approaching unity and hence are very wideband affairs. A practical value of  $Z_0$  for a wire quarter-wave 14 Mc/s aerial is 600 ohms. When loaded by a factor  $n = 3$  this becomes 200 ohms and the radiation resistance 100 ohms. If the loading were increased to four times the aerial would be almost critically damped or aperiodic.

The above analysis is quite rough but, nevertheless, practical aerials behave very much as this theory indicates. It only remains to consider what advantages they may have, and a simple way to construct them.

## Construction

The obvious method of construction is to insert insulators at 30 degrees electrical spacing (5 feet 6 inches for 14 Mc/s) in a wire aerial and then to bridge each insulator with the appropriate capacitor. The insulator need not be

special, as the aerial is highly damped by radiation; varnished resin board will do. The capacitors must withstand exposure; if the aerial is to be used for transmitting they must also handle power, and therefore should be of the stacked mica foil, and not the silvered mica type. They must be connected by flexible leads. Values are given in **Table 1**, but are not critical because this is a wideband aerial. Aerials made in this way perform as expected but present rather a "Christmas tree" appearance, and are expensive, requiring 18 good capacitors for a "three times" dipole. A far more elegant and much cheaper method is to use 80-ohm flat twin feeder as the aerial wire, cutting alternate wires to leave the correct overlapping lengths to form the capacitors. This is illustrated in **Figure 3**. The capacitance between conductors of a twin line is  $100\sqrt{K}/3Z_0$  pF per centimeter, where  $K$  is the dielectric constant; i.e., about 1.6 pF per inch for 80-ohm polythene line. The actual cutting must be done carefully and systematically because one wrong cut may ruin a long length of feeder.

The following notes, together with **Figure 3**, give details of a procedure which should avoid such accidents. The basic length of each section

Table 2. Dimensions in inches for cutting 80-ohm twin with 20 SWG (0.036 inch) conductors. Note: B and C =  $\lambda/12$ .

Frequency	7 Mc/s	14 Mc/s	21 Mc/s	28 Mc/s
$\lambda/12 =$	132 feet	66 feet	44 feet	33 feet
-	C   B	C   B	C   B	C   B
$n = 2$	87  45	47  19	33  11	26  7
$n = 3$	62  70	33  33	23  21	18  15
$n = 4$	54  78	29  37	20  24	16  17

is  $\lambda/12$ . The lengths marked C are the capacity overlaps; since the whole  $\lambda/12$  is not needed for C, there is a "dead" wire section B which is not used but is left in. The cuts, illustrated in **Figure 3**, are made with a sharp knife, taking care to expose only one wire each time. These cuts can be about 3/8 inch long; the exposed wire is cut and folded back as shown to hold tension.

Before cutting, the points should be marked out along the length of cable, and then checked. The marking board is ruled with lines 1, 2, and 3 spaced according to **Table 2**, and is provided with a slot at each end so that the cable can drop down and be held flat. It will help if the

cable is reeled between two cable bobbins.

The start of the cable is placed on line 1 and points 2 and 3 are marked on the *far* side, by small nicks or by blobs of quick drying cellulose paint. The cable is now moved to the left until mark 3 falls on line 1, after which points 2 and 3 are marked on the *near* side of the cable. This alternation proceeds along the entire length of cable.

When the cutting is completed, all exposed wire ends should be protected against damp by a heavy coat of tacky varnish or bitumastic paint. At the terminal end, both wires A and C should be cleaned and joined to the feeder.

**Table 2** gives dimensions for four bands and three different loadings. These are based on experimental results and are for 80-ohm twin with 20 SWG (0.036 inch) conductors (e.g., B.I.C.C.T.3066).

## Radiation patterns

The loaded dipole is very much like a collinear array but, of course, it is much simpler as there are no feeding and phasing complications. On the other hand, whereas the collinear array approximates a uniform current distribution, the loaded wire tends towards an exponential current distribution. The difference in radiation pattern is that whereas the collinear array has sidelobes, the loaded wire has a slightly broader beam for the same length of aerial but *no sidelobes*. Theoretical patterns for loading factors of  $n = 2, 3$ , and 4 are given in **Figure 4**, and practical models have been found to have very similar performance. These diagrams represent the horizontal patterns of horizontal aeri- als, but the upper half pattern would be that of the vertical or ground-plane version.

## Horizontal aeri- als

A dipole with a stretch factor of two is equal to a full-wave dipole but has advantages. The center impedance is about 200 ohms and can be fed with 250-ohm twin feeder. It will not work

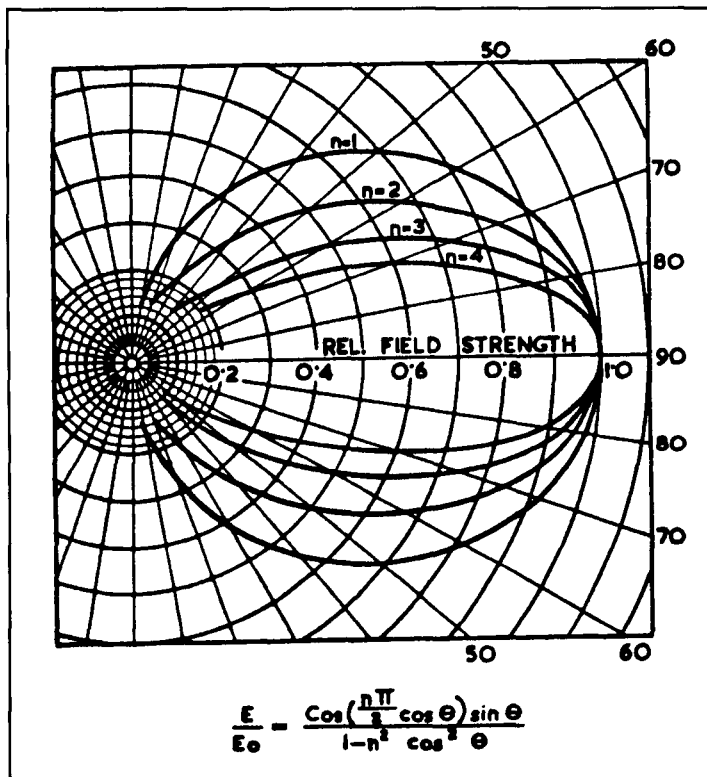

Figure 4. Radiation patterns of loaded dipoles for load or "stretch" factor  $n$ .  $n = 1$  is a plain wire half-wave dipole. Beamwidths are:  $n = 1$ , 78 degrees;  $n = 2$ , 56 degrees;  $n = 3$ , 42 degrees;  $n = 4$ , 32 degrees; and gains are 0, 1.5, 2.5, and 3.5 dB, respectively.



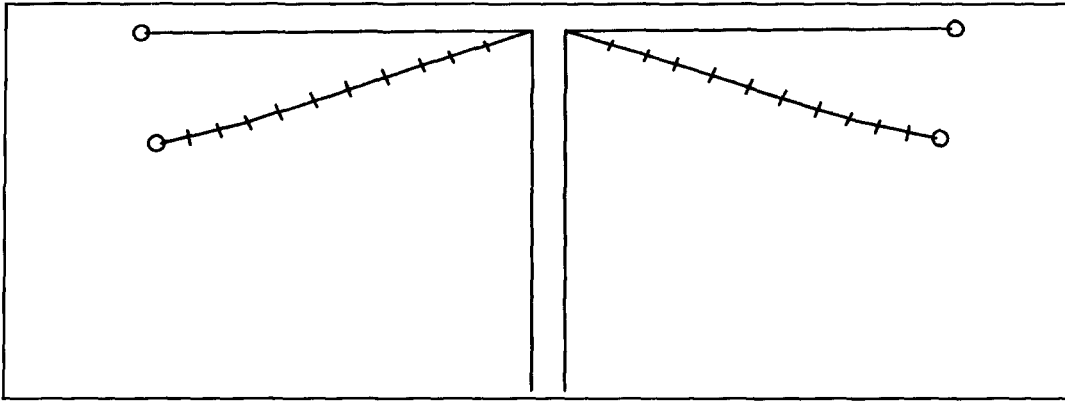

Figure 5. Showing how a loaded wire 14 Mc/s aerial can be assembled on the same supports and feeder as a plain wire 7 Mc/s dipole.

at lower frequencies, but still radiates well at higher ones as it tends to degenerate into a simple long wire, the series capacitances becoming less effective. For a 14 Mc/s aerial, the VSWR at 21 Mc/s is about 3:1, but at 30 Mc/s it will be 5:1 and a multi-lobe long-wire pattern appears.

A three times dipole has a higher impedance, 400 ohms, and although 250-ohm ribbon could be used, an open-wire line would be better. At 28 Mc/s the VSWR on a 400-ohm line would be about 2.5:1.

## Vertical aerials

The horizontal loaded aerial is seen to have useful features, but in the vertical application the loaded aerial is also quite attractive. It has only been made in the flexible form described above and, as such, needs a "sky hook." A rod form could be made with a 2:1 loading, but a higher ratio is not practicable because the lower  $Z_0$  of a rod makes the radiation load heavy and the current attenuates too rapidly.

A single stretched quarter-wave can be used with a ground plane, and **Figure 5** shows that such an aerial has very low angle radiation and good discrimination (in the receiver) against short skip high-angle interference. It is unlikely that many readers will be able to suspend more than a two  $\lambda/4$  for 14 Mc/s (33 feet high), but the alternative collinear aerial would be very difficult to design.

The main reason for using a ground plane with a normal quarter-wave aerial is because the alternative earth connection is very inefficient. A single spike earth may introduce about 50 ohms loss into the aerial. Since the radiation resistance is only 35 ohms, more than half the power fed to the aerial would be wasted in soil heating. An extensive earth mat of several wires may only reduce the loss to 20 ohms.

Now if the aerial itself has a high radiation resistance, then such earth losses are relatively

unimportant. The loaded aerial can therefore be used quite effectively against a moderate earth connection. The impedance of a double quarter-wave is about 100 ohms, and 80-ohm coaxial feeder could be used: the triple quarter-wave is about 200 ohms and a matching transformer is needed. The writer was able to support a triple (50 foot) 14 Mc/s vertical, and erected a driven pair, phased like the G8PO aerial (135 degree phasing and spacing). A Band 3 TV aerial made in the same way had a gain of 6 dB or more from 180 to 220 Mc/s with a vertical beamwidth of  $\pm 17$  degrees. The 14 Mc/s version could not be measured, but it certainly was powerful.

## Trump card

One feature of the loaded wire aerial is very useful and quite unique. The phase velocity is  $n$ -times greater than that of a plain wire (where  $n$  is the loading or stretch factor).

This does not mean that the wave travels faster than light, but it is a way of saying that the standing waves are  $n$  times longer. For this reason, the loaded wire will not be affected by a plain wire laid parallel to it. No coupling effects are noticed until the two are so close that the equivalent aerial capacities become affected. This means that a 14 Mc/s loaded aerial can be hung about a foot below a 7 Mc/s wire dipole, using the same supports (**Figure 5**). Further, it can be joined to the same feeder: at the lower frequency of 7 Mc/s the wire aerial has low impedance and the loaded aerial high, so all the 7 Mc/s power goes to the wire. At 14 Mc/s the wire is full-wave and very high impedance, but the loaded wire accepts power.

The television aerial mentioned above was actually supported a few inches either side of a Band 1 dipole and the two aerials were quite unaffected by each other. An aerial of this type has actually been made to work suspended

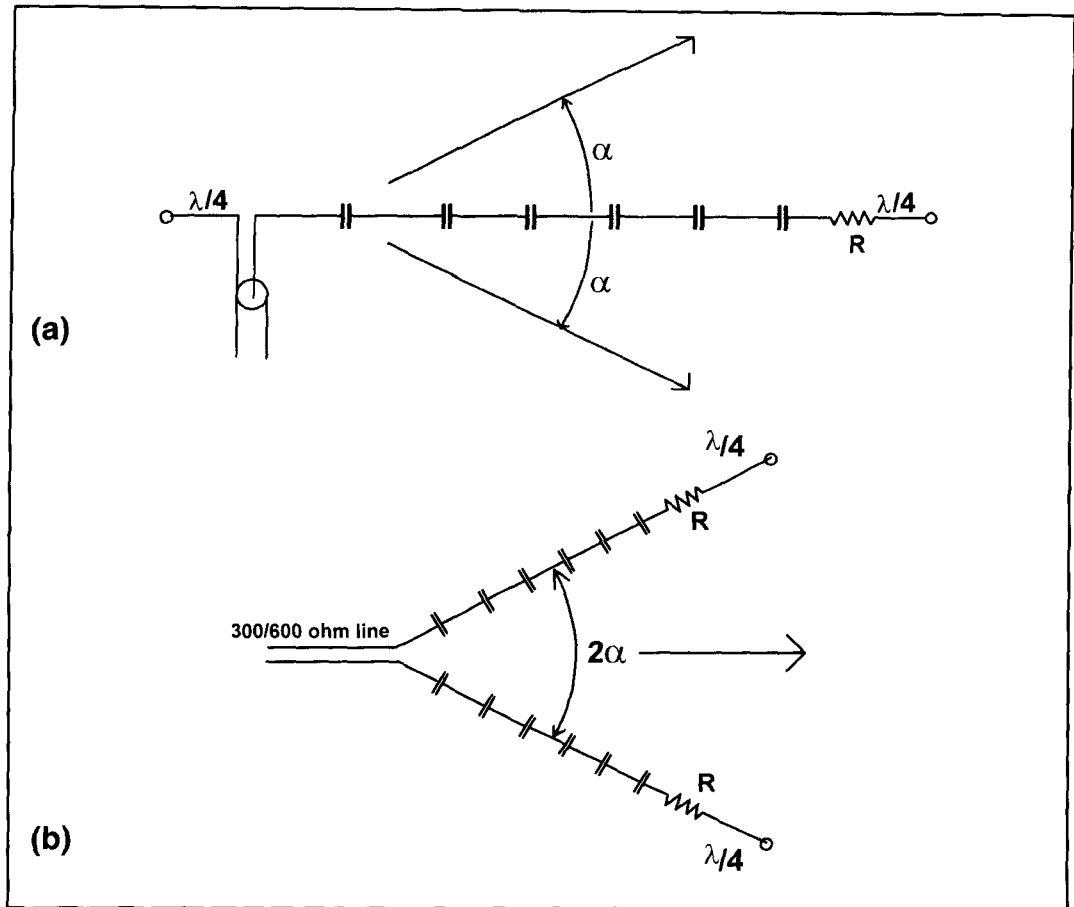

Figure 6. Terminated end-fire aerials: (A) single-wire version, and (B) Vee aerial. The angle  $\alpha$  depends only on the loading factor  $n$ ; the gain is proportional to length. The following figures are typical:

			Length $\lambda$	Gain 3 dB
$n = 2$	$\alpha = 30^\circ$	$R = 300$ ohms	$1\text{-}1/2 \lambda$	5
$n = 3$	$\alpha = 20^\circ$	$R = 200$ ohms	$2 \lambda$	6
$n = 4$	$\alpha = 15^\circ$	$R = 150$ ohms	$3 \lambda$	10

inside the frame of a steel tower—but for such drastic treatment the design must be modified.

## End-fire and Vee aerial

The loaded wire can also be used as an end-fire terminated aerial, but as such is very different from a long plain wire, which has a multi-lobe pattern. With the loaded wire there is one main lobe of radiation (conical about the wire, of course) at an angle depending on the load factor  $n$ . The gain is proportional to length but the beam angle is constant. The far end of the aerial is terminated by a suitable resistance (Figure 6A) connected between the end of the aerial and a quarter-wave artificial earth wire.

The single wire version in the upper diagram

is the basis of the old E.M.I. tilted-wire TV aerial, but needs an impedance transformer (not shown) and a coaxial line. The Vee aerial can be fed with a balanced line of impedance  $2R$  as given with Figure 6B. The gain figures shown are basic, but much higher effective gains are obtained over long distances because of the low angle projection of the main beam.

## Acknowledgments

The fundamental principle of the aerials described was discovered many years ago by E.C. Cork of E.M.I. Electronics, while the author carried out some of the applications discussed. The invention and its applications were covered by patents some of which are still valid.

# A BIDIRECTIONAL VERTICAL ANTENNA

*The half-square on 2 meters*

Occasionally, one needs a true bidirectional vertically polarized antenna at VHF, but the candidates are few. Ground-plane verticals, J-poles, collinear vertical arrays, and vertical dipoles all have circular azimuth patterns. Phased arrays using lumped constant components or transmission lines seem complex and offer loss sources from the larger collection of corrodible connections.

**Figure 1** pictures, in schematic form, several candidates for the job. Only the vertical dipole, which will serve as the standard against which the other antennas are measured, fails to show at least some directionality. All but one are poor performers when it comes to bidirectionality, with oval patterns having from nearly 5 dB front-to-side ratio to as low as less than 3 dB. **Table 1** summarizes the results of modeling these antennas at a 30-foot height. Only the half-square offers a vertically polarized pattern with the desired figure 8. **Figure 2** contrasts the sharp nulls of the half-square with the oval pattern typical of other antennas pressed into bidirectional duty.<sup>1</sup> Although the gain of a half-square in the desired direction (broadside to the array) over a vertical dipole is about 2.5 dB, the gain is less important than the front-to-side ratio (edgewise to the array), which offers a minimum of three S-units of rejection for even sloppy construction.

The half-square also offers a direct match for 50-ohm coax. This property simplifies construction and minimizes the number of connections to gradually go bad in the weather. Of the other candidates, only the right-angle delta loop, fed about 12 percent up one angled leg, offers equal simplicity, but it can't compete with the half-square pattern. The side-fed quad loops, like the equilateral delta loop, exhibit

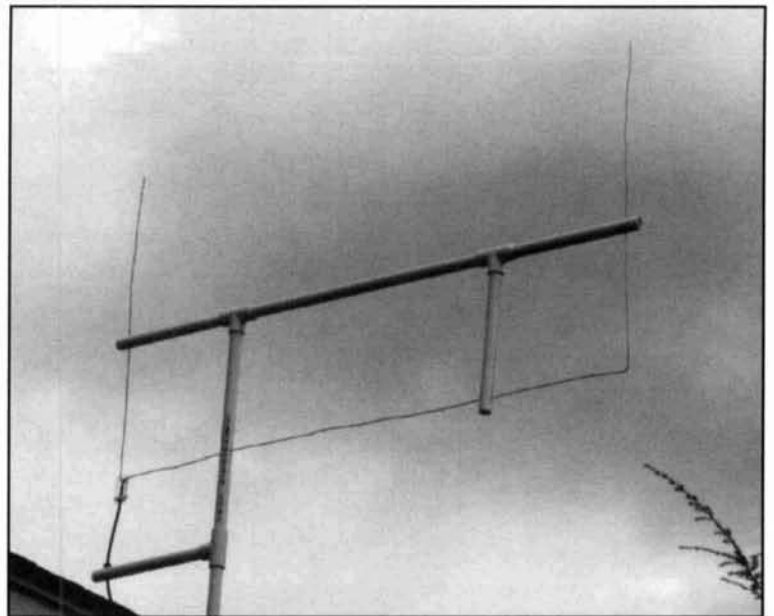

The author's bidirectional vertical antenna.

higher feedpoint impedances (along with merely oval patterns), calling for more complex matching to the feedlines most commonly used.

## A little half-square background

The half-square has had its home on the lower HF bands where the common configuration is to place the horizontal portion high and let the vertical portions hang down. This has obscured the intimate relationship between the half-square and the equilateral and right-angle delta loops. These latter antennas are normally

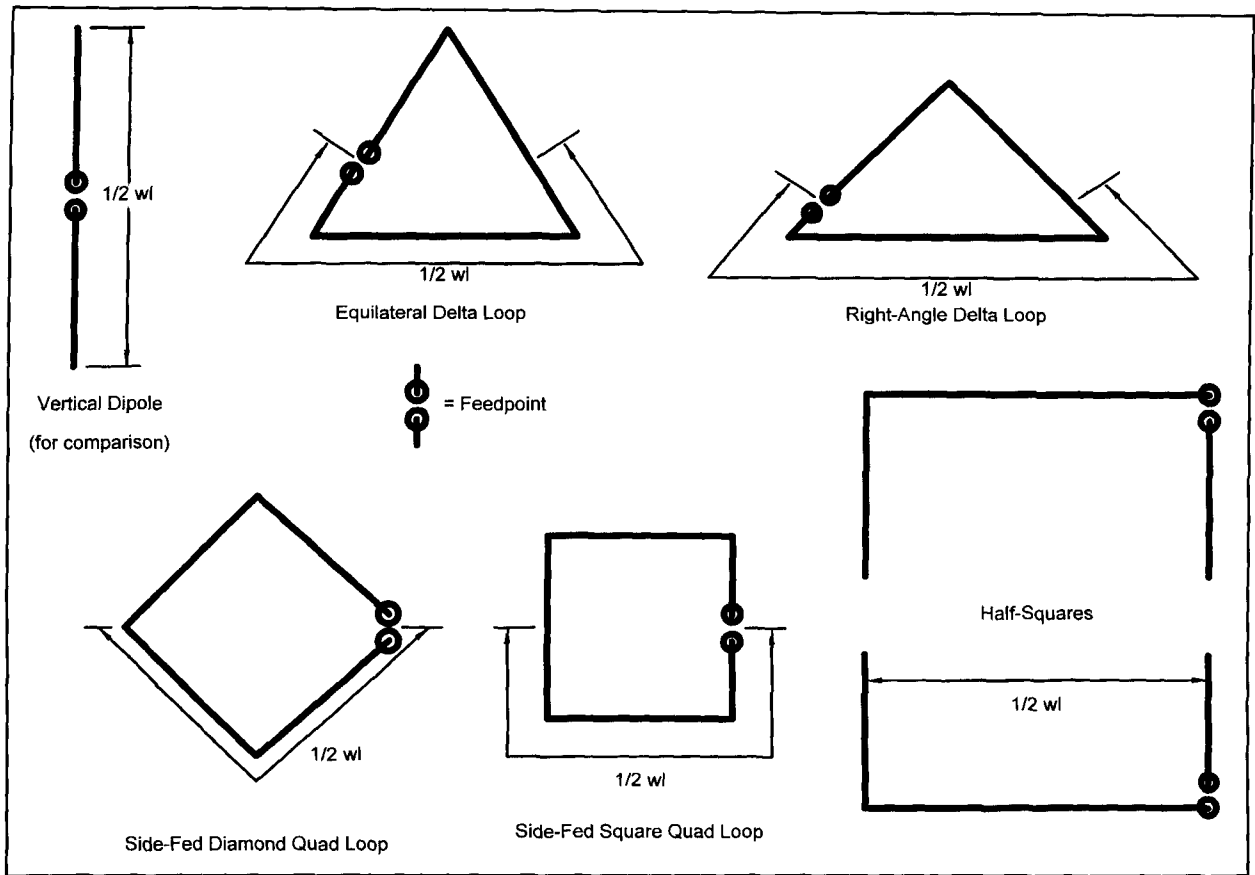

Figure 1. Some bidirectional, vertically polarized antennas.

constructed for low HF band use with the horizontal portion in the lower position.<sup>2</sup>

Even on the lower HF bands, the half-square offers more gain and directionality than either delta antenna. However, the antennas make up a family because, in each case, the feedpoint for a vertically polarized resonant loop is just about  $1/2$  wavelength distant along the wire from a second high-current, low-voltage point. The equilateral delta is fed, as the simple diagram in **Figure 1** indicates, about 25 percent of the way up one leg. The distance from that point in either direction to the corresponding high-current point is just about the same, and that point is about 25 percent up the facing leg. The right-angle version, with its lower feedpoint also has a longer base lag, which places its corresponding high-current point about 12 percent up the facing leg.

The apex of the triangle in each case is equidistant between the high-current points and is a position of minimum current and maximum voltage. Separating the wires at the apex by a reasonably small distance (so as not to introduce a significantly altered geometry) makes no difference to the operation of the antenna. The pattern shape, gain, and feedpoint impedance remain essentially unchanged.

By bending the angled elements into a vertical position and stretching the baseline to a full half wavelength, we place the feedpoint at a corner of the antenna. With appropriate wire trimming, we obtain a resonant antenna with a near-50-ohm feedpoint impedance that has excellent bidirectional characteristics and is mostly vertically polarized. Because the half-square operates by the same principles as the delta loops fed for vertically polarized radiation, it remains a "closed-geometry" antenna despite its "open" appearance.

The horizontal wire of the half-square is conventionally classified as a phase line in which two things occur. First, the current and its phase at the far end of the line are correct. As a result, the interaction of the fields from the two vertical elements produces a strong signal broadside to the assembly, with deep nulls off the sides or in the plane of the array. Second, the fields from the horizontal wire largely cancel themselves, leaving the antenna strongly vertically polarized.

The position of the baseline above or below the delta apex or the half-square vertical peaks makes no difference to antenna operation, either in free space or several wavelengths above ground. At HF, builders usually find it

more convenient to suspend the vertical wires below the horizontal wire. At VHF, self-supporting vertical elements suggest placement of the horizontal wire on the bottom so the feedline is removed as far as possible from the antenna fields.

## Building a 2-meter half-square

Construction of a VHF half-square offers almost unlimited variations. **Table 2** lists the dimensions modeled for resonant half-squares using a variety of materials of increasing diameter. All these models use the same material for vertical and horizontal portions of the antenna, as NEC-2 is not wholly reliable when models have wires of differing diameters meeting at angles. However, the trends should enable the builder to make reasonable interpolations. Note that, as with all "closed-geometry" antennas, element lengths increase as the element diameter increases.

In general, the most critical dimension is the length of the horizontal wire. For most construction methods, it is best to set this length and then trim the verticals for resonance. The result will be an antenna with close to a 50-ohm feedpoint impedance. A version with slightly less remnant horizontal radiation is possible, but it tends to have reduced side nulls and a higher feedpoint impedance. The performance differential may not be noticeable in practice.

The test antenna was built using a highly flexible construction method: supporting #12 copper wire (stripped house wiring) with a light and adaptable PVC frame. **Figure 3** shows the main features of the structure. The antenna proper consists of two pieces of wire: a 61.5-inch piece for the horizontal leg and the far vertical leg and a 21.5-inch piece for the directly

fed vertical leg. (For actual construction, it's best to begin with slightly long wires.) This choice of materials minimizes the number of connections. There are only two, one to each side of the coax feedline. These connections can be soldered and sealed, eliminating bi-metallic joints.

The basic PVC structure uses lengths of 1/2-inch nominal SDR-13.5, 315 pound pressure light-duty PVC for most parts. This lighter PVC uses the same Tee connectors and glue as the sturdier Schedule 40 material, which is used wherever strength is needed. The main vertical support on the right is constructed of this material. In my test version, I then transition with couplers up to 1-1/4-inch nominal schedule 40 PVC, which slips over a standard 1-1/4-inch diameter steel mast.

Each short leg of PVC from the Tees has a 1/8-inch hole to pass the #12 wire. The holes pass the wire freely, because the function of the legs is only to position the wire and resist wind-bending. I found it easiest to construct the horizontal section of PVC and then drill two holes 40 inches apart. After trial fittings and trimming, I slipped the vertical PVC pieces over the wire and then slipped the wire through the holes in the horizontal assembly. Gluing the PVC verticals into the Tees completed most of the construction.

The test antenna is a top-mount assembly. The offset mount allows the coax weight to counter-balance the longer run to the other vertical side of the antenna. The feedpoint connection is simple, consisting of a 1 by 2-inch scrap of 1/8-inch Plexiglas™ with two holes to pass short bends at the ends of the antenna wires. The coax center conductor and braid are soldered to these wire ends. A half grommet is placed over the coax and the grommet-coax

## Vertically Polarized Antennas for 2-Meters

Type	Gain in dBi	Front-to-Side Ratio in dB	Feedpoint Z R ± jX	Pattern Type
Vertical Dipole	6.57	0	75 + j 8	Circular
Equilateral Delta	7.46	<3	120 + j 5	Oval
Diamond Quad Loop	7.54	3	134 - j 2	Oval
Square Quad Loop	7.72	4	130 + j 2	Oval
Right-Angle Delta	8.01	<5	50 - j 2	Oval
Half-Square	9.15	20-30	52 - j 1	Figure 8

Note: All antennas were modeled of #12 copper wires, except the quad loops, which were #14 copper wire. Antennas were modeled at 146 MHz. The Deltas, Half-Square, and Vertical Dipole had their lower limit at 360 inches (30 feet), while the quad loops were centered at 360 inches (30 feet). The azimuth angle was 3 degrees in all cases.

**Table 1.** A comparison of some vertically polarized antennas for 2-meters.

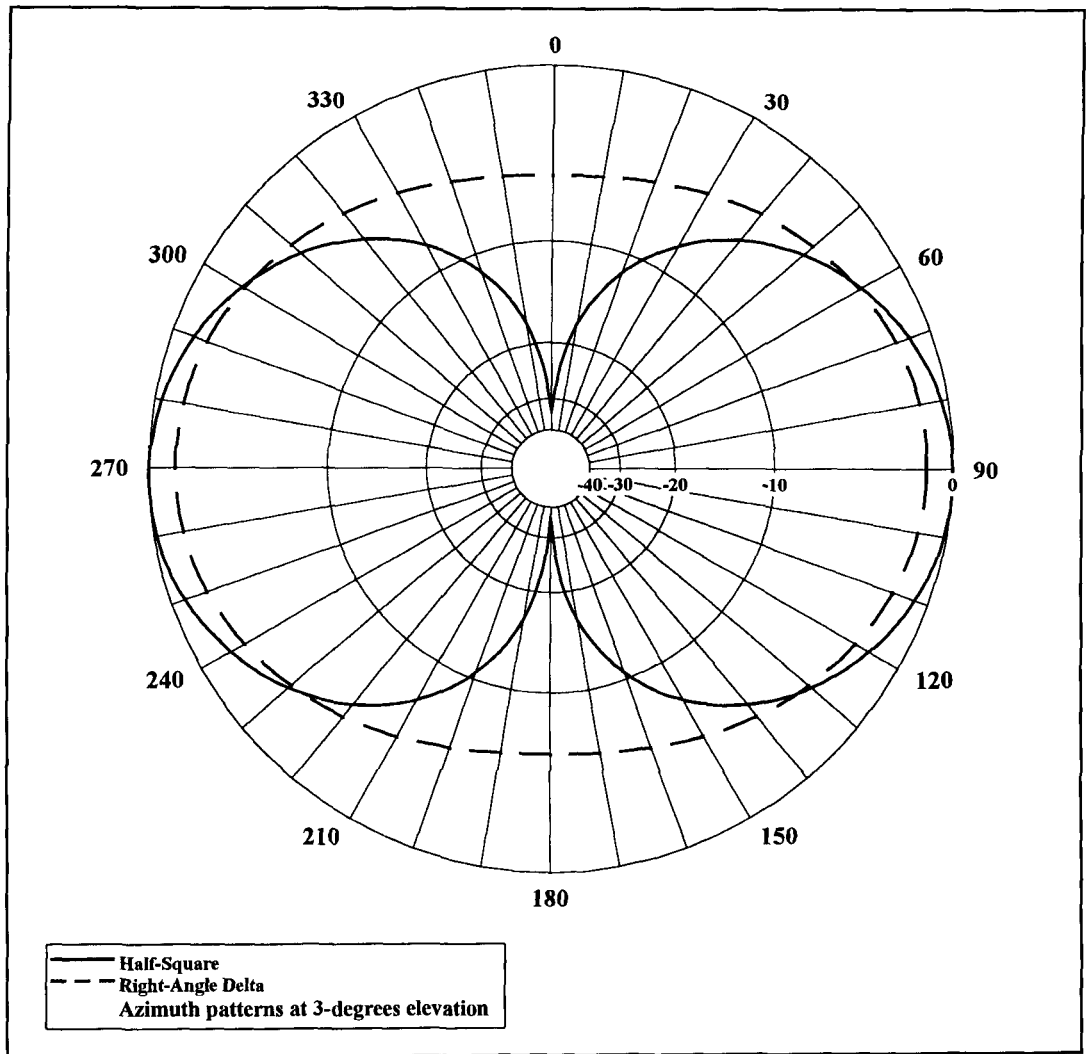

Figure 2. A comparison of 3-degree elevation azimuth patterns between the right-angle delta loop and the half-square. The right-angle delta loop pattern is also typical of simple vertically polarized antennas.

combination is clamped in place with a cable tie. The grommet prevents the cable tie from deforming the coax. With the coax clamped in place, the feedpoint connections cannot flex and break. The connections are well-coated with coax sealant.

Before soldering the connections, I passed the coax through a 1/4-inch hole drilled in the short section of PVC extending to the right of the main PVC mast. I cut open a 1/4-inch inside diameter grommet and used contact cement to lock it to the coax above the hole. The fixed grommet protects the antenna connections from downward forces.

Two points on the **Figure 3** diagram are marked as Mod. A and Mod. B. Modification point A is for side mounting the antenna to a tower. A builder could replace the short right thin-walled PVC with a longer length of Schedule 40 material. Of course, one would eliminate the vertical mast and replace it with a

down-pointing thin wall support like the one on the left of the diagram). Coax dressing is left to the builder's creativity.

Modification point B is for mounting the antenna broadside to a tower. A builder may choose to cut the horizontal PVC at the center and insert a Tee with the opening facing the tower. A length of Schedule 40 PVC would again provide the strength for supporting the antenna from the tower legs. Other modifications are certainly possible, as PVC lends itself to a large number of arrangements.

## Performance

In trials, the test antenna appears to perform as modeled. Tuning consisted of trimming the two vertical elements for minimum SWR on 146 MHz. Excursions across 2-meters show well below a 2:1 SWR at heights from five feet

Figure 3. A sketch of the 2-meter half-square PVC support system.

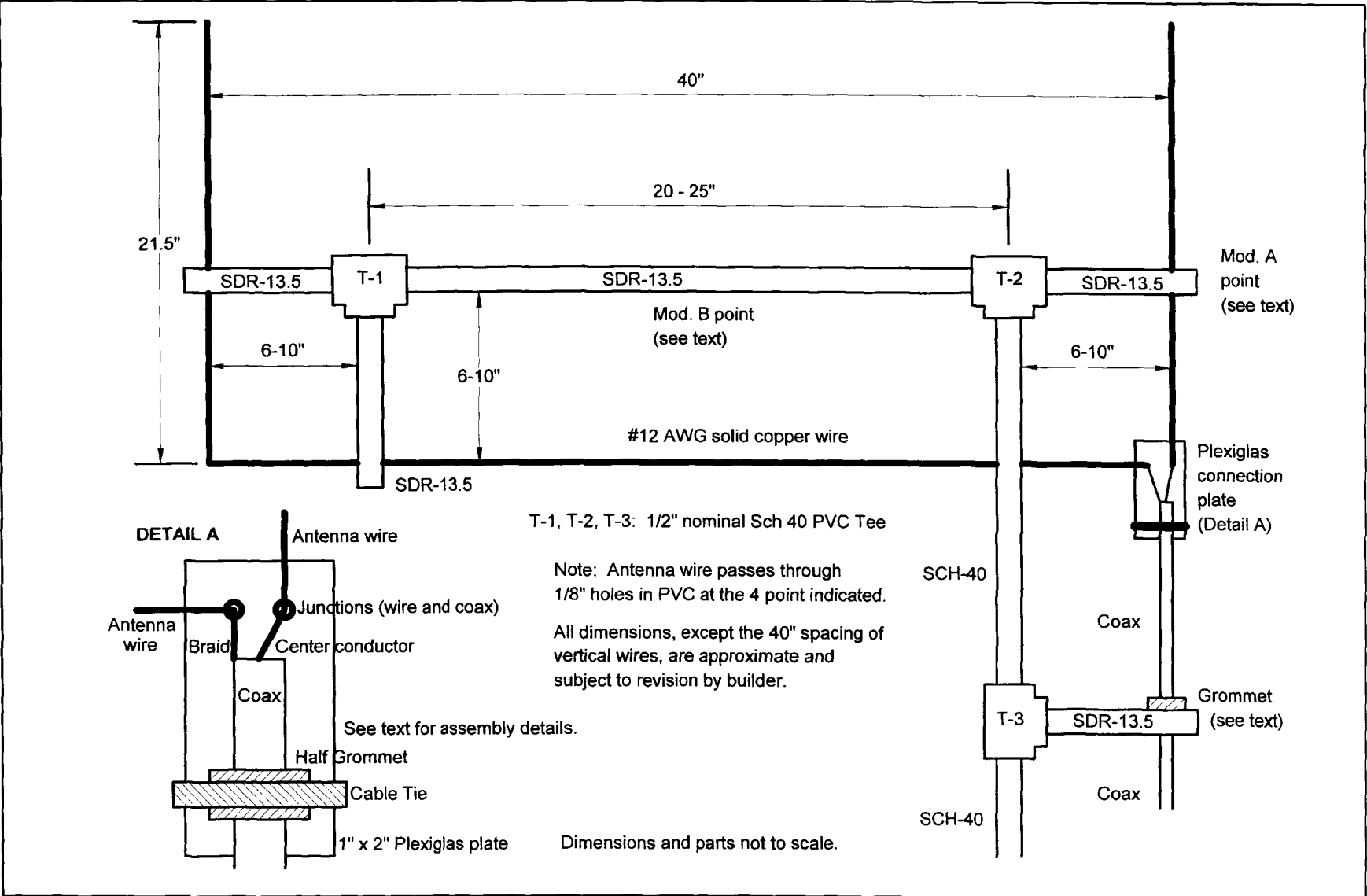

## Dimensions for a 2-meter half-square

Element Diameter (Inches)	Horizontal Wire Length (Inches)	Vertical Length (Inches)	Approximate Resonant Feedpoint Impedance (Ohms)
#12 (0.0808)	40	21.5	52
0.125	40	21.6	53
0.25	40.2	21.7	55
0.5	40.4	21.8	56
0.75	40.4	22.0	58
1.0	40.4	22.1	59

Table 2. Suggested dimensions for a 2-meter half-square using aluminum ranging from #12 AWG to 1-inch diameter.

upward. The side nulls are sharp enough to make the antenna useful for direction-finding exercises. Adjacent channel repeater interference from the antenna sides is easily eliminated by careful antenna aiming.

Models suggest that the antenna is relatively unaffected if side mounted to a tower; that is, with the tower in a plane with the elements. Hence, for a true bidirectional pattern, the edge-wise mounting scheme of Mod. A is recommended. Models also suggest that a nonresonant mast or tower can distort the pattern of the antenna if mounted broadside, as suggested in Mod. B. A distance of 16 to 18 inches from the mast raises the gain away from the mast by about 1 dB and yields a front-to-back ratio of about 6 dB. Although not too significant, if

one needs the slight distortion toward unidirectionality, the Mod. B mounting might offer the best performance.

Not everyone needs a bidirectional, vertically polarized antenna pattern on 2 meters. However, for those who do, the half-square offers a simple and effective way to meet this need. The use of PVC makes construction easy and cheap. Simple, effective, easy, and cheap makes a pretty good ham combination. ■

#### NOTES:

1. All models were run on a combination of EZNEC-M and NEC-Win Pro.
2. Delta Loops fed for vertical polarization are discussed extensively by John Devoldere, ON4UN, in Chapter 10 of *Antennas and Techniques for Low Band DXing*, 2nd Edition, American Radio Relay League, Newington, Connecticut, 1994. Ben Vester, K3BC is likely the first person to bring the half-square to the attention of amateurs in the 1970s in *QST*.

## PRODUCT INFORMATION

### HAM-Pack for Carrying Ham Stations

Cutting Edge Enterprises has developed the HAM-Pack for vacationing hams who wish to carry their 110-watt station on their backs on planes or trains, or safely and compactly in their cars. The man-pack carries new mobile rigs like the ICOM-706 or Yaesu FT-100 and has space for the rig along with a rechargeable power supply and mobile antenna.

The size of a piece of carry-on luggage, the backpack is constructed of heavy-duty black nylon with 1/4-inch foam packing. The radio is secured in the upper compartment of an adjustable radio "sling" that allows the unit to be raised or lowered for access and protection. Power cords pass through openings into the lower padded compartment designed to hold a rechargeable battery power supply (also available through Cutting Edge). The lid contains a pocket for microphone storage. The pack can be worn or carried by the handle at the top. A mobile antenna fits in a side pocket.

For further information, contact Cutting

Edge Enterprises, 1803 Mission Street, Suite #546, Santa Cruz, California 95060, phone (800) 206-0115, or check their website at <cee@cruzio.com>.

### Wirewound Miniature Chip Inductors

Pulse has a new line of 0603-sized miniature chip inductors. The PE-0603CD series provides inductance of 1.8 nH to 120 nH in 20 values in the industry standard 0603 surface mount package. The devices feature high Q and a high-resonance frequency, making them suitable for RF applications.

The new RF chip inductors are designed with a flat surface for pick and place compatibility, and include tin/lead terminations.

Typical Q and inductance over the operating frequency range and S-parameter is available on disk (request AN944-1) or via Pulse's website. Detailed information on the devices in this series is available on data sheet W704.P at <<http://www.pulseeng.com/products/literature/pdf.htm>>.



# THE LAST 100 YEARS IN COMMUNICATIONS

## *Part 1: Wireless, the early days*

---

**A**lthough it has only been an instant in time, a mere flicker of light in the cosmos, to mankind it's been an unbelievable leap in the field of communications. The telecommunications revolution begun during the last 100 years continues without stopping.

Nowadays, information is exchanged at transmission speeds not thought possible at the end of World War II. Hand-sent Morse code has become an obsolete communications mode. Solid-state devices and digital techniques have revolutionized communications. Digital forms of communication are now king.

### The beginnings

In America during the mid-1800s, the debate over state's rights and slavery was beginning to rage and the seeds of the American Civil War were being sown. Meanwhile, on the European continent, the Frankfurt Assembly was meeting to decide the future of the German state. Other political powers on the continent had been overthrown by revolutions in Berlin, Vienna, and Paris. Otto Von Bismarck, a Prussian Junker\* from Berlin was making his entry into politics and formulating policies for the future. Louis Napoleon Bonaparte was elected president of the French Republic.

On the scientific front, in 1850, Fizeau and Foucault measured the velocity of light. A few years later, Kirchoff discovered that the velocity at which an electric current traveled on a

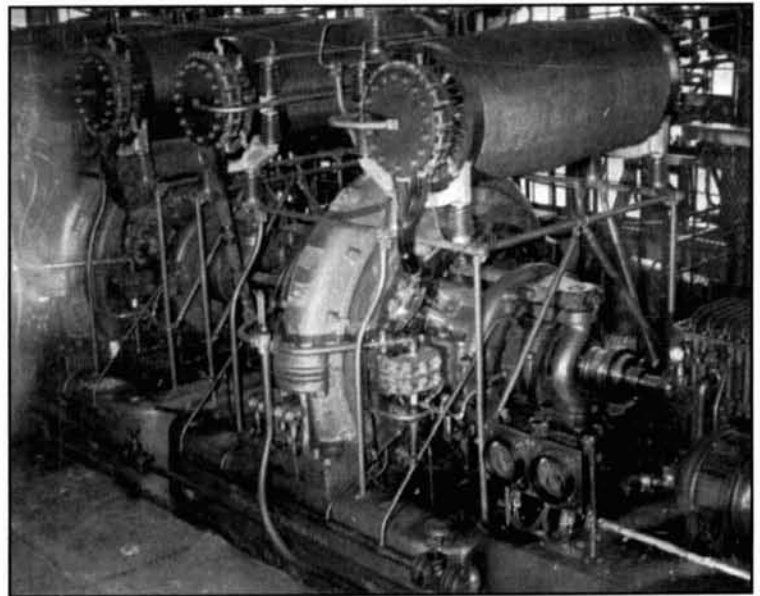

Photo A. Alexanderson alternator at the Goldschmidt Radio Tower on Hickory Island. (Courtesy of Charles Beulow)

wire in free space was virtually the same as the speed of light.

In England, James Clerk Maxwell was able to show that light and electromagnetic waves behaved in a similar manner. He found that light was another form of electromagnetic radiation and wrote his famous fundamental equations explaining electromagnetic fields. His work paved the way for the wireless.

Meanwhile, Helmholtz was studying light at Berlin University in Germany; his assistant was Heinrich Hertz, a former student. Hertz, a

---

\*A member of the Prussian landed aristocracy.

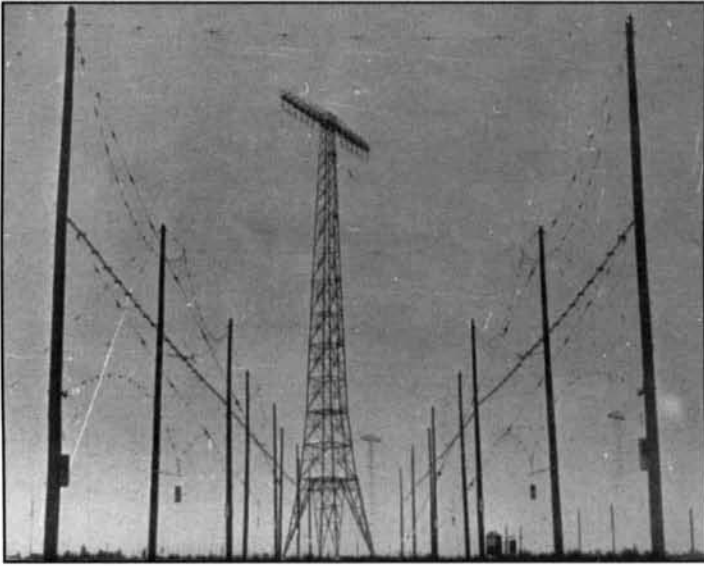

**Photo B.** An exterior view showing the Long Wave Towers at RCA's Radio Central Facility at Rocky Point, Long Island, in the early 1930s.

physicist, succeeded in proving Maxwell's theories correct in his own laboratory at Karlsruhe, Germany in 1886. Using both transmitting and receiving antennas, the receiving antennas having been formed in a circular wire loop, Hertz was able to transmit a signal at the 5-meter wavelength a short distance to the antenna loop.

Alexander Popov was a Russian electrical engineer and physicist who studied mathematics at St. Petersburg University in the city now called Leningrad. While teaching physics and electrical engineering at Mine Officers School and the Technical School of Naval Administration at Kronstadt, Popov had read Hertz's treatise on electrodynamics. Popov began to give lectures on new wireless developments. He developed a sensitive receiver to detect these new electromagnetic waves. He realized that the Navy would be interested in the new wireless techniques. In 1895, Popov began experimenting with the wireless apparatus at the Mine Officers School. The tests showed that transmitting distances up to about 200 feet were possible. Popov proposed that a vertical conductor should be erected and connected to the receiver to increase communication distance. His was one more attempt at using a vertical antenna to increase distance, probably taken from the work of Dr. Mahlon Loomis.

Dr. Loomis was known to have experimented with vertical copper wires suspended from kites in the United States during the Civil War. In 1866, he demonstrated signaling between two stations, one located in Virginia and the other on the shore of the Chesapeake Bay. Communications between the two stations were established by disturbing the electrical equilibrium

of the atmosphere. He was successful in obtaining a patent for his telegraph system in 1872; however, he was unsuccessful in obtaining funding from the United States Congress.

Experimenting further, Popov succeeded in sending a radio wave 2,000 feet to a receiver. This distance was increased to approximately three miles during subsequent ship-to-shore wireless experiments.

Guglielmo Marconi, recognized for his work in pioneering the wireless, verified Morse code communications across the English Channel in 1898. In 1901, Marconi established Morse communications across the Atlantic Ocean using antennas at the transmitter site at Cornwall, England, and at the receiver site, located at St. John's Newfoundland. The antenna at St. John's consisted of elevated wires held up by a kite in the wind.

## Enter Nikolai Tesla

About the same time as Popov and Marconi's experiments, Nikolai Tesla became interested in wireless communications. Tesla had studied at the Realshule in Karlstadt in 1873, later attended the Polytechnic School in Graz, and went on to Prague, Czechoslovakia, to continue his studies at the university. While studying physics and mathematics, he developed a curiosity about electricity. Upon graduation, he worked for the Austrian government's telegraph engineering department. Some time later Tesla went to Paris and, by 1894, had traveled to the United States.

Once in the U.S., Tesla went to work for the Edison Company, which eventually became General Electric. Unfortunately, shortly after he began working for the company, Tesla had a falling out with Thomas Edison. Tesla left Edison's employ and started his own laboratory, where in 1888 he patented the induction motor based on his rotating magnetic field theory. Tesla worked with the induction coils that were later to become transformers. He also proposed the ideal of alternating current polyphase transmission of electrical power. However, what is not too widely known is that Tesla gave a series of lectures in 1892 at the Royal Institution of Great Britain. During these lectures, he proposed the basic principles governing radio communications. He described the various components needed to construct the system and he proposed that components consisting of antennas and grounds be used in conjunction with tuned circuits at both the transmitter and receiver.

Tesla envisioned a worldwide radio network and, in 1899, he experimented with extremely low frequencies at his Long Island, New York, laboratory. He considered the theory that elec-

trical power could be transmitted and distributed by the same means without wires.

Fundamental studies, made by Tesla and the German scientist Sommerfeld, of extremely low frequencies are the basis for the development of the U.S. Navy's Project Seafarer. Seafarer is a worldwide submarine transmission system used to communicate with submarines underwater.

In 1909, Sommerfeld wrote a paper predicting mathematically that radio waves were attenuated as the wave spread out from the transmitting antenna. He found that radio wave attenuation was not only governed by the inverse square law, but also by energy absorption as the wave passed over the earth's surface.

Sommerfeld's work was followed by that of two Americans, Austen and Cohen, who worked at the National Bureau of Standards. They obtained their conclusions from practical experience in combination with experiments using field strength measurements. Austin and Cohen found that as the radio wave passed over the earth's surface, the rate of energy absorption was logarithmic. This phenomenon was similar to transmission line behavior. They also took into consideration wavelength, ground constants, and antenna parameters before arriving at an equation for predicting field strength.

The Sommerfeld and Austin-Cohen conclusions agreed that wave attenuation was proportional to frequency and that for long-distance telecommunications the best frequencies centered around 300,000 Hz or 1,000 meters. They had considered only the ground wave. At short wave frequencies the ground wave does not propagate very far, but attenuates rapidly from the antenna. During this time in history, short waves were considered useless for communications due to the wave attenuation along the earth's surface.

We can now see how Tesla and Sommerfeld's work made possible an extremely low frequency (ELF) communication system. The system works on the principle that the earth's surface and the ionosphere's bottom layer act as an effective wave guide, propagating a radio signal at 75 Hz with small signal attenuation. At this particular frequency, the radiated wave would penetrate the seawater surface to a depth of 400 feet, whereas radio wave penetration is slight in water when using very low and high frequencies (300 kHz to 30 MHz).

As was stated earlier, Tesla also experimented with transmitting electrical power. Today, his dream of electrical power could become a reality with the proposal to build a Solar Power Satellite (SPS). It would be necessary to place the satellite in geostationary earth orbit. Then electrical power from its solar cells would be converted into microwave energy and beamed to a receiving station on the earth's surface. At

the earth receiver, the microwave energy would be converted back to electrical power and distributed to customers.

Returning to our narrative, it is unfortunate to note that there were sometimes disagreements in the ranks of the wireless pioneers. In 1915, Tesla sought an injunction against Marconi's patents on basic radio. His lawsuit proved unsuccessful. In 1943, the United States Supreme Court recognized Tesla's claims. The court ruled against Marconi, upholding Tesla's achievements. Unfortunately, that very same year Nikolai Tesla died.

## The interim

Wireless communication at the beginning of the century was primarily achieved by spark gap transmitters and was not in widespread use. However, a catastrophic event proved the technology worthwhile. The British Marconi Company owned and operated a wireless station on top of John Wanamaker's department store in New York City. On the night of April 17, 1912, the passenger liner *Titanic* sank in the mid-Atlantic. The ship hit a large iceberg on her way to America. A young radio operator

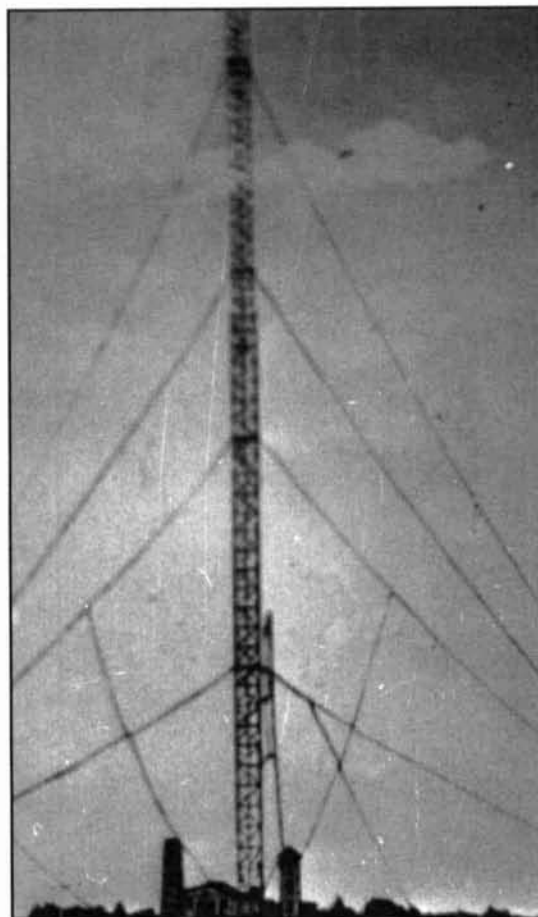

Photo C. the Goldschmidt Radio Tower at Eilvese near Hanover, Germany. (Courtesy of Mr. Wolfgang Schroder.)



**Photo D. The Goldschmidt Radio Tower at Eilvese: Kaiser Wilhelm is in the center, to his right is Admiral Emsmann, to his left Admiral Graf Plessen; both Admiral's were directors of the HOMAGES Company. In his left hand Professor Goldschmidt is holding a Tesla Gas Tube, used to light the station. (Courtesy of Wolfgang Schroder.)**

at the station named David Sarnoff received the terrible news. Sarnoff helped save passenger lives by directing ships to the rescue. Sarnoff later became president of the Radio Corporation of American (RCA).

After this tragic event, men dreamed of spanning the oceans using the wireless; however, the wireless spark transmitters were not yet powerful enough to communicate on low frequencies consistently. In addition, vacuum tubes of this period were not powerful enough to do the job.

It took another European immigrant to the United States to provide the answer. Dr. Alexanderson, of Upsala, Sweden, invented a new transmitting device called the alternator. The device made possible sustained and daily transoceanic communications between nations using continuous radio waves. Alexanderson, who had graduated from many of Europe's finest universities, dreamed of working with Charles P. Steinmetz, the wizard of alternating current in America. Alexanderson's dream came true in 1901 when he obtained a position on Steinmetz's generator design staff at the General Electric Company.

In 1904, Professor Reginald A. Fessenden, another wireless pioneer, had contracted General Electric to design and build a new alternator. The alternator was to use higher fre-

quencies never before used. The young man from Sweden got the assignment. On April 26, 1909, Dr. Alexanderson secured a patent for his new generating machine.

Known as the Alexanderson Alternator (**Photo A**), the machine was capable of generating high frequencies (upper end of low frequency spectrum). The device was driven by an electric induction motor. The alternator converted the mechanical rotation to alternating current at low radio frequencies of approximately 10 to 200 kHz. Alternator keying was accomplished by interrupting the direct current field supply either with a hand key or a magnetic modulator. The machine was capable of high transmitting power at low frequencies.

Frequency could be controlled accurately when the revolutions per minute (RPM) of rotating force was governed by a speed regulator. The frequency on which the alternator operated was determined by armature speed and the number of field poles in the machine. The alternator's output was connected to a transformer. The transformer output was then coupled to a multiple-tuned antenna—another of Alexanderson's inventions.

The alternator's performance surpassed the arc converter and spark-gap transmitters of the time. Some examples of very powerful long-wave transmitting stations were WQK and WQL at Rocky Point, Long Island (**Photo B**). These transmitters were running powers of two million watts output from Alexanderson alternators. At the end of World War I, it was the NSF wireless station alternator at New Brunswick, New Jersey, that transmitted President Wilson's "Fourteen Points" to the German government.

Due to Mr. Alexanderson's many pioneering accomplishments with the wireless technology, he received many honors. These included: Fellow of the American Institute of Electrical Engineers, Swedish Order of the North Star, Polish Order of Polonia Restituta, and honorary degrees from the Royal University of Upsala, Sweden, and Union College in the United States.

The multiple-tuned down-lead antenna system invented by Alexanderson was one way to decrease earth loss resistance. An alternative method was the Umbrella antenna, another form of capacitive top loading. This method was used quite extensively by the German radio engineers of the time. Specific examples were the German wireless stations at Tuckerton in New Jersey, and Nauen and Eilvese in Germany. The Umbrella antenna wasn't a German design. It was originally invented by Sir Oliver Lodge, an Englishman. The Umbrella antenna was used mostly on long waves for transmitting to increase antenna electrical height. The Umbrella made the antenna

electrically efficient, therefore, the antenna became a better radiator.

Lodge studied lightning and electricity. He attended University College in London and received his doctorate during 1877. Later, he became assistant professor of applied mathematics. Lodge investigated electro-magnetic waves and the wireless telegraph. In 1894, he developed a wireless system and wrote about it in an article titled "Signaling Across Space without Wires."

## The Germans

Before 1918, a German company built a wireless station in the small fishing and ship-building town of Tuckerton, New Jersey. It was unknown to the United States government. This station later became WSC, a commercial coastal radio station (open to public correspondence) operated by the Radio Corporation of America. The station is of special historical interest for many reasons, although many communications professionals and the general public aren't aware of them.

The station's story begins in Germany with Kaiser Wilhelm. The Kaiser thought that Germany should be linked to other nations in the world via the new wireless telegraphy. Kaiser Wilhelm provided the incentive for the development on wireless stations as a commercial business in Germany. He did this by making available the sum of one million gold marks to provide working capital for erecting stations at Eilvese, Germany and Tuckerton, New Jersey. The new company, founded in 1910, was called HOMAGES—an abbreviation that stood for Hoch Frequenz Maschinen Gesellschaft Mit Berschränkter Haftung (High Frequency Machine Business Gmbh). The firm's business partner was C. Lorenz A.G., a subsidiary of Standard Electric. These companies built two wireless stations: the Eilvese near Hanover in Germany (Photos C and D) and another at Hickory Island Tuckerton, New Jersey (Photo E).

Construction began with towers built by the Burgmann Werkstadt Company in Berlin, Germany. The towers were put together section by section using bolts and nuts to hold each section together. Each tower, when completed, was approximately 800 feet tall and was to be supported by guyed steel ropes every 200 feet in height. Each steel rope was insulated from attachment directly to electrical ground, forming the part of the capacitive top hat.

Meanwhile, Dr. Rudolph Goldschmidt, who taught at the University of Darmstadt in Germany, was hired as a consulting engineer to HOMAGES. Goldschmidt had attended the University of Darmstadt and graduated with a

diploma in engineering. In 1900, Goldschmidt was employed as an engineer in Berlin for the Allgemeine Electricitäts Gesellschaft (All Electric Business). Other engineers employed by the company included wireless pioneers Adolf Slaby and Graf Arco. They were known for their radio transmission procedures used aboard ships. Dr. Goldschmidt was chosen to select an appropriate wireless station site in America.

Dr. Goldschmidt made the trip to America to choose a usable telegraphy site. Station sites in northern-most New Jersey weren't suitable due to sleet and snow conditions. After careful study, he decided upon Manahawkin, New Jersey. His decision was based on the fact that atmospheric levels further south of this latitude would be extreme. These conditions would not be good for receiving signals from the other side of the Atlantic Ocean. However, just as Goldschmidt's mind was about made up, he heard about Hickory Island, three miles outside of Tuckerton, just south of Manahawkin. The island was situated on a salt marsh that provid-

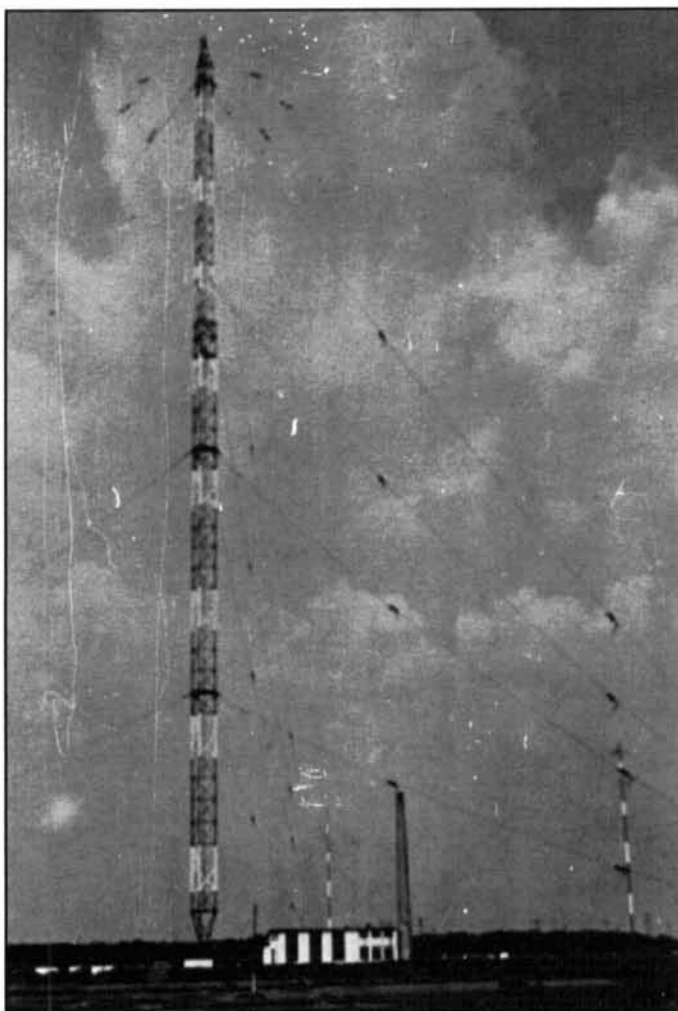

Photo E. The Goldschmidt Radio Tower under RCA management at Hickory Island, Tuckerton, New Jersey. (Courtesy of Charles Beulow.)

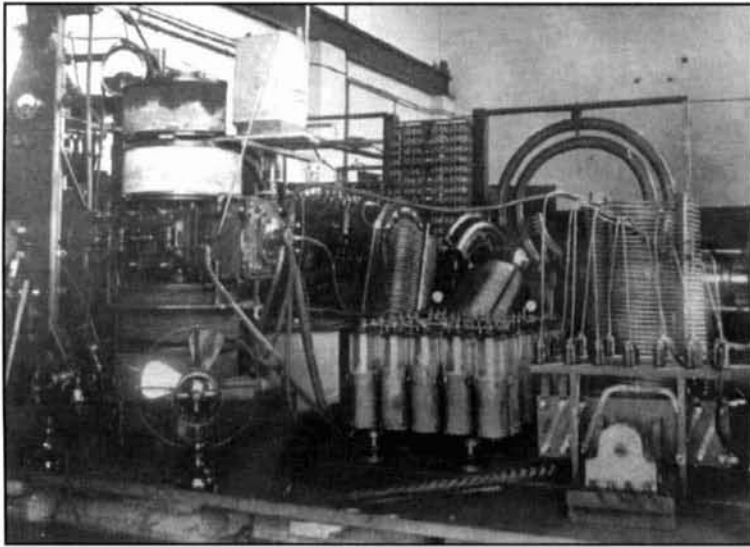

Photo F. One of the arc converters at the Goldschmidt Radio Tower at Hickory Island, Tuckerton, New Jersey.

ed good earth electrical conductivity and a vast sweep across Barnegat Bay to the Atlantic Ocean. It was on this site that Goldschmidt finally decided to build the German wireless station which later became the Goldschmidt Radio Tower.

The late Mr. Charles Buelow, chief rigger for the Goldschmidt Radio Tower and later a machinist's mate in the United States Navy, grew up with the radio tower. In an interview with the author, Buelow related the interesting history associated with the tower.<sup>1</sup> He recalled that the complete station was shipped to New York City by steamship. Then it was loaded on a train to Tuckerton, New Jersey. Meanwhile, he and twenty other Tuckerton men were digging the main tower foundation on Hickory Island. When the train arrived in Tuckerton, the wireless station and the tower sections were transported to Hickory Island by horse and wagon along a small dirt road.

By 1911, the station was completed and ready to operate. The station antenna consisted of a main mast reaching a height of approximately 820 feet. The umbrella top-loading hat had 35 sloping wires dropping down to 10-foot high insulated poles on the earth's surface; these poles surrounded the main tower. From the umbrella's top, vertical wires extended downward parallel to the main tower to the transmitter building. These wires served as the down leads to a very special alternator.

The Alexanderson alternator was just coming into its own, but the Germans sought a way to avoid the expense of using the patent rights of General Electric. Therefore, it fell to Goldschmidt to think of another method of generating continuous waves. Goldschmidt's clever mind developed the reflecting principle to generate higher frequencies, using a com-

pletely different principle than Alexanderson.

Goldschmidt's alternator worked on simple principles much different than those associated with the Alexanderson machine, which was of the induction type. The Goldschmidt alternator construction was similar to that of an ordinary generator, but it made use of the reflecting principle (harmonics). The Goldschmidt alternator's stator winding induced alternating current in the rotor winding of the alternator, due to the armature rotation. The rotor winding output was fed to a tuned parallel resonant tank circuit whose frequency was approximately 15 kHz. The tank circuit was tuned by using banks of capacitors that could be added or subtracted from the circuit as necessary to change the frequency. This parallel resonant circuit, working with the armature rotor winding, produced a magnetic field that reversed itself.

The frequency of this reversal was 30 kHz, which was reflected back into the stator winding. The stator winding had another resonant circuit tuned to 30 kHz and its frequency was beat against the 15 kHz, inducing a 45-kHz voltage in the rotor winding. The sum of this voltage and the 15 kHz produced a 60-kHz signal voltage that was reflected back into the stator winding. The stator winding had an antenna circuit tuned to 60 kHz, and it was in this manner that higher frequencies could be produced for transmitting.

The Goldschmidt alternator suffered from one particular problem. Due to the many reflections or harmonics produced in the windings, there were eddy and hysteresis currents. These currents would tend to burn out the internal machine windings. During World War I, one such an instance was thought to be an act of sabotage at the Tuckerton station. In fact, it was the very nature of the machine's internal workings that caused the burnout. The Goldschmidt alternator was capable of producing an output power of 200 kW.

The Goldschmidt Radio Tower also later used a Federal Electric Arc Converter (**Photo F**) along with an Alexanderson alternator as transmitters. Perhaps what is more intriguing about the wireless stations in Tuckerton and Eilvese is the role played by Nikolai Tesla. It is well known that Tesla had constructed alternators that obtained frequency outputs of approximately 300 kHz. In his radio patents, Tesla describes the use of resonant circuits throughout. Therefore, it is conceivable that Goldschmidt might have gotten his ideas for the reflection principle from Tesla designs. Nikolai Tesla indeed visited the Goldschmidt Radio Tower and talked with Emile E. Mayer, the chief engineer. During Tesla's visit, Mayer related that the station had a 6,000-mile transmitting range. Tesla replied that he already knew this to be possible from his earlier experiments.

Tesla's involvement didn't stop there because he sold his patent rights to the HOMAGES Company. Mr. Wolfgang Schroder, the proprietor of the administration building of the Goldschmidt wireless telegraphy station at Eilvese, during an interview with the author, stated that Tesla had sold the rights to his Tesla Gas Tube to the company.<sup>2</sup> The wireless station at Eilvese was lighted from the transmitters' nearby field, which ionized the gas in the Tesla tubes. The tubes did not need any direct electrical connection to a power source. This was possible due to the many high-powered harmonics present in the environment of the transmitting building. Also at that time, arc converters were using a compensated wave for transmitting and this added to the effect.

Tesla, himself, used gas-filled tubes for radio wave detection in receivers. He demonstrated such an apparatus in one of his lectures in St. Louis, Missouri.

## The war

The Goldschmidt Radio Tower was maintained and operated by German nationals living in America. However, events in Europe eventually overtook the wireless stations in America.

In the United States, the Gesellschaft Fur Drahtlose Telegraphie (Telefunken) and Allgemeiner Elektricitats Gesellschaft (All Electric Business for Wireless Telegraphy Company) all operated together, competing against the Marconi System. The famous WSL telegraphy station was another German enterprise operated at Sayville, Long Island, New York. The Sayville station was eventually closed down by the United States Government due to World War I.

The Sayville wireless station had an intriguing history. It sent shipping information obtained from New York City newspapers to Germany's Nauen wireless station POZ. The United States Federal Bureau of Investigation (FBI) thought that the WSL wireless station was in violation of the neutrality laws. Moreover, there was a real possibility that German submarines were receiving ship sailing information in order to position themselves to sink the ships.

A year earlier, in December 1914, Dr. Jonathan Zenneck (**Photo G**) and Professor Ferdinand Braun, inventor of the cathode ray tube, sailed to America. They were to testify in a patent case. The Marconi Company had brought legal action against Telefunken because of alleged patent violations. The case was probably a British government effort to close down the Sayville station after all diplomatic efforts failed.

The Norwegian steamer that carried Drs. Zenneck and Braun was also carrying two tow-

ers, each 492-feet tall. Along with the radio towers, there was a new engine and new circuits for a Goldschmidt alternator to replace the spark transmitter at the Sayville station.

Dr. Zenneck had American colleagues and lived a normal life in the United States until the outbreak of World War I. When the U.S. government seized the Sayville station at the beginning of the war, it also arrested Dr. Zenneck. He was imprisoned at Ellis Island and later interned as a prisoner-of-war at Fort Oglethorpe, Georgia. To pass the time, he taught physics to other internees during the war.

Although Zenneck was not a spy, he had held the rank of Captain in the German Seebataillon—a rank equal to that of Captain in the U.S. Marines. Yet, before he traveled to the United States, he had been discharged from the German Army. Zenneck's arrest created a big stir among the Germans because he was one of the wireless pioneers of Germany as well as a special adviser to the Kaiser.

In 1898, Doctor Zenneck and his teacher, Professor Ferdinand Braun, had established an experimental wireless telegraphy station in Cuxhaven which could communicate with the Elbe Lightships. The distances between the circuits were rather short. Dr. Zenneck realized that raising the antennas at the shore-side station and also on the ship (named *Sylvania*) would allow for greater transmission distance. His theory proved correct and the wireless transmission range was greatly improved. This discovery made it possible to establish a wireless circuit between Helgoland and Cuxhaven. Dr. Zenneck and other German pioneers initiated maritime communication services within



**Photo G.** Germany's famous radio pioneer, Dr. J. Zenneck, whose experiments on the North Sea led to further understanding of radio propagation.

To President Woodrow Wilson

Washington

during my visit to Eilvese Station I received your kind message. I thank you for your greetings, & return your congratulations for the opening of the wireless communication between Germany & America. I too consider it as an additional link, which will bind upon our two countries in mutual friendships & closer intercourse.

William F. R.

Photo H. Friendship message sent by Kaiser Wilhelm to President Wilson via the Goldschmidt Radio Tower's at Eilvese, Germany, and Tuckerton, New Jersey. (Courtesy of Wolfgang Schroder)

Germany. That's the reason why his arrest in the United States created such a sensation among German citizens.

It was not much longer before spy and war mania caught up to the Goldschmidt Radio Tower, too! The station's massive tower, capable of talking with Germany and her ships at sea, was cause for alarm for the American Navy. Before the British passenger liner *Lusitania* sailed from New York City, the German Ambassador Count von Barnstorf warned that the ship was carrying ammunition. The general public was warned not to use this ship for transportation to England.

It was alleged that the Goldschmidt wireless station in New Jersey, then managed by German nationals, sent the message "Get Lucy" to the waiting German submarine U-39 off the Irish coast. The *New York Times* reported the German U-39 as sinking the *Lusitania*, but in reality it was the underwater boat U-20.

Two years after the sinking of the *Lusitania* on May 7, 1915, the United States entered World War I—justifying its action by citing Germany's unrestricted submarine warfare policy. However, the *Times* newspaper that published the contents of the famous Zimmerman telegram, which called for Mexico and Japan to declare war against the United States, was the probable catalyst that created the push in the United States to enter the war against Germany.

The Goldschmidt Radio Tower ceased to operate under German workers. The United States Navy took over its operation during the war. It is ironic in that it was only a few short

years before that Kaiser Wilhelm sent a friendship message (**Photo H**) on June 19, 1914, from Eilvese station via the Goldschmidt Radio Tower in Tuckerton for President Wilson.

After the conclusion of World War I, the United States government felt that too many foreign interests had control of the communications facilities in the U.S. Therefore, many of the foreign holdings in the United States were turned over to American communications companies, namely a newly created company called the Radio Corporation of America (RCA). RCA acquired the Goldschmidt Radio Tower along with some American Marconi holdings.

It's entirely feasible that this wireless station could have transmitted a message to a waiting submarine. During 1916, this same station communicated with the *USS Ventura* off the coast of Sydney, Australia. The radio telecommunication distance spanned was 10,000 miles. However, in reality, it is possible that the Goldschmidt Radio Tower never sent the message to a waiting submarine as the rumors implied. After all, these rumors started to circulating two years after the *Lusitania's* sinking.

Meanwhile, in Germany after the war, the Allgemeine Elektricitats Gesellschaft (AEG) part of Telefunken, together with Siemens, established another company called Deutsche Betriebsgesellschaft fur drahtlose Telegraphie (DEBEG). The express purpose of this company was to provide expertise in maritime radio installations along with any necessary engineering work. Starting in 1914, this company installed 380 wireless stations aboard German ships. The DEBEG company also operated all German wireless telegraphy stations for a while. Shortly after the stock market crash on "Black Friday" in 1929, the Goldschmidt Tower at Eilvese, Germany, was closed. On August 7, 1930, the main tower with its four smaller ones were razed due to the lack of funds for maintenance. It should be noted that, during 1928, the Reich Post (The German National Post Office) acquired the station property.

One further note of interest. On the ocean passenger liner *Hamburg*, Kaiser Wilhelm was returning on a cruise from the Mediterranean and wanted to send a message. The message had to be telegraphed to the Marconi station at Borkum Island in the North Sea, then relayed to Germany. The Marconi station refused to relay any messages to any wireless station outside its own system. As a result of this incident, the Kaiser felt it was not in Germany's national interest to be without its own maritime and civil radio communication system. It was this circumstance that gave Kaiser Wilhelm the impetus to establish German coastal maritime wireless stations. The first one built and still in existence today is Norddeich Radio (callsign



DAN). This is where Drs. Ferdinand Braun and Jonathan Zebeck began their early wireless antenna experiments.

On June 1, 1907, Norddeich Radio was opened to public correspondence. It celebrated its 75th anniversary on June 1, 1982, as a ship-to-shore coastal radio station!

## The gigantic wireless station

On the other side of the world in the Dutch East Indies, the islands now called Indonesia, was another low frequency wireless station now forgotten in time and lost in the jungle. Dr. Cornelius J. De Groot designed this gigantic high-powered wireless station at Malabar, Java. The dream for the Europeans living on Java was to be able to communicate with Holland. To give some idea of the distances involved, it was 7,500 miles to Kootwijk, Holland, which was the location of the other wireless station.

To accomplish this feat, it was necessary to have a very high transmitting power and very tall antenna. The reason for this, according to contemporary theory, was that the wave front radiated from a long-wave antenna would be attenuated logarithmically as it traveled over the earth's surface. This action is similar to what happens as a radio wave propagates forward along a transmission line. It tends to lose power because of the resistance offered by the medium through which it travels. Rather than calculate the attenuation for various distances, engineers chose to talk in terms of meter-amperes. To communicate over the specific distance, 300,000 meter-amperes was required. This meant that the value of 300,000 meter-amperes was calculated to be the product of antenna height in meters multiplied by the antenna current.

It is evident from the above meter-ampere value that the arc transmitter and the antenna had to be of gigantic proportions to meet these requirements. These requirements made the Malabar wireless telegraphy station on Java the largest in the world at that time. The transmitter arc was capable of delivering 2.4 million watts operating output power to the antenna on 7 to 20-km wavelengths.

On May 5, 1923, the station officially opened with a much larger antenna system than originally thought could be built. The proportions were gigantic! The antenna was a flat-top configuration consisting of five ropes with a 7/8-inch copper wire wrapped around them. Each of the copper-wrapped ropes were 6,500 feet in length and stretched between two cliffs. The down-lead traveled almost 3,000 feet to the wireless station on the ravine floor below. The flat-top configuration had a constant pull applied to the copper-wrapped ropes to keep

them stretched. This was done by passing the ropes over large aluminum pulleys and keeping them taut with five motor-driven winches on the north cliff. The south cliff had counter weights on the flat-top rather than anchors. On the ends of the flat-top were strings of insulators near the corona shields to prevent arcing. Even with these preventive measures, there were traces of arcing due to the use of high power in a tropical climate.

The antenna down-lead was connected to a loading coil constructed of copper tubing that was silver-plated for efficiency. The loading coil was constructed so different wavelengths from 7,000 to 20,000 meters could be selected via a switch. The transmitter and antenna were fine tuned with a Rendahl variometer.

## The arc converter

The arc was one means of generating continuous waves on long wavelengths. Other transmitting methods used were limited to longer wavelengths where oscillating waves could be generated. None of the machines were capable of generating higher frequencies, except the Tesla coil. Tesla's coil could oscillate about 500 kHz and could compete with vacuum tube oscillators. During this period, there was no acceptable alternative to the radio frequency alternator or the arc converter.

Everyone is familiar with the film projection arc lamp used at movie houses. Two carbon electrodes are placed together with a current going through them. As the carbon electrodes are pulled apart and separated, the spark jumps between them giving off light and heat. The spark between the electrodes bends into an arc as the gap increases between the electrodes, hence, the origin of the name arc. Elihu Thomson experimented with the arc using metal electrodes, but found he could not produce continuous waves, not even damped waves at shorter wavelengths.

Nikolai Tesla also had experimented using carbon electrodes, but his arc only produced audio frequencies. Next, Duddell experimented with the arc. He placed a capacitor and an inductor in a series circuit. The circuit was then connected in parallel with the carbon arc electrodes. When direct current was applied to drive the arc, it began to sing, denoting oscillations. He thought (incorrectly) after experimentation that it was impossible to obtain oscillations beyond the frequency of 100 kHz.

Using Duddell's circuitry, Wertheim-Salomonson proved it was possible to obtain an oscillating frequency of 100 kHz. However, it was Professor Valdimar Poulsen, who was really able to solve the problem. He made significant revisions which resulted in an improved

arc that would generate radio frequencies having high power. The arc electrodes were placed in a magnetic field. The electrode having the positive potential was constructed from copper. The other electrode was carbon and it was discovered that, when alcohol was dripped on the arc flame, it produced a purer continuous wave note than ever before.

During 1913, the Federal Electric Company on the west coast of the United States took over the development of the Poulsen Arc. They made improvements in its design. The final result was a converter driven by a direct current generator, converting that current into continuous waves. The Federal Electric Arc Converter was used mostly by large wireless stations such as NSS at Arlington, Virginia, and RCA's Tuckerton station.

The Poulsen Arc did have drawbacks. The operator could not turn the arc on and off by keying it as this action would extinguish the flame. Two methods were developed to overcome the problem. The first was detuning the antenna tank circuit to a frequency other than the working frequency. This required a telegraph key be placed across a portion of the tank coil. When the key was closed, the proper amount of inductance was placed in the antenna circuit and the arc would transmit on the working frequency (compensated wave). The other method was to use a chopper circuit. Upon being keyed, the chopper circuit would modulate the arc carrier. This resulted in intelligible signals being transmitted by the converter. The problem with using the compensated wave or the chopper was that the arc would be operating continuously. Also, the arc was prone to radiating harmonics near its fundamental frequency. It was a general type of noise called mush and could be heard during reception. The mush characteristics that were specific to a particular transmitter would allow a radio operator to tell which station was on the air.

One of the improvements that made the arc converter a popular method of transmitting was the use of blow-out magnets. To start the arc, the electrodes are pushed together, making contact with each other. This action is called striking the arc. Very slowly the electrodes are drawn apart while watching the ammeter (the ammeter is placed in series with the arc electrodes), until the desired current level is reached. Should the gap between electrodes become too large, the flame will be extinguished. To stop this action, the magnetic field from the blow-out magnets prevents the flame from bending

too far. However, the real purpose of the magnetic windings is to provide a magnetic field to blow out the flame between oscillations. This action is known as sweeping out the heated ions from between the electrodes gap, cooling it down, and making it possible for further oscillations to occur. It is related to "quenching" which is used in spark transmitters.

## The Malabar arc converter

The arc constructed at Malabar was of gigantic dimensions. The lower section, that contained the arc core, weighed 28 tons (after construction). The copper wire used to wind the blow-out magnets weighed 22,000 pounds and could withstand 60 kW of electricity before the insulation broke down. The total weight from the blow-out magnets and their logarithmic cross-sectional shape weighed 260 tons. The actual arc chamber was constructed from brass weighing a total of 11,000 pounds.

Upon completion of the arc, and when the tests were finally conducted, it was found that the station had an enormous transmitting range. On the 7,500 and 10,000-meter wavelengths, the arc could provide communications with Holland during the tropical nights. During the daytime, the 15,000-meter wavelength was used, but transmissions to Holland were not 100 percent reliable. It was eventually found that the 16,000-meter wavelength was the best to use. The required transmitting power during daylight hours was 250,000 meter-amperes.

The station's signals were heard across oceans and continents, but when radio amateurs demonstrated the successful use of shortwave frequencies, it signaled the end of low-frequency communications. At a later date, sometime in 1942, the Malabar wireless station was dismantled. Because there are no complete records, much of the information is mere hearsay gleaned from nearby rice farmers who remembered the station on Java Island.

## Next time

In Part 2, we'll return to America and take up the story of wireless development on the other side of the Atlantic. A bibliography of sources will be included at the end of Part 2. ■

### REFERENCES

1. Interview with Charles Buelow.
2. Interview with Wolfgang Schroder.

# TRANSFERRING POWER WITH THE CONTROLLED-Q L MATCH AND A 6-METER APPLICATION

## *Operating CB power transistors at 50 MHz*

---

**W**hen RF signals are transferred between two units, it's usually important to ensure that the impedance levels of the two units are "matched." Without such matching, some of the RF signal will be lost. This matching principle applies regardless of whether the individual units are antennas, transmission lines, receivers, transmitters, or individual stages within a receiver or transmitter.

Radio amateurs have become very familiar with the importance of matching their antennas to the transmission line, and various SWR meters are in widespread use. These devices first appeared in quantity during the 1950s and have been continually upgraded since then. Practically every ham shack includes at least one. An example of a recent version of such a meter is the MFJ-259 SWR Analyzer, shown in the test setup photos (**Photos A and B**) accompanying this article.

Various networks are used to create a match between two units with different impedances. For instance, the driven element of a Yagi

antenna may have an impedance of 20 ohms and be fed by a 50-ohm transmission line. Or it may be necessary to match a crystal filter impedance to an IF amplifier.<sup>1</sup> It might also be important to drive the base input of a power transistor that may be as low as 2 to 6 ohms with a driver circuit designed for 100 ohms, or to match a 50-ohm load to a transistor power amplifier in a 10-watt mobile transmitter powered by the 12-volt automobile battery. In the mobile case, the 50-ohm load must be made to appear as 7 ohms to the collector ( $P_o = V^2/2R$ ) of the output transistor.

I'll describe the use of the controlled-Q L network to perform the match between different impedances. As you'll see, this particular network has several advantages over the ordinary L network or use of an RF transformer.

First, the tuned circuit

An ordinary tuned circuit, as shown in **Figure 1**, consists of a single inductor L and



Photo A. 14-MHz L match model.

capacitor C. If you attempt to measure the impedance across this parallel combination—by connecting an impedance meter between points A and B, for example—the impedance will rise to a very high value at the resonant frequency of the circuit. You could also place a tap on inductor L, say, at mid-point C.

If you were to connect a resistive load R from the tap to point B, the impedance measured from A to B at the resonant frequency would be  $4 \times R$ . The inductor would be acting something like an RF transformer with a 2:1 turns ratio providing a 4:1 impedance ratio. By positioning the tap at any point between A and B, practically any impedance ratio may be obtained. In this example, the measured impedance will be greater than the load R. This network could be used to step down a higher resistance source to drive a lower resistance load R. Looking at it another way, the circuit can step up a load R to present a higher resistance load to another circuit.

You can also reverse the position of the load and source by connecting the load to points A and B. The impedance measured at the tap would be  $R/4$ . Consequently, the circuit can also be used to step up a low-resistance source to drive a higher-resistance load. Most amateurs are familiar with the idea of placing a low-impedance tap on the inductor of a tuned circuit. It's frequently used on the input of a receiver to step up the 50-ohm input to a high

impedance for connection to the gate of a FET amplifier or the grid of a vacuum tube.

The tap doesn't have to be on the coil. You can also split the capacitor into two parts having the same total capacitance. For example, if C is 100 pF, split it into two 200-pF capacitors in series and connect the load R to the point between the two capacitors. Now you have the same 4:1 impedance ratio as you would with a center tap on the coil. The main difference is that you now need two capacitors instead of one, while the tap on the inductor usually costs nothing. It may also be hard to visualize the split capacitor as an RF transformer, but it works that way at the resonant frequency.

Because of the inductor's presence, this split capacitor network isn't the same thing as a capacitive voltage divider you might find in a 10:1 scope probe. For one thing, the load has to be connected to the tap with a scope probe. With the tuned circuit, the load can be a higher impedance than the source. That is, the load can be connected across the tuned circuit and the source can drive the tap point for an impedance step up with no loss of power. The scope probe just can't perform this impedance step up and will experience a loss of power.

Getting back to the original tuned circuit of **Figure 1**, you could also consider it a series resonant circuit by breaking the connection between L and C at point B and measuring the impedance between the two ends at A. In this case, you'd measure a low impedance (ideally a short) at the resonant frequency.

So, the tuned circuit looks like a high impedance if you connect it in parallel and a low impedance if you connect it in series. This is the principle of the ordinary L match.

## Ordinary L match

**Figure 2** shows an ordinary L match used to solve many matching needs. It's called an L match because the shape of the two elements, as shown in the diagram, resembles the letter L laying sideways and upside down! The L of the L match has nothing to do with the symbol L used for the inductor. The lower impedance,  $R_1$ , is connected in series with the coil and the higher impedance,  $R_2$ , is connected across the parallel combination of L and C. The design equations, which can be found in many handbooks are:

$$R_2 > R_1 \quad (1)$$

$$X_L = \sqrt{R_1 R_2 - R_1^2} \quad (2)$$

$$X_C = R_1 R_2 / X_L \quad (3)$$

$$Q = \sqrt{(R_2/R_1) - 1} \quad (4)$$

Note that the "loaded" Q is fixed by the impedance ratio and is usually quite low. For example, a 4:1 ratio gives a Q of 1.7. Also, the circuit is not exactly resonant.  $X_C$  is not equal

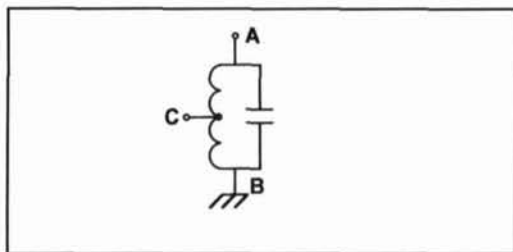

Figure 1. Ordinary tuned circuit.

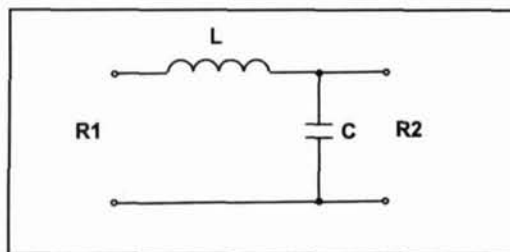

Figure 2. Ordinary L match.

to  $X_L$  at the operating frequency. However, the larger the impedance ratio, the higher the  $Q$  and the closer the circuit will be to resonating at the operating frequency. In operation you don't tune the circuit to resonance, for example with a dip meter, but instead tune for a matched condition; that is, with an SWR meter. As an alternative, you can tune  $L$  and  $C$  for maximum power transfer to the load. In theory, both  $L$  and  $C$  need to be adjusted for a perfect match.

You could also connect the low impedance in series with the capacitor instead of in series with the inductor. In this case, the values for  $X_L$  and  $X_C$  given above are reversed, but otherwise the operation of the circuit at the operating frequency is the same. (See **Reference 2** for a derivation of the equations.) In this case, the circuit acts like a high-pass filter so harmonics of the operating frequency aren't attenuated nearly as much as with the more common arrangement of **Figure 2** where the shunt capacitor and series inductor tend to suppress transfer of harmonics.

The low  $Q$  of the ordinary L match limits the amount of harmonic suppression. Low  $Q$  also

tends to make the tuning very broad. However, if one replaces the inductor  $L$  with a larger value inductor and then puts a capacitor in series to provide the same total reactance as  $X_L$  given above for the L match, there will still be a match at the operating frequency. In this case, the larger inductor will provide a larger  $Q$ . This is the basis of the controlled- $Q$  L match.

### Controlled- $Q$ L match

**Figure 3** shows the circuit diagram of the controlled- $Q$  L match. A second capacitor,  $C_2$ , has been added, and the inductor can now be made much larger than before. **Reference 3** provides information on constructing various inductors. The design equations are:

$$R_2 > R_1 \quad (5)$$

$$X_L = QR_1 \quad (6)$$

$$X_{C2} = X_L - \sqrt{R_1 R_2 - R_1^2} \quad (7)$$

$$X_{C1} = R_1 R_2 / (X_L - X_{C2}) \quad (8)$$

The  $Q$  can be selected to be any value greater than the  $Q$  of the ordinary L network.



Photo B. 14-MHz controlled- $Q$  L match model.

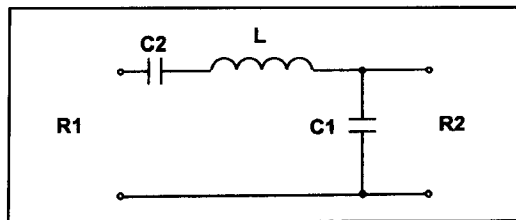

Figure 3. Controlled-Q L match

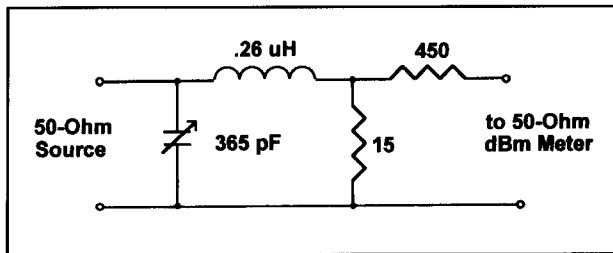

Figure 4. Circuit of 14-MHz L match and attenuating load.

For many power transfer applications, a  $Q$  of 10 is a good value to start with. Note again that the inductor along with the series combination of  $C1$  and  $C2$  are almost, but not exactly, resonant at the operating frequency.

The additional capacitor,  $C2$ , is in series with the low-impedance load, or source. This is quite fortunate because any reactance in the load can be "tuned out" by adjustment of  $C2$ . Suppose the load has some inductive reactance. This inductance will be in series with  $C2$  and will add to the controlled- $Q$  inductance. Tuning  $C2$  to a lesser value of capacitance effectively restores the total reactance of the series arm back to the desired value. Also, if the load has a capacitive reactance, this capacitance will be in series with  $C2$ . Tuning  $C2$  to a higher value, so

the effective capacitance of the two capacitances in series is the required value, again restores the matched condition. The only problem occurs if the capacitance of the load is less than  $C2$ . In this situation, no increased value of  $C2$  in series can reach the desired series value. In that case, additional inductance must be added.

What all this means is that it isn't necessary to know exactly the reactance of the low impedance load. With a controlled- $Q$  L network, reactance in the low impedance load is canceled when the network is adjusted for maximum power transfer. This is how the network is normally adjusted; i.e., with an RF voltmeter or a forward power meter at the output. There's no need to be concerned with the actual value of reactance of the low impedance load.

## Some typical calculations

Let's examine a practical example of matching a 50-ohm, 20-meter source (14 MHz) to a low-impedance load. This load could be:

1. The driven element of a beam antenna,
2. A short vertical antenna,
3. The base of a bipolar power transistor.

Assume the load is a resistance of 14.5 ohms. For a standard L network:

$$X_L = 22.7 \text{ ohms}$$

$$X_C = 31.9 \text{ ohms}$$

From the formulas for reactance:

$$L = 0.26 \mu\text{H}$$

Use 8 turns of no. 22 gauge wire on a T37-10 toroid core. Set to resonate with a 10-pF capacitor at 99 MHz.

$$C = 356 \text{ pF}$$

Use a 270-pF silver mica capacitor in parallel with a 20 to 250 pF air variable capacitor,  $Q=1.7$ , giving very broad tuning.

This case was modeled using the measurement setup shown in **Photo A**. An MFJ 259 SWR meter is used for the signal source. A Black Forest dBm Meter<sup>4</sup> is used to measure the transferred power. The MFJ 259 puts out about +2.5 dBm, so an attenuating load, as shown in **Figure 4**, is used to prevent overloading the dBm meter. Yes, a wimpy 2-mW will easily peg the dBm meter (but it's not likely to burn it, or anything else, out), giving you a feel for just how sensitive an instrument it is. This load has an effective resistance of 14.5 ohms and an attenuation of 25.35 dB. The variable capacitor is adjusted for maximum transferred power as measured on the dBm meter. Tuning is indeed very broad. From **Photo A**, we see that essentially all of the source power is transferred, and that the load presented to the source is 50 ohms of resistance.

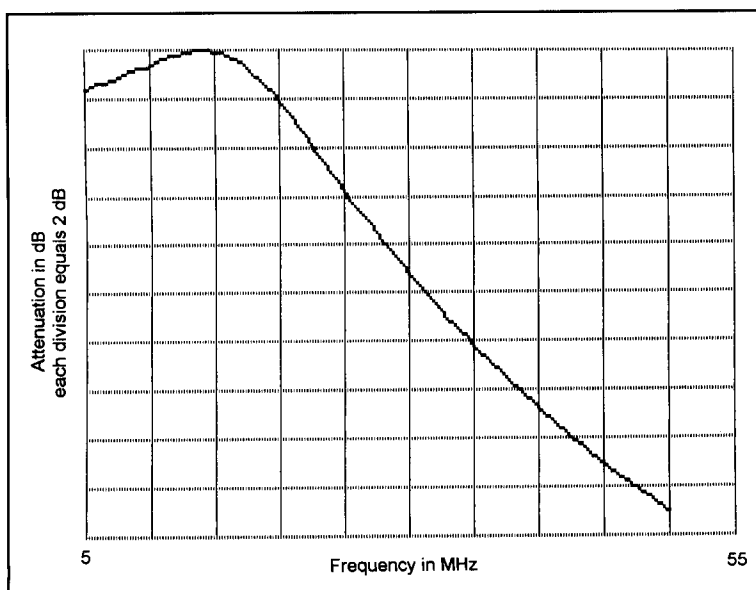

Figure 5. Frequency sweep calculation of 14-MHz L match.

A frequency sweep calculation from 5 to 50 MHz of this network is shown in **Figure 5**. Note that the second harmonic at 28 MHz would be attenuated by only 9 dB and the third harmonic by 15 dB.

Now let's examine what happens if we use a controlled-Q L network. Select  $Q = 10$ , a reasonable value suggested in many texts for use with power amplifier matching networks.

$$\begin{aligned} X_L &= 145 \text{ ohms} \\ X_{C2} &= 122.3 \text{ ohms} \\ X_{C1} &= 32 \text{ ohms} \end{aligned}$$

Then:

$$L = 1.66 \text{ } \mu\text{H}$$

Use 18 turns of no. 22 wire on a T50-6 core, set to resonate with 10 pF at 39 MHz.

$C2 = 93 \text{ pF}$ ; use a 140-pF air variable.

$C1 = 356 \text{ pF}$ ; same as for a standard L network.

This network is shown in **Photo B**.  $C1$  and  $C2$  are adjusted for maximum power transfer. Tuning is much sharper than before, especially when adjusting  $C2$ . As before, all of the power is transferred to the 14.5-ohm load and a 50-ohm resistance is presented to the generator (the MFJ 259).

A frequency sweep calculation from 5 to 50 MHz of this circuit is shown in **Figure 6**. The second harmonic of 28 MHz would be attenuated by 23 dB, and the third harmonic at 42 MHz by almost 30 dB.

## Using the controlled-Q L match at 6 meters

Driving the base input of a bipolar power transistor at 50 MHz is quite a challenge. For example, the MRF-476 used in CB radios at 27 MHz is also specified for reduced power (about 3 watts out) at 50 MHz. The base input impedance is 6.6 ohms of resistance and 0.55 ohms of series capacitive reactance. Over twice as much drive power is required at 50 MHz than at 27 MHz to produce the same 3-watt output.

Let's use a controlled-Q network to transfer power from a 50-ohm driver into the base as shown in **Figure 7**. Choose  $Q = 10$ .

$$\begin{aligned} X_L &= 66 \text{ ohms} \\ X_{C2} &= 49.1 \text{ ohms} \\ X_{C1} &= 19.5 \text{ ohms} \end{aligned}$$

Then:

$$L = 0.2 \text{ } \mu\text{H}; \text{ use 6 turns no. 22 wire on a T44-10 toroid core.}$$

$C2 = 64.8 \text{ pF}$ ; use a 39-pF silver mica in parallel with a 65 pF trimmer.

$C1 = 163 \text{ pF}$ ; use a 180-pF silver mica.

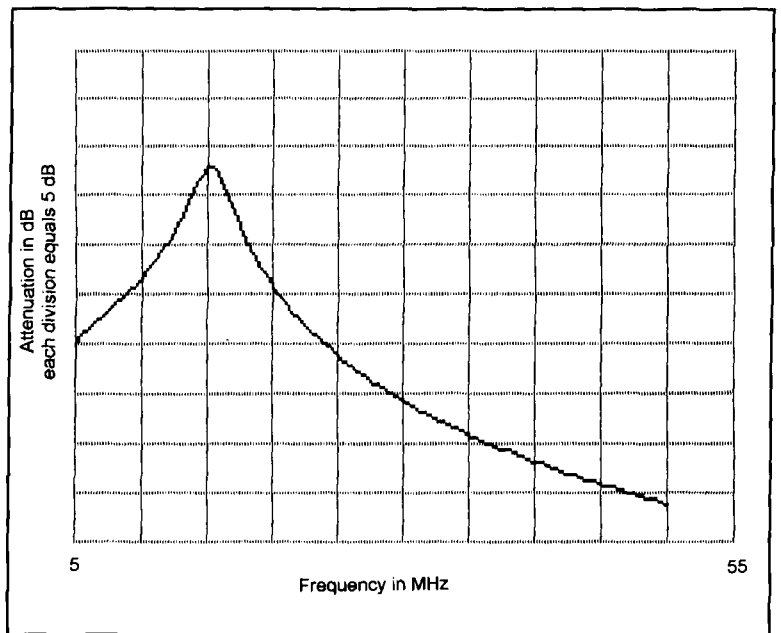

Figure 6. Frequency sweep calculation of 14-MHz controlled-Q L match.

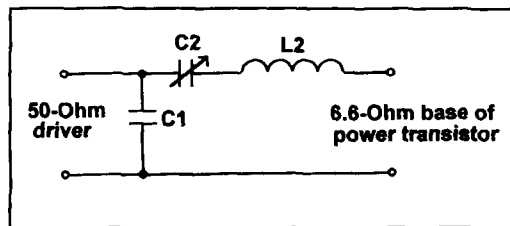

Figure 7. Circuit for matching the base of a power transistor at 50 MHz.

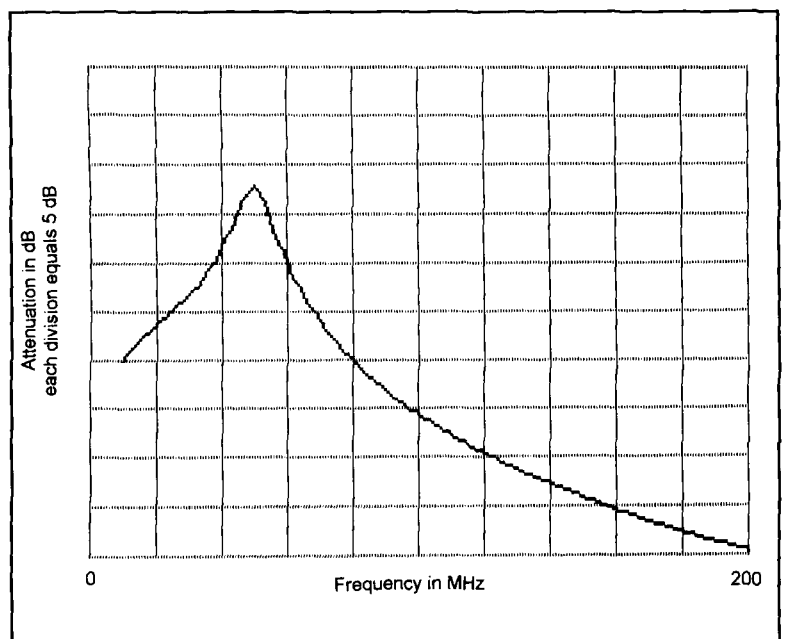

Figure 8. Attenuation of power transistor input network.

## Parts list for 6-meter amplifier

1	Aluminum enclosure 3.2 x 2.2 x 1.6-inch Hammond 1411D
1	Circuit board
T1	Power transistor MRF476, 2SC1306, 2SC1768, 2SC2075, 2SC2078, or ECG 235
L1	0.2- $\mu$ H 6 turns of no. 22 wire on T44-10 toroid
L2	10- $\mu$ H 14 turns of no. 22 wire ON FT37-61 ferrite toroid
L3	3- $\mu$ H 30 turns of no. 22 wire on T68-10 toroid
L4	0.3- $\mu$ H 8 turns of no. 22 wire on T44-10 toroid
D1	Silicon diode 1N4004
FB	Ferrite bead Fair-Rite #2743002122
2	0.01- $\mu$ F ceramic disc capacitor
1	10-pF NPO capacitor
1	39-pF ceramic disc
2	4 to 65-pF trimmer capacitors, 10-mm diameter
1	120-pF silver mica
1	180-pF silver mica
2	1-k, 1/4-watt resistor
1	47-ohm, 1/4-watt resistor
2	BNC connectors, chassis mount
1	RCA connector, chassis mount
4	4-40 x 5/8-inch machine screws, pan head
1	4-40 x 3/8-inch machine screw, pan head
13	4-40 hex nuts
4 inches	RG174/U coax
4 inches	Hook-up wire

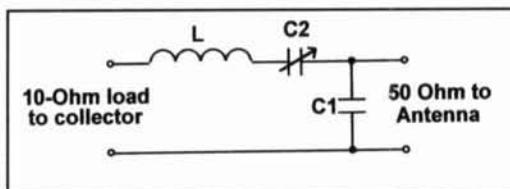

Figure 9. Output circuit matching with controlled-Q L network.

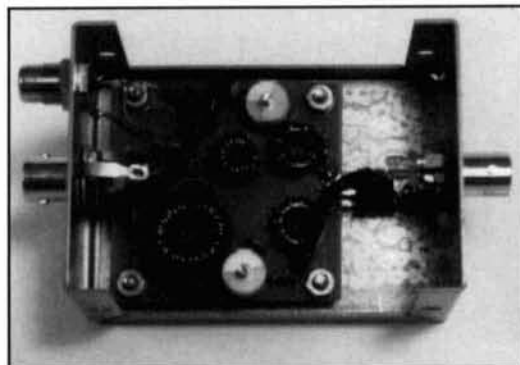

Photo C. The power amplifier.

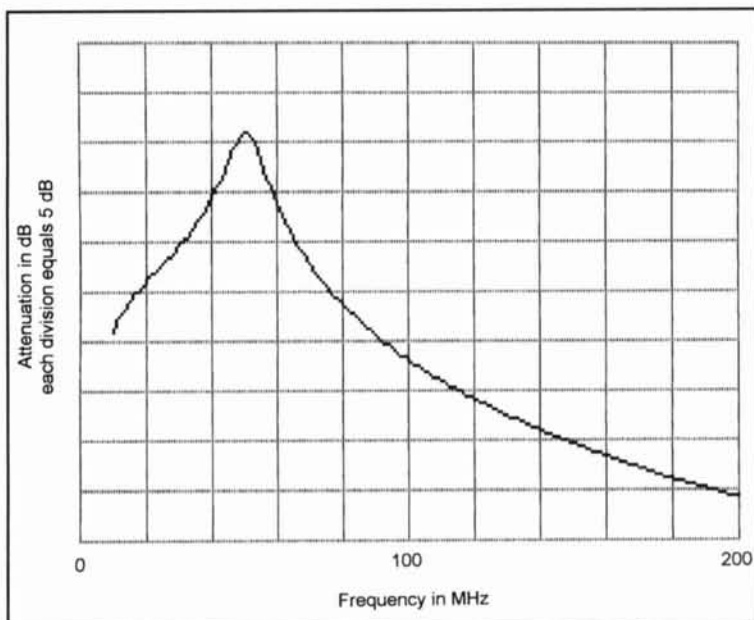

Figure 10. Attenuation of power transistor output network.

Note that the series combination of C1, C2, and L resonates at 52.26 MHz, forming a resonant circuit near the operating frequency. The transistor base forms the low impedance load (in series with the resonant circuit). The capacitance of the transistor base is compensated for by tuning C2 to a slightly higher capacitance. The actual tuning of C2, however, will be for maximum output of the transistor amplifier. As a result, the amateur will automatically account for the transistor base capacitance when tuning C2. With a Q of 10, tuning is reasonably sharp with no doubt about the correct point to set C2. A fixed value for C1 will normally be satisfactory. C1 would only need to be changed if the 50-ohm input SWR is not reasonably close to 1:1. As seen in **Figure 8**, this network will pro-



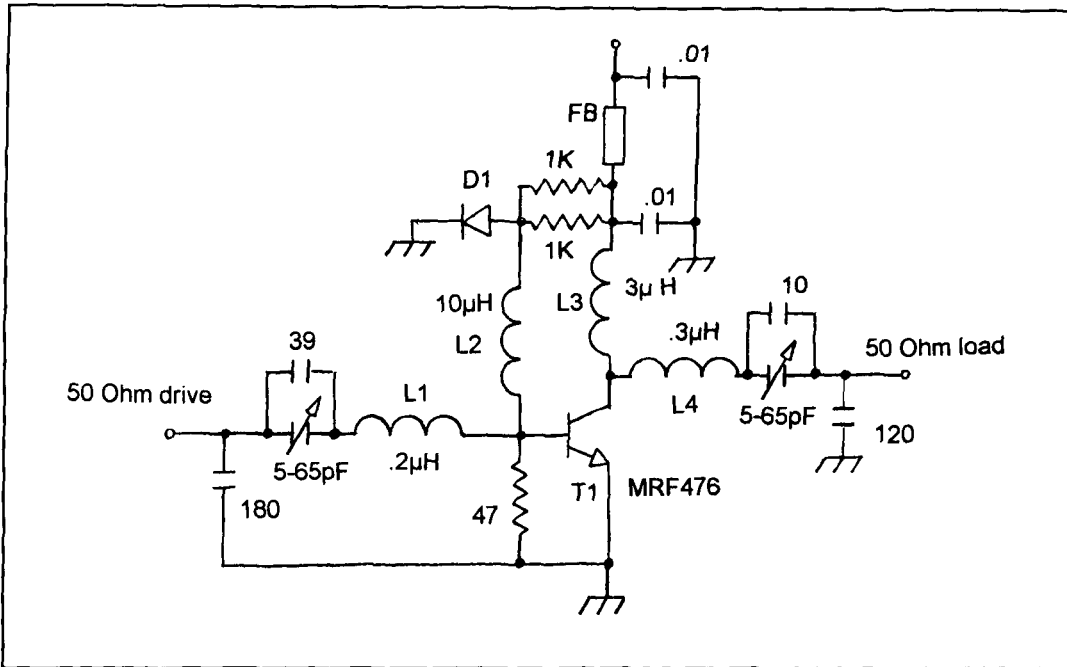

Figure 11. Circuit diagram of 6-meter power amplifier.

vide attenuation of any harmonics present in the driving source.

### Power amplifier output

To deliver more than 1 watt output with a supply voltage of 12.5 volts, the power transistor will need to be loaded with a resistance below 50 ohms. A controlled-Q L match can be used here to transform a 50-ohm load (a 50-ohm transmission line) down to, say, 10 ohms as shown in Figure 9. For this case:

$$\begin{aligned} X_L &= 100 \text{ ohms} \\ X_{C2} &= 80 \text{ ohms} \\ X_{C1} &= 25 \text{ ohms} \end{aligned}$$

Then:

$$\begin{aligned} L &= 0.318 \mu\text{H}; \text{ use 8 turns of no. 22 on a T44-10 toroid core.} \\ C2 &= 39.8 \text{ pF}; \text{ use a 65-pF trimmer with 10 pF in parallel.} \\ C1 &= 127.3 \text{ pF}; \text{ use a 120-pF silver mica.} \end{aligned}$$

Again note that C1, C2, and L in series resonate at 51.25 MHz. Figure 10 shows the attenuation sweep of this output network. The second harmonic is attenuated 23 dB and the third 31 dB.

### Power amplifier circuit

A circuit diagram for a complete 6-meter amplifier is shown in Figure 11. In addition to the MRF-476, various Japanese power transis-

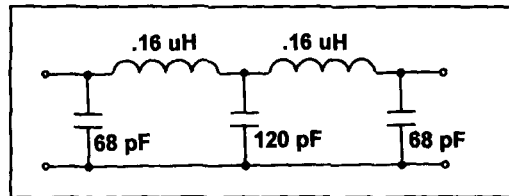

Figure 12. Printed circuit artwork for 6-meter power amplifier.

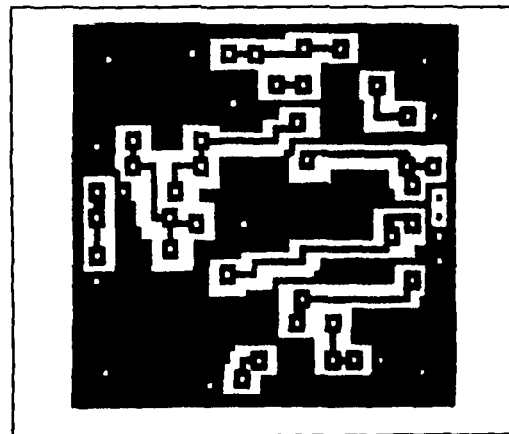

Figure 13. Component layout.

tors made for CB transmitters can be used. The 2SC1306, 2SC1678, 2SC2075, and 2SC2078, all provide more than 2 watts output at 50 MHz. There are many other types which will likely work, but I haven't tried them.

In addition to the controlled-Q L match networks, an RF choke supplies collector current

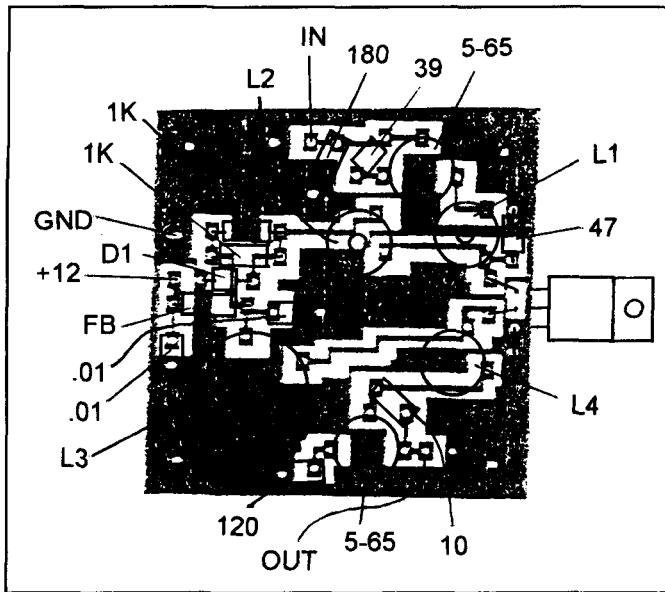

Figure 14. Mounting a TO-220 power transistor to the enclosure.

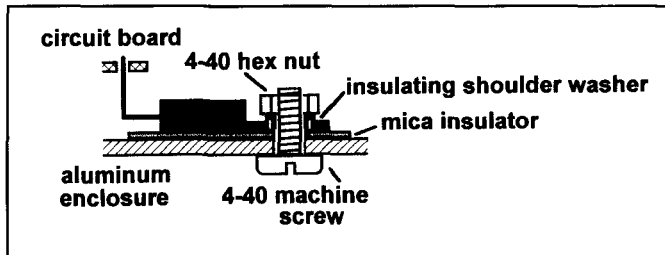

Figure 15. Half-wave filter for additional harmonic suppression.

and a diode network provides base bias. Neither of these are particularly critical. A type 10 powdered iron core is used for the RF choke to ensure a high impedance at 50 MHz. Almost any silicon rectifier diode can be used in the base bias network. About 15 to 50 mA of collector resting current is satisfactory. Under full drive, the collector current will be less than 1 amp. Power gain is more than 10 dB, so less than 0.2 watt in will give 2 watts out.

### Additional harmonic suppression

Actual measurements show that this amplifier puts out a second harmonic signal, 100 MHz, at least 33 dB below the carrier. The third har-

monic is at least 36 dB down. These figures are limited by the ability of my measuring equipment to reject the strong carrier and are probably much better. In any event, if you plan to use this signal to drive an antenna without an antenna tuner, additional harmonic filtering is recommended. A simple 50-ohm half-wave filter, as shown in Figure 12, will provide an additional 25 dB of attenuation at 100 MHz and an additional 46 dB at 150 MHz. The filter should be placed between the output controlled-Q L network and the antenna.

### Building the amplifier

Circuit board artwork and a component layout are shown in Figures 13 and 14. The power transistor should be mounted on an aluminum enclosure. This enclosure acts as a heat sink, as shown in Figure 15 and Photo C. The leads are bent upward at 90 degrees to enter the back side of the circuit board. Short jumper wires on the top of the board connect the transistor leads to the etched pattern on the bottom side. Circuit boards and a complete kit of parts are available.\*

### Adjustment

After building the amplifier, apply 12 volts and measure the resting current; it should be less than 100 mA. Apply drive power and measure the output. Adjust the input trimmer capacitor for maximum output first, then the output trimmer. That's it! Close the cover and your 6-meter "brick" amplifier is complete.

Why not try the controlled-Q L network and put out a nice signal (CW, SSB, AM, or FM) on 6 meters? ■

#### REFERENCES

1. J. Pivnichny, N2DCH, *Ladder Crystal Filters*, MFJ Publishing, Inc. 1999.
2. T. Cetalo, WA1SPI, "The Hairpin Match," *Communications Quarterly*, Summer 1994, pages 49-53.
3. G. Silva, I2EO, *Radio Components Handbook*, MFJ Publishing, Inc. 1997.
4. J. Pivnichny, N2DCH, "dBm Meter," *Electronics Now*, November 1995, pages 112-113, 158-159.

#### FOOTNOTE

\*Circuit boards for \$4 and a complete kit including drilled enclosure, BNC connectors, etched and drilled circuit board, power transistor, and all components and hardware for \$19.95 are available from Unicorn Electronics, 1 Valley Plaza, Johnson City, NY 13790; Phone: (800) 221-9454; Internet: <www.unicornetex.com>.

## PRODUCT INFORMATION

### Analog Dialogue Available Monthly on the Web

*Analog Dialog*, the technical magazine of Analog Devices, Inc., is now being published on the Analog Devices website at <<http://www.analog.com/analogdialogue>>. The magazine

includes technical articles, new-products briefs, updates on products and publications, and editorial notes. Readers can also gain ready access to archives with four years of converted print editions. Topics include products, applications, technology, and techniques for analog, digital, and mixed-signal processing.

Because we were unable to obtain reproduction permission from the author, the following article does not appear in the *ARRL Communications Quarterly Collection*...

## **The HBR Fifteen**

By M.A. Chapman, KI6BP

3625-7 Vista Oceana  
Oceanside, CA 92057

Summary: A high-performance CW receiver project for 15 meters. The dual-conversion design includes active, balanced mixers, a high-stability VFO with RIT and a 5-pole IF filter based on computer-grade crystals.

**Spring 1999 issue, pages 89-96.**

Please contact the author for additional information.

# ATMOSPHERIC OZONE

*A meteorological factor in low-frequency  
and 160-meter propagation*

**L**ow-band DXing takes place in the hours of darkness, and, by many accounts, the best times seem to be around dawn. The miracle of low-band DXing is the level of its success, given the heavy losses of 1.8-MHz signals from absorption in the lower parts of the ionosphere. But because the ionization in the upper *D*-region as well as the *E*-region at night still takes a toll, it has been suggested that conventional earth-ionosphere hops aren't the only propagation mode that carry signals to great distances; rather, there may be a form of

signal ducting in the electron density valley above the *E*-region at night. However, with sunrise, the lower *D*-region comes into play again and DX propagation comes to an end.

There are other aspects of low-band propagation that must be resolved: the "searchlight effect" and the variability of strengths of DX signals reaching one location as compared to another. It has been suggested<sup>1</sup> that variations in neutral density from atmospheric gravity waves (AGW) reaching the *E*-region could affect ducting, and thus contribute to those

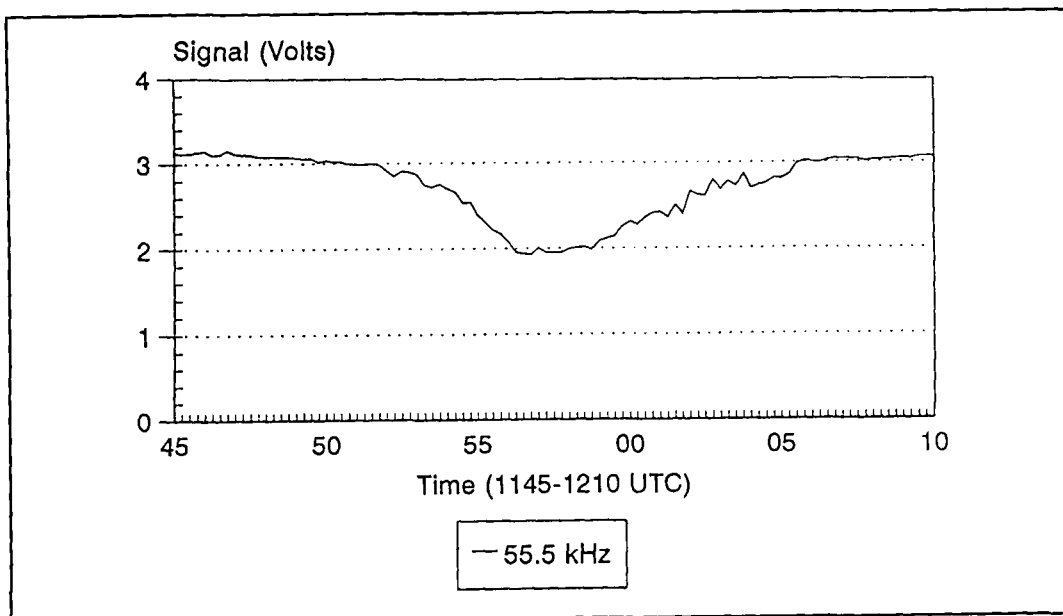

Figure 1. Sunrise profile of NPG signal strength, June 15, 1998.

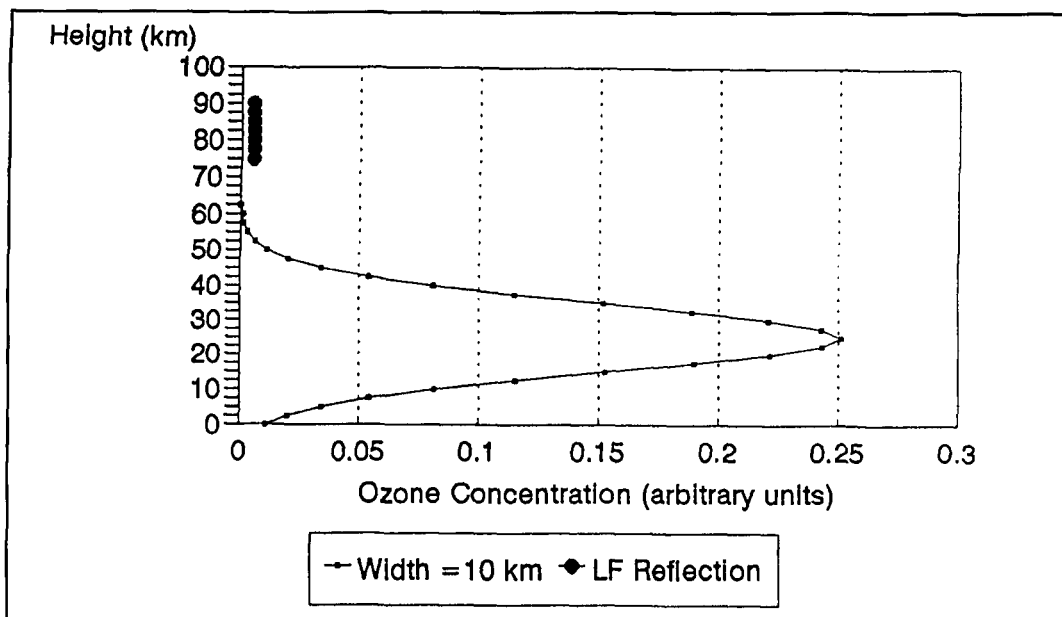

Figure 2. Atmospheric ozone distribution relative to the LF reflection region. The altitude distribution of ozone, using a bell-shaped curve with the peak height at 25 km and a standard deviation of 10 km.

aspects of low-band propagation. Also, ducting could be affected by ionospheric tilting in the *F*-region from solar heating at sunrise. The purpose of this note is to show that another atmospheric effect, from the ozone layer, can affect ionization in the *D*-region and thus signal strengths on the 160-meter band in the time around dawn. The effect was found by studying low-frequency propagation at sunrise.

## Sunrise

Illumination of the atmosphere overhead is normally discussed using the shadow of the solid earth. Thus, sunrise is preceded by three types of twilight: first astronomical, then nautical, and last civil twilight—when the sun is 18, 12, and 6 degrees below the horizon, respectively. For ionospheric purposes, one can convert those circumstances into regions that are either illuminated or are in the earth's shadow. Of course, there will be a certain amount of scattered sunlight, and that will contribute to the situation; but, generally speaking, solar illumination of the lower ionosphere proceeds downward at sunrise, with the 100-km level illuminated when the sun is about 10 degrees below the horizon, and the 60-km level when it is 8 degrees below the horizon. The time required for that transition across the *D*-region at mid-latitudes depends a bit on the season, but it is roughly 15 minutes.

The above discussion involves visible radiation, in the range of 400 to 700 nm. VLF studies show that signals are reflected at about the 90-km level at night, and that shifts to 75 km or

so when the sun rises. In that connection, the International Reference Ionosphere (IRI)<sup>2</sup> shows that an electron density gradient is responsible for the reflecting layer at night, and ion-chemistry indicates that the region below the reflecting layer is progressively populated by more and more negative ions, at the expense of electrons. As a result, whatever absorption takes place in the nighttime hours is due to the electron density above 90 km, where the electron-neutral collision frequency is relatively low.

With sunrise, the gradient changes as the negative ions are replaced by electrons, from photo-detachment of the negative ions and direct photo-ionization. The change results in an increase in ionospheric absorption of signals on 160 meters because of the greater electron-neutral collision frequency at the lower altitudes. It is that change which is discussed here, with the absorption of UV photons by atmospheric ozone delaying the transition from night to day in the lower ionosphere.

## LF signal propagation

The present study originated as one aimed at examining the influences on LF propagation and any possible relation to DXing on the 160-meter band. The method uses 55.5-kHz signals on a path from the U.S. Navy Station NPG at Dixon, California (38.4N, 121.9 W), to Guemes Island, Washington (48.5N, 122.6W). That path is 1,125 kilometers in length and within a few degrees of being in the N-S direction. NPG signal strength is recorded each day for a two-hour period surrounding sunrise.

The sunrise signature is always a dip and recovery in signal level that lasts 10 to 15 minutes. The variation in signal strength results from the interference between the ground wave and a one-hop skywave as the reflection region moves downward at sunrise. The midpoint of the path is near Cottage Grove, Oregon (43.45N, 122.25W), and that location is used as a reference point in the remarks which follow. The signal strength depends on the amplitudes of the skywave and ground wave and their initial phase difference, while the time variations result from the lowering of the reflection region of the skywave with sunrise. A typical sunrise signature, for June 15, 1998, is shown in **Figure 1**.

Early in the investigation it was found that strong magnetic storms have a profound influence on the sunrise signature, wiping it out and making the record appear as though the reflecting region did not change in altitude. The simplest interpretation was that magnetic activity gave rise to ionizing radiation in the region around the path midpoint, which then lowered the reflection region before sunrise ever occurred. That proved to be correct as the electron detectors on the NOAA-12 satellite showed electrons with energies greater than 300 keV incident over the reflecting region prior to sunrise. The first event of that type was in connection with the magnetic storm ( $A_p = 102$ ) in the first week in May 1998.

Since then, additional examples have been noted with strong magnetic storms and, in each case, the NOAA satellite confirmed the presence of energetic electrons in the reflection region. As shown in the analysis<sup>1</sup> of the May event, the energetic electrons coming down from above the *D*-region also go through the *E*-region, where 160-meter signals are propagated. In fact, the NOAA satellite showed the presence of electrons with lower energies, 100 keV and above, that would deposit their energy in the region of interest. Thus, the LF study served its purpose, showing one disturbance effect on 160-meter propagation. But the LF records also show another feature which bears on 160-meter propagation and, instead of involving the magnetosphere, it is of sub-ionospheric origin—from atmospheric ozone. Further, it is one that is present even during times of magnetic quiet.

## Ozone shadow

As indicated above, ground level sunrise and the various forms of twilight are discussed using the shadow cast by the solid earth on the upper atmosphere. In that regard, one can use the Interactive Computer Ephemeris (ICE)<sup>3</sup> to calculate solar zenith angles and the time when solar illumination reaches a given height in the

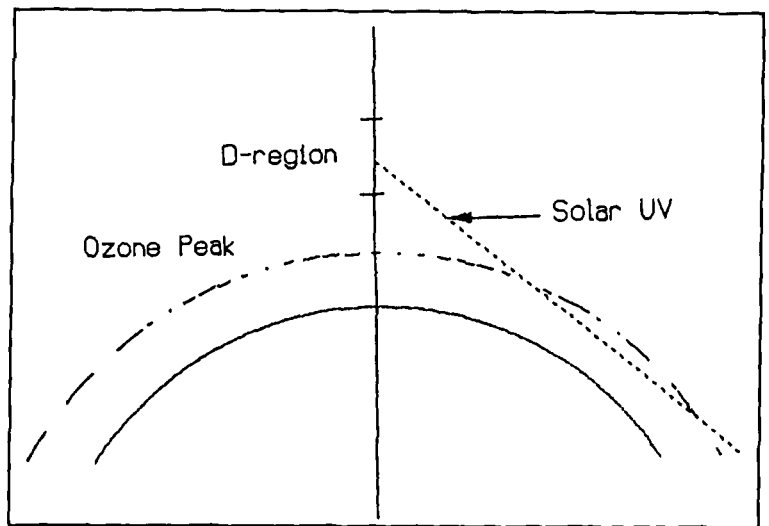

**Figure 3.** Illustration (not to scale) showing solar UV blocked from the *D*-region by the ozone layer.

ionosphere; all that is needed are the date, time, and the coordinates of the observing site as well as some simple trigonometry. For the sunrise signature of NPG signals, the downward motion of illumination at the midpoint on the path is of interest as it bears on the lowering of the electron density gradient in the LF reflection region from the photo-detachment of electrons from negative ions as well as direct ionization by energetic solar photons.

Early in the LF investigation, it became apparent that the sunrise signature was taking place later than would be expected if illumination of the *D*-region were controlled by the shadow of the solid earth. In fact, instead of having the *D*-region illuminated when the solar depression went from -10 degrees to -8 degrees, the sunrise signature indicated that the reflection was lowered when the angle went from about -6 to -4 degrees, significantly later than would be expected. This brought up the question of the shadow cast by the ozone layer.

The ozone layer is known to be fairly transparent in the visible region of the spectrum, 400 to 700 nm. Thus, its absorption spectrum peaks in the visible region at about 600 nm and has a small absorption coefficient, 0.06/cm/atm.<sup>4</sup> In the ultraviolet region, however, ozone is responsible for the depletion of solar radiation in the part of the spectrum between 200 and 300 nm. In that range, ozone has an absorption spectrum that peaks at 260 nm and has a much larger absorption coefficient, 140/cm/atm. Since the sunrise signature was delayed relative to what would be expected from the effects of visible radiation getting past the earth's shadow, the shadow of the ozone layer was then considered.

There is some precedent for this, as Reid<sup>5</sup> considered the shadow of the ozonosphere in

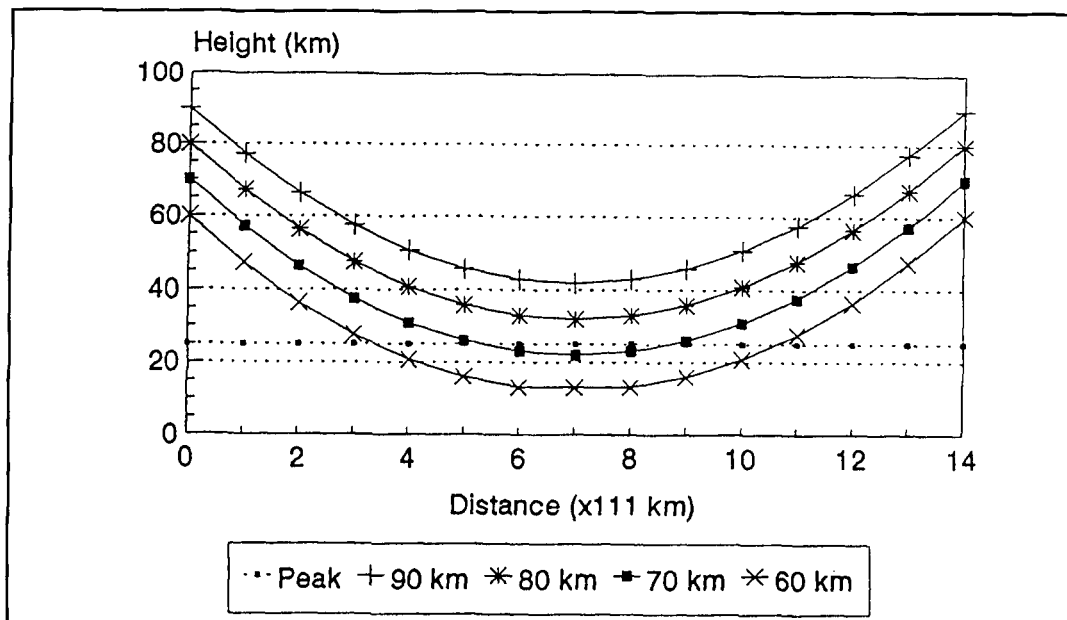

Figure 4. Solar ray paths at 7 degrees solar depression when transformed to plane geometry (paths relative to peak of ozone layer).

connection with the day/night ratio of ionospheric absorption of 30-MHz galactic noise during a polar cap absorption (PCA) event. In that circumstance, solar protons create more ionization deep in the *D*-region and ionospheric absorption from free electrons is reduced by negative ions being formed at night from collisional attachment of electrons to oxygen molecules.

With free electrons removed in that manner, PCA events show a reduction in the level of ionospheric absorption as the sun sets, and then a return back to a high level of absorption with sunrise. It was of interest to see if the recovery in absorption at sunrise could be attributed to the negative ions of molecular oxygen, with a small electron affinity (EA=0.15 eV) that could be easily overcome by visible radiation, or other negative ions whose photo-detachment required more energetic photons.

Reid's<sup>6</sup> analysis did not support the idea that negative ions of molecular oxygen were the principal participants in the nighttime *D*-region, as the recovery in absorption seemed more controlled by the shadow of the ozonosphere than the solid earth. But while it appeared that the photo-detachment processes responsible for the recovery in absorption involved negative ions with a greater electron affinity than that of molecular oxygen, no determination was made as to their identity.

## Ozone layer

Ozone is formed from the photo-dissociation of diatomic oxygen molecules above 25 km and

is then carried downward by atmospheric mixing processes. Various experimental techniques<sup>6</sup> show that the peak concentration of the ozone layer is found between 20 and 30 km at middle latitudes and that its content has a maximum in the spring and a minimum in the fall. But, on a day-to-day basis, the total ozone content in a column of the atmosphere is quite variable.

The vertical distributions of ozone discussed in the current literature are quite varied, ranging from those having well-defined peaks and, on occasion, to broad, flat maxima. For the present discussion, a bell-shaped curve<sup>7</sup> like the Gaussian Distribution was used:

$$N(H) = N_0 * (1/W * \text{SQRT}(2 * \text{PI})) * \text{EXP}(- (H - H_0)^2 / (2 * W^2))$$

In that expression,  $H_0$  is the height of the peak,  $W$  is the width of the distribution, and  $H$  is the altitude, providing a good representation of typical data and lending itself nicely to the calculations needed to explore the subject. Further,  $N_0$  is the total ozone content in a vertical column of 1 square-centimeter cross-section; that can also be expressed in terms of the thickness that the layer would occupy if the pressure and density were reduced to standard values (NTP) throughout the layer. The measurements are in Dobson Units (D.U.), 1E-3 atm-cm, and 300 D.U. corresponds to an ozone layer of 3 mm thickness. In that regard, the annual variation of the ozone content at mid-latitudes ranges from about 365 D.U. in the spring to 285 D.U. in the fall, with an average of about 325 D.U.

For the problem at hand, a Gaussian function was used to represent the distribution of ozone

molecules, peaking at 25 km altitude and with a standard or mean-square deviation of 10 km from the location of the peak value. About two-thirds of the ozone content was taken to be within  $\pm 10$  km of the peak altitude, as shown in **Figure 2**. And, to examine the advance of the shadow of an ozone layer on the LF reflecting region with sunrise, the total ozone content along the lines of sight were obtained for solar depression angles ranging from -11 degrees to -0 degrees (ground sunrise).

The geometry for a straight-line solar ray path going through a spherical ozone layer is shown in **Figure 3**. That figure, while exaggerated, shows how the ray path goes through different regions or densities in the ozone distribution. The same situation, now transformed to a plane geometry and the ray paths for various altitudes transformed to corresponding curved paths, is shown in **Figure 4**. The figure provides a clearer idea of how the UV light paths reaching the midpoint of the LF path, at altitudes from 90 to 60 km, would pass through the ozone layer at an angle of, say, 7 degrees below the horizon.

With the aid of the geometry in **Figure 3**, calculations were made to determine the total ozone content along oblique lines of sight to the altitudes of the LF reflecting region. Lines of sight passing across high altitudes encountered little ozone but below that, closer to the height of the ozone peak, the total ozone content for an oblique line of sight was much larger, many times the total ozone content (325 D.U.) in a vertical column of the atmosphere.

Because the ozone content in the vertical atmosphere is sufficient to block solar UV from reaching ground level, an oblique ozone column was considered to be opaque to solar UV when its content was 100 percent of that for a vertical atmosphere, and thus the height involved lay within the shadow of the ozone layer. However, considering that ozone is distributed continuously in altitude and does not have a sharp boundary, there is also the possibility of weak illumination and a height of interest was considered to lie within a penumbral region when the total ozone content on an oblique line of sight was between 100 and 10 percent of that for the vertical atmosphere.

As noted above, calculations were carried out using the altitude range from 90 to 60 km at the midpoint of the LF path and various depression angles. Different ozone distributions were also used in the calculations, with peaks from 20 to 30 kilometers and standard deviations about the peak altitude from 5 to 15 km. Those resulted in angular ranges of illumination of the LF reflection region, roughly 90 to 75 km altitude, and are shown in **Figure 5** for the case of an ozone peak at 25 km and width of 10 km. In

that figure, the depression goes from -11 degrees on the left to -2 degrees on the right, corresponding to the advance of time toward ground sunrise.

For any height at the midpoint of the LF path, that figure shows the transition from being in the earth shadow, then the ozone shadow, next the penumbral interval, followed then by full sunlight. Comparison of angles for illumination in that figure with the LF observations showed that the most reasonable fit of the sunrise signature data was a peak altitude of 25 km and a standard deviation of 10 km, as shown earlier in **Figure 2**.

By its presence, the ozone layer effectively delays the start of photo-detachment at the 90-km level in the reflection region by the amount of time it takes the solar depression angle to go from about -9 to -6 degrees. Of course, for a given ozone content, that varies somewhat with season, but amounts to a delay in the sunrise signature of around 15 minutes. Given the earlier remarks about the latitude variation and, in addition, observations of longitudinal and day-to-day variability of total ozone content, it is not surprising that the sunrise signature of the LF signals in the present study showed considerable variations in amplitude, with signal loss from -0.4 dB to -3.6 dB and an average of 1.6 dB.

The effect is clear: a sunrise signature on LF is delayed relative to what one would expect with the earth's shadow moving across the lower *D*-region. Moreover, examination of **Figure 4** shows that the variations are not to be attributed to the variability of the ozone distribution in the immediate vicinity of the midpoint of the path but, instead, at some distance, hundreds of kilometers to the east where the major part of the light path goes through the ozone layer.

## Discussion

Up to this point the discussion has been in regard to the sunrise signature of an LF path, showing how UV radiation reaches the gradient portion of the *D*-region where LF signals are returned to earth. For amateur radio purposes, say on 160 meters where ionization in the *D*-region is very important, the discussion now should shift from electron density gradients to just electron densities in the region as the latter are responsible for the heavy ionospheric absorption that goes with sunrise. But, in that case, the matter deals with how the sun rises *along* the slant path for RF coming down from the *E*-region, not vertically over a single site as was the case with the LF problem.

For the LF problem, the solar illumination can come from different directions, depending



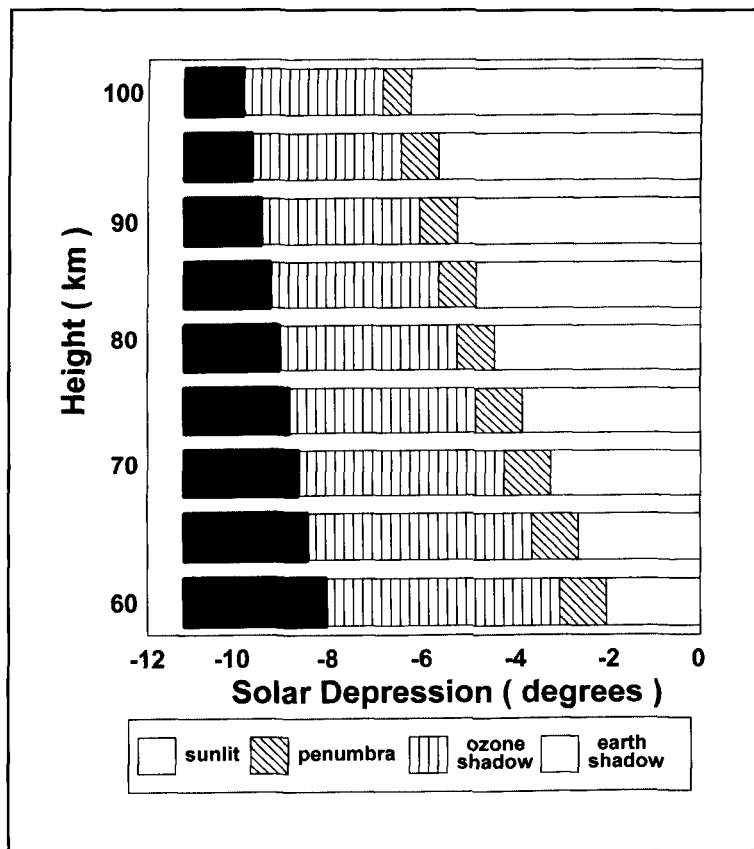

Figure 5. Illumination conditions in the D-region for various solar depression angles, using the ozone distribution in Figure 1.

on the season, and ranges from the northeast in the summer to the southeast in the winter. The simplest case is at the equinoxes where sunlight comes from the East. With changes in illumination along a vertical column at issue, the direction of solar illumination is immaterial. But that is not the case with the propagation of 160-meter signals in amateur radio communications as path directions can vary widely with respect to the terminator and the direction of solar illumination.

The simplest cases to consider are actually the extremes, when DX paths here in the mid-latitudes are nearly parallel to the terminator or perpendicular to it. That would be the case for signals from Germany or Japan reaching the Northwest United States at 1600 UTC on the winter solstice. Assuming a radiation angle of 15 degrees, the PropLab Pro program<sup>8</sup> shows that down-going signal paths at the end of the last F-hop would cross the 100-km level at about the 350-km ground range and the 60-km level at 200 km.

The first question is one about angles, those for solar radiation reaching the 100-km level and then the 60-km level, and over whatever obstacle lies in the path, atmospheric ozone or the solid earth. The same question can be put in propagation terms: When does solar radiation

reach the region of interest and how long does it take for the sun's rays to sweep down along a particular RF path, where photo-detachment of negative ions raises electron densities and increases absorption to higher values?

These are all matters of geometry and are readily solved using appropriate aids like the Spheric program,<sup>9</sup> which deals with all the details of great-circle paths, and the Interactive Computer Ephemeris (ICE) that serves as a Nautical Almanac. To examine those two extreme paths, parallel and perpendicular to the morning terminator, the Spheric program was used to find the coordinates for down-range locations on the two paths which are 350 km and 200 km from my QTH here in the Northwest.

The next step was to find solar depression angles that go with the start of solar illumination at the 90-km and 60-km levels, a spread to cover the D-region. That done, the ICE program was used to find, by iteration, the times when those solar depression angles were reached, first with the solid earth to be surmounted and then an ozone layer, with its effective height (40 km) chosen to correspond to a layer containing the bulk (87 percent) of a normal ozone layer.

Since the two paths differ considerably in direction, one running almost parallel to the terminator while the other is at 90 degrees to that direction, first illumination at the 100-km level will occur on the path from Germany, close to the terminator, and will be later on the path from Japan as the 100-km level is 350 km beyond from the terminator. The time difference amounts to about 24 minutes for both shadows, but the delay due to the ozone shadow is 17 minutes. Beyond that, the times required to illuminate the full region, 90 km down to 60 km, differ; the path that is perpendicular to the terminator requires about half the time as the parallel path—some 13 minutes as compared to 24 minutes for the ozone shadow—as its 60-km level is 150 km closer to the terminator than the 100-km level. So, to conclude the matter, other path orientations would have delays and durations within those ranges because of the ozone shadow.

## Conclusion

In considering the results given above for LF propagation, it should be noted that they stemmed from the decision to monitor NPG's signals—although it was made by accident and its value was not fully appreciated until data collection was well advanced. But there can be little doubt that atmospheric ozone plays a role in LF propagation because of its connection to processes in the lower D-region and the fact

that ozone can block UV radiation from reaching that altitude range at sunrise. And, unlike the sporadic magnetospheric effects discussed earlier, the LF study shows the ozone shadow has an effect, to some degree or other, every day of the week, month, or year, and requires no special solar or magnetic activity.

That makes atmospheric ozone a major variable in propagation in the LF range. However, its importance at a location on a given day or a given path depends on the ozone concentration, vertically and horizontally, hundreds of kilometers away. And, beyond distances, one has to think of the fact that the bottom of the ozone layer is stirred up by the polar jetstream as it wanders around in the course of a year. So ozone is surely important to propagation, but it would seem to be a factor which is poorly known at any one time.

As for amateur radio, ozone plays a role in 160-meter propagation, since by its presence it delays the onset of *D*-region absorption at dawn, making DX signals continue closer to

the time of sunrise. But the temporal and geographical variability of total ozone content means that some locations will enjoy more of a delay while others may experience less or, put another way, some locations will experience better DX conditions at a given time of day than others. I think everyone can agree that that has a familiar ring to it but there must be other types of processes involved, like those which affect signal ducting. ■

#### REFERENCES

1. R.R. Brown, "Unusual Low-Frequency Signal Propagation at Sunrise," *Communications Quarterly*, Fall 1998, page 67.
2. International Reference Ionosphere (IRI 90), D. Bilitiza, National Space Science Data Center, Greenbelt, Maryland, 1990.
3. ICE, Interactive Computer Ephemeris, U.S. Naval Observatory, 1988.
4. R.C. Whitten, and I.G. Poppoff, *Fundamentals of Aeronomy*, J. Wiley and Sons, 1971.
5. G.C. Reid, "A study of enhanced ionization produced by solar protons during a polar cap absorption event," *Journal of Geophysical Research*, Vol. 66, 1961, p.4071.
6. R.A. Craig, *The Upper Atmosphere*, Academic Press, 1965.
7. A. Brekke, *Physics of the Upper Polar Atmosphere*, Wiley and Sons, 1997.
8. C. Oler, "PropLab Pro, High Frequency Ionospheric Signal Analyst," *Solar Terrestrial Dispatch*, Stirling, Alberta, Canada, 1994.
9. *Spheric*, 1993. A shareware program by J.A. Wrotniak that is useful with spherical geometry calculations for navigation and astronomy.

## PRODUCT INFORMATION

### Cyber-Tour of Svetlana Vacuum Tube Manufacturing

Svetlana Electron Devices, Inc., offers a cyber-tour of their tube manufacturing facility in St. Petersburg, Russia. Simply go to the "Tube Zone" at <[www.svetlana.com](http://www.svetlana.com)> and click on "What's New" to view a series of photographs taken at the Svetlana plant in St. Petersburg.



### New Triodes for Svetlana

Svetlana Electron Devices, Inc., has introduced two new triodes to its line of plug-compatible power tubes: the 3CX800A7 and 8874/3CX400A7. The Svetlana SCX800A7 will be available this summer and the Svetlana 8874/3CX400A7 is now available from distributors worldwide.

For more information contact Svetlana at 8200 South Memorial Parkway, Huntsville,

Alabama 35802 (256-882-1344) or 3000 Alpine Road, Portola Valley, California 94028 (650-233-0429). E-mail can be addressed to <[info@svetlana.com](mailto:info@svetlana.com)> and <[www.svetlana.com](http://www.svetlana.com)>.



### Analog Devices and TechOnline Introduce DSP Learning Center on World Wide Web

Analog Devices, Inc., in conjunction with TechOnLine, Inc., offers an Internet-based training course for the ADI Visual DSP® development environment. "Getting Started with VisualDSP" <<http://www.analog.com/dsp>> is the first of several self-paced courses ADI plans to present. The course is available through TechOnLine University (<<http://www.techonline.com>>) which offers a curriculum of technical training courses for engineers.

Edited by Peter J. Bertini, K1ZJH  
Senior Technical Editor

*I am not one to pass up a "bargain," especially if the bargain happens to be in some form of exotic text equipment for my workbench! I've noticed that otherwise desirable surplus equipment, including spectrum analyzers and signal generators, that were "optioned" for 75-ohm impedance systems rather than the 50-ohm standard most amateurs prefer to work with, seem to have particular difficulty finding new homes. They often sell for considerably less than those with 50-ohm pedigrees. So it was with my latest acquisition, a Boonton 42B RF microwatt meter that came with a 75-ohm power sensor. WA4VZQ had faced similar situations and solved the problem using resistive matching techniques. Barry's introduction to minimum-loss attenuators and using attenuators for impedance is our lead presentation in this edition of "Tech Notes"!—K1ZJH*

## Resistive Impedance Matching and Minimum Loss Attenuators

*Using attenuators for impedance matching*

Barry L. Ornitz, WA4VZQ

Most amateur radio operators are familiar with attenuators for reducing signal levels. What is generally less known is that attenuators can be used for impedance matching. This issue came up recently when *Communications Quarterly's* own Peter Bertini acquired a new power meter with a 75-ohm input impedance, but needed to use the unit in 50-ohm systems. I had a similar application where I needed to convert the 600-ohm output impedance of a Hewlett-Packard 650A signal generator to 50 ohms. In both Peter's and my application, the impedance matching would have to cover many decades of frequency. Conventional impedance-matching networks with reactive components were eliminated as they operate over a very limited bandwidth. Broadband transformers were also quickly ruled out because of their bandwidth limitation of approximately one to one and one half decades.

### Using simple resistive attenuators

However, simple resistive attenuators may be used in these situations, providing a proper

impedance match to both terminal impedances. But this comes with a price. To provide the impedance matching, the attenuator must provide loss. In cases like Pete's, attenuation was already necessary to lower the sensitivity of his instrument. In my case, the amplitude of the signal generator also required attenuation. Both applications are suitable for this approach.

There are two basic forms of attenuators, with two versions of each. For unbalanced circuits, the *Tee* and *Pi* networks are normally used. The unbalanced versions of these networks, respectively, are the "*H*" and "*O*" networks. These are shown in schematic form in **Figure 1**. Looking into the left set of terminals, the impedance is  $Z_1$ . Likewise, looking into the right set of terminals, the impedance is  $Z_2$ . For the purpose of this discussion, let's define  $Z_1$  as the higher impedance of the two. By noting the inferred ground connection in the balanced networks, it can be seen that these are closely related to their unbalanced counterparts.

### Analysis

If an analysis is made of these circuits, it will quickly become apparent that below a certain value of attenuation, resistor values become negative and the network circuit can no longer be realized. This leads to the concept of **minimum loss attenuators**. Such attenuators operate with the minimum possible loss to provide a proper match to the impedances. Their actual attenuation increases as the impedance ratio increases. Several companies sell minimum loss attenuators for matching 50-to-75 ohm systems, which is a common application, but I have not found any manufacturers who make the 50-to-600 ohm variety I needed.<sup>1,2</sup> Thus knowledge of the network characteristics is needed to build your own custom attenuators.

We can begin by defining a term for the ratio of input power to output power:

$$K = \frac{\text{Power into Network}}{\text{Power out of Network}} \quad (1)$$

The value of **K** must always be greater than unity. Note that this is a ratio expressed as a dimensionless number. It may be converted to decibels by taking its base ten logarithm and multiplying by 10. With respect to minimum loss attenuators, the minimum value of the attenuation can be calculated by:

$$K_{\text{MIN}} = \frac{2Z_1}{Z_2} - 1 + \sqrt{\frac{Z_1}{Z_2} \left( \frac{Z_1}{Z_2} - 1 \right)} \quad (2)$$

Corrections to this note can be found on page A1 of this issue.

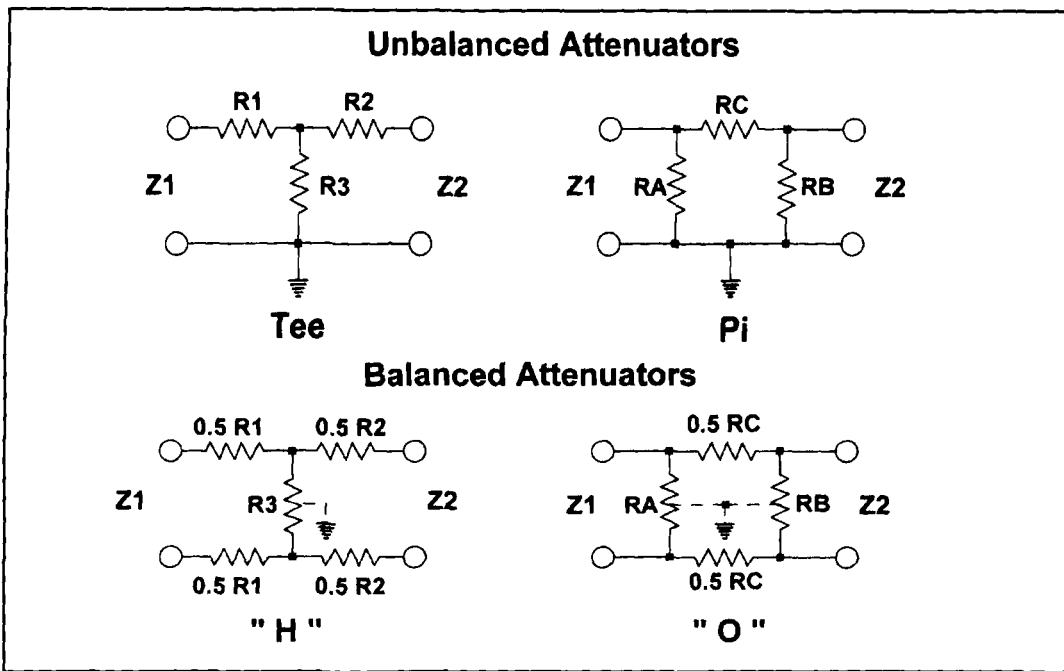

Figure 1. The two basic forms of attenuators.

If this value of attenuation is substituted in the following formulas, it will be seen that the value of resistor  $R_2$  becomes zero and the value of resistor  $R_A$  becomes infinite. Thus the minimum loss attenuator networks degenerate into two identical  $L$ -networks. A plot of the minimum attenuation (this time in decibels) versus the impedance ratio,  $Z_1/Z_2$ , is shown in Figure 2. It can be seen that when matching very large ratios of impedances, the losses can be quite high. But for the types of ratios we normally encounter, the losses are often not excessive.

While the above equation determines the minimum loss possible, it may calculate a value that is cumbersome to use. In the case of 75-to-50 ohm matching,  $K_{MIN}$  is approximately 3.7321 or 5.7195 decibels. This is not a particularly handy number to include in calculations involved with the end use of the power meter. Fortunately, there is a way to simplify these calculations. Remember that  $K_{MIN}$  is the minimum power ratio that can be obtained. But

there's nothing wrong with using a higher ratio for convenience. For example, in Pete's application, a value of 4 (6 decibels), or a value of 10 (10 decibels) will make using his power meter much easier. In my application of matching 600 ohms to 50 ohms,  $K_{MIN}$  works out to be a value of 45.9782 (16.6255 decibels). I used a value of 100 (20 decibels) to make my work easier.

Looking at the *Tee* network first, the component values may be calculated by these equations. Remember that  $Z_1$  is the higher impedance.

$$R_1 = \frac{Z_1 (K + 1) - 2 \sqrt{KZ_1Z_2}}{K - 1} \quad (3)$$

$$R_2 = \frac{Z_2 (K + 1) - 2 \sqrt{KZ_1Z_2}}{K - 1} \quad (4)$$

Impedance Ratio	Attenuation	Tee Network Values	Pi Network Values
75 ohms to 50 ohms	4 (6 decibels)	$R_1 = 43.350$ ohms	$R_A = 86.505$ ohms
"	"	$R_2 = 1.6836$ ohms	$R_B = 2227.3$ ohms
"	"	$R_3 = 81.650$ ohms	$R_C = 45.928$ ohms
600 ohms to 50 ohms	100 (20 decibels)	$R_1 = 577.130$ ohms	$R_A = 234.09$ ohms
"	"	$R_2 = 16.0192$ ohms	$R_B = 722.47$ ohms
"	"	$R_3 = 34.9910$ ohms	$R_C = 857.37$ ohms

Table 1. Calculated values for both networks.

$$R_3 = \frac{2\sqrt{KZ_1Z_2}}{K-1} \quad (5)$$

The equations for the corresponding *Pi* network are very similar. In fact, if conductance values are used instead of resistance values, the similarity is even more striking.

$$R_A = \frac{(K-1)Z_1Z_2}{Z_2(K+1) - 2\sqrt{KZ_1Z_2}} \quad (6)$$

$$R_B = \frac{(K-1)Z_1Z_2}{Z_1(K+1) - 2\sqrt{KZ_1Z_2}} \quad (7)$$

$$R_C = \frac{(K-1)Z_1Z_2}{2\sqrt{KZ_1Z_2}} \quad (8)$$

In situations where the attenuator is used between two equal impedances, these equations may be simplified. Again referring to the nomenclature used in **Figure 1**, the constant impedance resistors may be calculated by:

$$R_1 = R_2 = Z_1 \left( \frac{\sqrt{K}-1}{\sqrt{K}+1} \right) \quad (9)$$

$$R_3 = \frac{2Z_1\sqrt{K}}{K-1} \quad (10)$$

$$R_A = R_B = Z_1 \left( \frac{\sqrt{K}+1}{\sqrt{K}-1} \right) \quad (11)$$

$$R_C = \frac{Z_1(K-1)}{2\sqrt{K}} \quad (12)$$

For those interested in the derivation of these equations, a good reference is given by Landee, Davis, and Albrecht.<sup>3</sup> Everitt gives a more complete analysis where the equations are presented using combinations of hyperbolic functions.<sup>4</sup> The above equations require nothing more than a simple calculator for their solution. If balanced attenuators are needed, the  $R_1$ ,  $R_2$ , and  $R_C$  values may be split into two resistors of half their respective original value as shown in **Figure 1**.

### Some examples

To give some examples, let's use the two ratios used earlier. In the case of a 50-to-75 ohm attenuator, we calculated the minimum loss ratio to be 3.7321. To make things easier on Pete, we'll use a value of 4, which is 6 decibels, an easy number to work with. Likewise in my situation of 600-to-50 ohms, with a  $K_{MIN}$  of 45.9782, I will use a value of 100 which is 20 decibels.

For these two situations, we can calculate the values for both networks (**Table 1**). There is really no advantage of one network over the other except that the calculated values of one network may fall closer to standard resistor values than the values of the other.

When constructing these attenuators, 1 percent, 1/4-watt metal film or chip resistors are usually suitable within their power ratings. Using these resistors, with short lead lengths, one should be able to obtain a uniform response from DC to at least 450 MHz. For higher frequencies, special resistor constructions are necessary as found in the commercial attenuators. The Mini-Circuits minimum loss attenuators are rated to 2000 MHz and the Pasternack minimum loss attenuators are rated to 1000 MHz.

I hope this discussion has helped those needing to match dissimilar impedances over broad

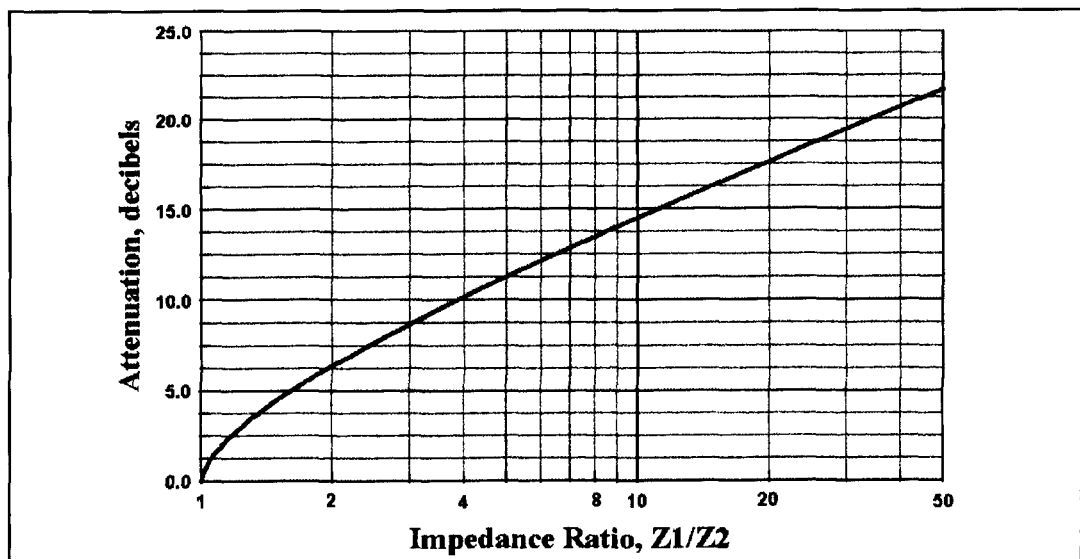

Figure 2. A plot of the minimum attenuation versus impedance ratio.

frequency ranges. The penalty one pays is attenuation, but in many applications, like those discussed, the attenuation is useful or at least not harmful.

#### REFERENCES

1. Pasternack Electronics, P.O. Box 16750, Irvine, California 92623-7451.
2. Mini-Circuits, P.O. Box 350115, Brooklyn, New York 11235-0003.
3. Robert W. Lantieri, Donovan C. Davis, and Albert P. Albrecht, *Electronic Designers' Handbook*, McGraw-Hill, New York, 1957.
4. William L. Everitt, *Communication Engineering*, McGraw-Hill, New York, 1937.

## Using Bessel-null Functions for FM Calibration

*Our senior editor recommends this technique!*

*Peter J. Bertini, Senior Technical Editor*

If you are like me, you've probably wished for a way to precisely measure FM modulation or to set generator deviation levels. Using one shop instrument to monitor another usually gives unexpected cumulative errors resulting from calibration tolerances and ambiguities in reading the calibration scales.

Several months ago I was assigned to do a review of the MFJ-224 2-Meter FM Analyzer. Trying to determine the device's FM deviation accuracy was a classic case of the dog chasing his tail. Depending on how I interpreted my settings on the generator, or the Analyzer's meter scale, my results were consistently unreliable. The FM generator I had on hand that day used a slide pot with particularly poor calibration marks to set the deviation. Digging back through some old reference material, I found the solution to my problems.

Here's a method to precisely set your FM signal generator modulation to any desired deviation level. Accuracies of 0.5 percent are easily achieved using common shop equipment.

## Understanding Modulation Index

The Modulation Index is found by dividing the frequency deviation by the modulating frequency. If applying a 1-kHz tone to an FM transmitter produces a deviation of 5 kHz, we would have a Modulation Index of 5. Likewise, a 1-kHz tone producing a deviation of 2 kHz would have a Modulation Index of 2.

## Bessel Null Functions

The carrier from an FM signal source will null when a Modulation Index of 2.405 is reached. This is easily demonstrated using a service monitor, such as the IFR-1200 Super S, which has an internal spectrum analyzer. The monitor is set to FM generate using the internal 1-kHz audio oscillator, and the spectrum analyzer is used to display the carrier.

As the FM deviation is slowly increased, modulation sidebands will appear symmetrically at 1-kHz intervals either side of the carrier frequency. When a Modulation Index of 2.405 is reached, the carrier will disappear,



**GET HOT!**

**GET A BLOWTORCH LOOP YAGI FOR 2304 OR 3456 MHZ!**

1376LY....12 ft boom, 2304!  
976LY.....8 ft boom, 3456!

CHECK OUT our ultimate 13 and 9 cm 76 element **LOOP YAGIS** with over 23 dBi gain. Check the new rugged double boom. Scrap your old dish! Get better performance with low windloading. Welding goggles optional!

FOR MORE INFORMATION CONTACT

**DIRECTIVE SYSTEMS**



RR # 1 Box 282 Dixon Road  
Lebanon, ME. 04027  
Tel: (207) 658-7758 Fax: (207) 658-4337  
www.directivesystems.com

## Antenna Software by W7EL

5-wire Yagi up to 50 and 100 ft.      8-48      EZNEC 1.0  
1995-11-14 13:51:23  
Freq = 14.2 MHz



EZNEC ("Easy-NEC") captures the power of the NEC-2 calculating engine while offering the same friendly, easy-to-use operation that made ELNEC famous. EZNEC lets you analyze nearly any kind of antenna - including quads, long Yagis, and antennas within inches of the ground - in its actual operating environment. Press a key and see its pattern. Another, its gain, beamwidth, and front/back ratio. See the SWR, feedpoint impedance, a 3-D view of the antenna, and much, much more. With 500 segment capability, you can model extremely complex antennas and their surroundings. Includes true current source and transmission line models. Requires 80386 or higher with coprocessor, 486DX, or Pentium; 2Mb available extended RAM; and EGA/VGA/SVGA graphics.

ELNEC is a MININEC-based program with nearly all the features of EZNEC except transmission line models and 127 segment limitation (5-8 total wavelengths of wire). Not recommended for quads, long Yagis, or antennas with horizontal wires lower than 0.2 wavelength; excellent results with other types. Runs on any PC-compatible with 640k RAM, CGA/EGA/VGA/Hercules graphics. Specify coprocessor or non-coprocessor type.

Both programs support Epson-compatible dot-matrix, and HP-compatible laser and ink jet printers.

**Prices** - U.S. & Canada - EZNEC \$89, ELNEC \$49, postpaid. Other countries, add \$3. VISA AND MASTER-CARD ACCEPTED.

Roy Lewallen, W7EL phone 503-646-2885  
P.O. Box 6658 fax 503-671-9046  
Beaverton, OR 97007 email w7el@teleport.com

leaving just the sidebands. Using the modulation level control to carefully null the carrier to maximum depth will give a precise deviation of 2.405 kHz. The ultimate accuracy is determined by the care used to set the null and the accuracy of the 1-kHz tone. Errors of 5 Hz will still give readings with at least 0.5-percent accuracy—more than needed for most applications.

If the modulation level is increased, the carrier will reappear and a second carrier null point will occur when the Modulation Index reaches 5.52. This gives an accurate check at 5.52-kHz deviation. Note that it is very important to be sure you are observing the carrier, as matching pairs of sidebands will also null at various levels.

Using the 1-kHz tone is convenient, but limits the user to 2.405 and 5.52-kHz calibration reference points. If an external variable audio oscillator is handy, it is easy to produce exact calibration points at any desired deviation level. Simply dividing 2.405 into the desired deviation frequency will provide the needed modulating frequency to produce the first Bessel-null at that deviation level. For example, to set the generator for a precise 5-kHz deviation, a modulating frequency of 2079 Hz is needed. Any

inexpensive frequency counter will do for setting the audio oscillator frequency.

If you don't have access to a spectrum analyzer capable of resolving narrow FM sidebands, it is also possible to use a receiver equipped with narrow CW filters to perform the same task. The filters must be sharp enough to reject the FM sidebands to permit observing the carrier null points. Lacking a good multimode VHF receiver with sharp CW filters, a converter can be used ahead of any HF communications receiver. The receiver needn't receive FM, but should be equipped with an S-meter to observe the carrier null point. Use care to ensure that you are tuned to the exact carrier and not to one of the sidebands, and also be careful to observe that the proper carrier null is being observed.

I tried this technique on a new IFR-1200 Super S to verify its FM deviation meter accuracy. While the readings were within specs across most of the ranges, when the deviation was precisely set to 5-kHz using the Bessel-null technique, the instrument showed a 4.8 kHz reading! Without a method of precisely determining deviation, even this instrument would be a poor choice to determine the calibration of another instrument. ■

# 800-522-2253

**This Number  
May Not Save  
Your Life...**

But it could make it a lot easier!  
Especially when it comes to  
ordering non-standard connectors.

### RF/MICROWAVE CONNECTORS

- Specials our specialty virtually any SMA, N, TNC, BNC, SMB, or SMC delivered in 2-4 weeks
- Cross reference library to all major manufacturers.
- Large inventory of piece parts for all types of coaxial connectors.
- Experts in supplying "hard to get" RF connectors.
- Connectors supplied to your drawings and specs.
- Our 56 Standard adapters can satisfy virtually any combination of requirements, between SMA, TNC, N, 7mm, BNC and others.
- Extensive inventory of passive RF/Microwave components including attenuators, terminations and dividers.

**NEMAL**  
Cable & Connectors  
for the Electronics Industry

NEMAL ELECTRONICS INTERNATIONAL, INC.

12240 N.E. 14TH AVENUE  
NORTH MIAMI, FL 33161  
TEL: 305-899-0900 • FAX: 305-895-8178  
E-MAIL: INFO@NEMAL.COM  
URL: WWW.NEMAL.COM

## Shortwave Receivers

### Past & Present

Communications Receivers 1942-1997

#### RECEIVERS PAST & PRESENT



- New 3<sup>rd</sup> Ed.
- 108 Chapters
- 472 Pages
- 840 Photos
- Printed 03/98
- Covers 1942 to 1997.
- 770 Receivers
- 660 Variants
- Includes 98 U.S. and Intl. manufacturers
- \$24.95 (+\$2 ship)

This huge 472 page Third Edition includes over 770 shortwave and amateur communications receivers made from 1942 to 1997. Here is everything you need to know as a radio collector or informed receiver buyer. Entry information includes: receiver type, date sold, photograph, size & weight, features, reviews, specifications, new & used values, variants, value rating and availability. Ninety eight worldwide manufacturers are represented. 840 Photos. Become an instant receiver expert!

**universal  
radio inc.**

### Universal Radio

6830 Americana Pkwy.  
Reynoldsburg, OH 43068  
♦ Orders: 800 431-3939  
♦ Info: 614 866-4267  
♦ FAX: 614 866-2339

## shoc® RSM5 \$172.-

- New:
  - Multiple Receivers
  - Office Compatible User Interface, Standard Toolbar
  - Intelligent Filter with History
  - Incremental Search
  - Y2K
  - Report Generator
  - Import (Klingeluss, ASCII, BBC, ILG, PerCon)

The new shoc® RSM 5 RadioSpectrumManager includes all drivers and the actual professional shoc® RadioData database with more than 74'000 records (26'000 Utility, 14'000 Broadcast, 34'000 VHF/UHF/SHF). Append/Edit of records, Database-Scanning, Station Identification, Multiple search filters, Channel control and Timer mode. \$95/98/NT. No dongle. Available version: Economic \$172.-, Standard \$309.-, Professional \$2415.-. shoc® can deliver drivers for the following equipment:

- AOR
- EKD
- ICOM
- JRC
- KENWOOD
- NEISNER+DOERING
- LOWE
- OPTOELECTRONICS
- RACAL
- ROSETTA
- ROHDE+SCHWARZ
- TSL
- TELEFUNKEN
- UNIVERSAL
- WATKINS-JOHNSON
- WAVECOM
- WINRADIO
- YAESU

## WAVECOM W40PC \$2480.-

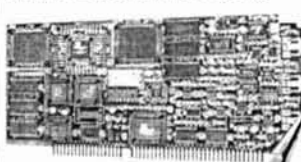

Data Decoder and Analyzer. The worldwide reference, used by most government bodies. More than 100 modes (HF/VHF/UHF/SHF)

supported. DSP technology with two 56002-66 MHz. FFT and code analysis. AF/IF Discriminator Input. Updates on Internet. \$95/98/NT. Other versions: W4100DSP, W4050 and W41PC (Up to 8 cards in one PC).

Also available from shoc® Training, Engineering and System Design, Satellite Equipment, Antennas, RACAL, Rohde&Schwarz, Kneisner+Doering, JSP, INMARSAT, JRC...

R.Haenggi, dipl. Ing. HTL  
CH-8499 Sternberg-Gfell  
Switzerland

☎ +41-52-394 12 55  
☎ +41-52-394 12 56  
☎ +41-79-421 50 37  
✉ sales@shoc.ch  
☎ www.shoc.ch

**shoc®**

The Radio Monitoring Company

## TECHNICAL CONVERSATIONS

(from page 7)

output." It is possible to heavily overdrive a linear amplifier until the SWR of its output impedance (looking back into the amplifier) is reduced to 1:1, thus producing a conjugate match. This condition only exists at that specific overdriving power level which is far into the nonlinear high distortion range. The FCC Rules and Regulations, Section 97.307 Parts (a) through (d) prohibit operating in this range. In normal speech operation, the SSB power output varies from zero up to the limit of the linear PEP range. The SWR looking back into the amplifier is typically on the order of 4:1 or so over most of the linear range. (Output network loss reduces the amplifier output SWR some from what is produced by the transmitting tube.) The purpose of a properly adjusted ALC circuit is to keep the signal PEP below the high splatter region.

Belrose does a clever job of mixing enough fact in with his fiction to make it believable to all except those very knowledgeable on this complex subject. Ham transmitters do not operate with a conjugate match, nor are they designed to. I have designed enough transmitters for The Collins Radio Company to know. The term "conjugate match" serves no useful purpose in the discussion of HF transmitter output networks and antenna coupling systems. Therefore, I again recommend that the term "conjugate match" be banished from all future discussion thereof. In fact, it would often improve clarity to avoid the word "match" when we really mean "impedance transformation."

**Warren Bruene, W5OLY**  
Dallas, Texas

### Check out our Web site!

Begin or renew your Communications Quarterly subscription, buy books, videos, calendars, cards, pins and more all on our "secure" Web site. Just point your Web browser to <http://www.communications-quarterly.com> and click on.

**Amplifiers. ATU Down Converters & Hard to Find Parts**

Celebrating 20 Years 1979-1999

<p style="text-align: center;"><b>LINEAR AMPLIFIERS</b></p> <p>HF Amplifiers PC board and complete parts list for HF amplifiers described in the Motorola Application Notes and Engineering Bulletins:</p> <table style="width: 100%;"> <tr> <td>AN779H (20W)</td> <td>AN 758 (300W)</td> <td>2 Meter Amplifiers (144-148 MHz) (Kit or Wired and Tested)</td> </tr> <tr> <td>AN779L (20W)</td> <td>AR313 (300W)</td> <td>35W - Model 335A, \$79.95/\$109.95</td> </tr> <tr> <td>AN 762 (140W)</td> <td>EB27A (300W)</td> <td>75W - Model 875A, \$119.95/\$159.95</td> </tr> <tr> <td>EB63 (140W)</td> <td>EB104 (600W)</td> <td></td> </tr> <tr> <td>AR305 (300W)</td> <td>AR347 (1000W)</td> <td></td> </tr> </table>	AN779H (20W)	AN 758 (300W)	2 Meter Amplifiers (144-148 MHz) (Kit or Wired and Tested)	AN779L (20W)	AR313 (300W)	35W - Model 335A, \$79.95/\$109.95	AN 762 (140W)	EB27A (300W)	75W - Model 875A, \$119.95/\$159.95	EB63 (140W)	EB104 (600W)		AR305 (300W)	AR347 (1000W)		<p style="text-align: center;"><b>HARD TO FIND PARTS</b></p> <ul style="list-style-type: none"> <li>• RF Power Transistors</li> <li>• Broadband HF Transformers</li> <li>• Chip Caps - Kemet/ATC</li> <li>• Metallized Mica Caps - Unelco/Semco</li> <li>• ARCO/SPRAGUE Trimmer Capacitors</li> </ul> <p>We can get you virtually any RF transistor! Call us for "strange" hard to find parts!</p>
AN779H (20W)	AN 758 (300W)	2 Meter Amplifiers (144-148 MHz) (Kit or Wired and Tested)														
AN779L (20W)	AR313 (300W)	35W - Model 335A, \$79.95/\$109.95														
AN 762 (140W)	EB27A (300W)	75W - Model 875A, \$119.95/\$159.95														
EB63 (140W)	EB104 (600W)															
AR305 (300W)	AR347 (1000W)															

For detailed information and prices call or write for our free catalog!

Phone (937) 426-8600  
FAX (937) 429-3811

**CCI Communication Concepts Inc.**

508 Millstone Drive • Beavercreek, Ohio 45434-5840  
e-mail: [cci.dayton@pobox.com](mailto:cci.dayton@pobox.com)  
[www.communication-concepts.com](http://www.communication-concepts.com)

**ADDITIONAL ITEMS**

Heat Sink Material  
Model 99 Heat Sink (6.5" x 12" x 1.6"), \$25  
CHS-6 Copper Spreader (8" x 6" x 3/8"), \$24  
Low Pass Filters (up to 300W) for harmonics \$12.95  
Specify 10M, 15M, 20M, 40M, 80M or 160M  
HF Splitters and Combiners up to 2KW

# The Anatomy of Precision Design

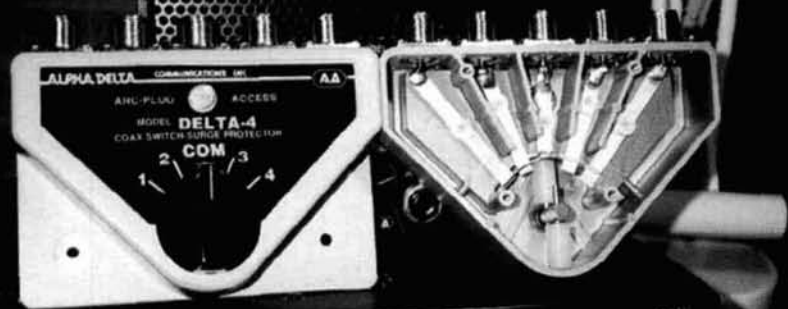

## The precision DELTA series surge protected coax switches

- **ARC-PLUG®** gas tube surge protection cartridge built-in. All circuits protected
- Master antenna ground function
- Low loss constant impedance micro-strip cavity design. Excellent co-channel isolation. No lossy wafer switches are used. Full power operation
- Positive detent roller bearing switch drive
- Used in commercial and military applications

Model **DELTA-2** (2 position, UHF connectors, 500 MHz).....\$49.95  
 Model **DELTA-2/N** (2 position, N connectors, 1.3 GHz).....\$64.95  
 Model **DELTA-4** (4 position, UHF connectors, 500 MHz).....\$79.95  
 Model **DELTA-4/N** (4 position, N connectors, 1.3 GHz).....\$89.95

The compelling need for Alpha Delta products: You need peak system performance. You wouldn't think of using anything less than Alpha Delta accessories for efficiency and protection.

Toll free order line (888) 302-8777 (add \$5.00 for direct U.S. orders. Exports quoted.  
 Website: [www.alphadeltacom.com](http://www.alphadeltacom.com)

**ALPHA DELTA COMMUNICATIONS, INC.**

P.O. Box 620, Manchester, KY 40962 • (606) 598-2029  
 fax (606) 598-4413

Alpha Delta — Compelling You Into the 21<sup>st</sup> Century





# 1999 Calendars, Books, Cards & Videos!

## 33 Simple Weekend Projects

by Dave Ingram, K4TWJ

Do-it-yourself electronics projects from the most basic to the fairly sophisticated. You'll find: station accessories for VHF FMing, working OSCAR satellites, fun on HF, trying CW, building simple antennas, even a complete working HF station you can build for \$100. Also includes practical tips and techniques on how to create your own electronic projects.



Order No. 33PROJ.... **\$15.95**

## W6SAI HF Antenna Handbook

by Bill Orr, W6SAI

Inexpensive, practical antenna projects that work! Guides you through the building of wire, loop, Yagi and vertical antennas.



Order No. HFANT..... **\$19.95**

## The NEW Shortwave Propagation Handbook

by W3ASK, N4XX & K6GKU

A comprehensive source of HF propagation principles, sunspots, ionospheric predictions, with photography, charts and tables galore!



Order No. SWP..... **\$19.95**

## Amateur Radio Equipment Buyer's Guide

This 144-page book is your single source for detailed information on practically every piece of Amateur Radio equipment and accessory item currently offered for sale in the USA complete with specs and prices. Also includes the most comprehensive directory of Ham product manufacturers and dealers in the USA.



Order No. EBG..... **\$15.95**

## The Quad Antenna

by Bob Haviland, W4MB

Second Printing  
An authoritative book on the design, construction, characteristics and applications of quad antennas.



Order No. QUAD..... **\$15.95**

## McCoy on Antennas

by Lew McCoy, W1ICP

Unlike many technical publications, Lew presents his invaluable antenna information in a casual, non-intimidating way for anyone!

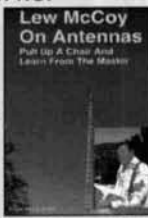

Order No. MCCOY.... **\$15.95**

## Building and Using Baluns and Ununs

by Jerry Sevick, W2FMI

This volume is the source for the latest information and designs on transmission line transformer theory. Discover new applications for dipoles, yagis, log periodics, beverages, antenna tuners, and countless other examples.



Order No. BALUN... **\$19.95**

## The Vertical Antenna Handbook

by Paul Lee, N6PL

Learn basic theory and practice of the vertical antenna. Discover easy-to-build construction projects.



Order No. VAH..... **\$9.95**

## Keys, Keys, Keys

by Dave Ingram, K4TWJ

You'll enjoy nostalgia with this visual celebration of amateur radio's favorite accessory. This book is full of pictures and historical insight.



Order No. KEYS **\$9.95**

**FREE SHIPPING**  
on orders over \$50\*



## CQ Award Pins

If you've earned any of CQ's Awards, you can also display the corresponding CQ Award pin. Available for WAZ, 5 Band WAZ, 160 Meter WAZ, CQ DX, CQ DX Honor Roll, WPX, WPX Honor Roll, and USA-CA awards. **ONLY \$5.00 EACH.**

## Playing Cards

Top quality, plastic coated playing cards. **ONLY \$9.95 per deck**



## 1999/2000 Calendars



Fifteen month calendars -  
January 1999 through  
March 2000

Please specify Amateur Radio or Classic Radio Calendar

**Fax us at 516-681-2926**  
**Call us toll free at 1-800-853-9797**

## Getting Started Videos - "How-To," Tips, Techniques & More!

- Ham Radio Horizons: The Video .. Order No. VHOR
- Getting Started in VHF .. Order No. VVHF
- Getting Started in Ham Radio .. Order No. VHR
- Getting Started in DXing .. Order No. VDX
- Getting Started in Packet Radio .. Order No. VPAC
- Getting Started in Amateur Satellites .. Order No. VSAT
- Getting Started in Contesting .. Order No. VCON



Only \$19.95 each  
Buy more and save!  
Buy 2 or 3 for \$17.95; Buy 4 to 6 for \$15.95  
Buy all 7 for your Club for only \$99.95

Name \_\_\_\_\_ Callsign \_\_\_\_\_  
Street Address \_\_\_\_\_  
City \_\_\_\_\_ State \_\_\_\_\_ Zip \_\_\_\_\_

Qty	Item #	Description	Price	Total Price
U.S. and possessions - add \$4 shipping/handling. *FREE S/H on orders \$50 and over. Foreign - shipping/handling charges are calculated by order weight & destination. *A \$4 credit will be applied for Foreign orders over \$50.			Shipping/Handling	
			Total	

Method of payment  Check  Money Order  Visa  MasterCard  Discover  American Express  
Credit Card No. \_\_\_\_\_ Expiration date \_\_\_\_\_





# "ATOMIC TIME"

Time Pieces Synchronized to the US Atomic Clock  
Accurate to ten billionth of a Second!



You can now have the world's most accurate time 24 hours a day. These smart clocks tune into the radio signal emitted by the US Atomic Clock in Colorado, which deviates less than 1 second over a million year period. They synchronize themselves automatically to the precise time and adjust for daylight savings. These precision ZEIT timepieces are engineered in Germany and are easy to use using the latest in radio-controlled technology. Just set the time zone and the built-in microchip does the rest.  
**"ZEIT Atomic Time" Precise, Reliable, Convenient**

## ZEIT Atomic Dual Alarm & ZEIT Atomic PC

Sleek European design with large 2 line LCD display with exact time in hours, minutes, seconds, month and date, or any two US and world times. At 8oz. Ideal for travel; incl. dual alarm with nighttime illumination, time zones and lithium battery backup. Super sensitive built-in receiver. 2AA. Incl. Black or Silver arch design at 5"x4"x2 1/2" **Sale! \$69.95**. Buy any two Clocks & get 20% off 2nd.



**NEW SALE \$69.95**

ZEIT PC with serial cable and software for WIN. Also shows UTC Time in 24 hrs mode. **Sale! \$99.95**

## ZEIT Atomic Wall Clock

with regular or Roman numerals. For home or office. One AA Battery. Large 12" **Only \$79.95 (\$99.95 in wood)**



**ZEIT Atomic Watches** are the world's most accurate watches. Shock-resistant polymer case with built-in receiver, hardened mineral lens, water resistant. Black or white dial & leather band. **Only \$149.95**  
**NEW ZEIT Digital Atomic Sportswatch** with UTC etc. **Just \$99.95**



**Call for full line of atomic clocks & watches**

**THE FUTURE IN TIME KEEPING**

**Credit Card Orders call toll free 800-339-5901 24hrs**

send checks / money orders for the total amount incl. S & H \$7.00 to: **ATOMIC TIME, INC.**

10526 W. Cermak Suite 300 West Chester, IL 60154 - Please mention promotional Code 8484 when ordering

Fax. 708.236.1205

<http://www.atomictime.com>

## From MILLIWATTS to KILOWATTS<sup>SM</sup>

**Largest inventory of Tubes, Transistors & RF Power Modules for Amateur Radio Equipment**



**Retube your Equipment with the Best Quality Products**



**100% Tested - Guaranteed to Perform!**

Tube	Mfg.	Singles	Match/2	Match/4
572B	Taylor	\$34.95	\$89.90	\$179.80
572B	Svetlana	54.95	119.90	239.80
811A	Cetron	18.50	38.90	77.80
811A	Svetlana	19.90	42.90	85.80
6146W	Syl/ECG	15.00	34.00	—
6146B	GE	21.50	44.90	—
3-500ZG	RFPARTS	119.95	249.90	499.80
3-500ZG	Taylor	109.95	229.90	45.80
4-400A	Taylor	120.00	250.00	500.00
3-500ZG	Amperex	189.95	3CX3000A7 Taylor	595.00
3-500ZG	Trilon	189.95	4CX250B Taylor	89.95
3CX400A7	Svetlana	320.00	4CX400A Svetlana	129.95
3CX3000A7	Svetlana	749.00	4CX800A Svetlana	179.95

### Eimac • Svetlana • Taylor Metal-Ceramic Tubes

3CX100A5	4-1000A	4CX1600B
3CX800A7	4CPX800A7	4CX5000A
3CX1200A7	4CX250B/R	4X150A
3CX1500A7	4CX350A	5CX1500A/B
3CX3000A7	4CX1000A	8560AS
3CX6000A7	4CX1500A/B	8930

**CALL FOR SPECIAL PRICES.**

Complete inventory for servicing Amateur, Marine, and Commercial Communications Equipment.

Se Habla Español • We Export

Visit our Web Site for latest Catalog pricing and Specials:  
<http://www.rfparts.com>

**Visit us at the Dayton Hamvention**

Booths 361-366

For Order pickup, contact us by April 30.



ORDERS ONLY

1-800-RF-PARTS • 1-800-737-2787

ORDER LINE • TECH HELP • DELIVERY INFO.  
760-744-0700

FAX 760-744-1943 TOLL-FREE FAX 888-744-1943

E-MAIL: [rfp@rfparts.com](mailto:rfp@rfparts.com)



## RF PARTS

435 SOUTH PACIFIC STREET  
SAN MARCOS, CA 92069



## VARI-NOTCH<sup>®</sup> DUPLEXERS

**FOR 2 METERS**

The TX RX Systems Inc. patented Vari-Notch filter circuit, a pseudo-bandpass design, provides low loss, high TX to RX, and between-channel isolation, excellent for amateur band applications. TX RX Systems Inc. has been manufacturing multicoupling systems since 1976. Other models available for 220 and 440 MHz, UHF ATV and 1.2 GHz.

### MODEL 28-37-02A

144-174 MHz

92 dB ISOLATION AT 0.6 MHz SEPARATION  
400 WATT POWER RATING

### TX RX SYSTEMS INC.

8625 INDUSTRIAL PARKWAY, ANGOLA, NY 14006

TELEPHONE 716-549-4700 FAX 716-549-4772 (24 HRS.) e-mail: [sales@txrx.com](mailto:sales@txrx.com)

A MEMBER OF THE BIRD TECHNOLOGIES GROUP



See Us At Dayton Booths 414-415

19" RACK MOUNT



**DEDICATED TO THE SCANNING AND SHORTWAVE ENTHUSIAST.  
WE'RE MORE THAN JUST SOFTWARE!**

**HOKA CODE-3 USA Version**

C U @ Dayton  
May 14 - 16  
Booth 634

"The Standard Against Which All Future Decoders Will Be Compared"

Many radio amateurs and SWLs are puzzled! Just what are all those strange signals you can hear but not identify on the Short Wave Bands? A few of them such as CW, RTTY, Packet and Amtor you'll know - but what about the many other signals?

There are some well known CW/RTTY Decoders but then there is CODE-3. It's up to you to make the choice, but it will be easy once you see CODE-3. CODE-3 has an exclusive auto-classification module that tells YOU what you're listening to AND automatically sets you up to start decoding. No other decoder can do this on ALL the modes listed below - and most more expensive decoders have no means of identifying ANY received signals! Why spend more money for other decoders with FEWER features? CODE-3 works on any IBM-compatible computer with MS-DOS with at least 640kb of RAM, and a CGA monitor. CODE-3 includes software, a complete audio to digital FSK converter with built-in 115V ac power supply, and a RS-232 cable, ready to use.

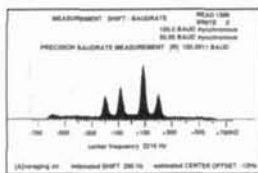

Simulated Speed Measurement Module

CODE-3 is the most sophisticated decoder available for ANY amount of money.

26 Modes included in STANDARD package include:

- Morse \*
- RTTY/Baudot/Murray \*
- Sitor CCIR 625/476-4
- ARQ - Navtex \*
- AX25 Packet \*
- Facsimile all RPM (up to 16 gray shades at 1024 x 768 pixels) \*
- Autopsc - Mk's I and II
- DUP-ARQ Artrac
- Twinplex
- All modes in typical baud rates with possibility of changing to any desired value of speed and shift.
- User can save incoming data to disk in either ASCII or raw bit form.

- ASCII \*
- ARQ6-90/98
- SI-ARQ/ARQ-S
- SWED-ARQ-ARQ-SWE
- ARQ-E/ARQ1000 Duplex
- ARQ-N-ARQ1000 Duplex Variant
- ARQ-E3-CCIR519 Variant
- POL-ARQ 100 Baud Duplex ARQ
- TDM242/ARQ-M2/4-242

- TDM342/ARQ-M2/4
- FEC-A FEC100A/FEC101
- FEC-S • FEC1000 Simplex
- Sports info 300 baud ASCII
- Hellsreiber-Synch/Asynch \*
- Sitor - RAW (Normal Sitor but without Synch,
- ARQ6-70
- Baudot F788N
- Factor \*
- WEFAX \*

**EXTRA OPTIONS**

- REG. PRICE
- Piccolo .....\$85.00
- Coquelet .....\$85.00
- 4 special ARQ & FEC systems: TORG-10/11, ROU-FEC/ RUM-FEC, HC-ARQ (ICRC) and HNG-FEC .....\$115.00
- SYNOP decoder .....\$85.00

**PROFESSIONAL CODE-3 DECODER**  
\$595.00 + S & H  
Includes: ALL Modes, Plus Oscilloscope\*, ASCII Storage, Auto Classify\*, and PACTOR\* Options  
with ALL EXTRA OPTIONS \$795.00 + S & H

ALSO AVAILABLE  
CODE-30 COMM.  
& CODE-300 GOVT.  
DSP-BASED Decoders  
\$5 CALL \$5

**CODE 3 - GOLD VHF/SW DECODER**  
\$425.00 + S & H  
Includes POCSAG & ACARS  
Plus \* Modes/Options  
with ALL EXTRA  
MODES/OPTIONS \$595.00 + S & H

Now Available - Stridsberg Engineering Multicouplers - "Call for Quantity Pricing"  
<http://www.scancat.com/mlticipr.html>

INTERNET WEB ADDRESS - <http://www.scancat.com> WEB E-MAIL - [scancat@scancat.com](mailto:scancat@scancat.com)  
FREE DEMOS ON THE WEB (S & H \$10 US, \$15 Foreign)

**COMPUTER AIDED TECHNOLOGIES** P.O. Box 18285 Shreveport, LA 71138  
Order direct or contact your favor- ite dealer  
Phone: (318) 687-4444 FAX: (318) 686-0449  
Info/Tech Support: (318) 687-2555 (9 a.m. - 1 p.m. Central M-F)  
Orders Only  
**888-SCANCAT**  
888-722-6228

**ADVERTISER'S INDEX**

Alpha Delta Communications ....CovII,109
Astron Corporation .....Cov IV
Atomic Time, Inc.....111
Communication Concepts Inc. ....109
Computer Aided Technologies .....112
Crestone Technical Books .....8
CQ Merchandise .....110
Directive Systems .....107
HAL Communications Corp.....Cov III
Lewallen, Roy, W7EL .....107
M <sup>2</sup> Antenna Systems, Inc .....7
Nemal Electronics.....108
Nittany Scientific .....5,112
RF Parts .....111
shoc .....108
TX RX Systems Inc .....111
Universal Radio, Inc. ....108

Reach this dynamic audience with your advertising message, contact Don Allen, W9CW at 217-344-8653, FAX 217-344-8656, or e-mail: [QtrlyAds@aol.com](mailto:QtrlyAds@aol.com)

**Antenna Software with the User in Mind!**

- Visualize the antenna structure as you design it!
- Output your analysis with fantastic plots!
- Simplify your design process - Save time and money!

**NEC-Win Basic**

- Easy data entry
- Cut, copy, and paste commands
- Different conductivities for each wire
- Built-in defaults for wire diameter
- Graphical ground plane selection
- Built-in defaults for ground planes
- Transmission lines and networks
- Automatic wire scale, rotate, and translate
- Graphical placement of sources and loads
- 3-D visualization of antenna structure
- Rotate, Zoom and Pan antenna structure
- Tabular data for VSWR
- Tabular data for input impedance
- Polar plots of power gain
- Antenna analysis with gain and delta probe
- Comparison of multiple antenna files
- 3-D surface plots of antenna patterns

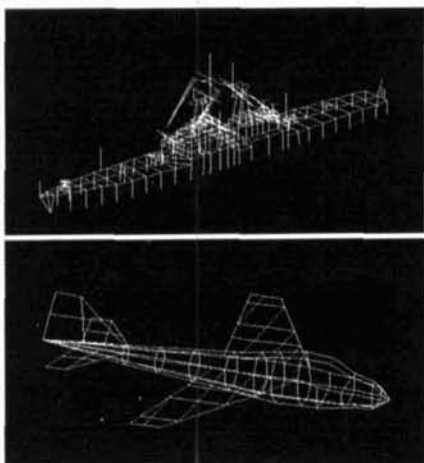

**NEC-Win Pro**

NEC-Win Pro includes all of NEC-Win Basic plus the full NEC2 command set.

- Arc, Helix, Cylinder, Wires, Surface Patches
- Source/Load/Wire/Current Identification
- Color display of currents on structure
- Numerical Green's Function
- Smith Chart, Polar and Rectangular plots
- 3-D surface plot ← antenna displayed in center
- Near Electric and Magnetic fields
- Dialog box input for each command

**Plotting includes:**

- |                 |                 |
|-----------------|-----------------|
| Power Gains     | Electric Fields |
| VSWR            | Currents        |
| Input Impedance | Axial Ratio     |
| Admittance      | Tilt Degree     |
| Near Fields     | RX Patterns     |

\*NEC-Win Basic and NEC-Win Pro include the popular NEC2 core.  
NEC-Win Pro includes an optimized 32-bit core which supports dynamic memory allocation to handle any size problem.

**Nittany Scientific, Inc.**  
1733 West 12600 South, Suite 420  
Riverton, UT 84065  
Phone/Fax: (801) 446-1426  
[sales@nittany-scientific.com](mailto:sales@nittany-scientific.com)

**NEC-Win Basic \$75.00**

**NEC-Win Pro \$425.00**

Major credit cards accepted!  
Orders shipped via UPS or Airmail within the US or Overseas!  
[www.nittany-scientific.com](http://www.nittany-scientific.com)

\*NEC-Win Basic and NEC-Win Pro were formerly owned by Paragon Technology



# CLOVER-2000

## High Performance HF Radio Protocol

### Fast, Reliable, Economical Communications

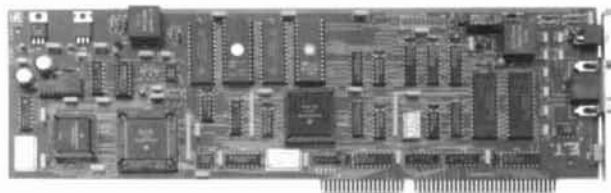

PCI-4000/2K Internal Modem



DSP-4100/2K External Modem

**CLOVER-2000** is an advanced modem waveform and protocol that is specifically designed for high rate data transmission via High Frequency (HF) radio. Available for use in HAL DSP-4100/2K or PCI-4000/2K modems, CLOVER-2000 automatically adapts to changing HF propagation conditions.

#### High Throughput & Adaptive ARQ:

CLOVER-2000 sends data over standard HF SSB radio channels at 3000 bps. Including error correction and ARQ overhead, CLOVER-2000 will deliver up to 2000 error-corrected bits/second over an HF radio link. The -50dB occupied bandwidth of the transmitted signal is only 2000 Hz. CLOVER-2000 may be used with *any* good-quality HF SSB transmitter and receiver.

The CLOVER demodulator measures Signal-to-Noise ratio (SNR), Phase Dispersion (PHS), and Error

Corrector activity (ECC) of each data block received. This information is used to determine which of the five modulation formats should be used during the next 5.5 second transmission. In contrast, other adaptive systems use only 1 or 2 modulation formats and selection is based only upon errors as they are received and not on real time measurements of actual channel parameters.

#### Error Correction Coding:

CLOVER uses Reed-Solomon error correction coding to combat burst-errors that occur on typical HF transmissions. Other ARQ modes may not include in-block error correction or use formats that require long inter-leave times to combat burst errors.

#### Bi-directional ARQ:

The CLOVER ARQ protocol allows real-time adaptive transmission of data *in both directions* on the ARQ link *without the need for special "over" commands*. CLOVER is also data transparent; the modem will send any 8-bit stream provided without modification and without requiring special command sequences. CLOVER-2000 is a low-cost and high throughput solution to your HF data communications problems. It is the "waveform of choice" for thousands of users throughout the world.

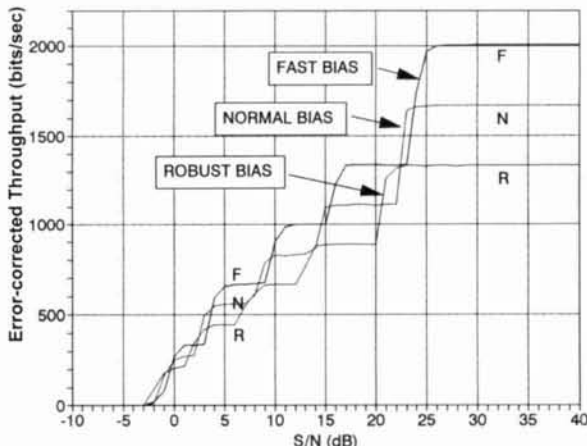

CLOVER-2000 Data Throughput



**HAL COMMUNICATIONS CORP.**

1201 W. Kenyon Road, P.O. Box 365

Urbana, Illinois 61801-0365

Phone: (217) 367-7373 FAX (217) 367-1701

www.halcomm.com

# .... POWER ON WITH ASTRON SWITCHING POWER SUPPLIES ....

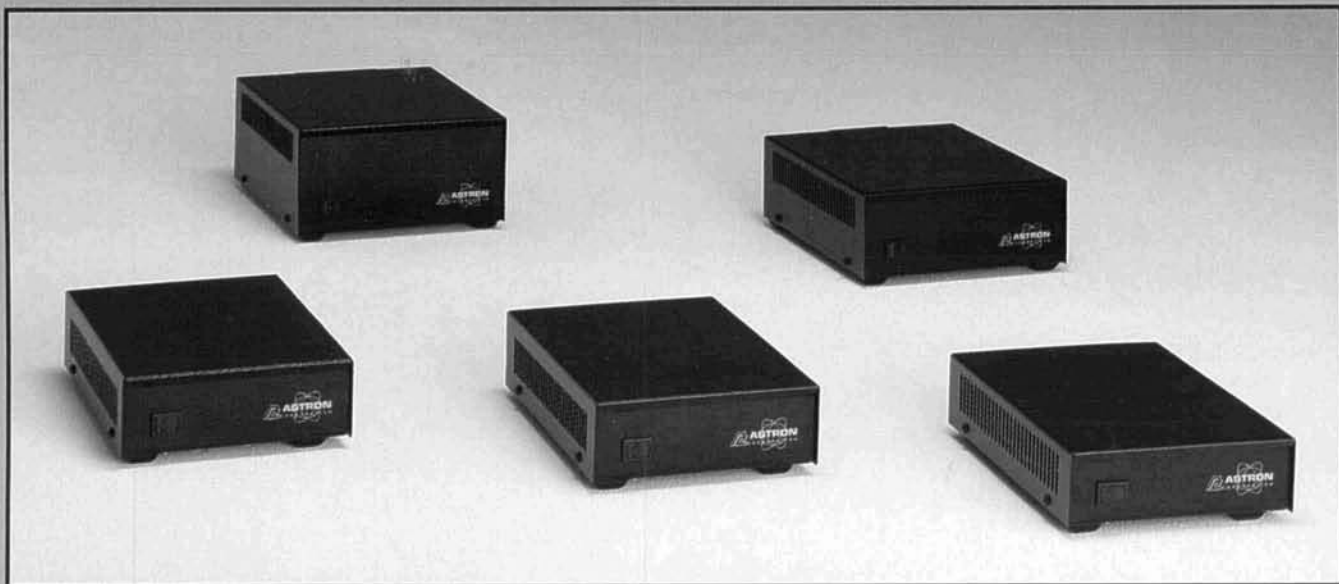

## SPECIAL FEATURES:

- HIGH EFFICIENCY SWITCHING TECHNOLOGY SPECIFICALLY FILTERED FOR USE WITH COMMUNICATIONS EQUIPMENT, FOR ALL FREQUENCIES INCLUDING HF.
- HEAVY DUTY DESIGN
- LOW PROFILE, LIGHT WEIGHT PACKAGE.
- EMI FILTER
- MEETS FCC CLASS B

## PROTECTION FEATURES:

- CURRENT LIMITING
- OVERVOLTAGE PROTECTION
- FUSE PROTECTION
- OVER TEMPERATURE SHUTDOWN

## SPECIFICATIONS:

INPUT VOLTAGE: 90-132 VAC 50/60Hz  
OR 180-264 VAC 50/60Hz  
SWITCH SELECTABLE

OUTPUT VOLTAGE: 13.8 VDC

MODEL	CONT. AMP	ICS	SIZE (Inches)	WT.(LBS)
SS-10	7	10	2.3 x 6 x 9	3.2
SS-12	10	12	2.3 x 6 x 9	3.4
SS-18	15	18	2.3 x 6 x 9	3.6
SS-25	20	25	2 <sup>7</sup> / <sub>8</sub> x 7 x 9 <sup>3</sup> / <sub>8</sub>	4.2
SS-30	25	30	3 <sup>3</sup> / <sub>4</sub> x 7 x 9 <sup>5</sup> / <sub>8</sub>	5
SS-25M*	20	25	2 <sup>7</sup> / <sub>8</sub> x 7 x 9 <sup>3</sup> / <sub>8</sub>	4.2
SS-30M*	25	30	3 <sup>3</sup> / <sub>4</sub> x 7 x 9 <sup>5</sup> / <sub>8</sub>	5

- \*with separate volt & amp meters
- All SS power supplies are available in a RACK MOUNT VERSION (3.5 x 19 x 9<sup>3</sup>/<sub>8</sub>)
- To order Rack Mount Version change SS to SRM (example: SRM-10)



9 AUTRY, IRVINE, CALIFORNIA 92618  
949-458-7277 FAX 949-458-0826

[www.astroncorp.com](http://www.astroncorp.com)

$$K_{MIN} = 2 \frac{Z_1}{Z_2} - 1 + 2 \sqrt{\frac{Z_1}{Z_2} \left( \frac{Z_1}{Z_2} - 1 \right)}$$

<b>Impedance Ratio</b>	<b>Attenuation</b>	<b>Tee Network Values</b>	<b>Pi Network Values</b>
75 $\Omega$ : 50 $\Omega$	4 (6 decibels)	R1 = 43.350 $\Omega$ R2 = 1.6836 $\Omega$ R3 = 81.650 $\Omega$	RA = 2227.3 $\Omega$ RB = 86.505 $\Omega$ RC = 45.928 $\Omega$
600 $\Omega$ : 50 $\Omega$	100 (20 dB)	R1 = 577.13 $\Omega$ R2 = 16.019 $\Omega$ R3 = 34.991 $\Omega$	RA = 1872.8 $\Omega$ RB = 51.981 $\Omega$ RC = 857.37 $\Omega$