

*****AUTO**3-DIGIT 857
 S101903 D08 0306
 BARRY MISHKIND 593
 2033 S AUGUSTA PL
 TUCSON AZ 85710 7905

Radio at Risk

John Gardner of Texas Instruments says a switch to HD Radio must occur soon.

Page 8

Talk Radio: The Beginning

There had been other interview programs. But this was different. Callers would be heard on the air.

Page 16

Radio World



\$2.50

The Newspaper for Radio Managers and Engineers

October 8, 2003

INSIDE

NEWS & ENGINEERING

▼ Dielectric Communications eyes HD Radio, and moves some operations from Maine to Indiana.

Page 6

▼ KDKA 'Dog House' restored.

Page 20



▼ 'Two O'Clock, Eastern Wartime.'

Page 23

STUDIO SESSIONS

▼ Lawson AIR Capsule Microphone; Seven Woods Audio Ursa Major Space Station Processor; and the plummeting price of hard drives.



Page 28

SCIENCE PRIZE

▼ AudioScience and Radio World send a prize to a reader in Alabama.

Page 4



Sign Up For NewsBytes Weekly Digest at www.rwonline.com

NEWS ANALYSIS

Radio Gets Its First Taste of TiVo

Inspired by the Personal Video Recorder, Products Allow Time-Shifting of Programs

by Frank Beacham

Since the VCR first made its way into the American living room in 1975, a few tinkerers have used videocassettes to record radio programs automatically. Though VCRs and timer-enabled audio recorders can be made to work, few offer an elegant and convenient way for listeners to time-shift radio programming.

Now, over a quarter century later, another video product, the TiVo personal video recorder, has spawned a variety of techniques for time-shifting radio programming to the listener's personal preference.

This time the technology works well, thanks to a combination of easy-to-use software, cheap data storage media and computing hardware that fits in the palm of a hand.

However, early users of personal audio recording technology are still experimenting to determine its value in their lives, said Rob Enderle, chief executive at Enderle Research in San Jose, Calif., a See RADIO TIVO, page 3 ▶



PoGo! Products makes Radio YourWay, an AM/FM radio/Flash memory recorder.

Lawyer Dana Raymond Remembered

by Naina Narayana Chernoff

NEW YORK Dana M. Raymond, a patent lawyer who won or settled 21 lawsuits on the behalf of the inventor of FM radio, died in August at the age of 89.

Raymond gained prominence as the attorney who represented Edwin Howard Armstrong, the electrical engineer who developed the basic electronic circuits for radio, radar and television and developed the method of wideband frequency modulation, known today as FM radio. In 1948, RCA and its broadcasting subsidiary, NBC, challenged Armstrong's claim, launching a lengthy legal battle between the inventor and several radio manufacturers.

Raymond first worked on the case at the New York-based law firm Cravath, Swaine and Moore as a young lawyer. After Armstrong's suicide in 1954, Raymond settled with the two companies for \$1 million after proving that neither RCA nor NBC had a legal claim on the patents.

See RAYMOND, page 6 ▶

Drive Your Business.

Introducing Expressfinancing on Harris digital broadcast equipment.

Now you can get 0% Financing* from American Express Business Finance on select Harris digital broadcast equipment.

0% financing.

0% Financing for 36 months

American Express Business Finance and Harris Broadcast Communications Division announce a new limited-time offer for your digital upgrade path.

- Get your digital solution up and running as quickly as possible with the leading broadcast supplier— Harris.
- Preserve your cash with a 36-month, no-interest financing plan on any equipment purchases of \$10,000.00 or more. Use your working capital to grow your business and earn higher profits.
- Move into the new generation of radio with digital solutions specifically designed for your industry. Don't settle for limited systems— integrate your business with anything from consoles, networking to transmission.

For more information on 0% financing of digital transmitters or other Harris equipment with American Express, please call your local District Sales Manager or Sandy Lam at 513-459-3719.

*Terms & Conditions Apply. Financing available through American Express Business Finance Corporation to qualified customers in the U.S. Financing is subject to credit approval and execution of standard American Express Business Finance documentation. 0% Financing available on 36 month term with \$1.00 purchase option. Offer ends December 31, 2003.



www.broadcast.harris.com



NEWSWATCH

Hill Wrangles Over FCC Rules

WASHINGTON Parallel battles in Congress and the courts continued in September, pushed by opponents of the FCC's new media ownership rules and others who support efforts to deregulate broadcasters further. Court action stayed the rules from going into effect, leaving the old rules in effect indefinitely.

The Senate voted 55-40 in September to pass a resolution to roll back the FCC's new rules, short of the 67 votes needed to override a threatened presidential veto.

The resolution went to the House, where its fate was uncertain; House leaders hadn't scheduled a vote. Other legislative efforts to reverse or limit the effectiveness of the new rules are underway.

Sens. Byron Dorgan, D-N.D., Russ Feingold, D-Wis., and Trent Lott, R-Miss., led the opposition in the Senate.

Feingold said after the vote, "I hope that the FCC will now understand how serious we are in Congress about this issue. They didn't just make an honest mistake. They didn't just misinterpret a complicated or ambiguous statute. They headed off in entirely the wrong direction."

Although Sen. Kay Bailey Hutchison, R-Texas, co-sponsored the resolution, she said

she feels radio is "quite diversified. We have plenty of voices in radio."

Senate Commerce Committee Chairman John McCain, R-Ariz., urged fellow senators to oppose the resolution and support a measure passed by his committee to let stand some of the rules, including the new radio market definition.

His House counterpart, Rep. Billy Tauzin, R-La., opposes the measure and wants to keep the new rules intact. He referred to a bill introduced earlier by Rep. Maurice Hinchey, D-N.Y., that would have not only reversed the rules but also brought back the Fairness Doctrine. That measure failed 254-174 in the House.

Other measures solely concerning the

TV audience cap issue were moving forward in both houses of Congress.

Powell: Consider public interest

After the Senate vote, FCC Chairman Michael Powell issued this statement:

"This resolution, if passed by the House and signed by the president, would only muddy the media regulatory waters. It would bring no clarity to media regulation, only chaos. It would create perverse results, such as a return to looser radio rules permitting greater consolidation.

"This is a harm the FCC's new media rules were designed to avoid. It would also reinstate ownership rules that were overturned by the courts. Under the terms of the resolution, the FCC would be forbidden from reissuing any substantially similar rules. In short, the agency would be powerless to cure the infirmities identified by the court."

Powell urged the House "to take a more considered view of the public interest."

Philly won't let go

A side drama was playing out in Philadelphia, where a federal appeals court said it would not surrender jurisdiction of a case involving the new media ownership rules.

The court earlier stayed the new rules, pending judicial review. In September, the court ruled it would not transfer the case to an appeals court in Washington, which previously ordered the FCC to eliminate the rules or have better justification for them.

The FCC and several broadcasters had sought to move the case to Washington, where the federal appeals court previously had heard challenges to the 35-percent TV audience cap. The Philadelphia court said it is qualified to decide whether the agency acted in the public interest.

Oral arguments are set for Nov. 5. The Prometheus Radio Project, a grass-roots group that supports LPFM, is the lead challenger of the FCC's new rules in the court. The group said it agreed with the decision to keep the case in Philadelphia.

— Leslie Stimson

Audioarts R-90

The Perfect Console for Multi-Studio Buildouts!

OUR NEW R-90 HAS THE FEATURES ENGINEERS WANT:

Two stereo program busses and two mono busses—one pre and one post-fader (perfect for backfeeds or on-the-fly mix-minus); dual phone caller support using Wheatstone's exclusive Bus-Minus® circuitry, which generates mix-minus caller feeds with the simple push of the module's MXM bus assignment switch. Both control room and studio monitoring with talkback are provided, including both pre and post studio and headphone level pot monitor feeds. You can even choose a second monitor module for studio two/headphone two output feeds, giving you plenty of monitoring flexibility. And while the frame is compact, it can accommodate up to 23 input or accessory modules in any combination. Because all switching is electronic (and all switches are LED illuminated) you can count on the ultimate in reliability. **THIS IS A TRULY VERSATILE AND COMPACT AUDIOARTS CONSOLE!**

Made in USA | tel 252-638-7000 / fax 252-635-4857 | sales@wheatstone.com | copyright © 2003 by Wheatstone Corporation

AUDIOARTS ENGINEERING
www.audioarts.net

NEWS	
Radio Gets Its First Taste of TiVo	1
Lawyer Dana Raymond Remembered	1
Hill Wrangles Over FCC Rules	2
From the Editor	4
Orban/CRL Posts Q2 Profit	5
Dielectric Grows HDR Line	6
NewsWatch	13
HD RADIO NEWS	
Gen-2 HD Radio Chips Ready	8
Fight Off Satellite, Go HDR	8
Kahn: FCC Should Act on Cam-D	11
Digital News	11-12
FEATURES	
Workbench:	
One More Radar Lover Gone	14
Talk Radio: The Beginning	16
AMBER Alert Web Portal	18
KDKA 'Dog House' Restored	20
Royalties Head Back to Court	22
Two O'Clock, Eastern Wartime	23
Flexibility Is the Path of Wisdom	26
A Hobby Is Born	27
STUDIO SESSIONS	
Drop in Drive Prices Spurs Upgrades	28
DAT-Quality Recording for a Song	30
Space Station: Blast From the Past	31
Lawson Mic Is a New Consideration	33
AES Convention Returns to New York	36
You Actually Worked One of Those?	39
OPINION	
Reader's Forum	45-46

Radio TiVo

► Continued from page 1

firm specializing in personal technology. "The segment is just emerging, and it's not clear exactly what the market is going to be looking for," Enderle said. "But I think it will take some time for the vendors to understand the user dynamics."

Enderle said popular radio programs that air nationally at a fixed time each day are easily recorded with simple timer-based technology, while music programming, unlike its video counterpart, has yet to be listed in well-developed databases. He predicted it will be five years before the technology matures, and by that time most copyright issues that are now so contentious will have been resolved.

Have it your way

Electronics and software makers have so far approached the "Radio TiVo" concept in two main ways: as self-contained hardware-based receiver/recorders that emphasize portability in the hands of the listener, and as software applications that harness the power of a personal computer to become a high-fidelity home entertainment center.

PoGo! Products of Brea, Calif., puts the entire device in the listener's hand. It's Radio YourWay, a 2.8-ounce, \$150 portable AM/FM radio/Flash memory recorder introduced last April. It lets the user record programming anytime, anywhere for later playback.

Recording can be as simple as pressing a button to record a particular broadcast; or its timer can be set up for unattended recording of one-time, daily or weekly programs.

The trade-off with the extremely compact Radio YourWay is audio quality. It records to 32 MB of internal Flash memory or to optional SD or MMC cards, sharing the same ADPCM codec used for voice recordings. This mid-range codec allows up to four hours recording on internal memory and is fine for talk and news programming. Critical listeners, however, will probably find it unsatisfying for music broadcasts.

Radio YourWay has many features beyond off-air recording, including MP3 and WMA playback, and quick file transfer via USB cable to a file manager application for Windows PCs. MP3 files also can be loaded to the device's memory for field listening.

Beyond talk

A less integrated recording system comes from RPR Products of Tucson, Ariz. RPR takes a handful of separate components and packages them in a notebook folder configured as a time-shifting system for talk radio programming. The package, ranging in cost from \$130 to \$220, depending on features, contains an AM/FM radio, digital IC recorder and FM transmitter to play the recording through a car radio.

Any techie could assemble an RPR-type package on his own, but the vendor emphasizes that it has carefully matched components and addressed common problems such as interference between digital recorders and AM receivers. To solve the interference issue, RPR said the radio and recorder are positioned apart in the carrying case.

More sophisticated, and emphasizing TiVo-like features, are new products

appearing as software applications and peripherals for use with personal computers. These use the PC's processing power and hard drive for high audio fidelity and more control tricks.

At a recent MacWorld computer show in New York City, Griffin Technology of Nashville launched its RadioShark, a \$50 AM/FM radio with time-shift and Internet recording capabilities for Apple's Macintosh computers.



Griffin Technology offers RadioShark, a radio with time-shift and Internet recording capabilities for Apple Macintosh computers.

RadioShark, connecting via USB cable, can receive and record AM or FM radio broadcasts, allowing users to schedule the recording of radio events in advance. It also can record Internet audio streams, either scheduled or real-time, from any streaming audio application available.

However, RadioShark's breakthrough feature allows the user to pause a live broadcast and then return to it in moments or even hours later, continuing where the listener left off. Just like TiVo.

"The fin-shaped device acts as the antenna and can be adjusted and positioned for best reception," said Andrew Green, Griffin's vice president of marketing. "Once connected, all radio tuning and control is through its full-featured front-end application."

Recordings made through RadioShark can be transferred to an Apple iPod music player or any other AIFF-compatible digital music player for portable replay. The product is scheduled for delivery in late October, Griffin said.

Play it back

The lowest-cost and most advanced automated audio recording products are software applications for personal computers.

Ironically, the major free streaming audio players eschew timed recording; but there are a growing number of third-party products for the Windows and Macintosh platforms. The good news is that with a broadband Internet connection and high-quality codec, these applications can provide the most control and best fidelity of any solution.

On the Windows platform, Replay Radio (\$29.95) from Applian Technologies of San Francisco mimics TiVo functionality for radio. Select a show, or station and time range, and the application records it for the user.

It works with Internet radio broadcasts in any format, including Real, Windows Media and others. Once your show is recorded, the application creates MP3 files or a CD for listening anywhere. The

entire process can be automated.

Replay Radio preprograms hundreds of shows and stations, making recording a point-and-click process. Applian also touts Replay Radio as a general-purpose recorder for archiving audio books, saving music, monitoring online police scanners and recording from devices attached to a PC (such as cassette decks or radio receivers).

For owners of Pocket PC devices, there's a separate Replay Player (\$19.95) application that allows programs recorded on by Replay Radio to work seamlessly on a portable device. Listeners easily can navigate radio programs recorded on their PC and quickly skip over blocks of commercials with the press of an on-screen button.

For users of Macintosh OS X, Audio Hijack Pro from Rogue Amoeba Software of Princeton, N.J., offers one of the most advanced personal audio recording applications available, at the modest price of \$30. Yes, listeners can automatically record radio broadcasts and audio from any other application on the computer. But with Audio Hijack Pro, the sound can be sweetened with industry-standard VST and AudioUnit audio effects, as well as 15 custom DSPs included with the application.

Audio Hijack Pro is flexible and powerful. It can record any audio type, be it Real, Windows Media, or AAC to the AIFF or MP3 formats. Low-quality radio signals can be enhanced with DSP

effects. Green Oak's Excitifier VST plug-in, which is included, can be used to "unmuddy" music by adding the upper harmonics back.

With support for Apple's built-in AudioUnit plug-in format, it comes with a parametric equalizer, a 31-band graphic equalizer, AUMatrixReverb and more. Audio levels can be monitored with the level meters, VU meters, menu bar Meters or mda's Specmeters VST plug-in, included. With the Pipe Dream plug-in, serious computer geeks can pipe audio to any command-line application.

For timed recordings, there's an entire package of timers. The application can function as an alarm clock, waking up the user to live radio, net streams, MP3s, DVDs, compact discs or any other audio desired. 

More Info:

Radio YourWay
www.pogoproducts.com

RPR
www.radioprogramrecorder.com

RadioShark
www.griffintechnology.com

Replay Radio
www.replay-radio.com

Audio Hijack
www.rogueamoeba.com/audiohijackpro

SCMS, INC.

YOU-KNOW-WE-KNOW-RADIO!



SPREAD TOO THIN AND FEELING DRAINED?

- Experienced Staff
- 26 Years of Personal Service
- Competitive Prices for over 600 Quality Manufacturers of New Equipment
- Huge Stock of Rebuilt RF and Audio Gear
- Extensive Rental Fleet (Audio, RF, Codecs, Test Equipment, and more!)
- Trade-Ins Welcomed

TRY SCMS ON FOR SIZE - WE CAN FILL YOUR NEEDS

<p>WEST COAST Doug Tharp Voice 866.673.9267 Cell 818.398.7314 Email dtharp@san.rr.com</p>	<p>CENTRAL Bernie O'Brien Cell 731.695.1714 Email bernieob@earthlink.net</p>	<p>NORTH-EAST Dan Lohse Voice 908.722.6015 Fax 908.722.4359 Pager 877.792.8024 Email scmsnorth@aol.com</p>
<p>SOUTH-WEST Tyler Callis Cell 817.312.6338 Email tylercallis@integrity.com</p>	<p>MID-WEST Mary Schnelle Voice 1.800.245.4307 Fax 513.583.1343 Email mschnelle@maryschnelle.com</p>	<p>MID-SOUTH Bob Mayben Voice 877.391.2650 Fax 256.543.0595 Email bobmayben@usa.net</p>

CORPORATE SALES OFFICE - PINEVILLE, N.C.

Toll FREE 800.438.6040 Fax 704.889.4540

Email sales@scmsinc.com
www.scmsinc.com

Audio Service for Radio Lovers

Lately, I've been driving around enjoying radio on cassette.

I've been listening to the DX Audio Service, an aural publication of the non-profit National Radio Club, the oldest and largest medium-wave distance-listening club, founded in 1933.

If you love talking with friends about the radio band, listening to distant stations or swapping tales of legacy call signs, this is for you. If you often find yourself stuck behind the wheel, this is *perfect* for you.

Frederick R. Vobbe is the publisher. The original publication was intended for a blind audience; but since it started — 222 issues ago, in 1985 — many sighted people have signed up.

The magazine is mailed to about 150 subscribers on C-100 cassette tapes each month. A U.S. subscription costs \$28.

"Nobody is paid for their service; many of us often have to pay out of our own pocket the costs of producing segments," Vobbe said. "We do this out of the need to share information and answer questions that most people don't have access to."

It started when a blind friend expressed envy that Vobbe could read issues of Radio World, Broadcasting and other

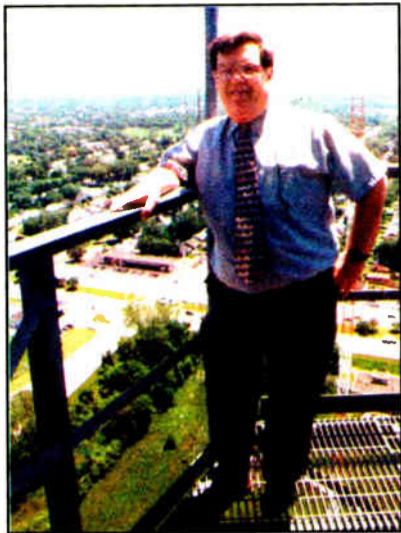

Fred Vobbe

trade magazines.

"I thought that I could just read some articles ... and then copy them off," Vobbe recalls. "The National Radio Club heard about me and asked if I would be interested in reading their magazine. A few other people in radio volunteered to read a few stories, and the

format was born."

Each contributor has an audio column; Vobbe edits the content and acts as host. Features include:

AM Switch — Call letter changes, technical changes, new stations and applications. Host Jerry Starr recently retired after 300 columns in DX News magazine and 200 in DX Audio Service. The new editor is Bill Hale.

Travellog — This is one of my favorite features. John Bowker, formerly of RCA, takes a frequency — say, 830 kHz — and drives from city to city to hear top-of-the-hour IDs from stations.

"John and Linda Bowker don't go anywhere without their cassette recorders and radios," Vobbe said. "It's not uncommon for them to plan a trip from their home in Tampa, Fla., based on what stations are along the way." Members often send recordings of stations to complement Bowker's collection of IDs.

Bandscan — Mark Durenberger, a long-time friend and contributor to Radio World, takes a look at how signals are received; he visits stations and gives us an audio tour. Mark talked and walked with Paul Jellison at historic WLW(AM) when I listened.

Sports — Which teams are on which stations, with which announcers? Says Vobbe, "Ken Onyschuk is one of those people you can mention a team name to and he knows the flagship station's call sign, frequency, the names of the play-by-play people and 50 percent or more of the affiliates. Amazing person."

Marketscope — Another of my favorites. Phil Wayne invites people to send airchecks of stations in a given city. "When you meet someone else who collects tapes, the first question you ask is always, 'What does radio sound like in your town?'" Marketscope covers this question with short snippets."

Vobbe will round out a tape with stories from publications, e-mail lists, FCC releases and other news; on the tape I sampled, he quoted a letter in Radio World about Cam-D. He engages readers in editorials and demonstrations on technology, such as how to select a loop antenna.

Lavell Jackson, owner and chief engineer of news/talker WGSV(AM) and country station WTWX(FM) in Guntersville, Ala., wins the prize in our New Technology Sweepstakes. You can sign up at www.rwonline.com.

Jackson's son Kerry, who works at the station, tells me his dad has been in radio for six decades and is a dedicated Radio World reader.

He wins an AudioScience ASI5111, a PCI audio adapter that features a mic pre-amp with phantom power. It provides stereo analog and digital I/O; mic input; two record streams; and four play streams. Audio formats include 8-, 16- and 32-bit PCM.

The analog interface is balanced and uses 24-bit oversampling converters. The digital interface can be software-configured for AES/EBU or S/PDIF operation.

The balanced mic input works with pro microphones requiring +48V phantom. Gain is adjustable up to 60 dB. Effects include a compressor/limiter/expander and three-band parametric EQ. Retail value: \$545.



From the Editor



Paul J. McLane

In the past, stories were sent in on reel tape or cassette; now most contributors use FTP. The program is distributed on cassette, although you can sample programs in Real Audio online.

A ham and an award-winning broadcaster, Vobbe is a vice president and chief operator for WLIO Television in Lima, Ohio, and a communications officer for the Allen County Emergency Management Office. He is co-chairman of the Lima-Ailen County EAS district and has volunteered for numerous community organizations. He collects oldies music and restores recordings of radio jingles and production.

He has interviewed people from Wolfman Jack to Mike Dorrrough. His favorites include Leonard Kahn, who spoke with him about AM transmission, distortion and fade, and Dave Graupner of TM/Century, "because the jingle business is such a mystery to people."

He recalls working with large multi-directional AM antenna arrays, like that of WLQV on 1500 kHz in Detroit — nine towers, 50 kW by day; 12 towers with 5 kW at night. He worked at WTUU in Toledo and several other stations in Ohio and Michigan. He has been an operations manager and announcer in several markets and did a stint with jingle company William B. Tanner.

More people would subscribe to the DX Audio Service if the word got out, Vobbe feels. "New subscribers ... often comment, 'I wish I would have known about you guys years ago.'"

To learn more, visit the club's Web site at www.nrcdxas.org.

Shouldn't your transmitter remote control be

Good As New?

BURK TECHNOLOGY

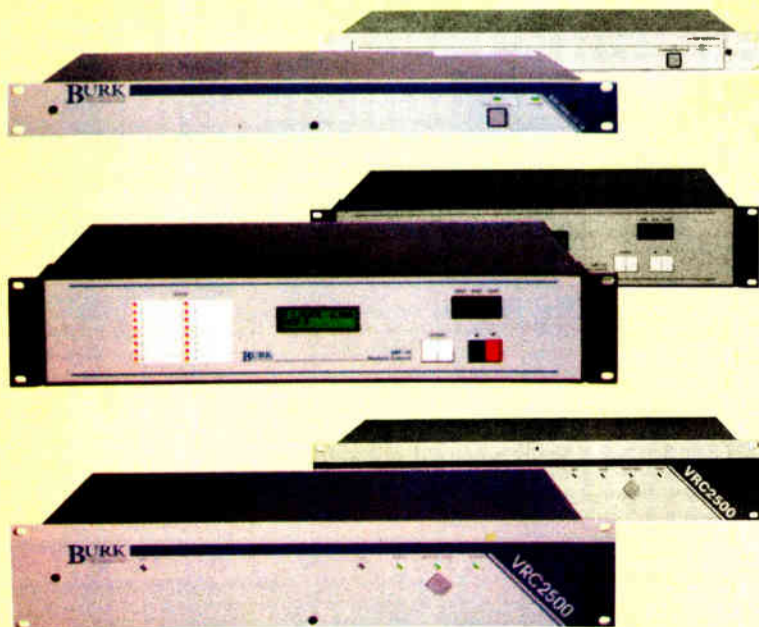

At Burk Technology, **your future needs are just as important as today's**. That's why our products feature the most robust designs for years of continued use. And that's why it's time your current product is **GOOD AS NEW**.

Take advantage of our **GOOD AS NEW** offer and get:

- All the latest hardware and firmware changes
- New Lynx 4 software for GSC3000 and VRC2500 users
- Front panel enhancements for ARC-16 systems
- New two-year factory warranty
- Same-day service

We'll bring **any** GSC3000, VRC2500 or ARC-16 up to date — **no matter when you bought it or who sold it to you**.

Call today to find out how you can benefit from Good As New.

800-255-8090 | WWW.BURK.COM

Raymond

► Continued from page 1

Just before Armstrong's death in February of 1954, Raymond helped file lawsuits against 21 other companies that refused to pay Armstrong for licensing the technology. During the 13 years that followed, he won or settled lawsuits on the behalf of Armstrong's wife Marian McInnis for a total of \$10 million.

"He was an innovative legal thinker who pursued the cases with success to protect the technology and intellectual output of Edwin Howard Armstrong," said Adam Brecht, the great-grandson of McInnis' brother. "He devoted a significant part of his career to the cases."

Raymond, who knew Armstrong before the litigation began, "won Armstrong's confidence ... by his ready grasp of FM and the technical-legal issues at stake," according to Lawrence Lessing, author of "Man of High Fidelity," a biography of Armstrong written in 1956.

The most pivotal decision among the court cases occurred in 1959, when Raymond asked for a trial before a judge in the lawsuit against Emerson Radio and Phonograph Corp. The attorney, according to his daughter Catherine Flickinger,

chose to ask for a judge instead of a jury trial — a choice commonly preferred for individuals suing large corporations.

Her father, she said, realized it was a complicated issue for a jury to understand and their verdict may not have stood up in court for future lawsuits whereas a judge's ruling would set a precedent for future cases.



Dana Raymond

In September 1959, the U.S. District Court in Manhattan ruled in favor of Armstrong's estate, making Emerson pay the standard royalty rates Raymond had argued for from the 21 companies, according to Lessing's book. Raymond

worked on the Armstrong lawsuits until 1967, when the U.S. Supreme Court refused to hear a case against Motorola, which he had won at the district court and circuit court levels.

Brecht said Raymond's work allowed Armstrong to get some credit for the invention of FM, for which the inventor is not widely known. "People don't connect FM with his name," he said. "It's an unfortunate

Brumbaugh, Graves, Donahue and Raymond.

As a lawyer, Brecht said, Raymond had a good understanding of electrical issues thanks to his work in the Army during World War II. A physics major at the University of California, Berkeley, he worked on the development of radar during an assignment in the Royal Air Force in Scotland.

Raymond gained prominence as the attorney who represented Edwin Howard Armstrong.

tragedy that we would like to change."

In an online seminar about the life of Armstrong, Raymond was quoted as saying, "Armstrong died thinking he was broke, yet he left a very well-to-do widow. And he was completely vindicated on his contributions to radio."

After the Armstrong case, Flickinger said her father decided to specialize in patents, trademarks and copyrights and worked on complex patent litigations for clients including Dr. Charles H. Townes, a Nobel Prize-winning physicist whose work helped lead to the development of the laser. In 1954, the attorney left Cravath, Swaine and Moore to become a partner at Campbell, Brumbaugh, Free and Graves, which later became

After serving in the war, Raymond returned to his birthplace, New York City, to work at the Industrial Conference Board and attend Columbia Law School. He was married for 50 years to Josephine Sheehan, who died in 2000. He is survived by three children including Flickinger as well as sons Peter and John Raymond, and seven grandchildren.

Flickinger said her father, an avid ocean swimmer, tennis, squash and chess player, went to the office every day until he was 86. In addition to being a member of the Radio Club of America, Raymond sat on the Armstrong Memorial Research Foundation.

"He had an interest in radio, always," she said. 🌐

Orban/CRL Posts Q2 Profit

Company Again Looks to Amend Loan Agreement With Harman

by Randy J. Stine

TEMPE, Ariz. Orban/CRL turned a profit in the second quarter of this year after two years of losses. Meanwhile, the supplier is seeking another debt restructuring from Harman International.

Buoyed by strong domestic sales of its Orban product line, processor manufacturer Circuit Research Labs Inc.

for Orban/CRL to repay both long- and short-term notes totaling just over \$8.1 million by Dec. 31 of this year.

According to the company's SEC filings released in August, "Management has been negotiating with Harman with respect to restructuring the existing debt. If such a restructuring occurs under the current terms being discussed, (Orban/CRL) would make a principal

The quarterly profit comes after two years of losses for the company.

reported net earnings of just over \$160,000, or 4 cents per share, for the second quarter of 2003. That's according to the company's most recent filing with the Securities and Exchange Commission.

CRL's net sales for the three-month period ending June 30 were approximately \$3.4 million. Sales of Orban products represented \$2.9 million of that total.

The second-quarter profit follows yearly losses of \$2.1 million and \$2 million in 2002 and 2001, respectively.

Meanwhile, CRL continues talks with Harman International Industries Inc. on ways to pay off debt from its acquisition of Orban from Harman in June 2000.

CRL agreed to pay \$10.5 million for Orban in that highly leveraged buyout. It has received several extensions on the debt to Harman, with the latest restructuring agreement in May 2002 calling

payment of \$1 million." No payment date was set.

The SEC filing continues, "\$3.5 million of the unpaid balance would be converted into shares of common stock of Orban/CRL. The remaining unpaid balance would be payable over five years in accordance with a payment schedule."

CRL President and Chief Executive Officer Jay Brentlinger declined to comment on the latest SEC filing and ongoing negotiations with Harman.

The filing showed that as of May 15, Orban/CRL was in arrears for the interest installments on the Harman obligation by \$780,000. The company did make \$300,000 in payments to Harman during the three-month period ending June 30.

Circuit Research Labs Inc. common stock is traded on the OTC Bulletin Board (NASDAQ:CRLI).



Buy one of our DA's, Phone Hybrids or Silence Sensors any time this year and get a

CT-2002 Clock - up/down Timer FREE! (a \$135.00 value)



601 Heron Drive, Logan Township, NJ 08085
(856) 467-8000 • (856) 467-3044 FAX
www.radiosystems.com

CALL ONE OF THESE PARTICIPATING DEALERS

-  BROADCASTERS
GENERAL STORE
 -  ESW
 -  Cruise-Kimzey
 -  SCMS INC
 -  Tech 119 Systems Group
- (352) 622-7700 (800) 426-8434 (800) 433-2105 (800) 438-6040 (888) 832-4638

Dielectric Grows HD-R Line

Company to Shift Radio Engineering and Some Manufacturing to Indiana Facility

by Randy J. Stine

RAYMOND, Maine With the first round of HDTV antenna conversions nearing completion, Dielectric Communications is looking ahead to what its executives believe will be the next big broadcast equipment market in this country: HD Radio.

As a result, the manufacturer of antennas and RF components will move radio engineering and some radio manufacturing from its 125,000-square-foot facility in Raymond, Maine, to a plant in Newburgh, Ind.

A company spokesman said the move is intended to better position Dielectric to serve radio broadcasters in their transition to digital broadcasting and speed delivery of equipment to the coasts. The company has added products for the HD Radio market and is in the process of developing a line of products for AM.

Dielectric Vice President of Marketing Jay Martin said the company is positioned to leverage a decade of digital development for television to benefit FM and AM broadcasters.

No longer primarily TV

"The realignment will allow us to focus on the radio product line. Up until now, we've primarily been a television business. With the HDTV boom, our main focus has been there and our engineering resources have been applied there. We wanted to put together a dedicated radio engineering team and have them concentrate on that discrete line of products," Martin said.

The shift will not result in the loss of jobs at either facility. Radio engineering design is already being done at the 76,000-square-foot Newburgh plant, with antenna manufacturing expected to

move in the fourth quarter this year, Martin said. Radio transmission line and RF systems manufacturing will remain in Raymond. He added, "We do expect to add employees once antenna manufacturing begins in Newburgh."

Dielectric, a unit of SPX Corp., has 80 employees in Newburgh and 240 at its Maine headquarters.

Martin said Dielectric has made two adjustments in its workforce as a result of the downturn in the HDTV antenna market and the overall economic uncertainty.

"We are currently operating at employment levels similar to that of early 2001," he said. He declined to say how many layoffs have taken place this year.

The company named Rex Niekamp to oversee radio and tower operations in Newburgh and has hired several sales people to support the radio product lines. Niekamp previously worked as senior director of Dielectric's Palmyra, Mo., television antenna design and manufacturing facility.

New products for digital radio are being manufactured, Martin said, including the HDR series antenna, an interleaved analog/digital antenna.

"It uses the same aperture as the analog array, but interleaved within that is the digital array with a different polarization. That way you get isolation between the two services and you can run very reasonable transmitter powers into both services."

Two master antennas for the FM broadband world include the FMVee top-mount radio antenna, and the Cavity Backed Radiator antenna. Both are designed for analog and digital services, he said.

Dielectric expects to introduce a line

of products for domestic AM radio broadcasters, too, focusing on RF components, tower and antenna structures initially, Martin said.

"AM radio is really a new market for us. Essentially, the AM antenna is the tower itself. (Since the purchase of Central Tower) we can now package the tower, the phasing cabinets, antenna tuning units and the transmission line as a complete system for the AM market," he said.

Martin said Dielectric has positioned itself with several acquisitions the past two years to take advantage of in-band, on-channel digital terrestrial radio broadcasting. The company purchased Central Tower of Newburgh, Ind., and TCI International of Fremont, Calif., in 2001. Central Tower sells both wireless and broadcast towers. TCI's strength in the

Dielectric's renewed focus on the radio antenna market is expected to result in more competition for other antenna manufacturers such as Electronics Research Inc. and Shively Labs.

"Dielectric has been a player in the FM radio market for a while. It seems logical that they would place more emphasis on radio now that the digital television implementation has passed its peak," said Kinsley Jones, engineering and marketing manager for Electronics Research Inc.

"Our industry enjoys an active and healthy competitive environment. The competitive balance will only change based on the performance of the competitors."

Jones said the advent of FM IBOC doesn't bring radically new technology, but instead an added importance on precision.

"Design, manufacturing and tuning practices that work well enough for ana-



Dielectric workers build a six-station FM combiner at the Raymond, Maine, facility.

high frequency and medium frequency fields and signal processing capabilities were a "natural fit" with Dielectric, Martin said.

New growth

The present business climate is challenging, Martin said, as it is for most every broadcast equipment supply company with the condition of the economy.

"However, we've enjoyed several years of growth because of the digital television boom. We are now envisioning radio as the next growth curve for us, primarily because of digital radio."

Martin said industry estimates indicate that 75 percent of TV stations in the country have purchased their first HDTV antenna.

"The remaining 25 percent are typically cash-challenged, in smaller markets and religious or noncommercial broadcasters," he said. "The good news is there will be a second round of maximizations for TV, probably into mid-2005 for the top 400 stations. However, the FCC has yet to define the dates."

Dielectric has preferred customer agreements in place with Cumulus Broadcasting Inc. and Cox Radio Inc., and is pursuing others, Martin said. Under terms of the agreements, Dielectric is the preferred supplier of antennas, transmission line and RF systems for Cumulus and Cox stations.

log alone won't necessarily produce a satisfactory result for IBOC," he said.

Shively Labs Sales Manager David Allen said, "Over the last 40 years we've heard about Dielectric's commitment to FM more than once. It usually coincides with a downturn in TV. Dielectric dominates TV because it is their primary focus at all levels of the company. It remains to be seen if they will truly refocus any of those resources to penetrate the FM antenna market at the level of Shively or ERI, or whether they'll just be diverted until they need them for TV again."

Allen said, "It's curious that (Dielectric) is setting up shop a thousand miles away (in Indiana) from top management, sales and their main engineering staff. FM antennas and combiners are not commodities. They are projects that require expertise from multiple disciplines."

Dielectric Communications was founded in 1942 as a joint venture between the Massachusetts Institute of Technology and Dr. Charles "Doc" Brown. Initially, the company designed feed systems for military radar. Dielectric began working with antenna makers Gates and RCA in the early 1950s supplying feed systems for their antennas and transmission lines. Dielectric was acquired by SPX, a global provider of technical products and systems, in 1998.

Audemat-Aztec

Measure your REAL FM COVERAGE

At a Price EVERY Station Can Afford!

Compact and easy-to-use, the NAVIGATOR 100 can be configured to measure single or multiple frequencies.

It provides complete high speed mobile analysis of FM modulation and field strength.

NAVIGATOR 100 includes a built-in GPS receiver for completely automatic signal mapping and a PCMCIA card for data storage. Compatible with mapping software MapPoint, MapInfo...

www.audemat-aztec.com • Aventura, FL USA: tel: +1 (305) 692 7555
Fax: +1 (305) 682 2233 - ussales@audemat-aztec.com

The Best Just Got Better!

With new rock solid, fully digital modem technology, the Matrix is the most reliable, best sounding codec available. And now the Matrix offers another tool for your remote kit: **The GSM Wireless Module.**

- New** Built-in GSM Phone.
- New** Aggressive Algorithm delivers 7 kHz on GSM.
- New** Error Handling Technique.
- New** External Antenna.
- New** Increased Power for More Reliable Connections.
- New** Remarkably Stable Modem Technology.

All this adds up to better stability, improved audio, and greater flexibility. Already own a Matrix? *Call us and we'll upgrade you to the newest modem technology for FREE!* Plus we'll be happy to set up a demo of the new GSM module.



Here is what some of our numerous Beta Testers had to say:

Clear Channel Director of Engineering for St. Louis Daryl McQuinn said: "Sounds much better than a bad [RPU], almost as good as a good [RPU], and way better than you should ever expect from a cell phone remote!" but all KLQJ's Program Director Al Brock could say was, "Wow!"

Shaun Kassity from Salem Communications' 104.7 The Fish in Atlanta: "Thanks to Matrix GSM we had the best sounding remotes ever on our station!"

Steve Kirsch of Silver Lake Audio: "The feed was rock solid. I'm very impressed—it sounds much better than I thought it would."

Collin Mutambo, Radio Simba, Kampala, Uganda: "We are indeed quite impressed."

But our personal favorite, from Jerry Dowd of Jefferson Pilot's WBT in Charlotte, NC: "We hope to keep the betas until you get nasty with threatening letters." Thanks Jerry. We'll take that as a compliment!

Testing has been successful in 25 US states and on 6 continents with more results coming in every day. The Matrix with the optional GSM Module delivers 7 kHz on GSM wireless. Now accepting orders.

See us at the NAB Radio Show Booth # 123

Call us today at 800-237-1776 to learn more about the Matrix!

COMREX

19 Pine Road, Devens, MA 01432 USA

Tel: 978-784-1776 • Fax: 978-784-1717 • Email: info@comrex.com • www.comrex.com

World Radio History

Gen-2 HD Radio Chips Ready

*TI Readies Second-Generation IBOC Chip;
Analog, Digital Processing on Single Baseband*

by Leslie Stimson

DALLAS Texas Instruments has its second-generation IBOC chipset ready for receiver manufacturers. TI and Ibiquty say this is the first chip with the analog and digital processing incorporated into a single baseband — reducing manufacturing costs.

The previous chip for HD Radios, released in August 2002, had analog and digital processing on separate chips. The digital portion was literally “bolted onto” the analog baseband, said TI spokesman John Gardner. One advantage of the new, integrated chip is the savings derived from eliminating a baseband, he said.

For use in automotive radios, the DRI250 chip integrates IBOC and intermediate frequency-sampled AM/FM, as well as audio processing and MP3 and Windows Media Audio CD support on the baseband.

Improved range

Gardner said combining these capabilities in software on one chip saves manufacturing costs. For example, the sample cost per unit for the DRI200 introduced last year at this time was \$50, while the sample price for the DRI250 is \$30.

The chip handles the IBOC modula-

tion and decoding necessary to process Ibiquty's AM and FM waveforms.

TI claims improved dynamic range for analog AM/FM in receivers using its software radio algorithms, including improved AM receiver behavior in the

presence of second-adjacent hybrid (analog and digital) signals.

Samples of both chips are to be available in the fourth quarter for use in 2004 HD Radios.

Gardner said the software-programmable chips will allow for features to be incorporated in the future such as surround sound for FM and time buffering for the ability to “rewind” live radio.

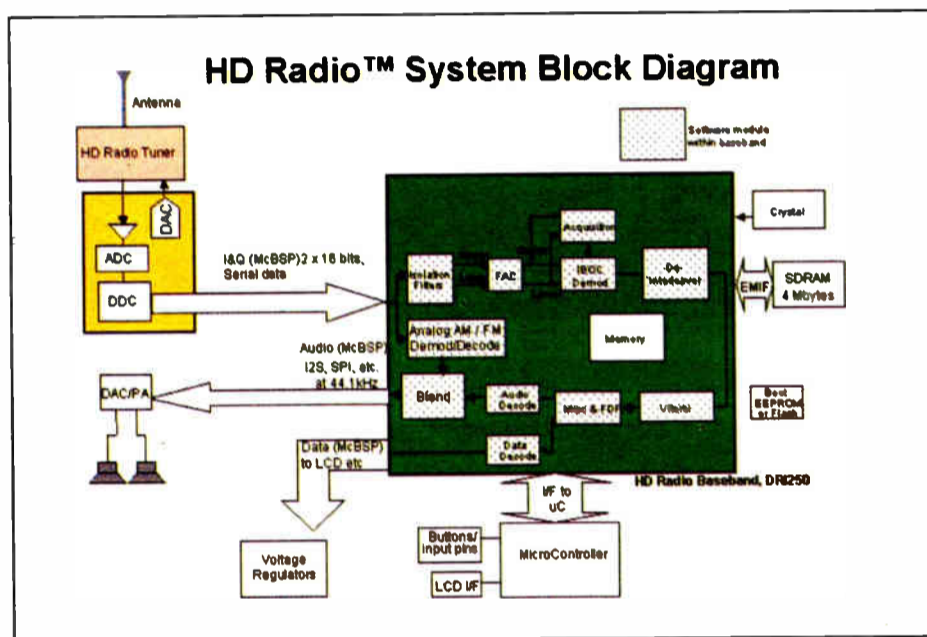

This diagram shows the components of the TI chip and how it relates to the rest of the receiver and to Ibiquty's system.

GUEST COMMENTARY

Fight Off Satellite, Go HD-R

More Content, Services Will Drive Digital Radio Sales

by John Gardner

The author is digital radio marketing manager for Texas Instruments.

In early June 2003, National Public Radio program host Robert Siegel interviewed Thomas Hazlett, a former chief economist for the FCC, about the possibility of removing free-to-air television broadcasts from the VHF and UHF bands, giving way to new, exciting wireless data services.

According to Hazlett, most people in the United States, 90 percent, already pay for their television, either through cable or satellite subscriptions. The switch reflects market realities.

This situation has some applicability to the emerging digital radio market. While not on the same order of magnitude, subscription-based services, such as XM Satellite Radio and Sirius, have established a strong foothold with today's radio listeners.

Consumers have shown a willingness to pay for and listen to this radio over existing free-to-air services. Defenders of terrestrial radio have looked to HD Radio as a means to compete effectively with their satellite counterparts.

In order to continue terrestrial radio's success, a switch to HD Radio broadcasting must occur soon. Without it, free-to-air, terrestrial radio broadcasting will give up significant ground to satellite radio in the coming years.

Satcaster growth substantial

XM and Sirius have shown phenomenal growth. Through its promises of clear digital sound, and more important, its offer of 100 channels of eclectic radio programming, satellite radio has brought in listeners by the hundreds of thousands.

XM has said that it is trying to reach a total of 1 million subscribers, while Sirius has made substantial progress in the past few months, bringing in more than 100,000 subscribers. These two companies will only continue to grow with the availability of factory-installed car radios and inventive prod-

See HD RADIO, page 10

The Wizard™ has gone STEREO!

The new **DIGITAL** FMSA-1 gives The Wizard System unmatched stereo monitoring capabilities. . .



Superlative stereo performance. Linear-phase filters that reveal the true performance of your audio processing. The stability of digital stereo demodulation. The sophisticated graphical presentation of The Wizard. And—with the RS-232 port—operation on site or off.

Contact Belar today for more details on what should be your next modulation monitor

BELAR ELECTRONICS LABORATORY, INC.
119 LANCASTER AVENUE • P.O. BOX 76 • DEVON, PA 19333-0076 USA
(610) 687-5550 • FAX (610) 687-2686
Call, write or FAX for more information on Belar AM, FM, Stereo, SCA, and TV monitors.
www.belar.com

TI said the benefit of upgradeable software was demonstrated in dramatic fashion when its first Ibiquty chip, the DRI200, accommodated Ibiquty's recent switch from PAC to the new HDC codec.











Gardner said TI's previous experience developing DSP chips for cell phones and Eureka-147 radios has enabled it to apply some of those technologies to terrestrial digital radio.













TI is an investor in Ibiquty. It predicts digital radios will replace analog radios in the United States by the year 2010.









A new companion analog front end complements the DRI250 baseband. TI's new mixed-signal DRI8201 chip provides the IF analog-to-digital converter, digital down converter and control digital-to-analog converter needed in a complete digital radio design to process the audio. The DRI8201 uses an 80-MHz, 12-bit ADC to digitize the AM/FM intermediate frequency signal from the radio tuner.

TI claims performance improvement through oversampling done by the 12-bit ADC on the chip. Through software radio algorithms, such as adaptive stereo separation and adaptive audio bandwidth control, the DRI250 addresses specifications for audio signal-to-noise ratio, total harmonic distortion + noise and stereo separation and sensitivity.

Chapter One

Once upon a time, a radio engineer  and talk show host named Steve  grew frustrated with the awful sound of his telephone  system. So, he read lots of books  about Digital Signal Processing and invented the  Telos 10. After that, Steve's phones sounded great, and he was happy. Lots of other radio stations that used it were  happy, too, and Steve's company grew large and hired more  smart engineers. They partnered with the MPEG folks  and introduced MP3 to the world with  Zephyr. And Zephyr sounded so good, it made *lots* of people  very happy.

About the same time, another radio engineer named Frank  was figuring out how to make audio sound both loud  and clean . Frank began building processors for lots of important  big-market radio stations. Soon, Frank teamed his audio chops  with Telos' DSP gurus , and built the first digital audio processor  that gave stations the loud, clean, punchy sound they wanted without the digital "grunge" – which made lots of Program Directors and engineers at even more radio stations happy . And Frank's processors became the choice of top stations like , , , ,  and many more.

Now, Steve and Frank's companies have the biggest R&D team  in the industry, with respected broadcast engineers like Jeff Keith , scientists like Greg Shay , and studio-audio experts like Mike "The Catfish" Dosch . These guys think up  lots of innovative gear together; cool stuff like the Zephyr Xstream  ISDN Transceivers with leading-edge MPEG AAC , and Omnia-6 , the broadcast audio processor preferred by major radio stations around the world, and the world's first broadcast phone system, TWOx12 , that takes advantage of the digital clarity of ISDN, and the truly amazing little Zephyr Xport  POTS+ISDN codec which features aacPlus® , and is winning lots of awards.

...and that's just the *beginning* of the story! 

Omnia
A Telos Company

Telos
AUDIO | NETWORKS

telos-systems.com
omniaaudio.com

The Telos logo, Zephyr, Omnia, TWOx12, Zephyr Xstream and Zephyr Xport are all registered trademarks of TLS Corp. ©2003, TLS Corp. All other trademarks property of their respective holders. All rights reserved.

HD Radio

► Continued from page 8

ucts such as Delphi's SkyFi XM Radio.

"Satellite radio could reach 6.2 million units in 2005. We expect it to hit 1.3 million in 2003, since it is at 800,000 now," said Ryan Jones, Yankee Group analyst.

"The radio market has a couple of years, but when we hit 2006 and 2008, they will start to see customers go away. Satellite radio is a legitimate threat to terrestrial radio. In order to keep up with all

held over those other encroaching technologies. While analog AM/FM will still point to localism as an advantage over satellite radio — and even this position might become tenuous — anecdotal evidence points out listenership will still diminish. A quick tune-in just for the local traffic and weather reports will satisfy most people.

Additionally, the subscription keeps listeners on the satellite dial, compelling them to tune in to where their money goes. Taking this line of thought to its natural conclusion, without listeners, radio's customers will no longer see local free-to-air broadcasts as a

Radio will start to lose customers in 'a couple of years,' according to one analyst.

the digital media, terrestrial radio has to go through an update."

While not evident to some, this subscriber growth will directly affect listenership of traditional radio. The old argument that radio survived TV, cable and the Internet will not work with satellite radio.

Satellite radio offers spontaneity and passive listening in a mobile environment — the main benefits non-digital or analog radio

viable medium with which to advertise, though they may see satellite as an alternative. Consequently, traditional radio will struggle.

Enter HD Radio technology, which has the capacity to provide high-quality sound, the propensity towards broadcast data services and the possibility of adding new content. Ibiqity, developer of the in-band, on-channel technology, claims that digital FM will sound better

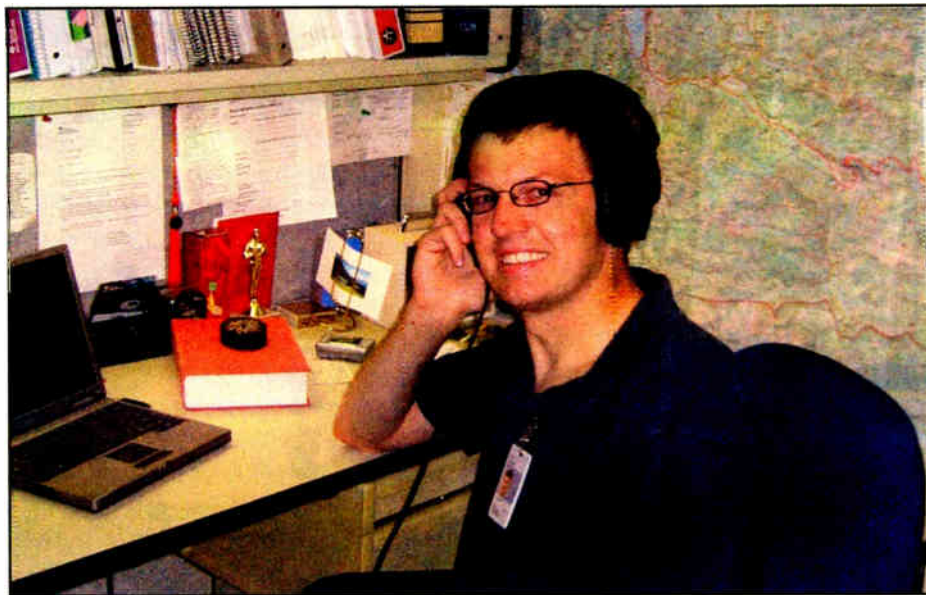

John Gardner

than analog, eliminating many of the destructive effects of multipath through IBOC's digital techniques.

In addition, HD Radio technology has an inherent capability of broadcasting data. Simple text displays, such as song and title information, already seen on satellite radio receivers, will become available with an HD Radio broadcast.

However, HD Radio transmissions can act as a data pipe, streaming a variety of content to a listener, including traffic, weather, sports and images. Broadcasters can send an endless variety of information, turning radio into a personal communication device. (For more on data in HD Radio, see www.ti.com for a Sept. 8, 2002, white paper on "Data and Audio Processing for Digital Radio.")

More programming possibilities

Finally, HD Radio technology enables more content on the air. This can happen in two ways.

First, NPR's Tomorrow Radio project, in which the digital channel is divided, could bring three separate services to the same station that originally broadcast one service: for example, a classical format, a talk radio format and a tertiary reading service.

Second, an increase in content could come from a revitalization of the AM band, because HD Radio technology brings the sound quality of AM to that of today's FM. New formats, previously unavailable with the old AM sound quali-

ty, become possible.

All of this digital radio technology will require receivers capable of handling the different advantages above, making HD Radio listening compelling enough to consumers who are already inundated with other digital technologies, like satellite radio. Some of these features, notably the Tomorrow Radio project, rewind radio and surround sound, are still under development.

Receiver companies will want to make sure that they plan their development accordingly, taking into account these possible features that make HD Radio technology worth the customers' purchase. Consequently, semiconductor companies will need to have flexible, robust platforms, such as TI's DRI line of HD Radio digital basebands, to accommodate HD Radio's potential benefits. Together, receiver and semiconductor companies will enable listeners to acquire and enjoy HD Radio broadcasts.

These broadcasts will come from traditional radio broadcasters, who, by quickly establishing HD Radio technology, will have a strong footing to compete, allowing them to provide their audience with compelling, better-sounding audio and feature-rich data services, giving listeners a reason to tune in and hear what's next.

Reach the author via e-mail at j-gardner3@ti.com.

RW welcomes other points of view. Send e-mail comments to radioworld@imaspub.com.

"We're On-Air in Five Minutes."



When you've got audio to cut and no time to spare...

Trust Short/cut 2000™ to get a move on. How fast is it? You'll be editing tracks as fast as you can push the buttons. And when you're working on-air, Short/cut's ten Hot Keys keep your best clips cued-up and ready to go.

We've also tripled audio storage to a whopping 12 hours — and with a hard drive so quiet you can work right next to an open mike.

Whether it's breaking news, phone-ins, sports, interviews, or live events, the new Short/cut 2000 is radio's #1 choice for stand-alone digital audio editing.



360 Systems, 5321 Sterling Center Drive, Westlake Village, CA 91361 • Phone (818) 991-0360 • Fax (818) 991-1360

DIGITAL NEWS

Germany Re-Focuses on Digital Radio

BERLIN Germany renewed its commitment to digital radio at the IFA event, according to a group promoting Eureka-147, which says that, as Europe's second-largest consumer electronics market, participation from Germany is key to manufacturers' rollout plans for digital radio abroad.

At a symposium hosted by Germany's public broadcaster, ARD, speakers representing different areas of the industry issued a call to work together for the success of DAB.

WDR Program Director Monika Piel called for new thinking, with public and commercial radio "pulling together." She said more money must be spent on new

content for DAB stations.

Thomas Hirschle, president of the Baden-Wuerttemberg Communications Authority, was critical of German broadcasters' track record on promoting DAB and called for a realistic and comprehensive strategy for introducing new services.

On a federal level, he said, agreements must be adhered to and the German states must stop "sitting on the fence."

German Minister of Economics Wolfgang Clement warned that lack of commitment to DAB — a broadcast technology largely developed in Germany — meant the country was forced to import more and more, rather than exporting its own innovations. He said DAB was taking too long to come to market and urged manufacturers and broadcasters to move with more speed.

Fifty Eureka radio products were on display; 47 digital radio services were on air during IFA, said to draw 150,000 attendees, according to the World DAB Forum.

DIGITAL NEWS

Orban/CRL Re-Ups With Ibiqity

TEMPE, Ariz. Orban/Circuit Research Labs Inc. renewed its technology and marketing development agreement with Ibiqity. Orban/CRL said the renewal underlines its commitment to cooperate with Ibiqity as Orban develops and markets audio processors for HD Radio.

Orban/CRL President/CEO Jay Brentlinger said Orban's Optimod-DAB 6200 was the first Optimod specifically designed for digital radio.

"After we released the 6200, we broadened the line with Optimod-PC, our Optimod on a PCI card and Optimod-FM 8400HD." He said the 8400 is the first all-in-one processor for both the analog and digital channels of Ibiqity's FM HD Radio system.

Kahn: FCC Should Act on Cam-D

NEW YORK Leonard Kahn thinks it's time the FCC acted on his request that the agency rescind its order authorizing stations to convert to HD Radio on an interim basis.

In January, Kahn suggested the commission create a blue-ribbon panel to study other digital technologies for terrestrial radio, including his Cam-D system.

Once his AM digital system is developed, he intends to begin developing an FM system, which he hopes to complete by the end of 2004, Kahn states in a new filing.

Kahn believes the commission should take "immediate action" on his petition "to get at the truth re digital radio and halt this display by the (National Radio Systems Committee) of enormous conflicts of interest.

"For AM radio to be considered as a source of receiver sales and means to force the public to supposedly help the economy by making useless almost half a billion radios is ludicrous," he wrote, "almost as ludicrous as offering a service that only functions during daylight hours ... A service that even during daylight hours creates significant interference between stations as distant as New York and Cincinnati during the daytime and completely destroys their operation during the night."

Of the NRSC, Kahn states, "The flaws of using unpaid engineers to evaluate highly complex technology has been proven over and over again going back to the days of Armstrong and his FM and through Crosby and FM stereo, and, of course, AM stereo." Kahn is a long-time AM stereo proponent.

His new filing does not include technical details of his Cam-D system, although Kahn does state one of the tests to be conducted this year "will prove that the new signal can be received at least with an 8 kHz stereo fidelity over 1,000 miles away and with full 15 kHz stereo being transmitted which will not create interference beyond existing AM signals."

— Leslie Stimson

Sony Commits to European DAB

BERLIN Sony has lent its support to the World DAB Forum and the Digital Radio Mondiale consortium by joining the commercial arms of both organizations.

Sony has been a member of both groups for many years in creating the digital standards that underpin Eureka-147 and DRM. Now the manufacturer is committing to support to commercialization of both technologies.

"We are actively supporting the spread of digital radio broadcasting in Europe and through our partnership with members of DAB and DRM we believe we can expand the use of digital radio in

Europe," said Fenno de Boer, group marketing manager business developments, Sony Personal Audio Europe.

Sony aims to bring portable digital radio receivers to Europe in early 2004.

BE Adopts New Ibiqity Codec

QUINCY, Ill. Calling it a "strong showing of support for HD Radio," Broadcast Electronics said it would begin shipping units with the new HDC codec this fall.

"BE engineers participated in critical listening tests of HDC that compared CD source material to that of HDC coded material," the company stated.

"HDC demonstrated to BE's satisfaction the ability to get across high-quality audio at the extremely low bit rates needed for AM HD Radio (at both the core bit rate of 20kbps and the secondary bit rate of 36kbps for enhanced frequency response). The codec likewise demonstrated excellent audio quality at the bit rates used for digital FM (96kbps and 64kbps)."

The manufacturer said it would update its generator product line and begin mailing to radio stations a software upgrade with the new HDC codec when Ibiqity Digital Corp released the codec.

BE intended to begin offering free software upgrades on CD-ROM for customers who previously purchased BE HD Radio signal generators.

BE said it had shipped approximately 30 HD Radio systems by mid-September.

If your choice is HDRadio,TM

Choose the Leader to get you there.

With the introduction of consumer HD Radio receivers, now's the time to choose HD for your operation. Who should you turn to for help and support? Choose the leader in HD Radio, choose Broadcast Electronics. With more systems installed, a broader array of quality engineered products, and the most experienced team in the industry, we can get you up and running in no time and save you money.

"We're excited about the impact of HD on the future of radio. BE's solutions have the flexibility to make our implementations easy and cost-effective."

—Bob Demuth, VP & Chief Technology Officer
Beasley Broadcast Group, Inc.



888-232-3268

www.bdcast.com

©2003. HD Radio is a trademark of iBiquity. The BE emblem is a registered trademark of Broadcast Electronics, Inc.

DIGITAL NEWS

XM Begins Campaign For 1 Million

WASHINGTON XM Satellite Radio has begun a sales, marketing and programming campaign to thank existing customers and gain new ones.

The elements of the so-called "1 million subscriber campaign" include a sweepstakes with prizes, such as a new Cadillac and Pontiac, an on-air contest and

XM Raises More Money

WASHINGTON XM Satellite Radio completed a stock offering in September that netted the satcaster \$150 million. The company sold approximately 11 million shares of stock to Legg Mason Funds Management Inc., Legg Mason Capital Management Inc. and another large institutional investor, each on behalf of its investment advisory clients.

XM expected to use the funding for the construction of XM-4, its new ground spare satellite, if insurance proceeds are

meantime, XM raised the money in case it doesn't receive the insurance money on time.

On the hardware side, Honda said XM Radio would be standard on certain models of its 2004 Accord. All 2004 Honda S2000 roadsters will be shipped to dealers as "XM-ready," later this year. The S2000 joins the Honda Pilot, already offered with XM as a dealer-installed option.

Earlier this year, XM Satellite Radio announced the addition of XM as standard equipment on the 2004 Acura RL, which went on sale in March, and the 2004 TL sedan, on sale this fall.

Joint DAB Radio Is Goal

BERLIN The World DAB Forum and the Digital Radio Mondiale Consortium are cooperating to help production of dual Eureka-147/DRM radios.

The groups have members in common; they announced their cooperation at the IFA consumer electronics event in Berlin.

Annika Nyberg, president of the World DAB Forum, said the outcome would be good for listeners.

"DRM is a market-driven system, so we are committed to strategic alliances that will increase listeners' options across the globe," said DRM Chairman Peter Senger.

Sirius Debuts Business Service

CLEARWATER, Fla. At the CES show in January, Sirius said it was developing ways to deliver its satellite radio service to businesses, such as restaurants, hotels, retail stores and malls. Now Sirius has reached an agreement with Applied Media Technologies Corp. to do that, and the service is ready. The price starts at \$24.95 a month.

At 60 music channels, it's more than

the satcaster originally was showcasing. At CES, Sirius displayed an example that could deliver up to eight channels per location.

"Large and small businesses alike can now set the mood at any high-traffic location, while giving business owners the peace of mind that they will never air competitors' advertisements, since all 60 music streams are totally commercial-free," said a company official.

AMTC specializes in telephone "on-hold" messaging systems.

RBDS Standards Up for Review

WASHINGTON The National Radio Standards Committee is reconvening its subcommittee on the Radio Broadcast Data System.

Members say it has been five years since the standard has been reviewed. The NRSC seeks to review standards periodically.

The group would have three options regarding the U.S. RBDS standard: leave it as is, retire it or change it.

Entercom Vice President of Engineering Marty Hadfield and Allen Hartle, president of The Radio Experience, have agreed to co-chair the committee. Former chair Scott Wright, who worked for Delphi at the time, is no longer working in the consumer electronics industry, sources said.

A number of companies including Microsoft, Clear Channel and Entercom have invested recently in FM subcarrier technology. More car radios now have RBDS capability, adding to increased interest among broadcasters, sources said.

The reconvening of the subcommittee was expected to be on the agenda at the NRSC meeting at the NAB Radio Show in Philadelphia, said NAB's David Layer.

— Leslie Stimson

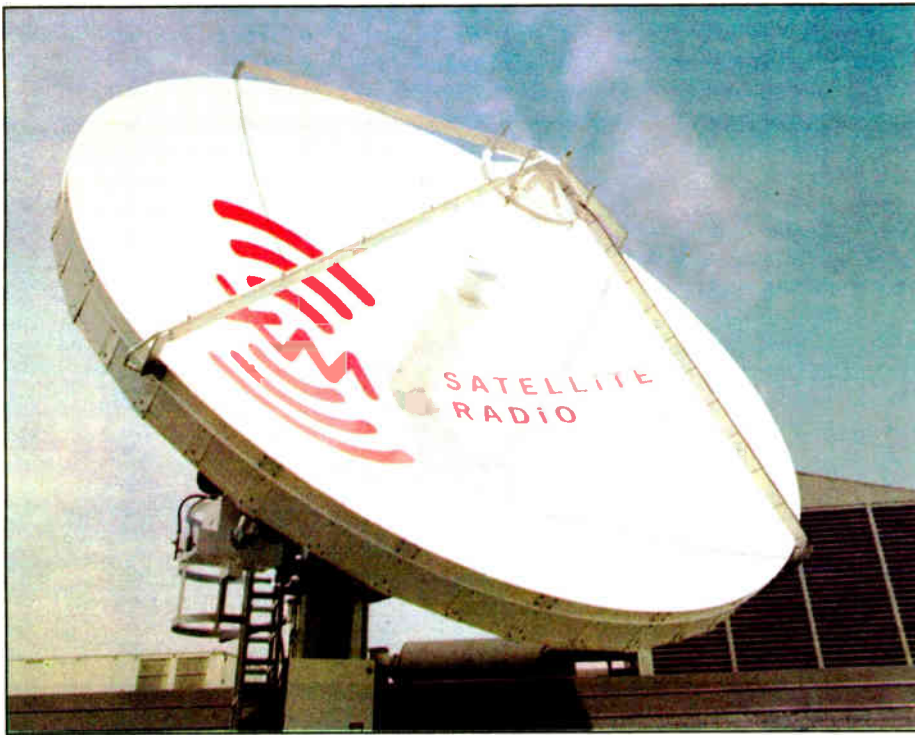

One of XM's Two Satellite Uplinks

a cross-country road trip. Two XM DJs were traveling the country in September to gain exposure for the satcaster.

Current subscribers earn points for others they successfully encourage to sign up.

The points are good for free months of XM service, hardware and gift cards.

not received in time. XM's two Boeing satellites have shorter than expected life spans, by 10 years, due to problems with their solar arrays. The problems do not affect the quality of the signal for the satellite service.

The satcaster and its insurer are arguing over XM's \$400 million claim. In the

Match-Maker™

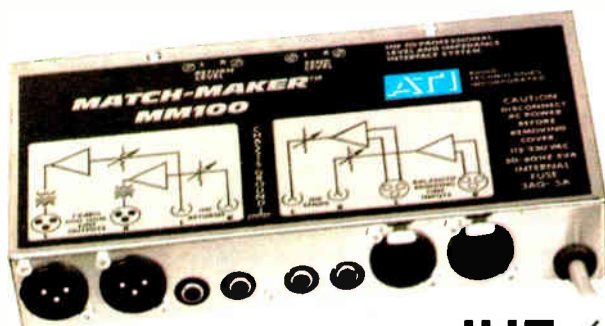

IHF ↔ PRO Level and Impedance Converters

BI-DIRECTIONAL FOR

- Digital Workstations
- Equalizers, Recorders and Sound Card
- Audio Effects Processors and Digital Reverb
- Dual Line Amp, DA, Splitter or Combiner

Interface consumer/industrial IHF (−10db) stereo source equipment and signal processing devices into professional studio +4dBm, 600 ohm systems without loading distortion, crosstalk, hum, response roll-off or RF pick-up.

True transformer output isolation, balance and protection with dynamic range better than 18 bit digital! Rugged gold connectors. Adjustable 6dB reserve gain – all channels. • Excellent RF immunity. Distortion 80dB below +22 dBm peaks (20 – 20Khz), under noise at +4dBm. Rack mount kits • Internal 115/230VAC Power • UL and CE markings.

Disc-Patcher™

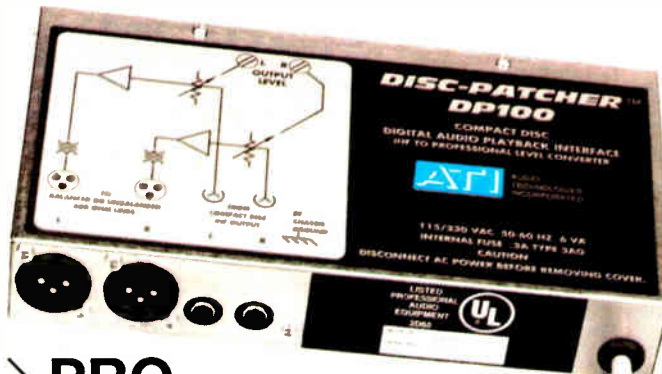

UNI-DIRECTIONAL FOR

- Disc Players and/or DAW
- ENG Cassette Dubbing
- Off-Air Monitor Tuners
- Console Audition Outputs

AUDIO TECHNOLOGIES INCORPORATED

Free Brochure Available Upon Request
<http://www.atiguys.com>

328 W. Maple Avenue, Horsham, PA 19044
800-959-0307 • (215) 443-0330 • Fax: (215) 443-0394

Pubcasters Get Break on Royalties

WASHINGTON The Corporation for Public Broadcasting has negotiated a deal with Ibiqity Digital Corp. covering license terms for public radio.

The primary audio license fee waiver was extended two months, to Aug. 29. This was to coincide with CPB dispensing station conversion funds. CPB was reviewing applications in September and hoped to announce details soon.

CPB also garnered an agreement to exempt public stations from royalty payments from ancillary data services associated with HD Radio, specifically for noncommercial programming, should pubcasters choose to split their channels. Also exempt from the data royalty to Ibiqity are noncoms that use their data services to provide information to the blind or hearing-impaired.

"The royalty fees are waived as long as the channel is operated as a noncommercial service," said Andy Bruno, CPB director of station advancement. He said public stations and NPR asked CPB to negotiate with Ibiqity on the agreement.

NEWS WATCH

In Cincinnati, Clear Channel To Move, Expand

CINCINNATI Clear Channel is moving studios of stations from the city of Cincinnati to Kenwood, a suburb, according to a report in the Cincinnati Business Courier and confirmed by engineering executive Jeff Littlejohn.

The company has outgrown its St. Gregory Street building. A station official cited price and location for the move.

Some 245 jobs will go with the stations, which include WLW(AM) and WEBN(FM). The company has signed a 10-year lease for part of the top floor of a facility in Kenwood. The new Bank One building will accommodate approximately 40 studios. Six of the eight stations are now in the Mount Adams area, where predecessor Jacor Communications once had its corporate headquarters.

More Time Granted For LPFM Comments

WASHINGTON The FCC has extended the deadline for public comments on the Mitre report.

The document looks at whether low-power FMs would cause interference to existing full-power stations if the LPFMs were licensed without third-adjacent-channel protections. The new deadline is Oct. 14 (MM Docket 99-25).

National Public Radio and the International Association of Audio Information Services asked for a longer extension. Both cited limited resources to evaluate the technical report. The organizations felt interested parties should have time to assess and "possibly test the validity of the report and its conclusions."

The commission said the public has had "ample opportunity" to become familiar with the Mitre testing parameters and to conduct its own studies. Granting a long extension would delay the agency's LPFM report to Congress, the agency stated.

Monitoring Service Promises 'Near- Census' of Radio Airplay

PHILADELPHIA The American Society of Composers, Authors and Publishers and YES Networks have formed an electronic, real-time media monitoring service called Mediaguide.

The company says its advantages over similar companies are that it's faster and programming content does not need to be encoded before it can be monitored.

Embedding some sort of identifying watermark into content so it can be tracked "requires cooperation of content owners and broadcasters and is a logistical nightmare," said Mediaguide Chief Executive Officer George Searle.

The company can track content such as

songs and ads in real-time. Executives said the system can determine the sequence of ads that run opposite a particular spot and the frequency of that ad.

"Broadcasters don't even know they're being monitored electronically," said Searle said.

Mediaguide monitors approximately 2,200 radio stations in 200 markets and says its database comprises millions of tracks. Its first two customers are the American Society of Composers, Authors and Publishers and YES Networks.

The company joins a market that includes competitors BDS and Mediabase;

it would also would like to expand its service to Canada, Europe and Asia.

Mediaguide can also monitor can also satellite radio, cable/satellite TV and the Internet.

The system uses a network of remote workstations to monitor signals. Content that a client wants to monitor is sent to Mediaguide, and a unique set of fingerprints is created. Mediaguide's system then compares those to the fingerprints in its memory.

Clients may view the information they request on their PC, Mediaguide told Radio World. For more information, go to: www.mediaguide.com.

Liquor Ad Code Updated

WASHINGTON The Distilled Spirits Council has updated its 69-year-old code of responsible practices, ad guidelines for marketing 2,800 brands of member company spirits, beer and wine products.

Key changes include a 70-percent adult demographic for all advertising placements — radio, TV, print and promotional events. The previous provision required a 51 percent adult audience.

Also, actors and models used in drinking ads must now be at least 25 years old.

The new code applies to all advertising and marketing materials developed after Oct. 1.

Logitek Brings Large Console Flexibility to small workspaces



Remora-10 console at
Cache Valley Broadcasting, Logan, UT



Possible Remora Configurations

Remora-4: four faders with controls for input assignment, monitors, and console functions

Remora-10 (shown): addition of six-fader module brings additional mixing capability with another stereo LED meter

Remora-16: incorporates Remora-4 base unit with two 6-fader modules

Remora-22: incorporates Remora-4 base unit with three 6-fader modules

You don't need to settle for less when designing small on-air or production rooms.

Logitek's Remora Digital Console brings you all the flexibility of larger consoles in a very small footprint. As a control surface for our Audio Engine digital router, the Remora offers you access to all inputs and outputs on the Audio Engine, multiple mix-minus busses, dedicated talkbacks, and more. Remora consoles give you fast, convenient tabletop installation—no need for cutouts or custom furniture designs. And, its attractive full color displays plus stereo LED meters give you all the information you need at a glance.

Try the Remora as a companion to our popular Numix console or on its own. You'll soon see why Logitek's Console Router Systems make sense for your facility.

Logitek Electronic Systems, Inc.

5622 Edgemoor, Houston, TX 77081 USA 713.664.4470 800.231.5870 www.logitekaudio.com

©2003 Logitek Electronic Systems, Inc.

Logitek
Console Router Systems



Radio World, October 8, 2003

Past columns are archived at www.rwonline.com/reference-room

One More Radar Lover Gone

by John Bisset

★ ★ ★

Larry Schropp of Schropp Electronic Services was called in to work with Winston Hawkins, technical director for the Vernon Family Stations, on a KU satellite receiver problem. It seems that one station's satellite receiver was dropping out periodically from 9 a.m. to 5 p.m. each day.

The receiver and LNB were replaced, but the problem persisted. Think on this puzzler and read on. We'll see later if you are right about what was causing this problem.

Just because summer is over (and, in much of the country, so are lightning storms), transmission line treats like the one in Fig. 1 don't necessarily go away.

This burnout at Mark Bohnett's WOLC in Princess Anne, Md., had nothing to do with good engineering practice gone wrong; Mark runs a first-class plant. But icy or wet weather and the absence of pressurization on lines or power foldback on transmitters need to be considered now.

As for Mark's failure at the harmonic filter, one thing is for sure: It wasn't due to a split or loose bullet. All the fingers were in place, as you can see in Fig. 2. Some of them broke off when the assembly was opened up, as expected. Sometimes insufficient support of rigid line can cause an internal failure.

Mark supported his line runs more than adequately; in fact, he's adapted a rigid conduit support, as seen in Fig. 3. The plastic bushing holds the line firm, without deforming the outer conductor.

I asked Mark where he got the "yel-

low" Kindorf that you see supporting the line section in Fig. 4. "From a can of paint," he replied. Mark painted the steel Kindorf sections so they would stand out from the gray color of the steel ceiling.

The sections were painted before they were installed.

"This way, the support structure is more visible, and it's less likely that someone would hit it with a ladder, or worse, their head or shoulder while working in the ceiling."

Reach Mark via e-mail to mbohnett@wolc.org.

★ ★ ★

Herm Reavis is executive vice president of the Mel Wheeler stations in Roanoke.

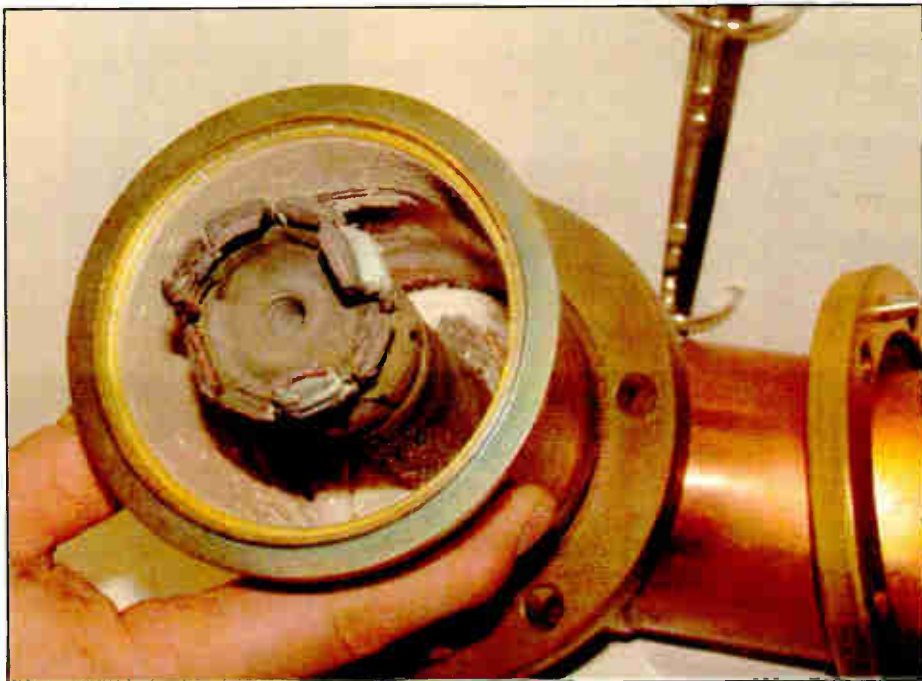

Fig. 1: Summer may be over, but transmission line treats like this one don't necessarily go away.

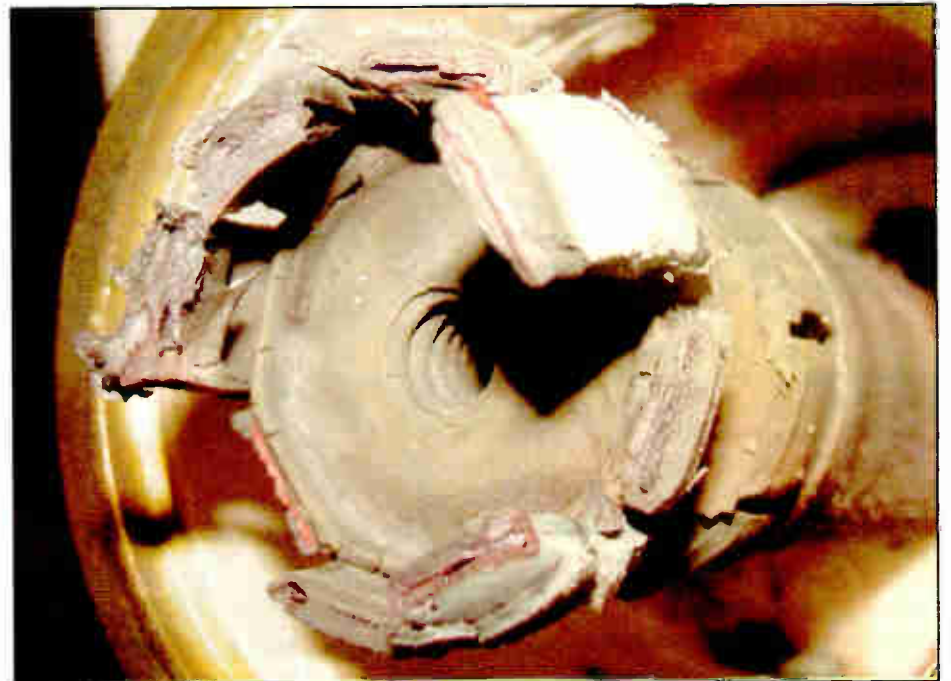

Fig. 2

It's a format converter for digital audio! It's a D.A. for digital audio! It's DigiMatch 2X6!

DigiMatch 2X6 converts between AES/EBU and SPDIF formats, and gives you 6 digital outputs! Use DigiMatch 2X6 to feed both AES/EBU and SPDIF gear! 1/3 rack width, built-in AC power supply.

In stock at all Henry Engineering dealers.

We Build Solutions



Blueboxes, Inc.

www.henryeng.com 626.355.3656



Va. An avid *Workbench* reader — though he admits to being a non-engineering type — Herm has devoted 55 years to broadcasting.

As the cold weather approaches, Herm reflected on a past column about “Sterno and SpaghettiO’s,” in which we compiled a list of items to have at your transmitter site, just in case you are stormed in.

He draws on just as many years of hunting duck, goose and deer and suggests stashing away a box of crackers, a chunk of cheese and several cans of Vienna sausages, as well as bottled water. It could be a life-saver.

If you don’t have a small refrigerator at the transmitter site, spring for wax-sealed cheese; it will last longer. Keep the food-stuffs in a sealed plastic bin, so the mice aren’t tempted.

Herm adds one important necessity: toilet paper. You might also include a couple rolls of paper towels. As with road flares in the trunk of your car, you hope to never need this winter “care” package. Take a few moments to plan now.

★ ★ ★

When Larry Schropp first started his story about the satellite receiver failing, mentioned at the beginning of this column, I was sure it was birds or bees in the feedhorn of the LNB.

But he said the problem started at 9 a.m. and continued till 5 or 6 p.m. I scratched my head. Birds and bees typically are away from their nest during the day, returning at dusk. This was just the opposite.

With the help of Technical Director Winston Hawkins, they hooked up a spectrum analyzer and confirmed that the problem was TI — terrestrial interference. The next question was where this was coming from. The two engineers cobbled together an efficient “sniffer.”

Using a 100-watt inverter to supply AC power in a vehicle, they powered one of the KU satellite receivers. The RF input was fed through a splitter that provided a DC power pass for LNB power. The satellite receiver was only used to provide DC to the LNB. An LNB was connected to the DC feed port of the splitter. The analyzer then was connected to the DC block port, giving them a picture of what the LNB “saw.”

Driving in concentric circles around the field where the dish was located, they found the culprit: a station employee’s vehicle had a Cobra radar detector plugged into the cigarette lighter. In this vehicle, the lighter was powered even when the engine was turned off. The detector was spewing all kinds of trash, much of it received by the station satellite dish. The employee would arrive at work at 9 a.m., then stay until 5 or 6 p.m. When he left with his errant radar detector, the satellite system returned to normal.

The employee still has the radar detector, but it’s unplugged when he pulls into the station parking lot. All in a day’s work for some super-sleuth engineering detectives. Thanks to Winston and Larry for sharing their brainteaser and the methods they used to find the problem.

John Bisset has worked as a chief engineer and contract engineer for more than 30 years. He is the northeast regional sales manager for Dielectric Communications. Reach him at (571) 217-9386.

Submissions for this column are encouraged and qualify for SBE recertification credit.



Fig. 3: Mark Bohnett supports his line runs with a rigid conduit system.



Fig. 4: Painted Kindorf stands out from the gray steel ceiling.

Great Software from BSI

BSI produces Simian digital automation, but did you know that we have a whole family of products for Radio?

WaveCart, Stinger, Speedy, Skimmer and WebConnect can all work together to make your station function professionally and sound amazing. In addition to the software that we have created, we offer partner products like AudioScience sound cards, Natural Broadcast Systems traffic and billing software and various other hardware accessories.

Any and all of our programs are available on our website for download. So install our software and play with it for as long as you want. Once you’ve decided that it’s the software for your station, give us a call or order online.



Broadcast Software International
 1925 Bailey Hill Road, Suite A
 Eugene, OR 97405
www.bsiusa.com
 888-BSI-USA1 (888-274-8721)
info@bsiusa.com

Para el español, llamada Felipe Chavez,
 Distribuidor de los E.E.U.U.
 (916) 368-6332
fchavez@ommedianet.com

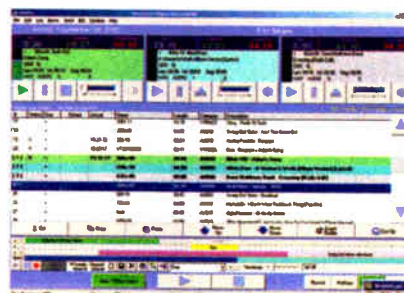

Simian digital automation
\$1499

WaveCart digital cart machine
\$299



Stinger instant audio player
\$199

WebConnect Pro email remote control
\$299



Speedy 4.0 CD-to-PC recorder
\$199

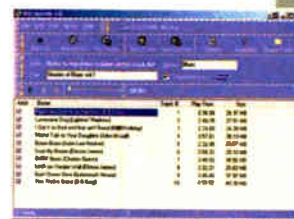

Skimmer easy audio logging
\$299

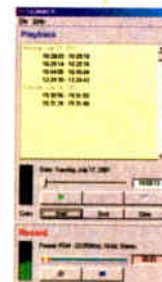

Thousands of users have discovered how easy and versatile BSI software really is.
Test and try before you buy.

FIRST PERSON

Talk Radio — The Beginning

by Ed Harvey

There had been other radio interview programs. But this one was going to be different. A new engineering technique would allow the voice of the caller to be heard on the air.

We were about to enter what would become known as the turbulent 1960s. The program director at WCAU(AM) in Philadelphia informed me that I had been selected to host a new type of program, one that had never been done: two-way talk. Our engineers had come up with a technique that would change radio.

An Ampex machine was outfitted with a second head so that the audio could be taped and played back a few seconds later. Any unacceptable language could be prevented from getting out over the air.

This was long before deregulation. Even words such as "damn" or "hell" were taboo. A bypass key labeled "Panic Button" was installed in the studio that would allow the host to cut off the tape output and the telephone. The result would be a few seconds of dead air before the program would be heard again, usually with a brief explanation for the period of silence.

After the offending words had cleared the playback head, the engineer would re-establish the tape delay system, and we would be back in business. The standard speed for audio was 7-1/2 inches per second. This meant that I had 3-1/2 seconds to absorb what had been said, decide whether it was unacceptable and react.

An unfortunate incident occurred on a Monday night program I hosted with the coach of the Philadelphia Eagles football team. This caused our engineering department to go to 3-3/4 inches per second, which would allow for a 7-second delay. But that is a tale for another time.

Phone company headaches

Bell of Pennsylvania then was part of the AT&T system. When the station approached Bell, there was a complete lack of enthusiasm, for this was "uncharted territory." The company cited all kinds of regulations with regard to non-company equipment being connected to its telephone network.

WCAU Chief Engineer Charles Miller was a friend of telephone company engineer Fred Shaw. Shaw worked with and tested modified Bell equipment at WCAU, and it worked. He went through Bell management levels and the station received approval to use the modified equipment.

Further discussions between Miller and Shaw resulted in a system to provide incoming callers with the program audio when put on hold by the producer. Shaw modified a 20-button call director so that a guest who was unable to be in the studio could be on a conference call. This was done in the studio for the talent and in the control room for the producer, thus permitting callers to talk directly with the guest in another location.

The ability to contact important but unavailable guests was a tremendous boost for the industry.

Shaw also worked with Miller on upgrading the overall quality of the telephone system. The number of callers attempting to contact the program sometimes caused massive breakdowns in the Philadelphia region of the Bell Telephone system.

Again, Shaw came to the rescue with a

choke number, COLFAX, which stopped calls at the point of origin if all circuits were busy. Through his efforts, busy signal counters were installed, but were often capable of reading only 9,999 calls started over during a program. These were the days of old mechanical-relay telephone-switching systems. Today, it would be computer-controlled, with no need for the choke.

Other stations across the country decided to try talk radio and experienced the same difficulties with their local telephone companies. Stations and telephone companies soon sent engineers to WCAU to determine how we solved the problems. Telephone companies adapted Shaw's methods and offered them as a service to customers.

A format is born

The news that I would get a shot at hosting the inaugural talk show came at just the right moment.

I had been hosting the morning show on WCAU, the first CBS network affiliate. Dr. Leon Levy was the owner of the station, and his brother-in-law, William Paley, was both owner and founder of CBS. The network was WABC (now WCBS) New York and WCAU Philadelphia.

The morning show had started in 1951 and featured a live band with both a male and female singer, along with a daily dose

of other nuts-and-bolts chores. After all, this was a momentous move in a new direction. So we set up an office with a secretary, a producer and myself.

By a great stroke of luck, the young lady who joined as the producer was the find of the century. Ronnie Snowden could make life much easier for the Bush administration today. I am certain she could find both Osama bin Laden and Saddam Hussein in a blink.



With Eva Gabor at the WCAU studios, circa 1965.



The author interviews Malcolm X at the Philadelphia Convention Center. Producer Ronnie Snowden sits at far right, in front of the remote engineer.

of "corn" I imported from my native Iowa and dispensed shamelessly.

Every year I would lose a musician or two, as their contracts called for more money and our program director would call for fewer musicians. By 1959 the show was down to a piano player, a singer and me.

At this time the program director invited me in for a chat. My thoughts were that I would lose my last two musicians and become a disk jockey, following the format of virtually every other station in town. But no.

I was informed that I would be hosting a revolutionary type of program: two-way talk. We would invite guests into the studios and the listeners would call in with their opinions or questions.

I pretended to know what it was all about and made one request: that I be assigned a staff to help out with the details of acquiring guests, doing research and

To give you an idea of her capabilities, on a Good Friday she found and persuaded to be our guests both Billy Graham and Norman Vincent Peale — a slam-dunk by anyone's scorecard.

Whatever heavenly star had been assigned to me certainly was sitting in the right house at the right moment when I was selected to host the show. I had no clue that, for more than a dozen years, I was to experience a smorgasbord of guests and callers who would amaze, amuse and annoy.

The show brought to our microphones world leaders, members of congress, cabinet members and presidents. It would host top Hollywood and Broadway personalities and famous authors. It would present the thoughts of the radical left and the arch-conservatives of the right, from Gus Hall, leader of the Communist Party in the United States, to Robert Shelton, head honcho of the Ku Klux Klan.

Malcolm X shared the microphone on a

number of occasions. I saw him change from the "angriest black man in the country" to a more mellow and reasonable advocate, a move that cost him his life.

I was picketed by a group protesting the appearance of the KKK leader. They wore sheets and displayed threatening signs, one of which read: "Ed You're Dead."

I was on the air when the station was invaded by the Weathermen terrorist group. Fortunately they got lost in the WCAU building and missed both master control and my studio. The police got there after they damaged a few offices and the newsroom.

From that day, the front doors of

WCAU were locked at all times. Today the only entrance for employees and guests is the back door, past security guards.

Caught on tape

When I was not in the studio, I was seldom without my attaché case tape recorder. It was with me when I flew piggyback with the Navy's Blue Angels; when I interviewed frightened refugees fleeing China into Hong Kong; when I chatted with the pearl king, Mikimoto, in Tokyo; when an impending storm forced our hydrogen-filled balloon down, smack in the middle of the grounds of the Graterford prison; and even when I danced with the Eskimos in Barrow, Alaska.

There was the exclusive interview with the captain and crew of a Russian "fishing trawler," later identified by the Navy as an espionage ship.

There was the heart-wrenching announcement of the fatal shooting of President Kennedy that, for some strange reason, beat the network announcement by a couple of minutes. I still have the tape and the teletype first flash of that tragedy.

There was the last interview with President Eisenhower before he left this mortal coil. The CBS network used excerpts from it in its eulogy.

Each of these occasions is a story in itself.

There is one final interview of which I often dream. I want to be sitting across from the president in the Oval Office with my tape recorder resting on his desk. The hotline phone rings. The president picks it up, answers, and, looking only slightly surprised, says, "It's for you."

When asked his opinion of current talk radio, Ed Harvey said, "I may have created a monster." The author lives in Valley Forge, Pa., where he writes three columns for area newspapers, in addition to hosting his radio show on WWDB(AM) in Philadelphia. 🌐

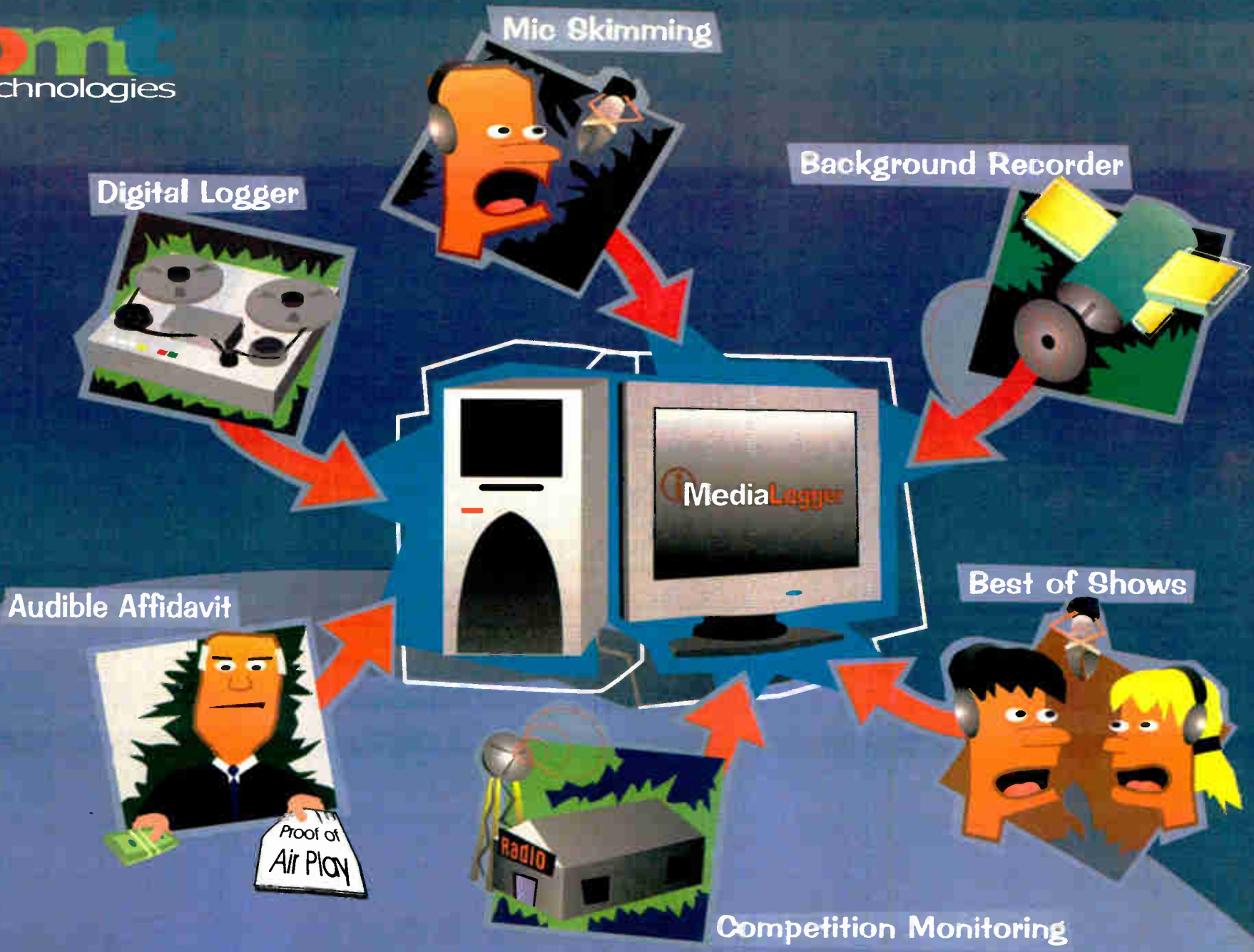

iMediaLogger From \$695

(ī-mē'dē-d-ə lô'gər) *definition:* The most complete, affordable, and easy-to-use automated audio recording solution available.

With today's ever increasing workload you have to do more with less and that's why having a multipurpose tool like iMediaLogger is key. Using a single computer workstation, iMediaLogger frees you from the costly maintenance of conventional and outdated equipment used for logging, recording, and skimming including reel to reel, DAT, and VCR recorders.

Used in hundreds of stations including all of the top 10 markets, this award-winning product allows you to:

- Simultaneously record up to 12 stereo or mono audio sources or streams
- Multiple compression formats
 - MP2, MP3, Windows Media Audio, Real Audio, PCM, and ADPCM
- Access your recordings anytime, from anywhere using its built in web browser interface
- Schedule time or closure based recordings
- Remotely configure and manage your iMediaLogger system

The next time you need to log, skim, or record, save yourself - and your station - plenty of time, money and headaches. With iMediaLogger, you will never have to change a tape again.



Winner of the NAB 2000 Radio World Cool Stuff Award

To learn more about iMediaLogger, visit www.omt.net or call 1-888-665-0501

SBE NEWS

AMBER Alert Web Portal

by Clay Freinwald

The author is chair of the SBE EAS Committee.

For radio broadcasters the Emergency Alert System, and especially AMBER Alert messages, present a number of challenges.

The problem is that the EAS "header codes," the data burst portion of the EAS message, do not contain sufficient specific information necessary for a station to participate fully in the recovery effort, primarily because the specifics usually are contained in the "voice portion" of the EAS message, and that is only transmitted once.

To be truly effective, the AMBER Alert message must be broadcast fairly often. The problem is where to obtain the text of the message to be repeated.

Broadcasters are not going to tolerate running a full-blown EAS message, complete with data bursts, that often. EAS is a great tool for the AMBER Alert program. However, we need something more.

Pilot project

This problem has been discussed on a national level by SBE's EAS Committee. In addition, the Washington State Emergency Communications Committee, which I also chair, has been searching for a method to distribute information about AMBER Alerts to stations since it began to develop the Washington state AMBER Alert program in November of 2001.

What we needed was another communications system that would provide broadcasters with information in greater detail so that they could effectively participate. Our goal was not to replace EAS but rather augment it.

Initially, we thought that a Web site

containing the necessary information would do the job. With likely every broadcaster having an online computer nearby, the information that needs to be repeated would be readily available, as would updates.

I asked the Washington State SECC to delegate the responsibility to explore this concept to Mark Allen, president of the Washington State Association of Broadcasters, who immediately took up the challenge. Allen, working with others, created a pilot project to provide a one-stop AMBER Alert information portal.

The AMBER Alert Web Portal will allow broadcasters and the public to access information about AMBER Alerts, including detailed information that cannot

for Missing and Exploited Children.

The AMBER Alert Web Portal is far more than just a Web page where broadcasters and the public can find information about an AMBER Alert.

First, it will not replace the EAS-based AMBER Alert activations, but will enhance the current plan by allowing local law enforcement in cities and states to post up-to-date information about an abducted child to a single AMBER Alert Web Portal.

Push alert

The instant a law enforcement agency posts information about an AMBER Alert to the Web Portal, the portal will "push" that information out to any person who

The Web Portal will allow broadcasters and the public to access details about alerts as well as photos of victims and abductors.

be transmitted in the AMBER Alert EAS message, as well as photographs of the victims and their abductors.

The strategic partnership to develop the project was created by the Washington State Department of Information Services, the Washington State Patrol, the state's Emergency Management Division, the Washington State Department of Transportation, the Washington State Association of Broadcasters, the Washington Association of Sheriffs and Police Chiefs and E2C (Engaging & Empowering Citizenship)/Earth 911. It has been endorsed by the National Center

has subscribed to receive it. There is no cost to subscribe. Law enforcement personnel, broadcasters and citizens will have the option to choose to be notified of alerts and status updates via e-mail, fax, text-enabled cell phone or other Web service notification methods such as paging or personal digital assistant (PDA).

Broadcasters will no longer need to call the law enforcement agency periodically to receive updated information or cancellation notices. That information will be pushed to those who subscribe, notifying them that there is an update, cancellation or other new information. They can then go to the Web Portal site to see the details of the update.

The portal will use a geographic information system to provide map-based search capabilities and convey location-based information to the public. Information on the portal can be displayed in visual, text or audio format, for both local and extended areas.

This information then can be used by participating radio stations for updating their announcements or as the basis of more-extensive coverage of the event by the station's news department.

Tests

The AMBER Alert Web Portal Pilot Project has undergone two highly successful tests.

The initial test of the AMBER Alert Web Portal took place May 29, 2003, in Washington state and was an unqualified success. When the alerts were posted, the Web Portal's software automatically notified pagers that each test participant had been given, as well as text-enabled cell phones of participants that had been programmed into the system. E-mail notifications of the AMBER Alert were received on the computer workstations at each participant's desk.

The system worked as expected, and many additional features were suggested to the design team for incorporation into the AMBER Alert Web Portal for the second test.

That test, on July 7, included more



states. Two different AMBER Alert scenarios were developed, and information relating to those two test incidents was relayed as though they were real alerts.

Each agency then worked with its emergency management agency to send a test EAS message (off-air) that indicated to stations that a test was in progress. Following the EAS message, the various law enforcement agencies posted the information about their respective incidents to the Web Portal.

The Web Portal pushed out notification of the incidents and the information to subscribers via e-mail, pager, text-enabled cell phone and PDAs. This notification allowed subscribers to go to the Web Portal to access further information, including the EAS message script and photos of the victim and the alleged abductor.

Subscribers were notified of subsequent updates of the information from each local law enforcement agency as the Web Portal pushed that new information or notices of the updates to them.

Broader use

Further refinement of the AMBER Alert Web Portal is ongoing, and plans are being finalized to put the portal into general use. Several state agencies and state broadcasters associations from around the country have expressed interest in becoming participants.

As you can see, there is a lot of behind-the-scenes work being done to enhance the AMBER Alert program and to provide broadcasters with the information necessary to raise the recovery success level even higher. To take advantage of this enhancement, those radio stations that are manned for the Amber Portal will require new procedures, such as having a computer in the on-air studio. For those stations that are operating unattended, EAS will remain, for the time being, the sole vehicle for distributing AMBER Alerts.

The work of the Society of Broadcast Engineers in the area of EAS is never without challenges. In the engineering tradition, the AMBER Portal project is indeed a "technical solution" to a problem.

I am fortunate to not only chair the SBE EAS Committee but also the Washington State SECC and am able to participate, at close range, in finding solutions to these issues with the goal of making EAS better for all.

If you have a thought or a question, drop me a note to k7cr@wolffnet.com. Feel free to check out the EAS portion of the SBE Web site for additional information about the ever-changing EAS.

If you are interested in subscribing for AMBER Alert information when the system becomes operational, go to www.kids911.org, click on the subscription button and fill out the information; or contact Mark Allen at WSAB@mail.tss.org.

SBS, Beasley Add HD-R Stations

MIAMI Two more stations in Miami have turned on HD Radio, including the first station in the Spanish Broadcasting System group to go IBOC digital.

Beasley station WKIS(FM) and SBS outlet WRMA(FM) share a combiner and antenna system. Both are using Broadcast Electronics equipment.

Beasley also is on with HD Radio in Miami at AM stations WQAM, WSBR and WWNN as well as Philadelphia's WXTU(FM).

BE released a description of the installation: "The two Miami stations, which share a master Alan Dick combiner and antenna system, feed HD Radio signals and analog signals bi-directionally into the master combiner for combined input to the antenna. Each station purchased BE's FS10 signal generator, FXi 60 exciter and FMi 201 transmitter. The BE equipment was installed separate from the analog FM transmission path as part of an isolated HD Radio system. ...

"By dual-feeding the antenna, the stations were able to use one polarity of the circularly polarized antenna for HD Radio and the opposite polarity for analog FM. The approach reduced the injec-

tor loss typical of high-level combining (10dB loss in HD Radio and a .45dB loss in analog), eliminating the need for Spanish Broadcasting and Beasley Broadcast Group to purchase higher-powered HD Radio transmitters to handle the injector load."

Ralph Chambers is DOE for the southeast operation of SBS. Bob Demuth is VP/CTO of Beasley Broadcast Group.

Walden Moderates AES Panel

NEW YORK Glynn Walden will moderate a high-profile panel of audio processing proponents at the AES show this week in New York. He was named a late replacement for Joe Capobianco.

Walden is known through his engineering tenures at Ibiqity Digital Corp. as well as CBS Radio and Westinghouse.

Participants are Marvin Caesar of Aphex; Mike Dorrough of Dorrough; Frank Foti of Omnia Audio; Rocky Graham of Dolby; Leonard Kahn of Kahn Communications; Thomas Lund of TC Electronics; Robert Reams of Neural Audio; and David Reaves of Translantech. A roundtable discussion is part of the session, on Saturday, Oct. 11.

MUSICAM USA

500 gives you more reasons

to own a new

NETSTAR™

Codec



The new NetStar IP & ISDN Codec gives you all these benefits:

- AAC, AAC-LD, MPEG 2, MPEG 3, G.722 and G.711 algorithms for the best audio and full compatibility
- Bi-directional audio over IP and ISDN
- Linear, uncompressed bi-directional audio over IP
- Ancillary Data and 8 Contact Closures over IP & ISDN
- Simultaneous connections on IP and ISDN
- Automatic backup of IP with ISDN, and vice-versa
- Full remote control and status monitoring from any Web Browser
- ...and lots more

Now, through December 31, 2003, we'll give you \$500 for every NetStar you purchase. Owning the world's best Codec has never made more cents!



Model 500 shown



MUSICAM USA
670 North Beers Street, Bldg #4
Holmdel, NJ 07733 USA
732-739-5600
732-739-1818 fax
sales@musicamusa.com
www.musicamusa.com

MUSICAM USA is the d/b/a of Corporate Computer Systems, Inc

\$500 MUSICAM USA Rebate valid with proof of purchase from any authorized U.S. based MUSICAM USA Distributor. Contact factory for details.

ROOTS OF RADIO

KDKA 'Dog House' Restored

by Ken R.

Ed Cooper was born in 1920, the same year KDKA(AM) in Pittsburgh signed on the air as the first licensed station with regularly scheduled programs. He was 10 years old when the transmitter was moved from East Pittsburgh to Saxonburg, Pa., where he lived.

"In the mid-1930s, the station was experimenting with vertical antennas, and they used a helium-filled balloon to raise a wire up in the air for testing," Cooper said.

"The test, done by engineer Ralph Harmon and others, was so successful that by Oct. 30, 1937, they had built a tower that was 718 feet tall including the base. I was at that dedication on that day, and there were about 25,000 people there."

Cooper earned his ham radio license in 1940 and his First-Class ticket the following year. He found employment at several AM stations before World War II, then worked in several branches of the service. After gaining experience as chief engineer at WJPA(AM) in Washington, Pa., he went to KDKA(TV) in 1952.

Back at the tower

During his career and afterwards, in retirement, Ed Cooper retained his fascination with KDKA radio.



The Restored KDKA 'Dog House'

When engineers erected that tower in 1937, there was a little building at the base that housed a spider coil.

"That is the device that provides an inductance to match the transmitter to the tower for radio frequency energy transfer," said Cooper. "When the transmitter site was moved from Saxonburg



Ed Cooper, W3UZG, has had a ham license since 1940.

for restoration."

The Dog House was at long last restored and a dedication ceremony was held June 28 of this year at Roebbling Park in Saxonburg.

Larry Berg, an announcer at KDKA and later WISR(AM) in Butler, Pa., was master of ceremonies. A daughter of

Elvyn Sollie was present, along with Mary Honzo, the 92-year-old widow of one of the KDKA engineers.

"Pamela Walters was the guest of honor and several people spoke, including myself," Cooper said. "I gave the history of the building."

Michael Young, general manager of KDKA, wrote a let-



ter to Allison Park in 1940, the engineers took the coil but built a new housing for it.

"The original housing, called the 'Dog House,' ended up in the care of Elvyn Sollie, one of the KDKA engineers. Sollie put it in his for his kids to play in."

When Sollie passed away, the property on which the Dog House sat was purchased by Pamela H. Walters, a lawyer in Saxonburg.

"The thing just sat there deteriorating," said Cooper. "For at least 10 years I advised the Saxonburg Historical and Restoration Commission that they should restore it and exhibit it for the public. Finally in October 2002 it was donated by Ms. Walters to the commission and moved to Duco Ceramics Corp.

ter to the restoration commission that was read by Roy Humphrey, an engineer at the station.

Reldon W. Cooper, a distant cousin to Ed, is chairman of the commission, which funded the restoration.

"I went to high school with Ed and we stayed in contact over the years," he said. "We had a lot of people here for the ceremony including the county commissioners and other dignitaries. We have the Dog House on display in the park and the coil is now in the Saxonburg Museum."

Some might consider the Dog House just a collection of boards, nails and other building materials. But fortunately Ed Cooper was able to convince others to see it as a valuable part of broadcasting history.

STATION/STUDIO SERVICES

OCTOBER CAR CARE MONTH VETERANS DAY THANKSGIVING SHOP YOUR HOMETOWN MERCHANTS MUCH MORE!

WE PROVIDE THE MESSAGES. YOU PRESENT THEM TO CLIENTS....

...AND BUSINESS GETS BETTER!

GBS SALES BOOSTERS - FULLY PRODUCED :30- AND :60-SECOND FEATURES

"Just want you to know how successful our 'SHOP AT HOME' Campaign is. So far, we have sold 29 packages at \$500 each..." -FL

"With your holiday series we sold about \$11,000 worth of greetings in this, our first holiday season on the air..." -TX

GRACE BROADCAST SALES
Toll-free 1-888-472-2388
Sound Ideas for Building Business™

FREE DEMOS & SALES TIPS!
www.gracebroadcast.com

WISHFUL THINKING

'WON'T INCREASE YOUR BILLING....

...whereas these

GBS SALES BOOSTERS WILL!

Oct. Car Care Month 4-H Week Farm Safety

Halloween Safety Blitz Veterans Day

Don't Drink & Drive Shop Hometown Merchants

Thanksgiving Christmas New Year More!

FREE DEMOS & INFO www.gracebroadcast.com

SPACE AVAILABLE

Call Simone For Details

1-703-998-7600 ext. 154

ATTENTION PROVIDERS!

Promote your services to **Radio World's** readers. Reach Radio Station and Recording Studio owners/managers and engineers with your message.

For information on affordable advertising call **Simone at 1-703-998-7600, ext. 154.**

MARKET PLACE

Marti Has New Dual-Frequency RPU

Marti has introduced a wide-band, dual-frequency RPU transmitter with models covering 135-180, 215-250, 235-265, 300-350 and 430-480 MHz.

Broadcasters who were once required to buy two transmitters for two frequencies spaced more than 2 MHz apart can purchase one SRPT-30 for any two frequencies within 30-50 MHz of each other, depending on the model.

"In the VHF band especially, there was a limitation in the (previous) crystal control design, so you could only have Frequency 1 and Frequency 2 about 2 MHz apart," the company said in a statement. "But with our RF synthesizer design, you can have frequencies up to 50 MHz apart, depending on the band, which gives you more frequency spacing options."

The SRPT-30 replaces the RPT-30 remote transmitter. Already on the market is the frequency-agile SRPT-40A RPU transmitter. The SRPT-30 is a 20- to 30-watt fixed-frequency transmitter.

For information contact the company in Illinois at (217) 224-9600 or visit www.martielectronics.com/front.html.

The New MASTER CONTROL XV

Three more reasons to make the switch!

Internet Voice Tracking™

Use top talent from across town or around the world.

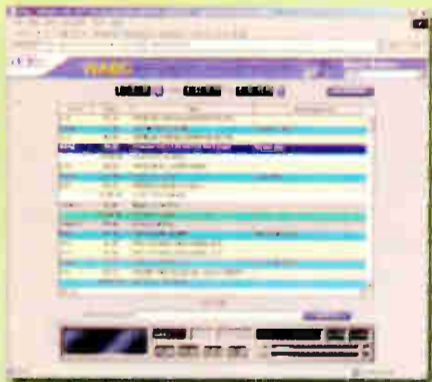

Living Log™

No more copying log out and into the studio. All schedule changes are immediate.



24 Hour Support

The average RCS support call is answered by a real human being in 12.5 seconds.* If you have a question, we've got the answer no matter what time.

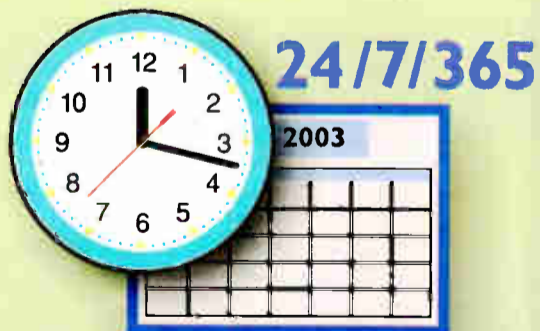

*From internal document (7/1/2001- 6/30/2002) based on more than 27,000 calls.

See the difference, hear the difference, get the best!



Master Control is Selector® smart.
For live-assist, automation, satellite,
Internet and remote broadcasting.

Internet Voice Tracking™ is protected by US Patent 6,223,210

Call, click or email now:
914-428-4600
info@rcsworks.com

www.rcsworks.com/howitworks

Royalties Head Back to Courts

by Craig Johnston

Acrimony has reigned abundantly between Webcasters and the music recording industry for years, but this summer has been quiet. Web Watcher remembers Davy Crockett saying to Georgie Russell in the second Mike Fink episode, "Georgie, it's too quiet."

So maybe we should have expected the thunderclap at the end of August when the Las Vegas-based Webcaster Alliance filed suit against the Recording Industry of America Association. WA President Ann Gabriel told Web Watcher it's not what the RIAA did that set them off. It's what they didn't do.

"The RIAA never negotiated a fair and equitable deal with small Webcasters," said Gabriel. She noted that for all the folderol when Congress passed last winter's Small Webcaster Settlement Act, only 35 companies have signed up to take advantage of the deal.

In a mid-summer press release, Gabriel stated, "After being told by RIAA attorney Gary Greenstein back in January that he didn't care if 25,000 Webcasters went out of business because then people would have to get their music from AOL, we became deeply disturbed by the anticompetitive attitude and actions of the RIAA and its members."

When Web Watcher phoned the RIAA for a response, the organization did not mince words. "This lawsuit is a publicity stunt that has no merit," said a spokesperson.

"Record companies and artists have worked earnestly and diligently to negotiate a variety of agreements with a host of new types of radio services, including commercial and non-commercial Webcasters.

"The music community is committed to supporting new, cutting-edge performance models such as Internet radio. Our focus remains on working with the Webcasting community to deliver music to fans in exciting and innovative ways."

While most radio stations are represented for both terrestrial radio and their Webcasting enterprises by the NAB, Gabriel notes that a number of these Webcast simulcasting radio stations also are members of the Webcaster Alliance.

Oh, and for what it's worth, at press time the Court of Appeals for the Third Circuit in Philadelphia is still sitting on an appeal filed by the NAB and several radio group owners. The appeal asserts the Librarian of Congress was wrong in including, under provisions of the Digital Millennium Copyright Act, terrestrial radio broadcasters who simulcast their over-the-air programming on the Internet.

★ ★ ★

The digital fingerprint of a song played is compared against a database of around 3.7 million songs.

Most of the noise about Internet radio operators paying to play music over the Internet has focused on copyright royalties paid to the recording companies, probably because radio has never paid them before. But Internet radio also has to pay composers and publishers, just as terrestrial radio has had to do for decades.

One of the challenges the music licensing organizations face is monitoring play of music they represent, both to be sure they collect appropriate payments and that disbursements are made to the proper composers and publishers. The SESAC organization has engaged a technical solution to this task.

SESAC has become the first corporate customer to the partnership of The CMJ Network and Audible Magic. The two companies have rolled out their Realtime Audio Metrics system, which utilizes the digital fingerprint of a music recording to identify it.

The digital fingerprint of a song played is compared against a database of around 3.7 million songs. Audible Magic adds 10,000 songs a week to that repository.

The initial effort has the RAM system monitoring 65 stations.

"Roughly one-third of the stations are currently being monitored through online broadcasts," said Jay Ziskrout, chief operating officer of CMJ Network. "We have various methods of monitoring stations; Internet broadcasting is only one of them. We are also able to monitor over the airwaves and with the direct participation of stations themselves."

This technology may be just the tip of the iceberg as far as Big Brother watching over what sound recordings terrestrial and

Internet broadcasters are playing and reporting. Because by its very nature Internet radio delivers its programming in digital form to any location in the world, Webcasters likely will be right in the crosshairs.

How's that old saying go? Just because you're paranoid doesn't mean they aren't watching you.

★ ★ ★

Terrestrial radio broadcasters questioning whether to begin, resume or continue streaming their programming over the Internet might want to take a look at a study done by the Interep Marketing Group.

We know that majority of Internet radio listening is done at work. But Interep has found that Internet users do the majority of their spending while online at work as well.

More than six out of every 10 dollars in e-commerce takes place from the workplace, according to the Interep study.



Prime e-shopping hours are from 11 a.m. to 2 p.m.

Interep Marketing Group president Debbie Durban told Web Watcher that these e-shoppers also are listening to Internet radio. "Studies show us that 65 percent of consumers are listening to Internet radio during that time."

Their study also shows that Internet users are 12 percent more likely to listen to radio during the morning and afternoon commutes.

It seems to Web Watcher that this kind of evidence cries for Internet radio commercials that give the listener a way to make purchases immediately upon hearing the ad. If your listeners are ready to buy from their workplace, why shouldn't they be buying from your clients?

★ ★ ★

Web Watcher thinks the Internet radio industry should be sad to see the collapse of IM Networks this summer, another victim of the dot-com bubble burst.

The company "IM Enabled" Internet streams to allow them to be tuned to on Internet radio appliances made by the likes of Philips, Panasonic and Creative Labs. In other words, its technology allowed listeners to tune in Internet radio stations much like you tune in terrestrial radio stations on a standard radio.

The cost to Internet radio stations of "IM enabling," or listing on the "dial," was free. The company's business plan called for collecting revenue from software licenses sold to the electronics makers.

But in the current investment climate it was unable to raise the necessary capital to continue. The word is that stations already "IM-enabled" will continue to be available of the dial of Internet radio appliances utilizing the IM software.

Though salaried employees of U.S. operations have been terminated, a sister company, IM Japan, apparently will continue to operate for the time being. That arm of IM licenses technology. 🌐

Guided Search @
www.mouser.com

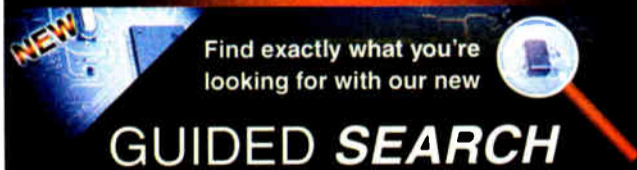

Find exactly what you're looking for with our new

GUIDED SEARCH

Mouser's new guided search has the advanced ability to match manufacturer's part numbers and keywords to "navigable" supplier and product categories. Allowing you to quickly limit your search to the product you are looking for.

Guided search simultaneously searches manufacturer's part numbers, Mouser stock numbers, keywords and cross reference part numbers.

Search results now include pricing, datasheets, manufacturer's part number, catalog page, and inventory status.

Guided search is the perfect compliment to Mouser's "Project Manager" and "Bill of Material Importer" for spreadsheets. These tools give engineers and buyers a great way to manage multiple projects and keep up-to-date on price and availability on a project by project basis.

www.mouser.com

The 'First 50 Giants Of Broadcasting'

Want to start a hot debate? Just issue a list of the "top 50" of anything.

Here's one worth arguing about. The Library of American Broadcasting is celebrating the grand opening of new quarters at the University of Maryland. A fundraiser and luncheon were held in New York City.

The event commemorated what the organization calls the First 50 Giants of Broadcasting, "men and women who pioneered the first generation of radio and television and on whose shoulders those media now stand."

Library officials said the list "should not be considered historically definitive, but rather as a starting point for the recognition of industry greatness." They expect to add additional names into their Giants of Broadcasting project.

The First 50 Giants of Broadcasting: Fred Allen, Edwin H. Armstrong, Lucille Ball, Jack Benny, Gertrude Berg, Edgar Bergen, Milton Berle, George Burns & Gracie Allen, Sid Caesar &

Imogene Coca, Frank Conrad, Joan Ganz Cooney, Bill Cosby and Walter Cronkite;

Also Bing Crosby, Powel Crosley Jr., Lee DeForest, Allen B. DuMont, Philo Farnsworth, Pauline Frederick, Dorothy Fuldheim, Jackie Gleason, Arthur Godfrey, Leonard H. Goldenson, Freeman Gosden & Charles Correll (Amos'n'Andy), Jack Harris, Paul Harvey, Ragan Henry and Bob Hope;

Also Stanley E. and Stanley S. Hubbard, Chet Huntley & David Brinkley, Jim and Marian Jordan (Fibber McGee & Molly), H. V. Kaltenborn, John Kluge, Guglielmo Marconi, Donald H. McGannon, Gordon McLendon, Tom Murphy, Edward R. Murrow, William S. Paley, Irna Phillips, Ward Quaal, J. Leonard Reinsch, David Sarnoff, Eric Sevareid;

And Frank Stanton, George Storer, Ed Sullivan, Sol Taishoff, Lowell Thomas, Vladimir Zworykin.

The library seeks to be a national resource on broadcast pioneers. Available materials on the 50, including papers, books and oral histories, are being assembled at the site, which occupies 25,000 square feet at the University of Maryland in College Park, Md.

BOOK REVIEW

'Two O'Clock, Eastern Wartime'

by Bob Kovacs

There was a time six decades ago when radio enjoyed its famous golden age, when creativity was king and images were painted in the imaginations of millions of listeners, through nothing more than words and sounds.

The era is relived in "Two O'Clock Eastern Wartime," a novel of murder and suspense that takes place in 1942 at radio station WHAR in the fictional town of Regina Beach, N.J.

Written by John Dunning and published in 2001, the story begins with the country at war and on "war time." In these early, uncertain days of conflict, the country needed the diversion of radio more than ever.

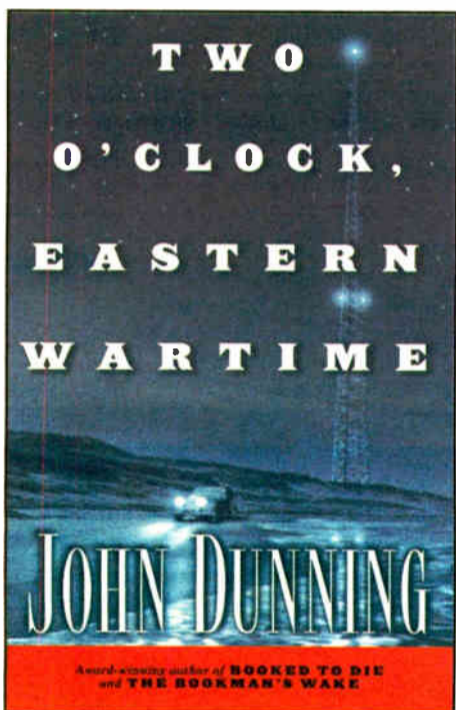

The story starts in California, where writer Jack Dulaney finds himself on a jail work gang for getting into a drunken fight with a cop. Dulaney's secretive friend, Marty Kendall, helps spring Dulaney from the work gang so that Dulaney can track down an old girlfriend who may or may not be in trouble. Jack carries a torch for the girl, Holly Carnahan. He also was a good friend of her father — who seems to be missing.

Dulaney makes his way to Holly's home in Pennsylvania looking for clues to her whereabouts, only to find the house empty — except for the body of someone he wasn't expecting. The clues lead him to Regina Beach, where he gets a job writing bumpers and filler for WHAR.

Challenging the networks

Located on the beach near New York City, WHAR has a mysterious but ambitious owner who may be connected to Holly in some way.

The owner decides he is going to acquire the talent to take on the big radio networks by presenting original dramas and musical programs. His idea is to challenge instead of pandering to the listener. Dulaney soon becomes the best writer in WHAR's stable, with a knack for creating dramas that cut against the grain of conventional radio entertainment.

Meanwhile, Holly is singing in a jazz

band in Regina Beach and soon is brought face to face with Dulaney — but it's not the meeting he expects.

There are many characters in this book but perhaps the most interesting is WHAR itself. The station, its equipment and its broadcasts play a central role in the story, right down to the reason murder and mystery hang like a cloud over the station.

The scenes in the studios, in which the original radio dramas are performed live, are the best part of the story. These moments — and there are several — are filled with loving detail of an era that has come and gone, as radio plays are

acted out with heart-pounding split-second timing to the accompaniment of a live orchestra and genuine do-it-yourself sound effects.

Dulaney rises quickly at WHAR and not only writes dramas, but directs them as well. At the same time, he slowly is getting reacquainted with Holly and looking for Holly's father.

Jack Dulaney is the Marlboro Man of radio: the strong, silent type, up for action at the right moment but never giving anything away, especially to the reader. Holly is the beautiful songbird with an unbounded future, haunted by a sad past and driven to find her father.

She, too, is prone to long fits of maddening silence. In fact, these two were so uncommunicative with the other characters and with each other that it was hard to understand why anyone wanted to spend time with either of them. If not for their amazing talents — Holly the singer and Dulaney the writer — they appear most likely to spend the rest of their lives as unapproachable recluses who waste their days feeding pigeons in the park.

In the studio

To a large extent, the scenes in the studio at WHAR mitigate the haltingly likable lead characters.

These thrilling moments made me understand for the first time why my parents still talked misty-eyed about

See TWO O'CLOCK, page 27 ►

**Clark Dixon, Chief Engineer
Clear Channel Tulsa.**

"We do numerous remotes and have had great success using Tieline codecs. Tielines codecs give us a lot of control we previously didn't have. They are versatile and they perform very well."

The Essential Codec Checklist

- Compatible with other 15kHz POTS codecs
- Unrivalled link stability over POTS (Used for STL's)
- Connects to other ISDN codecs via G.722 (ISDN option)
- 15kHz audio bi-directional over POTS
- 15kHz audio bi-directional over ISDN (optional)
- GSM Wireless Connectivity for mobile phones
- Automatic Intelligent Gain Control
- Low 100ms POTS latency
- Music/Voice + up to 9600bps data simultaneously
- Remote relay, RS232 control and remote audio level control
- Auto Reconnection on power or line loss
- Upgrade over the Internet
- Rugged Metal Construction

A small selection of network users

- | | | |
|---|---|--|
| <input checked="" type="checkbox"/> Clear Channel | <input checked="" type="checkbox"/> Jefferson-Pilot | <input checked="" type="checkbox"/> University of N. |
| <input checked="" type="checkbox"/> Entercom | <input checked="" type="checkbox"/> Broadcasting | <input checked="" type="checkbox"/> Alabama Sports |
| <input checked="" type="checkbox"/> Talk America | <input checked="" type="checkbox"/> Tribune | <input checked="" type="checkbox"/> Network |
| <input checked="" type="checkbox"/> Radio Network | <input checked="" type="checkbox"/> Broadcasting | <input checked="" type="checkbox"/> Tennessee Titans |
| <input checked="" type="checkbox"/> Sandusky | <input checked="" type="checkbox"/> Simmons Media | <input checked="" type="checkbox"/> Radio Network |



**Ask your favorite dealer
for a FREE demo today!**

Tieline 
TECHNOLOGY

www.tieline.com

Tieline Technology - 7202 East 87th Street, Suite 116, Indianapolis, IN 46256. Toll Free (888) 211-6989
email: sales@tieline.com

Real-World Expertise. Un

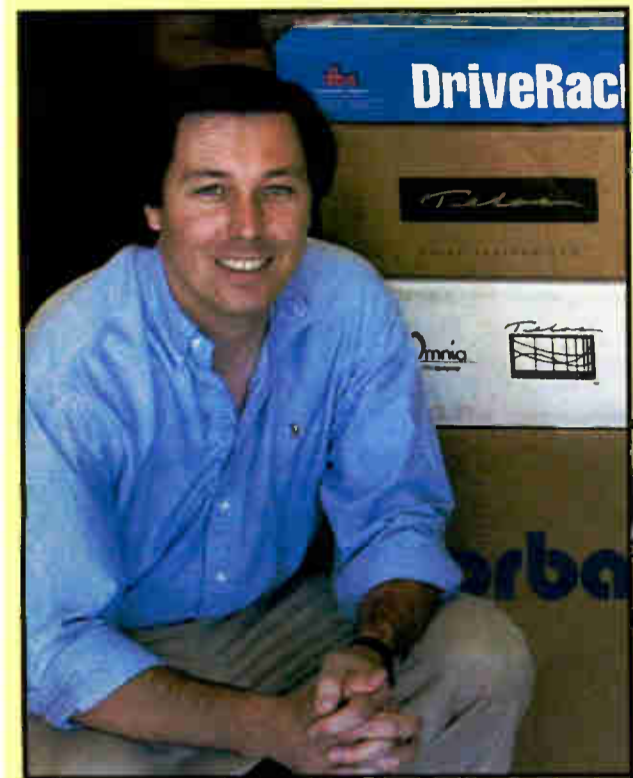

When you call BSW, you're talking to people who know their stuff because they offer real-world experience.

People like **John McDonald**. Just look at John's resume prior to joining BSW (we were certainly impressed): 12 years studio recording and production experience. Audio post production on *Spin City* and *Cosby*. Dialog recording on *Shrek* and *A Bug's Life*. Even a CLIO award!

Order from John McDonald by calling 800.426.8434 or emailing him at JohnM@bswusa.com

In spite of our nagging suspicion that John works for us so he can get great deals on recording equipment, we're proud that he's chosen to be part of BSW. And while John is our only Sales Rep who's worked with names like Eddie Murphy and Glenn Close, he's typical of the expertise you get when you call BSW.

Along with Tom, Laz, John L, Shannon, Gary, Ryan, Ricardo and Steve, John McDonald is another reason why BSW really is

your best source for pro audio – our friendly folks really do know their stuff. Call us today.



This is a photo of the BSW parking lot. It could have been taken any time between September and June. With nothing to do outside, we spend our time inside making sure you get the best service and selection possible.



Only \$199⁰⁰

AM/FM Tuner w/ XLR and Remote

The affordable Rolls RS79 has 12 AM and 18 FM presets that are retained when the power goes off. Its large LCD display remains visible even in bright daylight. This affordable AM/FM tuner also offers balanced XLR outputs, a signal strength meter and headphone jack, all packed into a compact 1RU chassis. Remote control included.

RS79 List 247⁰⁰
199⁰⁰



1U Rackmount Hybrid with AGC

The Telos ONE is the perfect low-cost solution for any telephone interface application. It automatically adapts to each call and all processing is in the digital domain. **Features:** sophisticated AGC on input and output; an advanced downward expander on the caller audio; digital processing to reduce feedback when monitoring with open speakers; the inputs are switchable for mic or line level and two outputs are provided.

ONE List 695⁰⁰
549⁰⁰

Telos

World Radio History



12-Channel Console Packed with Performance

A truly no-nonsense unit with plenty of usability, the new Audioarts R55 has 12 channels and 4 busses and offers a monitor module with talkback, an output for audition, pre- and post-mono fader outputs, plus independent meter select. **Features:** built-in cue speaker/amp and headphone jack/amp; stereo program output; plus two mono output busses. Plus, right now BSW adds a FREE phone module. Order today.

R55 List 5,795⁰⁰

CALL FOR PRICE



Dual-Level Desk With 8-Space Rack

QuikLok's smart new Z600 audio workstation is a beautiful mix of form and function, combining attractive cherry wood laminate tops and shelves with a black powder-coated 14-gauge steel frame. The desk's dual-level work area with a built-in 8-space rack between the shelf levels allows ample room for computer monitors, speakers, rack gear, mixers and more to be within easy reach and view, and an optional slide-out computer keyboard shelf (model #Z712) adds to the functionality. Get the most out of your limited production space with this efficient, stylish audio desk. Our low BSW price is only \$399⁰⁰.

Z600 List 599⁹⁵
399⁰⁰

Z712 Keyboard shelf
49⁹⁵

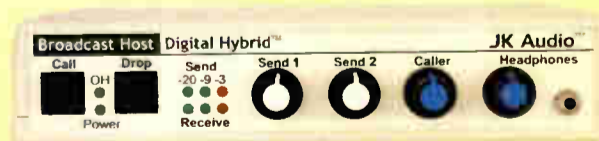

"Broadcast Host" Digital Hybrid

JK Audio's new Broadcast Host digital hybrid turns your desktop into a professional broadcast center. It allows you to send mic and line level signals into the phone line while maintaining excellent separation between your voice and the caller's. The stereo output jack on the back of the unit provides your voice on one channel and only the caller's voice on the other. The balanced XLR output jack contains only the caller's voice. **Features:** auto answer/disconnect; balanced XLR input with Mic/Line pad switch; 3.5 mm mono input; balanced XLR output; 3.5 mm stereo output (left=send, right=caller); 3.5 mm stereo output (mixed send and receive audio).

HOST List 495⁰⁰
459⁰⁰

JK Audio

Unbeatable Deals. BSW.

FREE
Phone Module
with Purchase
(a \$614 value!)

ance
5 modular console has 12
ut module with program,
ion, and much more.
ram and audition busses
odule with your purchase.

PARTS' ENGINEERING



Portable ISDN Codec with POTS Backup

The AEQ Swing is the ingenious ISDN audio codec that adds a POTS back-up connection with frequency extension and echo cancellation. Its built-in digital telephone hybrid can connect to an ISDN and analog line simultaneously, making it ideal for broadcasts that require a back-up or when ISDN lines aren't available. The microphone mixer features two headphone jacks with separate level controls and three mic inputs with built-in limiters. A four-wire connector permits auxiliary analog audio I/O. Call our knowledgeable sales staff today to get our lowest price on this AEQ codec.

SWING List 2,295⁰⁰ CALL FOR PRICE



SONY.

Great Value! Sony Wireless Systems

The Sony UWPS1 and UWPS2 are complete UHF diversity-reception wireless systems. The UWPS1 comes with a unidirectional condenser lav mic and bodypack transmitter, and the UWPS2 comes with a unidirectional dynamic handheld mic with an internal antenna; both offer level controls and 5/30 mW switchable RF power. The half-rack-size tuner is equipped with both balanced XLR and unbalanced 1/4" output. Two frequency ranges available - specify when ordering.

UWPS1	Lavaliere/bodypack system	List 640 ⁰⁰	499⁰⁰
UWPS2	Handheld system	List 640 ⁰⁰	499⁰⁰

Ten Stereo Inputs with Individual Faders

Soundcraft's SPIRIT ES stereo mixer (model #RW5653US) offers outstanding audio performance and an efficient, uncluttered board for easy mixing. Ten full-function stereo channels and 4 mono with mic and line inputs thru balanced XLR and 1/4" connectors offer optimum performance, and main stereo outs are on balanced XLRs for easy integration with professional equipment. **Features:** phantom power; stereo RCA I/O; long 100 mm faders; precision mic preamps; inserts for external processing; 3-band EQ with sweepable mids; 2 switchable aux sends. Optional 9U rackmount kit.

RW5653US List 599⁹⁶
499⁰⁰

RW5770 9U rack kit
25⁰⁰



Tried and Trusted Analog Voice Processor

The Symetrix 528E is still the broadcast standard analog voice processor with five major functions in a single-rack-space unit, at BSW for the low price of \$499⁰⁰. **Features:** microphone preamp with a switchable 15 dB pad; front panel mic/line level switch; 48V phantom power; voice symmetry switch (phase rotator) that corrects for excessive positive or negative signal peaks; de-essing with frequency and range controls; compression/limiting with downward expansion; 3-band parametric equalization. Balanced XLR mic and unbalanced 1/4" line level inputs; balanced XLR and unbalanced 1/4" outputs; 1/4" in and out patchpoints on each section.

528E List 749⁰⁰
499⁰⁰



Powerful Low-Cost Amplification



200 Watts Per Channel Under \$300!

The RMX850 power amplifier from QSC offers true professional-quality performance at a lower cost. **Features:** 200 watts/channel into 8 ohms; front-mounted gain controls; independent, user-defeatable clip limiters; selectable low-frequency filters (30 Hz or 50 Hz) to protect speakers and increase headroom; signal and clip LED indicators; variable-speed fan cooling; balanced XLR, 1/4" TRS and barrier strip inputs; binding post and Neutrik Speakon outputs.

RMX850 List 429⁰⁰

299⁰⁰

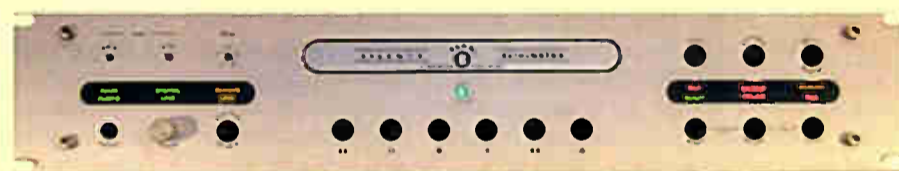

Eliminate Dead Air with the "Plan-B"

This Danagger back-up programming unit protects your station from losses due to unplanned outages by providing an alternate source of continuous backup programming. The Plan B's built-in CD drive plays all regular CD/CD-R/CD-RW discs and even MP3-encoded CDs for hours of programming. Your listeners won't even know the difference. The integrated voice remote control system automatically reports to station personnel when there's a problem, and it can be easily monitored and controlled by telephone.

PLANB List 1,850⁰⁰
1,629⁰⁰



Routes Six Phone Lines to a Telephone Hybrid

The Broadcast Tools TeleSwitch 6 routes up to six phone lines to most telephone hybrids. It can handle one hybrid and a standard single line call screening telephone set. If full call screening is not required, a second hybrid may be connected. The TeleSwitch 6 is supplied with one desktop switch console and a 1-RU controller. It even includes free screening software!



TS-6 List 829⁰⁰ **769⁰⁰**

BSW offers package pricing • Let us save you money on your next quote
800 • 426 • 8434 or online @ www.bswusa.com

Broadcast Supply
Worldwide.
Your Best Source
for Professional
Audio Products.



FACILITY PROFILE

Flexibility Is the Path of Wisdom

Wisdom Media Enjoys Life in a New Multimedia Facility in Bluefield, West Virginia

by Tom Vernon

With a global radio, TV and Internet facility operating from five buildings scattered across town, smooth operations and efficient communications can be difficult.

Such was the situation facing Wisdom

ers, four Musicam USA Prima 120 ISDN codecs, a Yamaha 01V digital console and an ENCO DADpro 32 system with three workstations, a file server and raid array.

At the core of Wisdom's infrastructure is a Wheatstone Bridge, which enables

self approach, Horne said, is that the staff has a much better understanding of how the facility operates.

Customization

While many of the installations at Wisdom are off the shelf, there were requirements that demanded innovative solutions.

At the top of the list was the need to keep in mind the needs of television.

the World Trade Center," Moore said. "In the new building we have designed back-up routes to Sirius, primarily with ISDN lines."

The planning and hard work that went into building Wisdom's new facility has paid off, they say; and the engineering staff is able to take a more proactive approach to their craft.

"In the old facilities, we got used to having catastrophic failures every week," Moore said. "Now we don't have those kinds of equipment problems, and we're able to focus on new projects."

Horne added, "Things are working so well, it's almost scary."



Carolyn Craft interviews a guest. The interview studio features custom mic mounts that don't obstruct talent's faces during TV simulcasts.



Operations Manager Craig Moore and Chief Engineer Jeff Horne designed Wisdom's new media facilities.

Media, a worldwide media resource of information, entertainment and transaction services for the health and wellness community, based in Bluefield, W.Va.

Following its move into a \$7 million building, Wisdom now broadcasts from state-of-the-art facilities. Work began in 2001; personnel moved into the new headquarters in November of last year.

Satellite and more

Wisdom's radio programming is broadcast over Sirius Satellite Radio and streamed on the Internet. Television broadcasts are sold to the C-band satellite dish industry, and are available via cable and satellite TV providers.

The radio side of Wisdom contains four studios: on-air, backup on-air/production, interview and radio edit suite. Studio furniture and two D-4000 digital audio consoles were provided by Wheatstone, which also provided Wiremax wiring interfaces and the Wheatstone Bridge router.

Other major pieces of equipment include four Panasonic SV-3800 DAT recorders, five Denon DN-C680 CD play-

flexible studio operations. Five salvos have been configured by the staff for both daily and emergency operations. Machine control logic, audio routing, microphone switching, tally, mute and cough switches can be reconfigured with the push of a button.

"A nice feature of this system is that all of these router control functions are available from the console," said Chief Engineer Jeff Horne. Operations Manager Craig Moore adds, "Having a centralized routing system with salvos has made our lives much, much easier."

While the equipment in many large media facilities is installed by outside contractors, the engineering staff at Wisdom elected to do the project themselves.

"We had the expertise in-house, and it was something we all really wanted to do," Moore said. "It turned out to be very challenging, but we learned a lot."

Wisdom's engineering staff of three was assisted with some of the computer projects by the IT staff; telephony personnel helped with the ISDN and T1 installations. An added benefit to the do-it-your-

Programs originating in the radio talk studios are simulcast on TV on occasion — a problem becoming familiar to many radio managers.

This required the talk studios to be equipped with standard track lighting and television lighting. The most difficult challenge, however, was creating low-profile mic booms that would not obstruct the camera's view of talent's faces.

"We took Wheatstone's mic risers and modified them to work with some aluminum parts of our own design," Horne said. "An added benefit to the custom mic booms was better sight lines between the talent and board operator position."

Documenting the studio furniture, signal flow and wiring in a large facility is a task unto itself. Horne used several types of software to keep track of Wisdom's infrastructure.

Studio furniture layouts were provided by Wheatstone in AutoCAD. Detailed graphics of the equipment in the facility, as well as signal flow diagrams, were created by Horne, also with AutoCAD. Documentation for the Wheatstone Bridge was done with spreadsheets using Microsoft Excel. Visio was used to create some of the rack layouts.

"In a large facility, it's important to be able to see things in two different ways," Horne said. "With the vast amount of wiring you need spreadsheets; but you also need a way to visualize the signal flow."

Building security isn't as much of a concern in the mountains of West Virginia as it would be in an urban area, although security guards and a card-key entry system are in place. Nevertheless, the events of Sept. 11, 2001, have shaped the planning of Wisdom's new facility. Moore explains:

"When 9/11 happened, we lost our audio feed to Sirius, which went through

Tom Vernon is a multimedia consultant working in Philadelphia. E-mail him at TLVernon@blazenet.net.

Wisdom Radio's Equipment

- Wheatstone D-4000 console (2)
- Wheatstone Bridge router
- Yamaha 01V board
- Enco DADpro32 (3 workstations, file server, raid array)
- Musicam USA Prima 120 ISDN codec (4)
- Telos Zephyr ISDN codec
- Telos 2x12 phone hybrid
- Orban Audicy audio editor
- Orban DSE 7000FX audio editor
- Fostex D-5 DAT recorder/player (3)
- Panasonic SV-4100 DAT recorder/player
- Panasonic SV-3800 DAT recorder/player (4)
- Denon DN-C680 CD players (5)
- HHB CDR850 Plus CD burner (2)
- Tascam RW2000 CD burner
- Sony MDS-E11 MiniDisc recorder/player
- Tascam 122 MKII cassette recorder/player (3)
- JBL 4208 speakers (8)
- EV RE-27 microphones (9)
- Neumann TLM 301 microphones (2)
- Avalon AD2202 mic preamp
- Intraplex STL Plus
- Orban 8200ST audio processor
- Eventide BD500 audio delay
- Yamaha SPX-990 voice processor
- Microboards Saturn II CD duplicator/printer
- Telex ACC2000 cassette duplicator (3)
- Sound Forge 6.0

Product Showcase



Model DAI-2 Dialup Audio Interface

- perform unattended remote broadcasts
- DTMF operated controller with relay outputs
- fully programmable output on any key press
- momentary and/or maintained relay outputs
- four logic inputs with programmable output
- balanced audio input and output with ALC

Sine Systems, Inc.

615.228.3500

more information: www.sinesystems.com

A Hobby Is Born

by Jim Hawkins

This is the first in a Radio World series of photographs of radio broadcast facilities and radio history from the collection of Jim Hawkins.

Around 1961, shortly after I had built my first 90-watt ham transmitter kit, an fellow teenage electronics enthusiast told me that the tall tower we could see in the distance belonged to WABC, which put out a power of 50,000 watts.

He told me he had visited the site some years before. He remembered a scene of huge tubes with water cooling coils. I had seen photos of transmitters of hundreds of

watts in radio amateur books. But the thought of 50,000 watts excited my imagination. I decided I had to get a better view of the site.

From my home in River Edge, N.J., I rode my bicycle south through Hackensack and found the tower in Lodi. It was just off of state Route 17. I brought my Yashica 35 mm camera with me and shot the billboard shown here at the foot of the driveway to the transmitter building. It was my first broadcast station-related photo. I developed the Anscochrome slide in my bathroom sink.

Subsequently I made my first inside visit to the WABC transmitter plant and the many others that I have taken since that time.

Visit Hawkins' Radio and Broadcast Technology Page online at www.jphawkins.com/radio.html.



WABC Billboard at the Transmitter Driveway Entrance on Route 17, Lodi, N.J.

Two O'Clock

► Continued from page 23

radio for many years after we had a TV. It also pointed out what a wasteland today's radio has become, with its predictable commercial-driven music formats and its angry purveyors of talk.

There is a mystery at WHAR and Dulaney actually uses a radio drama and the station itself to force the secret into the open.

There are many characters in this book, but perhaps the most interesting is WHAR itself.

Dunning, the author, has woven many memorable characters into this book, including the sexy German girl in the wrong place at the wrong time and several of the radio actors, particularly the cast of the "Negro show." But the most memorable characters are the radio station itself and the broadcasts; my memories of these remain sharp even as the motivations that drove Holly and Dulaney fade.

I recommend "Two O'Clock, Eastern Wartime" for its vivid portrayal of the golden age of radio. The author makes good use of the fictional setting of WHAR and its now-antique, yet marvelously effective technology. The solution to the mysteries in Regina Beach is quite a twist and many things are not exactly as they seem, including the broadcasts from WHAR.

The book was published by Scribner in hardback (\$26 retail) and Pocket Books in softcover (\$7.99).

Bob Kovacs is technology editor of TV Technology magazine.



Stuck With A Sound You Can't Get Rid Of?

YOU NEED THE NEW APHEX 2020MkIII AUDIO PROCESSOR



Settling for flabby, undefined bass? Buried, clouded, mids? Shrill, annoying high end that you just can't tune out of your current processor? Is your only comfort that some of your neighbors on the dial sound as bad or worse than you do? Then it's time to step up to the new Apdex 2020MkIII.

Radically new processing algorithms and circuitry bring even greater loudness while maintaining clarity and musicality. The bass is tight, deep and resonant, the mids are detailed and forward, and the highs are open and natural. The 2020MkIII is so powerful, yet so clean, it is the only "broadcast" processor used in world class post production and mastering facilities.

With an extensive range of useful controls you can readily achieve your own unique sonic signaturea sound that you'll never want to get rid of.

Call us today to audition the new 2020MkIII at your station.

APHEX
SYSTEMS

Improving the way the world soundsSM

11068 Randall Street, Sun Valley, CA 91352 U.S.A.
818-767-2929 Fax: 818-767-2641 www.aphex.com

Aphex is a registered trademark of Aphex Systems

Studio Sessions

**AES Returns
To New York**
See Page 36

Radio World

Resource for Radio On-Air, Production and Recording

October 8, 2003

Drop in Drive Prices Spurs Upgrades

by Ed Ritchie

Has the high cost of transitioning from tape to digital storage kept your station waiting on the sidelines to upgrade its automated systems? It may be time to take another look.

Drastic price drops in IDE/ATA hard drives have changed the price/performance landscape. The performance gap between high-cost, high-storage SCSI hard drives and IDE/ATA drives has closed dramatically, and pricing has fallen by as much as 33 percent. Reliability and new features have been added.

The good news is that automated systems no longer need to rely on SCSI drives, which were typically part of the central file server, storing the database, songs, spots and similar content. Yes, the SCSI drives are fast, but these internal drive arrays or add-on external arrays increased the cost of an automation system dramatically.

New systems

As an example, take a fully redundant, feature-rich automation system for a three-station site.

As recently as 2001, such a system could cost well over \$75,000, with much of the expense attributed to hard-drive

storage. Today, the budget for a similar system could come in at \$50,000 or less, thanks to the decreased cost of IDE/ATA drives. Those needing a typical small one-station system would fare even better, with hard-drive storage and multiple features costing about \$7,000.

But what about the raw speed and per-

formance advantages of SCSI? The drives can spin at rotation rates up to 15,000 RPM, as compared to a maximum of 7,200 RPM for IDE/ATA. Also, SCSI drives have a data transfer rates of 160 MBps vs. IDE/ATA at 100 or 133 MBps.

"Higher spindle speeds do translate to better performance," said Jeff Zigler, senior manager of engineering at Prophet Systems. "However in terms of most configurations, the performance offered by the IDE/ATA drives today are more than adequate to keep up with the demand. Since typically, the database is the main or only 'application' running on the server operating system, it becomes more a matter how many simultaneous reads and writes the 'system' must deal with. So a very large site might appreciate the faster access times of SCSI based solution."

More room to work

In terms of storage volume, IDE/ATA technology more than compensates for the difference in speed. In just the last two years, IDE/ATA has increased storage from 76 to 300 GB. SCSI capacity has increased

from 4 to 146 GB over the last six years. As a result of the dramatic capacity increase in IDE/ATA drives, stations can harness the power of multitask workstations with storage-intensive applications.

In the past, most workstations could not handle complex audio production work due to the enormous storage requirements. Now, workstations are capable of handling demanding productions tasks, playing out the on-air music and spot log locally, while leaving enough drive space to capture and time shift network programming.

The lower cost advantages also come with higher reliability. The IDE/ATA drives can be used in RAID (Redundant Array of Independent Disks) arrays for redundant storage and ease of recovery, in either internal drive arrays or add-on external drive arrays.

Keeping costs down

The use of IDE/ATA drives in place of the SCSI drives provide options for lower cost of ownership, or for larger storage arrays that still provide redundancy.

High-volume storage and redundancy are key issues at the New York City and Los Angeles locations of the Museum of Television and Radio. Each museum archives more than 110,000 radio and television shows, currently stored on tape. The New York facility is testing a hard drive-based data storage system from Nexsan Technologies. Using advanced IDE/ATA disk drives, the system stores and protects data with RAID technology.

"We have about three terabytes (TB) of storage in the testing stage," said museum director of engineering Fred

See DRIVES, page 29 ▶

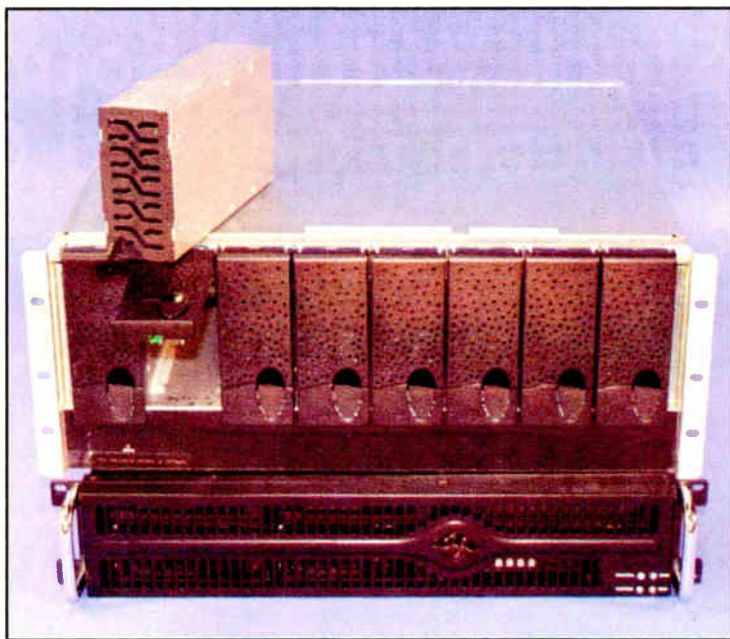

Traditionally, the advantage of external over internal drives was serviceability. IDE drives were usually internal and required disassembly of the hardware. SCSI drives were more commonly hot-swappable and in separate enclosures with easier access.

Interactive RDS/RBDS

Model 711 - \$1350

LINK IT TO STATION AUTOMATION!

This multi-featured encoder communicates with station automation to send song titles, phone numbers, contest results and promo or advertising messages for immediate display on listeners' radios. It also features the "TA flag," capable of temporarily overriding other program choices—even tapes and CDs—when your station broadcasts a traffic alert.

The 711 is quickly programmed with the usual format identifiers, translator frequencies and other static data. Its RS-232 serial interface connects with any PC, and with most automation systems for dynamic messaging. Giving access to all the most-used RadioData groups and features, this versatile encoder complies with both NRSC and CENELEC RadioData standards.



Inovonics
1305 Fair Ave. • Santa Cruz, CA 95060
TEL: (831) 458-0552 • FAX: (831) 458-0554
www.inovon.com • e-mail: info@inovon.com



Shown is a Prophet NexGen Digital Station with access to IDE backup; typical one-station setup could be as inexpensive as \$7,000.

PRODUCT GUIDE

Tapco Active Monitor Shown

Loud Technologies, formerly Mackie Designs, released the S-5 Active Studio Monitor, the next product in its relaunched Tapco line at a show in London in September. The product is expected to be available by year's end.

The S-5 is a compact bi-amplified monitor with dual internal amps that provide 120 W RMS (60 W for the 5-1/4-inch woofer; 60 W for the 1-inch tweeter).

Rear-panel controls permit acoustic tailoring with low-frequency boost and high-frequency cut/boost switches. Includes 1/4-inch TRS/XLR balanced and RCA unbalanced inputs. Retail



price: \$499.

For more information from Mackie, contact the company in Washington at (206) 465-6876 or visit www.tapcogear.com.

Mackie Becomes Loud Technologies

Mackie Designs said the company's corporate name is being changed to Loud Technologies Inc. to avoid confusion between Mackie the company and Mackie the brand.

The name change, it hopes, will clarify positioning for individual brands under the Loud Technologies umbrella. There are seven brands under Loud Technologies, which the company defines as follows:

- Mackie, its primary music industry retail brand;
- Tapco, an entry-level retail brand;
- EAW, high-end sound reinforcement and professional touring gear;
- RCF commercial/industrial sound equipment;
- RCF Precision, an OEM loudspeaker components brand;
- SIA Software; and
- Acuma Labs, a brand of embedded software solutions for pro audio.

Ownership and headquarters of the company remain unchanged.

For information contact the company in Washington at (425) 487-4333 or go to www.mackie.com. A new Web site, www.loud-technologies.com, is coming soon.

Drives

► Continued from page 28

Cotton. "It's about 300 hours of programming. We're beating up the system to see if we can break it. Things like pulling out the hot-swappable hard drives and interrupting the power supplies. But we haven't broken it yet."

"They have been testing that system for over a year," said Brendan Kinkade, marketing manager at Nexsan. "In designing these systems, we factor in the possibility of a drive failure. It's really a feature package with redundant power supplies and RAID controllers so there is no single point of failure. Our components are also hot-swappable so you don't have to power down."

Moving ahead

By tapping new USB and Firewire connectivity, manufacturers have designed new backup strategies. Using external, removable (portable) hard drives available with up to 250 GB, it is possible to maintain reasonably fast transfer rates. These drives allow for entire backups of the songs and spots libraries in a timely and cost-effective manner.

"Traditionally, the advantage of external over internal was serviceability," Zigler said. "Typically, IDE/ATA drives were mounted internally and were much more difficult to service, while SCSI storage solutions were usually mounted in removable drawers and often in a separate enclosure from the server."

"Another reason for external storage was flexibility. If you have externally located or removable storage you simply hang as much as you need off of the server."

What does this mean for those in the market for a budget-friendly automation system?

"Engineers and station management need to evaluate the options available to them for new automation systems or upgrades to existing systems," Zigler said. "Systems using hard-drive storage have become more cost-effective due to the use of the lower-cost IDE/ATA drives, typically in RAID configurations, for internal or external storage arrays. The new options available to stations are very cost-effective, feature-rich and highly productive for their operations."

Ed Ritchie is a Los Angeles-based writer specializing in radio, business and health issues. He writes for newspapers and trade publications.



Low Prices. Smart People.

CLEARANCE!

C414B/ULS
SALE Price too low to print!



RAMSA



WP1200

120W/ch - amps

\$289.00!

LAST CHANCE!



800-356-5844

www.fullcompass.com



audio-technica.

ATW-7376X

Handheld diversity wireless system

\$295.00!

Pro 227 Body Pack diversity wireless system

\$149.95!



HUGE B-STOCK & DEMO MIC SALE!!

Get a FREE catalog CALL TODAY!!



EW300IEM-SE wireless in ear monitors

\$595.00!!



Not a 9-5 shopper? Call 800-476-9886 8am-8pm M-F CST 10am-4pm Sat.

TIPS AND TRICKS

DAT-Quality Recording for a Song

by Bruce Bartlett

Many of us are recording stereo audio in the field. We might tape parts of a community music festival to create promos, record a local concert for airplay, capture ambient sounds for documentaries or do electronic news gathering.

An ideal recording medium for field audio might be a portable hard drive that records WAV files. Its sound quality can be state-of-the-art and the audio data can be downloaded quickly to a computer for editing — much faster than with DAT or cassette.

Here is a look at such a recording system. This battery-powered setup can record more than 15 hours of uncompressed CD-quality audio and costs about \$400.

The system

The system combines a portable microphone mixer with a hard-drive MP3 player. Some portable MP3 players, such as the Creative Nomad Jukebox 10 GB, have a stereo line-in jack that accepts analog audio or digital-optical audio. The Jukebox 10 GB can record this audio as a WAV file (or MP3 and WMA) on its internal 10 GB hard drive. A 10 GB drive can record more than 15 hours of stereo audio at the CD-quality 16-bits/44.1 kHz standard.

Specs for the Nomad Jukebox 10 GB are impressive: up to 98 dB S/N, 20 Hz to 20 kHz frequency response, less than 0.1 percent harmonic distortion and up to 11 hours of continuous battery life with one Lithium Ion long-play rechargeable battery or 22 hours with two batteries. The unit has USB and SB1394 connectors, analog audio line in/out and digital optical line in/out. List price is \$249.

Nomad Jukebox models are available with 6, 10 or 40 GB drives. More information is available at www.nomadworld.com.

com. A similar model, the Archos Jukebox Recorder 20, is described at www.archos.com/products/prw_500277.html.

These MP3 player/recorders are consumer units and are not up to professional standards of ruggedness, so handle with them care.

Small mixers

Most MP3 players do not have microphone inputs and none have XLRs, so a small stereo mic preamp is necessary. One such unit is the Rolls MX54s Promix Plus, which includes three XLR mic inputs with switchable phantom

Jukebox 1/8-inch stereo line-in jack. Set the trim pots on the Rolls to get the proper input level (-10 dBV) for the Jukebox. This is an analog-to-analog connection. The analog audio is digitized inside the Jukebox.

The Rolls MX54s Promix Plus sends line-level audio to the Jukebox, which records it on a 10 GB hard drive. And it is all portable, battery or AC powered, for about \$400.

The next step

A step up in quality (and size) is the Behringer Eurorack MXB 1002 battery-powered mixer with five XLR mic inputs

nectors: Home Audio and Portable Audio. Home Audio (consumer stereo) devices use 1/4-inch square TOSLINK connectors. Portable Audio devices, like MiniDisc or MP3 players, use mini-TOSLINK connectors that look like 1/8-inch phone jacks.

Most portable MiniDisc or CD players have jacks that handle both analog and digital signals. When you insert an analog plug into such a jack, the recorder detects that the signal is analog and enables the analog circuitry. When you plug a fiber-optic cable into the same jack, the recorder detects the digital signal.

The Nomad Jukebox 10 GB has a mini-TOSLINK digital optical connector. It could be used with a mic preamp/digital converter that has an optical output. To create a high-end audio recording system, the Apogee Mini Me portable mic pre/A-D converter (\$1,395) could be used



The Rolls MX54s Promix Plus



The Behringer Eurorack MXB 1002

power, low-cut switches, level and pan. This battery-powered unit costs \$155. Rated frequency response is 25 Hz to 16 kHz +0/-3 dB, and THD + noise is 0.02 percent. For more information, see www.rolls.com/rollsproducts/.

Using an adapter cable, connect the Rolls XLR line-out connectors to the

and three-band EQ. Rated frequency response is 10 Hz to 200 kHz, SNR is 120 dB EIN and battery life is 4 hours. Street price is only \$129. More information can be found at www.behringer.com.

Another option: The Black SBMP-01 battery-powered stereo mic preamp for \$699. Rated frequency response is +/-0.5 dB from 5 Hz to 150 kHz, EIN is -129.5 dB and THD + N is < 0.03 percent. More information is available at www.blackaudio.com/micpre.htm.

Also check out the Shure FP23 single-channel, battery-powered preamp designed for field use (\$420 per channel); info at www.shure.com/mixers/models/fp23.asp.

For quick interviews, you can use the microphone built into the Nomad Jukebox 10 GB wired remote. The Jukebox can record this mic signal as a WAV or MP3 file up to 2 GB in size. An FM wired remote accessory also has a built-in FM radio.

Digital optical connection

I have not used the Nomad Jukebox 10 GB, so I cannot comment on the noise level of its line-level input. It does, however, have a digital optical connector, which could accept digital audio signals from a preamp/converter.

Before explaining how this connection could be done, I need to explain digital optical connectors. The standard digital optical connection is TOSLINK, invented by Toshiba. TOSLINK transmits digital audio in S/PDIF format through a fiber optic cable. A 660 nm red light from the source device is sent through the cable to the recorder input.

There are two types of TOSLINK con-

nectors: Home Audio and Portable Audio. Home Audio (consumer stereo) devices use 1/4-inch square TOSLINK connectors. Portable Audio devices, like MiniDisc or MP3 players, use mini-TOSLINK connectors that look like 1/8-inch phone jacks.

For more information, see www.apogeedigital.com/products/prod_minime.html and www.m-audio.com/products/m-audio/C02.php.

Other recorder types

Another type of digital-audio field recorder (besides DAT) is the Marantz Professional CDR300 CD recorder selling for \$600 street (\$849 list). It features phantom-powered XLR mic inputs and can record directly to a CD-R or CD-RW. The resulting CD files can be read by your computer's CD-ROM and copied to hard drive as a WAV file for editing. See www.marantzpro.com/Products/CDR300.html.

Marantz Professional also offers a Flash-memory recorder with XLR inputs, the PMD670, selling for \$899 list. It can record MP3, MP2 or uncompressed 48 kHz DAT-quality WAV files. The USB port on the PMD670 connects to a computer for quick transfers. Costing about \$250, a 1 GB compact Flash card can record up to 75 hours of MP3 files or 1-1/2 hours of uncompressed WAV files.

Work is in progress to develop an all-in-one portable hard-drive recorder with XLR mic inputs. One is the Sound Devices 722 Portable Hard-Drive recorder, info at www.cascademedia.net/cgi-bin/cmedia/sd722.html.

Now we can record CD-quality audio in the field on hard drive, CD or Flash card for as little as \$400 to \$600.

A Rectifier To Fit Your Transmitter

No matter what transmitter you own, we can provide quality rectifiers from stock. We have a reliable, cost-effective solution to meet the requirements of most AM and FM transmitters built since the 1950s at prices better than the manufacturers'.



We Have CCA Rectifiers

Rectifier Upgrades Available
Same Day Shipments

electronics
em
manufacturing

www.rectifiers.com
800-649-6370

CKE

PRODUCT EVALUATION

Space Station: Blast From the Past

by Stephen Murphy

Chris Moore resigned his position as project manager at Lexicon and set off on his own to start a company called Ursa Major. The initial goal of the company was to create a reasonably priced digital reverb — a daunting task in the analog world of 1977.

The shoestring start-up outfit ultimately produced a unique effects processor called the Ursa Major Space Station SST-282, which debuted at the 1978 AES convention. The company's product gained attention and popularity among recording and broadcast facilities, eventually selling approximately 1,900 of the hand-built units in eight years.

The biggest departures from the original design are found on the inside of the unit. Instead of hundreds of ICs, a single 150 MHz 24-bit Motorola DSP chip handles processing duties.

Also gone from the internal circuitry are the early 11-bit floating-point A/D and D/A converters. Moore instead opted for an AES/EBU digital-only I/O design with no analog signal provisions.

Digital signals

Signal and power connections are made via a single permanent 12-foot cable that fans out into two XLR connectors for the AES digital I/O and a power

supply with detachable IEC A/C connector. Digital signals are carried on AES-specified 110-ohm cable.

The Space Station is a unique processor that practically defies description in print. Perhaps it would be useful to say it combines elements of early Eventide, Quantec and Lexicon units with a dash of Delta Effectron and Roland Space Echo thrown in for good measure.

But the bottom line is that the Space Station is the kind of processor you need to play with to appreciate. Because it has no presets, it is different every time you play with it.

Unlike many such reissues/recreations

of vintage gear that are hitting the market, designer Moore did not attempt to make a physical replica of the original. What he did instead was concentrate on duplicating the circuitry and sound of the original using a modern DSP processor as his breadboard.

Having had the privilege of using the vintage Space Station SST-282 for many years, I was stunned by Moore's recreation.

The Space Station does give the user some starting points by essentially dividing the unit's operation into three modes: SST Echo, SST Reverb and "Room." The first two modes comprise the recreation of the original Space Station, replicating the grain, grunge and limited (7 kHz) bandwidth of the SST-282. The Room mode is a new mode that uses the Motorola DSP to

See SPACE STATION, page 33 ▶



Moore is back with his new company, Seven Woods Audio (named after the W.B. Yeats poem), and an updated version of his much-revered processor, renamed the Ursa Major Space Station SST-206, which retails for \$1,195.

Features

The original Space Station was a 3 RU beast with a front panel that included 10 knobs, 14 buttons and a maze of silk-screened flow-chart legends and control labels. Inside the sheet metal housing were four printed circuit boards and hundreds of IC chips.

The \$1,995 reverb effect unit, relatively inexpensive for 1978, especially when compared to its closest competitor at around \$8,000, remains a staple on equipment lists of top engineers and producers. It is one of those almost-mythical vintage products that derive their aura from a unique sound and quirky interface.

The new Space Station bares little physical resemblance to its forbearer. Instead of a rack-mount sheet-metal enclosure, the SST-206 is a small, sleek enclosure measuring 5 by 6.5 by 0.6 inches, about the size and thickness of a thin paperback book.

In fact, at first glance the SST-206 appears simply to be the remote control for a larger rack unit — nonexistent in this case.

Like the earlier model, the Space Station user interface consists of 10 knobs. Two additional soft knobs that select the various audition delay patterns and operating modes have replaced the multitude of push buttons found on the original.

Hearing Is Believing

Zephyr Xport with aacPlus® will convince you!

Remember the first time you heard a Telos Zephyr using MP3 coding? You were probably stunned at how good it sounded. That's the same way we felt when we heard the new Telos Zephyr Xport with aacPlus®. Xport sends 15kHz audio over POTS lines - extra bandwidth for sparkling, crystal-clear sound that's superior to traditional POTS codecs.

Zephyr Xport lets you plug into any available POTS line and connect to your ISDN Zephyr Xstream at the studio. That's right... with Xport you dial POTS and it comes out ISDN! You save money because your Zephyr Xstream can now be used to receive ISDN or POTS remotes. There's also an ISDN option that lets Xport use ISDN as well as POTS for use on virtually any remote with any available analog or digital phone line.

Telos introduced the world to MP3 with the original Zephyr. Now they've introduced aacPlus®, the new MP4 standard, in the Zephyr Xport. aacPlus® sounds so good that XM Satellite Radio, Digital Radio Mondiale and many others are using it to deliver their critical audio. When Xport connects to a Zephyr Xstream, only a small portion of the connection is analog. Once the phone call gets to the nearest Telco central office it stays digital all the way to the studio, resulting in better data rates, more reliable connections and superb audio.

In fact we think Zephyr Xport is so good that we're offering you the opportunity to try one, risk-free, for 10 days. Put Zephyr Xport to work on your station and find out just how spectacular POTS remotes can sound! After 10 days you can send it back... but we think you'll be so impressed you'll want to keep it instead. Call us and request your free trial today.

Check send/receive levels and line conditions at a glance. Use the Select and Navigate keys to access fast on-screen setup menus.

Convenient 2-channel mixer with separate mic and line inputs makes Xport a self contained remote kit.

Headphone controls let talent monitor a customized mixture of send and receive audio.

Internal fanless power supply means silent operation with no "wall warts"

Optional ISDN upgrade lets Xport use analog or pure-digital phone connections.

Light but rugged extruded aluminum chassis and energy-absorbing bumpers help tame road thumps.

Storage for 100 Auto-Dial numbers and 30 frequently used location settings make remote setup fast and easy.

Interface connector provides use of 2 bidirectional contact closures.

Mic input features switchable built-in 12-volt Phantom power.

Aux interface lets you connect to a cell phone handset.

Output section includes direct output of far-end audio and an adjustable mix of local and receivable audio.

Ethernet port isn't just for one remote control; load the Xport driver software on your computer and send PCM audio directly into the codec for transmission.

Try the Zephyr Xport for 10 days*

*Please Call For Details

Your Number One Source For Broadcast Equipment!

Broadcasters General Store

FOUR OFFICES TO BETTER SERVE YOU!

Cindy Edwards 828-698-2893 cindy@bgs.cc	Cecile Gibson 937-783-2995 cecile@bgs.cc	Mark Goins 352-362-3704 mark@bgs.cc	Gary Tibbot 765-935-6707 gary@bgs.cc
---	--	---	--

Florida Home Office

1-352-622-7700

www.bgs.cc

Products & Services SHOWCASE

Superior Broadcast Products

FM TRANSLATORS

Frequency Agile Transmit & Receive
In a Wide Range of Power Choices
CALL FOR SPECIAL PRICING

SOLID STATE TELEVISION TRANSMITTERS

From 5 watts to 120 Kw
Starting at \$4990

ANTENNAS

UHF-VHF Panel Antennas
UHF Slot Antennas
Low Power Medium Power High Power
Custom Antenna Patterns

TELEVISION STL's & MICROWAVE

CALL FOR PRICING!!

FM TRANSMITTERS & EXCITERS

from 20 watts to 30,000 watts
30 watt exciters starting at \$995
250 watt Solid State Transmitter \$2750
1000 watt Solid State Transmitter \$6500
3500 watt FM Transmitter \$14,990

*** *Special Pricing* ***

10,000w FM Transmitter \$18,990
20,000w FM Transmitter \$35,990

FM ANTENNAS

Low Power Starting at \$495
Custom Designed Patterns
All Power Ranges
Full Wave Length or Half Wave Length

FM AMPLIFIERS

100 watt \$1195
250 watt \$1750

STLs

Complete Transmitters & Receiver

*** *Special Pricing* ***

\$3500

Superior Broadcast Products

WHERE WE BELIEVE IT IS AS IMPORTANT
WHO YOU BUY FROM AS WHAT YOU BUY!

CONTACTS

Jimmie Joynt Voice (800) 279-3326

Benny Springer

Voice (800) 695-7919
Fax (903) 297-4651
email bennySBP@aol.com
web: www.superiorbroadcast.com

17194 Preston Rd Suite 123-297 Dallas, Tx 75248

Telephone Solutions by CircuitWerkes



The HC-3 hybrid telephone autocoupler
The HC-3 is ideal for many tasks like listen & concert lines, remote broadcasting, IFB Interfaces, & More.



The New Telco-6, six line, incoming, ring detector
Is someone calling? Find out with the new Telco-6! The telco-6 detects telephone ring signals from one to six lines and provides a dry relay output for each line.

*More Features,
Better Price.*



CP-1 & CP-2 call progress decoders
Did you ever connect a telephone coupler to a phone line or PBX only to discover that it won't hang up? CircuitWerkes' call progress decoders can save the day on most systems. They listen for dial-tone or busy signals and, when present, force your couplers offline.



The AC-12 telco autocoupler bank
Get up to a dozen, full featured, telephone autocouplers in just 5.25" of rack space. The coupler bay features a common power supply and two audio busses for easy mass feeds. Individual couplers can be used for sending or receiving separately from the rest - perfect for IFBs. Newly updated design improves audio performance and overall reliability to a new standard of excellence!

CircuitWerkes - 352-335-6555 Fax 380-0230 http: www.circuitwerkes.com 2905 NW 6th Street, Gainesville, FL 32609

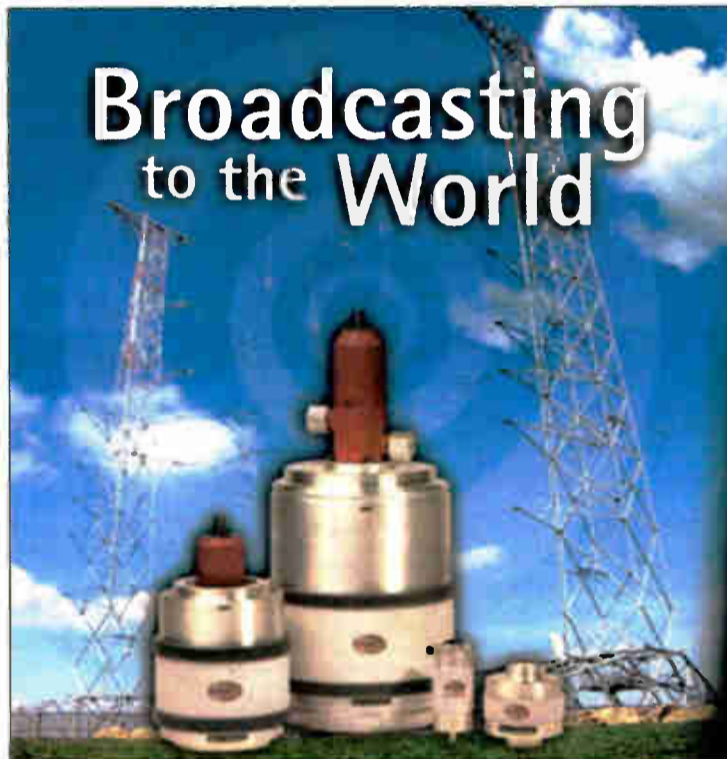

Broadcasting to the World



COMET NORTH AMERICA

421 Wards Corner Road
Cincinnati, Ohio 45140
Ph: (513) 831-5000
Fax: (513) 831-7889
www.cometna.com

- Full range of antenna configurations
- Installation/operation
- Standard equipment that meets all FCC requirements
- Professional TV test equipment to regularly test towers
- Trained in North America with Kintronic Labs to provide engineering expertise to broadcasters



Kintronic Labs, Inc.
134 Pleasant Grove Road
Burlingame, TN 37018
Ph: (615) 878-2181
Fax: (615) 878-4224
www.kintronic.com



DIGITAL ANTENNA MONITORS

In-Stock-Available for
Immediate Delivery



Price US\$2700.00 2 Towers
Will operate with any remote control equipment.



Price US\$2100.00 2 Towers
For AM directionals with studio located at transmitter site.

These monitors are state-of-the-art instruments of unequalled accuracy (.5% or better on ratio and .5° or better on phase) and stability. With typical modulation the true ratio readout of these monitors is a factor of 10 more stable than instruments that measure normalized amplitude, and their phase readouts are rock solid. Phase sign is automatic, no extra operation. In addition to the analog DC outputs for remote control the Model CMR has a multiplexed BCD digital output which can be used to drive the Remote Indicator Model CMR-1. RF inputs have dual protection. Gas discharge tubes across the sample line terminations plus relay protection.

GORMAN REDLICH MFG. CO.
257 W. Union St. Athens, Ohio 45701
Phone 740-593-3150 • FAX 740-592-3898
www.gorman-redlich.com/jimg@gorman-redlich.com

Efficient

Effective

Affordable

RADIO WORLD'S
Products and Services Showcase
provides a perfect medium for
marketing your products and services.

For more information, contact
Simone Fewell at
703-998-7600, ext. 154
to request a media kit.

Radio World

PRODUCT EVALUATION

Lawson Mic Is a New Consideration

by Alan R. Peterson

When discussing microphones for broadcast and voiceover use, a few familiar brands tend to bubble to the surface. Shure, Electro-Voice, Sennheiser and Neumann routinely are spoken in the same breath.

To a lesser extent, but by no means lesser performers, are Røde, Blue, Crown, CAD, Countryman and numerous others. As of late, inexpensive condenser units have come forth from Behringer, Samson, Marshall, Carvin and other manufacturers, with varying degrees of performance for the price.

The name Lawson pops up frequently in the music recording community, but not so in the radio or narration end of the business. With a design and manufacturing facility based in Nashville, this small company has been cranking out high-quality capsule mics for vocalists and musical instruments for a few years. One model even earned an award from Radio World's sister publication Pro Audio Review.

While it's not a prominent brand name in the voiceover microphone market right now, the introduction of the Lawson AIR microphone might move awareness of the company up a few notches.

Almost ready to hatch

The new AIR is in the final throes of beta testing, so while it is not yet available, here is an early glimpse, courtesy of Mr. Gene Lawson himself and RW.

First, the construction of the AIR mic. The beta model has a nickel-plated brass

pop screen and a turned aluminum body, about the size of the company's L47SH microphone but minus the gold trim and blue finish found on that model. I have been told this is not the official release design, as construction and body have not yet been finalized.

As is, its stubby temporary body and tall capsule cage gives it a look reminiscent of old "air raid" sirens of the 1950s, seen in movies and atop City Halls everywhere.

The capsule is protected by double screening — a large mesh screen sits atop a tighter screen with smaller spaces. Pop immunity is satisfactory on all but the closest of reads.

Thanks to its brass and aluminum body, the AIR mic has the heft of a mallet. Good thing, too, as users in the on-air studio likely will subject it to more abuse than it would receive in a music space. Radio broadcast mics suspended from booms are swung around mercilessly by air talent more preoccupied with their performance than with how delicate a microphone might be.

The robustness of this mic is bolstered further by the use of field-effect transistor circuitry rather than a vacuum tube. As a broadcast concession, this makes sense.

An oft-repeated mantra in these pages has been that broadcasters have been trying to eliminate tubes for 40 years. High-energy broadcasters cannot concern themselves with blown filaments, distortion or anything else that would inhibit performance and perhaps take a microphone out of service.

It should be noted this is still a fragile

condenser capsule microphone and a large degree of care must be practiced. This mic cannot be used to pound nails, as can an E-V 635.

Something else on-air talent might not be used to: This is a side-fire condenser mic (think Neumann, or the classic RCA 77DX). The standard for years has been front-fire units such as the E-V RE-20 or the Senny 421, and inexperienced performers used to pointing an instrument towards their mouths may get a little disoriented and go off-axis.

How close can you go?

Gene Lawson has said that the condenser capsule is based loosely on the classic U47 capsule, and that the microphone is best when worked closely. This is a contradiction to proper studio mic technique everywhere in the world, *except* in radio.

As we know, working a mic up close causes serious plosives and proximity effect (exaggerated bass response). This is why studio engineers everywhere put those pop-stopping embroidery hoops six inches in front of their microphones, and foam rubber companies get rich making slip-on pop filters.

But in commercial radio, all bets are off. In spite of the best training available, announcers want to eat the mic. Lips are right on the edge of the screen. Proximity

See LAWSON, page 34 ▶



Space Station

▶ Continued from page 31

its fullest, resulting in a high-quality room ambience/reverb stereo processor while still claiming a unique sound not easily found in common processors.

The original and reissue Space Station are plainly most appropriate for use by creative engineers, producers and musicians — the sort who have the time, patience and want to pull the unique effect out of the hat and be the hero of the mix.

So what can the Space Station do for the modern broadcaster? Not a whole lot for straight-and-narrow personalities. But for creative off-the-wall producers, morning shows, bumpers and jingles, it may be the cat's meow — or roar, depending on how one twiddles the knobs.

Beyond the new "Room" mode, essentially a high-quality reverb, the Space Station can be used in manners ranging from subtle enhancement to surprising and wild.

On the subtle side, the processor can be used as room ambience, a "loudness" enhancer, stereo widening and the like. Overt and frequently bizarre effects are just a few knob turns away, with effects ranging from straight and multi-tap echo/delay effects to comb filter and tuned resonant filter effects that are literally not available anywhere else.

In original 1978 Space Station literature posted on Seven Wood's site, Moore states that reverb effects have put "broadcast sound on the verge of a creative revo-

Product Capsule:
Seven Woods Audio
Ursa Major Space Station
SST-206 Processor

Thumbs Up

- ✓ Classy recreation of a classic effect
- ✓ Lots of knobs for infinite variation
- ✓ Previous circuitry duplicated on single DSP chip

Thumbs Down

- ✓ Digital inputs only
- ✓ Looks like a remote control

Price: \$1,195

For information, contact Seven Woods Audio in Massachusetts at (617) 489-6292 or visit www.sevenwoodsaudio.com.

lution." While not too far off the mark for the day, it seems a tad overstated today.

But for broadcast and studio professionals willing to invest a little time and money into the Ursa Major Space Station SST-206, the reward is a unique, fun and highly creative audio tool.

Stephen Murphy is a freelance engineer/producer with 20 years of experience in audio, radio and video production.

AEQ

Swing
Portable ISDN Audio Codec

- Compact, light weight and easy to operate with a worldwide ready ISDN connection.
- Works anywhere and is compatible with all codecs on the market.
- It has a built-in digital phone hybrid for POTS connection and it works simultaneously with the ISDN connection.

Now with MP3 !!!

Eagle
ISDN Audio Codec

- Stereo and Mono.
- Digital and Analog I/O.
- Capable of establishing an On Air conversation with two callers.

TH-02 Ex
Digital Telephone Hybrid

• Known worldwide for its high performance.

AEQ:
 Phone: 954-581-7999 Fax: 954-581-7733
sales@aeqbroadcast.com www.aeqbroadcast.com

Lawson

► Continued from page 33
effect goo-ood... fire ba-ad...

Lawson must have known this when he built the AIR microphone with an added 6 dB per octave of rolloff under 100 Hz. There would still be a satisfying low-frequency presence in the talent's voice, but not to the point of being wholly unnatural. And there is a slight lift centered around 4.5 kHz for clarity without harshness.

The beta version of the AIR microphone lacks flat/low-cut and attenuation

WMET(AM), a Washington talk station with new studios under construction and an increase to 50,000 watts underway.

Production for this station consists primarily of commercials, station imaging and recording bumps and promos for a series of off-air concert Webcasts.

Bypassing a Focusrite Voice Master Pro, the AIR mic had a spacious and open sound typical of condenser units. When worked the normal distance for which a capsule mic would be set, the bass response was indeed lacking. Gene Lawson was right: this microphone has to be worked up close and personal to bring out its character.

Adding in the mic processor kept these qualities in place, only making them a little more assertive. With compression, my "museum read" evolved into a lawyer commercial read ("Have you been injured in an accident or workman's comp case?").

Up close with compression is when the mic shines. Here is where imaging announcers do the Growl ("The city's Best R-r-rock is r-r-right hee-ere!") The Air mic is up to it, although up-close work carries some popped Ps and Ts, some juicy enough to squeeze through the mesh. I felt the mic needed a little more pop immunity.

Of course the proper technique of talking across the capsule at 45 degrees goes a long way to resolve this, but again, not everyone follows the rules.

No numbers yet

Published measurements of mic self-noise, TH+D and actual frequency response would not be appropriate at the present, as the microphone is still in the beta stage and is not quite up to spec; nor was it ready for sale at the time of this review. Some need to know this data before making a purchase, so the best I can tell you is be patient for the final specifications to be released.

Refinements are coming, along with a list price under \$900, which places it in the high range for broadcast mics but lower than the company's pro studio line. The heavy brass and aluminum case may change.

I hope more pop filtering goes in, and perhaps a classy looking shock suspension

Product Capsule:
Lawson AIR Capsule
Microphone (beta)

Thumbs Up

✓ Optimized for voiceover and announcer use
✓ Solid and weighty
✓ Internal FET circuitry immune to tube frailties

Thumbs Down

✓ Might be priced high for a broadcast studio mic

Price: \$900

For information, contact Lawson Inc. in Nashville at (615) 269-5542 or visit www.lawsonmicrophones.com.

In spite of the best training available, announcers want to eat the mic. Lips are right on the edge of the screen. Proximity effect goo-ood... fire ba-ad...

switches; it may be unnecessary to include them at all in the finished product, especially as Lawson realized the mic likely will be going through some extensive processing prior to air or to recording.

In use

My experiences with the AIR mic were in a temporary production room at

In its unprocessed form, the AIR mic had a wonderful body that lent itself to more sensual commercial reads, such as those for massage therapy and Cancun beach vacations. When worked closer, the mic took on an authoritative-sounding lift in the higher bass range that carried an all-facts feel, such as what is heard in museum headphone tours.

cage will come along as well. (Ed. Note: According to the manufacturer, an internal fine mesh pop filter has been added.)

Lawson's immediate hurdle will be to convince broadcasters to switch away from their big \$400 dynamic mics or their \$300 Røde condensers to investigate his company's higher-priced AIR mic. However, the company likely will find a receptive clientele in voiceover artists who find upper-end Neumanns a little out of range and the under-\$200 units from Marshall and Behringer inadequate.

◆ PRODUCT GUIDE ◆

Products for Radio Air & Production Studios

Mail info and photos to: RW Product Guide, P.O. Box 1214, Falls Church, VA 22041

Telos Archiving Program Suitable For Broadcast Apps

Telos Systems ProFiler Version 2.0 is an upgrade of its automated program archiving software.

ProFiler is used by broadcasters to store and retrieve program audio. It works with Telos balanced I/O audio cards, archiving program audio to time-annotated files using MP3 compression.

Users can listen to and work with audio files using a LAN or Internet connection. Archived audio can reside on a local hard drive, a Web or FTP server or networked drives.

Upgrades include support for recording of multiple simultaneous program streams using multiple balanced I/O audio cards, up to eight mono streams on a 1 GHz Pentium PC.

In addition to continuous logging, ProFiler provides a suite of skimming tools to capture programs for rebroadcast and to facilitate assembly of

airchecks. The SmartSkim mode lets users archive noncritical programming using maximum compression, then switch to high-quality skimming when talent mics are open.

Remote users can audition secure audio streams via LAN, WAN or Internet during capture. This is convenient for remote listening by managers, program directors and consultants.

ProFiler 2.0 runs on standard PCs under Windows 2000. In its simplest configuration the program records one stereo or two mono audio streams and includes a Telos professional balanced-I/O audio card. Telos audio cards can be added to extend the number of recorded streams. Retail price: \$595.

For more information, contact Telos in Cleveland at (216) 781-9310 or go to www.telos-systems.com.

Freelance Has Automation, 24/7

A new product, Radio Automation 24/7, has been introduced by Freelance Media Services.

The suite consists of two main programs — Broadcaster and Scheduler — that control to manage audio events and program elements. Functions and features handle a range of applications, such as automating an overnight shift or

running a 24/7 schedule.

Scheduler provides an interface for managing program and audio events. In Scheduler the user creates broadcast playlists, music rotations and event sequences. With CartChunk traffic data tags and ID3 info tags, the program can save audio cut information tags to the audio files without need of separate databases.

Broadcaster handles automation functions, from audio playback to external hardware control, including audio switcher and satellite receiver, as well as event logging and EAS logging.

The two programs work together; once program elements are created and set up in Scheduler, Broadcaster integrates each broadcast playlist into an on-air product using auto-ducking, voice-tracking and audio mixing based on the user's chosen settings and properties.

Price: \$975 for the Suite; bundle includes single-installation software licence for Broadcaster, 10-installation license for Scheduler (10 additional installations are available for an additional \$375) and a one-year subscription to Freelance Media Service's online support program. Online support provides e-mail and Web support, software updates and a variety of resources (Internet access required).

For more information, call the company in New Jersey at (856) 912-0676 or visit www.automation247.com.

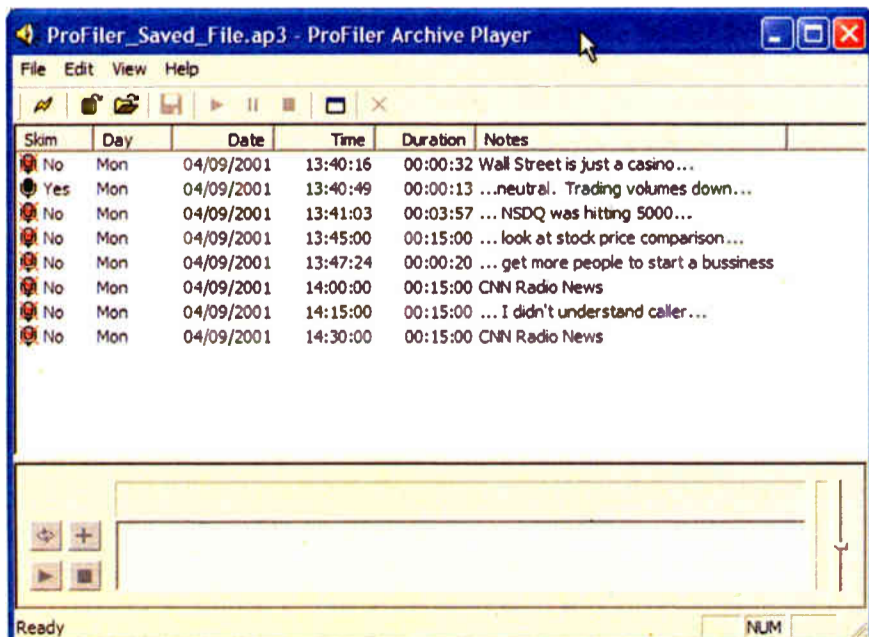

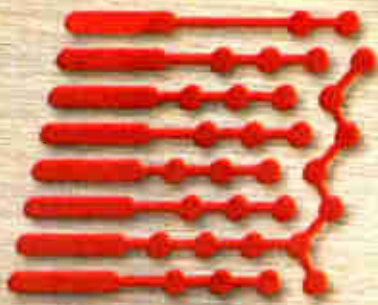

AUDIOARTS



SOURCE

Martinez



SOURCE

ADR-32
DIGITAL AUDIO ROUTER

GET BIG ROUTER FEATURES ON A SMALL ROUTER BUDGET!

Based on **WHEATSTONE's** highly acclaimed **BRIDGE TECHNOLOGY**, the new **AUDIOARTS ENGINEERING ADR-32** brings your studio trouble free mixed signal switching. You can choose from a combination of AES digital (with 24-bit SRCs) or 24-bit A-to-D input cards as well as a combination of analog and digital output cards to help keep this system future-proof. Since all signals are routed entirely in the digital domain, crosstalk is eliminated. The ADR has a built-in monitor speaker (w/level control and external output) and supports both 485 and Ethernet hardware controllers. It comes with **WHEATSTONE'S** highly acclaimed X-Point software that lets you configure, protect and integrate the system with our own consoles and third party automation systems.

BENEFIT from our extensive technology base; choose the Audioarts ADR-32 from Wheatstone—the digital audio leaders!



RF Specialties®

Concord CA 888-737-7321
Santa Barbara CA 800-346-6434
Valparaiso FL 800-476-8943
Richmond IN 888-966-1990

Kansas City MO 800-467-7373
New Ipswich NH 800-485-8684
Ebensburg PA 866-736-3736
Philadelphia PA 888-260-9298

Pittsburgh PA 866-412-7373
Amarillo TX 800-537-1801
Fort Worth TX 888-839-7373
Seattle WA 800-735-7051

AES Convention Returns to New York

by Brett Moss

The last time the AES show was scheduled to be in New York, September of 2001, the world was turned upside down. To the show organizers' credit, they managed to cobble together a show several months later in December. But it was a somber event, with many exhibitors, notably from the West Coast, choosing not to attend.

As of press time, things look to be



What: 115th AES Convention

When: Oct. 10-13, 2003

Where: Javits Convention Center, New York City

How: On-site registration is available until the day of the show; full program for members is \$300; nonmembers \$380.

Details: www.aes.org

much different and more optimistic for the 2003 show, Oct. 10-13 at the Jacob Javits Convention Center in Manhattan.

Big stuff

Who says there is a downturn in the audio industry? Things must be looking up if the large number of new consoles is any indication.

Out of the Yamaha stable is the latest in the venerable PM family of monitor mixing consoles, the PM5000. The idea is to marry the industry-standard PM4000 with the digital performance of the PM1D.

And speaking of digital consoles, Innova SON's Sy80 is new for the show. The Sy80 is the larger and upgraded version of the Sy40 live console. Debuting is the D20 Digital Input Mix Matrix from Cadac. The D20 is to be the head end for a modular, digital routing, mixing, processing system under the command of Cadac's SAM software. More modules will follow.

In the studio console market, look for a new, dedicated surround sound mixing board from API. The Vision Surround Mixing Console is a 5.1 format with preamps, processing and other whatnot courtesy of API's 500 series modules. API also is bringing out the 8200, a mixer aimed at DAW users needing

quality eight-channel input (courtesy of API 7800 master modules and 7600 channel strips).

For broadcasters, Calrec is demonstrating its new Hydra networking system. The system includes a mic preamp input module and is supposed to be compatible with all consoles in the Calrec product line.

And in the spirit of treating the dear departed kindly, Fairlight is back and with new products. Besides upgrading its QDC operating system it will show a new, smaller workstation for the DREAM series, the Station PLUS.

In the box

If there is a "box" show, it is AES. As usual, look for numerous new processors and mic preamps from established companies, boutiques and little guys just starting out.

Kind of hitting all three is Toft Audio Designs, showing several pretty silver boxes that are actually dual-channel strips the company has been teasing us with lately. Hopefully they are ready to ship.

Not to be left behind, George Massenburg has a new mic preamp and parametric EQ, the 2032, available for the show.

Millennia Media has a "Twin Topology" (tube and solid-state input paths) mic preamp/DI/parametric EQ all crammed into a very small, very busy box. It's called the TD-1 Twin Direct Recording System.

New from A Designs is an upgraded MP-2 preamp, the MP-2r (with more gain). Also from A Designs is an in-line level controller aimed at controlling levels to desktop powered speakers.

Moving from A to Z, Z-Systems has a new product, the z-Qualizer, a six-band digital parametric EQ. The z-Qualizer handles sample rates up to 192 kHz.

Yamaha will bring to New York a new reverb, the SPX2000. This 24-bit, 96-kHz addition to the SPX offers a new REV-X reverb algorithm.

Rane might win the award for most new products at the show. The PEQ 55 is a dual five-band analog parametric EQ with Rane's Accelerated Slope. The G4 is a digital quad gate with features aimed at the live sound, installation, studio and broadcast markets. The



Earthworks QTC30

MM42 is processor for working with monitor mixes.

Mic rounds

Besides offering the latest and coolest in new rackmounted toys, AES usually offers a nice selection of microphones at all ends of the market.

Anytime there is something new from Neumann it is worth a mention. The TLM 127 is a mid-priced multipattern condenser with a high-pass filter.

Another new Germanic studio mic is to be had from Dirk Brauner. The VMA Variable Pattern Tube Mic is just what it says it is, along with the addition of a vocal emphasis switch. Still in Central Europe, Sennheiser offers new members of the Evolution family. The 900 series has three new mics: the E935 and E 945 are vocal mics and the E 903 is a snare/instrument mic.

Soundelux has chosen to continue the trend of resurrecting the golden oldies. The e49 is another variable-pattern tube mic using the "kk47-style" large diaphragm.

Striking off on its own is

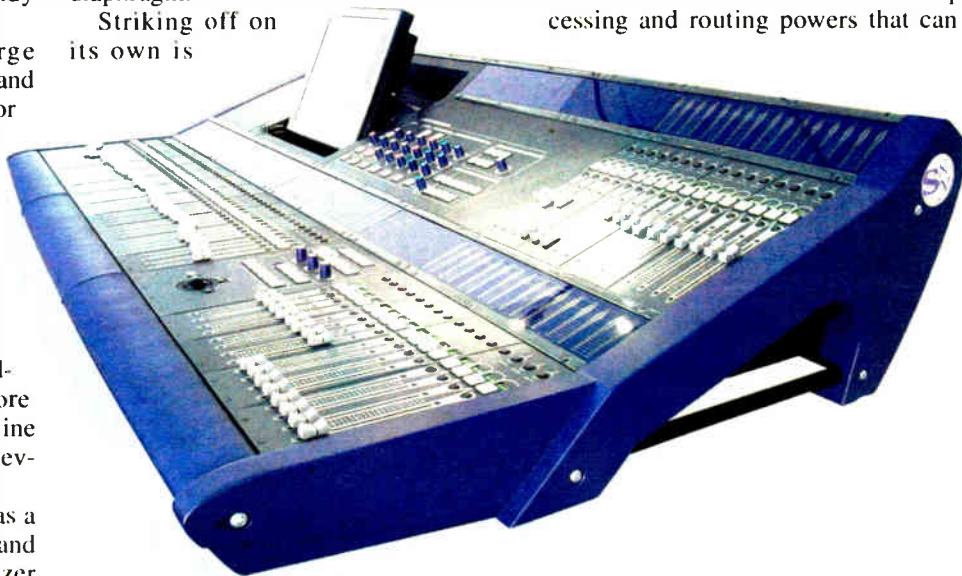

Innova SON Sy80 Digital Console

Earthworks with the QTC30, a more affordable version of the company's highly-rated QTC1.

For your listening pleasure, ADAM Audio is offering a new ribbon-powered speaker. The S5V-A is a three-way model with a ribbon tweeter utilizing ADAM's Accelerated Ribbon Technology. The low end is pumped out with a 12.5-inch Hexacone woofer.

Another nice (and expensive) powered speaker to debut at the show is the ATC SCM 12. The SCM 12 uses a 12-inch woofer in a two-way system.

If you don't have powered speakers and are in need of a new amp, Hot House Pro Audio has the Models 400, 600 and 1000 available. Hot House's irrepressible Richard Rose promises big things from these hunks of iron.

Once upon a time ...

... AES was pretty much a studio/broadcast show. But things have changed. This year expect to see new and improved system processors from facilities and live sound venues from Allen & Heath, Sennheiser, Shure, Symetrix, Lake Technology and Belgium's Apex.

There seems to be no end to the processing and routing powers that can be

Of Interest to Broadcasters

Several special events during the convention are of particular interest to radio and radio production attendees.

On Friday, from 1:30 to 4 p.m., the session "Rebuilding of New York Broadcasting" looks at how broadcast facilities were affected by the events of Sept. 11, 2001. Panelists from New York radio stations will discuss the transmission facilities that existed at the World Trade Center and Empire State Building prior to Sept. 11 and after the date, as well as solutions implemented after systems were disabled. Plans for Empire, 4 Times Square and Freedom Tower will be discussed.

"Audio Processing for Broadcast" is set for Saturday, from 11:30 a.m. to 2 p.m. Participants include Marvin Caesar, Mike Dorrough, Frank Foti, Rocky Graham, Leonard Kahn, Thomas Lund, Robert Reams and David Reaves. They will discuss compression, expansion, equalization curves and psychoacoustics, and how these audio processes affect presentation of the product.

"Digital Broadcasting in the United States" takes place Sunday from noon to 2:30 p.m. Panelists will discuss the arrival of satellite radio; in-band, on-channel radio; and digital television. The session also covers Digital Radio Mondiale. Participants include Leonard Kahn, Mark Kalman, David Layer, Tony Masiello, Don Messer, Robert Reams, Dave Wilson and moderator Dave Bialik.

Other AES sessions include basics of digital audio, audio networking, FireWire and USB, and "surround from stereo." A Friday session studies low-bit-rate coding including MPEG 4 AAC. Technical tours include "The History of FM and the Alpine Tower," with a visit to that landmark.

Schedules of sessions, exhibitors, booths and general information can be found at www.aes.org.

— Michele Kramer Peterson



Yamaha PM5000 Monitor Mixing Console



Millennia Media TD-1 Twin Direct Recording System

crammed into a digitally powered box. Also relatively new for the AES crowd is the growing number of wall and podium controllers for these boxes.

There was a time when "new" digital audio workstation software upgrades were eagerly anticipated by the AES crowd, but those days are gone. Expect major platform upgrades across the board with new plug-ins from seemingly everybody. An example of how everyone is into software? Mic processor Soundfield has a surround sound plug-in for the SADiE Series 5 platform. There will be many new peripheral introductions including input devices (some mentioned above). PreSonus is even debuting a desktop rack for preamps and processors called the MaxRack.

And last, in the miscellaneous category, Genex has a new remote (GXR948) and PC waveform audio editor (GXPC Edit) for its GX9000 and GX9048 high-end hard-disk recorders. Besides picking up some Countryman mics for distribution, Shure has a new active antenna combiner for wireless microphone systems, PA821. And Neutrik has a new family of heavy-duty RCA connectors.

Brett Moss is managing editor of Pro Audio Review, sister publication to Radio World.

PRODUCT GUIDE

Beta Site Launch For PRSS ContentDepot

An enhanced version of the PRSS ContentDepot is slated to launch this fall with expanded features and a Web interface.

The Public Radio Satellite System ContentDepot Catalog provides a central location for producers and program directors to find out about new public radio programs and obtain information about existing shows.

The enhanced version will permit stations to search for programs by distributor, length, category, genre, region and other criteria; download audition samples and promos; and access metadata about the program, including contact, rights and transmission information.

Producers will be able to upload and manage their own program audio and metadata online; submit programs for transmission by the System Technical Center; and upload on-air promos.

For more information, contact PRSS in Washington at (202) 513-2600 or visit www.prss.org.

The Dorrrough Loudness Monitor

Two 40-A2 meters in an optional dual rack

Today's audio requires careful attention to precise level control...
 Simultaneous display of Peak & Average. See the actual loudness of program content with the Dorrrough ballistics based on Time and Amplitude. Select from 6 different models including AES/EBU meters.

Features common to all models:

- Peak hold functions • Sum/Difference • Alarms for audio loss and full scale
- Scale selection for 14dB and 20dB of headroom
- AES/EBU includes more features



Remote

A wired remote for accessing phase from the 280 analog and 280 digital reading meters. Display the functions of L/R, Sum/Diff, Phase, Overs Display/Overs Reset, 3 sec. Peak Hold, Peak Hold Permanent, and Reference Mode. Red alarm status lights for Phase, BSC, and Full Scale.

Model RW-100



Please visit our web site www.dorrrough.com

Dorrrough Electronics Inc. 5221 Collier Place • Woodland Hills CA 91364
 Tel: (818) 998-2824 Fax: (818) 998-1507



Products & Services SHOWCASE

VoxPro PC

\$999

Fast, Simple, Voice-phone Editing, Network Included

Instantly share files room to room, user to user and more!



MP3

Import-Edit
WAV WMA AIF TOO

206.842.5202 x204
www.audionlabs.com

WhisperRoom INC.

SOUND ISOLATION ENCLOSURES

Celebrating over 12 years of reducing sound to a Whisper!

Recording, Broadcasting, Practicing

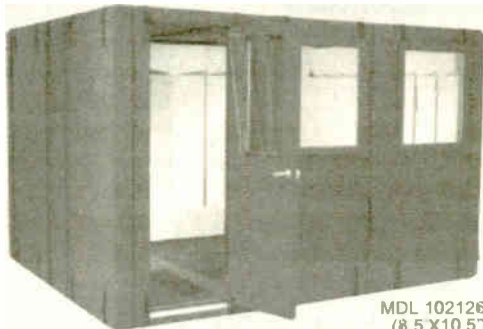

MDL 102126S
(8.5' X 10.5')

19 Sizes and 2 Levels of Isolation Available

New! SoundWave Deflection System

(Change parallel walls to non-parallel)

Immediate Shipping!

www.whisperroom.com

PH: 423-585-5827 FX: 423-585-5831

It's New!



FlipJack FJ-500

3 channel cell phone interface

- Two headphone jacks
- Two Mic inputs And a Line Input
- Connect To A Standard Telephone Line.
- Operates on "AA" batteries or external power
- Balanced Line Level Output
- Small Size: 1.5"H x 4.8"W x 4.5"D
- Tuner input for off-air monitoring
- LED level indicator

www.conex-electro.com

CONEX ELECTRO SYSTEMS

1602 Carolina St. P.O. Box 67 Bellingham, WA 98227
360-734-4323 FAX 360-676-4822
EMAIL conex@conex-electro.com

800-645-1061



MAGER SYSTEMS, INC.
The Best in Sound Furniture

Custom Studio Furniture

Since 1979 Mager Systems, Inc. has been custom designing and fabricating award winning furniture for the broadcast industry nationwide. We are still the innovators and leaders in solid surface tops and applications which comes with a 10-year warranty. Our complete one-stop-shop includes installation, turnkey rewiring, switches and components, conference rooms, reception desks, and office furniture. Our blending of art form with cutting edge techniques, and a clear understanding of each client's application allows us to produce your showcase tailored to your budget.



WBAA
Purdue University



Touch Sensitive Switches & Keyboards

TEL: 623-780-0045

FAX: 623-780-9860

mager@magersystems.com

www.magersystems.com

Visit our website for more information

MSI introduces our new award winning "Sound Choice" furniture. Our modular in stock furniture boasts unsurpassed quality for the economical budget with a 10-year limited warranty. See details on our website.

REMEMBER THE **CORTANA**

FOLDED **UNIPOLE ANTENNA?**

WE STILL MAKE IT WITH THE

SAME HIGH QUALITY MATERIALS

AND WORKMANSHIP.

IT FEATURES...

- BROAD BANDWIDTH for better sound,
- GROUNDED ANTENNA for lightning & static electricity,
- ELIMINATES ISOCOUPERS in VHF & UHF antenna lines,
- BEST ANTENNA FOR DIRECTIONAL ARRAYS.

ALSO

DETUNING SYSTEMS FOR ANYTHING THAT DISTORTS YOUR AM COVERAGE PATTERN: TOWERS, POWER LINES, TANKS OR ANY METAL STRUCTURE.

FOR INFORMATION CALL, FAX OR WRITE:

nott ltd.

4001 La Plata Hwy
Farmington, NM 87401

phone 505-327-5646 fax 505-325-1142

AM Antenna Solutions



LBA Tunipole™
Folded Unipole Systems



RF Components



Vacuum Capacitors



Diplexer, Triplexer and
Phasor Systems

COMET
Sold Here!

Reach further –
sound better!

LBA Technology, Inc.

3400 Tupper Drive, Greenville, NC 27834

800-522-4464 / 252-757-0279 / Fax 252-752-9155 / Email: Lbatech@Lbagroup.com / www.Lbagroup.com



LBA
Since 1963

Affordable, Flexible,
and Dependable???

You Bet!

PACEMAKER

III

Shown: PM-218



AUTOGRAM

800.327.6901

www.autogramcorp.com

You Actually Worked One of Those?

by Alan R. Peterson

As construction on the new WMET(AM) studios continues in downtown Washington, I have been amusing myself by engaging in a little shop talk with some of the technicians and engineers brought in for the buildout.

Once they find out I am the "other" Alan Peterson — that is, not the Talk editor for Radio & Records but "the ARP guy" or "the Trench guy" (a reference to the column I penned from 1989 to 1995) — the ice is broken and the running of the mouths can begin.

After talking about some of the people in common with whom we have worked over the years and what station "used to be really great before blah blah," the conversation inevitably turns to equipment we've had our hands on.

Funny how this topic always seems to bring out the ugliest reaction in people. Apparently, to many in our field, the only good gear that exists is the stuff we recommended and put in or the stuff we used at the best job we ever had.

The stuff the boss bought instead, after ignoring our wisdom, is crud. The gear at that station we hated and stayed at for two months is crud. Any brand or model that can be mispronounced in a derogatory manner is crud.

Yet all those stations owned it, used it and somehow stayed on the air.

I will admit to having had some personal preferences over the years, and while there are some studios best left for-

gotten, I can say, good or bad, I pretty much used it all.

Ye Bad Olde Days

Let me show you the studio in Fig. 1.

When I lost my PM drive-time show at WHEN(AM), Syracuse, N.Y., in 1989, I surfaced for a very brief time at the former WPCX(FM) in Auburn, N.Y., a country station few dozen miles out of the city.

Across the hall, the AM station held sway as the more prominent entity, using a kludged-together automation system now lost to antiquity.

The stuff the boss bought instead, after ignoring our wisdom, is crud. The gear at that station we hated and stayed at for two months is crud. Any brand or model that can be mispronounced in a derogatory manner is crud.

As you may see, for an FM station on the threshold of the 1990s, this is pretty sad. A pair of Micro-Trak turntables handled all of the music duties and had to be rubber-banded down when the station was simulcast on the AM side in the evening (note the tonearm in the foreground).

I cannot be sure anymore, but I believe those were Eumig cart machines to the far

right. While I was there, the bottom one was replaced with one of the giant ITC decks that could handle Type C carts. Despite the company's efforts to make the best deck they could, the Eumigs here were poorly maintained, sounded horrible and had grinding motor bearings.

I would have to travel far and wide to find five people to tell me that their favorite board of all time is this rotary-pot Ampro, also once offered under the RCA brand in the 1970s. Levels on this one were all over the moon, the plastic button caps would pop off and land in your lap

when you changed inputs and the mic key had almost no spring left in it.

But probably the primary reason I looked upon this console with such contempt was that I was coming off of using the largest, most magnificent linear-fader PR&E console I had ever touched at WHEN. It is so hard to go back to piloting a mail plane after you have flown the Concorde.

Don't even get me started on that Perry White/Daily Planet chair, that nutso European telephone and that particle-board plank that extends the desk surface.

Truthfully, this was a capable studio for the market it served. And while I wrestled with it, it really was not all that hellish. It is just that this studio meets Criteria #2 from before: I spent two months at this station before they tried to make me a full-timer at only \$4 per hour. They never saw me again.

Console McMuffin

Over the years, I have had mixed experiences with an old Cetec Centurion console, a Ramko board that kept popping logic chips on dry winter days, and I got lost on a large Harrison mixer. Somehow I managed.

There are two mixers that undeservedly picked up bad reputations mostly because of their brand names: McCurdy and McMartin. Bitter engineers and jocks tagged these with the unfortunate nicknames McCruddy and McRotten.

I have never had a complaint with either one. My first production console was one of the McMartin five-potters. KMJO(AM) in Omaha, a station I wrote about three years ago, had a McMartin as the heart of its newsroom.

As for the McCurdy, need I mention that no less than WNBC(AM) in New York pinned its entire hopes on one?

In 1978, Studio 2A was put into use as the primary on-air room for WNBC radio. Ditching turntables, management and engineering went with six ITC cart decks. The console that once pumped one of New York's most legendary signals into the ionosphere was a huge McCurdy stereo console. That's good enough for me.

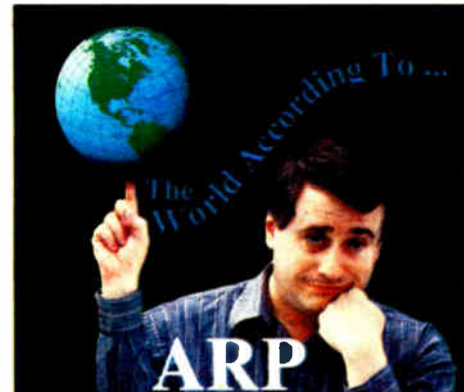

Besides, check out the small restored McCurdy mixer in Figure 2. How can you not love a face like that? Aww, ain'tt cuuute?

Tales are told over the years of one manufacturer or another having serious leakage problems between Program and Audition busses, or the Cue channel going over the air when a reel tape was fast-forwarded.

These tales often kept potential customers from examining what might have been good equipment choices from the outset.

The fault was always those crappy chips, the motherboard construction, the non-motherboard construction, the lack of shielding on the plug-in modules or the wrong kind of shielding on the plug-in modules ... you get the idea. It was always some other console that had the problems, never the one you bought.



Fig.2

Clever engineers got around the Cue leakage problems with a pair of clipping diodes, and handled the cross-channel issues by padding down the outputs, separating adjacent cables and actually grounding everything to a copper strap instead of a spare car battery cable. And of course, a quick call to the factory to let them know what they experienced.

The good ones took care of biz. The angry ones came up with the goofy names and the supposedly bad reputations.

Life goes on

Today, the bad names are reserved for digital automation and storage systems. One person who has worked with a particular system comes to a new gig and rags on the system in use there. Another boasts how he could create a better, more reliable system out of pipe cleaners, birdseed and a 286.

And some of these systems come with names that jocks and engineers will no doubt find ways to mess with, just as they always have.

So the cycle starts all over again, and a good 20 years from now, we will probably have bad things to say about the sand that was used to extract the silicon used in our on-air computer systems, and from what beach it was mined.

I grew up near Jones Beach, N.Y. I cannot wait to hear why someone considers that sand as crud. 🌐



Fig. 1: WPCX(FM) Auburn, New York 'Country 106.9.' ARP worked part-time here briefly in 1989 while between WHEN-WSBS gigs.

PRODUCT GUIDE

Orban Releases New Edition Of Popular Publication

Orban released the 2003 edition of "Maintaining Audio Quality in the Broadcast Facility." First published in the early 1980s in editions for AM and FM broadcasting, the volume has been updated several times.

The new edition combines the treatment of AM, FM and netcasting and discusses recording media system considerations and an enlarged digital technology section. Expanded material includes discussions of lossy compression and transmission codes.

Sections on maintaining analog turntables and tape have been retained. The company reasons that the information may provide a valuable resource to younger broadcast engineers.

For more information contact Orban in California at (510) 351-3500 or visit www.orban.com.

Middle Atlantic Has New Catalog

The Middle Atlantic Master Catalog features new products and solutions in an overview of the company's line of engineered mounting solutions for low-voltage applications.

Products include Middle Atlantic rack enclosure systems for broadcast and commercial A/V applications.

The Master catalog includes product listing of studio furniture, security surveillance and monitoring consoles, thermal and power management products and accessories. A new format, with products and related accessories on facing pages, makes it easier to order consoles and rack systems and options.

New products include an AXS-26 slide-out rack with a 26-inch-deep frame to accommodate deeper equipment. Also new is the SRSR rotating sliding rail with 23 inches of usable depth and locking points 0, 60 and 90 degrees for access to equipment.

To request a catalog in print or CD form, contact the company in New Jersey at (800) 266-7225 or visit www.middleatlantic.com.

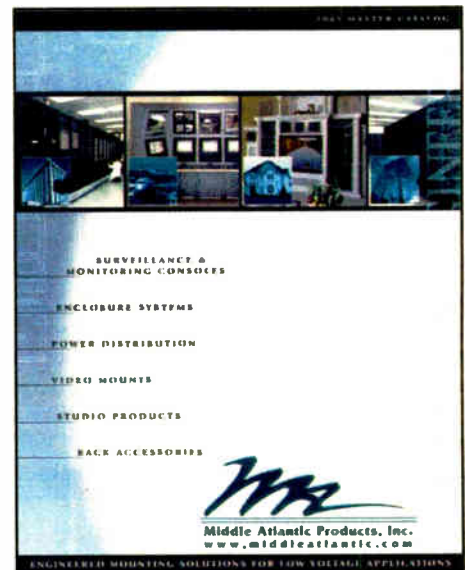

SH SHOWCASE SE

Products & Services

Affordable Custom Broadcast Furniture

Constructed, Delivered and Installed by



Now also serving you from the West Coast!

Studio Technology West
310B Coney Island Dr.
Sparks, NV 89431
TEL: 775-351-2042
FAX: 775-351-2082



TEL: 610-640-1229
FAX: 610-296-3402
32 Pennsylvania Avenue
Malvern, PA 19355

e-mail: sales@studiotechology.com
web: www.studiotechology.com

Couplers won't hang up on your phone line?
No problem with CircuitWerkes call progress decoders!



- Automatically disconnects auto-answer couplers & hybrids when calls are finished.
- Works with most PBX analog ports & POTS lines.
- Decodes standard dial and busy tones.

Many PBXs and a few telco COs do not provide the end-of-call battery signalling that makes telephone couplers and auto-answering hybrids hang up. CircuitWerkes call progress decoders listen for dialtone and/or busy (reorder) signals and force the attached unit to hang-up if they are detected. The CP-1 is installed as a daughter board in CircuitWerkes products & the CP-2 is a stand alone decoder that interfaces with any automatic coupler device. Call us or visit our web site at www.circuitwerkes.com for more info!

CircuitWerkes, Inc. (352) 335-6555



Photo courtesy Ed Dzubak, three-time Emmy winner and enthusiastic REALTRAPS customer.

MINITRAPS - AFFORDABLE ACOUSTIC TREATMENT FOR PRODUCTION STUDIOS

Nobody knows acoustic treatment better than REALTRAPS. With MiniTraps we raise the bar even higher with outstanding broadband performance at a very attractive price. They're lightweight, portable, easy to install, and absorb *three times more* than corner foam at 100 Hz. Pure genius. Only from REALTRAPS.®

For details and full specifications please call or visit our web site www.realtraps.com

REALTRAPS, LLC • 34 Cedar Vale Drive, New Milford, CT 06776
Toll-free: 866-REALTRAPS (866-732-5872) • sales@realtraps.com

Looking for a MANUFACTURER, a DISTRIBUTOR, a CONSULTANT?

Look no further...



The 2003 Radio World Directory Source Book is available for purchase!

To order copies contact: Simone Fewell at sfewell@imaspub.com or fax your request to: 703-671-7409

ONLY \$14.95
(INCLUDES SHIPPING/HANDLING)

There will be no billing, all orders must be pre-paid. We accept VISA, Master Card, and American Express.

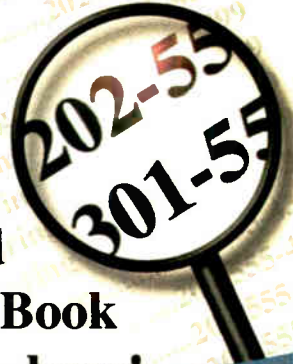

BROADCAST

Equipment Exchange

"Broadcast Equipment Exchange" accepts no responsibility for the condition of the equipment listed or for the specifics of transactions made between buyers and sellers.

ACOUSTICS

Want to Sell



Full product line for sound control & noise elimination.
www.acousticsfirst.com

AMPLIFIERS

Want to Sell

AudioClassics.com Buys-Sells-Trades-Repairs Vintage and High-End Audio Equipment. 800-321-2834 or steve@audioclassics.com.

ANTENNAS/TOWERS/CABLES

Want to Sell

Superior Broadcast Products FM Antennas All Power Levels. Contact Benny Springer Phone 800/695-7919

ERI 3 bay FM antenna tuned to 102.1 FM. 5 years old, great condition, \$1950. Rod Chambers KHJQ, 3015 Johnstonville Rd., Susanville CA 96130. 1-800-366-9162.

AM Ground Systems

Reliable. On-time Installation Quality Workmanship Ground System Evaluation and Repair
www.amgroundsystems.com 1-877-766-2999

263' guyed Rohn AM tower, lighting package included, well maintained, buyer arranges take-down, shipping. Phil Mueller, KCYN, 2573 N Radio Hill Rd, Blanding UT 84511. 435-259-1035 or 435-260-8033 (cell) or email: exnews@frontiernet.net.

S.W.R FM & Television Antennas Contact Benny Springer Phone 800/695-7919

ERI 3-bay FM antenna tuned to 102.1 FM, 5 years old, great condition, \$1950. Rod Chambers, 3015 Johnsonville Rd, Susanville CA 96130. 1-800-366-9162.

Want to Buy

200 to 300 foot self supporting tower. Ken Diebel, KHMB, 313 Ineichen St., Rayville LA 71269. 318-728-2370.

Radio World Equipment Exchange

AUTOMATION EQUIPMENT

Want to Sell

Smartcaster Jock in the Box CD automation system and live assist. Includes 8 Pioneer 18 disc CD changers, computer, cables, new rack. Great condition, \$3000+shpg. John Wilsbach, WMSS, 214 Race St, Middletown PA 17057. 717-948-9136.

QEI 7775 ATS-FM system complete with manual, working when removed from service, \$100. Duane Ashbaucher, WPOS, 7112 Angola Rd, Holland OH 43528. 419-865-5551.

Smartcaster Jock in the Box live assist CD automation system with 8 Pioneer 18-disc players, computer, hardware, rack, runs 24/7, \$3250 +shpg. John Wilsbach, WMSS, 214 Race St., Middletown PA 17057. 717-948-9136.

CART MACHINES

Want to Sell

Audi-Cord Series 100, stereo mod-quad-1 stereo R/P in working cond, mod-quad sequencer needs repair, also included are service manuals, \$150+shpg. Duane Ashbaucher, WPOS, 7112 Angola Rd, Holland OH 43528. 419-865-5551.

COMPLETE FACILITIES

NEW OR USED COMPLETE PACKAGES STUDIO/STL/TRANSMITTER/ANTENNA OR ANY COMBINATION OF ABOVE. -LEASE OPTIONS- -EMERGENCY RENTALS- -REMOTE BROADCAST RENTALS- SCMS, Inc. (800) 438-6040 "You Know We Know Radio"

CONSOLES

Want to Sell

Broadcast Electronics 8S, 8 channel audio board, BO. Ken Diebel, KHMB, 313 Ineichen St., Rayville LA 71269. 318-728-2370.

Two ATI Vanguard Series boards in working order. Will sell "as is" for \$250.00 each plus shipping and handling. For a picture of what onelooks like e-mail michael@rb.org or call Mike Raley @ (704) 523-5555.

DISCO-PRO SOUND EQUIP

Want to Sell

ATI Audio Distribution Amplifier 2016-1. We have about 10 of these as a result of studio renovations. They cost over \$1,100.00 new but will let these go for \$300.00 each plus S&H. Contact Michael Raley at (704) 523-5555 for more information or e-mail Mraley@rb.org for a picture.

Audio Arts 8400 Distribution Amplifier. We have about 15 of these as a result of studio renovation. They cost over \$1,100.00 new but will sell "as is" for \$300.00 each plus S&H. Contact Michael Raley at (704) 523-5555 or e-mail Mraley@rb.org for a picture.

Audio Cord Cart machines. We have about Several "E" series playbacks at \$20.00 each, 10 "DL" series playbacks and two "A" series playbacks at \$20.00 each. Most of them have been refurbished. We also have one "A" series P/R mono, two "E" series p/r mono, two "DL" series p/r mono and two "DL" series stereo p/r at \$100.00 each. Call Michael Raley @ (704) 523-5555 or e-mail Mraley@bbnradio.org for more information. No connectors are available. Will sell "as is". Shipping and handling charges apply. Call Michael Raley @ (704) 523-5555 or e-mail Mraley@rb.org for some pictures.

Denon 650 F CD player. Will sell "as is" for \$225.00 plus s/h. Email Mraley@rb.org for picture or call (704) 523-5555 for more information.

Enberg BA - 6 Annunciator. Four of them in great condition with no more than eight years of use in them. Original cost was \$359.00 each but we will sell them for \$225.00 each "as is" plus s/h. Call Mike Raley at (704) 523-5555 or e-mail Mraley@rb.org for more information.

Otari MX 50, and two MX 5050 all in good shape. Will sell "as is" for \$50.00 each plus s/h. Call Mike Raley at (704) 523-5555 or e-mail Mraley@rb.org for pictures. They work I'm just trying to get rid of them!

Revox Reel to Reel Recorders. Good for parts but might be repairable. We've got seven of them and can let them go for \$20.00 each plus s/h. Call Michael Raley @ (704) 523-5555 or e-mail Mraley@rb.org for pictures.

Radio World

Tascam CD 301 (Have two working units) will sell as is for \$225.00 each plus s/h. Email Mraley@rb.org for a picture or call (704) 523-5555.

Tascam Ministudio Porta One Cassette. Four mic lines for remotes This cost \$600.00 new but will sell "as is" for \$125.00 plus s/h. Call Mike Raley at (704) 523-5555 or e-mail mraley@rb.org for a picture.

Technics SL-D2 record player can let go "as is" for \$125.00 plus s/h. E-mail Mraley@rb.org for a picture or call Mike at (704) 523-5555 for more information.

Ten Nidec motors for Audio-cord "E" series. 117v 6H 3.1w 0.2amp 12p and 600rpms. Will sell "as is" for \$5.00 each. Working condition just somewhat noisy. Call Michael Raley (704) 523-5555 or e-mail Mraley@rb.org for pictures.

TFT 713 AM Frequency and Modulation Monitor. Cost \$3,400.00 new but will sell for \$1500.00 plus S&H. Needs re-calibration. Call Michael Raley at (704) 523-5555 or e-mail Mraley@rb.org for a picture.

Two B.E. Record Playback cart machines Two Stereo units "as is" for \$65.00 each and two mono units "as is" for \$50.00 each. Call Michael Raley @ (704) 523-5555 or e-mail Mraley@rb.org for pictures.

Two RTS 416 Distribution Amplifiers. Has slight problem pushing +4. Cost \$1,173.00 new but will take \$325.00 for each unit plus S&H. Call Michael Raley at (704) 523-5555 or e-mail Mraley@rb.org for a picture.

LIMITERS/AUDIO PROCESSING

Want to Buy

Teletronix LA-2A's, UREI LA-3A's & LA-4's, Fairchild 660's & 670's, any Pultec EQ's & any other old tube compressor/limiters, call after 3PM CST, 972-271-7625.

Orban 8100 XT2 (2) with or without zero card. Matt Connor, Martz Comm Group, 1592 Union St, #304, San Francisco CA 94125. 518-483-1100.

MICROPHONES

Want to Buy

RCA 77-DX's & 44-BX's, any other RCA ribbon mics, on-air lights, call after 3PM CST, 972-271-7625.

MISCELLANEOUS

For mike flags It's www.mikeflags.com

Want to Sell

1990 General 100KW 30 generator, propane, good condition. Barry O'Connor, KDES, 2100 Tahquitz Canyon Way, Palm Springs CA 92262. 760-325-2582 x237.

Arrakis 100RS, 16 stereo inputs, 4 stereo outputs, audio routing/switcher with manual, in good working condition, \$75 +shpg. Duane Ashbaucher, WPOS, 7112 Angola Rd, Holland OH 43528. 419-865-5551.

K-Y Filter Company 3010 Grinnel Place Davis, CA 95616



ELIMINATE BROADCAST BAND RFI

Plug-in telephone/modem RFI FILTERS

(530)757-6873

www.ky-filters.com/rw.htm

Bogen MXMA audio mixer in working conid, \$25 + shpg. Duane Ashbaucher, WPOS, 7112 Angola Rd, Holland OH 43528. 419-865-5551.

Proteck 20 MHZ Spec. analyzer (A-3502). Make a decent offer. Call Michael Raley @ (704) 523-5555 or e-mail Mraley@rb.org.

BAY COUNTRY BROADCAST EQUIPMENT

BUY - SELL - TRADE Your #1 Source For Quality Used Radio Broadcast Equipment View The Latest List On Line At: http://www.baycountry.com Or Call And We Will Fax It To You 7117 Olive Rd. Baltimore MD 21220 Toll Free: 877-722-1031 • FAX 786-513-0812 • E-mail: info@baycountry.com Member of BBB

Honeywell Medium Intensity Strobe System Model K-6 225 TW KVA.6 120 VAC. Lines include Royal electric 12/7 SOW 600v at 132' Royal Electric 12/5 SOW-A 90c and 60c with lengths or 52' and 160'. Good for parts only. Will sell total kit "as is" for \$1000.00. Call Michael Raley @ (704) 523-5555 or e-mail Mraley@rb.org

QEI Model ARC - 27 Automatic Remote Control- \$50.00 "as is" plus shipping and handling - Call Michael Raley @ (704) 523-5555 for more information or e-mail Mraley@rb.org for a picture.

TFT 886 AM EBS receiver for obsolete system, now useful as frequency agile AM receiver, excellent condition, \$50/BO + shpg. Bob Rivkin, KPLM/KJZ, 441 S Calle Encilia, #8, Palm Springs CA 92262. 760-320-4550.

RECEIVERS/ TRANSCEIVERS

Want to Sell

Wegener digital receiver model DR 96, BO. Ken Diebel, KHMB, 313 Ineichen St., Rayville LA 71269. 318-728-2370.

Radio World

5827 Columbia Pike, 3rd Floor Falls Church, VA 22041 PHONE: 703-998-7600 • FAX: 703-671-7409

Classified Advertising Rates Effective January 1, 2003

	1x	6x	13x	26x
1-9 col inch (per inch)	\$105	100	95	90
10-19 col inch (per inch)	\$90	80	70	60
Distributor Directory	\$130	125	120	115
Professional Card	\$100	95	90	85
Station/Studio Services	\$195	165	140	119
Classified Line Ad	\$2/word			
Blind Box Ad	\$15 additional			

Call Simone Fewell, Ext. 154, Classified Ad Manager, to reserve space in the next issue. Use your credit card to pay, we now accept VISA, MASTERCARD and American Express.

RECORDERS

Want to Sell

Revox A-77 R/P r-r in good condition, \$60 each + shpg. John Wilsbach, WMSS, 214 Race St., Middletown PA 17057. 717-948-9136.

Revox A77, 2 wood cases, \$60 +shpg, 2 rackmounts, \$150+ shpg, in good working condition, 10" reels, owner manual. Duane Ashbaucher, WPOS, 7112 Angola Rd, Holland OH 43528. 419-865-5551.

VoxPro Control Surface, (12) Mac based, ADB Bus control surfaces, \$500 each, shpg included to lower 48 states. John Arndt, Greater Media-Philadelphia, One Bala Plaza, #429, Bala Cynwyd PA 19004. 610-771-9698.

Radio World
Equipment Exchange

REMOTE & MICROWAVE

Want to Sell

CDQ Prima 110, ISDN audio codec, terminal adapter TA 101, NT1, \$750. 415-957-9131, jim@audioimages.com.

Marti RPT-15 and receiver. Complete RPU 450 system, also Moseley 30-watt system, \$1000 ea/BO. Patrick Lopeman, WMOM, 907 East Ludington Ave, Ludington MI 49431. 231-845-9666.

Moseley MRC-1620 remote control system complete with manuals. Barry O'Connor, KDES, 2100 Tahquitz Canyon Way, Palm Springs CA 92262. 760-325-2582 x237.

WE RENT FOR LESS
Hotlines FM Exciters
Zephyrs STL's
Nexus FM Pwr Amps
Audio Test Equipment
If we don't have it, we will get it!
SCMS, INC. (800) 438-6040
"You Know We Know Radio"

Moseley 1600 microprocessor remote control, w/manual, in good condition, \$400/BO + shpg. Bob Rivkin, KPLM/KJJZ, 441 S Calle Encilia, #8, Palm Springs CA 92262. 760-320-4550.

Superior Broadcast Products
FM STL Transmitter & Receivers 3,500 for both
Contact **Benny Springer**
Phone 800/695-7919

Moseley 1620 microprocessor remote control, w/manual, good condition, \$400/BO +shpg. Bob Rivkin, KPLM/KJJZ, 441 S Calle Encilia, #8, Palm Springs CA 92262. 760-320-4550.

SPACE IS AVAILABLE!
To advertise, call
703-998-7600,
ext. 154.

Moseley Taskmaster 20 remote access program version 2.3.9 w/manual, \$100/BO + shpg. Bob Rivkin, KPLM/KJJZ, 441 S Calle Encilia, #8, Palm Springs CA 92262. 760-320-4550.

Want to Buy

Small Hispanic non-profit in need of ISDN studio codec, working or not, donation is tax deductible. Bob Duke, KBBF, 735 Camellia Ct, Santa Rosa CA 95407, or email: dukerat@sonic.net.

SATELLITE EQUIPMENT

Want to Sell

Channel Master, 1.8 meter antenna system, Type 183, 1.8M, C-band, Offset Tx/Rx antenna System, complete with all mounting hardware, and instructions. Mounting post (steel pipe) not included, new in the box. List price is \$1500 from Channel Master, make offer. Bill Hearst, Clarion County Bdcg, 1168 Greenville Pike, Clarion PA 16214. 814-226-4500.

Three Zephyrus Analog Sat Receivers \$20.00 each "as is" and one Digital Zephyrus sat receiver for \$100.00 "as is" plus shipping and handling - Call Michael Raley @ (704) 523-5555 for more information or e-mail Mraley@rrb.org for a picture.

Wegner DN 86 Digital Audio Receiver 3944.1 MHZ - \$200.00 "as is" plus shipping and handling - Call Michael Raley @ (704) 523-5555 for more information or e-mail Mraley@rrb.org for a picture.

STATIONS

Want to Sell

Atlanta Metro AM Radio Station. 1KW profitable, \$750K firm. Mark, 1-706-692-4100.

Want to Buy

AMS, FMs, translators, non-commercial, commercial, PFMs, no station to small, in RI, CT, MA. Will consider partnership. Michael Cardillo, 151 Morgan St, Cranston RI 02920. 401-942-8341 after 6PM EST or e-mail: mondomikeradio@aol.com.

STEREO GENERATORS

Want to Sell

Onan 7.5 KW generator with transfer switch, propane. Barry O'Connor, KDES, 2100 Tahquitz Canyon Way, Palm Springs CA 92262. 760-325-2582 x237.

TAX DEDUCTIBLE EQUIP

Want to Sell

A non-profit 501(c)(3) Christian Ministry, seeks tax deductible donations of working professional grade live/post radio production equipment of studio automation systems, modulation monitors, DAT, CD players, mikes, turntables, mixing boards, and other radio production equipment. Also, need transmitters, translators, transmission lines, and antennas to be used in our Youth Radio Ministry Training Program. All donations will receive a tax deductible receipt and God's blessings for their donations. Minister Dr. R. Hodges, 916-721-3285 or info@lwcr.org.

CONSULTANTS

EVANS ASSOCIATES Consulting Communications Engineers

FCC Applications • Design • Field Engineering • Tower Detuning Upgrade & Relocation Studies • AM Directional Array Tuning & Proof

EXPERTS IN:
TV • DTV Transition • FM • Directional Antennas • RF Exposure

210 S. Main St., Thiensville, WI 53092, (262) 242-6000, FAX (262) 242-6045
<http://www.evansassoc.com> Member AFCCE

Consulting Communications Engineers EMC Test Lab

- FCC Applications and Field Engineering
- Frequency Searches and Coordination
- AM-FM-CATV-ITFS-LPTV
- EMC Test Lab-FCC and European (IEC)

OWL ENGINEERING, INC.

E-mail: info@owleng.com **651-784-7445** Fax (651) 784-7541

5844 Hamline Ave. N., Shoreview, MN 55126 *Member AECCE

FASTER... MORE ACCURATE RADIO COVERAGE

- Real Time 3-D Displays
- Interference calculations
- Cost effective mapping
- Fully integrated databases
- Used by the FCC
- Latest standards built-in

RADIO SOFT

Visit us on the web at www.radiosoft.com
109 West Knapp Ave., Edgewater, FL 33091 (305) 426-2521

System One Communications
Broadcast Constructors & Consultants
Houston, Texas
888-625-5649

- AM-FM Site Construction Specialists
- Complete Tower Service
- Antenna & Transmission Line Diagnostics

GRAHAM BROCK, INC.
BROADCAST TECHNICAL CONSULTANTS
Full Service From Allocation to Operation AM/FM/TV/ATV Services
Field Work Antenna and Facilities Design

Over 35 years engineering and consulting experience

912-638-8028
202-393-5133
www.grahambrock.com

M Celenza
Communications Consultants
FM-AM-TV-LPTV-LPFM Applications, Amendments, Upgrades, Frequency Searches, Directional Antennas
Field Work (Station Inspections)
631-928-0077
Fax: 631-928-1905
41 Kathleen Crescent, Coram N.Y. 11727

MULLANEY ENGINEERING, INC.
Consulting Engineers

- Design & Optimization of AM Directional Arrays
- Analysis for New Allocation, Site Relocation, and Upgrades AM-FM TV LPTV
- Wireless Cable (MDS/MMDS/ITFS/OFS)
- Environmental Radiation Analysis
- Field Work
- Expert Testimony

9049 Shady Grove Court
Gaithersburg, MD 20877
Phone: (301) 921-0115
Fax: (301) 590-9757
email: mullengr@aol.com

Communications Technologies, Inc.

Radio Frequency / Broadcast Engineering Consultants

AM FM TV LPTV Cellular/PCS Site Analysis

P.O. Box 1130 / Marlton, NJ 08053
Tel: 856/985-0077
Fax: 856/985-8124
web: commtechrf.com

Clarence M. Beverage
Laura M. Mizrahi

Doug Vernier
Telecommunication Consultants
Broadcast Engineering Consulting
AM/FM/TV/LPTV/DTV
Custom mapping service
Frequency searches
Propagation prediction
FCC application preparation

VSoft
SOFTWARE FOR YOUR PC
(800) 743-3684
www.v-soft.com

David C. Schaberg
Allocation Specialist
FM & AM Frequency Searches
Move-ins, upgrades, allocations
Maximization of signals
"If someone else says it can't be done, then we want the opportunity to prove them wrong!"
Since 1989
3105 S. Martin Luther King Jr., Blvd.
Lansing, MI 48910-2939
www.starradio.net
800-393-1037

dataworld

Market Analysis
Engineering Software
Ethnic/Demographic Data
Custom Full-color Mapping
Sales Marketing Packages

www.dataworld.com 800-368-5754
info@dataworld.com fax: 301-656-5341

Structural Analysis

ERI
Electronics Research, Inc.
7777 Gardner Road
Chandler, IN 47610
(812) 925-6000
www.ERInc.com

REGISTERED PROFESSIONAL ENGINEERS
STRUCTURAL ANALYSIS
ERI Incorporated 1943
TOWER REINFORCING

R. MORGAN BURROW, P.E. & ASSOCIATES, P.C.
ALLOCATION STUDIES
AM, FM, TV, LPTV, New to license, site relocation, FM upgrades, duplex

FIELD WORK A SPECIALTY

- AM Directional antenna adjustment, measurement & proof
- FM & TV field intensity & other measurements for facility inspections for purchase/resale purposes
- HAD/HAZ measurements, RAD/DIR, HAZard evaluation
- CATV Leakage testing

ELECTROACOUSTICS
OSHA measurements
304-258-7921 • Fax 304-258-7927

Planck Technical Services, Inc.
Broadcast Construction/Service

909-370-4515
www.plancktech.com

- AM-FM-LPTV-SW Station construction
- Tower Construction
- Transmitter/Antenna Service

AW Online

To advertise in Radio World
e-mail: stewell@imaspub.com

Visit our web site: www.rwonline.com

DISTRIBUTOR DIRECTORY

The following distributors serving the broadcast industry would be glad to help you with any of your requirements.

CORNELL-DUBILIER MICA CAPACITORS

FROM STOCK

JENNINGS VACUUM CAPACITORS

FROM STOCK

JENNINGS VACUUM RELAYS

SURCOM ASSOCIATES

2215 Faraday Ave., Suite A
Carlsbad, California 92008

(760) 438-4420 Fax: (760) 438-4759

e-mail: link@surcom.com web: www.surcom.com

...Some people get hooked on broadcast equipment big time...they think about it...dream about it...talk about it all the time...for example...us...
RADIO! The beat goes on!
CROUSE-KIMZEY OF ANNAPOLIS
tops in broadcast equipment

1-800-955-6800

ask for Kathleen

kkannapolis@worldnet.att.net

Are You a Distributor?

ADVERTISE HERE!

Space is available.

Call 703-998-7600, ext. 154.



POWER TUBES
REBUILT

1/2 THE COST
OF NEW!

ECONCO

TEL: 800-532-6626
INTL: +1-530-662-7553
FAX: +1-530-666-7760
www.econco.com
SE HABLA ESPAÑOL



TRANSMITTERS

Want to Sell



(5) Five KW FM's. Continental Communications., 314-664-4497, ContComm@sbcglobal.net.

CCA AM-1000-D 1 KW AM. Continental Comm., 314-664-4497, ContComm@sbcglobal.net.

Harris BC-5-HA, 5 KW AM (2). Continental Comm., 314-664-4497, ContComm@sbcglobal.net.

OFF THE AIR?
Emergency Back-up Rentals

FM Exciters - STLS -
FM Pwr Amps - Antennas -
Studio & Test Equipment

SCMS Inc (800) 438-6040
"You Know We Know Radio"

Harris MW-5-B, 5 KW AM (5). Continental Comm., 314-664 4497, ContComm@sbcglobal.net.

CCA HELP

- Rotron Blowers ▪ Rebuilt Plate Blockers ▪ Tubes
- Tube sockets/parts ▪ most all transmitter parts
- rebuilt tuning line assemblies

Goodrich Ent. Inc
402-493-1886

www.goodrichenterprises.com cgoodrich@tconl.com

McMartin BF-5K, 5kW FM. Factory rebuilt in perfect, like new condition, includes new tubes, tested & tuned on your frequency. Guaranteed, fully adjustable from 0 to 5.5 kW. Goodrich Enterprises Inc, 402-493-1886.

Harris MW5A 950 kHz, 5 KW AM transmitter in excellent condition, very clean, no PCB's, \$7000. Mike Ripley, KOZE, POB 936, Lewiston ID 83501. 208-743-2502.

RANGEMASTER AM: Legal FCC Part 15 type accepted transmitter, 1-2 miles range possible! 919-367-0607 or go to www.am1000rangemaster.com.

CCA 5000D, single phase 5 KW FM currently on-air. Great for start up or back-up, \$3950/BO. Patrick Lopeman, WMOM, 907 East Ludington Ave, Ludington MI 49431. 231-845-9666.

Energy-Onix MK 5.5 5500 watt FM transmitter with manual, very good condition, can put on your frequency. Barry O'Connor, KDES, 2100 Tahquitz Canyon Way, Palm Springs CA 92262. 760-325-2582 x237.

Superior Broadcast Products
FM Transmitters
20 watts to 30 Kw
Contact **Benny Springer**
Phone 800/695-7919

Harris 20H3 in good condition with manual & spare parts, can put on your frequency. Barry O'Connor, KDES, 2100 Tahquitz Canyon Way, Palm Springs CA 92262. 760-325-2582 x237.

Harris SX-1, 12 KW AM transmitter and phasor, vintage 1982 in good condition, located in Gaithersburg, MD, \$6000/BO as is, where is. Abe Farber, WMET, 520 Broad St., Newark NJ 07102. 973-438-4499 or email: abe@corp.idt.net.

Nautel FM5, brand new, never used, with NE30 exciter, tuned to 102.1, single phase power supply, \$27,000. Ted Austin, Fremont Bdctg, POB 17, St Anthony ID 83445. 208-624-3387.

AnaCom ANASAT - C Series C-Band Transceiver 10 watt just reconditioned \$6,000.00. For Technical Information e-mail Rmuffley@bbnradio.org for purchase call Michael Raley at (704) 523-5555 or e-mail at Mraley@rrb.org for pictures.



CCA 8000G FM transmitter, excellent condition with a spare PA tube, still in the box. Cale Sharp, WASE, 519 North Miles St, Elizabethtown KY 42701. 270-766-1035.

Classic Collins 20v2 transmitter. Operating when removed from service, tuned to 790, buyer arranges shipping or pickup. Phil Mueller, KCYN, 2573 N Radio Hill Rd, Blanding UT 84511. 435-259-1035 or 435-260-8033 (cell) or email: exnews@frontiernet.net.

Peter Dahl single phase converter kit for 25-30 KW transmitter, \$3000. Carl Haynes, Dominant Comm Corp, POB 9734, Jackson MS 39286. 601-981-9808.

QEI FMQ 10000 transmitter tuned to 100.1 in good working condition and can be returned on the field. This was installed in March of 1994 but will be replaced by another xmitter sometime at the end of the summer of 2003. This xmitter cost \$30,000.00 new but will let go for \$18,000.00. Call Mike Raley @ (704) 523-5555 or e-mail Mraley@rrb.org.

QEI FMQ series 6.0 to 9.6FM. This xmitter did a tour of duty in Argentina but some goofy laws in this country made it impossible to permit the station to operate at this power. To make a long story short it was only in operation no more than four months. Will let this go for \$22k firm. Call Mike Raley at (704) 523-5555 or Email Mraley@rrb.org for pictures.

SINGER (remake of CCA) model FM 20,000 E tuned to 89.5FM. Currently in "fairly good" operating condition, with a TPO of 17.1 KW. This can be retuned on the field and parts are available through Goodrich Enterprises (402)-493-1886. Call Michael Raley @ (704) 523-5555 or e-mail Mraley@rrb.org for pictures. \$7,250.00 and buyer arranges shipping.

TUBES

Want to Sell

FOR THE BEST PRICE
& 24 Hr service on transmitting tubes & sockets/parts, new & rebuilt call Goodrich Ent. at 402-493-1886 day or night, www.goodrichenterprises.com.

TUBES, Eimac, Svetlana
ams@hard-to-find.net Fax:
905-844-6263 Phone: 905-844-5772 www.hard-to-find.net

RF PARTS COMPANY • Broadcast • Industrial Communications

• EIMAC • TAYLOR • ECONCO • SVETLANA

Also
Motorola • Toshiba • SGS-Thomson
& Mitsubishi Semiconductors

Catalog: www.rfparts.com
Bilingual - We Export

760-744-0700 • 800-737-2787
Fax: 760-744-1943 E-mail: rfp@rfparts.com

EMPLOYMENT

HELP WANTED

Growing Chicago organization seeks FT Chief Engineer for 4 AM radio stations. Minimum 10 years experience. Must be able to handle transmitters, towers, studios, facilities, computers, FCC compliance, etc. Great benefits. EOE. MPRADIO@SBCGLOBAL.NET.

POSITIONS WANTED

An eager, hard-working rookie looking for the experience of a lifetime in radio. Open to change and willing to relocate. Call Traci "Aries" Anderson, 469-223-7434.

Friendly, industrious, commercial FCC-1st Class with rader-amateur radio extra licensed, asst CE, seeks FT, PT, contract, with AM, FM, cable, TV, preferred within 75 mile radius of metro NYC area. 718-969-5224 or write: Mitchell Rakoff, 110-64 Queens Blvd, PMB# 494, Forest Hills NY 11375-6347 or email: MitchellRakoff@yahoo.com.

New to radio and looking for work. Willing to relocate. Works hard and is very creative. Jennifer, 405-360-4071.

On-air talent yearning to launch your station to new heights. Steve "The G-Man" Garner, ABS grad, seeking any position, format or location. steveandamyg@netzero.com.

Radio school educated and ready to give your station 110%. Call Donna, 405-787-4233.

Recent broadcasting school graduate that is ready and willing to do what it takes to keep your station on top. Will relocate. Jerry,jwj1911@aol.com.

Rookie just out of school with good grades, looking for on-air or production position. People person, high energy and willing to go anywhere you need me. Lynn, 405-302-5674.

Rookie seeking on-air/production. Hard-working and very energetic. Learns new techniques fast. Confidants and committed to your station. Will relocate and prove myself. Don Hightower, 972-278-6424 or 214-325-2986 or email: spidercarnage@joimail.com.

Sports broadcaster interested in play-by-play, color announcing, sportscasting, or producer. Great sports knowledge. Willing to relocate. Call Matt, 918-241-8695.

The hottest American Broadcasting School DJ has now graduated and is looking to help out in any way I can. One call and I'll be there. Jabaar, 405-728-3171.

CE position wanted. Experienced with computers, transmitters, automations, DCS, UDS, digital studios. Robert King, 978-479-4855.

SERVICES

Got Services?

Spotlight them here!

For more details, call Simone Fewell at 703-998-7600, ext. 154 or e-mail: sfewell@imaspub.com

TRANSCOM CORP.

Serving the Broadcast Industry Since 1978

Fine Used AM & FM Transmitters and Also New Equipment

USED FM TRANSMITTERS				NEW TV - VHF		NEW TV - UHF	
2.5kw	1978	Collins 831D2	10 watt	500 watt	10 watt	500 watt	
3kw	1996	QEI Quantum	100 watt	1,000 watt	100 watt	1,000 watt	
3.5kw	1985	BE FM 3.5A	250 watt		250 watt		
5kw	1985	Harris FM5K					
10kw	1988	BE FM 10A					
10kw	1980	Harris FM10K					
20kw	1982	Harris FM20K					
20kw	1978	Collins 831G2					
20kw	1989	QEI FMQ20.000B					
25kw	1997	CCA 25,000G (single phase)					
25kw	1980	CSI T-25-FA (Amplifier Only)					
25kw	1982	Harris FM25K					
30kw	1984	BE FM30					
40kw	1978	2-RCA BTF 20E1 (combined)					
50kw	1982	Harris Combiner w/auto exciter-transmitter switcher					
USED AM TRANSMITTERS							
400wt	1991	Nautel P400 (solid state)					
5kw	1982	Harris MW5A					
5.10kw	1982	Continental 316F					
50kw	1985	Continental 317C2					
50kw	1986	Nautel AMPFET 50					

2655 Philmont Ave #200, Huntingdon Valley, PA 19006
800-441-8454 • 215-938-7304 • FAX No. 215-938-7361
VISIT OUR NEW INTERNET SITE: www.fmamtv.com
SEND YOUR E-MAIL REQUESTS TO: transcom@fmamtv.com

D And C Electronics

An International Distributor of RF Components

Tubes

NEW & REBUILT

TRANSMITTERS, STUDIO EQUIPMENT, STLS, ANTENNAS, RADIO DATA SYSTEM (FOR CAR RADIO DISPLAY) EXCITERS-TRANSMITTERS, TRANSLATORS, MIXERS-CONSOLES, RADIO LINK RPU, MOSFETS, VACUUM CAPACITORS, SOCKETS

Eimac Pro-Tek®
SVETLANA OMB EEV

BEST PRICES To Order: 1-800-881-2374 FROM OUR STOCK
Outside U.S. (352) 688-2374
Se Habla Español

3089 Deltona Blvd. Spring Hill, FL 34609 352-688-2374
BEST SERVICE Fax 352-683-9595
Website: www.dandcelectronics.com

ENTER TO WIN

Here's your chance to unpack **FREE GEAR** in 2003.
Enter to win one of 26 New Technology prizes.

Over the past two years, Radio World and dozens of industry suppliers have joined forces to award more than \$115,000 worth of radio and pro audio gear — from microphones, master clocks and sound cards, to audio processors, routers, CD mastering machines and shopping sprees.

In 2003 you can expect a similar range of cool New Technology products from our great sponsors. It takes only seconds to sign up online. And best of all, there are 26 chances to win in 26 drawings - - one for every issue of Radio World. This is our way of saying "thank you" for allowing us to bring you New Technology for the past 27 years.



To enter the sweepstakes you must complete these 3 easy steps:

- 1 Go to our website www.rwonline.com
- 2 Click on the New Technology Sweepstakes icon
- 3 Follow the instructions and fill out the electronic entry form - that's it, you're done!

So what are you waiting for? Don't miss out in '03. Enter to win New Technology products from these fine Radio World supporters:



Contest Rules: To enter the drawing, simply register online at www.rwonline.com/sweeps. 26 drawings will be held throughout the year. Contest registration expires Dec. 3, 2003. Final contest prize announcement on Jan. 1, 2004. One prize per winner. All contestants MUST reside in the United States and have a valid mailing address. Winners should receive prizes within 30 days of notification; however, actual delivery time may vary and is not guaranteed by IMAS publishing. Federal, state and local tax/tariffs may apply to prizes and are the sole responsibility of the winner. Employees and affiliates of IMAS Publishing are not eligible.

ADVERTISER INDEX

This listing is provided for the convenience of our readers.
Radio World assumes no liability for inaccuracy.

PAGE	ADVERTISER	WEB SITE URL
10	360 Systems	www.360systems.com
33	AEQ	www.aeqbroadcast.com
27	Aphex Systems	www.aphex.com
12	ATI	www.atiguys.com
6	Audemat-Aztec Inc.	www.audemat-aztec.com
38	Audion Labs	www.voxpro.net
38	Autogram Corporation	www.autogramcorp.com
8	Belar	www.belar.com
11	Broadcast Electronics	www.bdcast.com
15	Broadcast Software Int'l (BSI)	www.bsiusa.com
31	Broadcasters General Store/Telos Systems	www.bgs.cc
24-25	BSW	www.bswusa.com
4	Burk Technology	www.burk.com
32	Circuit Werkes	www.circuitwerkes.com
40	Circuit Werkes	www.circuitwerkes.com
30	CKE/HVCA	www.rectifiers.com
32	Comet North America	www.cometna.com
7	Comrex	www.comrex.com
38	Conex Electric Systems	www.conex-electro.com
37	Dorrough Electronics	www.dorrough.com
29	Full Compass	www.fullcompass.com
32	Gorman-Redlich Mfg. Co.	www.gorman-redlich.com
1	Harris	www.broadcast.harris.com
14	Henry Engineering	www.henryeng.com
28	Inovonics	www.iovon.com
38	LBA Technology	www.lbagroup.com
13	Logitek	www.logitekaudio.com
38	Mager Systems	www.magersystems.com
22	Mouser Electronics	www.mouser.com
19	Muscam USA	www.musciamusa.com
38	Nott Ltd.	www.nottltd.com
17	OMT Technologies	www.omt.net
21	Radio Computing Service (RCS)	www.rcsworks.com
5	Radio Systems	www.radiosystems.com
40	RealTraps LLC	www.realttraps.com
3	S.C.M.S.	www.scmsinc.com
26	Sine Systems	www.sinesystems.com
40	Studio Technology	www.studiotechology.com
32	Superior Broadcast Products	www.superiorbroadcast.com
9	Telos Systems	www.telos-systems.com
23	Tieline America	www.tieline.com
2	Wheatstone	www.audioarts.net
35	Wheatstone	www.wheatstone.com
47	Wheatstone	www.wheatstone.com
48	Wheatstone	www.wheatstone.com
38	Whisper Room	www.whisperroom.com

ACTION-GRAM

EQUIPMENT LISTINGS

Radio World's Broadcast Equipment Exchange provides a FREE listing service for radio stations only. All other end users will be charged. This FREE service does not apply to Employment Help Wanted ads or Stations For Sale ads. These are published on a paid basis only. Send your listings to us by filling out the form below. Please be aware that it takes one month for listings to appear. The listings run for two consecutive issues and must be resubmitted in order to run again. Thank you.

Please print and include all information:

Are you currently a subscriber to Radio World?
 Yes No

Signature _____ Date _____

Contact Name _____
 Title _____
 Company/Station _____
 Address _____
 City/State _____
 Zip Code _____
 Telephone _____

Brokers, dealers, manufacturers and other organizations who are not legitimate end users can participate in the Broadcast Equipment Exchange on a paid basis. Line ad listings & display advertising are available on a per word or per inch basis.

WTS WTB Category: _____
 Make: _____ Model: _____
 Brief Description: _____

 Price: _____

*Closing for listings is every other Friday for the next month's issue.
 All listings are run for 2 issues unless pressed for space or otherwise notified by listee.
Broadcast Equipment Exchange
 PO BOX 1214, Falls Church, VA 22041 • Tel: 703-998-7600 • Fax: 703-998-2966

◆ READER'S FORUM ◆

Bigger Fish to Fry?

As I sit here finishing up the Aug. 13 issue, I can understand Radio World covering Webcasters a little, and I can certainly understand write-ups on shortwave stations, for those are real broadcasters.



Stephen Provizer

However, why does Radio World care to devote precious print to pity some pirate, Part 15 broadcaster? Aren't the pages of Radio World more valuable than some station that struggles to cover two city blocks?

The headline reads "Provizer Leaves Station He Started." The photo of him holding a mic looks like some dark, hateful man with utter contempt for life, staring a hole through the heart of my corporate employers. With all due respect for your fine publication, why do you think I care?

Memo to RW: Nobody out here in the trenches of real life cares about some left-winger with a Radio Shack "150-in-1" AM broadcaster kit outside of Boston. We have much bigger fish to fry. As I skimmed the article, for I am a RW cover-to-cover reader, I just kept thinking to

myself, "Good!"

My grandfather told me once, "Don't tell people your problems. Half of them don't care and the other half are glad." He was right.

*Paul Shinn
Stockton, Calif.*

RDS Crosses Borders

Thanks to Radio World and Randy Stine for the fine article on RDS ("RDS Slowly Gaining Acceptance," Aug. 13). I hope it encourages other stations to begin using this valuable resource.

As keeper of the North American RDS Log, I can attest that RDS is indeed gaining acceptance by the number of additions and changes I've made to the log in just the last month. I'm pleased with the growth in the United States, and amazed at all the Canadian stations that are now beginning to use RDS.

It's a pleasure to receive each and every issue of Radio World and the weekly e-mail update. Keep up the great work.

*John Zondlo
North American RDS Log
Yukon, Okla.*

Give the People What They Want

We've established that radio is becoming unimaginative in many areas of the United States. That is certainly a shame, but I was wondering when it became useless to tune to radio in times of bad weather or emergencies to get news and information.

I reside in a small market. Several nights ago our area was hit with severe widespread storms. The entire listening area lost power at about 9:30 p.m. Minutes after the power went out, I switched on my battery-operated 800 MHz scanner and heard crews reporting downed trees and power lines in many communities.

I then turned on the radio to get more information. (I might preface this by mentioning that even though this is a small market, several stations are owned by large media corporations.) I went up and down the FM dial to no avail. Every station was airing satellite programming or pre-recorded programs, and stations that were live could not break format to put on local news.

I then tried the AM band. While we have four AM news/talk stations in the immediate area, none of them was giving any information. I asked myself what the use was in even switching on the radio. Unless there were EAS messages from the National Weather Service, I would hear nothing about emergency conditions.

Have radio station owners forgotten whom they are here to serve? People want information in times of emergency.

Radio is the perfect medium to provide information quickly. It is easier to get on the air, for there are no camera crews involved. It can give people a quick description of what is known, and ask people in the affected area to call in if it is safe for them to do so. If no further information can be provided, return to normal programming and break in when necessary.

At least you are giving the listeners what they want: news and information.

*Mike Stevenson
Former Engineer
Wellsburg, W.Va.*

Don't Forget the Little Guys

I read Tom Ray's letter ("IBOC Misinformation," Sept. 1) and felt I had to reply. What really gets my dander up was the comment in the fifth paragraph alluding to "a new age in broadcasting ... and redefining coverage areas."

If anyone reads between the lines, Mr. Ray is telling us that many if not most AM radio stations will suffer insignificant loss of coverage under IBOC-AM. Of course, if you're a 50 kW clear-channel station on the low end of the dial like WOR, you can reduce power to 12.5 kW and still have pretty good coverage over your main listening area.

But what's to become of radio stations with low power and already poor coverage

on the high end of the dial? I'm the program director of a severely directional AM station that would suffer irreparable harm under IBOC-AM. In fact, my owners would probably turn the station dark because our very limited 10 kW signal would be knocked down to 2.5 kW, and we would barely cover our city of license.

IBOC-AM is a bad idea. It's not a cure for what ails AM in particular, or radio in general. What broadcasting needs is compelling programming that entices the public to listen — not fancy, half-assed gimmicky audio gadgetry that succeeds for its promoters by destroying what already exists.

*Mark Carbonaro
Marina, Calif.*

A Call for AM Compassion

I am writing in response to Mr. Thomas Ray's comments that appeared in the *Reader's Forum* of the Sept. 1 issue. He said, "We are on the verge of a new age in radio broadcasting as we know it. Like it or not, we are going to have to, in some cases, redefine coverage areas and how we do things."

I am of the impression that IBOC is supposed to clean up the AM band and make it somewhat competitive to FM. If so, then can we expect FM-type programming on the AM band? I have to wonder if there isn't another way to "clean up" the AM band. Despite its inherent limitations, one of the neat things about AM is the ability to DX. Take that away and you are depriving the AM band of one of its strengths.

Mr. Ray also said, "If the only thing IBOC does for AM radio is force stations to straighten out their bad antenna systems, there will be a major improvement in AM broadcasting and it will all be worth it." Isn't the act of forcing stations to straighten out their bad antenna systems an FCC function? Why punish the entire AM band?

I respect Mr. Ray's knowledge, but I don't perceive any compassion for the AM listener and/or the AM broadcaster. Let us not have Clear Channel in name only.

*Neil Leibowitz
Jupiter, Fla.*

Forward March

I'm glad to hear that RDS is gaining acceptance. Audemat-Aztec has been active in RDS and been part of the RDS forum since its creation in 1987. The engineers in our research and development department have worked with this forum to improve the RDS standards. We sold over 8,000 encoders worldwide to the most demanding broadcasters.

When we decided to reinforce sales action in the United States with our Miami office, which opened in March, I hoped that RDS would move forward. And in fact it has.

Following the request of our United States customers, Audemat-Aztec has adapted the FMB80, a dynamic RDS generator with embedded web server.

Thank you for mentioning two of our U.S. customers, the Radio Experience



Audemat-Aztec's FMB80 RDS Generator

and dMarc Networks. This illustrates RDS outlets and other broadcasters will want to move to RDS. I believe there is a true application for RDS in the States and North America, like there is in Europe.

*Christophe Poulain
Vice President of
Business Development
Audemat-Aztec Inc.
Miami*

How to Submit Letters

Radio World welcomes your point of view on any topic related to the U.S. radio broadcast industry.

Letters should be 100 to 300 words long; the shorter the letter, the better chance it will be published in full. We reserve the right to edit material for space. Longer commentaries are welcome but may not reach print as quickly.

Include your name, address and contact information, as well as your job title and company if appropriate.

Send letters via e-mail to radioworld@imaspub.com, with "Letter to the Editor" in the subject field; fax to (703) 820-3245; or mail to Reader's Forum, Radio World, P.O. Box 1214, Falls Church, VA 22041.

◆ READER'S FORUM ◆

Humble Beginnings

Regarding Glynn Walden ("Walden Will Be Missed, And How," Aug. 13), I can say, with some accuracy, that I was there in the beginning.

Glynn hired me in 1982 as a vacation relief operator for KYW(AM) NewsRadio. Today, I am here at WPHT(AM), due to the great influences of many, including Glynn himself.

I remember the first interview I had with Glynn. I told him about my upbringing in a slightly shabby but efficient little electronics business my father operated, affectionately known as "the TV repair shop." Glynn had similar exposure as a young man, and I like to think we both got our real beginnings in those surroundings. I guess we learned our customer service skills that way.

Fast-forward 10 years to when Glynn was director of engineering for Group W circa 1992, and I had first learned of the movement toward DAB (then known as Acorn DAB). Knowing what I now know about the industry, he clearly was a visionary. Glynn had an impressive presentation, and I knew we were at the beginnings of something fascinating.



Back where it all began for Dave Skalish: Leon's TV Repair Shop

Paul McLane reminisced of meeting with Glynn, who spoke of "inventing the next century of radio." I can relate to the story Paul wrote so well.

I, too, get emotional. I think of that shabby little TV shop in a time when radios were better-made, my father

puffing his pipe filled with Prince Albert, and bench testing perhaps a dozen auto radios. As a youngster considering the thought of becoming a broadcaster, I knew there were many great things to come.

I am grateful I met Glynn along the way to help me realize that. I can say, with great assurance, we haven't heard the last from Glynn.

*Dave Skalish Sr.
Infinity Broadcasting
Bala Cynwyd, Pa.*

Pat on the Back

Thanks for the nice review, Alan Peterson ("Orion Platinum: Synth Beds For All," Aug. 13).

You actually took the time to dive into the program, which is highly appreciated. Not all reviewers do so. The demo clip is also very good.

Let us know whenever you want to review any of our products in the future.

*Richard Hoffmann
Synapse Audio Software
Bonn, Germany*

'A Very Dangerous Farce'

I have been a member of the radio industry since the early 1970s. I went through the ropes, the multiple phone licenses, and have been knowledge of the FCC Act of 1934, which Congress has since trashed.

This one ("Senators Disturbed by Dixie Chicks Ban," Aug. 13) is easy. The congressional hearings on the Dixie Chicks ban are, to quote a line from the movie "And Justice for All," "a very dangerous farce."

The government does not have the authority or right to tell the media what to air and when. The hearings are dead wrong in even questioning the bans.

Sen. John McCain, among others, doesn't seem to understand what a free

Isabel: Radio Was Ready

Last month's Hurricane Isabel caused much damage along the eastern seaboard of the United States.

Thanks in part to a long tracking period, stations we monitored followed the storm for a week, reported on it with a relative minimum of hype (unlike some TV news programs) and got through it. Audiences were ready and rode it out. (The editorial offices of Radio World were in its path but were spared damage short of a rushed deadline and some wet carpets.)

The disaster and cleanup offer fresh reminders of procedures and rules.

First, insist that your listeners include a portable receiver as part of their survival kits. For stations in the hurricane zone, this is a good time to do so, while Isabel is a recent memory.

We have advocated the use of battery operated portable radios tuned to news stations and the National Weather Service NOAA weather band in our particular regions.

Good choices these days are hand-cranked receivers made by Baygen, Coleman and others. Peltier-powered radio receivers built into kerosene "hurricane" lanterns are less attractive, given their use of flammable fuel in enclosed spaces.

For many people without power during and after the storm, the radio was their only link to vital safety and health information.

Did you know this? AM stations that normally reduce power at night are allowed to use "full daytime facilities during nighttime hours to broadcast emergency information ... when necessary to the safety of life and property, in dangerous conditions of a general nature and when adequate advance warning cannot be given with the facilities authorized" (73.1250, paragraph E & F).

But before you throttle up, review the whole rule. An AM station may go full power, but only for the proper reasons. These do not include sponsorship of emergency storm coverage nor the chance to go all-music. The rules are clear regarding non-commercial operation and use of music during an emergency. And don't forget that a report must be submitted to the FCC regarding the nature, duration and content of the emergency broadcast when it is all over.

Low-power FM stations now will be participating in the EAS chain. A public notice issued by the FCC last year announced that low-power FM operations are to install and operate EAS decoders. In July of this year, the commission granted an equipment authorization to a receive-only EAS unit made by TFT, making the emergency notification service available through community radio stations, allowing a further opportunity to super-serve their fiercely loyal listenership.

In a twist of irony, the original FCC notice is dated Sept. 19, 2002 — a year and a day before Isabel first tore through North Carolina and beyond.

Finally, although much criticism is routinely leveled against "conglomerate" radio, Hurricane Isabel revealed an interesting fact here in Washington: stations owned by Clear Channel, ABC and Infinity stayed on the air, for the most part, with minimum interruption. Meanwhile, eight AM stations best described as "mom-and-pop" operations or owned by budget-driven corporations got knocked off the air. Hats off to proper planning and maintenance by the Big Dogs. Stations that lost service should use this opportunity to review their facility designs and backups.

Radio pretty much got it right before, during and after Isabel. Nice work, everybody.

— RW

nation is. The most important aspect of broadcasting over the air is "in the public interest." In this case, the public strongly said, "We don't want to hear the Dixie Chicks!" We, the broadcasters, said, "Fine we won't play them."

This decision didn't come from the government, nor should it ever. Content is left to the broadcast facility, ownership, audience and market.

As a broadcaster, I applaud the facilities that banned the Dixie Chicks as a result of public outrage, for it was our decision to make, not the government's. This is not a matter of blacklisting or censorship, but rather responding to our bread and butter.

It's very simple, senators. It is not your choice. There is absolutely no requirement or guarantee that any artist be given airplay. The fact that we are a free market that enjoys the benefits of the First Amendment to the Constitution, overrides any uninformed representative like McCain or Barbara Boxer. They have the option of leaving this country and living somewhere else where their hypocritical opinions are not protected.

The ban was appropriate, and we had the right to do it. This is not the government's jurisdiction.

*John Curtis
J. Curtis Communications
Baywood Park, Calif.*

—EDITORIAL STAFF—

Paul J. McLane	ext. 117	Editor
Leslie Stimson	ext. 129	News Editor/Wash. Bureau Chief
Michele Kramer Peterson	ext. 149	Studio Sessions Editor
Kelly Brooks	ext. 136	Buyer's Guide Editor
Thomas R. McGinley	—	Technical Adviser
Alan Peterson	—	Technical Adviser
John Bisset	—	Contributing Editor
Skip Pizzi	—	Contributing Editor
T. Carter Ross	ext. 120	Editor-In-Chief (International)
Marguerite Clark	—	Editor (International), Milan
Rogelio Ocampo	ext. 121	Latin America Editor in Chief
Karina Gerardi	ext. 137	Latin America Editor
Terry Hanley	ext. 130	Editorial Assistant & Listings Coordinator
Peter Finch	—	Editorial Assistant, Milan

—EDITORIAL CONTRIBUTORS—

W.C. Alexander, Bruce Bartlett, Frank Beacham, Naina N. Chernoff, Harry Cole, Troy Conner, Vince Ditingo, Mark Durenberger, Charles Fitch, Ty Ford, Scott Fybush, Harold Hallikainen, Jeff Johnson, Craig Johnston, Paul Kaminski, Peter King, Mark Lapidus, Mark Persons, Sharon Rae Pettigrew, Michael LeClair, Carl Lindemann, Frank R. Montero, Ted Nahil, Tom Osenkowsky, Ken R., Rich Rarey, Randy Stine, Travis the W/O Guy, Barry Umansky, Tom Vernon.

Radio World

Vol. 27, No. 21 October 8, 2003

Telephone: (703) 998-7600 • Business Fax: (703) 998-2966 • Editorial Fax: (703) 820-3245
E-mail: radioworld@imaspub.com • Web site: www.rwonline.com

—ADVERTISING SALES REPRESENTATIVES—

US East: John Casey	330-342-8361	Fax: 330-342-8362	e-mail: jcasey@imaspub.com
US West: Dale Tucker	916-721-3410	Fax: 815-352-1698	e-mail: dtucker@imaspub.com
Product Showcase & Classified Ads: Simone Fewell	703-998-7600 x154	Fax: 703-671-7409	e-mail: sfewell@imaspub.com
Germany, Austria, Switzerland: Charles Kingston	+49-69-4908-5785	Fax: +49-69-4908-5804	e-mail: chaskingston@t-online.de
European Sales Mgr., Africa, Middle East: Raffaella Calabrese	+39-02-7030-0310	Fax: +39-02-7030-0211	e-mail: rcalabrese@imaspub@tin.it
Japan: Eiji Yoshikawa	+81-3-3327-2688	Fax: +81-3-3327-3010	e-mail: call@msn.com
Asia/Pacific: Wengong Wang	+86-755-5785161	Fax: +86-755-5785160	e-mail: wwg@imaschina.com
Latin America: Alan Carter	703-998-7600 x111	Fax: 703-671-7409	e-mail: acarter@imaspub.com

NEXT ISSUE OF RADIO WORLD OCTOBER 22, 2003

For address changes, send current and new address to RW a month in advance at P.O. Box 1214, Falls Church, VA 22041. Unsolicited manuscripts are welcomed for review; send to the attention of the appropriate editor.

—ADMINISTRATION & PRODUCTION—

Steven B. Dana	President/CEO
Carmel King	VPI Group Publisher
Marlene Lane	Editorial Director/COO
Chuck Inderrieden	CFO
Eric Trabb	Sales & Marketing Director
John Casey	Associate Publisher
Annette Linn	Production Director
Melissa SE Robertson	Production Publication Coordinator
Kathy Jackson	Ad Traffic Manager
Milagros Castañeda	Classified/Product Showcase Layout
Robert Green	Circulation Manager



Radio World (ISSN: 0274-8541) is published bi-weekly by IMAS Publishing (USA), Inc., P.O. Box 1214, Falls Church, VA 22041. Phone: (703) 998-7600, Fax: (703) 998-2966. Periodicals postage rates are paid at Falls Church VA 22046 and additional mailing offices. POSTMASTER: Send address changes to Radio World, P.O. Box 1214, Falls Church VA 22041. REPRINTS: Reprints of all articles in this issue are available. Call or write Joanne Munroe, P.O. Box 1214, Falls Church, VA 22041; (703) 998-7600; Fax: (703) 998-2966. Copyright 2003 by IMAS Publishing (USA), Inc. All rights reserved.

—Printed in the USA—

WHEATSTONE D-4000

DIGITAL AUDIO CONSOLE



Based on the technical architecture of our popular D-5000, this new D-Series console is totally modular, offering features to satisfy the most demanding engineers—but at a lower price point than its predecessors.

- Hot-swap design
- Four stereo mix buses
- Six pointer-style true VU meters
- Any mix of digital and analog inputs
- AES and balanced analog outputs
- Choice of master clock rates
- Up to 4 mix-minus outputs using SPD-4000 phone remote modules
- 24 bit A-to-D conversion on analog inputs,
- A/B source switching with fully independent logic and machine control
- Mode selection on stereo inputs
- Low profile drop-through counter design
- Multiple studio outputs with talkback interrupt

Wheatstone has more digital audio experience than most of our competition combined. The D-4000 is a truly high performance, reliable console that will make your transition to digital a pleasure. Benefit from our expertise — **CHOOSE WHEATSTONE** — the Digital Audio Leaders!

See us at the NAB Radio Show Booth # 14

 *Wheatstone*



GENERATION 9 DIGITAL CONTROL SURFACE

Designed to integrate flawlessly with the Wheatstone BRIDGE digital audio network router, the Generation 9 control surface allows you to easily create large or small platform-based systems that are exceptionally user-friendly and flexible. Wheatstone BRIDGE network cages house all I/O ports and engine cards, and may be wired in tandems within a single equipment room or interconnected to separate remote locations by means of fiberoptic or CAT-5 cables to provide single wire studio integration schemes.

Once configured, the system operates entirely independently of external computers. Configuration itself is intuitive and carried out onsite by means of user-friendly graphic interfaces provided by Wheatstone desktop software. We have gone to great lengths to make these setups easy for your field engineers, allowing expansions and changes to be achieved painlessly. Naturally, the Generation 9 system also takes full advantage of Wheatstone's exclusive VDIP® configuration

software as well, so that studio functions (like mutes, fader and timer starts, tallies, etc.) are easily accomplished right at your desktop. Once set-up is completed the desktop is disconnected; all settings are retained in nonvolatile storage and the entire system runs standalone. Ethernet protocol is built in, providing interface with automation, scheduling, and hardware controllers as you require.

Whether you're planning a small, centrally located studio network or a large, multiple format build-out, the Generation 9 Digital Control Surface can form the basis for a fully integrated, reliable and user-friendly broadcast system that will handle your most demanding requirements and be able to change with your varying needs as they arise.

At Wheatstone we have more combined digital design expertise than anyone. **Benefit from our hard work!** Choose **WHEATSTONE—the Digital Audio Leader.**

 **Wheatstone Corporation**

600 Industrial Drive, New Bern, North Carolina, USA 28562
www.wheatstone.com / sales@wheatstone.com

copyright © 2003 by Wheatstone Corporation

tel 252-638-7000 / fax 252-635-4857

See us at the NAB Radio Show Booth # 14