

House Bill Deregulates Radio

by Jacqueline Conciatore

WASHINGTON A U.S. House bill that would lift all radio ownership caps is good news to broadcasters worried about how they are positioned to compete against other media providers, but the proposal faces political hurdles ahead.

The mammoth telecommunications reform bill containing the broadcast deregulation provisions passed the House Commerce Committee 38-5 in late May, despite opposition from some leading Democrats.

Under the bill, rules that limit radio broadcasters to 20AM/20FM stations nationwide and three to four stations per market, would be abolished. And

the ceiling on national ownership reach for TV broadcasters would rise from 25 percent to 50 percent, although it would be held at 35 percent for the first year.

These provisions, about which there is some disagreement on both sides of the aisle, were tacked onto the original draft bill as an amendment from Rep. Cliff Stearns (R-Fla.), co-sponsored with Rep. Thomas Bliley (R-Va.) and Jack Fields (R-Texas).

The House telecom bill also would eliminate cross-ownership restrictions, so that in a given market one company could own two TV stations, the cable company and a newspaper.

The bill will be put before the full House for a vote some time after July 4, sources said. There will almost certainly be attempts to strip out the broadcast deregulation provisions,

possibly from Rep. Edward Markey (D-Mass.) or Rep. John Dingell (D-Mich.), who has expressed concern about the elimination of cross-ownership restrictions.

In the meantime, the Senate is grappling with its telecom reform bill.

At press time, Sen. Bob Dole (R-Kan.) had just brought it to the floor, according

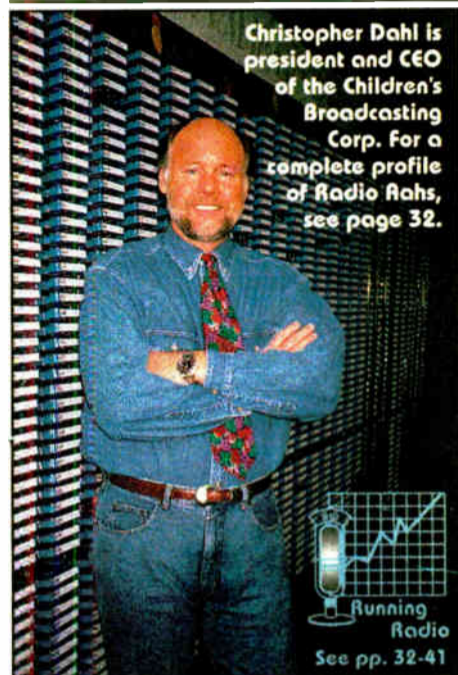

Christopher Dahl is president and CEO of the Children's Broadcasting Corp. For a complete profile of radio Aahs, see page 32.

Running Radio See pp. 32-41

ISDN Rate Structure Is Up for Comment at FCC

by Lynn Meadows

WASHINGTON The Federal Communications Commission (FCC) backed away from requiring phone companies to charge users of derived-channel lines like Integrated Services Digital Network (ISDN) on a per channel basis.

The commission's Common Carrier Bureau announced in late May that it will not enforce the rule that was confirmed in January while it accepts comment on alternative methods of charging for ISDN lines.

ISDN lines improve voice quality from remote sights because they transmit digital rather than analog data. Although the lines that carry the signal are the same as standard analog transmission lines, advanced equipment is used to code and decode voice and other information into digital data and transmit it over virtual channels.

The type of ISDN service used by radio broadcasters is Basic Rate Interface (BRI), that splits the signal into two voice channels plus an extra channel to carry signal information. The cap for subscriber line charges is \$6, meaning the maximum cost to radio stations for a BRI line under the current rule would have been \$12.

Hardest hit by the per channel charge would be companies that transmit video. These consumers use the Primary Rate Interface (PRI) service which divides a line into 23 voice-grade equivalent channels. "I am sure it was the PRI ISDN customer base that brought about this speedy reconsideration," said Lynn Distler, vice

president for marketing at Comrex Corp., a manufacturer of telco decoders and encoders (codecs).

Despite a ruling in January to charge ISDN lines on a per-channel basis, a

continued on page 14 ►

The Phantom

Hard Disk Digital Audio Automation by RDS

The Phantom ends the confusion of automation by keeping everything organized and under your control. Live all day, satellite all day, or both- the Phantom is the one system that truly adapts to your station's operation. Available from the Harris Allied broadcast audio pros.

1-800-622-0022 Fax 317-966-0623
Southern CA 1-800-690-2828

HARRIS ALLIED

to sources. Although it did not come out of committee with any broadcast deregulation provisions, observers expect an amendment that would lift ownership rules.

One Senate staff member said the broadcast deregulation provisions would be offered by Sen. Larry Pressler (R-S.D.), who chairs the Commerce Committee.

Sources said the ultimate deregulation package—a rewrite of the Communications Act of 1934—may be significantly less extreme by the time both Houses vote and rework the final plan in conference.

Although there have been reports that Vice President Gore, FCC Chairman Reed Hundt and National Telecommunications Information Administration (NTIA) head Larry Irving each have criticized various aspects of the telecom reform bills, including the broadcast deregulation provisions, there has not been official warning of any veto.

Radio in favor

Most radio broadcasters are in favor of the deregulation proposal.

Although the National Association of Broadcasters has remained neutral about the bill because its television members are divided about the ownership provisions, it pushed Congress to include the radio reform in the telecom bill.

After the House committee action, NAB President and CEO Edward Fritts called the reform bill "a historic milestone for

continued on page 11 ►

NEWSWATCH

Professional Audio Society Enhances Membership Categories

HOLLYWOOD, Calif. The Society of Professional Audio Recording Services (SPARS) created a new membership category to more fully represent the entire profile of the pro audio industry.

The new "individual membership" category is open to individuals presently engaged in or utilizing the services of the recording industry—provided they do not qualify for any of the society's five other membership categories.

Michigan Association of Broadcasters Annual Meeting Scheduled

LANSING, Mich. The Michigan Association of Broadcasters (MAB) will hold its 47th Annual Meeting and Management Retreat August 27-29.

Speakers include management consultant Dr. Sean Joyce and broadcast sales consultant Jason Jennings.

A panel titled "Lunch and the Law" will include input from Congressman John Dingell, Gary Fries, President and CEO of the Radio Advertising Bureau, and John David from the National Association of Broadcasters.

DX Service Celebrates 10th Anniversary

MANNVILLE, N.Y. This year marks the 10th anniversary of the National Radio Club's DX Audio Service. The service, which started with volunteers reading information from DX News Magazine, evolved into a format that includes interviews and covers both AM and FM changes.

The service, available each month on a 90-minute cassette, is offered for a fee to blind listeners and others who are interested in radio.

New Station Totals Published by FCC

WASHINGTON The Federal Communications Commission released an update of broadcast station totals. As of

April 30, there were 11,840 radio stations broadcasting in the United States.

Of these, 4,913 were AM stations, 5,173 were FM and 1,754 were non-commercial FM stations.

The total number of TV stations was 1,531.

Radio Revenue Posts 'Healthy' Growth in 1995

NEW YORK The Radio Advertising Bureau (RAB) announced that local and national spot advertising revenue increased 10 percent in April 1995 compared to April 1994.

Based on a pool of more than 100 markets, RAB reported that year-to-date revenue through April increased 13 percent compared to the same period in 1994.

"Our analysis suggests that we should continue to enjoy healthy revenue increases through the summer months—and beyond," said RAB President and CEO Gary Fries.

Leadership Conference Steering Committee Formed

DALLAS William Figenshu, president of the radio division for the Viacom Broadcast continued on next page ▶

Success Means Making the Right Decisions



We DID.

OUR NEW R-60 CONSOLE has what stations really want: reliable illuminated switches—*everywhere*; smooth feeling P&G faders; a powerful monitor section. Our exclusive Simple Phone™ module is friendly and easy-to-operate, providing error-free talk segments.

The R-60 is **TOTALLY MODULAR** to streamline service—no motherboard mounted components. The quality of each module is unsurpassed; we even measure every resistor, capacitor, and diode

before it's installed. Completed consoles are burned in prior to final test. Meticulous care is the key here, so you can expect the ultimate in reliability.

Perhaps more important than high technology features and good looks is the fact that the R-60 is built and supported by Audioarts Engineering—a highly professional and dependable company you can count on.

A SUCCESSFUL STATION BEGINS WITH R-60.

 **AUDIOARTS ENGINEERING**

7305 Performance Drive, Syracuse, New York 13212 (tel 315-452-5000 / fax 315-452-0160)

Index

FEATURES

- Decipher Renewal Paperwork Maze**
by Harry Cole 14
- Communications Options to Consider**
by Barry Mishkind 17
- Examining Commission's EAS Rules**
by Harold Hallikainen 19
- Finer Points of House Monitor Systems**
by Tom Vernon 26
- Building Simple Balanced Circuits**
by Jim Somich 30

RUNNING RADIO

- Radio Aahs Programming Child's Play**
by Alan Haber 32
- Spin-off Radio Show Reached Stardom**
by Read G. Burgan 33
- Production Libraries Enhance Bottom Line**
by Alan Peterson 37
- Exploring Washington Web Sites**
by Alan Haber 41

Group, and Jim Thompson, president and CEO of Liberty Broadcasting Corp., were named chairman and vice chairman, respectively, of the Marketing Leadership Conference Steering Committee of the Radio Advertising Bureau.

The Radio Advertising Bureau (RAB) established the steering committee to "lay the groundwork" for the group's Marketing Leadership Conference and Executive Symposium scheduled for February 1996.

Tapeless Audio Directory Available

WASHINGTON Published by independent consultants SYPHA, the fourth edition of the "Tapeless Audio Directory" is a buyer's guide to professional random access recording, editing and replay systems. It provides comprehensive details on more than 200 digital audio workstations, as well as cart replacement and broadcast automation systems.

The information provided includes target markets, hardware and software specifications, operational features, networking and file translation capabilities, archiving and backup facilities, future development plans, training and customer support, typical configurations and costs, and suppliers details for the United States, Europe and the Far East.

For convenience, the directory is divided into two main sections, editing and broadcast systems. Editors has been organized into stereo/four-channel and multi-channel categories, while broadcast has separate categories for news/speech, cart replacement and live-assist/automation.

The directory covers existing systems as well as those to be launched and those on which development has been halted.

The "Tapeless Audio Directory" is available from NAB Publications at 800-368-5644 or 202-429-5373; fax: 202-775-3515; and from Opamp Technical Books at 800-4-BOOKS-1 or 800-468-4322; e-mail: opamp@netcom.com for \$25.

FCC Reports on ISDN Growth

by Lynn Meadows

WASHINGTON The Federal Communications Commission (FCC) released its first Infrastructure Report in April detailing the changes in technology at telephone companies from 1989 to 1993.

The report indicates that the hardware required for ISDN services increased significantly over the four year period. Lines available for Basic Rate Interface (BRI), the two channel ISDN service used for carrying voice, increased from 126,276 lines in 1989 to 587,229 lines in 1993.

Primary Rate Interface (PRI) ISDN lines also increased during the four year period. The PRI lines divide into 23 channels to carry video and voice. The number of lines capable of transmitting PRI data increased from 124 in 1989 to 5,814 in 1994.

To obtain data, the FCC surveyed each of the regional Bell companies and companies owned by GTE.

The report, however, is only as good as the information provided by the local telephone conglomerates. Some companies have interpreted the questions and definitions differently over the past several years.

For instance, Bell Atlantic for the years 1989 through 1991 responded to the survey by including only the BRI lines in use. For 1992 and 1993, it began reporting the count of all BRI ISDN interfaces whether or not they were actually in service.

The report states that "the lack of a critical mass of customers using ISDN has been a major stumbling block in the proliferation of end-to-end digital services." The data for 1994 has not been analyzed yet.

Coalition Lobbies Senate

by Lynn Meadows

WASHINGTON In an eleventh hour addition to the ongoing debate over the telecommunications bill, the Coalition for Broadcast Diversity faxed a statement to Senators urging them not to address radio and television ownership deregulation in the pending bill.

According to the statement, there are several "dangerous possibilities" that could result from deregulation. "In addition to the threat to diversity in the marketplace of ideas, there is a concern that employment will suffer in the local media industry as well." Also possibly at risk say members is the "existence of affordable advertising rates for local businesses."

The newly formed coalition includes Greater Media Inc., Jersey Shore Broadcasting Corp., Press Broadcasting Co., and Beasley Broadcast Group. Meredith Broadcasting Group is also a member lending its support to television issues.

"Broadcasting is a strong business with excellent growth potential," the Coalition states, "It works socially and it works economically. It isn't broken and doesn't need fixing."

The fax arrived the same day Senate Majority Leader, Senator Bob Dole (R-Kan.) temporarily halted debate on the legislation in order to give senators time to read all the amendments. It is these amendments that address removing the caps on group ownership.

Proponents of deregulation see lifting the ownership cap as a way to improve economies of scale and "level the playing field" in anticipation of the arrival of Digital Satellite Radio which will be able to broadcast multiple stations to every market.

The Coalition disagrees stating, "If this legislation is passed, the competitive playing field will be significantly tilted in favor of large owners who can effectively shut out smaller companies from access to program suppliers, networks, etc. as well as dominating the advertising market."

In the three page statement, members explain why they believe more small owners have not stepped forward to protest the removal of ownership caps. "Many small broadcast companies have passive investors, whose desire to cash out in the bull market of consolidation effectively silences their broadcaster managers from speaking out on this issue."

The NAB Radio Board has been a strong supporter of ownership deregulation. The Radio Board voted unanimously to support lifting the current ownership restrictions.

The NAB did not have any comments on the Coalition for Broadcast Diversity's opposing position. A spokesman for the NAB said "we'd like to reiterate our [radio] board's support for ownership deregulation."

The new coalition expects to receive support from stations across the country and will continue to press Congress to leave ownership deregulation off the bill...

CREATIVE PRODUCTION BEGINS HERE ...

with the Roland DM-800 Digital Audio Workstation. Compact, easy to use, with a price that blows the competition away.

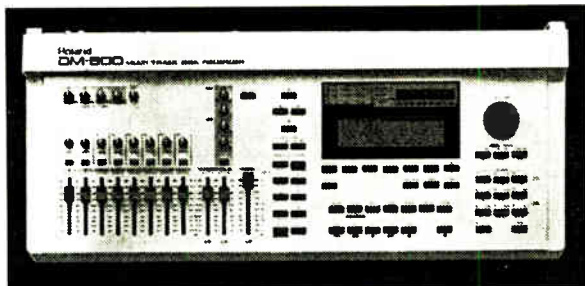

Creative production sells, and with a list price of \$7,495.00 ... the DM-800 is all you need, all in one box and all at one low price!

Please call today for full color brochure and ABG system pricing.

WE ARE THE INDUSTRY STANDARD.

AUDIO
broadcast group inc.
SOUTHEASTERN SALES OFFICE
200 Fareway Drive, Suite 2
Smithfield, North Carolina 27577
Phone: 800-369-7623
Fax: 919-934-8120

AUDIO
broadcast group inc.
MAIN SALES OFFICE
2342 S. Division Avenue
Grand Rapids, Michigan 49507
Phone: 800-999-9281
Fax: 616-452-1652

AUDIO
broadcast group inc.
WESTERN SALES OFFICE
P.O. Box 1638
Palmdale, California 93550
Phone: 800-858-9008
Fax: 805-273-3321

YOU MAY ALSO REACH US ANYTIME VIA ELECTRONIC MAIL

cServe: 75371,144
internet: support@abg.com

Going Codec?

Go Comrex.

Beyond superior broadcast quality and rugged reliability, Comrex codecs are backed with an invaluable extra: Direct, personal tech support from someone who is prepared to provide whatever level of assistance you need. Just one toll-free phone call away.

With our full range of codec technology and a reputation for integrity and objectivity, we're able to offer the best sounding, cost-effective solution for SW56, ISDN or dedicated digital lines.

Questions about compatibility, connectivity, delay, system and transmission costs? We have the answers. And we'd be happy to arrange a demonstration.

A partial listing of Comrex codecs:

DXR (rackmount) DXP (portable)	DX100	DX200
G.722 (CCITT)	apt-X	ISO/MPEG Layer II MusicLine™
Excellent for Talk, Sports, AM or Voice Programming	Good choice for STL, Studio-to-Studio and higher quality audio	Superb FM remotes, Studio-to-Studio Links, Music Programming

U.S. 1-800-237-1776 • UK 0 800 96-2093
Europe: Request your free Comrex calling card.

Dynamic, ongoing support is also available via:

- Comrex ACCESS – quarterly newsletter
- Fax-on-Demand – library of technical and applications information
- Comrex Users' Forum, PC-networked on CompuServe
- Comrex Handbook – "Digital Telephony"



COMREX®

Comrex Corporation, 65 Nonset Path, Acton, MA 01720
508-263-1800 • Fax-on-Demand 508-264-9973 • Fax: 508-635-0401

All-out War Hits Washington Airwaves

WASHINGTON All-out radio war has hit the mean streets of the nation's capital. Top-ranked WPGC-FM is taking a frontal assault from Washington radio veteran Cathy Hughes and her WKYS-FM. This one ought to be good.

WPGC-FM has ranked No. 1 in this market since 1990—for at least 17 consecutive Arbitron ratings periods. Success like that, as you all know, is hard-earned. WKYS-FM is going to have to be good, really good, to take down this powerhouse.

Yes, the music playlist on WPGC-FM is very tightly programmed and researched and tweaked. But music alone does not a station make.

For starters, WPGC-FM tied itself early and intrinsically to the Washington community. Not only with its community

forum features celebrities, politicians and Washingtonians speaking their minds on topical issues. Recently, for example, it sponsored a sort of town meeting between rival gangs on the air.

Other community programming includes the "Stop the Violence" campaign, "Books Not Bullets" and an annual Coat Drive that recently collected

and distributed 50,000 coats to area needy residents.

I could go on for quite a while about what WPGC-FM does that makes it the No. 1 station by far in this market. And by

extension, what WKYS-FM is going to have to do better to knock it down a peg. But the point really is that in market after market, radio war after radio war, the station on top is always the one that supervises its community with more than just music.

I think it is an exciting time for radio formats. AM is alive with the sound of talk and aggressive, in-your-face formats that are generating lots of attention and revenue for radio. WPGC-FM's sister station on AM is now programming a street-oriented blend of rap and hip hop that targets the 12-17 year olds—much more exciting and intense a format than the business radio via satellite format it had before.

Whatever happens in Washington radio... happens. The fun part for those of us on the sidelines is watching radio get better by virtue of market competition. If there are two great FMs on the dial going all-out to serve Washington, then Washington benefits. And regardless

of who ends up No. 1 in an Arbitron survey, that is really what radio is about for the listeners.

And if the radio war has more people sampling FM radio, then FM benefits. A strong radio contingent in any market helps sell retailers on the media. And that means more dollars on the bottom line, and more effective spots for your advertisers.

★ ★ ★

Many of you may have already spotted the new byline in *RW*, that of Lynn Meadows. Lynn joined us last week and will be the key contact person for news. Lynn has worked as a radio new director,

is computer savvy and she has a degree in government. Give her a call with any news bits you might hear, or drop her a line via e-mail at 74103.2435@compuserve.com.

★ ★ ★

Elsewhere on this page is a picture of Nancy Widmann, president of CBS Radio (and the only woman at the head of a major radio group) receiving an AWRT Genii award. She has also been selected to receive this year's National Radio Award from the National Association of Broadcasters. Congratulations for some well-deserved recognition!



95.5 FM
WPGC
Continuous Music

affairs programming and constant and far-reaching presence, but by giving the community air time in other ways. For example, WPGC-FM is willing to play new artists, with an emphasis on new local artists.

On another front, the station does not bury its public affairs programming on Sunday morning between 5 and 6 a.m. Albie D., the station's music director, created the program "Yo Listen Up" that airs on Monday nights. The public

CBS Radio President Nancy Widmann received the 1995 American Women in Radio and Television (AWRT) Genii Award, along with fellow honorees Aaron Spelling and Sela Ward. The event marked the 40th anniversary of the Genii Awards and the second year for a separate radio category. The event was sponsored by the Southern California chapter of AWRT and was held at the Beverly Hilton in Los Angeles.

Pictured l to r: Dayna Adams, AWRT president; Peter Lund, president, CBS Broadcast Group, who spoke on Nancy Widmann's behalf; Nancy Widmann; Diane English, keynote speaker; Aaron Spelling, and Karen Tobin, past chapter president and vice president, marketing, KIIS-AM-FM Los Angeles.



COUNTRY
&
WESTERN

AM



ARC-16: the logical choice for LMA and duopoly transmitter control.

For more information on the ARC-16 family of transmitter controls, contact Burk Technology.

1-800 255-8090

BURK
TECHNOLOGY

7 Beaver Brook Rd., Littleton, MA 01460
Phone (508) 486-0086, Fax # (508) 486-0081
email danrau@burk.com

Put
us in
your sites.

READERS FORUM

If you have comments for Radio World, call us at 800-336-3045 or send a letter to Readers Forum (Radio World, Box 1214, Falls Church, VA 22041 or MCI Mailbox #302-7776). All letters received become the property of Radio World, to be used at our discretion and as space permits.

Stop the stereotype

Dear RW,
This is in response to Chris Trace of WKNE in New Hampshire and his letter in the May 3 issue.

I will support congressional cuts of CPB funding when commercial radio stations begin airing public affairs and educational programming during times other than on Sunday mornings between 5-8 a.m., when not many people are listening, just so the station can say it actually does offer such programming.

NPR and local public radio stations dare to provide in-depth coverage of many non-political, non-partisan subjects during prime-time hours. Something that cannot be said of any commercial station to which I have ever listened.

It is time we quit stereotyping public radio listeners as upper-class snobby liberals. As a radio listener, I not only listen to NPR but also the local commercial news/talk, CHR, progressive rock and classical music stations. Take heed, many of your listeners may tune into public radio for what you do not provide, and with the attitude which you displayed in your recent letter, will you not be insulting a segment of your own listeners if they were to read your 'Perrier drinkers' depiction?

Bernie Ksiazek
North American Networks Inc.
Washington, DC

"The Birds"

Dear RW,
Ralph Townsey's "Birds on the Antenna" article reminded me of a story told by my predecessors.

WMBI is also one of the early AM licenses. Broadcasting began in 1926 from the near-north side of Chicago. In 1929, the transmitter plant was moved to then rural Addison, Ill., and a flat top antenna similar to the one described in

the RW article was installed. It too was plagued with periodic instability, but the cause was immediately known and one might say, anticipated with relish.

The problem occurred in the winter and as one might guess, happened when ice began building up on the wire cage.

Someone had the foresight to suspend this arrangement on pulleys and counterweights so instead of breaking, the whole arrangement slowly descended toward the roof of the transmitter building.

The solution was simple—a 12 gauge shotgun and a box of shells.

The site enjoyed the luxury of a rural, bucolic location. Blasting away on the iced-up antenna posed little threat to anyone and rewarded the shooter with a certain amount of satisfaction. With ice removed from the wires, the cage returned to its normal position. A trip to the hardware store to lay in more ammo and the staff was ready for the next event.

The two towers and the wire cage have long since been replaced by a Blaw-Knox vertical radiator, but the concrete piers and steel stubs of the old remain.

Bob Caithamer, director of engineering
Moody Broadcasting, Chicago, IL

Give us a break

Dear RW,
Your newspaper is a must-read for any radio industry types. We rely on your news articles to make informed decisions about purchasing equipment and operating our facilities. Therefore, we rely on your editors to separate wild claims from objective reporting.

Given that, I am very concerned that you would insult us with an article so obviously full of self-righteous claptrap as the April 19th piece about WINB and the "Main Street Forum." This self-congratulatory report asks us to accept at face value that this far-right propaganda machine is "a news/talk network" that is accepted by thousands of "contemporary

On With the Tests

The news that Eureka-147 will not receive permission to conduct field tests at L-band in San Francisco should not slow down the Electronic Industries Association (EIA) testing process for digital audio radio systems. If and when the European consortium decides to pull out of the process, six alternative systems remain—systems that survived the lab-testing process and now are ready for the rigorous field tests.

The National Telecommunications Information Administration (through which experimental L-band spectrum is acquired) should have been more forthcoming with EIA when one of its technical representatives participated in the preparatory discussions for the testing process. Yes, NTIA made its position clear at WARC '92—no L-band for the United States, only 2.3 GHz or in-band systems—but remaining silent while an L-band system was admitted into the testing process could have been perceived as tacit permission to test at L-band. NTIA should have insisted on S-band or in-band proponents only.

Interested U.S. parties can sample Eureka-147 field tests in Canada or Europe. Scientific curiosity aside, there is little point in testing a system at L-band for the United States. However, testing should proceed for the other six systems without undue pressure from the outside.

The concept of a worldwide standard for digital audio radio is an agreeable thought but not necessarily an economic need. The digital audio radio system of choice in this country can more than support receiver manufacturers catering to it. Our 260 million consumers, champions of spending, far outweigh Canada's 27 million, even if joined with the United Kingdom's 57 million and France's 57 million and Germany's 80 million. From a manufacturing standpoint, the numbers speak for themselves.

Now, if only our political associations would speak plainly with each other.

—RW

patriotic Americans huddled around their (shortwave) radios."

Gimme a break. WINB is a marginal operator that most people have never heard of. It sells its blocks of airtime to any right-wing hack with a budget to spew whatever they want. Stations like this have been operating around the fringes forever.

Please do not insult us with a headline touting "Main Street's Diverse Programming"—these shows are one ultra-right diatribe after another. These people have the right to call themselves whatever they want, but we expect you at RW to do a better job at editing their press release copy.

John McNary
Los Angeles, CA 90034

Ham Radio

Dear RW,
You have helped preserve radio's heritage with the feature article from Al Parker (Fond Recollections of Radio Ham, RW, April 5). But some might miss the connection between the hobby of ham radio and the profession of broadcasting and the craft of engineering.

When I was a college intern at a kilowatt daytimer at the start of my career, both my on-air skills and my technical grasp of radio had been given a strong foundation from "playing radio" with my AM station on the shortwave ham bands.

Interviewing local newsmakers was much like the conversation it would sometimes take to bring someone out about themselves on the airwaves at home. And getting good audio quality during field recording came from the same technical background it took to get my 1950 Collins transmitter sounding good.

These days, there are not as many places a would-be broadcaster can polish the skills needed to do a job in journalism, engineering or programming. That makes the vintage radio facet of the ham radio hobby even more important as a learning ground offering hands-on experience.

The Amateur Radio Service has a mandate to maintain a skilled pool of radio operators with both the technical and logistical expertise it takes to supply public service in times of disaster and emergency. I see little difference in the high communications standards I follow in the hobby, as I apply them to my career in radio.

The payoff ranges from having a delightful and satisfying job, to having fellow humans tell me I sound better on the "big rig" at home than on some of the network affiliates that carry my work!

Paul Courson, Business Editor
Associates Press Radio Networks
Washington, DC



Vol. 19, No. 13 June 28, 1995

Editor in Chief.....Lucia Cobo
Technical Editor.....Alan Peterson
Associate Editor.....Whitney Pinion
Staff Writer.....Lynn Meadows
Contributors.....Frank Beacham/N.Y., Bruce Ingram, Pamela Watkins, Nancy Reist, Alan Haber
Technical Advisors.....John Bisset, Tom McGinley
Editorial Director.....Marlene Lane
Assistant Editorial Director/Audio.....Alan Carter

Radio World (ISSN: 0274-8541) is published bi-weekly by Industrial Marketing Advisory Services, Inc., 5827 Columbia Pike, Suite 310, Falls Church, VA 22041. Phone: 703-998-7600, Fax: 703-998-2966. Second-class postage rates are paid at Falls Church VA 22046 and additional mailing offices. POSTMASTER: Send 3579 forms and address changes to Radio World, P.O. Box 1214, Falls Church VA 22041. REPRINTS: Reprints of all articles in this issue are available. Call or write Regan Deatherage, P.O. Box 1214, Falls Church, VA 22041; (703) 998-7600; Fax: (703) 998-2966. Copyright 1995 by Industrial Marketing Advisory Services, Inc. All rights reserved.

—PRINTED IN THE USA—

Next Issue of
Radio World
July 12, 1995

Correction

Figure 2 on page 17 of the May 31 issue ("Shaped Probes Ease Compliance") had incorrect numbers. The figure should have run as follows:

determining compliance in multisignal environment

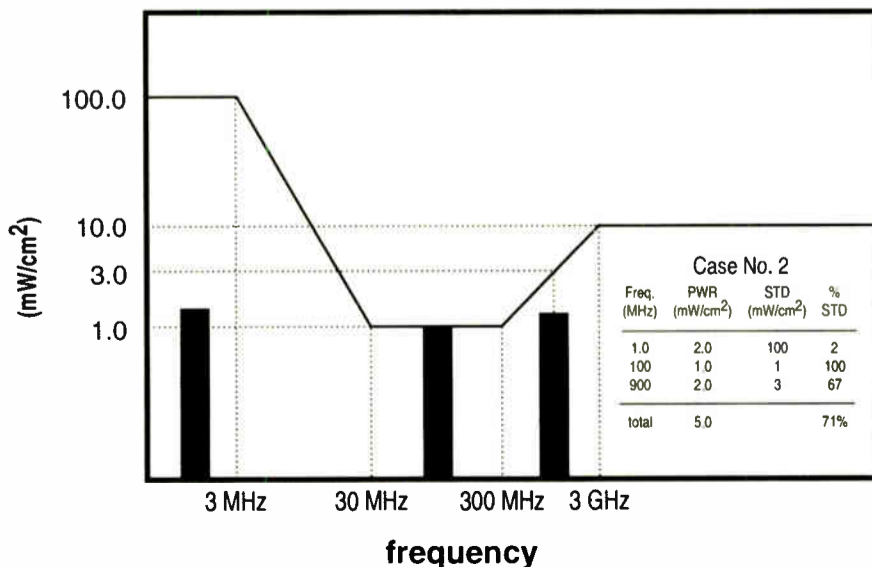

World Media Expo Set for Big Easy

by Whitney Pinion

WASHINGTON Even though the worst heat of summer will have passed, the humidity will still linger in New Orleans when the second annual World Media Expo (WME) rolls into town Sept. 6-9.

Once again, WME will combine exhibitions with the conferences of National Association of Broadcasters (NAB), Society of Broadcast Engineers (SBE), the Society of Motion Picture & Television Engineers (SMPTE) and Radio-Television News Directors Association (RTNDA).

The NAB Radio Show promises something for everyone, from general

managers to group operators to engineers. The day before the exhibit floor opens, NAB will offer guided tours of some of New Orleans' top radio stations. Participants will get a glimpse of the technology and programming that make these stations successful.

Experts at NAB's digital radio seminar on Sept. 7 will offer advice on preparing stations for the digital age without wasting time or money on unproven technology. This seminar has a separate registration fee and will be open to all registrants of the NAB Radio Show, RTNDA, SBE and SMPTE conferences.

Mel Karmazin and Lowry Mays, CEOs of Infinity Broadcasting and Clear Channel

Communications, respectively, will participate in the session, "Radio: Today's Trends, Tomorrow's Opportunities."



Other familiar names at the Radio Show will include Ben Cohen and Jerry Greenfield, founders of Ben & Jerry's Ice Cream & Frozen Yogurt, who will share their unusual marketing approach during the NAB Radio Luncheon. Another high-

Alert System), unattended station operation, and digital and RF for radio.

The annual Ham Radio Reception on Sept. 8 and SBE's annual Awards Banquet the following evening will highlight the conference.

The Society of Motion Picture and Television Engineers (SMPTE) will also be on hand at WME. SMPTE, a technical association for motion imaging fields such as television, film, electronic imaging and multimedia, will be holding its technical conference in conjunction with the show.

SMPTE's four-day technical program will feature nearly a dozen sessions, two professional seminars and several workshops and educational offerings. A major theme of the SMPTE conference will be digitization, a subject that has entranced the television industry in recent years as much as it has radio.

Although most of SMPTE's sessions focus on images, some might be beneficial to radio folks. Of particular interest will be a seminar called "Internet for the New User," which promises to clue atten-

Three days of technical papers, the heart of the SBE Engineering conference, will begin on Sept. 7.

light of the luncheon will be the presentation of the NAB 1995 National Radio Award to CBS Radio's Nancy Widmann.

The finale of the Radio Show will be the Marconi Awards Dinner and Show the evening of Sept. 9.

Special one-day Ennes Workshop sessions will precede the SBE Engineering Conference. These interactive sessions, conducted by trained specialists, will offer detailed information on maintaining and operating key types of broadcast equipment.

Three days of technical papers, the heart of the SBE Engineering conference, will begin on Sept. 7. The papers will provide attendees with a comprehensive update on broadcast regulation and technology. Topics will include EAS (Emergency

dees in on short-cuts to the information superhighway.

The Internet program will be held on Saturday, Sept. 9, with both morning and afternoon sessions planned.

Although the majority of the sessions will be open only to registrants for a particular conference, there will also be a number of sessions not affiliated with any one organization. A person registered with any of the four conferences will be able to attend these sessions.

Also, at press time there were plans to identify crossover sessions for registrants of any of the conferences.

□ □ □

Mark Hallinger, news editor of TV Technology, contributed to this article. ☺



Hassle-free Widgetry.

Yet another unique, problem-solving widget for the broadcaster. Announcing the Telestor by Henry Engineering.

Telestor takes the hassle out of recording news reports, weather updates, and other "actualities" that are sent via dial-up phone line.

There's no need to have someone put a cart in a recorder, start the machine, record the actuality, check the cart, and take it into the air studio. Telestor does it automatically.

Simply connect Telestor to a regular phone line. It

answers the line, waits for the Touch-Tone password, then records the audio from the line. After the feed, Telestor plays it back to the caller for verification. It can be re-recorded if necessary. If not, the caller hangs up. That's it. The actuality is now ready for instant on-the-air playback.

Telestor stores one message in digital memory, up to 5-1/2 minutes long.

Telestor is available now from Harris Allied.
1-800-622-0022
Fax 317-966-0623
Southern CA 1-800-690-2828

HARRIS ALLIED

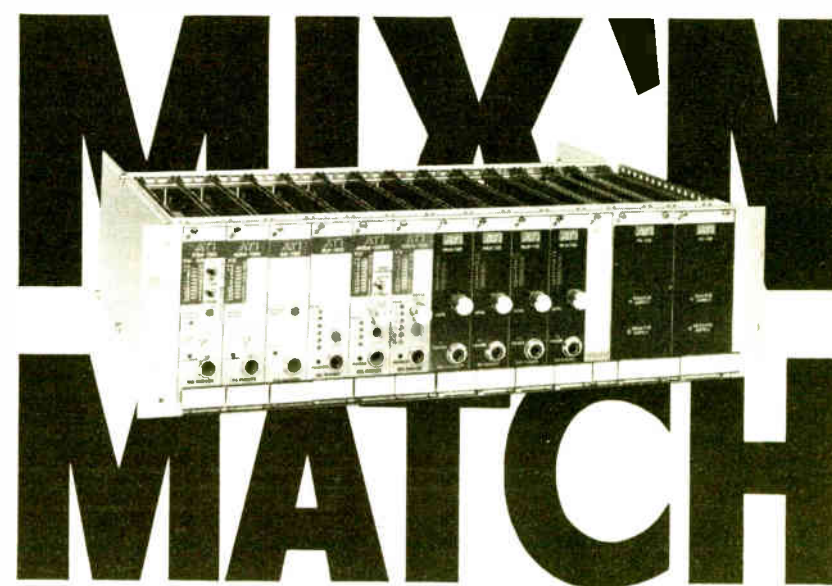

System 10,000 Modular Amplifiers

Over 40 interchangeable Microphone, Line and Audio DA Modules for you to mix 'n match to your requirements.

Call, fax or write for free detailed brochure

AUDIO TECHNOLOGIES, INC.
328 W. Maple Ave., Horsham, PA 19044, USA
(215) 443-0330 • FAX (215) 443-0394



No Compromises.



This *is* the only world class, fully configured, ready-to-put-on-the-air console that **starts under \$6,000** for 12 channels—the Auditrionics 2500 Series.

For most broadcasters, an audio console buying decision has always presented the dilemma of sacrificing quality and reliability for price. Not any more.

The Auditrionics 2500 Series is the intelligent choice for those of you no longer willing to invest in mediocre

products but who demand a superior product at an affordable price. Harris Allied and Auditrionics are happy to provide your solution. Impeccable design, precision manufacturing, value pricing in a full featured, compact audio console. And, you get a combination of Auditrionics' quality and support with Harris Allied's unequalled customer service and support. No matter how you look at it, you can't lose. Call today

1-800-622-0022
FAX 317-965-0623
Southern CA 1-800-690-2828

CHECKLIST

- Solid State Switching
- Fully Modular
 - DC Control
 - 20dB Headroom
 - A/B External Logic
 - Actively Balanced
- Telephone Conferencing
- Conductive Plastic Faders
- External Cue & Headphone Assignment
- Easily Accessible Wiring on Motherboard Connectors

 **HARRIS
ALLIED**

Two Proven Methods To Attract More Listeners.



[Shock Jock*: About \$500,000]



[OPTIMOD 9100: About \$5,000]

That's the price of succeeding in AM radio these days: you can buy a big expensive star to reach a larger audience, or put an OPTIMOD-AM at the transmitter. Both give you the strength to be different, even double your audience size. But by "maximizing" your power with the 9100, you also get the closest thing to FM sound with unmatched efficiency.

True, extending your reach while saving on power isn't nearly as much fun as hiring a big, loud star*. But which sounds better to *you*: a bigger mouth, or a bigger bank account?

orban

H A Harman International Company

© 1995 Orban and OPTIMOD are registered trademarks. 1525 Alvarado St., San Leandro, CA 94577 USA
Phone 1-510-351-3500 Fax 1-510-351-0500. E-mail custserv@orban.com

Circle (28) On Reader Service Card

World Radio History

FCC Strives for Accessibility Via the PC

Editor's note: Having just unveiled its retooled information site on the Internet's World Wide Web to a waiting, diverse audience hungry for information, the Federal Communications Commission (FCC) is finding itself in the thick of the information superhighway.

Commission Chairman Reed Hundt has big plans for the FCC's Web site. He spoke about the commission's place on the information infrastructure with RW's Alan Haber.

RW: I understand the FCC's Web site was created as a result of your interest in getting the commission onto the information superhighway.

H: When I got here, I was very distressed to find out that the FCC was not on the cutting edge, but was as far back as you could possibly be on the information highway. We did not have computers on people's desks, we never used electronic mail, we were not on the Internet. It was appalling. This organization has been and is ready for radical reform, and it starts by us learning to communicate with each other as well as with the outside.

So now we are all on e-mail. We send almost 100,000 messages internally a week, and we have opened ourselves up to the outside. We do not want you to have to hire lawyers and lobbyists to find out what is going on here. We want ourselves to be transparent to the public. That is what we have gotten out of the World Wide Web access and our other forms of openness.

RW: So, in other words, the Web site was really an extension of that.

H: Oh, absolutely. It is a window on the agency. It is a door that anybody in the country can walk through. And, in terms of Web access, we are getting 6,000 hits a day.

And every one of those was a communication with the FCC that those people either could not do before or had to hire a lawyer or lobbyist to handle for them. And you know, that is not right. We are supposed to be open to the public.

RW: Aside from the ease with which people can get information off of a Web site, what are the benefits for the FCC having a site, and what are the benefits for people accessing it?

H: I suppose the number-one benefit is that they can find out what is going on. They can decide to participate in auctions. They can learn about what regulations create fair rules of competition so that they can enter new markets. They can get information so that they can invest more intelligently.

Also, and last but not least by any means, they have an opportunity to tell us what they think we ought to do, and we really need the public input.

RW: Do you think a Web site is an effective way for radio broadcasters to reach their listeners?

H: Absolutely true. It is an effective way to reach the listeners. It is also an effective way to talk to the FCC. I mean the Internet, generally. We would

be delighted to hear from radio broadcasters about any issue over the Internet. They can communicate directly to me, and are very welcome to do so... There is no reason to rely on newspapers and word-of-mouth. I would be happy to explain to anybody directly what we are doing.

RW: Some radio stations are providing the opportunity for visitors to their Web sites to hear them in real time. If the technology improves to the point that people can listen to radio over the Internet in basically perfect sound quality, do you think this type of delivery method could evolve into an alternative program source for listeners?

H: I think there are going to be lots of different ways that people will access radio in the future. Another example is the digital

audio radio satellite, which in a number of years will be up and will be broadcasting radio.

Another example is terrestrial digital in-band, which is going to change radio. I think that those are probably more significant than the access to radio over the Internet, but all three developments show that radio is about to go through enormous change, is about to have enormous opportunities for expansion.

RW: What do you think about listening to the radio over the Internet?

H: I think it is fine if they are going to do it. It is a little awkward. The key to radio now is that it is utterly portable... You do not have that same facility vis-à-vis the Internet, unless you have, of course, a very upscale portable laptop computer and a wireless modem, which is a little bit more pricey than the (cost of a portable radio). So I think that is a fairly high-end (and) specialized use. I would not think it is as significant as the coming digitalization of radio, in terms of a factor that is likely to radically change the industry.

RW: What is radio's role on the information superhighway?

H: Radio is one of the key lanes, and it is going to be more and more interesting, and more and more important. The key change is the change to digitization, which is going to greatly expand the opportunities that radio broadcasters have.

RW: How do you think the way the FCC is going onto the information superhighway fits in with the government's outlook on the topic?

H: I think what the FCC is doing is kind of a model for the entire government. We are trimming down and

speeding up our deliberations. We are trying to be more productive, and, at the same time, we are trying to be open to the public in totally new ways. And I think we are succeeding.

We are going through more change right

they have accepted it, and are aware of its possibilities?

H: Oh, yeah. This is taking off, sort of at an exponential rate. I really do not know what the boundaries are, if any.

RW: Do you think the FCC staff is excited about the possibilities?

H: People here have been very frustrated for a very long time about the difficulties in talking with each other, the slowness of our processes, the unnecessary logistical problems involved in just arranging internal meetings. We understand what communications can do, and we have not been able to do it. It is like a bunch of fine basketball players who do not have a basketball. But now that we have the PCs, you know, the place is changing itself overnight.

RW: So anybody, from the average citizen who may just have a passing interest in broadcasting, to a student or government person or a broadcaster, can find information and benefit from the FCC Web site?

H: That is exactly right.

RW: If you had to pick one thing that would say to you that the Web site has done its job, what would it be?

H: It would be the sheer fact that we have 6,000 interactions with the public over the World Wide Web per day. I mean, that alone proves that we are being much more successful than in the past in serving the public.

□ □ □

FCC Chairman Reed Hundt can be reached by e-mail at rhundt@fcc.gov. The FCC's Web site makes its home at <http://www.fcc.gov>.



FCC Chairman Reed Hundt



now than ever before in the whole history of the FCC. When I got here, (the FCC) was fairly impervious to change. But we are in the middle of fairly radical reform right now.

RW: What are some of the other programs the FCC has that relate to reaching out to the public through the information superhighway?

H: We are going to use the World Wide Web for regular virtual meetings with the public, for lots of press interaction. We are going to use the World Wide Web to put the different bureaus on line, in real time, so that they can talk with their industries. These are some of our plans for the future.

RW: How is the FCC staff taking to the Web? Do you think

MOVING?...

Don't leave us behind!

Mail or fax
your current label
and new address
(with effective date) to:

Circulation, RW,
PO Box 1214
Falls Church, VA
22041
or
FAX 703-998-2966.

Address changes
will be processed
within four weeks of receipt.

Thanks!

**RF ENGINEERING
SOFTWARE**

dataworld®
authorized distributor of
EDX Engineering Software

- ◆ SIGNAL™
MSITE™ and TPATH™
package
- ◆ MSITE™
Wide area coverage
prediction
- ◆ TPATH™/RPATH™
Point-to-Point Link Studies
- ◆ International Terrain Data

dataworld®

Established 1971

800-368-5754
Fax: 301-656-5341

Circle (117) On Reader Service Card

Why Did 5 Different Radio Station Groups Order 10 or More LPB Consoles in Single Orders in 1994?

YOU CAN RELY ON LPB.

Stations on 6 continents rely on LPB for superior performance, excellent RFI immunity, outstanding durability, and unmatched value.



Signature III Series



7000 Series

LPB[®]

**28 Bacton Hill Road • Frazer, PA 19355 • (610) 644-1123 • Fax (610) 644-8651.
E-Mail lpbinc@aol.com**

INTERNATIONAL UPDATE

Canada Introduces Eureka-147 TravelGuide

by James Careless

TORONTO As the implementation of Eureka-147 for digital radio moves forward, promoters are introducing ancillary services to make the new service more attractive to broadcasters and to grab the attention of consumers.

Canada, a staunch supporter of Eureka-147 for Digital Audio Broadcasting (DAB), used the annual Canadian International Auto Show to debut TravelGuide, an in-car navigation and traffic monitoring system delivered on L-band via Eureka.

The government of the province of Ontario—developer of TravelGuide—set up a working display during the February trade show with the cooperation of Chrysler and Digital Radio Research Inc. (DRRI), the Canadian industry/government group spearheading the drive toward achieving DAB in Canada before the end of the century.

Prototype configuration

Chrysler supplied a convertible to demonstrate a prototype "commercial" configuration of TravelGuide and a mini van to allow visitors to see the system in

action on the streets of downtown Toronto.

The car featured a small, in-dash Sony video display that was manipulated by a small remote control. The van used a laptop fixed to a steel pedestal positioned between the driver and passenger seats.

TravelGuide integrates police reports with information on traffic flow gathered by both buses and on-road sensors. These provide a data stream that is relayed via L-band to a digital radio equipped with a small monitor screen. Control is executed using either keys or—theoretically for now—voice recognition.

This design offers users important benefits. They can key in their current location and a destination, and then ask the computer for the most efficient route based on present conditions. TravelGuide then displays a route on the monitor screen—which is meant to be used primarily before the drive, not during—and also supplies audio instructions to the driver.

The audio instructions include a route overview spoken by the system's voice synthesizer during the on-road demo.

An example: "From Toronto Convention Centre, two hundred, fifty-five

Front Street West, Toronto, to Pearson International Airport Terminal Two, Toronto—total distance, thirty-five point three kilometers; thirty-eight minutes."

The system also provides turn-by-turn,

there was a snowstorm in Alabama several years ago, which was a complete freak occurrence, you would know about it."

From the point of view of the public, TravelGuide was a high-tech novelty,



Canada launched an in-car mapping system using Eureka-147 DAB.

U.S. Legislators Take On Radio Deregulation

► continued from page 1
the radio industry."

Station owners said the bill will help position them as players in a new media marketplace that is growing more fiercely competitive almost daily. One concern is the upcoming direct satellite broadcast



service that could deliver up to 60 channels of audio per market.

The consolidations that will emerge from an easing of ownership restrictions will lead to stronger, more cost-efficient stations, broadcasters said. And it will lead to more choices for listeners, if the most recent broadcast deregulation results prove anything, according to Richard Ferguson of NewCity Communications.

"If you have one FM in a market, you will go for the biggest (audience) share possible," Ferguson said. "Now with multiple facilities, people are saying, 'I can have a couple of niche formats.' We just put a jazz station in San Antonio. We created a new format—rhythm and romance, in Orlando."

Though some critics worry that the deregulation will lead to a dangerous level of concentration in various markets, Ferguson and others said existing antitrust provisions will prevent that.

Bill Stakelin, president and CEO of Apollo

Radio Ltd., said he believes the FCC will still maintain oversight. "I see good, strong companies," he said. "I do not think controls will ever be taken away. The FCC will set guidelines and be charged with the responsibility of setting criteria that will let people know when there is too much concentration and control in a market."

□ □ □

Jacqueline Conciatore is associate editor of the National Public Radio Current.

on-road instructions as the trip progresses, such as: "One—drive west on Front Street four hundred meters to Spadina Avenue. Turn left; select right lane after turn."

Data collected by TravelGuide is continuously updated, and new accidents and other problems are relayed to the driver immediately. The system, in turn, suggests alternative routes as needed.

Currently, there is only enough information collected for TravelGuide to cover downtown Toronto, according to Jackson Wong, the designer of TravelGuide who is with the Ontario Ministry of Transportation.

"In the future, when you are taking a trip from Toronto to Orlando, Fla., you will receive relevant information for the parts that you're travelling through," Wong said. "So in situations like when

albeit one that is only two to five years away from market, according to government sources.

Proof of potential

But for engineers like Wong, the system is proof of the potential for L-band DAB to supply new and different services and to do far more with datacasting than can be done currently with the Radio Data System (RDS).

"The RDS format is a fairly modest low data rate format" in its current analog configuration, Wong said.

"The kind of format that is being discussed and being deployed for trial here in digital radio makes use of the RDS format at a very high speed, and we are also experimenting with completely new services that RDS cannot cover—things

continued on page 13 ►

BROADCAST AUDIO ROUTING
SAS 32000 SWITCHER

High-performance audio products for broadcast
8 YEARS
Typical applications include remote routing, monitor switching, ISDN interface assignment, and control room output / transmitter routing.

Specifically designed for Radio, the SAS 32000 Stereo Audio Routing & Mixing System is perfect for directing signals throughout any size broadcast facility.

Unlimited summing of inputs is standard and allows for mix-minus feeds, IFB and voice-over work. System sizes up to 32 x 16 stereo in one 3 RU frame. The modular matrix configuration expands to 192 x 192.

- Serial RS-232 ports for terminal end modem control; RS-485 for local panels.
- Destination-oriented modular control panels adapt to console fit as well as standard rack mount.
- Custom and turnkey systems available.

Sierra Automated Systems & Engineering Corporation
2112 North Glenoaks Blvd. Burbank, CA 91504 818.840.6749 Fax 818.840.6751

SIERRA AUTOMATED SYSTEMS
BROADCAST & COMMUNICATIONS

Circle (33) On Reader Service Card

Products & Services Showcase

For more information on the products shown below, circle the appropriate Reader Service No.(s) on the enclosed Subscription/Reader Service card or contact the advertiser directly.

S.C.M.S., Inc. Charlotte, N.C.

Low Prices – Experienced Staff
New and Re-built R.F. and Audio

THIS MONTH'S SPECIAL

DIGITAL — DIGITAL — DIGITAL

▪ THE NEW STEALTH 4 TRACK DIGITAL
WORK STATION NOW WITH EFFECTS
PACKAGE STANDARD STARTING AT \$1,995.00

▪ THE NEW RDS AUTOMATION SYSTEM NOW
AVAILABLE WITH HARD DISK MUSIC STORAGE
FOR LESS THAN THE COST OF C.D. STORAGE

▪ CALL S.C.M.S. FOR DETAILS!

— You Know We Know Radio —
Toll-Free 800-438-6040
FAX 704-889-4540

READER SERVICE NO. 114

Composite Audio DA and Switcher!



The CDS-200 Composite
DA/Switcher

APPLICATIONS

- Switching Between Composite STL's
- Main/Alternate Processing Switching
- Feed Two Transmitters, and an RDBS Encoder
- Feed one SCA Generator to Two Transmitters
- Distribute Composite with the Ease of Audio

FEATURES

- 2 Input Switcher
- 3 Isolated Outputs
- Individual Level Control for Each Output
- Front Panel and Remote Control with Full Status
- Power Fail Memory with Bypass Mode
- Inputs Selectable for Balanced or Unbalanced Operation
- Front Panel Test Jack

bdi Broadcast Devices, Inc.
5 Crestview Avenue
Peekskill, NY 10566

Tel: (914) 737-5032 Fax: (914) 736-6916

181READER SERVICE NO. 181

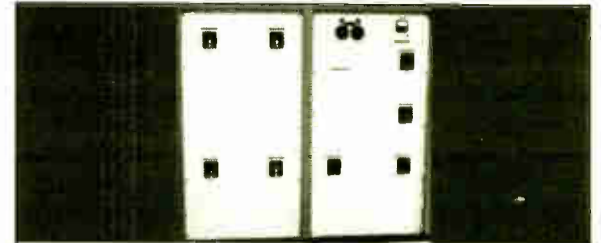

- CUSTOM ANTENNA PHASING SYSTEMS
- ANTENNA CONTROL SYSTEMS
- AM/MF ANTENNA TUNING UNITS
- DIPLEXERS & MULTIPLEXERS
- TRANSMITTER COMBINERS
- DUMMYLOADS (WITH MATCHING NETWORK)
- ASSOCIATED RF COMPONENTS
- CALL OR FAX FOR MORE INFORMATION

PHASETEK INC.

550 CALIFORNIA RD. UNIT 11
QUAKERTOWN, PA 18951

PHONE: 215-536-6648

FAX: 215-536-7180

See Us At NAB Booth 5427

READER SERVICE NO. 214

Quality* Power Tubes

3CX15,000A7	4CX1600B	4CX250R/7580W
3CX15,000A3	4CX1500A	4CX250BT
3CX10,000H3	4CX800A	4CX250BC/8957
3CX10,000A7	4CX400A	4CX250B/7203
3CX3000F7/8162	4CX350AC	4X150A
3CX3000A7	4X350A/8321	5CX1500B
3CX2500H3		5CX1500A
3CX2500F3/8251		YC130/9019
3CX2500A3/8161		8560AS
4CX15,000A/8281		811A
4CX10,000D/8171		833A
4CX5000A/8170		833C
4CX3500A		



- Watch this list grow.
- Manufactured in Russia's largest power tube factory.
- Shipment from USA stock.
- Generous* warranty based on high quality.
- Honest prices based on quality at low cost.

Broadcasters

Phone: 205-882-1344
FAX: 205-880-8077
800-239-6900

OEMs, Distributors

Phone US: 800-578-3852
Int'l & US: 415-233-0429
FAX: 415-233-0439

READER SERVICE NO.183

Integrated Excellence!

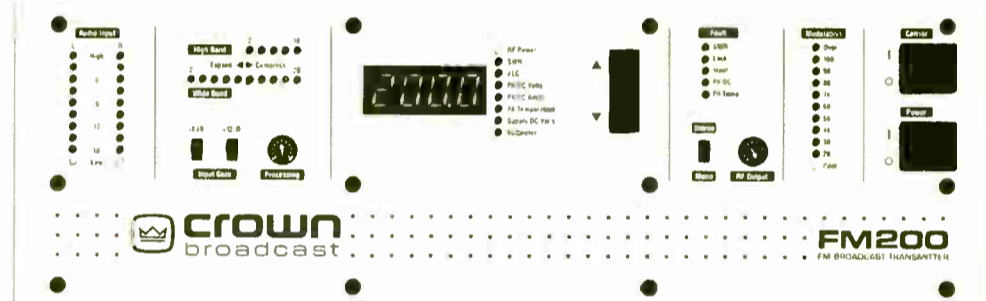

Integrated Excellence. The best way to describe Crown Broadcast FM transmitters. Available in 30, 100, 200 and now 500 watt models.

Each integrated FM package includes:

- FM Exciter
- Audio Processor
- Stereo Generator
- RF Amplifier

All of which operates from your AC or DC power source.



A Division of Crown International, Inc.
1718 West Mishawaka Road
Elkhart, Indiana 46515-1000
Fax 219-294-8302
Broadcast Sales 219-294-8050

READER SERVICE NO. 13

AXS (Ax'-sess)... Jocks Love It!

AXS is an entirely new approach to digital audio controllers. It starts with superb audio using the premium quality apt-X™ system. AXS is easy to learn, easy to use, and powerful beyond words.

AXS is a modular design that begins as a simple cart replacement and grows to any combination of CD, hard disk, satellite or specialty programming with ease.

AXS has all the sophisticated feature options including device independent multi-channel background audio record and replay. Macro programming makes tough to run event sequences easy. Software drives a powerful programmable real time IOMAP.

Jocks love AXS: A fast 99 page, 28 button Jock F/X panel that can be time linked and remote wired is standard.

Use a software driven four-channel stereo audio switcher with on-screen control or the powerful eight-channel dual-buss routing switcher, or include both if you wish. AXS is controlled through a trackball, touchscreen, keyboard, buttonbox, telco or remote modem.

AXS Systems...

From \$6000.00 using your i86 computers and hard disks.

READER SERVICE NO. 206



AXS

The Management

800-334-7823 • 817-625-9761

FAX 817-624-9741

P.O. Box 1-36457 Fort Worth, TX 76136

1700+ Stations • Our 14th Year

DIGITAL ANTENNA MONITORS

In-Stock-Available for
Immediate Delivery



Price US\$2400.00 2 Towers

Will operate with any remote control equipment.



Price US\$1780.00 2 Towers

For AM directionals with studio located at transmitter site.

These monitors are state-of-the-art instruments of unequalled accuracy (.5% or better on ratio and .5° or better on phase) and stability. With typical modulation the true ratio readout of these monitors is a factor of 10 more stable than instruments that measure normalized amplitude, and their phase readouts are rock solid. Phase sign is automatic, no extra operation. In addition to the analog DC outputs for remote control the Model CMR has a multiplexed BCD digital output which can be used to drive the Remote Indicator Model CMR-1. RF inputs have dual protection. Gas discharge tubes across the sample line terminations plus relay protection.

GORMAN REDLICH MFG. CO.

257 W. Union St. Athens, Ohio 45701

Phone 614-593-3150 • FAX 614-592-3898

READER SERVICE NO. 53

INTERNATIONAL UPDATE

DAB Forum Promotes Eureka Agenda

GENEVA "More successful than one could have hoped for" is how Franc Kozamernik of the European Broadcasting Union (EBU) described the inaugural meeting of the EuroDab Forum.

In fact, nearly 200 representatives from all over the world attended, including not just Europeans but Canadians and Americans as well. Australia, China, India and Mexico also committed to joining the group.

Less formal

As a result of the success of the first meeting, several aspects of the forum will be changed. Even though the name will remain EuroDab, there will no longer be separate categories for European and non-European members. The memorandum of understanding also

was eliminated, and the forum will function much more as an open discussion group with less formal rules.

Among the surprises to come from DAB progress reports from various countries was the announcement from Belgium that the country will establish one DAB forum for both the Flemish and Francophone communities. The country is known for usually having different forums and groups for each language sector.

Hungary also announced that it is moving ahead quickly with plans to establish a DAB forum. A lot of support for the Hungarian DAB forum comes from the private commercial market.

Along those same lines, Kozamernik reported that he was officially contacted by the Popov Research Institute in St. Petersburg, Russia, which told him they

would like to join the group. This is the first official contact from Russia concerning DAB.

Poland is moving along quite rapidly with DAB and had a large representation at the meeting. Poland is one of the countries most keen on DAB right now, according to Kozamernik.

The Americans attending the meeting tended to be more from the manufacturing side, including representatives from Motorola, WorldSpace and Delco.

Therefore, it was no surprise that the interest in DAB from the Americans was from a commercial aspect. For example, Kozamernik said the U.S. car industry is interested in DAB because it manufactures automobiles for both the Canadian and European markets.

He said he also feels that there was a political reason behind the U.S. representation. Presently, 1.5 GHz is not allowed for allocation in the United States. Also, said Kozamernik, "The IBOC approach has limited scope. It can only duplicate existing sound channels on the FM band, whereas Eureka-147 can multiply the number of programs by a factor of 10."

The next EuroDab Forum meeting is Oct. 11, in London. The group also decided to sponsor a European DAB day next year, although exactly what that will entail was not been decided.

Another move promoted by the forum is

to conduct a major marketing study of Europe and the rest of the world concerning Eureka-147. The study would examine to what extent Eureka-147 is economically viable via satellite to mobile and non-mobile users.

This concern is driven by the amount of increasing competition in satellite delivery. Currently, several new satellite-based audio/data broadcasting systems are under development.

Proliferation worries

They include: Worldspace, Immarsat, European Space Agency, Voice of America/JPL, Radiosat, Astra ADR (Europeanwide satellite sub-carrier system) and CD Radio, a U.S. domestic satellite system.

What also worries people like Kozamernik is that this could lead to a proliferation of a number of different systems for global or regional satellite sound broadcasting.

This would not only be inconvenient for broadcasters and consumers, but would mean higher costs for receivers because the market would be so fragmented. That could happen because these competing systems would use different transmission standards and incompatible receivers.

The study also will examine the suitability of Eureka-147 for local services and certain copyright issues that are not fully defined. Manufacturers need to have a clear picture on which patents and copyrights are involved. There are similar questions coming from broadcasters, who even question which trademarks and logos they are allowed to use.

Eureka TravelGuide

▶ continued from page 11

like map display, which obviously requires quantum leaps of more information per second than RDS can carry."

As it turns out, Wong prefers L-band Eureka DAB over other alternatives simply because it has enough bandwidth to handle a broad range of services like "Yellow Pages," stock quotes and paging.

"Everything eats up bandwidth," he said, "and L-band is about the only technology that's 'doable' in the next five, 10, 20 years, that has this kind of capacity. FM-RDS will not."

For the broadcasters who attended the auto show to see the TravelGuide demo, the display was another step on the road to realizing DAB as a fully viable medium that is only a few years away, according to Canadian Association of Broadcasters President and CEO Michael McCabe.

Other services

"I think that by '97 or '98 you will start to see the first genuine, fully-operational digital stations," McCabe said. "And people will get not only high-quality sound, they will start to get some of these other services that come along with it."

Certainly the successful unveiling of TravelGuide helped get the point across that DAB is coming, a point hammered home to visitors by a DRRI audio-video display.

Another factor boosting this message was the North American debut of a Philips commercial-grade Eureka receiver, one that DRRI Vice President Duff Roman said is similar to consumer sets now being released in the European marketplace.

Taken as a whole, the TravelGuide/ DRRI clearly demonstrated that L-band-delivered data services are both practical and reliable in a mobile environment and that these services need not just be "updated" versions of existing products. They can be new and different, carving out market niches where none existed before.

For the general public, the display showed digital radio as a working reality. They were exposed to the fact that, right now, many of the major stations in Toronto are simulcast via DAB and that someday soon they, too, will have access to DAB receivers like the Philips model that was on display.

The TravelGuide/DRRI display did its job. What remains to be seen is whether commercial L-band DAB can do the same.

□ □ □

James Careless covers the industry in Canada for Radio World.

AS-101 Audio Switcher

- Illuminated and legendable control buttons
- Instant or overlap switching
- Front panel accessible level controls
- Options include: RS-232 interface, remote control, relay-follow-switch outputs
- Network proven quality and reliability

10 Stereo In - 1 Stereo Out

P.O. Box 1342 Bellingham, WA 98227
1-800-545-1061 FAX (206) 676-4822

Conex Electro-Systems, Inc.

Circle (2) On Reader Service Card

AA-51A AUDIO ANALYZER NEW \$3770; UPGRADE \$1560

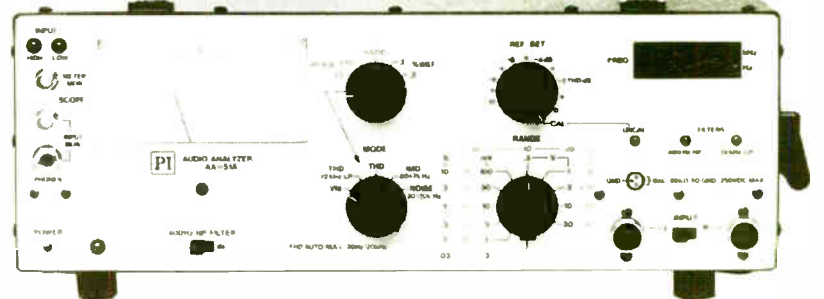

MEASURES:

- ✓ HARMONIC DISTORTION
- ✓ VOLTS
- ✓ dB; dBm (600 ohms)
- ✓ FREQUENCY
- ✓ WOW & FLUTTER
- ✓ STEREO PHASING
- ✓ SIGNAL + NOISE
- NOISE
- ✓ INTERMODULATION DISTORTION
- ✓ DIFFERENTIAL GAIN OF STEREO CHANNELS

FEATURES:

- ✓ AUTO-NULL THD+N
- ✓ SHIELDED & BALANCED STEREO INPUTS
- ✓ COMPATIBLE WITH NAB TEST DISKS
- ✓ FREQUENCY READOUT
- ✓ SWITCHABLE HIGH-PASS AND LOW-PASS FILTERS
- ✓ VERNIER SET-LEVEL CONTROL
- ✓ HEADPHONE INPUT MONITOR PORT

PLEASE CONTACT US FOR COMPLETE DETAILS



Potomac Instruments, inc.

932 Philadelphia Ave., Silver Spring, MD 20910
Phone 1-301-589-2662 • Fax 1-301-589-2665

Circle (48) On Reader Service Card

COLE'S LAW

Decipher Renewal Paperwork Maze

by Harry Cole

WASHINGTON As I have previously noted in these pages, renewal time is fast approaching for radio stations throughout the land. What I have not focused on yet, however, is what this means for station engineers. Can they just sit back, content that more than a decade of deregulation has taken them out of the renewal loop? Nope.

The 1995 renewal application (no longer a mere postcard, but now an actual, multipage form, proving that the 1980s really are over) continues to contain the following question which will

ordinarily send management personnel screaming down to their engineers for the right answer: "Would a Commission grant of this application come within 47 C.F.R. Section 1.1307, such that it may have a significant environmental impact, including exposure of workers or the general public to levels of RF radiation exceeding identified health and safety guidelines issued by the American National Standards Institute?"

While your standard Yes/No boxes follow the question, those are illusory: if you answer Yes, you have to include a separate exhibit, but if you answer No, you still have to "explain briefly why not."

In order to answer No to this question you have to be able to answer No to each item on an eight-item laundry list relating generally to "environmental" matters. Here is the list:

1. Does your facility involve high-intensity white lighting in residential neighborhoods?
2. Is your facility located in an officially designated wilderness area or wildlife preserve?
3. Does your facility threaten the existence or habitat of endangered species?
4. Does your facility affect "districts, sites, buildings, structures or objects significant in American history, architecture, archaeology, engineering or culture that are listed in the National Register of Historic Places or are eligible for listing"?
5. Does your facility affect "Indian religious sites"?
6. Is your facility located in a floodplain?
7. Did your facility require construction that involved significant changes in surface features?
8. Is your facility in violation of FCC-established guidelines regarding exposure

to excessive RF radiation?

The first seven of these questions should probably be pretty easy for just about everybody to complete. The tricky one is the eighth item.

To help you deal with the RF question, the FCC has created some "RF Radiation Compliance Worksheets/Instructions." Reliance on these worksheets is not mandatory, but it may be quite helpful.

continued on page 17 ▶

ISDN Fees in Question

▶ continued from page 1

spokesman for the FCC said. "It is our understanding that most companies have not been assessing a per-channel fee."

In a written statement, the Common Carrier Bureau stated: "We believe that the public interest is best served by focusing our resources on reaching an equitable long-term resolution of these issues as quickly as possible rather than devoting resources to enforcing a rule that is subject to possible amendment."

The decision was anticipated by industry manufacturers. "I am not surprised that they are reconsidering their previous ruling," said Distler.

The FCC proposed several alternatives to the per-channel charge for ISDN lines. The simplest is a return to charging one subscriber line charge per BRI or PRI line. Telecommunications Engineer Jeff Fritz, who chairs the National Information Infrastructure Working Group, supports this approach. "It was fair," he said. However, he noted that all of the proposals were "reasonable."

Another pricing option proposed would establish a charge proportional to cost. Phone companies would use the ratio of cost in providing an ISDN line to the cost

Copies of the worksheets are included in the "License Renewal Forms and Instructions," which the commission has presumably mailed out to each licensee. If you did not get a copy of that mailing, or if you cannot find the RF worksheets, just dial 800-671-2233 for the FCC's own "Radio Renewal Information Line." The forms, instructions and worksheets can be faxed out to you directly.

Do not assume because you have the RF worksheets, it will be a breeze. Even with the forms, you will have to (a) review some preliminary conditions to make sure

of providing an ordinary line. If that cost were six times as great, the charge for ISDN lines would be six times the charge of ordinary lines.

Fritz points out that using this method, the charges would vary between each local exchange making it difficult for broadcasters to correctly estimate the cost of a remote sportscast, for example.

Distler agreed. "I think it would be almost impossible to derive an 'average cost' of installing an ISDN line." Distler supports another FCC proposal that would give phone companies more flexibility in determining SLC rates.

Arthur Constantine, vice president of sales and marketing for New Jersey-based CCS Audio Products, a codec manufacturer, also favors some flexibility. "I think the FCC should allow telephone companies to provide ISDN services to radio stations for free," he said. "Radio stations provide valuable public services that cannot be obtained anywhere else."

For broadcast stations, the best pricing option will depend on how they use ISDN services. Neil Glassman, marketing director for Telos, a Cleveland-based codec manufacturer, explains that a station in a big city doing many local remotes might be affected by a higher SLC. Stations that do fewer remotes farther away may be willing to pay a higher SLC in exchange for a lower long distance rate.

Most people agree, however, that whatever the new pricing scheme adopted, the overall ISDN rates will continue to drop. Says Distler, "ISDN is a very cost-effective way for radio stations to transfer high-quality audio at today's rates even at an additional six dollars per month."

In its statement requesting comment, the FCC stated, "We must be careful to avoid erecting regulatory barriers to the development of beneficial new technologies." Michel Daley, a spokesman for Bell Atlantic, agreed. "With the introduction of the notice of proposed rulemaking we are now back on track towards introducing ISDN to all of our customers," he said.

This comes as good news to industry watchers who see the United States as sluggish in its conversion to ISDN lines. Japan, France and Germany all have a high market ISDN penetration.

Bell Atlantic was one of the first to object to the ruling in January to charge customers per channel. Along with NYNEX and others, the company requested an emergency waiver in February to be allowed to charge per line rather than per channel.

The FCC requires any responses to the notice of proposed rulemaking to be returned for discussion by mid-July. A ruling is expected after that.



LMA/DUOPOLY CONTOUR MAPS

The **DATAWORLD** LMA/DUOPOLY Market Survey Contour maps present a precise electronic verification of overlapping and intersecting contours.

AM 5 mV/m and FM 3.16 mV/m City Grade contours are shown in full color, including transmitter site indicator. The map is supported with a printout showing all of the stations which appear on the map.

Daily updating of **DATAWORLD'S** AM and FM databases protects against errors and omissions.

OTHER MAP OPTIONS

- SHADOWING (TERRAIN SHIELDING)
- CONTOUR COVERAGE
- POPULATION DENSITY
- ZIP CODE BOUNDARIES
- RECEIVED SIGNAL LEVEL
- SPECIAL REQUIREMENTS

1990 CENSUS

WHO ARE YOUR LISTENERS?

1990 BUREAU OF CENSUS POPULATION COUNTING

- Comprehensive Ethnic and Demographic Data
- Ethnic/Demographic Data Available for Each Zip Code Within Coverage Area
- Age Analysis Reflected in Ethnic Breakout
- Resolution Increased to Block Level
- Percent of County Coverage Shown

ETHNIC PIE-CHART DISPLAY

- Projects Ethnic Population in Multi-Color Pie Chart Form

dataworld®

800-368-5754 FAX: 301-656-5341

The Wizard™ has gone STEREO!

The new **DIGITAL FMSA-I** gives The Wizard System unmatched stereo monitoring capabilities. . .



Superlative stereo performance. Linear-phase filters that reveal the true performance of your audio processing. The stability of digital stereo demodulation. The sophisticated graphical presentation of The Wizard. And—with the RS-232 port—operation on site or off.

Contact Belar today for more details on what should be your next modulation monitor.



BELAR ELECTRONICS LABORATORY, INC.
119 LANCASTER AVENUE • P.O. BOX 76 • DEVON, PA 19333-0076 USA
(610) 687-5550 • FAX (610) 687-2686

Call, write or FAX for more information on Belar AM, FM, Stereo, SCA, and TV monitors.

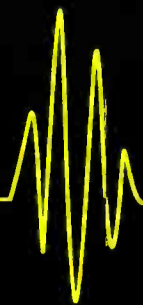

DEAD AIR

When Silence Isn't So Golden

Silence means money out the door.

For reliability you can count on - trust PR&E
to keep you on the air. Day in, day out. Year after year.

Just ask WOWO, proud owners of BMX 22
serial number 001, still on the air after 17 years.



P&E. Simply the best on-air and production consoles made.



PACIFIC RECORDERS & ENGINEERING CORPORATION
207C Las Palmas Drive Carlsbad, CA 92009 Tel. (619) 438-3911 Fax (619) 438-9277

DESIGNS THAT MAKE THE DIFFERENCE

Circle (18) On Reader Service Card

World Radio History

Safe



LAYER III

- Both the superior audio of Layer III and compatibility with installed Layer II-only codecs. Zephyr costs about the same as Layer II-only equipment.
- Only Layer III permits mono 15kHz operation on a single ISDN "B" channel or one Switched 56 line. This can greatly reduce your transmission costs.
- Clean, uncluttered front panel for simple operation. Full metering, call-duration timer, headphone jack, and mic/line inputs.
- Split channel mode allows individual mono signals to be transmitted to separate sites.
- RS-232 bi-directional data at 9600 baud for communications and control.
- Four end-to-end "contact-closures" for remote machine operation.
- The ideal solution for remote broadcasts, ad hoc networks, voiceovers, distribution of commercials, backup to satellite and microwave links, and many other applications.

Bad weather.
Finicky
players.
Losing streaks.

When it comes to sports, you can't control everything. But with Zephyr, you can guarantee that every game you broadcast will sound great.

Combining the most advanced digital audio techniques and the most practical features, Zephyr is the easiest way to use ISDN or Switched 56 for sports broadcasts.

Zephyr's Layer III provides the best broadcast sound quality, and Layer II and G.722 compatibility let your Zephyr connect to every major codec out there.

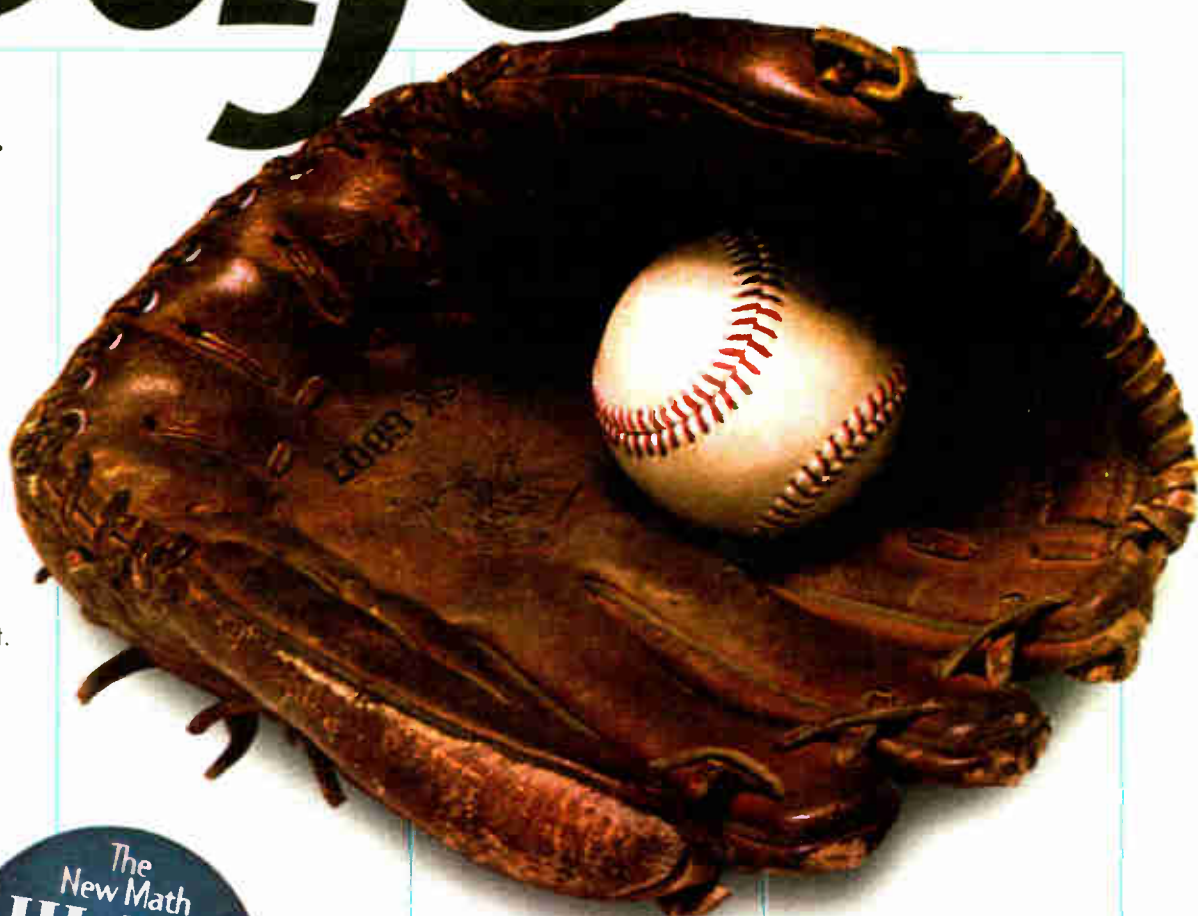

It's full duplex, so cues can be sent from the studio without the cost of additional phone lines.

Zephyr includes an ISDN terminal adapter and our ISDN Telephone mode allows you

to place a standard voice-grade call to a Plain Old Telephone Service (POTS) phone.

With Zephyr, you are always ready for the opening pitch, the kickoff, the jump ball, the face off... and your listeners.

only from



2101 Superior Avenue
Cleveland, Ohio 44114
216.241.7225
Fax: 216.241.4103
email: info@zephyr.com



The Best Way to Hear from There™

Telos **Zephyr** DIGITAL NETWORK AUDIO TRANSMITTER

Maze of Renewal

► continued from page 14

that you can even use the worksheets in the first place (there are a number of types of situations for which the worksheets do not apply) and (b) go through some calculations which will remind you a lot of filling in your federal income tax forms.

The purpose of these RF calculations is to determine whether the level of RF radiation to which the public is exposed in the area of your antenna is excessive. There are, of course, a variety of different ways by which this determination can be made. The RF worksheets allow you to run a relatively simple set of calculations using some information about your antenna(s) and supporting structure(s) and, for TV and FM stations, your ERP. The calculations also include, for FM stations, a multiplication factor designed to give a "worst-case" determination of RF. If you pass the test using such worst-case numbers, you should pass under any real world scenario.

Do not freak out, though, if you do not pass the worst-case test. Even if that happens, you can still offer an explanation based on such considerations as antenna radiation patterns, actual measurements of RF showing compliance, and the like.

Before trying some such alternative explanation, though, you would probably be smart to get hold of a copy of OST Bulletin No. 65, issued by the FCC's Office of Science and Technology. This little classic (real name: "Evaluating Compliance with FCC-Specified Guidelines for Human Exposure to Radio Frequency Radiation") is pretty much the last word on RF exposure matters. (Want your own copy? Dial 202-418-0200 and order one now directly from the FCC.)

And finally, even if you do find that, no matter what, your facilities produce excessive RF, that still does not necessarily mean that your renewal will be denied. Rather, it just means that you will have to include, as part of your renewal application, an environmental assessment addressing the problem.

Of course, one of the usual goals of renewal applicants is to get their renewal applications granted as quickly and as smoothly as possible. If that is your goal, too, you would probably be well-advised to do what you can to assure that your facilities are within the FCC's RF guidelines.

If maximum avoidance of delay or other hassle is a high priority in your universe, you may wish to consider delegating the RF question to your consulting engineer.

And remember that, in a pinch, you can always call on your communications lawyer.

□ □ □

Harry Cole is a principal in the Washington-based law firm of Bechtel & Cole, Chartered. He can be reached at 202-833-4190.

KEYBOARD CONNECTION

Communication Options to Consider

by Barry Mishkind

TUCSON, Ariz. It is an old joke. A traveler discovers he is lost and approaches a farmer, seeking directions to the nearest town. The farmer knows the town, knows where it is, but finally tells the traveler "you can't get there from here."

Broadcasters who need help with equipment or software sometimes can find getting to the right person with the right information may seem almost as difficult a proposition.

How it was

Of course, there are the traditional routes: calling the manufacturers or their reps. Some manufacturers have excellent support programs, with highly skilled customer service technicians ready to handle any problem.

But, given the number of stations and the number of technical service folk, time zone differences and other factors, actually reaching the right person can still be a challenge. Most of us have played telephone tag at one time or another, or ended up cursing the incessant busy signal or the endless ringing when we needed help quickly.

Efforts to improve customer service over the years have brought answering services and machines, fax machines and the oft-hated voice mailboxes with their endless menu choices. All are efforts to take messages when people are busy or out. Each has its drawbacks. Messages and faxes pile up at the reception desk; fax machines run out of paper; voice mail can get erased by a power glitch.

All of which brings us to e-mail.

How it can be

E-mail really is the '90s. Electronic mail is transmitted from your computer via one or more networks and ends up in the account of the recipient. He can be around the block or around the world. In fact, most e-mail is delivered within minutes.

On the other hand, sometimes you cannot get there from where you are. A primary hurdle is having the exact e-mail address. Just one wrong letter or number in the address, and the message is rejected, bounced back to you, or just disappears into the "bit bucket." This can happen frequently when messages cross over to different networks. In fact, one major network had a reputation of "dumping" e-mail (deleting it) when its system got busy.

This brings up two important pieces of so-called Net etiquette. Because the one sending a message to you cannot always be certain you received it, it is a kindness to respond, even if only to say "message received." The flip side is: do not assume a lack of reply is because the other person is rude. They might not have gotten your e-mail. Personally, I have even had messages to other **RW** writers disappear, and it was only by my sending a follow-up that I got contact and a reply.

Benefits of e-mail

Nevertheless, there are some real benefits from e-mail. First, as I mentioned, it can be sent virtually instantaneously. For those with live on-line connections, their screen can tell them immediately when a message has arrived.

If your message needs to be routed to someone who can provide a better answer, this also takes mere nanoseconds.

Multiple copies can even be sent to several people in a company if a difficult or multipart question has come up. And, because it is electronic, there is no potential problem of running out of paper.

A third benefit comes when a problem or

to on the phone. Yet, in the computer age, we can find ourselves communicating with others without even hearing their voice.

So, it is nice to have an opportunity to get together at trade shows and meet the folk with whom you have been exchanging e-mail. This year, **RW** sponsored the Third Annual Computer Users' lunch meeting on Tuesday during the NAB show. More than two dozen people showed up and chatted about everything from specific programs to increasing the availability of the Society of Broadcast Engineers (SBE) echo.

Topping the list of door prizes were several broadcast industry-oriented items. Communications Data Services provided a full color propagation map. And both Rules Service Company and Pike & Fischer provided a computer set of the FCC Rules and Regulations.

DacEasy sent a couple of copies of its Instant Rolodex, along with the new DacEasy Accounting for Windows (a CD with more than \$700 of software perfect for use by small businesses).

Groliers provided the Groliers Multimedia Encyclopedia. From Mindscape came the newly updated Grammy Awards Multimedia CD-ROM, complete with more than 35 audio/video clips of winning songs.

Parsons Technology sent along its Information Please Business Almanac and Desk Reference (a CD with lots of legal software and other business software), and a copy of It's Legal, a package to help write contracts, wills, etc.

Microsoft Corporation sent copies of the MS Professional Office, and the 1995 copies of MS Bookshelf, MS Encarta and MS Cinemania.

And from Symantec we had copies of Norton Utilities, the Norton Desktop and Norton Anti-Virus programs.

I would like to offer my sincere thanks to all these fine companies that helped make this year's lunch gathering a stand-out part of the NAB convention.

□ □ □

Barry Mishkind can be reached at 520-296-3797, or via the Internet: "barry@coyote.datalog.com."

Here are some valuable e-mail addresses you will want to clip and save.

Sales and Tech Support E-mail addresses:

Equipment Manufacturers

CRL crl@crlsystems.com
 Hallikainen and Friends ap621@cleveland.freenet.edu
 LPB lpbinc@aol.com
 Modulation Sciences esmail@ios.com
 Nautel nautel@fox.nstn.ca
 Wheatstone audioarts@delphi.com

Manufacturers Representatives:

Audio Broadcast Group 75371.144@compuserve.com
 or support@abg.com
 Mark Persons mpersons@brainerd.polaristel.net

Miscellaneous:

Communications jr@comm-data.com
 Data Services john@dataworld.com
 Dataworld zwheat@pf.com
 Pike & Fischer

If your company is not listed here, send your e-mail address to barry@coyote.datalog.com for inclusion in the next update.

question arises in the middle of the night. Rather than missing connections (or sleep), an e-mail message can be sent anytime, and the company can have the answer in your mailbox when you awaken.

To see who is connected, I surveyed a number of manufacturers and reps at the recent National Association of Broadcasters (NAB) show. Quite a few now have, or are planning to have, e-mail addresses for sales and technical support. While some are a bit hesitant to get into e-mail activity, one vendor told me he can handle 50 e-mail messages much faster than 10 phone calls, identifying the ones needing telephone assistance more quickly.

It is always nice to meet the voices you talk

SUBSCRIPTION/READER SERVICE FORM																																																							
Radio World																																																							
FREE Subscription/Renewal Card																																																							
I would like to receive or continue receiving Radio World FREE each month. <input type="checkbox"/> Yes <input type="checkbox"/> No																																																							
Signature _____	Date _____																																																						
Please print and include all information:																																																							
Name _____	Title _____																																																						
Company/Station _____																																																							
Address _____																																																							
City _____	State _____ ZIP _____																																																						
Business Telephone () _____																																																							
Please circle only one entry for each category:																																																							
I. Type of Firm																																																							
D. Combination AM/FM station	F. Recording Studio																																																						
A. Commercial AM station	K. Radio Station Services																																																						
B. Commercial FM station	G. TV station/teleprod facility																																																						
C. Educational FM station	H. Consultant/ind engineer																																																						
E. Network/group owner	I. Mfg. distributor or dealer																																																						
	J. Other _____																																																						
II. Job Function																																																							
A. Ownership	G. Sales manager																																																						
B. General management	E. News operations																																																						
C. Engineering	F. Other (specify) _____																																																						
D. Programming/production																																																							
<table border="1"> <thead> <tr> <th colspan="2">Reader Service</th> </tr> <tr> <th colspan="2">July 28, 1995 Use until Sept. 20, 1995</th> </tr> <tr> <th colspan="2">Please first fill out contact information at left. Then check each advertisement for corresponding number and circle below.</th> </tr> <tr> <th colspan="2" style="text-align: center;">Purchasing Authority</th> </tr> <tr> <th>1. Recommend</th> <th>2. Specify</th> </tr> </thead> <tbody> <tr><td>001 023 045 067 089 111 133 155 177 199</td><td></td></tr> <tr><td>002 024 046 068 090 112 134 156 178 200</td><td></td></tr> <tr><td>003 025 047 069 091 113 135 157 179 201</td><td></td></tr> <tr><td>004 026 048 070 092 114 136 158 180 202</td><td></td></tr> <tr><td>005 027 049 071 093 115 137 159 181 203</td><td></td></tr> <tr><td>006 028 050 072 094 116 138 160 182 204</td><td></td></tr> <tr><td>007 029 051 073 095 117 139 161 183 205</td><td></td></tr> <tr><td>008 030 052 074 096 118 140 162 184 206</td><td></td></tr> <tr><td>009 031 053 075 097 119 141 163 185 207</td><td></td></tr> <tr><td>010 032 054 076 098 120 142 164 186 208</td><td></td></tr> <tr><td>011 033 055 077 099 121 143 165 187 209</td><td></td></tr> <tr><td>012 034 056 078 100 122 144 166 188 210</td><td></td></tr> <tr><td>013 035 057 079 101 123 145 167 189 211</td><td></td></tr> <tr><td>014 036 058 080 102 124 146 168 190 212</td><td></td></tr> <tr><td>015 037 059 081 103 125 147 169 191 213</td><td></td></tr> <tr><td>016 038 060 082 104 126 148 170 192 214</td><td></td></tr> <tr><td>017 039 061 083 105 127 149 171 193 215</td><td></td></tr> <tr><td>018 040 062 084 106 128 150 172 194 216</td><td></td></tr> <tr><td>019 041 063 085 107 129 151 173 195 217</td><td></td></tr> <tr><td>020 042 064 086 108 130 152 174 196 218</td><td></td></tr> <tr><td>021 043 065 087 109 131 153 175 197 219</td><td></td></tr> <tr><td>022 044 066 088 110 132 154 176 198 220</td><td></td></tr> </tbody> </table>		Reader Service		July 28, 1995 Use until Sept. 20, 1995		Please first fill out contact information at left. Then check each advertisement for corresponding number and circle below.		Purchasing Authority		1. Recommend	2. Specify	001 023 045 067 089 111 133 155 177 199		002 024 046 068 090 112 134 156 178 200		003 025 047 069 091 113 135 157 179 201		004 026 048 070 092 114 136 158 180 202		005 027 049 071 093 115 137 159 181 203		006 028 050 072 094 116 138 160 182 204		007 029 051 073 095 117 139 161 183 205		008 030 052 074 096 118 140 162 184 206		009 031 053 075 097 119 141 163 185 207		010 032 054 076 098 120 142 164 186 208		011 033 055 077 099 121 143 165 187 209		012 034 056 078 100 122 144 166 188 210		013 035 057 079 101 123 145 167 189 211		014 036 058 080 102 124 146 168 190 212		015 037 059 081 103 125 147 169 191 213		016 038 060 082 104 126 148 170 192 214		017 039 061 083 105 127 149 171 193 215		018 040 062 084 106 128 150 172 194 216		019 041 063 085 107 129 151 173 195 217		020 042 064 086 108 130 152 174 196 218		021 043 065 087 109 131 153 175 197 219		022 044 066 088 110 132 154 176 198 220	
Reader Service																																																							
July 28, 1995 Use until Sept. 20, 1995																																																							
Please first fill out contact information at left. Then check each advertisement for corresponding number and circle below.																																																							
Purchasing Authority																																																							
1. Recommend	2. Specify																																																						
001 023 045 067 089 111 133 155 177 199																																																							
002 024 046 068 090 112 134 156 178 200																																																							
003 025 047 069 091 113 135 157 179 201																																																							
004 026 048 070 092 114 136 158 180 202																																																							
005 027 049 071 093 115 137 159 181 203																																																							
006 028 050 072 094 116 138 160 182 204																																																							
007 029 051 073 095 117 139 161 183 205																																																							
008 030 052 074 096 118 140 162 184 206																																																							
009 031 053 075 097 119 141 163 185 207																																																							
010 032 054 076 098 120 142 164 186 208																																																							
011 033 055 077 099 121 143 165 187 209																																																							
012 034 056 078 100 122 144 166 188 210																																																							
013 035 057 079 101 123 145 167 189 211																																																							
014 036 058 080 102 124 146 168 190 212																																																							
015 037 059 081 103 125 147 169 191 213																																																							
016 038 060 082 104 126 148 170 192 214																																																							
017 039 061 083 105 127 149 171 193 215																																																							
018 040 062 084 106 128 150 172 194 216																																																							
019 041 063 085 107 129 151 173 195 217																																																							
020 042 064 086 108 130 152 174 196 218																																																							
021 043 065 087 109 131 153 175 197 219																																																							
022 044 066 088 110 132 154 176 198 220																																																							
Copy & Mail to: Radio World, PO Box 1214, Falls Church, VA 22041, or FAX to: 703-998-2966																																																							

THE StereoMaxx 3-PACK: MARKET WINNING SOUND.

SOUND BETTER AND LOUDER WITH A REAL IDENTITY
WITHOUT SPENDING BIG MONEY FOR BIG NAME PROCESSORS.



The StereoMaxx: Spatial Image Enlargement.

When everyone in town is processed to the hilt, what can you do to win the sound battle? The answer is StereoMaxx. It makes your station sounds bigger, not just louder, by enhancing and enlarging your station's stereo image, making it wider and deeper beyond the boundaries of the speakers. No matter what type of radio your listeners tune, StereoMaxx will make your station sparkle with energy and excitement. While your competition will sound flat, dull and lifeless by comparison. And when you use it with our Composite Processor and the FM ModMinder, you get to be the most identifiable station in your market. Guaranteed.

The Composite Processor: 6 dB More Loudness. U.S. Patent 4,441,199.

Add up to 6dB more loudness, without ringing or overshoot, giving you the maximum modulation the law allows. Installed at your transmitter site, working with the StereoMaxx or any other existing processor, the CP-803 will make your air chain the loudest in town. This patented clever processor deals with the composite signal out of the stereo generator, avoiding many conventional audio problems associated with other (even some famous) processors.

Don't Pay Big Money For Big Name Processors.

Big name processors come in two basic versions: The economy model that does very little and the expensive models that do too much. Either way, your station may be stuck with the same sound as your competition. Big money for big name processors does not necessarily mean market winning sound.

The FM ModMinder: Absolute Max Modulation.

Digital technology and the FCC approved measurement method utilized in the FM ModMinder enable your station to operate at absolute maximum legal modulation. If your competition is not FM ModMinder equipped, your station will have them beat. Guaranteed. Easy dial-up access software included so you can perform a host of test functions by remote control from your office based PC (or from anywhere else in the world), giving you peace of mind every day.

Here's The 3-Pack Deal: Buy The StereoMaxx & ModMinder. Get a Free Composite Processor.

We give you a free CP-803 Composite Processor when you buy the StereoMaxx and the FM ModMinder together (you save \$1,495). Or, if you don't need all three, your MSI dealer will surely give you a great deal on any one or two of them. And if you're running duopoly, here's an opportunity to get the MSI processors you need on a great deal for all your stations. Act now, because this is a limited time offer.

Sound Better And Louder With A Real Identity.

*Call your MSI dealer or
call toll free (800) 826-2603
to receive full information and
to discuss your requirement.*

modulation sciences, inc.

12A WORLD'S FAIR DRIVE SOMERSET NJ 08873
TEL. (908) 302-3090 FAX. (908) 302-0206

INSIGHT-ON-RULES

Examining Commission's EAS Rules

by Harold Hallikainen

SAN LUIS OBISPO, Calif. On Dec. 9, 1994, the Federal Communications Commission (FCC) released a Report and Order that replaces the existing Emergency Broadcasting System with a new Emergency Alert System. It also issued a Further Notice of Proposed Rulemaking regarding EAS for cable systems, MDS (wireless cable), Digital Audio Radio and other services.

In this article, I will take a close look at the new rules regarding broadcast stations. This article is based on a review of the Report and Order and discussion with FCC staff and others. The full text of the report and order is available on Internet at <<http://fcc.gov/>> or <<http://slonet/~hhalika/>>. It is also available by fax at 805-

decoders in stations must be modified to respond to the existing two-tone (853 and 960 Hz) attention signal in a minimum of three and a maximum of four seconds. Currently, decoders are required to respond in eight to 16 seconds. Decoders can be modified anytime before July 1.

Starting July 1, two-tone encoders may be modified to transmit the attention signal for eight to 25 seconds. The shortened tone was suggested by the National Association of Broadcasters (NAB) in its EBS petition. The eight-second minimum with a decode time maximum of four seconds ensures broadcast stations will continue to properly receive the EBS tones.

Starting July 1, stations may start using the new EAS codes in addition to the shortened EBS tone.

Starting July 1, 1996, stations must use

broadcast the two-tone "attention signal" during monthly tests and during emergencies. Paragraph 95 of the Report and Order indicates that retention of the tone or not making it excessively short was due to comments from a couple of organizations representing disabled persons. It was thought that the tones would catch someone's attention better than a short audio frequency shift-keyed (AFSK) chirp.

In operation

In addition, though not mentioned in the Report and Order, there are several thousand consumer receivers in operation

around the country that detect the two-tone attention signal. Continued use of the two-tone attention signal allows these receivers to continue to operate.

Currently, the two-tone attention signal provides a very limited form of message addressing. Receivers are muted unless an emergency message is sent. The EAS expands the addressability of the system.

The EAS protocol uses an audio frequency shift-keyed asynchronous data signal with one start bit (always space), eight data bits, no parity bit and one stop bit (always mark). The data is transmitted at 520.83 bits per second with a mark frequency of 2083.3 Hz and a space frequency of 1562.5 Hz. The rules do not specify tolerances on these frequencies. The asynchronous "8 none 1" is also not clearly specified in the rules. The tones

continued on page 21 ▶

Table 1. - The EAS Protocol

[PREAMBLE] ZCZC-ORG-EEE-PSSCCC + TTTT-JJJHHMM-LLLLLLLLL-
(one second pause)
[PREAMBLE] ZCZC-ORG-EEE-PSSCCC + TTTT-JJJHHMM-LLLLLLLLL-
(one second pause)
[PREAMBLE] ZCZC-ORG-EEE-PSSCCC + TTTT-JJJHHMM-LLLLLLLLL-
(one or more second pause)
(two-tone attention signal for 8 to 25 seconds)
(emergency audio programming)
[PREAMBLE] NNNN
(one second pause)
[PREAMBLE] NNNN
(one second pause)
[PREAMBLE] NNNN
(one or more second pause)

541-0201. You may also want to check the FCC's fax server at 202-418-2830.

Implementation timetable

No changes are required until July 1. However, by July 1, all existing EBS

the new EAS codes along with the shortened EBS tone.

Starting July 1, 1996, stations no longer need to maintain the existing two-tone decoders. All station alerting is done by the new EAS codes. Stations must continue to

How The Americans Make Commercial Radio Pay!

RADIO...theBOOK by Steve Warren

A fun, practical, Programming Manual and Idea Book for Program Directors and Operations Managers

PLEASE PRINT ALL INFORMATION

I would like to order _____ copies of Radio...the book @ \$35.00 ea = \$ _____ * total. (*price includes shipping)

Mastercard Visa American Express

Card Number: _____ Name: _____

Expiration Date: _____ Shipping Address: _____

Name on Card: _____

Signature: _____

Phone: _____ Fax: _____

TO ORDER BY FAX
1-800-827-9055

TO ORDER BY PHONE
1-800-827-1722

MAKE CHECKS PAYABLE TO: MOR MEDIA

Radio World
TOOLS of the TRADE

OR MAIL TO:
Radio World
Tools of the Trade
P.O. Box 1214
Falls Church, VA 22041 USA

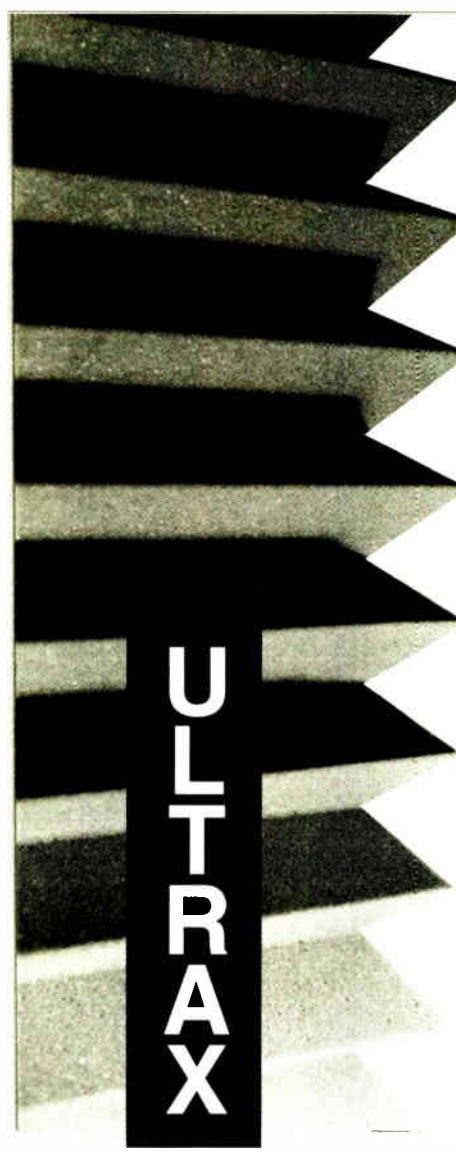

Simply the World's Best Acoustic Foam

CLIENTS: AT&T, Sony, Kodak, Ford, Hitachi, Toshiba, Universal Studios, 20th Century Fox, Maury Povich Show, Warner Bros., Rockwell, U.S. Government, Bell Research Labs, Chevron, Editel, Opryland U.S.A., Pat Duke (Voice of McDonald's, Miller Beer), UCLA, Dennis DeYoung (Styx), Baldwin, Dick Ervasti (Voice of NFL on Fox), Music Bakery, Martin Marietta, Manley Labs...

Top broadcasters, engineers and facility designers know there's no better way to absorb unwanted sound than with the highest quality foam. Ultrax from Harris Allied is that foam.

You have too much invested to let undesirable reflections ruin your monitoring, recording or broadcasting environment. Ultrax works up to 60% better than that other stuff— and it costs a lot less.

Now, you can actually afford as much acoustic foam as you need! Let us help solve your sound problems.

1-800-622-0022
Fax 317-966-0623
Southern CA 1-800-690-2828



Products & Services Showcase

For more information on the products shown below, circle the appropriate Reader Service No.(s) on the enclosed Subscription/Reader Service card or contact the advertiser directly.

SOLID STATE 2, 4 & 5 kW FM BROADCAST

POWER AMPLIFIERS

CALL 800-986-9700

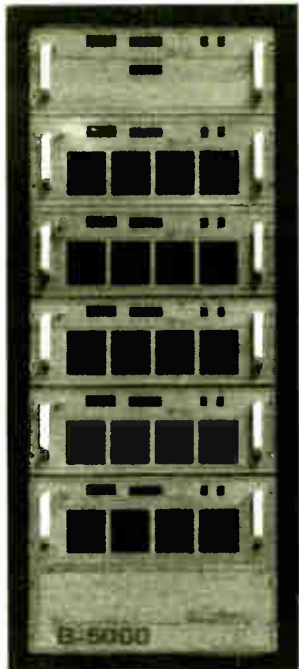

1kW INTERCHANGEABLE MODULES

2 YEAR WARRANTY

HARMONIC FILTER

5' RACK

MODEL	POWER
B-2000	1000 - 2200
B-3000	1500 - 3300
B-4000	2000 - 4400
B-5000	3000 - 5500



**Silicon Valley
POWER**
AMPLIFIERS

The RF People

800-986-9700 FAX 408-986-1438

529 FORMAN DRIVE, CAMPBELL, CA 95008

READER SERVICE NO. 160

The Circuit Werkes AC-12 Telephone Autocoupler Bay



Get up to 12 couplers in a neat, compact chassis

- Auto answer & disconnect.
- 2 audiobuses for mass feeds.
- Individually card selectable buss or auxilliary audio I/O.
- LED indicators for ring, clipping, power & online.
- Ring counter answers on user settable ring number.
- Momentary or latching dry contact outputs at pickup.
- Remove & install cards without affecting the rest.
- A special, non-bussed, balanced audio card for IFB feeds, etc., is available.

The AC-12 rack-mounted coupler bay is the best way to eliminate a wall or cabinet full of yesterday's couplers. Our unique dual audio busses eliminate the tedious and messy wiring associated with networks and other mass feeds. Each card can also individually either send or receive telco audio. Best of all, a fully loaded AC-12 lists for under \$185 per coupler.

Circuit Werkes

6212 SW 8th Place
Gainesville, Florida 32607
(904) 331-5999 / fax 331-6999

READER SERVICE NO. 82

FREE SHIPPING*

FOR OUR COAX SWITCH FAMILY



WHY SWITCH TO MCI?

- QUALITY • PRICE - 7/8" - \$2,450
- DELIVERY - 1 5/8" - \$2,800
- RELIABILITY - 3 1/8" - \$3,600
- PERFORMANCE - 4 1/16" - \$5,000
- BROADBAND - 6 1/8" - \$6,200
- COMPACT SIZE

Control Panel also available upon request.

*Continental USA-regular ground service only

For More Information Call:



MICRO COMMUNICATIONS, INC.
P.O. Box 4365 • Manchester, NH 03108-4365
Toll Free: 1-800-545-0608 • Fax: 603-624-4822

READER SERVICE NO. 168

MATCHBOX II IS BEST FOR DIGITAL

with its HI-GAIN mode for Power-Mac* and other digital editor sound cards

NEW!!



HE HENRY ENGINEERING

TEL (818) 355-3656
FAX (818) 355-0077
FAX on-Demand Doc #120 (818) 355 4210

Get MATCHBOX II to convert your Power-Mac* audio to *balanced* professional levels!

Only MATCHBOX II has *programmable gain* that's optimized for digital editor sound cards.

15,000 units in use worldwide!

- ◆ HI-GAIN mode for digital editors
- ◆ All four outputs adjustable
- ◆ Pro-grade gold-plated RCA jacks
- ◆ Over 110 dB dynamic range
- ◆ Self-contained power supply

*Power-Mac is a trademark of Apple Computer

READER SERVICE NO. 99

UNIVERSAL SCPC

XE-1000



SCPC BROADCAST AUDIO RECEIVER

New, affordable, frequency-agile receiver, direct channel entry by keyboard, selectable companding 1:1, 2:1, 3:1, wide/narrow bandwidth, de-emphasis selectable, 950-1450 MHz, line output 600 ohms, muting, transponder agile. LNB power supply, 50-channel memory, full baseband output, high-quality audio. Every needed feature at a sensible price (lowest in the industry). Write or call for full information on this quality receiver—the answer for your station. Networks call for prices.

UNIVERSAL ELECTRONICS, INC. 4555 Groves Road, Suite 12 Columbus, OH 43232
Communications Specialists Phone: (614) 866-4605 Fax: (614) 866-1201

READER SERVICE NO. 199

Radio World

Vol. 19, No 13 Radio's Best Read Newspaper June 28, 1995

Attention Advertisers!

Reach 20,000+ broadcast professionals! **Radio World's Product Showcase** provides a perfect medium for test marketing your products and services. It's an efficient, effective and affordable advertising option.

Product Showcase ads always get impressive results!

Advertise in the Product Showcase Directory!

"It Works! It's Great!"

For more information, including rates and deadlines, fax your sales representative at
1-703-998-2966
or call
1-800-336-3045

Advertising is good for business!

Look at New EAS Rules

► continued from page 19

must modulate the transmitter at least 80 percent (peak), according to 11.51(f). Many stations are not meeting the existing

currently transmitting the code. When packets are relayed, this is the only field that is changed.

NNNN is an End of Message indicator.

It can mute consumer receivers or return stations to normal programming automatically. The rules do not specify the contents of the one-second pause. It could be one second of silence, one second of normal program audio or one second of 2083.3 Hz. Paragraph 110 of the R&O refers to "unobtrusive tests" of the system where only the EAS data is sent. They estimate the tests would take about six seconds and be unintelligible to listeners. If an average alerting packet runs 58 bytes (including preamble) and each byte is 10 bits (including start and stop bits), it would take a little over a second to transmit. The End of Message packets

are considerably shorter, running 20 bytes with the preamble. These each take about 400 milliseconds. It seems that the

"unobtrusive test" would be less obtrusive if program audio were allowed in the pause periods. The data bursts would then sound something like the data bursts we currently hear on some networks for station equipment control.

Decoders must receive two identical headers (of the three transmitted) to be considered valid. This is the system error checking.

Typical tests

Stations will be required to initiate weekly tests of the system (see 11.61(a)(2)). Prior to July 1, 1996, tests include the existing attention signal and EBS test script. These tests (as existing tests) are to be conducted weekly on random days and times between 8:30 a.m. and sunset. Starting July 1, 1996, stations (except class D NCE and LPTV) are to run the "unobtrusive" tests consisting of the EAS header transmitted three times, followed by the EAS EOM transmitted three times. Stations are required to log EAS test transmissions and receptions. No audio message is required. Only the AFSK data stream is broadcast. These tests are not relayed to other stations.

Monthly tests in odd-numbered months will be run between 8:30 a.m. and sunset. Tests in even-numbered months will be run between sunset and 8:30 a.m. These tests include the EAS header, the two-tone attention signal, a test script and the EAS EOM. Broadcast stations do not originate this test, but instead relay tests that are received from other sources. The test is originated by "local or state primary sources" (such as a county or state

emergency operations center).

Stations in the originating local area or originating state are required to retransmit the test within 15 minutes of reception. Because the new system will use a web topology instead of the existing tree structure, there will be many loops, making it possible for the station to receive a message several times, each arriving over a different route. The decoder ignores subsequent identical messages, preventing continuous transmissions.

Stations pre-program their EAS decoder as to what areas and which event codes they wish to respond to. All stations must respond to EAN (national emergency) messages. On receiving a valid EAS header, the decoder displays the identifying data and notifies the operator if the header matches one of the

continued on page 22 ►

Table 2. - EAS Event Codes

EAN	National Emergency Action Notification
EAT	National Emergency Action Termination
NIC	National Information Center
NPT	National Periodic Test
RMT	Required Monthly Test
RWT	Required Weekly Test
TOA	Tornado Watch
TOR	Tornado Warning
SVA	Severe Thunderstorm Watch
SVR	Severe Thunderstorm Warning
SVS	Severe Weather Statement
SPS	Special Weather Statement
FFA	Flash Flood Watch
FFW	Flash Flood Warning
FFS	Flash Flood Statement
FLA	Flood Watch
FLW	Flood Warning
FLS	Flood Statement
WSA	Winter Storm Watch
WSW	Winter Storm Warning
BZW	Blizzard Warning
HWA	High Wind Watch
HWW	High Wind Warning
HUA	Hurricane Watch
HUW	Hurricane Warning
HLS	Hurricane Statement
TSA	Tsunami Watch
TSW	Tsunami Warning
EVI	Evacuate Immediate
CEM	Civil Emergency Message
DMO	Practice/Demo Warning
ADR	Administrative Message

modulation requirements because of the manner in which their audio processing equipment handles the tones.

As shown in Table 1, each data packet starts with a preamble (16 bytes of hex AB). It is followed by a string of ASCII characters (with the most significant bit a zero or space). The "ZCZC" is sent as a four-character ASCII sequence. It is a "start-of-message" flag.

Identifiers

ORG is a three-character identifier indicating who originated the activation of the EAS. Only five ORG codes are assigned. These are EAN (Emergency Action Notification network of program networks and suppliers for a national alert), PEP (Primary Entry Point, key broadcast stations which can provide national emergency information if EAN fails), WXR (National Weather Service), CIV (civil authorities, such as EAS activations by state or county governments), and EAS (Emergency Alert System activations by broadcast or cable systems).

EEE is a three-character "event code" that identifies the type of emergency. These are listed in Table 2.

PSSCCC defines the location of the emergency. Each state is assigned a number (SS). Each county is assigned a number (CCC). If the CCC is 000, the emergency covers the whole state. P is 0 if the emergency covers the whole county. P can be a number 1 through 9 to cover nine portions of a county (generally scanning west to east, north to south).

TTTT defines the valid duration of the emergency in HHMM format with 15-minute resolution below one hour, then 30-minute resolution.

JJJHHMM defines the time the message was originally released. JJJ is a three-digit number representing the day of year (1 January is 001). HHMM is the time in UTC (the old GMT). The use of UTC was selected since emergency messages may cross time zones.

LLLLLLLL is the identity of the station

For the world's strongest AM transmitters, look to Nautel

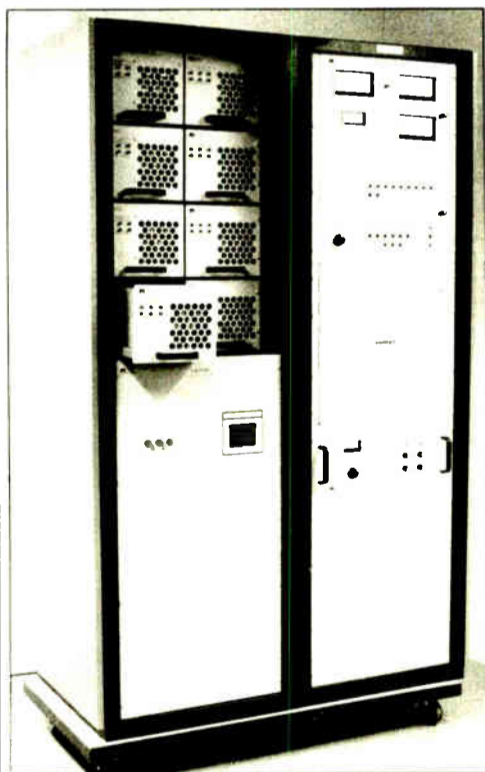

Totally solid state AMPFET ND 10 10kW AM

Nautel AM transmitters keep you on the air with an unmatched combination of value, performance and reliability

Low cost of ownership - with typical efficiency ratings up to 80 percent, a totally solid state Nautel transmitter pays for itself in tube replacement and utility

Superior audio transparency - Nautel AM transmitters utilize inherently linear digital Pulse Duration Modulation for the cleanest sound you can broadcast. Audio is ruler-flat throughout the range and distortion is typically less than 0.5%

Field-proven reliability - Nautel transmitters give you multiple protection systems for both power line and lighting transients, VSWR protection, soft failure design, reserve cooling and safe on-air servicing

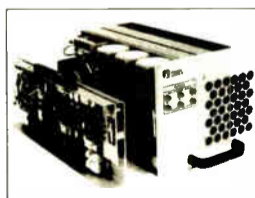

Removable AM Power Module

Make a strong transmitter choice. Call us today for all the facts on our totally solid state AM and FM transmitters.



Nautel Maine Inc.
201 Target Industrial Circle
Bangor, Maine 04401 USA
Phone: (902) 823-2233

Nautel
(Nautel Electronic Laboratories Limited)
R.R. #1, Tantallon, Halifax County,
Nova Scotia, Canada B0J 3J0
Fax: (902) 823-3183

Circle (84) On Reader Service Card
World Radio History

SINE SYSTEMS

Innovative Solutions

Walkaway Specialist:

- EBS Compliance Tools
- Remote Transmitter Control & Monitoring
- Dial-up Remote Broadcast
- Program Automation Accessories & Studio Aids

Feature Product

DAI-1

The DAI-1 Dial-Up Audio Interface provides an array of features unparalleled in the industry. It combines an autocoiler, a dial-out alarm, two AGCs, a DTMF operated equipment controller and an audio switcher into one affordably priced device. It is commonly used as a tool for "walkaway" EBS compliance. Another popular application is to allow "dial-up" remote broadcasts when the studios are unmanned. The DAI-RP provides a space to rack-mount the DAI-1, a power supply, a screw terminal interface module and five general-purpose relays for equipment control and audio switching. The optional DB-1 50 millisecond delay board prevents DTMF tones getting on the air. The optional CI-1 Composite Insertion Module is available for use when discrete audio is unavailable.

For more information on this or any other quality-built Sine Systems products, contact your favorite broadcast equipment supplier or call "Sine" any time. Also, try our 24 hour Fax-on-Demand line.

www.913.258.0000
Fax: 913.257.2307
Free On Demand: 813.257.2303

FAX-ON-DEMAND

972 Main Street
Nashville, TN 37208-0614

Circle (112) On Reader Service Card

Look at New EAS Rules

► continued from page 21

stored emergency types. The decoder records up to two minutes of emergency programming followed by the EAS EOM. The operator may then relay the message using the received EAS header information and the recorded emergency audio. If necessary, the emergency programming may be translated to another language for that station's audience.

It seems that local EAS plans should be set up to either include separate distribution webs for each language spoken in an area (and broadcast), or a single web that could be used with the emergency operations center giving the emergency instructions in several languages sequentially (like the announcements in airports).

Automation

The new system has many features making automation possible. It still has a few requirements disallowing automation (such as the required check of the Authenticator Word List in 11.54(a)(2)), but I expect further refinement of the system to make automation feasible. This, combined with the proposed reduction in operator requirements (discussed last month) would allow unattended operation of broadcast stations.

I see the EAS as a web of nodes, all interconnected by several communica-

tions paths. National, state and local emergency agencies have several entry points to the web. A county emergency operations center might have an EAS encoder driving phone lines or a county radio system driving the EAS decoders at several stations in the area. When an emergency occurs, the emergency official could push a button on a map of the county identifying which area(s) require notification. She/he would then push a button marked "Evacuate Immediate" (or other event code) and wait for the "green light". The green light would be lit after the three EAS headers and the two-tone attention signal are sent. The official would then give the emergency instructions and push the EOM button. This audio (AFSK data stream, attention signal and voice announcement) would be sent to several stations in the area. Stations that have programmed their EAS systems for this area and event type would immediately broadcast the EAS codes (regenerating them, substituting their own call letters) followed by the attention signal, the emergency audio and the EAS EOM.

Because it takes time to fully decode the EAS data stream and regenerate it, it is necessary to buffer the audio. The new EAS systems will include a two-minute (minimum) audio storage. Other stations monitoring this station will similarly receive the

EAS data stream and rebroadcast it. The "immediate" retransmission is required only for national (EAN) messages.

State and local messages may be delayed up to 15 minutes (see 11.51(k)(2)). It appears that EAS systems could be designed to interface with program automation systems to run the emergency message during the next break, avoiding

keyboard that are used to program the system and display information pulled from received EAS headers.

The systems will also have a serial data port to relay EAS data to and receive EAS data from non-audio circuits (digital data circuits, RBDS encoder/decoder, etc.). It appears (based on 11.32(a)(2), 11.32(a)(3), and 11.32(a)(1)) that the

Stations in the originating local area or originating state are required to retransmit the test within 15 minutes of reception.

program interruption. This, however, seems to add unnecessary complexity. If the use of EAS is indeed reserved for true emergencies, it appears immediate retransmission is appropriate.

Although the Report and Order recognizes the possibility of manufacturing separate encoders and decoders, I suspect most units will be integrated. This vastly simplifies the interface requirements when the system must automatically relay an emergency message. So, here is what I see as the new EBS box.

New hardware

An "integrated" EAS unit would be required to have at least two audio inputs. These would monitor other EAS sources, such as other broadcast stations, state and local emergency communications circuits, weather service radios, etc. A state EAS plan provides the monitoring assignments for each station. The topology is designed to provide several paths from an originating point to all participants so a failure at any one point does not disrupt the system.

I would suggest a "program loop-through" similar to many existing EBS systems. The loop-through should be designed to consider the varieties of program transmission methods. At a minimum, I would suggest a way of handling balanced stereo audio and composite stereo. On receiving appropriate EAS codes, the system would drop whatever audio is being passed through and substitute its audio (the EAS tones, attention signal, time delayed emergency program, EAS EOM), then return to normal audio.

The system will have a display and

EAS systems do a speed conversion from 520.83 bps used over audio channels to 1200 bps for digital circuits.

Vast improvement

The new system appears to be a vast improvement over the existing EBS. This is the third EBS system I have worked with, starting with the old 1 kHz tone and carrier drops (which typically tripped breakers on our old transmitter). The addressability, web network structure and features that allow for automation look very good. There are still a few things to be worked out, and some room for additional features.

I would like to see the EAS protocol expanded a bit to allow a plain text packet between the header and EOM packets. The packet could also include a language identification code. An emergency operations center could then generate a text message along with a voice emergency announcement. This text message could be relayed to RBDS receivers, electronic billboards, television stations and CATV systems where a voice announcement may not be appropriate.

Once again, I invite you to read the Report and Order yourself. It is available via Internet or fax, as described above.

□ □ □

Harold Hallikainen is president of Hallikainen and Friends, a manufacturer of transmitter control and telemetry systems. He also teaches electronics at Cuesta College, San Luis Obispo, and is doing lots of contra dancing. He can be reached at 805-541-0200; fax: 805-541-0201. He can also be reached on Internet at ap621@cleveland.freenet.edu.

TRANSMISSION SOLUTIONS

Nearly 500 Broadcasters
Have Found That Harris DX Transmitters
Practically Pay for Themselves.

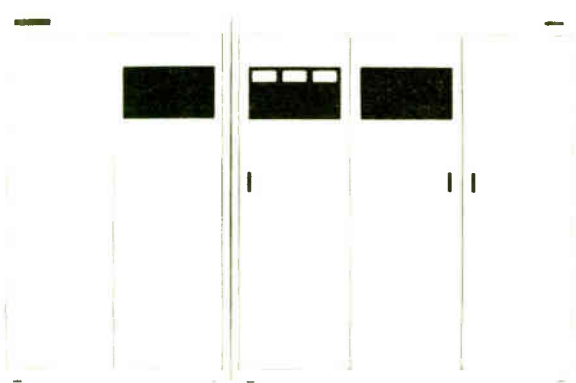

With typical AC to RF efficiency of 85% or better and the lowest life cycle operating cost of any AM transmitters. From 10 kW through 2 MW. To learn how a Harris DX transmitter can increase your profits, please contact our radio sales department by fax (217-224-1439) or by phone:

217-222-8200

**HARRIS
ALLIED**

P.O. BOX 4290 • QUINCY, IL 62305-4290

©Harris Corporation 1994

Circle (170) On Reader Service Card

BIG...RICH...FULL DIMENSION CONCERT SOUND

The CP2013 is the only composite processor with a fast, peak responding AGC. *Why?* Because most AGC amplifiers are too "envelope destructive" to be used this way.

The Benefits?

- Incredible spatial effect due to enhanced L-R
- Eliminates excessive subsonic energy
- Much cleaner than conventional composite clippers
- 1.5dB louder, due to low second harmonic clipper, converts "would be" distortion into useful modulation.



COMPROC CP-2013

Other features include two composite outputs, and a new zero phase shift pilot feed-through circuit requiring no setup.

BIG SOUND...MEANS BIG NUMBERS

CALL NOW!!

HINAT HINDES inc

42 Elaine St., Thompson CT 06277
203-935-9066 or 203-935-9242
FAX: 203-935-9919

Circle (200) On Reader Service Card

out there



on the CUTTINGEDGE



don't be afraid of **market dominance**

unity 2000i fm & unity am
broadcast processors



CUTTINGEDGE

2101 SUPERIOR AVENUE • CLEVELAND, OHIO 44114 • TEL: (216) 241-3343 • FAX: (216) 241-4103

Circle (8) On Reader Service Card
World Radio History

Why is DIGILINK the Hard Disk System fo

Because ...

- **Over 1,000 Workstations have been sold**
Customers come back again and again !
- **Digilink replaces ALL tape equipment- carts, reels, etc.**
use it for Live On Air, Production, and Automation !
- **Digilink saves money every day**
No carts to lose, jam, or destroy
No routine maintenance, no heads to adjust, no cleaning
No carts to replace when a hard disk lasts an average 15 years
No reel tape to replace because you cut & splice electronically
- **Digilink costs less than tape equipment.**
The average Digilink with 10 hours of stereo storage is under \$8,000
The \$8,000 list price includes 600 one minute carts worth of storage
That means a Digilink is a \$5,500 machine with \$2,500 in media
- **Our Gemini Live On Air pushbutton control puts carts at your fingertips**
for fast On Air operation, every jock can even have his own set of carts
- **Digilink performs 8 channel multitrack editing for under \$2,000 !**
-or- use our stand alone Trak*Star multitrak Editor for under \$6,000 !
The only multitrack radio editor that can provide 100% On Air backup !
- **Network News, Production, Air, and even Traffic... over 15 studios !**
to transfer audio, text, & schedules in perfect digital on our network



DIGILINK

Hard Disk Digital Audio Workstations

#1 Selling for Radio ?

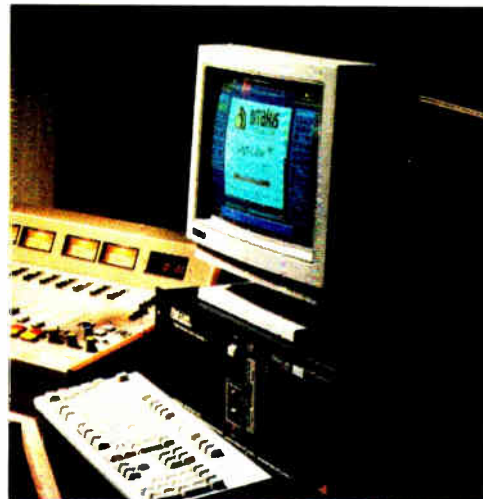

We are #1, because we are leading the way...

With over 1,000 workstations sold, Digilink is by far the #1 digital audio system for live On Air radio, Production, and Automation. Digilink has achieved this unique success because it is easier to use, does much more, and costs less than any other digital product on the market today.

Digilink does more than other systems because of its abilities in On Air with live, CD, & satellite; in production with its multitrack editor; and in news with text. This makes it so that a Digilink workstation can be placed in each studio of your station to replace cart machines, reel machines, CD players, and often even consoles. At an average price of under \$8,000 per studio, Digilink is actually less expensive than the tape equipment that it replaces while giving you CD quality audio performance, an average media life of over 15 years, and equipment that requires no routine maintenance. You can even create a digital highway around your station by connecting all of your Digilink workstations and scheduling computers on our digital network to transfer audio, text, and schedules in perfect digital between studios.

With its ability to *simultaneously* record, play, crossfade, and network transfer, a single Digilink workstation can do all that is required for recording and playback for an entire studio. It is literally a studio in a box. It can be crossfading out of a CD into a hard disk song, dropping a hard disk jingle over the middle of the crossfade, recording a network audio feed for later playback, and receiving a new spot over the network from the production workstation. Digilink is the complete digital solution to your radio station's studio needs.

To create a *professional* digital broadcast solution you can't simply buy a digital audio board and IBM PC computer. Therefore, Arrakis builds our own DSP board; SCSI board; I-O board; audio routing switchers; video switchers; and modular, broadcast quality cabinets. This makes Digilink remarkably powerful with radio specific features such as digital crossfade and Trak*Star multitrack editing. This also reduces cost so that we are able to sell Digilink for as little as 1/2 the price of other products which have to buy less powerful cards and mark them up. Perhaps most importantly, building Digilink ourselves assures you of long term customer support from a single *broadcast* source. With Digilink, you don't have to be a computer expert, because we are.

Whatever your studio needs- to replace a cart machine, add a new production studio, or add some level of automation, Digilink can do the job. Put a Digilink in one studio today, another next year, add a scheduling computer and network, and you will eventually discover that you have painlessly gone digital one step at a time. There is no question that Digital audio is here *TODAY*- it improves your sound, speeds your production, increases your reliability, and reduces your costs. Call and find out why Digilink is #1 and why customers come back again and again: customers like the United States Air Force who have selected Arrakis Digilink, consoles, and furniture for all of their radio stations worldwide.

for more information call... (303) 224-2248

arrakis
SYSTEMS INC.

2619 Midpoint Drive, Fort Collins, CO. 80525
Voice- 303-224-2248, Fax- 303-493-1076

STATION SKETCHES

Finer Points of House Monitor Systems

by Tom Vernon

HARRISBURG, Pa. A good house monitor system should be an essential component of any radio station. Older systems often evolve into a nightmare of intermittent L pads and randomized series/parallel speaker combinations that almost work, while some newer systems feed off-air audio through the zone page speakers of the phone system. While the latter is convenient, the audio quality of two-inch speakers in plastic enclosures is not exactly awe-inspiring.

This month's discussion will focus on

how to design and build a reliable house monitor using a constant-voltage distribution system.

First requirement

Your first need is for a stable source of uninterrupted off-air audio. The best choice is a fixed-tuned receiver with a good outside antenna. Older analog tuners can drift off frequency and are easily tampered with. Newer digital tuners will default to who-knows-what after a power failure. Modulation monitor feeds may subject the station to ear-splitting tones and periods of silence whenever the

monitor is calibrated. At best, you may be able to modify the monitor so that the audio feed is disconnected when calibration tones are present.

The amplifier must have a suitable power rating for the number of speakers that are being driven. Although any amp will do, make life easy on yourself and purchase one that has its output set up for a 70.7 V system. Do not forget to leave some reserve for future expansion. For a small system with seven or eight speakers, an amp with 20-30 W RMS output should do nicely.

To be more scientific, the amplifier

should be able to put out about 1 1/2-times the power of the speakers connected. Thus, if the sum of the speakers is 25 W, the amplifier should be capable of producing 37.5 W.

The easiest way to handle audio distribution from the monitor amp is with a constant voltage distribution system. Some of the most common volt arrangements are 70.7 and 25. This concept confuses some people, because we usually match impedance in ohms, and 70.7 V transformers have their primaries specified in watts. Fear not, there is a logic to this system.

Back to basics

Getting back to basics, the source impedance of a transformer may be calculated as follows:

$$Z = E^2/W$$

where: Z=impedance
E=voltage
W=watts

For a 70.7 V system, it looks like this:

$$Z = \frac{70.7 \times 70.7}{W}$$

Rounding off the voltage figure:

$$Z = \frac{5000}{W}$$

Thus, for a 20 W amplifier, we would have an impedance (Z) of 250 ohms. The

Table 1.

A listing of output powers and their corresponding impedance taps for 70.7 volt systems. All figures are derived from the formula $Z = 5,000/W$.

POWER OUTPUT (WATTS)	IMPEDANCE TAP FOR 70.7 VOLT LINES
5	1,000
10	500
15	333
20	250
25	200
30	166
40	125
50	100
60	83
80	62.5
100	50

flexibility of a constant voltage system comes from the many ways we can split up this 250-ohm load. Figure 1 illustrates a simple system with four 5 W speakers, and shows its equivalent circuit. Referring back to Table 1, 5 W corresponds to 1000 ohms. Four parallel 1000 ohm transformers present a load of 250 ohms to the amplifier. Alternately, larger rooms may be assigned speakers with higher power specifications.

In summary

To summarize, each speaker must have its own line-matching transformer, and all transformers are connected in parallel to the amplifier. The sum of the transformer primary power ratings must equal the output power of the amplifier, no more, no less.

It is often desirable to have individual
continued on page 28 ►

Who says it's lonely at the top...



For 25 years we've helped set industry standards. Thanks to you, we're the driving force behind EAS!

A Long History of Leadership

25 years ago, TFT developed the first practical, off-air modulation monitors. When TV stereo was born, we developed the first BTSC aural modulation monitor. We pioneered the FM synchronized booster system. We introduced the only digital STL that accommodates additional subcarriers.

For 25 years we've listened to our loyal customers, and together we've helped set the standards for an industry. Now we're at it again. This time we've got a jump on EAS, the new Emergency Alert System.



Low cost, easy EAS

As one of the originators of the EBS standards back in '75, TFT has been the major force behind EAS. We've put our new low cost, easy EAS encoders and decoders through the FCC field tests in Denver and Baltimore, worked with government agencies and customers, and now we're ready for broadcasters and cablecasters. And we're here to help you with a low cost, easy transition!

We're ready to supply the broadcast & cable industries with low cost, easy-to-use, encoders & decoders.



TFT INC

Sound Quality for Over 25 Years!

3090 Oakmead Village Drive, Santa Clara, CA 95051-0862
Phone: (800) 347-3383 (408) 727-7272 Fax: (408) 727-5942

Call TFT Today for Your FREE Primer on EAS

For years folks have relied on us for direction into the future. And again we're here to help. We've put together a comprehensive Primer on the new Emergency Alert System. You'll learn about FCC rules & regulations, equipment descriptions, implementation, and application diagrams. It's all yours FREE for the asking. Call or fax TFT now, and we'll send the info you need on the new EAS. 1-800-347-3383

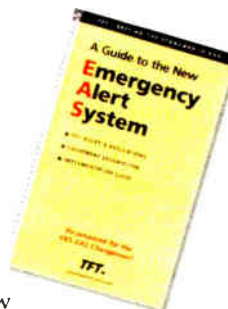



**BSW is proud to announce
the return of the legendary
Sennheiser HD414 headphone.
This special limited edition,
in honor of Sennheisers 50th
anniversary, is now available
from BSW.**

**only \$59.95
while supplies last!**

Equipment Solutions To Keep You Number One

BSW[®]

BROADCAST SUPPLY WORLDWIDE

7012 27th Street West
Tacoma, WA 98466 USA

Call Now!!

800 . 426 . 8434

Fax: 800 . 231 . 7055

House Monitor System

► continued from page 26

volume controls for each speaker location. There are two ways to do this: with a 10-ohm pot connected as a voltage divider between transformer secondary and speaker, or with an 8-ohm T or L pad. The voltage divider mismatches the transformer somewhat at extremes of its rotation, while T and L pads often become scratchy and end up being a maintenance chore.

When installing a house monitor system, take care not to create a future nightmare. Wiring speakers with phone wire or small gauge shielded pair is not a good idea. Use 16-gauge speaker wire, solder all connections and be sure to leave service loops behind speakers so

that subsequent maintenance is not a hassle. Do yourself or your successor a favor and create some written documentation while the details of the project are fresh in your mind.

House monitor systems are often neglected in favor of higher priority projects. With care in planning and installation, however the house monitor can reliably deliver your off-air signal throughout the station, and need not be a source of constant aggravation.

□ □ □

Tom Vernon is completing a Ph.D. at the University of Pennsylvania in Philadelphia. His radio home is the university's public station, WXPN-FM. Tom may be reached at 717-367-5595.

Figure 1.

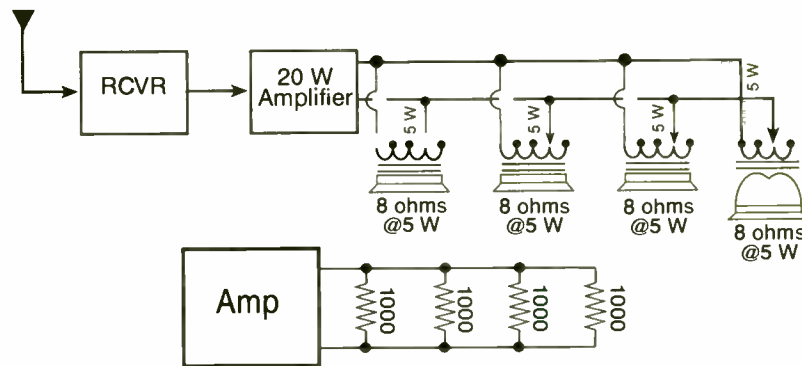

Fig. 1. 70.7 V house monitor system with 20 W amplifier, and its equivalent circuit. As long as the transformer primaries add up to 20 W, any combination of power levels may be selected.

Products & Services Showcase

For more information on the products shown below, circle the appropriate Reader Service No.(s) on the enclosed Subscription/Reader Service card or contact the advertiser directly.

ARE YOU LOOKING FOR A COST EFFECTIVE ALTERNATIVE TO MANUFACTURER SERVICE?

SERVICE, REPAIR & CALIBRATION

- STL's • RPU's • TSL's
- Exciters • AM/FM Broadcast Monitors • Remote Control Systems

SPECIALIZING IN EQUIPMENT BY

- Belar • Marti • Moseley • McMartin
- TFT • And others...

► An authorized TFT service center ◀

IN CASE OF EMERGENCY

We can help get you back on the air with our STL Loaner Program. We have STL's available that will be set to your frequency prior to shipping. We also provide over-the-phone technical assistance.



2198 Hubbard Lane, Grants Pass, OR 97527

(503) 471-2262

READER SERVICE NO. 89

Shape Up!

Coverage. Saturation. DBk contours. In FM broadcasting, the "bottom line" is always based on your pattern.

More than any other manufacturer, Shively has the experience and reputation for providing crucial pattern solutions for critical propagation problems. On any tower. At any power level. Remember, **it pays to be heard.**

A good pattern. The shape you need. Talk to your consultant. And contact us.

Shively Labs

A Division of Howell Laboratories, Inc.

19 Harrison Road, Bridgton, ME 04009
207-647-3327 FAX 207-647-8273

READER SERVICE NO. 113



Econco REBUILT POWER TUBES



Approximately One Half the Cost of New

3,000 Hour Unconditional Guarantee

Call for Our Price List

Econco 1318 Commerce Ave. Woodland, CA 95695
Phone: 916-662-7553 Fax: 916-666-7760 Telex: 176756
Toll Free: 800-532-6626 From Canada: 800-848-8841

READER SERVICE NO. 177

Attention Advertisers!

Reach 20,000+ broadcasting professionals! RADIO WORLD's Product Showcase provides a perfect medium for test marketing your products and services. It's an efficient, effective and affordable advertising option! For more information, including rates and deadlines, fax your sales representative at

1-703-998-2966

or call

1-800-336-3045

Emph'asize it!



WITH THE

Emph'asizer™ AUDIO PROCESSOR

- DJ Personality Processor
- Production Tape Processor
- Phone Line EQ and Noise Suppressor
- Room Equalizer and Gated Mike Control
- Gated Recovery Compressor
- Four Parametric Equalizers
- Unobtrusive Background Noise Gate
- Mike and Line Level Inputs and Outputs

CALL OR WRITE FOR A FREE DETAILED BROCHURE.



AUDIO (215) 443-0330
TECHNOLOGIES (215) 443-0394
INCORPORATED (800) 959-0307

328 W. Maple Ave., Horsham, PA 19044, USA

READER SERVICE NO. 16

EVEN THE BEST CAN BE MADE BETTER

Introducing the new

MINI-MIX 12A

THE COMPACT MIXER WITH A COMPACT PRICE FROM THE QUALITY LEADER

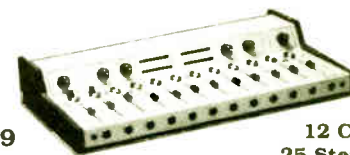

\$3499

12 Channels
25 Stereo Inputs

Service & Affordable Quality for Over 23 Years

AUTOCGRAM CORPORATION

1500 Capital Avenue (214) 424-8585
Plano Texas 75074-8118 1-800-327-6901

FAX (214) 423-6334

READER SERVICE NO. 71

Products & Services Showcase

For more information on the products shown below, circle the appropriate Reader Service No.(s) on the enclosed Subscription/Reader Service card or contact the advertiser directly.

VACUUM & GAS CAPACITORS



Over 800 Capacitor Models

Voltage Ratings to 100 kv
Variable & Fixed
Vacuum & Gas
Unlimited Capabilities

Applications: Communications, Power, Electronic, Semi-Conductor Fab, Dielectric Heating Equipment, & Medical MRI & Heart Defibrillators. Ask about our vacuum & gas relays & other components.

JOSLYN JENNINGS CORP.

Phone: (408) 292-4025 Fax: (408) 286-1789

Request a *FRLE* catalog

READER SERVICE NO. 145

TWO NEW ADDITIONS TO THE COAXIAL DYNAMICS WATTCHMAN® TRANSMITTER PROTECTION SYSTEMS

Models 81081 and 81082 with 15/30/60 kw Meter Scales

NEW!
4-1/16 and 6-1/8 series line sections and elements to add to our exciting line-up



WATTCHMAN—protects your transmitter and transmission line system. A permanent 19 inch rack installation used with any dual socket line section 7/8", 1-5/8", 3-1/8" and elements (additional) to monitor CW, TV, and FM power. Model 81070 features two easily read meters to monitor both forward and reflected power. The reflected meter provides a front panel adjustable set point which controls the trip level for fast transmitter shut down and alarm. Abnormal load conditions quickly cause transmitter shut down in less than 15 milliseconds including control relay. Both visual and audible alarms indicate system malfunction. Contacts provided for remote alarm and reset switching. Contact us for your nearest authorized Coaxial Dynamics Representative or Distributor in our World Wide Sales Network.



COAXIAL DYNAMICS, INC.

15210 Industrial Parkway • Cleveland, Ohio 44135
(216) 267-2233 or 1-800-COAXIAL • Fax: (216) 267-3142
Service and Dependability... A Part of Every Product

READER SERVICE NO. 59

PROGRAM • ABILITY

Programmable Digital Remote Control.

What others promise. Hallikainen & Friends delivers to your exact specs with the DRC 190. With its extended BASIC language, the DRC 190 can control, alarm, display and log measured and calculated system parameters. Typical installations also generate a daily report showing the minimum, maximum and average of each parameter, simplifying oversight of the system. For true flexibility of user control over evolving equipment demands, get with the program, get the DRC 190.

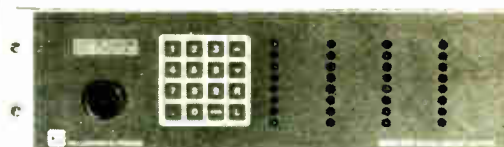

PROGRAMMABLE EXPANDABLE AFFORDABLE DRC 190

HALLIKAINEN & FRIENDS

141 Suburban E4, San Luis Obispo, CA 93401-7590 USA

805-541-0200

READER SERVICE NO. 76

Three's Company, Not a Crowd with RDL Rack-Ups™!

Compact tools to make your job easier. Three of these IHF-Pro Interfaces ... audio or video DAs ... Mic Preamps ... Line Amps ... Audio Meters ... and/or Video Attenuators fit in one rack space! All feature advanced circuitry and great specs ... plus reliability that's backed by a THREE YEAR Warranty! There are 9 **RACK-UP™** audio and video tools from RDL™. Call us today at 800 281-2683 or 805 684-5415 for your free catalog to see which ones you need to solve your problems!

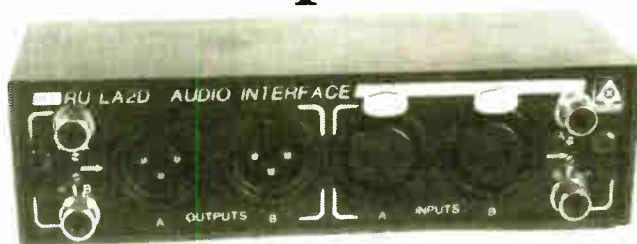

RDL Radio Design Labs

P.O. Box 1286 ■ Carpinteria, CA 93014

In Europe call (31) 20-6238 983 Fax (31) 20-6225 287

© Radio Design Labs

READER SERVICE NO. 91

Excalibur Electronics CDA-1

Composite Distribution Amplifier



This 1 in, 3 out distribution amplifier allows you to distribute stereo composite and/or subcarrier signals as easily as audio.

- ◆ DC-100 kHz frequency response
- ◆ 90 dB signal/noise ratio
- ◆ +6 dB to -20 dB gain range
- ◆ Individual 20-turn output trimmers
- ◆ 1 1/4" rack mount enclosure

EXCALIBUR ELECTRONICS, INC., CHANTILLY, VIRGINIA

Please circle our bingo number for a data sheet and a dealer list.

READER SERVICE NO. 30

Call MYAT For Rigid Line & Components

Facing a "right now" emergency? Planning a new installation? Upgrading your facility? Whatever the need, MYAT is the solution. MYAT products are quality-built for maximum performance and long life. And we take delivery commitments seriously.

Call your favorite RF distributor or MYAT direct at 201-767-5380, or fax 201-767-4147 for our complete catalog and reference guide.



380 Chestnut St

P.O. Box 425

Norwood, NJ

0 7 6 4 8

READER SERVICE NO. 191

World Radio History

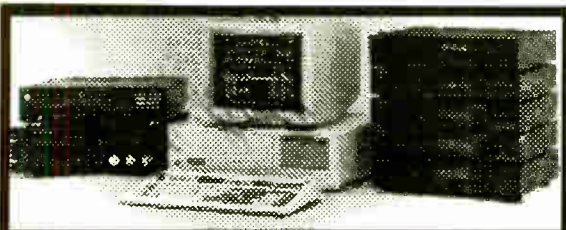

DIGITAL ON-AIR SOLUTIONS

- Feature Rich Live Assist and Walk Away
- On-Line Redundancy...No Black Box
- The Best Integrated Play List Scheduler (Music & Breaks) & On-Air Playback
- Dolby AC2 Overlapping Hard Disk Audio
- Music on Hard Disk and/or CD Jukeboxes
- Provide Computers/Players & Save \$\$\$ or Buy/Lease From Us

WEST/INT'L
310/670-7500
FAX 310/670-0133

EAST
803/370-2400
FAX 803/370-2314

READER SERVICE NO. 45

Building Simple Balanced Circuits

by Jim Somich

BROADVIEW HEIGHTS, Ohio In recent columns, I covered the basic concept of cookbook circuit design and showed examples of the two most common audio op-amp circuits: the non-inverting stage and the inverting stage.

These stages are referred to as voltage amplifiers. They are used in applications where it is not necessary to deliver large amounts of power (voltage and current) to a load. It is relatively simple to extend our cookbook approach to designing simple output stages that can supply considerable power to either

headphones or loudspeakers.

This month I will also show you how to construct simple balanced input and output stages using op-amps. These electronically-balanced circuits can be used in place of audio input and output transformers in most circuits at a substantial reduction in cost. Armed with these simple cookbook circuits, you will be able to design many of your own small audio projects.

Supply power

Figure 1 is the schematic for a non-inverting voltage amplifier stage, such as I discussed last month, driving a push-

pull Class-B Darlington power transistor output stage. Note that feedback is taken after the Darlington. A Darlington power

pins and a case connection) they look like conventional bi-polar junction transistors. Power Darlington offers higher input resistance and current gain than individual transistors.

Most op-amps are ill-equipped to deliver substantial power to a load with-

With simple cookbook circuits, you will be able to design many of your own small audio projects.

transistor consists of two bi-polar power transistors on a single chip. The transistors are DC-coupled internally as emitter followers. Because they are packaged in discrete cases with three pins (or two

out performance degradation, but the addition of a simple Darlington output stage turns the common voltage amplifier into an op-amp power amplifier. A power amplifier can deliver both voltage and current to a load. This is the best way to configure an operational amplifier to drive a loudspeaker or headphones.

The Darlington pair shown in Figure 1 is a Motorola MJ1001 (NPN) and MJ901 (PNP). This pair has a maximum power dissipation rating of 70 W and a collector breakdown voltage of 80 V. They will withstand a constant collector current (I_c) of 10 amps! In practice you should not exceed 65 to 75 percent of these ratings. This would translate into a maximum collector voltage of 50 V.

In the real world, I would run this pair off a bi-polar 30 V, allowing a lot of headroom. In this circuit configuration, they will deliver 15 to 25 W of clean power to a 4-ohm load.

Too hot?

If you try to push this pair to full dissipation, they will get quite warm. Be sure to use adequate heat-sinking. My cook-

CELEBRATE RADIO'S 75TH ANNIVERSARY AS YOU PREPARE FOR THE FUTURE!

Join the industry's best at The NAB Radio Show and find real solutions to real problems. You'll address the issues of today and discover the tools needed to ensure your future success. From technological issues, new revenue streams and duopolies to creative leadership techniques and regulatory issues—**there is something here for everyone on your staff!**

Take part in an intense one day Digital Radio Seminar, a must for GM's, engineers, operations managers and group operators, and hear expert advice and solutions to prepare your radio facilities for the digital age without wasting assets on unproven technologies. A special emphasis will be placed on the first public release of DAB test data.

Management sessions will help you achieve maximum results from your station and staff; programmers will learn ways to improve listener loyalty and market share; and sales and marketing professionals will benefit from RAB's high-energy sales & marketing sessions.



RADIO THE NAB SHOW

SEPTEMBER 6-9, 1995
EXHIBITS: SEPTEMBER 7-9, 1995
New Orleans Convention Center
• New Orleans, Louisiana, USA •



DON'T MISS THESE NAB RADIO SHOW HIGHLIGHTS...

- Mel Karmazin and Lowry Mays, CEO's of two of the world's largest, most influential radio groups, explore "Radio: Today's Trends, Tomorrow's Opportunities."



- At the NAB Radio Luncheon Ben Cohen and Jerry Greenfield of Ben & Jerry's Ice Cream share their



secrets to success and Nancy Widmann, President of CBS Radio, receives the National Radio Award.

- "Opportunity '95 the Complete Radio Job Fair" provides managers and owners with an opportunity to meet qualified individuals seeking careers in radio.

- Join FCC Chairman Reed Hundt at the Friday morning FCC Chairman's Breakfast and meet Commissioners James Quello and Susan Ness,



staff, as they take part in a variety of regulatory sessions.

- Celebrate everything that makes radio great today at the NAB MARCONI Radio Awards Dinner & Show. Entertainment provided by Premiere Radio Networks.



- "Radio: Profiting From Technology in the '90s." In an exciting FREE session for all World Media Expo and NAB Radio Show attendees, Dr. John D. Abel, NAB's Executive Vice President of Operations, will show you, through entertaining demonstrations, how innovations like data broadcasting, the Internet, the World Wide Web, digital compression and other exciting opportunities made possible by digital technologies can impact your business and your bottom line.



book rule of thumb is: If you cannot touch the device for more than 10 or 15 seconds, it is running too hot!

Circuit modifications could include an output coupling capacitor to block DC from the output. Make sure the cap is large enough that you do not start to roll off low frequencies. Large polarized electrolytics work fine. You might also consider an in-line 1 or 2 amp fuse, such as a 3 AG, that will (hopefully) blow before your speaker or phones.

There are dozens of Darlington pairs listed in the data books. I am only using this pair as an example. The beauty of cookbook designing is that you can use what you have on hand or what you can easily acquire. Just remember to watch the maximum collector voltage rating and use adequate heat sinking.

Op-amps are, inherently, differential
continued on next page ►

WORLD MEDIA EXPO '95

SEPTEMBER 6-9, 1995
Exhibits: September 7-9, 1995
New Orleans Convention Center
New Orleans, Louisiana, USA

DISCOVER INNOVATIVE PRODUCTS & SERVICES

By registering for The NAB Radio Show, you'll also have free access to World Media Expo, featuring over 400 of the world's leading suppliers and manufacturers of products and services for broadcasting, communications, and production/post-production. Don't wait until NAB '96 to see the latest products and services—Register Today!

YES! Please send me information on The NAB Radio Show and World Media Expo!

Name _____ Title _____
Company _____ Call Letters _____ AM FM
Address _____
City, State, Zip Country _____
Phone _____ Fax _____
E-Mail Address _____ E-Mail Service _____

FAX THIS COMPLETED FORM TO: (202) 429-5343

RW

You can also receive information from:

Fax-on-Demand—dial (301) 216-1847 from the touch-tone handset of your fax machine and follow voice instructions.

World Wide Web—<http://www.nab.org>

To speak with an NAB staff member call (800) 342-2460 or (202) 775-4970.

To learn more about exhibiting at World Media Expo, call (202) 775-4988.

Figure 1.

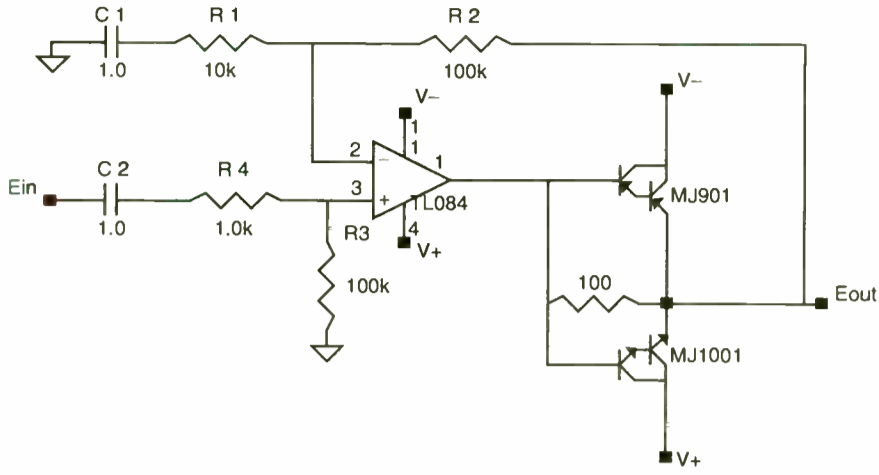
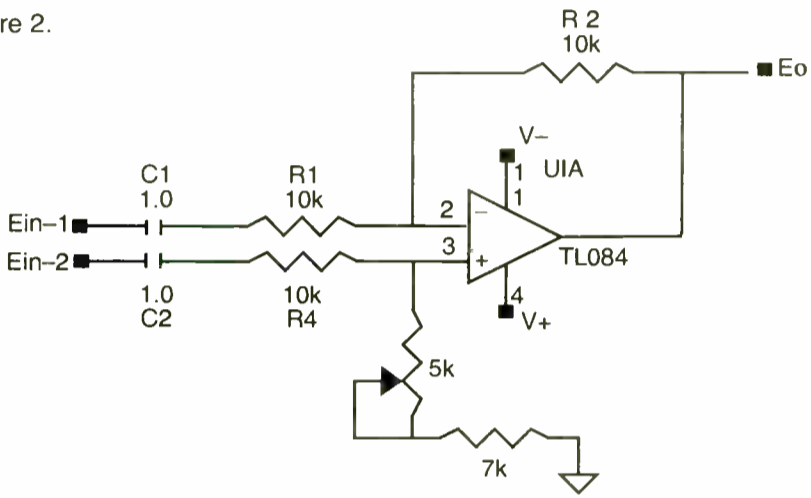

Figure 2.



devices. They respond to the difference voltage on their inputs. However, in most applications, they are run unbalanced: one side against ground. It is relatively simple to configure any op-amp for a balanced input. This is very useful when you want to connect the op-amp across a balanced audio line and do not want to unbalance the line by grounding out one side. A balanced input will also exhibit high common-mode rejection. This means that any noise picked on by the input leads will be canceled by the device. It will allow

input lines longer than a few inches without noise pickup.

Simple stage

Figure 2 is a simple differential input stage. It is self-explanatory except for the pot which is used to maximize the common-mode rejection. Connect an oscillator high side to both input terminals, the other side to ground, and use the pot to null the output.

Because op-amps can invert or not invert a signal, they can easily be configured as balanced line drivers. Figure 3

shows just such a stage. One side is a non-inverting voltage amplifier and the other side is an inverter. By definition, therefore, the output is balanced to the ground. The output terminals are at opposite polarity at any given instant and neither is grounded.

That is all for this month. I will return to the cookbook from time to time to examine useful circuits that can be whipped up without much bother. Next month, I plan to discuss the design of a simple FM stereo demodulator that is easy to build and very handy for testing and adjusting your processing.

□ □ □
 Jim Somich is a radio broadcast engineering consultant and president of MicroCon Systems Ltd., a manufacturer of broadcast equipment. He can be reached at 216-546-0967.

Figure 3.

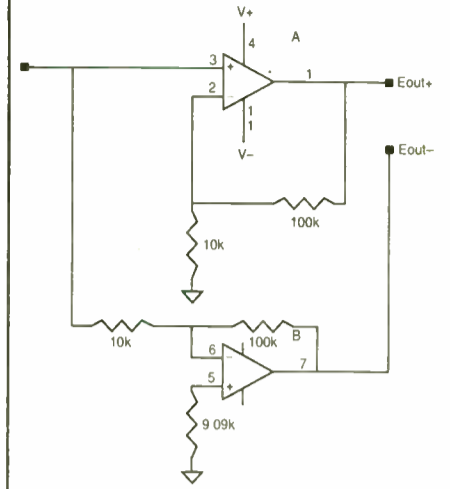

FM PROCESSING BREAKTHROUGH!

Now You Can Be Dominant and Sound Great at the Same Time

We have re-written the book on FM composite processing. Move up to the crystal-clear sound of the FM FlexiMod and control your market with a **dominant, dynamic** new sound.

The FM FlexiMod is the culmination of ten years of research into aggressive composite processing. Its new approach to loudness control without distortion, will revolutionize the sound of your station.

The FlexiMod will add sparkle and body to over processed, multi-generation audio, and enhance all program material for a consistent, dominant on-air sound.

The secret behind the breakthrough performance of the FM FlexiMod is our proprietary c-limiter circuit. This hybrid limiter-clipper will give you brick wall modulation control with extremely low second-harmonic distortion products.

Loudness without grunge!



The FM FlexiMod is the only processor you will need to guarantee your *dynamic presence* on the dial. It will clean up your sound and increase your loudness by 3db or more!

We guarantee it!

FlexiMod: Already *over-achieving* in major markets nationwide
Only \$1395.

Available direct from MicroCon Systems or from selected dealers.
30 day no risk on-air trial

For further information contact:

Jim Somich at MicroCon Systems Ltd. • (216) 546-0967

Quantum FM

Solid State

Solid Reliability

from

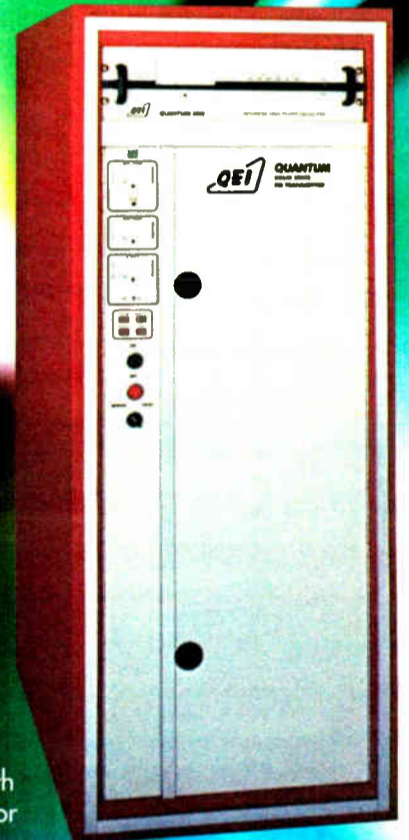

- Proven reliability
- Maintenance-free FET technology
- Self-contained modules with own power supply regulator
- Compact size reduces shipping costs, allows affordable air shipment
- Power levels between 300 Watts and 6 kW
- Modular design offers buy-only-what-you-need affordability and convenience

For the same price you pay for a tube transmitter, you can now have a superior solid state FM transmitter with high-power, advanced technology exciter and cableless combiner. The modular design of QEI's QUANTUM-Series FM transmitters offers the advantage of buying only the amount of power you need...and means that you can upgrade to higher power levels whenever you're ready.

QUANTUM from QEI-the people who have been designing and building solid state transmitters longer than anyone else in the industry.

You need to know more! Call Jeff Detweiler today toll free
(800) 334-9154.

QEI Corporation
 One Airport Drive • P.O. Box 805
 Williamstown, NJ 08094

Tel (800) 334-9154
 Fax (609) 629-1751

24-Hour Service Hotline
 (609) 728-2020

Running Radio

**Your Guide to
Production
Libraries
See pp. 37-39**

Your Resource for Business, Programming & Sales

Radio Aahs Programming Child's Play

by Alan Haber

SILVER SPRING, Md. Nine-and-a-half year old Michael Shevitz is on the "Tour du Jour" this morning. He and his classmates are watching mega-cool DJ Kenny Curtis strut his stuff behind the microphones of Radio Aahs affiliates WKDB, WKDL and WKDV, three AM stations serving the Baltimore, Washington and Northern Virginia areas, respectively (WKDL is the originating station; the others are repeaters, but with local IDs and commercials).

Michael is this morning's guest DJ. And he has done a great job. Kenny thanks him for coming out to the station. "And we are going to take you out," he says, excitedly, "with a song that you requested to hear. From the soundtrack of the motion picture Free William—Willie to his friends, of course—this is Michael Jackson, asking the question, 'Will You Be There?'" And the answer is, "Yes, you

will." He addresses Michael, star DJ of the day. "Way to go, duuuude!"

The music starts to play, and Kenny talks it up: "Great music for great kids, in the Radio Zone—1570, 1460 and 1050 on your AM radio (a show biz pause) thing."

Just your average wacky DJ doing his average wacky thing—for kids.

The Radio Zone

The "All-American Alarm Clock" show, heard weekday mornings 6-11 a.m., is unique among the programs carried by the 27 stations in the 24-hour-a-day Radio Aahs children's radio network. Although the other affiliates carry the network's Alarm Clock show, WKDB, WKDL and WKDV carry a locally-originated version, hosted by Curtis and sidekick Susan Huber (network programming is carried the rest of the day and night).

Kids programming has worked out well for the three stations, the oldest of which is just over two years old. Joan Homa

Schultz, the stations' general manager, is thrilled with the progress so far. "I think we have made tremendous ground when you figure that we just started totally from scratch," she said.

Shultz estimated the three stations' audience to be more than 200,000 people—both kids and adults—a week.

Families, in other words. "I feel like we have a focus group every single solitary day," said Shultz. Parents "cannot wait to come in and they will stay in here and talk to you for 15 minutes, and say 'I just let you know what I think about your radio station, how much I love it. You know, I listen all the time. I drop my kids off at day

care or at school, and I'm on my way to work, and I am all the way downtown and I'm still listening to your radio station.'"

A local presence, in the form of the locally-produced morning show, was important, according to Schultz. "Radio

has always had its best results in a grass roots community-type outreach," she said. "We just want this to be a family community radio station." From a sales and business standpoint, she added. "It is absolutely critical to be able to have live promotions, giveaways, kids calling in, so that they are not just calling in to the 800 number of the Radio Aahs network."

Advertising, which has been growing steadily for the stations, is diverse: everything from kids-oriented accounts to the more traditional types—banking, automotive, healthcare, and performing arts institutions, for example.



DJ-in-training Michael Shevitz

Kids are part of the on-air mix. For example, movie reviews and reviews of the circus, even of restaurants, are done by kids. "Kids love listening to other kids," said Schultz.

continued on page 34 ►

We Have What You Need!



COMPACT DISC PRODUCTION MUSIC AND SOUND EFFECTS LIBRARIES

Call, write or send us a fax and it will be a pleasure for us to send you a complete catalog of our compact disc libraries free of charge. Our catalogs have a large variety of what you need for your productions. For your convenience, we will be pleased to send you a demonstration compact disc containing all the information you need to place your order. But we can't send you our catalog until you get in touch with us.

**Take the first step
and contact us today!**

Valentino

...a complete library of production music and sound effects in an exclusive binder system.

Valentino

...Our products are used for productions around the world.

Valentino, inc

500 Executive Blvd., P.O. Box 534, Elmsford, NY 10523 USA
TEL: +1-914-347-7878 FAX: +1-914-347-4764

NOTE

Here's the GOOD news!
Digital audio systems
you can trust are made
by I.T.C., the company
you know for dependable
radio products. Let us
show you REAL solutions
for your audio needs.
Call 1-800-447-0414

THE BENCHMARK
For the past 25 years...



IN BROADCASTING
For the NEXT 25 YEARS

International Tapetronics Corporation, 2425 S. Main Street, Bloomington, IL
Phone: (800) 447-0414, (309) 828-1381, Fax: (309) 618-1386

ROOTS OF RADIO

Spin-off Radio Show Reached Stardom

by Read G. Burgan

LAKE LINDEN, Mich. If you think that "The Great Gildersleeve" was a radio series about a Water Commissioner played by Willard Waterman... you are wrong. Then again... you are right. Confusing? No more so than the life of radio's most infamous blowhard and lover, Throckmorton P. Gildersleeve.

As radio programs go, "The Great Gildersleeve" was hardly a pioneering show. When it first appeared on Aug. 31, 1941, radio was well beyond its infancy. But it broke new ground in at least one area—the spin-off, where a new program is created by spinning off a program based on one of another program's characters—and gave radio listeners one of its most enjoyable programs for nearly 18 years.

Peary's brainchild

"The Great Gildersleeve" was the brainchild of Harold Peary. Peary, whose original name was Harold Jose Pereira de Faria, was a Portuguese immigrant. He began his career in radio in the late 1920s, using his abilities as a character actor and singer in a variety of roles on both the west coast and in Chicago. In



Harold Peary

San Francisco he was featured on an NBC program called "The Spanish Serenader."

While in Chicago he joined the cast of the "Fibber McGee and Molly" program.

At first he played a number of fairly anonymous roles, but eventually began playing a character called Gildersleeve. For a while the character was fairly amorphous, hardly being the same from one program to the next. But with Peary's urging and help, the character began to take shape.

By the late 1930s, Throckmorton P. Gildersleeve had moved next door to Fibber McGee and Molly in Wistful Vista. McGee and Gildersleeve were cut from the same bolt of cloth. Both were boastful, abrasive and short-tempered. For nearly two years they traded insults and looked for ways to do each other in.

Gildersleeve was one of the few characters on the show who was a match for the obnoxious McGee. His stock phrase was, "You're a haaaard man, McGee."

But Peary had ambitions beyond Wistful Vista. In 1941 Kraft Foods cast Peary in his very own show, "The Great Gildersleeve," originating in NBC's

Hollywood studios and airing on Sunday evenings from 6:30-7 p.m. Peary was 35 years old, had curly hair, a dark mustache and weighed in at 220 pounds when he began his new series.

The early episodes created a detailed snapshot of Gildersleeve, including the fact that he graduated from Princeton with the class of 1914. Assuming he was 22 years old when he graduated, that would have made him 49 years old in 1941. But network news releases in 1943 listed Gildersleeve as 42 years old! As the series progressed, these kinds of details faded into the background.

In the transition episode aired on Aug. 31, 1941, Throckmorton P. Gildersleeve boards a train to leave Wistful Vista and travel to Summerfield to assist his nephew Leroy and niece, Marjorie, who have been orphaned. When he leaves, he tells the staff of his Gildersleeve Girdle Works (Our motto, "If you want a corset, of course it's... Gildersleeve") that he will only be gone a few days... at least three days, or maybe the end of the week."

Girdle works

For the rest of the 1941-1942 year, his

employment status is in limbo.

While he frequently makes reference to his Girdle Works company, he never returns. In later episodes he comes and goes from his office, but we are not told what he does aside from managing the affairs of his nephew and niece—and these are not spelled out.

It goes without saying that Harold Peary was the Great Gildersleeve. His voice was perfect for the part. His trademark was a laugh that has been described as hefty, lecherous, and dirty. The truth is, however you describe it, Peary's laugh was the one all-consuming, identifying trademark of the Great Gildersleeve. His most frequent exclamation was, "This is going to be one of my baaaaad days." Peary's size paralleled that of Gildersleeve, who was described as portly. Many episodes

continued on page 35 ▶

YOU CAN SHARE PROGRAMMING AMONG YOUR RADIO STATIONS ... At a Lower Cost Than Ever Before!

Share-programming among your station group or with other stations by sharing day parts, entire formats or by delivering your top-rated talent to other markets coast to coast. You can spread overhead costs, increase the quality of programming at the local station and build your audience by creating a satellite radio network. And now new digital satellite technology makes radio networking more affordable than ever before. Let us offer you a complete solution for your radio networking needs.

Call us at (202) 414-2626

NPR SATELLITE SERVICES®

Has moved to:

635 Massachusetts Ave., NW, Washington, DC 20001-3753
(202) 414-2626

Radio Aahs: A Tremendous Number of Opportunities

Targeting a rather unique audience (unique in the face of some of the more traditional radio audiences, that is), Minneapolis, Minnesota-based Radio Aahs offers an enriching listening experience 24 hours a day, enhanced by a strong creative heart that reaches out to the entire family.

"At night, (Radio Aahs is) just like regular radio," said Christopher T. Dahl, president and CEO of Radio Aahs's parent company, Children's Broadcasting Corporation. "Most people listen and consume radio during the day. Kids are not any different, although kids are not up at night as much as maybe their adult counterparts are."

Nevertheless, said Dahl, "Kids are up. They are sick. They cannot sleep. Their parents are not home, and the other part is that they go to bed with the radio on..." It was important for Radio Aahs's programming mix to ensure that kids would not tune in and hear dead air at any time of the day or night, "or worse yet, hear programming that did not relate to kids' radio," said Dahl.

Radio Aahs may well be "the only full-time, 24-hours-a-day, seven-days-a-week, kids media resource in broadcasting today," according to Dahl. Further, it is not just for kids—it is for parents, too.

It is important not to alienate the parents, said Dahl. The Children's Broadcasting Corporation's stated mission "is to entertain and educate children and their families through positive multimedia programming and products." Radio Aahs is the Corporation's messenger, forging on with the needs of children and their families always foremost in mind.

Weekday program offerings range from "Avenue 'A,'" an exercise in imagination and music hosted by Amy, to "Great Music for Great Kids," during which Stix Franklin spins the platters that matter for night owl listeners and Jana welcomes the early birds. On weekends, live broadcasts from Disneyland in California and Walt Disney World in Florida are part of the entertaining on-air mix.

Before Radio Aahs grew into a network, it was the format at flagship station WWTC-AM in Minneapolis. Twenty-seven stations are signed on as Radio Aahs affiliates, but Dahl said he is not concerned with the number of affiliates; he is concentrating on market coverage—right now the network is in just over 30 percent of the United States (with one exception, on AM stations; affiliates include KPLS-AM in Los Angeles/Orange County and KAHZ-AM in Dallas, Ft. Worth).

Radio Aahs presents another alternative to advertisers who traditionally spend their dollars

with television and print media. "There is a billion dollars' worth of advertising that's aimed at kids—specifically at kids," said Dahl. "And, unlike the adult advertising world, where you have got a hundred different alternatives, you really just have two alternatives (for kids advertising)—primarily print and television. These people are looking for new ways to advertise to kids."

In other words, as the saying goes, kids are people, too. "We treat them that way," said Dahl. "I think advertisers and sponsors are aware of what Radio Aahs does and think this is really by and large a good place to showcase their products."

Dahl said Radio Aahs intends to "continue forging ahead to get the top 100 market coverage." Additionally, he said he is looking to "continue to build the network, but also to take advantage of the brand identity that we are creating. You ask a child in Minneapolis or Baltimore or Washington what Aahs means, and he or she will say it is the radio station. I think that the franchise itself, the name Aahs, has a tremendous amount of appeal beyond just radio advertising."

Dahl pointed to the recently launched Radio Aahs magazine as an example. "The magazine brings us into publishing," he said. Overall, he noted that there is "a tremendous number of other opportunities out there for us."

Radio for Children

► continued from page 32

All kinds of music (and artists) are played on the All-American Alarm Clock show—everything from rock to country and classical, from lots of Motown to, say, a selection from "The Lion King" movie soundtrack. Parents "love that we are exposing their kids to different things," said Schultz, "in a very non-educational, non-hey-kid-you-are-learning-something-here (way)."

The music does not necessarily have to be geared specifically toward kids, but, said Curtis, the music has to be "content appropriate... We have a line... We don't want to cross the line too much, but, at the same time, we don't want to be too goody-goody either." The last thing a kid wants to listen to is music

that's supposed to be for kids, he added.

The biggest challenge, said Curtis, is programming for the wide age range of the audience, which stretches from about four to 14. "My target audience in this show is a family stuck in a car," he said. "The idea is a radio station that can give them everything they need and want in one morning without changing the station," including traffic, weather and sports, which is delivered by, not coincidentally, a kid, who Curtis said is hilarious. He remembered a line the kid spoke: "'The Bullets stink, let's face it.' I mean, you would think the kid was 50 the way he talks," he said. "It is hysterical."

The stations run a lot of contests, but, according to Schultz, "the winning is

not so much in the prize. The winning is just in getting through and having the right answer... If it was coming from Mom and Dad, saying

'Go to the atlas, go to the dictionary,' I mean, forget it. Because we say it as media, it is cool, and that is something else that... is not lost on the parent, that we are all working on this project together."

Kenny Curtis, wacky morning DJ cutup, is a natural behind the mic, relating to kids on the air and in the studio as

part of the "Tour du Jour" as if he were a kid himself. He cannot believe how much fun he is having. Amazingly, this is his first radio gig, but it is not his first

kids-oriented job—Curtis spent five years hosting a kids' TV show on the Fox TV affiliate in Baltimore. Bright and bubbly co-host Susan Huber has been on the show since November 1993.

Having local personalities on the morning show is a good thing, said Curtis: "You have got your own human marketing tool. That way you have a personality to send to places, and it is easier to sell because you can do contests and promotions that are live. As long as you are taking cues from the network, and there is a consistency in programming, it is okay."

Programming the station is more of a collaborative than an individual effort, said Program Director Dan Turner. "This (format) is unique because it has never been done before, and that is what attracted me to it," he said. "I look at children's radio, really, as the last bastion of creativity in radio."

The "All-American Alarm Clock Show" and, for that matter, Radio Aahs, goes down like a great, magical breakfast. Magic, in fact, may well be an integral element in the fabric of cut-up Curtis and his show. Legerdemain was, in fact, integral to a segment of today's Tour du Jour.

After turning the kids into chipmunks with the help of some production sleight-of-hand, the cheerful host asked the kids if they knew how he achieved the trick. "Was it magic or was it a machine?" he asked. "Machine!" came the cry back from the kids.

"Yeah," said Curtis, perhaps a bit dejected at the response. "Nobody says magic anymore." Except, that is, for the listeners, perhaps.



Analog & Digital A2-D

Audio Measurement System

The affordable instrument
Designed to meet the challenges
of tomorrow's testing needs

- Analog & Digital Generator and Analyzer
- User friendly front panel
- Stand-alone or remote control via RS-232 or IEEE-488
- Portable

We set the standard in making audio testing AFFORDABLE

NEUTRIK AG
Liechtenstein
Tel: 075 / 237 24 24
Fax: 075 / 232 53 93

NEUTRIK Instrumentation
USA / Canada
Tel: 0514 344 5220
Fax: 0514 344 5221

NEUTRIK
Germany
Tel: 0941 98041
Fax: 0941 99 97 72

NEUTRIK UK
Great Britain
Tel: 0983 811 441
Fax: 0983 811 439

NEUTRIK Zürich AG
Switzerland
Tel: 01 734 0400
Fax: 01 734 3891

CONNECTING THE WORLD

Circle (111) On Reader Service Card

World Radio History

Gildersleeve on Radio

► continued from page 33

included jibes about his girth.

During the first year, the episodes were written by Leonard L. Levinson. From the very first episode, many—but not all—of the characters that became a part of the series were present. Nephew Leroy was an outspoken brat who had the measure of his uncle "Mort" and was quick to deflate his pompous ego with his classic response: "What a character!" Much to the chagrin of parents everywhere, Leroy gave the kids of the forties several clichés including, "Are you kiddin" and "For Corn Sake."

Walter Tuttle began the role in 1941 when he was 18 years of age but looked and sounded like the twelve-year-old he was playing.

Softer role

Niece Marjorie played a softer role. She served as a buffer between Leroy and his "Unk," while fending off Leroy's jabs at her boyfriends. Lurene Tuttle played the role for the first three years. Lillian Randolph played their black maid, Birdie Lee Coggins. While Birdie was a stereotypical role, Lillian Randolph gave the character life and

joy. She never hesitated to contradict Gildersleeve and often had the last word.

The last of the early characters to stay with the show was Judge Horace Hooker, played by Earle Ross. "Gildie" runs afoul of the judge while on the train to Summerfield and begins a lifelong feud with the "old goat." In point of fact, Ross makes Hooker sound like an old goat. His high-pitched nasal rattle of a laugh was unmistakable.

But the first year's episodes were flat. Most of the time was spent with his nephew and niece, and although it made for pleasant listening, it just was not great stuff.

In 1942, John Whedon took on the writing, and was later joined by Sam Moore.

Almost immediately two changes were made. One was the introduction of Peavey, the local druggist. Peavey was reminiscent of Wallace Wimple of Fibber McGee and Molly. Both were hen-pecked. Peavey was played by Richard LeGrand, who began the role at 60 years of age. LeGrand had played in vaudeville since 1901, and in radio since 1927. People could not wait to hear him say dryly, "Well, now, I wouldn't say that."

New job

The second major change was getting Gildersleeve appointed as the Water Commissioner of Summerfield. This gave him status in the community, a real job that people could relate to (Although

continued on page 40 ►

Running Radio Marketplace

A Supermarket of Radio Station Services

For information on the services shown below, circle the Reader Service number on the enclosed card or contact the advertiser directly.



COUNTS DOWN COUNTRY'S TOP 40

THE NASHVILLE RECORD REVIEW, HOSTED BY LORIANNE CROOK AND CHARLIE CHASE OF TNN'S MUSIC CITY TONIGHT, IS ONE OF RADIO'S FASTEST GROWING COUNTRY COUNTDOWN SHOWS.

A FOUR-HOUR WEEKLY SYNDICATED RADIO PROGRAM PRODUCED ON COMPACT DISC.

FOR MORE INFORMATION CONTACT

EAST: FRANK IACONA, (203) 965-6217
WEST: CRAIG CHAMBERS, (303) 771-9800

Reader Service No. 202

Garth Brooks Michael Caine Norman Lear Hugh Downs
Dan Rather Jane Seymour Chuck Norris Lee Greenwood

What Do All These Stars Have In Common?

They've Spent Their Weekend With Ron Seggi!

You've Promised Your Listeners the Moon... Now Give Them The Stars...



"The Ron Seggi Show" is syndicated exclusively by "The USA Radio Network." Call Affiliate Services for Market Availability at 1-800-829-8111.

Rich Little Dick Clark Frank Sinatra Jr. Robert Blake

Reader Service No. 133



Branson Music Network, serving America via digital satellite from the live entertainment Capitol of the world, Branson Missouri.

Live 24 hours a day with star interviews, contests, 800 request line, and fun!

We mix the best new country and the classic songs from yesterday.

You will also have available many special programs and features. Call 800-680-2261 for more information.

Reader Service No. 179

Attention Advertisers!

Reach **20,000+** broadcast professionals. RADIO WORLD's **Running Radio Marketplace** provides a perfect medium for test marketing your products and services. It's an efficient, effective and affordable advertising option!

For more information, including rates and deadlines, Fax **Skip Tash** at

1-703-998-2966
or Call **1-800-336-3045**

FCC FINES

...are not the **ONLY** reasons for the revolutionary new 1995 operations, technical and compliance system from **BIGBOOK**. Here are a few others:

- ★ WALKAWAY ★ PROFIT
- ★ RENEWAL ★ EAS SYSTEM
- ★ FREE REGULATORY HOTLINE

FREE info: 1-800-669-3993

Reader Service No. 156

Products & Services Showcase

For more information on the products shown below, circle the appropriate Reader Service No. (s) on the enclosed Subscription/Reader Service card or contact the advertiser directly.

The best way
to pull off a lot of tricks
with one small box...

DC metering amp
AC or DC Gain
Stereo 30 DB
Balanced to Unbalanced
Line Amplifier
Mono Gain 60+ DB
Distribution amplifier
Unbalanced to Balanced
Microphone pre-amplifier
AM NRSC de-emphasis filtering
Consumer audio to console level
Telephone line to audio console level

Zercom
CORPORATION



rack mount or surface mount

The Zercom 'Gain Box'
For only \$179.00

Available through all major dealers

P.O. Box 84, Zercom Drive
Merrifield, Minnesota 56465-0084
218/765-3151-Fax 218/765-3900

READER SERVICE NO. 220

WIRELESS IFB SYSTEM

Used by hundreds of TV stations for van-to-field cueing in ENG & SNG applications. Transmitter provides mix of program and instructions to rugged, pocket receivers.

- 100% duty cycle
- Wideband audio
- Excellent operating range



COMREX®

Comrex Corp., 65 Nonset Path, Acton, MA 01720
Tel: 1-800-237-1776 Fax: 508 635-0401

READER SERVICE NO. 36

PTEK

is proud to announce that



PETER FORTH

Has been appointed **PRESIDENT** of PTEK a quality supplier of all your FM Power amplifier needs.

408-448-3342 FAX 800-416-7934
1814 Schooldale Dr. San Jose CA 95124

READER SERVICE NO. 68

The MicMan™ Jr. - A 2 Channel Preamp



The MicMan™ Jr. Portable Mic Preamp

- 1 dB noise figure
- Gain range +26 to +82 dB
- 0.001% THD @ 1 kHz. @ A=40 dB

Benchmark
...the measure of excellence!

- 160 kHz bandwidth for transparent sound
- Fixed, (external PS-1), or portable use
- Uses standard alkaline batteries
- +12 or +48 V phantom microphone power
- Great value-\$425 with external power supply!

BENCHMARK MEDIA SYSTEMS, INC.
Phone 800-262-4675, FAX 315-437-8119

READER SERVICE NO. 105

THE FINEST STUDIO SYSTEMS IN THE BROADCAST BUSINESS



Audio Broadcast Group Inc.
Studio Furniture & Prewired Systems

Your studio environment specialists
for the last 35 years.

We Are The Industry Standard.

For additional information on how we can serve you, please call today.

SOUTHEASTERN SALES OFFICE
200 Fareway Drive, Suite 2
Smithfield, North Carolina 27577
Phone: 800-369-7623
Fax: 919-934-8120

MAIN SALES OFFICE
2342 S. Division Avenue
Grand Rapids, Michigan 49507
Phone: 800-999-9281
Fax: 616-452-1652

WESTERN SALES OFFICE
P.O. Box 1638
Palmdale, California 93550
Phone: 800-858-9008
Fax: 805-273-3321

For 35 years

YOU MAY ALSO REACH US ANYTIME VIA ELECTRONIC MAIL

cServe: 75371,144
internet: support@abg.com

AUDIO
broadcast group inc.

READER SERVICE NO. 151

REMEMBER THE **CORTANA**
FOLDED **UNIPOLE ANTENNA?**
WE STILL MAKE IT WITH THE
SAME HIGH QUALITY MATERIALS
AND WORKMANSHIP.
IT FEATURES...

- **BROAD BANDWIDTH** for better sound.
- **GROUNDING ANTENNA** for lightning and static electricity.
- **ELIMINATES ISOCOUPERS** in VHF and UHF antenna lines.
- **BEST ANTENNA FOR DIRECTIONAL ARRAYS.**

Also

DESIGNING SYSTEMS THAT DISTURBS YOUR AM
COVERAGE PATTERN. TOWERS, POWER LINES, TANKS OR ANY
METAL STRUCTURE.

FOR INFORMATION CALL, FAX OR WRITE

nott ltd.

4001 La Plata Hwy
Farmington, NM 87401
Phone 505-327-5646 Fax 505-325-1142

READER SERVICE NO. 197

Production Libraries Enhance Bottom Line

by Alan Peterson

WASHINGTON Radio stations constantly advertise new technologies, new artists and wild new image promotions. Yet many ignore the necessity of up-to-date production music to enhance creative efforts. Some rely on out-of-date vinyl libraries or even jazz or New Age CDs sent by record companies; an unwise choice from marketing and legal standpoints.

Production music is as much a part of a station's success as personalities, programming and processing. Yet, while hundreds of hours go into programming music selection and rotation, only a fraction of that time is given to the sound of station production. Commercials can represent up to 20 percent or more of any broadcast hour, so high quality production music becomes a necessary tool rather than a luxury.

Production library providers FirstCom, OmniMusic and TM Century can offer reasons why any effective production library is necessary to accomplish the goal of the "total sound."

Why a library?

"To come screaming into the '90s," said Richie Allen from TM Century. With music trends constantly evolving, a timely production library means a seamless flow from music into spots and promos. FirstCom's Carol Riffert refers to these elements as "the second part," and acknowledges that the combination must fit; that is, commercial and promo production should match the overall pace of the station's sound.

OmniMusic's Doug Wood agrees the sound of station production should be every bit as good as the programming, especially because audiences can very easily tell the difference. The good news is, a library need not be a collection of both usable and unusable cuts anymore.

For example, a country station needing a basic library would require upbeat and down-tempo cuts, some novelty music and a solid holiday collection.

Previously, the only choice would have been a stock library also containing cuts appropriate to CHR and urban stations. Part of the investment would remain on the shelf unused. Now, companies like FirstCom will assemble custom libraries based on station need, instead of all-inclusive collections. Format compatibility is assured, because the station selects music specific to their requirements.

In radio production, speed equals profit. Good sounding spots turned around quickly gives the production department time to work

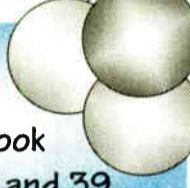

See the
Production
Services Sourcebook
on pages 38 and 39.

on specs for new clients. Instrumental album collections are, for the most part, serious time wasters (as well as being illegal; more below), so a fully-cataloged, cross-referenced music library means better productivity.

However, time spent referencing a catalog to find music appropriate in mood and tempo could mean more time wasted looking for the right cut. Beginning with its most recent library, TM offers a CD-ROM of music samples allowing production directors to audition cuts instantly and check for compatibility with other cuts. TM's Richie Allen claims a 60 percent savings in time spent searching for music, translating into more time to be creative on spec spots for new business.

Tight budget?

Rates for leasing a library can be based on criteria including production load and output, and sometimes Arbitron market ranking. Stations in Tyler, Texas, would not pay the same as New York for the same library. Some companies such as OmniMusic make no distinction when it comes to market sizes, and lease their libraries for a constant price. An attractive alter-

native for smaller market stations on lean budgets is to "buy out" older music collections.

Different needs

Larger market stations need to be on the cutting edge, but musical tastes in lesser markets do not change as dramatically. Some well-seasoned cuts may be considered safe in less competitive markets. Get specifics from individual companies, because a buyout may actually mean a "license in perpetuity" in which the production company would still retain rights to the music. Always ask.

Most compelling is this: Production music is written and licensed specifically for station use. Using old instrumentals, NAC jazz CDs and popular music is not only bad practice, but illegal as well. For example, a car dealer wishes to use the song "On the Road Again" to promote the dealership. The first violation would be public performance (of the recording), outlined in detail in a station's ASCAP or BMI agreement.

The second would be mechanical rights, in which the publisher is supposed to be paid for use of the song itself (not the recording). Music considered

"in the public domain" is also off-limits. While a classical piece written by Mozart may be fair game, the recording of it made last year would not be. Statutory penalties for even one copyright violation can run well into the thousands, so using in-house CDs and records to save on a library may actually cost the station money in damages levied by copyright holders.

Looping music samples from the production company's demo CD is also illegal. Most companies will issue an order to "cease and desist," although both Carol Riffert and Doug Wood prefer to call the offending station first to offer them their respective company's library.

A good investment

A well produced production library is a solid investment, making commercials and promos sound as exciting as programming. Many larger market stations update or even change libraries frequently, but small and medium market operations will find a standard three-year lease plan quite satisfactory and profitable. Considering how much thought, strategy and research goes into programming music for a station, the selection of production music should be approached with similar consideration.

STATION/STUDIO SERVICES

BUY-OUT MUSIC — \$99

Sixty 60-second music beds for ... \$99
198 :30 & :60 music beds for ... \$198
120 production effects "Zings, Zaps and Zoodads" for \$99
122 New Lasers & Sweepers for ... \$99

For FREE DETAILS on
production music, sound
effects, call

.....
Ghostwriters (612) 522-6256

READER SERVICE 204

427 SOUND EFFECTS \$89.00

For a 5-CD set with a 30-day
money-back guarantee.

Take an extra \$10 off if you mention this ad!

Send \$79 to Ghostwriters
2412 Unity Ave. N., Dept. RW
Minneapolis, MN 55422

For credit card orders call
(612) 522-6256

READER SERVICE 204

ATTENTION PROVIDERS!

Promote your services to **Radio World's** 20,000+ readers. Reach Radio Station and Recording Studio owners/managers and engineers with your message. For information on affordable advertising call **Simone** at **1-800-336-3045**.

What is this man doing?



... he is optimizing his audio processing!

You no longer have to compromise your station's sound. Format changes, audience profile variations and cut-to-cut music inconsistencies present challenges that no ordinary processor can hope to deal with. That's why Inovonics pioneered the *Programmable Processor*.

Our Model 250 behaves just like five independent audio processing chains. The AGC action, Compression, Equalization and Limiting of each of these chains can be custom-tailored to any specific audio feed or to any station format. This gives precisely the proper processing to make any program source or format sound its very best. No compromise.

Controlled by station automation, a time clock, or simple manual selection, the 250 provides processing which can change with your programming throughout the broadcast day. What's more, our RS-232 Interface Option can put the 250 under continuous computer control with almost endless processing possibilities.

Has the Inovonics 250 proved to be ahead of its time, or haven't you been keeping up?



MODEL 250 - PROGRAMMABLE BROADCAST AUDIO PROCESSING

Inovonics, Inc.

1305 Fair Avenue
Santa Cruz, CA 95060 U.S.A.

TEL: (408) 458-0552
FAX: (408) 458-0554



Production Services Sourcebook

ABC Sound
125 West End Avenue
New York, NY 10023
212-456-5621; fax: 212-456-5623
Contact: Arthur Burns

ABC Sound is a dynamic digital audio production facility with a full range of SFX and stock music as well as creative designers to apply them.
Circle Reader Service 3.

Aircraft Production Libraries
162 Columbus Ave.
Boston, MA 02116
800-343-2514; fax: 617-542-7222
80 Cds and growing. Aircraft Production Libraries and specialty packages; "Rock Sweepers," "American Music Series," "Ads up for Commercials." No scraps, just fresh stock music.
Circle Reader Service 103.

Associated Production Music
6255 Sunset Blvd., Ste. 820
Hollywood, CA 90028
213-461-3211; fax: 213-461-9102
Contact: Connie Red
9 libraries/over 1200 CDs, personalized broadcast package, music search services, 10 new CD releases monthly, KPM SFX library (700+ effects).
Circle Reader Service 98.

AVDeli
1137 N. Osborne Blvd.
Racine, WI 53405
414-632-8610; fax: 414-632-5527
Contact: Joe Kelly
Leading production libraries for Alternative, Rock, Country, CHR and Urban Radio. All on CD.
Circle Reader Service 118.

Capitol/OGM Production Music
6922 Hollywood Blvd., Ste. 718
Hollywood, CA 90028
800-421-4163; fax: 213-461-1543

Contact: Curt Kendall
Home of the award-winning OGM production music for easy contemporary programming. Frequently updated. Plus the new OGM Premium line. Sound effects available.
Circle Reader Service 94.

Catspaw Productions Inc.
560 Dutch Valley Road
Atlanta, GA 30324
404-876-2287; fax: 404-881-8409
Contact: Larry Melnick
"The Roto Tiller in the Garden of Audio" providing everything from two major voiceovers (Doug Paul and John Willyard) to hot original music.
Circle Reader Service 90.

Dave Dworkin's Ghostwriters
2412 Unity Ave. N.
Minneapolis, MN 55422-3450
612-522-6256; fax: 612-522-6256
Contact: Dave Dworkin
Production music and effects. Buyouts on CD with a 30-day money-back guarantee.
Circle Reader Service 46.

DeWolfe Music Library
25 W. 45th St.
New York, NY 10036
212-382-0220; fax: 212-382-0278
Contact: Andrew Jacobs
250-CD music library encompassing all styles of music for use in radio commercial works. Bonus, 16-CD SFX set available as buy-out.
Circle Reader Service 69.

Dimension Music & Soundeffects Inc.
P.O. Box 992
Newnan, GA 30264-0992
800-634-0091; fax: 404-253-9388
Contact: Rex M. Bell
Dimension has expanded its music

selections to over 70 CDs. Also available is our holophonic soundeffects library and two CDs of electronic effects. Call for a demo CD.
Circle Reader Service 72.

Dorgan Belle Music Productions Inc.
8009 Forest Trail
Dallas, TX 75238
214-340-4389; fax: 214-340-4388
Contact: Sally Dorgan Potts
Affordable commercial jingle campaigns for radio stations and advertising agencies. Production facilities in Dallas and Nashville. Call for demo cassette.
Circle Reader Service 81.

FirstCom Music
13747 Montfort Drive, Ste. 220
Dallas, TX 75240
800-858-8880; fax: 214-404-9656
Contact: Andrea Bergeron
The original pick and choose library—you do not pay for music you do not need. Ask about our 25 percent exchange privilege for new releases.
Circle Reader Service 106.

Hooks Unlimited
200 Old 63 S., Ste. 103
Columbia, MO 65201-6081
314-443-4155; fax: 314-443-4016,
e-mail: Hooks Hooks.com
Contact: Bemie Grice
Hooks Unlimited, "The world's premier music hook service," provides hooks which accurately represent the music, are digitally produced, consistent in length and clear sound.
Circle Reader Service 37.

ITEX Media
10300 S.W. Greenburg Road, No. 370
Portland, OR 97223
503-244-4673; 503-245-0748
Contact: John A. Holmes

There is no cash fee for the purchase of the library. All we ask in return is a credit with your station or company.
Circle Reader Service 95.

K. K. Kreative Koncepts
36 New Market Dr.
Delaware, OH 43015
614-363-7344; fax: 614-363-5826
Contact: Kurt S. Kaniewski
Write and produce "Kreative" radio commercials... write and produce harder edge commercials like concert spots, race track spots, car dealer spots, etc.
Circle Reader Service 54.

Media Jam
P.O. Box 5372
Louisville, KY 40255
800-536-6007; fax: 502-239-9200
Contact: Brian Curella
Station ID jingles, voice-liners, production library.
Circle Reader Service 126.

Metro Music Productions Inc.
37 W. 20th St.
New York, NY 10011
800-697-7392; fax: 212-229-9063
Contact: Joanne Morse
A powerful contemporary production music library. Music ranges from cutting-edge urban to rock, jazz, blues, dramatic themes. Metro also offers custom music for promotion, news, sports and show opens.
Circle Reader Service 55.

The Music Bakery
7522 Campbell Road, Ste. 113-2
Dallas, TX 75248
800-229-0313; fax: 214-414-3160
Contact: Donna Gallagher
The Music Bakery's CDs are packed with brilliant compositions, using plenty of real acoustic instruments played by professional studio musicians. "The highest quality, royalty-free buy-out available, period."
Circle Reader Service 154.

Music Source
615 East Pike
Seattle, WA 98122
206-323-6847; fax: 206-323-6896
Contact: Jim Wolfe
Hot Trax-country-volume one-a library CD of hot "new country" trax. A must for every country station, "Sounds like Garth Brooks band without Garth."
Circle Reader Service 189.

Network Music Inc.
15150 Ave. of Science
San Diego, CA 92128
619-451-6400; fax: 619-451-6409
Contact: Ken Berkowitz
Network Music Library-140 volumes of music on CD with monthly new releases-plus Sound Effects, Sockwave, Brainstorm, Primrose and Classical Libraries to choose from.
Circle Reader Service 155.

Non-Stop Music Library
915 W. 100 S.
Salt Lake City, UT 84104
800-554-6462; fax: 801-531-0346
Contact: Susie Davis

THE SECRET'S OUT—DIGITAL FURNITURE

MODULAR
FLEXIBILITY
WITH A
CUSTOM FIT

We Offer Six Elegant
Lines of Studio Furniture

4153 BONITA STREET
SPRING VALLEY, CA 91977
PHONE 619/698-4658
FAX 619/698-1268

MURPHY
STUDIO FURNITURE

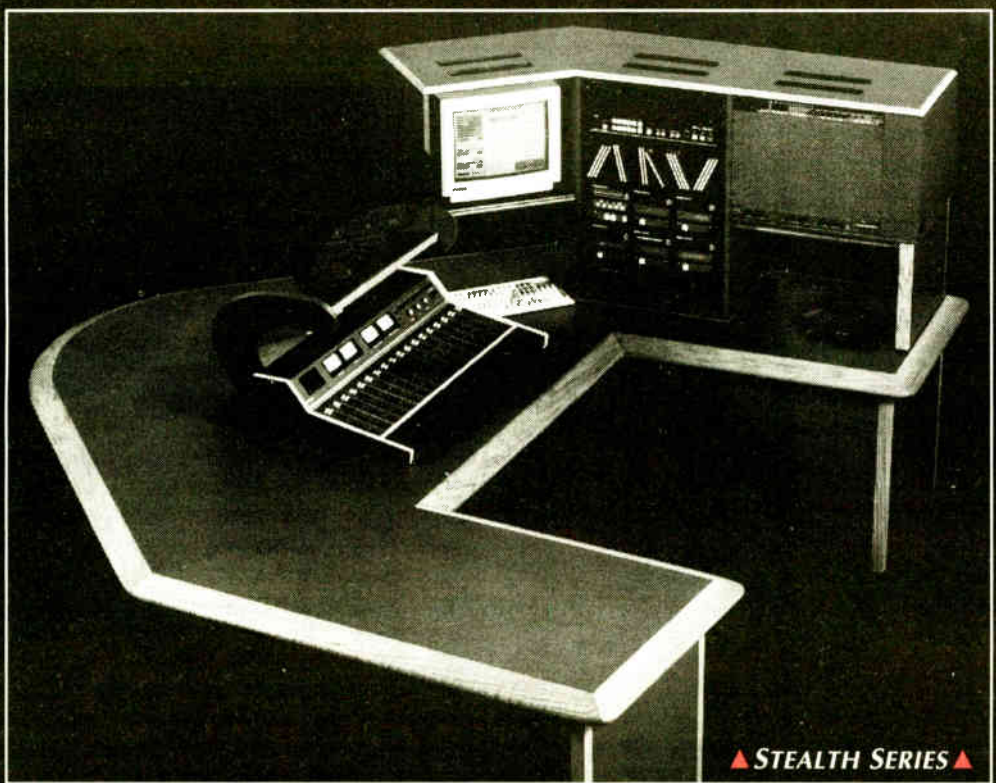

Circle (149) On Reader Service Card

World Radio History

We proudly feature the newest, high-end production library in the industry and concentrate on the latest sounds and recording techniques to produce our CDs.

Circle Reader Service 92.

O Boy! Productions
1498 Harbert Ave.
Memphis, TN 38104
800-789-OBOY; fax: 901-278-7722.
Contact: Tom Lonardo

Production music, libraries, custom jingles, music for film radio & TV.

Circle Reader Service 161.

Omnimusic
6255 Sunset Blvd., Ste. 803
Hollywood, CA 90028
213-962-6494; fax: 213-962-4556

Omnimusic supplies 112 CDs of music and SFX to production media. Licensing available on annual blanket (unlimited use) and, per production. SFX on a buyout basis. Bi-monthly releases.

Circle Reader Service 164.

Radio Potato Inc.
1926 Stoneway
Grapevine, TX 76051
800-468-6874; fax: 817-488-6177
Contact: Mike Fuller, Marshall Such

Radio Potato provides radio stations around the world with production elements, PD movie drops, sounder packages for news/talk/sports and a full service production library called "The Spud."

Circle Reader Service 58.

Radio Today Productions
1776 Broadway, 4th floor
New York, NY 10019
212-581-3926; fax: 212-459-9343
Contact: Tom Shovan

Ambush, news/talk production library; Continuous Climax, CHR production library. All libraries updated every two weeks on CD with new material.

Circle Reader Service 193.

Signature Music Inc.
1531 S. Calumet Rd.
Chesterton, IN 46304
800-888-7151; fax: 219-921-0704
Contact: Joanne Mullin

30 CDs; acoustic and electronics. One-time payment lifetime license or annual lease, 6 CDs of 30s & 60s (378 cuts) plus logos, transitions & stingers. New demo CD available.

Circle Reader Service 60.

Sound Ideas
105 W. Beaver Creek Rd., Ste. 4
Richmond Hill, ON L4B 1C6 Canada
905-886-5000; fax: 905-886-6800
Contact: Brian Nimens

Producer of the world's largest commercially available SFX library on CD and Sound Ideas music library; introducing the Twentieth Century Fox sound effects library and MIX II.

Circle Reader Service 115.

Steel Works
101 Marshall Ave.
Floral Park, NY 11001
516-328-1587; fax: 516-328-1587
Contact: Ben Steel

Custom song parodies/music tracks/jingles/movie & TV drops voiceovers.

Circle Reader Service 166.

Techsonics

709 Shadowfield Ct.
Chesapeake, VA 23320
804-547-4000; fax: 804-436-5928
Contact: Steve Peppos

7 different libraries, for IDs, sweepers and music: Turbo Techsonics, Chainsaw One, Primo Promos, Earthquake Techsonics 2 The Music Library, Rock Flash and House Jamz.

Circle Reader Service 176.

Thompson Creative
4631 Insurance Ln.
Dallas, TX 75205
214-559-4086; fax: 214-521-8578
Contact: Ben Freedman

Thompson Creative is one of the world's leading suppliers of station ID jingle packages for all formats.

Circle Reader Service 135.

TM Century, Inc.

2002 Academy Lane
Dallas, TX 75234
214-406-6800; fax: 214-406-6890
Contact: Rick Lemmo

Provides a wide selection, including MEGA music, a 104-CD, full service library with a CD-ROM catalog; 3 for 1, with the widest selection of music and formats at new rates to fit any budget; and Slam Dunk, covering rock, urban and specialty categories in 19 CDs.

Circle Reader Service 136.

TRF Music Inc.
747 Chestnut Ridge Rd.
Chestnut Ridge, NY 10977
800-899-MUSIC; fax: 914-356-0895
Contact: Ken Gilman

TRF has been a leading source of music used in television, radio, film and multimedia productions, offering

over 50,000 selections from 4000 discs of production music.

Circle Reader Service 96.

Valentino Production and Sound Effects Libraries
500 Executive Blvd.
Elmsford, NY 10523
800-223-6278; fax: 914-347-4764
Contact: Tom Valentino

The Valentino Production Music Library is a 74-CD collection produced for broadcasters and licensed on an annual basis. The Valentino Production Sound Effects Library is a 44 CD collection and is sold on a buy-out basis. Both libraries have a no cost CD-ROM multimedia reference disc for either the PC or Mac platforms.

Circle Reader Service 147.



Slay the dragon of high costs and worry!

Whether you're a small station looking for peace of mind, or a huge broadcasting association looking for an economical and efficient way to run four or more stations, we have your system. Satellite, Hard Drive Music Automation, Time and Temperature announce, Voice tracking, Digital editing—no problem. Plus our central file server lets you instantaneously share all audio and data with no irritating peer to peer transfer delay. Let Audio Wizard™ for Windows™ be your knight in shining armor!

Prophet Systems, Inc.
1-800-658-4403

In Australia, New Zealand, and Pacific Rim, contact Broadcast Solutions Pty Ltd. at (02) 439-6662.

Fear no competition.

- ◆ Runs 5 or more stations!
- ◆ Multi-track Wizard Editor!
- ◆ Expandable to 30 or more users!
- ◆ Live, satellite and automated modes!
- ◆ Backtime System, fills out each hour!
- ◆ Full Equipment and Data Redundancy!
- ◆ Instant audio access... NO transfer delay!
- ◆ Button Bar with Quick Record Capabilities!
- ◆ Automatically record and play network feeds!
- ◆ The ONLY true multi-user system on the market!
- ◆ Unsurpassed FLEXIBILITY, runs any program log!
- ◆ On-Line Copy Entry System, integrate your stations!
- ◆ Automatic Block Stretch / Squeeze for perfect timing!
- ◆ Exclusive Automated Time and Temperature Announce!
- ◆ The Leading Hard Drive Automation System in the industry!
- ◆ VoiceTRAC System, pre-record "live" shows weeks in advance!



Audio Wizard™ for Windows™

The Flexible Digital Automation System featuring Windows and Novell Technology

Windows is a Registered Trademark of Microsoft Corporation. Novell is a Registered Trademark of Novell, Inc. Compaq is a Registered Trademark of Compaq Computer Corporation.

Circle (140) On Reader Service Card

World Radio History

Gildersleeve on Radio

► continued from page 35

one wonders why he did not go to work until 10 a.m.!), and real problems to deal with. For the next 16 years, Throckmorton P. Gildersleeve would be known as the Water Commissioner of Summerfield.

The process by which Gildersleeve became Water Commissioner introduced a third change—serialization. It took three episodes to have Gildersleeve appointed Water Commissioner. In the past, each of the episodes had been complete in itself, with little link to one another. From then on, there often would be running themes, frequently with cliffhanger endings to keep the audience

in suspense until the following week.

In later years, several months were required to resolve the plot when Gildersleeve ran for mayor or when he found himself engaged to both Leila Ransom and Eve Goodwin. Perhaps the most famous of the Gildersleeve serials was the finding of a lost baby. A nationwide contest was held in which listeners wrote in their suggestions for the baby's name. Thousands responded. It was radio at its best.

Blunting the edge

Whedon and Moore also took the edge off of Gildersleeve's character. On the Fibber McGee and Molly show, he was a

foil for McGee. But there was no McGee in Summerfield. While Gildersleeve remained pompous, a blowhard, and a stretcher-of-the-truth, he became mellow and warmer.

On most radio shows, romance was left to the young. But as Summerfield's most eligible bachelor, Gildersleeve became a first-class lover, albeit by 1940s standards. Throckmorton dated Summerfield's most beautiful women, wrote them poetry, stole their kisses and wooed them with his beautiful baritone singing voice.

Later, one more feature was added to the Gildersleeve mix—the Jolly Boys. The Jolly Boys was a social club consisting of Gildersleeve, Peavey, Judge Hooker, and two additional regulars, Floyd Munson the barber, and Police Chief Gates. Floyd was played by Arthur

Q. Bryan, Gates by Ken Christy. Ironically, Bryan later joined the cast of Fibber McGee and Molly as Doc Gamble, helping to fill the void created when Peary left that series.

The Jolly Boys was a loosely defined group who met in the hall above Floyd's barbershop. Unlike the Rotary or Kiwanis Clubs, it had little purpose other than to provide a place for the boys to play games and sing. Their motto was: "One for all and all for one." More often than not their meetings turned into a free-for-all. The Jolly Boys provided a natural setting for Peary to showcase his baritone voice, and sing he did—both as a soloist and as a member of the Jolly Boys quartet. In later years, entire broadcasts were devoted to Gildersleeve's attempts to revive interest among the members of that lagging organization.

Film career

The Great Gildersleeve appeared in several movies during the 1940s, including Look Who's Laughing (1941), where he appeared with a number of radio stars, including Fibber McGee and Molly and Edgar Bergen. Two Gildersleeve movies were released in 1943, The Great Gildersleeve and Gildersleeve On Broadway. While these films gave Gildersleeve fans a chance to actually see their hero, they disappointed many because, with the exception of Lillian Randolph, none of the other Gildersleeve regulars were featured (Richard LeGrand does appear in a delightful portrayal of Peavey in the second film). Leroy was played by a soprano singing angel faced boy who would have made Walter Tetley ill.

After nearly 10 successful years as the Great Gildersleeve, Harold Peary grew tired of the role and quit. The last program featuring Peary aired on June 14, 1950. With the originator of the role gone, you would expect the program to die. Right? Wrong.

The program resumed on Sept. 6, 1950, with Willard Waterman in the lead role. Waterman's career had paralleled Peary's. He began in radio in Chicago in 1936 and went on to play numerous roles on network radio. His voice so closely resembled Peary's that most people never noticed the difference. And one has to admit that there is something singularly appropriate about a man named Waterman playing a Water Commissioner.

Like other radio programs, "The Great Gildersleeve" began to fall on hard times in the mid 1950s as television gradually eclipsed radio. In 1954 the program became a daily, 15-minute series. In 1955 it returned to a weekly half-hour program, in which form it continued until 1958.

Harold Peary died in April of 1985 at the age of 76. Willard Waterman died this year on Feb. 1, at the age of 80. Fortunately, recordings of most of the Great Gildersleeve series have survived. This slice of radio's golden age will undoubtedly garner a whole new generation of followers in the years ahead.

One can almost hear Peavey saying, "Well, now I wouldn't say that." With Leroy adding, "Are you kiddin'?" Followed by Gildersleeve's, "Leececeeroy!" And then an all-knowing, self-satisfying laugh....

□ □ □

Read Burgan is a free-lance writer and a former public radio station manager who can be reached at (906) 296-0652 or through e-mail at AH746@detroit.freenet.org.

**I F YOU'RE IN RADIO...
HERE'S YOUR
OPPORTUNITY TO TELL
YOUR STORY TO EVERY
MAJOR MARKETING,
ADVERTISING AND AGENCY
EXECUTIVE IN AMERICA.**

This special section will illustrate the incredible radio story, how for 75 years, America's first mass medium helped shape and mirror American life and history. How radio made most of the products and services we know today household brands.

This special radio section will illustrate each of radio's decades, its impact on America and the world. We'll take an in-depth look at the people, the music, the entertainment, the news, the research and radios critical role in the marketing mix. We'll detail how radio works for American marketers yesterday, today and explore how it will work well into the 21st Century.

THE OPPORTUNITY:

If you're a radio network, representative, group owner, advertising or promotion agency, research company, syndicator or have any involvement in radio...this special 75th Anniversary section will be the most comprehensive vehicle you could ever have to deliver your message to virtually every major advertiser and agency in America.

THE CIRCULATION:

This story is so important to American marketers there will be one of the biggest bonus distributions in Adweek history. In addition to the Adweek / Mediaweek / Brandweek circulation of 91,000 there will be a *Special Bonus* distribution of 15,000 to:

*NAB Radio '95 Convention (Sept. 1995)

*The Association Of National Advertisers (ANA) Annual Convention (Oct. 1995)

*AAAA (American Association Of Advertising Agencies) Media Conference (Feb. 1996)

*Ad Club Of NY-Radio 75th Birthday Luncheon (Nov. 2, 1995)

If you've been part of the radio story or are involved with radio this is an opportunity you can't afford to miss.

FOR MORE DETAILS AND ADVERTISING INFORMATION CALL:

Robin Haas	(NY)	212-536-6532
Steve Crane	(Chicago)	312-464-8530
Ami Brophy	(LA)	213-525-2276

ISSUE DATE: SEPT. 4TH, 1995



BE A PART OF
RADIO
HISTORY

Radio
1920-1995
75TH
Anniversary

ADWEEK
MAGAZINES
PRESENT

THE
SPECIAL
RADIO
75TH
ANNIVERSARY
COMMEMORATIVE
SECTION

Exploring Washington Web Sites

by Alan Haber

ALEXANDRIA, Va. "You are what you is," or so, said Frank Zappa many moons ago. The way I figure it, you are either an outdoors type of person with an affinity for fresh flowers, clean air and furry little animals jumping with abandon over your picnic basket, or you are an indoors, couch potato type of egg.

Count me happily among the latter group, of which I have been a card-carrying member since my childhood. My mother used to beg me to go outside and play when I was a kid, and I would happily oblige, provided I could listen to the radio while doing so.

Remember that I was a kid in the days before everything electronic became portable, so I was pretty grumpy when I was outside the house, away from my bedroom or the family room. Now, of course, everything is portable, so I can listen to the radio or enjoy just about anything electronic when I am outside.

I can even work on *Haberspace* on my notebook computer, but I am having a hard time finding a cable to help me connect from faraway, outdoor locations to the telephone jack on the wall—any wall. So I am spending a lot of time indoors, negotiating the Web, looking for great radio sites.

I have been checking out the Federal Communications Commission (FCC) Web site from time to time, and, frankly, I had not been all that impressed with it—until now.

Whereas until recently you would have

been greeted by the FCC logo and some plain text links—a rather cold-looking user interface—you are now welcomed by an attractive home page, featuring a banner incorporating the full-color FCC emblem, and a nice color photo of the FCC commissioners. In addition, some clickable buttons take you to the various pages on the site, including ones that contain the commission's Daily Digest, current rulemakings, and contact information for visitors who want to know more.

The site, which is being accessed by 6,000 people a day (from as far away as Japan), first went up on the Web last December because the Web was deemed to be an important new medium for transmitting information to the public and, what is more, FCC Chairman Reed Hundt felt it was a good way for the commission to get its documents into the public's hands (see related story page 3).

The FCC's Sheryl Segal is in charge of managing published documents and user access; Andy Fishel, in the commission's

Office of the Managing Director, and Mark Corbett, formerly of Intel, are also involved.

Planned enhancements to the site include a search capability, so visitors can find documents that contain information on particular subjects with ease. It is possible that the current 56 kilobit telephone line may be upgraded in the future, if site traffic warrants.

I think you will be pleased with the new-generation FCC Web site. Check it out at <http://www.fcc.gov>.

And now, the envelope please (Haberspace staff drags said envelope into Haberspace World Headquarters): an enthusiastic round of applause, if you will, for the FCC's Web Site, my Neat (and Most Improved) Site of the Month.

There has also been a flurry of Web activity at the National Association of Broadcasters (NAB).

"We are trying to encourage broadcasters to adopt new technologies," said Walt Wurfel, senior vice president, public affairs and communications. "We had noticed... that a bunch

of TV and radio stations were beginning to use Web sites for their various local contacts with their audiences... and we just are looking for a way to use every communications medium to spread the word about broadcasting, the NAB and NAB shows."

A Web site, Wurfel added, was the next logical step up from the NAB's fax-on-demand services. The NAB site offers a variety of information, from news about the upcoming World Media Expo to NAB news releases.

One of the association's aims, said Wurfel, "is to reach more people than we can through the mail. Our budget only allows us to go to the member contact at each station, which is the general manager, and yet, we serve engineers and a lot of other people at stations."

The NAB is also looking to reach the public with its Web site. "Broadcasting needs to be understood better by everybody, from the average Joe, who happens to be a legislative assistant on Capitol Hill, to professors of journalism who are always looking for information," said Wurfel. "This helps us answer a lot of the more frequent requests before they get asked. One of the information resources available on the site is "Online @ NAB," an Internet newsletter "that kind of explains more in layman's terms, and in a little broader (way) than our legislative and regulatory focus, what is happening in the world of broadcasting."

Issues are posted on the Web site each week for people who do not subscribe to it through e-mail.

Don't forget to e-mail me at zoogang@ix.netcom.com with news about your station's Web site, and interesting radio-related Internet stuff.



Broadcasters have problems. AEQ offers advanced solutions.



The BC-500 Mixing Console

- ▶ The AEQ Mixing Console BC-500 has in mind those radio stations seeking the best audio quality at a competitive price. Its designers paid great attention to the control layout.
- ▶ Logical control design ensures a quick learning period as well as trouble free operation.
- ▶ Advanced true modular design allows total flexibility.
- ▶ The chassis incorporates built-in meters and speakers.
- ▶ The standard configuration includes the following features:
 - ▶ Six dual stereo inputs.
 - ▶ Four mono inputs (Mic/Line selectable).
 - ▶ One Telephone Hybrid interface.
 - ▶ Studio control Intercom monitor.
 - ▶ One main stereo output plus mono sum output.
 - ▶ Power supply for On Air signaling.
- ▶ The BC-500 provides 4 blank modules to enhance this configuration.



The MP-10 Portable Mixer

- ▶ Five transformer balanced inputs (Mic/Line selectable).
- ▶ Front panel input controls.
- ▶ Can be linked together to increase number of inputs.
- ▶ Transformer balanced outputs.
- ▶ Internal Ni-Cad rechargeable batteries provides 4 hour autonomy.
- ▶ Automatic switch to battery in case of power failure.
- ▶ Dual mode dialing keypad (tone/pulse).
- ▶ Three headphone output jacks.

Also from AEQ..

Broadcast automation system and hard disk audio storage, multi-standard Audio-codecs, Multiconference telephone systems, Broadcast mixing consoles, stereo audio monitors, line terminal equipment, power amplifiers...



The TH-02EX Mk-II Digital Hybrid

- ▶ Frequency Extender Mode as standard feature.
- ▶ Works with one or two telephone lines.
- ▶ Second line provides full Multiconference Mode. The operator and two callers can talk and listen to each other simultaneously.
- ▶ Hybrid null of 60 dB's.
- ▶ No adjustment required.
- ▶ Ideal companion for TLE-02 Portable Mixer.

The TLE-02 Portable Mixer

- ▶ On Air phone call with audio presence, depth and clarity of voice. No "telephone sound".
- ▶ Designed for non-technical users, ideal for field reporters.
- ▶ Light weight (3.3 Lb) and great autonomy, using 8 AA batteries.
- ▶ Dialing pad in front panel (pulse/tone selectable).
- ▶ Independent level control of Mic/Line input, auxiliary input and headphones.



AEQ AMERICA: 2211 South 48th Street, Suite H - Tempe, AZ USA 85282
Phone: (1 602) 431 0334 - Fax: (1 602) 431 0497

Broadcast Equipment Exchange

"Broadcast Equipment Exchange" accepts no responsibility for the condition of the equipment listed or for the specifics of transactions made between buyers and sellers.

AMPLIFIERS

Want To Sell

Henry Engineering C250AB10 linear pwr amp, tuned to 950 kHz, 75W carrier, 250W peak, rated @ 75W but could do 125W, 2000 hrs w/LBP xmtr, \$750. K Riggs, KTBR, POB 1760, Roseburg OR 97470. 503-672-4427.

Want To Buy

Record Cutting Equipment. 612-869-4963.

Jampro JHPC-9 FM on 93.1, new, in original box. Caribbean Comm. Co., 330 E Kilbourn Ave, Milwaukee WI 53202 USA. 414-283-4515 or FAX 414-283-4505 for more information.

ANTENNAS/TOWERS/CABLES

Want To Sell

Jennings RG31A5750F21 coaxial vacuum relay, 6", 115V actuator, 325 kw @ 30 MHz, \$500/BO. Bill D, HCJB World Radio, 1718 W Mishawaka Rd, Elkhart IN 46517. 219-294-8398.

RCA-Dielectric DCR-C-12 bay hi pwr 100.3, \$6500; ERI FML 2 bay rotiller 100.1, low pwr, ec, \$4500; ERI FML 1 bay rotiller 96.7, \$1500; Shively 2 bay hi pwr 95.3, \$4500. R L Wachter, KNSX FM, 984 N Jefferson, St Louis MO 63031. 314-921-2121.

FM ANTENNAS

Circular - Horizontal - Vertical
High & Low Power
Stacked Arrays (up to 16 bays)
QUALITY BAYS
516-226-5979

Shively 3 bay 6813 FM antenna, 92.1 MHz w/tra lg radomes, new in 1985, xln cond, can be re-tuned 90-94 MHz, will deliver to factory for re-tuning, \$2500. B Williamson, WNHQ, 28 Jones Rd #3, Milford NH 03055. 603-672-9292.

Bogen MO-100A tube 100 W booster amp, 2 ea 8417 (666) pwr tubes, 1 ea 7247 (12AX7) driver, \$100+shpg. R Evans, 704-524-7983.

Jampro JLCP-7 7-bay circular polarized, tuned to 106.3 MHz, BO. R Meyers, Sound Masters Rec, 4700 SW 75 Ave, Miami FL 33155. 305-264-5963.

3" HELIAX STANDARD COAXIAL CABLE

50-Ohm, unused, cut to length. Priced below market. Shipped instantly.
Call Basic Wire & Cable
(NANCY) 800-227-4292
FAX: 312-539-3500

Jampro JLLP-2 antenna, less than 5 yrs old, with heaters, tuned to 94.5, can be returned in field w/factory instructions, \$2200. 505-538-3396.

50 plus sections of 3 inch rigid transmission line, excellent condition, will sell any quantity. 806-372-5130.

Want To Buy

ERI Multi-bay rotiller needed on or near 93.3 & 97.5, 400-1000 tower needed for class upgrade. R L Wachter, KNSX FM, 984 N Jefferson, St Louis MO 63031. 314-921-2121.

3 or more bay class A size antenna on 105.9 wanted to trade for cash or huge 4-bay Phelps-Dodge CFM-HP-4, end fed w/3 1/8" inter-bay line, prefer heaters, low wind load. K Tuckerman, WMMC, 217-826-8017.

Non-comm/educational station looking for antenna & tower w/lights, will give receipt. KADU, 218-263-3000.

AUDIO PRODUCTION

Want To Sell

Sontec 250B EQ, \$2000; API 560B EQs (2), \$650/ea; Audio+Designs Compex limiter F760X-RS, \$900; all 4, \$4000; Shure FP 11 port headphone amp, \$125; Shure FP 12 port mic/line amp, \$125. D Glasser, Airshow, 7021 Woodland Dr, Springfield VA 22151. 703-642-9035.

CASSETTES • CARTS • REELS

J & I AUDIO/VIDEO

A wholesaler in the Radio and Television market.
Now running SPECIALS on audio and video:

BASF CASSETTES-AMPEX R-Rs
AUDIOPAK, FIDELIPAC & ITC CARTS
DAT & THE NEW R-CD

For more information
call Kris Elliot at
1-800-942-1711

or write to: **J&I Audio/Video**
20899 Kelvin Pl.
Woodland Hills, CA 91367

Circle (24) On Reader Service Card

Zephyrus 304 receiver-audio card-tone decoder, never used, BO; Microphase Communications MP-2030S, 1 yo, BO; Bext exciter, 25W tunable, almost new, BO. D Magnum, WBOG/WUSK/WTMB, 800-736-9264.

Avcom Inc EBS-1000, BO; Belar FM & AM FM amps (2), BO; RF mod GTN 88S Gates radio component, BO; Yesco Music Syst 8-trk model 820, BO. WYKS-FM, 904-331-2200.

Yamaha 2031 graphic EQ, \$175; Otari MX-5050BII 2-trk, \$1100; Tascam 22-4 4-trk, \$450; Aphex M-120 dist amp, \$100; Mod Assoc dist amp, \$100; Micro-trak 6411 phono preamp, \$50; Sennheiser MD-421, \$200. 510-895-6358.

Bulk eraser, \$49; Stewart 4 ch D-box, \$95; Cue command decoder, \$125; NEW Tascam midiizer MTS1000, \$450; Infonics 7" reel copier 1-3 copies, 2 @ \$125 ea; Furman elec crossovers, \$95; Peavey M2600 pwr amp, \$375; Crest FA800 PWR AMP, \$475. W Gunn, POB 2902, Palm Springs CA 92263. 619-320-0728.

Roland SRV 2000, \$525; dbx 503 expander/comp, \$290; Orban 414-A stereo compressor, \$425/BO; UA 565-filter, BO. T Coffman, 619-571-5031.

ADC 1/4" patchbays and cords, NEW, UNDER HALF PRICE, ADC TT patchbays, \$129 up, NEW cords, \$9.95. W Gunn, POB 2902, Palm Springs CA 92263. 619-320-0728.

Symetrix 528 voice proc, brand new in box, \$425. J Johnson, KHTR, 509-332-6551.

DaviSound "INNER TUBES" pro audio tube processors! Compressors, EQ, other "Tool Boxes", custom assembled and handcrafted! MCP DaviSound, PO Box 521, Newberry, SC 29108. 803-276-0639.

Good used studio tape 1/2" \$15, 1" \$30, 2" \$55. W Gunn, POB 2902, Palm Springs CA 92263. 619-320-0728.

Want To Buy

RCA BA-6A or 86; Collins 26-J; Langevin AM-7A limiter; Langevin AM-5301 amp; Langevin AM-5116-b preamp; Langevin passive EQ 251A-252A or Altech; GE GE-7 limiter; any passive filters or EQs; stereo adapter for Audiomax II RZ or UTC-HA 106 (2) & UTC-HA-114 xfrms. P Barlow, 909-613-1323.

MXR-Neve-API EQs, mic-pres, delay, etc. T Coffman, 619-571-5031.

Ampex tube mixers, plug-in mic preamp modules for PR10's, Altec or other tube compressors, Mackie mixers. W Gunn, POB 2902, Palm Springs CA 92263. 619-320-0728.

AUTOMATION EQUIPMENT

Want To Sell

SMC 350 Carousels (6) w/manuals, BO; 2-slot SMC cart drawers (4), BO; 19" racks on casters (5), BO; SMC 3060 60-event programmer, BO; SMC AS-10 source cntlr w/cards & remote, BO; SMC DP-1 digital programmer, BO. R Miller, WKEI/WJRE, 217-824-3395.

BE Cntrl 16 compl, or will sell components separately, incl 5 Revox R-Rs, 3 16m Go-Carts, 2 triple-deck cart machines, BO. B Stanley, 616-925-9300.

Harris 7002 Instacart, 5 ITC 750's, 3 snl plys, floppy disc backup, incl sample AC music library on 90+ reels, no monthly fees, BO. J David, KMPC/KSTG, POB 907, Skiston MI 63801. 314-471-1520.

Harris 9000 (5) ITC 750, Carousels, dual floppy drives, snl cart deck, plus more, currently on-air, avail 7/95, \$2500. Tom, 715-234-9059.

Schafer 7000 w/Audiofiles, lvl 1A software, DAT backup, xtras, good cond, \$3500. Jim, 814-255-4186.

Want To Buy

Need bearings for 16m Insta-Carts, shafts, old Insta-Carts @ reasonable prices. S Smith, KBFV, Box D, Bellingham WA 98225. 360-734-8555.

CART MACHINES

Want To Sell

BE Splicefinder eraser, less than 1 yo, seldom used, \$750. R Statham, 407-692-1000.

ITC Delta stereo cart machines (4), w/all tones, xln cond, \$600/ea; plybk printed circuit cards (3) for ITC SP cart machines, \$85/ea; cue printed circuit cards (3) for ITC SP plybk machines, \$85/ea; ITC Delta rcd/plybk cart machine w/all tones, xln cond, \$900; capstan motors (3) for ITC 750 R-R machines, factory recond, \$150/ea; plybk, rcd amp & cur bias cards for ITC 750 R-R machines, \$100; printed circuit cards (assorted) for SMC DS-20 switcher & model 452 Carousels, \$50-\$150. R Statham, 407-692-1000.

Audicord mono cart machine, excellent condition, \$650. 806-372-5130.

WANTED USED CART MACHINES

FIDELIPAC CTR10 & CTR100 SERIES
CASH PAID OR WILL ACCEPT IN TRADE
CALL FIDELIPAC AT **609-235-3900**

BE 5400C PB stereos (2), excellent condition, \$2500/ea. S Cooper, WRIC-FM, POB 838, Richmond VA 24641. 703-964-4066.

Scully L50313-9 not working, probably parts only, record/play with roller cabinet, BO; ITC triple deck mono cart machine, heads OK, motor weak, \$300. R Wittick, 916-283-1370.

SpotMaster stereo plyr, BO; Tapecaster 700RP, BO; ITC stereo rcd, BO; ITC mono rcd, BO; ITC ESL-4 plyr, BO; ITC Encore RP, BO; ITC SP, BO. WYKS-FM, 904-331-2200.

Great Prices on original equipment tape heads for ITC, BE, Fidelipac, Otari, Tascam & others!
(804) 984-4255



Tapecaster X-701 mono PB, xln cond, very clean, guaranteed w/manual, \$295. K Lamson, 510-447-7405.

Tapecaster cart machines (2), 1 R/P & 1 ply only, both have new motors w/about 25 hrs use, BO. D Kirby, Rhapsody Prod, POB 1543, Palm Springs CA 92263-1543. 619-320-1782.

BE 5300C tripledeck, stereo, PB, mint less than 50 hrs, BO. R Kaufman, Pams Prods, POB 462247, Garland TX 75046. 214-271-7625, after 3PM CDT.

ITC System 99B stereo record/play; tones, ELSA, auto head: \$1200/firm. C Scott, WKYU-FM, (502) 745-5489.

Want To Buy

ITC, BE, Fidelipac cart machines: single, triple, mono, stereo, play & record/play. Call M O'Drobinak @ 619-758-0888.

CASSETTE/TAPE RECORDERS

STUDER SERVICE SPECIALIST

Thousands Served • Unbeatable Rates
Precision Capstan Resurfacing
Audio Advantage
Tel (615) 742-3834
PRICE-QUALITY-SERVICE
Let Us Prove It

Want To Sell

Ampex parts, xport & electronics parts, from 350 units to MM1200 rcds, some new, most used, in super cond, motors, headstacks, guides etc, lots of stuff; also 3 Scully 280 electronics comp, \$100/ea. M Gore, 415-469-0136.

Infonics SRC-4 1/4" reel to 4 stereo cass dupe, new rollers, belts, capstan shaft sleeve, works good for its age, service manual incl, \$1000/BO. F Badaeux, The Musik Factory, 1812 Procter St, Port Arthur TX 77640-6746. 409-982-7121.

Revox B77, hardly used, perfect, 3 3/4-7 1/2 ips, 2-trk, \$650. B Meuse, Muse Audio Arts, 600 Rainbow Dr #107, Mountain View CA 94041. 415-969-2433.

Studer B-67, 7.5/15/30 ips, 1/4" 2-trk, compl w/remote cntrl, manual & xport cover, fully svcd, xln cond, good heads, \$1600/BO. R Streicher, 818-359-8012.



706 Rose Hill Drive Charlottesville VA 22901



RFC-1/B shown above w/ 8 channel relay panel

Call us for the Best New & Completely Rebuilt Equipment! (804) 984-HALL (4255) Fax: (804) 984-FAXX (3199)

The RFC-1/BHV3 provides transmitter power control, has alarm dial out for 6 numbers, and provides up to 64 channels of control & metering. Up to 8 action sequences and 80 timed functions can be stored in non-volatile memory. Three levels of security codes are standard for multi-user sites. Data I/O port to a computer or printer is possible with the optional RS-232 adaptor. Only your imagination will limit your uses for the RFC-1/B! Best of all is the actual sampled human voice on the new HV3 model. Call your HE sales engineer for a free booklet or fax describing all of the RFC-1/B's possibilities!

Optional Sine Systems Accessories:

- | | |
|---------------|---------------------------------------|
| AFS-1 | Dual Channel Audio Failsafe |
| RS-232 | Serial Data Adaptor |
| SP-8 | Heavy Duty Surge Protector |
| ACM-1 | AC Current Monitor (for tower lights) |
| RK-3 | Rack Mount Kit; mounts up to 3 units |
| TM-1 | Temperature Monitor Unit |
| DAI-RP | Relay Panel Kit |
| DB-1 | Delay Board for DAI-1 (50 milisecond) |
| SU-5 | Update your RFC-1 to real human voice |

CASSETTES/RECORDERS...WTS

Uher CR-134, doesn't work, clean w/manuals, \$25. G Hultman, Hultman Media Svcs, 300 Limp Creek Rd, Grants Pass OR 97527. 503-474-6466.

REVOX PARTS/SERVICE

Cassette-CD-Open reel NOS PR99 repros. CALL Capstan resurfacing, ALL BRANDS
JM TECHNICAL ARTS
30 Music Sq. W. #156
Nashville, TN 37203 (615) 244-6892

Ampex 600 1/2-trk 7.5 ips 7" reel, good cond, will trade for Magnecord 748 or 1048 10.5" reel in good cond, \$100+shpg. E Lightman, WEDL Radio, 550 Merchant St, Ambridge PA 15003-2463. 412-266-2802.

Ampex 440 1/2" 4-trks (2) w/stands, BO; Ampex 440 stereos (2) in stands, BO; Ampex 400 monos (2) in stands, BO; Ampex ATR 800 for parts w/stand, BO; Ampex 440 xports (3), BO; Ampex 440 wood stands (3), BO. K Alford, 206-285-2295.

MCI JH-110B stereo in roll-around console, BO; Otari MX-5050 MKIII 8-trk, BO; Otari MX-70-16 w/compl remote, BO; Scully 280 stereo in roll-around, BO. B Hildebrand, 314-427-2727.

MX5050 BII-2 1/4" 2-track, completely rebuilt, excellent condition, 90 day warranty, BO. 415-589-5206.

Revox PR99R-RB (4) w/25 Hz, xint cond, \$600/ea or \$2000/all. L Mariner, KDLK/KLKE Radio, 107 Center D, Del Rio TX 78840. 210-775-9583.

Otari MX50N - mint condition, less than 100 hours use, \$1500/BO. 609-737-2586.

Otari 5050-SHD 8 track 1/2" newly rebuilt, heads have full, life left, \$1800. W Gunn 619-320-0728.

Sony TC-630 early 70s stereo, very good cond, sound working order, \$175+shpg. M Tam, Multi Path Prod, 7110 Cody St, Shawnee KS 66203-4332. 913-631-9638.

Tascam DA-30 DAT recorder, like new condition, less than 100 hrs, never rack mounted, BO. T Alexander, WDOK-WRMR, 1 Radio Ln, Cleveland OH 44114. 216-696-0123.

Teac X7R R-R, like new, \$400. B Pitts, WJBY, POB 930, Gadsden AL 35950. 205-442-1222.

Telex stereo Copyette 1 to 1 cass copier, new PB head, manuals, good cond, \$300. F Radeaux, The Musik Factory, 1812 Procter St, Port Arthur TX 77604-6746. 409-982-7121.

CLEAN PATCH BAYS
NO DOWN TIME

VERTIGO BURNISHERS AND INJECTORS RESTORE ORIGINAL PERFORMANCE TO YOUR PATCH BAYS
\$34.95 Ea.
VERTIGO RECORDING SERVICES
12115 Magnolia Blvd. #116 818-907-5161
North Hollywood, CA 91607 fax 818-794-3763

One Otari 4 Track Tape Recorder...BQ-II series...good condition...might need some new heads...\$2400.00. Call 806-372-5130.

Otari Mark II-IV 1/2" 4-track, multi-track, mint, less than 50 hours, Best Offer. R Kaufman, Pams Productions, POB 462247, Garland TX 75046. 214-271-7625, after 3PM CDT.

Scully '100' recorders, record/play amplifiers, 8, 16, 24 track heads. Sequoia Electronics, 4646 Hounds-haven Way, San Jose CA 95111. 408-363-1646.

Tascam ATR 60 8 trk w/stand, remote, \$2250; Otari 5050-8 new heads, rebuilt, \$1595; Ampex 440E-8, \$1950; Tascam 25-2, \$495; Ampex ATR700, \$495; Scully 16 trk 2", \$2950; Tascam 52 top of line, \$650; M79-24 fully rebuilt, \$9,500; Tascam locator for 85-16, \$375; Fostex E22 1/2" timecode deck, \$950; Fostex A80 8 trk w/45D mixer, \$995. W Gunn, POB 2902, Palm Springs, CA 92263. 619-320-0728.

SCULLY TAPE RECORDERS PARTS AND SERVICE
SEQUOIA ELECTRONICS
(408) 363-1646
FAX (408) 363-0957

Tascam 32 2-chnl rcds/repros (2), very good cond, \$1000/ea/BO. R Wittick, 916-283-1370.

Want To Buy

Slow rcdg R-R machine for station log. 809-352-7440.

Elmo DR-1 & SR-1 cass tape rcd-s; Almo GS-1200 stereo projectors; Fisher Price PXL-1000 video rcd-s; Bolex & Arriflex 16mm cine equip. Henry, 914-949-5920.

Ampex ATR100 taperecorders for parts. Circuit cards, heads, motors, machine parts, or electronic parts. Call 818-907-5161.

CD PLAYERS

Want To Sell

Sony CDK-006 juke boxes (3). 2 totally refurbished to factory specs, 3rd in svc & working properly, \$1395/ea for refurbished units, \$995 for other. Jim, 717-692-2193.

COMPUTERS

Want To Sell

Roland DM-80 hard disk edit syst w/8-chnl rcd, cntrlr, faders, QUERTY keyboard, MIDI, 2x1.2 Gig SCSI drives, analog-digital I/O, SMPTE, chase etc, \$7500/BO; Turtle Beach 56k HD edit 386/40 EISA computer w/8MB RAM, 670, 1GB, 5.25", video card + 19" NEC XL monitor, digital I/O MIDI box, fully working, many gold/platinum CDs on this syst, \$1250. T Dorsey, 615-259-4452.

CONSOLES

Want To Sell

Langevin Discrete consoles, BO; AM-4 console, BO; AM-1/AM-2 mixers & many parts, BO; P Barlow, 909-613-1323.

Quantum Audio Lab QM-8P console w/pwr sply & manuals, as is, \$495. David C, KYKZ, POB 999, Lake Charles LA 70602. 318-439-3300.

Used input mods for Arrakis 12,000 console, orig style, not Turbo version faceplate, TPM1 25, TRS-2, DA-2, TPM3-2, TPM2-2, TCRM1-1, also blank mod covers, 7 avail, BO. E Monskis, 717-653-0800.

Ampro Microtouch 5-chnl stereo, good condition, \$500; Russco 505 5-chnl mono, good condition, \$400. M Persons, KLKS Radio, 402 Buffalo Hills Ln, Brainerd MN 56401.

Autogram AC-8 stereo, xint cond, \$2000. 510-895-6358.

Gates Yard board, recently gone thru with new switches & condensers, has had proof, also compl set of new connectors to connect all inputs to board, BO. D Kirby, Rhapsody Prod, POB 1543, Palm Springs CA 92263-1543. 619-320-1782.

Shure M267 4-chnl mic mixer, XLR inputs, good cond, \$275. B Taylor, 617-266-4220.

Soundtrax 16-chnl production console, \$950/BO. B Pitts, WJBY, POB 930, Gadsden AL 35950. 205-442-1222.

Tascam 4-channel mixer, recorder model ministudio, Porta-One, excellent condition, guaranteed with manual, \$295. K Lamson, 510-447-7405.

Ramsa 820 20x8x16 with meter bridge, \$1795; Quantum 23x16x24 as used by LA Philharmonic, \$3750. W Gunn, POB 2902, Palm Springs CA 92263. 619-320-0728.

Want To Buy

API, Neve whole or parts, working or not. T Coffman, 619-571-5031.

Neve consoles: any condition or parts Also: UA, UREI, Teletronics, Fairchild, RCA, Pultec, API, any TUBE GEAR or COMPRESSORS Call 201-656-3936 or fax 201-963-4764

Howe 7500 manual. G Jacques, KBZR-FM, 7434 E Stetson Dr #265, Phoenix AZ 85251. 602-423-9255.

DISCO-PRO SOUND EQUIPMENT

Want To Sell

Roland RSS-8048 sound space proc, 4 in-8 out 360 degree-3D of 4 mono signals, with case, \$7500; Roland R-880 digital reverb with remote & R Nichols & G Massenburg prog cards, like new, 2 avail, \$1750/ea. T Dorsey, 615-259-4452.

Fostex 3180 reverb unit, will trade for UREI, Cooper Time Cube model #920-16. E O'Brien, Imperial Sound, 383 N Studio St, Terre Haute IN 47803-9773. 812-877-2663.

JBL 4410A(L) 3-way studio monitor speaker, used approximately 8 hours, mint with warranty card, \$298+shipping. R Evans, 704-524-7983.

FINANCIAL SERVICES

EQUIPMENT LEASING

Excellent rates • Fast approval

Call for quote

Jon Fugler, Broadcast Innovations (805) 594-1235

EQUIPMENT FINANCING

ON ALL RADIO EQUIPMENT

- Easy to qualify
- Fixed-rate, long-term leases
- Any new or used equipment
- 100% financing, no down payment
- No financials required under \$50,000
- Refinancing existing equipment

ENF EXCHANGE NATIONAL FUNDING

Call Mark Wilson (800) 275-0185

FINANCING

LOANS BY PHONE (800) 699-FLEX

- We finance all types of Broadcasting Equipment
- Flexible Credit Criteria
- Flexible Payment Plans
- No Down Payment, No Payments For 90-Days Available

To apply or request additional information call Jeff Wetter.

FLEXLEASE, Inc.

LIMITERS

Want To Sell

Orban 424A gated compressor/limiter/de-esser, \$325. J Mueller, Family Stations Inc, 290 Hegenberger Rd, Oakland CA 94621. 510-568-6200 x240.

Texar Audio Prisms (2) w/Optimod card, will trade for S/A 7300 Sedat 4 card, BO. D Solinske, WWRM, 877 Exec Ctr Dr W, St Petersburg FL 33702. 813-576-1073.

Want To Buy

Gates, Inovonics, Fairchild, RCA, UREI, Teletronics, all types, solid state & tube. T Coffman, 619-571-5031.

Fairchild 670 or 660 tube compressor/limiter, Teletronics LA-2A tube compressor/limiter or UREI LA-3A solid state compressor/limiter, call after 3PM CST. 214-271-7625.

MICROPHONES

Want To Sell

AKG D-140 dynamic cardioid mics, \$225/pair. R Streicher, 818-359-8012.

Sennheiser 421s (3) w/boom clamp & wind screen, xint cond, \$200/ea. 813-732-5339.

Sennheiser MKH-40 cardioid & MKH-30 figure-8 w/MS clip & shock mount cradle, \$1600. D Glasser, Airshow, 7021 Woodland Dr, Springfield VA 22151. 703-642-9035.

AKG C414 TL II, mint cond, orig box, case & manuals, \$1200. Mark S, 605-374-3424.

Electro-Voice 635A dynamic, omnidirectional mic w/stand adapter, \$95. B Taylor, 617-266-4220.

Shure 561 mic on Shure 540A desk stands, many avail, fair to good cond, \$10-\$50/ea. Al, 712-362-4119.

Shure 330 uni-directional ribbon, very clean, in red Shure bag, \$75. G Hultman, Hultman Media Svcs, 300 Limp Creek Rd, Grants Pass OR 97527. 503-474-6466.

Sony ECM377 large dia. cond mic, \$495; RCA 77DX w/new ribbon, Crown GLM200 lavalier like new, \$125. W Gunn, POB 2902, Palm Springs CA 92263. 619-320-0728.

Want To Buy

AKG 451-EB, AKG 460-EB, EV RE-27, more. T Coffman, 619-571-5031.

Inexpensive hand-held wireless mic w/receiver. Al, 712-362-4119.

Old mics, call plates, on-air lights. J Phillips, 414 Washington Ave, Defiance OH 43512. 419-782-8591.

RCA ribbons, AKG 451's, Neumann KM84's, U87's AKG 414's. W Gunn, POB 2902, Palm Springs CA 92263. 619-320-0728.

RCA 77DXs/44BXs ribbon, chrome/TV grey, gd cond, BO. R Kaufman, Pams Prods, POB 462247, Garland TX 75046. 214-271-7625, after 3PM CDT.

77-DX's, 44-BX's, WE KU-3A's On-Air lights, recording lights & audition lights. Top price paid. Fast response. Bill Bryant Mgmt, 2601 Hillsboro Rd, G12, Nashville TN 37212. 615-269-6131, FAX: 615-292-3434.

MISCELLANEOUS

Want To Sell

75kW gen, Fermont model MEP006A, 6 cylinder turbochrgd, self-contained 50 gal tank, load tested, 3 phase, 4 wire, 1,575 hrs, no autostart, BO. Paul, WYMG Radio, 217-546-9000.

KEM 6 plate 16mm #1950 laser disc plyrs, Pioneer 4400/6000/6200/7820 or Sony 2000, \$250/ea; many various 3/4" Sony or JVC plyrs & rcds, \$150-\$350; Nagra 3 for parts, good heads, \$200. B&H projectors 1592c or Jan, \$325/ea; plus many odd items. Peter or Mark, 212-719-2744.

IBM System 36 mainframes (2), BO; Telrad office phone syst w/30+ phones, BO; RCA 10-bay FM antenna (95.7) w/radomes, BO. K Alford, 206-285-2295.

Onan/Cummins 30 kW gensets (2) diesel, one 800 hrs, \$7500; one 1500 hrs, \$9500; day tank w/auto oil level cntrl, \$16,000/all. R Wittick, 916-283-1370.

AUDIO TRANSFORMER MAGIC
9K-600-6
audisar
P.O. Box 1561, Bellevue, WA 98009
206-454-2040

Circle (47) On Reader Service Card

Singamo G4 .00062/30kV mica capacitor for xmtr or ATU, \$45+shpg; General Radio Type 5 3 ganged Variac, 5 amp, 0-135VAC, \$35+shpg. R Evans, 704-524-7983.

Spring cleaning has arrived, 3 pg list of equip incl R-Rs, audio proc & tape NR for sale, call fax or e-mail for list & method of reply. C Scherer, CBRE, WMMS/WHK/WMJ, 216-781-9667, 216-771-1007 FAX. chriss@wmms.com.

Want To Buy

Jazz record collections, 10" LP/12" LP be-bop, swing, dixie, highest prices paid. B Rose, Program Recdgs, 228 East 10th, NYNY 10003. 212-674-3060.

MONITORS

Want To Sell

Belar FMM-1 & FMS-1 monitor & stereo monitor, \$300/both. M Gollub, WMJS, POB 547, Prince Frederick MD 20618-0547. 410-535-2201.

Belar AMM-2 mod monitor w/remote meter panel, works fine, \$1000. R Wittick, 916-283-1370.

TFT 730-A SCA monitor, \$100; 7610/7630 remote, \$200. D Gilliam, 1435 S Dobson, Mesa AZ 85202. 602-969-3413.

DISTRIBUTOR DIRECTORY

The following distributors serving the broadcast industry would be glad to help you with any of your requirements.

CORNELL-DUBILIER MICA CAPACITORS

FROM STOCK

JENNINGS VACUUM CAPACITORS

FROM STOCK

JENNINGS VACUUM RELAYS

SURCOM ASSOCIATES

2215 Faraday Ave., Suite A
Carlsbad, California 92008
(619) 438-4420 Fax: (619) 438-4759

...country, top 40, news, urban, talk, jazz, the classics, mixed bag...

RADIO! The beat goes on!

CROUSE-KIMZEY OF ANNAPOLIS

tops in broadcast equipment

1-800-955-6800

ask for Kathleen

MONITORS...WTS

Motorola AM stereo monitor, on your frequency, \$3500. 806-372-5130.

RECEIVERS & TRANSCEIVERS

Want To Sell

SCA RECEIVERS—ALL TYPES

Reading Service / Ethnic / Data Professional / Table Will work to meet your receiver needs

DAYTON INDUSTRIAL CORP. (Manufacturer)
2237 Industrial Boulevard
Sarasota, FL 34234
Tel: 813 351 44545 FAX: 6081

REPAIR SERVICES

DENON CD CART PLAYER REPAIR

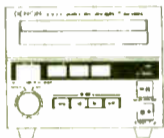

- Same Day Service
- Reasonable Rates
- We honor Denon Warranty

AUDIO VIDEO SERVICE LABS, INC.
800-765-4434
Quality Denon Service Since 1991
"The Best Kept Secret in Broadcasting"

REMOTE & MICROWAVE EQUIPMENT

Want To Sell

Burke ARC-16 studio cntrl unit, BO. J David, KMPL/KS98, POB 907, Sikeston MO 63801. 314-471-1520.

RENT IT HERE! Call Steve Kirsch for Details

COMREX 1, 2 & 3-Line Extenders Switched 56/ISDN Systems
TELOS Zephyr Digital Phone Hybrids
CCS "PRIMA" CODECS PP-410 Automatic Mixers
SHURE REMOTE AUDIO PACKAGES

SILVER LAKE AUDIO • 516-623-6114 • FAX: 516-377-4423

Marti RMC-15T transmitter unit, Marti RY-15 transmitter unit relay interface, Marti RY-30 transmitter unit relay interface to expand up to 30 channels, Marti RMC-15S studio unit, RMC-30S studio unit to expand up to 30 channels, may be used with telco or SCA. RY-30 & RMC-30S have never been used, all excellent condition, \$1595. David C, KYKZ, POB 999, Lake Charles LA 70602. 318-439-3300.

Marti RPT-15 UHF xmtr, 2 frequency with encode, BO; Marti CR-10 UHF receiver, 2 freq with decode, BO. B Hildebrand, 314-427-2727.

WE RENT

TELOS ZEPHYR

NEW CCS "Prima" Codecs Stereo RPU, NO License
Frank Grundstein Audio/Video Consultants
COMREX 3 line extender
610-642-0978

Moseley TRL-1 system, Moseley MRC-1600 RC system, TFT 7700 composite STL transmitter, Elgin phone coupler EC-30AR, BO. 510-895-6358.

Gentner EFT-3100 3-line frequency extenders, like new, \$5000/pair. Steve Kirsch, Silver Lake Audio, 2590 Hillside Ct, Baldwin NY 11510. 516-623-6114.

Symetrix TI-101 phone hybrid, excellent condition, \$350. M Persons, KLKS Radio, 402 Buffalo Hills Ln, Brainerd MN 56401.

SOFTWARE/ DATABASES

Want To Sell

RADIO STATION DATABASE: Obtain info & print mailing labels on 11,950+ US stations. Gives phone/fax. Numerous coarches (calls 24 formats state/city/markets etc.) Available MS-DOS or MAC, only \$129.95 incl quarterly updates! VISA/MC orders 1-800-626-2360 ext 300
BBH Software, Inc.
Info 303 592 3780 Fax 303 363 8742
Circle (70) On Reader Service Card

SATELLITE EQUIPMENT

Want To Sell

Comstream ABR200, used 2 yrs, good cond, \$1500. K Allgood, KAJK, 337 W 15th St, Eureka CA 95501. 207-445-3699.

Scientific Atlanta Dat cards (3), BO; Phasemaster 10,000 W snl to 3 phase converter, very good cond, \$2000. R Wittick, 916-283-1370.

UNIVERSAL SPCX XE-1000

NEW!

SCPC BROADCAST AUDIO RECEIVER

New, affordable, frequency-agile receiver, direct channel entry by keyboard, selectable companding 1:1, 2:1, 3:1, wide/narrow bandwidth, de-emphasis selectable, 950-1450 MHz, line output 600 ohms, muting, transponder agile, LNB power supply, 50 channel memory, full baseband output, high-quality audio. Every needed feature at a sensible price (lowest in the industry). Write or call for full information on this quality receiver—the answer for your station. Networks call for prices.

Phone: (614) 866-4605 Fax: (614) 866-1201

UNIVERSAL ELECTRONICS, INC. 4555 Groves Road, Suite 12 Columbus, OH 43232
Communications Specialists Phone: (614) 866-4605 Fax: (614) 866-1201

SATELLITE EQUIPMENT

Want To Sell

BUY

Satellite Systems pays cash for Westwood One Radio Networks satellite receivers!

REPAIR

Satellite Systems repairs all major brands of satellite equipment, including the Fairchild Dart 384 and Scientific Atlanta. Our turn-around time averages 24-hours. Plus, we provide pre-and post-service support along with a 90-day warranty.

SELL

The Ariel Digital Satellite Receiver

- 5 card slots
- 1 year warranty
- Compatible with Fairchild Dart 384
- Excellent technical support

SATELLITE SYSTEMS

Satellite Equipment for Radio

615 East Brookside
Colorado Springs, CO 80906
(719)634-6319 Fax: (719)635-8151

STATIONS

Want To Sell

1000 watt AM located in Southern New England; incl all studio and xmtr equip; 400 K or BO. Serious buyers call 1-800-845-0338.

10K AM in North Central AZ. 520-774-0864.

Full Time clear channel 50 KW daytime, reduced power nights in capital city. 501-470-1525 (nights).

Want To Buy

Bdct group skg FM commercial sta to lease/purchase in IN, IL, OH or MI. Mr Stevens, POB 428267, Evergreen Park IL 60642-8267.

STEREO GENERATORS

Want To Sell

Motorola C-QUAM gen on 620, sell or trade, BO. D Solinske, WSUN, 877 Executive Ctr Dr, St Petersburg FL 33702. 813-579-3316.

TAPES/CARTS/REELS & CD's

A&D

Cart Rebuilding

Do Bad Carts Have Your Temperature Rising?

Let A&D clean, load & pack your carts. They'll be serviced within 10 working days! Guaranteed!

3706 Vold Ct. 715-835-7347
Eau Claire WI 54701 Fax: 715-835-1151

SERVICES

LOCATION SERVICES IN THE UNITED KINGDOM

Planning remotes from the U.K.? we provide a comprehensive service

- we organize venues for your shows
- we provide temporary equipment
- live links via ISDN/Switched 56
- experienced radio engineers
- we help you line up guests

Contact London (44) 81 442 8900
Good Morning from Great Britain
Wired for Sound Ltd., London N15

REMOTE EQUIPMENT RENTALS

COMREX and GENTNER

1, 2 & 3-Line Extender Systems
Now With The New TELOS ZEPHYR
MARTI VHF/UHF RPU Systems
ISDN & Switched-56 Systems
Call or FAX Dwight Weller

WELLER AUDIO-VISUAL ENGINEERING

Baltimore, Maryland
Phone: (410 or 800) 252-835 FAX: (410) 252-4261

Tower Sales & Erection

Turn-key Development Installation & Maintenance
AM/FM Broadcast TV
Marine, S, J, J, J, J
Antennas & Towers

TOWERCOMM
Communications Specialists

Ben Wall President
4017 Truask Dr
Baltimore, MD 21214
(410) 781-3106
Fax: (410) 781-6341

G.K. PAINTING CORP.

Industrial & Commercial Painting
Sandblasting & Waterblasting

Special Coating
(specialize in radio towers)

703-978-1824
Fax: 703-978-1824
5141 Bradford Drive, Annandale, VA 22003

Consulting Communications Engineers

- Station improvement and modernization
- FCC Applications and Field Engineering
- Frequency Searches and Coordination
- AM-FM-CATV/ITFS-LPTV



OWL ENGINEERING, INC.
1-800-797-1338

1306 W. County Road, F, St. Paul, MN 55112 (612)631-1338 Member AFCCF

EVANS ASSOCIATES

Consulting Communications Engineers

TV • FM • AM • ITFS • Satellite
FCC Applications, Design and Field Engineering

Video Data/Voice • Light Fiber & Microwave • Wide-Area Networks & STL's

210 S. Main Street
Thienville, WI 53092
(414) 242-6000 • FAX (414) 242-6045
Member AFCCF

HARRIS ALLIED PARTS AND TECHNICAL SUPPORT

Now we can be reached online via e-mail.
TSUPPORT@HARRIS.COM
For your parts needs or with any technical problems you're having.

Propagation Services

- FM Studies
- Population Studies
- FCC/FAA Databases
- PC Software

Communications Data Services, Inc.

800-441-0034
703-534-0034
fax 703-534-7884
6105-E Arlington Blvd.
Falls Church, VA 22044

DON'T GAMBLE WITH YOUR ADVERTISING DOLLARS!



Advertise in Radio World and reach 22,000+ broadcast professionals.

Call Simone TODAY!
800-336-3045

PC - SOFTWARE

AM/FM TV Search Programs
Contour Mapping-STL Paths
RF HAZ-1990 POP Count
FAA Tower-Draw Tower

Doug Vernier
Broadcast Consultant
1600 Picturesque Dr
Cedar Falls, IA 50613

800-743-DOUG

North America RF & Audio

Mirkwood Engineering Services

Broadcast and Telecommunications Consultants

Multidiscipline Engineering and Planning Firm including • Application & Allocation Services
• Project Engineering & Construction Management • Site Acquisition
• Rural & Remote Site Installations
• Field Service • Studio Design & Installation
50 Park Ave. Claremont, NH 03743
(603) 542-6784

W. LEE SIMMONS & ASSOC., INC.

BROADCAST TELECOMMUNICATIONS CONSULTANTS

5 Gracefield Road
Hilton Head Is., SC 29928
1-800-277-5417
803-785-4445
FAX: 803-842-3371

PC SOFTWARE FOR BROADCASTERS: TRAFFIC, BILLING & ACCOUNTING

Powerful, inexpensive. Works with automated, satellite or live operations. INTERFACES with popular DIGITAL AUTOMATION SYSTEMS. Try it for 60 days, no obligation.
Absolute Broadcast Automation
Naples, Florida (813) 643-3689

FM TRANSMITTER HELPLINE

24 Hour Emergency Phone Consultation
Specializing in:
• CCA/CSI
• Arcing Problems
• All FM Transmitters
MBE Enterprises
Phone: 818-772-8017
Pager 818-604-7925

MULLANEY ENGINEERING, INC.

Consulting Engineers

- Design & Optimization of AM Directional Arrays
- Analysis for New Allocation, Site Relocation, and Upgrades AM-FM TV LPTV Wireless Cable (MDS/MMDS/ITFS/OFS)
- Environmental Radiation Analysis •Field Work
- Expert Testimony

9049 Shady Grove Court
Gaithersburg, MD 20877
Phone: (301) 921-0115
Fax: (301) 590-9757



Where In The World Are You?

Reach radio professionals worldwide by advertising in **Radio World's** international edition. Call for more information.
800-336-3045

MLJ

Moffet, Larson & Johnson, Inc.
Consulting Telecommunications Engineers

Two Skyline Place, Suite 800
5203 Leesburg Pike
Falls Church VA 22041

(703) 824-5660
FAX: 703-824-5672

Member AFCCF

T. Z. Sawyer Technical Consultants

AM-FM-TV-LPTV
1-800-255-2632
FAX: (301) 913-5799
6204 Highland Dr.
Chevy Chase, MD 20815

- FCC Applications & Exhibits
- Experimental Authorizations
- AM Directional Antennas
- High Power Antenna Arrays
- Frequency Studies
- STL Applications
- Class Upgrades
- Station Inspections

TAPES/CARTS/REELS...WTS

Scotch radio prod facility deleting classic rock library on vinyl, 7 & 10.5" reels, \$300/BO. 703-578-3014.

Audiopak A-2, lg quantity of brand new, never used carts, music lengths, various sizes, \$1.50/ea. M Gollub, WMJS, POB 547, Prince Frederick MD 20618-0547. 410-535-2201.

Pams Jingles ref tapes, 1951-1976, Best Offer. R Kaufman, Pams Productions, POB 462247, Garland TX 75046. 214-271-7625.

Scotch radio production facility deleting classic rock library in vinyl, 7 & 10.5" reels, \$300/Best Offer. 703-578-3014.

TAX DEDUCTIBLE

Want To Sell

Bdct equipment needed for university, anything useable, will pay shipping. R Kafarski, WONY, MOC West St, Oneonta NY 13820. 607-436-2507.

Non-comm/ed station looking for 250' tower with lights, will disassemble & give tax receipt. Jarel, KADU 90.1 FM, 218-263-3000.

TEST EQUIPMENT

Want To Sell

Tektronix 492 10MHz-40GHz spectrum analyzer, port with all mixers & antennas, \$900. B Nagy, KOOP, 505 San Jacinto, Austin TX 78765. 512-471-4286.

HP 331A distortion ant with manual, \$350+shpg; HD 204C audio oscillator with manual, \$150+shpg; HP 403B AC voltmeter with manual, \$125+ shpg; HP 120B oscilloscope with manual, \$100+shpg; HP 5245L counter, \$100+shpg; HP 5328A counter, \$150+shpg. E Luttrell, WIDS, RR6 Box 175, Liberty KY 42539. 606-787-9622.

General Radio 724-A absorption wave meter, 16 kHz-50 MHz, 7 plug-in coils, as is in wood case with instructions & schematic, \$50+ shpg; General Radio 1931 distortion analyzer, extra clean, reworked & ready to use, \$100+shpg; 500 W dummy load, \$50+shpg; Stoddart NM-30 tube type field strength meter with case & manual, 20 MHz-40 MHz, spare parts mod, Tektronix power supply, \$200+ shpg; various HP meters & military audio & RF generators, Best Offer. R Evans, 704-524-7983.

Heathkit tube type FM tuner compack, \$20+shpg. R Evans, 704-524-7983.

TRANSMITTERS

Want To Sell

Marti RPT-25-R transmitter, tuned to 455.0875, no power cord, unit came with station when purchased 8/92, used once, unsure of actual time, good shape, \$350. K Riggs, KTBR, POB 1760, Roseburg OR 97470. 503-672-4427.

CSI 1980 transmitter AM, 1 kW, like new, BO. J Wood, FAX 807-840-1588.

Bauer 607 1 kW FM transmitter, BO; Gates (Harris) FM-10B 10 kW FM with TE-3 exciter with Optimod wideband input card, Best Offer; RCA BTA-50H 50 kW AM, removed from service 11/94, Best Offer. R Meyers, Sound Masters Recording, 4700 SW 75 Ave, Miami FL 33155. 305-264-5963.

Continental AM transmitters (2), 1 kW on 1240 kHz, 1 on 1340 kHz, 1 only new 65 W LPB plus ant on 1340 kHz, cheap. B Gillespie, 604-442-5844.

Harris FM 2.5 k with MX-15 exciter spares, like new, \$12,500; ERI 2-bay low power Rototiller, 107.1 mHz, \$2200; Harris/Gates FM 2.5H3, ok condition, \$5995. Chris 816-628-5959.

Cetec-Sparta 602A 2.5 kW FM xmtr tuned to 100.9 MHz with exciter manuals, new final, \$8500; Jampro 3-bay antenna, 100.9 MHz with radomes, \$2500; package, \$10,000. R Mason, WKEY/WIQO-FM, 508 W Oak St, Covington VA 24426. 703-962-1133.

Used equipment for sale: Belar SCM-1, Belar RFA-1, Belar FMS-1, Belar FMM-1, Moseley MRC 1600 system, TFT EBS receiver/generator, Gentner patch panel, and Harris racks. Call Transcom Corporation 800-441-8454 or 215-884-0888.

CCA AM 10,000 1974 in Albuquerque, 10,000W AM transmitter on 1000 kHz, good condition, \$10,000; Harris FM-2.5K in Albuquerque, 2500W FM transmitter on 97.7 MHz, including low pass filter & MS-15 exciter, good condition, \$9500. M McNeil, Guardian Comm, 800 Compton Rd #33, Cincinnati OH 45231. 513-931-8080.

Want To Buy

50 kW AM transmitter. A Weiner, 207-985-7547.

Used LPB AM carrier current, or Radio Systems, must be in good shape, also used LPB FMS 2000 cable FM mod. G Gaula, KLBN-AM, POB 1058, Lebanon OH 97355-0967. 503-258-2190.

Want to buy FM xlators. E Kelley, 915-366-3711.

BEXT
Great new or demoed FM transmitters, exciters, amps and STL's, some at discount prices
USA 619-239-8462
FAX: 619-239-8474

Bext T-800 transmitter, less than 3 years old, new tube & spare used tube, \$4500. 505-538-3396.

QEI amplifiers, exciters and stereo generators. All are reconditioned and are tuned and tested on your frequency. 6 month warranty is included. If you want quality used equipment, call or fax 609-232-1625 and ask for Bob Brown.

MARATHON PRODUCTS COMPANY

Audio Cartridge Rebuilding Division

Rebuilding/reloading, like new, all brands, any length up to & including 3.5 minutes, \$1.95 for Standard Tape, \$2.15 ea. for HOLN Tape. FOB out plant, 48 hrs delivery. (New rate effective 3/1/95)

New NAB Marathon cartridges prices on request.

35 Years professional experience!
Lifetime member AES R.D. MYERS Sr.
Manufacturers of Audio Devices,
Continuous Tape Mag.

69 Sandersdale Rd. Charlton, MA 01507
1-508-248-3157 or 1-508-853-0988

Circle (93) On Reader Service Card

1-800-TAPE WORLD or 1-800-245-6000
We'll beat any price! \$1.95 SHIPPING • FREE CAT.

SONY	MAXELL	TDK	FUJI
DAT-120 7.49	DAT-120 7.99	DAT-120 6.99	SVHS-120 6.99
DAT-120 9.99	KL115-90 1.99	SA-90 1.99	74 10-99
120V 2.09	KL115-90 2.09	SA-90 1.99	DR-1-90 6.99
1-750HG 3.99	120HG 2.79	1-120HG 2.49	DENON
JVC T-120 1.39	S-120 6.99	H-8-120 5.99	DAT-120 6.49
JVC S-120 5.99	S-120 8.99	CD-120 9.99	DAT-60 4.99

TAPE WORLD 220 SPRING ST. BUTLER, PA 16003. FAX 412-283-8298
OVER 500 DIFFERENT. SAME DAY SHIPPING. M-F, 8-5

30-40 carts with new tape, some require new foam pads, Best Offer. D Kirby, Rhapsody Production, POB 1543, Palm Springs CA 92263-1543. 619-320-1782.

10 1/2" audio tapes, 110 A/C automation reels, 90 oldies reels, \$1.50/each+shipping. J Egloff, 513-922-7049.

Want To Buy

Fidelipac/Audiopak Mastercart II gold or AA-4 light blue in 2:30 through 4:00 lengths, must be in very good condition, call after 3PM CST. 214-271-7625.

ACTION-GRAM

EQUIPMENT LISTINGS

Radio World's Broadcast Equipment Exchange provides a FREE listing service for radio stations and recording studios only. All other end users will be charged. Simply send your listings to us, following the example below. Please indicate in which category you would like your listing to appear. Mail your listings to the address below. Thank you.

Please print and include all information:

Contact Name _____
Title _____
Company/Station _____
Address _____
City/State _____
Zip Code _____
Telephone _____

I would like to receive or continue receiving Radio World FREE each month.
 Yes No
Signature _____ Date _____

Please Circle only one entry for each category

I. Type of Firm

D. Combination AM/FM station
A. Commercial AM station
B. Commercial FM station
C. Educational FM station
E. Network/group owner

F. Recording studio
G. TV station/teleprod facility
K. Radio Station Services
H. Consultant/ind engineer
I. Mfg distributor or dealer
J. Other _____

II. Job Function

A. Ownership
B. General management
C. Engineering
D. Programming/production

G. Sales Manager
E. News operations
F. Other (specify) _____

WTS WTB Category: _____
Make: _____ Model: _____
Brief Description: _____
Price: _____

WTS WTB Category: _____
Make: _____ Model: _____
Brief Description: _____
Price: _____

*Closing for listings is every other Friday for the next month's issue. All listings are run for 2 issues unless pressed for space or otherwise notified by listee.

Broadcast Equipment Exchange

PO BOX 1214, Falls Church, VA 22041 • Tel: 800-336-3045 • Fax: 703-998-2966

You Need It... WE MAKE IT!

Your one call for Quality, Reliability and Economy in FM transmitters

- **SST Series** — Low Power Solid State FM from 30 to 500 watts.
- **Legend Series** — Medium Power Solid State FM 1 to 11KW
- **ECO Series** — Medium Power Grounded Grid Triode, Single Tube FM from 4 to 11 KW.
- **MK Series** — Medium and High Power Grounded Grid Triode, FM from 1.5 to 50 KW

The **ECO - 10**

"The Transmitter People"
Energy-Onix
518-828-1690
FAX: 518-828-8476
752 Warren Street, Hudson NY 12534

Circle (139) On Reader Service Card

TRANSMITTERS

Want To Sell

TRANSCOM CORP.

Serving the Broadcast Industry Since 1978

Fine Used AM & FM Transmitters and Also New Equipment
For the best deals on Celwave products, Andrew cable and Shively antennas.

500 W FM 1985 QEI 675 T500	5 kW AM 1987 Continental 315-R1
1 kW FM 1978 Collins 831C-2	5 kW AM 1978 Harris MW5A/R
1 kW FM 1975 RCA BTF 1E2	5 kW AM 1981 Harris MW5B
2.5 kW FM 1983 Harris FM2.5K	5 kW AM 1977 RCA BTA 5L
3 kW FM 1974 Harris FM3H	10 kW AM 1974 CSI T-10-A
5 kW FM 1974 Harris FM5H3	10 kW AM 1975 Continental 316-F
5 kW FM 196? Gates FM5B	
10 kW FM 1968 RCA BTF 10D	
20 kW FM 1974 Collins 831G-2	
20 kW FM 1976 Harris FM20H/K	
20 kW FM 1968 RCA BTF 20E	
25 kW FM 1975 Sparta 625-A	

1077 Rydal Road #101
Rydal PA 19046

800-441-8454 • 215-884-0888 • FAX No. 215-884-0738

Circle (116) On Reader Service Card

McMartin AM/FM transmitter, any model, exciter or stereo modules. Goodrich Enterprises, 11435 Manderson, Omaha NE 68164. 402-493-1886.

TUBES

Want To Sell

4CX5000A mod tube, made in China, just tested, near new, \$300. R Wittick, 916-283-1370.

807, 811, 813, 8874, 8877, 4-400, 4-1000, 4CX250B, RCA, Amperex, EIMAC, etc. Westgate 800-213-4563.

ECONCO

Quality Rebuilt Tubes

Approximately 1/2 the Cost of New

Call for Our Price List

800-532-6626
916-662-7553

Circle (208) On Reader Service Card

D and C Electronics Co.

Lowest Price on Tubes including:

4-1000A/3-1000Z/
8877/4CX250B/833A
4-500/5-500/4-400/
4CX 3500/5CX1500
and much more!
Factory Warranty!

1-800-881-2374
(904) 688-2374

Se habla Español
FAX: (904) 683-9595

REBUILT ELECTRON TUBES

Partial List: 6623, 23791, TH150, 6425F, 5604, 6696, 6697, 5681, 5682, 5671, 7804, 3CX10,000H3, 3CX20,000H3, 4CX5000A, 4CX35,000C

Worn out power tubes purchased

Vacuum Tube Industries, Inc.

1-800-528-5014
508-584-4500 X75

TURNTABLES

Want To Sell

Russco turntables (2) with Shure arms & preamps, good condition, \$110/each. 813-732-5339.

ADVERTISE!
in RADIO WORLD'S

BROADCAST EQUIPMENT EXCHANGE

CALL 800-336-3045

EMPLOYMENT

To place ads in this section, use the ActionGram form. To respond to box numbers write Radio World, PO Box 1214, Falls Church, VA 22041. Attn: _____

POSITIONS WANTED

Experienced engineer, directionals, RF, studios, computers, seeking full-time maintenance position w/board shift, small community, easy living. Engineer, 7894 Palm Grove, Indianapolis IN 46219.

If you are in the NJ, PA, NY area & need an experienced radio professional who can do anything & everything, I'll help make your station #1 no matter what format. 919-310-5394.

Over 5 yrs exper in live & satellite, excellent dj, prod, good at news too, please hire me, OH, IN, MI. Dan, 810-476-4498.

Radio engineer, 25+ yrs experience, all facets, 50 kW AM & 100 kW FM directionals, plus more to tell. So AZ only. Peter, 520-744-3660.

Recently out of broadcasting school, hardworker, willing to travel, looking for on-air, prod, traffic. Joey, 405-449-3683.

Talented on-air, creative in production, grad of bdcg school seeks ft employment w/your station. Brian, 405-789-3771.

Versatile, intelligent! Great for start-ups or existing stations, wants F/T air-shift, 1st PD gig, never promoted, tired of unrated markets, uncompetitive pay. Janet, 502-895-5888.

Young, enthusiastic radio rookie looking to make name in broadcasting field, like central part of US but willing to move. Matt, 405-772-1630.

The Richie Rich Show will take an audience hostage, on-air, production, copy, sales, rookie but ready! Any format...let's get ready to rumble! Richard, 405-677-4373.

If your small/med market needs another voice, call me! On-air, copy & prod skills, also news & sales! Glenda, 918-742-1227.

Looking for radio news job in AL, MS, AR, I have over 25 yrs exper in all areas of radio, available immediately. Bill, 205-685-0795.

A fresh voice for sports radio that can do it all, play-by-play, reporting, sports talk. Andy, 412-687-8723.

I do voice-overs freelance, specialty: soft sell. Ready to work for you! Kim, 209-436-4669.

Radio rookie just out of school & eager & ready for an exciting career doing on-air, production or news, focusing on OK, AR or southern KS. Gail, 405-758-1224.

Ready to "age to perfection" with your station, copy/production, voice-overs, on-air, ready to travel! Smooth voice, any format. Brandee, 918-486-3987.

SWM seeks fun-loving station, trained rookie will satisfy your every desire, on-air, prod, sales, no job too weird. Randy, 405-478-7325.

Take your news dept to the top! Talent-ed radio news pro seeks ND or report-er/anchor job @ medium-mkt station, prefer PA. Michael, 205-230-3754.

Young, energetic, currently employed, play-by-play man with 6 years experience & strong production skills looking for better opportunity, can work alone, willing to relocate. Derek, 505-392-5367.

Major Mkt/large station experienced Chief Engineer considering supervisory/corporate chief's position. 25 yrs exper, directionals, applications, great organization, looking for stable company w/excel remuneration. Respond to: Radio World, POB 1214, Falls Church VA 22041. Attn: Box # 95-6-28-1RW.

CE 15+ yrs exper, upgrades, new construction. 805-473-0871.

Ready to rock your listeners' sox off! Bright young talent, willing to do what it takes! Steve, 918-742-1227.

HELP WANTED

Chief Engineer - Two Class C FM's and one Class B AM directional in Southeast, Gulf coast area require full time engineer. Must have experience in both digital and analog studio and transmitter equipment as well as hold an FCC General or SBE certification. Send resume to Radio World, POB 1214, Falls Church VA 22041. Attn Box #95-6-28-2RW.

Groups of 6 radio stations in Northeast seeking experience chief. Knowledge of RF, studio maintenance, computers, digital audio a must. Good pay and benefits. Reply to: Radio World, P.O. Box 1214, Falls Church VA 22041. Box RW95-5-31-2RW.

NEWS POSITION: Christian music, news and information network in upstate, NY needs experienced, ministry-minded reporter/editor/anchor to work in high gear, issues-oriented newsroom. Send resume and tape to: News Director, Family Life Network, POB 506, Bath, NY 14810. EOE.

C.E: SW Kansas mkt leader needs a take charge individual to maintain multi-station facility. AM directional & class C FM's hard-drive audio exper helpful. Fax 316-276-3568 or send resume & salary history to Don Brintnall, KBUF, 1309 E Fulton St, Garden City KS 67846.

CE for 10 kw AM DA-2 contemplating new studio construction. Resort community, western state. Competency in: AM DA's, PC computer systems, PC computer networks, TVRO studio/RF construction, maintenance, FCC compliance. Minimum five years experience and FCC General Class Permit. Resume, references, salary expectations, and credentials to: "Resumes" at 2950 SW 2nd Avenue, Fort Lauderdale, FL 33315 or FAX to 305-524-8734 EOE

ADVERTISER INDEX

This listing is provided for the convenience of our readers. Radio World assumes no liability for inaccuracy.

Page No.	Advertiser	Reader Service No.	Page No.	Advertiser	Reader Service No.
41	AEG	102	37	Inovonics	57
6	ATI	203	28	J Squared Technical Service	89
28	ATI	16	42	J&I Audio/Video	24
40	Ad Week	—	29	Joslyn Jennings Corp.	145
24, 25	Arrakis	10	10	LPB	158
2	Audiarts Engineering	79	45	Marathon Products	93
3	Audio Broadcast Group	187	20	Micro Communications, Inc.	168
36	Audio Broadcast Group	151	31	MicroCon Systems	101
42	Audisair	47	18	Modulation Sciences	110
47	Auditronics	39	38	Murphy Studio Furniture	149
28	Autogram	71	29	Myat Inc	191
44	BBH Software	70	30	NAB	—
27	BSW	157	33	National Public Radio	65
14	Betar	125	21	Nautel	84
36	Benchmark Media Systems	105	34	Neutrik	111
35	Branson Music Network	179	36	Notch Ltd.	197
12	Broadcast Devices, Inc.	181	8	Orban	28
4	Burk Technology	41	36	PTEK	68
20	Circuit Werkes	82	15	Pacific Recorders	18
29	Coaxial Dynamics	59	12	Phasetek	214
3	Comrex	142	13	Potomac Instruments	48
36	Comrex	36	29	Pristine Systems	45
13	Conex Electro-Systems	2	39	Prophet Systems	140
12	Crown Broadcast	13	31	QEI	211
23	Cutting Edge	8	29	Radio Design Labs	91
14	Datavorld	209	12	S.C.M.S.	114
9	Datavorld	117	28	Shively Laboratories	113
46	Econco	208	11	Sierra Automated Systems	33
28	Econco	177	20	Silicon Valley Power	160
45	Energy-Onix	139	21	Sine Systems	112
29	Excalibur	30	12	Svetlana Electron Devices	183
37	Ghostwriters	204	46	Svetlana Electron Devices	162
12	Gorman Redlich	53	26	TFT	165
35	Group W	202	16	Telos Systems	73
42	Hall Electronics	76	12	The Management	206
29	Hallikainen & Friends	16	46	Transcom Corp.	116
22	Harris Allied	170	35	USA Radio Network	133
6	Harris Allied	86	20	Universal Electronics	199
19	Harris Allied	216	32	Valentino Inc.	61
1	Harris Allied	22	46	Varian	185
7	Harris Allied	119	48	Whetstone	120
20	Henry Engineering	99	35	Wind River Broadcast Center	156
32	Hwa-Hwa	200	36	Zercom	220
	ITC	218			

Publisher	Stevan B. Dana	Ad Traffic Coordinator	Kathy Jackson
Associate Publisher	Carmel King	Ad Production Coordinator	Lisa Lyons
Marketing Consultant	Al Leon	Production Assistant	Cristina Stigel
Marketing Assistants	Regan Deatherage, Annette Deutscher	Ad Coordination Manager	Laune Anne Tarlington
Production Director	Lisa Stafford	Circulation Director	Simone Mullins
Publication Mgr/Desktop Systems Mgr	Jukanne Shannon Stone	Circulation Manager	Eleya Finch
Classified/Showcase Production Coordinator	Vicky Baron	Accounts Receivable	Steven Bowman
			Steve Berio

Advertising Sales Representatives	
U.S. East: Skip Tash	703-998-7600 Fax: 703-998-2966
U.S. West: Dale Tucker	916-721-3410 Fax: 916-729-0810
International: Stevan B. Dana	+1-703-998-7600 Fax: +1-998-2966
Europe: Dario Calabrese	+39-2-753-0274 Fax: +39-2-753-2696
Japan: Eiji Yoshikawa	+81-3-3327-2688 Fax: +81-3-3327-3017

Free Subscriptions are available upon request to professional broadcasting and audiovisual equipment users. For address changes, send current and new address to RW a month in advance at P.O. Box 1214, Falls Church, VA 22041. Unsolicited manuscripts are welcomed for review; send to the attention of the appropriate editor.

The Auditronics 801 Clean Air Policy.

What we surround ourselves with says a lot. The Auditronics 801 series says you won't settle for anything less than pure, seamless audio. More standard features than the others. Tomorrow's technology with the freedom to add options. The 801 says you know that when you own the best, the sky's the limit. Write or call for a free brochure.



The Sound Of Perfection

AUDITRONICS

3750 Old Getwell Road, Memphis, TN 38118
901-362-1350, FAX: 901-365-8629

Circle (39) On Reader Service Card

*We've taken all we know, all you've asked for,
and the very best of today's technology to
bring you our **FINEST AUDIO CONSOLE***

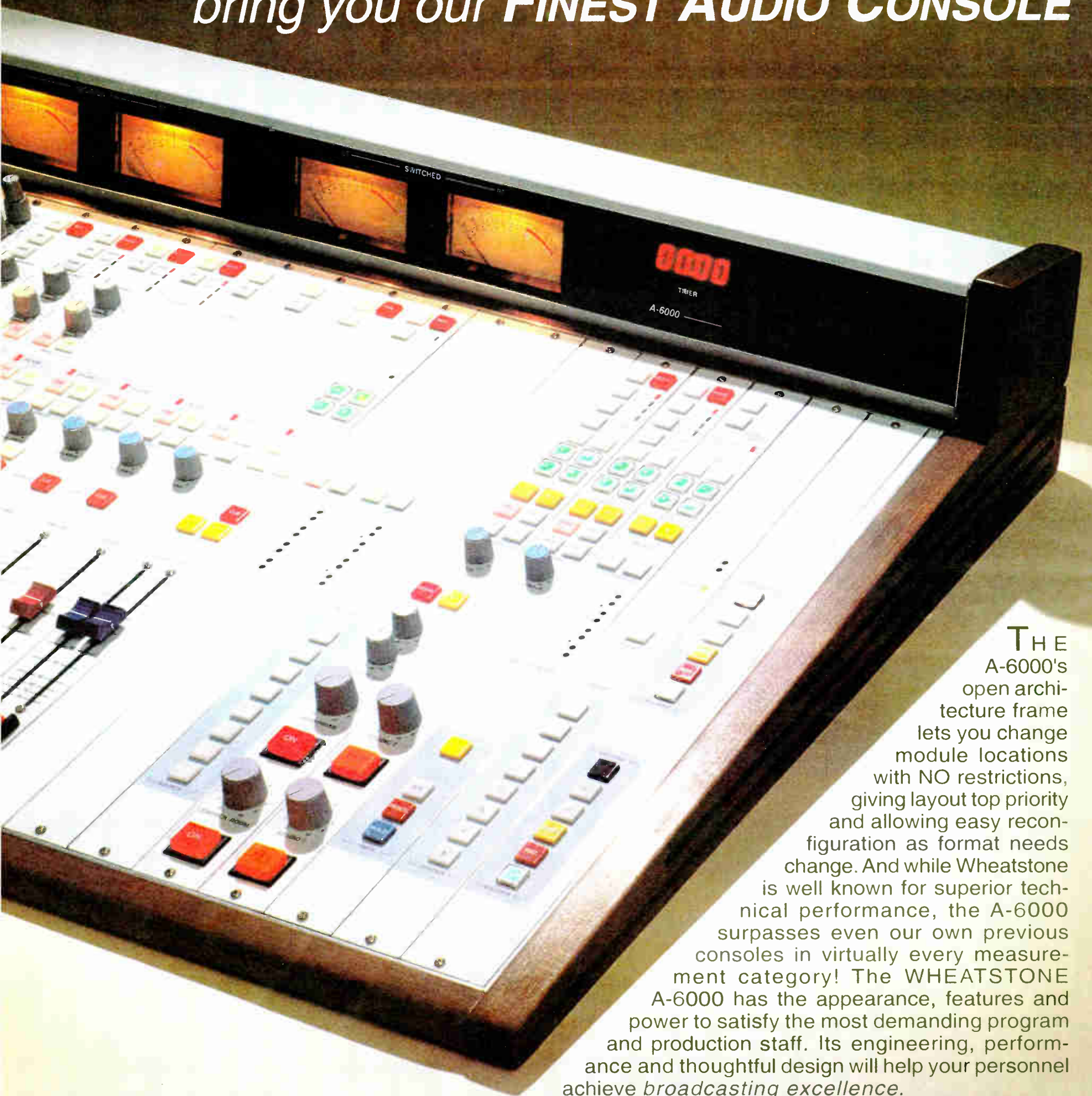

THE A-6000's open architecture frame lets you change module locations with NO restrictions, giving layout top priority and allowing easy reconfiguration as format needs change. And while Wheatstone is well known for superior technical performance, the A-6000 surpasses even our own previous consoles in virtually every measurement category! The WHEATSTONE A-6000 has the appearance, features and power to satisfy the most demanding program and production staff. Its engineering, performance and thoughtful design will help your personnel achieve *broadcasting excellence*.

A - 6 0 0 0 B R O A D C A S T C O N S O L E

7305 Performance Drive, Syracuse, NY, 13212
(tel 315-452-5000 / fax 315-452-0160)

 Wheatstone Corporation

Circle (120) On Reader Service Card

World Radio History