

\*\*\*\*\*3-DIGIT 857  
 0101 000296705 9504 BUE 9702  
 TOM MILLER  
 KTZR  
 ASST CE  
 2033 S AUGUSTA PL  
 TUCSON AZ 85710-

# RadioWorld®



Vol 19, No 4

Radio's Best Read Newspaper

February 22, 1995

## Congress Threatens Public Radio Funds

by Thomas Pear

**WASHINGTON** Ending Congressional funding for the Corporation for Public Broadcasting (CPB) could spell the end of National Public Radio as it is known today.

At least that's what NPR President and CEO Delano Lewis said, no matter how extreme that sounds. While most of the publicity surrounding threats on Capitol Hill to eliminate federal funding for CPB focuses on public television, Lewis recently testified to NPR's uncertain future before a House Appropriations subcommittee.

"Many rural and small stations would have to cut programming, and if that happens we would not be able to continue the (NPR) program," he said later when questioned privately.

While public television has enormous retail potential through "Sesame Street" and "Barney" toys—about \$20 million annually from Barney alone, according to CPB President and CEO Richard Carlson—Lewis noted there are no retail possibilities like that for NPR.

Public radio may be forced, then, to saturate programming with endless share-athon money gimmicks, much like present-day television evangelists, Lewis said.

### Subcommittee hearing

Still, Lewis vows to fight for NPR federal funding, although Congress seems poised to go through with slashing CPB.

The subcommittee, which met to discuss cutting the nearly \$300 million federal government annual contribution to CPB, heard a number of testimonies both for and against CPB. CPB is a federal corporation that Congress established solely for funding public broadcasting: NPR and PBS.

While NPR itself only gets about a million directly in federal funding, about \$63 million goes to NPR's 520 member stations that use the money to purchase NPR programming. Without enough purchasing stations, NPR could collapse, according to Lewis.

"How would local public radio stations replace the 16 percent of their funding that CPB funding represents on average," he questioned in testimony.

Caryn Mathes, the general manager of NPR affiliate WDET in Detroit, said CPB budget cuts would definitely affect

the station's programming. The station may lose its ability to provide dual-service programming. WDET then would be forced to choose between broadcasting culturally diversified music, that makes up 70 percent of the station's programming, and NPR news and information, which makes up 30 percent of the station's programming.

### Hurts quality

Duane W. Ryan, the director of KENW(FM) and KENW-TV in Portales, N.M., also said lost CPB funding would most likely hurt his station's quality of programming. His FM receives more than \$50,000 each year from CPB, which comes out to about 23 percent of the

station's budget.

Although Eastern New Mexico University and private donations provide additional revenue for the stations, chances are they could not replace any lost CPB revenue, Ryan noted.

There's not enough of a population base



**Our Largest Ever Digital Audio Workstation Buyers Guide Begins on page 48**

**Complete User Reports on Studer Dyaxis (above), Pacific Recorders ADX and other DAWs**



in Eastern New Mexico to bring in substantial private donations, and Eastern New Mexico University's budget is already "maxed out," he said.

So, along with cutting personnel, the

continued on page 9 ▶

## NEWSWATCH

### FCC Seeks to Re-establish Ousted Forfeiture Rules

**WASHINGTON** The FCC recently issued a Notice of Proposed Rulemaking (NPRM) seeking comments on its forfeiture policy statement.

Broadcasters and other interested parties have until the end of this month to file comments, after which FCC staffers will have 10 days to file reply comments, noted FCC Attorney Ana Curtis. The commission could adopt the policy statement as early as June.

The proposed forfeiture policies, according to a commission news release "are virtually identical" to 1991 guidelines that were thrown out by a U.S. Court of Appeals in the District of Columbia last summer.

At the time of its decision, the court ruled that the FCC's 1991 "Policy Statement on Fines and Forfeitures" is substantive and, therefore, should have been subject to the same public notice and comment procedures that all major commission rules must pass.

"Basically all that happened is

continued on page 2 ▶

**45,000 WATTS**  
**WITH NO COMBINER**  
**ALL IN LESS THAN 21 SQ. FT.**

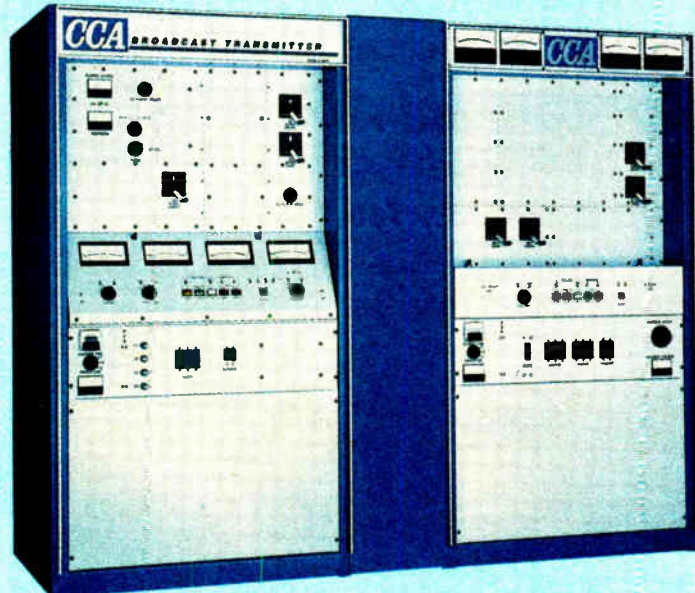

- Single-ended PA.
- Conservatively rated.
- Driver may be connected directly to antenna in case of emergency.
- DC grounded-grid triode.
- 24-hour service, 365 days-a-year.

**CCA**

**CCA Electronics, Inc.**

P.O. Box 426 • 360 Bohannon Road  
 Fairburn, Georgia 30213 • USA  
 (404) 964-3530 • FAX: (404) 964-2222



Circle (7) On Reader Service Card

World Radio History



# NEWSWATCH

► continued from page 1

that the court said we should have gone through notice in adopting it," Curtis said.

The policy statement allowed the FCC to fine up to \$25,000 per violation for each day of a continuing violation as long as the total amount assessed for a continuing violation does not exceed \$250,000 for any single act or failure to act. Under the policy statement the FCC can still waive or deviate from assessed fines, Curtis pointed out.

In 1992 the United States Telephone Association (USTA) filed suit against the FCC in conjunction with a number

of co-plaintiffs, including the National Association of Broadcasters. They argued that without an NPRM the fine schedule violated a number of federal procedures, including the 1934 Communications Act and the FCC's own rules. The ruling saved USTA from dishing out money for its own assessed fines.

The court mandated NPRM, then, seeks comments on whether or not the base forfeiture amounts are set at appropriate levels for broadcasters.

The FCC says those disagreeing with the Policy Statement on Forfeitures and Fines should propose their own alternatives and

give reasoning as to why their own proposals would be more effective.

For more information broadcasters can call Curtis at 202-418-1160.

## House to Rethink Mandatory Affirmative Action Advertising

**WASHINGTON** Congress could redesign affirmative action requirements that mandate corporations to advertise on predominately African-American radio stations.

Hearings could come as quickly as next summer, according to a GOP staffer.

House Judiciary Committee Chairman Henry Hyde (R-Ill.) referred to a Justice Department's chastisement of the Maryland-based Chevy Chase Savings

Bank for not having enough branches in predominately African-American neighborhoods as "disturbing."

The department then forced heavy quotas on the bank, including advertising in predominately African-American newspapers and on predominately African-American radio stations.

Addressing a gathering sponsored by the Institute for Justice in the Capitol, Hyde said the department's repudiation of the Chevy Chase Bank is an example "of the way the Justice Department is reaching to the outermost points of the galaxy on making quotas the operative principle of civil rights enforcement."

## Dunnifer Wins Round One

**SAN FRANCISCO** Citing constitutional concerns, a federal court refused to  
continued on page 15 ►

When looking for a digital audio system for automation of satellite programming or live assist, there would appear to be many choices. But if you're looking for a system which is flexible enough to give you total control without sacrificing your sanity, there is only one choice. The Phantom by RDS.

You will see the difference as soon as you see the Phantom in action. The display provides you with all of the information you need to see in a clean, concise manner, without the crowded look that you'll find in other systems. If you are familiar with the most popular software on the PC, then you may already know how to use the Phantom. The Phantom's pull-down menus guide you through all of the steps involved in setup and daily operation, from creating and scheduling clocks to creating and editing logs.

## The PHANTOM Digital Audio Automation

The Phantom ends the confusion of automation by keeping everything organized. The Phantom simplifies your daily operations by keeping information such as input changes, voice changes, and clock changes in their own individual schedules rather than in the log. You can leave those liners and other voice drops out of the log because the Phantom will do them for you. The Phantom allows you to date new schedules to begin weeks, months, or even years in advance. When your satellite network informs you that there will be a voice substitution on Thursday, two weeks from today, you can prepare for it *today*.

The Phantom can retime spots to fit them cleanly into a satellite break without inserting silence, overlapping, or running late. The Phantom



can create reports to keep you informed on a number of topics, from a list of expired spots to an analysis of potential mistakes in your log. The Phantom also maintains a history of system activity.

The Phantom has the features that others would want you to believe are theirs exclusively. The Phantom remains *completely* functional during recording, sensing relay closures and starting breaks as easily as it does when it is not recording. The Phantom can fill incomplete breaks with spots from a list you specify without ruining product separation.

While other systems tie your hands and limit your flexibility by only offering 3 or 4 inputs, the Phantom gives you 6 stereo inputs, using its AMX-84 solid state switcher, with the option of increasing the number of inputs to 14 or more. If your station is News/Talk, you know how important this can be.

The Phantom allows you to change the sampling rate, digital format, and stereo/mono settings at will to meet your needs for an individual spot. The Phantom offers a number of digital formats, including the new Dolby AC-2 format, as an option.

Call us today to find out how your station can benefit from the advanced technology of the Phantom and the experience of RDS.

**1-800-521-5222**  
912-987-2501 • FAX: 912-987-7595  
P. O. Box 980, Perry, GA 30169

**RDS** REGISTER  
DATA  
SYSTEMS

## Index

### FEATURES

- Certain AMs Qualify for Power Increase**  
by W.C. Alexander 16
- Keep Turntables in Tune for Classic Vinyl**  
by Tom Vernon 19
- Workbench**  
by John Bisset 20
- It Was 1969 and I Spun 45s**  
by Ken R. 44

### STUDIO SESSIONS

- t.c. electronics Upgrades M5000**  
by Ty Ford 25
- Audiophile Sound from Genelec's 1030As**  
by Bruce & Jenny Bartlett 29
- Production Challenges for 'ATC'**  
by Rich Rarey 31
- Seeing Red Instead of Green**  
by Ed Bukont & John Gatski 34
- Digital Resolutions for the New Year**  
by Mel Lambert 36
- Improved Scoopman, Broadway Mics**  
by Frank Beacham 37
- Multitracking from Eight to 16**  
by Bruce & Jenny Bartlett 40

### BUYERS GUIDE

- USER REPORTS**
- Foundation 2000 Built for Speed**  
by Bruce & Jenny Bartlett 49
- Arrakis Trak\* Star 8: Several Machines in One**  
by John Peace 51
- WJR Says 'Bye' to Analog with Korg**  
by Rick Wiggins 53
- ADX Lightens Workload**  
by Jim Bollella 53
- Money-saving SAW Shines at WPLY**  
by Sean Caldwell 54
- SADiE: Cornerstone of Digital Studio**  
by Steve McFarland 57
- Sonic Solutions Replaces Razors**  
by Peter Swanson 58
- Microsound Delivers at Woodstock '94**  
by Chris Andersen 59
- Synclavier Exceeds Expectations**  
by Ed Douglas 60
- Studio Knows No Limits with Dyaxis**  
by Jim Baldree 61
- User Expectations Changing As DAW Technology Improves**  
by Whitney Pinion 61
- DSE-7000 Allays Fear of Digital**  
by Steve Wilmes 63

### TECHNOLOGY UPDATES

- ITC 64
- Roland 67
- Digidesign 67
- The Blue Group 67
- Otari 67
- Audion Labs 67
- Sony 68
- OSC 68
- LPB 68
- Turtle Beach 68



# DARS Systems on First Step of Long Journey

## Numerous Regulatory Barriers Still Ahead for Proponents of Digital Satellite Radio As They Wait for Commission to Develop Rules

by Thomas Pear

**WASHINGTON** Although the Federal Communications Commission (FCC) recently allocated spectrum for digital satellite radio, proponents still have to

cross numerous regulatory barriers before the technology becomes a broadcasting reality.

While the process could begin within the next few months, said Acting FCC Spectrum Chief Larry Petak, when it would be completed is "anyone's guess."

"It's potentially a lengthy process," especially, he added, "if contentions are made."

Cliff Burnstein one of the co-owners of Cue-Prime, a digital satellite broadcasting company, agreed that satellite radio is vulnerable to opposition and is still on the horizon.

"We still have to go a long way," he said. "I kind of take things one day at a time."

### Next step

The next step for digital audio radio services is for the FCC to establish a service rule proceeding, where the commission creates a wide variety of rules regulating the new technology that future DARS broadcasters would have to comply with.

During that process the commission will decide a number of spectrum issues like how to divide S-band spectrum into different frequencies and whether or not to designate a certain amount of spectrum as non-commercial. And the commission would have to determine bandwidths and emissions.

The commission also would establish procedures for licensing DARS broadcasters, he noted.

After the rules are drawn they then go out for public debate through a Notice of Proposed Rule Making (NPRM).

During that 30 to 90 day period both proponents and opponents have an opportunity to file written comments.

That could open a doorway for DARS opponents to create round two in the battle of whether or not to allow DARS because the FCC is required to examine

comments before it issues a Report and Order.

Digital satellite broadcasters can file frequency petitions after the Report and Order is filed.

The four companies that already have petitions on file—Satellite CD Radio, American Mobile Satellite Corp., Digital Satellite Broadcast Corp (DSBC) and, of course, Cue Prime—may have an opportunity to modify their petitions to comply with newly established rules before any

noted.

Despite the opposition fanfare, some of the major broadcast groups are not threatened by the prospect digital satellite radio.

### No major harm

"I'm not sure there's going to be a major harm to broadcasting," said one high-level employee in a large broadcasting corporation who requested not to be named.

USA Digital Radio Project Manager Jeff Andrew said he was not surprised at the FCC decision to allocate satellite spectrum.



additional petitions are accepted by the FCC, Petak noted.

Group owners react

"In the past, when dealing with satellite broadcasters, the commission has given applicants time to amend applications to newly adopted service rules," Petak

"We were kind of disappointed, but we thought it was inevitable," he said. When questioned about the threat digital satellite broadcasting poses to digital terrestrial broadcasting Andrew replied: "We don't feel that satellite is going to be a huge threat."

**While the process could begin within the next few months, when it would be completed is "anyone's guess."**

### RBDS Update

**WASHINGTON** See pages 12 and 13 for the sixth quarterly edition of RBDS Roll-Call, a comprehensive and as up to date-as-possible list of U.S. radio stations on the air with the Radio Data System (RDS), the sub-carrier that can transmit various types of data and information to RDS receivers. The Roll-Call also lists RDS equipment manufacturers, receiver manufacturers and service providers.

In a future issue RW plans to tackle RDS' status in the U.S.—now that standard has been in place for more than two years. Meanwhile, we will continue bringing the listings in order to chart the growth of the RDS industry.

## TXL-110, TXL-210

Transmission Limiters

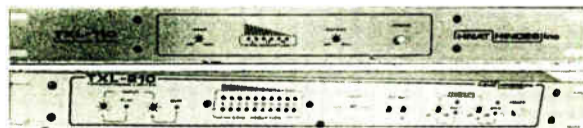

**ENVIRONMENTALLY SAFE... NO EAR POLLUTION...**

Just CLEAR, BIG DIMENSION SOUND.

Today's digital audio imposes a new requirement on broadcast transmission systems, particularly audio processors.

The TXL series Transmission Limiters are designed to preserve your program resource and deliver it intact to the transmission system, without the familiar processing residue that cost rating points.

The TXL series limiters are also safe to your FINANCIAL ENVIRONMENT... (No slick, multicolor full page ads to pay for).

CALL TODAY...For more on the TXL-110 & TXL-210 capabilities.

**H NAT H INDES Inc**

42 ELAINE ST., THOMPSON, CT 06277  
203-935-9066 / 9242 FAX 203-935-9919

Circle (179) On Reader Service Card

## Strike One, You're Out

Continental and Current Technology,  
Teaming up for tomorrow today.



21.5, 25, 27.5,  
30 & 35 kW Transmitter



**Current Technology**

Continental transmitters come equipped with protective internal devices. Other sensitive equipment in today's facilities can be taken out of the game by a single lightning strike or power surge.

Play smart — protect your station from dead air for seasons to come by installing the Current Technology suppression filter in tandem with your Continental transmitter.

**Contact your Continental Sales Manager before you strike out.**

**1-800-733-5011**



Continental Electronics Corporation

P.O. BOX 270879 DALLAS, TEXAS 75227-0879 214-381-7161 FAX 214-381-4949

Circle (60) On Reader Service Card



# Building Tomorrow's Infrastructure Today

**WASHINGTON** This issue's *Buyer's Guide* makes a great showing for a product category that did not even exist five years ago: digital audio workstations, or DAWs, as they are affectionately referred to here at **RW**.

Not long ago—less than two years, in fact—engineers argued, in these very pages, about the pros and cons of digital compression and what digital manipulations could mean to the life of your audio. Now, DAWs are the hottest item in the marketplace, with so much new product being designed and shipped that we can barely keep up with the news.

The hardware manufacturers are now cranking out drives and other internal computer organs that have very small rates of failure. And people like this new durability and have come to demand it. But hardware is not the only aspect of technology changing. Many of today's innovative new products are software-driven, a feature that extends the life of a product, given the only modernization a box needs can be received via modem in the form of a software upgrade.

But the whole issue of DAWs and what they allow you to do with and to audio points to a larger issue that is changing the way the radio industry conducts business. Digital is everywhere and it is software-driven. Be it the latest codec from CCS (the Prima) or a Digi-Link or Track\*Star 8 from Arrakis, digital abounds.

It stands to reason then, that the radio industry will continue to develop digital services to offer the public and create for itself lucrative new revenue streams.

If half of that battle is software development and the integration of new digital services into the hardware and daily routines of the radio industry, this issue's *Buyer's Guide* proves the industry is well on its way to victory. In fact, radio broadcasters and the software developers and equipment manufacturers that serve

them have already proven they can navigate through cyberspace.

Other evidence of the strength of the software infrastructure is the alacrity with which station automation software, a fledgling business less than five years ago, has been accepted by broadcasters. Competitive music and news/talk stations find they almost cannot do without software packages that did not exist a short time ago, including:

- Live-assist programs that allow a talk show host to know everything about the listener waiting on the line. Name, address and various other demographics (as well as the topic the listener wants to talk about) are all flashed up on a computer screen, which also tells you when to play the commercial;
- Systems to automatically record and store satellite program material and integrate it into prepared broadcast schedules which may be programmed and ready weeks or months in advance. Some systems are capable of receiving and processing data files for later retransmission by RBDS, FM subcarriers and other means;

- Software designed to keep track of traffic and billing, ad sales and station maintenance schedules that is often flexible enough to fit into any size operation, from a small rural station, to

a multistation duopoly/LMA and sometimes a national group.

Innovative software developers, with suggestions from their radio customers, are continually making it easier to broadcast high-quality programming with significant long-term savings.

The down side to all this high-flying cyber-navigating, of course, is that high-tech efficiency sometimes costs people their jobs. The time is now to do a little

more work and use a little more imagination in continuing the personal education process so that as the business changes,

effort last year.

Each year, federal employees participate in the CFC by donating money



From l to r: Wayne McKee, Beverly Baker, Commissioner Rachelle Chong, Chairman Reed Hundt, Commissioner Susan Ness, Kara Casey, Commissioner Andrew Barrett, John Winston

individuals are changing to meet the new demands of the business.

The sky is the limit when you navigate with software. It is time to figure out ways to expand your business and find ways to convert your already-demonstrated mastery of computer technology into new digital services for the consumer and business.

★ ★ ★

If one of your favorite pastimes involves complaining about government agencies, you are not alone. And I've done my share of complaining about "Big Brother" in his many incarnations. But I believe credit should be offered where credit is due, and on that note, I extend congratulations to the FCC staff.

Late last year, Energy Secretary Hazel O'Leary, national chair of the Combined Federal Campaign (CFC), presented the FCC with the CFC Chairman's cup for the agency's successful CFC campaign (see photo). The commission raised more than \$220,000 in 1994, 35 percent more than in 1993. Eighty-one percent of the commission's employees supported the

through payroll deductions or by making specific contributions. The employees can select recipients from among participating charitable organizations.

Every year the CFC awards only two Chairman's cup awards, one for the larger departments or agencies and one for departments or agencies with fewer than 5,000 employees.

★ ★ ★

Last but not least, two items of particular interest to **RW** readers. In this issue you can find the first edition of *Public Domain*, a new monthly column by Rich Rarey, the technical director of NPR's "All Things Considered." Rich will be sharing his experience and practical tips in the studio with you, as well as conducting product evaluations of new or interesting gear.

Next issue, Alan Haber will launch *Radio Online*, a monthly column devoted to helping you "surf the cyber waves" and all that good stuff. Alan has uncovered mountains of good stuff out there, and *Radio Online* will help guide you through the maze.

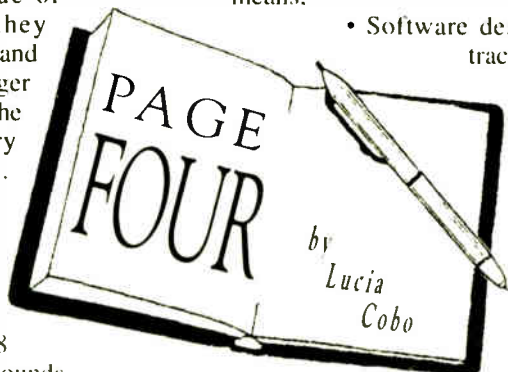

## Transmitter Control can be a Bear

You need to make sure you can stay on the air and stay legal. At the same time, you need to keep operating costs under control.

Choosing the right remote control system is the first step.

The ARC-16SA\* from Burk Technology lets you control your transmitter from any phone. You can establish off-premises control points for unattended operation, or supervise non-technical operators by phone.

The annual savings can be thousands of dollars.

The ARC-16SA is part of a modular system. For full-time control, add a studio unit. Multi-site options make it easy to control several transmitter sites or even control studio equipment such as program automation.

Call now for your copy of our new catalog, then ask us to show you how we can improve your operation and your bottom line.

Call TOLL FREE  
1-800 255-8090

**BURK**  
TECHNOLOGY  
We've moved!

7 Beaver Brook Road, Littleton, MA 01460  
Phone (508) 486-0086, Fax# (508) 486-0081

Circle (102) On Reader Service Card

World Radio History



## READERS FORUM

If you have comments for Radio World, call us at 800-336-3045 or send a letter to Readers Forum (Radio World, Box 1214, Falls Church, VA 22041 or MCI Mailbox #302-7776). All letters received become the property of Radio World, to be used at our discretion and as space permits.

### Things to remember

Dear RW,

It has been several weeks since the original story about Underwriters Laboratories' (UL) approval of broadcast equipment, which revolved around my station—KKLA Los Angeles, first appeared (RW, Oct. 19, 1994). I have read with interest several articles since then regarding the implementation of third party approval. I would like to comment on the most recent article, that included numerous comments from UL Engineer Tony Bodetti.

First of all, we should not lose sight of who the regulatory agencies are. In the case of the KKLA Mt. Wilson installation, Los Angeles County is the agency. In L.A. the electrical inspectors work with the Department of Building and Safety.

The electrical inspectors are obligated by law to ensure that installations meet certain code requirements. Hence, we have the National Electrical Code (NEC) 1993 edition adapted by the National Fire Protection Association (NFPA). This was the code book used by the electrical inspector upon his visit to Mt. Wilson.

Upon reading the code book, I find no section dealing with third party verification (UL). As a matter of fact, Chapter 8 Articles 800-820, that deal with communications type equipment, only cover amateur radio and CATV systems. I find no reference to radio or television professional equipment. Article 810-1 specifically says it does not cover equipment and antennas used for coupling carrier current to conductors. Doesn't this mean transmitters?

The only reference that may apply relates to power supplies in excess of 300 volts, that must be interlocked so they are shut off if their access doors are opened. I know of no transmitter manufacturer

that does not already have this feature in place.

Teresa Hrones from UL seems to think that inspecting one piece of equipment from each run is the answer. I do not agree. What about 10-year-old equipment that is moved from one site to another as in the case of a transmitter relocation? Would UL like to put a sticker on a 50 kW ampliphase? What about transmitters that are charged in the field? A CCA-FM model 2.500E transmitter is FCC type-accepted for 2,500 watts.

By changing the platter transformer and diode stacks, it can become a 5,000 watt FM transmitter at less cost than buying a new FM transmitter. But would UL have to come out and re-certify the rig? I certainly hope not! I have seen nothing mentioned about grandfathering older equipment.

Let's take into consideration the statement that inspectors have found sloppy installations. I once worked at a station where the high voltage vault to the transmitter was connected to the transmitter with a RG-8 coax, so I know it happens. Certainly the installations need to be done according to good engineering practices and standards, and possibly this area needs tighter control rather than regulating the manufacturer.

This type of regulation would force the station engineer, and, hopefully, the owner to ensure they have a safe plant. What good is certifying the equipment if the installation is sloppy?

A UL certification on broadcast equipment is tantamount to having the "Good House Keeping Seal of Approval" put on a street sweeper (thanks to Dick Rudman). It does nothing to ensure proper operation of the sweeper, except drive its cost higher.

UL is a private concern that gets the majority of its operating costs from certifying consumer type equipment (toasters etc). In my opinion, local government agencies and UL are imposing themselves in an area that is already well regulated by the FCC. UL should stick to hair dryers and toasters and leave the broadcast engineering to the FCC, the NAB and the SBE.

Mark S. Pallock  
Chief Engineer, KKLA  
Los Angeles

### The toaster police

Dear RW,

It worries me that Underwriters Laboratories is finding reason to justify its existence within the broadcast industry (RW, Jan. 25). I receive an increasing number of calls from California station managers and engineers who have been told by local bureaucrats to remove equipment from the equipment racks because it does not have the sacred UL sticker.

Considering that most professional equipment is installed by a technically competent person and mounts in a grounded, metal equipment rack there exists little danger to public safety in the event of an equipment failure.

I laughed out loud at the quote by Teresa Hrones, UL media relations asso-

## Don't 'Newt' NPR

The Speaker of the House of Representatives Newt Gingrich has gone too far in his zeal to streamline this country's budget. Doing away with funding for the Corporation for Public Broadcasting reduces the budget by nano-parts, yet causes great harm to the broadcasting business, a large number of communities across the nation, and to the ideal of educational programming everywhere.

While public television may have the promise of merchandising revenue to fall back on, no such possibility exists for National Public Radio (NPR) and the non-commercial stations it serves.

As the story on page 1 of this issue indicates, the end of funding for NPR would spell disaster for a great many small and rural stations that often serve as the sole source of information and programming for small communities—oftentimes carrying out broadcasting's charter of community service and dedication far better than their commercial brethren. Many of these small stations rely on these same funds for equipment purchases and to help them complete their fundraising efforts.

Mr. Gingrich needs to think of the larger issues involved here. National Public Radio serves as a national radio service that provides quality programming (on both sides of the political spectrum) that differs from programming found on ratings-pressed commercial stations.

One of government's roles (for which citizens pay taxes) is to foster the growth of new technologies that can ultimately benefit the population. NPR has been on the leading edge of broadcast technology for quite some time: first in implementing digital equipment, CDs, satellite services (a self-supporting division) and first with RDS (now recommended by the FCC for the new EAS system). Furthermore, NPR engineers and technicians constantly participate in industry forums and tests for new technologies, e.g., the DAB listening tests in Canada.

And while the Speaker's aim may be a politically desirable one, he has gone too far. Funding for the Corporation for Public Broadcasting is no pork barrel spending. It serves a large segment of the nation's population as well as the loftier goals of education and research. Look for your budget pennies elsewhere.

—RW

ciate, stating, "The cost of UL investigation is not going to increase the price of a unit significantly."

The broadcast industry is a finite market with a limited number of potential customers. This means that expenses must be absorbed by the limited number of units produced.

The manufacturers serving the broadcasters feel every dollar of increased expense. We must pass on the expense of \$3,000 to \$5,000 that UL charges to pass blessing on any particular unit.

All units submitted by Symetrix for testing were returned in unsaleable condition (read: destroyed). Ms. Hrones's statements about "non-destructive" testing does not ring true in our experience.

Hrones misled Mr. Pear when she implied that UL inspects "one sample" and if it passes, then "the entire line" receives certification. A manufacturer must submit multiple units of each model for testing. For example, a successful test of a Symetrix 528E does not grant UL approval on the 501. Each model in our product line must be submitted. UL would dictate that a transmitter manufacturer submit samples of its entire catalog of transmitters in order to gain the mystical seal of approval.

If a manufacturer makes any changes to the power supply components over the life of the unit, the upgraded model must be resubmitted for testing. We cannot change the transformer, fuse holder or even the power switch without starting the process anew. If UL approval becomes a requirement in the broadcast industry, station owners will pay more for equipment.

Is UL approval necessary in the industry? Broadcast equipment is installed and

operated by professionals. Do we need government, or UL, protection from ourselves? UL has a role in protecting little old ladies from getting shocked when plucking Pop Tarts out of the toaster while sitting in the bathtub.

Why doesn't the U.S. Army ask UL for approval on M16s? How many of the fire trucks that you see speeding down the street have UL approval? Most people are too busy making ends meet to realize that the local government bureaucracy exercises control over the citizens only to the extent that the public relinquishes authority over their lives to them.

All station owners need to be on their phones and word processors to their mayors, city councilmen and governors, protesting this latest bureaucratic intrusion into our industry.

If we all roll over and play dead, the government juggernauts and the wannabe authorities (read: UL) will crush us into dust as they assume even more authority. The result will be increased equipment costs and higher business taxes to feed government payrolls and pensions as these jackals seek out new carcasses on which to feed.

If the NAB had more nerve, it would use its political clout to burn UL's fingers at even the mention of certifying broadcast equipment. This action should be popping circuit breakers at the SBE offices in Indianapolis. Fortunately, we don't get all the government that we pay for, but if we let the "toaster police" weasel their way into our industry, we are all in for a shocking awakening.

Walt Lowery  
Symetrix Inc.  
Lynnwood, Wash.

# Radio World

Vol. 19, No. 4

February 22, 1995

Editor-in-Chief.....Lucia Cobo  
Managing Editor.....John Gatski  
Associate Editor (News).....Thomas Pear  
Associate Editor.....Whitney Pinion  
Contributors.....Frank Beacham/N.Y.  
Bruce Ingram, Pamela Watkins  
Nancy Reist, Alan Haber  
Technical Editor.....John Bisset  
Technical Advisor.....Tom McGinley  
Editor (International).....Alan Carter  
Editor (Radio World Magazine).....Charles Taylor



Radio World (ISSN: 0274-8541) is published bi-weekly by Industrial Marketing Advisory Services, Inc., 5827 Columbia Pike, Suite 310, Falls Church, VA 22041. Phone: 703-998-7600, Fax: 703-998-2966. Second-class postage rates are paid at Falls Church VA 22046 and additional mailing offices. POSTMASTER: Send 3579 forms and address changes to Radio World, P.O. Box 1214, Falls Church VA 22041. REPRINTS: Reprints of all articles in this issue are available. Call or write Regan Deatherage, P.O. Box 1214, Falls Church, VA 22041; (703) 998-7600; Fax: (703) 998-2966. Copyright 1995 by Industrial Marketing Advisory Services, Inc. All rights reserved.

—PRINTED IN THE USA—

**Next Issue of  
Radio World  
March 8, 1995**



# Telecommunications Player Purchases IDB

by Eric L. Odell

**JACKSON, Miss.** Consolidations and acquisitions in the radio industry not only happen to stations, but also to industries that revolve around radio. Case in point: the recent acquisition of IDB, a leading provider of radio transmission services, by telecommunications giant LDDS.

While AT&T, MCI and Sprint bank their individual growth on a continuing war of advertising attrition, LDDS Communications Inc. used its recent IDB acquisition to enhance its role as the nation's fourth largest provider in long distance and data services.

That merger, along with LDDS' acquisition of WilTel Network Services, provides a new competitor to "The Big Three" with stronger leverage in the foreign telecommunications markets and fiber optics network services.

The birth of another telecommunications giant occurred on Dec. 30, 1994, when stockholders for LDDS and IDB approved the proposed merger.

The merger was finalized later that day. Then on Jan. 5, 1995, LDDS officials announced that they had finalized the acquisition of WilTel.

"Between the merger of LDDS and IDB and the acquisition of WilTel's digital fiber optic network, LDDS can essentially provide 'one-stop-shopping' in telecommunications services to the business community," said LDDS Director of Investor Relations Beverly Buckley.

In a letter to shareholders, LDDS President and CEO Bernard J. Ebberts said "IDB's strength in international communications and WilTel's state-of-the-art digital network will be excellent complements to LDDS' current operations."

"We look forward to capitalizing on the potential synergies expected from the combination of our operations," he added.

LDDS provides both domestic and international long-distance telecommunications services to business and residential customers through its digital network. However, its international services have been limited because of difficulties in obtaining foreign operating agreements in foreign countries. IDB, on the other hand, had obtained 59 switched voice and 160 private line operating agreements in foreign countries.

With the LDDS/IDB merger, the company expects to become a stronger player in foreign communications. IDB had a very impressive number of foreign operating agreements. LDDS had some, but not a lot," Buckley said. "It is a very difficult and slow process to develop these operating agreements with foreign countries. It

was fortunate for LDDS to obtain such a large number of agreements in one transaction."

Shareholders were asked to vote on the merger in two separate meetings held here in Jackson. The merger was approved by a 68 percent margin. As a result, holders of IDB common stock will receive a .476879 LDDS share for each IDB share in a tax-free exchange accounted for on a pooling interest basis. Note holders will receive the corresponding exchange ratio adjustment to their common stock conversion price.

The merger had been clouded for a short time during the fourth quarter of 1994 with allegations that IDB mobile had infringed upon SynTech's software copyrights. However, the U.S. District Court for the District of Columbia dismissed all the claims asserted by SynTech and ruled that IDB could own and use the software.

"That is something that can be corrected by our own accounting procedures," Buckley said.

In addition to private line and long distance telephone services, the merger with IDB will allow LDDS to enhance

its services in facsimile and data connections, mobile satellite communications as well as radio and television transmission services.

The acquisition of WilTel from the Williams Companies, Inc., on the other

**LDDS now is the nation's fourth-largest provider in long distance and data service.**

hand, allows LDDS to expand its work in fiber optics. The fiber optic network was sold to LDDS for \$2.5 billion. Though Williams accepted the LDDS offer for the network, the company will retain certain other WilTel business units including WilTel Communications Systems, a national telecommunications equipment supply and service company, and Vyvx, which operates a national video network specializing in broadcast

television applications.

The digital fiber optic network was one of only four of its kind in the United States. The combination of LDDS and WilTel networks will result in a 15,000 mile state-of-the-art system. Much of the LDDS existing long distance traffic will be transferred to the combined network, resulting in significant cost reductions, according to Buckley.

"LDDS can now offer a wider range of products and services, especially those services geared toward larger telecommunications users," she said, adding that WilTel's fiber optic network specializes in large business customers such as government agencies and Fortune 100 companies. "The acquisition will complement our emphasis on the smaller business customer and enable LDDS to focus more on major, mid-sized accounts."

LDDS accomplished the WilTel acquisition after it had complemented a \$3.41 billion credit agreement with a group of banks managed by NationsBank. In addition to the purchase of WilTel, the credit agreement refinanced LDDS' existing outstanding indebtedness. 

## FROM THE FIELD

# WTIM Back On-Air Two Days after Fire

by Cliff Wygant

**TAYLORVILLE, Ill.** It was just another day of broadcasting. At least that's the way it started to shape up for Matt McLemore, station manager and morning host of WTIM Newstalk 1410 as he signed on at 5:30 a.m. on Tuesday, Jan. 24.

McLemore is well liked in this central Illinois community of 12,000. He hosts the station's program from sign-on until noon. Each day, he announces birthdays, offers his opinions and discusses items that can be bought and sold.

At 6 a.m., he powered up the main transmitter to its pre-sunrise setting of 500 W. At 6:02 a.m., the station went off the air. McLemore was called by the transmitter remote control unit (affectionately nicknamed "Remo") and discovered the transmitter was experiencing a power failure.

## Fire and flood

The day also started out in quite a normal fashion for Randal Miller, the station's owner and general manager. Miller decided to get into the office a little early to take care of paperwork before the usual flood of phone calls began around 8 a.m. After rising, Miller noticed that the station was off the air. He called McLemore, who told him of "Remo's"

call. Miller called the unit and was able to turn the backup transmitter on, but no audio was received.

Miller then called the station engineer, Jim Dunn, a 25-year veteran of radio. Dunn advised him to go to the transmitter site and unplug the receiving unit in case it locked up due to the power failure.

On his way to the site, Miller noticed the obvious lack of tower lights. Assuming he would find a power failure, Miller went through the woods to the site, set in a large clearing.

As he rounded the last bend, Miller's anger over having to spend his time flipping a little switch turned into shock as he saw black smoke billowing out of the back of the transmitter building. He called the fire department from his cellular phone.

Miller shut off power to the site in the hopes of saving some, if not all, the equipment. He watched, heartsick, as 25 years of work seemed to be going up in smoke.

The fire department arrived and spent about an hour putting out the blaze that had been raging inside the metal building. Miller spent that time on his car phone, calling his insurance agent. The agent advised Miller to put together an inventory list and to start getting proposals from vendors.

By 8 a.m., Miller was in his office at the

station, talking with vendors and lining up proposals. The staff was busy fielding phone calls from listeners who were trying to tune in. During the time the station was off the air, it received hundreds of phone calls from listeners and many more from other area stations and media outlets. All expressed concern and offered help.

By noon on the same day, Miller had a complete proposal from one vendor and one almost-complete proposal from another. These were sent to the insurance company, who would be sending out an adjuster the following morning.

The next day arrived and the station began its second day of silence. Miller met with the adjuster who advised him that a new transmitter would have to be rented because the insurance company wanted a complete investigation into the cause of the fire. So Miller went back to work.

## Lease first

The vendors were notified of the change and proposals were sent back and forth. The WTIM fax machine was hard-pressed to keep up with the amount of paper being pushed through it.

At 2:45 p.m., an agreement was reached with Broadcast Electronics, and Miller was on his way to Quincy, a trip of 165 miles, to pick up a new transmitter. Even on the trip over, there were still phone calls and arrangements to make: the phone was almost as busy as the fax machine.

At 7 a.m. on Thursday, Jan. 26, Miller was met at the site by Dunn, two station employees and an electrician, to move the 400-pound transmitter into its new home. Once in the building, Dunn and Miller had the unit powered up and were testing it by 9 a.m. At 10 a.m., Miller called the station and told McLemore to get ready to start programming. At 10:02 a.m., exactly 52 hours after going off the air, WTIM resumed programming.

□ □ □

Cliff Wygant is an account executive at WTIM. Reach him at 217-824-3395. 

## NANOAMP SERIES™

### IHF to PRO Interface Amplifiers

**UB400** Four Channel Unbalanced to Balanced

**BU400** Four Channel Balanced to Unbalanced

**BI100** Stereo Bi-Directional

- Low Noise & Distortion • Groundable Outputs • Front Panel Gain Controls
- Quality XLR Connectors • Desktop and Rack Mount Kits



328 Maple Avenue  
Horsham, PA 19044, USA  
(215) 443-0330 • FAX (215) 443-0394  
800-959-0307

CALL OR WRITE  
FOR A FREE  
DETAILED  
BROCHURE

AUDIO TECHNOLOGIES INCORPORATED



Circle (17) On Reader Service Card



# THINK OF THEM AS YOUR MUSICAL INSTRUMENTS.

If a studio guitarist showed up strumming a plastic ukulele, you'd laugh. Not out loud. But you'd laugh.

On the other hand, if the same guitarist caught you recording on anything other than Sony media, he wouldn't be amused. Not one bit.

You are as important to the final sound of every cut as the artists themselves. They rely on your expertise. And the best way to prove it to them is through your choice of recording products — your professional instruments, Sony's pro audio digital line.

We pioneered the entire digital movement and invented metal technology. Others have copied it. Sony has forged ahead.



Using the foremost knowledge, vision and design in the digital audio world has resulted in the most reliable, accurate reproduction of any original source.

Be it a classic six-string guitar — or a toy ukulele.

And no matter where you're working — in the control room, on location or in your basement, Sony has everything you need to capture every inspired sound. DASH, DAT, DTRS and Disc.

After all your work's done, write an acceptance speech.

With Sony's digital audio products, you'll have all the necessary tools for a 'Best Sound Engineer' award. Or even better — 'Musician of the Year.'

## SONY

A COMPLETE LINE OF DIGITAL AUDIO MEDIA PRODUCTS

© 1994 Sony Electronics Inc. Reproduction in whole or in part without written permission is prohibited. All rights reserved. Sony is a trademark of Sony Electronics Inc.

Circle (191) On Reader Service Card



# IT'S ALL IN THE AudioVAULT.®

Only AudioVAULT OnLINE™ systems provide *all* the important digital audio capabilities radio stations want.

**Integrated Cut-and-Paste Editing:** Perform simple production on AudioVAULT with no additional software. Optional: the AudioVAULT MTE™ eight-track editor, with seamless Windows interface.

**Business Connection:** AudioVAULT OnLINE connects with your traffic and billing system and music rotation software. You'll save time and reduce mistakes.

**Power On-Board:** The AudioVAULT Multi-processor System Board incorporates Digital Signal Processing (DSP) and fast SCSI interfaces for simultaneous multi-user access to your digital audio. Its AES-EBU inputs and outputs effect perfect transfers.

**Windows™ On-Screen Control:** Clear, consistent Windows interface system speeds the addition of new functions and accelerates staff training.

Windows is a trademark of Microsoft Corporation.

**Central Audio Storage with Dynamic Access :** All audio cuts are instantly available to all studios, even while you're recording new material.

**Versatile Automation Interface:** AudioVAULT easily connects with automation controllers like BE CORE™ or Format Sentry™, plus online news editors and routing switchers.

**Programmable Controls:** Production audio cuts, telephone and network recording, even transmitter or studio lights can be assigned to on-screen buttons or console switches.

For complete information on AudioVAULT OnLINE Digital Audio Systems, contact your Broadcast Electronics representative or:

Solid Company;  
Solid Support: Our factory support staff and your BE representative help keep your system up and running.

**BE BROADCAST ELECTRONICS, INC.**

WORLD LEADER IN RADIO BROADCAST TECHNOLOGY

4100 N. 24th • P.O. Box 3606 • Quincy, IL 62305-3606 • (217) 224-9600 • FAX (217) 224-9607



# Congressional Ax Could Hurt NPR

► continued from page 1

station would have to cut NPR programs like "Morning Edition," he said.

"Where we would be hurt is we couldn't give as good a service," he said, "provided the service is still there."

"If those sorts of funds were not available you would not get some of the programming you get now," KENW Associate Director Jim Zupancic added.

However, Ryan is hopeful that Congress will not completely cut CPB, although he acknowledged that CPB will have to endure its "fair share" of cuts as Congress attempts to balance the budget and reduce taxes.

"I believe wiser cooler heads will prevail."

One station very concerned about CPB funding cuts is KHSI(FM), another New Mexico rural station serving the Zuni Indian tribe. Unlike its KENW counterpart KHSI does not receive support from a college or university.

The station relies on its approximately \$26,000 in CPB funds, about one quarter of the station budget, for equipment purchases and other capital expenditures.

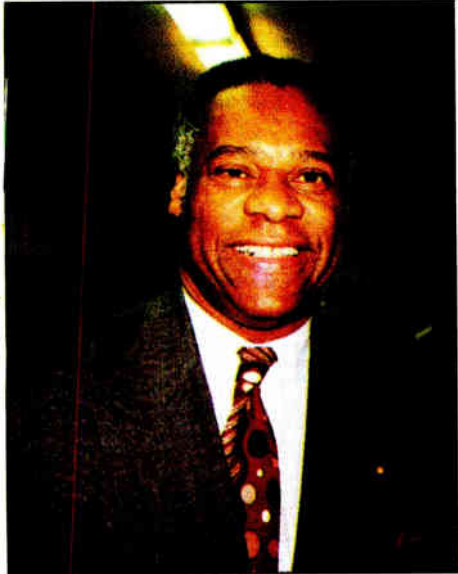

Delano Lewis

Currently KHSI is attempting to buy a digital workstation and a Sony MiniDisc. Without CPB funding "it would probably take some sort of fund raising initiative," said Station Manager Duane Chimoni.

But like KENW, the Zuni station is lacking the dense population base needed to support the station and 8,000 to 9,000 Zuni living in close proximity to the station really do not have the financial resources to support a radio station.

Most live off meager profits they make from sales of hand made jewelry, arts and crafts. "The economic base is not there," Chimoni said.

WDET also occasionally uses CPB funds for equipment purchases. A couple of years ago the station procured a loan from Wayne State University to purchase a computer for the station and is paying back the loan with CPB funds, Mathes noted.

## A necessary budget cut

Conservatives testifying before last month's committee meeting argued that cutting public broadcasting is a necessary step towards balancing the budget.

But Rep. David Obey (D-Wisc.) noted that CPB's \$300 million a year comes out to 3/1000 of one percent of the entire federal budget. In contrast, Obey pointed out, the Pentagon spends about \$300 million every 10 hours.

"We ought to look at illegitimate tax expenditures, which grant special tax favors," he said.

Lewis noted that NPR is only costing the taxpayer about 29 cents per person

## Lewis vows to fight for NPR federal funding.

per year, and said CPB funding enables NPR to attract other funds. "Every dollar in federal funding... leverages \$5 in

other funding."

At WDET, Mathes noted that her station uses CPB funding to pay for postage on mailings sent to listeners for raising additional revenue and the aforementioned computer the station purchased is for databasing the station's listener list, which will help the station compile mailing lists.

Also, CPB funding pays WDET leased antenna space on a Detroit Board of Education tower.

Rep. Steny Hoyer (D-Md.) said the deficit has increased because entitlements, a type of guaranteed congressional expenditure, have increased. He then added that discretionary spending, which

includes public broadcasting, has decreased.

"This is a very very small percentage of the discretionary dollars we spend," he said.

Rep. Roger Wicker, a freshman Republican congressman from Mississippi, said a tough budget cutting decision would have to be made on public broadcasting before Congress could deal with the tougher issue of entitlements.

"I don't see how we'll make tough decisions on entitlements without making tough decisions on Public Broadcasting."

But Lewis noted that NPR is irreplaceable.

"No one else is providing the programming and services that NPR and its member stations offer to local communities," he said. "There are no Arts and Entertainment or Discovery channels for radio." ☺

## Radiosoft FMR Database — Allocations

Accurate Coverage  
Absolute Simplicity

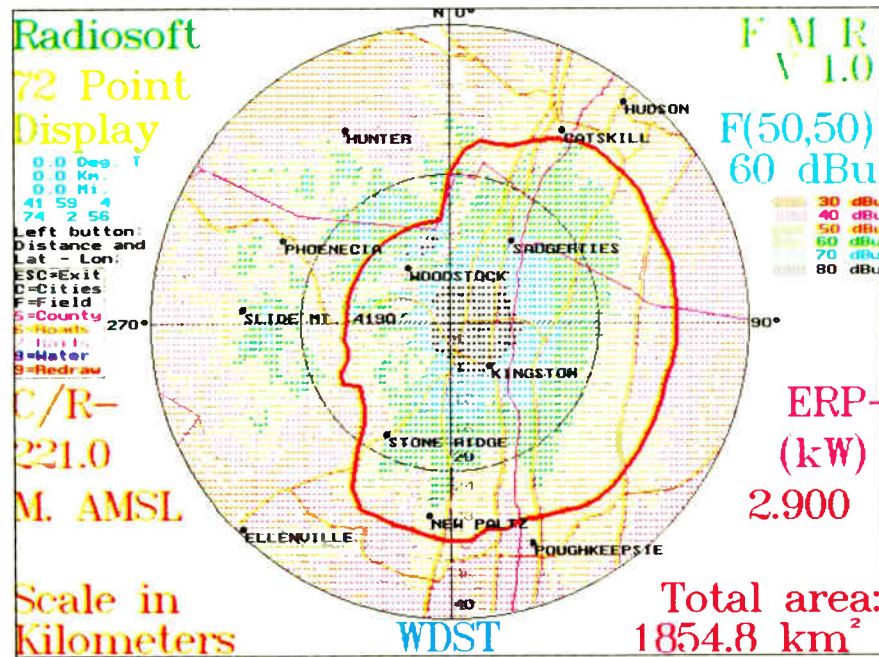

This versatile software package has something for everyone:

- > A manager's presentation to banker, broker or corporate
- > A sales presentation to clients both new and old
- > A market analysis (including formats) for programming, LMA's or acquisitions
- > An engineering study for translator/booster/upgrade: site analysis, coverage, interference and ERP
- > A consultant's complete toolkit in one program suite
- > Able to run under windows or DOS

Radiosoft's FMR Database contains more information about more broadcast stations than any other programs, including the ones used by the FCC! And it's all current, easy, very accurate ... and incredibly **FAST!**

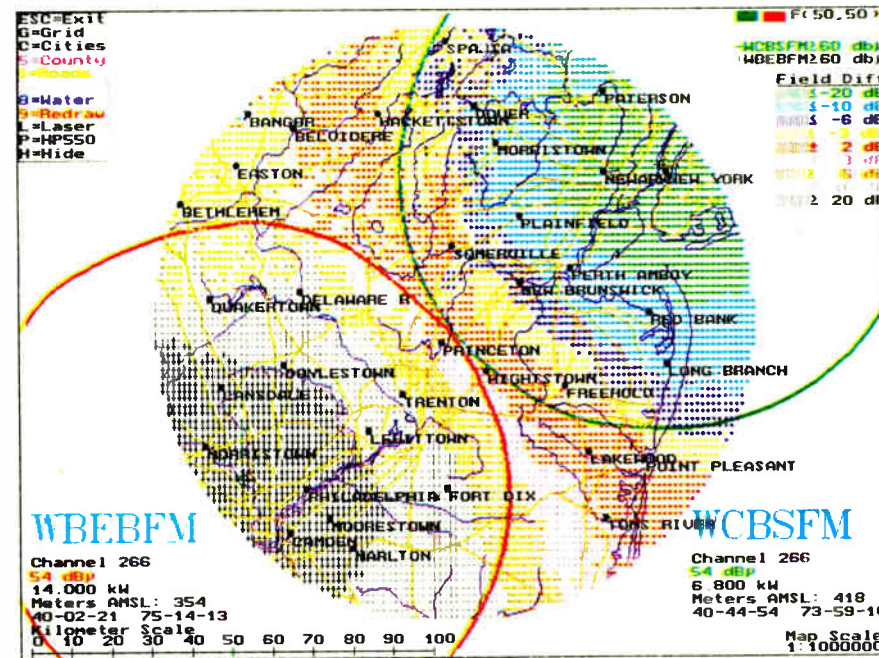

Last year, we gave away our popular 3DFM viewer (run directly from FMR) as an NAB show special. This year, we aren't going to the show, so we decided to give away our brand new *Shadow Matrix* Interference module if you order by April 1st; if you already own FMR, write, call or email and we'll send it, free!\* Here's an example: the famous short spacing between WCBS (NY) and WBEB (Philly). The picture shows DIFFERENTIAL FIELDS, the difference between the two stations at any single point on the Matrix.

The FCC has cochannel at 20 dB desired-to-undesired; what do you think? We like 5 or 6 dB  
Radiosoft, 120 N. Riverside Drive, Edgewater, FL 32132-1716 Phone: (904) 426-2521, FAX (904) 423-0821  
email:pmoncure@enterprise.AMERICA.com \*mention "fine print", and we'll also send you our STL program free.



# RF Emissions Can Detoxify Soil

by Dee McVicker

**PHOENIX** RF isn't just the stuff that radio broadcasting is made of. It is also the stuff of toxic waste cleanup. So, not only is RF found in the air but it is also found in the ground to eradicate contaminants.

Research organizations such as the IIT Research Institute (IITRI) in Chicago, began eyeing RF not too long ago in order to heat-extract toxic chemicals out of the ground. The institute had used RF in the '70s for experimental tar extraction. In the '80s, in conjunction with the Environmental Protection Agency, IITRI applied the theory to remove toxic waste from the earth.

## Precedent set

"The idea in the '70s was to recover bitumen (tar) from Utah tar sands without having to excavate and heat the soil. By injecting RF energy into a block of tar sand, the temperature could be raised

to apply the same soil volumetric heating process as a method of cleaning contaminated soils without having to excavate the earth."

The use of 60 Hz or RF energy with an electrode array inserted into a contaminated zone was shown to be an effective way of raising soil temperature and ultimately vaporizing hydrocarbon contaminants for recovery above ground. For low temperature applications where the desired temperature is below the boiling point, an electromagnetic 60 Hz method is used. But for temperatures exceeding this, the RF method is more applicable and can save excavating dollars and prevent toxins from becoming airborne.

## Fire pit

The institute's first recent decontamination field experiment using RF was done at the Volk Air National Guard Base, with a primary objective of cooking the ground enough to create gases that could be collected and contained elsewhere.

ground using triplate electrode arrays. They hauled in a 45-foot trailer that contained a modified Navy transmitter, a 40 kW AN/FRT6, for the in situ soil excavation. Frequencies of 2 to 13 MHz were applied to electrodes placed in the ground in drilled bore holes, with power con-

and others, that they recently specified a new 100 kW generator for the purpose of on-the-road RF soil decontamination, and contracted Armstrong Transmitter Corp. to build it.

In addition to being ruggedized for mobility, with extra shielding, the 100 kW Armstrong was built for 3, 6 and 12 MHz frequencies and for a variety of loads.

Load variances are one of the main con-

**Research organizations such as IIT Research Institute (IITRI) in Chicago began eyeing RF a few years ago.**

veyed to the soil by means of coaxial cables. A matching network was used to control power transfer to the soil and two perforated metal tubes were laid on the surface of the ground underneath a silicone rubber sheet. These tubes were connected to a vapor treatment system, which collected the gases.

Later, the group tested ground samples for remaining contaminants. They found that more than 99 percent of the volatile contaminants and more than 94 percent of the semi-volatile contaminants were removed, encouraging the group to get serious about applying the method elsewhere and on a much larger scale.

## Sludge test

They reported similar findings in another, more extensive test of a sludge evaporation basin known as Basin F. Here, the soil was contaminated with several pesticides and covered with a five-foot-thick clay cap. Using the same RF method, the group heated 50 cubic yards of the soil to temperatures in excess of 250 degrees Celsius over a one-month period. The result: Removal of the pesticides was in the range of 98 to 99.6 percent.

The field experimenters were so encouraged by the results of these tests,

siderations of the method, according to Stangel. "Instead of going into a 50 ohm antenna, we're going into the earth so we have horrendous mismatches. And, as a result of that, we have to have a couple different stages of impedance matching to minimize reflective power," he said.

The customized transmitter is specified for up to 3:1 VSWR at full output, according to Armstrong's Bob White, who said the unit was completely customized from the empty cabinet on up. The 100 kW will be placed in a new trailer, along with a dummy load for testing loads before powering up the 100 kW on-site.

With the additional power, IITRI expects to be able to eradicate toxins from areas 50 feet by 100 feet and 20 feet deep. Temperatures vary between 100 and 300 degrees Celsius, depending on the type of toxin being eradicated. With those temperature and RF ratings, Stangel is quick to point out that safety precautions will be observed at all times. "We have to go out of our way to contain stray emissions in the vicinity of the electrode array.

Both personnel safety and equipment susceptibility issues must be considered," he said.

The new 100 kW will be traveling across the countryside, cleaning up the environment as it goes, starting in the next few months.

□ □ □

Dee McVicker is a freelance writer and regular contributor to *RW*. She can be reached at 602-545-7363.

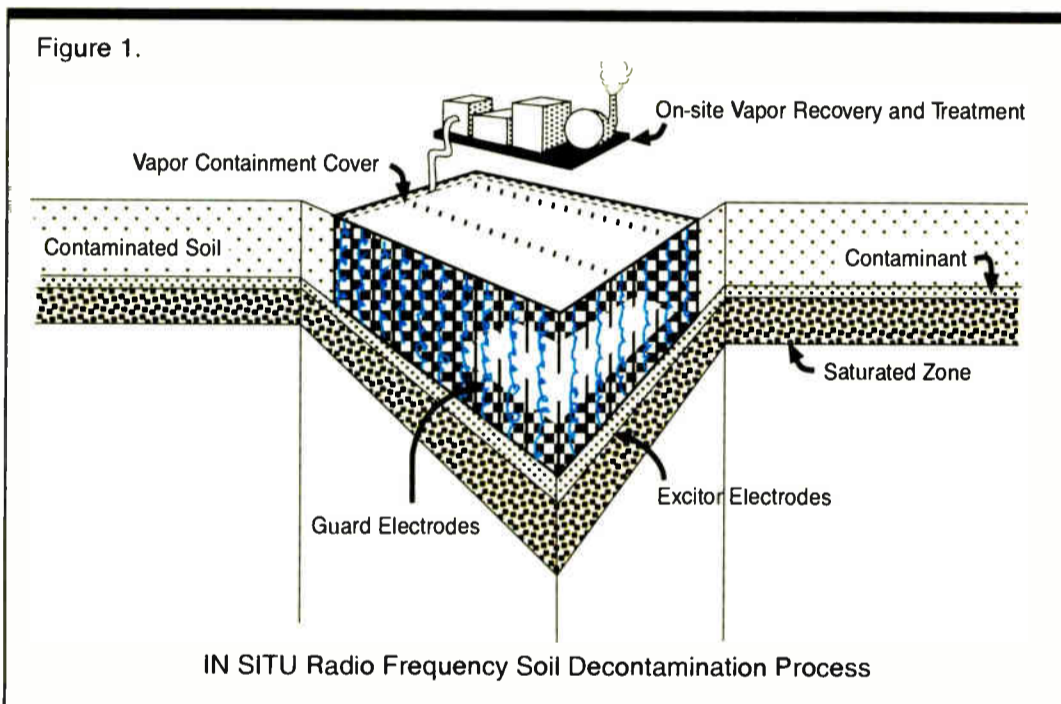

sufficiently to lower the viscosity of the bitumen so that the bitumen could be retrieved by one of several petroleum methods," said Jim Stangel of IITRI. "In recent years, as environmental cleanup issues became more important, we began

The goal was to get the ground hot enough, over 100 degrees Celsius, to boil hydrocarbon chemicals out of the soil along with steam formed by vaporization. IITRI set up site at an old fire training pit and pumped 40 kW of RF power into the

First class quality First class performance

Incredible price! -- \$995\*

**No-compromise RBDS just became affordable!**

**Phone 1-800-TECTAN-1 for details.**

\* Limited time introductory price for E-1 Encoder. Introductory price for the E-2 Encoder is \$1195. Shipping & handling \$25 additional for 2-day air shipment anywhere in the U.S.A.



“My bottom line was time. I was spending way too many late hours in the 24-track room just to get one show up on the bird each week. The average teen attention span being what it is, we were juggling hundreds of elements per show to get the impact we wanted, and I had to do something to get it under control.

We began evaluating the competing digital audio workstations, and finally installed a Spectral AudioEngine. The technology made sense, the interface looked ‘broadcast familiar,’ and the power and flexibility were mind bending.

Suddenly, I wasn’t waiting in line for the studios, and I wasn’t dreading the post. I was asking a lot more creative ‘what if’ questions, and answering them, all in the digital domain. And best of all, we could put an untrained person in front of the system and have them productive in just a few days.

I now produce four weekly versions of the program, have added 150 Stateside releases, 50+ foreign releases, and Armed Forces – and, I’ve discovered that my wife is an incredible cook.”

**—Todd Busted, Senior Producer  
Moody Broadcasting Network**

## What’s *Your* Bottom Line?

Spectral, Inc. is a pioneering developer of Windows-based Digital Audio Workstations. Our experience shows in the speed, power, and reliability of our workstations and related equipment. That is why large corporations and small independents around the world rely on Spectral systems to improve their competitiveness and efficiency.

Today’s high-impact, fast moving shows require more elements and more edits, often with fewer man-hours available to produce them. And every day it seems there is another new system on the market designed to cut, copy, and paste audio. So give us a call and have us show you how a Spectral system can improve more than just editing. Because *our* focus is on your bottom line.

Spectral, Inc. 18800 142nd Avenue, Woodinville, WA 98072 voice: 206-487-2931 fax: 206-487-3431 BBS: 206-487-7011



**SPECTRAL**



# RBDS ROLL CALL

The following is **Radio World's** quarterly listing of RBDS stations, equipment and receiver manufacturers, and service providers. If you would like to be included in the next listing, contact John Gatski at 703-998-7600.

## RBDS Equipment Manufacturers/Distributors

AEV (Encoder)  
Via Saviolo Budrie  
Di S. Perisceto  
Bologna, Italy

Bradley Broadcast (Encoder)  
8101 Cessna Avenue  
Gaithersburg, Maryland 20979

Broadcast Electronics (Encoder)  
4100 North 24th St.  
P.O. Box 3606  
Quincy, Illinois 62305

Broadcast Supply Worldwide (Encoder)  
7012 27th St. West  
Tacoma, Washington 98406

Circuit Research Labs (Encoder)  
2522 W. Geneva  
Tempe, Arizona 85282

Harris Allied (Encoder)  
3712 National Road West  
Richmond, Indiana 47374

**Modulation Sciences  
(Encoder/Monitor)  
12A World's Fair Drive  
Somerset, New Jersey 08873  
Contact: Judy Englert  
908-302-3090  
Reader Service 99**

**modulation sciences**

RDS Diagnostix (Test/Decoder)  
74 Hanover Road  
Mountain Lakes, New Jersey 07046

Audio Broadcast Group (Encoder)  
2342 S Division Ave  
Grand Rapids, Michigan 49507

**RE America, Inc. (Encoder)  
31029 Center Ridge Road  
Westlake, Ohio 44145  
Contact: Andy Bosworth  
216-871-7617  
Reader Service 189**

**re**

Rohde and Schwarz (Encoder)  
4425 Nicole Drive  
Lanham, Maryland 20706

**SCA Data Systems (Encoder)  
2912 Colorado Ave.  
Suite 200  
Santa Monica, California 92404  
Contact: Mark Medow  
310-315-9930  
Reader Service 68**

**S.C.A.**

Teli AB (Encoder)  
14980 Nunashamn  
Sweden

**Tectan (Encoder)  
Box 27157  
Concord, California 94527  
Contact: Judy Pendleton  
800-TECTAN-1  
Reader Service 135**

**TECTAN  
RBDS PRODUCTS**

VG Electronics (Encoder)  
Theaklen Drive  
Hastings East Sussex TN34 1YQ England

## RBDS Receiver Manufacturers (with current U.S. models)

**Advanced Digital Systems  
(PC RDS Receiver)  
13909 Bettencourt Street  
Cerritos, California 90701  
Contact: Mike McCoy  
800-888-5244  
Reader Service 203**

**ADS**

Access (Paging)  
6620 Riverside Drive  
Suite 200  
Metairie, Louisiana 70003

Delco Electronics (Car)  
1 Corporate Center  
Mail Station CT-16A  
Kokomo, Indiana 46904

**Denon (Car/Home)  
222 New Road  
Parsippany, New Jersey 07054  
Contact: John Casey  
201-575-7810  
Reader Service 24**

**DENON**

Grundig (Portable)  
3520 Haven Ave., Unit L  
Redwood City, California 94063

Modulation Sciences (Data)  
12A World's Fair Drive  
Somerset, New Jersey 08873

Onkyo (Home)  
200 Williams Drive  
Ramsey, New Jersey 07446

Philips Car Stereo (Car)  
9600 54th Avenue  
N. Minneapolis, Minnesota 55442

Pioneer (Car)  
2265 East 220th St.  
Long Beach, California 90810

## RBDS Service Providers

Access/Spartan (Paging)  
6620 Riverside Drive,  
Suite 200  
Metairie, Louisiana 70003

**DCI (Global Positioning)  
20045 Stevens Creek Boulevard,  
Suite 2A  
Cupertino, California 95014  
Contact: Ron Haley  
408-446-8350  
Reader Service 177**

**DCI**

**Coupon Radio (Information Services)  
10 Rockefeller Plaza  
New York, New York 10020  
Contact: David Alwadish  
212-595-1313  
Reader Service 77**

**CouponRadio**

Sage Alerting (EBS)  
700 Canal Street  
Stamford, Connecticut 06902

SATX (Data Broadcast Software)  
Milestone Technologies  
2221 Mariner Circle,  
Raleigh, North Carolina 27603

**Specialized Comm. (Music Information)  
1638 153rd St. SE  
Bellevue, Washington 98007  
Contact: Allen Hartle  
206-641-9043  
Reader Service 54**

**MusicBoard**  
RBDS Software

Terrapin (IVHS Services/Diff-GPS)  
11958 Monarch Street  
Garden Grove, California 92641

If you would like to feature your company's logo and information on the RBDS Roll Call page, contact your Radio World sales rep.



# RBDS Stations

Station	Freq.	City
<b>ALABAMA</b>		
WZYP-FM	104.3	Athens
WRJM-FM	93.7	Geneva
<b>ARIZONA</b>		
KKFR-FM	92.3	Phoenix
KSLX-FM	100.7	Scottsdale
<b>CALIFORNIA</b>		
KSIO-FM	96.1	Brawley
KLON-FM	88.1	Long Beach
KPCC-FM	89.3	Los Angeles
KTWV-FM	94.7	Los Angeles
KCRW-FM	89.9	Los Angeles
KATM-FM	103.3	Modesto
KHOP-FM	104.1	Modesto
KNPR-FM*	88.1	Ridgecrest
KSFM-FM	102.5	Sacramento
KPBS-FM	89.5	San Diego
KPLM-FM	106.1	Palm Springs
KYXY-FM	96.5	San Diego
KDFC-FM	102.1	San Francisco
KEAR-FM	106.9	San Francisco
KALW-FM	91.7	San Francisco
KKSF-FM	103.7	San Francisco
KCBX-FM	90.1	San Luis Obispo
<b>COLORADO</b>		
KMUI-FM	100.3	Denver
KCFR-FM	90.1	Denver
<b>CONNECTICUT</b>		
WSHU-FM	91.1	Fairfield
WPKT-FM	90.5	Hartford
WHCN-FM	105.9	Hartford
<b>DISTRICT OF COLUMBIA</b>		
WAMU-FM	88.5	Washington
WETA-FM	90.9	Washington
WDCU-FM	90.1	Washington
WGAY-FM	99.5	Washington
<b>FLORIDA</b>		
WAPN-FM	91.5	Daytona Beach
WSFP-FM	90.1	Ft. Myers
WAOA-FM	107.1	Melbourne
WLRN-FM	90.3	Miami
WTMI-FM	93.1	Miami
WMFE-FM	90.7	Orlando
WOCL-FM	105.9	Orlando
WUFT-FM	89.1	Gainesville
WOWW-FM	107.3	Pensacola
WFLZ-FM	93.3	Tampa
<b>GEORGIA</b>		
WDMG-FM	99.5	Douglas
WSTR-FM	94.1	Smyrna
WABE-FM	90.1	Atlanta
WCLK-FM	91.9	Atlanta
WKLS-FM	96.1	Atlanta
<b>ILLINOIS</b>		
WCIL-FM	101.5	Carbondale
WLRW-FM	94.5	Champaign
WBEZ-FM	91.5	Chicago
WXRT-FM	93.1	Chicago
WLS-FM	94.7	Chicago
WNUA-FM	95.5	Chicago
WNIJ-FM	90.5	DeKalb
WLLR-FM	101.3	East Moines
WAAG-FM	94.9	Galesburg
WSWT-FM	106.9	Peoria
WDBR-FM	103.7	Springfield
WGFA-FM	94.1	Watsika
WPGU-FM	107.1	Urbana
<b>INDIANA</b>		
WSHW-FM	99.7	Frankfort
WENS-FM	97.1	Indianapolis
WZPL-FM	99.5	Indianapolis
WITZ-FM	104.7	Jasper
WZVZ-FM	92.7	Kokomo
WWKI-FM	100.5	Kokomo
WMRI-FM	106.9	Marion
WLEZ-FM	102.7	Terre Haute
WXKE	103.9	Ft. Wayne
<b>IOWA</b>		
KRVR-FM	106.5	Davenport
KMFG-FM	103.3	Des Moines
WMT-FM	96.5	Cedar Rapids
KOEL-FM	92.3	Oelwein
KUOO-FM	103.9	Spirit Lake
KAYL-FM	101.5	Storm Lake
<b>LOUISIANA</b>		
WGGZ-FM	98.1	Baton Rouge
KFXV-FM	96.7	Morgan City
WLMG-FM	101.9	New Orleans
WMYZ-FM	95.7	New Orleans
KCIL-FM	107.5	Houma
KMUJ-FM	100.1	Shreveport
<b>MASSACHUSETTS</b>		
WBUR-FM	90.9	Boston
WGBH-FM	89.7	Boston

WBCN-FM	104.1	Boston
WBOQ-FM	104.9	Gloucester
WBCS-FM	96.9	Newton
WMJX-FM	106.7	Boston
<b>MARYLAND</b>		
WHFS-FM	99.1	Annapolis
WEAA-FM	88.9	Baltimore
WIYY-FM	97.9	Baltimore
WXYV-FM	102.7	Baltimore
WETH-FM*	89.1	Hagerstown
<b>MICHIGAN</b>		
WIOG-FM	102.5	Bay City
WLLZ-FM	98.7	Detroit
WKOI-FM	95.5	Detroit
WJLB-FM	97.9	Detroit
WORS-FM	105.1	Detroit
WDBM-FM	88.9	East Lansing
WKAR-FM	90.5	East Lansing
WLAV-FM	96.9	Grand Rapids
WKLO-FM	94.5	Holland
WRKR-FM	107.7	Portage
<b>MINNESOTA</b>		
KBEM-FM	88.5	Minneapolis
KNOW-FM	91.1	St. Paul
KSJN-FM	99.5	St. Paul
KTIS-FM	98.5	Minneapolis
<b>MISSOURI</b>		
KYYS-FM	102.1	Kansas City
<b>NEBRASKA</b>		
KESY-FM	104.5	Omaha
<b>NEVADA</b>		
KKLZ-FM	96.3	Las Vegas
KNPR-FM	89.5	Las Vegas
KNPR-FM*	88.7	Boulder City
KNPR-FM*	91.7	Beatty
KOMP-FM	99.3	Henderson
KNPR-FM*	88.7	Indian Springs
KNPR-FM*	89.5	Laughlin
KNPR-FM*	88.7	Moapa Valley
KNPR-FM*	88.7	Pahrump
KBUL-FM	98.1	Reno
KNEV-FM	95.5	Reno
KNPR-FM*	88.1	Scotty's Junction
KNPR-FM*	105.1	Searchlight
KLUC-FM*	98.5	Las Vegas
KFMS-FM	101.9	Las Vegas
KWNR-FM	95.5	Las Vegas
KEYV-FM	93.1	Las Vegas
KRRI-FM	105.5	Las Vegas
KOMP-FM	92.3	Las Vegas
KEDG-FM	103.5	Las Vegas
KFBI-FM	107.5	Las Vegas
KYRK-FM	97.1	Las Vegas
KLNR-FM*	91.7	Panapa
KTPH-FM*	91.7	Tonopah
KEYV-FM*	103.5	Laughlin
<b>NEW JERSEY</b>		
WFPG-FM	96.9	Atlantic City
WKDN-FM	106.9	Camden

WBGO-FM	88.3	Newark
WFME-FM	94.7	Newark
WNNJ-FM	103.7	Newton
WPAT-FM	93.1	Patterson
WADB-FM	95.9	Point Pleasant
WCHR-FM	94.5	Trenton
WBSS-FM	97.3	Millville
<b>NEW MEXICO</b>		
KKOB-FM	93.3	Albuquerque
<b>NEW YORK</b>		
WAMC-FM	90.3	Albany
WGY-FM	99.5	Albany
WZRO-FM	102.3	Albany
WSKG-FM	89.3	Elmira
WHTZ-FM	100.1	New York
WNEW-FM	102.7	New York
WNYC-FM	93.9	New York
WBEE-FM	92.5	Rochester

WROZ-FM	101.3	Lancaster
WFLN-FM	95.7	Philadelphia
WHYY-FM	90.9	Philadelphia
WMMR-FM	93.3	Philadelphia
WRTI-FM	90.1	Philadelphia
WPLY-FM	100.3	Philadelphia
WXPB-FM	88.5	Philadelphia
WDUQ-FM	90.5	Pittsburgh
WRTI-FM*	97.7	Reading

<b>RHODE ISLAND</b>		
WWBB	101.5	Providence
WHJY-FM	94.1	Providence

<b>TENNESSEE</b>		
WYPL-FM	89.3	Memphis

<b>TEXAS</b>		
KEAN-FM	105.1	Abilene
KNLE-FM	88.1	Austin
KTTX-FM	106.1	Brenhane
KTEX-FM	100.3	Brownsville
KKYS-FM	104.7	Bryan
KORA-FM	98.3	Bryan
KTEX-FM	106.9	Bryan
KAYD-FM	97.5	Beaumont
KOXY-FM	94.1	Beaumont
KYKR-FM	95.1	Beaumont
KCBI-FM	90.9	Dallas
KERA-FM	90.1	Dallas
KBNA-FM	97.5	El Paso
KILT-FM	100.3	Houston
KUHF-FM	88.7	Houston
KJMZ-FM	100.3	Irving
KOOH-FM	106.5	Jacksonville
KYKX-FM	105.7	Longview
KKMY-FM	104.5	Orange
KCRN-FM	93.9	San Angelo
KXTN-FM	107.5	San Antonio
WACO-FM	99.9	Waco

<b>UTAH</b>		
KSOS-FM	106.9	Ogden
KSOS-FM*	92.1	Salt Lake City
KSOS-FM*	96.7	Salt Lake City
KISN-FM	97.1	Salt Lake City
KSOS-FM*	98.3	Utah County

<b>VIRGINIA</b>		
WLTY-FM*	95.7	Norfolk
WNVZ-FM	104.5	Norfolk
WESR-FM	103.3	Onley
WKOC-FM	93.7	Virginia Beach
WCDX-FM	92.7	Richmond

<b>WASHINGTON</b>		
KFAE-FM	89.1	Richland
KISW-FM	99.9	Seattle
KUOW-FM	94.9	Seattle
KMPS-FM	94.1	Seattle
KEZE-FM	105.7	Spokane
KRPM-FM	106.1	Tacoma

<b>WISCONSIN</b>		
WIZM-FM	93.3	LaCrosse
WERN-FM	88.7	Madison
WUWM-FM	89.7	Milwaukee
WMYX-FM	99.1	Milwaukee
WMSE-FM	91.7	Milwaukee

**NEW!**  
With digital option prepared for mixed signals

**A2**  
Audio Test System

- Bit Analyzer
- Jitter Analyzer
- D/A Converter
- AES/EBU Generator

14 instruments in one

- easy to operate
- storage capabilities
- highest performance
- large graphics display
- AS03 software package for remote-control and automatic tests
- comprehensive two-channel system
- PC-and printer communication

The leading instrument

Neutrik AG, Neutrik Zürich AG, NCV GmbH, Neutrik Marketing Ltd., Neutrik Division of Japan, Neutrik Instrumentation  
 Uschenstein, Switzerland, Germany, United Kingdom, Japan, Canada/USA  
 Tel 075/2329666, Tel 01/7340400, Tel 0941/98041, Tel 071/7928188, Tel 03/54112551, Tel 514/3445220  
 Fax 075/2325393, Fax 01/7343891, Fax 0941/999772, Fax 071/7928187, Fax 03/54112827, Fax 514/3445221

800-661-6388

**NEUTRIK**  
CONNECTING THE WORLD

Circle (169) On Reader Service Card



# Canadians Issue RDS Guidelines

by Christopher Morris

**VANCOUVER, Canada** While the number of FM stations transmitting Radio Data System (RDS) information more than doubled in the U.S. last year, RDS displays are finally starting to show up in car radios, high end tuners and even portables.

But what's happening in Canada?

Many U.S. RDS broadcasts are already received in major Canadian cities, either directly or through cable. However, so far there are no Canadian RDS broadcasts, although last year the CBC conducted RDS test transmissions in

Toronto. Nor is there a Canadian RDS standard. Much of Canada's energy has been put into developing a digital audio broadcast standard.

Canada's lack of attention to RDS is set to change, however. Industry Canada, the government body that manages the radio spectrum, has issued broad guidelines that allow a broadcaster to put RDS on the air, using the U.S. RBDS standard that was implemented in January 1993.

The Canadian Radio-Television and Telecommunications Commission (CRTC), which licenses the Subsidiary Communications Multiplex Operation

(equivalent to the U.S. SCA service on 67/92 kHz), would also need to be notified as a formality.

At the same time, the Radio Advisory Board of Canada (RABC) in Ottawa is developing a Canadian RDS standard, through an industry committee. Some of the differences from the U.S. standard to be tackled include a Canadian station call letters algorithm (for generating the unique PI code), an English/French language bit, differing program types (PTY), additional specification of navigational information and a province/city database.

It is expected that the Canadian standard will be available later this year.

Meanwhile, in early April, the CBC will start regular RDS broadcasting from all major cities coast to coast. This follows an agreement with DCI of Cupertino, California.

DCI will use RDS Group 6 and the CBC's extensive national network of FM transmitters to provide differential global positioning (GPS) corrections, greatly enhancing the accuracy of civilian navigational equipment.

Other Canadian FM stations are expected to follow, to make their call signs "visible" on the dial, along with all the other benefits RDS provides to the radio audience.

□ □ □

*Christopher Morris is a mechanical engineer for SkyTrain, a mass transit service in Vancouver, British Columbia, Canada.*

## WELCOME TO THE DIGITAL WORLD OF DIGILINK

- Replace cart machines live On Air while adding walkaway CD, Satellite, or Tape automation
- On Air Base Price starts under \$8,000
- 8 Track Editor base price starts under \$5,500
- Smallest systems start at 10 hours stereo audio storage (20 hours mono)
- Network more than 15 Digilink workstations



With over 500 workstations sold worldwide in the last 18 months and more than 400 of those workstations sold in the U.S.A, it is little wonder that Digilink is the #1 choice for a digital audio hard disk workstation for professional radio broadcasting. Whether for On Air, Production, News, or Automation... Digilink does it ALL.

For more information about the #1 selling digital audio workstation for Radio, call or write...

303-224-2248

## ARRAKIS

© 1993 Arrakis Systems inc. 2619 Midpoint Drive, Fort Collins, CO. 80525

Circle (95) On Reader Service Card

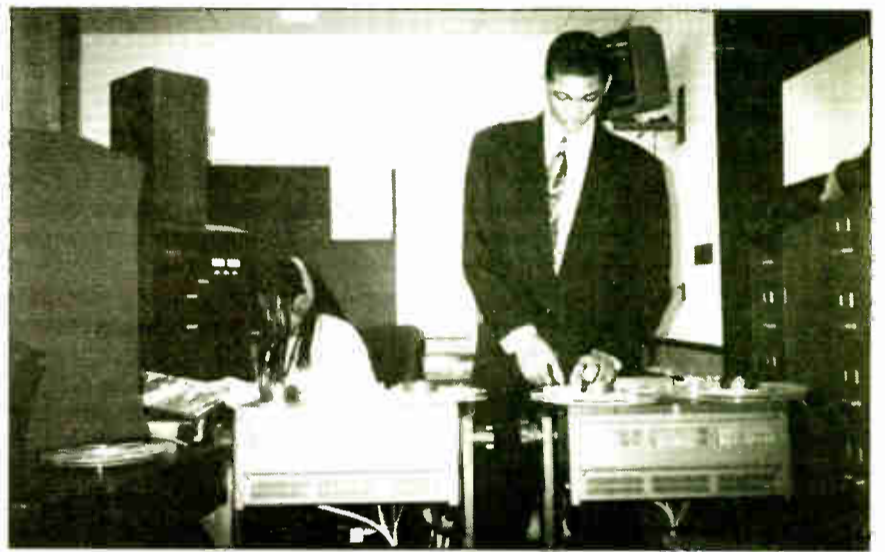

### NPR Youth Initiative

Sixteen-year-old Charles Palmer (front) and 15-year-old Mictrena Mickel (back), two sophomores at Washington's McKinley-Penn High School— an inner city magnet school— are learning broadcasting skills through a new closed-circuit radio facility that was recently donated to the school by National Public Radio (NPR). The facility is part of NPR's "D.C. Youth initiative," which also provides students with a training program. Bell Atlantic, District Cablevision, the Morris and Gwendolyn Cafritz Foundation and the Eugene and Agnes E. Meyer Foundation have joined NPR to support the project in its first year. "It's a good program," Palmer said. "It keeps the attention of a lot of youth— it keeps them out of trouble."

## RBDS

EASILY  
INSTANTLY  
INEXPENSIVELY

... with these two, brand-new products, INOVONICS has you covered, coming and going!

**710 ENCODER:** Just \$995 and **no computer required!** The non-volatile memory holds 16 separate frames of program and format identifiers, alternate frequencies, radiotext messages and traffic or emergency flags. A built-in data interface lets you upgrade later to full dynamic operation for revenue-generating paging, GPS, coupons, contests, etc.

**510 DECODER:** Connects to your existing FM Mod-Monitor. The front-panel LCD display shows RBDS injection level and allows you to scroll through and read all the data groups. An RS-232 port gives unlimited access to raw RBDS data for telemetry and other in-house functions.

## Inovonics, Inc.

1305 FAIR AVE., SANTA CRUZ, CA 95060 U.S.A.  
TEL: (408) 458-0552 — FAX: (408) 458-0554



Circle (56) On Reader Service Card



# NEWSWATCH

► continued from page 2

grant the FCC a temporary injunction to shut down Micropower station Free Radio Berkeley while the commission administratively pursues permanently taking the station off the air.

"They basically set a precedent," Dunnifer said.

The next move is up to the FCC. The FCC must decide whether or not to continue pursuing Dunnifer by collecting previously assessed fines.

The commission appeared to be pursuing a strategy of slapping a shut-down injunction against Free Radio Berkeley until fines were settled, and then keeping that settlement process in indefinite limbo. If the FCC had been successful, this scenario could have kept the injunction in indefinite limbo as well.

Dunnifer's operation is part of a growing number of micropower broadcasters who transmit signals anywhere between a half watt to 30 watts, serving as local community leaflets, Dunnifer said.

While the FCC has dubbed Dunnifer as an airwaves pirate, he and his National Lawyers Guild attorney Luke Hiken see Dunnifer as an airwaves "liberator."

Dunnifer sees his case as more than just the FCC trying to shut down an illegal broadcaster. He is battling what he believes is a system of large broadcasting corporations controlling the airwaves.

"We shall not be moved or stymied by a justice system that means, in reality, "just us" corporations," he previously said.

He has vowed to fight the FCC all the way to the U.S. Supreme Court, stating that the commission "can kiss my Bill of Rights."

## NAB Budget Increases

**WASHINGTON** The National Association of Broadcasters (NAB) reports that its board of directors recently approved the association's \$28.9 million expense budget for the 1995-1996 fiscal year and the association's \$32.2 million revenue estimate.

Those figures are up 8.7 percent and 9.6 percent respectively from the 1994 and 1995 fiscal years.

## Equipment Exporter to Build U.S. Plant

**RICHMOND, Ind.** Broadcast Richmond, a distributor of professional broadcast equipment to Latin America, the Far East and Africa, will build new facilities here to accommodate sales, warehousing, equipment testing and shipping.

Joe Ziemer, Broadcast Richmond president, who started the export company in March 1993, said he will build a facility of approximately 4,000 square feet on two acres he recently purchased in a Richmond industrial park.

A feature Ziemer highlighted is the dedicated test area for prewired program racks.

Broadcast Richmond exports radio and TV equipment for more than 100 manufacturers that specialize in studio and transmission systems and prewired custom-designed racks.

For information from Broadcast

Richmond, contact Joe Ziemer in Richmond, Ind., at telephone: 317-966-6468 or fax: 317-966-5505.

## Box to Chair Radio Show Steering Committee

**WASHINGTON** The NAB recently announced that EZ Communications President Alan Box will chair the 1995 steering committee for September's New Orleans NAB Radio Show.

The committee sets the radio show's agenda, and is divided into three sub-

committees. Jeff Trumper, Denise Oliver and Doyle Rose will chair the management, programming and sales and marketing subcommittees respectively.

## Spurlock Named NAB Director Of Senate Congressional Relations

**WASHINGTON** Patricia Spurlock started her new position as the NAB's director of Senate congressional relations on Jan. 17.

Spurlock was previously a legislative assistant to Virginia Senator Chuck Robb where she handled commerce committee issues, including telecommunications issues. She also served in

various departments within Bell System Companies.

## Large Share of Houston Duopoly Sold for \$26.8 Million

**HOUSTON** Clear Channel Communications recently closed its \$26.8 million purchase of 80 percent ownership in AM duopoly KPRC and KSEV.

The sale, exclusively brokered by Michael Bergner, is believed to be the third highest price ever paid for AM facilities.

Sunbelt Broadcasting, primarily owned by Steve Sellers and Dan Patrick will retain 20 percent interest in the duopoly. ☐

Now at more than 90% of the leading major market stations... thank you.



PR&E consoles... for broadcasters who place a high priority on reliability, features, performance and ease of use.



Pacific Recorders & Engineering Corporation  
2070 Las Palmas Drive, Carlsbad, CA 92009  
Tel: 619-438-3911 Fax: 619-438-9277 GSA: GS-03F-4064B

DESIGNS THAT MAKE THE DIFFERENCE

Circle (146) On Reader Service Card

World Radio History



FEEDLINE

# Certain AMs Qualify for Power Increase

by W.C. Alexander

**DALLAS** The rule changes that took place in October 1991 allow AM stations to upgrade their facilities. The stations most likely to benefit are the old Class 3 stations operating on regional channels. All these stations have been re-classified as Class B stations under the new rules, changing the old 5 kW power cap to 50 kW.

If such a station can employ a directional antenna or other means to limit radiation toward

other co- and adjacent-channel stations, a power increase may be possible. Since the rule change, some 65 stations have taken advantage of the new rules to improve their facilities. Let's look at a few preliminary steps that you can take to find out whether a daytime power increase is possible for your station.

### Know the rules

The normally protected groundwave contour for Class B and Class D AM stations is 0.5

mV/m. Other stations must provide varying degrees of protection to this contour, depending upon frequency relationship.

For co-channel stations, the interfering-to-protected contour ratio is -26 dB (a voltage ratio of 1:20). Nominally, this means that the 0.025 mV/m contour of a proposed co-channel operation cannot overlap the 0.5 mV/m contour of an existing station.

Conversely, the 0.025 mV/m contour of the existing station cannot overlap the 0.5 mV/m con-

tour of the co-channel proposed operation. This is known as "interference received." There is an exception to this particular prohibited overlap, but that would not apply in the case of an existing station upgrading its facilities.

For first adjacent channel stations, the ratio is -6 dB (a voltage ratio of 1:2). The 0.25 mV/m contour of a proposed operation cannot overlap the 0.5 mV/m contour of an existing first adjacent-channel station. Likewise, the existing station's 0.25 mV/m

contour cannot overlap the proposed first adjacent-channel station's 0.5 mV/m contour.

There is no protection ratio for second or third adjacent-channel stations per se—a "prohibited overlap" rule applies instead. The 5 mV/m contours of second adjacent-channel stations and the 25 mV/m contours of third adjacent-channel stations cannot overlap one another.

### Look at the contours

With these rules in mind, the next step is to find the protected and interfering contours of all nearby co- and first adjacent-channel stations, along with the 5 mV/m and 25 mV/m contours of all the nearby second and third adjacent-channel stations, respectively.

To begin, you will need three things: a current FCC AM database, the appropriate ground conductivity (M-3) maps, and the FCC groundwave curves for all the frequencies being considered. The database is available on-line through Broadcast Data Services, Dataworld and others, or you can purchase it from numerous vendors. The M-3 maps and groundwave curves are available from the FCC's copy contractor or your consulting engineer.

Using the database, retrieve all the records for all the stations from three channels below to three channels above your frequency within a fixed distance of your site. Use your transmitter site coordinates for the center of the search. If your area has relatively low ground conductivities (4 mS/m or less), use 500 km as the search radius.

Now plot the transmitter site location of your station on the M-3 map. Using a divider, use the lat-long scale provided in the margin of the M-3 to plot the location accurately. Continue by plotting the sites of the other stations found in the search, beginning with those closest to your site and working outward.

### Closest co-channel

Pick the co-channel station closest to your site and, using a straight edge, draw a line directly between the two sites. Using a protractor, mark off radials from the other station in five-degree increments to either site of the direct bearing over an arc of 30 degrees or so.

Using a divider, straight edge and the map scale, find the distance from the other station's site to each conductivity break along each of the radials marked in the previous step to a point that equals the distance between that station and yours. For example, if your station is 300 km from the other station, find the distances to all the conductivity breaks on all the marked radials out to 300 km from the other station's site.

With the appropriate FCC groundwave curves graph and the inverse distance field (IDF) value for the other station's

continued on page 18 ►

# Move Up from Carts to Touchscreen Digital Audio

## Play Any Audio at a Touch

**Nothing else** makes radio as fast or easy as having all your spots, sounders and sweepers start with your fingertip—**always on-line and ready** to play from hard disk. And **nothing else** makes your station sound as good or as exciting as touchscreen digital and creative talent with the **new Scott Studio System!**

Here's how it works: Six buttons on the left of the 17" computer touchscreen play what's on your program log. Scheduled spots, promos, PSAs and live copy come in automatically from your Scott System Production Bank and your traffic and copy computers. You see legible labels for everything, showing full names, intro times, lengths, endings, announcer initials, outcues, posts, years, tempos and trivia. Your jocks can rearrange anything easily by touching arrows (at mid-screen), or opening windows with the entire day's log and lists of all your recordings.

On the right, 18 "hot keys" start **unscheduled** jingles, sounders, effects, comedy or promos **on the spur of the moment**. You get 26 sets of 18 user-defined instant "hot keys" for your jocks' different needs.

Large digital timers automatically count down into times, and flash at 60-, 45-, and 30-seconds before endings. You also get countdowns the last 15 seconds of each event.



The Scott Studio System is your **best** way to make the move to digital audio and eliminate troublesome carts. Each button on the touchscreen plays whatever you want instantly. All scheduled spots, jingles, promos and scripts come in from your traffic and copy computers.



### The World's Fastest Playback!

Touch either of the two buttons at the top right of the main screen to see our "Wall of Carts" with all your audio **on-line!** Touch the sound, spot, jingle, promo, PSA or comedy you want and it plays **instantly**. Or, you can put it anywhere you want in the day's schedule. Audio is displayed any five ways you like.

The Scott System also gives you a "Make Good" button so it's quick and easy to reschedule missed spots or promos.

### Instant Requests from Hard Drive

Our most popular option is a 9 gigabyte disk with digital music. The audio quality of the Scott System hard drive meets or beats the best CDs. We'll pre-dub **1,000 songs** from CDs off **your playlist free!**

Nothing is faster than requests from the Scott System! You get five "Wall of Carts" with music that plays at a touch! Songs are displayed by title, artist, year, length, category, or any ways you like.

### Live Copy On Screen

Live tags, weather, promo copy, music trivia, contest copy and winners' lists automatically pop up on your Scott System's screen.

### The Best Digital Audio

When spots, promos, PSAs, or any other digital audio events are recorded, they're immediately playable in **all** your Scott System air studios. Nobody wastes time carrying carts down the hall or redubbing spots for additional stations.

One question you **don't** have to worry about with the Scott System is "What if it breaks?" The Scott Cart Replacement System comes complete with **every** spot and jingle stored **redundantly** on **two** hard disks with a **split-second** switch to the "hot standby" computer and its own backup audio outputs! You get touchscreen convenience, digital quality, and backup redundancy for no more money than cart machines and commercial carts.

### Sound Better With Digital Editing

Scott Systems' graphic waveform editors work wonders with phone calls in the air studio and creative spots and promos in production.

### Your Best Investment

The Scott System **leads the industry** with the biggest broadcast groups like Shamrock, Alliance, Salem, Saga, Liggett, Regent, Tichenor, Hefel, Waterman, Max, Atlantic, and Rawico in Canada. Our major markets include Detroit, D.C., Dallas, Miami-Ft. Lauderdale, San Diego, Denver, Oklahoma City, San Antonio, and others large and small from Bangor to Bakersfield.

**Scott Studios Corp.**  
13375 Stemmons Freeway, Suite 300  
Dallas, Texas 75234 USA  
8 0 0 7 2 6 - 8 8 7 7  
**(800) SCOTT-77**

Circle (84) On Reader Service Card



# Sorry, FedEx.<sup>®</sup> Sorry, UPS.<sup>®</sup> Sorry, DHL.<sup>®</sup> Sorry, Airborne.<sup>®</sup>

Save on overnight shipping and save your sanity. With Zephyr™ and ISDN or Switched 56, your commercials, promos, and voiceovers can be delivered *right now* in full broadcast fidelity.



"Zephyr has allowed us to 'stretch' the production window," says Joe Cipriano, the voice of the Fox Television Network.

From Zephyr's first demonstration, "everyone was blown away by the quality coming down the phone line," says Cip. "People didn't believe it."



Chris Clausen, who has lent his "pipes" to the NBC-Network, Federal Express, and Chevrolet, among others, quips "When it positively, absolutely has to be there the next minute,

Zephyr is the choice." Zephyr is "ideal" for people without engineering background, adds Clausen. "It's so well designed."

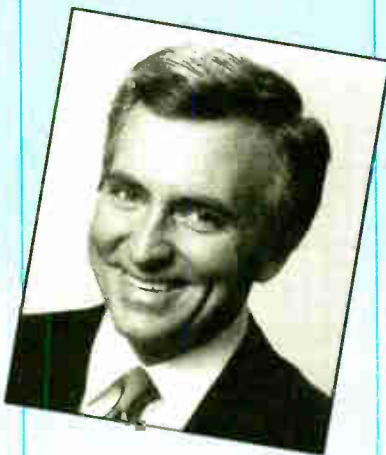

Zephyr uses Layer III efficiently and economically to code and decode the audio for transmission.



No other telephone-based system provides Zephyr's full broadcast bandwidth with equal quality in both mono and stereo.

*only from*



2101 Superior Avenue  
Cleveland, Ohio 44114  
216.241.7225  
FAX: 216.241.4103

- Full duplex 15kHz stereo operation on one ISDN line using Layer III coding.
- Mono 15kHz operation on a single ISDN "B" channel or one Switched 56 line.
- Compatibility with older 7kHz codecs that use G.722.
- 9600 baud RS-232 bi-directional data for communications and control.
- Four end-to-end "contact-closures" for remote machine operation.
- The ISDN terminal adapter is built-in. A V.35/X.21 port allows Zephyr to be connected to Switched 56 lines and other data paths.
- Unique telephone-mode allows Zephyr to operate as an ISDN phone set. Zephyr is capable of dialing any standard analog telephone line for low-grade voice communications.
- Designed for simple operation with full metering, headphone jack, and straightforward controls.
- Each Zephyr unit serves as both a transmitter and a receiver.



**The Best Way to Hear from There**

*Telos* **Zephyr** DIGITAL NETWORK AUDIO TRANSMITTER

Telos System, Zephyr, and "The Best Way To Hear From There" are trademarks of TLS Corp. Other trademarks are property of their respective owners.

Circle (208) On Reader Service Card

World Radio History



# Some AMs Hike Output

► continued from page 16

antenna on each marked radial, use the "equivalent distance method" (described in 47 C.F.R. §73.183(e) and §73.183(f)) to find the distance to the other station's 0.5 mV/m and 0.025 mV/m contours on each marked radial. Plot a point on each radial representing the distance from the other station's site to each of these contours, then connect the points for each contour using a smooth curve.

To find the maximum permissible radiation (MPR) from your station to the other station, first draw a line from your site to the closest point on the other station's 0.5 mV/m contour. Measure the distance

from your site to this point. Note the bearing and find the distance to all the conductivity breaks along this radial as you did on the radials from the other station. With the appropriate FCC groundwave curves graph, determine the correction factors for all the conductivity breaks using the equivalent distance method.

### Reverse the factors

Reversely applying the accumulated correction factor for the last conductivity on the radial before the other station's 0.5 mV/m contour is encountered, find the field strength on the groundwave curves graph that corresponds to the distance from

your site to that contour. Divide 0.025 by this value and multiply by 100 mV/m. This will yield the maximum IDF that your station can radiate without overlapping the other station's 0.5 mV/m contour with your station's 0.025 mV/m contour.

Repeat this procedure on the radial from your site to the closest point on the other station's 0.025 mV/m contour. This time, divide 0.5 by the field strength value read on the graph and multiply by 100. This will yield the maximum IDF that your station is permitted to radiate without interference received from the other station.

Whichever of these two calculated maximums is lowest represents the maximum permissible radiation from your station toward the other station. It is possible, in areas with varying conductivity, that the closest points on the 0.5 mV/m and the

0.025 mV/m contours of the other station will be on widely separated azimuths. In that case, both may be significant in a directional antenna design.

Now, continue with this procedure for all the other nearby co-channel stations. Plot their 0.5 mV/m and 0.025 mV/m contours, find the bearing to the nearest point on each from your site, and find the MPR toward each.

When all the co-channel MPRs have been computed, move on to the first adjacent-channel stations. Plot their 0.5 mV/m and 0.25 mV/m contours and find the nearest point bearing to each from your site. Find the maximum IDF toward each point in the same manner as with the co-channel stations, dividing the value of your contour (0.5 mV/m or 0.25 mV/m) by the field strength found on the graph and multiplying by 100 mV/m. Again, the MPR toward each station is the lower of these two numbers.

### Second and third too

Finally, find the MPR toward all the nearby second and third adjacent-channel stations using the 5 mV/m and 25 mV/m contours, respectively.

To see what can be achieved in the way of maximum power for your station using its existing site and antenna system, you will need to know your existing IDF on the radial toward each of the other stations' contour nearest points. If your station is presently non-directional, the IDF is the same in all directions and that makes it easy. Otherwise, calculate the standard-pattern IDF value for your station on each radial. Then divide the MPR toward each station by your station's IDF on that bearing. Do this for all the bearings you have calculated. Find the lowest number, square it and multiply by your present power. This will give you an idea of what power is permissible using your existing antenna system.

If this preliminary study shows that a substantial increase may be possible, get on the horn to your consulting engineer and discuss it with him. Have a full day-time allocation study run and, if necessary, a new directional pattern designed.

Should the power you calculated come up much lower than your present power level, it is probably due to existing overlaps with other stations. Many stations were permitted on the air in the late 1950s and early 1960s with some of the protection standards waived, and this resulted in a lot of existing overlaps. The new (1991) rules also created a lot of existing first adjacent-channel overlaps by implementing a new -6 dB protection ratio. In the past, FCC policy has been that existing overlaps can remain as long as the total area within the overlap zone does not increase. Therefore, it may still be possible to achieve an upgrade using a directional antenna, limiting radiation in the direction of the existing overlap while letting it out in clear directions.

Keep in mind that consulting engineers have access to a lot of resources that may give different results than you achieved in your study. An example of this is the use of measured conductivity data; this must be obtained from the FCC's files and will often have considerable effect upon the allocation picture. Making conductivity measurements along certain radials is another tool that can sometimes be used to advantage. If the measured conductivity is considerably lower than that shown on the M-3 map, the MPR along the measured radials becomes higher.



## The Dolby DSTL<sup>®</sup> has always been known for great specs.

## Here's another.



If you shop for equipment by the numbers, there's one more you can't ignore: the new, competitive price of the Dolby Digital Studio Transmitter Link. You already know the DSTL can't be beat when it comes to performance. But the latest developments in its RF design let us lower prices without compromising its robust, interference-free operation and high quality audio.

Call us today to find out more at **800-DOLBY-RF (365-2973)**. Our numbers will make both you and your bottom line happy.

\*Suggested list price of the two channel system. Suggested list price of the four channel system including the optional digital stereo generator is \$14,900. Contact your local distributor for actual prices. For those of you who read the fine print, you'll be glad to know that you can order the two channel DSTL with our new AES/EBU digital input at no additional charge. It's also available to retrofit to existing 2-channel DSTL systems. We're doing our part to make the all-digital signal path a reality!

Dolby Laboratories Inc. • 100 Potrero Avenue, San Francisco, CA 94103-4813 • Telephone 415-558-0200 • Facsimile 415-863-1373  
 Dolby Laboratories Inc. • Wootton Bassett • Wiltshire SN4 8QJ • England • Telephone 0793-842100 • Facsimile 0793-842101 • Telex 44849  
 Dolby, DSTL and the double-D symbol are trademarks of Dolby Laboratories Licensing Corporation ©1994 Dolby Laboratories Inc. 594/10339



Circle (171) On Reader Service Card



STATION SKETCHES

# Keep Turntables in Tune for Classic Vinyl

by Tom Vernon

**HARRISBURG, Pa.** Industry experts predict that thousands of records will never be re-mastered and released as compact discs. For stations with classic album rock or nostalgia formats, this means a continued depen-

force is within the specified range. There is a trade-off here. Higher tracking force equals better sound, but with increased record wear. Lighter force is less destructive to records, but getting top sound will be more difficult. One leading tone-arm has a self-calibrating system for

tedious trial and error process of adding weight and balancing several times.

With phono cartridges, azimuth is defined as the perpendicular angle of the stylus to the record when viewed from the front of the cartridge. To adjust the azimuth you will need a cart alignment jig or a small mirror. Verify that the reflection of the front edge of the cartridge is parallel with the scribed line on the jig.

If you're using a small hand mirror, then the front edge of the cartridge and its reflection must be parallel. You may need to bend the cartridge mounting ears ever so gently to achieve perfect alignment, or mount a small rubber grommet under the cartridge so that the mounting screws function as an adjusting medium, as in tape heads. Proper azimuth adjustment is vital to good stereo separation. (See Figure 1a.)

**Stylus overhang**

Stylus overhang refers to the distance the stylus extends beyond the center of the turntable. This may be checked via the overhang adjustment tool that comes with the headshell, or with the cartridge alignment jig. The latter has the advantage of taking into consideration the mounting position of the tone arm. Some headshells allow you to slide the cartridge

back and forth, others have a series of tapped holes where the cartridge may be mounted. In

that the shank of the stylus is parallel with the tone arm tube, as viewed from the top or bottom (Figure 1c). Deviations from this will result in a fixed tracking error, and added distortion.

Like tape heads, phono cartridges must be precisely oriented in relation to the medium they encounter, or audio quality will suffer. Once steps are taken to properly orient the cartridge and

Table 1.

Item	Description
stylus force gauge	Shure SFG-2 or equivalent
test record	Audio-Technica AT-6605 CBS stereo test record STR-116
cartridge alignment jig	Cart-A-Lign or equivalent

dence on turntables, if only to resurrect *discus obscurus*, and setting tracking force; simply slide the small weight to the

Figure 1a.

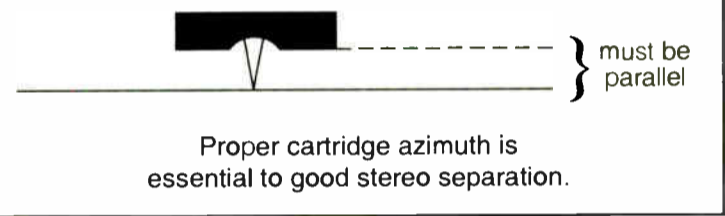

dub it to another medium.

Some small market and college stations may still be heavily dependent on turntables. This month's column explores turntable system maintenance, and how to squeeze the most out of what was once the mainstay of music radio.

First, the requisite test gear needs to be assembled. This may be difficult if you are starting from scratch or missing items, as none of these things are still manufactured. Table 1 gives a complete listing.

**Start alignment**

Alignment starts with the turntable enclosure. Verify proper alignment, front to back and side to side, with a bubble level. Most pieces of furniture have floor levelers, so fixing this is an easy process.

Next, be sure the cabinet has enough mass so that the stylus does not pick up footsteps, building vibrations or feedback from monitor speakers. The latter is particularly hideous, as it can cause muddiness and loss of definition, in addition to feedback.

The usual remedy is to load the pedestal down with cement blocks or sandbags. Just be sure you stack the weight evenly, and the unit is still level after being loaded. If you have the enclosure-within-an-enclosure scheme, be sure the inner cabinet does not touch the outer, and that all wiring has sufficient slack.

Verify that the stylus tracking

Figure 1b.

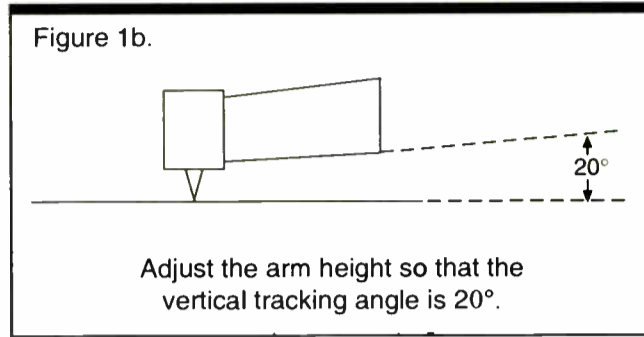

any event, overhang should be  $\pm 1/16$  inch from the reference line.

Figure 1c.

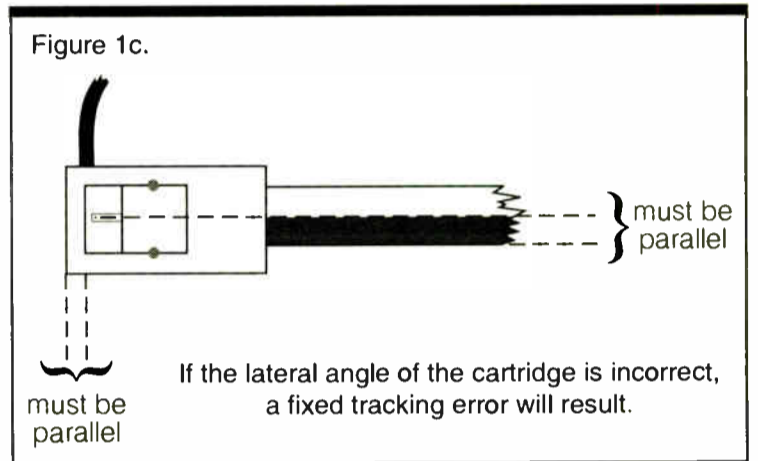

The vertical tracking angle must be adjusted so the diamond tip is parallel with the record surface, when viewed from the side. This equates to 20 degrees, and is adjusted by raising or lowering the arm height, as illustrated in Figure 1b.

Finally, the lateral angle of the cartridge must be adjusted so

set its tracking force, electronic alignment can begin, and that is where we'll resume in the next edition of *Station Sketches*. See you then.

Tom Vernon's other writing activities involve reviews of multimedia CD-ROMs for computer magazines. He can be reached at 717-367-5595.

## COMPRESSED COMPRESSOR

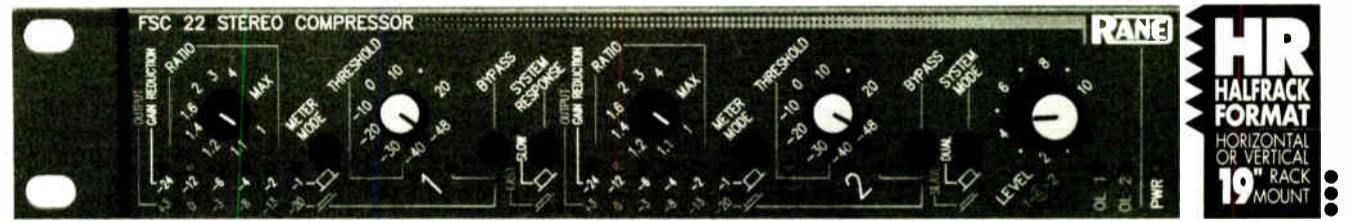

Meet the little cousin to the widely acclaimed DC 24... but don't let the size fool you.

The FSC 22 is very big on performance and features. Like switchable attack/release response, dual-mode metering to display either gain reduction or output level, and an Input Trim switch to match -10dBV or +4dBu systems for minimum noise and maximum headroom. It's even got those clever new Neutrik connectors that accept three-pin or 1/4" connectors!

Back these features with the superlative VCA performance that made the DC 24 famous, and you've got yourself a top-notch compressor/limiter that's ideal for studio or home recording, live sound, broadcast or post-production. Mount two horizontally for 4 channels in a 19" 1U space. Or rack-'em up vertically for 20 channels across for patching into console inserts.

No job is too big or too small for this pint-sized wonder.



**FSC 22**

STEREO COMPRESSOR / LIMITER

RANE CORPORATION 10802-47th Ave. W., Mukilteo, WA 98275 (206) 355-6000

Circle (220) On Reader Service Card



# WORKBENCH

## More to Tower Paint Than Meets the Eye

by John Bisset

**SPRINGFIELD, Va.** It will be spring soon, and if you budgeted for tower painting this year, now might be a good time to seek out your local Sherwin-Williams paint store. Tell the store manager that you would like to speak to a professional coatings sales representative to prepare a paint spec for your tower.

There are more than 800 of these reps. working out of more than 2,000 Sherwin-Williams paint stores.

John DiMarco is one such representative, and he covers the Washington metro area. His free service includes visiting the tower site, assessing the condition of the tower paint, discussing the owner's requirements—does he want a paint job to last two or 10 years—and determining

the limitations of getting the job done, including what kind of surface preparation is required and whether the work can be done during the day or at night.

The professional coatings sales rep will then assist the station engineer in preparing the bid specs, and recommend the name and addresses of several local painting contractors. The station awards the contract to the painter of its choice.

While the towers are being painted, the Sherwin-Williams rep will visit the site periodically to insure the specs are being met. Once the job is done, a final inspection will be conducted. This symbiotic relationship worked well for WFAX in Falls Church, Va. Mitchell Miller was pleased with the entire process. Because the station's tower is located in a shopping center, the painting was done at night to minimize spills on shopping center patrons' cars. The professional painting contractors got the job done quickly by using a pneumatic basket or bucket. It stands to reason that the job would go much faster if you are not worrying about losing your grip as you paint.

I was curious as to how Mitch found out about Sherwin-Williams' service. It

seems he had made no progress in finding a tower company to paint the station's tower and figured a paint store might be able to help. Finding John DiMarco at Sherwin-Williams was like striking gold.

You have probably found, like I have, that few tower companies want to be bothered with painting towers these days. You may have also found that if dealing with gypsy crews, the job may never get done. We had a station here in Washington where the crew painted the underside of the round members only. Looking up from the ground, the job looked great. From the air was a different story.

At another station, the crew demanded half payment on arrival, purportedly to purchase supplies. Their supplies included a large quantity of beer and they disappeared from the job site a third of the way through. The station was out the deposit money, plus the job still wasn't done. On top of that, the crew made off with the paint.

I have also seen sloppy paint jobs on AM towers that included painting over the insulators for sampling loops or coax lines that were supposed to be isolated from the tower. All of these nightmares can easily be alleviated by writing a paint spec.

continued on page 22 ▶

## JOIN THE HUNDREDS WHO HAVE USED DIGILINK TO ACHIEVE ECONOMIC RECOVERY

- ❑ 10 hours of stereo digital audio storage for \$7,995\* complete
- ❑ Satellite, CD, Tape, and Hard Disk Automation
- ❑ Simultaneous Play, Record, & Network transfer
- ❑ Digital Editor with Waveform Editing for tight production
- ❑ Crossfade CD's, sources, and hard disk audio
- ❑ Music Scheduling system built in for basic CD automation
- ❑ Digital Networking for transfer of audio and schedules

Digilink is the #1 selling digital audio hard disk system in radio today. You can replace your cart machines for live On Air and have an automation system for walk away at the same time! Link over 15 workstations & scheduling computers on our digital network and transfer audio and schedules between your studios.

For more information, call or write **ARRAKIS,**

**(303) 224-2248**

the premier broadcast manufacturer of consoles, furniture, Digilink and Trak\*Star digital audio products.

Consoles  
Modulux  
Trak\*Star  
Digilink  
Modulink

## ARRAKIS

\* Suggested retail price. Complete system

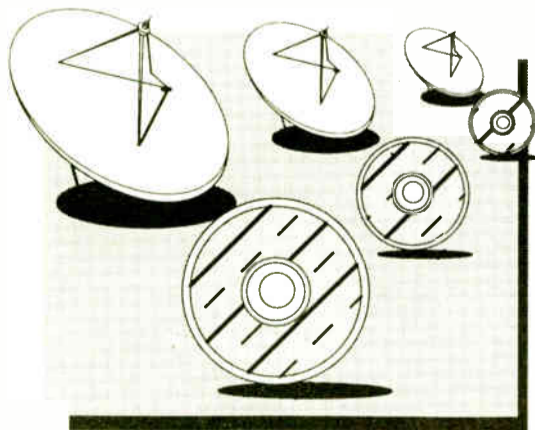

© 1993 Arrakis Systems inc. 2619 Midpoint Drive, Fort Collins, CO. 80525

Circle (4) On Reader Service Card

**AEV CELEBRATES AN UNPRECEDENTED OUTSTANDING WORLDWIDE SUCCESS!**

Radio Stations from all continents enthusiastically praise **EXCLUSIVE FM** as an extraordinary and absolutely exclusive event!



**AEV Exclusive FM AUDIO PROCESSOR**

**ASK FOR IT,**  
the whole world is asking for it.



**ELECTRONIC BROADCAST EQUIPMENT**

AEV  
ITALY  
Phone  
39 + 51  
950249  
950350  
Fax  
950201

© CURVA KAPPA Ph. Paride Venturilli

Circle (1) On Reader Service Card



# *Powerful, affordable* multi-track digital audio editing for broadcast production

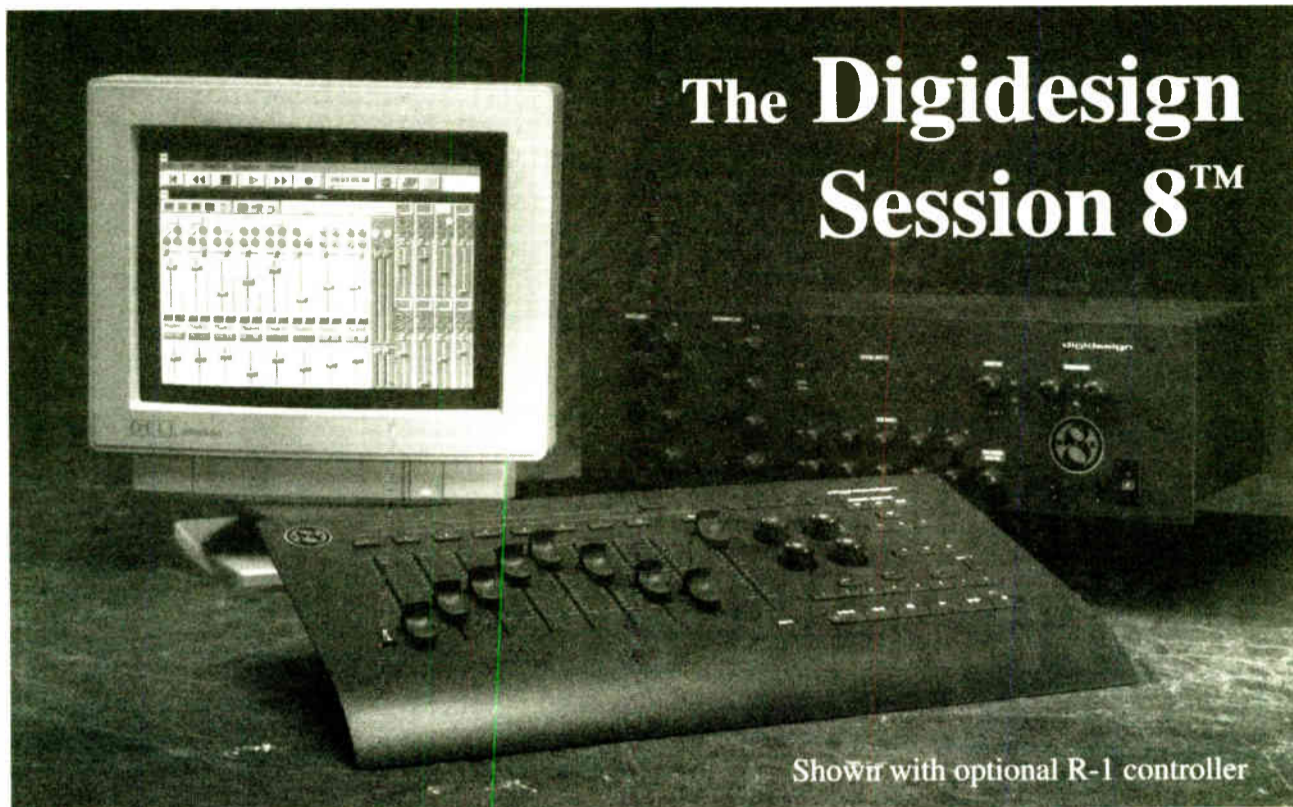

Digidesign's award winning Session 8 brings together direct-to-disk digital multi-track recording, digital mixing, track bouncing, random access "cut and paste" style editing, and digital signal processing. It operates on IBM compatible or Apple Macintosh computers and can be used as a complete stand-alone studio or in conjunction with your existing mixer and effects.

One of the first things you'll notice about Session 8 is how good it sounds. It supports 16-bit audio for 20 Hz to 20 kHz frequency response. It also has the simplest user interface available in a computer based editing system. If you know how to use a recorder and mixer, Session 8 will be a snap!

There's never been a better time to buy a Session 8 than right now. New software features include **Audio Scrub** that imitates rocking the reels on a tape machine and **Shuffle Edit** for creating automatic butt-splices and inserts. New audio interfaces add even greater system flexibility. Session 8 Mac now supports **Sound Designer II** for advanced features and third party plug-in compatibility as well.

Best of all it's available from Digidesign, the manufacturer with more workstations in broadcast production than any other, and BSW, the industry leader in service and selection, with over 20 years experience in serving broadcasters.

Now you can own a complete Session 8 system with R-1 remote for less than \$5,000.00 plus your Mac or IBM compatible computer. So what are you waiting for! Call BSW today for details.

**Call The BSW Digital Product Specialist Nearest You For Complete Details!**

#### **West Coast Region**

**Rick Kemp**

**Phone: 800 • 426 • 8434**

**Fax: 800 • 231 • 7055**

#### **Northeast Region**

**Craig Klein**

**Phone: 800 • 762 • 5566**

**Fax: 703 • 720 • 0710**

#### **Southeast Region**

**George Pupala**

**Phone: 800 • 518 • 5950**

**Fax: 404 • 518 • 5946**

# **BSW**

BROADCAST SUPPLY WORLDWIDE

7012 27th Street West Tacoma, WA 98466 USA



# Tips for Workstations

► continued from page 20

If you want further information on Sherwin-Williams' service, circle **Reader Service 118**. If you have any tower painting horror stories, fax them to me for inclusion in *Workbench*. Your fellow engineers would appreciate knowing how you handled the nightmare.

Lest I become barraged by letters from legitimate tower painting companies, I know there are some good ones out there. However, on behalf of my engineering brothers and sisters, I have got to ask, "Where are you?" It would sure help to see your business card in the services section of *RW*.

Getting Sherwin-Williams into the act means that reputable painting contractors will be recommended. These are not necessarily tower climbers, so you may want to carefully outline your specifications. The finished product will last and is far from slip-shod.

★ ★ ★

It amazes me how '95 seems to be the year for digital workstations. If your station has not budgeted for one, expect your program director and production guy to start hounding you for even the cheapest system. Once you get one on board, the fun will come when it is time to troubleshoot it.

Let me offer first-hand advice—even though it is digital, keep it simple. A case in point... Recently we experienced a distortion problem with an AKG editor. The left channel would just start sounding very strange. After exchanging audio boards and searching for that "digital bugaboo," the problem was traced to the XLR connectors. In order to properly mount the PC in the workstation stand, right-angle XLRs are used.

As you may know, these connectors are not the greatest for reliable, long-term connections, especially when the cables get flexed. The tension put on the cables as the workstation was moved out for cleaning, maintenance, etc., took its toll. One of the wires broke and was alternately opening up or shorting to the other pins.

The moral of the story: Just because it is digital does not mean the problem is with the computer.

Speaking of workstations... Alan Peterson, *RW's From the Trenches* columnist, sent in a tip courtesy of Laura Tyson at Roland. Alan has a Roland DM-80 digital audio workstation at WNNK-FM Harrisburg, Pa. and was running into a situation where the unit would suddenly change time base and then refuse to run.

Apparently there is a secret keystroke sequence that "hotkeys" the DM-80 from Internal clock mode to MIDI timecode. This feature permits music-to-video users to jump back and forth between modes. The "secret" combination is easy to press accidentally during a project, resulting in a DM-80 that sits with a flashing Play light, but no playback.

To return to the proper mode, press System and look for the field that displays Time Base. Most likely it will read: MTD (for MIDI time code). Use the data wheel to return it to Internal, and the DM-80 will sync up to its own internal clock and run the same as always.

Although Alan forwarded this tip to *Workbench*, he wanted readers to know the real credit came from his production department and Laura Tyson.

★ ★ ★

Thank you for your submissions to *Workbench*. This column is really your column. Taking the time to send a submission, no matter how brief, demonstrates your commitment to helping others. As many of the "oldtimers" retire and leave broadcasting, hundreds of simple tips slip away. I would like to encourage you to make a resolution to submit something to *Workbench* this year. *RW* will send you a modest thank you, and you will be helping your fellow broadcast engineers.

□ □ □

John Bisset is a principal with Multiphase, a contract engineering and special projects company based in Washington. He can be reached at 703-323-7180. Faxed submissions can be sent to 703-764-0751, and when printed, qualify for SBE re-certification credit.

# Cash In On a Digital Audio Codec!

## Intraplex is Making You an Offer You Can't Refuse.

### HOW CAN YOU REFUSE?

Have your fax call our fax. For a digital audio codec that does it all:

- CD Quality
- Full Duplex 7.5 kHz, 15 kHz, & 20 kHz
- ISDN S/T & U Interfaces
- MPEG II & G.722
- Musicore® Compatible
- Portable, Self Contained
- Plug and Play

Name \_\_\_\_\_  
 Company \_\_\_\_\_  
 Call Letters \_\_\_\_\_  
 Address \_\_\_\_\_  
 City \_\_\_\_\_ State \_\_\_\_\_ Zip \_\_\_\_\_  
 Tel. \_\_\_\_\_ Fax \_\_\_\_\_

Hurry. Like All Good Offers, Ours Expires Eventually.

(In this case, on May 31, 1995).

Circle (22) On Reader Service Card



Intraplex, Inc.  
 3 Liberty Way  
 Westford, MA 01886-3636  
 Tel.: (508) 692-9000  
 Fax: (508) 692-2200

## MOVING?...

Don't leave us behind!

Mail or fax your current label and new address (with effective date) to:

Circulation, *RW*,  
 PO Box 1214  
 Falls Church, VA  
 22041

or  
 FAX 703-998-2966.

Address changes will be processed within four weeks of receipt.

Thanks!





# Feedforward control for better sounding radio



Vital to the great sound of the Unity 2000i is our use of feedforward control circuitry. By using feedforward control, the Unity 2000i will always operate at the same processing ratio, providing a wider range of operation. This yields improved sonic consistency, regardless of the amount of processing employed.

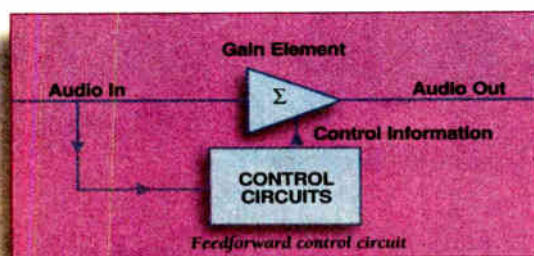

In feedforward dynamics control, the input audio signal to the gain-control circuits is monitored and, if necessary, adjusted before the gain element. The resulting control information is then "fed forward" to the gain element. This produces dB-linear gain control at a consistent ratio that remains constant regardless of the amount of processing employed.

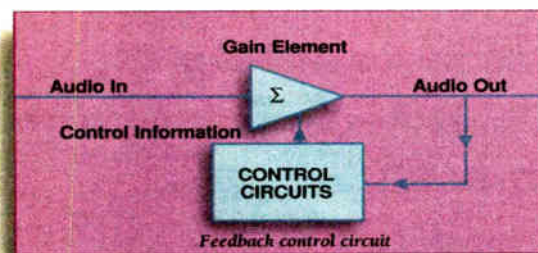

Feedback systems, found in most other broadcast processors, have "sweet-spot" windows that narrow with the changing of ratios as the amount of processing

varies. This is why most, if not all, feedback processors develop a thick, dense, mushy, and unnatural quality to their sound as they are driven deeper into gain reduction. With the Unity 2000i, you have a

system that will maximize your audio quality and fulfill your competitive requirements. It's a difference that you and your listeners can hear.



Alligator 90-100FM, Corner of Craven & Carlyle Streets, Napier, Hawkes Bay  
Phone: 834 1190 Fax: 834 1160 PO Box 1152 Napier

## ABOUT OUR UNITY 2000i

While in the set up process for THE ALLIGATOR 90-100 FM we looked at many FM processors, and after hours of listening to other stations in multiple markets around the country, and reading everything available about the options, we chose the UNITY 2000i from Cutting Edge.

Not only has the UNITY 2000i's flexibility enabled us to customise our sound to get exactly what we want, but it is so easy to use.

Using the UNITY 2000i as our processing, we have easily achieved a market leading sound. LOUD, yet retaining the high quality with crisp clear top end, plenty of bass and a nice "warm" rolling sub-bass using the enhancer. No sucking compressors, popping or distortion, constant levels on CD/Hard Drive automation system and great stereo separation.

In a market of 12 highly competitive radio stations, we have the best quality sound by far, so good we have even had calls from opposition station's program directors, stereo retailers, and hi-fi buffs from around town ask us how we do it!

In general I consider "MY" UNITY 2000i.... "GOD'S GIFT TO RADIO".

*A Jeffries*

ANDREW JEFFRIES  
PROGRAMME DIRECTOR  
THE ALLIGATOR 90-100 FM  
NAPIER, NEW ZEALAND



**the unity 2000i**  
the world's best sounding FM processor



2101 SUPERIOR AVENUE, CLEVELAND, OHIO 44114 • TEL: +1 (216) 241-3343 • FAX: +1 (216) 241-4103

CUTTINGEDGE

Circle (152) On Reader Service Card

World Radio History



# OUR PHYSICAL CONSOLE ISN'T AN OPTION. IT'S THE WHOLE IDEA.

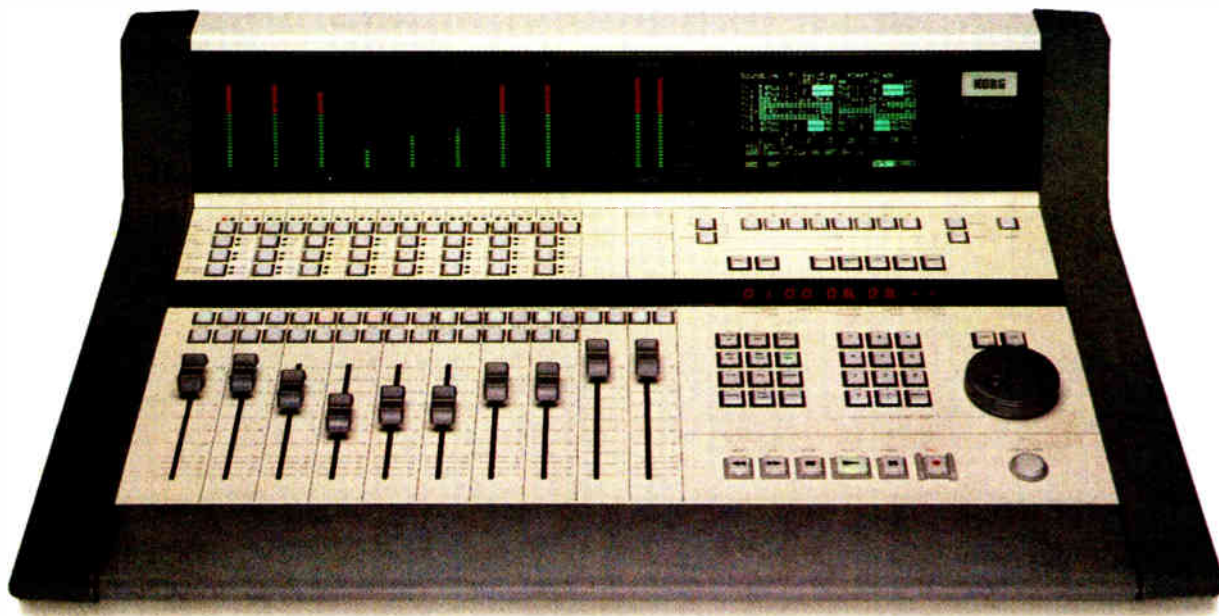

## Random Access Digital Audio Production by SoundLink.

**No mousing. No fumbling. And no nonsense. We designed the SoundLink Digital Audio Production System just as our most demanding customers asked us to: Without compromise.**

**We built an intuitive, full-featured console to give you complete control of random-access digital recording, editing and audio mixing. Along with digital signal processing, machine control, MIDI capabilities and synchronization.**

**So if you're working in radio or any other audio environment, now you can enjoy all the benefits of random-access digital editing with**

**the advanced features you need.**

**And instead of being forced to**

**work on an imaginary desktop, you get all the comfort of the real thing.**

**Best of all, SoundLink is a perfectly integrated system, rock-solid and hassle-free—not a fragile mix of components.**

**For more information, just pick up your physical telephone and call Korg Professional Audio at 800-645-3188, ext. 280.**

*"SoundLink has not only made every production operation faster, it's also expanded my creative capabilities to include things I could never tackle with analog equipment."*

— Rick Wiggins, Creative Director  
WJR-AM, Detroit  
Capital Cities/ABC, Inc.

*"It's one of the few pieces of equipment at the station I don't have to worry about."*

— Fred Holub, Chief Engineer  
KLAX-FM/KXED-AM, LA  
Spanish Broadcasting System

*"This is the 90s production room solution. Its integrated digital console, storage and editing combine to make one of the most efficient and cleanest operating studios you can find anywhere."*

— Roy Pressman, Tech. Director  
WLVE-FM/WZTA-FM/WINZ-AM  
Paxson Broadcasting, Miami

**If you need complete control over your digital production, anything less really isn't an option.**

**SoundLink® KORG**  
Professional Audio

© 1994 Korg USA, 89 Frost St., Westbury, NY 11590. SoundLink is a registered trademark of Korg USA.

Circle (121) On Reader Service Card

World Radio History



# Studio Sessions

Mercedes Quality  
from **Genelec**  
See p. 29

Equipment and Applications for Radio Production and Recording

## PRODUCT EVALUATION

### t.c. electronics Upgrades M5000

by Ty Ford

**BALTIMORE** Having received accolades and awards for the M5000 Digital Audio Mainframe almost two years ago, t.c. electronics of Denmark has continued to develop new software for the system, the latest of which is called MD2 (\$600).

With the MD2 upgrade, the M5000 can now be used as a tri-band compressor/limiter/expander (all functioning simultaneously) through either its analog or digital I/Os. Additional copies of the software, at \$300 a copy, allow a single M5000 to handle from two to four gain reduction jobs independently, within the same two-rack-space mainframe.

The A/D-D/A converters in the analog modules are quoted as 18 bit, 64x oversampling in and 20 bit out. The internal bus is 24 bit. The digital I/Os will accommodate 32 kHz, 44.1 kHz and 48 kHz through SP/DIF, AES/EBU or optical ports. The M5000 comes with a memory card slot for JEIDA or PCMCIA cards.

The 3.5-inch front-panel diskette drive is another option for saving and loading user programs and new algorithms. The company offers trial versions of new software programs and upgrades. They are unlockable with a code issued by the factory and programmed to work for a certain number of hours before becoming inaccessible.

All processing is done in the digital domain. There are up to 57 different parameter adjustments for the MD2 gain reduction algorithm. The algorithm can be used as a one-, two- or tri-band stereo

processor with adjustable frequency crossover points and 1/3 octave resolution. The stereo compressor, limiter and expander each operate independently on up to three frequency bands.

MD2 also includes a soft clipper, a digital "look ahead" function to prevent overshoots. Gain reduction junkies take note: This software, when improperly used, could swallow you up whole, leaving

rest of your audio chain is still analog, you can save a few bucks by opting for the DSP2. The bottom line here is that a M5000 setup to control the audio for two analog-in transmitters would run \$6,464.

Broadcast engineers with a duopoly or AM/FM combo can process both stations' audio separately from the same rack. If all sources are digital, and subsequent stages past the M5000 have digital

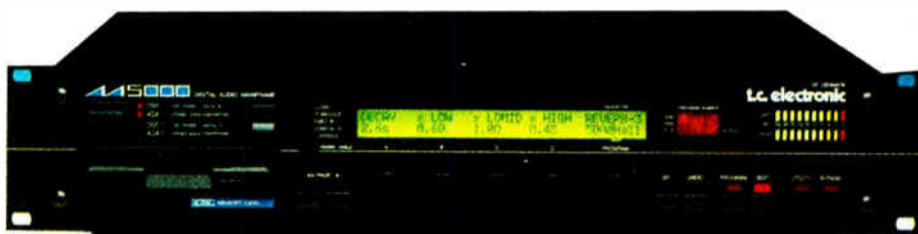

With the MD2 software, the M5000 is a powerful processor.

only the tip of your tweek stick, which it would spit out so forcefully that the stick would be buried irretrievably in the sales manager's head.

#### Modular approach

The M5000 takes the modular approach. The two-rack-space unit holds up to four modules. When fully loaded with four digital cards, the M5000 provides separate processing for four digital stereo signals. For every analog signal you wish to process, one analog module and one digital module are needed.

There are two digital cards. The DSP1 card costs \$500 more than the DSP2 card, because it has digital I/Os. If the

inputs, the M5000 could be configured as four separate digital compressor/limiter/expanders. According to the manufacturer, if the M5000 loses power, it will still pass all audio.

There is also a blank faceplate version of the M5000, the M5000X, in case you don't want people to be able to get to the controls or be able to see your settings. It requires the ATAC remote unit (\$1,775), a small unit with a large cold-cathode, backlit, bitmapped display, which can control up to ten M5000Xs via an RS-485 interconnect. The ATAC comes with a 10-meter cable.

Production directors will be whining a lot if the chief engineer gets an M5000

for the transmitters because, in addition to the dynamic control provided by the MD2 software, the unit also has very nice-sounding reverb, delay, chorus effects and digital sampling. A fully-loaded sampler (3 SIMMs) provides 380 mono seconds at 44.1 kHz and 349.2 mono seconds at 48 kHz with 24-bit resolution.

#### Digital toolbox

Describing those features, however, requires more space than I have for this article, especially since t.c. electronics has just debuted "MD2 Part Two." The Digital Toolbox.

Implementing The Digital Toolbox, a free upgrade, requires a M5000 with two digital cards. All digital routing between digital cards is done internally. The Digital Toolbox allows dithering to 16-, 18- or 20-bit resolution; digital filtering with DC cancelling; stereo four-band digital parametric EQ with 1/3 octave resolution; fade in/out tools with Fletcher-Munson filtering; balance and phase adjustments for M/S encoding/decoding; swap and delay functions; high-resolution (72 dB) metering with peak hold; a phase correlation meter and a digital audio calibration section with tone generator.

Although I didn't get a chance to play with the Toolbox, the 57 adjustable parameters for the dynamics section kept me more than busy. The M5000 comes with a list of dynamics presets. You can edit these and save them as your own masterpieces.

This brings me to my first minor complaint. Even though the manual is well laid out and fairly easy to understand, the "Save" process, which allows particular settings to be saved and named, could use

continued on page 27 ►

## SINE SYSTEMS

**Walkaway Specialist: Innovative Solutions**

- EBS Compliance Tools
- Remote Transmitter Control & Monitoring
- Dial-up Remote Broadcast
- Program Automation Accessories & Studio Aids

(615) 228-3500  
FAX 227-2367  
1020 Maxwell Avenue, Nashville, TN 37206-3554

24 Hour **FAX**  
**ON-DEMAND**  
(615) 227-2393

Circle (27) On Reader Service Card

## DIGITAL AUDIO ANALYZER

•••••

**DAA-50**

**Clip it to your belt and go!**

The DAA-50 contains a high quality digital to analog converter so you can monitor the audio through headphones with a fully adjustable volume control. The DAA-50 tests and identifies a variety of information about your digital audio signal displayed through easily defined LED status indicator lights. Compact and lightweight, the DAA-50 can be used when and wherever it's needed.

- Comprehensive Analysis
- Hand-held, Compact, Go Anywhere
- Battery or AC Powered
- Reliable, Easy to Use

CRL's digital audio analyzer will provide comprehensive analysis of your digital signals. The DAA-50 is your hand-held passport to the digital audio domain!

**Call today for more information!**

**Circuit Research Labs, Inc.**  
602 438-0888 • Fax 602 438-8227

Circle (82) On Reader Service Card



# A Few of the Best Reasons to Choose Harris Allied

## Telephone Interface Solutions by Gentner

SPH-5A Analog Hybrid

SPH-5 Analog Hybrid

Digital Hybrid 1A

Digital Hybrid III

G2500 Superhybrid

G3200 Superhybrid

We are your single source for the complete line of Gentner telephone equipment.



Microtel



Hybrid Coupler



Auto Coupler



TS612 DCT Multi-Line Telephone

## Enhance Your On-Air Signal With Auditronics

**210 Series Consoles.** The radio console for the 90s. Designed to take advantage of the latest technological innovations and provide you with exceptional quality and long-term reliability at a very affordable price.

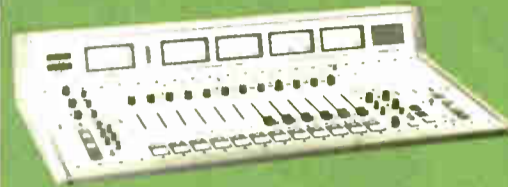

**800 Series.** Designed as an on-air console for DJ operation and production applications. Both mono and stereo microphone and line inputs. It features the most extensive user-programmable logic control system.



## Digital Profit Booster



**Arrakis Digilink.** The perfect replacement for magnetic tape-based reel and cart machines. Boosts your station's profits by improving your sound, increasing station efficiency, and reducing maintenance.

## Quality Sound Support by Audio-Metrics



**DA-8000.** The highest quality audio distribution amplifier that provides transparent audio distribution with extremely low distortion and high signal-to-noise ratio. We designed it for easy setup and use anywhere in the world. You'll enjoy years of trouble-free service and excellent audio performance.

**CD 10E Compact Disc Cartridge Machine.** A friendly, likeable programming tool that will encourage you to take compact discs direct-to-air. Now with Orange Book capability.



Model 14198R

Model 51900-3

**Mic Arms.** Where space is a premium, and strength and durability are essential.

Model 51900

## Digital Audio Made Simple



**ENCO DAD486x.** Simply "touch & go" with the friendliest Digital Audio Delivery System. A true cart machine replacement that really performs at your fingertips.

## Radio Systems by Broadcasters for Broadcasters



**DDS® Digital Cart Machine.** The premier user interface for Radio Systems' Digital Delivery System. Designed to provide total access to all DDS® functions and audio sources, yet be incredibly easy to use.

**RS-Series Consoles.** The first mid-priced audio console that installs quickly, repairs easily, and lasts so long that customers worldwide are very satisfied. There are a lot of mid-priced consoles available that look good and offer similar features on the outside, but RS-Series console owners would buy another because of what's inside.



## World Class Products. Worldwide Support.

**USA**  
317-935-1704  
Fax 317-966-0402

**CANADA**  
Orders 1-800-269-6817  
Phone 514-421-6272  
Fax 514-421-2712

**EUROPE**  
Phone +44 (0)223-415459  
Fax +44 (0)223-210441

**LATIN AMERICA**  
Phone 305-266-8050  
**Mexico Only** 95-800-205-5435  
Fax 305-266-0401

**ASIA PACIFIC**  
Phone 603-4569227, 4576222, 4566011  
Fax 603-4579240

**FRANCE**  
TEL: 1/49 91 02 31  
TEL VOITURE: 07 03 52 40  
Fax 1/49 91 02 45





# M5000 Upgraded With MD2

► continued from page 25

some streamlining. Comparisons can be made between adjustments, and there's also a front-panel bypass switch. These are vital to this system because, with this many adjustable parameters, you will, at some point, become incapable of distinguishing what sounds good or better.

I suggest that new users work off-line for a few days until the frenzy of dealing of dealing with 57 parameters subsides.

## Parameter plus

In addition to the analog input and output levels, R/L balance, low cut, LF/MF crossover, MF/HF crossover, Soft Clip, individual band levels, 0 dB Reference and meter resolution adjustments, the following list of parameters and their ranges must be read to be appreciated. So here they are by section:

**Compression Threshold:** up to three bands, each adjustable from -40 dB to +12 dB. **Compression Ratio:** up to three bands, each adjustable from Off through 1.12:1 to Infinity:1.

**Compression Makeup Gain (read only):** up to three bands, automatically adjusted. **Compression Attack:** up to three bands, each adjustable from 0.3 milliseconds to 100 milliseconds.

**Compression Release:** up to three bands, each adjustable from 20 milliseconds to 7 seconds. **Compression Feed Forward:** up to three bands, each adjustable up to 25 milliseconds of delay that allows the compressor to prepare for

the incoming audio. This value should be set equal to or greater than the compressor attack time. The Nominal Delay setting must always be equal to or greater than the Feed Forward time.



**Compression Crest Factor:** up to three bands, each adjustable through Peak, RMS and 6 dB to 24 dB. Determines whether compressor will react on peak levels, RMS levels or in between.

**Limiter Threshold:** up to three bands, each adjustable from -12 dB to 0 dB. **Limiter Ratio:** up to three bands, each adjustable between Off and Infinity:1. **Limiter Attack:** up to three bands, each adjustable from 30 microseconds to 10 milliseconds. **Limiter Release:** up to three bands, each adjustable from 20 milliseconds to 7 seconds.

**Limiter Feed Forward:** up to three bands, each adjustable up to 25 milliseconds. Similar to the compressor in operation. This value should be set to equal to or greater than the Limiter Attack value. If set to 0 dB, the limiter will behave as a standard analog limiter, and may pass overshoot audio.

**Expander Threshold:** up to three bands, each adjustable from -94 dB to -15 dB. **Expander Ratio:** up to three bands, each adjustable from Off up to Infinity:1. **Expander Attack:** up to three bands, each

Product Capsule: **t.c. electronic**  
**M5000 Processor**

 <b>Thumbs Up</b>	 <b>Thumbs Down</b>
✓ monster processing ✓ relatively "future proof"	✓ slightly expensive

For more information, contact t.c. electronic at 805-373-1828; or circle **Reader Service 50**.

adjustable from 0.3 milliseconds to 100 milliseconds. **Expander Release:** up to three bands, each adjustable from 20 milliseconds to 7 seconds. **Expander Range:** up to three bands, each adjustable from -40 dB to 0 dB.

**Parameter Link (PAR-LNK):** Toggles On/Off. When on, this links the parameters on any given page so that adjustment of one knob changes the values on all of the bands. Don't use this if you want different values for each band to remain different. It readjusts the bands to the same value.

**Nominal Delay:** up to 25 milliseconds of digital delay, common to all bands. The nominal delay value should not be set lower (faster) than either the compressor or limiter Feed Forward parameters. Doing so will disable those parameters.

Navigation controls for the M5000 menu system consist of knobs and toggle switches. By the second or third day of use, my use of those controls became automatic. Most of the dynamics control windows, in addition to showing the specific adjustments for a set of parameters, show the metering for the amount of compression, limiting and expansion for each band of audio. This visual support is extremely helpful.

Like most first-time users, I immediately became overly fascinated with the possibilities. After micro-tweaking for several

hours, my listening differentiation was so greatly reduced that I had to give up and come back the next day with fresh ears.

## Sound quality

The M5000 does offer a truly amazing amount of control over the audio that passes through it. Although the user who is relatively uninitiated in the intricacies of gain reduction can get excellent results with presets, it is the "power user" who plumbs the depths of the device in search of the ultimate adjustment who will most appreciate the M5000. It is, after all, being promoted to mastering engineers as a device to be used for cleaning up the funky little things that happen during music recording sessions that are ignored or overlooked.

Radio and TV engineers may actually have to deal with a much wider spectrum of problems, due to the increased number of audio sources.

In conclusion, while the M5000 is certainly not a cheap box, especially for single-application purposes, its value becomes more apparent when it is configured for multi-application uses. Uses such as processing audio for two transmitters or as an effects processor, equalizer and sampler during a recording session and a mastering tweaker during the final mix for spots or music are definitely in the realm of possibility.

In my opinion, the t.c. electronics M5000 is the road more manufacturers should be on.

□ □ □

To order Ty Ford's book, "Advanced Audio Production Techniques," call 800-366-2665.

## STATION/STUDIO SERVICES

**427 SOUND EFFECTS**  
**\$89.00**

For a 5-CD set with a 30-day money-back guarantee.

Take an extra \$10 off if you mention this ad!

Send \$79 to Ghostwriters  
2412 Unity Ave. N., Dept. RW  
Minneapolis, MN 55422

For credit card orders call  
**(612) 522-6256**

READER SERVICE 96

**Save Money**  
**Be Legal**

Have your EBS Equipment modified for the New Short Tone

We're the  
**SHORT-TONE SPECIALISTS**

- ✓ All makes, all models
- ✓ \$75 pre-paid includes Decoder and switchable Encoder mods.
- ✓ Return Shipping FREE!

**AddieTech Inc.**  
438 N. Waiola  
LaGrange Park, IL 60525-1824  
708-579-3749 FAX 708-579-3754

READER SERVICE 185

**BUY-OUT MUSIC — \$99**

- Sixty 60-second music beds for . . . \$99
- 198 :30 & :60 music beds for . . . \$198
- 120 production effects "Zings, Zaps and Zoodads" for . . . \$99
- 122 New Lasers & Sweepers for . . . \$99

For FREE DETAILS on production music, sound effects, call

**Ghostwriters (612) 522-6256**

READER SERVICE 96

**A funny thing happens when you don't advertise...**

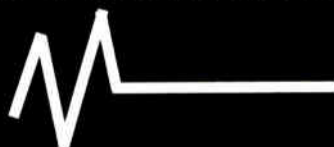

**NOTHING!**

### ATTENTION PROVIDERS!

Promote your services to **Radio World's** 22,000+ readers. Reach Radio Station and Recording Studio owners/managers and engineers with your message. For information on affordable advertising call **Simone** at **1-800-336-3045**.

## For the world's strongest AM transmitters, look to Nautel

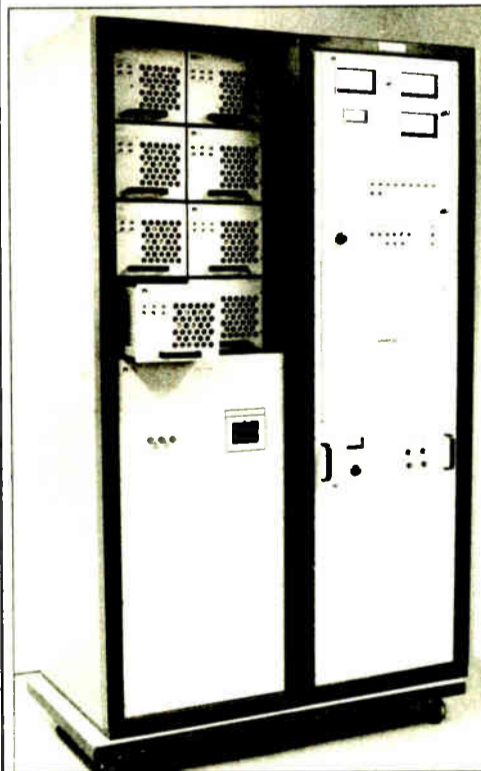

Totally solid state AMPFET ND 10 10kW AM

Nautel AM transmitters keep you on the air with an unmatched combination of value, performance and reliability

**Low cost of ownership** — with typical efficiency ratings up to 80 percent, a totally solid state Nautel transmitter pays for itself in tube replacement and utility

**Superior audio transparency** — Nautel AM transmitters utilize inherently linear digital Pulse Duration Modulation for the cleanest sound you can broadcast. Audio is ruler-flat throughout the range and distortion is typically less than 0.5%

**Field-proven reliability** — Nautel transmitters give you multiple protection systems for both power line and lighting transients, VSWR protection, soft failure design, reserve cooling and safe on-air servicing

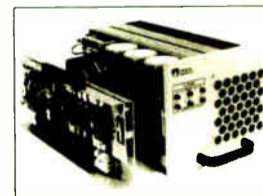

Removable AM Power Module

Make a strong transmitter choice. Call us today for all the facts on our totally solid state AM and FM transmitters.



**Nautel Maine Inc.**  
201 Target Industrial Circle  
Bangor, Maine 04401 USA  
Phone: (902) 823-2233

**Nautel**  
(Nautel Electronic Laboratories Limited)  
R.R. #1, Tantallon, Halifax County,  
Nova Scotia, Canada B0J 3J0  
Fax: (902) 823-3183



# Products & Services Showcase

For more information on the products shown below, circle the appropriate Reader Service No.(s) on the enclosed Subscription/Reader Service card or contact the advertiser directly.

## Composite Audio DA and Switcher!



The CDS 200 Composite DA/Switcher

### APPLICATIONS

- Switching Between Composite STL's
- Main/Alternate Processing Switching
- Feed Two Transmitters and an RDBS Encoder
- Feed one SCA Generator to Two Transmitters
- Distribute Composite with the Ease of Audio

### FEATURES

- 2 Input Switcher
- 3 Isolated Outputs
- Individual Level Control for Each Output
- Front Panel and Remote Control with Full Status
- Power Fail Memory with Bypass Mode
- Inputs Selectable for Balanced or Unbalanced Operation
- Front Panel Test Jack

**bdi** Broadcast Devices, Inc.  
5 Crestview Avenue  
Peekskill, NY 10566

Tel: (914) 737-5032 Fax: (914) 736-6916

READER SERVICE NO. 14



## THE CELLULAR DIFFERENCE

- Easy to Use
- Reliable
- Cost Efficient
- Portable
- Flexible



Technology & convenience combine to bring you on-the-spot remote broadcast capabilities with excellent sound quality. Cellular transceiver, frequency extender, and mixer all in one! Powered by Ni-cad rechargeable batteries or AC power supply — utilizes cellular technology or land lines.

For more information call

**1-800-852-1333**

READER SERVICE NO. 37

## The CircuitWerkes DTMF-16 TouchTone Decoder



### Inexpensive & Convenient Control

- Decodes all 16 DTMF tones.
- Bridging input & high current opto-isolated outputs.
- Jumper selectable beep-tone acknowledges commands.
- Momentary or Interlocked Latching output modes.
- Available with built-in AC-2 autocooper to form a dial-up remote control.
- Suggested list price is an economical \$189

The DTMF-16 is excellent for interfacing various networks to automation, controlling remote satellite receivers, repeaters, etc. The compact, light & rugged DTMF-16 can be put almost anywhere to provide the remote controls that you need. For more info, contact your favorite broadcast supplier or call us.

## CircuitWerkes

6212 SW 8th Place  
Gainesville, Florida 32607  
(904) 331-5999 / Fax 331-6999



READER SERVICE NO. 151

## B-SERIES FM BROADCAST POWER AMPLIFIERS

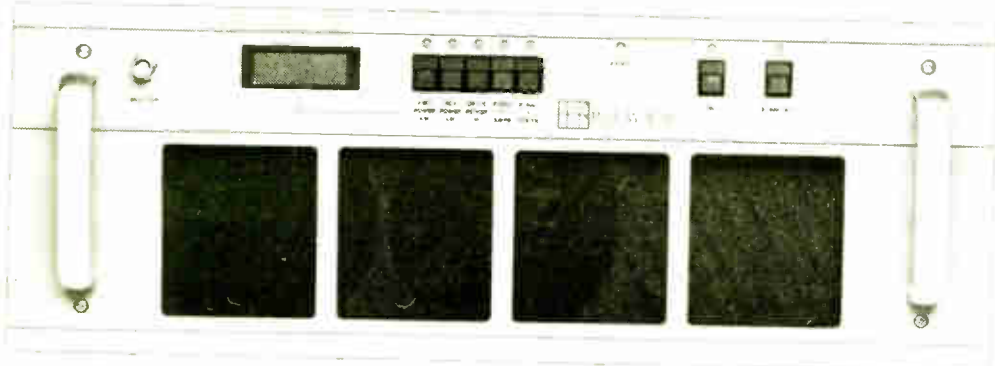

*Reliability through design is the key to the B-series power amplifiers*



**Silicon Valley  
POWER  
AMPLIFIERS**

The RF People

Silicon Valley Power Amplifiers, a quality supplier of OEM modules is now producing a range of compact power amplifiers. All units are complete with rack slide ready to install in a 19" rack system.

Power outputs 150W, 300W, 600W, & 1250W

For prices and delivery CALL 1-800-986-9700

READER SERVICE NO. 3



## Econco REBUILT POWER TUBES



*Approximately One Half  
the Cost of New*

3,000 Hour Unconditional Guarantee

Call for Our Price List

Econco 1318 Commerce Ave. Woodland, CA 95695  
Phone: 916-662-7553 Fax: 916-666-7760 Telex: 176756  
Toll Free: 800-532-6626 From Canada: 800-848-8841

READER SERVICE NO. 197

# 50,388

## ELECTRONIC COMPONENTS

Whether you order 1 part or all 50,388...MOUSER stocks and...ships same day!!

CALL (800) 992-9943

for your FREE CATALOG

# MOUSER ELECTRONICS

2401 Hwy 287 N. Mansfield, TX 76063  
Sales & Stocking Locations Nationwide

READER SERVICE NO. 80

## THE FINEST STUDIO SYSTEMS IN THE BROADCAST BUSINESS

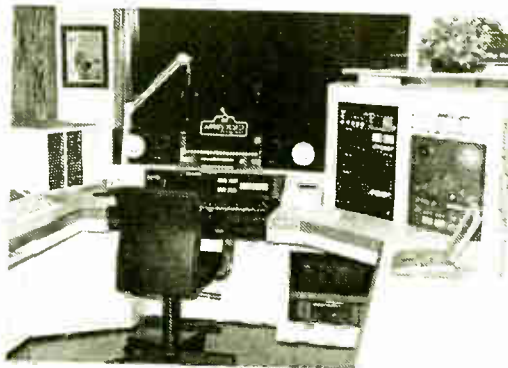

**Audio Broadcast Group Inc.**  
Studio Furniture & Prewired Systems

Your studio environment specialists for the last 35 years.

We Are The Industry Standard.

For additional information on how we can serve you, please call today.

**SOUTHEASTERN SALES OFFICE**  
200 Fareway Drive, Suite 2  
Smithfield, North Carolina 27577  
Phone: 800-369-7623  
Fax: 919-934-8120

**MAIN SALES OFFICE**  
2342 S. Division Avenue  
Grand Rapids, Michigan 49507  
Phone: 800-999-9281  
Fax: 616-452-1652

**WESTERN SALES OFFICE**  
P.O. Box 1638  
Palmdale, California 93550  
Phone: 800-858-9008  
Fax: 805-273-3321

For 35 years

YOU MAY ALSO REACH US ANYTIME VIA ELECTRONIC MAIL  
75371.144@compuserve.com

**AUDIO**  
broadcast group inc.

READER SERVICE NO. 6



## PRODUCT EVALUATION

# Audiophile Sound from Genelec's 1030As

by Bruce Bartlett  
with Jenny Bartlett

**ELKHART, Ind.** I have almost nothing to say about the powered, Genelec 1030A nearfield speakers. That is the highest compliment I can pay to a pair of monitors.

They are so neutral, they have no "sound" color to speak of. Like a wallflower, they disappear into the background and just let you hear your mix—bad or good.

Made in Finland, the pricey Genelec 1030A (\$2,000 per pair) is a two-way, ported nearfield monitor with a built-in power amp. The drivers are bi-amped, which gives more SPL and less distortion than an external amp of equal power.

When you first pull one of these speakers out of its packaging, you know this is a serious listening tool. Construction quality is superb.

## Features

On the front, we see a 6.5-inch ported woofer and a 3/4-inch metal-dome tweeter. The woofer has a rubber surround. The tweeter is mounted in a wide-open horn that Genelec calls a DCW, or Directivity Control Waveguide. According to Genelec, the DCW provides uniform dispersion, as well as "perfect phase and delay uniformity at the crossover frequency."

On either side of the DCW are two slits that form the port. A pilot light on the front baffle shows when power is on.

On the back panel are DIP switches for treble tilt, bass tilt, and bass roll-off, which let you match the speaker to any application. Switch functions are clearly labeled. The owner's manual recommends switch settings for five different speaker positions.

I agree with the suggested setting of -4 dB low-frequency shelving for nearfield use. Incidentally, the manual is a model of good technical writing and layout.

A rotary pot sets the input sensitivity from -6 to +6 dBu for 100 dB SPL at 1 meter. Signal input is via an XLR connector. On the back are the on-off switch and AC mains input.

Inside the cabinet, a power amp provides bi-amping. The amplifier is shock mounted to prevent rattling. Available "short-term" power is 80 watts for the woofer and 50 watts for the tweeter. A special circuit protects the drivers from overload. Both speakers are identical, and each has its own power amp.

You can set the speaker horizontal or vertical. The cabinet measures about 12 inches high by 8 inches wide by 9 inches deep. It weighs 15 pounds.

Although each speaker is compact, the sound is big and loud. Peak SPL is rated at 115 dB at 1 meter.

I auditioned the Genelec 1030A before

making any measurements. The opinions here are my own, and are not a critique by RW.

## Listening tests

On Donald Fagen's "Kamakiriad," the vocal sounds natural, not tubby. The overall sound is smooth and non-fatiguing. Being small, the speakers lack deep bass but don't sound thin. Bass is tight. There's a very wide sweet spot, so the producer and mix engineer can hear the same amount of treble. Percussion is clear without being sizzly.

Los Lobos' "Kiko," a pop recording with abundant percussion and deep bass, plays very loud without a sense of strain. You can turn up the amp into distortion, but it's more than loud enough before distortion sets in. Great tonal balance—not boomy, not thin. Detailed sound.



On Bryans Adams' "I Need Somebody," the sound is aggressive. Lots of snare smack and guitar crunch. And with Pat Metheny's "Secret Story" CD, the sound has fantastic impact. You can hear everything that's going on in this complex mix, such as detailed triangle hits and guitar strums.

With John Scofield's jazz CD, "Time On My Hands," the Genelec sounds the least colored of any speaker I have ever heard. Cymbals are clean but not piercing. Bass isn't boomy.



Genelec 1030A nearfield speaker

The Holly Cole Trio's "Blame It On My Youth," reveals the Genelec's only real shortcoming in that deep bass notes are

Product Capsule: Genelec 1030A Nearfield Monitors	
 <b>Thumbs Up</b>	 <b>Thumbs Down</b>
<ul style="list-style-type: none"> <li>✓ flat response</li> <li>✓ built-in amp</li> <li>✓ accurate imaging</li> </ul>	<ul style="list-style-type: none"> <li>✓ deep bass is weak (normal for small speakers)</li> <li>✓ expensive</li> </ul>
<small>For more information, contact QMI at 508-435-3666; or circle Reader Service 100.</small>	

weak, but they are not doubled in frequency by second-harmonic distortion. Also, lack of subwoofer-type bass is normal for small speakers.

Acoustic-bass slaps have a palpable quality. Ms. Cole's vocal is warm and realistic.

Paul McCartney's "Unplugged" CD has pretty, delicate acoustic guitar sounds. The 1030A is the best reproduction of this CD I've ever heard. The sound is clear but not harsh, and stereo imaging is very sharp.

On Stravinsky's "Firebird Suite" recorded by Telarc, the deep bass-drum roll is sensed rather than heard. String tone is just right, with a gentle airiness. Bass-drum whacks really hit you. Brass is clear but not edgy or sizzly.

Using a Techtron TEF analyzer, I measured the Genelec 1030A with a mic one meter away at woofer height. Its time response is good but not spectacular. The woofer kicks in about 0.2 Msec after the tweeter, then there's some cabinet-edge radiation 0.2 Msec later, about 16 dB down.

The frequency response is amazingly flat. It's 55 Hz to 17 kHz  $\pm 2$  dB, the flattest nearfield I've yet measured. Off-axis response at 30 degrees is down only a few dB above 1 kHz, showing that the dispersion is very wide.

## Summary

The Genelec 1030A is easily the finest nearfield monitor I have ever reviewed. It sounds neutral and measures extremely flat. Thanks to its tone controls, you can tailor its response for a variety of situations. The internal bi-amping gives plenty of loud, clean sound.

If you're ready for Mercedes quality, you'll find that the Genelec 1030A is well worth its price.

□ □ □

*Bruce Bartlett is a microphone engineer and technical writer for Crown International, and the author of "Practical Recording Techniques," published by Howard Sams. Jenny Bartlett is a technical writer. Bruce can be reached at 219-294-8388.*

## ~COOL JOB OPENING~

This dynamic, high-tech company is looking for a  
**CUSTOMER SUPPORT ENGINEER**  
 to provide our customers with product and systems information and after-sale technical support.



**Us:** The world's premier manufacturer of digital telephone interfaces for talk-shows and call-in programming. And (if you've been on the moon all year and don't already know) we make the Zephyr™ for ISDN-based programming and production. We offer:

- Over a decade of technological innovation and a track-record of superior customer satisfaction.
- Competitive salary in a city where your paycheck goes farther than it would in, say, L.A.
- A very cool work environment with a view of a Great Lake, a great ball park, and the Rock and Roll Hall of Fame.



**You:** Have broadcast audio engineering experience, preferably in radio; are a good problem solver who wants to use this talent to help others; can explain technical concepts to other people over the telephone and in writing; know your way around a Mac or Windows; have strong organizational skills; and last but not least, are willing to take on new challenges.

You want a job where:

- Initiative, leadership and creativity are rewarded.
- Everyday is dress-down day.
- You never have to wear a beeper again.



If you're interested, send your resume or qualifications letter to:

**Telos Systems**  
 2101 Superior Avenue • Cleveland, OH 44114  
 Fax: +1 (216) 241-4103 • Email: telos@aol.com  
 No telephone calls, please.

In the spirit of our commitment to diversity, we welcome applications from all individuals.

 **Communications Data Services**  
 Incorporated

## Online Engineering Services

- **FM Studies** - conduct spacing and interference studies for proposed FM facilities
- **Distance to Contours** - produce distance to contour tabulations and maps of predicted coverage area
- **Population Count** - produce detailed population analysis studies for a given facility
- **Zip Code Analysis** - produce zip code analysis studies to analyze market coverage
- **Terrain Data Analysis** - calculate HAAT and produce terrain profiles
- **Coverage Maps** - complete Real World™ propagation prediction services

6105 Arlington Blvd.  
 Falls Church, Va. 22044  
 800-441-0034/703-534-7884 (fax)  
 Richard P. & Richard L. Biby - Principals

Circle (109) On Reader Service Card



# Products & Services Showcase

For more information on the products shown below, circle the appropriate Reader Service No. (s) on the enclosed Subscription/Reader Service card or contact the advertiser directly.



## Excaltibur Electronics

### CDA-1

Composite Distribution Amplifier



This 1 in, 3 out distribution amplifier allows you to distribute stereo composite and/or subcarrier signals as easily as audio.

- ◆ DC-100 kHz frequency response
- ◆ 90 dB signal/noise ratio
- ◆ +6 dB to -20 dB gain range
- ◆ Individual 20-turn output trimmers
- ◆ 1 3/4" rack mount enclosure

EXCALIBUR ELECTRONICS, INC., CHANTILLY, VIRGINIA  
Please circle our bingo number for a data sheet and a dealer list.

READER SERVICE NO. 21

## EVEN THE BEST CAN BE MADE BETTER

Introducing the new

### MINI-MIX 12A

THE COMPACT MIXER WITH A COMPACT PRICE FROM THE QUALITY LEADER

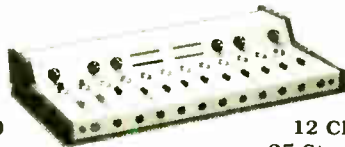

\$3499

12 Channels  
25 Stereo Inputs

Service & Affordable Quality for Over 23 Years

**AUTOGRAM**  
CORPORATION

1500 Capital Avenue (214) 424-8585  
Plano Texas 75074-8118 1-800-327-6901

FAX (214) 423-6334

READER SERVICE NO. 38

## AUTO-ANSWER TELEPHONE COUPLER

Ideal for unattended situations such as listen lines, IFB feeds, dial-up networks, remote transmitter sites & satellite links.

- Clean connection to phone line
- Easy to install
- Send or receive program
- F.C.C. registered



**COMREX**

Comrex Corp., 65 Nonset Path, Acton, MA 01720  
Tel: 1-800-237-1776 Fax: 508 635-0401

READER SERVICE NO. 19

## Call For Rigid Line & Components

Facing a "right now" emergency? Planning a new installation? Upgrading your facility? Whatever the need, MYAT is the solution. MYAT products are quality-built for maximum performance and long life. And we take delivery commitments seriously.

Call your favorite RF distributor or MYAT direct at 201-767-5380, or fax 201-767-4147 for our complete catalog and reference guide.



380 Chestnut St  
P.O. Box 425  
Norwood, NJ  
0 7 6 4 8



READER SERVICE NO. 132

A Broadcast Industry

# BEST BUY

Mono Record/Play Stereo Record/Play

\$1420 \$1640

F.O.B. Factory  
Reliable/Rugged/Professional Design



DL Series

## AUDI-CORD CORPORATION

1845 West Hovey Avenue  
Normal, Illinois 61761 USA  
Phone 309-452-9461  
Fax 309-452-0893

Available Through Your Regular Distributor

READER SERVICE NO. 66

## THE WORLD'S BEST TELEPHONE COUPLER! AT THE LOWEST COST AND FEATURE LOADED!

INTRODUCING...

### THE TAC AND TAC+ (shown)



- A must for radio reporters
- Tuck in field bag for remotes

TAC \$89.50

TAC+ \$99.95

Call your distributor or order direct

1-800-688-8208

Mix voice with external feed • Monitor continuously • Compatible with virtually any phone • Output signal for recording • TAC+ features: 6 step, 60db attenuator • Select 8-32 or 600 ohm transformer input • Cough button • Two year full warranty • Shock padded vinyl carrying case available \$9.95

Connects between handset and base

BY **SOUND AMERICA**

• MANUFACTURER OF THE VENERABLE VOICE-ACT

READER SERVICE NO. 61

## Attention Advertisers

Reach 22,000+ broadcast equipment buying prospects at AM, FM and AM/FM radio stations, networks and groups, recording studios, engineering and consulting firms every month.

Products & Services Showcase appears in every issue of Radio World. To advertise your product or service, contact Simone Mullins at

**RADIO WORLD**

P.O. Box 1214

Falls Church, Va 22041 USA

Tel: 1-800-336-3045

FAX: 703-998-2966



# Production Challenges for 'ATC'

*Editor's Note: The following is a new column that will appear regularly in Studio Sessions. Rich Rarey, technical director of National Public Radio's "All Things Considered," will share his musings on the inner workings and techniques of NPR's technical production as well as his own insight on radio production. Several of his columns also will feature hands-on reviews from NPR studios.*

by Rich Rarey

**WASHINGTON** Welcome to The Public Domain, a forum on radio public, and... well, who knows what other topics?

Things have been busy here at NPR lately—they tell me it has to do with some sort of fuss about funding for public broadcasting—but in spite of the fuss, we are still distributing network programming every day and evening, as usual.

NPR's oldest program, "All Things Considered," is preparing for a format revision and enhancement this fall; the news program will be extended to two hours, with the live feed beginning an hour earlier, at 4 p.m. (eastern).

While an additional half-hour combined with an earlier broadcast time seems like a modest endeavor for ATC, the changes will bring more depth to NPR News in general, because the supporting "desks" (foreign and national, for example) will be adding reporting and editorial staff. Of

course, this adds to the technical demands.

Being technical director, it is my job to make sure the electronic components and the talent work smoothly together in order to produce a quality program.

The NPR news magazines, of which ATC, "Morning Edition," and "Weekend Edition" are examples, are comprised of news pieces that range from one minute to 22 minutes in length. These pieces are filed by reporters working alone or with NPR producers and engineers, and each receives a notable amount of aural attention.

## Master "feed"

Allow me to elaborate. Let's take a typical reporter, we'll call him "Willy," and send him overseas. I should mention that "Willy" could well have been "Wilma," because the NPR reporter pool has many talented women and men. After "Willy" arrives at the international trouble spot and gathers his interviews, he will then create a master "feed" cassette by dubbing the actualities he's selected from the original machine to his second cassette machine.

He'll then find a quiet spot to record his voice tracks onto the feed cassette. Depending on his deadline, he may dub whatever ambience he's gathered onto the feed cassette, or he may simply cue the original cassette to the first ambience section he wishes to feed.

Now, "Willy," how will you feed your material? If the area has an infrastructure, such as ISDN service, using existing



## PUBLIC DOMAIN

terminal adapters and codecs is preferred. The BBC has extensive links throughout the world, and can sometimes provide higher fidelity paths back to

London, where NPR can route it to dedicated fiber circuits to Washington.

## ISDN or POTS?

Otherwise, plain old telephone service (POTS) will have to do, enhanced by a single line Comrex or other frequency extender.

If "Willy" is gathering interviews and has to file without enhancing equipment, Alligator clips (known by the BBC as "Croc" clips) pinched on the two phone mouthpiece terminals will work for feeding tape (although in some countries it's illegal to dismantle telephones). If actuality tape is an absolute must, placing the telephone mouthpiece over the cassette's playback speaker is a last resort.

continued on page 32 ►

## Your Link to Higher Performance at a MARTI Price.

### MARTI Composite STL-15C

By using Hybrid and monolithic microwave integrated circuits with surface mount technology, we increased performance and reliability while reducing costs. This translates to value and savings on your bottom line.

For 35 years MARTI has been engineering value into every piece of equipment. Now we've built the STL-15C at a lower cost with improved performance, in only two rack spaces. For more information on the Composite STL-15C at a MARTI price, call (817) 645-9163.



# MARTI

The Performance-Value Leader in Broadcast Equipment

1501 N. Maine, Cleburne, TX 76031

Phone: 817-645-9163 Fax: 817-641-3869

Dealer inquiries accepted. Contact Jim Godfrey.

Circle (31) On Reader Service Card

## Quantum FM

Solid State

Solid Reliability

from



- Proven reliability
- Maintenance-free FET technology
- Self-contained modules with own power supply regulator
- Compact size reduces shipping costs, allows affordable air shipment
- Power levels between 300 Watts and 6 kW
- Modular design offers buy-only-what-you-need affordability and convenience

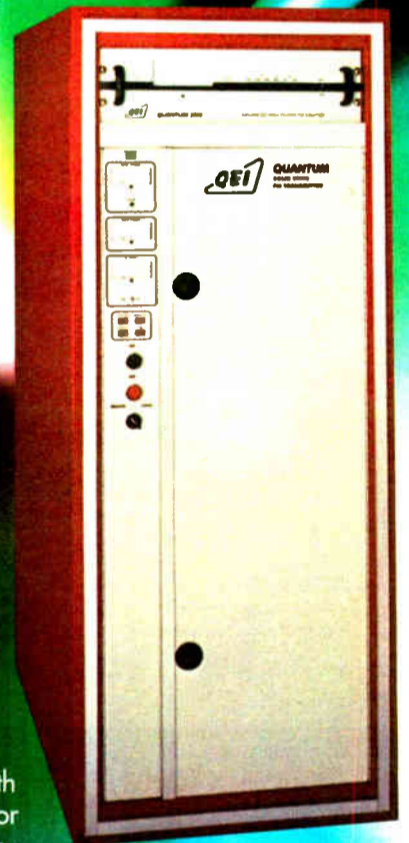

For the same price you pay for a tube transmitter, you can now have a superior solid state FM transmitter with high-power, advanced technology exciter and cableless combiner. The modular design of QEI's QUANTUM-Series FM transmitters offers the advantage of buying only the amount of power you need...and means that you can upgrade to higher power levels whenever you're ready.

QUANTUM from QEI—the people who have been designing and building solid state transmitters longer than anyone else in the industry.

You need to know more! Call Jeff Detweiler today toll free (800) 334-9154.

QEI Corporation  
One Airport Drive • P.O. Box 805  
Williamstown, NJ 08094

Tel (800) 334-9154  
Fax (609) 629-1751

24-Hour Service Hotline  
(609) 728-2020

Circle (26) On Reader Service Card



# Production Challenges

► continued from page 31

POTS connections from strife-torn places are precious: getting a telephone call through can take 30 minutes, and "Willy" and the NPR Washington engineers are extra careful not to accidentally "lose" the call.

In more severe locales where POTS is not a reliable option, we've had reasonable luck by using rented satellite telephones. Modern satellite phones are briefcase sized, capable of powering from AC or car battery DC, and with the reduction in size is the reduction of complexity of finding the proper satellite.

Although these great devices work well for offshore oil rigs and construction people, we've found that their analog audio bandwidth is severely limited, and digital artifacts halo and hector "Willy's" voice and sound.

## Using digital codecs

In 1994, NPR engineer Leo del Aguila took a satellite telephone to Haiti to assist the NPR reporters there, and he used a CCS CDQ1000 ISDN codec connected to the data port of the satellite phone. This gave truly remarkable results, roughly a 10 kHz bandwidth both sending and receiving.

In remote locations where television networks have set up shop, renting their spare satellite audio channels for feeds to the United States has provided better-than-POTS quality, but usually forces the

NPR crew to work within the television transmission deadlines.

Signals from these satellite channels have required extensive planning to route to NPR. If the originator is CNN, for instance, the signal is beamed to New York or Atlanta, thence to a domestic satellite, then to NPR. I'm personally looking forward to portable transmission technology that is globally available, has high audio quality, does not require any local infrastructure, and most importantly, won't blow the entire engineering budget on its use. Say, the Star Trek communicators with a "tape input" jack would do fine—but until then we'll have to make do with the old ways.

Now that "Willy" has an audio connection to NPR in Washington, he plays his master feed cassette and his ambience to the Record Central (RC) facility. The RC engineer adjusts incoming level, monitors quality control—listening for peak distortion, hum, and working with the reporter to minimize other noise—and ensures that the material is being recorded, but does not add EQ.

## The finished pieces

As NPR reporters usually file pieces that vary in finished length from two to 18 minutes, in addition to filing news spots, the time needed to feed the material grows; a finished five-minute piece that has three components, reporter

tracks, interview actualities and ambience may take 15 minutes or more to feed in its component form. A green postcard, called the QC form, is affixed to the reels as they leave the RC. The form is a check-box review of the sound quality, with spaces to write specific problems the RC engineer has heard.

This one card is the link between the production staffs and technical staffs; it provides continuity to track technical problems the reporter may have producing the piece, and gives the mixing engineer advance information on what audio problems, if any, are in the piece.

Sometimes material is so poor, it is rejected by the engineer. Causes such as distortion, unintelligibility, reporter's cassette head azimuth changing, all can

Paragraphic EQ and dbx compression/limiting. The mixing engineer will almost always need to assign one EQ chain to clean up the actualities and the second to enhance the reporter's tracks as needed.

Complex news pieces, usually longer, will have several "scenes" where interviews and sound take place. The ambience is used here to aurally change "scenes." If "Willy" had several of these ambience cuts, and expected them to be mixed together with the tracks and actualities, we would have five reels playing at once—a bit much to control without automation. So a submix of the tracks, actualities and one ambience section is created first, then played back with the additional ambiences mixed in as "Willy" has directed in his script.

When the piece is finished, it's timed and leadered and labelled, ready for air. On breaking news, it may be finished twenty seconds before it's to air, or may even be played

## This thumbnail description of "Willy" basically demonstrates the way we put together "All Things Considered."

ruin the material.

The rejection follows the piece and must be overridden by the program producer if it is to be mixed for air. Fortunately for "Willy," all of his tape has arrived, and sounds fine.

A production staffer splits "Willy's" tracks, actualities and ambience into separate reels, and splices paper leader tape around every element. (As an aside, we technicians liked the strength of plastic leader tape, but the plastic tended to hold static electricity, and could make electrical "pops" upon playback.)

After leadering, "Willy's" separated components are taken to a news studio and mixed together from multiple analog reel-to-reels into the finished news piece.

## A little EQ

The engineer will apply audio processing to the components, typically filtering first, then EQ, then a light touch of compression to restore natural apparent loudness. Each NPR news studio has two channels of UREI Little Dipper filtering, Orban

back from the production studio it was mixed in—because there is not enough time to physically run it into the NPR studio 2A, the news on-air studio. (When this happens, I always get a "Broadcast News" flashback—sometimes art imitates life.)

This thumbnail sketch of Willy the reporter sending material to NPR for broadcast is basically the way we put together segments for each "All Things Considered." Although a piece's content is as fresh as today's news, the methods we employ to get it on the air, sounding as good as it possibly can, are—though perhaps not "old fashioned"—remarkably proven.

In coming months I'd like to introduce you to some of the "players" in public radio, and respond to the many good topic suggestions you've already e-mailed to me. Until next month, I remain, your obed't eng'r.

□ □ □

Rich Rarey can be reached on the Internet at [rrarey@npr.org](mailto:rrarey@npr.org)

## Want To Know How We Raised DAW Performance To New Heights?

Unlimited tracks. Greater control and flexibility to assemble, manipulate and modify. Amazing speed to edit and playback instantly. Reliability and confidence unique to the world of Digital Audio Workstations. Plus a level of audio quality that is discernably higher, even to the most discriminating ears.

It's the most logical and comprehensive solution for digital audio recording, assembly, processing and mixing. **Perfect for radio and broadcast production**, project studios, and sound for picture.

It's called the MicroSound Professional Desktop Audio System, and it represents an essentially different approach to disk based systems. **True** (non-linear) Random Access Editing™ and proprietary Floating Tracks™ architecture dramatically enhance creative freedom and save time.

Perhaps the only aspect we didn't raise is MicroSound's surprisingly reasonable price. **MicroSound: Proven**, Professional Desktop Audio from Micro Technology Unlimited. The sky's the limit.

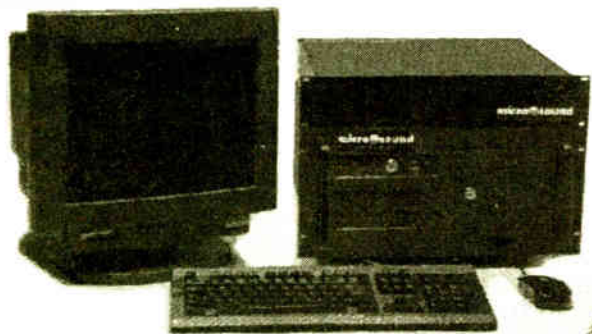

**microsound™ The Better Way.**

Want to get the rest of the story? Call or write us for a free guide to Professional Desktop Audio.

Micro Technology Unlimited PO Box 2106, Raleigh, NC (USA) 27619  
Voice: 919-870-0344 Fax: 919-870-7163

Circle (78) On Reader Service Card

## This is what you get.

You asked BEXT to build the best high-performance FM exciter, put it in a no-frills package, and bring it to you at the most competitive possible price. To guarantee that you get everything you deserve, we bring you the new LEX 25, backed by our two year warranty and 24-hour engineering hotline.

LEX 25

25 Watt FM Exciter

S/N: >80dB

THD: <0.03%

\$1,995



1045 10th Ave.  
San Diego, CA 92101  
619-239-8462  
FAX: 619-239-8474

**BEXT**

Circle (33) On Reader Service Card



You used to have excuses for using a consumer CD player. Perhaps you wanted audiophile sound quality, but then you had to put up with pre-historic user controls. Maybe you wanted an inexpensive player, but then you were saddled with awkward operation, marginal reliability and even worse sound.

# YOU HAVE NO MORE EXCUSES.



The DN-650F Professional CD Player changes everything. Denon has combined their legendary audiophile sound quality with powerful features developed specifically for studio and broadcast applications. Industry-proven professional controls include true instant start, auto cue-to-music, index search and a full complement of professional input/outputs, such as balanced and unbalanced audio, digital out, and a GPI interface. In addition, you can format these features for your specific applications.

The Denon DN-650F. Professional performance, economical price. And no excuses.

**DENON**  
The First Name in Digital Audio



## PRODUCT EVALUATION

# Seeing Red Instead of Green

by Ed Bukont  
and John Gatski

**FALLS CHURCH, Va.** The \$60 Whirlwind Cable Tester has been available for several years. It is used by a number of music studios and musicians for determining the condition of microphone and other kinds of audio cables. It seems a natural for broadcast use.

Whirlwind makes a lot of quality products including cables, connectors, mixers, etc. A robust, palm-sized device packaged in a shielded metal "bud-box" type enclosure, the Cable Tester appears to be a quality product.

Housed in a 4.5-inch-by-2.5-inch black-metal case, the Cable Tester provides a lot of connectors and LEDs for determining cable status. Included are XLR male and female jacks, two quarter-inch jacks and two phono jacks. A simple power switch and LED indicate when the 9V-battery-powered device is on. LEDs light to indicate correct phasing between signal conductors and ground/shield conductors. There are a total of five LEDs.

### Belt-carried

An attached belt clip keeps the unit close at hand and positioned for easy connection to cables when you are squat-

ting down behind a rack in some dark corner of the stage or studio. The use of LEDs rather than incandescent lamps ensures a longer life and that the indicators will work when they are supposed to—especially in dark corners. Because the unit only sees occasional duty usage, battery life should be considerable.

Cable testing is straight forward with the XLR-to-XLR. When evaluating an

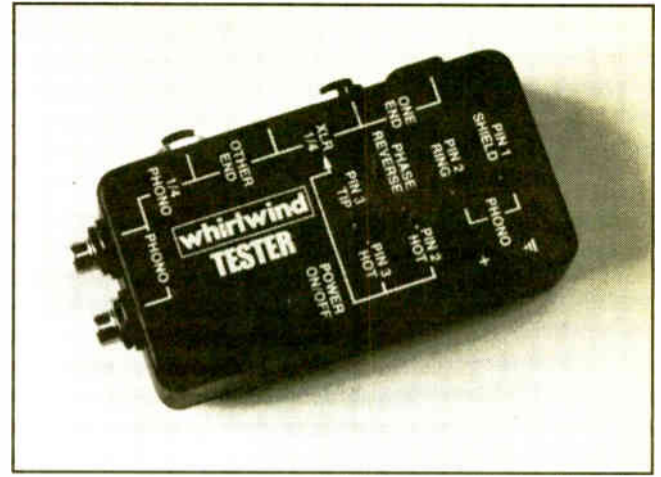

Whirlwind Cable Tester

XLR-to-XLR, all the green LEDs light. If Pins 2 and 3 are reversed, the red phase reverse light lights.

This red LED is a bit confusing, however, because it also lights when Pin 2 is hot during XLR-to-quarter-inch or RCA jack combo testing. Some people may think that the red light is indicating a problem with Pin 2 being hot because the LED is glowing red.

This procedure is further confused by the fact that the Pin 3 hot LED is green. If you read the owner's booklet, howev-

### Product Capsule: Whirlwind Cable Tester



**Thumbs Up**

- ✓ inexpensive
- ✓ sturdy
- ✓ convenient



**Thumbs Down**

- ✓ Pin 2 hot/XLR phase reversal share same status LED

For more information, contact Whirlwind at 716-663-8820; or circle **Reader Service 10**.

er, it tells you how to test the different kinds of cables and connectors, and that Pin 2 hot is the red LED.

Still, this double-duty red LED is somewhat confusing. It would be better if the phase reversal used the red LED and the Pin 2 hot had its own green LED.

### The hot pin topic

This brings up another issue: Why is Pin 3 hot anyway? Although this setup is common in the music industry, it is not the standard established by the Audio Engineering Society, the Society of Motion Picture Television Engineers or others. The standard stipulates that the "hot" pin of a 3-Pin XLR is Pin 2.

The common misconception of Pin-3 began during the late 1950s as a disagreement between Ampex and its competitors of how to view the connector. Although the argument was seemingly laid to rest nearly 20 years ago, some insist (including Whirlwind) that there is a difference between the "broadcast" standard of Pin-2 and the so-called "music or recording" standard of Pin-3.

All in all, the Whirlwind Cable Tester is a well-built, seemingly durable, portable tester that tests the majority of cables that broadcast production people use. I do have reservations about the red LED being used for phase reverse and Pin 2 hot, but once you learn what it means in different applications, there is no problem. Still, the Whirlwind Cable Tester is high on our list of maintenance must-haves.

□ □ □

Ed Bukont is a contracting engineer for Multiphase Inc. in Falls Church, Va.



## Put The Control Back In Your Control Room.

TM century

It's the **Ultimate Digital Studio** from TM Century. And it's the ultimate in new technology for giving program directors and air personalities more control than ever before. More local market control than de-centralized satellite networks or other digital systems. More creative control with a design based on live assist but with walk-away capability. More audio quality control, with CD changers rather than multiple hard-disk compressions that decrease your on-air sound quality. And even more risk control,



*"I'm sure I'm speaking for the rest of the KVIL personalities... We absolutely love the UDS. I can't even imagine running a radio show without it."*

Ken Barnette  
KVIL 103.7 FM  
Dallas, Texas

with compatibility for any other software you have, and flexible enough for expansion and changes. Yet it's the easiest of all systems to use, with features like hot buttons and pop-up windows instead of confusing icons, error-prone touch screens and multi-layered commands. Find out more about The **Ultimate Digital Studio**, the system designed by radio people for radio people. Call **1-800-TM-CENTURY®**, or **1-214-406-6800**.

## The Ultimate Digital Studio®

Circle (112) On Reader Service Card

World Radio History



# COMPETITIVE EDGE.



**Today's AMs** face too much competition for too few advertising dollars. That's why Orban's OPTIMOD-AM has become the weapon of choice for competitive broadcasters in every market.

**OPTIMOD-AM** produces maximum loudness, consistency and clarity on all types of AM radios, using every last watt of your authorized power to extend your listenable area and increase your billing opportunities.

**A powerful six-band limiter** and patented distortion-canceling multi-band peak controller deliver deep, tight lows and clean, transparent highs. You get the closest thing to FM sound, with maximum intelligibility in the essential voice frequencies.

## Comprehensive controls and metering

allow you to easily fine-tune your sound, keeping it distinct and aggressive in a changing marketplace.

## Fully NRSC and EBU/CCIR compliant

and with mono units easily field-upgradable to stereo, OPTIMOD-AM meets today's standards and protects your investment as you grow.

And Orban's superior customer service is there if you need it to provide world-class support for you and your in-house or contract engineering staff.

**Give your programming a chance** by making sure it gets heard. Call your Orban dealer today for an on-the-air evaluation, and put OPTIMOD-AM to work protecting your bottom line.



© 1993 AKG Acoustics, Inc.  
Orban and Optimod are registered trademarks of AKG Acoustics, Inc.  
AKG is a registered trademark of Akustische u. Kino-Geräte Ges.m.b.H., Austria.

**orban**<sup>®</sup>  
A Division of AKG Acoustics, Inc.  
1525 Alvarado Street, San Leandro, CA 94577 USA  
Tel: (1) 510/351-3500 Fax: (1) 510/351-0500

Circle (59) On Reader Service Card

World Radio History



## DIGITAL DOMAIN

# Digital Resolutions for the New Year

by Mel Lambert

**LOS ANGELES** I hope it is not too late to wish RW readers the compliments of the season, and to offer my own short list of New Year Resolutions, with a digital spin. Here they are:

- Come to Terms with Digital Connectivity. There is no denying that both within a radio station and between media delivery centers around the country, the reliable transmission of digitized information is one of the key factors to a successful future. Accessing stored sound files from remote hard drives requires a reliable, robust network that can be used to relay material from one location to another.

## Hard drives

While a standardized file structure and data-storage format might be something that we'll see in the near future, today's manufacturers are at least listening to the marketplace and innovating designs that enable stations to source drives from third-party vendors. The resulting cost savings and non-reliance on a single vendor can only raise the comfort threshold in these newer—and sometimes baffling—technologies.

In addition to the familiar ISDN, DC3, T1 and other data highways that are finding increasing application in the land of radio, there are newer, emergent technologies that are worthy of our attention. ATM (Asynchronous Transfer Mode) is being offered in a growing number of workstations and music-replay systems, to enable high-speed access to remote storage devices and other components.

With its theoretical data throughput of several gigabytes per second using twisted pair or optical connections, ATM holds a great deal of promise for intra-system connections, as well as potential application for home-delivery systems of the not-too-distant future.

- Become more "Compression-Conscious." Digital audio data compression, in one form or another, is impacting just about every aspect of modern broadcasting, from satellite delivery systems and backhauls, to data storage and STL links.

## Inevitability of compression

These complementary encode/decode systems can dramatically reduce the amount of spectrum and storage space required to carry 16-bit audio over terrestrial and satellite transmissions, as well as enhance the amount of available space for hard-disk/floppy/MO recorders.

In practical terms, the vast majority of the currently available codecs are extremely reliable in operation and, with care and attention to some primary operational factors, can provide reliable functionality within a variety of applications. However, as I have mentioned before, data compression is, essentially, a destructive process, whereby data is removed from a signal. In most cases, we cannot hear the results—the system vendors wouldn't remain in business for very long if the process was too obtrusive—but care does need to be paid to certain factors.

For example, encoding delays might cause problems if, for example, audio from a sports remote is being carried over a data-compressed ISDN link, and the commentator or talent is monitoring off air. And in some transform-based systems, dependent upon the width of each frequency band and the degree of overlap, decoding the signal might produce small amounts of pre-echo.

By far the biggest constraint, however, comes from the inability to perform multiple generations. Each time the material is decoded, re-encoded and stored to hard disk, for example, our audio signal is passing through another generational stage.

As with all signal-processing techniques, there is a finite limit to the number of times that we can perform these encode/decode cycles before the result becomes highly audible.

The bottom line is simple: Limit the number of analog encode/decode stages to the minimum, and study the effects of

**These encode/decode systems can dramatically reduce the amount of spectrum and storage space requirements.**

sequential coding using different algorithms. Specifically, we should determine how the coding scheme handles random and sequential errors in the transmission or recording medium. We should also determine what artifacts might be produced if the signal is to be equalized, compressed or otherwise processed after it has passed through a bit-reduction system. (We might also attempt to find out what compression schemes, if any, have been used on material that is arriving via modem or other delivery systems.)

- Investigate Data-Storage Options. For the majority of stations, the storage of material on a variety of media can produce headaches of legendary proportions. Storing and accessing NAB carts, CDs, DAT tapes, analog reel-to-reel tapes, etc. is normally a matter of providing sufficient physical space within the traffic, production and/or air studio, and then labeling everything so that it can be found with a minimum of delay.

## A blessing or nightmare?

Digital storage systems, on the other hand, can be a blessing and a logistical nightmare. While everything is now gathered together neatly and conveniently in one location (maybe across multiple-net-

worked drives), their organization into file directories can mean that finding a specific data file or schedule log can slow down the operation. Also, backing up and restoring literally gigabytes of data needs to be approached with methodical patience and consistency.

In many cases, there are alternate solutions. Removable hard drives allow portions of a playlist, for example, to be held on one or more drives and then transported easily from one location to another. High-capacity MO drives allow "plug-

and-play" for a growing number of workstations—provided that they offer sufficiently fast seek and access times—while Data DAT, Exabyte and other linear media can store a great deal of data in a remarkably small amount of space.

- Familiarize yourself with Integrated Designs. With disparate techniques for storing and accessing the materials required for radio programming—including music, commercials, jingles, liners, IDs and other digitized audio—I would hazard that successful workstation and audio-delivery devices will include the ability to control a variety of system functions from the console or alternate control surface.

## A need for standardization

In addition, the use of standardized control protocols for DAT machines, CD players, cart machines, etc., enables these and other devices to be controlled from that same central location. Fortunately, a growing number of radio equipment manufacturers are now incorporating standardized command protocols—including nine-pin P2 and its variants, network-capable ES-Bus schemes plus MIDI Machine Control. This development will streamline the integration of additional system components, including signal-processing devices such as compressors, limiters, reverbs and equalizers. In addition to conventional transport and electronic commands—including stop/start/play/ wind and record-enable functions—ES-Bus allows status and other information to be extracted from distant systems.

For automated record/replay operations, the ability to poll each transport for machine-status and location information means that automated sequences can be initiated, and pre-programmed "What-if?" sequences implemented if, for example, a CD player stops suddenly, or fails to respond to a set of transport commands.

As always, the start of a new year provides a timely opportunity for all of us to examine technical and operational alternatives now being offered to broadcasters. As is now becoming obvious, implemented correctly, the new generation of digital technologies will revolutionize the way we can generate, schedule and deliver high-quality audio to our listening audiences.

□ □ □

Mel Lambert is a principal of Media&Marketing, a Los Angeles-based consulting service for the professional audio industry. He can be reached at 818-753-9510.

## Your Listeners Are Ready For RDS/RBDS... Are You?

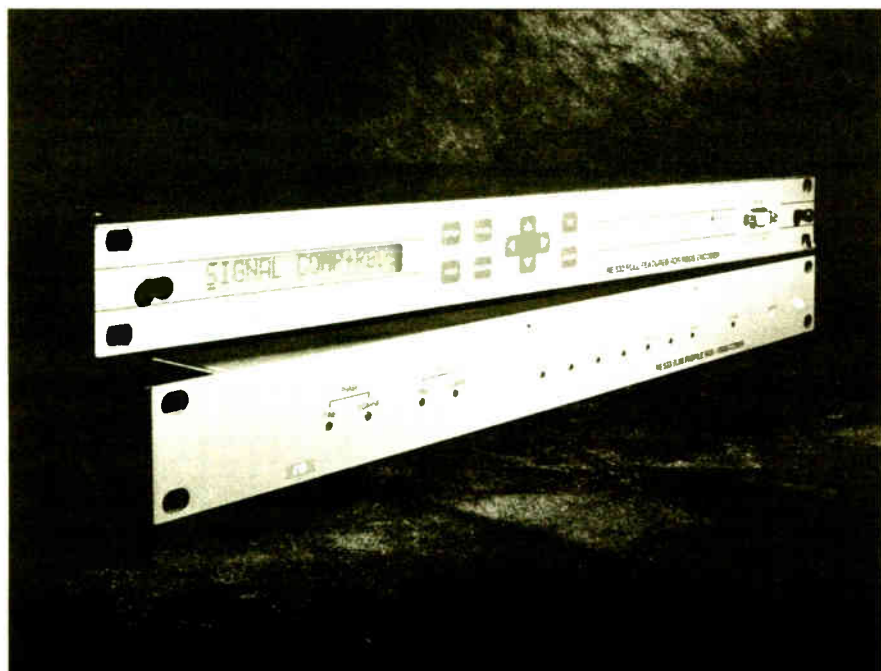

Available through: ▲ Broadcasters General Store ▲ Harris Allied ▲ RF Specialties

This year, RDS/RBDS consumer radios are being purchased by your listening audience, which means the time is right to pursue the revenue opportunities RDS/RBDS has to offer.

RE AMERICA continues its tradition as the leader in RDS/RBDS technology, now with a family of products. Whether you choose the RE 533 for single-user datacasting or the RE 532 for multi-user datacasting, RE has the right encoder to meet your budget and operational needs.

RE takes the risk out of choosing an RDS/RBDS encoder by employing flashprom technology in both the RE 533 and the RE 532. Future upgrades and enhancements are simply downloaded via disc software available from RE. You make the choice, the RE family has got you covered.



RE AMERICA, INC.  
31029 Center Ridge Rd.  
Westlake, Ohio 44145

Phone: (216) 871-7617 ▲ Fax: (216) 871-4303



## SIGNAL-TO-NOISE

# Improved Scoopman, Broadway Mics

by Frank Beacham

**NEW YORK** Audio recording has always been more about art than science. That is one of the reasons it's so much fun. Every time the big guys make leaps toward the "perfection" of audio technology, some little guy comes along, bucks the trend and creates a classic recording on a shoestring in a garage.

It was with great amusement that I read the recent story in the New York Times on the movement of many major recording artists to add hiss, distortion, noise and other imperfections to their new releases. The trend even has a buzz word: "lo-fi."

## Back to "lo-fi"

I was particularly amused that some radio stations complained that a recent Mariah Carey recording of the song "Dream Lover" had a defect when, in fact, old-fashioned needle scratches were mixed into the tracks intentionally.

At first, Columbia Records decided to remove the ticks from the master tape but decided to drop any changes when the tune hit the top ten on Billboard's charts.



Scoopman II and docking station

Another irony is that Sony, one of the world's premier manufacturers of digital recording equipment for studios, owns Carey's record company. So much for that corporate synergy.

The reason for the retreat from digital, say some in the recording industry, is a yearning by audiences for more genuine performances. Super-clean, highly produced records sometimes come off with a cold perfection that is often too slick and overly processed.

"There's definitely a trend toward dirtier tracks," said David Kahne, a senior executive at Columbia Records. "Tape hiss, guitar-amp noise, low-level garbage. Five years ago, we would have cleaned all that up. But today, the prevailing wisdom is to go lo-fi and let that noise become part of the music."

According to the Times, artists such as John Mellencamp, Los Lobos, the Red Hot Chili Peppers, Dr. John and Richard Thompson are retreating from the sound of digital recording. Those who have already achieved commercial success with lo-fi are Beck, Sebadoh, Liz Phair, P.J. Harvey and Sheryl Crow.

The staple hardware of lo-fi includes cheap microphones, four-track analog tape recorders, tube electronics and classic instruments, like the Fender Mustang electric guitar that was favored by the late Kurt Cobain of Nirvana. For the real purist, Kahne said, vintage recording tape is a must, even though it's almost impossible to find.

Of course, this movement didn't happen overnight. Back in 1982, Bruce Springsteen recorded the album

"Nebraska" in his basement on a four-track cassette portable studios. These days, the multi-channel analog cassette-based project studio is so inexpensive that virtually anyone can afford to own and use one.

It is refreshing to observe that a lot of people are now returning to the basics in audio recording. Of course, the real artistry in recording has always been in the imagination, not in the hardware. But that's a lesson that each generation seems to have to re-learn.

A Scoopman Flash! For fans of Sony's

not so lo-fi "Scoopman" digital tape recorder, there's great news. This summer Scoopman II (also known as the Model

recorder at CES in Las Vegas last month. However, our friend Michael Garrison, owner of The DAT Store in Los Angeles,

**Super clean, highly produced records sometimes come off with a cold perfection.**

NT-2) will finally appear. Though silent on the specs and price, Sony showed a mock-up of the new subminiature digital

learned in Japan that Scoopman II will include four seconds of RAM storage  
continued on page 39 ▶

## The Legend Continues.

### The Old Standard.

Our M267 Mixer is more than the best selling mixer of the last ten years. It's the most versatile, the most durable, and the best performing. You trust it in your rack — you trust it on the road. And while production environments have changed, your mixer remained the same. Until now.

### The New Standard.

Our new M367 Portable Mixer gives you all the reliability and durability of the M267, plus a list of new features and improvements. We made it over 25 dB quieter with a low noise circuit — ideal for digital formats. We added two more mic line inputs, bringing the total to six. We added peak LEDs. And we gave it 12 and 48-volt phantom power for your condenser mics.

What we didn't change was its toughness. It's still made with a rugged all-metal chassis and manufactured in the USA with legendary Shure durability.

### The New Features.

Without increasing the size, we were able to pack in dozens of new features and improvements. The M367 has all the features of the M267, plus:

- Input peak LEDs
- Detachable power cord
- Two XLR outputs
- Easy-access side battery compartment
- Headphone monitor circuit
- Output peak/limiter LED
- Balanced, 2-position mix bus
- Adjustable limiter threshold
- Battery/AC VU meter illumination
- Monitor input sensitivity selector
- Program/monitor input selector

With the Shure M367 mixer, we've just raised the standards. It's time you raised yours.

**For The Shure Dealer Nearest You,  
Call 1-800-25-SHURE.**

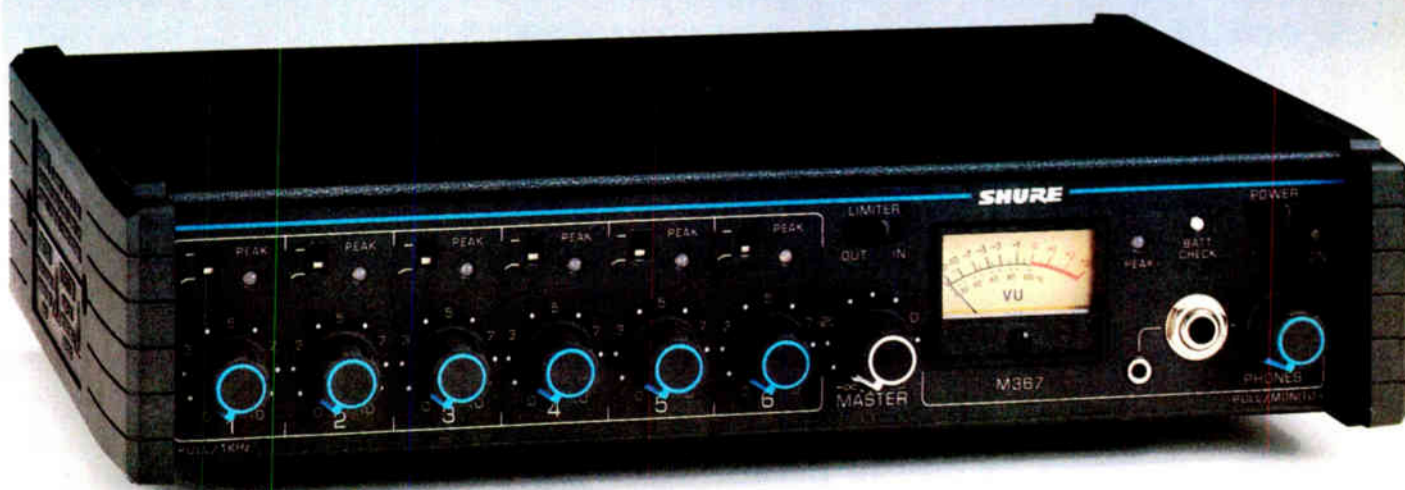

THE SOUND OF THE PROFESSIONALS... WORLDWIDE. **SHURE®**

Circle (210) On Reader Service Card

World Radio History





## Meat And Potatoes à la Fidelipac

### Cartridge Machines

The DYNAMAX CTR10 Series needs no introduction. Over 10,000 units are installed in all four corners of the globe. Over the years, the unit has been refined and now includes a brushless DC servomotor. The CTR10 Series combines good value, reliability and high quality audio.

### Tape and Tape Cartridges

DYNAMAX COBALT Cartridges provide excellent high frequency response, high sensitivity and increased head room, and are ideal for top quality reproduction from a digital audio source.

The AUDIOMAX 4000 offers premium quality as well as phase and bias compatibility with more expensive Type AA-4 cartridges and is suggested for stereo applications requiring elevated recording levels.

The MASTER CART yields maximum performance at standard operating levels and is well suited for general purpose stereo recording.

The MODEL 300, workhorse of the broadcast industry for thirty years, this cartridge is intended for monophonic use at standard recording levels.

DYN-400X Professional Back Lubricated Recording Tape is a low noise mastering tape for use at standard recording levels and is available on NAB hubs or 7 inch reels.

### Magnetic Erasers

The DYNAMAX ESD10 uses dual full-track erase heads to ensure deep cart erasure of 75 dB or more. The patented splice detector which requires no sensitivity adjustments rapidly locates the splice and positions it perfectly before recording.

The BLANK-IT hand held eraser is molded of rugged plastic for light weight, easy to handle, quick and accurate tape erasing in any setting.

The MODEL 400 table-top eraser features a hardwood case, scuff resistant laminate top and removable aluminum pivot pin permitting erasure of audio, video or computer tape reels up to 11 inches in diameter x 1 inch wide.

### Other Accessories

Fidelipac offers CARTRIDGE STORAGE SYSTEMS in numerous configurations including a 25 slot vertical wall rack, a 200 slot mobile carousel rack mounted on heavy duty casters, and table-top units which hold 96 cartridges or up to 48 cartridges (as shown above).

Fidelipac's world standard WARNING LIGHTS are available in eight different languages plus custom versions on request. Back illuminated brilliant red letters on an opaque black foreground command attention and visibility.

In addition, other useful accessories (not shown) include alignment cartridges and precision gauges for head insertion and right angle zenith calibration.

For a complete menu or information about our digital audio products, call Fidelipac.



**DYNAMAX**<sup>®</sup>  
BROADCAST PRODUCTS BY FIDELIPAC<sup>®</sup>

Fidelipac Corporation □ P.O. Box 808 □ Moorestown, NJ 08057 U.S.A. □ TEL 609-235-3900 □ FAX 609-235-7779

Circle (71) On Reader Service Card



# Scoopman Adds New Features

► continued from page 37

memory that will allow a new auto reverse feature to function without losing any of the recording. On 120-minute cassette, it will be capable of two hours of uninterrupted recording.

The gold-colored NT-2, which is even

**Today's audiences are conditioned by the compelling sound of TV and movies.**

smaller than the original NT-1 Scoopman, also adds solenoid controls and features an optional docking station that will allow the user to record 48 and 44.1 kHz digital tape formats through an optical digital input. The NT-2, like its predecessor, records only in the 32 kHz mode.

**Evil SCMS**

An optical digital output on the docking



Sondheim miking Broadway

station will allow direct digital dubbing from the NT-2. The dubs can be in the original 32 kHz format or converted by the dock to 44.1 kHz. This conversion will allow master tapes made on the NT recorder to be dubbed digitally to the DAT format.

Unfortunately, the evil Serial Copy Management System (SCMS) is at work here to complicate the dubbing process, but it is easy enough to beat the system, and I'm sure many users will.

The NT format—with its postage stamp-sized digital cassettes and lack of data compression—is one of audio's best-kept secrets. However, some very distinguished recordists have begun using the format. Garrison's DAT Store recently sold an NT-1, the original Scoopman, to Frank Sinatra, who uses it to record and evaluate his rehearsals.

**Sondheim's tirade**

Stephen Sondheim, one of Broadway's most influential composers, had some harsh words for modern audio technology at a recent Showbiz Expo discussion in New York City. Sondheim said he and collaborator Hal Prince used to sit in the second balcony to view plays in the era before amplified sound in Broadway theaters.

"Up there you had to really listen," Sondheim said. "You'd lean forward in your seat to hear the voices on the stage. "In doing so your concentration becomes laser beam intense. You may be 150 feet away but you are in the play."

But today's audiences, Sondheim said, are conditioned by the compelling sound of TV and movies. "If a (Broadway) show is not miked (and amplified) they will turn it off," he said.

And the same goes for the actors. Sondheim said he tried an unmiked rehearsal of "Sunday in the Park with George" with actors Mandy Patinkin and Bernadette Peters, both of whom have powerful voices. Both, he said, were so used to hearing their voices bounced back at them from the sound reinforcement system that they felt the performance wasn't working without the microphones.

At this point, Sondheim said, he regrettably gave up on returning

Broadway theater to its unamplified state.

A new edition of "The Binaural Source," a comprehensive catalog of binaural recordings for headphone listening, is now available. This excellent free booklet, the work of John Sunier, is chock-full of useful info on binaural recording and features about 100 binaural recordings for sale from every genre of music. Check it out for a sensational audio experience. Call 800-934-0442 to order.

□□□

Frank Beacham is a writer, director

World's Only Catalog of Recordings for Headphone Experiences

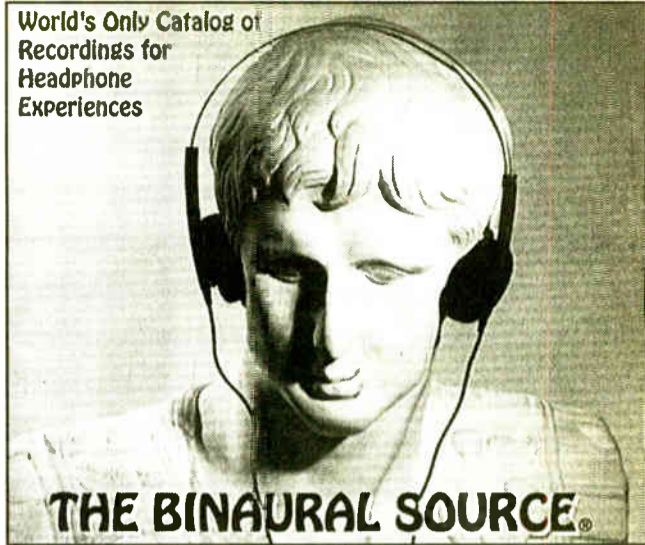

Latest on binaural

and producer. His address is 163 Amsterdam Ave. #361, New York, NY 10023. E-Mail: beacham@radiomail.net.



## Systems with Style

When KABC/KLOS decided to rebuild from the ground up, they called Pacific Recorders & Engineering to provide its expertise in studio systems planning and execution. After all, when you're dedicated to winning, you don't gamble with success. PR&E has a proven track record of building the world's leading broadcast facilities for over twenty years. This record translates into the uncommon depth and breadth of experience which we bring to each new project. From news to rock, talk, or full-service, we're comfortable and conversant with all formats.

When you see the attention to detail, the design elegance, and the fanatical commitment to quality, you quickly realize why PR&E consoles and studio systems are found in nearly every leading broadcast facility in the nation.

But what may really surprise you is how much money you can save by working with us. That's right, save money. You see, we design and build so many world-class studio systems, we avoid the "surprises" by having the details down to a science. Why don't you give us the opportunity to work with you on your next studio project? We think you'll be pleasantly surprised at how easy it is to realize the operational efficiency and benefits of a genuine PR&E system.



Pacific Recorders & Engineering Corporation  
2070 Las Palmas Drive, Carlsbad, CA 92009  
Tel: 619-438-3911 Fax: 619-438-9277 GSA: GS-03F-2057A

**DESIGNS THAT MAKE THE DIFFERENCE**



Circle (25) On Reader Service Card



# Multitracking from Eight to 16

by Bruce Bartlett  
with Jenny Bartlett

**ELKHART, Ind.** If you want to record a concert with the best possible mix, the way to go is multitracking. I'll describe how I used this method to record a concert by Mississippi Heat, a Chicago blues band.

The mics were supplied by the PA company, TPC Productions in Bridgeman, Mich. Shure SM57 cardioid dynamics were used except for two EV CS-15 cardioid condensers over the cymbals. There were seven mics on the drum set, three vocal mics, and one mic each on two electric guitars and the harmonica amp.

The mics were split three ways to the house mixer, monitor mixer, and my recording mixer (see figure). A passive device, the splitter had three outputs wired in parallel—no transformers.

Hum was no problem because TPC supplied its own distributed power system. Also, each mic connector on the splitter had a ground-lift switch. If we heard a buzz on a particular mic channel, we flipped the ground lift. We also got rid of buzzes by turning off phantom power on all but one console.

TPC loaned me a 40-input Studio-master console to do the recording mix. Biggest one I ever used. I was havin' fun. Using a Tascam DA-88, I recorded

on all eight tracks with digital precision.

Because the DA-88 can record nearly two hours of CD-quality music on a Hi-8 video/audio cassette, it's ideal for taping live concerts. No more frantic reel changes. I fed the eight outputs of the DA-88 back into the console to create a monitor mix, and recorded the monitor mix onto DAT as a backup.

Back home after the concert, I mixed the eight tracks to a stereo DAT while adding EQ, vocal compression and reverb. Because the close-up mics picked

Recording scheme

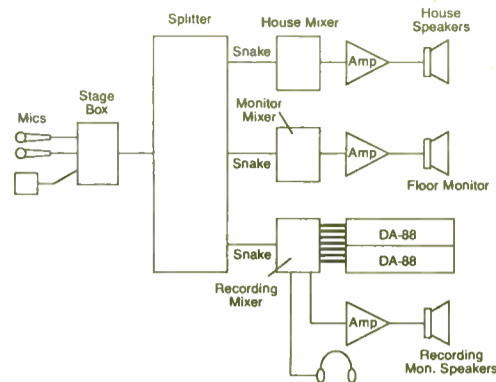

up no room sound, we needed reverb to get a live feel. EQ was minimal: a slight boost at 5 kHz on the drums for attack, 10 kHz on the cymbals for crispness, 60 Hz on the kick for bottom, and 3 kHz on the kick for attack.

We had no tracks to spare for audience reaction. So after each song, I turned up the master faders to hear the applause that leaked into the stage mics.

After some editing on a digital audio workstation, the tape was played October 8 over WVPE-FM, the local blues/jazz/folk station.

Two weeks later I recorded a live concert of New Wings of Faith, an R&B gospel band with eight singers. It was my first use of two sync'd DA-88s to record 16 tracks. I connected the special sync cable between them, set one machine to address 0 and the other machine to address 1. Then machine 1 chased the transport actions of machine 0.

When you hit record on the master DA-88, the slave DA-88 takes a few seconds to lock to the master. Then the two machines track with single-frame accuracy. It's an amazing sight.

These were the track assignments:

- Track 1: kick SM57
- Track 2: drum mix: hi-hat, snare, toms (SM57s), overheads (EV CS15s)
- Track 3: keyboards (left mix direct input)
- Track 4: keyboards (right mix direct input)
- Track 5: Percussion mix (two EV RE-16s)
- Track 6: sax/synth mix (EV RE-16 and direct input)
- Track 7: lead vocal (Crown CM-312 headworn mic)
- Tracks 8-16: vocals and audience

To fit everything onto 16 tracks, I set up submixes for the drums, keyboards, percussion and sax. In a typical drum submix, all the mic faders are set to the same level, but the cymbals' condenser mics are turned down a few dB to compensate for their higher sensitivity. I put the kick drum on its own track because its level in the mix is critical.

To mike the audience in stereo, I placed a pair of cardioid mics in an ORTF array, near the front of the house aiming toward the rear. This way, the audience mics picked up less of the house speakers. The mics also picked up the audience in front of their mouths, which helped articulation. While mixing, I could bring up the audience mics enough to hear clapping without muddying the sound.

The musical program flowed from one song to another with no breaks for 90 minutes. I knew I could not handle a 90-minute nonstop mixdown. So I mixed the program in segments, then edited them together later with a DAW.

The 16-track digital format proved to be ideal for concert recording. I was glad that I could make most of the mixing decisions after the concert.

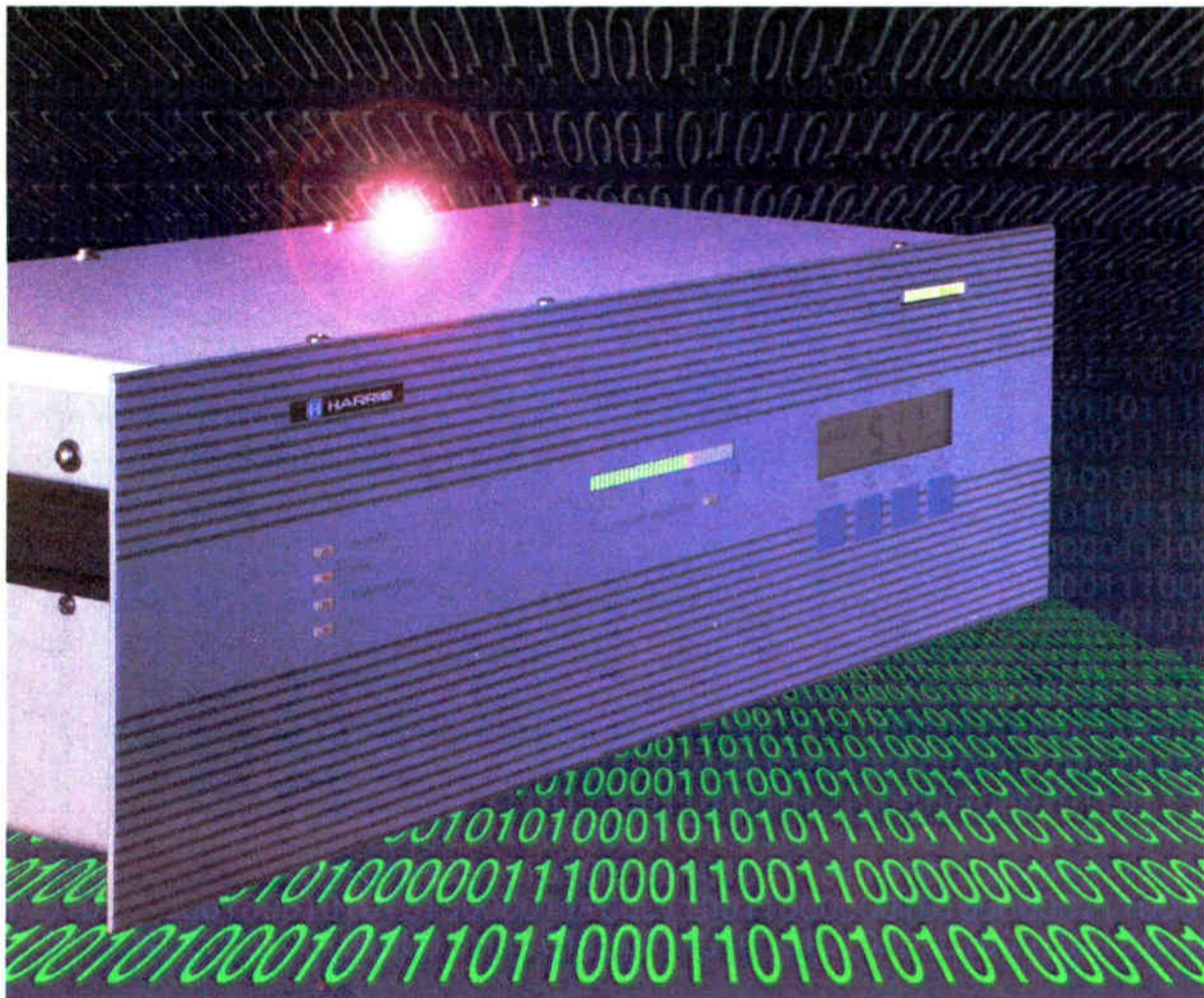

## Stop sending your listeners mixed signals.

Make your move toward a complete digital air chain with the Harris DIGIT™ FM Exciter. The radio dial can be a confusing place for today's FM listeners.

They've heard the hype for "improved sound" from CDs and other digital program sources. But for many stations, the missing link in the air chain has been the exciter. Outdated analog technology often stifles the full potential of digital input.

With the Harris DIGIT™

FM Exciter – the world's first and only truly digital exciter – you can use your analog processing chain now, then quickly, easily, upgrade to a 100% digital air chain. Your listeners will get the sound quality they expect, while your station will get new market prominence. You'll also be prepared for an even broader digital future.

Compatible with virtually all FM transmitters, the 50 watt DIGIT provides 32-bit Direct Digital Synthesis precision for an incredibly stable,

clear signal that is not subject to degradation over time. No tweaking or tuning is ever required for full digital performance.

Upgrade now with the Harris DIGIT FM Exciter and your listeners will get the message loud and clear. Call us today for complete specifications.

**U.S. and Canada: 217-222-8200**  
or fax 217-224-1439  
**International: 217-222-8290**  
or fax 217-224-2764

**HARRIS**  
**ALLIED**





# LOG FOR LESS

Everyone loves Eventide digital audio-loggers. They've thoroughly obsoleted old-fashioned reel-to-reel logging recorders. But for some stations, our 24-channel model VR240 is more than the budget can handle. And many stations will never need to record up to 24 channels.

## 500 hours, half the price

The Eventide VR204 4-channel digital logger is the perfect answer. It costs less than half the price of a fully optioned Eventide VR240! The high density DDS2 drive of the VR204 can actually record more than 500 hours, divided among up to 4-channels, on a single DAT tape. That's twice the record time of our original models.

## Built-in hard disk

The VR204 is a single drive machine, yet it can play and record simultaneously. That's because it features an ingenious built-in hard disk memory module that keeps recording even if the tape is playing back an

earlier segment (or if the tape runs out). When the tape resumes recording, the content of the hard disk is transferred to tape, maintaining the completeness of the taped log.

## Two-way compatibility

There's also a play-only model, the VP204, which is ideal for the GM's or PD's desk or for the group's main office. And both the VR204 and VP204 can playback any of the 24 channels recorded on an Eventide VR240.

Keep an accurate audio record of everything that goes out on your air. Keep track of the competition as well. Contact your broadcast dealer or Eventide for the full story on the economical VR204. Because without an Eventide digital logger, you really don't know what you're missing.



**Now record  
500+ hours on  
one tiny DAT tape**



**Eventide**  
the next step

One Alsan Way, Little Ferry, NJ 07643  
Tel 201-641-1200 Fax 201-641-1640



# CCS Introduces the

# CDQ *Prima* Series



CDQ*Prima* Model 120 shown

## Five of the best codecs in the world

**A**fter you've built over eight thousand codecs, what do you do for an encore?

Introducing the CDQ*Prima* Series, our third generation family of five codecs built with one goal in mind—to give you the most advanced communications tool in the world.

With ISDN rapidly becoming available everywhere, line charges dropping and new standards emerging, you need a full bandwidth codec that can grow with you and not leave you stranded. And growing is what CDQ*Prima* does best.

We've eliminated obsolescence from CDQ*Prima*. Every CDQ*Prima* model can be upgraded directly over the ISDN line, so changing chips when standards come and go is a thing of the past. And our modular construction makes hardware upgrades a snap.

CDQ*Prima* gives you full 20 kHz bi-directional stereo, plus ancillary data and SMPTE time code. World standard MUSICAM<sup>®</sup> and G.722 audio, with connectivity to over ten thousand codecs worldwide. And built-in ISDN terminal adapters with internal bonding to take you all the

way to astounding 384 kbps audio quality.

CDQ*Prima* lets you program each unit for automatic functions and instant networking with no external hardware. And with five models to choose from, there's a CDQ*Prima* to fit your budget.

We've got lots more to tell you about the new CDQ*Prima*. Call us, or your authorized CCS dealer for details, and be ready for tomorrow with the best codec in the world today.

 **CCS** Audio Products  
Crystal Clear Digital Audio

670 North Beers Street, Building 4, Holmdel, New Jersey 07733 USA Phone: (908)739-5600 Fax: (908)739-1818

Circle (163) On Reader Service Card  
World Radio History



# PRODUCT GUIDE

Companies with new product announcements for Studio Sessions Product Guide should send them to Radio World, c/o Studio Sessions Editor, 5827 Columbia Pike, 3rd floor, Falls Church, Va. 22041



## Sony Printable Surface CD-R

Sony's new professional recordable CDs come in two lengths (64 and 74 minutes) and with writable labels that allow ink-based labeling directly on the disc.

Both versions have a matte-gold finish that allows the direct writing without having to add labels. For more information, contact Sony at 201-930-1000; or circle Reader Service 196.



## Audio Precision PCMCIA Interface

Audio Precision's new PC interface fits any Type II PCMCIA slot on notebook computers, allowing the System One test instrument to be used with small portable computers. Typical applications include broadcast and field engineering.

For more information, contact Audio Precision at 800-231-7350; or circle Reader Service 90.



## Comrex Portable Digital Codec

Comrex's latest digital codec, Model DXP-G.722 brings 7.5 kHz audio via 56 or 64 kilobit per second (kbps) phone lines, such as ISDN or Switched 56.

Comrex's "baby" codec features external adjustable mic/line input, headphone

jack and front panel input level and sync status.

For more information, contact Comrex at 508-263-1800; or circle Reader Service 182.

## Symetrix DYNA-Squeeze 8-Channel Compressor/Interface

Symetrix's 488 compressor/interface is designed to work with the new crop of multitrack recorders, such as the Tascam DA-88 and the Alesis ADAT, Fostex RD-8 and Sony's new Hi-8 digital recorder.

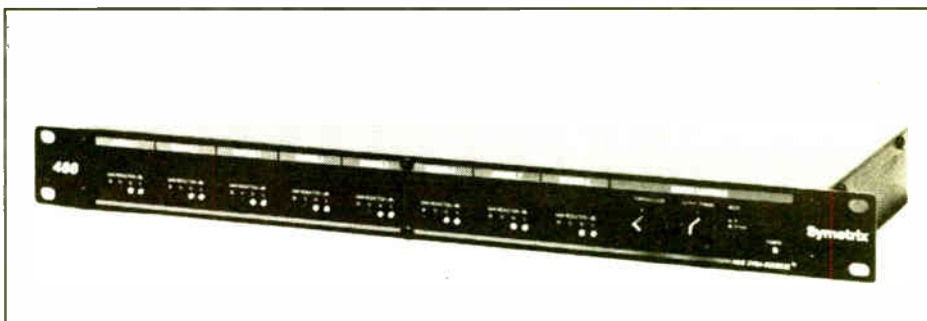

According to the company, placing the 488 between the recorder and console "squeezes" the tracks toward the upper end of the recorder's dynamic range.

Features include easy set up, +/- 10 dB gain trim, +4 dBu, -10 dBV output level, and balanced/unbalanced jacks. For more information, contact Symetrix at 206-787-3222; or circle Reader Service 157.

# What is DaX™?



**CD-Quality Audio**  
Packaged copy, bits, program logs, local options, playlists in flexible format for seamless rejoins and accurate time checks.

**Graphics**  
Send pictures to affiliates to enhance on-air descriptions of products, features and events.

**News, Wire Feeds and E-Mail**  
Instantly update news. Send announcer cues, intros, outros, latest artist trivia, Billboard rank.

- Localize National Shows
- Deliver Targeted Commercials Instantly
- Delayed Broadcasts
- No Transcoding
- Update Breaking news
- Remote Live Assist or Automation
- Affidavit services for rapid billing/cash flow cycles
- Works with Satellite, ISDN, Switched 56 or Phone Lines
- Audio Waveform Editing, Text Editing and Graphics Available

## Think of it as an audio fax machine!

An audio fax machine so powerful it can deliver CD-quality radio programming, music, news, commercials, or production instantly to individual stations, regions or the entire country. The basic DaX™ PC platform comes with information storage capability greater than 6 CD-ROMs and is expandable to greater than 100. A proven winner in the field for over a year, the DaX™ is the only store and forward system that's already operating successfully in the real world. The first and still the best.

**(805) 523-2310**

Let us customize the DaX system to your application!

**CaliforniaDigital**

Digital Audio Systems  
CaliforniaDigital Audio Systems, Inc.  
P.O. Box 120  
Moorpark, CA 93020  
(805) 523-2310 Tel  
(805) 523-0480 Fax

©1994 CaliforniaDigital Audio Systems, Inc.  
Patents, copyrights and trademarks applied for.



# It Was 1969 and I Spun 45s

by Ken R.

**TOLEDO, Ohio** When I first sat down between those two 16-inch turntables and stared into that mic for the first time in the late 1960s, Bill Drake-ism had not yet completely muffled personality radio with the blanket of ultra-tight formats. General managers had not yet completely squeezed the life out of most

radio dayparts in an effort to obtain a uniform "product." And satellites were used for spying on Russians, not providing 24-hour chunks of programming.

Disk jockeys (we actually spun 45 rpm records) had the chance to experiment, to be heard. Because most markets only had a handful of AM radio stations (FM was only heard in doctors' offices), each station had a significant

share of the audience. The shift from 10 a.m.-3 p.m. was known as "Housewife Time" in those days... and even that daypart had a huge audience.

## No splinters yet

Formats hadn't yet splintered into "A/C," "Soft A/C," "A/C for People with..." and on and on. There were but three formats: MOR stations (Middle of the Road for those of you born

after 1960), Top 40 stations (now called CHR), and a few little country stations. You could tell a country recording artist by his pointy shoes, enormous sideburns which came to a

some things haven't changed that much.

At programming meetings, we used to guess which records and features people would like to hear on the radio. Today stations buy

## We used to guess which records people would like to hear on the radio.

point mid-cheek, and those songs about bars and women. Well, come to think of it...

research. The research tells them their audience wants a better variety of soft hits, no rap and a better selection of Freddy and the Dreamers records, for example. Thus, the station slogan becomes... "This is K-Poop, with a better variety of soft hits, no rap and a better selection of Freddy and the Dreamers records."

After every darn song they repeat this rambling litany! Stations even make the poor receptionist mouth this pabulum every time she picks up the phone.

Then you have all these computers. I guess back then mainframes existed at giant universities and space centers, but people didn't use them for organizing checkbooks, let alone running a radio station.

Back when I obtained my third class license, I had to study hours and hours and drive 100 miles to take a test just to get it. People who bought radio stations actually liked radio. They hung onto their little stations, nurtured them, listened to them, got involved with them. Today radio "properties" are swapped like trading cards, and the people that own them aren't even radio people. They're insurance companies or publishing houses with someone in charge of "Broadcast Properties Acquisition."

I can't imagine any of these guys stopping into the studio to pal around with the air talent. Come to think of it, there are not that many air talent people! The format's coming out of Phoenix on the bird. ("It's 22 past the hour.")

## Slogans abound

And what ever became of call letters? They used to come in two flavors: W and K. Those were followed by two or three more letters chosen from the alphabet. Occasionally these would spell something cute like "WHAT?" or "WHO?" Now call letters have been replaced by words like Kiss, Magic, Arrow and Power Pig (hello?). A station's legal call letters are usually snuck in with the city of license in a one-second blurb between two spots at :55 past the hour.

All these "move-in" stations think no one will find out they're really in suburbia (not in Metropolis) if they bury the name of the actual community they promised to serve. Citizens groups used to care about this and write the FCC when a station's programming wasn't doing anything to serve the community.

continued on page 46 ►

## OUR DIGITAL AUDIO WORKSTATION IS NOW PERFORMING WITH THE FOLLOWING GROUPS



ADAT is a registered trademark of Alesis Corp.



### Vermont Public Radio

*Sam Sanders, a happy Foundation 2000 user since January, estimates that he has cut his production time in half.*

Our unique Edit Controller looks and feels just like the recorders you work with every day—no keyboards, front-end computers or mice to slow you down. The built-in touch screen shows you a wave form picture of your sound for instant visual reference. There's even an ASRC option so that you can convert one sample rate to another.



### Audio Mixers, New York

*Fred Venitsky (pictured) and Jimmy Regan have the distinction of owning and operating the most used Foundation 2000 on the planet.*

Foundation 2000 is fast and easy to use. Audio scrubbing is so clean, you'll swear you're rocking reels. Edits are seamless. Fades are smooth and glitch-free. Plus, you can specify the "Light Pipe" for direct interface with the popular ADAT™ and RD-8™ digital recorders.

## FOUNDATION 2000LS

Designed specifically for broadcast production, this random access recorder/editor features the speed, the ease of use, and uncompromising audio quality of Foundation 2000—for less than \$15,000! It's the same dedicated user interface with touch screen display, real time operation, event based editing, wave form display, and expandability to a full Foundation 2000 at any time—the only workstation of its kind to offer this important feature. Test drive the high performance Foundation 2000LS in your studio. Call 1-800-7-FOSTEX or 212-529-2069 today to schedule a demo.



**Fostex**



~~\$924~~

**\$10,000**

## FEEL BETTER?

For \$924\*, we have trouble convincing some of you that The CardD System™ is a powerful digital audio editing system. There's an easy solution, though. We could raise the price. Or, you could take advantage of BSW's 30-day trial offer and find out for yourself! The CardD System— The CardD Plus™ and FastEddie™.

### Digital Audio Workstation Myths

#### Exploding the Price Myth

**Myth:** "I have to spend \$10,000 to get a professional digital audio workstation."

**Fact:** The CardD System's FastEddie™ software gives you the fastest and easiest cut-and-paste editing you will find at any price. The waveform display gives you sample-accurate editing. The CardD System's Card Plus™ audio board has truly outstanding sound quality. You can pay a lot more and get a system that won't do your radio production work as well as The CardD System.

#### Exploding the Multitrack Myth

**Myth:** "I need a multitrack digital audio workstation to do voice-overs."

**Fact:** FastEddie's split-screen editor and MIX tool let you overlay sounds. You can lay a voice over a music bed, and then lay sound effects on top of the voice-over. There is no limit to the number of sounds so you can layer in FastEddie. So, even though The CardD System is called a "2-track" system, it does the production work that used to require a multitrack tape machine.

#### Exploding the Complexity Myth

**Myth:** "Digital Editing is complicated to learn and use."

**Fact:** Most CardD System users were editing on tape before purchasing The CardD System. The CardD System is easy to install on your IBM-compatible computer, and the FastEddie editing program is very intuitive and easy to learn. FastEddie comes with a Quick Start guide and a tutorial, including sample sound files. Hundreds of CardD Systems are in radio stations doing daily production work.

The **CardD Plus**™

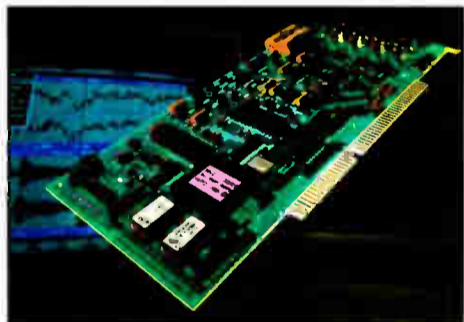

and

**FastEddie**™



"...unbelievable...this is one piece of gear you should hear for yourself."  
-Home & Studio Recording, Sept '92

"exceptional... The sonic quality from the hardware is superb rivalling digital equipment many times the price."  
- Audio Media, March '94

"The fastest cut & paste editing I have ever seen...an ideal replacement for quarter inch tape editing...time with a razor blade can be slashed by 300%...affordable digital editing has finally arrived!"  
Paul M. Robbins, Technical Director  
Thames Valley Broadcasting pic.

**\*Combined list prices of The CardD Plus and FastEddie. Call for the BSW price!!**

*Equipment Solutions To Keep You Number One*



Phone: 800 • 426 • 8434

Fax: 800 • 231 • 7055

7012 27th Street West Tacoma, Washington 98466 USA



# Spinning 45s in 1969

► continued from page 44

Now this is such a non-issue as to be a joke.

And then there's the music. Each year Beatle records get more and more airplay because the tunes had a melody and some emotions people could relate to. Will anyone still be singing Snoop Doggy Dog's songs in 20 years? How about next week?

The program director who was my mentor (the late Don Armstrong) used to tell me announcers were guests in peoples' homes. He made sure we never said anything that would bring shame to the radio station. He wouldn't want his kids or his mother to hear anyone with a potty mouth. Character mattered. Today bathroom habits, sexual apparatus and about anything else you could imagine are used on the air in an effort to get ratings. And surprise... they do get

ratings today.

When I chose to end my radio career in 1977, I had a brief stint as a television director. One old timer at the station told me about the good old days when they used to edit video tape with a razor blade. We laughed at his description of this stone age technology because we had brand-new 2-inch video tape machines (which have long ago become fossils consigned to the junk heap). Now I am one of those old guys.

In re-reading these musings, I know I sound pretty bitter here. But actually, for the last 16 years, I've enjoyed a great career running a jingle and audio production studio with state-of-the-art equipment that produces commercials for the kind of radio that I have just criticized. It's just every so often I think about the "radio" I entered in 1969... the "radio" that doesn't exist anymore.

□ □ □

*Ken R. is president of Ken R. Productions in Toledo and an occasional contributor to RW.*

# Audio Data Compression

LISTEN TO THE VOICE OF REASON

*"apt-X audio compression gives me quality without compromise."*

**Jesse Rae**  
SINGER SONGWRITER



Cult Scottish funk artist Jesse Rae is yet another convert to direct dial digital recording using the apt-X based 3D2 and DSM100 Digital Audio Transceivers. Jesse joins a growing list of over 300 studios – worldwide – who use the DSM100 for recording over both ISDN and Switched 56 networks.

When quality counts – apt-X audio coding is the preferred choice. Ask over 100 leading manufacturers of professional audio equipment who, after careful evaluation, have opted for the most robust – and most apt compression solution. apt-X based equipment is now incorporated in a wide variety of products from digital cinema playback systems to STLs – making it the natural choice for audio professionals.

The apt-X audio compression solution is equally applicable to storage and editing applications and is available in component, board level and software products.

Listen, then decide.  
Call APT for details.

## Audio Processing Technology

HEADQUARTERS NORTHERN IRELAND:  
TEL: +44 (0)1232 371110  
US OFFICE: TEL: +1 213 463 2963  
JAPAN OFFICE: TEL: +81 3 3520 1020



# 60 Years Ago

Reprinted from Radio World February 16, 1935. Editor's note: The RW of old, printed for a time in the 1920s and 1930s and today's RW are unrelated except in name.

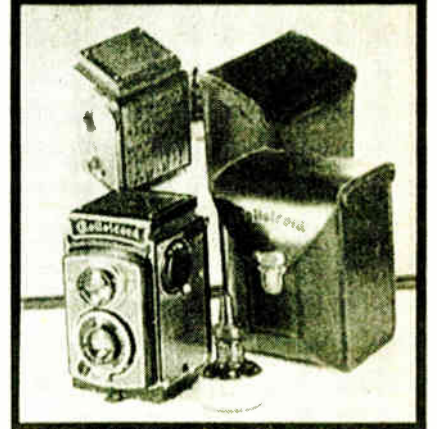
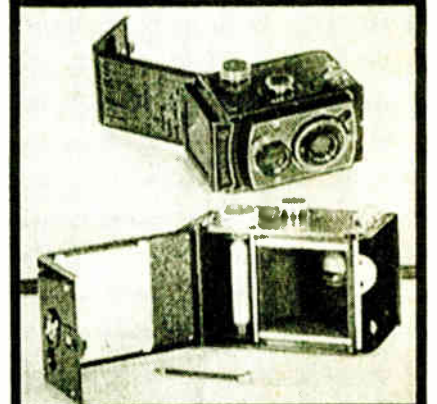
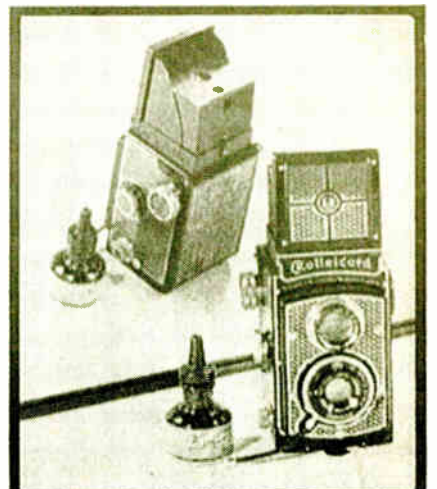

A camera of especial fitness for radio uses in photographing the screen image of a cathode ray oscillograph is the reflex, focusing hood type illustrated. It uses standard roll film.

**Next Month in Radio World's Buyers Guide: Microphones**



# Every City Has One.



**A Number One Station.**

The A-6000 On-Air Console is for you.

 **Wheatstone Corporation**

7305 Performance Drive, Syracuse, NY. 13212  
(tel 315-452-5000 / fax 315-452-0160)

World Radio History Service Card



## Digital Audio Workstations

### PRODUCT EVALUATION

# Foundation 2000 Built for Speed

by Bruce Bartlett  
with Jenny Bartlett

**ELKHART, Ind.** For many years I have reviewed software that converts a computer into a digital audio workstation. The time is right to look at a stand-alone, hardware-based DAW to see what

you get for the extra cost.

The fastest one on the market is the Fostex Foundation 2000. An eight-track digital audio recorder, editor and mixer, the Foundation 2000 records on hard disk or magneto-optical (MO) disk.

The 2000 is meant to be an inexpensive editing system that is easy to learn and fast to use. According to Fostex, you can learn the system in about 15 minutes with no computer background.

The system comes in two main parts: the disk drive/electronics unit and the Edit Controller. The electronics unit is a 19-inch by 12-inch by 24-inch gray box, while the Edit Controller is the size of a computer keyboard.

### Hands-on controls

Because the Edit Controller works with buttons, it is an easy transition for those who prefer hands-on controls. It has four groups of buttons: "tape" transport, editing, memory points and display controls. You point at a touch-sensitive screen to display tracks, meter the audio and perform other functions. There's a big LED time display. A solid brass jog/shuttle wheel lets you smoothly scrub the sound track. It has a nice feel, and the sound is just like tape scrubbing.

Because the Edit Controller lies flat on your desk, it's much less fatiguing to use than a computer monitor and mouse. So the 2000 is ideal for stations that do a lot of editing and need to do so very quickly.

The 2000 has 16 audio channels and records on eight tracks. Audio specs exceed those of compact disc. The 18-bit A/D converters use 64 times oversampling, while the D/As use eight times oversampling.

Plug-in modules let you expand and

configure the system to meet your needs. Here are the options:

- RPE (removable project environment) is a removable hard disk drive that stores 540MB or 1.2GB. The RPE inserts into other Foundation 2000 systems for easy project transfer. You can also plug in a 5.25-inch half-height SCSI device of your choice, even a magneto-optical (MO) drive. More drives and archiving devices can connect to the rear SCSI port.

- ACE Card 1 is an internal digital mixer. It does eight by two mixes in real time

Standard features include RS-422 nine-pin master/slave machine control, MIDI, MTC, GPI, SCSI expansion, serial communication and cascading/expansion ports. The MIDI and RS-422 ports can talk with external

controllers and transports, such as the Fostex RD-8 digital multitrack.

Fostex offers many Foundation 2000 systems with different options built in. Make sure you get what you need. The system I reviewed, Foundation 2000LS, costs \$16,995. It comes

without a mixer but includes a sync board, letting it be a master or slave to a video transport. Most broadcasters will be happy with the 2000LX (without sync), which costs \$14,995, or the non-expandable 2000RE, costing \$8,995. To

### Product Capsule: Fostex Foundation 2000



**Thumbs Up**

- ✓ very fast
- ✓ ergonomic
- ✓ easy to learn



**Thumbs Down**

- ✓ noisy fan (see text)
- ✓ no programmable ducking (see text)
- ✓ occasional lag in soundtrack scrolling

For more information, contact Budd Johnson in California at 310-921-112; or circle **Reader Service 53**.



Foundation 2000: A standalone, hardware-based DAW

and includes three-band parametric EQ. ACE Cards 2 and 3 (out later this year) are an eight-bus mixer with compressor, limiter, noise gate, selectable EQ and more aux sends. Other ACE cards are being developed. Time compression/expansion is available via software.

- Synchronizer Module is an LTC reader/generator and VITC reader, with word clock and video sync references. The unit chases timecode while playing audio in forward and reverse directions. It supports hard lock when it follows sources that are slower than play speed.

- Two-channel I/O Module has two analog ins, four analog outs, AES/EBU and SPDIF digital in/out. Analog Multichannel I/O Module gives you eight analog ins and outs. Digital Multichannel I/O Module offers eight digital ins and outs, SDIF-2 multichannel and ADAT optical formats.

- DFM Module is an automated mixer with moving faders and LED readouts.

- S/Link and Edit View software from Synclavier convert audio and EDL files between other DAWs and the 2000.

compare, a computer with eight-track editing software and a 1GB hard drive costs about \$3,750, but it's harder to learn and use.

### Using the system

The Foundation 2000 really is easy to learn. In about 10 minutes I assembled the unit and connected it to my mixer. In another 15 minutes I had recorded and overdubbed four tracks of music, voice-over and sound effects. In another 90 minutes, I finished the quick-start tutorial that covered editing basics. The clear, concise user manual was a big help.

The cooling fan in the electronics unit is very noisy, so you might have to put the unit in another room. Fortunately, a long cable connects the electronics unit to the Edit Controller.

You can get up to speed quickly because the 2000 records, overdubs, plays and shuttles much like a tape recorder. There's no need for a keyboard, monitor or mouse. Some computer editors can slow your creative flow and make editing difficult, but the Foundation 2000 lets you breeze through

continued on page 51 ►



## LMA/DUOPOLY CONTOUR MAPS

The **DATAWORLD** LMA/DUOPOLY Market Survey Contour maps present a precise electronic verification of overlapping and intersecting contours.

AM 5 mV/m and FM 3.16 mV/m City Grade contours are shown in full color, including transmitter site indicator. The map is supported with a printout showing all of the stations which appear on the map.

Daily updating of **DATAWORLD'S** AM and FM databases protects against errors and omissions.

### OTHER MAP OPTIONS

- SHADOWING (TERRAIN SHIELDING)
- CONTOUR COVERAGE
- POPULATION DENSITY
- ZIP CODE BOUNDARIES
- RECEIVED SIGNAL LEVEL
- SPECIAL REQUIREMENTS

## 1990 CENSUS

### WHO ARE YOUR LISTENERS?

### 1990 BUREAU OF CENSUS POPULATION COUNTING

- Comprehensive Ethnic and Demographic Data
- Ethnic/Demographic Data Available for Each Zip Code Within Coverage Area
- Age Analysis Reflected in Ethnic Breakout
- Resolution Increased to Block Level
- Percent of County Coverage Shown

### ETHNIC PIE-CHART DISPLAY

- Projects Ethnic Population in Multi-Color Pie Chart Form

**dataworld**®

800-368-5754 FAX: 301-656-5341



### WARD-BECK SYSTEMS

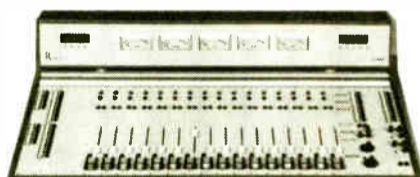

### RENAISSANCE SERIES RADIO CONSOLES

The perfect choice for today's "desk-top" radio environment.

- Integrates easily with most automation systems
- Includes four telephone send outputs
- Fully modular to simplify expansion and service
- 8, 16 and 24 input channel mainframes available
- Operates in live, live assist and walk-away modes

Value priced to fit most budgets!

Ward Beck Systems Ltd.  
841 Progress Avenue, Scarborough,  
Ontario, Canada M1H 2X4  
Phone: (416) 438-6550  
FAX: (416) 438-3865  
Now Toll Free 1-800-771-2556



# Equipped for

## RADIO PRODUCTION

# Success

### SYSTEMS

3 systems with MediaNet  
and NoNOISE

### PROJECTS

Radio commercials for ABC Prime  
Time TV and ABC News, Disney's  
"A Fireside Chat with Donald Duck,"  
Mrs. Bush's Storytime

"The system's flexibility opens up  
creative windows; it allows me to  
do edits I've never done before."

—LESLIE MONA MATHUS

Ask any leading radio facility why they chose the Sonic System for production, and you'll hear the refrain, "It's fast; it's flexible; it's the best system available."

Radio spot producers boast how even the smallest Sonic System lets them manipulate 8 to 12 separate tracks in real time without bouncing. Their deadlines aren't as daunting with a system that provides background loading and tape layback while editing continues in the foreground.

### SYSTEMS

2 systems for radio production  
and mini-features

### PROJECTS

Supplier of recorded comedy for  
nationwide radio stations; multi-hour  
music specials including the MTV  
Video Music Awards Specials; and  
hundreds of other radio programs

"The Sonic has cut our production  
time in half; how we got along  
without it in the past, I don't know."

—LARRY MORGAN

Chief engineers praise the easy system expansion via modular hardware and software options such as a digital mixing desk, external controllers, or NoNOISE tools for clean-up of noisy location recordings and archival material. At the end of a session, they can record finished programs directly to CD-R for on-air playback or syndication.

Broadcast managers applaud how MediaNet has revolutionized their entire facilities—small systems for basic recording and editing, linked to larger systems with edit lists, and sound files passing seamlessly from room to room.

### SYSTEMS

2 systems with MediaNet for  
radio drama, music, and promo  
production

### PROJECTS

Ross McDonald's "Sleeping Beauty"  
and "Rare On Air;" and KCRW's in-  
studio live performance CD series

"It's the fastest and most flexible  
system there is. We use it for almost  
every project; I haven't touched a  
reel-to-reel machine in months."

—BOB CARLSON

For radio production, no other system can match the price or performance of Sonic Solutions. Eight-track editing/mixing systems now start at just \$3,000; please call us for more information.

## ABC RADIO NETWORKS, NEW YORK



## PREMIER RADIO NETWORKS, LOS ANGELES



## KCRW, LOS ANGELES



# SONIC SOLUTIONS

1891 East Francisco Blvd. San Rafael, CA 94901 Tel 415 485-4800 Fax 415 485 4E77

Circle (216) On Reader Service Card  
World Radio History



# UNREEL

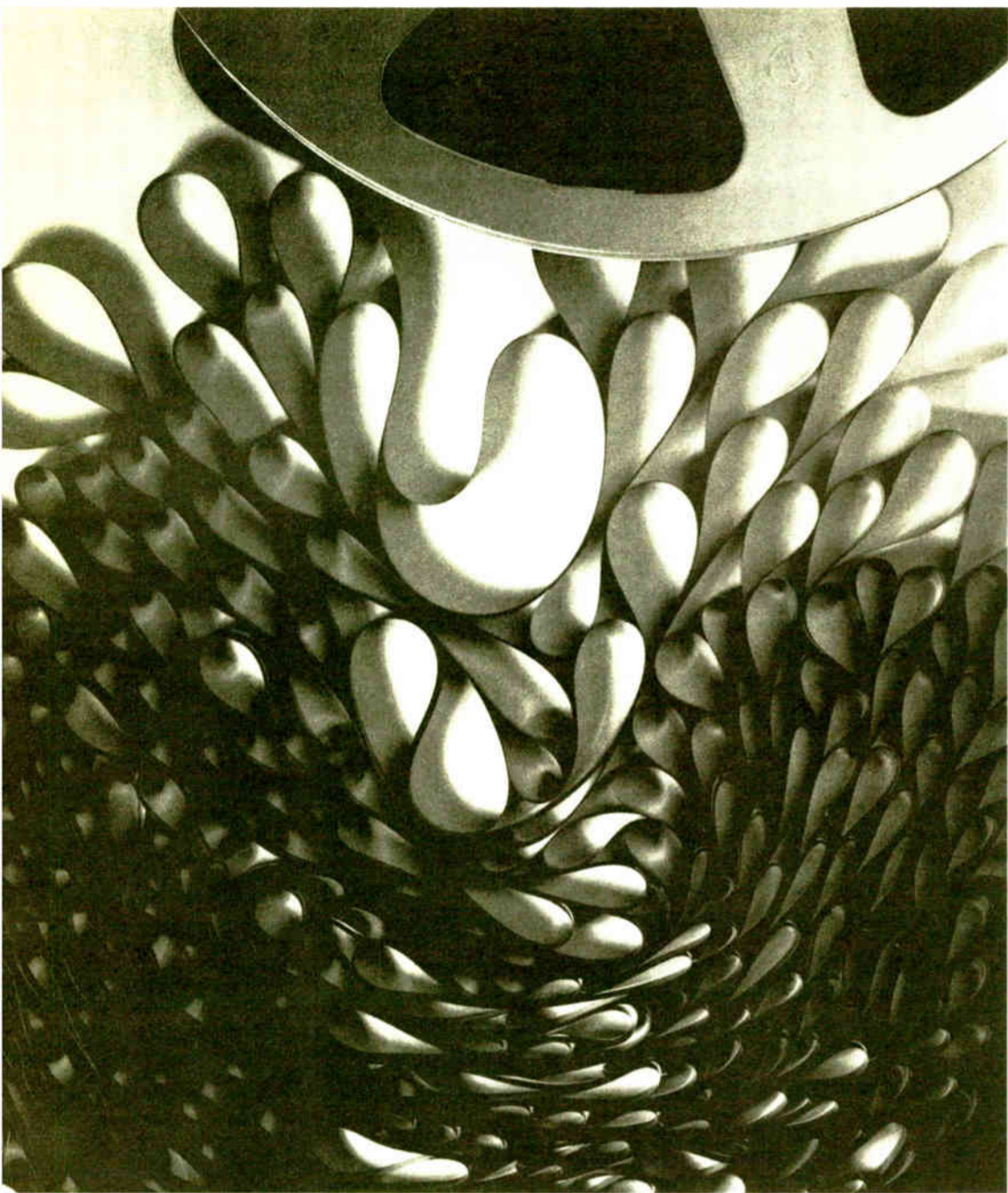

**H**ave you ever thought about professional digital audio editing? Too slow? Too expensive? Difficult to understand? SADiE™ Disk Editors have changed all that. For a start SADiE™ runs on a PC, so you get much more computer for far less money. It has a fully functional Windows user interface, non-destructive sample accurate editing, real time cross fades with real time automated digital mixing, bounce down, overdub, EQ and dynamics control. And real time-saving.

SADiE™ Disk Editors have sold worldwide into broadcast, post-production, studios and mastering organisations. They have already been really put to the test out in the field and our existing customers will be pleased to see some of their suggestions in SADiE™ Version 2.2. The SADiE™ Disk Editor is just \$9,995\* for a complete turnkey system, to include a 486/66DX PC, 2.0 Gbyte SCSI drive, 2 in: 4 out SADiE™ (digital/analog/SMPTE timecode support) and breakout box. Software updates are free for the lifetime of the product and there are *no hidden software extras*. It's all included in an honest straightforward price.

**If it sounds unreal - why not pause for a couple of minutes today and phone or fax for some information.**

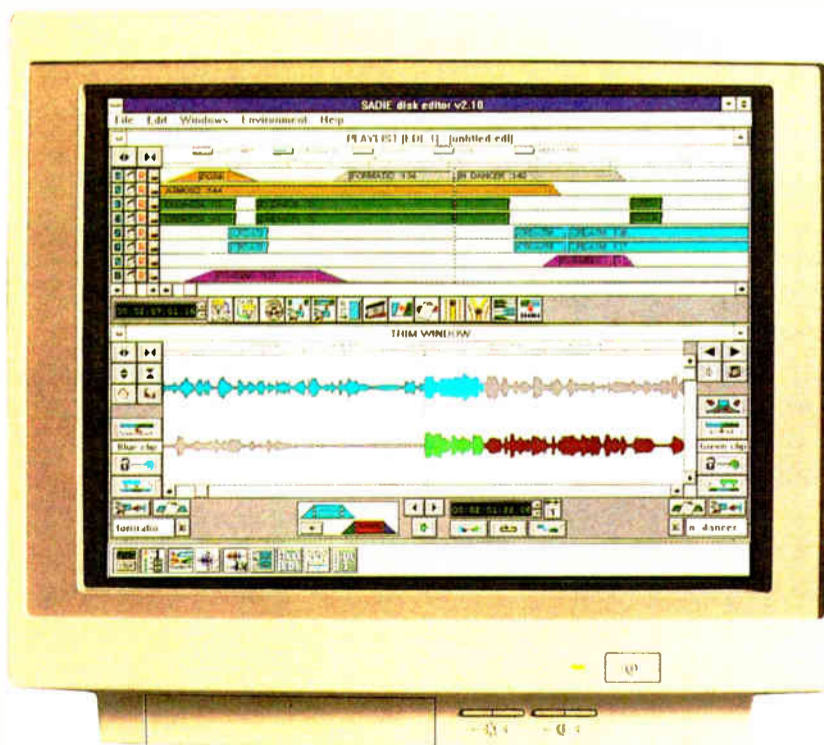

Windows 3.1\* on  
486/66 host computer

Rapid graphical  
editing

Clear user interface

Fully non-destructive,  
sample accurate  
editing

Creates edits while  
recording

All crossfades  
calculated in real-  
time

Jog and shuttle scrub  
modes

Unique Trim Window  
allowing real-time  
adjustment of audio

Real-time automated  
mixdown...

.. Bounce down

.. Dynamics control

.. EQ

.. Digital resampling

.. Time scrunch

.. Noise reduction

.. Overdub

.. Reverse playback

AES/EBU, SPDIF  
and balanced  
analog I/O

All standard sample  
rates

Full SMPTE  
timecode  
support with chase  
and trigger lock



Studio Audio Digital Equipment Inc  
1808 West End Avenue  
Suite 1119  
Nashville, TN 37203  
USA  
TEL: 615 327 1140  
FAX: 615 327 1699

#### SADiE™ DISTRIBUTORS WORLDWIDE

Argentina Kappa T 081 31 0818 F 081 31 1493 • Asia Pacific VW Marketing T +44 372 728481 F +44 372 724009 • Australia TVC T 09 249 6688 F 09 249 6858 • Canada JSGS Ltd T 416 751 7907 F 416 51 7975 • Denmark SC Sound T 43 99 88 77 F 43 99 80 77 • Finland oy HedCom AB T 90 682 866 F 90 682 8489 • France Coach Audio T 87 77 00 00 F 87 77 01 21 • Germany Stefan Mayer Audio Engineering T 0 6851 6519 F 0 6851 6519 • Hong Kong/China Digital Professions Ltd T 852 318 0588 F 852 305 1455 • India Sound Team T 22 801 3275 F 22 861 9677 • Israel Sontronic's Electronic Equipment T 03 5705223 F 03 6199297 • Japan Otartec T 03 3332 3211 F 03 3332 3217 • Korea Avix Trading Co. Ltd. T 02 565 3565 F 02 565 3561 • Netherlands JTM T 035 233 448 F 035 247 649 • New Zealand V de T 09 444 6085 F 09 444 7837 • Philippines Trac's T 2 631 3277 F 2 631 326 • Poland Unico T +44 223 63025 F +44 223 301488 • Russia Triarios T 095 909 5773 F 095 909 0501 • Singapore/Malaysia/Indonesia Font Point T +65 338 1826 F +65 337 7156 • South Africa Tru-fi Electronics SA (Pty) Ltd T 011 462 4256 F 011 462 3303 • Spain Lexon T 93 203 48 04 F 93 280 40 29 • Sweden Tranzicom T 08 730 3710 F 08 730 5125 • Switzerland Media Solutions T 064 41 57 22 F 064 41 00 35 • Thailand KDM Trading T 2 318 2724 F 2 318 6186 • UK Studio Audio & Video Ltd T 01353 648888 F 01353 648867 •

\* Windows is a registered trademark of Microsoft Inc. † Plus local taxes, duty, and delivery where applicable. Studio Audio & Video Ltd reserve the right to change specifications without prior notice.

Circle (206) On Reader Service Card



## USER REPORT

# Arrakis Trak\*Star 8: Several Machines in One

by John Peace  
President  
The A.P.E.  
Audio Production Experts

**FLORENCE, S.C.** At Audio Production Experts, "the A.P.E.," we provide audio for various radio and television/cable markets. A.P.E. contracts with stations to produce commercials as if we were actually at the station. We turn around the orders just as quickly as in-house salaried staff, which means we have to have quick, versatile and professional-quality equipment.

## One for all

Our production is currently heard throughout the southeastern region of the United States. From complex, high-energy automobile dealership production, to sophisticated, laid-back retirement village audio, we use the Arrakis Trak\*Star 8 instead of reel-to-reel for recording production elements and for final mix-down of voice and music tracks for TV and radio production. We have used the Trak\*Star 8 in all of our production applications since June 1993 and find it to be extremely user friendly and very easy to teach to the new staff "talent."

Having tested several digital audio

workstations (DAWs), I have concluded that the Trak\*Star 8 is absolutely the best buy for the money. In particular, I



A.P. relies on the speed, versatility of Trak\*Star 8.

have compared Trak\*Star to many Windows-platform sound cards and various Audio Workshop-type software. Not only are the Trak\*Star analog-to-digital conversion cards superior in audio quality, but the software also

gives you many options in production editing. Trak\*Star also maintains distortion-free audio, even when utilizing all

edits in a non-destructive environment, gives you limitless possibilities for producing creative, professional-sounding audio.

## Support department

Our unit also integrates with radio stations utilizing the Arrakis DigiLink system for easy digital-to-digital dubbing via 3.5-inch floppy disk or LAN networking. After final mix-downs, we archive production on DAT.

When you need support, Nancy, Glen and the gang in the Arrakis support department are extremely knowledgeable of their product and very capable of walking you through any problems that may arise.

After more than 23 years of producing radio and television commercials, I can honestly say that the Arrakis Trak\*Star 8 is one of the best pieces of equipment you can have in the production department. It cost less than a pair of new reel-to-reels and functions as several machines in one. You don't even need to have a working knowledge of computers or be a DOS guru to crank out great spots. Just turn it on and add talent.

□□□

For information, contact Jon Young in Colorado at 303-224-2248; fax: 303-493-1076; or circle Reader Service 164.

## Hands-on Fostex DAW

► continued from page 48  
projects.

Here's how you might put together a typical spot with a music bed, announcer and sound effects. Record stereo music on tracks 1 and 2, voice on 3, and effects on 4.

First, set tracks 1 and 2 to record-ready mode. Buttons in use light up. Tap Meter on the touchscreen; a row of meters appears so you can set levels.

Next, tap Tracks on the touchscreen to see the eight tracks. You can zoom in to see one or two tracks at a time. Hit the Record and Play buttons, and record the music bed. Repeat this process for tracks 3 and 4 to overdub voice and effects. Audio is displayed as a soundtrack on the touchscreen.

You might want to edit the voice track by doing an automatic punch-in (Auto Record). It's easier than with a tape recorder. Jog to the punch-in point, press In, jog to the punch-out point and press Out. Rewind to the top and hit Record. The 2000 will start recording at the In point and will exit record mode at the Out point.

Editing speech is a piece of cake. First you touch a blank area of the screen and set the voice track to record-ready. Zoom in to the desired resolution of the waveform (zooms are instant). Then press the Ripple button, which will slide audio to fill in the gap where you will cut out material. To cut out an unwanted sentence, jog or play to the beginning of the goofed sentence and press In. Jog to the end of the goofed sentence and press Out. Press Cut and the edit is done.

Edits are non-destructive because you can Undo and Redo them, six levels deep. Even if you accidentally record over a track, you can recover the previous audio by tapping Undo. Seems like

magic the first time you try it. Edits are saved to disk automatically. When you turn off the machine and turn it back on, your work in process comes back up.

As you record or play back, the audio waveform scrolls past a stationary cursor. This is more intuitive than in a software DAW, where the cursor scrolls past the waveform. When you scrub quickly with the 2000, though, the waveform scrolling lags slightly behind the scrub-wheel action. You might want to scrub by ear rather than by eye.

As for other features, the 2000 can instantly trim the start and end of an audio event. Cut, copy, paste and adjust overall gain in a track. Slide audio events in time. Store audio in a built-in librarian for later retrieval. Drop up to 500 markers to mark desired segments of sound. Find cue points instantly. Fade in, fade out or do real-time crossfades on all tracks at the same time. There's no wait for a crossfade to calculate. The system is not designed to duck music under voice, but you can do it with your mixer or with the optional plug-in mixer.

The Fostex Foundation 2000 is a pleasure to use. Although it costs more than a computer workstation, it lets you zip through projects with less fatigue. It's an easy transition for station personnel. And it's a fully professional system, free of bugs. Three station engineers I called said that it worked great and quickly paid for itself.

□□□

Bruce Bartlett is a microphone engineer and technical writer for Crown International, and the author of Practical Recording Techniques published by Howard Sams. Jenny Bartlett is a technical writer. Bruce can be reached at 219-294-8388.

eight tracks simultaneously. Many of the other systems I have tested distort as you add more tracks, and the units sum all of the audio files.

The ability to manipulate audio levels throughout the spot at any given edit point, as well as the ability to undo and try another combination of settings and

## NEURAL WHAT?

5

Neural Network.

Neural networks are the next step beyond digital. They are a new technology emerging from university laboratories across the country.

Now, neural networks power the most advanced, on-air audio processor you can buy. For under a thousand dollars, you can plug this new technology into your existing Optimod 8100\*.

If you need more power and you need it now, call (800)806-5498. We'll do the rest.

**CLARK**  
COMMUNICATIONS

208 West Hamilton Avenue - P.O. Box 20  
State College, PA 16804-0020 - Phone: (800) 806-5498

\* Optimod is a trademark of AKG Acoustics, San Leandro, CA.

Circle (131) On Reader Service Card



# Products & Services Showcase

For more information on the products shown below, circle the appropriate Reader Service No. (s) on the enclosed Subscription/Reader Service card or contact the advertiser directly.

## PORTABLE OFF SITE EBS MONITOR \$350<sup>00</sup>

Tuneable AM/FM Receiver and FCC Certified Decoder Model C.D.



Ideal for use during hours of unattended operation at the studio and transmitter site. With modern remote control equipment the alert message can be put on the air with a telephone.

Decoder in a minibox (price \$250) is available for use with receiver of your choice, or the decoder can be driven by phone line audio.

**Gorman Redlich Mfg. Co.**  
257 W. Union St. Athens, Ohio 45701  
FAX 614-592-3898 • Phone 614-593-3150

READER SERVICE NO. 12

## Never Go Off the Air Again.

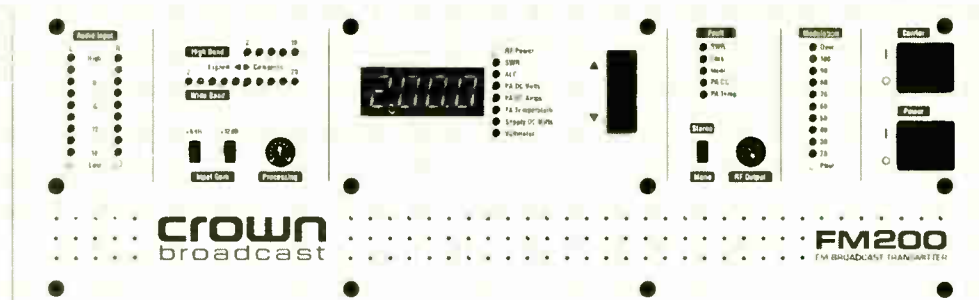

When the power fails, your signal won't. Crown's FM200 transmitter, with optional automatic back-up power, will keep your station on the air. Available in 30, 100 and 200 watt models.

Each FM200 includes:

- FM Exciter
- Audio Processor
- Stereo Generator
- RF Amplifier

All of which operates from your AC or DC power source.

**Crown broadcast**

A Division of Crown International, Inc.  
1718 West Mishawaka Road  
Elkhart, Indiana 46515-1000  
Fax 219-294-8302  
Broadcast Sales 219-294-8050

READER SERVICE NO. 42

# Shively

A good FM antenna is crucial to quality broadcasting. An antenna that is merely adequate will compromise the performance of even the best studio equipment and transmitter.

Shively regularly includes standard features that other companies either provide only as options or simply do not offer.

At Shively, we design and build antennas of uncompromising technical quality and performance. And, we build them to last.

call or write for more information

## Shively Labs

A Division of Howell Laboratories, Inc.

19 Harrison Road, Bridgton, ME 04009  
207-647-3327 FAX 207-647-8273

READER SERVICE NO. 108

## ARE YOU LOOKING FOR A COST EFFECTIVE ALTERNATIVE TO MANUFACTURER SERVICE?

### SERVICE, REPAIR & CALIBRATION

- STL's • RPU's • TSL's
- Exciters • AM/FM Broadcast Monitors • Remote Control Systems

### SPECIALIZING IN EQUIPMENT BY

- Belar • Marti • Moseley • McMartin
- TFT • And others...

An authorized TFT service center

### IN CASE OF EMERGENCY

We can help get you back on the air with our STL Loaner Program. We have STL's available that will be set to your frequency prior to shipping. We also provide over-the-phone technical assistance.



2198 Hubbard Lane, Grants Pass, OR 97527

**(503) 471-2262**

READER SERVICE NO. 63

## DIGITAL AUTOMATION SYSTEM

- The Best Integrated Play List Scheduler (Music & Breaks) & On-Air Playback Combination Available Today
- Music on Hard Disk and/or CD Jukeboxes
- Dolby AC2 Overlapping Hard Disk Audio



- Auto-Trim... Auto-Record... Auto-Convert
- Feature Rich Digital Automation at an Affordable Price & Updated Quarterly
- Complete On-Line Redundancy
- Provide Your Own Computers/Players and Save \$\$\$, or Buy/Lease From Us

WEST/INT'L  
**310/670-7500**  
FAX 310/670-0133

EAST  
**803/370-2400**  
FAX 803/370-2314

READER SERVICE NO. 150

## Introducing (ta-da) The Jr. Audio Director Plus™!

It's an 8 input to 2 output ON LINE or monitoring device.

\$550



The new Benchmark Jr. Audio Director Plus™ brings more to the party! It brings more control and selection features, and a stereo headphone amplifier, along with the performance and value that are traditionally a Benchmark for the industry.

In a half wide, 1RU high chassis, the Jr. Plus has two input switch banks which allow left and right outputs to select between eight sources. Additional switches provide a Mono Mix, with adjustable gain reduction of 3 to 6 dB, and a Right Channel Polarity reversal. LEDs indicate switch action. Inputs may be passively mixed ahead of the input amp by depressing two or more buttons.

Installation is "instant" with a No-Mod Rack Mount adapter and plugable Euro-Style barrier strips.

Available now.

**Benchmark**  
the measure of excellence

BENCHMARK MEDIA SYSTEMS, INC.

Phone 800-262-4675, or 315-437-6300, FAX 315-437-8119

READER SERVICE NO. 40

## Attention Advertisers

Reach 22,000+ radio station owners, managers, engineers & consultants!

Products & Services Showcase appears bi-monthly in the pages of Radio World.

For more information, contact Simone Mullins at

### Radio World

P.O. Box 1214  
Falls Church, Va  
22041

Phone:  
**800-336-3045**

FAX:  
**703-998-2966**





## USER REPORT

# WJR Says 'Bye' to Analog with Korg

by Rick Wiggins  
Creative Director  
WJR(AM)

**DETROIT** There is one piece of equipment in my studio without which I could not function. Take every other scrap of gear away. As long as I have that one indispensable tool, I'll be fine. That one tool that I value above all others is... my typewriter. The second most valuable piece of gear in the room is my Korg SoundLink.

My technical understanding of this workstation is hardly extensive. When I get into my car, I don't care what makes it go and stop. I don't care how I get there, as long as I get there. Likewise in the studio. If I can get a piece of equipment to do what it says it can do and it makes something sound the way I hear it in my head, then I'm a happy production guy.

Although the SoundLink is sturdy, it is not designed to satisfy a production director who lives for "soundscaping," "sweetening" and adding "just a touch of EQ." What the SoundLink is designed to do is a myriad of production tasks that will render your analog studio obsolete.

The fact that everything I need is in the SoundLink, and that I know how to find it all and use most of it, is an indescribable

boon. Push a button or two, spin the wheel, and there are your effects, storage, mixing, cutting and pasting.

I have a few favorite features on the SoundLink. The waveform scrubbing works great. I'm told that this function has something to do with precise editing; I like to scrub backwards and make myself sound like a character from Twin Peaks.

## Storage, retrieval

I am also impressed with the storage and retrieval ability of this workstation. It provides roughly four hours of hard drive capacity before you have to back up to an 8mm data storage tape. No more closets full of 10-inch master reels.

Backing up to a tape, restoring from a tape and clearing backed-up material from your hard drive working area are all fairly time-consuming operations on this system. You can get these processes started in a matter of seconds, but you'll have to give the SoundLink ample time to do its thing.

Full-range EQ, limiter and reverb all offer the ability to establish and then save almost countless individual sets of parameters, which can be accessed for future applications.

The automation capability of this workstation is almost too cool. No more trying to remember what comes up when, on

which track and how loud it is relative to the 36 other elements you can't remember. Lay in your sounds, put them where you want them, establish your effects set-

ture of the SoundLink: the Undo button. There is only one level of Undo, but that is enough to have saved me from spinning out on more occasions than I can possibly recall.

Perhaps the single most impressive feature of this system is its remarkably user-friendly manual. There is a huge book of hieroglyphics, too, but the slender quick reference manual should help you slash your way out of just about any dead end. It is a wonder of simplicity: simpler, in fact, that the SoundLink itself.

## Training regimen

The Korg professional who spent two days training me on the system suggested that it would be "at least six months before you feel comfortable enough to start doing all your stuff on the SoundLink." Putting it all in perspective, though, if I had wanted a simple system, I would have bought some toy. But I wanted something with slightly more extensive capabilities.

The day the Korg guy left is the day I said

goodbye to analog production, and I have never gone back.

The SoundLink is not my favorite creative tool. But until the company fits it with a Correcto ribbon, it's as close to perfect as anyone, technically adept or not, has a right to expect.

□ □ □

For information, contact Rod Revilock in New York state at 516-333-9100; fax: 516-333-9108; or circle Reader Service 167.



SoundLink: No Correcto ribbon, but close to perfect

tings, etc. Then, simply roll the thing from the beginning, mixing as you go.

After you have done all your slide fader moves, they are in there for keeps, pre-mixed by you anytime you call up the session containing that piece of work. Don't like what you did? Keep all but the part you don't like and re-mix it. Don't like any of it? Hit the Undo button and mix it again, erasing a piece or track at a time, or all at once if you have the guts.

That brings me to the most valuable fea-

## USER REPORT

# ADX Lightens Workload

by Jim Bollella  
Production Director  
WMMX-WOCT(FM)

**BALTIMORE** We inherited our Pacific Recorders and Engineering (PR&E) ADX workstation when we bought what is now WOCT. Fortunately, we also inherited the engineer who bought the system and who received training from PR&E. As production director, I was lucky enough to arrive after the ADX acquisition.

Flexibility is the word that conveys all of the benefits I get from the ADX. It offers plenty of problem-solving options to the user, all of them easy to access. I can't explain all the intricacies of the ADX, but I hope to cover some of the features that have made life in the age of production-hungry duopolies a little more enjoyable.

Somewhat unique to the ADX is the interface panel. The panel allows most of the often-used functions (fade in/out, edit mode, auto locate, copy/paste, etc.) to be accessed without the mouse or keyboard. Having worked on a mouse-based system in the past, I can say that the speed increase is significant.

The interface panel (by Pacific Recorders and Engineering) seems largely responsible for making the software (by Do Re Mi) more practical for radio applications. If the interface panel were to go dark, all of the functions could still be performed with mouse and keyboard.

Clients are amazed when they see their spots edited on the workstation. They're astonished at the speed, ease and accuracy. A production person, though, will be much more impressed by the multitude of

features that allow you to manipulate edited sound cues.

Any cue can simply be clicked and dragged to any of the eight tracks. No other steps are necessary. Horizontal and vertical moves are quicker and easier on the ADX than on any other system I've seen or read about. The capture function brings any selected cue to the time line regardless of location. I punch the capture button like a rat in a behavior modification experiment.

For minute adjustments in timing, nudge buttons are provided on the interface panel. They offer one frame + or - and quarter-frame + or - increments. I use these buttons constantly to get that perfect timing that took far too long with analog (and digital systems without nudge capability). I am spoiled by them and can't imagine working on a digital system without them.

In the mix view, so many parameters are adjustable that final mixdown is often more like babysitting. These parameters include fade ins/outs, volume of each cue, sync points, crossfade, segue and splice.

Because our console is severely limited (it's an on-air board), I appreciate being able to do as much as possible on the workstation. We have a Pacific Recorders console coming, but it's good to know you can plug the ADX into any studio and it will perform beautifully.

Another facet of the system's flexibility is the ease with which entire folders and individual sound cues can be imported to any location almost instantaneously. We use two hard drives and a magneto-optical drive (MOD), so this is more than a

continued on page 59 ►

**You can measure... with the best monitor and the most accurate test set.**

The FMM-2/FMS-2 series monitors provide an even greater degree of precision measurement than ever before... **You can measure S/N below 90 dB, You can measure crosstalk below 85 dB, You can measure separations of better than 70 dB, You can measure frequency response to better than 0.25 dB, You can measure distortions to lower than 0.01%, and much more...** Our uncluttered panels and autoranging voltmeters make these measurements a dream.

**BELAR ELECTRONICS LABORATORY, INC.** (610) 687-5550  
LANCASTER AVENUE AT DORSET, DEVON, PENNSYLVANIA 19333  
Call or write for more information on Belar AM, FM, Stereo, SCA and TV monitors.

Circle (130) On Reader Service Card



## USER REPORT

# Money-saving SAW Shines at WPLY

by Sean Caldwell  
Production Director  
WPLY(FM)

**PHILADELPHIA** A large part of a production director's job requires editing and multitrack production, so when a new product comes out that simplifies the task and doesn't cost an arm and a leg, I smile. Software Audio Workshop, or SAW 4.0, a professional Windows-based eight-track digital audio workstation from **Innovative Quality Software**, provides several benefits, with only a couple minor disadvantages, compared to

more costly digital editors.

One of my client stations, Gannett's KHKS(FM) in Dallas, introduced me to the software. They demonstrated the program, mentioned the price and I was sold. List price is \$600, but you can find it on the street for less than \$500.

SAW, categorized as software, does not require the purchase of any costly proprietary hardware. Instead, the program uses any sound card you have through Windows, quite a benefit because many of today's sound cards are capable of sounding every bit as good and much less expensive than the \$5,000 analog-

to-digital converters found in some other products. SAW, combined with a 486 computer, a sound card and a 1GB hard drive, provides a great digital multitrack system for under \$4,000.

A station without digital equipment in the production studio suffers a real competitive disadvantage. With the SAW program, we produce promos, commercials and song edits cleaner, faster and more precisely than ever before. The digital editor really shines when it comes to spot updates and revisions. If I need to move a music bed back to accommodate a slightly longer voiceover, I simply click

and it's done.

It still takes time to input the music, voice and sound effects, but I have input some of our most used elements for instant recall on any project. Once the elements are in the system, you're ready to piece the project together. Position the music, voice and any other elements wherever you want, relative to each other. SAW processes everything with incredible speed. Compared to other workstations at our station or others I have used in the past, this system is by far the fastest. SAW makes promo and commercial production a breeze with a sensible screen layout, fast screen redraws and down-to-the-sample editing resolution.

Another feature I like is the utilities rack. This software add-on—that lists for \$349 and sells on the street for around \$275—has really been a plus. You access the utilities via a SAW pull-down window. With this software, you can use audio compression and limiting, parametric EQ with adjustable hi- and low-pass filters, echo and delay, auto-panning, and file format and sample rate conversion.

Select a region, visually set up the compressor's threshold, ratio and peak levels and preview the sound. If it sounds right, hit OK and the file is altered. If you decide later you don't like the sound, select Undo and the last alteration is immediately erased. In the future I would love to see a reverb algorithm, but the fact that SAW can do the above processing is currently an advantage over many other workstations.

There must be a downside for any workstation costing less than \$25,000, right? Right. At present, the eight-track SAW is made up of four stereo tracks. That's great for music, but for voice you're eating up two tracks on the screen and hard drive when you only need one. Not a problem when the new version comes out the second quarter of 1995.

In the preliminary look, you might ask, "Where are the faders?" They are on-screen, and over time I have found this to be an advantage. In the past I put together a very fast-moving promo with many bed and effect changes. Only after the seventh try mixing down the project did I get all the volume changes right. With SAW (or any other digital editor without an outboard fader unit) you spend more time pre-planning your volume changes. Come time for mix-down, there is nothing to do but hit start. One feature I wish this system had is "group move" capability on the multitrack screen.

Users of Windows will most likely feel comfortable learning SAW, but if using a computer and Windows is new, this program may be a challenge. For hardware, I purchased the Audio Labs Card+, which has the ability to add a digital I/O card. The Turtle Beach cards are also highly recommended for professional audio use.

SAW is a great choice if you are looking for an entry-level audio workstation. You may find you like SAW better than most other high-end workstations. The program is fast. Innovative Quality Software's technical support is excellent and buying it won't take out your engineering budget for the next two years. The new version of SAW is on the way with 16 individual tracks and even more features.

□□□

For information, contact Thomas Stewart in Nevada at 702-435-9077; fax: 702-435-9106; or circle Reader Service 174.

## Call the Pioneers!



Courtesy, Colorado Historical Society F20.275

**B**ack in 1988 when NSN introduced VSAT satellite technology to the broadcast industry, there were fewer than 1,500 VSAT terminals in the USA. Today there are over 100,000!

Over the years, we've installed more than 80 uplinks and over one thousand remote sites worldwide. And we've blazed a few trails including the first ComStream ISO/MPEG VSAT digital audio and data networks in the USA, Venezuela, and the Bahamas; the first "store & forward" localized satellite audio networks in the USA and Thailand; and the first VSAT SCPC paging data distribution network in Hong Kong.

Experience and service is why NSN Network Services is the nation's preferred choice for VSAT networks and the largest authorized distributor of ComStream digital audio equipment.

303♦949♦7774

800♦345♦VSAT  
8 7 2 8

Fax 303♦949♦9620

E-mail: sales@vsat.nsnnet.com  
tech@vsat.nsnnet.com

And you won't pay any more than you would buying direct from the manufacturer. NSN offers complete, turnkey networks with spacetime for **coast-to-coast stereo audio starting at just \$1,295 per month!** Look to us for:

- ☞ ComStream Digital Audio Satellite Network Equipment
- ☞ Satellite Data Networks
- ☞ Network Design & Licensing
- ☞ Domestic & International Spacetime
- ☞ 24-Hour Technical Support
- ☞ Installation & Training
- ☞ Lease Financing

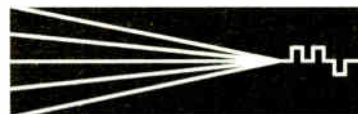

**NSN NETWORK  
SERVICES**  
SM

Avon, Colorado USA

NSN is an authorized distributor of Gilat, ComStream, GE Spacenet, and other fine satellite and broadcast communications products.

Circle (129) On Reader Service Card





Change ...IN RADIO, COUNT ON IT.

Change

# Change

**DCS IS THE ONE HARD DISK SYSTEM  
RADIO DEPENDS ON TO KEEP UP WITH IT.**

CHANGE

**25** Tuesday  
January

New  
Format  
  
New  
Network

**T**hink about it. How much has changed at your station in the past year? Two years? Three years? Have you changed formats? Network and program suppliers? Switched to satellite or CD jukeboxes or back to live? Rebuilt your studios? Become part of an LMA or duopoly?

**C**hange is one reason why DCS (Digital Commercial System) from Computer Concepts is the industry's leading hard disk system, year after year. It never locks you into one way of doing things.

**D**CS accommodates every network or satellite program service currently on the air or on the way. So if you change affiliations or program suppliers, you don't have to worry about system cues or variable local insertion windows.

**A**s your studio configuration changes, so can DCS. Unlike most systems, we give you a choice of storing audio in a central database, or distributed among DCS workstations... or both. Some of our users now place all of their commercial and music inventory onto the DCS hard drives. When you're ready to go all-digital, DCS will be ready too, with AES/EBU digital inputs and outputs available, as well as analog.

**17** Friday  
June

Move to  
New Studios  
  
Satellite  
Overnight

**A**nd if you're looking at a duopoly or LMA, you'll be glad to know that many DCS units are employed in such remote or multi-control arrangements.

**M**anaging change is hard enough. Shouldn't you have the hard disk system that can help you keep up with it all? Call Computer Concepts for more information and a list of hundreds of satisfied DCS customers.

**12** Monday  
December

LMA  
Starts  
Today



# Why Did 5 Different Radio Station Groups Order 10 or More LPB Consoles in Single Orders in 1994?

## YOU CAN RELY ON LPB.

**Stations on 6 continents rely on LPB for superior performance, excellent RFI immunity, outstanding durability, and unmatched value.**

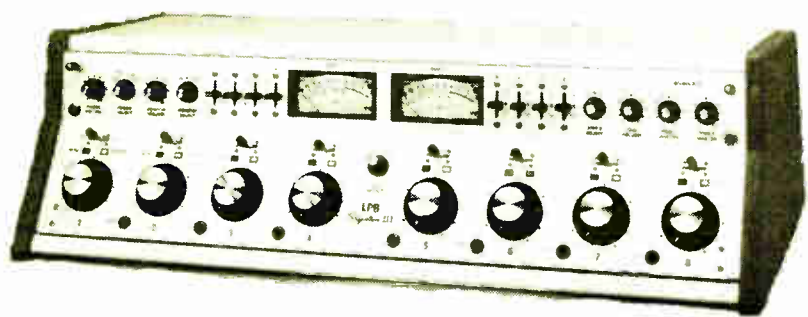

**Signature III Series**



**7000 Series**

# LPB<sup>®</sup>

28 Bacton Hill Road • Frazer, PA 19355 • (610) 644-1123 • Fax (610) 644-8651.  
E-Mail [lpbinc@aol.com](mailto:lpbinc@aol.com)



## USER REPORT

# SADiE: Cornerstone of Digital Studio

by Steve McFarland  
Production Director  
WCCO(AM)

**MINNEAPOLIS** After using Studio Audio Digital Equipment's SADiE for almost a year, we feel certain that it is and will continue to be the cornerstone of our digital studio. After spending a lot of time searching for a platform to fit with existing equipment and looking for the means to spread the latest technology throughout the other recording studios, we found that SADiE would allow us to realize our plan for future growth.

Much of the beauty of SADiE is that it can be installed in an existing PC, a 486 dx 2/66, with the familiarity of a Windows-based system. We also wanted to take advantage of Studio Audio's advanced DSP technology. Another consideration was the price; the SADiE was very affordable.

Though SADiE's manual states that the software is designed to be simple to understand and to use, it is a very complex system. Prior knowledge of Windows and MS-DOS based computers is most helpful in flattening your learning curve. Don't be put off by the system's complexity. Once you learn the basics, you'll be amazed at the ease with which you tackle the extra features.

The fader automation is a great feature. I use it to create almost every promo and commercial. It is also necessary when using a mouse to control up to eight tracks simultaneously. With this feature you can make countless corrections to achieve that flawless mix. The automation information can be stored and recalled, and re-created or changed or overlaid with another track.

The length of any given production is limited only by the size of your storage space on a SCSI hard drive. A number of our commercial and promo productions have been longer than usual. Having the extra room to maneuver and work within the system has been a lifesaver.

SADiE is also a timesaver. For programs requiring many of the same basic production elements, being able to produce clips and jingles and beds only once and then storing them to be recalled and positioned in multiple promos has saved us vast amounts of production time, without a loss of quality. Imagine creating a highly produced top-of-the-hour ID for each baseball game of the season. SADiE has allowed us to do that in record time.

## Analog mindset

Marking, editing, trimming and cross-fading basics become second nature once you escape the mindset of analog production and step into the world of non-destructive digital editing with SADiE. But that's not all that is available.

Though I didn't think that I would ever stop calling upon my Digitech TSR-24 multi-effects processor or even the old Eventide Model H3000 Ultra Harmonizer, I have found myself taking advantage of the convenience of SADiE's digital signal processing. Functions include bounce; dynamics, such as compressor controls, expander controls and gate controls; EQ; noise abatement; resampling, including digital varispeed, sample rate conversion and sub-sample microtiming; and timescrunch. I must confess that I am glad that the harmonizer is still available, as SADiE's time-

scrunch leaves quite a bit to be desired.

Our facility also includes a Kurzweil K2000 keyboard. I have created MIDI-sequenced music tracks using Cakewalk Professional 3.0 and processed them to SADiE, also running on the screen.

If you are considering using your studio to generate extra income, it is possible SADiE can help. The system allows for controlled CD and cassette pre-mastering, as well as

audio-video post production. A complete DAT backup system is also included.

If you are considering SADiE, I would suggest a large monitor, possibly a 17-inch one. Some icons and buttons may not seem terribly intuitive at first, particularly if you have trouble seeing all the detail. It is a loaded system, but there is always help available; that may be the best value of an already value-packed deal. We purchased

our SADiE system directly through Jeff Boggs, the stateside representative.

The service and follow-through have been outstanding. We have put beta versions of software through the grinding mill and made a number of improvement suggestions that have been welcomed with an open mind. Software updates are delivered promptly, questions answered quickly and solutions to system challenges handled professionally.

□ □ □

For information, contact Jeff Boggs in Tennessee at 615-327-1140; fax: 615-327-1699; or circle Reader Service 161.



## The Power Studio From Roland

The new DM-800 provides power, speed, portability and reliability like no other system available.

**Power** Eight discrete tracks with 100 layers per track. 12 channel automated mixing and EQ. Time compression and pitch correction. Nondestructive, full featured editing. Sub-frame accurate SMPTE sync. Optional ADAT, DA-88 or RS-422 interface.

**Speed** The DM-800 is easy, fast and quick to learn, using powerful hardware controls with tape recorder style punch in and out. No computer required.

**MIDI Support** The DM-800 supports MMC, MTC and dynamic functions like tempo mapping, bar and beat editing,

control of external sequencers and trigger mode for instant phrase playback.

**Portability** All the features and functions you need are contained in a single 12 pound unit. You can literally grab it and take it with you. Uses internal and external SCSI drives. View any level of information on the built-in LCD or plug the DM-800 directly into your video monitor.

**Reliability** The DM-800 is a completely dedicated piece of hardware with Roland's renowned reliability.

**Price** Incredible Power. Incredible Price. \$5995.

Call today for your free brochure and video.

**Roland**<sup>®</sup>

Roland Corporation U.S. 7200 Dominion Circle Los Angeles, CA 90040 (213) 685-5141 Ext. 756 Fax (213) 726-3267  
Roland Canada Music Ltd. 5480 Parkwood Way Richmond, B.C. V6V 2M4 (604) 270-6626 Fax (604) 270-7174

Circle (148) On Reader Service Card



## USER REPORT

# Sonic Solutions Replaces Razors

by Peter Swanson  
Engineering Supervisor  
WGBH(FM)

**BOSTON** Ever since the advent of affordable digital recording, we at WGBH have been looking for a way to edit our work in the digital domain. We were dubbing our digital masters onto analog tape and then blade editing. When DAT became available, we recorded on DAT, edited on analog and dubbed back to DAT for air. Even when DATs replaced our cart machines, we still aired a product several generations down, edit-

ing with the "Gillette" method and throwing lots of tape in the dumpster.

Five years ago we began our search for a tapeless digital editing system. Luckily, as our search progressed, many players entered the market, and systems that cost hundreds of thousands of dollars were eclipsed by newer designs at much lower prices. After a two-year search, we made our selection: Sonic Solutions. What drove us to purchase a Sonic was a set of powerful features, namely modularity, expandability, speed and the ability to perform multiple tasks simultaneously.

Sonic Solutions workstations, even at the

entry level, offer the ability to edit while recording. We can load one person's material while editing and auditioning a separate project. With mid-level Sonic Systems, you can load in and load out while editing related or unrelated material.

Although the Sonic was one of the more expensive systems when we bought ours, its power and exclusive features easily justified the cost difference. Since then, Sonic's prices have dropped to the point where I would be hard pressed to consider the competition.

Modular features that we have added include TimeTwist, a very powerful time-

squeezing and -stretching feature which now comes bundled with the "Radio Station" package. It practically paid for itself when we were able to take a custom-composed and -recorded theme made for our sister (WGBH-TV 2) station's programs and painlessly shorten it to fit a condensed time slot.

We have also added NoNoise to our system. Problems such as tape hiss, background hum, rumble and surface noise are easily eliminated with this powerful tool. Designer Reverb allows us to fatten up audio without leaving the digital domain.

## Day-to-day editing

As an electronic "blade" editor, the Sonic System is fast and flexible. All edits are non-destructive. Your original recording on the computer's sound hard disk is never altered. All splices are transparently written to an edit decision list (EDL) file. Splices are accomplished in a flash, because Sonic does not have to calculate and re-record the sounds that occur across a splice. Instructions saved in an EDL tell the system what pieces of files to join, and it does so, on the fly, during playback.

An exceptionally valuable tool is the ability to tweak parameters of a splice and test the results in real time. Anything you don't like? Just hit Cancel or Undo. You can set multiple levels of Undo. Sonic Systems also does all equalization, level adjustment, compression, gating and expansion in real time.

You get an on-screen digital virtual console as part of your system. Sliders and equalizer controls can be manipulated via mouse or a MIDI controller. If you like, the Sonic can record and remember your fader moves as you play your EDL.

Editing is both an aural and a visual experience. You can scrub edit audio in a way that sounds like reel-rocking in the analog world. You can also see what you are about to cut. We edit a lot of dry reads by a terrific presenter who happens to make a lot of mouth noises. The Sonic System quickly zooms and redraws its waveform display, so we can pick out and eliminate little clicks, smacks and pops.

## Software "tune-ups"

When we took delivery of our first Sonic, we were working on software release 1.3 and it worked well. There were aspects that were a little clunky, but the overall effectiveness of the system was undeniable. Three years later, we are on version 2.15, doing slick drag-and-drop editing track to track that I could not have envisioned on day one.

Given the solid design of the DSP cards and system architecture, the software "engine" can be tuned up with each revision. Every few months, we get a shipment of the latest model of the Sonic System. Those floppy disks make our system as current as the systems being shipped today. As I write this, we are installing our second Sonic Solutions system.

The Sonic Solutions systems work on a Macintosh platform. Being a DOS partisan, I probably spent more time on the phone with Sonic in the beginning than a Mac user might. This has never been a problem because Sonic's customer support has been absolutely top quality. I have found phone messages from support people, checking to see if their suggestions for fixing a problem had worked.

□□□

For information, contact Mary C. Sauer in California at 415-485-4800; fax: 415-485-4877; or circle Reader Service 46.

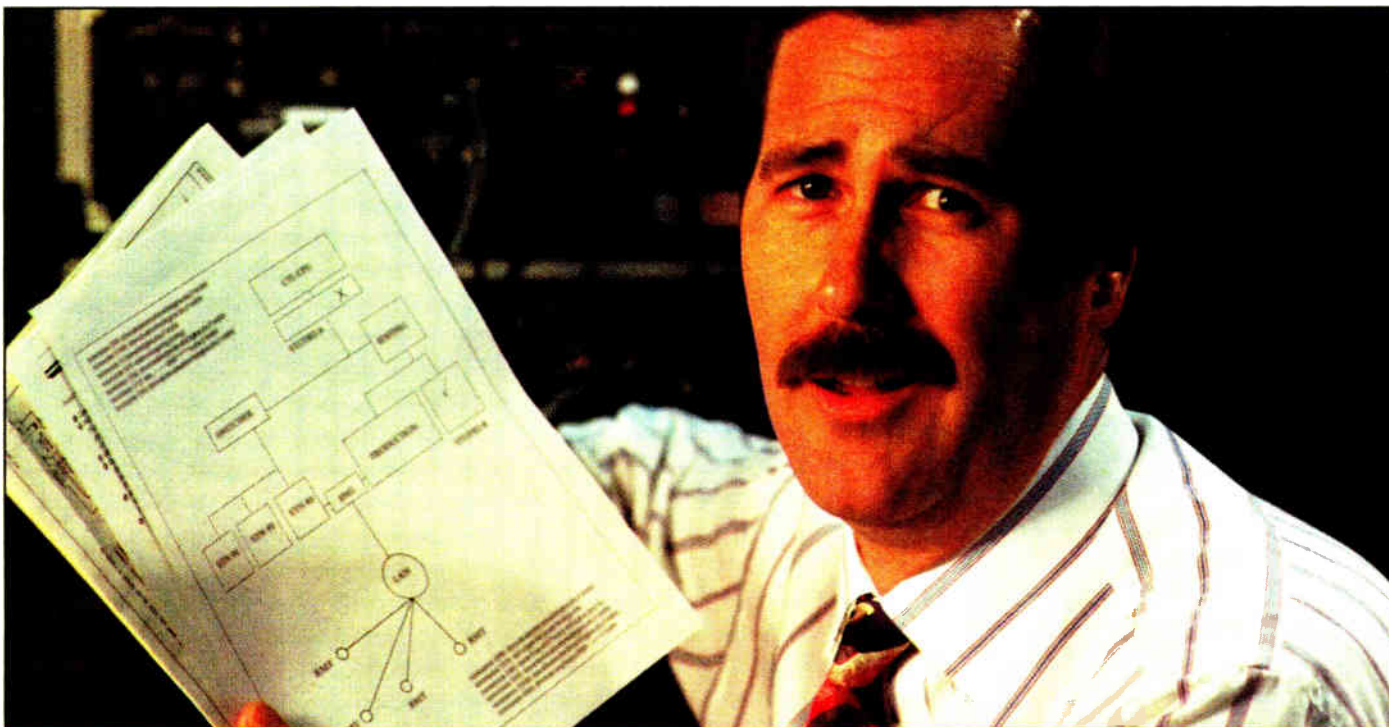

TRYING TO MAKE SENSE OUT OF DIGITAL AUDIO SYSTEMS?

## There is a better way!

It's not easy trying to understand the conflicting claims made by different manufacturers when you're buying a Digital Audio On-Air & Production System, whether a single, multipurpose Workstation or an integrated, multiple studio setup. At one end of the spectrum, you're faced with a wide variety of simple "Cart Machine Replacements," and on the other, products whose complexity confounds even the most seasoned broadcast engineer.

The ENCO DAD486x Digital Audio Delivery System solves the problem! DAD is simply the most powerful On-Air & Production system available, yet its uncomplicated approach and inherent ease of operation makes immediate sense to any user.

- Intuitive On-Screen displays that are immediately familiar to operators. Optional Touchscreen makes operation quick and easy.
- Complete On-Air flexibility with various "Virtual Machines" for Live Assist, Automation, or Satellite Programmed operations. Interface to other equipment plus scheduling and billing packages. Seamless segue and voiceover transitions sound "Live" in all modes. Script capabilities can be included.

- Full production capabilities, including Graphic Cut & Paste Assembly Editing. Includes analog and digital inputs/outputs. Interfaces with most multichannel editing packages.

- Runs on DOS for proven speed, reliability, and compatibility with other equipment; not an operating system originally intended for multimedia applications. This is a professional tool meant to produce efficiency and profits, not entertain the staff!

- Operates on common off the shelf computers and network architecture. You won't be locked into proprietary hardware that may not be available whenever you need service.

- No monthly licensing fees, DAD is an outright purchase. Software upgrades are free for the first year.

- DAD is proving itself everyday in radio and TV facilities worldwide.

Call Your DAD486x Dealer or ENCO  
For Complete Information

**ENCO**  
SYSTEMS, INC.

24403 Halsted Road, Farmington Hills, MI 48335 USA  
TEL: 800-362-6797 or 810-476-5711 FAX: 810-476-5712



## USER REPORT

# Microsound Delivers at Woodstock '94

by Chris Andersen  
Owner  
Nevessa Production

**SAUGERTIES, N.Y.** In the chaotic atmosphere of music, mud and madness here last August during Woodstock '94, Nevessa Production provided editing services to MediaAmerica for the nationally syndicated radio broadcast coverage of the three-day event.

MediaAmerica's agreement with Polygram, so as not to infringe on the FPV television coverage, was that stage performances be excerpted. Our other editing duties included processing the constant flow of audio field reports and interviews from the teams of reporters.

## The proposal

When Frank DeSantis, director of programming for MediaAmerica, first approached me about the task, he was looking for a team of fast razor blades and analog decks. I knew I had a better way. My experience with

**Microtechnology Unlimited's** Microsound

digital audio editor as a playback source for television production for the last six years proved it to be a fast, great-sounding and highly reliable system.

Considering the volume of material to be quickly edited at Woodstock, I proposed to provide two Microsound units and two engineers to handle the task. Frank, although initially apprehensive about trusting his show to a computer, was convinced that the Microsounds could do the job after a demonstration in Manhattan in July.

At the show were two revolving stages, with a recording truck assigned to each

half of the stage. These four stereo feeds were fed to our 48-foot broadcast trailer and routed to DAT machines that recorded everything. A team of tape operators monitored these machines and logged the performances, noting any profanity, which could not be tolerated in our broadcast.

The digital outputs of these recorders fed the AES digital inputs of our Microsound editing systems so that we could transfer directly from the stage, time permitting. Two additional DAT recorders within the editing suite fed the SP/DIF digital inputs of the computers for material from the reporters' DATs or stage performances that were recorded earlier.

The two Microsound editors ran on



Chris Andersen, ready to edit with Microsound

Windows 3.11 on stock 486 IBM-platform computers with 8MB of RAM in each. They shared 3GB of storage over an ethernet network that provides just over 4.5 hours of CD-rate audio.

## Non-stop shifts

For three days, my associate Ted Orr and I handled all of the editing in almost non-stop shifts. The field reporters rushed in with their hot interviews, telling us what to cut. With Microsound, this process is extremely fast. You just highlight the area to be deleted, hit one key

and boom: next edit, please. Because all editing is non-destructive, second thoughts were easily accommodated by the ability to undo anything at any time.

Lynnsey Guererro, chief producer of the broadcast, handed us a tape of an artist's performance with instructions of which songs he wanted to include in the segment. We loaded the selections into the editor, tipped and tailed each, and overlapped the applause in and out. If we found any profanity within the selection, Microsound enabled us to reverse the tiny portion of the program that included the offending word without changing the beat or inserting a distracting masking beep. These reversals were virtually undetectable.

Once assembled, we output the edited segment to a DAT machine and then tossed it down to the broadcast booth at the end of the trailer. After a while, the room at the end of the trailer felt like an insatiable monster constantly hungry for more program. The analog outputs of the Microsound units were also routed directly to the broadcast booth.

When the schedule was especially tight and there was no time to transfer to a DAT, we played our segments out of the computer directly to air. It was thrilling in a way to know that my hard drive was connected to 250 radio stations and all of America. Because Microsound has never crashed in my experience, I was confident in its ability to perform in this critical application.

The show ended Sunday night, with an exhausted but satisfied crew. To his surprise, Frank DeSantis was promoted in the closing credits to vice president of programming for MediaAmerica, in part for his successful coordination of this difficult radio event. The rest of us still haven't seen the last of the mud.

□□□

For information, contact David Cox in North Carolina at 919-870-0344; fax: 919-870-7163; or circle Reader Service 204.

# Production More Enjoyable with ADX

► continued from page 53

little handy. A transfer window exists in every mix view so that with a few clicks of the mouse, you can transport any sound cue from any source into the current mix instantly. Again, I'm spoiled by this feature.

As mentioned, the ADX will perform in any studio, but it is designed to perform best in the most demanding applications. With the flying fader mix station, it is highly competitive, perhaps the best in its class, in my opinion. To use the Mixstation module, you must have a Pacific Recorders production console, either the Productionmixer or the ABX. However, PR&E has developed another workstation with the automated mixing surface right on the workstation. I think it's called the Ensemble.

Because I am currently without a Mixstation, the extent of my knowledge is limited. I do know that each module has a window indicating what cue is being played as well as what is coming next, and mix corrections are as easy as placing your finger on the fader as it moves. Every facet of the mix is remembered. It's quite a time and effort saver over on-screen automation I have seen. Also, the price has recently dropped quite a bit.

Of course, the ADX is not without faults. The biggest drawback for me is the lack of on-board processing. I need much more in the way of outboard gear to get what I'm really looking for, and even that will not replace on-board capabilities. Just the addition of EQ would be a big improvement.

There have been a few small glitches in the software, and we've had to call PR&E to work through a couple of them.

Nothing major, and I am told they will be fixed in the soon-to-be-released software update.

Because of these problems, I've had the chance to test PR&E's customer service, which has been great. They make sure you understand everything about the problem and how to solve it before they hang up the phone.

The ADX will crossfade, segue and splice elements via buttons on the interface panel, but I never use these functions because they can't give me exactly what I want. I always customize fade times, for instance, to fit the situation. Prefab functions just do not mesh with the creative process very often. In fact, they're almost a contradiction. That's why I keep pushing for a mix station.

I spent a couple of days with our engineer learning to use the ADX and then a couple of days on my own literally playing with it. Some systems are easier to learn, but I don't believe they offer the flexibility, speed and power of the ADX. Less powerful software, after all, is always easier to learn.

I always tell anyone who asks me about workstations to check out the ADX. To date, I have yet to talk to anyone who hasn't been thoroughly impressed after doing so. The flexibility of the ADX indeed saves time, but ultimately, I find it improves the quality of my work. And that is what we're all after.

□□□

For information, contact Steve Scoville in California at 619-438-3911; fax: 619-438-9277; or circle Reader Service 92.

COME TO THE  
CHOICE OF RF  
ENGINEERS FROM  
COAST TO COAST  
FOR YOUR AM  
ANTENNA SYSTEMS  
OR  
COMPONENTS

KINTRONIC



LABS, INC.

WE NOW ACCEPT VISA,  
MASTER CARD  
AND DISCOVER CARD

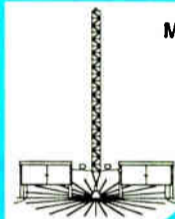

MULTIPLY  
ANTENNA  
SYSTEMS

FOLDED  
MONOPOLES

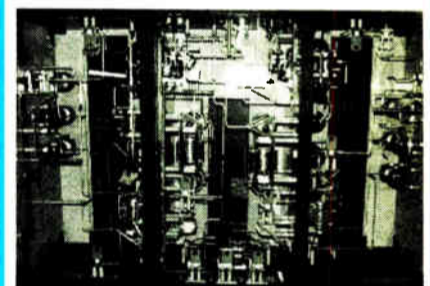

DIRECTIONAL ANTENNA  
PHASING SYSTEM  
WMAL-AM RADIO  
CAP CITIES/ABC  
WASHINGTON, DC

KINTRONICS PRODUCTS  
INCLUDE:

- BROADBAND ANTENNA TUNING UNITS
- DIRECTIONAL ANTENNA PHASING AND MATCHING SYSTEMS
- MULTIPLY ANTENNA SYSTEMS
- FOLDED MONOPOLE KITS
- TRANSMITTER COMBINERS
- DUMMY LOADS (CONVECTION COOLED UP TO 20 KW + MOD.)
- FIXED AND VARIABLE INDUCTORS
- RF CONTACTORS (SPDT & DPDT)
- CUSTOM SWITCHING SYSTEMS & CONTROLLERS

KINTRONIC LABORATORIES INC.  
P.O. BOX 845  
BRISTOL, TENNESSEE 37621-0845  
PHONE: 615-878-3141  
FAX: 615-878-4224

Circle (214) On Reader Service Card



## USER REPORT

# Synclavier Exceeds Expectations

*Multi-Track Employs Three Systems from Synclavier That Meet the Demanding Needs of Digital Editing*

by Ed Douglas  
Sound Editor/Digital Systems Integrator  
Multi-Track Digital

**TORONTO** When Multi-Track decided to go digital in 1988, it set some pretty high criteria for any prospective system. The market then consisted of proprietary digital editors, as the technology for Mac- or PC-based systems was non-

existent. The only system that met and exceeded the company's exacting requirements was the Synclavier 9600. Multi-Track Digital now has three of these systems.

### Seamless integration

This system may not be for the faint of heart. The Synclavier 9600 offers complete integration of hard disk and RAM-based sample playback. The system that

I work on has 16 tracks of direct-to-disk playback, 28MB of sample RAM with 32 voices and uses a Mac II as its front end. It offers a seamless integration of disk-based and RAM-based events in its 200-track sequencer.

The system has always offered SMPTE chase and lock with one-quarter frame accuracy. The responsiveness and sonic clarity of its audio scrubbing is unparalleled, and it offers a non-destructive editing accuracy of 80 subframes.

The system defaults to recording at 50 kHz, although it is capable of recording one to four channels anywhere from 1 to 100 kHz in 0.1 increments and can be configured to record up to 16 channels simultaneously. Digital inputs are also an option.

The Synclavier Company seems committed to keeping up with the latest technology when it comes to storage, currently offering compatibility with 5GB removable drives for quick turnarounds on projects. (9GB removable compatibility is coming.) Magneto-optical (MO) storage is also available for RAM-based samples.

After the tracks were cut, the producer decided to revoice one of the secondary characters. With 27 minutes on each of the 16 direct-to-disk tracks, I found some room, recorded the new material and, lo, the reading was faster than the original. No problem. Opting not to use time compression/expansion, I decided to edit my way out. The ability to ripple and shift all of my edits for dialogue, music and effects as I cut in the new material saved time, hassle and my stomach lining.

### Software is key

The key to a great digital editing system is its software and interface. The EditView front-end software for the

**The responsiveness and sonic clarity of its audio scrubbing is unparalleled.**

Synclavier provides a horizontal or vertical timeline with configurable tracks and outputs. Non-destructive fade-ins/-outs

and region tweaking are accomplished by dragging handles on each event. The audio is scrubbed during the dragging process, which allows for quick and accurate placement of handles with no guesswork. A time-saving waveform display will be available in the next update.

For those of you who are in a lather at the level of sophistication outlined above but think the hardware is out of your budget, the Synclavier Company is hard at

work on a version of EditView that will run other manufacturers' hardware.

### To pool or not to pool

The Synclavier incorporates a rigid architecture in regards to tracks per drive. There are strict limits to the number of events that you can play off one track, regardless of how many voices your system has.

Systems that use track pooling allow you to have a maximum number of voices from a single drive, regardless of the location of the audio on the drive.

Removable drives reduce the advantages of the former scheme to a degree that I am envious of the flexibility of a track pooling architecture. It is my wish that The Synclavier Company address this hurdle in future updates.

The software is good and keeps getting more powerful. The hardware is solid, sometimes running three shifts, 24 hours a day, for up to two months without complaining. That kind of reliability is worth a great deal when you can't afford to have any downtime.

□ □ □

For information, contact Monica Meagher in New Hampshire at 603-448-8887; fax: 603-448-6350; or circle Reader Service 86.

## I COULD HAVE BOUGHT A DIGILINK!

Are you thinking about replacing your old cart machines with 'Digital Carts' such as floppies, flopticals, Bernoullis, or Opticalst??? Well, think about it a little more! Add up the list price for a digital cartridge recorder, just a single player, AND the floppy disks--- and you will find that you could have bought a Digilink workstation for \$7,995 that gave you 'Live' -AND- 'Automation' capabilities!!!

A Digilink workstation stores audio on an internal hard disk and comes out of the box with a capacity of 547 one minute, stereo carts for only \$7,995. Even better, the Digilink hard disk has an average 15 year life. Imagine how many floppies you will break, wear out, lose, and replace over 15 years. That doesn't count all of the floppy disk mechanisms that will jam, break, and simply fail...

Also with a Digilink, you get much more! You can stack up hundreds of 'carts' in the play list and just walk away. You get satellite automation in the Digilink workstation and can optionally add CD players. A digital audio cut and splice editor even comes standard with Digilink. Because Digilink will play and record at the same time, you can play a spot to air while it starts a scheduled network autorecord. You can even network delay with Digilink.

With all of these features, it is easy to see why there are more than 500 Digilink workstations around the world from Paris to Moscow to Taiwan to Jamaica and in your own backyard. Don't suddenly come to the realization that you could have bought a Digilink!

Call Arrakis now...

(303) 224-2248

## ARRAKIS

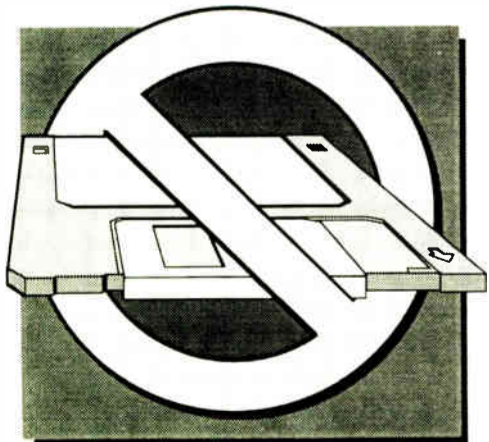

© 1993 Arrakis Systems Inc. 2619 Midpoint Drive, Fort Collins, CO. 80525

Circle (190) On Reader Service Card



Synclavier 9600 means no downtime for Multi-Track

What if your client asks to doppler, pan and chorus a sound? Fly the track to RAM with a single click; it's now available on the keyboard. Play it at the desired pitch, patch pan to the mod wheel, set chorus depth, rate and modulation, arm a sequencer track and record into it while locked to picture, shifting the Pitch and Mod wheels to taste. Done.

All of these settings are stored with the sequence, so recalling a sequence prompts the system to look for all soundfiles used within it, disk- or RAM-based.

Oh, did I mention MIDI? The system has an integrated MIDI interface as well, and can trigger your favorite synth or FX unit via MIDI events from the sequencer.

### Acid test

Although the systems at Multi-track are used primarily for dialogue and sound effects editing for feature films and television, I have cut an entire radio play on the system. The layout was as follows: four tracks of dialogue, six tracks stereo FX, plus specifics and stereo ambiance loops played back from RAM, four tracks of stereo music being played back simultaneously, and all elements available to be cut, replaced or shifted with a minimum of effort.



## USER REPORT

# Studio Knows No Limits with Dyaxis

by Jim Baldree  
Chief Engineer  
Pfeifer Studios

**LOS ANGELES** There are a lot of digital audio workstations on the market, and deciding which one to buy is no easy task. After seeing most of them in action, it's amazing to realize that all of them are ultimately trying to do the same thing. They all look different, sound different and even perform similar tasks differently.

I purchased the Studer Editech Dyaxis II system for a number of reasons. First and foremost is sonic quality. When doing pre-mastering editing for CD projects, I always point out to my client the Dyaxis II's excellent sound quality, achieved by Studer's proprietary A/D-D/A conversion technology.

During a recent project, for instance, the source material was not DAT but analog half-inch tape. After completing the project, we compared the original analog half-inch with the output of Dyaxis II, and the results were remarkable. No one in the room could tell if we were

listening to the half-inch tape or the Dyaxis II. This is truly a testament to Dyaxis II's sonic characteristics which do not color the original material during the transfer, editing and lay-back process, a feature often overlooked when comparing workstations.

I also produce commercials and promos, both audio for video and radio spot production. While most DAWs provide simple editing functions, the Dyaxis II's editing tools, via the controlling MultiMix software, are intuitive, fast and powerful with functionality far beyond the rudimentary cut-and-paste capabilities associated with some systems.

In addition to the editing features, I need a system that can mix with full dynamic automation, eliminating the need for a large console. Dynamic automation is simply the ability to remember or automate each output volume fader change, channel routing, muting and panning information. I can create as many different mixes as needed and recall any mix at any time. Everything (music, dialogue, sound effects and

voiceover) is mixed and stored by the Dyaxis II.

One of my favorite features is "ingredient" automation, which is different from the channel-based output automation. Ingredient automation is the ability to remember or automate volume changes on each ingredient (e.g., clip/edit). Why is



Pfeifer Studios appreciates Dyaxis II's sound quality.

this so important? Because Dyaxis II can play an unlimited number of ingredients at the same time, it's important that each ingredient can have not only its own volume level, fade in and fade out, but also have its own fader. This means that I can slope, duck and fade each ingredient individually.

Another feature I need is the ability to play as many tracks as I want without running out of "voices" and being required to sub-mix elements. Every DAW has its limit of tracks that it can play in real time. This limit, based on available bandwidth, is usually eight, 12 or 16 playable tracks at once depending on how much

money you have. After this limit is reached, other DAWs apply the "brick wall" effect, keeping you from playing more tracks than it can play in real time.

After having worked on the Dyaxis II, it is difficult to imagine working on other systems where I had to worry about how many playable tracks were available. The Dyaxis II can always play as many simultaneous tracks (i.e., ingredients) as I want by utilizing a feature not found in any other DAW that I know of called non-real-time mixing. I just keep creating more virtual tracks for any of the outputs and it just keeps playing them all.

There is an algorithm within

the MultiMix software that is always analyzing my VirTraxx (i.e., virtual tracks) workload. If it encounters an area it can't play in real time, then it simply performs a temporary sub-mix to an empty part of one of my hard disks. For my clients and for me, that means that, creatively, there are no limits. I can continue layering, adding, modifying, over-dubbing and recording new audio elements and it just keeps playing everything.

All of this technology, including a 1GB hard drive, is housed inside a three-rack-space chassis. Up to six additional drives, either optical or fixed hard drives, can be attached to each processor and up to six processors can be combined, providing up to 24 channels of I/O with 48 tracks of real-time playback. Dyaxis II comes standard with the ability to sync to house sync, chase to time-code, and has full machine control. For those applications where no time code or synchronization capabilities are needed, such as radio production, an even lower-cost entry-level version is available. It simply connects to a Macintosh with one SCSI cable and one serial cable. There are no cards that have to go inside the Mac, and there are no special interface boxes needed.

There are many more reasons why I chose the Dyaxis II, but these are fundamental. I hate work-arounds and limits, and the Dyaxis II keeps me from dealing with either.

□ □ □

For information, contact Gerry Kearby in California at 415-326-7030; fax: 415-326-7039; or circle Reader Service 29.

## INDUSTRY ROUNDUP

## User Expectations Changing As DAW Technology Improves

by Whitney Pinion

**WASHINGTON** The need to have audio product in a digital form and the desire for speedier production continues to drive the use of digital audio workstations (DAWs), according to manufacturers. As the technology for DAWs matures, so too do the expectations of their users.

Tim Schweiger of BSW says that as the PC takes over in the realm of digital audio production, customers are becoming more demanding of the software and its capabilities. "Several years ago, users were amazed that PCs could replace hardware," he says. "Now they're asking, 'Is that all it does?'" And customers expect these improved capabilities at a reduced price.

One of the expectations of users that pressures workstation manufacturers in a powerful, positive direction, says Korg's Rod Revilock, is that people do not want to accept computer system idiosyncrasies. "People using the first digital systems were expecting them to crash," he says. Now, "manufacturers are having to come up with equipment that's as stable as traditional audio equipment."

Schweiger says that he has noticed that manufacturers are incorporating hardware into their equipment, actual control panels instead of a mouse or keyboard. The computer is gradually becoming the "silent partner" in digital audio production, he says. Users are satisfied having a computer as the brain of the system, but they want more hands-on control.

Revilock agrees that computer-based systems will continue to proliferate, even though many people are not comfortable using traditional computer controls to do audio production. "Most systems are trying to replace the keyboard and mouse

for a more efficient utilization of technology" like random access, he says.

Although a number of useful features, including more audio tracks for recording and mixing, time compression and FQ, are being incorporated into computers, some people in the industry have become disillusioned with the computer and want to return to a hardware platform. Schweiger calls these people "power users," production people who generate a high volume of commercials and other material.

Hardware-based systems tend to cost more than those that are PC-based, yet users have the advantage of a dedicated production device, one that's not being shared with, say, word processing. Plus, the speed of the system is not dependent upon the processing speed of the computer.

Users are hardly calling for a return to razor blades. To remain competitive, the radio broadcast market must continue to be more and more digital, says Eric Richardson of Fostex. "Digital audio workstations are the perfect means for transmissions between producers of material and broadcasters," he says.

What gets verbalized the most is that users want interfaces that they are familiar with. Revilock says, "It's actually got more to do with what works rather than with what the user is familiar with," he says. Trying to improve traditional interfaces is an example of "reinventing-the-wheel-just-to-do-it kinda thing."

Ultimately, users are going to be drawn to solid products with reliable customer support. "The vast majority of the market wants a complete solution and someone who will stand behind it," says Jon Young of Arrakis. He said that eventually he expects to see this complete digital solution in a single box.

**NOTE.**  
Over 25% of all digital audio systems sold to radio are no longer in use!  
If you want results - not disappointments - call I.T.C. today.  
800-447-0414

**THE BENCHMARK** **it** **IN BROADCASTING**  
For the past 25 years... For the NEXT 25 YEARS

International Tapetronics Corporation, 2425 S. Main Street, Bloomington, IL  
Phone: (800) 447-0414, (309) 828-1381, Fax: (309) 828-1386

Circle (79) On Reader Service Card



# Products & Services Showcase

For more information on the products shown below, circle the appropriate Reader Service No. (s) on the enclosed Subscription/Reader Service card or contact the advertiser directly.

## STABILINE™ Uninterruptible Power Supplies



**19-inch rack mount . . . just the right size for studios and mobile production vehicles.**

These true on-line UPS systems provide a reliable source of clean, continuous, sine wave AC power to broadcast and other voltage sensitive equipment. They accept industry standard 19-inch rack enclosures and can be mounted with or without standard slide rails, by L support brackets or by front panel plate. Typical operating times range from 10 to 30 minutes at full load and 25 to 60 minutes at half load. Auxiliary battery packs can extend time. All units are equipped with an RS-232 signal level interface DB-25 connector that interacts with commercially available computer/LAN operating system software for an orderly system shutdown. Ratings in 800 and 1250 VA, 120 V, 60 Hz models. Complete literature on request.

Call 1-800-446-6161 in USA & Canada

**SUPERIOR ELECTRIC** Bristol, CT 06010  
Tel: 203/585-4500  
WARNER ELECTRIC Fax: 203/582-3784

READER SERVICE NO. 153

## AUTOMATED FM ANTENNA PATTERN MEASUREMENTS



Using the Dept. of Defense Global Positioning System (GPS), and our hi-tech airplane, let us show you the signal your station is really transmitting. We measure each and every degree of both the horizontal and vertical patterns. Your signal is your most important asset! Don't guess. Be sure you're getting the maximum possible coverage. Call us today for a brochure or confidential consultation.

**STEPHENS COMMUNICATIONS INC.**  
Little Rock, AR. • (501) 821-5756

READER SERVICE NO. 175

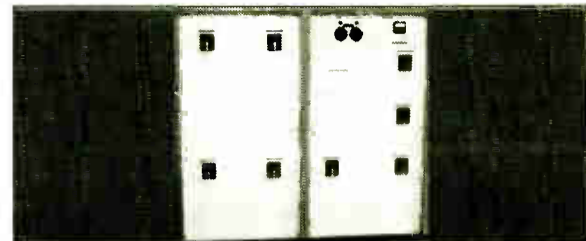

- CUSTOM ANTENNA PHASING SYSTEMS
- ANTENNA CONTROL SYSTEMS
- AM/MF ANTENNA TUNING UNITS
- DIPLEXERS & MULTIPLEXERS
- TRANSMITTER COMBINERS
- DUMMYLOADS (WITH MATCHING NETWORK)
- ASSOCIATED RF COMPONENTS
- CALL OR FAX FOR MORE INFORMATION

## PHASETEK INC.

550 CALIFORNIA RD. UNIT 11  
QUAKERTOWN, PA 18951

PHONE: 215-536-6648

FAX: 215-536-7180

READER SERVICE NO. 36



## IS LOOKING FOR AGENTS

10,000 TV TRANSMITTER  
4,500 VHF-FM TRANSMITTERS  
600 TV LINKS FROM 2 TO 18 GHZ  
installed everywhere in the world.

DO YOU HAVE THE RIGHT NUMBER TO SHARE OUR SUCCESS?

**TEKO TELECOM SRL**  
Via dell'Industria, 5  
40068 S. Lazzaro (Bologna) Italy  
Tel. +39 51 6256148

READER SERVICE NO. 16

## Going Digital?

When You're Ready,  
We're Ready.

## WireReady NSI.

Framingham, Massachusetts • 800 833-4459 • 508 879-0080

• WireReady™ • ScriptReady™ • CartReady™ • PhoneReady™ • StormReady™

READER SERVICE NO. 87

**WireReady™** products let you use your station's own computer(s) to:

- computerize wire services and satellite network log printers,
- manage local news, promo copy, and your sales effort,
- produce, store, and playback digital audio, automated or live.

Ready to find out how to get high-performance features like these for a fraction of the cost of other systems?

Then you're ready for **WireReady™**.

Call today.

SEE US AT  
NAB BOOTH #2108

## How Good Can a Mixer This Size Be Anyway?



Actual Size

Try great specs to start with. Then add reliability that's backed by a THREE YEAR Warranty! It's just one of the 37 **STICK-ON™** products from **RDL™**. Find out how **RDL STICK-ON** innovations can make your job easier. Call us today at 800 281-2683 or 805 684-5415 for your free catalog of these great value tools!



**RDL** Radio Design Labs

P.O. Box 1286 ■ Carpinteria, CA 93014  
In Europe call (31) 20-6238 983 Fax (31) 20-6225 287

© Radio Design Labs

READER SERVICE NO. 198



## STATI-CAT

makes  
Lightning Prevention  
**Easy!**

**Cortana**  
Corporation

Write to us today for a **FREE** brochure!

P.O. Box 2548, Farmington, NM 87499

Call (505) 325-5336

FAX (505) 326-2337

READER SERVICE NO. 34



## USER REPORT

# DSE-7000 Allays Fear of Digital

by **Steve Wilmes**  
**Production Director**  
**WFBO-FM/WZRX-FM/WNDE-AM**

**INDIANAPOLIS** Supervising production at a multistation group is not advised for those who seek a calm, leisurely career. Our production schedule averages 40 to 50 new spots per week, plus a lot of spot assembly with tags and numerous station promos. That keeps about 15 people hopping in and out of our three production rooms.

When we first considered moving to digital production, I found the prospect unsettling. Analog had drawbacks, but at least everyone knew how to use it. As for digital, we couldn't spend months retraining our staff. And what if the digital system were to crash? We can't afford any downtime.

In 1991, with these reservations in mind, I attended a dealer's mini-seminar on the Orban DSE-7000. I was amazed at how much it could do and how easy it was to bounce sounds around. The monitor screen was new, although the control surface looked familiar. Impressed, we asked to have a demo DSE-7000 sent to the station. We bought our first one that year, we bought a second one last year and we plan to buy our third this year.

It was immediately apparent that the DSE-7000 was far easier to use than

**The DSE-7000 is a complete system that comes ready to use out of the box.**

other workstations available at the time, or today, for that matter. Ease of use, combined with superb sound, convinced us to buy the first one. Reliability and major system upgrades convinced us to stick with it for our second and third units.

The DSE-7000 is a complete system that comes ready to use out of the box. The control surface has familiar features, such as long-throw faders, backlit tape transport controls and a scrub wheel. All mixing and editing functions are real time in RAM, and processing is linear PCM.

The DSE-7000 offers simultaneous real-time manipulation of eight tracks and allows bouncing of all eight tracks, plus two effects returns to any one or two tracks for infinite layering. Editing features include instantaneous Undo, dedicated edit point buttons, and functions that were either tedious or impossible on analog: leader, cut, copy, move, loop, swap and backtime, etc.

Since we bought our first unit, the DSE-7000 has gone through several hardware and software upgrades, as well as substantial price reductions. Hardware upgrades include RAM memory expansion up to 70 track minutes (at 32 kHz), DAT backup, digital I/O, full sample rate conversion and availability of up to 2GB of hard disk storage.

All DSE-7000 software upgrades are free. One new software feature that really impresses me is on-board time compression and expansion. What if you have a perfect 22-second read for a 20-second doughnut? No problem. The DSE-7000 can squeeze it to fit effortlessly. The sound quality on this feature is unbelievable.

Of course, some other workstations boast more options, most of which might be great for video post production or MIDI recording but not really necessary for cranking out radio spots. In fact, we've had a popular Mac'n'mouse system

installed here for two years, but only one member of our staff has bothered to master it.

That's one reason we're getting a third DSE-7000. Everybody here loves it. The screen is basically self-explanatory. If you get stuck anywhere in the process, just push the Help button. The software tells you where you are and provides options for your next step. It's essentially a built-in user's manual.

The DSE-7000 is so straightforward that we've had people from the sports staff come in and teach themselves to

edit actuality pieces. Some had their first pieces on the air just a few hours later. Most of our production staff fully mastered the system within a couple weeks. All told, we probably have 20 users on the system any given week.

As for reliability, we've had zero downtime on our first unit in four years of use. It never crashes. I think the only maintenance so far has been replacement of a light bulb under a switch.

These days, no matter how hectic it gets, I have no digital fears. The DSE-7000 never lets us down, and because it saves so much time, it gives us the opportunity to be more creative in our work.

□ □ □

For information, contact Chris Holt in California at 510-351-3500; fax: 510-351-0500; or circle Reader Service 105.



## Let the VRC-2000 watch your remote transmitter site.

This is Mary Beth, your babysitter. Sure, she's great at tossin' a frozen pizza in the oven, finding *Knot's Landing* reruns, and tucking the kids in. But would you trust her with your "baby" at the transmitter site? With millions of dollars of equipment and thousands of dollars of FCC fines and downtime at stake, watching over your remote transmitter isn't your average babysitting gig.

The answer is the VRC-2000 Remote Control from Gentner. It not only monitors your transmitter, it can make changes for you automatically. If something goes wrong, it calls you or your technical staff to report the problem. Usually the problem can then be fixed by the VRC-2000, as you talk to it through your phone or your PC. Plus, you can access the



VRC-2000 from virtually anywhere. It's like having a person on duty at your remote transmitter site 24 hours a day, only it's more reliable and won't get cheese on the equipment.

Utilize the VRC-2000 to monitor and adjust everything you need at your transmitter, then relax — the babysitter's on duty. Call 1-800-945-7730

for more VRC-2000 information. And while on the line, ask about Gentner Conference Call Services.

 **Gentner**

The World Leader in Broadcast Telephone Interface Products



**People, Promotions and Appointments**

In January, **Harold W. Lorensen** retired from **Superior Electric**. The longest-serving employee in the company's history, Lorensen joined Superior Electric in 1948, 10 years after its founding.

**JBL Professional** announced three appointments within the company. **Mark Mayfield** was named market manager for sound contracting, cinema and residential sound; **Mark Halvorsen** was appointed project manager for JBL's Control Series speakers; and **Marc Spector** was named marketing manager for the musical instrument, broadcast and tour sound markets.

**Neotek** selected **Stephen Rose** as the

company's new director of sales and marketing.

**Neutrik USA** announced the hiring of

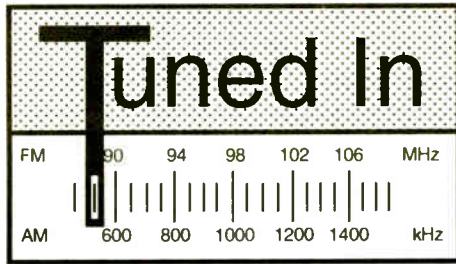

**Mike Lynch** as western regional sales manager, and the promotion of **Ellen Wagner** to the position of marketing communications coordinator.

**North America Network** added three new staff members. **Bob Dane** joined the

sales and marketing department as an account executive for the Washington, D.C., area. **Lynn Harris Medcalf** joined the station services group as a RadioTour manager. **Tim Reilly** accepted the position of marketing assistant.

**Alan Hardiman** joined **The Synclavier Company** as director of sales.

**Eventide** announced the appointment of **Nicholas Rose** as director of audio engineering.

**David A. Jones** was hired as general counsel of **Hubbard Broadcasting Inc.**

**Hajime (Jim) Yamaguchi** was elected president of **TEAC America Inc.**

**EFI Electronics** announced the appoint-

ment of **Richard D. "Dick" Clasen** as the company's new president and CEO.

**Company News**

**Harrison by GLW** moved its Nashville offices. The new address is 7104 Crossroad Blvd., Suite 118, Brentwood, TN 37027; phone: 615-370-9001; fax: 615-370-4906.

**Harris Corp.'s Broadcast Division** was awarded a contract from the U.S. Information Agency (USIA) to furnish the world's first one-megawatt solid state medium-wave broadcast transmitter.

**Omnitronix Inc.** was awarded a contract for the U.S. Special Operations Command for the design and production of a solid state, frequency-agile and mobile AM broadcast transmitter.

**California Microwave's** subsidiary, **ViaSat Technology**, appointed **Unisource Satellite Services**, located in the Netherlands, to be a European distributor of LYNXX transportable Inmarsat-B terminals.

The Cumming, Ga., facility of **Panduit Corp., Identification Products Division**, was awarded Registered Firm status in compliance with the requirements of ISO 9001:1987.

**Tektronix Inc.** announced that it signed eight regional sales firms to serve as manufacturer's representatives in the United States. These firms include: **Hartmann and Associates** of Chicago, Ill.; **Hartmann Associates** of Long Valley, N.J.; **Marketing Concepts** of Irving, Texas; **Northshore Marketing** of Seattle; **Optimark** of Chestnut Hill, Mass.; **Preco Inc.** of Scottsdale, Ariz.; **Studio Supply Co.** of Nashville, Tenn.; and **David Carroll Electronics Inc.** of Richmond, Calif.

**QMI** announced its appointment of **Mid-America Marketing Associates Inc. (MAMA)** as its exclusive representatives serving the Illinois and Wisconsin markets.

# The Digital System Everyone's Chasing...

the industry-leading **Wizard For Windows™** by Prophet Systems.

The competition is trying to catch up to our innovative features

- ◆ Exclusive Automated Time AND Temperature Announce!
- ◆ VoiceTRAC System, pre-record "live" shows weeks in advance!
- ◆ Backtime System, fills out each hour!
- ◆ Unsurpassed FLEXIBILITY, runs any program log!
- ◆ Button Bar with Quick Record Capabilities!
- ◆ On-Line Copy Entry System, integrate your stations!
- ◆ Automatically record and play network feeds!
- ◆ The leading Hard Drive Automation System in the industry!
- ◆ The ONLY true multi-user system on the market!
- ◆ Automatic Block Stretch/Squeeze for perfect timing!
- ◆ Full Equipment Redundancy!

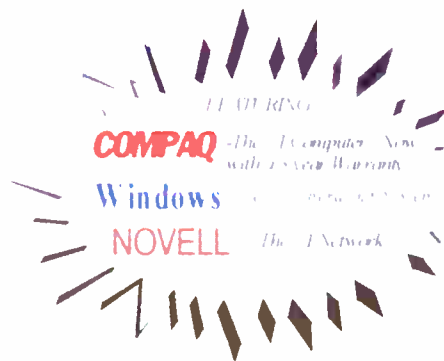

WIZARD FOR WINDOWS CONTROL

Friday September 23, 1994 15:46:48

Block Time 00:01:45 Event Time 02:32 Intro 4

STATION # 2 LOGO FM

System Mode-MANUAL Block Fill -ON  
 CDA Module -OFF Resync Mode -ON  
 Def. Source -HI Recept Optos -YES  
 Block Play -OFF  
 Shift -884 BILL SMITH

ACTIVE SOURCES

STRT	DESCRIPTION	CRDB	SPOT	CUT	LENGTH	SYS #
15:46:42	CRIMM NICE TO BE WITH YOU-GALLERY	00:01	00:02:35		1:53:12:9	
	Spot Block				00:00:00	113829
	HILL TOP CAPE (PAUL REY)	00:00:07	00:00:59		2:46:7:5	
	SARGENT IRRIGATION (P. LHOUMET)	5:20:45	00:00:45		15:705:7	
	End Of Block				25:42:12	
	<0:00> UENTURA HIGHWAY-AMERICA	0:02:00	00:03:18		12:47:49:1	

FR	PLAY	TO	STOP	STOP/END	SKIP	record off
A	UPBEAT JINGLE	00:07	B DOWN JINGLE	00:00	C AFRICA	00:00
D	LADIE'S LAUGH	00:03	E TELE (JERRY)	01:13		
F	STAR TREK TRAN	00:11	G AL ONE AGAIN (H	00:11	H MEDUSA JINGLE	00:04
I	CRASH AND BURN	02:36	J CAN'T TOUCH TH	00:17		
K	JINGL F LONG FA	00:00	L FTRIAL PLAMP	02:52	M TELE (JERRY)	01:13
N	NOW AMI FORVF	00:00	O MORNING SHOW	00:14		
P	1999	00:00	Q CAN'T STOP THE	00:46	R TELE (LISA)	00:26
S	EVERY BREATH Y	00:00	T DOOR OPEN	00:07		
U	HOT ROD LINCOL	02:41	V DOOR SLAM	00:02	W BURBING LOVE	00:00
X	CAN'T TOUCH TH	00:17				
	EXIT					

Control Room with Button Bar Overlay

- ◆ Runs 4 or more stations!
- ◆ Live, satellite and automated modes!
- ◆ Expandable to 20 or more users!
- ◆ Multi-track Wizard Editor!
- ◆ Instant audio access.. NO transfer delay!

For information about radio's premier digital automation system, call Prophet Systems, Inc.

**1-800-658-4403**

In Australia, New Zealand, and Pacific Rim, contact Broadcast Solutions Pty Ltd. at (02) 439-6662.

**TECHNOLOGY UPDATE**

**ITC**

**ITC DigiCenter Can Accommodate Up to 225 Workstations**

**BLOOMINGTON, III.** ITC's DigiCenter provides the networking and management capability to integrate a multitude of digital audio workstations.

DigiCenter's hardware and software create an environment for a Central Audio Library Manager while providing on-line access by a host of workstations, both internal or third party. DigiCenter can network 255 workstations, and offers real-time execution of network events.

Workstations can be traffic and music computers, waveform editors, on-air studios, and provide production, accounting, library database management and other functions. Traffic and music schedules are managed in the background and sent to any workstation on the system for execution. Editors can directly exchange files with DigiCenter's audio library.

For information, contact **Charlie Bates** in Illinois at 309-828-1381; fax: 309-828-1386; or circle **Reader Service 81**.



# Wizard For Windows™

The Flexible Digital Automation System featuring Windows and Novell Technology

Windows is a Registered Trademark of Microsoft Corporation. Novell is a Registered Trademark of Novell, Inc. Compaq is a Registered Trademark of Compaq Computer Corporation.

Circle (73) On Reader Service Card



# There are many reasons for choosing AEQ products. Here are just a few.

## Control and Flexibility in your Remote Event Transmission



### The AEQ Portable Mixer MP-10

Ideal for remote event transmission.  
Easy to install and operate.  
Provides portability and autonomy.  
Carrying case included.

#### Special features:

- Five transformer balanced inputs selectable Mic / Line.
- Front panel input controls.
- Capable of linking mixers together to increase number of inputs.
- Transformer balanced outputs.
- Internal Ni-Cd rechargeable batteries provides 4 hour autonomy.
- Automatic switch to battery if power fails.
- Dialing keypad, dual mode Tone / Pulse.
- Three headphone output jacks.

## The Ideal Combination



### Digital Telephone Hybrid AEQ TH-02 EX

- Frequency Extender Mode as standard feature.
- Works with one or two telephone lines.
- The second line provides full Multiconference Mode. The operator and two callers can talk and listen to each other simultaneously.
- Hybrid null of 60 dB's.
- No adjustment required.
- Ideal companion to work with AEQ Portable Digital Line Extender TLE-02.

### Portable Digital Line Extender AEQ TLE-02

- On Air phone call with audio presence, depth and clarity of voice. No "telephone sound".
- Easy to use. Designed for the non-technical user.
- Ideal for field reporters, totally portable. Light weight: 3.3 Lb.
- Great operation autonomy, using 8 AA batteries.
- Dialing pad in front panel, and Pulse / Tone selectable.
- Independent level control of Mic / Line input, auxiliary input and headphones.

## Stereo Quality Monitoring at Mono Price

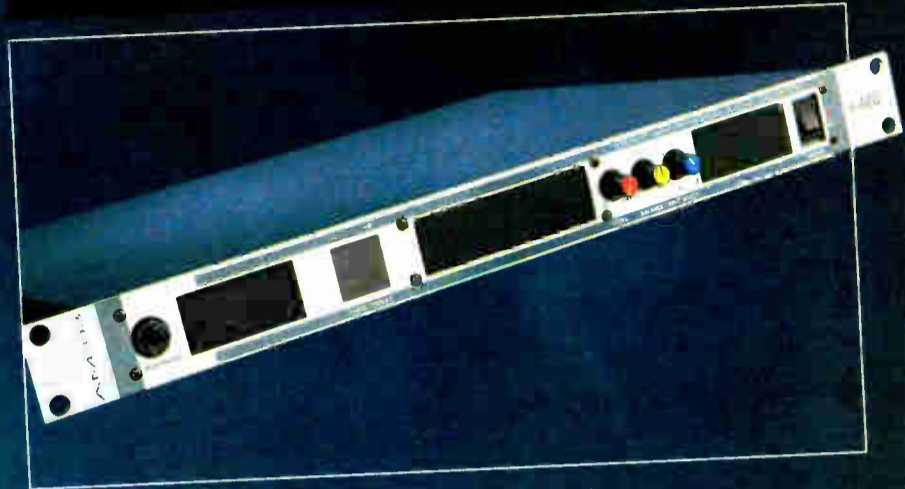

### The AEQ AM-03 Stereo Audio Monitor

- Designed to meet the monitoring needs of technicians working in VTR rooms, OB vans, radio and TV controls, etc.
- All the controls are in the front panel to facilitate easy and accurate operation:
  - Input selector (three selectable stereo inputs).
  - Output channel selector and balance.
  - Gain control and power switch.

#### Features:

- Three way audio system (mono for low and stereo for mid and high frequencies), consisting in five speakers. All contained in one unit 19" rack space.
- Electronically balanced inputs and outputs, with XLR connectors.
- Incorporated limiter for speakers protection.
- Audio phase meter.
- Headphones connector with automatic speakers disconnection.

## Value & Performance



### AEQ Mixing Console BC-500

- The AEQ Mixing Console BC-500 is designed for those radio stations seeking great audio quality at a competitive price. Its designers paid great attention to the control layout: the logical control design ensures a quick learning period as well as a trouble free operation.
- Advanced true modular design allows total flexibility. The module chassis has built-in meters and speakers and comes in a standard configuration with the following capabilities:
  - Six dual stereo inputs.
  - Four mono inputs Mic / Line selectable
  - One Telephone Hybrid interface.
  - Studio control Intercom monitor.
  - One main stereo output plus mono sum output.
  - Power supply for On Air signaling.
  - The AEQ BC-500 comes with 4 blank modules to enhance this configuration.



AEQ AMERICA, Inc.: 2211 South 48th Street, Suite F - Tempe, AZ USA 85282  
Phone: 1 (602) 431 0334 - Fax: 1 (602) 431 0497

Circle (28) On Reader Service Card

World Radio History



The RDS-1 keeps getting better, because it's the industry's first and only software controlled RDS Coder. That means that changes to the RDS Standard, and our own ongoing upgrades, are as simple as loading a new disk in your RDS PC.

The RDS-1 gives you flexibility and control you can't get anywhere else, like 255 Radiotext messages of unlimited length, full automation of RDS functions, and easy setup right out of the box. Animate your station on your listener's radios *while you transmit profit-making Transparent Data*. Only the RDS-1 does it all!

# Now the wait is over!

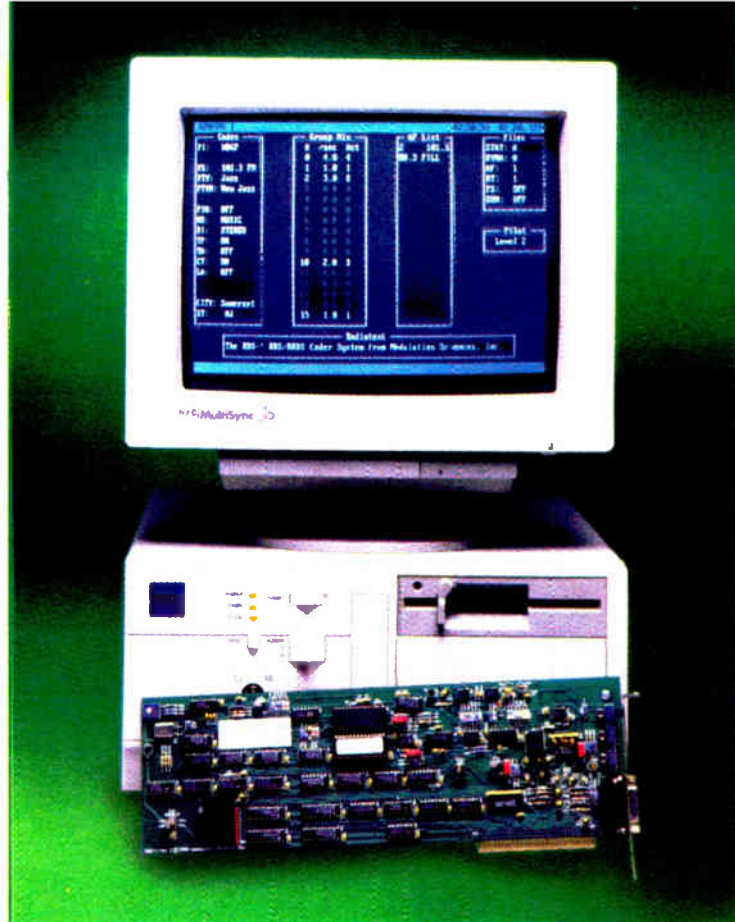

Model RDS-1 RDS System Generator & Software

Modulation Sciences gives you everything you need to put  to work today

Our new RDS Data Receivers give you profit-making access to the full RDS data stream. Now you can lease the RDS data channels that conventional RDS receivers ignore. Use the RDS-X2 to feed billboard displays, provide stock market updates, and actuate remote control.

Individually addressable, the RDS-X2 gives you and your data transmission customers robust, error-corrected reception of any and all RDS data, plus audio and composite outputs. And innovative features like onboard data filtering, Antenna Diversity and Beacon Tuning™ make RDS datacasting simple and reliable.



Model RDS-X2 RDS Data Receiver

Whether you're already on the air with RDS, or only thinking about it, you need our new RDS Monitor. The PRD-3000 decodes, displays, analyzes and stores the complete RDS data stream, and it measures RDS injection level to 1/10 of 1 percent.

Data is displayed on any desk or laptop DOS or Windows® PC. Plugged into our optional tuner, the PRD-3000 lets you examine the most minute details of your RDS signal, *and everyone else's*. Like all MSI products, the PRD-3000 is supported by a bold three year warranty.

*There's no longer a reason to wait for RDS to happen. All the tools you need are here today – courtesy of the RDS Authority . . .*

**modulation sciences, inc.**

12A World's Fair Drive • Somerset, NJ 08873 USA  
Voice (908) 302-3090 • Fax (908) 302-0206  
Toll Free in USA (800) 826-2603



Model PRD-3000™ Precision RDS Decoder/Monitor/Analyzer

Circle (51) On Reader Service Card

World Radio History



**ROLAND**

**Roland DM-800 Multitrack Disk Recorder Offers Full Features of Digital Audio Workstation**

**LOS ANGELES** The DM-800 multitrack disk recorder from Roland, weighing less than 13 pounds, is a portable, full-featured digital audio workstation.

The DM-800 offers non-destructive recording and editing.

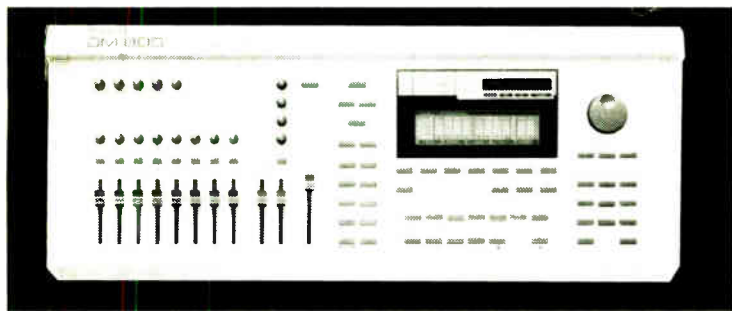

**TECHNOLOGY UPDATES**

video display output, optional ADAT or DA-88 communication bus, 300 virtual tracks, full dynamic automation and an optional RS-422 interface.

This unit incorporates a 12-channel digital mixer, including eight dedicated faders with gain and pan control, two stereo aux returns and a stereo main output fader. Roland's proprietary DSP provides a 24-bit two-band, fully automated, semi-parametric digital EQ with controllable gain and frequency on all channels.

Tape-like transport controls for record functions and an alpha dial and alphanumeric keypad contribute to the ease of operation of the DM-800. Five function keys control editing functions, such as punch-in/out, section loop, audio profile, preview scrub, time stretch/compression, and manual mix or compu-mix selection. Also included are eight triggers and 40 markers.

A built-in LCD display for viewing system, waveform and track-based parameters comes standard on all units.

For information, contact Erika Lopez in California at 213-685-5141; fax: 213-726-8865; or circle Reader Service 136.

**OTARI**

**Otari Offers New Software, Hardware For RADAR System**

**FOSTER CITY, Calif.** Otari offers new software features and hardware options for the RADAR (random access digital audio recorder). This multitrack hard disk recorder now features reverse play to timecode, jog nudge, interlock, additive and momentary solo modes, one-button record and track-arm record, programmable peak and clip hold times, reverse clipboard, and .WAV file import utility.

The optional ADATLINK card allows optical digital connection between RADAR and the Alesis ADAT/Fostex RD-8. This card inserts into the RADAR's internal bus and allows the RADAR to be used as an editor for audio recorded on the ADAT. A parallel interface card allows RADAR to be controlled from Otari remote controllers, as well as automation systems such as SSL, Neve and GML. The RADAR backup station is an off-line system designed for backup of RADAR removable hard disks. The system uses a standard PC computer with supplied software and hardware interface card.

The RADAR is available in 8-, 16- and 24-track configurations. The 8- and 16-track versions are expandable with 8-track upgrades to 24 tracks. The optional remote is fully functional, with 99 cue points, scrub/job wheel, Qwerty keyboard, keys for track arming and soloing, and dedicated edit function keys.

For information, contact James Goodman in California at 415-341-5900; fax: 415-341-7200; or circle Reader Service 35.

**DIGIDESIGN**

**Upgraded ProTools Package by DigiDesign Includes Application Software, NuBus cards and the Company's Audio Operating System**

**MENLO PARK, Calif.** The latest version of Digidesign's Pro Tools digital audio workstation increases modularity and expansion capabilities by providing users up to 48 tracks of record/play, up to 64 analog or digital channels of I/O and the Digidesign TDM virtual digital mixing and plug-in environment.

Pro Tools is sold as a "core system" with the choice of an eight-channel Digidesign audio interface. The Pro Tools III core system consists of one Disk I/O, a NuBus card that supports SCSI hard disk connection for up to 16 tracks of record/play for one or more hard disks, as well as support for one eight-channel audio interface; one DSP Farm, a NuBus card that supplies hardware processing power for mixing and plug-ins; Pro Tools 3.0 application software; TDM-enabling software and bundled DSP plug-ins; and DAE, the Digidesign audio operating system.

This system offers 16 digital tracks (or voices) and support for eight channels of system I/O with the addition of a Digidesign audio interface. Customers have the choice of the 882 I/O or the new 888 I/O audio interface to complete their system.

For information, contact Wendy Butler in California at 415-688-0611; fax: 415-327-0777; or circle Reader Service 5.

**THE BLUE GROUP**

**PhoneByte from The Blue Group Emulates Reel Machine on IBM**

**CLEARWATER, Fla.** PhoneByte from The Blue Group is a custom software package designed to emulate a reel machine in a specific environment. Running on an IBM-compatible 486 computer, PhoneByte interfaces with the air studio telephone hybrid to automatically record phone calls and time them, inserting a time/date stamp and labeling each of them. This software can store, sort, recall, stack and edit audio files.

Operated with either a mouse or custom keyboard, PhoneByte remotes to the user's console much like a reel or cart machine but offers extended remote capabilities. Files can be stored in mono or stereo, compressed or uncompressed audio, at 15 kHz or better. Timers indicate edited and unedited file lengths, with count-up and countdown timers on playback.

The one-keystroke design simplifies and accelerates operation. Stacking allows a random selection of calls to be played back in selected order, either individually or as a series. Editing is done with a basic cut-and-paste style similar to razor blade-type editing. PhoneByte is non-destructive, and all edits can be adjusted or deleted. With the optional Personal Touch feature, each user can build a unique array of drops, liners and sound effects.

PhoneByte also can be used for any recording and playback in the on-air studio.

For information, contact Ben Umberger in Florida at 813-442-1665; fax: 813-531-4897; or circle Reader Service 212.

**AUDION LABS**

**VoxPro Replaces Reel-to-Reel Recorders For On-Air Broadcast Studio Operations**

**SEATTLE** VoxPro 1.5 from Audion Laboratories is a digital sound editing system specifically designed to replace reel-to-reel tape recorders in on-air broadcast studios. Created by broadcast veterans, VoxPro operates like a word processor for sound.

Employing an ultra-high-speed, control room-oriented user interface, VoxPro enables DJs, news announcers, producers and other control room professionals to record and edit broadcast-quality audio with speed and precision, using the simplicity of cut, copy and paste.

VoxPro 1.5 includes two new features that add to the product's ease of use and performance. First, VoxPro can be configured for operation in 16-bit stereo or 16-bit mono. Both modes provide digital audio that is CD quality (44.1 kHz sampling rate).

Second, the Time Slip function allows the user to separate the left and right channels in a stereo recording so that one channel plays first with the other channel following it. With Time Slip, if a caller speaks at the same time as the announcer, the

user can select the portion of the recording where the voices overlap, and separate the left channel from the right.

For information, contact Warren Schirtzinger in Washington state at 800-869-7765; fax: 206-313-0611; or circle Reader Service 125.

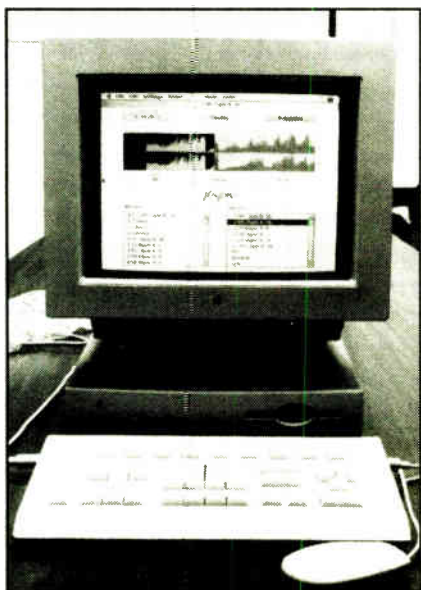

**FM BROADCAST POWER AMPS**

*... the low-cost way to increase power*

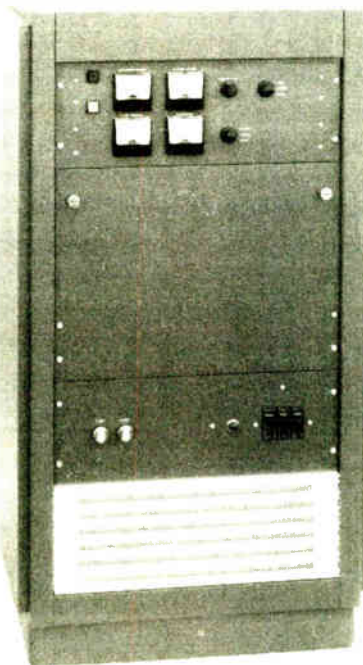

HENRY FM Broadcast Power Amplifiers are a significantly less expensive way to upgrade to "Class A" service. The initial cost is low, and maintenance is easy.

HENRY amps are also suitable for new construction or backup service at high power stations. Eimac ceramic triodes are used in grounded grid... a design that is conservative, reliable, stable and very economical.

All HENRY amps are type accepted for use with any type-accepted 10 watt exciter. Input and output low-pass filters are built in for service as a primary or backup transmitter.

Call or write today for additional information, prices and specifications.

**HENRY RADIO**



2050 South Bundy Drive  
Los Angeles, CA 90025  
Phone (800) 877-7979  
or (310) 820-1234  
FAX 310-826-7790



## SONY

## Sony DAE-D5000 Unit Expands Capability

**MONTVALE, N.J.** The new DAE-D5000 digital audio workstation from Sony Electronics complements the 24-bit random access storage capabilities of the Sony PCM-9000 Master Disc recorder to provide a stereo digital audio workstation with digital audio resolutions up to 24 bits at 48 kHz.

With the DAE-D5000, audio can be edited directly on the PCM-9000's removable and rewritable MSD-1200 magneto-optical (MO) discs. Unlike hard disk-based editors that require program material to be uploaded to a workstation for editing and processing, then down-

loaded for transfer and storage, the DAE-D5000 edits audio directly on the rewritable MO disc. Edit decision lists can also be stored directly to the same disc.

This editor can control Sony's PCM-1630/DMR-4000 master recording system as well. It features three automated faders that provide edit point crossfades and mixes, which can be stored in memory. A four-band equalizer and a dynamic processor with limiter/compressor and expander/gate functions are built into the DAE-D5000.

The DAE-D5000 will be available in March.

For information, contact Ron Remschel in New Jersey at 201-358-4196; fax: 201-358-4907; or circle Reader Service 141.

## 8 TRACK DIGITAL EDITING BREAKS PRICE BARRIER \$5,495\*

- ❑ A digital audio editor designed for *Radio* production
- ❑ Learn to use in minutes, *much faster than tape*
- ❑ Cut, splice, move, and fade up to 4 stereo tracks
- ❑ Use Scrubbing to edit with your ears
- ❑ Use visual waveform editing to edit with your eyes
- ❑ An UNDO button enables you to go back and fix mistakes
- ❑ Digital Networking to transfer audio to your On Air machine
- ❑ Add Trak\*Star-8 software to a Digilink for only \$2,000

Trak\*Star-8 is the first cost effective multitrack digital audio editor designed for the radio broadcast professional. Fast and easy to use, produce your commercials on Trak\*Star and then transfer them in digital straight to the Digilink in your On Air studio. Dramatically reduce production time and save money !!!

For more information, call or write  
ARRAKIS,

(303) 224-2248

Consoles  
Modulux  
Trak\*Star  
Digilink  
Modulink

the premier broadcast manufacturer of consoles, furniture, Digilink and Trak\*Star digital audio products.

## ARRAKIS

\* Suggested retail price. Complete system

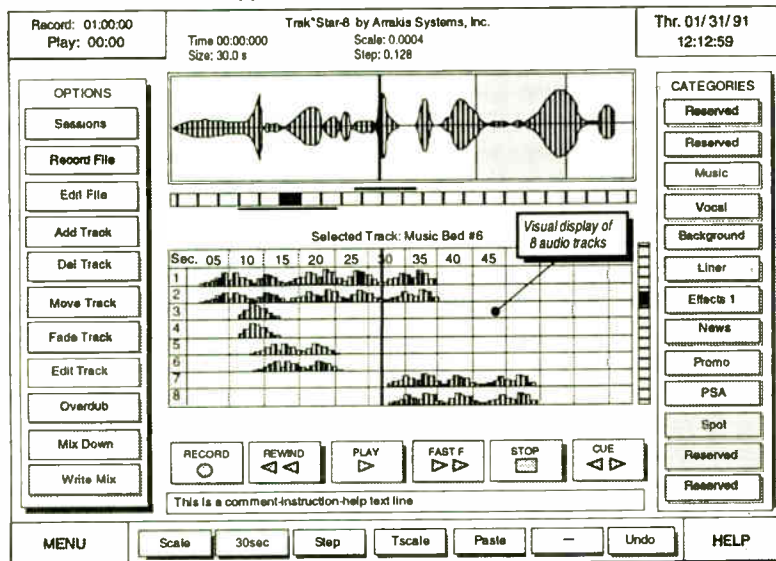

© 1993 Arrakis Systems Inc. 2619 Midpoint Drive, Fort Collins, CO. 80525

Circle (114) On Reader Service Card

## OSC

## DECK II Macintosh Software Integrates Digital Audio, MIDI; Upgrade Available

**SAN FRANCISCO** DECK II from OSC is a Macintosh-based software that integrates digital audio and MIDI. This software also runs on any Quadra 840AV, Quadra 660AV or Centris 660AV. Version 2.2 of DECK II plays backup to 12 tracks of 16-bit digital audio on any Power Macintosh, with no audio card or additional hardware required.

DECK II allows the user to record up to 999 virtual tracks. Playback track capacity is determined by individual hardware configuration. DECK II imports standard MIDI files (type 0 and 1) and plays them back in synch with audio files. It reads and outputs MIDI time code at all frame rates, and, using any SMPTE-to-MIDI interface, DECK II reads and writes SMPTE time code as well.

By using OSC's new Trans\*port util-

ity, the user can exchange session material between DECK II and any digital audio/video workstation that implements the open media framework interchange (OMFI).

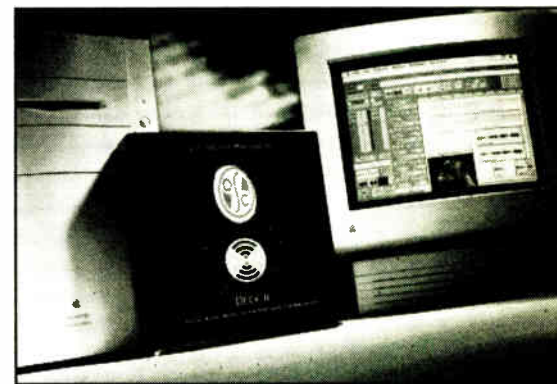

Version 2.2 of DECK II is a free upgrade, available upon written request, for all owners of version 2.1.

For information, contact Todd Souvignier in California at 415-252-0367; fax: 415-252-0560; or circle Reader Service 75.

## LPB

## SALSA Automation System from LPB Opens Possibility for Four Operation Modes

**FRAZER, Pa.** The LPB SALSA (Satellite Automation Live Studio Assist) digital audio systems offer four main modes of operation and for any size radio station. SALSA serves up satellite formats and provides special broadcasts, including live, delay record and remotes. SALSA handles up to 15 networks and an unlimited number of events per hour.

Automatic silence-sensing and emergency stepping keep listeners from ever hearing an error. SALSA's 21 sets of source tables allow specific sequences of spots for each time slot. Satellite fills can be personalized, down to the time announcements, for every person at a station.

With a library of more than 300 songs on a single DDS-2 tape, and a standard 1GB hard drive, the SALSA runs a complete format from its built-in scheduling

software. The DDS tape holds a library, and SALSA loads what it needs, as it needs it, plays it and clears it from the drive.

A new telephone interface—available at NAB '95—allows remote telephone recording by market professionals, sales staff or emergency personnel without interrupting local production recording or on-air hard drive audio.

Another new feature of the SALSA available at this year's NAB is the CD recorder option. Built into the SALSA, the CD recorder allows the user to dump production work to a single CD (up to 74 minutes of spots), which can then be played on any CD player in the station.

For information, contact John E. Devecka in Pennsylvania at 610-644-1123; fax: 610-644-8651; or circle Reader Service 128.

## TURTLE BEACH

## WAVE Edits Wave Audio in Windows on Hard Disk

**YORK, Pa.** WAVE for Windows, a graphics software package from Turtle Beach Systems, is designed to edit wave audio on the hard disk of any Windows 3.1-compatible computer. WAVE provides recording, editing and playback of digital sound. With WAVE, the user can rearrange a piece of recorded music, add fade-ins and fade-outs, choose from a wide selection of sound special effects, such as reverb, digital delay, echo and flange, boost the low end on sound effects with the parametric equalizer, remove mistakes and pauses from narration tracks, and create unusual system sounds.

WAVE works with any Windows 3.1-compatible sound card.

WAVE has all the features of a tape recorder and works with 8- or 16-bit, mono or stereo, 11.025, 22.05 or 44.1 kHz sampling rates. It can import and export .SMP, .SFI, .WAV, .16, .8 and .VOC file formats.

New features of WAVE include an on-line help function and a speed controller, which can alter the speed of a recorded file, making it up to 200 percent faster to 50 percent slower. WAVE also features new automated effects presets, called EFX Clips. The user can make narration sound like a cyborg and add "total grunge" distortion to a guitar track or a "grand canyon" reverb to voice files.

For information, contact Stacey Pierson in Pennsylvania at 717-767-0257; fax: 717-767-6033; or circle Reader Service 41.



# Products & Services Showcase

For more information on the products shown below, circle the appropriate Reader Service No.(s) on the enclosed Subscription/Reader Service card or contact the advertiser directly.

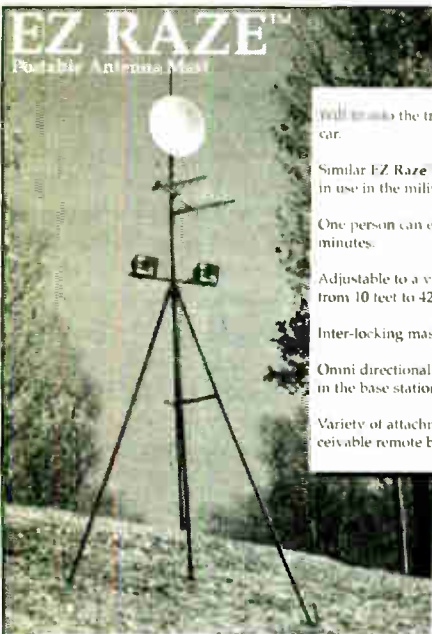

**EZ RAZE™**  
Portable Antenna Mast

will attach to the trunk of almost any car.

Similar EZ Raze™ models currently in use in the military.

One person can easily erect mast in 5 minutes.

Adjustable to a variety of heights, from 10 feet to 42 feet.

Inter-locking mast safety mechanism.

Omnidirectional rotation for honing in the base station.

Variety of attachments for every conceivable remote broadcast situation.

Attach a satellite dish, yagi antenna, whip antenna, lighting or speaker attachments individually or together.

Easily carried and erected almost anywhere indoors, outdoors, buildings, hillsides, stairs or rooftops.

**EZ RAZE™**  
Old Stone Corporation  
800-538-4977  
We accept VISA & Mastercard

**READER SERVICE NO. 126**

## AXS (Ax'-sess)... Jocks Love It!

AXS is an entirely new approach to digital audio controllers. It starts with superb audio using the premium quality apt-X™ system. AXS is easy to learn, easy to use, and powerful beyond words.

AXS is a modular design that begins as a simple cart replacement and grows to any combination of CD, hard disk, satellite or specialty programming with ease.

AXS has all the sophisticated feature options including device independent multi-channel background audio record and replay. Macro programming makes tough to run event sequences easy. Software drives a powerful programmable real time IOMAP.

**Jocks love AXS:** A fast 99 page, 28 button Jock F/X panel that can be time linked and remote wired is standard.

Use a software driven four-channel stereo audio switcher with on-screen control or the powerful eight-channel dual-buss routing switcher, or include both if you wish. AXS is controlled through a trackball, touchscreen, keyboard, buttonbox, telco or remote modem.

**AXS Systems...**  
From \$6000.00 using your 486 computers and hard disks.

**READER SERVICE NO. 219**



## AXS

### The Management

800-334-7823 • 817-625-9761  
FAX 817-624-9741  
P.O. Box 1-36457 Fort Worth, TX 76136  
1700+ Stations • Our 14th Year

**READER SERVICE NO. 219**

**NEW Receiver!**

# UNIVERSAL SCPC XE-1000



## SCPC BROADCAST AUDIO RECEIVER

New, affordable, frequency-agile receiver, direct channel entry by keyboard, selectable companding 1:1, 2:1, 3:1, wide/narrow bandwidth, de-emphasis selectable, 950-1450 MHz, line output 600 ohms, muting, transponder agile, LNB power supply, 50-channel memory, full baseband output, high-quality audio. Every needed feature at a sensible price (lowest in the industry). Write or call for full information on this quality receiver—the answer for your station. Networks call for prices.

**UNIVERSAL ELECTRONICS, INC.** 4555 Groves Road, Suite 12 Columbus, OH 43232  
Communications Specialists Phone: (614) 866-4605 Fax: (614) 866-1201

**READER SERVICE NO. 192**

## VACUUM & GAS CAPACITORS



Over 800 Capacitor Models  
Voltage Ratings to 100 kV  
Variable & Fixed  
Vacuum & Gas  
Unlimited Capabilities

Applications: Communications, Power, Electronic, Semi-Conductor Fab, Dielectric Heating Equipment, & Medical MRI & Heart Defibrillators. Ask about our vacuum & gas relays & other components.

**JOSLYN JENININGS CORP.**  
Phone: (408) 292-4025 Fax: (408) 286-1789  
Request a FREE catalog

**READER SERVICE NO. 172**

# Radio World

Vol. 19, No 4 Radio's Best Read Newspaper February 22, 1995

## Attention Advertisers!

Reach 22,000+ broadcast professionals! **Radio World's Product Showcase** provides a perfect medium for test marketing your products and services. It's an efficient, effective and affordable advertising option.

**"It Works! It's Great!"**

Product Showcase ads always get impressive results!

Advertise in the Product Showcase Directory!

For more information, including rates and deadlines, Fax Simone at 1-703-998-2966 or call 1-800-336-3045

Advertising is good for business!

**READER SERVICE NO. 194**

## Quality\* Power Tubes

3CX15,000A7	4CX1500A	4CX250BT
3CX15,000A3	4CX800A	4CX250BC/8957
3CX10,000H3	4CPX800A	4CX250B/7203
3CX10,000A7	4CX400A	4X150A/7034
3CX3000F7/8162	4CX350AC	5CX1500B
3CX3000A7	4CX350A/8321	5CX1500A
3CX2500H3	4CX250R/7580W	YC130/9019
3CX2500F3/8251		5U4G
3CX2500A3/8161		6AS7
4X15,000J/8910		6550B
4CX15,000A/8281		8560AS
4CX10,000D/8171		811A
4CX5000A/8170		833A
4CX3500A		833C
4CX1600U		
4CX1600B		



• Watch this list grow. • Generous\* warranty based on high quality.  
• Manufactured in Russia's largest power tube factory. • Honest prices based on quality at low cost.  
• Shipment from USA stock.

See Us At NAB '95 in Booths 5313/5314

<b>Broadcasters</b> Phone: 205-882-1344 FAX: 205-880-8077	<b>OEMs, Distributors, Volume Purchasers</b> Phone US: 800-578-3852 Int'l & US: 415-233-0429 FAX: 415-233-0439
---	---

**READER SERVICE NO. 215**

# Byte it with



**PhoneBYTE**  
Digital Phone-Bit Recorder

A Digital Recorder specifically designed to record phone calls and play them back quickly and easily.  
Fast nondestructive editing.  
Easy access and fast stacking of bits.  
The most powerful way to record and air phone-bits.

**The Blue Group**  
1001 Ridge Avenue  
Clearwater, FL 34615  
TEL 813. 442.1665

**READER SERVICE NO. 194**



# MARKETPLACE

Recently Introduced Products for the Radio Broadcast Professional

## Audio Analyzer

The Panasonic Factory Automation Co. offers the VP-7732A audio analyzer with digital interface that can be used for DCC, MD, CD, DAT and satellite broadcasting PCM applications. The VP-7732A offers digital signal sources based on EIAJ.

A sine wave is generated by a 24-bit audio sample signal. The VP-7732A also offers three types of analog signal sources: a direct digital synthesizer (DDS) with frequency range of 5 Hz to 210 kHz, a low-distortion RC oscillator with frequency range of 10 Hz to 50 kHz and an optional signal source for IMD measurement.

The graphic display offers spot and two-dimensional measurement, spectrum measurement with FFT analysis and direct digital audio signal analysis.

The VP-7732A also offers multiple measurement functions, including DC level, DC level ratio, AC level, AC level ratio, frequency, THD, THD+N, S/N ratio, phase, wow and flutter, PCM dynamic range and optional IMS SMPTE/CCIF.

For information, contact Kevin Dunoon in Illinois at 708-288-4471; fax: 708-288-4430; or circle **Reader Service 30**.

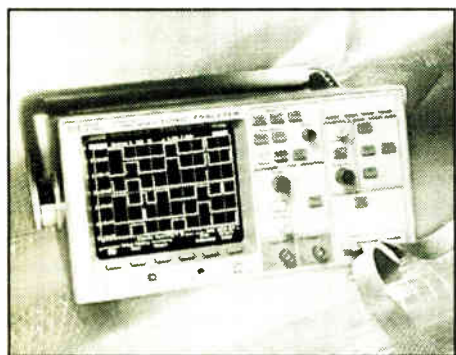

## Logic Analyzer

Combining an oscilloscope with a logic analyzer, the 16-channel HP 54620A from Hewlett-Packard gives engineers and technicians the ability to troubleshoot complex digital circuits quickly and easily.

The HP 54620A is designed for engineers who routinely use an oscilloscope instead of a logic analyzer to test and debug new circuit designs. Logic analyzers tend to be more complex than needed for routine debugging, yet oscilloscopes offer only one or two channels.

The HP 54620A features a simplified control panel and streamlined setup procedures. The unit uses oscilloscope-like knobs. All functions of the HP 54620A are accessible through direct-access controls.

The unit also allows users to connect an oscilloscope via a front-panel trigger output. Linking the two instruments gives users a complete picture of circuit operation, with the logic analyzer providing signal relationship information and the oscilloscope displaying parametric waveform information.

For information, contact Hewlett-Packard in Colorado at 800-452-4844, ext. 8598; or circle **Reader Service 115**.



## Digital Processing Software

Waves offers WaveShell, a program which allows real-time processing of digital audio with any one of Waves' plug-ins.

WaveShell turns the Q10 parametric equalizer, the L1 ultramaximizer and the C1 compressor/gate into "outboard" digital processors for real-time applications, such as DAT-to-DAT or DAT-to-CDR mastering, tracking and mixing. Waves plug-in users can select any one of the processors installed on their system and adjust all parameters in real time. WaveShell also allows the user to load, save and perform and A/B comparison of setups.

Version 1.0 of WaveShell runs on DigiDesign DSP hardware for the Macintosh.

For information, contact Brian Covington in Tennessee at 615-588-9307; fax: 615-588-9472; or circle **Reader Service 23**.

## Wireless Mic System

The Vega PRO 2 wireless microphone system includes the R-32B true-diversity receiver, equipped with Vega's Dynex III audio processing. This processing provides exceptionally high signal-to-noise ratio and low distortion. The receiver is designed to be highly selective, incorporating GaAsFET RF amplifiers, miniature helical resonators and 11 poles of IF filtering.

PRO 2 systems are available with either bodypack or hand-held transmitters, with a variety of microphones and mic elements also available.

For information, contact Paul Baughman in California at 800-877-1771; fax: 818-444-1342; or circle **Reader Service 160**.

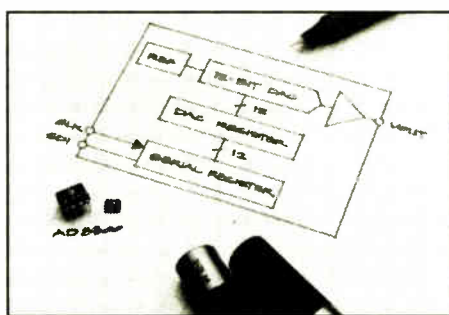

## D/A Converter

The AD8300 from Analog Devices is a 12-bit voltage-output D/A converter that operates from a single 3-volt supply. It requires no external components and integrates a converter, reference and output amplifier into a compact SO-8 or eight-pin DIP package. The size and low power consumption of 4.5 MW make the AD8300 make well suited for portable equipment or for use in PCM-CIA cards.

With a minimum supply voltage of 2.7 V, the AD8300 can comfortably operate

from battery supplies, even in cold weather or at the end of battery life. With a maximum supply voltage of 5.5 V, it can be used in traditional 5-volt logic systems.

For information, contact the company in Massachusetts at 617-937-1428; fax: 617-821-4273; or circle **Reader Service 209**.

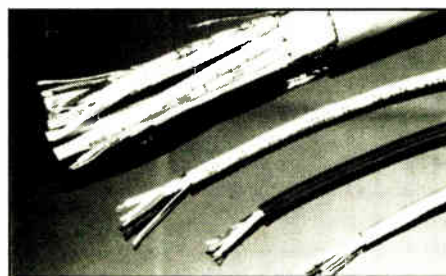

## Digital Audio Cables

Gepeco International Inc. offers the two-pair (Part No. 552402) and eight-pair (Part No. 552408) cables, designed specifically for use in digital audio and time code applications. All of the Gepeco multi-pair digital audio cables, which also include four- and 12-pair cables, maintain 110 ohm AES/EBU time code requirements, conform to NEC Article 800 and are UL Listed Type CM.

These cables utilize two solid polyethylene rods for mechanical and electrical stability of the cable. Set between twisted insulated conductors, these rods prevent the conductors from moving inside the jacket and obstruct air from entering the pairs.

Other features include 24-gauge tinned copper conductors, individually shielded and jacketed pairs, and an alphanumeric surface print for easy pair identification.

For information, contact Greg Hansen in Illinois at 800-966-0069; fax: 312-733-6416; or circle **Reader Service 213**.



## Digital Packet Radio

Azden Corp. offers the PCS-9600D, a 35 W digital packet radio. The PCS-9600D transceiver incorporates all the special features required by high-speed packet radios. Included are 35 W of high-power output, 20 kHz wideband IF, wide frequency range from 430-450 MHz and solid state diode TX/RX switching. A full touch-tone microphone is included for voice operation.

For information, contact Sid Wolin in New York at 516-328-7500; fax: 516-328-7506; or circle **Reader Service 67**.

## Vocal Processor

The Vocalist VHM-5 by DigiTech is a vocal processor that provides natural-sounding harmonies with complete editing and programming capability. This

processor accommodates up to five-part harmonies and even compensates for off-key vocals. The Vocalist also offers full MIDI compatibility, as well as 128 factory presets and 128 user-definable programs.

Other features of the Vocalist include on-board synth and keyboard for cue-in tone, simplified harmony editing and selection, built-in mic preamp and headphone jack, and programmable portamento, vibrato and volume.

For information, contact Bruce Holt in Utah at 801-566-8800, ext. 587; fax: 801-566-7005; or circle **Reader Service 200**.



## XLR Receptacles

The Neutrik A and B Series of XLR receptacles are available in every configuration and for all methods of assembly, including P.C. mount, horizontal, vertical, left or right horizontal, and IDC contacts. All of these XLR chassis connectors offer high population density in a compact unit. They also feature a reliable "tuning fork" contact principle; all male/female contacts, including the soldering area, are hard gold-plated. An optional pin one direct-to-ground (chassis) facility is available.

For information, contact Ellen A. Wagner in New Jersey at 908-901-9488; fax: 908-901-9608; or circle **Reader Service 207**.

## TECHNOLOGY UPDATE

### SPECTRAL INC.

#### Spectral Translator Acts As Link Between Company's Digital Audio Workstations and Modular Multitracks

**WOODINVILLE, Wash.** The Spectral Translator from Spectral Inc. permits direct digital communication between Spectral's high-speed digital audio workstation and the new modular digital multitracks from Alesis, Fostex, Tascam, Sony and Yamaha.

In addition to allowing any two devices in these formats to talk to one another, the Translator allows stations with either individual or networks of Spectral digital audio workstations to lock them to any of these multitracks for track expansion or editing and to back up hard disk-edited audio at eight times real time.

For information, contact the sales department in Washington state at 206-487-2931; fax: 206-487-3431; or circle **Reader Service 159**.



**Broadcast  
Electronics  
AIR TRAK  
At-A-Glance**

- Available 6, 8, 12, 18 or 24 channel consoles
- VCA Audio Control
- Stereo & Mono audition and program outputs
- Optional P&G Linear faders
- Multiple-source input mixing
- Quiet Electronic switching
- Versatile talk-back system
- Dual synchronous clock/timer

# More Board For The Buck.



Top-of-the-line performance at a lower cost is what Broadcast Electronics AIR TRAK studio consoles are all about. The AIR TRAK 90 is among the most technically advanced console on the market - engineered to include all the features you'd ever want or need. And on-air talent tells us the AIR TRAK is among the easiest to operate. Simply put, AIR TRAK consoles from Broadcast Electronics give you more board for your buck.

### Backed by Our Commitment to You.

AIR TRAK consoles are all BE. Field-proven and backed by Broadcast Electronics 24-hour commitment to service and your operation. Even though you might expect to pay big bucks for BE quality like this, you won't. You'll get more bang (and board) for your buck with BE.

**To get more board for your buck, call today**

## 217-224-9600



# **BROADCAST ELECTRONICS, INC.**

**WORLD LEADER IN RADIO BROADCAST TECHNOLOGY**

4100 N. 24th Street/P.O. Box 3606/Quincy, IL 62305-3606/(217)224-9600/Fax: (217)224-9607





# The Dynamax MX Series

"E" Models From 8 to 18 Channels  
New Beige Finish or Metallic Gray

- True modular design
- Ultra-reliable motherboard construction
- VCA mixer and monitor control
- Active balanced line inputs, transformer isolated mic inputs
- Active balanced main and monitor outputs
- Full monitoring/cueing facilities with VCA level control and active source selection
- Built-in cue amp with speaker and amplified stereo 8-ohm headphone output
- Independent remote start for each "A" and "B" input
- Opto-isolated remote module on/off
- Selectable fader start
- **New** Optional 5-band mic EQ module with pan
- **New** Telephone interface module

- Two inputs per module, mic/line or line/line – line input may be mono or stereo, consumer or professional format
- Four assignable outputs – two stereo plus two mono
- Available in 8, 10, 12, 14, 16, or 18 channel models
- Independent level controls for each "A" and "B" input
- Separate audio and logic power supplies
- Sturdy, all-steel construction
- Durable Lexan overlay control surfaces
- Count-up event timer standard
- Two input expansion switches standard
- Excellent RF immunity
- **New** Studio talkback/monitor module

*Equipment Solutions To Keep You Number One*

**BSW**  
BROADCAST SUPPLY WORLDWIDE

Toll Free 800-426-8434

Toll Free Fax 800-231-7055

7012 27th Street West Tacoma, Washington 98466

Circle (20) On Reader Service Card



# Broadcast Equipment Exchange

"Broadcast Equipment Exchange" accepts no responsibility for the condition of the equipment listed or for the specifics of transactions made between buyers and sellers.

## RADIO RESOURCES

Over the last 2 years we have purchased \$1 million of quality pre-owned equipment from broadcasters. Fax or call us with a list of your excess equipment and we will let you know how we can increase your cash flow.

Looking to **save dollars** by purchasing a piece of quality pre-owned equipment? We have a variety of items available from turntables to transmitters. A partial list of available equipment can be obtained via fax by calling toll free 1-800-832-2329 ext 737, or call us with your specific requirements.

**NRSC Splatter Measurements** are coming again! Call early to reserve your rental of the Tektronix Spectrum Analyzer. We also have Potomac field strength meters (AM & FM), and a Delta impedance bridge plus receiver/generator for rent.

For competitive prices on **new equipment items** just give us a call for a price quote.

Call Steve or Chuck  
**1-800-54 RADIO**  
1-410-783-4635 (FAX)

Circle (165) On Reader Service Card

## AMPLIFIERS

### Want To Sell

Dynaco ST70 tube amp, pre-amp and tuner; Classic Sherwood 3 way speaker system (2), BO. R Davis, Wango Records, 304-274-1419.

**Inat-Hindes SX-87** phone hybrid, early version, \$150. S Schweiger, WXLO, 250 Commercial St, Worcester MA 01608-1721. 508-752-1045.

**Ward Beck** dist amp, \$300/BO. T Ray, WTIC, 203-522-1080.

## ACOUSTICS

### Want To Sell

## STUDIOFOAM

SOUND ABSORBENT WEDGES

TESTS UP TO 40% BETTER THAN SONEX

COSTS LESS • BETTER COLORS • BETTER CUT

1"-\$8.99 • 2"-\$11.99 • 4"-\$22.99

20/box • 12/box • 8/box (all 2"x4")

Clients: Ford Motor Co.-Kodak-US Gov't  
Dennis DeYoung (Styx)-Rockwell Int'l-MTX  
Manley Audio Labs-Warner Bros.-Editel  
Bell Tel. Rsrch. Labs-Opryland USA-Hitachi  
Baldwin Pianos-Martin Marietta-Music Bakery

Min. 1 Box • MC Visa Discover AmEx

Call For Free Samples & Brochure!

USAFOAM • Box 23384 • Indianapolis IN 46220 • 317-251-9292

**1-800-95-WEDGE**

Circle (188) On Reader Service Card

## AMPLIFIERS

### Want To Sell

**NAD 3130** stereo amp, \$100. R Miller, Miller Media Group, Taylorsville IL. 217-824-3395.

**Radix DA-1600** 16 chnl, 2 in, 16 out, perfect cond, \$99. R Erak, GMI Media Group, 2012 S 314, Federal Way WA 98003. 206-839-9414.

### Want To Buy

**McIntosh MI-200** rackmount tube amp. 212-343-0265.

## ANTENNAS/TOWERS/CABLES

### Want To Sell

**Andrew (2) 2" flanged rigid 3 1/8" sections**, in box, never used, \$125 ea; **Scala HCDA-5** cut to 92.1, used one year, \$160. K Browall, KTRZ, Box 808, Riverton WY 82501. 307-856-2922.

**2 bay FM** on 89.3, \$200. R Miller, Miller Media Group, Taylorsville IL. 217-824-3395.

**Cable Wave A 10R 50507 1 5/8 in coax**, approx 6 275' rolls w/connectors, \$1100/roll. S Ross, Quinn Bdcg, 733 N Green St, Brownsburg IN 46112. 317-852-9119.

**300' towers (2)** in WV, buyer responsible for removal, BO. Jack, 304-562-9155.

**ERI GSCPS**, 8 bays, on 94.9. G Hofer, KJLT, POB 709, N Platte NE 69103. 308-532-5515.

**FM 10 bay high power** on 99.5, \$5500. F Hoffman, Corpus Christi TX. 512-851-1725.

**Rohn 45G 30'** new tower, \$850; **MarkGrid 10'**, 950 MHz, dish new never used, \$2000. D Lang, NW TalkRadio, 7404 SE Johnson Ck, Portland OR 97206. 800-313-5313.

**10 bay ant ERI FMH-10AC** circular polarized, tuned to 105.5, new, \$35,000; **100' 3" Helix**, new on reel, \$5/ft; **100' of new 3" cable wave CC300-50J** on spool, \$15/ft; **lg spool for 3" wave guide**, new, \$500. M Wodlinger, 813-262-1118.

## NEW ANDREW CABLE

Have tons of LDF 2-50, 3/8" @ only .75/ft.

Jim Mussell, 1421 Bay Ave. Santa Maria, Ca. 93454

805-922-7775 fax 925-6663

**Continental G5CPS-12**, 12-bay, broadband centered at 105.5, operated at 107.5, \$17,000; **Andrew HJ8 3" line**, 440', \$4000; **Miscellaneous parts** from dismantled DA, variety of caps, coils, switches, BO. J Mulhem, KSCB, 1600 E 8th, Liberal KS 67901. 800-373-3891.

**ERI 1105** medium power and dual cycloid, on 98.3 MHz, \$1850. Max, KCMJ, Box 551896, Dallas TX 75355. 800-891-006.

## TOWER LIGHTING CONTROLS

For Aviation Obstruction Lights, Beacons, and Strobe Light Systems.

Photoelectric controls that conform to FAA requirements. Some models are also available on a custom basis.

**PRECISION**  
PRECISION MULTIPLE CONTROLS, INC.  
33 Greenwood Ave. • Milford, NJ 07432  
Tel (201) 444-0600 • Fax (201) 445-0575

**Hughey Phillips** tower light controller spare parts. New, large assortment, (thermal relays, mercury switches, motors, more). \$235/lot. K Ellis, POB 782, Pikeville NC 27863. 919-242-6000.

### Want To Buy

**10-12 bay centered CP system** on 93.5 or lower, need high pwr. E Moody, KJEM, 216 N Main, Bentonville AR 72712. 501-273-9039.

**6-8 bay FM** on 95.1 or 95.3, prefer ERI or Jampro. L Fuss, WDTL, POB 1438, Cleveland MS 38732. 601-846-0927.

**FM antenna tuneable to 105.9 MHz**, 6-10 bays; **Rohn tower sections 25G**, 45G, 55G or 26KD, 300' Helix xmsn line 1 5/8" or 3". J Powley, WAOM, 1512 Sherwood Dr, Reidsville NC 27320. 910-342-1843.

## AUDIO PRODUCTION

### Want To Sell

**8 track studio equipment**, complete studio. H Sewell, Oakridge, 2001 Elton Rd, Haltom City TX 76117. 817-838-8001.

**Aphex 10/4** audio interface, -10/+4, \$99. R Erak, GMI Media Group, 2012 S 314, Federal Way WA 98003. 206-839-9414.

**Cypher time code generator/reader** system w/video inset card, Shadow II time code module, machine control synchronizer and Softouch keyboard controller w/microcomputer regulator, exc cond, \$6000/BO. K Johnson, Audio One, 325 W Huron St, Chicago IL 60610. 312-337-5111.

**dbx 263X** de-esser, variable freq 800-8000 Hz, mint cond, \$85. W Haley, Rt 2 Box 362-B, Gordonsville VA 22942. 703-832-5247.

**Hewlett Packard 3490A** rk mt millimeter w/data interface, \$125; **Remote control** and manual for Yamaha REV-7, \$30; **MXR side-car console-mount Autoflanger**, \$300. R Santo, Box 634, Bryantville MA 02327. 617-293-5671.

**Langevin 119A Progar AM7A** limiter, AM 5301 level line or hitecs-filters, CBS stereo adapt for Audimax II RZ or UTC HA106 xfrms, HA 114 many Langevin parts & chnl, strips for trade or sale. P Barlow, Studio Trax, 382 N Lemon Ave, Walnut CA, 909-594-1841.

**Howe Phase Chasers (3)**, exc cond, \$250/all. F Hoffman, Corpus Christi TX. 512-851-1725.

**Master Room XL121** reverb unit, \$125; **SAE 5000A NR** unit, \$100. C Stalnaker, KDDK, POB 100, Little Rock AR 72203. 501-372-7740.

**SAVE \$300 ON TT 96 & 144 POINT PATCH BAYS** brokers of fine and coarse used equipment **audio village 619/320-0728**

**McMartin LR1004C** comp/limiters, \$300/pr; **Altec 1589C** mic pre, stereo in, mono out, \$125/ea or 3/\$300; **Kahn Symetra-Peak SP51a** passive filters, \$300 pr; **Ampex AM-10** 6 chnl mic pre/mixer, stereo out, \$175. R Santo, Box 634, Bryantville MA 02327. 617-293-5671.

**360 Systems DigiCar/I** model 1000, in gd cond, w new 44 MB cartridge drive, manual, keyboard adaptor cable, Digital Audio Disks, new (4), used (6), BO. S Runck, KFNW, 701-282-5910.

**Fostex 3180** reverb unit, will swap for Urei "Cooper Time-Cube". E O'Brien, Imperial Sound, 383 N Studio St, Terre Haute IN 47803-9773. 812-877-2663.

**Henry Engineering Mix Minus Plus**, new, \$90; **Henry Engineering LogiConverter**, new, \$90; **Valley International HH2X2B** Level Matching Interface, \$150. C Scherer, WMMMS, 200 Skyline Office Tower, 1660 W 2nd St, Cleveland OH 44133. 216-781-9667.

**Micro Technology** microsoudn digital audio workstn, 2 gig HD editor, 486 computer, AES/EBU in out +4 bal in out, rack config, \$9500. P Boone, UNC Public TV, 306 Emerson Dr, Mebane NC 27302. 919-563-3995.

**Moseley TFL-1** Audio Limiter, \$150/BO; **Barcus Berry** audio processor, \$500/BO; **Eventide FL-201** flangers (2), \$200/ea/BO; **DBX 363X** noise gate, \$150/BO; **Orban 111B** reverb units (2), \$150/ea/BO. T Ray, WTIC, 203-522-1080.

**ADC 1/4" patchbays** and cords, NEW, UNDER HALF PRICE, ADC TT patchbays, \$129 up, NEW cords, \$9.95. W Gunn, POB 2902, Palm Springs CA 92263. 619-320-0728.

**Good used studio tape 1/2"** \$15, 1" \$30, 2" \$55. W Gunn, POB 2902, Palm Springs CA 92263. 619-320-0728.

**Panasonic SV255 DAT**, \$1100; **Audio Technica AT4462**, \$800; **Ashly GQ2131 EQ**, \$700; **dbx 140**, \$125; **SAE 5000**, \$150; **Burwen TNE7000**, \$300; **Burwen 1201**, \$125; **Advent Smaller Speakers**, \$200/pr; **Macintosh C8** pair - rebuilt with custom power supplies, \$1500/pr; **Haller THX 9300**, \$850. Call 718-367-5385.

**UREI LA4** mint pr, \$1095; **Lexicon Alex**, \$295; **bulk eraser**, \$49; **Stewart direct boxes** mono, \$50; **4 Ch**, \$95; **Cue command decoder**, \$125; **ABC Network decoder**, \$125; **NEW Tascam midizer MTS1000**, \$750; **Dyna stereo 120** rack mt amp, \$229; **Sherwood FM tuner**, new tubes, \$49; **Infonics 7"** reel copier 3 copies, \$125 ea; **Crown & Furman** elec crossovers, \$95. W Gunn, POB 2902, Palm Springs CA 92263. 619-320-0728.

### Want To Buy

**Altec 436A**, Roland Dimensions D, Ampex MS-10, Roland SDE-3000 and old tube Fender amp in need of repair. R Santo, Box 634, Bryantville MA 02327. 617-293-5671.

## MERCENARY AUDIO

### WANTS TO BUY YOUR:

NEVE-SSL-TRIDENT-AMEK  
UREI-TELETRONIX-FAIRCHILD  
PULTEC-LANG-LEXICON  
UNIVERSAL AUDIO-NEUMANN  
AKG-TELEFUNKEN-AMS

ANYTHING THAT IS  
OF EXCEPTIONAL  
AUDIO QUALITY!

TOP DOLLAR PAID

"this is not a problem"  
(508)543-0069 TEL  
(508)543-9670 FAX

**Ampex tube mixers**, plug-in mic pre-amp modules for PR10's. W Gunn, POB 2902, Palm Springs CA 92263. 619-320-0728.

## HALL Electronics

706 Rose Hill Drive Charlottesville VA 22901

### Check out these Great Deals on Rebuilt Equipment!

Orban 8000A FM Stereo Optimod -	REBUILT	\$ 1,495
Aphex Dominator II Stereo Limiter -	DEMO	\$ 795
Otari MX-5050 Mark III-2 1/2 Track Stereo Reel -	REBUILT	\$ 2,195
Revox B-77 Reel 7 1/2 & 15 IPS -	REBUILT	\$ 895
Teac X1000R 1/4 Track Stereo Reel Auto Reverse -	REBUILT	\$ 595
McMartin B-502 5 Pot 10 Input Stereo Console -	REBUILT	\$ 595
Urei 530 Stereo Equalizer -	REBUILT	\$ 295
Potomac SMR-11R Precision Broadband AM Tuner -	LIKE NEW	\$ 1,295

## LPB SALSA - \$ 8995 LIST

386DX33 PC System with 1 Gigabyte Hard Drive  
Open-ended architecture, always upgradeable  
Simultaneous Record and Play of audio  
Stereo and Mono audio

User-controlled variable audio overlap for live-sounding segues  
Accepts downloads from all traffic and music scheduling systems  
Provides a 31-Day historical log of everything that aired and when  
System support available 24 hours a day, 365 days a year

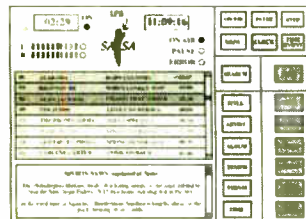

## LPB®

The LPB Signature III series consoles have electronic/mechanical reliability second to none.

We have a \$158 Pot Dual Mono Console in stock available for immediate shipment for just \$4095!

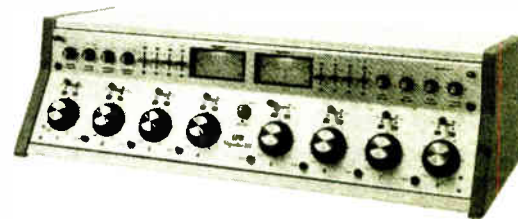

\$15 Model Shown

## TASCAM DA-88

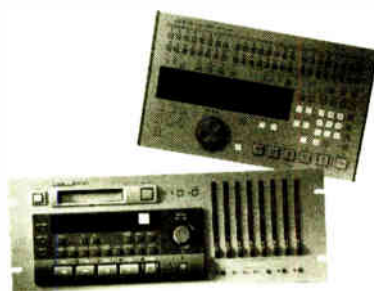

The new technology of the DA-88 will dramatically change the way we work in the studio, not how we operate the recorder. The DA-88 is a linear digital 8 track multitrack recorder that uses Hi-8mm metal particle tape. It is designed to operate in the same fashion as any TASCAM deck you have ever used.

The DA-88 features "ATF" or Automatic Track Finding which is the heart of the 8mm format that allows the DA-88 to consistently and accurately lock multiple decks and always have perfect interchangeability of tapes and decks.

List \$ 4,499 IN STOCK!

Call us for the Best Digital, New & Completely Rebuilt Equipment! (804) 984-HALL (4255) (804) 984-FAXX (3299)

Circle (9) On Reader Service Card



## AUDIO PRODUCTION...WTB

Howe stereo Phase Chaser corrector. J Luebbe, 10490 Taconic Tr, Cincinnati OH 45215. 513-772-1919.

Audio Precision System One audio analyzer. J Urbanczyk, 5520 W Trouhy Ave, Skokie IL 60077. 708-676-9177.

## AUTOMATION EQUIPMENT

## Want To Sell

360 Systems DigiCart with 400 MB internal hard drive, Dolby AC-2 compression, \$3500. L Fuss, WDTL, POB 1438, Cleveland MS 38732. 601-846-0927.

BE automation system with controller, live assist racks, Carousels (4), ARS1000 (2), 48 tray Insta-Cart w/interface, Wegener satellite receiver, all service manual, exc cond, \$5000. F Hoffman, Corpus Christi TX. 512-851-1725.

Cetec 7000 w/5045 event memory; 350 series Carousels (4); 250 series Carousels (3), \$1000. E Moody, KJEM, 216 N Main, Bentonville AR 72712. 501-273-9039.

Cetec Audiofile II (2), 1 gd cond, other for parts, you pick up or pay shipping. \$275/both. E Moody, KJEM, 216 N Main, Bentonville AR 72712. 501-273-9039.

Drum/tray motors for IGM 250 or 350 Carousel, never used. \$100. F Vobbe, GNBC, Box 5031, Lima OH 45802. 419-228-4199.

MW Persons 3-A programmer, \$375. G Fuller, WKKR, 205-745-4656.

Sentry ES-12 audio cntrlr w/20 Pioneer 6 pack CD players, \$6500/BO. C Stalnaker, KDDK, POB 100, Little Rock AR 72203. 501-372-7740.

Complete Systemation automated systs (2), \$6000. M Wodlinger, 813-262-1118.

Smartcaster 8 kHz mono HD audio computer, 4 hrs storage, recent factory refurbished, \$3500. R Miller, Miller Media Group, Taylorsville IL. 217-824-3395.

SMC 24 cart mono, 6 complete units in racks, \$300. D Lang, NW TalkRadio, 7404 SE Johnson Ck, Portland OR 97206. 800-313-5313.

BE Control016 complete systems w/IGM Go-Carts (4), spare parts, \$1000. B Moede, WEMI, 1909 W Second St, Appleton WI 54914. 414-749-9456.

Cetec Schafer brain, 19 audio inputs, lockout/alarm, manual, override panel, power supply, BO. J Mulhern, KSCB, 1600 E 8th, Liberal KS 67901. 800-373-3891.

Format Sentry FS-12C, 1 48 tray IGM Instacart, 4 R-R ITC playback machs, 1 Panasonic CD player, 1 Tandy 1,000 SL computer, 1 Tandy DMP printer, 1 Spolmaster record playback cart mach with 5KH tone alert, 1 DRS uninterruptable power supply, 2 6' racks, & all related equipment, all new, owe \$16,000, will sacrifice. A Terry, 703-647-8493.

Smartcaster digital automation system, stereo, simul record/playback, all accessories, never used, \$10,000/Best Offer. T Ray, WTIC, 203-522-1080.

SMC 350 RSB carousels (4), gd cond, \$250/ea, \$800/all. P Patton, WWAM, POB 279, Jasper IN 37347-0279. 615-942-1700.

Cetec 7000 automation system. With (3) terminals, (9) ITC R-R, (5) Sono-Mag carousels, (2) 48 tray ITC Instacarts. System price \$5000. Call Tu-Mar Broadcasting, Houghton MI. 906-482-7700.

Smarts SAT-PAC Smart Caster with 100 Meg HD, dbx external audio processor, Smarts Isobar Line filter and UPS emergency power supply. Best Offer, include shipping. Dave Peters, Norwest Financial. 800-247-0032.

## Want To Buy

SMC 250 Carousel manual. J Chion, Rt 2 Box 533, Tall FL 32311. 904-878-5746.

## CART MACHINES

## Want To Sell

BE Spotmaster Super B, R/P, pay shipping and it's yours. B Howard, KOFO, 320 E Radio Rd, Ormasa KY 66067. 913-242-1230.

BE 3000 R/P in gd cond, BO. D Missad, WOOD, 180 N Division, Grand Rapids MI 49503. 616-459-1919.

Fidelipac CTR-100 (9), play only, \$500; CTR-100 (2) R-P, \$700. G Saber, WQOK, 8601 Six Forks Rd, Raleigh NC 27615. 919-848-9736.

Great Prices on original equipment tape heads for ITC, BE, Fidelipac, Otari, Tascam & others!

(804) 984-4255

**HE HALL Electronics**

Fidelipac CTR-90 stereo play, \$600; ITC WP stereo R/P, \$650; ITC WP mono R/P, \$550. G Fuller, WKKR, 205-745-4656.

ITC RP/Premium mono, 3 tone R/P, all mods, vgc, incl spare audio card, starter cap and manuals, \$750; RCA RT-27A (3), RT-7A (2), spare parts, spare motor, all docs, \$75 + shpg. F Vobbe, GNBC, Box 5031, Lima OH 45802. 419-228-4199.

ITC 99B completely refurb, R/P, stereo, new logic and audio cards, gd cond, \$1950. J Katonah, WFGB, POB 777, Lake Katrine NY 12449. 914-336-6199.

UMC plybk cart machine, \$75/BO; UMC rcd/plybk cart machine, \$150/BO. T Ray, WTIC, 203-522-1080.

Spotmaster TP1A cart winder, w/new splice block, vgc, \$100. F Vobbe, GNBC, Box 5031, Lima OH 45802. 419-228-4199.

AudioCord A Series stereo cart plyrs (2), 1 ITC SP stereo cart plyr w/SAW card, 1 Tapecaster 700 stereo cart rcd, 1 Otari CTM10 stereo/mono cart plyr, lk new, 1 ITC Delta I/IV stereo cart rcd, just rebuilt by ITC, BO. J Pierce, KMZQ, 702-595-5705.

No matter how you stack it...



## Nobody reconditions tape heads like JRF.

- Heads restored to new performance spec at a fraction of new cost
- Cart machines and all open reel formats
- Full line of replacement heads for all manufacturers

Experience the difference experience makes. Ask around. Nobody treats you or your heads better than JRF.



249 Kennedy Rd., Greendell, NJ 07839  
(201) 579-5773 Fax (201) 579-6021

Fidelipac 300 series carts, large quantity, various lengths, most in excellent condition, some new, \$3 or \$4/ea+shipping. M Sophos, WDFH, 21 Brookside LN, Dobbs Ferry NY 10522. 914-693-3963.

ITC Delta Stereo rcd/ply, lk new, wks grt, \$1000/BO. C Scherer, WMMS, 200 Skylight Office Tower, 1660 W 2nd St, Cleveland OH 44133. 216-781-9667.

RCA/BE RT120 Series stereo R/P, rebuilt; PB machine, manuals, spare parts, new carts, \$1300/all or BO. J Stromquist, WNCB, 2828 Piedmont Ave, Duluth MN 55811. 218-722-3017.

Tomcat and Micromax; Otari Mark II 8 trk w/DBX; Splicefinders, compressors and more. J Rivers, KTLV, Dallas. 214-630-9400.

UMC Beaucart 201-121-049 ply only deck, no top cvr, \$150/BO; BE 2100 ply only, missing top & bottom cvrs, \$150/BO. R Thompson, KLON-FM, 1288 N Bellflower, Long Beach CA 90815. 310-985-5566.

BE 5300C tripledeck, stereo, PB, mint less than 50 hrs, BO. R Kaufman, Pams Prods, POB 462247, Garland TX 75046. 214-271-7625, after 3PM CDT.

LOWEST COST digital cart machine. the AUTO-MATE uses your IBM 386+ and SoundBlaster card. Introductory price: \$149.95! FREE demo disk/information: (503) 769-2886.

## Want To Buy

BE 3-deck cart mach, motors must be rebuildable, \$100. D Rust, BE, 217-224-9600.

UMC Bearcart, cart machines, will pay \$50 non-working, up to \$125 working. Don, WMCB, 601 22nd Ave, Meridian MS 39307. 601-693-1450.

ITC, BE, Fidelipac cart machines: single, triple, mono, stereo, play & record/play. Call M O'Drobinak @ 619-758-0888.

## CASSETTE &amp; REEL-TO-REEL RECORDERS

**STUDER SERVICE SPECIALIST**

Thousands Serviced • Unbeatable Rates  
Precision Capstan Resurfacing

**Audio Advantage**

Tel (615) 742-3834  
**PRICE-QUALITY-SERVICE**  
Let Us Prove It

## Want To Sell

Fostex R8 8 trk, 1/4", never used, \$1800. J Davis, WJSP, Rt 1 Box 140, Warm Springs GA 31830. 706-655-2145.

Revox PR99 near mint stereo, reproduce only R-R w/25 Hz decoder, \$400. M Persons, 402 Buffalo Hills Lane, Brainerd MN 56401.

Scully 284B gd cond, \$5000. H Sewell, Oakridge, 2001 Elton Rd, Haltom City TX 76117. 817-838-8001.

Sony TCD-D7 used twice, pwr supply and manual, \$425. C Denson, Crystal River Prod, POB 722, Thompson Falls MT 59873. 406-827-4611.

3M M79 24 trk w/Select Take 2, \$7000; Ampex A 440-B, 1" 8 trk, \$1000. B Yauger, VCA, 9332 Larson Road, Cassville NY 13318. 315-839-5841.

Ampex ATR800 \_ 2 track w/remote, pedestal and spare electronics, \$2000. B Yauger, VCA, 9332 Larson Road, Cassville NY 13318. 315-839-5841.

Inovonics 380, gd cond, BO; Akai 4000 DS MK II, gd cond, BO. D Missad, WOOD, 180 N Division, Grand Rapids MI 49503. 616-459-1919.

**REVOX PARTS/SERVICE**

Cassette-CD-Open reel  
Rebuilt A77s, \$850.00  
Capstan resurfacing, ALL BRANDS.

**JM TECHNICAL ARTS**  
30 Music Sq. W. #156  
Nashville, TN 37203 (615) 244-6892

ITC PB decks, \$125. D Lang, NW TalkRadio, 7404 SE Johnson Ck, Portland OR 97206. 800-313-5313.

ITC 750 (2) stereo decks, \$150/ea; Scully 280-B SP-14 stereo rcd, \$400; Ampex 440-C stereo rcd w/console, \$800. G Fuller, WKKR, 205-745-4658.

Otari MX5050-2S, good condition. Meets all specs, \$950. Lawrence Gable, Reunion Entertainment, 407-646-6827.

Tascam MSR 16 \_ 16 trk dbx-1 parallel and serial ports, \$2800. D Lewis, 4th St Studio, 88 4th St, Bangor ME 04401. 207-941-0810.

Nagra-3 w/pwr sup, R-R, exc cond, \$1000; MCI 8 trk w/remote, exc cond, \$2000/OBO; Otari 8 trk w/auto locator, R-R, exc cond, \$2000. K Johnson, Audio One, 325 W Huron St, Chicago IL 60610. 312-337-5111.

Otari 7308 8 trk 1" recorder, low hrs, heads exc, 15/30 ips, w/remote, \$2500; Studer Revox PR99 2 trk, 7 \_ & 15 ips, low hrs, exc cond, \$1600; Ampex 440, 2 trk R/P 7 \_ & 3 \_ ips, \$500; Scully 280, 2 trk, PB only, 7 \_ & 3 \_ ips, \$200; Teac A-2000 1/4 trk R/P, 7 \_ & 3 \_ ips, exc cond, \$200. L Wagner, ARN, POB 1788, Orlando FL 32802. 407-299-1299.

## HEAD RELAPPING/REPLACEMENT

All tape and film formats  
30 years experience

**iem**

350 N. Eric Drive  
Palatine, IL 60067  
708-358-4622

Otari MX 5050 2 chnl R-R, exc cond, \$950. P Kelnor, 11461 Encore Dr, Silver Spring MD 20901. 301-681-9257.

Revox PR99 2 trk stereo PB, \$500. C Stalnaker, KDDK, POB 100, Little Rock AR 72203. 501-372-7740.

Revox A77B good condition, \$100+ or trade. A Branch, WGHR, 2402 Woodridge Dr, Decatur GA 30033. 404-325-7847.

Scully 284 1" 8 trk R-R, take up reel, alignment tape and manual inc, gd cond, BO. F Cataldo, FC Sound, 351 Carlism Dr, Rochester NY 14609.

Scully 250 R-P R-R 3 \_ and 7 \_ speeds, \$100. R Miller, Miller Media Group, Taylorsville IL. 217-824-3395.

Radio Systems RS-DAT (3), RS-670's in good condition, no rack mounts, \$1500/ea OBO; RS-1000 with rack mount, \$1900/OBO; Otari ARS-1000 PB machines in good condition, \$425 ea/OBO. C Barniowski, WLPE, 706-733-8201.

Technics 10A02 R-Rs (2) + 1 for parts, BO. J Pierce, KMZQ, 702-595-5705.

Ampex ATR 100 (2) 4 trk \$3500 ea, 2 trk 1/2" \$4000, (2) 2 trk 1/4" \$2500 ea. 212-343-0265.

Otari Mark II-IV 1/2" 4-track, multi-track, mint, less than 50 hours, Best Offer. R Kaufman, Pams Productions, POB 462247, Garland TX 75046. 214-271-7625, after 3PM CDT.

Otari 5050-SHD 8 trk 1/2" newly rebuilt, heads have full, life left, \$1800. W Gunn 619-320-0728.

Scully '100' recorders, record/play amplifiers, 8, 16, 24 track heads. Sequoia Electronics, 4646 Hounds-haven Way, San Jose CA 95111. 408-363-1646.

**NORTRONICS REPLACEMENT TAPE HEADS**

Test Tapes, Degaussers, Gauges, Cleaners, Swabs, Lapping Films, Splice Bars/Tabs, and Demagnetizers

**SEQUOIA ELECTRONICS**  
(408) 363-1646  
FAX (408) 363-0957

Uher CR134 cassette, \$195; DAT decks with new heads \$550, Tascam ATR 60 8 track with stand, remote, \$3250; Otari 5050-8 no hrs on heads, \$1595, Ampex 440B-8, \$2450; Tascam 25-2, \$695; Ampex ATR700, \$695; Scully 16 track 2", \$3450; Tascam 52 top of line, \$950; M79-24 fully rebuilt, \$11,500; Tascam locator for 85-16, \$495; Fostex E22 1/2" timecode deck, \$1400; Fostex A80 8 track with 450 mixer, \$1350; Tascam 5, \$450; Nagra 10" reel adaptor, \$950. W Gunn, POB 2902, Palm Springs, CA 92263. 619-320-0728.

## Want To Buy

Inovonics 405 control unit for Ampex transports or equiv. D Dintenfass, 206-784-4803.

Any working R-R, or non working, players or recorders. Don, WMCB, 601 22nd Ave, Meridian MS 39307. 601-693-1450.

Ampex ATR100 taperecorders for parts. Circuit cards, heads, motors, machine parts, or electronic parts. Call 818-907-5161.

## CD PLAYERS

## Want To Sell

Otari MS 5050-B (2), 2 trk, mint cond, \$1900 ea/BO. C Barniowski, WLPE, 706-733-8201.

## COMPUTERS

## Want To Sell

Opamp Labs 2008-RS, 20 input, 8 buss + stereo out, 2 16x2 remix/cue sections, \$1500. L Wagner, ARN, POB 1788, Orlando FL 32802. 407-299-1299.

Tandy TRS 80 model 2 with DMP 120 printer, \$100. R Miller, Miller Media Group, Taylorsville IL. 217-824-3395.

## CONSOLES

## Want To Sell

Gates Stereo Yard, fair cond, prefer pick-up, \$200; Gates mono board, Octal-Base tube type, prefer pick-up, \$100. R Blair, Columbia School of Bdctg, 5808 Columbia Pike, Baileys Crossroads VA 22041. 703-820-2020.

Auditronics 8x4x2 with power supply, patch bay, custom made cabinet, excellent condition, \$3500/BO; Studer 12x2 portable with custom made cabinetry, good condition, \$4000. K Johnson, Audio One, 325 W Huron St, Chicago IL 60610. 312-337-5111.

BE 8 ch Spotmaster stereo board, ok condition; Carvin MX 1202, 12 channel, Best Offer. D Missad, WOOD, 180 N Division, Grand Rapids MI 49503. 616-459-1919.

McMartin B-803 needs amp and monitor, \$50 + shipping. B Howard, KOFO, 320 E Radio Rd, Ormasa KY 66067. 913-242-1230.

EV/Tapco 6000R 6 chnl rack mixer, XLR inputs, hi & lo EQ, reverb, \$200. W Haley, Rt 2 Box 362-B, Gordonsville VA 22942. 703-832-5247.

RCA BC-7, 10 chnl, stereo, \$600; LPB 5 chnl mono, \$750. G Fuller, WKKR, 205-745-4656.

Tascam M216 16 chnl stereo mixer, \$600; Sparta 5 pot board for parts, \$50. R Miller, Miller Media Group, Taylorsville IL. 217-824-3395.

Broadcast Audio Series II consoles (2), good cond, spare parts & manuals, 1 BE 150A console, exc cond with manual, BO. J Pierce, KMZQ, 702-595-5705.

LPB S-15A, 8 pot, 24 input, mono, exc cond, \$1300. J Wisbach, WMSS, 214 Race St, Middletown PA 17057. 717-948-9136.

Mackie 1604, \$575; Soundcraft Spirit 24x24, \$3950; Ramsa 820 20x8x16 w/meter bridge, \$1950; Quantum 23x16x24 as used by LA Philharmonic, \$4950. W Gunn, POB 2902, Palm Springs CA 92263. 619-320-0728.

## Want To Buy

Tascam M-208 or M216, mixer in perfect condition. N Sabu, Joyful Sounds Rec, 48 Moody Road, N Little Rock AR 72120. 501-835-7260.

Gates Yard, Yard II or Studioette, need not be working, pwr sup not req'd, must be cosmetically clean, prefer low price/trade. F Vobbe, GNBC, Box 5031, Lima OH 45802. 419-228-4199.

Gates Yard, tube or solid state. E Allman, WFIV, POB 55519, Orlando FL 32855. 407-847-4422.

Ramko DC-38 need 4 ins input card, working or not. D Roberts, WDUZ, POB 310, Green Bay WI 54305. 414-468-4100.

Neve console, any type and parts. 212-343-0265.

## DISCO-PRO SOUND EQUIPMENT

## Want To Sell

Digitech 256 XL multi-effects processor, low hours, excellent algorithms, \$250; Tascam PB-23P, patchbays, 32 1/4" points front and back, mint condition, \$75/ea or \$300/all. M Ravain, Trinity Christian Rec, POB 2479, Flaglor Beach FL 32136. 904-439-3671.

Electro-Voice Delta Max 15" concert speakers with controller, low hours, no aeroquip, \$2000/pr; JBL 4312A studio monitors, 12", 3 way mirror image, mint condition, \$500/pr. M Ravain, Trinity Christian Rec, POB 2479, Flaglor Beach FL 32136. 904-439-3671.

## DISTRIBUTOR DIRECTORY

The following distributors serving the broadcast industry would be glad to help you with any of your requirements.

...country, top 40, news, urban, talk, jazz, the classics, mixed bag...

RADIO! The beat goes on!

**CROUSE-KIMZEY OF ANNAPOLIS**

tops in broadcast equipment

1-800-955-6800

ask for Kathleen

**CORNELL-DUBILIER MICA CAPACITORS**

FROM STOCK

**JENNINGS VACUUM CAPACITORS**

FROM STOCK

**JENNINGS VACUUM RELAYS**

**SURCOM ASSOCIATES, INC.**

2215 Faraday Ave., Suite A

Carlsbad, California 92008

(619) 438-4420 Fax: (619) 438-4759



**DISCO-PRO SOUND EQUIP...WTS**

Realistic MD 1890 speakers (2), \$190/pr. R Miller, Miller Media Group, Tavoicrv.la ll. 217-824-3395.

**EBS EQUIPMENT**

**Want To Sell**

**ALERT! ALERT!**

From EBS to EAS in \$94 flat...

Comply and avoid tune out! Send in your working EBS equipment and we'll recalibrate it to the new 8 second EAS standard for \$94 including return shipping via surface. Expedited shipping will require an upcharge. Call for Repair Authorization no. and further info! From the service pros at Harris Allied!  
**317-962-8596 ext. 234**

**FINANCIAL SERVICES**

**EQUIPMENT FINANCING**

ON ALL RADIO EQUIPMENT

- Easy to qualify
- Fixed-rate, long-term leases
- Any new or used equipment
- 100% financing, no down payment
- No financials required under \$50,000
- Refinancing existing equipment



Call Mark Wilson  
**(800) 275-0185**

**LIMITERS**

**Want To Sell**

Orban 8100, \$1600. S McGrath, WGNV, 429 Little Britain Rd, Newburgh NY 12550. 914-561-2131.

Raytheon tube limiter, mono behemoth, \$400. R Sarita, Box 634, Bryantville MA 02327. 617-293-5671.

EXR SP-2 projector, stereo audio exciter, \$99. R Erak, GMI Media Group, 2012 S 314, Federal Way WA 98003. 206-839-9414.

Orban 8100A w/XT chassis, vgc, \$4100; Modulation Sciences CP803, composite clipper, \$500. G Saber, WQOK, 8601 Six Forks Rd, Raleigh NC 27615. 919-848-9736.

Hnat-Hindes prototype mic processor, \$50; CBS Audimax III, mono, nds wk, cleaning, \$50. S Schweiger, WXLO, 250 Commercial St, Worcester MA 01608-1721. 508-752-1045.

**THE**  
**Purple Processor™**  
Finally! A loud, clear and DYNAMIC FM processor without the grunge! We can prove it!  
Call **1.800.732.7665** for a DEMO.

stereo prep processor, SEP-800 spectrum energy processor, SMP-850 stereo mod processor, & SG-800-A stereo gen, \$4000/pkg. L DuPree, KQID, 1115 Texas Ave, Alexandria LA 71301. 318-445-1234.

Harris MS-15R stereo gen, \$1000/BO. R Thompson, KLON-FM, 1288 N Bellflower, Long Beach CA 90815. 310-985-5566.

**Want To Buy**

Fairchild 670 or 660 tube compressor/limiter, Teletronics LA-2A tube compressor/limiter or UREI LA-3A solid state compressor/limiter, call after 3PM CST. 214-271-7625.

**MICROPHONES**

**Want To Sell**

AKG C422EB, large diaphragm stereo, phantom pwr, remote pattern selector, 20-meter cable, windscreen and shock-mount, exc cond, \$1850; AKG D-140 cardioid, \$225/pr; AEA MS-38 DM dual matrix decoder, line-level in and out, \$250. R Streicher, Pacific Audio-Visual, 545 Cloverleaf Way, Monrovia CA 91016. 818-359-8012.

Shure VM-1 mic stand isolators (4), \$25. W Haley, Rt 2 Box 362-B, Gordonsville VA 22942. 703-832-5247.

EV RE20's, \$275-325; Sony ECM377 large dia. cond mic, \$495; RCA 44BX matched set of 3, \$3950; Shure new SM7, \$395; AKG new D112, \$295; Crown GLM200 lavalier like new, \$125. W Gunn, POB 2902, Palm Springs CA 92263. 619-320-0728.

**Want To Buy**

77-DX's, 44-BX's, WE KU-3A's On-Air lights, recording lights & audition lights. Top price paid. Fast response. Bill Bryant Mgmt, 2601 Hillsboro Rd, G12, Nashville TN 37212. 615-269-6131, FAX: 615-292-3434.

RCA mics, call plates, on air and recording lights, J Phillips, 414 Washington Ave, Defiance OH 43512. 419-782-8591.

RCA BK6-B, lavalier mic, D Dintenfass, 206-784-4803.

**THE**  
**Purple Processor™**  
Finally! A loud, clear and DYNAMIC FM processor without the grunge! We can prove it!  
Call **1.800.732.7665** for a DEMO.

parts. W Sear, Sear Sound, 353 W 48th St, NY NY 10036. 212-582-5380.

RCA mics for collection or trade, on-air lights, recording lights, J Phillips, 414 Washington, Defiance OH 43512. 419-782-8591.

RCA ribbons, AKG 451's, Neumann KM84's, EV 635A, W Gunn, POB 2902, Palm Springs CA 92263. 619-320-0728.

RCA 77DXs/44BXs ribbon, chrome/TV grey, gd cond, BO. R Kaufman, Pams Prods, POB 462247, Garland TX 75046. 214-271-7625, after 3PM CDT.

**MISCELLANEOUS**

**Want To Sell**

6' equipment rack, D Missad, WOOD, 180 N Division, Grand Rapids MI 49503. 616-459-1919.

Alden C-2000M color radar w/Sony Trinitron monitor, \$1000. C Porter, WCAZ, POB 498, Carthage IL 62321. 217-357-3128.

Equipment racks 54.25" panels space, 30" deep w/casters and internal ventilation, \$150 ea + shpg. D Barnett, KKUP, POB 820, Cupertino CA 95015. 408-325-5015.

Giant red boombox, 26' tandem axle trailer, \$20,000. D Bryan, POB 485, Carthage IL 62321. 217-357-6610.

Onan 7.5 kW, natural gas GenSet, w/transfer switch, low hours, \$7250. D Lang, NW TalkRadio, 7404 SE Johnson Ck, Portland OR 97206. 800-313-5313.

Road cases 24"x27"x15", suitcase style, military spec, \$100 ea. L Wagner, ARN, POB 1788, Orlando FL 32802. 407-299-1299.

Gentner SPH-5A phone hybrid, \$400/BO; Titus MLW-1 auto audio switch, \$900. T Ray, WTIC, 203-522-1080.

**Rotron Blowers** for Elcom, Harris, CCA, CSI, McMortin, rebuilt & new. Goodrich Enterprises Inc. 11435 Manderson St Omaha, NE 68164 402 493 1886 FAX 402 493 6821

Abco 500-cart lazy susan (2), \$100. P Patton, WWAM, POB 279, Jasper IN 37347-0279. 615-942-1700.

Gentner Microtel telephone-tape interface, barely used, \$215. Bill, 617-266-4220.

High voltage xformer, 208-220 volt input taps (3), 2900-3300 volts out at 600 MA, \$180+shpg; High voltage choke, 10 Henry, 10 KV, \$80+shpg; High voltage filter capacitors, 2 5mfd, 7500 volt, 1 20mfd, 2000 volt, 1 10mfd, 2000 volt, no PCBs, \$20/ea. K Lamson, 510-447-7405.

Modulation Sciences CLD-2500 composite line driver syst, \$1000. S Schweiger, WXLO, 250 Commercial St, Worcester MA 01608-1721. 508-752-1045.

**Want To Buy**

Bdctg Yearbook one or 2 yrs old for retired engineer. E Davison, 813-866-2635.

Adventures Jennings add on promotion print ideas from late 1970's. C Adams, WKUZ, POB 342, Wabash IN 46992. 219-563-4111.

Broadcasting & Cable yearbook, last years @ low price. F Badeaux, 1812 Procter St, Port Arthur TX 77640. 409-982-7121.

Neil Terrell Tiger Tape sides 11 & 12; Book by Powell, "How To Fund Station, Everything You Wanted To Know." C Adams, WKUZ, POB 342, Wabash IN 46992. 219-563-4111.

Jazz record collections, 10" LP/12" LP be-bop, swing, dixie, highest prices paid. B Rose, Program Recordings, 228 East 10th, NYNY 10003. 212-674-3060.

**MONITORS**

**Want To Buy**

Belar, TFT or similar, FM modulation monitor, stereo. J Powley, WAOM, 1512 Sherwood Dr, Reidsville NC 27320. 910-342-1843.

Potomac AM-19 at least 5 towers. G McClintock, WNQM, 1300 WWCR Ave, Nashville TN 37218. 615-255-1300.

**RECEIVERS & TRANSCEIVERS**

**Want To Sell**

Sony ST555ES stereo FM tuner, 8 presets, 2 antenna inputs, \$125. R Streicher, Pacific Audio-Visual, 545 Cloverleaf Way, Monrovia CA 91016. 818-359-8012.

**GE Superadio III**, custom modified w/noise free SCA w/improved selectivity & sensitivity, \$95. Other modifications avail. Performance guaranteed. **800-944-0630**

ICOM IC-V100 2-way radio system, with power supply, req ICOM programmer to set frequencies, \$1200. S Schweiger, WXLO, 250 Commercial St, Worcester MA 01608-1721. 508-752-1045.

**SCA RECEIVERS—ALL TYPES**

Reading Service / Ethnic / Data Professional / Table  
Will work to meet your receiver needs

**DAYTON INDUSTRIAL CORP.**  
(Manufacturer)  
2237 Industrial Boulevard  
Sarasota, FL 34234  
Tel: 813 351 4454 FAX: 6081

**Want To Buy**

FM tuner/receiver w/multiples MX or composite output. B Campbell, KRIG, Bartlesville OK. 918-333-7943.

**REMOTE & MICROWAVE EQUIP**

**Want To Sell**

CCS CDQ2000 encode/decode system w/5 multirate DSU's for switched 56 service, \$5200; Wegener 1600 card cate w/tone encoder card and PANDA2 card, \$700. D Ryan, RSN, 800-742-3969.

Burk TC-R set up for phone line use, incl RP-B relay panel, \$1200. J Katonah, WFGB, POB 777. Lake Katrine NY 12449. 914-336-6199.

**RENT IT HERE!** Call Steve Kirsch for Details

**COMREX**  
1, 2, & 3-Line Extenders  
Switched 56/MSDN Systems

**TELOS**  
Zephyr  
Digital Phone Hybrids

**GENTNER**  
EFT-3100 3-Line Extenders

**SHURE**  
FP-410 Automatic Mixers

**REMOTE AUDIO PACKAGES**

**SILVER LAKE AUDIO • 516-623-6114 • FAX: 516-377-4423**

MCI PTS10/PRS10 Composite STL 945.5. BO. J Pierce, KMZQ, 702-595-5705.

MCI PRS-10, composite STL. D Lang, NW TalkRadio, 7404 SE Johnson Ck, Portland OR 97206. 800-313-5313.

Hallikainen DRC 1900, studio and xmtr units, \$900. F Hoffman, Corpus Christi TX. 512-851-1725.

MicroTrak sports remote mixer, almost new, \$100. D Lang, NW TalkRadio, 7404 SE Johnson Ck, Portland OR 97206. 800-313-5313.

Moseley MIU-2 AM metering insertion unit, \$125. C Stalnaker, KDDK, POB 100, Little Rock AR 72203. 501-372-7740.

TFT 7601 rem cntrl, 10 chnl, gd cond, \$550. B Spitzer, WLS Comm, Box 460, Rapid City SD 57701. 605-343-6161.

Symetrix 108 Bdct phone system, 8 lines, 3 Hybrids, \$1000/BO. T Rusk or J Harvill, KSSN-KMKV, 501-227-9696.

TFT 7601-R and TFT 7601-T, cntrls rem xmtr via telco lines or microwave, 10 chnl, never used, must sell, BO. Marty, MSTV, 1263 Pomeroy Rd, Arroyo Grande CA 93420. 805-489-0919.

CCS Micro 56 56 kB dig codec sys w/codec box (2), and modem (2), V35 cables (2), \$3000. R Cowell, KNTR, POB 308, Ferndale WA 98245. 206-384-5117.

**WE RENT**  
**TELOS ZEPHYR**  
**QEI QUICK-LINK**  
Stereo RPU, NCJ License  
Frank Grandstein  
Audio/Video Consultants  
**COMREX**  
3-line extender  
**610-642-0978**

Marti STL8-950 STL xmtrs (2, non-cert), on 951.375 & 951.625 MHz, nds work, cleaning, \$400/ea; Marti R200-950 STL receivers (2), on 951.375 & 951.625 MHz, nds work, cleaning, \$400/ea; Marti SCG-8H subcarrier gen, on 67 kHz, nds cleaning, \$300. S Schweiger, WXLO, 250 Commercial St, Worcester MA 01608-1721. 508-752-1045.

**SUPER ROVING RADIO...five year.** Excellent condition, new, \$40,000. Make offer. Send replies to: Radio World, POB 1214, Falls Church VA 22041. Attn box #: 95-2-8-01RW.

**UNIVERSAL SPCX XE-1000**

**NEW!**

**SCPC BROADCAST AUDIO RECEIVER**

New, affordable, frequency-agile receiver, direct channel entry by keyboard, selectable companding 1:1, 2:1, 3:1, wide/narrow bandwidth, de-emphasis selectable, 950-1450 MHz, line output 600 ohms, muting, transponder agile, LNB power supply, 50-channel memory, full baseband output, high-quality audio. Every needed feature at a sensible price (lowest in the industry). Write or call for full information on this quality receiver—the answer for your station. Networks call for prices.

Phone: (614) 866-4605 Fax: (614) 866-1201

**UNIVERSAL ELECTRONICS, INC.** 4555 Groves Road, Suite 12 Columbus, OH 43222  
Communications Specialists Phone: (614) 866-4605 Fax: (614) 866-1201

Marti SCG-10 subcarrier gen, 39khz, \$200/BO; Marti SCG-10 subcarrier detector, 39khz, \$200/BO; Coastcom SSB subcarrier system, 67khz-102khz, \$350/BO; TFT remote control system, \$800/BO. T Ray, WTIC, 203-522-1080.

Mosely TRC-15, taken out of svc in upgrade, manuals, \$700+shpg. R Peterson, KDMO-AM, 221 E 4th, POB 426, Carthage MO 64836. 417-358-6054.

**Want To Buy**

Marti MR-30/150-170 RPU Rcvr, \$75. M Persons, 402 Buffalo Hills Lane, Brainerd MN 56401.

STL rcvr, 950 MHz band, working or not for low price or tax deduction. D Barnett, KKUP, POB 820, Cupertino CA 95015. 408-325-5015.

**SATELLITE EQUIPMENT**

**Want To Sell**

Mobile satellite telephone, ABB Saturn-M Mini phone. Contact W. Johnson at 301-622-4884.

SA 9000 10' dish with extender panels and Avcom 2 receiver and motor drive and LNA for \$300. You haul. D Hurd, Nova Earth Stns, E1111 Ever-ett, Spokane WA 99207. 509-483-2473.

**BUY**

Satellite Systems pays cash for Westwood One Radio Networks satellite receivers!

**REPAIR**

Satellite Systems repairs all major brands of satellite equipment, including the Fairchild Dart 384 and Scientific Atlanta. Our turn-around time averages under 24-hours. Plus, we provide pre-and post-service support along with a 90-day warranty.

**SELL**

Ariel Digital Satellite Receiver—5 card slots, Fairchild compatible.

Zephyrus SCPC 700 System Receiver and other available models. Just call and ask!

**SATELLITE SYSTEMS**

Satellite Equipment for Radio  
615 East Brookside  
Colorado Springs, CO 80906  
(719)634-6319 Fax: (719)635-8151

**PHONE: 703-998-7600 FAX: 703-998-2966**



Call Simone Mullins, Classified Ad Manager, to reserve space in the next issue. Use your credit card to pay, we now accept VISA and MASTERCARD.

**RadioWorld**

5827 Columbia Pike, 3rd Floor  
Falls Church, VA 22041

**Select from these categories for best ad positioning:**

- |                            |                           |                          |
|----------------------------|---------------------------|--------------------------|
| Acoustics                  | Consoles                  | Software                 |
| Amplifiers                 | Disco-Pro Sound Equip.    | Stations                 |
| Antennas & Towers & Cables | Financial Services        | Stereo Generators        |
| Audio Production (Other)   | Leasing                   | Tapes, Carts & Reels     |
| Brokers                    | Limiters                  | Tax Deductable Equipment |
| Business Opportunities     | Microphones               | Test Equipment           |
| Cart Machines              | Miscellaneous             | Transmitter/Exciters     |
| Cassette & R-R Recorders   | Monitors                  | Turntables               |
| CD Players                 | Receivers & Transceivers  | Positions Wanted         |
| Computers                  | Remote & Microwave Equip. | Help Wanted              |
|                            | Satellite Equipment       |                          |

**Classified Advertising Rates Effective January 1, 1994**

	1x	3x	6x	12x
1-9 col inch (per inch)	\$60	58	54	49
10-19 col inch (per inch)	55	52	49	44
Distributor Directory	100	95	90	85
Professional Card	65	60	55	50
Classified Line Ad		\$1.50 per word		
Blind Box Ad		\$10 additional		

To compute ad costs: Multiply the number of ad inches (columns x inches) by the desired rate schedule for your per unit cost. Example: a 3" ad at the 1x rate is \$180, at the 3x rate \$174, at the 6x rate \$162, at the 12x rate \$147, etc.







**TRANSMITTERS...WTS**

Harris 3.5kw FM xmtr, 7 yo, excellent condition, \$15,000. M Wodlinger, 813-262-1118.

Sparta 680 exciter with 681 meters and Moseley SCG-3T stereo generator, \$1075 + shipping, 207-623-3036.

**BESCO** World Leader in AM - FM Transmitters  
Internacional  
"Now in our 30th year"

**91 AM & FM Pre-Owned Units in Stock**

- ✓ ALL - Powers
- ✓ ALL - Manufacturers
- ✓ ALL - Instruction Books
- ✓ ALL - Complete
- ✓ ALL - Spares

Call and take advantage of our liberal trade-in plan. Tune and test on your frequency, available on site. Complete inventory on request.

Phone: 214-630-3600  
Fax: 214-226-9416

Versa Count LA150 150 W solid state FM amp. N Beardsley, 906-753-6930.

Energy Onix MK22 22 kW FM with exciter, less than 2 yrs old. C Springer, KLMR, POB 890, Lamar CO 81052. 719-336-2206.

1972 CCA 10 kW, good condition, \$10,000. M McNeil, Guardian Communications, 800 Compton Rd, Cincinnati OH 45231. 513-931-8080.

BE FX-30 FM solid state exciter, \$2995. Max, KCMJ, Box 551896, Dallas TX 75355. 800-891-006.

Continental 317-C2, 50,000 W AM, good condition, \$15,000 FOB Jacksonville; Gates FM-20 H3, 20,000 W FM, fair condition, \$10,000 FOB Jacksonville. P Christensen, Prism Broadcasting, 3101 University S, Jacksonville FL 32216. 904-783-3711.

Harris BC-5H 5000 W AM, you pay shipping, Best Offer; Harris direction transmitting equipment for 5000 W transmitter, you pay shipping. Jack, 304-562-9155.

CCA Electronics has the following trade-in equipment for sale: Wilkinson FM20000B 20KW FM, AEL 12KD 12KW FM, demo CCA FM60G 60 watt exciter, demo CCA FM4000GS 4KW FM, harmonic filter and directional coupler for 20-25kw CCA/CSI, \$600 each or both for \$1000. Also RCA BTA-50 50KW AM. Please contact Steve, Howard, or Darrin at 404-964-3530. Se habla espanol - Pregunte por Tyler.

CCA TF 20 F 20 kW, factory mod to 23.5 kW, new driver, choke, meters plus spares, possible partial trade for 10 - 12 kW plus cash, \$23,500. J Lien, WNXR, 715-372-5400.

**INCREDIBLE FM RADIO TRANSMITTERS**

**TAYLOR**  
The Transmitter People

Taylor Bros. (Oldham) Limited, Lee St. Oldham England.  
Tel: 44 (0)61 652 3221, Fax: 44 (0)61 626 1735  
US Sales Fax 407 363 2818  
Satisfying Customers Since 1965

1Watt	\$1,138.
30Watt	\$1,499.
300 Watt	\$3,174.
600 Watt	\$5,960.
1K Watt	\$8,716.
2K Watt	\$11,905.
4K Watt	\$20,741.

LPB AM-30 30 W AM on 540 kHz, excellent condition, \$900/BO. D Barton, KNAK, POB 636, Delta UT 84624. 801-864-5111.

BE, QEI, CSI, etc, 1-2 kW, no exciter needed, less than \$1000. A Branch, WGHR, 2402 Woodrige Dr, Decatur GA 30033. 404-325-7847.

**THE Purple Processor™**

Finally! A loud, clear and DYNAMIC FM processor without the grunge! We can prove it!  
Call 1.904.622.7700 for a DEMO.

Used equipment for sale: Belar SCM-1, Belar RFA-1, Belar FMS-2, Belar FMM-1, Moseley MRC 1600 system, Urban Optimod 8100A, dbx 160 & 160X compressor/limiter, Dielectric coaxial switch with switch panel, TFT EBS receiver/generator, Gentner patch panel, Electro Impulse 5 kW dummy load and Harris racks. Call Transcom Corporation 800-441-8454 or 215-884-0888.

4CX250B, 4-400, 833, 813, 5CX1500, 4-1000, all types, fully guaranteed EIMAC, Amperex, RCA, Westgate 800-213-4563.

New McMartin 20 W, BIM-8000 FM exciter, New McMartin IBM1005D FM relay/rebroadcast covrs; also some used McMartin B910 exciter, 15W, Goodrich Inter., 11435 Manderson St., Omaha, NE 68164, 402-493-1886 fax 402-493-6821

Harris SX 5-A, 1989, solid state 5k transmitter, excellent condition, tuned to 1410 khz, \$23,000/BO. G Richardson, WJLD-AM, 1449 Spaulding Ishkooda Rd, Birmingham AL 35211. 205-942-1776.

**Want To Buy**

10 or 12 kW FM, up to 10 years old, must be very solid. J Lien, WNXR, 715-372-5400.

10 or 20 W AM, tube or solid state. E Allman, WFIV, POB 555519, Orlando FL 32855. 407-847-4422.

10, 15 or 25 kW AEL in good condition. T Hodgors, KLYK, 14 E Main St, Walla Walla WA 99362. 509-529-6242.

5 kW FM transmitter with or without exciter, state condition, price; 1 - 3.5 kW FM transmitter with or without exciter for standby. J Powley, WAOB, 1512 Sherwood Dr, Reidsville NC 27320. 910-342-1843.

TRANSMITTERS - TV/FM/AM, new and used. Tubes, xmtr parts. 305-757-9207.

McMartin AM/FM transmitter, any model, exciter or stereo modules. Goodrich Enterprises, 11435 Manderson, Omaha NE 68164. 402-493-1886.

**TUBES**

**Want To Sell**

**FOR THE BEST PRICE**  
& 24 Hr service on transmitting tubes call Goodrich Ent Inc at 402-493-1886 day or night, FAX 402-493-6821.

ITT Jennings vacuum contactor w/230 VAC solenoids, brand new, never used, will sell for half price. G Lee, 416-421-5631.

**Svetlana**  
ELECTRON DEVICES

**Quality Power Tubes**

3CX15,000A7	4CX400A
3CX15,000A3	4CX350AC
3CX10,000H3	4CX350A/8321
3CX10,000A7	4CX250R/7580W
3CX3000F7/8162	4CX250BT
3CX3000A7	4CX250BC/8957
3CX2500H3	4CX250B/7203
3CX2500F3/8251	4X150A/7034
3CX2500A3/8161	5CX1500B
4X15,000J/8910	5CX1500A
4CX15,000A/8281	YC130/9019
4CX10,000D/8171	5U4G
4CX5000A/8170	6AS7
4CX3500A	6550B
4CX1600U	8560AS
4CX1600B	811A
4CX1500A	833A
4CX800A	833C
4CPX800A	

• Watch this list grow.  
• Shipment from USA stock.  
• Manufactured in Russia's largest power tube factory.  
• Generous warranty based on high quality.  
• Honest prices based on quality at low cost.

See Us At NAB '95 in Booths 5313/5314

**Broadcasters**  
Phone: 800-239-6900  
205-882-1344  
FAX: 205-880-8077  
OEMs, Distributors, Volume Purchasers  
Phone US: 800-578-3852  
Int'l & US: 415-233-0429  
FAX: 415-233-0439

Circle (72) On Reader Service Card

Premier  
**Eimac**  
Remanufacturing

**Power You Can Trust**

Power Grid Tube Remanufacturing with New Tube Processes

Call 800-414-8823

**varian**

Circle (119) On Reader Service Card

**ECONCO**

Quality Rebuilt Tubes  
Approximately 1/2 the Cost of New

Call for Our Price List  
**800-532-6626**  
**916-662-7553**  
**FAX 916-666-7760**

Circle (2) On Reader Service Card

**ADVERTISE!**  
in Radio World

For details, call Simone at  
**703-988-7600 TODAY!**

**TRANSCOM CORP.**  
Serving the Broadcast Industry Since 1978

Fine Used AM & FM Transmitters and Also New Equipment  
For the best deals on Celwave products, Andrew cable and Shively antennas.

1 kW FM 1978 Collins 831C-2	1 kW AM 1980 Continental 314R-1
1 kW FM 1975 RCA BTF 1E2	5 kW AM 1977 RCA BTA 5L
2.5 kW FM 1983 Harris FM2.5K	
3 kW FM 1980 CSI 3000E	
3 kW FM 1974 Harris FM3H	
5 kW FM 196? Gates FM5B	
10 kW FM 1968 RCA BTF 10D	
20 kW FM 1976 Harris FM20H/K	

1077 Rydal Road #101  
Rydal PA 19046  
800-441-8454 • 215-884-0888 • FAX No. 215-884-0738

Circle (101) On Reader Service Card

**You Need It... WE MAKE IT!**

Your one call for Quality, Reliability and Economy in FM transmitters

- **SST Series** — Low Power Solid State FM from 30 to 500 watts.
- **Legend Series** — Medium Power Solid State FM 1 to 11KW
- **ECO Series** — Medium Power Grounded Grid Triode, Single Tube FM from 4 to 11 KW.
- **MK Series** — Medium and High Power Grounded Grid Triode, FM from 1.5 to 50 KW

**The ECO - 10**

"The Transmitter People"  
**Energy-Onix**  
518-828-1690  
FAX: 518-828-8476  
752 Warren Street, Hudson NY 12534

Circle (217) On Reader Service Card



### Want To Buy

Western Electric 357A or 357B, 350A, 331A, 349A. P Patton, WWAM, POB 279, Jasper IN 37347-0279. 615-942-1700.

### TURNTABLES

#### Want To Sell

RCA 16" xcrptn console TT (2), BO. R Davis, Wango Rcds, Rt1 Box 112, Falling Waters WV 25419. 304-274-1419.

Russco Studio Pro (2) with Micro Trak tonearms, \$50 ea; RCA phono preamps (2), \$50 ea; Russco Fidelity Pro TT preamps (2), \$75 ea; Technics SP-25 with pro base and tonearm, \$475. G Fuller, WKKR, 205-745-4656.

Patch cables (39), TT, Monster ProLink and Alden/Switchcraft, \$300/all or \$7.50/ea. R Santo, Box 634, Bryantville MA 02327. 617-293-5671.

CCS Micro 56 codec (2), Tele-processing Products Model 1 modems (2) for duplex 7.5 kHz audio transmission via 56 kB digital telephone lines, cables included, \$3500. Comrex DXR codec (2) and Teleprocessing Products modems, \$3500. R Cowell, Help Ministries, POB 308, Ferndale WA 98248. 206-384-5117.

Technics SL1200MK2 quartz with Shure M44-7 cartridge and stylus with dust cover, \$150; QRK TT (3) without tonearms, \$50/ea; ATI Encore series preamp (2), \$75/ea. R Miller, Miller Media Group, Taylorsville IL, 217-824-3395.

Technics SP-10 MK-II turntables (2), no bases, tonearms or pre-amps, have power supplies, \$350/ea/Best Offer. T Ray, WTIC, 203-522-1080.

Technics SP-25 turntables (5), 3 with covered base, AudioTechnica tone arms, Audiometrics pre-amps, Best Offer. J Pierce, KMZQ, 702-595-5705.

Technics SP-25 turntables (2), \$150/ea; Audio-Technica ATP-12T tone arms (2), \$150/ea; Stanton 680SL cartridges (2), \$30/ea; ATI P-100 phono pre-amps (2), \$200/ea; ATI P-1000 phono pre-amp, \$275. S Schweiger, WXLO, 250 Commercial St, Worcester MA 01608-1721. 508-752-1045.

**ADVERTISE!**  
in **RADIO WORLD'S**  
Broadcast Equipment Exchange  
**CALL 703-998-7600**

## WANTED!

Transmitting Tubes

We BUY & SELL all types of transmitting/receiving tubes.

C&N Electronics  
Harold Bramstedt  
6104 Egg Lake Road  
Hugo, MN 55038

(612) 429-9397 ext.23  
(800) 421-9397 ext. 23  
FAX (612) 429-0292

Circle (49) On Reader Service Card

The advertising deadline for the APRIL 5 issue of **RADIO WORLD** is **MARCH 10, 1995**.  
Call Simone Mullins at **1-703-998-7600** for details on placing your display ad in the Broadcast Equipment Exchange.

# EMPLOYMENT

To place ads in this section, use the ActionGram form. To respond to box numbers write Radio World, PO Box 1214, Falls Church, VA 22041. Attn: \_\_\_\_\_

### POSITIONS WANTED

JANET (502) 895-5888. Versatile, intelligent, great for start ups or existing stations, wants FT airshift, first PD gig, tired of false starts and unrated, small markets.

Recent grad, creative, energetic, good worker, seeking first pro AT job, love writing and producing spots, will relocate. Tom, 612-866-9421.

### HELP WANTED

**Chief Engineer** w/exp on AM directional and FM w/proven track recd. Must be organized, computer literate (incl Novell Netwk), and must be unwilling to accept nothing less than perfection. Immed opening, top 20 Midwest mkt. All replies in confidence. Send resume and salary history to: Radio World, POB 1214, Falls Church, VA 22041. Attn Box #: 95-2-22-01RW.

**TELOS SYSTEMS**  
has a rare employment opportunity that may be just right for you.  
Check out our ad on page 29.  
If you are the right person for the job and do not apply...we both lose!

**Gen Manager/Sales Managers:** Bdcgt company w/9 radio stns in W.VA/Ohio region. The Maslow Media Group, Fax Resume: 703-841-9355. Other positions (TV). **JOB BANK:** 301-552-7000. 2030 Clarendon Blvd, Suite 505, Arlington VA 22201.

20+ yrs SBE cert, bdcgt school grd ACE exp, FCC, 1st cl gen/radar, marine, extra, ham, RP, seek job in KY. C Hamlin, 606-523-0901.

AT w/sports bkgrnd looking for FT news and PBP pos. Lisa, 612-788-5495.

Bdcgt student would like oppty to heat up your station. Roosevelt, 405-631-1187.

Christian broadcaster looking for prog pso in small market, NW or AZ preferred, 20 years exp. E Puchalski, 909-889-3812.

**Creative Midwest farm boy seeks PM**, prd in P3, desire FT; tape and resume. Dave, 612-693-6583.

**Energetic broadcaster** w/5 years public radio and TV exp ready to work where you are. Christopher, 402-551-4665.

**Experienced middays, remotes, production, news, phones, and more**, ready to relocate and work for your team. Angela, 405-573-0579.

Fish waiting for bite, serious, energetic, witty AT, ready to move, any format, reel me in. Hilary, 612-623-3962.

**Graduate** seeks FT employment in any market, work hard at MD, PBP, AT, sales; tape & resume. Sean, 612-263-1728.

**Help!** Country jock wants out of new/talk, 14 years exp, ready to work overtime, prefer Deep South or VA. Brian, 904-453-8849.

**Pure Talent!** Seeks bigger and better, willing to relocate, good attitude, great ethic, awesome pipes, 5 yrs exp. Kevin, 800-332-0983.

**Young AT/exp LA producer** seeks FT AT & prod, sales, ???, ready for next challenge, all fmts and markets, will relocate. Ken, 213-661-6078.

**Tight board** with smiling voice, good time personality looking for rock format. R Ray, 15 Crofoot Sandwich IL 60548.

**Engineer 20+ years exp, SE only, D Sailer**, 205-699-6425.

**Exp sportscaster**, looking for full-time pos, have exp in College Basketball, Minor-League Football & various Baseball Games, attended & completed ESPN Sportscaster Workshop. R Lillard, 804-239-9758.

**Hardworking programmer** seeks to take your station to the next level, PD/mgmt, experienced. Roger, 615-235-6889.

**CE/TD 25+ years exp domestic and int'l**, AM stereo to 150 kW, FM to 100 kW ERP, digital audio and computer literate, prefer FL or SE. Bruce, 915-833-7651.

**Home with the armadillos**, native Texan, recent bdcgt school grad, seeks FT C & W on-air/prod pos in TX. Buddy, 817-244-3724.

**Trustworthy young grad** willing to relocate for job on-air, production, copy, news or sales. Steve, 405-672-9024.

**Radio pro** victim of format flip, experienced in Boston, NYC and Houston seeks on-air/marketing pos, multi-track, computers and excellent pipes. David, 713-661-9510.

**7 years exp** ready to relocate with huge collection of R&B classics, loves programming/prod, For tape, resume, references, call: John, 910-292-9700.

I will work great personality, can do talk, news and public affairs, all formats. Steve, 708-757-7275.

Finally a personality who CAN do it all, programming, production, copy, on-air, and more. Joe, 813-772-8170.

Page No.	Advertiser	Reader Service No.	Page No.	Advertiser	Reader Service No.
27	Adlec Tech	185	59	Kintronic Labs	214
65	AEO	28	74	Korg	121
20	AEV SNC	1	56	LPB	39
6	ATI	17	76	Marathon Products	147
14	Arrakis	95	31	Multi/Broadcast Electronics	31
20	Arrakis	4	32	Micro Technology Unlimited	78
60	Arrakis	190	66	Modulation Sciences	51
68	Arrakis	114	28	Mouser Electronics	80
30	Audi-Cord Corporation	66	30	Myt Inc	132
28	Audio Broadcast Group	6	54	NSN	129
46	Audio Processing Technology	137	27	Nutrel	158
79	Audiotronics	122	13	Nutrik	169
30	Autogram	38	69	Old Stone Corp	126
21	BSW	199	35	Orban	59
45	BSW	211	15	Pacific Recorders	146
53	Behr	130	49	Pacific Recorders	25
52	Benchmark Media	40	62	Phasetek	36
32	Bext	33	62	Pristine Systems	150
28	Broadcast Devices, Inc	14	64	Prophet Systems	73
8	Broadcast Electronics	187	31	QEI	26
71	Broadcast Electronics	176	36	RE America	142
4	Burk Technology	102	62	Radio Design Labs	198
78	C&N Electronics	49	73	Radio Resources	165
1	CCA Electronics	7	9	Radisoft	116
25	Cellcast Communications	37	19	Raine	220
28	Circuit Werkes	151	2	Register Data Systems	144
51	Clark Communications	131	57	Roland Corp	148
29	Communications Data Service	109	16	Scott Studio	84
55	Computer Concepts Corp	181	52	Shively Laboratories	108
30	Comrex	19	37	Shure Brothers	210
3	Continental Electronics	60	28	Silicon Valley Power	3
42	Corporate Computer System	163	25	Sine Systems	27
62	Cortana	34	49	Sonic Solutions	216
52	Crown Broadcast	42	2	Sony Pro Tape	191
23	Cutting Edge	152	30	SoundAmerica Corp	61
48	Dataworld	13	11	Spectral, Inc	178
33	Denon America	202	62	Stephens Communications Inc	175
18	Dolby	171	50	Studio Audio & Video Ltd	206
77	Eaton	2	62	Superior Electric	153
28	Eaton	197	77	Svetlana Electron Devices	72
58	Enco Systems	166	69	Svetlana Electron Devices	215
77	Energy Onix	217	34	TM Century	112
41	Eventide	120	10	Teclan	58
30	Excilbur	21	62	Teko Telecom SRL	16
38	Fidelipac	71	17	Telos Systems	208
72	Fidelipac	20	29	The Blue Group	194
44	Fostex Corp	15	69	The Management	219
63	Genier	127	77	Transcom Corp	101
27	Ghostwriters	96	73	USAFoam	188
52	Gorman Redlich	12	69	Universal Electronics	192
73	Hall Electronics	9	43	Varian	119
26	Harris Allied	69	48	VirteX/California Digital	64
40	Harris Allied	183	47	Ward-Beck Systems Ltd	104
67	Henry Radio	48	80	Wheatstone	88
3	Hnat Hrides	179	62	Wheatstone	76
61	ITC	19		Wireready	87
14	Inovonics	56			
22	Intralex	22			
52	J Squared Technical Service	63			
69	Joslyn Jennings Corp	172			

Publisher	Stevan B. Dana	Ad Production Coordinator	Kathy Jackson
Associate Publisher	Carmel King	Production Assistant	Laure Anne Tarkington
Marketing Consultant	Al Leon	Production Assistant	Cristina Strigel
Marketing Assistant	Annette Deutscher	Ad Coordination Manager	Simone Mullins
Production Director	Lisa Stafford	Circulation Director	Eleya Finch
Publication/Desktop Sys. Mgr	Julianne Shannon Stone	Circulation Manager	Steven Bowman
Classified/Showcase Production Coordinator	Vicky Baron	Accounts Receivable	Steve Berto

**Advertising Sales Representatives**

U.S. East: Skip Tash	703-998-7600 Fax: 703-998-2966
U.S. West: Dale Tucker	916-721-3410 Fax: 916-729-0810
International: Stevan B. Dana	+1-703-998-7600 Fax: +1-998-2966
Europe: Dario Calabrese	+39-2-753-0274 Fax: +39-2-753-2697
Japan: Eiji Yoshikawa	+81-3-3327-2688 Fax: +81-3-3327-3010

Free Subscriptions are available upon request to professional broadcasting and audiovisual equipment users. For address changes, send current and new address to RW a month in advance at P.O. Box 1214, Falls Church, VA 22041. Unsolicited manuscripts are welcomed for review, send to the attention of the appropriate editor.

**SUBSCRIPTION/READER SERVICE FORM**

**Radio World**  
February 22, 1995 Use until May 22, 1995

**FREE Subscription/Renewal Card**  
I would like to receive or continue receiving Radio World FREE each month.  Yes  No

Signature \_\_\_\_\_ Date \_\_\_\_\_

Please print and include all information:  
Name \_\_\_\_\_ Title \_\_\_\_\_  
Company/Station \_\_\_\_\_  
Address \_\_\_\_\_  
City \_\_\_\_\_ State \_\_\_\_\_ ZIP \_\_\_\_\_  
Business Telephone ( ) \_\_\_\_\_

Please circle only one entry for each category:

**I. Type of Firm**

D. Combination AM/FM station	F. Recording Studio
A. Commercial AM station	K. Radio Station Services
B. Commercial FM station	G. TV station/teleprod facility
C. Educational FM station	H. Consultant/ind engineer
E. Network/group owner	I. Mfg, distributor or dealer
	J. Other _____

**II. Job Function**

A. Ownership	G. Sales manager
B. General management	E. News operations
C. Engineering	F. Other (specify) _____
D. Programming/production	

**Reader Service**  
Please first fill out contact information at left. Then check each advertisement for corresponding number and circle below.

**Purchasing Authority**  
1. Recommend 2. Specify 3. Approve

001	023	045	067	089	111	133	155	177	199
002	024	046	068	090	112	134	156	178	200
003	025	047	069	091	113	135	157	179	201
004	026	048	070	092	114	136	158	180	202
005	027	049	071	093	115	137	159	181	203
006	028	050	072	094	116	138	160	182	204
007	029	051	073	095	117	139	161	183	205
008	030	052	074	096	118	140	162	184	206
009	031	053	075	097	119	141	163	185	207
010	032	054	076	098	120	142	164	186	208
011	033	055	077	099	121	143	165	187	209
012	034	056	078	100	122	144	166	188	210
013	035	057	079	101	123	145	167	189	211
014	036	058	080	102	124	146	168	190	212
015	037	059	081	103	125	147	169	191	213
016	038	060	082	104	126	148	170	192	214
017	039	061	083	105	127	149	171	193	215
018	040	062	084	106	128	150	172	194	216
019	041	063	085	107	129	151	173	195	217
020	042	064	086	108	130	152	174	196	218
021	043	065	087	109	131	153	175	197	219
022	044	066	088	110	132	154	176	198	220

Copy & Mail to: Radio World, PO Box 1214, Falls Church, VA 22041, or FAX to: 703-998-2966

**ABOUT OUR EMPLOYMENT SECTION**

**HELP WANTED**  
Any company or station can run "Help Wanted" ads for \$1.50/word or buy a display box for \$60/column inch. Payment must accompany insert, use your MasterCard or VISA; there will be no invoicing. Blind box numbers will be provided at an extra charge of \$10. Responses will be forwarded to listee, unopened, upon receipt. Call 800-336-3045 for details.

**POSITIONS WANTED**  
Any individual can run a "Position Wanted" ad, FREE of charge (25 words max), and it will appear in the following 2 issues of Radio World. Contact information will be provided, but if a blind box number is required, there is a \$10 fee which must be paid with the listing (there will be no invoicing). Responses will be forwarded to the listee, unopened.

Mail to: **BROADCAST EQUIPMENT EXCHANGE**  
PO Box 1214, Falls Church, VA 22041 Attn: Simone Mullins



# INTRODUCING THE AUDITRONICS 2500 SERIES THE LAST SMALL CONSOLE YOU'LL EVER HAVE TO BUY



Some people believe small means limited. At AUDITRONICS we believe small is a challenge. That's why we have again defined a new standard of excellence by combining impeccable design, precision manufacturing, and value pricing in a full featured, compact audio console. The 2500 Series is loaded with all of the "me too" features found in the competition's "wannabe world class" consoles. Plus the 2500 Series delivers much more, including:

- **SOLID STATE SWITCHING** of all signal paths
- **DC CONTROL** of all level functions
- Telephone **CONFERENCING** capability
- **20dB HEADROOM** maintained throughout
- Easily accessible wiring on **MOTHERBOARD CONNECTORS**
- **ACTIVELY BALANCED** input, patch points, and floating outputs
- Linear **CONDUCTIVE PLASTIC** 100mm faders (P & G Standard)
- Comprehensive **A/B EXTERNAL LOGIC** control
- External line selector with **CUE AND HEADPHONE ASSIGNMENT**

And remember, AUDITRONICS is the company that still supports the first console it ever sold -- over 28 years ago. So you no longer have to compromise with a "wannabe". With the 2500 Series you get the real thing!

**THE ONLY WORLD CLASS CONSOLE AVAILABLE AT "wannabe" PRICES.**

**AUDITRONICS**

3750 Old Getwell Road, Memphis, TN 38118 (901) 362-1350 FAX (901) 365-8629



# Success Means Making the Right Decisions



*We DID.*

**OUR NEW R-60 CONSOLE** has what stations really want: reliable illuminated switches—*everywhere*; smooth feeling P&G faders; a powerful monitor section. Our exclusive Simple Phone™ module is friendly and easy-to-operate, providing error-free talk segments.

**The R-60 is TOTALLY MODULAR** to streamline service—no motherboard mounted components. The quality of each module is unsurpassed; we even measure every resistor, capacitor, and diode

before it's installed. Completed consoles are burned in prior to final test. Meticulous care is the key here, so you can expect the ultimate in reliability.

Perhaps more important than high technology features and good looks is the fact that the R-60 is built and supported by Audioarts Engineering—a highly professional and dependable company you can count on.

**A SUCCESSFUL STATION BEGINS WITH R-60.**



**AUDIOARTS ENGINEERING**

7305 Performance Drive, Syracuse, New York 13212 (tel 315-452-5000 / fax 315-452-0160)