

# Radio Guide

[www.radio-guide.com](http://www.radio-guide.com)

Digital Issue Now On-Line

July-August 2019 – Vol. 27, No. 4

## Leading Edge Remote Technologies



Photo courtesy of Mark Wittkoski, featuring Cumulus Grand Rapids broadcasting at a Whitecaps Minor League Baseball Team Game.



4314

PRSR1 STD  
U.S. POSTAGE  
PAID  
PERMIT NO. 410  
BEAVER DAM WI

\*\*\*\*\*AUTO\*\*ALL FOR ADC 913  
K.M. RICHARDS  
SS6 P6  
K.M. RICHARDS PROGRAMMING SVC.  
PO BOX 7427  
VAN NUYS CA 91409-7427

### AARON 650

FM REBROADCAST RECEIVER



For Challenging Reception Scenarios.

# 'Nuff Said!



P.O. Box 69456  
Odessa, TX 79769  
432-943-2588  
[www.jammin947.com](http://www.jammin947.com)

Hi Hank,

About a year ago I installed a Power Clamp TVSS surge suppressor unit at our AM transmitter site. We were upgrading from 5kW to 12kW and I wanted to protect the new transmitter from "dirty power". We're located in the middle of an oil field about 8 miles out of town, and I replace about 30 MOSFETs each year in our 5kW solid state transmitter.

After reading a testimonial from someone who experienced similar problems, I made sure that a Power Clamp was included in the budget. Now, with 13 months since PowerClamp's installation, I have not had to replace one. The box of MOSFETs is collecting dust.

We recently bought an unbuilt FM station and guess what I ordered for that transmitter site?

PowerClamp has kept us on the air and reduced our maintenance costs.

Thanks for an effective solution!

*Bob Souza,*

Managing Partner

KCKM 1330 - 12,000 Watts  
Monahans, TX 79756

PowerClamp TVSS units by Sine Control Technology prevent transmitter damage by greatly reducing the effects of AC power line spikes and surges. Thousands of units are in use at broadcast stations, hospitals, data centers, airports, and other mission-critical installations.

**Stay On The Air with  
PowerClamp Surge Protection!**

Contact any Sine Control / Henry Engineering dealer,  
or visit [www.henryeng.com](http://www.henryeng.com)

Tel: 562-493-3589



# Radio Guide

## Contents

July-August 2019

## In This Issue

Critical Content for Radio

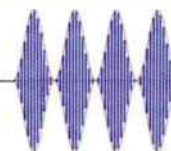

<b>Cover Story</b> .....	4
<i>Leading Edge Remote Technologies</i>	
<b>Studio Site</b> .....	6
<i>CD or Not CD?</i>	
<b>Chief Engineer</b> .....	8
<i>Read the Manual</i>	
<b>FCC Focus</b> .....	10
<i>Satellite Program Network Feeds Under Attack</i>	
<b>Transmitter Site</b> .....	12
<i>Who's Minding the Store?</i>	
<b>Tips From the Field</b> .....	14
<i>Replacement Batteries for the Samsung S5 Phone</i>	
<b>Radio History</b> .....	16
<i>The Unsung Heroes of Frequency Modulation</i>	
<b>Tower Topics</b> .....	18
<i>The TV Repack Tower Crews Are Working Hard</i>	
<b>Maintenance Guide</b> .....	20
<i>Plan to Be Safe</i>	
<b>IT Guide</b> .....	26
<i>Installing Linux for the Newbie – Part Eight</i>	
<b>Engineering Perspective</b> .....	30
<i>So Just What Does It Take?</i>	

<b>Shop Talk</b> .....	34
<i>Misc. Tips and Thoughts</i>	
<b>Small Market Guide</b> .....	38
<i>Silence</i>	
<b>Monitors &amp; Metering</b> .....	40
<i>A Low-Cost RF Monitoring Unit</i>	
<b>Service Guide</b> .....	44 & 45
<i>Radio Equipment, Products, and Services</i>	
<b>Radio Classifieds</b> .....	3 & 45
<i>Buy and Sell Used Equipment On-Line – FREE of CHARGE</i>	
<b>Gear Guide</b> .....	46
<i>New Product Releases, Reports, and Information</i>	
<b>Final Stage</b> .....	47
<i>Convention, and Event Register – Advertiser Information</i>	

## Radio Guide

Volume 27 – Issue 4

Radio Guide Website: [www.radio-guide.com](http://www.radio-guide.com)  
 Classified Ads: [www.radio-classifieds.com](http://www.radio-classifieds.com)

PO Box 20975, Sedona, AZ 86341

Phone: 928-284-3700 • Fax: 866-728-5764

Ray Topp (publisher & editor) – [radio@rconnect.com](mailto:radio@rconnect.com)

Radio Guide, ISSN 1061-7027, is published bi-monthly, six times a year, by Media Magazines Inc., PO Box 20975, Sedona, AZ 86341. Radio Guide is copyright 2019, Media Magazines Inc., and may not be copied, reproduced, or stored in any format, without the written permission of the publisher.

**Cover Story – by Jacob Daniluck, Tieline (page 4)**

**Leading Edge Remote Technologies:** "Many people think using IP to broadcast and stream live is a relatively recent technology, however that's far from the truth. The first remote broadcasts over IP were in the early 2000s, as cell-phone networks emerged offering GSM wireless data technologies."

**Studio Site – by George Zahn (page 6)**

**CD or Not CD:** "In the last two weeks, I've had to come to grips with the possible death knell of the CD as a data and audio storage device. Recent news stories are fanning the "funeral pyre" of the CD in broadcasting. There is some reason to believe the CD is not ready for File 13 just yet, but here's the sobering news ..."

**Transmitter Site – by Gary Minker (page 12)**

**Who's Minding the Store:** "As luck would have it, your tower crew is just hanging around the house and they pop over for a climb to find things that no Chief Engineer ever wants to see. Molten BB's of copper sitting on an insulator and the accompanying length of outer conductor with blotchy black and orange spots. This is going to turn in to a fight for your job."

**Tower Topics – by Wiely Boswell (page 18)**

**The TV Repack Crews Are Working Hard:** "The repack work being done will have an effect on a lot of us in radio. Here is my experience thus far as the tower crew gets the work done on our tower. We have a TV station broadcast antenna right under our FM antenna, making RF safety requirements come into play as the work is done."

# Radio-Classifieds.com

- Buy or Sell Your Used Equipment
- Place as Many Ads as You Like
- FREE! – There's Never Any Charge



Home Register Login Submit ad Search

**Radio-Classifieds.com** Latest 20 ads

Please register or log in.

Antennas [0]	Codecs & AoIP [0]	Internet & Stream [0]	STL, RPU, TSL [0]
Audio Amplifiers [0]	Computers & IT [0]	Microphones [0]	Satellite Gear [0]
Audio Delay [0]	Consoles & Mixers [0]	Monitors & Rcvrs [0]	Speakers & Phones [0]
Audio Editing [0]	Directional Gear [0]	Phone & Hybrids [0]	Timers & Clocks [0]
Audio Processing [0]	EAS Gear [0]	RDS, RBDS, SCA [0]	Tools & Test Gear [0]
Audio Routing [0]	Exciters & Gens. [0]	Recorder & Player [0]	Towers & Coax [0]
Audio Storage [0]	Furniture & Racks [0]	Remote Control [0]	Transmitters [0]
Automation [0]	Grounding & Surge [0]	RF & HV Equip. [0]	MISC OTHER [0]

Powered by Media Magazines Inc. - Publisher of Radio Guide Magazine | Contact Us

- End Users – Buy or Sell Used Equipment – No Limit!
- Manufacturers – Sell Your Demos and Overstock
- Enter and Edit Your Own Ads – Photos Included

## Leading Edge Remote Technologies

by Jacob Daniluck, Technical Sales Specialist, Tieline

The latest remote codecs have evolved into “remote studios” and offer significant benefits over codecs of old.

Before considering today’s remote technologies, let’s think back to not so long ago and how remote technologies have evolved from the 1990s until today. In the beginning, remote codecs were designed to:

1. Eliminate the need for an expensive and cumbersome Remote Pickup Unit (RPU) with a Marti.
2. Improve on poor quality narrowband 3 kHz audio sent over standard copper POTS lines using the G.711 codec.
3. Take advantage of available or privately installed ISDN lines to broadcast high quality remote audio.

Companies such as Tieline, Telos and Comrex broke new ground and offered technologies that supported sending high quality bidirectional audio between a studio and remote site, with vastly scaled down equipment requirements, when compared to the RPU model.

### The Evolution of IP for Remote Broadcasts

Many people think using IP to broadcast and stream live is a relatively recent technology, however that’s far from the truth. The first remote broadcasts over IP were in the early 2000s, as cell-phone networks emerged offering GSM wireless data technologies. Suddenly, networks could broadcast remotes quickly at a moment’s notice from anywhere, with cellular wireless data coverage. No RPUs or copper POTS and ISDN lines required.

Over the last decade or so, remote connectivity has been enhanced by the increased data capacity of 3G and 4G LTE networks, coupled with much wider cellular network coverage.

### Today’s Remote Streaming Technologies

A decade or so ago the primary concern was how to get remote audio back to the studio reliably, whether that was over IP, ISDN or POTS. Now that the use of IP is more ubiquitous, especially in countries with advanced broadband infrastructure, network coverage is much easier to connect over reliably.

However, the nature of sending IP packets over the public Internet means redundant IP backup streams are still essential, especially for mission-critical broadcast infrastructure like studio-to-transmitter links (STLs). In addition, cellular wireless networks are only as good as:

- The coverage they provide.
- The speeds they support.
- The number of users sharing data.
- Whether QoS is available.

IP connections over the open Internet are also vulnerable to variations in connection bandwidth and outages. Therefore, it is necessary to employ strategies to ensure redundancy in the event of IP packets being unable to reach their destination, or being delayed significantly.

### Importance of Redundant Streaming

IP packets carry the IP addresses of their source and destination and can take completely different routes through different networks and switches, as routers determine the best route to take, or the most efficient node through which to reach the destination.

Redundant streaming is an IP packet replacement strategy whereby a codec can simultaneously send more than one identical data stream, to ensure that if IP packets are lost or arrive late, packets can be replaced from the other redundant stream. The decoding codec automatically reconstructs audio packets into a perfect single stream on a first packet arrived basis

to ensure audio integrity. This technology allows switching back and forth, without loss of audio, from either data stream to ensure smooth playout of audio.

Additional redundancy is achieved by using IP links from two or more IP network providers to decrease the risk of a catastrophic loss of data. Some codecs support multiple redundant streams over multiple networks, which greatly increases the reliability of streaming over IP. In this situation packets are assembled on a first packet arrived basis from any of the redundant streams, as shown in the following image.

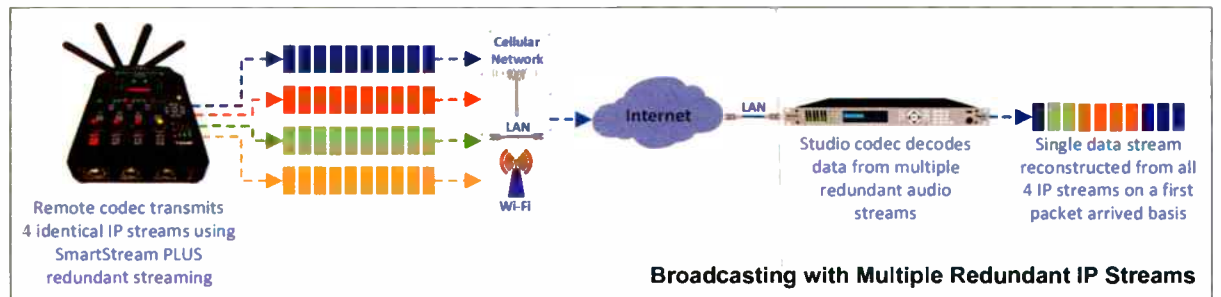

### Vertical Integration of Outboard Equipment

There has also been a trend for broadcast manufacturers to vertically integrate complementary equipment into their products. In recent years codec manufacturers have focused on adding more advanced features into compact equipment, to eliminate the need for expensive and bulky outboard gear like mixers, limiters, compressors, equalizers, playback equipment and recorders. This is now available in a single remote codec – with no other equipment required.

This has obvious advantages, including:

- *Portability: It’s much easier to ship equipment to remote sites.*
- *Less equipment is required: Broadcast setups are more streamlined and take less time.*
- *Podcasts can be produced onsite, and recorded files transferred over FTP, to improve production turnarounds.*

In a sense it has been a natural progression to add more features into remote codecs. Engineers are often forced to “do more with less,” sometimes because of scarce resources, and often just to streamline operations. By pushing the envelope of “what’s possible,” codec manufacturers are providing new options and engineers are taking full advantage.

### Significance of Opus and SIP for Interoperability

Opus as an encoder has grown in significance for broadcasters since it was first added to a professional broadcast audio codec in 2012. This is largely because it is an open source codec capable of high performance at both high and low bit-rates. It is also widely used in WebRTC applications and is one of the optional audio codecs mentioned in the EBU N/A/CI 3326 standard for Audio Contribution over IP, or SIP. This means Opus has been implemented by several codec manufacturers for SIP interoperability over IP.

SIP (session initiation protocol) has grown in importance for broadcasters, and it does have its place from an interoperability perspective, but it also has its downside. Before using SIP over IP, it is useful to understand that:

1. SIP requires both codecs to be configured with the same settings before connecting or the connection will fail.
2. SIP connections are more complex to configure.
3. Not all professional codec manufacturers are fully compliant with all requirements for interoperability.
4. SIP does not support advanced software enhancements

which deliver redundancy and rock-solid reliability over IP, e.g. failover connections, redundant streaming, IP bonding, or error concealment strategies.

So while SIP is important from an interoperability perspective, it lacks the “secret sauce” you get when using two proprietary codecs from the same manufacturer. Codecs from the same manufacturer will generally connect more easily and offer redundant streaming, IP bonding, error concealment, and a host of other cool network configuration and monitoring features.

### Cellular Remotes

In general, look for equipment that supports MIMO (Multiple Input Multiple Output) technology for 4G-LTE cellular connections when broadcasting. MIMO waves are slant polarized to support independent streams of data over the same cell tower frequency. MIMO is the standard downlink configuration for cellular modems over LTE networks, and this requires two separate external antennas for each modem for best performance. More antennas should provide better reception, which in turn will provide the best opportunity to achieve higher bandwidth connections than over single channel systems.

In time 5G cellular networks will deliver significantly higher bandwidth connections, however it may take quite some time to significantly roll out infrastructure. For those purchasing broadcast codecs today, most manufacturers should offer an upgrade path to support 5G network infrastructure as it is rolled out. Make sure you verify this before purchasing new equipment.

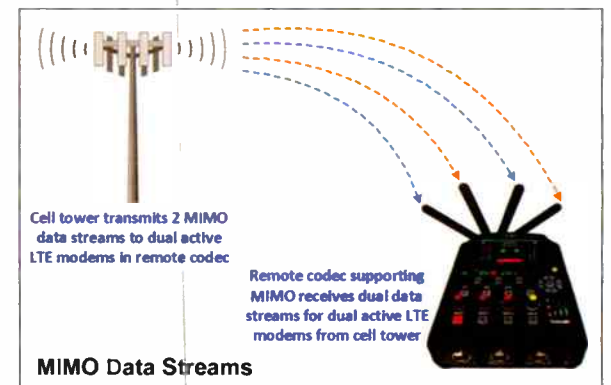

### Remote Control: Final Piece in the Puzzle

Perhaps the last piece in the puzzle for engineers has been adding remote control to other innovations.

One of the down sides of a remote broadcast is that it is often very “remote.” In the past, engineers have often had to try and sort out connection issues at the remote broadcast site over the phone, or drive across town to get to the venue, which wasn’t always practical or even possible. Recent innovations in cloud-based server technology can provide engineers with complete remote control over all their codec assets.

How is this possible? Codec manufacturers have implemented Cloud Codec technology which allows remotely-connected devices to “reach out” and ping cloud-based servers to identify themselves as soon as they connect to the Internet – before they have dialed the studio. This allows an engineer at their home studio, or anywhere with an Internet connection, to monitor the connection status of multiple remote devices simultaneously. All units can be configured, connected and controlled remotely. It’s almost like being at every remote site. With this level of control available, late night rescue missions to get back on the air can be avoided more often than not. – Radio Guide –

**marantz**  
PROFESSIONAL



**PMD661 MKIII**  
Handheld Solid-State Recorder  
with File Encryption

FROM RECORDING TO TUNING TO PLAYBACK,  
**WE HAVE THE SOLUTION.**

Explore an array of problem solvers from Denon Professional and Marantz Professional.  
All at the best price from ProAudio.com.

**DENON**  
PROFESSIONAL



**DN-300R MKII**  
Solid-State SD/USB Audio Recorder



**DN-300CR**  
CD Recorder



**DN-300DH**  
AM/FM/DAB+ Digital Turner



**DN-300C MKII**  
CD/Media Player with Tempo Control



**DN-700R**  
Network SD/USB Audio Recorder



Learn more at [proaudio.com](http://proaudio.com)  
or call us at (800) 433-2105 for more information.

World Radio History

**PROAUDIO**  
com  
smart sound solutions

## CD or Not CD?

*Is a long-time recording medium finally being phased out?*

by George Zahn

For the long-timers out here with me, we've seen a few audio formats come and go. I was giving a tour of my station to some youngsters recently and was shocked to see that not only did the kids not have a clue about LPs and 45s, but a few of the younger parents looked on as if to say "That's what my parents and grandparents used to have." Youch!

So we've seen reel tape, cassettes, plus digital media such as PCM/Beta and VHS, Digital Audio Tape, and MiniDisc come and go. Many of these media depended far more on mechanical precision (the DAT helical scan track was basically the width of a human hair) than on the optical storage capability of digital media. The MiniDisc was basically a highly compressed digital file on an optical disc in a floppy-style case.

Flying under the obsolescence radar has been the compact disc. While still used far less than a decade ago, it's interesting to think how many songs or recorded radio programs are still archived on CDs. While reels and cassettes clinch, stick, and stretch or break, and DAT players are still very few and light years between, the CD has an estimated shelf life of at least one hundred years if you don't scratch the thing up.

Largely because we still have the functioning CD recording decks in our infrastructure, our station still records to CD for quick recording in the studio and ripping transfer into our editing computers in offices. At some point, I see us going to hybrid CD/USB recorders for such a purpose, and eventually archiving on large capacity hard drives as terabytes become cheaper and cheaper. But the CD is still a staple in our house.

### Reality Check

In the last two weeks, I've had to come to grips with the possible death knell of the CD as a data and audio storage device. Recent news stories are fanning the "funeral pyre" of the CD in broadcasting. There is some reason to believe the CD is not ready for File 13 just yet, but here's the sobering news.

When replacing an OEM car radio in my used van, I looked at after market units at a nearby big box store. Some still have a CD slot, but even some of the 2-DIN larger models are offering non-CD players, filled with all the newer options – BlueTooth, USB, Satellite, iHeart, Pandora, a basic 1/8 inch auxiliary, plus the latest Apple CarPlay and Android Auto. That was strike one.

I went to another big box store to start scoping out new laptops to replace older Windows 7 models before the Microsoft support ends in January, 2020. Only a very small percentage of any of the newest laptop models had a CD/DVD burner. "They've just sort of given up on them," explained a salesman about my age. Of course you can still get an outboard USB burner if needed.

### The Vinyl Countdown

The rest of the bad news? I've seen at least two reports that indicate that Best Buy will apparently be yanking commercially-recorded CDs in the second half of this year. Downloads and streaming have really

decimated the market for recorded CDs. One industry report from the RIAA indicated that CD sales in 2000, of more than \$13 billion, was down to just under \$1 billion three years ago. Ironically, Indie rockers may be the saving grace for CD, since it is a far more economical way to distribute hard copies of their music versus vinyl production and sales.

So how do the stations that are using CDs for archiving, and even quick transfer, adapt? There are many professional CD players still out there and likely will be for some time. So even if your station is like ours (roughly 90% Wide Orbit audio delivery to maybe 8-9% played from CD to – wait for it – maybe 1% still from an occasional LP cut), the CD players are not likely to be a short term supply issue.

Tascam and Denon continue to make the crux of CD players and recorders, although we have also used some Stanton models as well. If you're restocking on CD players, you can look for significantly higher prices for the pro units with balanced XLR outputs. For instance, a Denon DN-300C MKII unit with unbalanced outputs will generally run just over \$200 per deck, with the balanced output Denon DN-700C unit closer to \$490.



CD player manufacturers are touting something that broadcasters won't use as often as dance or exercise instructors, but most newer units have pitch adjustments of up to plus or minus fifteen percent (sixteen percent on the Stanton C.4202 model). This is really only helpful if you're playing an archived CD that has old tape audio on it in which the tape player used was running at a slightly incorrect speed.

Other models include BlueTooth connectivity (not so hot for live applications because of the slight delay) and even iPod Lightning docking. Many of these options are features that remote DJs or gyms might find more attractive.

### Drawing a Blank

Our station does order blank CD-Rs throughout the year, and so far, they seem to be in ready supply. We use two of the Tascam CD-RW900 MKII recorders (unbalanced inputs, at about \$250 purchase price), and we have our best success with Sony CD-Rs. Others will throw errors on occasion. That is about the only headache I will not miss when CDs go virtually extinct.



Tascam CD-RW900 MKII

Many stations who recorded on CD in studio are now using hybrid recorders. It's a great way to hedge bets going forward in case recordable CDs ride off to

the audio sunset. The hybrid still allows for CD recording and playback and also USB flash drive recording (wav or MP3). Each production person can simply carry a lavalier necklace drive with them from studio to editing room. In theory, this should save money over the CD recorder and purchasing blank CDs (or even CD-RWs).

Again, hybrid recorders can range in price depending on the balanced or unbalanced inputs or outputs. Most all recorders will have digital inputs. Denon, for example, offers a hybrid recorder, the Denon DN-300R MKII accepting SD or USB.



### Networking Opportunity

Among the newest innovations in this area is a non-CD Network digital recorder. Denon makes the Denon DN-700R which allows the unit to be connected to the station's IT infrastructure to record from multiple locations with remote control through the network. It has two SD/USB card slots, plus cascading and backup recording when a drive is full. This unit is being touted as a great archiving resource for stations.



Denon DN-700R

The network recorder comes with full balanced ins and outs, plus AES/EBU in and out and Coax S/PID in and out. It also features recording to two locations at once. This unit does not have a CD recorder. It does accept SD and SDHC, and Denon claims it takes most all USB drives.

Another idea is to use the hybrid recorder to record USB audio for production and still archive shows on CD if that's easier for a station. Eventually, we can store plenty of audio on a 2, 3 or 4-TB drive, but that's a lot of eggs in one basket. Large solid state drives might well make that a better choice as they become available.

As many of us enter new fiscal years, we have to ask the question as to whether we want to continue to invest in a format that may not be there in five years. Also, the thought of archiving shows and production elements to a well-organized hard drive makes locating past audio much easier than sifting through CD cases or spindles of old show CDs. But old habits tend to linger even if they don't make the most sense, and until we reach an emergency in which everything needs to be replaced, many of us may be reluctant to change.

For those of us who have lived long and depended on the CD medium, the indications are that it may be coming to an end sooner than later. The litmus test may well be when recordable CDs become harder to locate. Is your station using CD for production or archiving, or possibly a hybrid system? Share your ideas and we can all learn together!

*George Zahn is a Peabody Award winning radio producer and Station Manager for WMKV-FM at Maple Knoll Communities in Springdale, Ohio. He is a regular contributor to Radio Guide and welcomes your feedback. Share your stories with others by sending ideas and comments to: gzahn@mkcommunities.org*

# All Digital AM Ready



Nautel is a proud supporter of All Digital AM experimental broadcasting.

All Digital AM transmission opens the door for near FM audio quality in the AM band. Every NX Series transmitter is All Digital AM HD Radio capable\* with the addition of an HD Engine card and a Nautel HD MultiCast+ Importer/Exporter.

\*All Digital AM broadcasting requires an experimental license.

Call your Nautel Rep today  
**877-628-8350**

**RADIO SHOW**

Visit Nautel at  
**Booth 136**

[www.nautel.com/NX](http://www.nautel.com/NX)  
**Because Radio Matters**

**HD Radio**<sup>®</sup>  
Digital AM & FM  
OPTIMIZED

**nautel**

# Chief Engineer

## Read the Manual

by Scott Schmeling

I was installing a new Omnia Volt audio processor recently. (My *gosh* these things have changed in the last 35 years!) It came with a 6-page Quick Start Installation Guide. It's six pages, but there are a lot of pictures showing where to plug what, etc. The guide is broken into sections: Initial Setup & Audio Connections, and Audio Configuration (both input and output). This little 1RU box does a *lot*, but the Quick Start Guide sticks to the basics and takes you step-by-step through the installation to get you up and running in as little time as possible.

The *last* item in the Output Configuration caught my eye and really made me think. Item 17 under Output Configuration said, in bold letters, "Read the complete user manual!"

I *am* a reader. I mostly read equipment and software manuals, but my job is to keep things running as well as possible and inside those manuals I find a wealth of information.

When I was just a young "Engineering" (probably a sophomore in high school), I was working part-time at KSDR in Watertown, South Dakota. The owner of the station allowed me to take equipment manuals home to read. The old Gates Modulation Monitor manual taught me how AM modulation worked. In the cart machine manuals (Harris and Insta-Cart) I learned how cart machines worked and how to adjust them.



Gates Modulation Monitor



The turntable manuals had instructions for aligning the tone arm to avoid cue-burn on the records. (All you who know what *cue-burn* is please raise your hands!) Reading the manuals is how I became an Engineer! That, and going to school to get my "First Class Ticket" (sadly, we don't need those anymore, either!)

Years later at KVAA (KV91), an AM in Volga, South Dakota, we had an Inovonics MAP (Multichannel Audio Processor). I remember the audio was split into 8 bands and there were two controls, (compression and something else) for each band. I had that AM sounding as good as any FM around! (Actually, that's me being modest – really, it sounded *better* than most FM's around there.)

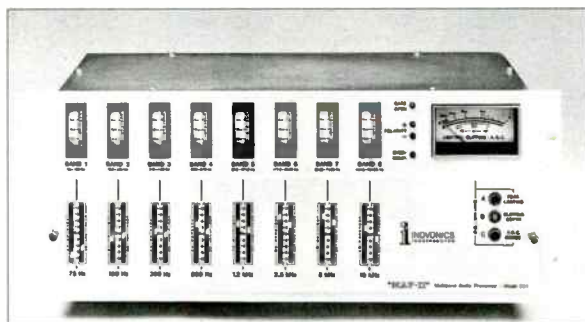

Inovonics MAP II Model 231

Another one I remember very well was in about 1983. I had started at KSQY (K-SKY) FM in Deadwood, South Dakota. Our market was primarily Rapid City, South Dakota, and Gillette, Wyoming. The studios were on the second floor of an historic bank building (safe to say, *every* building in Deadwood is historic) and the transmitter site was on top of Terry Peak, or as I liked to say, "On the mountain."

I remember we had a QEI Modulation Monitor with a set-able Peaks lamp and a digital display that counted our 100% peaks. The display could count to 19. When the count reached 10 the display would flash – and every minute it would reset to 0 and start counting those 100% peaks again. Although in this case, within a second of resetting it would be flashing 19 again! It was flashing 19 all the time! Even worse, our average modulation was only about 50%, so in Rapid City and Gillette we sounded much quieter than the competition.

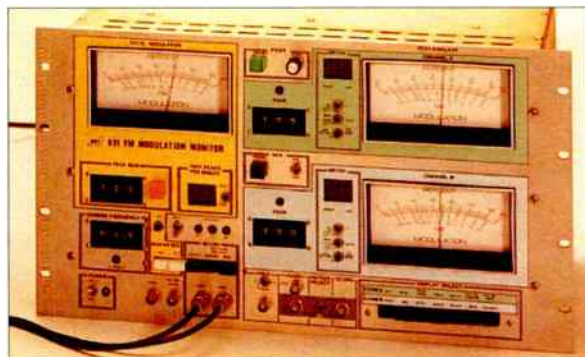

QEI Model 691 Modulation Monitor

I had been told that the former Program Director had attended a session at the Conclave titled something like, "How to Adjust your Optimod - For Program Directors." There are *so* many things wrong with that. Why do you think Orban put a *lock* on the control panel?

We had an Orban Optimod 8100 running in the split-chassis mode. There was no line-of-sight to Terry Peak from the studio location so our STL method was two equalized telco pair. I got the Optimod manual out and started reading. Inside was the complete procedure for setting up the Optimod from the audio input to the composite output. After reading through the procedure a few times, I decided I was ready to give it a shot.



Orban Optimod 8100A

Since it involved taking the music off and putting tones on, we thought it best to do this at night. Tommy, our night guy, would be assisting me at the studio.

Side note: I don't remember Tommy's last name, but we shared the same birthday. In fact Tommy and I, and Greg the (new) Program Director, shared the same birthday. A math professor at Black Hills State College ran the numbers and determined that the chances of *three* people in a group of *five* having the same birthday was 1 in 1.2 million! USA Today even ran it. South Dakota Senator (at the time) Tom Dashle also had the same birthday ... it was a very popular date I suppose ... but I digress.

When test time came, we cut the music, made the appropriate announcement, fired up the tone generator, and started adjusting the studio chassis. When that was as it should be, I headed "up the mountain" to adjust the stereo generator portion of the Optimod.

I don't remember how long it took, but when we were satisfied it was as good as it could be, I packed up my stuff and headed back down – I had an air shift starting at 6:00 a.m.

But here's what I remember most vividly. Later in the morning, while I was still on the air, Ken Mills, the station manager, called me. The first words out of his mouth were, "What did you *do* last night?!" Ken said he could hear the fret work on the guitars. He was hearing audio detail that he hadn't heard before. And that he was in the lobby of the Hotel Alex Johnson (in Rapid City) made it even more remarkable – we were every bit as loud as every other station.

Reading the manual definitely paid off.

I'm still a manual reader. But things certainly have changed. Now, more often than not, a printed manual is not included with new equipment. There may be a CD or flash drive with the manual in PDF form, or as was the case with that Omnia Volt processor, there was a Quick Start Guide and instructions to download the manual from the manufacturer's website.

But whether the manual was included as a PDF, or I downloaded it, I still *print* it out and put it in a 3-ring binder. Granted, having the manual on your laptop (or tablet or reader) can be very handy, but I also like having the printed manual. I can write things in it or use sticky notes to tab or flag a particular part of the manual for easy finding. And I always have a ream of 11x17 paper for printing the schematics. They're much easier to read when they're *bigger*!

I hope your summer has been going well for you. Remember to keep your air filters clean, check your air conditioners (if you have them) and ... keep it between 90 and 105!

Scott Schmeling is the Chief Engineer for Minnesota Valley Broadcasting. You may email him at: [scottschmeling@radiomankato.com](mailto:scottschmeling@radiomankato.com)



# ViA The Remote Codec of Choice...

## The ViA now supports 7 IP interfaces:

- Internal module supports 2 SIM cards for Telco diversity (coming soon)
- Supports built-in Wi-Fi (no USB modem required)
- Connect 2 air cards and 2 Ethernet connections
- Rock solid IP connections with primary and redundant streams using SmartStream PLUS.
- Control remotely from anywhere with the new Cloud Codec Controller (sold separately). Watch the video.



<https://youtu.be/S1WZ6TacYDI>

ViA



Wi-Fi  
Built-in

**Tieline** ✓  
The Codec Company

317-845-8000 | sales@tieline.com | tieline.com

## Satellite Program Network Feeds Under Attack

By Gregg P. Skall and Bob Silverman, Womble Bond Dickinson (US) LLP

Radio's post baby boomers may not recall the days before satellite programming feeds when nearly all radio was locally produced. Visitors to early 80's radio conventions watched open jawed at demonstrations of national radio programming delivered live, anywhere in the country, for broadcast over their local stations. We now know that satellite delivery ushered in national disk jockeys and personalities with nationwide talk shows. Radio adjusted and some now rely heavily on satellite feeds to make their bottom line work. But now, network radio distribution faces a new challenge.

Most radio networks rely on C-Band (3.7-4.2 GHz) satellite, the most durable satellite band due to its penetration and reliability. The five major commercial radio networks, Learfield, Orbital Media Networks (OMNi), Premiere Networks, Skyview Networks, and Westwood One use C-Band and it has been reported that C-Band supports content delivery to more than one-hundred million television households. SES, a major satellite service provider, reports that the vast majority of the underlying news, entertainment, sports and weather content traverses a C-Band satellite network at some point.

### Threats to C-Band

Mobile broadband service is in transition to fifth generation, or 5G wireless, but it is a voracious spectrum hog. 5G is touted as being able to handle a thousand times more traffic than today's 4G networks, ten times faster than 4G LTE, permitting the downloading of an HD movie in under a second. It's believed to be the future foundation of virtual reality, autonomous driving, the Internet of things, and many other new innovations. Politicians claim we are in an international race with China and Europe for 5G dominance. So, in the 2018 Mobile Now Act, Congress charged the FCC and NTIA to study the feasibility of sharing the band for 5G in the same legislative package that provided additional funding for the television repack and for radio stations that have to incur costs to accommodate the TV repack. The FCC then launched an inquiry to explore reallocating the C-Band downlink for 5G. Clearly these actions pose a serious challenge to the continued viability of C-Band for broadcast distribution.

### The Radio Networks

A few years ago Skyview Networks reported that C-Band satellite delivered the following network shows:

Rush Limbaugh, CBS News, Sean Hannity, NBC Sports Radio (Mike Florio, Newy Scruggs, Mark Malone), Talk Radio Network (Sam Sorbo, Roy Masters, Robert Davi), Skyview Networks play-by-play sports and news programming, ABC Radio, ABC News, Dave Ramsey, Westwood One News, Business Talk Radio Network [BTRN] (Ray Lucia, Business Rockstars), Michael Savage, Carson Daly, Sports Byline, Mark Levin, Sports USA, Touchdown Radio, Phil Valentine, CBS Sports Radio (Jim Rome, Doug Gottlieb, Damon Amendolara), Brownfield Ag News, Charles Osgood, Cigar Dave, Delilah, Glenn Beck, Doctor Oz, Big Boy, Steve Harvey, Learfield Sports, Bobby Bones, Dan Patrick, IMG College Sports, John Tesh, Nashville Hot Country, Ask Heloise, The Ray, Café Nashville, Rocky Mountain News Network, North Carolina News Network, United Stations Radio Networks' Nights with Alice Cooper, Lex & Terry, HardDrive XL, Open House Party, Westwood One 24-hour satellite formats and more than 1,000 other show titles that are delivered via AMC-8.

As listed by Skyview Networks as of November 2016 – <http://skyviewnetworks.com/news/press-releases/ses-satellite-replacement-2017-2/>

Clearly, C-Band is important to radio. To get its handle on radio's use of C-Band, last year the FCC opened windows for C-Band receive-only dish owners to register their earth stations. Neither the legislation nor the FCC, however, provided any explicit protection against interference.

In recent comments, some proponents for C-Band reallocation have proposed that all or most all broadcast program delivery should be transitioned to the Internet via fiber.

**T-Mobile:** T-Mobile is perhaps the most aggressive proponent of C-Band transition, proposing to auction all 500 MHz of C-Band spectrum with an incentive auction modeled on the FCC TV repack, employing a forward auction for terrestrial operators to establish a purchase price in a Partial Economic Area. That purchase price would be offered to satellite operators and earth station registrants to clear the band. T-Mobile then proposes that broadcast networks be distributed via broadband fiber.

T-Mobile claims its incentive auction proposal would comply with the Communications Act, allow participation by all stakeholders, and benefit U.S. taxpayers by returning a portion of the proceeds to the U.S. treasury. If neither satellite operators nor earth station registrants clear the band at the purchase price, the forward auction resumes at a lower clearing target such as 400 MHz instead of 500 MHz.

**The ACA Proposal:** The ACA (America's Communications Association, formerly the American Cable Association) makes a more conservative proposal, aiming to clear 370 MHz of C-Band and a longer timeline for fiber deployment (up to five years in rural areas), and fiber deployment costs (up to eight-billion). ACA apparently now believes this is a one-time opportunity to get the transition to a future-proofed fiber network funded through a C-Band auction, believing that the transition to fiber was coming anyway and having concern over the C-Band Alliance (CBA) proposal. ACA proposes a timeline in three parts: (1) Urban/fiber-rich areas could be cleared in eighteen months, (2) suburban/easy-to-build markets in three years; and (3) rural/remote areas in five years and reimbursement for non-MVPD C-Band users of about three to four-hundred million dollars per year for the migration to the upper portion of the C-Band, to repoint antennas if needed, and install filters.

**AT&T:** AT&T proposed an "alternative private auction" wherein the FCC would use Section 316 of the Communications Act to modify the space station owners' licenses to create a partitioned authorization and a record to determine the amount of spectrum to be repurposed for flexible use. Under the AT&T plan, space station owners could sell the partitioned spectrum via private auction and submit a transition plan for shifting C-Band use based on reasonably projected future demand.

### The C-Band Alliance Proposal

The C-Band Alliance – composed of the four major satellite operators in the U.S., Intelsat, SES, Telesat, and Eutelsat – proposes to quickly clear C-Band spectrum, predicated on the idea that there is no unused mid-band spectrum to support 5G deployment. It would clear 200 MHz including a 20 MHz guard-band, launch additional satellites, re-point existing antennas and use filters to clear spectrum in 18 to 36 months, utilizing a private, market-based auction to transfer the spectrum to wireless it claims would be open and transparent.

The CBA claims that Section 316 of the Act and the Constitution's Takings Clause prevent the FCC from unilat-

erally authorizing new terrestrial mobile operations in the C-Band without its consent because fixed satellite service and terrestrial mobile services are not compatible co-frequency uses. However, CBA claims that receive-only earth station registrants have no *independently enforceable* rights against harmful interference. Their non-interference benefits are derived entirely from the rights of space stations licensees.

T-Mobile, however, claims there is consensus that earth station registrants are licensees under Title III of the Communications Act, and that they must be an independent part of the band clearing process and allowed to compete in a reverse auction. Verizon also commented that there is no precedent of law or policy preventing earth station operators from being considered licensees, although it opposes T-Mobile's plan as unlawful.

**Lawmakers Weighs In:** In May, Senators Roger Wicker (R-MS), Chairman of the Committee on Commerce, Science and Transportation, and John Thune (R-SD), Chairman of Subcommittee on Communications, Technology, Innovation and the Internet, wrote to Chairman Pai stating "winning the race to 5G requires world-leading technology, access to spectrum on which 5G systems will operate, and the ability to deploy services to the American people, including Americans in rural areas." They emphasized Congress' direction in MOBILENOW to evaluate wireless use of C-Band and urged the Commission to act quickly to make that spectrum available for 5G. Over in the House, Rep. Doris Matsui (D-CA) recently released a draft bill – <https://matsui.house.gov/news/documentsingle.aspx?DocumentID=1875>

– proposing a compromise approach to reallocated C-Band, and Communications Subcommittee Chairman Mike Doyle (D-PA) and Matsui reportedly are working on legislation that would require an FCC C-Band auction within an expedited timeframe – <https://www.broadcastingcable.com/news/house-gets-c-band-earful>

### Conclusion

Clearly a shake-out and shake-up is in the works for delivery of broadcast and cable network programming. Increased emphasis will be placed upon the idea of transitioning all program delivery to fiber over the Internet. However most engineers agree that fiber is not yet up to the task, not yet sufficiently deployed, and lacks the reliability required by television and radio networks. As this matter progresses, broadcasters must remain vigilant and increasingly participate in the policy discussions that may determine the future delivery viability of the network programming upon which many rely. The Wireless and International Bureaus and offices of Engineering and Technology and of Economics and Analytics have issued a public notice – <https://docs.fcc.gov/public/attachments/DA-19-678A1.pdf> – seeking comments on the AT&T and ACA plans as well as a technical study on satellite and fixed wireless point-to-multipoint co-existence. Comments are due by August 7 and replies by August 14.

*This column is provided for general information purposes only and should not be relied upon as legal advice pertaining to any specific factual situation. Legal decisions should be made only after proper consultation with a legal professional of your choosing.*

*Gregg Skall is a partner of the law firm Womble Bond Dickinson (US) LLP. He frequently lectures on FCC rules and regulations, represents several state broadcaster associations and individual broadcasters and other parties before the Federal Communications Commission in their commercial business dealings.*

*This column is provided for general information purposes only and should not be relied upon as legal advice pertaining to any specific factual situation. Legal decisions should be made only after proper consultation with a legal professional of your choosing.*

# Sicon-8 Internet & Voice Remote Control



## The CircuitWerkes Sicon-8 Remote Monitor & Control

- Uses Dial-up, Internet Web server or free Siconcontroller Software!
- 8 channels of metering, status and control (expandable to 32) and up to 5 alarms per channel.
- No accessories necessary to control your site right out of the box.
- Auto-ranging, auto-calibrating meters make setup a snap.
- Includes: Function scheduler, auto-logging & alarm reporting.



## Internal Web Server



## Free Siconcontroller Software

The Sicon-8 lets you control your site via Internet with its internal Web server, via telephone, auto-answering cell phone or with our free software. Setup is a breeze using the Siconcontroller software that also includes scripting, e-mail alerts, multi-site management, virtual metering & much more!

# Web-Based Remote Controls w/Streaming Audio Option

Introducing the SiteSentry4 (4 channel remote control), SiteSentry2 (2 channel remote control) & WAM-2 audio monitor

- Web enabled remote controls with 6 relay outputs & 2 status inputs on all units.
- All units detect Stereo or Dual Mono Silence (independantly adjustable channels).
- User-programmed relays (DPDT) close automatically or via Web control
- All products include onboard temperature sensor
- Internal logging with onboard e-mailing.
- Supports DDNS services and Netbios names
- Upgradable firmware. Keep your product current with downloadable updates!
- Streaming audio option encodes Ogg-Vorbis & decodes mp3 or Ogg-Vorbis.

SiteSentry4



SiteSentry2



WAM-2



# Remote Broadcasting Solutions

Discover more online at [www.circuitwerkes.com](http://www.circuitwerkes.com)



## MicTel Mic/Line to Telephone Interface

- Outputs & Inputs for telephone handset, cellular phone or balanced line level at up to +10dBm.
- Operates up to 36+ hours on two 9V alkaline batteries.
- High quality, user-switchable, internal limiter prevents clipping
- External power input with silent, auto-switching battery backup.
- Individual gain controls for send, receive & headphones levels.



## Unattended Dial-Up Broadcasts with the DR-10

- The DR-10 is a Dial-Up remote control with balanced, telephone audio input & output that can control many automation systems or your audio console for unattended remote broadcasts.
- Our Silencer™ option removes control tones from the audio path.
- Use the DPDT relays to insert the phone audio directly into the program path when necessary, especially for emergencies.



## TelTap Pocket-Sized Manual Telephone Coupler

- Can be used as a phone tap or a passive manual telephone coupler.
- Send or receive telephone audio.
- Compact size & low cost makes the TelTap a great addition to your remote kit for main or backup capabilities.

# Lots More CircuitWerkes Problem Solvers

- Transcor-15 - Move up to 16 contact closures from room to room over an audio cable
- DT-232 - Turns DTMF sequences into user-programmed serial outputs & action steps
- FSK Encoders, decoders, transceivers and contact-to-FSK encoders/decoders.
- SUB-03 Subaudible tone decoder and SEN-6 Subaudible encoder.
- HC-3 telephone autocoupler and AC-12 rack of autocouplers
- DTMF-16 and CS-8 DTMF tone decoders.

Find Full product info & downloadable manuals online at [www.circuitwerkes.com](http://www.circuitwerkes.com). 352-335-6555

# Transmitter Site

## Who's Minding the Store?

### Watt? No Meters?

by Gary Minker

Congratulations!

You spent over \$375,000 on a new antenna system with a three station combiner that will be owned by you, operated by you, and money will be paid to you for the use of input ports two and three. Wow, what a deal to make your tower profitable. This was a real coup, and your boss man, General Mangler and even the owner will be so pleased. You think that you did everything right. The tower is great, and the best of vendors were selected to provide the components – you even had a say in who the installing crew was. And the vendor of the combiner came down to sweep the whole shootin' match and swore on his breakfast of biscuits and possum that everything was up to snuff.

What could possibly go wrong?

Time passes and your company collects piles of printed presidents and just when you think that things are dandy several years down the road, your port two and three tenants are squawking something about no range and lots of static. You did not notice this, since your station is automated, you don't listen to the format, and no one answers your phones. Ooops! What could possibly be wrong? The transmitter is happy, there are no V.S.W.R. alarms. The remote control is saying that you are making power, and for some reason you think, so is everyone else to some degree. There is clearly a rat in the kitchen but you just don't have the vision of what it could be.

Let us review what you have. There is this combiner system. It was tuned up and running cool. The antenna swept great ... past tense.

There have been no storms, tornado's or other signs of demise to trip your trigger. Things should be wonderful in your life but from the mounting phone calls, your life is beginning to stink. What are you missing? Common sense kicks in like the app on your phone and you drive to the transmitter site to be greeted by a room full of coolness, a strange smell, humming transmitters and no apparent sign of trouble. After fifteen or twenty minutes, you make way to leave the building and when you step out of the door, you can't help but notice the small smoldering, nearly extinguished grass fire on the back side of the building.

So many things rocket through your now damaged mind. Fire, though inspirational, does not belong at your transmitter site, and the possibilities of generation sources race through your over taxed brain cells. I am the only one here, and the gate to the compound was locked. There was no lightning. The list goes on and on until you are narrowly missed by a flaming piece of plastic that has fallen from on high.

This can't be right. Fire does not typically come from the top down ... uh oh! It is now that you realize that if your antenna is on fire or the line is on fire.

When you designed your money making scheme to pay the tower expenses, a small but important list of items was nixed by the owner. Not being a transmitter type of guy, he didn't see the need for the extra Watt Meter or monitoring package. He said that you would be fine without it since you have a Watt meter in the transmitter, right? Wrong! The Watt Meter in the transmitter is watching the input to your constant impedance combiner input that has a really nifty dummy load on the opposite port to catch little evil things that might make their way backward through the combiner. You are running a quarter million dollars worth of antenna

without a Watt Meter, Watcher, or any other type of reverse and forward power metering on it! After you put out the grass fire you run inside and start killing transmitters only to notice that the client boxes are already dead. Your next move is to put your hand foolishly onto the dummy loads on the combiner inputs and while the first two are cool as a Coke on ice, the third dummy is still on fire and now so is your hand.

Now that the site is down, you remember that there is a directional coupler installed on the main trunk line so you grab your Spectrum Analyzer and set it up for a forward power measurement. You sheepishly hit run on your transmitter and a reading is obtained. You quickly move the test cable to the reflected port and the reading only goes down by 3.2dB. Whoa ... antennas should have a Return Loss of hopefully greater than 20dB. You check again and sure enough you have a reading of 3.2dB. A quick calculation says that this number divided by 2 roughly equals the insertion loss of the main trunk line to the antenna and what is left of your now mushy mind says that the flaming ball of goo that nearly hit you was part of something on the tower – your antenna system is on fire and you could lose your job over this.

### I Need a Tower Crew

Your phone won't stop ringing, you quickly learn to hate your once favorite ring tone, and the one call that you have to take is the General Mangler who is driving with the owner in your direction. As luck would have it, your tower crew is just hanging around the house and they pop over for a climb to find things that no Chief Engineer ever wants to see.



Molten BB's of copper sitting on an insulator and the accompanying length of outer conductor with blotchy black and orange spots. This is going to turn in to a fig for your job.

### Who's Minding the Store?

This is the dangerous part, where you try to walk the fine line of calling your superiors stupid and cheap, while trying to explain that this is not your fault – and yup, they are stupid and cheap. Good luck with this.



Initially, there is a lot of yelling and finger pointing both verbally and literally. You explain to them that what apparently is a fire upstairs has blown out three reject loads, and attempted to, if not succeeded, in damaging three transmitters – and took out two power dividers along with a bunch of rigid line.

You haven't even gotten to answering their question of *why* did it do that, for which there is no apparent answer other than the guys working on the tower lights seemed to have shoved a piece of rigid out of alignment which caused it to arc internally. Since the twins "cheap and stupid" insured that there was no metering on the main antenna trunk line to see the failure, three transmitters kept pumping 27,000 Watts apiece in to a welding experiment. Ouch, it is *still* your fault, but the yelling stopped while they bat their deer in the headlights look of bewilderment at you.

### So Many Great Choices

With so many great choices for RF power and V.S.W.R. monitoring, the original decision to save the \$3,000 to \$6,000, and skimp on the monitoring system, turned out to be pretty (go ahead and say it) stupid. A single poor decision will set three stations back three weeks to running at a thousand Watts each. But thanks to your very creative Line Sweeper, Tower Crew, their well equipped work truck, along with some ingenuity, they will not have to spend three weeks waiting for parts totally off the air. Neither you nor, unfortunately, the tenants had a say in the lack of monitoring equipment for which they hold your people ultimately responsible for their damages.

There are so many ways to monitor your power. You could even do it the super cheap way with a pair of detectors along with appropriate attenuators. Just wire the detectors directly to the analog input of your el-cheapo remote control to get linear, offset, and sort of calibrated readings, that could warn you way in advance of impending doom. I get it that you are not about to tell the General Mangler that this whole problem could have been detoured for the lack of a couple of hundred bucks, but going forward, keep this from happening as an entry in your book of, "Don't Let This Happen To You" and make the suggestion.

Metering does not have to be fancy or cost a lot of money. Take advantage of the already installed directional port, add a few appropriate attenuators and install some detectors, or if you have slug capable sections, install sniffers with the power handling ability, build some small potentiometer settable filter boxes and wire these cheap gems to your remote control.

You might get to keep your job or contract and be the hero instead of the other way to go. Weigh the odds. Spend \$23,487 on parts, Tower Crew and Line Sweeper or \$433 on do it yourself parts for a cool power monitoring system. It is your choice.

Gary Minker owns Radio Works R.F. Consulting Email him at: [gary@RadioWorksRFConsulting.com](mailto:gary@RadioWorksRFConsulting.com) or call 561-346-8494. Find Gary on the web at [www.RadioWorksRFConsulting.com](http://www.RadioWorksRFConsulting.com)



RF Detector



Line Slugs

make your AM  
**GREAT**

...with ORBAN's  
Flagship AM Processor!



Louder, cleaner, brighter, FM like audio with a fatigue free quality that attracts listeners and holds them

Call to schedule a  
**FREE DEMO**

Get yours from **SCMS** for **\$7391.**



1-800-438-6040 | www.scmsinc.com

Broadcast Equipment Solutions | 19 reps across the U.S. and Latin America  
World Radio History

# Tips From the Field

## Replacement Batteries for the Samsung Galaxy S5 Series Phone

by Bob Reite CBT

One of the few cell phones with an easily replaceable battery is the Galaxy S5 Series. I find it very handy to be able to swap out a weak battery for a freshly charged one, rather than have to hunt for an AC outlet or 12 Volt car adapter to recharge an internal battery. In fact, I bought a spare phone of this make and model so that when my active one finally dies, I can just move my backed up data to the spare.

Samsung no longer supplies replacement batteries – they would rather have you buy a new phone at this point. I would only consider a new phone if a current model had an easily replaceable battery. In any case here is a report on the search for a new battery to fit my old phone.

### “OEM Samsung Battery” Sold on Ebay

Searching Ebay led me to purchase two samples of a Samsung EB-BG900BBC 2800 mAh cell phone battery for \$5.99 each. They arrived fairly quickly by USPS First Class Small Package, but not correctly labeled. Li-ion batteries not shipped in the equipment they power must be labeled with the new UN3480 label and the phrase “Surface Mail Only, Lithium-ion Batteries – Forbidden for Transportation Aboard Passenger Aircraft.” The cells came with no name on the battery label and a slip of paper with sentence, “Dear sir/madam. In order to make custom cleared easily, we cover the Samsung Logo by one more sticker. Remove the first layer sticker to get truth.” This made me suspect that the goods were counterfeit, otherwise why would the importer try to hide the manufacturer’s name.

Physical examination, after carefully peeling off the top label, revealed the following:



The genuine battery has a white indicator that turns red if it gets wet. The counterfeit item was missing the indicator, even though there was a recess molded in the case for it.

The QC code on the counterfeit was blurry as if there was too much ink. In addition, the two samples of the counterfeit battery had the same serial number. Genuine items will have unique serial numbers. The counterfeit also did not have the embedded Near Field Antenna, but I don’t use that feature so that part didn’t matter to me.

I then thought, “Who cares, if they will last as long as the original, I don’t care who made them.” So I did some electrical tests. For all of the tests, all samples of new batteries were run through three charge-discharge cycles by using them in a phone. I was in a hurry to get results, so I first tested both samples at the 5 hour rate which is 560 mA through a constant current load.



### QC Code is Blurry on Counterfeit Battery

I have seen different values published as the “fully discharged” voltage. My phone considers the battery to be fully discharged at 3.5 Volts. I’ve seen 3.2 and 3.0 Volts given, as well as 2.5 volts for some Li-ion chemistries. All of these values are at the point where the discharge curve falls abruptly. I decided to use the 2.5 Volt value, to give the batteries the best chance of success, as well as to see how well they stand up to the abuse of deep discharge.

The constant current load is pretty simple, consisting of a MOSFET mounted on a heatsink, a one Ohm 5 Watt resistor (which serves as a current sample and part of the load), a 500K pot, a LM358 op-amp and a 5 VDC wall wart. The minus of the wall wart supply and the battery under test go to one end of the one Ohm resistor. The other end of the resistor goes to the source of the MOSFET and the inverting input of the op amp. The wiper of the pot goes to the non-inverting input, and the two ends go to ground and the +5 volt supply. The output of the op amp goes to the gate of the MOSFET. The drain of the MOSFET goes to the positive terminal of the battery under test.

For comparison, I also tested an old, but still usable, genuine Samsung battery. The old Samsung battery lasted 3 hours 20 minutes, for a calculated capacity of 1866 mAh. The counterfeit sample ran for 3 hours 6 minutes, giving 1736 mAh. The counterfeit sample two ran for two hours 55 min for 1633 mAh. After that, sample two refused to accept a charge. I then measured the mAh capacity at the 20 hour rate (140 mA) which would be closer to actual use in a phone. The surviving counterfeit battery lasted 14 hours 29 min for a measured 2030 mAh capacity, not the claimed 2800 mAh. The old Samsung battery lasted 14 hours 51 minutes for 2080 mAh.

I contacted the seller with my findings and he agreed to give me a full refund. He even paid for the return shipping, so at least I got all of my money back.

### Generic Battery Sold by Battdepot.com

I then ordered two replacement batteries from a company that made no effort to hide their origin or claim to be from Samsung when they were not. The cost was \$13.99 each. Like the Ebay seller, Battdepot.com shipped the product via USPS without proper labeling.

Interestingly enough, both samples of this battery shut down at 2.8 Volts before the 2.5 Volt “total discharge” voltage value I was using was reached. The first time this happened, I thought I had killed yet another

battery, but after being allowed to rest a few minutes at no load, a voltage of 2.9 Volts was measured and I was able to fully recharge them. As Li-ion batteries are destroyed by discharging them to zero, it appears that these batteries are protected from such an eventuality if the phone fails to shut down on low battery.



### Generic Battery From Battdepot.com

This battery is claimed to have a 3800 mAh capacity. However, so that I would be comparing “apples to apples,” I set the constant current load to 140 mA for a 2800 mAh capacity at the 20 hour rate. If the battery was indeed 3800 mAh, it should last over 27 hours at a 140 mA current drain. Sample number one lasted 19 hours 42 minutes for a measured capacity of 2750 mAh – just shy of 2800 mAh before shutdown. Sample two lasted 20 hours 1 minute for a measured capacity of 2802 mAh. Based on the measured capacity, I’m certain that “3800” was a misprint, these should have been sold as 2800 mAh batteries. Also note that these batteries might have run ten to fifteen minutes more if I was actually able to run them down to the 2.5 Volt level.

### Model CEL-I9600NF Sold by Best Buy

I decided to see if I would get a better battery by paying more. At \$24.99 each, the Best Buy offering is nearly twice the cost of the other two brands that I tested. Because of the cost, I only purchased one sample. The battery was shipped via UPS Ground, properly labeled in accordance with UPS regulations.



### Model CEL-I9600NF From Best Buy

The BestBuy offering does include the Near Field antenna. Best of all, this battery did live up to the capacity claim, running for 20 hours and 19 minutes for a total measured capacity of 2844 mAh at the 20 hour rate.

### Bottom Line

In this case, the phrase, “You get what you pay for” certainly held true. Stay away from the, “It’s too good to be true” sellers on Ebay. Although one sample from Battdepot.com did not quite live up to even my expectations of 2800 mAh, when you calculate the cost per mAh they are still a bargain. If you need and use the Near Field feature of the phone, the only option is to purchase the model CEL-I9600NF battery sold by Best Buy.

Bob Reite operates his contract engineering firm, Telecentral Electronics, Inc. servicing radio stations in Pennsylvania and New York state and may be contacted at [br@telcen.com](mailto:br@telcen.com)

# RE~~X~~THINK Radio

Welcome to  
Broadcast 3.0



## Introducing The Über-Node.

Power Core is designed with flexibility in mind. So you can combine AoIP streaming with device administration on a single Ethernet port... or place them on separate ports. Power Core lets you design your network your way.

Power Core can handle up to 128 MADI channels, standard. 4 front-panel ports (two dual-redundant pairs) with SFP make it easy to bridge your AoIP and baseband digital signals.

Think Power Core looks awesome outside? That's nothing compared to the sheer processing might inside, with a 1920\*1920 routing matrix, 96 DSP channels and 80 summing buses. All your friends will be so envious.

Information please: high-resolution color display with rotary encoder provides easy front-panel access to network information and settings

Power Core is 100% standards-compliant - because proprietary AoIP is so 2003. Up to 256 channels of true AES67 and RAVENNA streaming, on two front-panel Ethernet ports. Even complies with the ST2110-30 standard. Because you can't be too future-proof.

Power Core supplies 64 channels of GPIO via standard RAVENNA and open-source Ember+ protocols. Need physical connections? Use the front-panel interface. Highly logical.

The Lawo logo. Your assurance of meticulous engineering and premium components, uncompromisingly crafted to the highest German standards.



Power Core is the only broadcast AoIP node with ST2022-7 Seamless Protection Switching, giving you dual discrete links to your network core. Completely redundant, with automatic, inaudible switching. Now that's what we call peace of mind.

Connect your AES / EBU devices. Expansion card has 4 digital stereo inputs with broadcast-grade sample rate conversion, and 4 digital outputs.



Everybody's got a few analog sources. Line input & output cards with 4 stereo (8 mono) channels make connections a snap.

Lots of talking to do? 8x Mic/Line card with Phantom power does the trick.

Studio I/O card is perfect for on-air rooms. 2 Mic/Line inputs, 2 Line outs for speakers and 2 headphone feeds.

Got DANTE®? No problem. Power Core equipped with a DANTE expansion card gives you access to a whole world of pro-audio devices. Two mirrored ports with onboard SRC provide 64 channels of I/O.

If four front-panel MADI ports aren't enough, you can add more. Dual-port MADI expansion cards give you two SFP ports with 64 channels each.

Power Core is already the highest-capacity AoIP node + console engine in the world. 8 rear-channel expansion slots make it capable of even more.

Dual-redundant power, of course. Our hardened internal auto-switching power supply is backed up with an inlet for external power too.

As proof, we present Power Core: the modern, super-compact AoIP audio interface that packs hundreds of stereo channels into just 1RU. Handles AES67, MADI, analog, AES3 – even Dante®. You'd need 24 rack units of old-style nodes to equal all the I/O available in just one Power Core.

Impressive, yes? But audio I/O isn't the end of Power Core's capabilities. There's DSP; a lot of it — 96 channels of EQ, dynamics and mixing. AutoMix, too. Plus routing: 1,920 crosspoints, enough to switch an entire multi-station broadcast facility.

Power Core is flexible, too. Pair it with our award-winning Ruby radio console and it's the most powerful mixing engine ever. Put it in your rack room and presto! it's a high-density audio interface with built-in routing. Remote-control it with our VisTool GUI Builder software, and it's the heart of your TOC.

Power Core. The Über-Node has arrived.



Power Core is the perfect AoIP supernode. But it's also a powerful mixing engine. Pair it with our award-winning Ruby – the beautiful, powerful, intuitive surface your talent will be clamoring to get their hands on. Or control your Power Core with Lawo VisTool for a custom “virtual console” with context-sensitive multitouch controls.

Join us  
@TAB

www.lawo.com

World Radio History

Join us  
@IBC

## The Unsung Heroes of Frequency Modulation

by Steve Callahan

Imagine what it would be like to have a world without FM. We all know that Major Edwin Armstrong developed the concept of Frequency Modulation and defended it for decades against the legal wrangling of the Radio Corporation of America or RCA. The Major's untimely death brought that legal battle to an end but also signaled the beginning of experimentation and expansion of Frequency Modulation as a viable competitor to the then dominant Amplitude Modulation.

There are two other names who played a valuable part in the advancement of Armstrong's concept of FM. One of those is Franklin M. Doolittle of New Haven, Connecticut. Doolittle was an experimenter, electrical engineer and builder of a fledgling radio station. On November 27, 1922 Radio Inspector Walter Butterworth traveled from Boston to personally inspect Doolittle's radio apparatus at 817 Chapel Street in New Haven. Butterworth was so positively impressed with Doolittle's backyard radio apparatus that he recommended that the U.S. Commerce Department's Bureau of Navigation grant a new Class A limited three-month commercial license. WPAJ, with 30 Watts at 833 kilocycles, was now Connecticut's first commercial radio station. It was located upstairs from the Doolittle Radio Corporation which was busily assembling radio receiving sets to receive the new radio station's signal.

On August 6, 1924, The Bureau of Navigation's Radio Division authorized Doolittle's WPAJ, now operating at 100 Watts, to conduct duplex, or binaural, broadcasts on two frequencies, 1120 and 1320 kilocycles. The same program was broadcast over both signals utilizing two microphones each feeding its own transmitter. That was the day that stereo broadcasting was born. Doolittle said, "Listeners were invited to join in the experiments of such unheard things as stereo broadcasting years before there were any stereo records." On November 4, 1924, Doolittle obtained a patent (#1,513,973) for a "Useful Improvement in Radiotelephony" for his binaural broadcasting.

In December of 1925, WPAJ's call letters were changed to WDRG for Doolittle Radio Corporation. WDRG was licensed to operate on 1120 kilocycles but in early 1927, power was increased to 250 Watts and the frequency was changed to 1090 kilocycles. By late in 1927 WDRG was operating with 500 Watts of power and in 1928 WDRG's frequency changed once again, this time to 1330 kilocycles.

1933 saw a boost to 1,000 Watts and in 1934 it grew to 2500 Watts day and 1000 Watts at night. In 1936, Doolittle received permission to build and operate W1XSL on the West Peak of Meriden Mountain in Meriden, Connecticut – one of twelve "Apex" AM high frequency experimental stations, to be operated at 40.3 megacycles with 1,000 Watts of power. The call letters of the experimental station changed in 1938 to W1XPW.

On February 14, 1941, Doolittle's experimental FM took part in a unique FM radiorelay test. Major Armstrong spoke via telephone from New York City to studios in Boston. That call was relayed to W1XOJ in Paxton, Massachusetts, which then relayed the call to W1XER on

Mount Washington, New Hampshire. Armstrong's telephone call, with engineers at each site speaking to him, was then relayed back to Paxton and then on to Doolittle's W1XPW at Meriden Mountain, which then relayed the programming to Armstrong's experimental FM at Alpine, New Jersey. This multi-station FM test proved the ability to rebroadcast a quality FM signal across long distances, thereby eliminating the need for costly telephone lines.

This audiocut is almost 30 minutes long but well worth the time to listen to Major Armstrong himself comment on the quality of the relay:

<https://soundcloud.com/search?q=w1xoj>

This unique test would not have been possible without another unsung radio pioneer. John Shepard III was born in Boston in 1886. He grew up in Providence, Rhode Island and joined the family business in Boston, The Shepard Department Store. In 1922, AM radio was all the rage and John Shepard realized that his store needed a radio department where he could sell pre-assembled radio receiving sets. He quickly decided that if he owned a radio station, he would sell more radio sets, so on July 31, 1922 WNAC in Boston debuted with a mixture of music, news, religious services and educational lectures. He applied for another station, this one in Providence, with the call letters WEAN which would serve the Shepard Store in that city. He then created the Yankee Network when he linked the Boston and Providence stations together and shared programming between the two.

Paul DeMars, was a brilliant radio engineer and was also the Yankee Network's Chief Engineer. DeMars convinced Shepard to invest in the new radio technology called Frequency Modulation and they set about building W1XOJ on Asnebumskit Hill in Paxton, near Worcester, Massachusetts which was soon followed by W1XER on top of Mount Washington in New Hampshire. The two stations were linked together and became the first FM radio network.

Those two Shepard experimental stations, along with Doolittle's Connecticut experimental FM were the



Major Armstrong and Franklin M. Doolittle



John Shepard III

necessary components for Armstrong's FM relay. It's fascinating to know that back in those days it was possible to receive FM signals over the air over long distances with full quieting. This would be impossible today with the proliferation of the FM band throughout the country.

I had the privilege of being Chief Engineer at WEAN in Providence and I was always pleased to be able to add some valuable piece of radio history to the station archives. Unfortunately, I don't know if that unique and valuable archive still exists, after many ownership changes and consolidation.

Early on in my career I spent five years working at a station on Asnebumskit Hill in Paxton which was just down the hill from what we referred to as the "Armstrong Tower."

I didn't know how historic it was at the time, until I met a fellow engineer who said that his father was one of the Armstrong engineers who worked at the site during its construction and during the FM relay tests. He also volunteered that a tube from one of the Armstrong FM transmitters had been in his house for years and was used as a door-stop! I would have treasured ownership of that door-stop tube but unfortunately it wasn't meant to be.

However, my technical duties these days require that I visit the Armstrong tower regularly and recently I visited the West Peak of Meriden Mountain and saw the 85 foot monopole which was the antenna support structure for Doolittle's experimental FM station W1XPW.

Thanks to the readers who commented on my visit to the Connecticut Antique Radio Museum in the previous edition of Radio Guide. It was indeed a pleasure to spend a few hours remembering radios and TV's that were such an important part of our past.

Richard Lee, the President of the New Jersey Antique Radio Club enjoyed my article and kindly invited me to visit their Radio Technology Museum next time I'm in New Jersey. They are at 2201 Marconi (That's right!) Road in Wall Township, New Jersey 07719. They are open for your visit on Wednesdays, Saturday and Sunday from 1:00 to 5:00 p.m. On-line they can be found at [www.NJARC.org](http://www.NJARC.org)

I'm sure that his invitation extends to all of you who enjoy classic communications.

Many thanks to Ed Brouder, the Man from Mars, for valuable facts from his WDRCOBG.com website. Ed's also the author of "Granite and Ether," the definitive New Hampshire radio history text.

Thanks also to Dan Kelleher, radio engineer and broadcast archivist extraordinaire.



The Armstrong Tower in Paxton, MA Today

Steve Callahan, CBRE, AMD, is the owner of WVBF, Middleboro, Mass. Email at: [wvbf1530@yahoo.com](mailto:wvbf1530@yahoo.com)





**SMARTS**  
Broadcast Systems

(800) 747-6278

www.smartsbroadcast.com

sales@smartsbroadcast.com

## **Skylla**

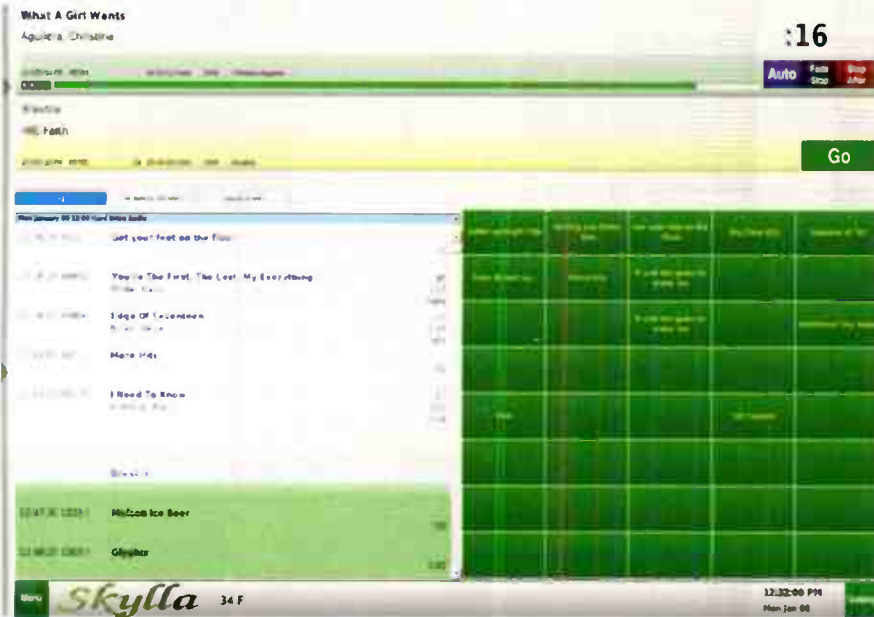

### Skylla's Smart Features:

**Smart Special Events** like ballgames, national and local.

**Smart Satellite** support, complete with incoming RBDS data, announcers, clocks, break-tracking, and automatic break fill.

**Smart Automatic Downloads** of audio from the Internet.

**Smart Automatic Unattended Recording** by time, closure, or both.

**Smart Voice Tracking** allowing people to voice track at the same time to the same log, both at the station and remotely. Also allows voice tracking to future yet-to-be-merged playlists.

**Smart Design.** For uptime and reliability: Linux. For data safety: RAID and machine-to-machine backups of audio and data.

## **SkyllaPad**



Simplify local sports broadcasts.

With features found only on SkyllaPad, broadcasting remote sporting events has never been easier.

You supply audio, SkyllaPad supplies control. With the touch of a button on a Smartphone, tablet, or laptop, you're on the air and in charge of your remote.

## **SecGen**

Traffic & billing software designed for you.

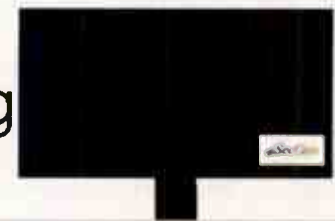

SecGen, the second generation of our original Smarts program, lets you define the setup by matching the program to your station's formats and breaks. Combined with the ability for single user, multi user, and remote user, SecGen can be customized to fit your needs.



**SMARTS**  
Broadcast Systems

## The TV Repack Tower Crews Are Working Hard

by Wiely Boswell

There is quite a flurry of activity as TV broadcasters go through another major channel transition. The good news is the off air viewer still gets to think it's the same channel number. The required off-air rescan education spots are under way for those coming up to their mandated transition date.

The repack work being done will have an effect on a lot of us in radio. Here is my experience thus far as the tower crew gets the work done on our tower.

We have a TV station broadcast antenna right under our FM antenna, making RF safety requirements come into play as the work is done. My first RF power down requirement came when the two ERI engineers climbed our tower. They were to do a site survey of the existing TV antenna and its mounting to ensure the new permanent antenna will mount as designed when it arrives. The ERI engineers also have a drone pilot's license and used a drone to make an aerial video for future review. In this tightly phased repack schedule there is little or no time for a do over by the antenna manufacturers or tower crews. Tower crews are hard at work, spending lots of time, going from site to site putting up temporary wide band antennas and coming back later in the schedule to change out the main antenna and rigid line.

Coast to Coast Tower Service, Inc. was tasked with the project and was coordinating with ERI. When crews such as this mobilize, things happen. The right equipment and supporting parts have to be delivered to the site. Large equipment, some of it local rental, starts to show up. The advance team assembles the antenna with mounts before the rest of the crew arrives. Then the rigging begins after an initial confirmation with project manager. The first line up is the tag line. In this case it was attached to the tower above where the side mount antenna will go. The fence around the base was taken down and the line pulled in a clear path direction away from the face/leg where the antenna mount was to be located. In our case the AGL height was 300', the tag line attached at 325', with the line being tensioned and anchored on the ground at about 60' away from the base. A large pulley was strapped into position at the base of the tower. The load steel cable was pulled from the drum hoist through the pulley up the tower to another pulley near the tag line attachment. This lifting cable was used with a lift pulley riding on the tag line to raise equipment and personnel up to the mount location.

Safety is of total concern all the way. Meetings were held reviewing safety procedures each morning with the crew. Climbing and lifting equipment was also inspected. The cable drum hoist is an amazing work of machinery. This hoist also has multiple safety features and uses disc drum braking with backup systems. To control cable movement takes operator pressure on the controls constantly. An operator who falls away from the controls stops any cable movement.

His responsibility is intense as he raises heavy loads and crew members. **Figure 1** shows Andy Jaramilo at the controls. He has seen a lot in his 30+ years in tower work. To be sure, this site was a baby project compared to the 2000' towers with candelabra mounted antennas weigh-

ing thousands of pounds they put up. They also work with "picks" involving helicopters. Some antennas are so heavy a helicopter can not lift them. They typically use 80+ foot sectional gin poles with mounts that allow movement for these large scale projects.



Andy Jaramilo at the controls.

As a side note, if tower sections and gin poles do not allow some bending they will break. I saw a photo of a tower being erected with an incredible bow during a wind storm but that was said to be a normal reaction in large winds.



**Figure 2** shows the top of a gin pole with the revolving pulley called the Rooster head. **Figure 3** shows the special base of the pole called the "Whale tail". They incorporate various sizes of pole assemblies to fit the job requirements. Another interesting piece of equipment is the "Headache Ball." This weight is used to counteract the cable weight as the ball is raised to the top. The actual weight depends on the number of feet and size of cable used. When up in the work area the ball is just about the

right height to accidentally hit your head on and thus explains the name.

The azimuth and height of the new interim antenna on the tower was confirmed one more time before the work began. The antenna provided by ERI was a wideband design (470-700 MHz) which allows operation on current frequency and switch over to the new lower channel frequency. Lots of assembly had been done on the ground with flanges that had specific plus or minus 45 degree couplings and even a small dummy load in the design.

They look like a 10' tall 100 gallon water heater and two of them were mounted vertically above each other. I sent some photos to our studio staff and convinced them we were now finally going to have hot water on our tower see **Figure 4** below.



Figure 3

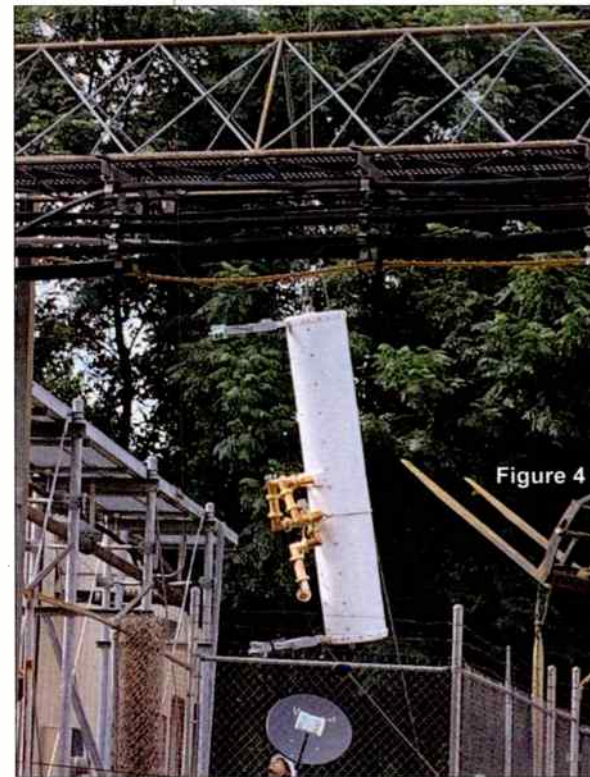

Figure 4

They next pulled up the 2-1/4" coax line utilizing a second pick at 150' to keep the line from elongation damage by not supporting the entire weight of 300' of line being raised. The line was secured, run in the building, and ERI was there again to sweep the line and antenna.

The site was cleaned up and they were on the road again to the next location. I was impressed with their communication, professionalism, and focus on getting the job done in order to meet the tough demands of the schedule. Perhaps they will be coming to your tower as the TV repack phases progress.

*Wiely Boswell is Chief Engineer of Faith Broadcasting, Montgomery, AL; CBRE, CBNE, and SBE 118 Chairman. He may be contacted at: [Wiely@faithradio.org](mailto:Wiely@faithradio.org)*

ARRAKIS SYSTEMS INC.

# ALWAYS THE LEADER

For more than 35 years, Arrakis Systems has led the way with ground breaking innovations in cost effective, reliable Radio consoles... including USB, Bluetooth, world standard DANTE IP connectivity for ALL consoles and 'New for 2018' the DARC series AoIP consoles.



ARC-8  
only \$899

ARC-10  
from \$1,799

ARC-15  
from \$3,999

MARC-15  
from \$5,775

## D.A.R.C.

Dante AoIP Radio Console uses the world standard DANTE IP protocol with more than 300 manufacturers and 1,000 compatible products. From only \$2,400.

operate from anywhere that you have wideband internet !!!

[www.arrakis-systems.com](http://www.arrakis-systems.com)

World Radio History

970-461-0730

# Maintenance Guide

## Plan to Be Safe

by Barry Mishkind

Years ago, one of the Big Three car manufacturers came up with the slogan: "Safety is Job One." This simple, yet profound, statement somehow seems to be ignored so often during times of stress or when things get busy. However, the implications are very serious, and deserve due consideration.

You probably can name many dangerous occupations: construction workers and laborers often get hurt on the job, chemical workers (including beauty salon operators) have respiratory or skin problems, meat cutters and alligator handlers seem to lose a lot of little appendages, and the list goes on. In broadcasting, we immediately think of the dangers faced by tower climbers. And then there are safety issues concerning engineers in general.

### Volts and Deadbolts

While final amplifier voltages on solid-state transmitters are significantly lower than tube models, current is still high – enough that manufacturers continue to add "Danger!" stickers to the transmitters. Add to that the potential personal security concerns of exiting a transmitter room door at 2:00 a.m., and you have some real workplace issues that deserve proper consideration. If you are a manager, the word "liability" should be flashing in your head right now.

Perhaps one of the most troublesome issues arising out of consolidation is the increased workload placed upon engineers. While some companies and markets are exceptions, in many places broadcast engineers now are a vanishing breed. Yet, at the same time, a fair number of managers – most of them never having been to a transmitter

site – have a highly inaccurate view of what an engineer is and what they do. They consider an engineer merely an expense – an expense to be reduced or avoided whenever possible.

Without dwelling upon the number of light bulbs changed, toilets fixed, lawns mowed, or home stereos repaired, in this discussion we will concentrate on the safety and personal security aspects of an engineer's activities. (OK, one short diversion: How many GMs does it take to change a light bulb? None, that is what they keep engineers around for! If that is the attitude in your facility, please raise your hand now.) To be fair, we also need to ask: Have these GMs ever been educated as to what their technical department is all about?

### Don't Touch That!

Many places around a transmission facility can be dangerous – from the transmitter itself to the tower environment. And additional hazards lurk at the studio as well. One of the reasons OSHA mandates "lockout tags" on breakers and disconnect boxes is how easy it is for someone to happen upon an open box, without knowing someone is working in a room far away. A quick flick of a switch, and someone could get zapped.



Sample Lockout Tag

True, it is not uncommon for an engineer to be alone at the transmitter site, so it might seem as though a lockout tag would not be of much use there. On the other hand, it is easy to get busy and become so engrossed in the task at hand that you forget whether the breaker is on or off. And when alone it can be especially dangerous, because it only takes a tiny memory slip and one could literally turn to toast.

Here is another potentially lethal situation, combining two errors: A disk jockey suddenly notices the transmitter is off the air, and pushes the remote control "On" button. Meanwhile, the engineer is working inside the transmitter, having forgotten to disengage the remote control. It does not even sound funny, does it?

### Initial Survey

Whenever an engineer arrives on site for work, whether at a transmitter site or a studio, it is essential he survey the situation and be very aware of which circuits and equipment are energized. Also the condition of the site itself deserves attention, because in addition to technical problems, there are hazards from a variety of two, four, and multiple-legged creatures. So include those concerns, too.

Why not start at the entrance? What do you see? Is the gate in good repair, as well as the fence? While the engineer may be in a hurry to solve an off-air situation, a broken gate or cut in the fence can alert him to intruders who may well have had a hand in causing the problem. A great many stations *do not* take the time to secure the service disconnect boxes outside the building. More than one station has gone "silent" because a local kid played "let's pull the handle."

While you are checking outside, include the towers and bases, as well as the buildings. In most cases, graffiti is not a good sign – for several reasons. It indicates there were unwanted visitors; and if not cleaned up it will attract more defacing. You might have to repaint two or three times, but once the local kids figure the building is not abandoned (they never see you, right?), they will usually move elsewhere. (Continued on Page 22)

## Why Not Switch to



## Complete FM / TV Product Line

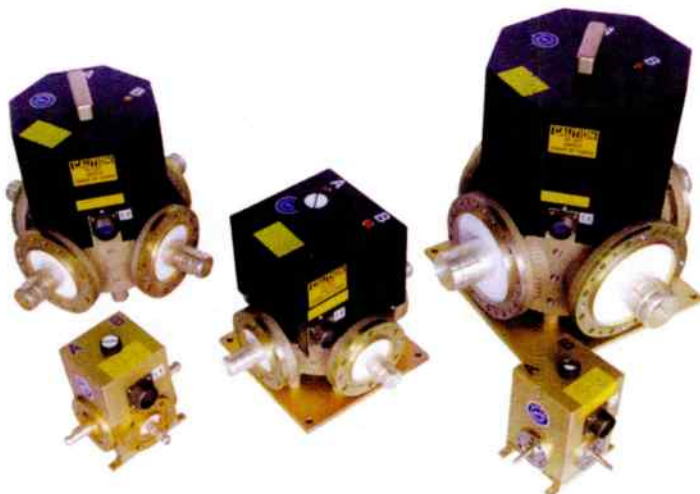

Coax switches available in  
Type-N and 7/16 DIN and  
7/8" through 6-1/8"

- Antennas
- Splitters
- Notch Filters
- Harmonic Filters
- Power combiners
- Channel combiners
- N +1 Switching Matrix

Control panels available.

A subsidiary of **MEGA** RF Solutions

[www.megaind.com](http://www.megaind.com)

Toll Free: 800-545-0608 | [www.mcibroadcast.com](http://www.mcibroadcast.com)

# Open the door to *your* possibilities!



**ON THE AIR**

Powerful, state-of-the-art automation with the flexibility to grow with you...

- The power of OPX in one stand-alone computer
- Easy to learn
- The power to handle the largest audio libraries
- Satellite and live programming
- Additional stations
- Remote voicetracking
- Remote control

## OPXONE



**Call (888) 274-8721**  
(888) BSI-USA-1  
or email us at [sales@bsiusa.com](mailto:sales@bsiusa.com)

## Plan to Be Safe

— Continued from Page 20 —

Locks, chains, gate hinges. And as you approach the main door, see if there are indications of crowbar application. This could be an early warning sign of impending invasion, and merit installing a more secure entryway.

### Inside

Inside the building, the first thing that comes to mind is the condition of the entryway. Is there sufficient light and a walkway clear and free of clutter that could cause tripping and injury? A quick check of the surroundings should verify that no intruders have been inside the building.

Getting down to the issue at hand, whether your visit is for routine maintenance or an emergency visit to get the system back up, the key word is caution. With caution you will avoid many potential causes of injury. Even if you plan to work with the power off, disable the remote control — an unexpected “command” can come when you least expect it.

Clearly the best protocol is to have two persons on site at all times. In some markets, the union contracts forbid an engineer to work alone on high voltage. And some companies make this their policy as well. A second person can be instrumental in saving a life in case of accident, whether by performing CPR, calling 911, or simply being ready to kill the power switch. A second person also can be “in charge” of remembering if the tower is hot or not, and determining “go” and “no-go” for climbers.

Whether or not your chore is routine maintenance, it is important to know *exactly* which disconnect feeds which equipment. Mark or label each box clearly. And, unless you

are testing the transmitter’s operation, turn it *off* before opening the transmitter.

However, this does *not* eliminate all danger. Inside your transmitter are all manner of large capacitors. They can hold enormous charges. And sometimes the interlocks do not work properly: they may be broken, defeated, or lead to an “open” drain resistor. Worse, you might just find a disconnect switch was mis-labeled or broken. Mounting neon bulbs across power leads is a good way to have visual confirmation of power status. A bulb could be mounted on the disconnect, and one *in* the transmitter.

All of this leads us to grounding sticks, and the many lives they have saved. In short, *always use the grounding stick!* Engineers who have had a screwdriver or wrench turn into in an ad hoc grounding stick will tell you how impressive the “flash” can be!

It might seem awkward or inconvenient, but until you have ensured all power sources are discharged, having a hand in a pocket will prevent many an inadvertent “circuit” from being formed through your body. Once everything is discharged, then you can use both hands. But, be sure you have carefully made the way safe.

The safe use of various tools and chemicals are definite topics for another article. The same applies to the necessary maintenance on air condition systems, generators, etc., that are found at many sites. Meanwhile, we will assume your maintenance visit is successful.

### Safe Practices Continue

Even after you have serviced the transmitter (or other gear), there are some important things to do before getting back in the car and heading home.

First and foremost is to document what you did. Maintenance logs are no longer required as in years past. However, the same issue applies as with studio logs: If you have an issue during an inspection, well kept logs will demonstrate that you do not typically run without regard to your

licensed values. It will also provide a paper trail for replaced parts, and what parts of your transmission system need the most work.

Restoring power disconnects and remote control to their proper operating positions should be done by now, and as you prepare to leave, ensure the air conditioning/heating and lights are set for “unattended mode.” As you secure the building, take care of your personal security. Again, two people on site are much better than one, in case some two legged animals are waiting for you to exit into the dark.

Better yet, have a camera set up to show you what is outside, before you exit. Even if your gate is closed, the “smell of activity” attracts some less than savory sorts. Management that does not acknowledge the need for sufficient plans to insure the safety of the individual is asking for a major liability lawsuit.

As you drive away, you might use your cell phone to call the studio or remote control and ensure it is working normally. Some stations even “remote” the light over the door for positive indication things are working (and it sure keeps you from having to get out of the car in the dark!).

### Site Safety Checklist --

1. Site appearance: Are the fences and buildings all secure, with no indication of vandalism?
2. Building integrity: Are the doors secure, properly lit inside (and outside after dark), and walkways clear?
3. Disable the remote control system.
4. Disconnect the power to any equipment you plan to service. Use lockout tags “to be sure.”
5. Use the grounding stick!
6. Keep a hand in a pocket until you are sure gear is completely safe.
7. Handle tools and chemicals safely.
8. Note down all relevant details of your work in the maintenance log.
9. Make sure power and remote control are restored to “normal” operation.
10. Check on any untoward activity outside.
11. Lock up carefully.



**Coaxial Dynamics**  
A CDI INDUSTRIES, INC. COMPANY  
SPECIALISTS IN RF TEST EQUIPMENT & COMPONENTS

COAXIAL DYNAMICS has been a leading manufacturer of precision equipment for the measurement and termination of RF Power since 1969. Our equipment is used by engineers in a wide variety of applications throughout the world.

Our products include:

- Directional Wattmeters for both Analog & Digital applications from 1 W to 100 kW and from 2 MHz to 2.3 GHz.
- Watchman RF Monitor/Alarm Systems.
- Line Sections & Plug-In Elements.
- RF Loads - Dry, Oil, Water, and Air designs up to 200 kW.
- Low Pass Filters & Power Sensors.

6800 Lake Abram Drive, Middleburg Hts., Ohio 44130, USA  
440-243-1100 • Toll Free: 1-800-COAXIAL • Fax: 440-243-1101  
E-Mail: sales@coaxial.com • Web Site: www.coaxial.com

- **Broadcast Equipment** •  
Watchman - High Power Wattmeters - Elements
- **Line Sections & Meters** •
- **Termination Loads** •  
Dry - Oil - Water - Air



# From analog FM to best-in-class HD Radio on your schedule and budget



Flexiva FMXi 4g

Transition to superior digital with exceptional ease and affordability

## Flexiva™ Gen4 Engine HD Radio Solution

- High-efficiency transmitters with industry-leading performance and compliance
- Industry's most advanced quality and diagnostics with robust Flexiva exciters
- New Flexiva **FMXi 4g** combines import/export functions into a single embedded device, including dynamic time/level/phase correction
- End-to-end management for multichannel program transport and delivery

NEW



TRANSPORT



TRANSMIT  
TELEVISION



TRANSMIT  
RADIO

# GATESAIR®

Connecting What's Next  
[www.gatesair.com/flexiva](http://www.gatesair.com/flexiva)

Since 1922, GatesAir has remained the industry's most trusted supplier for the over-the-air TV and radio networks worldwide. World-class engineering and industry-leading innovation marry outstanding performance with the industry's highest reliability and operational efficiency. Our impeccable sales and service bring it all together for our valued customers.





## Take Your Audience Places No Other Processor Can

Meet X5 – the most advanced, finest sounding broadcast audio processor ever designed. It's loaded with inventive technology that dramatically improves your sound AND delivery all while letting you be counted by every PPM out there.

There's never been anything like X5.



BETTER SOUND  
MORE LISTENERS **X5**



wheatstone.com/X5-rg1



## X5 Behind the Screens

### PPMport

#### INSERT LOOP FOR PEOPLE METERS

X5 features an insert loop to interface your ratings encoder AFTER the processing. This delivers a signal with greatly reduced audible artifacts, which ensures you'll be moving all those meters out there.



#### UNIFIED PROCESSING®

Each X5 function in the chain interacts closely with other functions to deliver just the right amount and type of processing needed, letting you create a sound that's as close to the original as possible while still dominating the dial.



#### FM/HD SIGNAL SYNC

Integrated HD and FM analog signal alignment keeps listeners tuned in to your station even during extreme HD/FM blending conditions. No external boxes needed and no more "dip and skip" in reception that can cause tune out, affecting TSL.



#### LIKE THE NSA FOR YOUR X5

Live Logger keeps track of everything happening on your X5. Preset takes? Remote login? Audio failover? Every event is date and time stamped so you can review it. X5 takes audio to a whole new level and, with Live Logger, gives you absolute and complete peace of mind.



#### INTELLIGENCE KNOWS ITS PLACE

Limitless Clipper uses proprietary high-frequency distortion canceling technology to pass the highs, but not the overshoot. No more "spitty" highs or pops from clipping; no IM distortion whatsoever. This clipper will take all the highs you can give it and never give you back IMD. This clipper, along with X5's Phase Linear dynamics, gives you the most powerful FM processor on earth.



#### STUDIO-TRANSMITTER LINK

MPX SyncLink extends the X5 with HD/FM alignment from your studio to your transmitter site. It carefully keeps the HD and FM packets in sync so time alignment done with the processor at the studio is maintained straight through to the receiver.

SEE X5 AT NAB BOOTH N6806



1.252.638-7000 | wheatstone.com | sales@wheatstone.com

World Radio History

## Installing Linux for the Newbie

Getting Around the Windows Obsolescence Situation – Part Eight

by Tommy Gray – CPBE, CBNE

### Putting Linux to Work!

Hi Again! Last time we talked about Linux audio editing, and remote control. This time I plan to take you through a topic of interest these days, things that the broadcast engineer comes up against from time to time, and that Linux has good solutions for. Since the last installment I have been putting in security camera systems in a few places and have come up with several good solutions.

If you have the blessing of Internet service at your transmitter site, then IP cameras are something you need to invest in. They are inexpensive, and provide a great way to monitor your sites when you are away. There are features that most good systems share in common. The items in the list below are things that I personally consider as necessary:

1. Easy and intuitive setup.
2. Reasonable cost (cheap).
3. Reliability.
4. High quality video with motion sensor recording.
5. The ability to see at night as well as it does in the day.
6. Notifications through Email as well as text messaging in case of an alarm.
7. Ability to be remotely maintained and configured.

There are other features that all good systems have that I did not list here but these are a very good starting point for a workable system for your transmitter sites (or studios). Now I thoroughly understand that many of you do not have such luxuries as security cameras in your budget, but I will offer here solutions that meet the requirement of #2 above – reasonable cost, or simply put, “Cheap.”

### Getting Started

**Just the Basics:** First there is the basic system – a simple IP camera that has nothing but a cell phone app to control and monitor your camera. A single IP camera and an iPhone or Android phone app will give you decent monitoring. In my search for several different size workable systems I found an IP camera on eBay that cost me \$39 with free shipping. It had very high quality 1080P video with night vision. It had an app I downloaded from the Apple store, and that allowed me to have a working security camera system that did everything in the list above and more. The video quality is very good with the 1080p, and the night vision has a good range of 50 feet or more of very clear video. The unit has a space for a simple SD memory card of up to 128 GB and can record and save many hours of your recordings.

You can manage it all on the phone app from anywhere in the world you have cell service. My total setup time for this

simple solution was under one hour and most of that was spent trying to interpret the instructions!

I have this camera setup in my office for testing and have checked it from hundreds of miles away, and it works great. This particular camera is an “sriHome” brand. The price, as I said, was \$39 on eBay with free shipping and I got it in three days. There are tons of others that work just as well. This is just one among many.

### Next in Line (More Bells and Whistles):

The next simple and easy, but really great system, was one I found on eBay and installed in a local church I help with. We needed a good system that was cost effective but had much greater capabilities than a single camera system. This was a rather large church facility that had several large areas outside that needed monitoring as well as numerous entrances and exits. For this application, I found (once again on eBay) an eight-camera system that came with its own NVR (Network Video Recorder), and included as an option, a 1TB hard drive for storage. It was a “Jennov” brand and the entire system, with eight, 1080p WiFi cameras with all the capability listed above, cost us a little over \$400. The system came with the cameras already paired to the NVR which was also the Wifi host, and when plugged in and turned on they immediately came up working with crystal clear full color 1080p video.

The beauty of WiFi cameras is that there are no cables to run and all you have to have is an electrical outlet to plug them in. Our electrician installed an outlet at each chosen location right beside the cameras and the total cost for the system and the electrical work was just a tad over \$700, ready to roll. The included software was great and allowed a ton of different setup options from very intuitive and very good GUI menus.

(Continued on Page 28)



got all these features in your DA?

The **NEW** Radio Systems ADA-2X8SS

2 STUDIO Stereo INPUTS to eight isolated OUTPUTS

with Front Panel VU METERS, Headphone AMP and sets

plus Silence SENSE with EMERGENCY Switch-Over, Remote Control

and full StudioHub + Connectivity.

radio SYSTEMS ADA-2x8SS

radio SYSTEMS

601 Heron Drive • Logan Township, NJ 08085 • (856) 467-8000 phone • (856) 467-3044 fax • www.radiosystems.com

# Introducing mixIT

## Compact size – touchscreen control – low price

Announcing the console for managers, engineers and operators who want the versatility and intuitive operation of a touchscreen-managed AoIP console system but who need a lower price... mixIT.

- 12 faders with versatile AoIP I/O
- 12 mix-minus busses
- Touchscreen control plus metering
- Functionality includes scene selects, router controls, and more
- Only \$5800 with the new JET67 AES67 engine



Logitekaudio.com • 800.231.5870

World Radio History

  
**Logitek**

Networked Audio Consoles

– Continued from Page 30 –

The system allows playback of all recordings easily, in case you need to review something – all built-in. There is a USB port to connect either a flash drive or a USB hard drive for backup and for sharing the videos outside the system.

The system also has a free cloud service that allows you to install either an iPhone or an Android phone app for monitoring just like the aforementioned single camera system.

**Don't Want to Take the High (priced) Road?**

In my research, and since this is all about Linux systems I naturally had to have a good option for all my Linux Mint Cinnamon systems. Now I am not saying that I am a cheapskate, but I will say that sometimes I have been accused of being "Frugal." That is why I love the Linux systems so much. They are not at all lacking in security camera options as well. In fact some of the most popular and widely used systems out there are Linux based. One of the most popular systems states on its website that it has never, nor does it ever intend to, sell or develop Windows software!

Now I realize that you can find all kinds of reviews on the web about available free software, but I will share with you my personal experience. A simple Google™ search for "Free Linux Security Camera Software" will give you a list of the most popular ones with reviews. However, some of these reviews are very old and the systems they talk about, that you will be installing on, are not the current versions. Some simply do not work anymore (at least they didn't for

me). The two top most mentioned systems are "Zoneminder" and "Xeoma." There are numerous install instructions out there for Zoneminder, and though it is touted to be the best software, installing it can be a real nightmare. I spent many years as a programmer so getting software installed is usually an easy task for me. Not so with this one though. I followed every piece of instruction I could find and though I was not the only one who could not get it working (many comments on the web), I finally just gave up. It was totally free and had a ton of capabilities (Maybe you can have better luck that I did with it).

**Moving On ...**

So, I moved on to the next option. It was "Xeoma." Unlike Zoneminder that installed in a terminal, and required you to perform numerous operations just to get it on the computer, Xeoma has an installer that only required me to click on the icon, and it did everything quickly and was working in a flash. It even did a search for cameras on my network and found the little camera I had been using for test, in under a minute. Instantly it showed up on the screen and I was in business. The only drawback with it, though it works really well, and was simple to install, is that the free version is limited in what you can do with it. If you want to do more, you have to purchase a license for the options you want. It is supposed to support three cameras in the free version and since I only have one on hand right now I can't test that just yet. The part I love is that it works on my Linux Mint Cinnamon system, can run in the background without interfering with other operations, and looks great with a very high resolution screen – and it only requires a very small amount of hardware resources.

Setting up the recordings onto a flash drive or an external drive is a breeze as well. If you want a good system that will support up to 2000 or so cameras, this one will do

it, by adding on optional modules. My whole point to this exercise though was to do something that was free, or cheap, and was easy to use and setup on my available Linux Computer. Also, most of the systems out there also support Arduino or RaspberryPi as they are small footprint software, so if you are into that you have something to use with your Linux computers.



Did I mention that it also does facial recognition, logs license plates, can tell if someone in the camera's view looks hostile, etc? If you want a great system this might be it. No I don't work for them nor do I get a commission. It just worked for me and with all these neat features you might like it too!

Enjoy!

*Tommy Gray is a veteran broadcast engineer currently staying busy doing engineering in the gulf south, through "Broadcast Engineering & Technology LLC," a Louisiana based Consulting and Contract Engineering Firm, serving the U.S. – www.BEandT.com*

# Quality FM & TV Antenna Systems



SLANT-V  
DIRECTIONAL

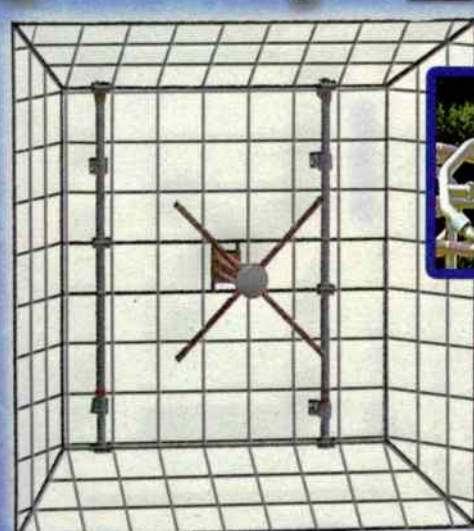

FM PANEL



POWER-TILLER



POWER-TILLER  
WITH RADOME

PSI is dedicated to designing and manufacturing the highest quality product. Working diligently with station engineers, consultants and outside vendors ensures that each project is completed to the customer's satisfaction.

Wide range of antenna models are available at all power levels, directional and non-directional, multi-station and more.

Additional products include..

- Transmission Line
- Combiners
- Filters
- Turnkey Systems



## Propagation Systems, Inc.

Phone: (814) 472 - 5540      Fax: (814) 472 - 5676  
 Email: sales@psibroadcast.com      www.psibroadcast.com

Remote monitoring from  
hundreds of miles away,  
all in a smartphone.

**You got this.**

# SOFIA 568

FM / HD Radio SiteStreamer+™



The new SOFIA 568 FM/HD Radio SiteStreamer+ takes it up a notch combining remote off-air monitoring with a host of features to ensure that you are the first to know when there is a problem. You've got the tool to listen to the off-air programming and confirm that Artist Experience graphics are displaying correctly.

## It's a SiteStreamer PLUS.

The elite SOFIA SiteStreamer+™ (plus) series includes additional features to the SiteStreamer product line.

- Internet listening stream for up to 10 listeners
- Displays HD Radio Artist Experience graphics and station graphics on Web interface
- Adjustable Audio Outputs in L/R Analog, AES digital, and Dante AES67 AoIP
- Monitor multiple transmissions sequentially with StationRotation™
- Alarms & notifications sent via email or SMS messaging
- Remotely monitor fulltime off-air FM and HD Radio signals
- Easy set up and operation; full SNMP support



**INOVONICS**  
BROADCAST

### WHY INOVONICS?

- Quality Solutions. Competitive Prices
- Quick to install. Easy to Program
- Three-year Factory Warranty.
- Quality after sales service.

www.inovonicsbroadcast.com  
sales@inovonicsbroadcast.com  
831-458-0552

# Engineering Perspective

## So Just What Does It Take?

by Jim Turvaville

There are times in life and work experiences that one may have to just back up a few steps and have a heart-searching moment. As the miles and years lay behind me like an old melody, out of tune and out of time, those “aha!” moments are happening a bit more frequently these days. Usually it revolves around just how much this industry has changed in my 40 plus years of involvement, and with few exceptions it is the revelation of just how the technological changes have affected our day to day operations and work.

As a bit of personal history, my first radio station exposure was in the mid 70's at the local AM station when I was in High School. This specific station was built in the early 50's by a guy who had come home from World War 2 with a Purple Heart, having lost one arm at the elbow in the fighting. He had been in the radio and radar division in the war, so he knew enough to be able to do the technical requirements to build an AM radio station. It was a daytime-only authorization on a regional channel, as the local channels were all taken in that area. Still, a 220 foot tower was stood up behind a farm house a mile north of town and the station began its life. The founder operated the station for nearly 10 years before selling it to a local businessman, who still owned

it when I was a child; a new building was built next to the old one and a complete brand new station was turned on in the early 70's. In a fluke accident, the old station burned to the ground shortly after the transition to the new building so I never had the opportunity to see it in person. The FCC had once visited the station a few weeks after the new owner took over, and he was fined by them for failure to construct the station within the standards of good engineering practice. I asked him what the old station looked like back then and he just chuckled and said, “well, it looked like a radio station built by a one-armed man.” In a moment of irony, my own mother was heard on that old original radio station as a teenager with her family, on at least one occasion during their Sunday live musical programs – not knowing that one day her own son would work there.

In that era, radio was big and frankly quite messy. Small town stations had a control room with several microphones, turntables, transcription players, tape decks (later cart machines); a studio with microphones for newscasters, and usually a podium for live speakers, additional microphones for other speakers or singers, and usually at least a piano or even an organ. Larger market stations would have even more space and acces-

sories to make their local live programs happen. I can only imagine the training and attention required to be the board operator; to be a designated transmitter operator was even more complicated and meter readings were taken on a continual basis while the station was operating. Radio was king, but it sure took a lot of “stuff” to make it happen; and a good number of people in the process as well.

As we fast forward to the late 70's, that “new” local radio station became my first exposure to radio. We no longer had a big studio with a podium and piano, but did have a desk through the glass wall with two microphones on it, where we did live newscasts and hosted a myriad of weekend live speakers and preachers. The control room had the RCA BTA-1R3 transmitter at the back wall, a mere 8 feet from the operator sitting at the RCA Studioette console with 2 microphones flanked by 3 turntables, 2 lock-and-load cart machines, a telephone and a couple of portable 7-inch reel-to-reel machines sitting on the countertop. The reel-to-reel machines were mostly for long-form programs which the station aired on a daily basis, but were on occasion pressed into service for commercial playback when we got a spot load that exceeded our limited inventory of A-size carts.

It was there that I first became a radio operator, and the complexity of operation was not in excess of what a High School kid of the times could learn and mostly master. That era still had us taking transmitter readings every few hours, and the First Phone of that second owner on the wall was still required. I quickly met the contract engineer who came in every Sunday night at sign off and made a friend of him, and he let me tinker

(Continued on Page 32)

## It's Time to Get Into the Mix



### ProMix 4

The ProMix 4 is a compact full-featured monaural audio mixing console perfect for almost any broadcast studio, while excelling in remote broadcast and podcasting applications. It features three combination microphone/line inputs and a dedicated fourth input that may be switched between a balanced line input and the built-in USB audio interface. Other

features include: switch selectable program limiter, XLR program output, monitor output with muting and volume control, mix minus output for connection to an external telephone hybrid, on-air light relay output, and three 1/4" stereo headphone outputs with individual controls for volume, mix, and pan, allowing custom headphone mixes.

Broadcast Tools is a Veteran Owned Business  
Designed, Assembled and Supported in WA State, USA.  
[www.broadcasttools.com](http://www.broadcasttools.com)

**BROADCAST**  
*t o o l s*  
**PROBLEM SOLVED**

# Cable Vendor Suddenly Gone?



Angry Audio is your NEW supplier!



Dual XLR female adapter cable



Dual XLR male adapter



Dual RCA male adapter cable



Single XLR male adapter



Dual XLR female adapter



Dual XLR male adapter cable



Shielded CAT-5 patch cable



Adapters and cables bundles

And now, a few excuses to buy more cables!



Failsafe Gadget

*Switches to backup audio in the event of silence.*



Guest Gizmo

*Professional Headphone amp with cough button*



Balancing Gadgets

*Precision unbalanced to balanced audio converters*



Mic Tally Gizmo

*Illuminates the M!KA mic arm tally*



© Angry Audio 2019  
[www.angryaudio.com](http://www.angryaudio.com)

World Radio History

### So Just What Does It Take?

– Continued from Page 30 –

with the studio stuff during the week. I was too naïve to realize that he was the winner there, I did all the work in the station (except the transmitter stuff) and he collected the paycheck. But I was bitten by the bug, and the rest – as they say – is just history for me.

As I finished school, went to college and got my own First Phone License, I ended up back at that same local station on a couple of occasions. Once to build the companion FM station which also involved yet another studio with more microphones, cart machines and tape decks that filled nearly the entire room. On another tour of duty there, we grew up to automation, and that involved racks of equipment, even for a satellite delivered format. After a tornado felled the 1952 tower into the roof of the building and destroyed the studio, I had the opportunity to actually buy the five acres, license and whatever could be salvaged from the station for the sum of \$5,000. I helped a fellow worker there who did buy it and got it cleaned up and back on the air where yet another friend of mine now owns and operates it with two companion FM translators.

Now fast forward to today, as I sit at my desk where I do my projects for clients in my semi-retirement mode, while watching my sole full time employee run the five full power radio stations I own in under 500 square feet. The front office desk where she works has six computers

– one for each station and a work station for her – on one KVM, so it's all neat and compact. Daily logs, billing and accounting, as well as light production needs and editing, are done at one desk. We have one "live" studio for whatever needs befall each station, which can accommodate a small band (we've done it once just to say we have) with up to eight mics or instruments into the on-air board. It can be used live on any station as we need, but is mostly for recording of programming we produce for each various signal. We have "ditty desk" setups for each station which has nothing more than a single microphone, small table-top mixer (mostly Arrakis ARC8 units) and a couple of PC's on a KVM to use one mouse and keyboard. One is for the automation computer and all of the audio sources for that station; the other is used for editing, recording, Internet browsing, and IP audio connections via Skype, Hangouts and Magic Jack feeds. Amazing as it might sound, a complete station setup sits on top of a single filing cabinet.

As I mentally contrast what I am involved with today, to what "radio" was when I was hooked on it back in the 1970's, and even more mind-boggling, what "radio" was like back in the "Golden Era" of the 30's to the 60's ... along comes the heart-searching moments of reflection of just how much the world has changed in this industry we call radio broadcasting. To the listening ear, it's still much the same as it always has been; our listeners don't really care or have a preference of where these audio sources come from or how they get to them from us. As long as we continue to program material to entertain and inform them in a way that no other national or syndicated source can do, we will retain their ear. But from this side of the radio, evolution could not be defined any clearer – what once

took massive square feet and piles of equipment and personnel is now accomplished in software on a computer that sits on top of a filing cabinet.

I have a client who is moving an established and rather complicated Network Operations facility from one location to another, and has contracted me to assist in the re-design of the studio and control layout. I have gone out of my way to not as much suggest what should be done, but to task the owners to really consider what they do *not* want to do, and why. If your master control studio is primarily only used as an assimilation and dissemination point for your program material, then just what actual gear is going to be needed on a daily basis to accomplish that task? If we had all of the needed audio source equipment in the server room, and used an IP routed audio system to each "studio" as needed, would that not accomplish the end-goals of the network programming?

I have had long discussions with Network management about their actual needs and how to meet them efficiently without layering complications and equipment which will never have much actual use in the operations. Using technology to the fullest capability, while maintaining maximum functionality and flexibility in an affordable manner, has now become the driver in operational design. Given the current state of technology and how fast it seems to advance, my sage advice to all is to buckle up and hang on – it only gets faster from here.

*Jim "Turbo" Turvaville is semi-retired from 40 years in full-time Radio Engineering and lives in Rural Wheeler County Texas in a "tiny house" where he maintains a small clientele of stations under his Turbo Technical Services ([www.jimturbo.net](http://www.jimturbo.net)) operation providing FCC application preparation and field work.*

**ALTRONIC RESEARCH INC.**  
Performance By Design

**RF DUMMY LOADS  
for ALL YOUR  
APPLICATIONS**

- AIR-COOLED
- HDTV
- HD
- WATER-COOLED

**ALTRONIC RESEARCH INC.**  
P.O. Box 249 Yellville, Arkansas 72687 870-449-4093 Fax: 870-449-6000  
E-mail: [info@altronic.com](mailto:info@altronic.com) Web Site: <http://www.altronic.com>



# AUDIO. IT'S WHAT WE DO.

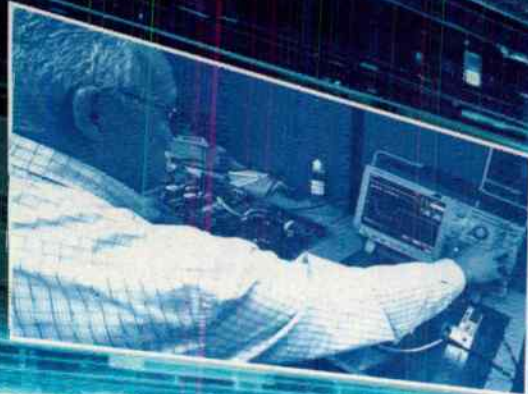

And we've been with you every step of the way. From analog to digital to AoIP to your entire networked ecosystem.

### Let Us Be Your Trusted Partner

We're not just manufacturers and software developers, we're your partner in standards-based AoIP broadcast solutions and processing built on award-winning technology, trusted by the biggest names in the media landscape.

### Audio Is Our Thing

We deliver innovative, intuitive audio solutions that meet the challenges you face head on, so that you can spend less time solving problems and more time creating the most exciting and engaging audio experiences imaginable for your audience.

### We're Up for Any Challenge

Together, no audio challenge is too big, no technology is beyond reach. And no solution—large or small—is unobtainable.

#### IP CONSOLES & ROUTING



The Best-Selling Consoles. From the Inventors of AoIP for Broadcast

#### RADIO PROCESSING



Because Great Sound Matters Most

#### IP COMMUNICATIONS



Telos VX®, the VoIP Talkshow System That Pays for Itself

#### RATINGS CONFIDENCE



Make Every Listener Count

SHAPING THE FUTURE OF AUDIO

THE TELOS ALLIANCE®

TelosAlliance.com | inquiry@telosalliance.com | +1.216.241.7225



## Miscellaneous Tips and Thoughts

In helping with a few transmitter installations, I have learned a few things that you might find interesting. These items are in no particular order, and I hope you will get something out of those items I share in this column.

If you know of some helpful information that would be of interest to the engineering community, please contact me at the email address listed at the end of this column and share it with me so I can share it with others.

### Wrong RF Connector

We were installing new transmission line at one of our transmitter sites and were about to install a connector on the end that was to go into the transmitter building. The connector was supposed to be a "gas pass" type – that is, it's supposed to let nitrogen flow through the entire transmission line and into the antenna. After careful examination, I noticed there were no holes to let the nitrogen flow. We had specifically ordered connectors that would allow nitrogen to pass through to the antenna, but we were sent the wrong kind. It pays to be careful to inspect your RF connectors before installation and make sure you have the right kind of connector before you head out to the tower site. This mistake cost us a day and a half on the project. This solid aluminum connector cannot be drilled to make it a "gas pass" connector. I called the distributor and they strongly advised against it.

This particular connector also requires a sealant called "plast." Once injected into the connector by way of a valve, the sealant is supposed to cure for 24 hours. This is something you need to take into your planning. Until the "plast" has cured, you don't want to inject dry air or nitrogen into the line.



Finally, remember to bring plenty of "O" rings along. As you know, you can't pick these up at your local hardware store. You might be able to get some from an automotive store, but that's not a certainty.

### Less Wire to the Transmitter

With the implementation of IP into more and more equipment in the radio broadcasting world, it is now possible to connect your Burk Plus Touch to your modern

transmitter simply by connecting your transmitter and Burk to your Ethernet switch. You can forget about running a jacket full of wires between the transmitter and the remote control. If you take this approach, you will pay about \$500 for the SNMP software upgrade to allow your Burk to talk to the transmitter.



There are other items you will still need, to connect to your status and monitoring connections that are not handled by the SNMP – things like your room temperature monitor or your entry alarm.

Burk has a webinar you can view on-line that discusses the SNMP and how it works with your equipment. Using SNMP and Ethernet cables could save you time and money when connecting your remote control to your transmitter. If your IP switch ever fails, you will need to swap it out for a new one.

### IP Reset

If you find yourself driving out to the transmitter shack to reset some quirky equipment that seems to lock up now and then, you can reduce or eliminate the trips by using an IP AC switch to restart it.



(Continued on Page 36)

 <p>Studio Items Inc</p>   <p>Mic Booms On-Air Lights Speaker Mounts <a href="http://www.studioitems.com">www.studioitems.com</a></p>	<p>TORPEY TIME <i>(The Good Time People)</i></p>   <p>Clocks Up/Down Timers <a href="http://www.ram68.com">www.ram68.com</a></p>	<p>Dixon Systems</p>   <p>News Mixers Line Matchers <a href="http://www.ram68.com">www.ram68.com</a></p>	 <p>RAM Systems</p>   <p>Broadcast Furniture Sound Absorption Panels <a href="http://www.ram68.com">www.ram68.com</a></p>
--	--	--	--



# Broadcasters General Store

Family Owned & Operated Since 1979

352-622-7700

www.BGS.cc

**SNMP Direct CAT 5 connect BDI Products  
To Your Burk, Davicom and Relio Remote**



RF Support including all BDI:

DPS-100D Power Meters

SWP Series Controllers



Audio Switchers including all BDI:

ATB/GPM/DAB Digital/Analog  
Audio Switchers



Tel. (914) 737-5032 [www.broadcast-devices.com](http://www.broadcast-devices.com)



**ULTIMA™ MIC**



**The Standard In Visual Radio**



SMS-2-UPL  
(Shown with optional Mic-Lite™)



Unobstructed Lines of Sight  
Showcase the Talent, Not the Equipment

**Future-Proof Your Studio With Ultima™  
The Most Scalable Microphone & Monitor Support System Available**

- ❖ All Components Drop Together Quickly & Easily
- ❖ Holds Up to 6 Mics or Monitors in Any Configuration (up to 120 lbs.)
- ❖ Unsurpassed Range of Motion & Control
- ❖ Performance, Longevity and Legendary O.C. White Quality

Contact us at: 413-289-1751 or visit [www.ocwhite.com](http://www.ocwhite.com)



**Brand Your Station**



**RDS MESSAGING**

RDS ENCODING, DECODING, RECEIVERS & SIGN DRIVERS

- Advanced Dynamic RDS Encoding
- Supports automated playout systems
- Monitor & log your FM/RDS broadcast
- Decode & display RDS data
- RDS Receiver & Sign Driver
- Remote scheduler

**Guest Interviews  
Don't have to be Complicated.**

Quality Interviews, Simple Setup.



**COMREX**





## Miscellaneous Tips and Thoughts

– Continued from Page 34 –

Providing your Internet connection is up and running, you can log into the AC switch and with a mouse click, power off/on, restarting that finicky box of electronics.

If your Internet goes down, then your options are greatly limited. You could wire up a low-voltage relay to your remote control and the equipment that has a reputation for locking up. Of course you will need a reliable phone connection of some sort. That relay could reboot your Internet modem and put you back in business.

### Pressurizing the Transmission Line

As you well know, it's important to keep your transmission line pressurized and dry. There are two ways of accomplishing this, and I have heard arguments for using one method over the other.

The first method is using nitrogen gas. A large bottle can last many years if your line has no leaks. Having a nitrogen bottle connected to your line uses no electricity and requires no maintenance. However, you do want to keep records of the amount of nitrogen in the tank and check it often. If the reading on the gauge stays the same for weeks and months, then your line is probably in great condition and there are no leaks.

If, on the other hand, if the gauge slowly moves downward, it's time to hunt for a leak. The slow leak can often be the most difficult to locate. I have used a product called "Snoop" to squirt on the joints and connections throughout the transmission line. Some engineers prefer to just use dish soap, but it can bubble up before you find an air leak, deceiving you into thinking you have found the leak. Snoop, is a liquid that does not bubble up as fast as dish soap, but will when you actually locate the leak.

The other method to keeping your line dry and pressurized, is to use a dehydrator. A new dehydrator can cost between two and three thousand dollars. When it nears the end of its life cycle, rebuilding one can cost around five-hundred dollars.

The advantage of a dehydrator over a nitrogen bottle, is not having to replace it every few months, or more often if your leak is more serious. The dehydrator can keep the line dry and pressurized with little or no help from you. It does, however need the desiccant changed periodically. You would rotate out the "wet" desiccant for a dry, fresh batch, and take the used batch and bake it in an oven for 30 minutes at 300 degrees. Changing the desiccant is much easier and less costly than installing a heavy bottle of nitrogen.

I have seen both the expensive dehydrator and the nitrogen bottle replaced with a small air compressor. For about \$100, and the cost of connecting a cylinder full of desiccant, you can keep your transmission line pressurized with clean, dry air. Some air compressors have a regulator on them to keep the output pressure at a set level. For the compressors that do not have a regulator, for around \$100 you can purchase one and

connect it to the air output. For about \$300, you can have a compressor, regulator, and a desiccant cylinder connected to your transmission line. This arrangement is considerably less expensive than a name brand dehydrator.

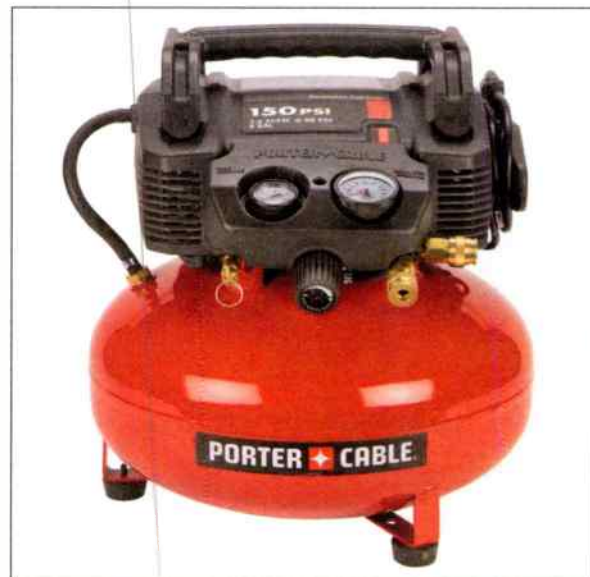

So there's my story: I hope you have learned something. What's your interesting and educational story? If you have some information that will help a fellow engineer, please, let me hear from you today. My email is [stuzeneu@sbe.org](mailto:stuzeneu@sbe.org).

*Steve Tuzeneu, CBT, is a staff engineer with the Bible Broadcasting Network in Charlotte, NC. He is a member of the SBE, and an extra class radio amateur.*

# More than JUST a SIGN

103.7 KISS FM ON AIR

JAYS GoVideo! In Prog

1010 WIN ON AIR

A+E NETWORKS ON AIR

CUSTOM  
COLOR  
FONT  
LOGO  
LETTERING  
DESIGN

WWW.TITUSLABS.COM

TITUS TECHNOLOGICAL LABORATORIES



# Look below the surface

Appearances can be deceiving. Axia® iQx looks like a traditional console, but it's actually a surface and mix engine rolled into one. We dove deep with AES67, giving you access to every source, anywhere on the network. iQx is affordable, allowing you to maximize existing network resources without paying for I/O you don't need! With nearly limitless connections, we can't even fathom the possibilities.



[TelosAlliance.com/iQx](http://TelosAlliance.com/iQx)

Available in the US from BGS cc



SHAPING THE FUTURE OF AUDIO

THE TELOS ALLIANCE®

[TelosAlliance.com](http://TelosAlliance.com) | [inquiry@telosalliance.com](mailto:inquiry@telosalliance.com) | +1.216.241.7225

World Radio History

# Small Market Guide

## Silence

Or should I say that awful word in broadcasting, "Dead Air."

by Roger Paskvan

Radio has come full circle over the past few years and many stations in small markets don't always keep up with the Jones. It seems the Ma and Pa operations tend to stagnate or get set in their ways, never wanting to change or upgrade. There is a lot of new stuff out there and some of it can really solve a lot of problems, or at least make life easier. I have personally been to small market stations where the staff is still on call, told to monitor the radio and respond to any off-air situations, to alleviate the situation of "dead air." Although this works, it is prehistoric in today's radio world.

I have installed silence sensors at several stations in small rural markets that monitor an FM tuner and dial a pager or cell phone if the station quits. This is the way it's done and all stations should be doing this on a daily basis, especially if they are automated. Almost all stations today have encroached on the digital domain and are streaming one or more of their station signals via the Internet. According to a recent study by the Data Firm LOOP (Lots Of Online People), 24% of millennials listen only on-line. This includes cell phones and computers. This is why it pays to have your stations streaming on the Internet.

The problem at the station end of things with streaming is that it is not real convenient to monitor

compared to the conventional radio station with a FM radio. You have to physically bring it up on your phone or through an available computer to see if it is really running. In a lot of stations, the stream quits for some reason and may be off for days until someone calls the station and complains. On the other side of this, a jock may be responsible for checking the stream each day, but in the Internet world, it could be working now and gone in three minutes, due to a computer glitch or Internet failure.

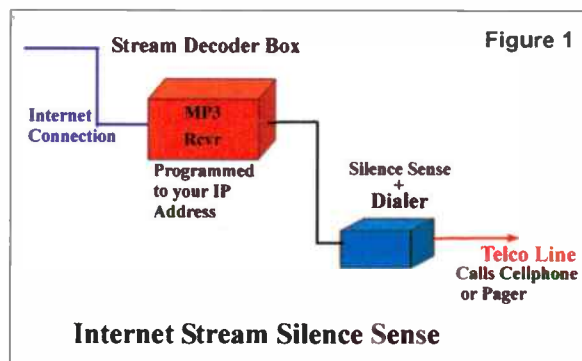

I recently installed several stream monitors with dialers to solve this very problem. The biggest headache is to find a reliable stream decoder in a stand-alone box.

You could use a computer, but why tie up a computer for such a minimal task. Our station had a surplus of Barix Exstreamer 100's laying around. Although these units are made for point-to-point links utilizing proprietary encoding, the box itself will decode MP3 files and provide audio to feed a dialer. It's just a matter of programming the Ex100 to your stream's IP address.

Another inexpensive option is to program a Raspberry Pie mini-computer for MP3 decode to your stream IP address. These little \$25 toys do a real good job of providing reliable audio. Next you feed the audio into a commercial silence sense box with a built-in dialer. There are a lot of choices here and I have used the "Tiny Tools VAD-2" with good success. Or if you like to hook up things, the Viking K-1900-5 is an old reliable dialer which we have had running for years. A quick Google search will open up many more brands.

Referring to Figure 1, the pre-programmed stream decoder provides audio just like the older FM tuners for off-air. Once you have audio from your stream, it is fed into the silence sense module. If the stream quits, the dialer tone-dials the control operator displaying stream failure on station WXYZ. Those not wanting to use private cell phones for work can issue a pager that will display the message. The on-call person's pager is rotated each week. Many stream failures are usually corrected by restarting the source computer. Anything deeper means you call your IT person. Once implemented, your station will be more reliable, providing service to all the younger people in your audience.

Roger Paskvan is a Professor of Mass Communications at Bemidji State University, Bemidji, MN. You may contact him at: [rpaskvan@bemidjistate.edu](mailto:rpaskvan@bemidjistate.edu)

# VERY SPECIAL PRICE

ALL YOU NEED FOR FM OR AM TRANSMITTERS



**ELENOS**  
World Broadcast Experience

ETG 2000 2kW \$7,999.00\*

ETG 3500 3.5kW \$11,399.00\*

ETG 5000 5kW \$15,399.00\*

ETG 10000X \$28,499.00\*

CALL NOW +1 217 224 9600

**ELENOS Main Features:**  
30,000 installations Worldwide | Energy Efficient - 72% AC to RF or Better  
Compact | WEB / SNMP Included | Higher Powers Available

**SERVICE AND SUPPORT FROM BE IN QUINCY, IL - USA**

BE Broadcast Electronics  
Radio & TV Broadcast Equipment and Solutions Worldwide | © Elenos Group 2019  
[www.bdcast.com](http://www.bdcast.com)

**ELENOS** itelco

**BE**  
Broadcast Electronics

**60**  
ANNIVERSARY

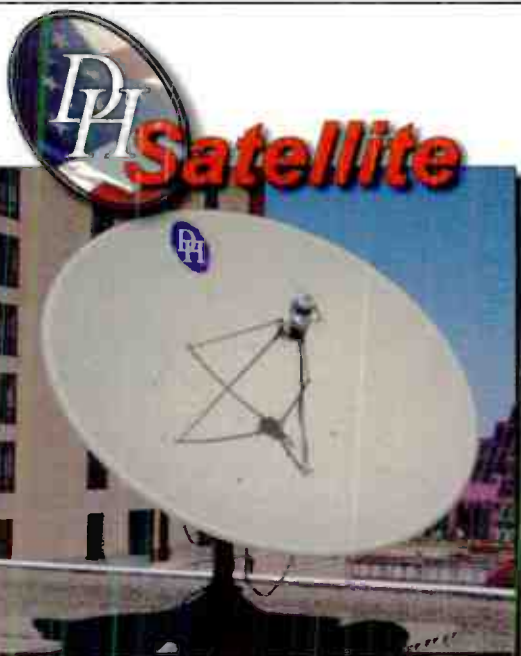

**DH Is The Industry Standard!**

For over 35 years, our 1-piece antenna has outperformed the rest! The 4-piece, 3.7m has the same accuracy because we use 8 computer generated templates and attach them to the back prior to cutting the antenna. This allows for ...

- Superior Quality    Quick Delivery
- Easier Installs    Cheaper Shipping
- Fits Into Service Elevators For Roof Installs



**Our New  
4 or 8-Piece  
Freight  
"Shippable"  
Antenna**

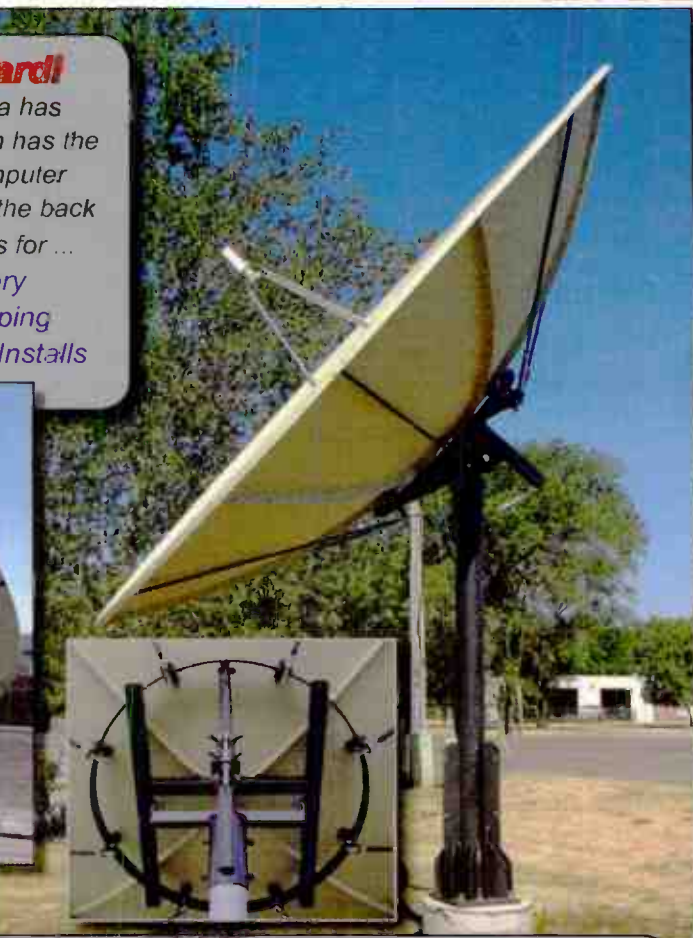

**DH 1-piece Antenna Sizes Available  
From .6m to 5.0m**

**DH Sectional Antennas Available:**  
1.8m ~ 2.4m ~ 2.7m ~ 3.0m  
3.7m ~ 4.2m ~ 4.5m ~ 5.0m

**Mount Options:**

- Fixed Az-EI, Polar Tracking, Horizon to Horizon Tracking
- Fixed & Dual-Powered Gibraltar Az-EI
- Dual-Powered Gemini Az-EI

**For More Information: [dhsat@mhtc.net](mailto:dhsat@mhtc.net)**

**[DHSatellite.com](http://DHSatellite.com) ~ 800-627-9443**

# fuhgeddaboutit!

Admit it; you'd love to forget all about your FM antenna. You'd be perfectly happy if it were to spend decades out of sight, out of mind, and out of your budget. You just want it to work; day in, and day out.

We understand.

Shively designs antenna systems to work flawlessly. Year after year. At any site. Under any conditions. For any power level. Happily, in the background.

FM First.

This was Ed Shively's vision in 1963, when he founded the company; and over 50 years later, we're still doing our best to be absolutely forgettable.

## Shively Labs®

A Division of Howell Laboratories, Inc.    Bridgton, Maine 04009 USA

Call Toll-Free: (888) SHIVELY

Or visit us on the Web at: [www.shively.com](http://www.shively.com)

- An Employee-Owned Company since 1995 -

# Monitors & Metering

## A Low-Cost RF Monitoring Unit

by John L. Marcon, CBRE CBTE 8VSB Specialist

A pleasant surprise is something we wish would always happen in our life. The reality is, they are few and far between. In the broadcast engineer's mind, one of the pleasant surprises is the repack. The repack is somewhat like a fairy godmother (FCC) who waved her magic wand and voila! The transmitter site gets transformed with new and shiny things. Even better, they're not just new, but top-of-the-line new.

We just finished the repack in one of our TV stations and a brand new 3 kW is now the main transmitter and the older 2 kW as the standby. There are directional couplers in both transmitters but for our set-up, we requested a separate directional coupler to be installed at the output port of the RF switch. In addition, we also requested a RF monitor unit that will convert the directional coupler RF signal to a DC level adequate for the remote-control system. This will also help in checking for trouble in the RF switch and will also tell if the RF is mistakenly directed towards the dummy load instead of going towards the antenna.

Unfortunately, our request to purchase a new RF monitoring unit was not approved. In other words, we had to pay for a new unit. A new monitoring unit would cost more than \$5,000. This was just an ungodly price range so I thought of some other way to do the RF monitoring. We just pulled out a used transmitter and four detector circuit boards were inside it, so I thought of using one of those for this project.

There were three boards needed for this project: The detector circuit, the boost circuit and the dual voltage power supply. I also needed two panel mount N connectors and a box to put them altogether.

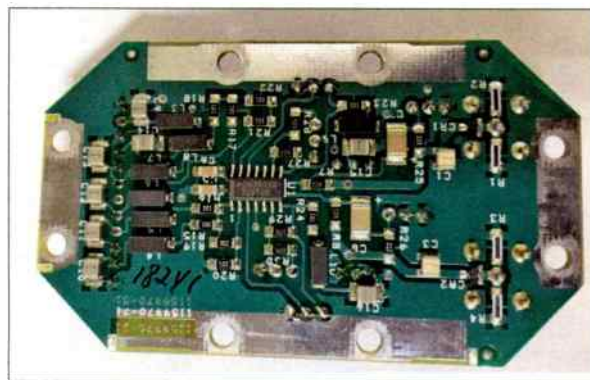
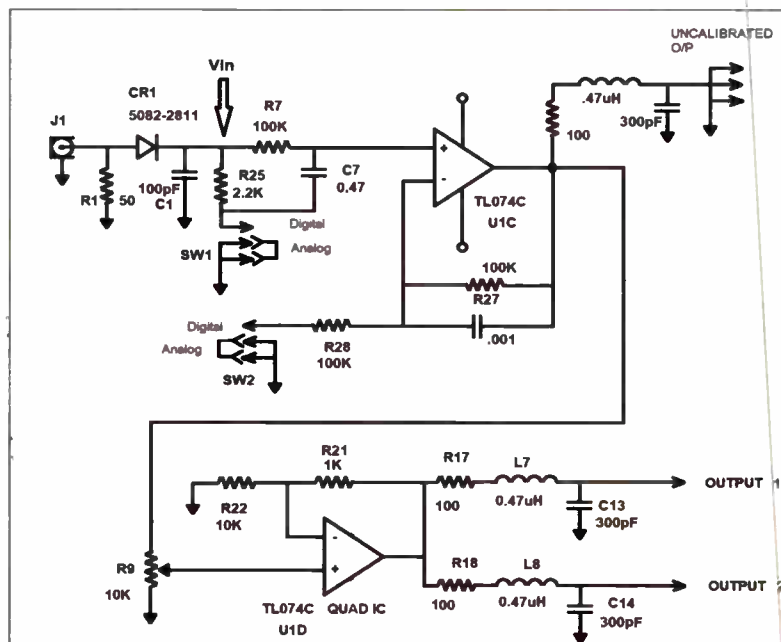

**Figure 1: The Axcera Detector circuit board. This can be used for either Analog or digital signals using jumper sockets mounted on the board itself (other side of the board).**

### The Detector Circuit Board

This board from Axcera was well built, simple and reliable. The description of the circuit is as follows:

The detector circuit converts a sample of the RF forward and reflected power to a DC voltage. The RF signal comes in from an SMA female connector J1. CR1 is the detector and converts the RF into pulsating DC. C1 filters the pulsating DC signal to become a flat DC voltage. When the socket switches SW1 and SW2 are plugged for analog mode like shown on the diagram, the DC signal level  $V_{in}$  coming from the C1 and CR1 junction will also be the same DC level at the non-inverting input of the U1C



**Figure 2 – Detector Circuit**

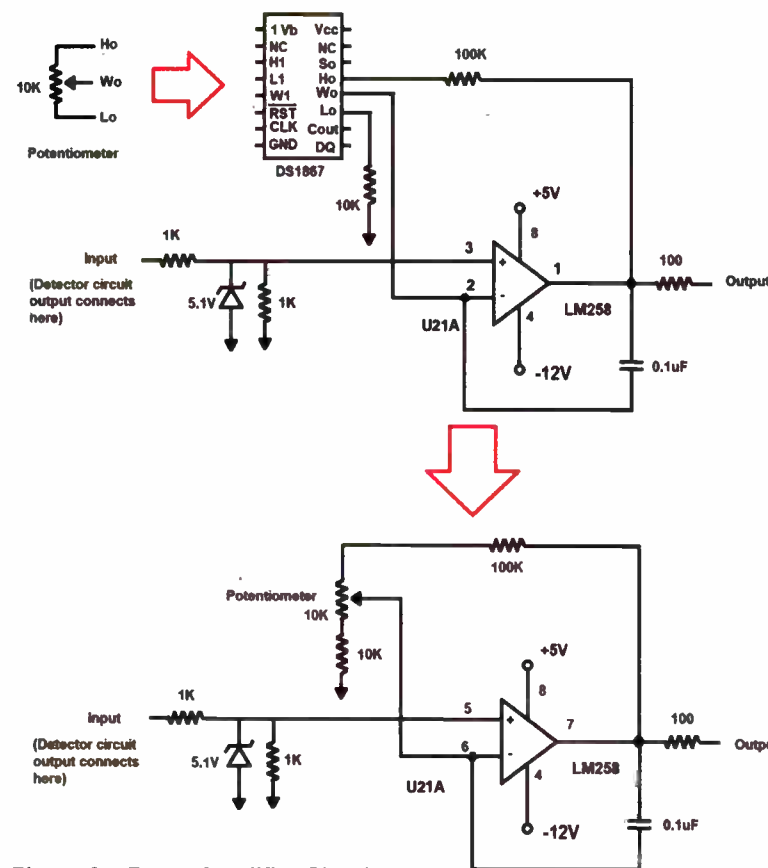

**Figure 3 – Boost Amplifier Circuit**

op-amp. Because of the high impedance at the (+) input of the op-amp, the current going in is negligible. R28 is floating and therefore the op amp will be in buffer mode making the output voltage equal to the (+) input voltage.

In Digital mode, SW1 connects the R25 (2.2K) and the R28 (100K) to ground. The same  $V_{in}$  will still be at the (+) input of the op-amp. However, there will be some gain

at the output of U1C. The amplifier gain =  $(100K+100K)/100K = 2$ . In other words, the output will always be twice the input voltage.

U1C output goes to potentiometer R9, which is for adjusting the output of the whole circuit. Interestingly, U1D output gain is only 1.1. The L filter L7 and C13 further refines the DC signal before it goes to the output. The power supply for this circuit is +/-12V.

The op-amp is a TL047 Quad IC. The low noise J-FET input impedance is high and ideal for high fidelity audio pre-amp. However, in this application, it was used only to boost the DC level.

### The Boost Circuit Board

In the transmitter where the detector board came from, a boost circuit amplifies the output of the detector board. The boost circuit works as follows (See Figure 3).

The output of the detector circuit connects to the 1K resistor at the input side of this op amp. A zener diode limits the input voltage to 5.1V before it enters the non-inverting input of the LM258 op-amp. The two 1K resistors form a voltage divider, reducing the voltage at the (+) input of the inverter to one-half of the input voltage. To control the gain remotely, a programmable potentiometer DS1867 IC is used. The power supply of the op-amp is an uneven +5V and -12V.

In the circuit that I made, I replaced the DS1867 with a regular 10K potentiometer (bottom) because its function is the same as a potentiometer. This 10K potentiometer, the 10K fixed resistor to ground and the 100K, set the gain of the op amp. The maximum theoretical gain can be expressed as:  $Gain = V_{out}/V_{in} = (1 + (100K+10K)/10K) = 12$

With the parts on a breadboard, the max output I obtained was only 3.8V. This was obviously not a gain of 12. There were two reasons for this: First, the voltage divider at the input of the LM258 reduced the input to half and secondly, the + V supply was only limited to +5V instead of the max +32V.

At any rate, the 3.8V was enough for the application and it was likely that they designed it that way to protect the metering from overvoltage. I proceeded to solder them on a printed board and also soldered a screw type terminal strip where I wired the power supply, input and output connections.

Another circuit board acquired for this project was the +/- 12V power supply. There were a number of inexpensive switching power supply on the market and the one I chose was the Meanwell PD2512, which was an open frame, 1Amp +/-12V AC to DC converter. This was more than enough to power the two op-amp boards.

(Continued on Page 42)



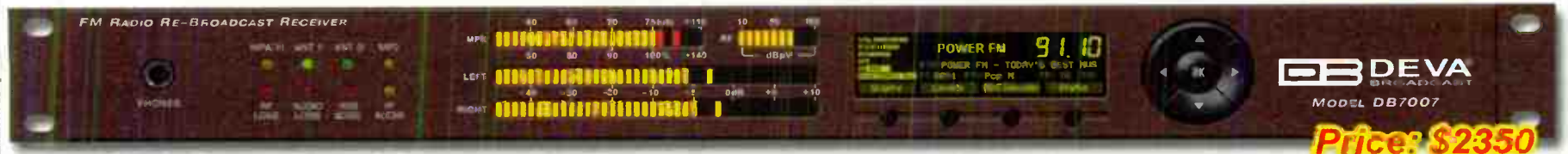

Modulation Monitors • Rebroadcast Receivers • RBDS Encoders • Broadcast Tools

## Kintronic



## Labs

Solutions for ALL FM Installations

Introducing Two New Products



FM Combiners

Model FMC-1.5 Isocoupler  
for low-loss isolation  
solution



LAB4.50 Automatic Dehydrator  
with 165,000 hour MTBF



Full line of Isocoils  
for co-locating 1  
or more FM  
Translators on  
AM tower



DL-25K-FM  
FM Dummy Load  
25kW  
VSWR: 1.15:1

ADDRESS: P.O. Box 845, Bristol, TN 37621

PHONE: 1-423-878-3141

EMAIL: ktl@kintronic.com

### A Low-Cost RF Monitoring Unit

– Continued from Page 40 –

I installed all three boards (the detector circuit, boost circuit and power supply), tested them again, and the results were OK. I also got two N-type chassis mounted connectors with the other end having SMA connectors. These fit nicely with the detector board which has an SMA connector as well.

All the parts inside the box – (See Figure 4). The top picture shows the detector board on the left, boost circuit on the middle and the power supply on the right side. All the items were used parts except for the boost circuit and the +/-12V power supply. The bottom picture shows the box being tested at the transmitter site.

#### Initial Calibration

In our overall set-up, the monitoring of all the transmitter sites is performed in a central location. The computer program that is used for this system is called the Monet. All the metering signals are displayed on GUI screens at each site and at the central location. At the transmitter site, I connected the RF monitor unit to this Monet system. The directional coupler at the RF switch output port was not yet installed so I used the directional coupler of the new transmitter for the initial calibration.

Both the forward and reflected power readings are important but I was actually more interested on the accuracy of the reflected power reading. In the initial tests, I realized that when there was a high level of RF at the input, it saturates the amplifier and the output did not respond correctly. This became evident when I reduced the transmitter power and the reading stayed at 100%. A 6dB attenuator at the input solved this problem.

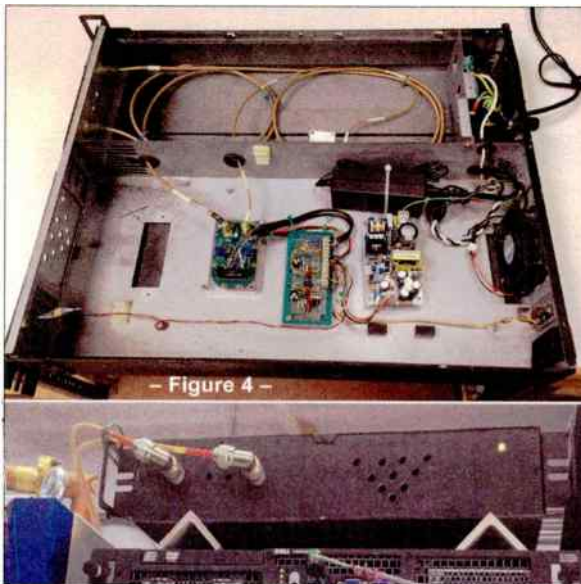

– Figure 4 –

The next test was to see whether the monitor unit output reading could accurately track the power reduction, especially at 80% (FCC window is 80% to 110% for TV). Thus, with the transmitter set to 100%, I adjusted the Monet reading to be 100% as well. Then I reduced the power to 90% and then 80%. There was a 2%

difference at 90% and 3% difference at 80%. The discrepancy can be due to the mask filter not responding proportionately or it may also be due to the Monet. For the moment, I just took note of these differences and moved to the next step.

The usual calibration procedure for a reflected power meter is to have it connected to the forward power sensor with a 10dB attenuator. The transmitter power is then set to 100% while the reflected power meter is set to 10% to match the 10dB attenuation.

Interestingly, I was already getting a reflected reading of 0.44 on the Monet although I had not plugged the cable yet. I found out that the setting on the Monet was not set to “power” but on “linear” (those who worked with remote control systems are familiar with this). I then corrected this setting and calibrated the reading using the above procedure. Afterwards, I connected the unit to the actual reflected power sensor of the transmitter (after the mask filter) and it reads 0.01%, which was a little low. I was expecting just a little less than 0.1%.

The box is currently connected to the Monet for transmitter monitoring. I will do the final calibration when they installed the directional coupler at the output port. By then, I would also have our Agilent power meter, which incidentally is also undergoing calibration. I should be able to get better results with the power meter in hand and I expect this RF monitor unit to function well and last for a long time.

*John L. Marcon, CBTE CBRE 8VSB Specialist, is the Chief Engineer for Victory Television Network (VTN) in Arkansas, with international experience in both Radio and Television Broadcast, and has an Electronics Teaching background.*



The  
**Broadcasters' Desktop Resource**  
... edited by Barry Mishkind – the Eclectic Engineer

[HOME](#) | [NEWS](#) | [ARTICLES](#) | [MANUFACTURERS & VENDORS](#) | [SERVICES](#) | [SUPPORT](#) | [RESOURCES](#) | [USED](#) | [BUY/SELL](#) | [SITE SEARCH](#) | [CONTACT](#)

Looking for an Internet archive of broadcast news and articles on technical, IT, and managerial issues?  
The Broadcasters' Desktop Resource is at: [www.theBDR.net](http://www.theBDR.net)  
Avoid missing out on anything – you are invited to sign up for the one-time-a-week BDR Newsletter. We promise to never flood your inbox!

**Some things you might want to know about:**

- 1/18 - [An overview of interesting things from CES 2017](#)
- 1/18 - [Original iPhone now a museum piece](#)
- 1/18 - [Spectrum Auction seems finally to be concluding](#)
- 1/12 - [Court stops evictions by American Tower](#)
- 1/11 - [FCC plans to remove letters and email from Public File](#)
- 1/11 - [Bill Sacks passes away](#)
- 1/9 - [Norway to abandon analog FM this year](#)
- 1/5 - [Obama nominates Rosenworcel back to FCC](#)
- 1/4 - [The Difference and Why It is Important - Tom Osenkowsky](#)
- 1/2 - [The End is Coming for AMCB and 139 degrees](#)
- 12/30 - [Enforcement Watch: Failure to ensure tower lft/painted: \\$25k](#)
- 12/28 - [Checking it Out: Road testing the Inovonics 531N FM monitor](#)
- 12/28 - [PSHAB issues initial report on the 2016 EAS NPT](#)
- 12/23 - [iHeart gets negative response from the ISDA](#)
- 12/21 - [Alternatives to Wired Ethernet Networks - Dana Puopolo](#)
- 12/20 - [Cumulus in trouble again with NASDAQ](#)
- 12/19 - [FCC Seeks comments to reduce EEO recruitment requirements](#)
- 12/15 - [The Worst: Walking in to Find No Joy at All](#)
- 12/14 - [Keep the Flu Out - Keep Your Staff In](#)
- 12/7 - [Checking it Out: The Inovonics 525N - Alan Alsobrook](#)
- 12/7 - [FCC Commissioner Ready to Fire up the Weed Whacker](#)
- 12/7 - [Spectrum Auction is Not Making the FCC Look Very Good](#)

Check it out now!  
<http://www.theBDR.net>

# MAXIMIZE COVERAGE MINIMIZE COSTS

with Bext FM Antennas

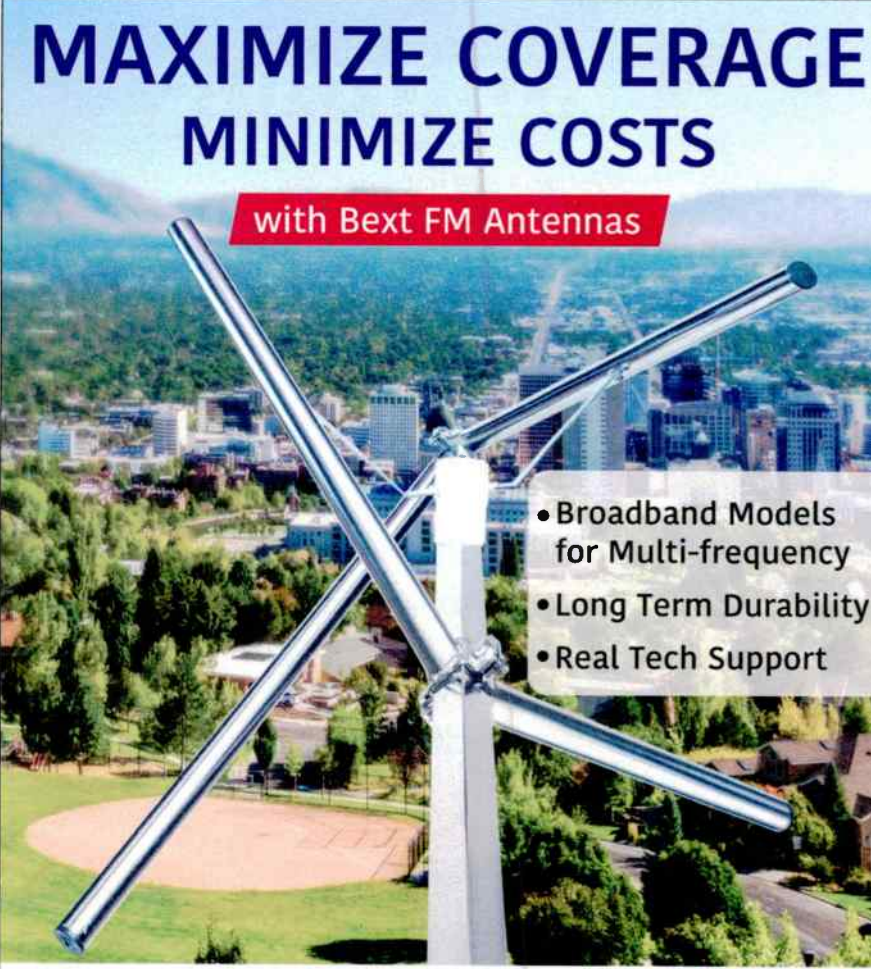

- Broadband Models for Multi-frequency
- Long Term Durability
- Real Tech Support



888 239 8462

[www.bext.com](http://www.bext.com)

# ECONCO

## Rebuilt Power Tubes



*Approximately One Half the Cost of New*  
**3,000 Hour Unconditional Guarantee**  
 Call for Your Quotation



Phone: 530-662-7553 • Fax: 530-666-7760  
 Toll Free: 800-532-6626  
**www.econco.com**  
 1318 Commerce Ave, Woodland, CA 95776

# Pacific NW FM Station For Sale

In the heart of the beautiful NW,  
 a C3 FM (25KW) is now available.  
**REASON FOR SALE? OWNER IS RETIRING.**

Reaching about 500,000  
 population, it currently  
 has a loyal audience  
 for the oldies format.

**Equipment Inventory is available.**  
**Tower Leases in place for main  
 and booster transmitters.**  
**Office and Studios easily relocated.**  
**There is no cashflow or real estate.**

**\$1,250,000**  
**CALL RON - 541-460-0249**

## TRANSCOM CORPORATION

*Serving the Broadcast Industry Since 1978*

Visit Our Website – [www.fmamtv.com](http://www.fmamtv.com)  
 Send your e-mail requests to: [transcom@fmamtv.com](mailto:transcom@fmamtv.com)

### Fine Used AM & FM Transmitters & New Equipment

<b>AM</b>	5 kW	2007	BE AM 5E - <i>Solid State</i>
	25 kW	2009	Nautel XR25 - <i>Solid State</i>
<i>Please see our current listings on our website.</i>			
<b>FM</b>	55 W	2000	Harris DIGIT™ CD
	5.0 kW	1988	BE FM5C - <i>Solid State, Single Phase</i>
	5.0 kW	2018	Nicom NTI5000 - <i>Solid State, Single Phase</i>
	7.5 kW	2005	Harris Z7.5CD - <i>Solid State</i>
	10.0 kW	1988	BE FM10A - <i>Dual 5 kW</i>
	10.0 kW	2001	Harris Z10CD - <i>Solid State</i>
	20.0 kW	1992	Harris HT20CD
	21.5 kW	2008	Continental 816R2C
	25.0 kW	1996	Continental 816R3
	25.0 kW	2004	Harris HT25CD
<i>Please see our current listings on our website.</i>			

#### Used Misc. Equipment:

Bird Model 8932, 10kW Air-Cooled RF Load

#### Exciters:

Harris DIGIT™ – New 30W Synthesized



*Please go to our website for updated listings.*  
*Retuning and testing available – call for quote!*  
**OMB STL systems for radio, complete  
 with antenna and cable for under \$5,000!**

PO Box 26744, Elkins Park, PA 19027  
 800-441-8454 • 215-938-7304 • Fax: 215-938-7361



Special Cortex 320  
 Pre-Launch  
 Offer

## SERIES CORTEX

Remote Site Management System



[ CORTEX 320 COMING SEPTEMBER 2019 ]

[cortex.davicom.com](http://cortex.davicom.com)  
 YouTube f

T. 1 877 282-3380  
[dvsales@davicom.com](mailto:dvsales@davicom.com)

## TLM-1 TOWER LIGHT MONITOR

Total Monitoring for Older Lighting Systems

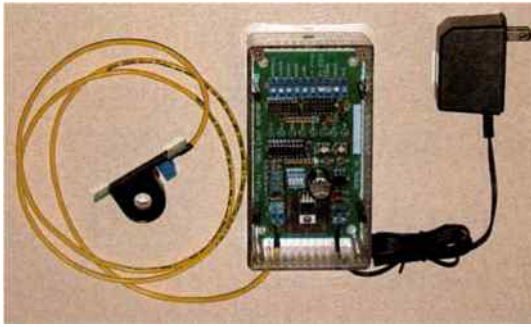

A microprocessor based system designed to monitor the status of FAA type A incandescent tower lights.

- Individual alarms for photocell, flasher, beacon & marker.
- Status outputs for lights on/off and beacon on/off.
- LED indicators for each alarm and status output.
- Opto-isolated fail-safe outputs for each alarm.
- Easy setup – one button calibration.
- Installs at the circuit breaker panel.
- Available through broadcast distributors.

**FM Services**

[www.towermonitor.com](http://www.towermonitor.com) • 336-667-7091

## Consulting Professional Engineers

### ● Expert Witness Testimony

- FCC Applications
- Frequency Searches
- Co-location Studies
- Coverage Modeling & Maps
- Interference Analysis Studies
- RF Exposure Studies & Reports
- Custom Map Preparation

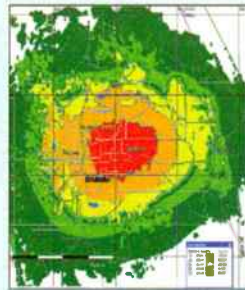

**Call us now  
to discuss your  
project needs.**

**352-367-1725**

**RFEngineers, Inc.**  
[alex@rfengineers.com](mailto:alex@rfengineers.com)

## ICE KRACKERS®

The Solution Since 1979

### NEED ICE DAMAGE PROTECTION FOR YOUR TOWER?

For over 35 years our US Patented product has been successfully used to protect guy wire anchor hardware and dampers used on towers all across the United States and Canada.

Our product doesn't wear out and is galvanized for rust protection. In most cases, the Ice Kracker can be installed in minutes and is supplied with all necessary hardware.

The average cost for a tower is about \$500.

[icecrackers.com](http://icecrackers.com)  
800-747-8921  
[icecrackers@comcast.net](mailto:icecrackers@comcast.net)

Mention this ad and  
get a discount on your order.



## The Leader in Broadcast Engineering Software!

- Create stunning "real-world" coverage maps, interference studies, and population reports with Probe 4™
- AM Pro 2™, used daily by FCC engineers, performs skywave and groundwave allocation studies and AM coverage mapping

- Find STL broadcast auxiliary and Part 101 microwave frequencies and generate PCN letters with Microwave Pro™
- Map FM stations and find upgrade possibilities using FCC minimum separations and contour-to-contour methods with FMCommander™

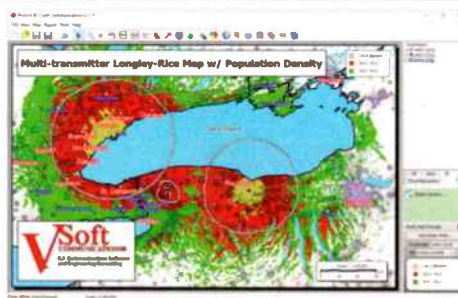

[www.V-Soft.com](http://www.V-Soft.com) - [info@v-soft.com](mailto:info@v-soft.com) - 1-800-743-3684

## TRANSMITTING CAPACITORS

MICA-VACUUM-CERAMIC

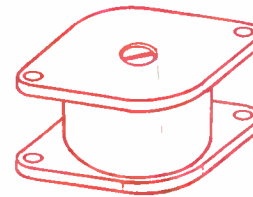

SURCOM ASSOCIATES, INC.  
(760) 438-4420  
[LINK@SURCOM.COM](mailto:LINK@SURCOM.COM)

Celebrating 35 Years of service  
to the broadcast community.

# RF is good for you!



# RF Specialties® Group

[www.rfspecialties.com](http://www.rfspecialties.com)

Check our website for the office nearest you.

## Doug Vernier

Telecommunications Consultants

- FCC Applications for AM, FM, TV, DTV, LPTV, STL
- Upgrade and Due Diligence Analysis
- Frequency Searches
- Site Relocations
- Propagation Prediction with Custom Mapping
- Demographic Analysis
- Directional Antenna Design



We use V-Soft Software!

[www.v-soft.com](http://www.v-soft.com) [consulting@v-soft.com](mailto:consulting@v-soft.com) 800-743-3684



## AM-FM Transmitters

Pre-Owned – Tuned  
and Tested to Your Frequency

[www.Besco-Int.com](http://www.Besco-Int.com)

Rob Malany – Owner

321-960-4001 • [sales@Besco-Int.com](mailto:sales@Besco-Int.com)



From our Facility to yours



Design & Integration



Repairs & On-Site Service Calls

**LIGHTNER ELECTRONICS** www.lightnerelectronics.com

Toll Free 1-866-239-3888 Shop online www.broadcastavsales.com

# Radio-Classifieds.com

- Buy or Sell Your Used Equipment
- Place as Many Ads as You Like
- **FREE!** – There's Never Any Charge



**Radio-Classifieds.com** Latest 20 ads

Please register or log in.

Antennas [0]	Codecs & A/D [0]	Internet & Stream [0]	STL, RPU, TSL [0]
Audio Amplifiers [0]	Computers & IT [0]	Microphones [0]	Satellite Gear [0]
Audio D/S [0]	Copiers & Mixers [0]	Monitors & Receiv [0]	Speakers & Phones [0]
Audio Editing [0]	Overhead Gear [0]	Phone & Hybrids [0]	Towers & Cocks [0]
Audio Processing [0]	LXS Gear [0]	RDS, BBDS, SCA [0]	Tools & Test Gear [0]
Audio Routing [0]	Facilities & Gen. [0]	Recorder & Player [0]	Towers & Coax [0]
Audio Storage [0]	Furniture & Racks [0]	Remote Control [0]	Transmitters [0]
Antennas [0]	Grounding & Signs [0]	RF & MV Equip. [0]	MISC OTHER [0]

self aware never self conscious

self aware never self conscious

IP-12

Powered by Media Magazines Inc. - Publisher of Radio Guide Magazine | Contact Us

# Gear Guide

## How Much Is That Transmitter?

by Ron Erickson

The young lad was only twelve years old when he discovered the fascinating world of radio. It was 1964 and there was a lot to hear on the air. His mother was a professor at a college in Oregon. She went to some night classes and her son went to the campus with her. One night while roaming around, he discovered the 10 Watt educational radio station. The student DJ's let him into the studio and showed him how to cue records and operate the console. That was when the radio bug bit and from that first night's encounter, he knew he wanted to be on the air. He begged for a 101 Electronic Projects Kit he found in an Allied catalog. Why? Because one of the projects was an AM Radio Transmitter. He built a small radio station in his bedroom with one record player. Most weekends, he rode his bike to commercial stations in town. Local radio announcers gave him tips and Associated Press newswire copy.

One visit in the summer he met a Gates Radio salesman at one station. The boy talked him into giving him one of those very cool hard bound broadcast catalogs. The black & white pictures of equipment fueled his desire to learn everything about radio. He devoured every word of the equipment descriptions and practically drooled over the pictures. Story to be continued later ...

Back to today, recently I found a website that you may wish to bookmark. It is really packed full of links and historical radio stuff. Truly an amazing treasure of old radio, including some photo copies of (wait for it) old broadcast catalogs. A light went on some-

where above my head and I thought it might be fun to look at some 1000 Watt FM transmitters back then and compare pricing through the years.

So here's our first one, a 1964 Gates FM-1C with a beautiful two-tone gray and black accent cabinet with brushed aluminum trim. The transmitter contained (23) tubes in the exciter, (2) 6146 in the IPA and (2) 4-400A as the final amplifier. With all those tubes, this cabinet needed some ventilation!

The 1960's price? \$5,895 – Stereo Generator? \$1,495.00.

Next we'll look at a 1973 Harris FM-1H3 1kW. With a Solid State TE-3 Exciter and (1) 4CX1000A tube, this transmitter featured stability and reliability, Harris wrote it this way: "The 100% solid state Direct Carrier Frequency Modulation (DCFM) exciter provides a full 10 Watts output, and is completely self-contained within the FM-1H3. With 'DCFM' and Digital Automatic Frequency Control, highly improved carrier stability and excellent frequency response are assured. Forced air cooled, the 4CX-1000A power amplifier stage is mounted in a fully shielded enclosure to eliminate power losses by radiation or interaction." The 1973 price? \$12,075. Stereo Generator? \$1,570.

Time traveling forward to 1994, we'll look at the new Harris HT1FM. Solid State FET RF Amplifiers replace tubes in this transmitter.

It also included integrated RF Amplifier modules, each with their own AC power supply. Each amplifier was self protected against AC or DC overloads. THE-1 Exciter came standard in each HT1FM.

Also included was an Automatic Power control with VSWR proportional fold-back and auto-restart in the case of AC interruptions. The next photo shows the THE-1 Exciter included in the HT1FM transmitter. Total 1994 price? \$19,330.

Back in the 60's, companies like Gates, Collins and to a lesser extent Sparta, sold it all. In those radio catalogs

you could find consoles, microphones, cart machines, turntables, modulation monitors, audio limiters, frequency monitors, transmitters, antennas – everything you needed to build a station. Small wonder why that twelve year old boy in my story would day-dream about owning radio station equipment.

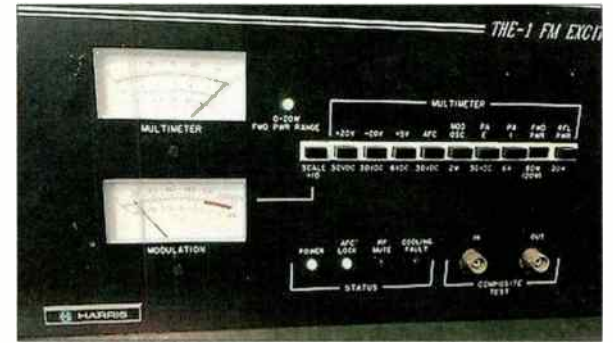

1994 Harris THE-1 Exciter

The rest of the story? The boy practiced reading out loud every day, carefully enunciating every word. The lad learned everything he could about radio. By age fourteen, he rode a Greyhound Bus alone into Portland, Oregon and found his way to the FCC field office where he passed the Third Class License test. By age fifteen, he landed a part time weekend job on a 1000 Watt Daytime AM station. He was on the air six to midnight at age 17 as a summer job. If you guessed that boy was me, you would be right.

Look back at those historical transmitter prices. Compare with what you can buy today. I'm showing advertised list prices but most dealers offered discounted prices.

Now you can buy a 1000 Watt FM transmitter from many different companies, and most are almost small enough to fit into a suitcase. Some of them have a built in stereo generators or even simple FM audio processors. Bext has the model XL1000 with a list price is \$8,795. The Nautel VS-1 EIA shows a list price of \$8,400. Crown Broadcast advertises the FME-1000 with a list price of \$6990. PTEK offers the FM1050ES for \$6,889. It is capable of producing 1200 Watts and it has a built in stereo generator. The NiCom NT1000 wins with the lowest list price at just under \$5,000. Prices on stereo generators have not changed much, while the pricing for FM Audio processing certainly has.

David Gleason has put together an incredible website that includes almost everything radio. You might enjoy visiting [www.americanradiohistory.com](http://www.americanradiohistory.com) where you can find thousands of archive broadcast publications and more.

If you're looking for a used transmitter, I built a website that brings together in one location the listings from Besco, Transcom and private listings – [www.am-fmtransmitters.com](http://www.am-fmtransmitters.com)

Ron Erickson is a regular reviewer for Radio Guide. He is also a broadcast consultant, engineer and air talent. You may contact him at 541-460-0249 or write [ronerickson@gmx.com](mailto:ronerickson@gmx.com)

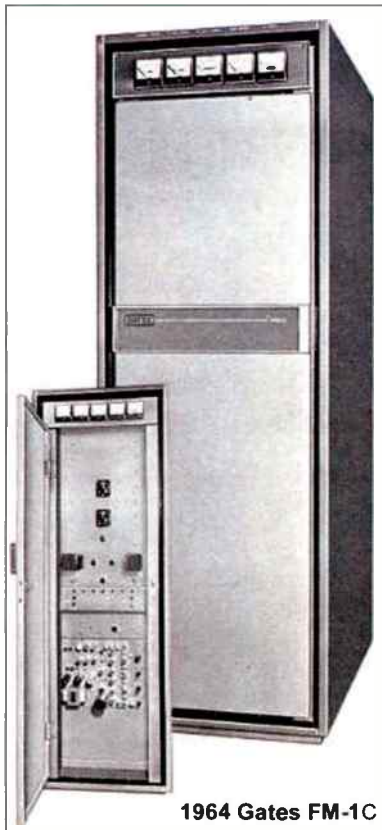

1964 Gates FM-1C

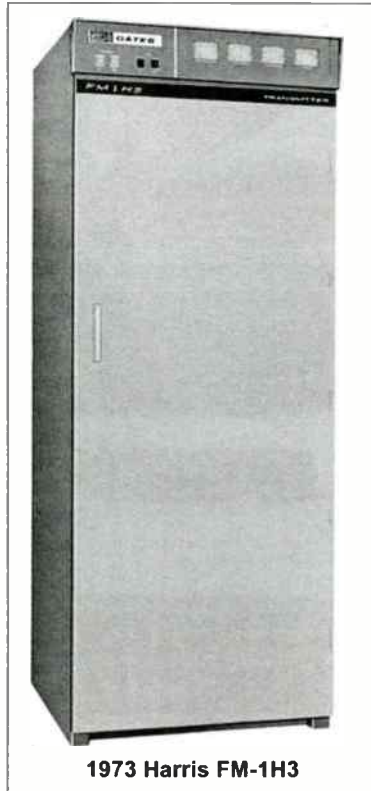

1973 Harris FM-1H3

TIME TO SYNCHRONIZE

**ES-185E/NTP6 GPS Master Clock**

Accurately generate time code with ESE's Master Clock via the 12-channel GPS receiver and output multiple types of Time Code, SMPTE-LTC/EBU, ESE, IRIG-B, ASCII (RS-232 & USB), and an extremely accurate 1PPS signal. Further reliability with dual battery back-up, and new control panel software. ESE's NTP6 feature provides an NTP server compatible with the latest version of Internet Protocol, IPv6. You can also easily interface with new or existing computers, automation and clock systems. Visit [www.es-web.com](http://www.es-web.com) for all your time synchronization needs.

[www.es-web.com](http://www.es-web.com)  
+1-310-322-2136

Precision | Innovation | Proven

RADIUS XP

MODULUX

BIRCHLINE TALK TABLE

**GRAHAM STUDIOS**  
Broadcast Furniture

815-222-3556 | [www.graham-studios.com](http://www.graham-studios.com)  
866-481-6696

# FINAL STAGE



## RADIO ROUNDUP

### The Radio Guide Event Register

Email your dates and info to: [radio@rconnect.com](mailto:radio@rconnect.com)

#### Texas Association of Broadcasters (TAB)

August 7-9, 2019

JW Marriot Downtown, Austin, Texas

[www.tab.org/convention-and-trade-show](http://www.tab.org/convention-and-trade-show)

#### 2019 Nebraska Broadcasters Assn. Convention

August 13-14, 2019

Embassy Suites, LaVista, NE

[http://ne-ba.org/news\\_and\\_events-convention.asp](http://ne-ba.org/news_and_events-convention.asp)

#### NAB Radio Show

September 24-27, 2019

Hilton Anatole – Dallas, Texas

[www.radioshowweb.com](http://www.radioshowweb.com)

#### 2019 IEEE Broadcast Symposium

October 1-3, 2019

Hartford Marriot Downtown, Hartford, CT

<http://bts.ieee.org/broadcastsymposium/>

#### WBA Broadcasters Clinic

October 15-17, 2019

Madison Marriot West – Madison, Wisconsin

[www.wi-broadcasters.org/events/broadcasters-clinic-2/](http://www.wi-broadcasters.org/events/broadcasters-clinic-2/)

#### Ohio Broadcast & Technology Conference

November 14, 2019

Columbus Convention Center – Columbus, Ohio

<https://oab.org/engineering/obmtc/>

## Radio Guide Advertiser Info – July-August 2019

### Advertiser - Page

Altronic - 32  
 Angry Audio - 31  
 Arrakis - 19  
 BDR - 42  
 Besco - 44  
 BEXT - 42  
 Broadcast Electronics - 38  
 Broadcasters General Store - 35  
 Broadcast Software Intl. - 21  
 Broadcast Tools - 30, 47  
 CircuitWerkes - 11  
 Coaxial Dynamics - 22  
 Davicom - 43  
 Deva - 41  
 D&H Satellite - 39  
 Econco Tubes - 43  
 ESE - 46  
 FM Services - 44  
 FM Station For Sale - 43  
 GatesAir - 23  
 Graham Studios - 46  
 Henry Engineering - 2  
 Ice Crackers - 44  
 Inovonics - 1, 29  
 Kintronic Labs - 41

### Website

[www.altronic.com](http://www.altronic.com)  
[www.angryaudio.com](http://www.angryaudio.com)  
[www.arrakis-systems.com](http://www.arrakis-systems.com)  
[www.thebdr.net](http://www.thebdr.net)  
[www.besco-int.com](http://www.besco-int.com)  
[www.bext.com](http://www.bext.com)  
[www.bdcast.com](http://www.bdcast.com)  
[www.bgs.ec](http://www.bgs.ec)  
[www.bsiusa.com](http://www.bsiusa.com)  
[www.broadcasttools.com](http://www.broadcasttools.com)  
[www.circuitwerkes.com](http://www.circuitwerkes.com)  
[www.coaxial.com](http://www.coaxial.com)  
[www.davicom.com](http://www.davicom.com)  
[www.devabroadcast.com](http://www.devabroadcast.com)  
[www.dhsatellite.com](http://www.dhsatellite.com)  
[www.encco.com](http://www.encco.com)  
[www.eso-web.com](http://www.eso-web.com)  
[www.towermonitor.com](http://www.towermonitor.com)  
 541-460-0249 (Ron)  
[www.gatesair.com](http://www.gatesair.com)  
[www.graham-studios.com](http://www.graham-studios.com)  
[www.henryeng.com](http://www.henryeng.com)  
[www.icecrackers.com](http://www.icecrackers.com)  
[www.inovon.com](http://www.inovon.com)  
[www.kintronic.com](http://www.kintronic.com)

### Advertiser - Page

Lawo - 15  
 Lightner Electronics - 45  
 Logitek - 37  
 Mega Industries/MCI - 20  
 Nautel - 7  
 Phasetek - 47  
 ProAudio.com - 5  
 Propagation Systems (PSI) - 28  
 Radio-Classifieds.com - 3, 45  
 Radio Systems - 26  
 RF Engineers - 44  
 RF Specialties - 44  
 SCMS - 13  
 Shively - 39  
 Smarts Broadcast Systems - 17  
 Stackley Devices - 47  
 Studio Items - 34  
 Surcom - 44  
 Telos - 33  
 Telos Axia - 37  
 Tieline - 9  
 Titus Labs - 36  
 Transcom - 43  
 V-Soft Communications - 44  
 Wheatstone - 24, 25, 48

### Website

[www.lawo.com](http://www.lawo.com)  
[www.lightnerelectronics.com](http://www.lightnerelectronics.com)  
[www.logitekaudio.com](http://www.logitekaudio.com)  
[www.mcibroadcast.com](http://www.mcibroadcast.com)  
[www.nautel.com](http://www.nautel.com)  
[www.phasetekinc.com](http://www.phasetekinc.com)  
[www.proaudio.com](http://www.proaudio.com)  
[www.psbroadcast.com](http://www.psbroadcast.com)  
[www.radio-classifieds.com](http://www.radio-classifieds.com)  
[www.radiosystems.com](http://www.radiosystems.com)  
[www.rfengineers.com](http://www.rfengineers.com)  
[www.rfspecialties.com](http://www.rfspecialties.com)  
[www.scmsinc.com](http://www.scmsinc.com)  
[www.shively.com](http://www.shively.com)  
[www.smartsbroadcast.com](http://www.smartsbroadcast.com)  
[www.stackleydevices.com](http://www.stackleydevices.com)  
[www.studioitems.com](http://www.studioitems.com)  
[www.surcom.com](http://www.surcom.com)  
[www.telosalliance.com](http://www.telosalliance.com)  
[www.telosalliance.com](http://www.telosalliance.com)  
[www.tieline.com](http://www.tieline.com)  
[www.tituslabs.com](http://www.tituslabs.com)  
[www.fmamtv.com](http://www.fmamtv.com)  
[www.v-soft.com](http://www.v-soft.com)  
[www.wheatstone.com](http://www.wheatstone.com)

## PHASETEK INC.

### Custom Phasing Systems

Phasetek, Inc. is dedicated to provide the broadcast industry high quality AM Phasing and Branching systems, Antenna Tuning units, Multiplexers, and RF components.

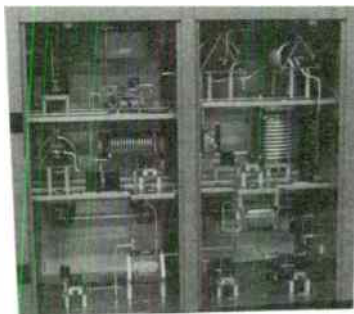

Phone: 215-536-6648  
[sales@phasetekinc.com](mailto:sales@phasetekinc.com)  
[www.phasetekinc.com](http://www.phasetekinc.com)

## Remote Reboot of AC Powered Devices

Stackley  
 Devices  
 LLC  
 (609)  
 647  
 9677



RemOutlet  
 Reboot  
 Mini  
 \$179  
 Adjustable  
 Power  
 OFF Time

[www.RemOutlet.com](http://www.RemOutlet.com)

## No 3-phase power? No Problem!

Operate any 3-phase broadcast transmitter from a 1-phase utility supply!



- Turn any location into a 3-phase site within hours!
- Save thousands \$\$ on utility line extensions
- Recommended by leading transmitter manufacturers
- True 3-phase, not open delta
- Over 1500 Radio & TV installations worldwide
- Rotary design stores energy and rides-through line transients far better than electronic devices.

If you have ANY questions about 3-phase electric power for your broadcasting application, do yourself a favor and call Kay Industries first!



**Kay Industries**  
**PHASEMASTER®**  
 Rotary Phase Converters

South Bend, IN  
 800-348-5257

Fremont, CA  
 877-348-5257

The World Leaders in Single to Three-Phase Power Conversion

## Passing the Test



### Universal 4.1 MLR»Web

The Universal 4.1 MLR»Web is a web based transparent four input, one output switcher/router with mechanical latching relays designed to pass AES or stereo balanced signals. The unit may be configured to monitor for stereo analog audio silence or loss of AES clock when configured for AES switching.



Broadcast Tools is a Veteran Owned Business  
 Designed, Assembled and Tested  
 in Washington State, USA.  
[www.broadcasttools.com](http://www.broadcasttools.com)

**BROADCAST**  
**tools**  
 PROBLEM SOLVED



WHEATNET-IP INTELLIGENT NETWORK

**THE FUTURE  
CAN BRING  
ANYTHING**

**LXE IS  
READY FOR  
EVERYTHING**



Virtually every button, knob, and display on the LXE is programmable using ConsoleBuilder. And you can design dynamic custom touchscreen interfaces to augment LXE's extensive screen set with ScreenBuilder.™ Need more input faders? Enable up to four layers to multiply the number (up to 32) in the same footprint.

Whether it's 2020, 2040, or 2080, your LXE will adapt to your needs.

Your Forever Console: [wheatstone.com/lxe-forever-rg](http://wheatstone.com/lxe-forever-rg)



**Wheatstone**  
BROADCAST AUDIO PERFECTIONISTS

phone 1.252.638-7000 | [wheatstone.com](http://wheatstone.com) | [sales@wheatstone.com](mailto:sales@wheatstone.com)

World Radio History