

# Radio Guide

[www.radio-guide.com](http://www.radio-guide.com)

Digital Issue Now On-Line

November-December 2016 – Vol. 24, No. 6

## Not Again – A Very Wet Autumn



PRRST STD  
U.S. POSTAGE  
PAID  
PERMIT NO. 410  
BEAVER DAM WI

**Inovonics RDS/RBDS Encoders:**  
*Next generation branding and messaging.*



Models starting at \$590

**INOVONICS**  
BROADCAST





## MEET SAM... Your Trusty Station Watchdog

Are you OFF AIR? No audio? EAS alert received? Request line ringing? Transmitter site intrusion? SAM lets you know now!

The Systems Alert Monitor (SAM) is an effective way to monitor station operations! SAM provides instant visual indication of system status, alerts, emergency and priority situations.

- Video messages alert personnel to take action!
- Plays audio alerts and sends email messages
- Monitors up to 15 systems for faults or status
- Easy to set up text, colors, display time, etc.
- Display your station logo when idle

SAM is highly customizable and versatile, yet easy to set up and use. And when your gear or needs change, SAM can be easily reconfigured in minutes. SAM works with any HDMI video monitor (not included).

SAM is eager to watch over you! Woof!



**WE BUILD SOLUTIONS:** DIGITAL SOLUTIONS. ANALOG SOLUTIONS. FUNCTIONAL. RELIABLE. AFFORDABLE.



Phone: 562.493.3589 • email: henryeng@aol.com

[www.henryeng.com](http://www.henryeng.com)







Photo by Rob Goldberg  
radioDNA

## On-Air Exhilaration. Every Single Day.

What makes Wheatstone consoles best-of-class?

Breakthrough technology with award-winners like WheatNet-IP Intelligent Network & bus-minus. Unique design ingenuity. Precision production/starship-grade materials. Obsessive Wheatstone quality. FullTime support.\*

What does all that get YOU? Absolutely spoiled...



### LX-24 Control Surface

Exceptional console at every level, fully loaded and completely customizable.



### L-8/L-12 Control Surfaces

Outstanding companion to the LX-24, perfectly sized for newsrooms, etc.



### IP-12/IP-16 Control Surfaces

Precisely designed and engineered for peak performance at mid-size stations.



### The IP Network is IN the BLADE...Like DNA

Each powerful BLADE-3 (point-of-use interface) contains the entire WheatNet-IP Intelligent Network to route I/O, access sources, add processing, mix to/from any device. Plus routable logic, silence sensing, gain control, automated mixing, discovery/control, and much more. Format agile: AES67, MADI, AES/EBU, TDM, Analog, and AoIP.



\*Includes on-site commissioning, in-factory total-system proof-of-performance testing, installation support, and real 24/7/365 service. We don't mess around.

Learn more: [wheatstone.com/consoles](http://wheatstone.com/consoles)



Designed and built in the USA. Phone +1-252-638-7000 | [wheatstone.com](http://wheatstone.com) | [sales@wheatstone.com](mailto:sales@wheatstone.com)



# Radio Guide

## Contents

November-December 2016

## In This Issue

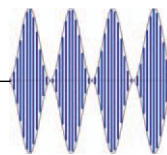

### Critical Content for Radio

<b>Cover Story</b> . . . . .	<b>6</b>
<i>Not Again!</i>	
<b>Studio Site</b> . . . . .	<b>8</b>
<i>The FYI on USB – Maximizing Audio for Computer Editing</i>	
<b>Transmission Guide</b> . . . . .	<b>10</b>
<i>Distance to Fault Measurements in Transmission Lines</i>	
<b>Telemetry &amp; Control</b> . . . . .	<b>12</b>
<i>CircuitWerkes Sicon-8 Remote Control</i>	
<b>FCC Focus</b> . . . . .	<b>14</b>
<i>Do You Remember?</i>	
<b>Maintenance Guide</b> . . . . .	<b>16</b>
<i>Keeping Stuff Out of Your Transmitters</i>	
<b>Station Stories</b> . . . . .	<b>18</b>
<i>Caring for KMPX &amp; KPPC – Burning Herbs and Spinning Cat</i>	
<b>Tips From the Field</b> . . . . .	<b>20</b>
<i>Creative Wire Management</i>	
<b>Emergency Prep</b> . . . . .	<b>26</b>
<i>Do You Have a Safety Net?</i>	
<b>Transmitter Site</b> . . . . .	<b>30</b>
<i>The Case of the Door-Controlled Transmitter</i>	
<b>Monitors and Meters</b> . . . . .	<b>34</b>
<i>Old Ain't Bad – Rebuilding a Simpson 260 Meter (Part 1)</i>	

<b>Practical Engineering</b> . . . . .	<b>38</b>
<i>Successful Troubleshooting</i>	
<b>Small Market Guide</b> . . . . .	<b>42</b>
<i>Buyer Beware – Even in Small Market Radio</i>	
<b>Service Guide</b> . . . . .	<b>44 &amp; 45</b>
<i>Radio Equipment, Products, and Services</i>	
<b>Radio Classifieds</b> . . . . .	<b>45</b>
<i>Buy and Sell Used Equipment – FREE of CHARGE</i>	
<b>Gear Guide</b> . . . . .	<b>46</b>
<i>New Product Releases and Information</i>	
<b>Final Stage</b> . . . . .	<b>47</b>
<i>Convention, and Event Register – Advertiser Information</i>	

## Radio Guide

Volume 24 – Issue 6

**Radio Guide Website:** [www.radio-guide.com](http://www.radio-guide.com)  
**Classified Ads:** [www.radio-classifieds.com](http://www.radio-classifieds.com)

PO Box 20975, Sedona, AZ 86341  
 Phone: 928-284-3700 • Fax: 866-728-5764

Ray Topp (publisher & editor) – [radio@rconnect.com](mailto:radio@rconnect.com)

Radio Guide, ISSN 1061-7027, is published bi-monthly, six times a year, by Media Magazines Inc., PO Box 20975, Sedona, AZ 86341. Radio Guide is copyright 2016, Media Magazines Inc., and may not be copied, reproduced, or stored in any format, without the written permission of the publisher.

### Cover Story – by Scott Schmeling (page 6)

**Not Again:** “I went back to the studio to see what we could put together to get back on the air ... I was going to need two FM’s, one AM, and an AM translator, prioritized in that order. To my advantage, I had a 250 Watt Crown backup transmitter not in use, and another VS1 translator not yet in service – plus a 1000 Watt backup AM still in the box, at other transmitter sites.”

### Transmission Guide – by Mike Hendrickson (page 10)

**Distance to Fault Measurement in Transmission Lines:** “We have all experienced that moment when we discover that the transmission system or antenna is not doing what we want. The indicated reflected power has changed and we cannot account for what happened. Icing has been eliminated because the day is sunny and warm, so what do we do now?”

### Maintenance Guide – by Gary Peterson (page 16)

**Keeping Stuff Out of Your Transmitter:** “All of us experienced engineers can think of many things that can be done with our time, other than removing dust and critters from transmitter cabinets. So, you can understand that I am always on the lookout for tricks to keep stuff out of the transmitters in the first place.”

### Monitors & Meters – by Tommy Gray (page 34)

**Rebuilding a Simpson 260:** “Working with vintage transmitters sometimes is better done with vintage test equipment. The one piece of equipment I am going to talk about for the next few issues, is a very common VOM called the Simpson 260.”

### Gear Guide – Equipment for Radio (page 46)

- Broadcast Devices – SWP-300 RF Site Controller
- DM Engineering – Mic-Pod
- ESE – GPS-Based ES-410 Frequency Standard

## Bay Country Broadcast Equipment

Buy • Sell • Trade

Your #1 Source for Quality  
Used Radio Broadcast Equipment

View our latest list of equipment on-line at:

[www.baycountry.com](http://www.baycountry.com)

Or call and we will fax it to you.

All equipment sold with a 15 day return guarantee.

### Turn Your Excess Gear Into Cash

Fax or email your list to us and we will respond with our offer promptly. We only buy good working equipment with traceable serial numbers.

Fax Your List Today – 443-596-0212



<http://www.baycountry.com>

(Website Updated Daily)

E-mail: [sales@baycountry.com](mailto:sales@baycountry.com)

877-722-1031 (Toll Free) 443-596-0212 (Fax)

7117 Olivia Rd, Baltimore, MD 21220



## Your Transmission Site General Manager

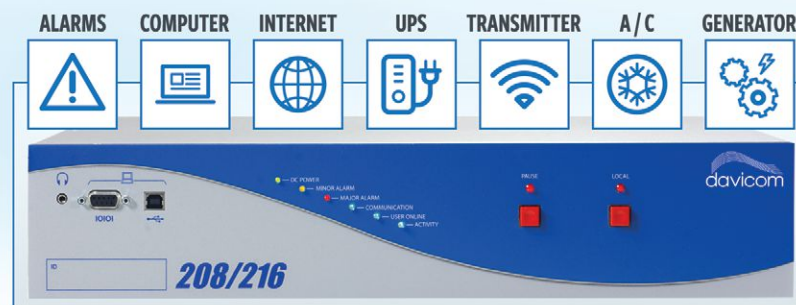

### The Davicom Site GM has the following qualifications:

- SNMP Agent for legacy equipment
- SNMP Manager for SNMP devices at the site
- Web Server dispatcher
- PPP access for LAN backup by dial-up
- Modbus master
- Regular GPIO



Intelligent Monitoring Systems

T. 1.418.682.3380  
[dvsales@davicom.com](mailto:dvsales@davicom.com)



# Get the story from the palm of your hand

Your story is out there - around the community, on the street, in the trenches. That's why your broadcast equipment needs to be as flexible as the stories you cover. ACCESS 2USB transmits two-way audio over the Internet wirelessly by using Wi-Fi and Cellular data services.

Our CrossLock technology ends the coverage guessing game. With the ability to use multiple networks at once, CrossLock will intelligently monitor and dynamically adjust modems in real time for an extra layer of reliability.

NEED ACCESS?  
CONTACT US:

1 800 237 1776  
info@comrex.com



© 2016 Comrex Corporation

ACCESS  
2USB

WIRELESS CODEC FOR AUDIO OVER IP



CrossLock™ VPN

Learn more at [www.comrex.com](http://www.comrex.com)

COMREX  
BROADCAST RELIABLE





## Not Again!

### A Very Wet Autumn

by Scott Schmeling – Minnesota Valley Broadcasting

I'm at a loss – I couldn't decide what to title this article: "Here We Go Again?" "Twice Is Two Too Many?" "Done That, Didn't Like It?" I decided on "Not Again!"

On Thursday, September 22, 2016, at 1:41 in the morning, my phone rang. (A call at that time is *never* good!) One of the Sine Systems remote controls was calling to report an alarm at a transmitter site. There was no RF output and I could not bring it up by remote. So, just like any of you would, I got up, dressed and headed out – not exactly sure of what I would find. But I had a fairly good idea.

We had been experiencing a *very* wet autumn. There had been many days with rain, sometimes as much as six or seven inches. But on that night we got *13 inches* of rain! It was still raining as I drove away.

While driving, I tuned in to our other stations to be sure everybody else was on the air. They were, thank goodness! I called one of our AM's that was manned at that time, to see if I should expect any "issues" while I drove. Radar was showing rain but nothing else to be concerned about. *But*, about 2/3 of the way there, orange traffic cones suddenly appeared diverting traffic off Highway 14 and into Waseca, Minnesota – water was over the highway in a low spot just ahead.

When I got to the site, it was dark, and *still* raining. I got my flashlight and took a look at the field. It was much worse than I has expected!



Another 500 Year Flood?

This was September 22nd. On September 23rd, 2010 the same area had flooded (hence, the "Not Again," etc.). This was one day shy of being six years *to the day!* That flood had been deemed "The 500 Year Flood!"

I drove to the studio to check my options and to wait for the sun to come up so we could get a better look. I also started mentally inventorying what we had and what may have been damaged.

The site has two towers. For the FM tower we had a Nautel NV20, a Harris HT10, a Nautel VS1 for a translator, and a Nautel VS2.5 as a backup for any of the three. Plus, of course, STL's, remote control, etc. For the AM tower, we had a Nautel DN5 for day use, a Harris Gates-ONE for night, and an old LPB-60 that I just couldn't throw away.

At 7:15 the sun was up and the rain had let up a little, so I headed back out. What I saw was much worse than I expected. Water was literally up to the doorknob on the FM building and even higher on the AM building! This was considerably higher than six years ago.

I went back to the studio to see what we could put together to get back on the air. I had to assume *everything* was no longer operable, so I was going to need two FM's, one AM, and an AM translator, prioritized in that order. To my advantage, I had a 250 Watt Crown backup transmitter not in use, and another VS1 translator not yet in service – plus a 1000 Watt backup AM still in the box, at other transmitter sites. In addition, I also had a Marti PNP 1000, 1 kW backup transmitter, at another site on the other side of Minnesota. By early afternoon the rain had stopped and the water had receded considerably. I took off driving to "harvest" three of the four transmitters I would need.

About 7:00 that evening, I was back, the water was down, and we had a "duck boat" for carrying the equipment. Brad (assisting me), Kevin (electrician), and I, put on some chest waders and headed out to the FM building. In the boat we had the Crown, the VS1, my laptop and camera, a 1-5/8" Flange-to-N adapter, and some RG214. If you're counting, that's only *two* FM transmitters. The translator would have to wait. We got the boat solely for transporting equipment. The driveway was long enough and the water deep enough that we certainly didn't want to try to carry it out, and risk falling into the water. Kevin, the electrician, was with us "just in case," but it was great having a third set of hands.



The Water Line

When we got to the building, a quick check verified the breakers had not tripped. In fact, the blower on the HT10 was running. I'm not sure about the fans in the NV20. We turned those two breakers off and took a look around.

First, the water level had been about 18 inches higher than six years ago. That's significant, because six years ago we had lifted both transmitters and put them on up on cement blocks and a 6x6, raising them above the water of 2010. *We thought* we were safe!

Next, the plate transformer and chokes of the HT10 had definitely been in water, but nothing else. The NV20 has 24 power supply modules in the bottom of the cabinet – 15 of them had been under water. In addition, the exciter had been at least half submerged.

If that weren't enough, the VS2.5 had been completely under water and the VS1 had been slightly over half submerged!

It was obvious these transmitters were not going to work tonight – we went to work getting *something* on the air.

Using adapters, the 1000 Watt VS1 replaced the NV20 and the Crown 250 Watt replaced the HT10. Both stations were on the air by 8:15 p.m.!

That was enough for one day. We turned the thermostats for the intake blower and exhaust fan as low as they would go to guarantee they would both continue to move air all night – regardless of temperature.

Friday was spent talking to manufacturers to see how quickly we could get the parts we needed. I opted to replace *all* of the power supplies in the NNV20, plus, of course, the exciter. Not enough power supplies were in stock and the exciter would have to be assembled – nothing would ship until next week. The two VS transmitters were shipped to Nautel for evaluation (found not economically repairable).

On Monday, my friend and frequent assistant, Marv Olson, joined me and we started cleaning and troubleshooting. Also, the Marti NPN 1000 was brought out and we did a little shuffling of who was on what, and got the translator back on.



No Escape for This ONE

Over in the AM building, a Harris GatesONE had been on the air – it was in nasty shape! The ND5 had a power supply problem before the flood and no power had been applied. That turned out to be a blessing. After a thorough cleaning with brushes, distilled water, and denatured alcohol, we reassembled the power supply and applied AC. A randomly tripping circuit breaker was traced to a power line filter that sits directly on the AC input to the transmitter – the clue that there was an issue was the water dripping out of the filter case! After replacing the filter we found one bad IC in the exciter. After that was replaced, we ran the ND5 at about 500 Watts into a dummy load for a couple days. There were no problems and we ran it up on the antenna – it's humming right along.

After the NV20 power supplies and exciter arrived we plugged them in and ran the transmitter into a dummy load, again for a couple days. One RF module went out and two PA Amplifier cards failed. Once they were replaced it made full power and is running like a top!

The plate transformer on the HT10 was found to be bad – the flames shooting out the top when the plate button was pressed was a pretty good indication! It was decided that the cost to replace the transformer was too high and a new transmitter was ordered.

We are taking a few steps to guard against this happening again. I'll tell you about them later. I mentioned earlier that the 2010 flood had been dubbed "The 500 Year Flood." I'm calling *this* on the SIX YEAR FLOOD! With any luck, I'll be retiring in *five* years!!

Before I go ... I'd like to wish all of you a very Merry Christmas and a Wonderful 2017. Until next time – keep it between 90 and 105!

*Scott Schmeling is the Chief Engineer for Minnesota Valley Broadcasting. You may email him at: scottschmeling@radiomankato.com*



# GV Series

3.5 kW – 88 kW  
Digital/Analog FM



**HD Radio**<sup>®</sup>  
Digital AM & FM

## Digital, Efficient, Intelligent, Refined

Meet the new GV Series, the culmination of years of Nautel digital/analog transmission innovation. Nautel's field-proven high-power FM architecture is mated with the industry's most advanced RF technologies and Nautel's award winning control system to set a new standard for digital performance, efficiency, serviceability and unmatched functionality. Learn more at [www.nautel.com/GV](http://www.nautel.com/GV)

**Smaller  
Footprint  
GV30<sup>N</sup>**



Making Digital Broadcasting Work.

[nautel.com/GV](http://nautel.com/GV)

**nautel**



## The FYI on USB

### Maximizing Your Audio for Computer Editing

by George Zahn

In previous issues, we discussed ways of making any office, or even a closet, an extra digital audio workstation by utilizing your desktop or laptop computer and installing some basic audio editing software. That works well if you have a place to record voice or other audio in another studio, perhaps to a CD or data card, so that you can get it into the computer. Another option is to have a small mixing console that allows you decent microphone pre-amps and mixing ability to plug into the computer's soundcard.

In addition to the additional cost for the extra equipment, one dilemma remains – signal-to-noise ratio. While some of the newest sound card and audio input technology can yield a signal-to-noise ratio of better than -120 to 1 (120 decibels of audio over 1 decibel of noise), some older cards don't even list SNR on their basic specs. We speak and hear in analog sound, but computers process that sound as digital audio.

The noise I'm talking about is not the external noise from the computer fan or other mechanical noise. That's in its own realm and can be mitigated by baffling or even placing the core computer in another room. The SNR is affected by the computer's Analog-to-Digital Converter. We'll use ADC for short. The computer you may be using uses either a built-in audio chip or a sound card that interfaces with the analog audio (microphone or line) jacks on the computer.

#### Keep It "Sample"

Going back to Digital Audio 101, the ADC takes analog audio from microphones or non-digital consoles and samples that audio, converting it to a quantized data stream that the computer sees as the audio. Without the ADC, the computer cannot handle the audio we want to manipulate in any software.

The digital audio takes the form of samples that are then stored on standard or solid state drives, flash drives, thumb drives or as "optical" digital audio on CD or DVD. While in the computer realm, the audio is simply a complex stream of zeroes and ones in binary bits that form long chains that can have up to 44,1000 (44.1k) samples for each second of audio on CD or the 48,000 (48k) PCM rate. Recording at lower bit rates yields a bit less than CD quality and has lower fidelity, but saves digital storage space.

#### Noise Will Be Noise

If you're plugged into a mini-plug microphone jack on a computer that has an standard equipment, non-specialized audio interface, you can adapt the best microphone to access that MIC input – and get less than ideal quality audio. Microphones create a much lower audio level than line devices, and any microphone amplification in the computer itself is unlikely to be as clean as a basic mixing console microphone pre-amp. It's possible that the line input may be a bit cleaner since you're not depending on extra amplification to make its audio usable. If you've ever tried using an inexpensive gaming headset microphone/headphone combo, you know that many of the mics made to just plug into the mini-plug on your computer have limited frequency response as well, often with little bass content. For broadcast we must do better.

Beyond the audio jack standard interfaces, the ADC is the area where noise can be introduced when working with

your computer. If you're simply using the computer for production of podcasts or streaming, that might be passable, but please remember that anyone listening is likely listening on far better speakers connected to their computer than we had ten years ago. Signal-to-Noise on the Internet may not be as critical as SNR for broadcast, but it will eventually catch up as stations increase the quality of their streaming and on-line or cloud media archiving.

So how do we avoid buying an expensive sound card interface to give us great SNR? We can avoid that interface altogether by utilizing a feature that has been staring us in the face for years – the USB port. What was once a limited field has boomed in USB microphones. These are basic microphones, often dynamic, condenser and unidirectional (it helps reject some of the computer fan noise if the desktop is sitting right next to you). The USB mic does two things for you. It boosts level and completes the analog-to-digital conversion before it ever leaves the device.

#### The Best is "Yeti" to Come

That doesn't make each USB microphone a one-stop solution. While many run between \$50 and \$150, you still want to make sure that the SNR is solid – better than 100 to 1 – which means it has a clean ADC and internal amplifier. Some of the better touted USB mics to hit the market include the Yeti (list about \$150) from Blue which claims to be a plug and play condenser microphone with three capsules and 4 switchable polar pattern options (uni, omni, bidirectional, and bidirectional stereo). It has a built-in mute button, and a volume control for headphone line-out (more on the headphone issue in a moment).

Just some of the other USB mics that are out there include the Samson Go Mic (List \$40), the Conneaut (CAD) U37 is generally under \$50, and Audio Technica has the AT 2020USB at around \$120. Many of these mics also feature a large diaphragm to enhance bass response on voice. There are dozens of options, but if the price points seem to good to be true, they may be. If you're looking a specs, many of these microphones will list maximum Sound Pressure Level, but not necessarily the Signal To Noise Ratio.

When you see a figure such as 120 dB SPL, that simply means the element can handle high sound pressure levels



Blue Yeti



Samson Go Mic

before distorting. The lower price point may also indicate the ADC in the microphone may be of lesser quality, potentially affecting the SNR.

The other major consideration that isn't specified accurately enough on most USB mics is the Frequency Response of the microphone. Frequency Response indicates the fidelity that a microphone can reproduce from bass through the mid-range and into the treble areas of the spectrum. Just seeing a frequency response of 20Hz-20,000Hz doesn't tell you anything because it doesn't indicate how accurate the microphone is throughout that range.

In general, a good Frequency Response rating should include a decibel range. For instance, a frequency response of 30Hz to 18,000Hz, plus or minus 1dB, tells you that the microphone will reproduce those frequencies accurately within a 2dB variation. That's really good. Simply listing the frequency range, without the variation of plus or minus a number of decibels, means virtually nothing.

#### Better "Latency" Than Never

When converting audio from analog to digital before it enters the computer, you have to allow for a certain amount of latency, the slight delay it takes the ADC to sample and quantize the sound into audio. That's why many USB mics have headphone outputs that let you hear your microphone output before the digital conversion. While the delay is minimal, listening to the post-converted audio off of the computer headphone output can be disconcerting. That's why many USB mics have a separate headphone output and volume control for it.

So you may have reservations about USB microphones despite the low cost. There is another option. Whether you already have a decent small mixer or just want to plug your tried-and-true studio microphone into your computer, you can do that with a USB interface. These devices range in price from \$50 to \$100 for a simple, one XLR input to USB output. These devices do the same ADC and level boost that the USB mic does, but the input is a microphone that you already know and may be using.



PreSonus Studio 192 Mobile

More robust USB converters may have multiple and higher quality microphone pre-amps, line level inputs, and pre-latency headphone output in addition to USB output, many with USB 2.0. Some even have FireWire outputs.



Tascam UH 7000

They range from devices such as the PreSonus AudioBox, the Alesis iO2 Express and the Mackie Onyx Blackjack (all in the \$100 retail range) to the heftier and more feature laden Tascam UH 7000, PreSonus Studio 192 Mobile, and Roland Octa-Capture (the Roland has 10 inputs including 8 mic pre-amps) all in the \$400 to \$800 retail range.

*George Zahn is a Peabody Award winning radio producer and Station Manager for WMKV-FM at Maple Knoll Communities in Springdale, Ohio. He is a regular contributor to Radio Guide and welcomes your feedback. Share your stories with others by sending ideas and comments to: gzahn@mkcommunities.org*



# The award winning combination



(( ViA ))

Join the #ViARevolution



**Merlin**  
PLUS



[www.tieline.com](http://www.tieline.com)

317-845-8000  
[sales@tieline.com](mailto:sales@tieline.com)

**Tieline**   
The Codec Company



## “Distance to Fault” Measurements in Transmission Lines

by Mike Hendrickson

I received a request from Stu Tell, a long-time colleague and friend, to talk about distance to fault measurements in transmission line systems. This topic will be quite extensive and I cannot cover it in one article. This is the introduction.

We have all experienced that moment when we discover that the transmission system or antenna is not doing what we want. The indicated reflected power has changed and we cannot account for what happened. Icing has already been eliminated as the cause because the day is sunny and the temperature is well above freezing. So what do we do now?

One of the problems that we encounter is that much of the transmission line involved is not easily accessible to us. If the problem is at an AM radio station much of the line may be buried. If it's a FM station, most of the line is on the tower along with the antenna. This means that all of our trouble shooting must be done “remotely” using test equipment.

The first time I encountered a problem like this, I had only a wattmeter to tell me that something was wrong. I borrowed a TDR, but it did not tell me where the fault was located. It wasn't until the line shorted that I was able to locate the problem and make repairs.

We know that a TDR or Time Domain Reflectometer is a type of “radar” for transmission line. There is a fast rising DC pulse sent down the line from a pulse generator through a “T.” Monitoring the line through the “T” is an oscilloscope. The oscilloscope is monitoring both the incident pulse and watching for reflections. If there is a fault in the line, or the line is not terminated in a resistive load that matches the impedance of the line, there will be reflections. The location of the fault can be determined by the time interval between the incident pulse and the reflection, provided you take into account the velocity factor of the line. The TDR is excellent at locating severe faults in transmission lines, but it doesn't do as well in locating partial faults. The TDR also will not work at finding faults if there are bandwidth limitations in the system before the fault. Another thing about the TDR is that it can be so basic that you can actually build it out of a 555 timer chip and a good oscilloscope.

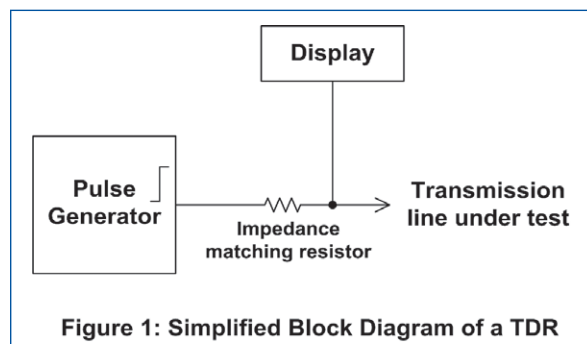

Even though the TDR has limitations, it is a very useful item of test equipment. Other test equipment you may want to consider is the combination of a spectrum analyzer, tracking generator, and a directional coupler. If you already have the spectrum analyzer and tracking generator, the only addition you need is a wide band directional coupler such as the Narda 3020A. The tracking generator generates a swept frequency signal that is transmitted down the transmission

line. Like any RF signal, the sweep frequency travels down the line until the signal encounters the antenna. Then the antenna frequency range is radiated and the other frequencies are reflected back to the source. The directional coupler directs the reflected signal to the spectrum analyzer. The spectrum analyzer displays the signal as return loss. This system is known as scalar analyzer. There is no phase or vector information obtained.

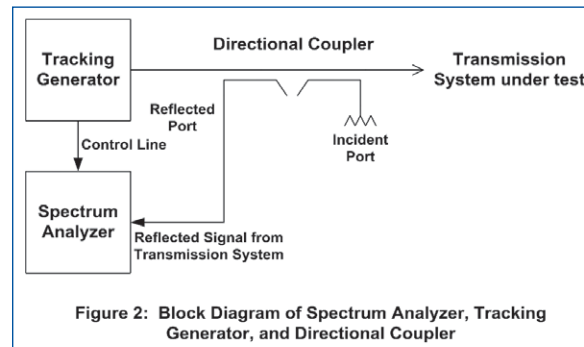

The spectrum analyzer, tracking generator, and directional coupler will enable you measure the performance of the antenna system and line. You will see the bandwidth limitations of the system, but you will not see the location of any faults – just that there *are* faults.

The final item of test gear that I've used is the vector network analyzer or VNA. One difference between the VNA and other test equipment is that not only does the VNA provide scalar or amplitude information about the transmission system, it also provides vector or phase information. It's the addition of the phase information that makes the VNA so very useful.

The VNA is somewhat similar to the spectrum analyzer, tracking generator, and directional coupler combination – but on steroids. The signal generator sends a signal up the transmission line to the antenna through a directional coupler. A sample of this signal is provided to a receiver in the VNA. From the directional coupler, the signal that is reflected from the load is provided to another receiver. The amplitude and phase information from the two receivers are supplied to a CPU. The information is compared and the result is the amplitude and phase of the reflected signal.

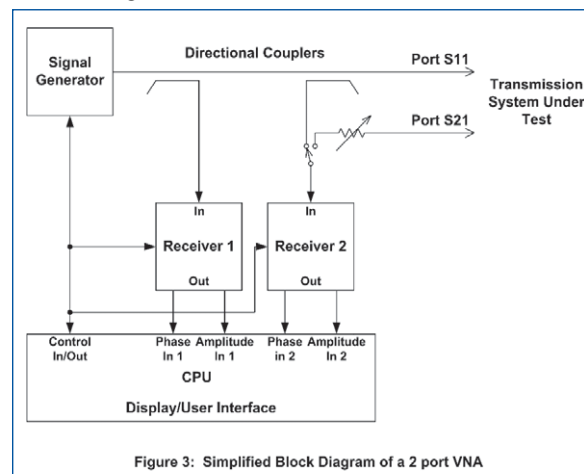

Once we have the both the amplitude and phase information about the reflected signal, we can do all kinds of

interesting things. The CPU can generate several different types of charts that can be displayed. We can look at VSWR, return loss, a polar chart, a smith chart, and others. The VNA will provide us with the resistance and reactance of the load presented to the port of the VNA.

Here is the interesting thing about a VNA: since we have the vector information, we can use Fourier transforms to generate a distance to fault display – in other words, a very high quality TDR. Depending upon the VNA, you can adjust the frequency sweep used by the TDR function. You can also set the start and stop distances for the measurements of faults in a line. As an example, you could set the analyzer to sweep a line using a frequency range of 250 MHz to 750 MHz. Since you can set the start and stop distances, you could closely examine a possible problem several hundred feet away. This would enable you to see slight faults or bumps in the return loss of the line. It would also give you an exact distance to the end of the line since this is not in the range of the FM antenna on the end of the line. You could also set the sweep for just the FM band. This would enable you to still examine the line even through there are tuned elements inserted in the transmission line.

Like a spectrum analyzer and tracking generator, you can also perform tests through a device such as a low pass filter. The VNA will supply not only the amplitude of the signal passing through the device under test, but also information about phase, time delay, and so on.

One of the big disadvantages of the VNA has been its cost. Most of them are over \$10,000. If you are willing to lose some of the capabilities of the expensive units, there is one solution. This is the Array Solutions VNA2180 or the VNA UHF. The VNA2180 is selling for \$995 and the VNA UHF is selling for \$1,295. The VNA2180 has an upper frequency range of 180 MHz with a power output of +7 dBm. The VNA UHF has an upper range of 1.2 GHz and a power output of -13 dBm.

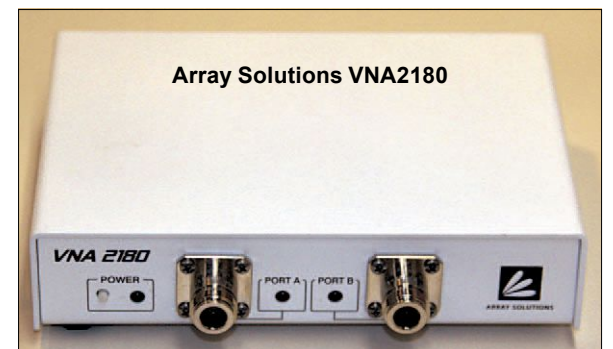

Both of the Array Solutions VNAs have a TDR function. But, the function is limited to a frequency sweep of the entire range of the unit. The displayed trace is shown as transmission line impedance vs. distance. On the other VNAs that I've used the displayed trace is shown as return loss vs. distance. The Array Solutions units will also not permit you to adjust the start distance and stop distances for a closer examination of the possible faults.

One of my concerns with the Array Solutions VNA was the accuracy of the measurement. A couple of years ago Steve Brown of Radio Rangers, LLC., Doug Thompson, and I did a comparison between an Agilent VNA, an Anritsu VNA, and an Array Solutions VNA2180. We were pleasantly surprised that the results of the measurements on all the VNAs showed the same results.

In my next article I will explain more about making actual measurements of the transmission system. Until next time, happy engineering!

*Hendrickson, CPBE, CBNT is the retired Chief Engineer of American Public Media Group. He has been involved in Broadcast Engineering since 1969. Over this time period he has been involved with all aspects of broadcast engineering from the technical to the budgeting. He may be reached at: mikelakeville@gmail.com*



# Get the Most features per \$\$ on the market

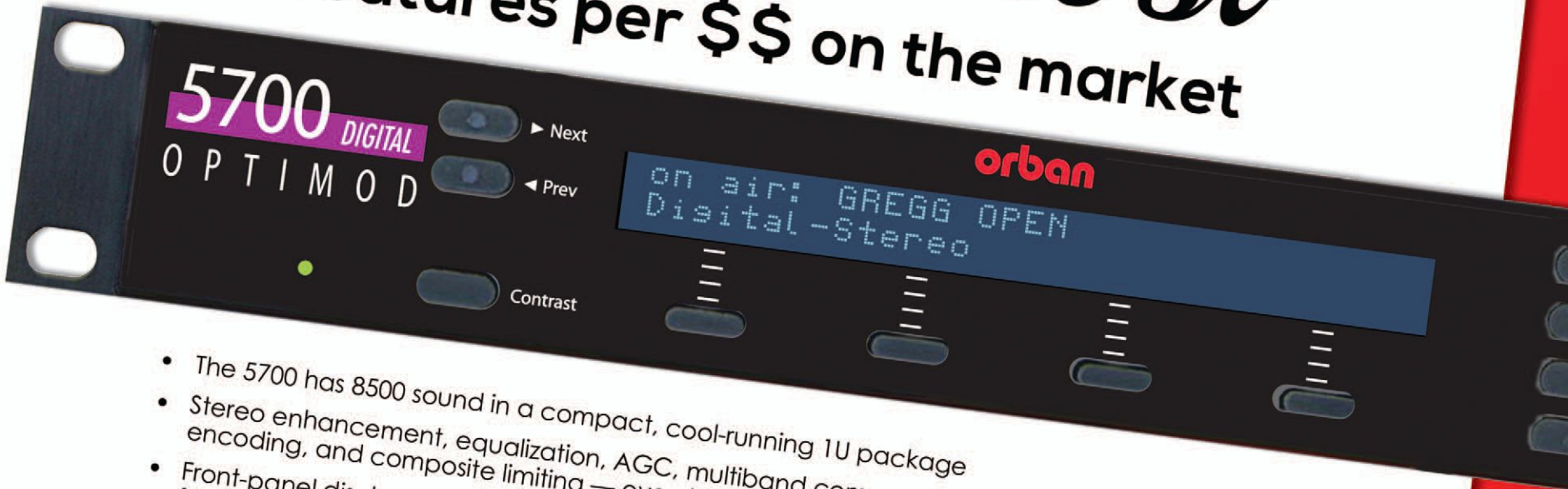

- The 5700 has 8500 sound in a compact, cool-running 1U package
- Stereo enhancement, equalization, AGC, multiband compression, low-IM peak limiting, stereo encoding, and composite limiting — everything that you need to compete in your market
- Front-panel display includes a 2x40-character LCD and LED bargraphs that show all metering functions of the processing structure (Two-Band or Five-Band) in use
- Two equalizers, multiband compressors, and peak limiters, allowing the analog FM and digital media processing to be optimized separately
- More than 20 excellent sounding, format-specific factory presets get you started

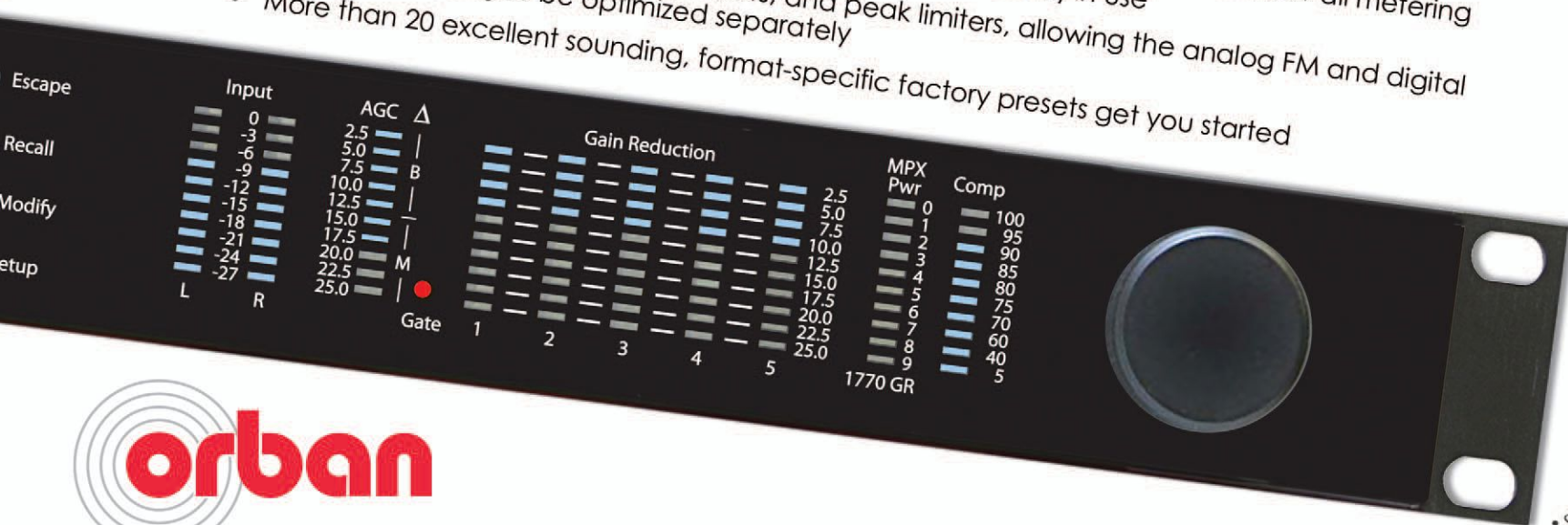

• Starts at \$4990.

CONTACT **SCMS** for **ORBAN** products



18 reps across the U.S. and latin America

Broadcast Equipment Solutions | 1-800-438-6040 | [www.scmsinc.com](http://www.scmsinc.com)



## CircuitWerkes Sicon-8 Remote Control

by Kyle Magrill - CircuitWerkes

Remote controls have evolved over the years and continue to do so today.

Those who have been in the broadcasting business for many decades can easily remember the Rust, Gates and Mosely controls that relied on dedicated lines between the studio and transmitter. In the late 1980s, the dial up remote control took the field by storm. Names such as Gentner, Sine Systems, Burk and others were all leaders in the field. Today, some of those names are still big in the industry, but only because their products have continued to evolve to keep up with the changing demands of today.

One of the big paradigms has been a shift towards network and Internet control.

10+ years ago, when we began design work on our first full-featured remote control, the Sicon-8, networking was incorporated as more of an after-thought than as a main design feature.



For those unfamiliar with the Sicon-8, it is a transmitter/site controller with dial-up and Internet control. There are eight metering inputs and eight status inputs, combined with eight channels of raise & lower relays (16 in total). The metering inputs can measure raw voltages from -12V to +12V and can automatically scale the inputs to the appropriate values. Status inputs are optically isolated. All control is available via telephone, serial/USB connection or Webserver. Every control method may be used simultaneously. Programming is done via the supplied Sicontroller software over a serial/USB connection or by telephone. Almost everything that can be programmed via serial port can also be programmed via telephone.

The configuration settings are saved in the software and also uploaded to the Sicon-8 chassis. If the computer crashes, the user can install the software on a new PC and download the settings from their hardware. The reverse is also true. Settings saved in the software can be used to quickly reprogram a Sicon-8 or program clones.

Every Sicon-8 made in the past 10 years can be upgraded to the latest firmware, so when new features are introduced or a bug is fixed, most users can download the newest firmware from our Website and flash their own firmware upgrade.

Even as more and more transmitters are equipped with internal Webserver, remote controls are still very popular. This is, partly, because most broadcast plants are too complex to be satisfied with whatever interface is built into the transmitter. An external remote control lets you operate multiple devices from one access point, effectively tying the various equipment together into a unified plant. The remote control is the nexus of this integrated system.

Redundancy is also important. The ability of the Sicon-8 to communicate via Internet or telephone lets you maintain control, even if one or the other goes down. Anyone who has ever been stuck trudging up some mountain to manually reset their transmitter will appreciate this aspect. Even when phone lines are not available, the Sicon-8 has proven to work well with many of the cellular home phone adapter boxes. With monthly prices starting at \$15, these adapter boxes are a great

way to add extra connectivity. When an alarm condition occurs, the Sicon-8 will pick up the phone line and call you, or it will text you, or both.

For many people today, networking is the number one priority in a remote control. For the first eight years of the Sicon-8's life, we used a commercial Webserver with limited capability. It became very clear to us that something far more powerful was going to be needed. The result was the development of our own Webserver to replace the old commercial product that we had been using. The new Webserver is far more powerful than its predecessor – in some cases even exceeding the abilities of the main Sicon-8.

One of the most noticeable changes was to the user interface. The old interface was text based, but the new interface is graphical and is designed to mimic the look and feel of the Sicontroller software that we supply with the units. At a glance, users can now easily see if the readings are within the normal range. Information about which alarms are active can also be seen.

Just below is the original Webserver with the new Webserver32 shown below that. Both Webserver are displaying the same information.

Ch #	Name	Value	Status	Control
1	TX-1 Plate Volts	13456. Volts	VSWR Overload	ON
2	TX-1 Plate Amps	4.494 Amps	OKay	OFF
3	TX-1 Power Out	29.61 KiloWatts	Status 2	Raise
4	TX-1 Power Out %	100.8 Percent	Status 3	Lower
5	I/OBC PWR	0.130 Percent	Status 4	Raise
6	Transmitter VSWR	10.08 Watts	Status 5	Lower
7	room temp	74.55 Degrees	Status 6	Raise
8	Stack Temp	0.149 Degrees	Status 8	Lower

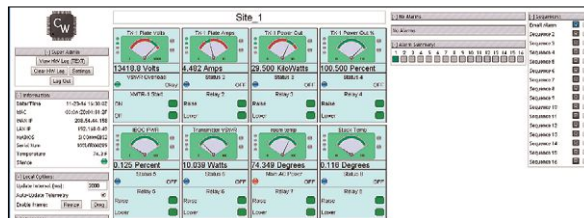

Most users with Internet service want to be able to do at least two main things: First, they need to be able to see their Web interface over the Internet. Pinholes or Port Forwarding are commonly used to get Webserver connected to the Internet. Our on-line technical manuals ([circuitwerkes.com/support.html](http://circuitwerkes.com/support.html)) for Web enabled products describe how to do this. Second is alarm reporting.

### Alarm Reporting:

Once you have your unit visible on-line, the second most frequently asked question is, "how can my unit email or text me if there is trouble?"

In our devices, setup for this is done in three steps. First, we setup our general email settings which include the SMTP server data (A), port number (B) and reply address (C). We also have to enter the email addresses or SMS text addresses of those we want to receive emails (D). See **Figure 1**.

Next, we create an action that will be used to send the emails when triggered. In this example, we take a reading, pause briefly and then send the email. Last, we configure what alarm event is going to trigger the action.

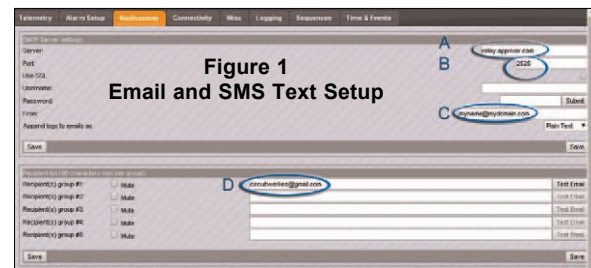

Figure 1  
Email and SMS Text Setup

Sequence #	Sequence Name	Log/Readings	Action #1	Action #2	Action #3	Action #4	Action #5	Action #6
Sequence 1	Dead Alarm	Log/Readings	2	Email Log	3	No Action	0	No Action
Sequence 2	Sequence 2	No Action	0	No Action	0	Emergency Raise Relay	0	No Action
Sequence 3	Sequence 3	No Action	0	No Action	0	Latch Raise Relay	0	No Action
Sequence 4	Sequence 4	No Action	0	No Action	0	Emergency Lower Relay	0	No Action
Sequence 5	Sequence 5	No Action	0	No Action	0	Latch Lower Relay	0	No Action
Sequence 6	Sequence 6	No Action	0	No Action	0	Dead Alarm Event	0	No Action
Sequence 7	Sequence 7	No Action	0	No Action	0	Main Alarm	0	No Action
Sequence 8	Sequence 8	No Action	0	No Action	0	Override Alarm	0	No Action
Sequence 9	Sequence 9	No Action	0	No Action	0	Hide Email Group	0	No Action
Sequence 10	Sequence 10	No Action	0	No Action	0	Override Email Group	0	No Action
Sequence 11	Sequence 11	No Action	0	No Action	0	Log/Readings	0	No Action
Sequence 12	Sequence 12	No Action	0	No Action	0	No Action	0	No Action
Sequence 13	Sequence 13	No Action	0	No Action	0	No Action	0	No Action
Sequence 14	Sequence 14	No Action	0	No Action	0	No Action	0	No Action
Sequence 15	Sequence 15	No Action	0	No Action	0	No Action	0	No Action
Sequence 16	Sequence 16	No Action	0	No Action	0	No Action	0	No Action

We can have many different alarms that trigger the same action sequence. That way, we can have multiple alarms that email or text us.

### Logging:

Most stations keep logs of their transmitter performance. Not only can these be useful in spotting equipment problems, they are invaluable if the FCC ever questions if your station is complying with the rules. Logging can be done on a periodic schedule, like every number of hours, or at specific times of the day. Emailing of logs is similar to emailing alarms, except that we use time to trigger the appropriate sequence rather than an alarm event.

In addition to the hardware log kept on the Sicon-8 hardware, the Sicontroller software has a separate logging utility that keeps its own local log and can even automatically print or email the log for you. If you need to keep a log, then the Sicon-8 can help you.

### Schedules:

The Sicon-8 includes a 128 event main scheduler and a 50 event secondary scheduler. The schedulers get their time from a battery-backed real time clock onboard the Sicon-8, so it will keep time, even if unplugged for days. When connected to the Internet, the Webserver can sync the onboard clock to an NTP server.

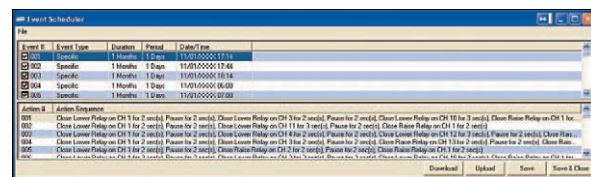

Schedulers are commonly used by AM stations to either change power or antenna patterns. At a minimum, most AM stations need 12 events for morning and 12 events for evening. Many stations need more events for pre-sunrise and critical hours settings. Another useful function of the event scheduler is muting and unmuting tower light alarms. Many stations don't run tower lights during daytime hours, but need to know if the lights are not working at night. By muting that channel's alarm reporting during daytime hours and activating alarm reporting at night, they will know if the lights are not working when they should be working, but won't be bothered when the lights should be off.

Even some FM stations use event schedules. Changing satellite transponder channels and audio feeds at the transmitter are just two examples of things that can be done.

As technology continues to advance, your ability to do more and more things with these new tools can be a great thing. The Sicon-8 is a flexible and upgradeable system with loads of useful features. It's right at home everywhere you need remote facility monitoring and control, from 250W FM translators to 500 kW shortwave stations.

Contact CircuitWerkes at: [www.circuitwerkes.com](http://www.circuitwerkes.com) or phone: 352-335-6555



# Pick a Winner

**THE ASI67XX SERIES** is yet another Notable Solution from AudioScience. With up to 8 stereo balanced analog and AES/EBU inputs and outputs, along with our unique “anything to anywhere” mixing and routing, the ASI67xx series has everything you need in one place. That includes industry required features such as balanced analog and AES/EBU I/O, MRX simultaneous multi-rate mixing, TSX time scaling, a low profile PCIe form factor and GPIO. Windows/Linux drivers and BOB bundling are available. With up to 8 cards in one system, the ASI67xx series cards are the winning numbers for your audio needs. Call us at +1-302-324-5333 or email [salesasi@audioscience.com](mailto:salesasi@audioscience.com) to learn more.



[www.audioscience.com](http://www.audioscience.com)





## Do You Remember?

by Peter Gutmann

In going through a trove of old papers I came across a booklet in which the NAB had reviewed recent changes in broadcast regulation and previewed upcoming trends. It was issued in 1981 – and it provides a fascinating reminder of how much things have changed since then.

First, though, some perspective ... While it seems hard to recall (or, depending on your age, to imagine), 35 years ago was a prehistoric era for personal and business communication. Faxes took 6 minutes per page; home computers had just begun to emerge; mobile cell phones, email and the World Wide Web were still ten years away; and the first smart phone (although rather dumb by modern standards) would not surface for another twenty.

But let's focus on radio. Deregulation was in the air, lofted by a new FCC chairman and three (of seven) new commissioners who had been nominated by the President – *and then routinely confirmed by the Senate (!!!)*. The Commission had just *eliminated*: the requirement to formally ascertain community issues that station programming was to address; the need to prepare and retain detailed program logs; limits on hourly commercial time; requirements to broadcast specified amounts of non-entertainment programming in specific categories (and at renewal time to justify any shortfalls documented in program logs for a composite week); detailed showings of legal and financial qualification for construction permits; assessment of entertainment formats as a basis for evaluating competing applicants; and the need for technical directors to hold first-class licenses. For noncommercial stations it had relaxed severe restrictions on fundraising activities and expanded the information that could be included in donor acknowledgments.

But far more lay immediately ahead. Do you remember?

**Annual Financial Reports** – The dreaded FCC Form 324 was a financial report that broadcast licensees had to file each year. The form required extensive disclosures, including detailed breakouts of revenue from time sales, barter and other sources; expenses in each of 16 technical, programming, selling and administrative categories; and costs and depreciation of land, tower, equipment and other property. In 1980 the FCC had proposed streamlining the form but wound up abolishing it altogether, having concluded that the burden upon licensees did not justify the collection of station-specific data to assess the industry's economic status and that pertinent information could be sought were a specific need to arise.

**EEO Reports** – In August 1981 the Office of Management and Budget disapproved the FCC's EEO reporting form that required submission of a detailed ten-point model program. In the meantime, the Commission continued to require annual reporting by stations having five or more full-time employees of the race, sex and job title of each employee, the race, sex and former and new job titles of all promotions and the recruitment source, race, sex, job title and disposition of each applicant. Renewal processing guidelines required EEO scrutiny of licensees failing to employ minorities or women at a ratio of at least 50% of their workforce availability overall and 25% in upper-four job categories.

**Renewal Audits** – Although the license renewal form had just been reduced to a few certifications that literally fit onto a postcard, 5% of renewal applicants were to undergo

an audit to scrutinize the former degree of programming and technical detail.

**License Renewal Procedure** – Under then-applicable practice, a license renewal applicant faced possible challenges in which its past performance could be weighed against newcomers' paper proposals. Ultimately, the Commission (with Congressional authorization) would adopt a two-tiered approach in which comparison with a challenger's application would be made only after determining that an incumbent had failed to document a favorable record during its past license term.

**Comparative Hearings** – Although the efficacy of the comparative hearing system was under increasing doubt, several more years would be required to eliminate the standards under which competing applicants for new facilities or major changes would be assessed. These encouraged contrived structures that purported to separate equity and control in order to maximize credit for diversification (i.e., having the fewest other significant media interests), integration (voting owners serving as on-site managers) and female or minority status. Ultimately the hearing process would yield for noncommercial stations to a point system lottery and for commercial facilities to auctions in which it was assumed that the highest bidder would best serve the public interest (a cynical approach which, for what little it might be worth, I've never understood).

**Public Letters File** – I had to smirk when I was reminded that in 1981 the FCC had just proposed eliminating the requirement that letters from the public be retained in the local public inspection file for three years. As 2016 draws to a close the FCC is still considering whether to eliminate this last vestige of paper public files.

**Dual-Band Receivers** – Congress was considering legislation to require that all radios be equipped to receive both AM and FM broadcasts, so as to increase use of the still-struggling FM spectrum and to encourage program diversity that presumably would result.

**AM Technology** – A proposal to reduce AM spacing to 9 kHz was rejected by the Region 2 Administrative Radio Conference. The FCC amended its rules to require all AM directional antennas to convert to standard patterns, so as to foster a uniform method (abetted by computers) to develop maximum expected operating values. After reducing interference protection for existing clear channel stations, the FCC granted seven new AM applications and paved the way for up to 125 more, with possible priority for minority and non-commercial applicants. The problem of Cuban interference remained unresolved after the Cuban delegation walked out of a Region 2 conference. While Congress considered extending daylight savings time – which would not occur until 1987 (from six to seven months) and 2007 (to eight) – the Commission took steps to provide AM daytimers with pre-sunrise (and eventually post-sunset) authority to operate with reduced power.

**AM Stereo** – The Kahn system had obtained an early foothold in the marketplace, but after five years of testing the Commission rejected it (along with two others) and selected the Magnavox system as the single AM stereo standard for the US. (Upon reconsideration, the FCC would reverse itself to let all four incompatible standards compete in the marketplace, but the outcome was stymied by consumer confusion and industry disinterest.)

**FM Technology** – Not to be outdone by the prospect of multi-channel AM, and notwithstanding the failure of incompatible home quad systems during the prior decade, the FCC continued to consider the adoption of standards for FM quadrasonic broadcasting. Ultimately that, too, was left to the chaos of a futile marketplace battle and would never rise past an experimental phase.

**Ownership and Trafficking Restrictions** – The crossownership rule barred the common ownership of more than one AM and one FM station in the same community and the FCC was considering further limiting local ownership to a single station. Also under consideration was eliminating the anti-trafficking rule, which required that, absent extenuating circumstances, a broadcast license be held for three years before it could be sold.

**Personal Attacks and Political Editorializing** – The FCC had not yet acted on NAB proposals to eliminate these rules that required notification and an opportunity to respond whenever a station broadcast an attack on the honesty, character, integrity or like personal qualities of an identified person or group, or an endorsement or other editorial view identifiable with a candidate. Ultimately both rules would be eliminated, although not until 2000, even though the Fairness Doctrine on which they were based would be abolished in 1987.

**Reasonable Access** – In July 1981 the Supreme Court issued its Carter-Mondale decision in which it tipped the balance toward entitling federal candidates to insist upon purchasing time in non-regular lengths unless a station could establish a realistic danger of substantial program disruption.

**Reporting Election Returns** – Prompted by concern that early projections of the 1980 Reagan victory had suppressed turnout in Western states and might have affected the outcome of other contests, Congress was considering a number of bills to delay the reporting of election returns until polling places had closed in all states.

**Advertising Content** – Under consideration were numerous proposals that would have regulated (or disallowed tax deductions for) ads for alcoholic beverages, over-the-counter drugs and home insulation, mandated certain nutrition and warranty information, and otherwise impacted broadcast sponsorship.

**Fees** – After a federal appellate court had struck down the FCC's prior fee schedule, Congress didn't advance a further proposal in its 1981 budget. But relief would be only temporary – filing fees (to cover the FCC's allocated costs for processing various applications) would resume in 1985 and would be adjusted biennially for inflation, and annual regulatory fees (to cover the remaining cost of FCC operation) would follow in 1993. Both types of fees were intended to make the FCC self-sustaining, yet further funds soon would be generated through auctions for new commercial facilities.

It all seems so very long ago ...

So what prompted this plunge into nostalgia? Well, I'll be retiring at the end of the year, so this will be the last of my Radio Guide legal columns, which I hope have been helpful, or at least interesting. I'm not sure what lies ahead for me just yet, but if you share my passion for classical music I invite you to explore my website, [classicalnotes.net](http://classicalnotes.net), or to stay in touch at: [peter@classicalnotes.net](mailto:peter@classicalnotes.net). As for radio, I can only hope that it retains its essential values to ensure that it will remain a vital cornerstone of our society.

In any event, I sincerely wish you and yours the very best in whatever the future may hold.

*Peter Gutmann is a partner in the Washington, DC office of the law firm of Womble Carlyle Sandridge & Rice, LLP. He specializes in broadcast regulation and transactions. His email address is: [pgutmann@wcsr.com](mailto:pgutmann@wcsr.com)*



# Skylla Automates Baseball - Flawlessly

- Rain Delays - No Problem!
- Games After Midnight - No Problem!
- Local Games - No Problem!

Whether you need network sports automation with full walkaway, or just a better way to broadcast your local games, we've got you covered.

We were the first company to automate satellite feeds in 1989 ... and today, we still lead the field with the best walkaway automation for sports.

Our unique sublog system allows you to schedule and forget each game ... when the closures fire, the ballgame starts. You can relax and have a hot dog.

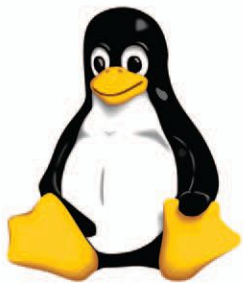

## Automation That Is Bullet Proof

Our Linux operating system was built to do one thing: run your audio. You'll find that Skylla takes you to a whole new level of reliability. You'll get better security. You'll get better support - because we built your system, took a picture of it, and then installed it for you. There will be no surprise operating system updates. Rather, we'll have your back ... 24/7/365. We will solve problems for you.

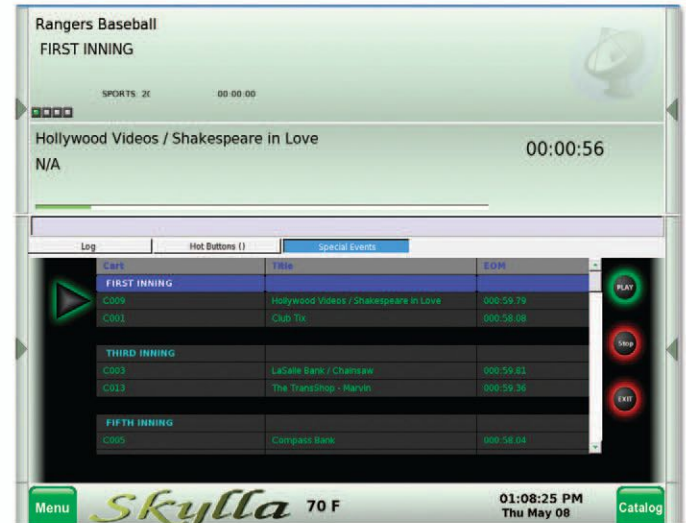

"Making a four-station investment in Skylla was one of the best decisions I've made in 36 years of small market ownership. Our stations sound better, Skylla support is outstanding and I consume a lot less Roloids than before making the change. My only regret is not doing business with Smarts many, many years sooner than I did."

- Roger Utnehmer, Nicolet Broadcasting, Sturgeon Bay, WI



1-800-747-6278

www.SmartsBroadcast.com



## Keeping Stuff Out of Your Transmitters

by Gary Peterson

You can probably guess that I hate cleaning transmitters. Don't you?

All of us experienced engineers can think of many things that can be done with our time, other than removing dust and critters from transmitter cabinets. So, you can understand that I am always on the lookout for tricks to keep stuff out of the transmitters in the first place.

If you dislike spending your maintenance time cleaning dirt and dead bugs out of transmitters, the following tips may help make your life more pleasurable.

### First Line of Defense

To get into your transmitter, "stuff" has to get into your building and then get past the air filters. That means properly sealing doors and all the other openings in the transmitter building is your first line of defense.

If your site is such that you may track in dirt or mud, etc., have a broom handy – or a shop vac, or something – to reduce the supply of materials that can be stirred up and become airborne, ultimately getting to the transmitter.

Of course, not only do you want/need to keep out the dirt, dust, and water, but you want to prevent unwanted guests from taking up residence in the building – or worse, inside the transmitter. Indeed, many engineers have anecdotes about the animals that gave their lives to prevent an *All Bee Gees Weekend* or *Mungo Jerry Hit Marathons*.

The invasions do become more common as the change to the fall and winter seasons tempts the many and diverse local creatures to seek out warmer and more hospitable residences for the winter. Even if they do not get into the transmitter, the squatters do tend to leave annoying reminders of their presence. So, all your efforts to keep them out in the first place will be rewarded with a great reduction in cleaning duty.

### The Insect Barrier

It only takes a small space for critters to enter, so it is probably easiest to build a barrier with insects in mind – and the larger animals will also be blocked.

Carefully check the weather stripping on doors and windows from time to time. Change them when it seems they are not completely filling the space. Appropriate screens should be in place anywhere ventilation openings exist. To close off any entry points where conduits or coax come into the building use those cans of "instant foam." They are great for closing such gaps as well as other openings, like along roof lines, etc.

The use of a good insecticide around the walls and openings will go a long way to reducing the number of critters in the building. I also like to use naphthalene mothballs to discourage both little and some not so little "tenants" from taking up residence.

Unfortunately, no matter what you do, some critters will find a way around it. For whatever reason, up here in South Dakota certain years and/or seasons seem to result in huge infestations of various insect species. In a bad year the "miller" moths can quickly clog a transmitter air filter. They even seem to be able to easily get into what is, for all practical purposes, a tight building.

### A Flying Critter Trap

I actually came up with a "homebrew" solution that seems to work fairly well when the millers get real bad.

What I do is leave a pan of water on the floor, mixing in a bit of liquid dishwashing detergent to it – most any soapy material should work. The only other thing needed is a trouble lamp to clamp to the pan.



The way it works is simple. When the rest of the transmitter room is dark, the moths are attracted to and circle the light attached to the pan.

Eventually, each of the critters will hit the water and the detergent will wet their wings. None of those critters will make it over to clog the air filter on the transmitter.

On my next trip to the transmitter site, all I had to do was dump the water-detergent mix with all the drowned moths and refill it with a fresh mixture. If you try this approach, just make sure that you use enough mixture to last without entirely evaporating before your next visit.

### Helping the Filters Filter

However, no matter what you do, most sites cannot really achieve the "clean room" status that would make transmitter filters unnecessary.

Obviously, the more stuff your air filters catch, the less stuff you will have to deal with inside the transmitter cabinet.

Personally, I like to use disposable fiberglass filters and change them frequently – but do have a conversation with your transmitter's manufacturer to make sure this will not create any problems with the air flow design of the unit.

Furthermore, it is possible to greatly increase the efficiency of your air filters. The trick is to use a good filter spray.



For some time, I have used RP brand "Filter Coat." Filter Coat is available at some hardware stores, and heating/ventilating and air conditioning shops also may carry it.

"Filter Charger" is another product that comes in a aerosol spray can. It can usually be found at Home Depot, Amazon, or similar outlets.

### Tips for Effective Filtering

The application of Filter Coat is quick and easy.

Just take a new air filter outside and lean it up against the perimeter fence. Shake the container well and apply a light coat to both sides of the filter before installing.

Be prepared: you will be amazed at how quickly the filter gets dirty. When I began doing this, I tried spraying the filter on only one of the two transmitters at our site. Within a few weeks the difference was obvious. Take a look:



The filter on the left is shown after three weeks in typical service way up here on the dry, dusty "Plains." The filter on the right is a new filter.

Yes, you will have to change filters more often. But the important part, as you can see from the picture, is that *the dirt does not end up inside the transmitter*, where it adheres to all manner of irregular surfaces and, therefore, is much more difficult to remove.

I would encourage you to try a filter spray yourself. The next time you open up the equipment for maintenance, you will notice the difference, and smile.

These are just a couple of easily implemented ideas. Perhaps you have some other tricks that have worked at your site. If so, please share them with us.

After all, a clean transmitter is a happy transmitter!

*This article was originally published on the Broadcasters' Desktop Resource, [www.theBDR.net](http://www.theBDR.net) in October 2016.*





ARRAKIS SYSTEMS INC.  
ARRAKIS SYSTEMS INC.

# All Arrakis consoles now have AoIP!

For more than 35 years, Arrakis Systems has led the way with ground breaking innovations in Radio. Now with SIMPLE-IP, all Arrakis consoles can be linked with the World Standard DANTE AoIP protocol for less than \$1,000 per studio. Visit our website today !!!

ARC-8  
only \$849



ARC-10  
from \$1,699

ARC-15  
from \$3,799



MARC-15  
from \$5,499



Digilink-Xtreme



## SIMPLE-IP

ACCENT furniture



Digilink-HD



## Caring for KMPX and KPPC

*Burning Herbs, Spinning Cat and Tainted Water Cooler*

by Mike Callaghan (1944-2016)

When I worked for KPPC in the basement of a church in Pasadena, the station was owned by the National Science Network. They had four stations, WNCN in New York City, WDFH in Chicago, the station in Pasadena, and KMPX in San Francisco. The California stations weren't making any money, so we didn't get to spend any.

I got to take care of KPPC and KMPX. KMPX had an engineer on call for emergencies, but the routine stuff? I did that.

In those days Pacific Southwest Airlines had a special flight from Los Angeles to San Francisco. It was called the Midnight Flyer. Basically, it was supposed to carry mail in the cargo hold – so if you flew it, you carried your baggage. But it was cheap. \$10 cash bought you a seat. No checks, no credit cards and no questions asked. You handed the flight attendant \$10 and you got on the plane. You can imagine the type of jet-setter you'd encounter on this thing. The plane had no sooner left the ground, than the cabin would fill with fumes from burning herbs, and it was all you could do to keep from getting loaded just by breathing.

After an hour or so of recreational aromas, the plane would touch down in San Francisco and a Ford Pinto would be waiting for me at Hertz. I detested that car, but it was all we were told we could afford. So I'd throw my toolkit in the passenger seat, and I'd make the trip to Mt. Beacon, where the transmitter was. I'd get there about 2:00 in the morning, and I'd call the studio to sign the station off.

Then I'd open the doors and address the RCA BTF-5B. It was a tired old girl, and I'd blow out the dust and clean everything in that rig that needed to be cleaned. That usually took until about 4:00 o'clock – if there weren't any surprises. Once I was done, I'd call the studio and we'd go back on the air. I'd lock everything up, and climb back in the Pinto for the drive to the manager's apartment. She was Ranny Dean, and she ran the station with a tight fist. I'd get to her apartment about 5:00, and she'd get up and change the sheets on the bed. Then we'd have breakfast and she'd go into the station early while I climbed into the sack. I'd sleep until about noon. Then I'd get up and drive to KMPX for the studio work. That involved changing styli, cleaning the tape decks and cart machines, doing all the usual stuff.



The KMPX studios were in an interesting location. Due to a misunderstanding, the building the station had leased for the studios was above a machine shop, and the noise level was incompatible with radio broadcasting. Because the rent budget had been squandered, the actual broadcasting came from a tenement in the worst part of the city. The air studio was in one bedroom, and the production studio was in another. The business office was in the living room, and there was just one bathroom for everyone.

The building was on the side of a hill, and the parking lot was down the hillside below the apartment. To get in from the parking lot, you'd get out of your car and walk to the end of the block. Then you'd climb up the sidewalk to the street above, and walk back down the block to the front door. This was a royal pain. So someone came up with an idea. They bought a 20 foot extension ladder and propped it between the parking lot and the air studio window. To save the long walk, you'd just climb the ladder to get into the station.

As the staff came to work in the morning, the ladder would see a lot of traffic. The jocks were supposed to keep the monitors down low because we had neighbors, and there was absolutely no sound treatment that worked worth a darn. One notorious neighbor lived upstairs. Mrs. Holmes was an old widow who had no use for anyone else, much less a bunch of hippie radio people coming up and down the ladder at all hours of the day or night. After a few days of our rowdiness, she caught on. She figured out what we were doing, and got an FM radio. If the speakers were too loud, she'd wait until the microphone was open, and start hammering on the floor with a mallet. This was a giant distraction when a jock was trying to be laid back and to set a mellow mood. She had the same floor plan as we did, so swapping the air and production studios wouldn't have helped. We finally ended up doing most of the production with headphones.

KMPX had a mascot. A small black cat named "Baby Huey" had the run of the place and was well known to the staff. A lot of the time, he'd be curled up in a corner of the air studio. But Huey had one aggravating habit. He liked to ride on the turntables. He'd do this without warning. In the middle of a song, there'd be a horrendous screech and the stylus would be knocked off the cut. There'd be a pause, and the mike would open with an apology, and the cut would either resume or start over. We tried keeping the cat out of the studio, but he'd find his way in eventually.

One day someone had an idea for a really stupid stunt. They dumped a goodly dose of LSD in the Sparkletts cooler. I never drank from it; I'm a Diet Coke drinker. Although I wasn't up there when this happened, I certainly heard about it the next time I was. I understood they brought in a bunch of part-timers to try and run things while the regular staff got straightened out.

Finally someone tried to convince Mrs. Holmes that she'd be happier in a different apartment. I think they made her some kind of offer. But she was adamant – she'd lived in the same place for 30 years and had many fond memories of herself and her loving husband in their home, so she wasn't excited about leaving. What she really wanted was for all of us to go away. I saw her point.

That aluminum extension ladder could get pretty noisy if you moved too fast going up or down – and there were people on it all the time.

But I was talking about doing the routine maintenance on the studio equipment. This took me from when I got there from Ranny's apartment, until about the close of business. The station would go on the air from the production room while I went through the air studio. It was a pretty simple arrangement: three turntables, two cart machines, an Ampex 350 for laying down interviews and playing the weekend preachers, and a pair of E/V RE16's. The console was a custom slide pot board we had a twin for in Pasadena. I was pretty proud of it. It was much too nice considering where it was being used.

My last experience at KMPX was when I got a panic call from the emergency engineer. The station was off the air because the antenna had burned up. It had been off for almost a day. He needed me to bring up a spare bay from Pasadena. KPPC was on 106.7, and KMPX was on 106.9 – close enough. I had an old horizontally-polarized bay I could bring. I took it to the Burbank airport and got hassled because PSA didn't know what it was and didn't want it on their airplane. But one of the pilots was a ham, and he intervened and got me on the flight.

I got the antenna element to San Francisco and grabbed the Hertz Pinto for Mt. Beacon. When I got there I could see we were in trouble. There were burned stripes on the rigid transmission line all the way up the tower – no VSWR protection here. The line came horizontally out of the building and made a right angle bend up the tower. So I got the tools and unbolted the line at the flange right above the elbow. This angle was right in the center of the four tower legs. I got the bay I had brought with me out of the Pinto and bolted it to the top of the flange.

Then I went into the building and prayed the transmitter would still run. I didn't see anything obviously wrong when I opened the doors, but the plate breaker had tripped. This was not a good sign. I closed the breaker and warmed up the filaments while I ran the power all the way down. Finally, after the tube had warmed up, I turned on the plates. They chunked on, and I turned the power up just a little bit. I was getting some power to the antenna, but the standing waves were higher than I wanted. Even so, I was able to get a kilowatt out. I called the studio and they were all excited.

They could hear the carrier, and Ranny had started making up for lost time. She was playing every single commercial she'd missed since the station went off. I explained we barely had a signal on the air. She said an affidavit was an affidavit. Who'd know if we were at low power? I didn't want to argue. I mean, she'd be able to make them all good after the antenna was fixed anyway. The station ran on the single mismatched bay for two weeks while a new antenna and feedline were installed. It didn't have any ratings to speak of anyway. Neither did the station in Pasadena. It was time to start looking for something else to do. My next stop was KWST in Los Angeles, and that's yet another story...

*Unfortunately, that story must remain untold.*

*The radio industry is remembering radio engineer Mike Callaghan, who died on Saturday, November 5, 2016, at age 72. Mike was the well known chief engineer for Clear Channel station KIIS-FM in Los Angeles, and he held that position for close to 40 years. Mike had retired in 2013.*

*He has written for Radio Guide since 2006, and his observations and practical information will certainly be missed by all. - Editor*

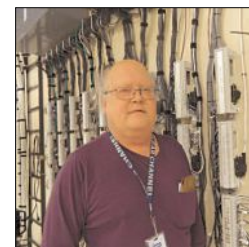



# RF Switch Controller With Smarts

# SWP-200

SCALABLE RF SOLUTIONS FOR PROJECTS OF ANY MAGNITUDE



**DPS-100D  
True RMS  
RF Power Meter**

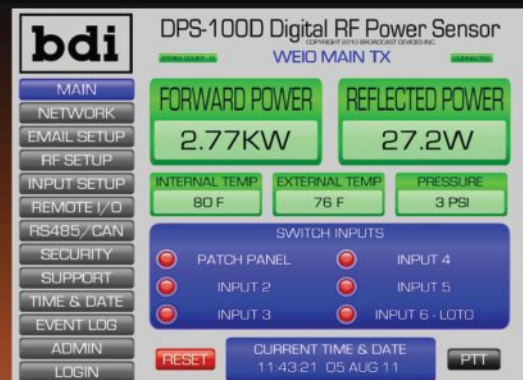

The DPS-100D and SWP-200 are part of a growing number of RF site management products offered by BDI. The DPS-100D true RMS RF power meter offers industry leading features and performance. The built in web server provides remote access and control of all vital parameters. Supports SNMP for remote control along with other popular network protocols. The DPS-100D RF Power Meters can also be daisy chained as part of a simple or complex RF transmission monitoring system using standard CAT 5E STP cables. Put one anywhere you want to monitor RF FWD/REF power. **Need RF switch control?**



**SWP-200  
Intelligent  
RF Switch Controller**



The SWP-200 is a stand alone 1RU RF switch controller which can control any brand of motorized RF switch. In addition the SWP-200 manages transmitter interlocks and simplifies the connection of interlock paths. When installed as a system together with a DPS-100D, the SWP-200 provides complete Hot Switch protection by preventing the movement of a switch if RF is present. The SWP-200 also doubles as a rack mounted RF power display for up to 2 DPS-100D Sensors.

For complete information on these or any of our RF and audio products please contact us  
[www.broadcast-devices.com](http://www.broadcast-devices.com) **Broadcast Devices, Inc.**  
Tel. (914) 737-5032 Fax. (914)736-6916





# Tips From the Field

## Creative Wire Management

by Jim Turvaville

While most Engineers have their plate more than full on any given day, much of those days are spent in fire fighting mode or routine maintenance, rather than doing things that make you go home at night and feel like you've accomplished something worthwhile. We all do this work because we love it – or at least we got into it for that reason – and everyone finds their sense of accomplishment in different ways. One way I always felt like a job was well done was if it *looked* well done. From my early days 35+ years ago, I always felt like something worked better if it looked better – it was a plus if someone else noticed as well. It was a *huge* plus if the one who noticed it was the boss.

So if you're in need of a little bit of a challenge to your gauge of success, then there's nothing like gleaning the ideas from others to help make that challenge manageable. To add to that challenge, I'm going to share some of my wire management experience and tips without the benefit of photos. That gives me the challenge of properly describing my methods in a way that is easy for you to understand. So, here goes.

### Zip Ties

Our world would be incomplete without the nylon zip tie and its variations. Invented in 1958 by Maurcus Logan,

the "Ty-Rap" was specifically for use in aircraft wiring harnesses – and having worked in the aviation industry for a short period of time and using the wax lacing cord myself, I have a unique appreciation for his invention. They have evolved with special variations, from surgical sutures to law enforcement restraint devices, and the slang term "Zip Tie" probably comes from the sound they make when closing rather than the speed at which we tend to go through our stash of them. Our engineering world sees them with identification tags on them and screw mounting holes, among the many variations commercially available.

I have found a few creative ways to use zip ties in my organization which you might find helpful. First, the ties with the screw ring on top are available at your big-box hardware stores in at least one size, and that mounting ring on the top is perfectly sized for using a standard drywall screw for mounting. A bag of ties and a hand full of 1-1/4" drywall screws and you can take the underside of any counter top and make a straight wire chase in a couple of minutes. Just remember to think of how that tail will come up and close in the zip tie, which means you may have to put it through the screw backwards to what may be intuitive. I've also made two parallel chases of these ties under a counter, one for audio cables and one for power cords, just to keep them separate and orga-

nized at the same time. Come to think of it, a third set would let you put KVM cables separated from audio and power as well. Just remember that you should never zip tie CAT cables – certainly not very tightly if you do, as that affects the noise rejection capability of UTP cables and will alter their performance in a gigabit environment.

Secondly, I've gotten over the fear of zip tying a zip tie to a zip tie. That may sound silly, but it did take me 30 years to realize that you can actually do that and the world will not stop turning. I had a situation where the previous engineer was kind enough to use the nice self-adhesive 1" nylon squares made for mounting on a surface and looping a zip tie through, and had even used the proper size screw in the middle for added support. But the bundle I was attaching to those nice squares needed a wider zip tie than would slide through the mounting slots on the square. In a moment of desperation I used a small zip tie on the mounting square parallel to the direction of the bundle and closed it completely, giving me a half-inch wide slot to use for the zip tie around my wire bundle. No, it's not as tight as going directly to the mounting square, but it certainly worked just fine and has lasted for many years in service. I have also learned to use long zip ties and make a double loop around a bundle before closing, which adds a good bit of tightness and grip to the bundle without as much pressure in one place. It has the added benefit of giving you the ability to cut it one time behind the zipper and add to the bundle, and replace it with a single loop of the same recycled tie.

That experience has led to several experimental uses where a 90-degree attachment is needed. For example, you are running a wire bundle through a ceiling chase and crossing perpendicular to the sprinkler system pipe. Just

(Continued on Page 22)

**broadcast your world**

EM 5000 HE DIG PLUS

**FM & TV TRANSMITTERS  
MICROWAVE LINKS  
VERTICAL & CIRCULAR  
POLARIZATION FM ANTENNAS  
TV PANNELS  
STUDIO TO TRANSMITTER LINKS**

EM 1000 HE DIG PLUS

SGP-1 ANTENNA

MP-1 ANTENNA

**OMB**  
BROADCAST

3100 NW 72nd. Ave. Unit 112 - Miami, FL — 33122 USA - [www.omb.com](http://www.omb.com)  
Pol. Ind. Centrovía · C/Paraguay, 6 (La Muela) · 50198 Zaragoza (Spain)



# Work smarter. Anywhere.

*Remote access is here!*  
**Simian Radio Automation  
with iPad, iPhone  
and Windows remote.**



**Call (888) 274-8721**  
(888) BSI-USA-1  
or email us at [sales@bsiusa.com](mailto:sales@bsiusa.com)



### Creative Wire Management

– Continued from Page 20 –

put a zip tie around the pipe, then zip your bundle to that tie and cinch both tight; you'll have a strong connection that will not alter the straight run of the bundle. If you have two solid items crossing at right angles, then just a pair of zip ties placed in opposing directions will secure them without changing their trajectory.

Using zip ties makes it very easy to put the final touches on a wiring project, especially one which will not see much need for rearrangement in the future. I have purchased the "cheap" version of them (usually in the wild colors which tend to identify them as less than industrial rated) and just been satisfied to know that I'd be cutting them off several times before I was done; then replacing them all with the "nice" version as the final touch. And if you do a lot of the finish work with zip ties, then invest in the "zip tie gun" that cinches them to your pre-set level of tension and shears of the end cleanly. You may not want to spend \$200 on a fancy one, but the \$20 one will probably work just as well, but not as long.

#### Velcro

Also a product of the 1950's, the hook and loop fastener was patented in 1955 by a Swiss electrical engineer who got the idea walking his dog in the woods, seeing how the burrs clung to his trousers (and his dog), and just knew that could be turned into something useful. Thank you George de Mestral, my life would be of much less value without your epiphany. He named his invention

Velcro from the French words "velours" which means "velvet" and "crochet" which means "hook." The early cotton version proved impractical and they are now made almost exclusively out of nylon and polyester. While the name Velcro is a patented invention by a specific company, I join the rest of the world in using it as a generic term for a hook and loop fastener.

I discovered the value of Velcro when I started working so much with CAT cables – as the warning is always to avoid zip ties on them in order not to compromise the EMI and RFI rejection designed into UTP by the spacing between the pairs. Then my first full-time IT guy, Kevin, had a long-running but good natured rivalry between him and his Velcro, and me and my zip ties. I'm not sure I ever converted him to appreciate zip ties, but he sure did convert me to appreciate Velcro. I now carry no less than 3 or 4 rolls of it at all times, especially since discovering the 3/4" by 35 foot roll of it, available at my local Harbor Freight store for under \$10.

Using Velcro is not unlike zip ties, though I find it more difficult to make the final finished product as neat and orderly with the hook and loop fastener product. I have combined then by using the 1-inch squares attached to a smooth surface and zip tying a piece of Velcro to it for bundling cables. Because it comes on a roll, the length needed can be customized easily, as long as one also has a nice pair of scissors to go with your tool kit. I happen to favor the "wire scissors" with the little notches on the side for stripping small gauge wire (a staple of Telco workers for decades) which are commonly available at your big-box hardware stores for about \$15. They also are excellent for cutting and trimming Velcro for various uses.

Custom uses of Velcro include cutting that 3/4" wide roll in half and getting twice the length, as the 3/8" size is useful for most applications of wire bundles up to a couple

inches in diameter. You can also stretch the more narrow size a bit tighter than the wide, but it will naturally have a bit less strength because of it. I have also been guilty of crisscrossing Velcro around a small item in order to create effective mounting or attachment designs. For example, one of the small multi-compartment plastic boxes (about 6"x10") that carries a selection of resistors, small connectors, screws, etc. in my tool box, has one horizontal and two vertical Velcro bands around it to keep from spilling its contents in my travels. The nature of the Velcro holding onto itself at right angles means none of the bands slip off the box, but easily come open for access to the contents.

Taking the effort to put the final touches on a project with zip ties or Velcro may not make it function any better, but by looking a bit more sharp others may think it will – and that may be all that matters.

*Jim "Turbo" Turville is semi-retired from 38 years in full-time Radio Engineering and lives in Rural Wheeler County Texas in a "tiny house" where he maintains a small clientele of stations under his Turbo Technical Services (www.jimturbo.net) operation providing FCC application preparation and field work.*



COAXIAL DYNAMICS has been a leading manufacturer of precision equipment for the measurement and termination of RF Power since 1969. Our equipment is used by engineers in a wide variety of applications throughout the world.

Our products include:

- Directional Wattmeters for both Analog & Digital applications from 1 W to 100 kW and from 2 MHz to 2.3 GHz.
- Wattchman RF Monitor/Alarm Systems.
- Line Sections & Plug-In Elements.
- RF Loads - Dry, Oil, Water, and Air designs up to 200 kW.
- Low Pass Filters & Power Sensors.

6800 Lake Abram Drive, Middleburg Hts., Ohio 44130, USA  
440-243-1100 • Toll Free: 1-800-COAXIAL • Fax: 440-243-1101  
E-Mail: sales@coaxial.com • Web Site: www.coaxial.com

- **Broadcast Equipment** •  
Wattchman - High Power Wattmeters - Elements
- **Line Sections & Meters** •
- **Termination Loads** •  
Dry - Oil - Water - Air





# From analog FM to best-in-class HD Radio on your schedule and budget

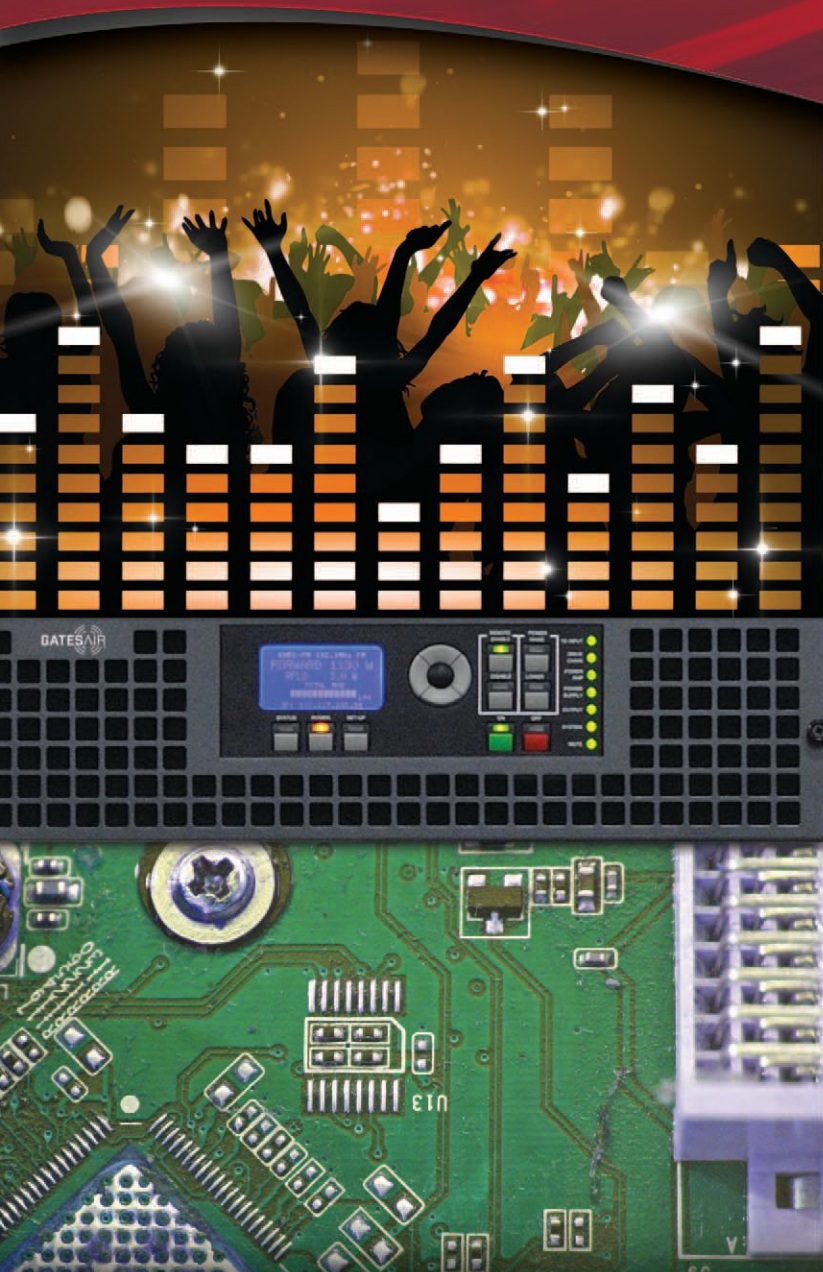

Transition to superior digital with exceptional ease and affordability

## Flexiva™ Gen4 Engine HD Radio Solution

- High-efficiency transmitters with industry-leading performance, compliance
- End-to-end management for multichannel program transport and delivery
- Industry's most advanced quality and diagnostics with robust Flexiva excitors



CREATE



TRANSPORT



TRANSMIT  
TELEVISION



TRANSMIT  
RADIO



Connecting What's Next

[www.gatesair.com](http://www.gatesair.com)

Since 1922, GatesAir has remained the industry's most trusted supplier for the over-the-air TV and radio networks worldwide. World-class engineering and industry-leading innovation marry outstanding performance with the industry's highest reliability and operational efficiency. Our impeccable sales and service bring it all together for our valued customers.







## This Finger Controls Your Revenue. What's It Gonna Choose?

This finger has Irritable Tuner-Button Syndrome. It's caused by sound from outdated audio processors.

Advanced new technology for sculpting powerful, persuasive sound. Integrated processing tools – Mastering Limiters, Intelligent AGC, AirAura Spectral Control, Vorsis Bass Tools, Multipath Control, and of course Baseband 192 for the all-digital processor to transmitter chain at near zero latency. These tools share data interactively, constantly optimizing your settings for consistency, track after track.



### FM-55/AM-55/FM-25

Superior processors that bring startlingly loud and clean sound to new price points.



### AirAura X1

Extraordinary touchscreen processor features and super fine resolution audio.



### Aura8-IP

BLADE-3 that gives you eight stereo channels of killer audio processing anywhere on your network.

Wheatstone processors come with presets crafted by our own processing gurus. Our beautifully engineered GUIs give you amazing control. Upgrade to Wheatstone. Keep your listeners tuned in and your management smiling.

Learn more: [wheatstone.com/processors](http://wheatstone.com/processors)







## Solid Precision... Raw Metal to Heavy Metal

(or pop, jazz, classical, hip-hop, AOR, CHR, top 40, oldies, talk, etc)

Ultra-precise metalwork and fabrication using lightspeed-class materials and techniques. Advanced surface-mount technology for flawless circuitry. Meticulously assembled by people who've made their careers crafting these consoles for years. From concept to delivery, each Audioarts AIR Series console is a Wheatstone thoroughbred, designed and built to be the centerpiece of your studio.



### AIR-1 USB

Compact 8-channel powerhouse, 2 mics/6 Lines.  
Great for small stations and remotes.



### AIR-4

Remarkable 12-channel console, A/B, & Mix Minus.  
Major market features at a small market price.



### AIR-5

Phenomenal 16-channel console, built for studios that have a lot of inputs. Sometimes you need a fader for everything.

Super Quiet mic preamps, built-in USB, hybrid-ready phone input channels, talkback, and much more.  
Perfect for any professional broadcast studios, remotes, LPFMs, podcasters, and streamers.

### AIR Series Consoles: Hardcore Pro From Start to Finish

Learn more at [audioarts.com/air](http://audioarts.com/air)





# Emergency Prep

## Do You Have a Safety Net?

by Steve Callahan

A very wise man once told me that a radio station with only one transmitter is like a high wire artist working without a net. It's just a matter of time until you have a real big problem.

I like back-ups. I have four operating transmitters at my radio station and I have three STL paths. There are very few components of my radio station that I don't have two or three of. Take a look around your station and see how many backup systems you have or, more importantly, where you *don't* have a backup.

### Let's Start at the Transmitter Site

If you have a transmitter that is fairly new you probably bought it with the promise and intent that it was unlikely to fail anytime in the near future. I once worked for a 10 kW AM station that had a brand new solid state transmitter with ten power modules. If one of the power amp modules failed then the output would only go down by a factor of 10%. That certainly sounds like a good idea – however, there is one small switching power supply that operates the control circuitry of this transmitter, and if it fails you are just plain out of luck. I've had to eventually replace that power supply in every one of that manufacturer's transmitter that

I've maintained. Every time I see one, I immediately tell the station owner to get a new power supply and keep it handy. This is a \$125 part that's most certainly a good thing to have on the shelf as a backup.

Take a look around your transmitter site. Is there an older transmitter that once worked day in and day out but now just won't start? If it's from a manufacturer that's no longer in business, or a model that's no longer factory supported, how about getting a smaller, state of the art backup?

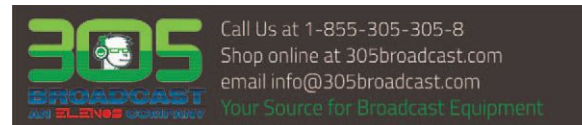

Tony Gervasi of **305 Broadcast** in Miami recently told me a story of a station in Florida that had the misfortune of being in the path of a hurricane. They had only one transmitter and it had suffered some storm damage and wouldn't start. After three days of being off-the-air, and trying to get the main transmitter operating again, this high-billing station's engineer was more than exhausted – so he called Tony and it took just two hours for Tony to get a lower power

backup transmitter to the site and he helped the frustrated engineer get a signal back on the air. Aren't backups a great thing?

Does that non-operational transmitter in the corner of your transmitter building have an exciter? With the right transmission line adaptors and a patch panel, or even a coaxial switch, you can have a usable backup to get something on the air. It's true that even 50 Watts is better than no Watts and you'll be surprised at how well even 50 Watts does to cover your city of license.

I once built a new FM station with a used four-bay antenna. I only needed three bays, so the fourth bay was a bonus. The transmitter was several miles away on a mountain at the end of a long power line, but the studio was located on the top floor of the tallest building right in the downtown area of the city of license. I mounted the single bay antenna on a pipe on the roof and ran the half-inch coax down one story to the on-air studio.

There I put a 50 Watt exciter in the rack and set it up, so all they had to do was flip one switch to turn on their "backup" transmitter in case they lost power at their normal transmitter. My thinking was, if they lost power to the mountain top, but had power at the studio, why not put the backup at the studio? The extra special bonus to this is they now had a backup exciter for their main transmitter just in case they ever needed one. Over the years that studio-based backup was used several times during bad weather and related power outages and most recently the studio exciter was pressed into service at the mountain.

(Continued on Page 28)



Radio Systems, Inc.  
601 Heron Drive  
Logan Township, NJ 08085  
(856) 467-8000 phone  
(856) 467-3044 fax  
www.studiohub.com

## IMAGINE Plug and Play ANY Studio Device\* with StudioHub+

StudioHub+ is the Pre-Wired, CAT-5, Adapting, MatchJacked, RJ-45, Dongled, Analog AND Digital, Console Harness, Tie-Line, Talent-Panel, Pre-Powered, Shielded, Plug-and-Play

### WIRING SOLUTION!

Use it to save time and money on your next studio installation.

\*More and more of the best broadcast manufacturers now feature StudioHub+ inside, so you can plug-and-play your next installation.





IT'S

# INO mini MANIA

\*SMALL IN SIZE, BUT PACKED WITH  
**MONITORING MUSCLE**



FILLING YOUR RACK WITH GREAT  
RADIO EQUIPMENT SINCE 1972



Customize your RackPack!

MODEL 703 LIST PRICE: \$590



RDS Encoder

MODEL 223 LIST PRICE: \$990



Multimode Audio Processor

MODEL 636 LIST PRICE: \$750



NOAA Weather Receiver

## SiteStreamer™ GALORE! Web-Enabled Monitors

MODEL 637 LIST PRICE: \$750



AM Remote Monitor

MODEL 635 LIST PRICE: \$850



FM/RDS Remote Monitor

MODEL 638 LIST PRICE: \$950



HD/FM/RDS Remote Monitor

MODEL 639 LIST PRICE: \$920



FM/HD Confidence Monitor

MODEL 634 LIST PRICE: \$750



AM Confidence Monitor

MODEL 633 LIST PRICE: \$790



FM/RDS Confidence Monitor

MODEL 514 LIST PRICE: \$590



FM Multiplex Decoder

MODEL 300 LIST PRICE: \$790



AES Distribution Amp Plus!

MODEL 402 LIST PRICE: \$750



RDS Sign Driver



## MONITOR YOUR INTERNET RADIO STREAMS

MODEL 610 LIST PRICE \$990  
INTERNET RADIO MONITOR

RACKPACK BUNDLE (TWO 610's)  
**SAVE \$135**



RACK 'EM UP  
**SAVE MORE!**

Choose from a wide variety of INOmini's and create your own RackPack monitoring solution!

Three INOminis fit in the optional 1U 19" Rack Shelf. Special pricing varies with models selected.

**WOW**  
SUPER VALUE

CONTACT YOUR PREFERRED INOVONICS DEALER FOR A

**SUPER VALUE OFFER!**

sales@inovonicsbroadcast.com  
www.inovonicsbroadcast.com  
831-458-0552



## Emergency Prep

– Continued from Page 26 –

### How's Your STL?

If it's a microwave link, something as simple as water in a connector can ruin your day and silence your station. Your old RPU gear that you used for remotes way back when, can be used for a limited time each year as a backup STL if it's needed in the event of an STL failure. I'll bet that the receive antenna is still on your main tower. With a yagi antenna at your studio pointed toward the receive antenna, you've got a viable emergency STL backup system.

If you're lucky enough to still have a copper phone line at your transmitter site, how about pressing that old POTS codec, you used to take to remotes, into backup STL duty? Put one end at the studio and the other end at the transmitter site and you have a very respectable way to keep your station on the air in the event of an STL failure.

I used to think that alternate transmitter sites were a costly investment but over the years I have tried to prove that wrong. I once worked with another local station's engineer to develop a proposal to mount a small frequency agile backup transmitter and a one-bay antenna on the top of a downtown building and share the cost. If either of our stations lost our main site, we could get back on the air from our shared backup site. Of course, it would be "first come, first served" but unfortunately that proposal never got very far until years later a third station revived the idea and built at that same location.

A couple of months ago I got a request from a station to install a modest studio in their transmitter room. This is normally not such a good idea but if your main, and only, studio has a catastrophic failure, then a small backup studio anywhere in the building will save the day and the billing. They used some surplus equipment and that helped to keep the costs low.

I've recently been toying with utilizing a transmitter originally designed for Part 15 use as a backup transmitter for an AM station. If you're unfamiliar with Part 15 of the FCC rules, it covers low power transmitters like garage door openers and baby monitors.

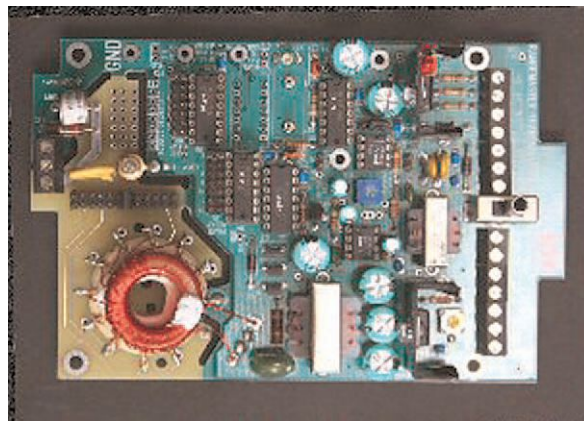

Hamilton Rangemaster Model AM100PR

The **Hamilton Rangemaster** Model AM100PR ([am1000rangemaster.com](http://am1000rangemaster.com)) and the **Radio Systems** TR-6000 ([www.radiosystems.com/lowpower.html](http://www.radiosystems.com/lowpower.html)) are FCC type accepted Part 15 AM radiators. They are small cigar-box sized transmitters with a whip antenna mounted on top of the box. My thought is if a studio

was right in the center of town, this possibly might help you serve your city of license if you have a catastrophic failure at your main tower.



Radio Systems TR-6000

However, you have to read the FCC rules, specifically Section 15.219, very carefully. Paragraph "A" specifies that the total input power to the final radio frequency stage ... shall not exceed 100 milliwatts – yes, that's milliwatts! Paragraph "B" specifies that the total length of the transmission line and ground lead (from the transmitter box to a ground rod) shall not exceed three meters. Now don't go out and tell the FCC that I told you it was OK, as this possible backup is still a work in progress.

*Steve Callahan, CBRE, AMD, is the owner of WVBF, Middleboro, Mass. Email at: [wvbf1530@yahoo.com](mailto:wvbf1530@yahoo.com)*



**Broadcasters' Desktop Resource**  
... edited by Barry Mishkind - the Eclectic Engineer

**Sign Up For the One-Time-a-Week  
BDR Newsletter at:**  
<http://lists.theBDR.net/mailman/listinfo/bdr>

## Why Not Switch to

Toll Free: 800-545-0608



## Complete FM / TV Product Line



### Coax switches from 7/8" through 6-1/8"

- Antennas
- Splitters
- Notch Filters
- Harmonic Filters
- Power combiners
- Channel combiners
- N +1 Switching Matrix

Control panels available.

A subsidiary of **MEGA** RF Solutions

Toll Free: 800-545-0608 | <http://www.mcibroadcast.com/>



# M4.2 TIME LOCK™



**Your Most  
Cost Effective  
Time Alignment  
Option!**

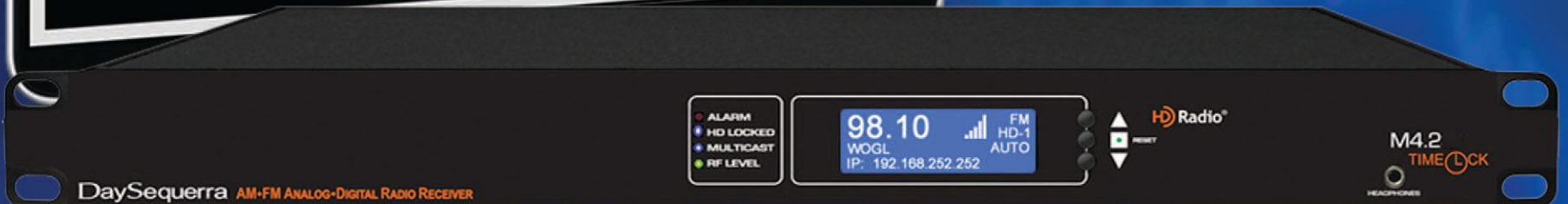

**List Price: \$1800**

- ✓ Reports **HD Radio®** Analog/Digital Time Alignment Problems
- ✓ Remotely Monitor and Log Diversity Delay
- ✓ Now Streams TimeLock™ Correction Vectors to your Orban, Omnia and Wheatstone Audio Processors, along with GatesAir HDE-200 and Nautel Exciters

**Want a single box Correction? Check out our M4DDC TimeLock.**

**DaySequerra**  
www.daysequerra.com



# Transmitter Site

## The Case of the Door-Controlled Transmitter

by Rolin Lintag

One morning, after working six hours since 10:00 p.m. of the previous night, I thought it was just another night of preventive maintenance at the transmitter site. I was alone on top of the mountain one cold Arkansas winter night, and was ready to go home. So I pulled the door behind me and was about to pull out my key to lock the door when I heard the audio of our broadcast go silent.

Hmm ... what was going on?

So I opened the door again and the transmitter started to come back up. Everything was green and no alarm LED had latched.

OK, it was 4:00 a.m. in the morning. I was tired, and I just wanted to go home *now*. It had better not be any HV issues.

I'm sure most of you guys can relate to this, which happens more often than we want to admit. But it was an issue that could take the station off the air. I might have gotten called out again that morning in the middle of my sleep, so I decided to tackle it right away, and get a good morning's sleep later on. So I did what most of you will also do.

### Try to Replicate the Problem

After finding no clues on the transmitter that went back on the air just fine, I stepped out of the building and slowly closed the door. The transmitter remained ON.

OK, it looked like the transmitter just wanted me to slowly close the door, right? Not really.

So I closed the door the way I used to, and there it went – “clunk.” The transmitter went off air as if someone inside had opened the HV cabinet door.

Hey, I was too tired to play games now so whoever was playing pranks on me ... it was not funny!”

No, I did not say that, but I actually wanted to kick the door and let off some steam – but being the boring engineer that I am, I had to channel my steam where it could turn some gears to work and get me out of this place soon.

### Find the Possible Cause

So it looked like there was some interlock that was being opened. It was the most probable hypothesis I could come up with for the effect I had observed. The action of the door closing was mechanical, which took out the electrical life of the transmitter somehow. The next question to be answered was, “Which interlock was being bothered by the action of closing the door?”

So I started pushing the transmitter HV cabinet doors to see if it turned the transmitter off ... no, not these ones.

### Don't Leave Any Stones Un-Turned

OK, how about the interlock on the dummy load which is actually a micro-switch at the coax panel.

Just how was the building door related to that micro-switch? But I had to rule that one out as well, even just so I could tell myself I checked that, too.

Not that one. Perhaps I needed more clues?

Actually, I had more clues that would come up, if I only asked the right questions.

### What Changed Recently, That Could Have Caused This?

The last time I was at this site, I was bothered by hundreds of lady bugs conglomerating on the walls. Prior to that, some yellow jackets had made their way inside the building too, which was not good. Having been bitten three times by yellow jackets, I was not gonna let them score against me again.

Last time, I plugged all the openings to the building. There were some HVAC units that were removed when we changed from a split system to one wall mounted Bard unit. So I had plugged all the conduit openings where these wasps and lady bugs go through to get inside the building. I had to make sure that snakes did not get through as well, so it was a must do task. Winter has a way of inviting unwelcome guests into the building.

So the building was now off-limits to insects but was air tight as well. I did notice there was more resistance to closing the door, other than the usual positive air pressure.

Could it be that closing the building door could actually force some air into places where it could cause the transmitter to go off air?

### Think Outside the Building Too!

There was another interlock that I would *not* have lined up as a suspect, if I had not had more clues.

(Continued on Page 32)



**Not to brag, but  
our story is *fascinating*.**

Founded in 1971 as **Crouse-Kimzey Company**, our history actually dates back to the 1930s in the earliest days of radio. Our co-founder's father engineered the very first of more than 30 state networks now operating in the United States. Following in his father's footsteps, and after building a cable TV system and 2 successful radio stations, John Paul Kimzey went on to co-found the equipment sales company known today as **ProAudio.com**. Over the last 45 years, we have grown to be direct dealers for over 400 professional audio, video, lighting, broadcast and telco brands.

**Crouse-Kimzey**  
COMPANY

New look. Same smart solutions.  
[proaudio.com/history](http://proaudio.com/history)

Call us toll-free at (888) 810-8694

**PROAUDIO**  
smart sound solutions





# BROADCASTERS GENERAL STORE

*Serving the Broadcast Industry since 1979*

BGS's goal is to provide you with the best service possible, coordinating orders from over 400 manufacturers. Please give us a call @ **352-622-7700** or visit us at **www.bgs.cc**



**For Challenging Reception Scenarios**



## AARON 650 FM REBROADCAST / TRANSLATOR RECEIVER

- Unique Software Defined Radio (SDR) front-end
- Unparalleled sensitivity, selectivity, and RF shielding
- Total control over bandwidth blend & multi-path mitigation with Manual Reception Processing
- Built-in Band Scanner™ and MPX, FFT
- No Dead Air—audio failover to SD Card or Web Stream
- Dynamic Web Interface for remote control & monitoring

## Satellite Made Easy



**GPI-16 Plus/RJ** General Purpose Input Module  
The GPI-16 Plus/RJ provides a simple way to interface your satellite receiver's relay outputs to your automation system by converting contact closures into USB/RS-232 Serial data.

**COA-37 XDS/RJ** Connect-O-Adapter  
The Connect O' Adapter 37 XDS/RJ converts your satellite receiver's male DB-37 relay connector to four RJ45 connectors that can be easily connected to the GPI-16 Plus/RJ or a punch block using Cat5 cables.

**BROADCAST<sup>®</sup>  
tools**

**PROBLEM SOLVED**  
[www.broadcasttools.com](http://www.broadcasttools.com)

Designed, Assembled, and Tested in Washington State, USA.

## Industry Leaders in Design and Integration

We provide the highest quality in studio design and integration.  
Custom furniture • Full integration services • RF services



**GRAHAM STUDIOS**

Broadcast Furniture  
(866) 481-6696 • [graham-studios.com](http://graham-studios.com)



Broadcast Engineering  
(304) 416-3269 • [xenirad.com](http://xenirad.com)

**SECOND OPINION COMMUNICATIONS, INC.**  
(815) 222-3556 • [secondopinioncomm.com](http://secondopinioncomm.com)

## Get the story from the palm of your hand

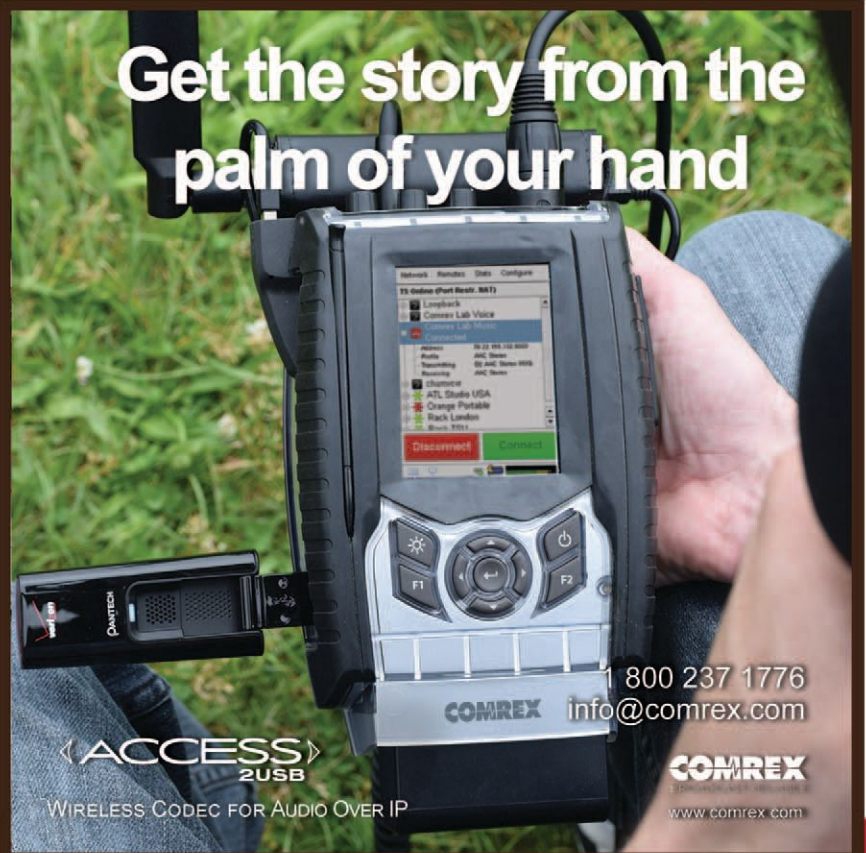

800 237 1776  
[info@comrex.com](mailto:info@comrex.com)

**ACCESS 2USB**  
WIRELESS CODEC FOR AUDIO OVER IP

**COMREX**  
[www.comrex.com](http://www.comrex.com)





### Door-Controlled Transmitter

– Continued from Page 30 –

This transmitter uses a Beam transformer to produce the 25kV needed by the tube power amplifier. The transformer is immersed in oil and encased in a tank outside the building. Part of that Beam transformer case is a cabinet where the filter capacitor is located together with control connections for the Beam transformer cabinet door interlock.

This must be the culprit interlock. It was outside the building, but it might as well have been the one causing this symptom since it fit the MO (Modus Operandi). Besides, it may have been the only one I had not checked yet.

So I went outside the building, opened the cabinet door and checked the terminal strip where the door interlock was connected to. The micro-switch worked correctly, according to the DMM I was using, so the next logical thing to do was to tighten all the connections on the terminal strip. The connection for the interlock was a bit loose – not much, but just a wee bit loose. I don't remember having ever tightened these connections, so I made sure my flat screwdriver tightened them enough to make a solid connection. Well, I replaced the spade lugs as well, just to make sure they were snug and fit properly on the terminal strip. It was tempted to just use the old lugs but doing it right, saves more troubleshooting time later on. Besides, we still needed to get the job done right even at 5:00 a.m., right?

So I closed the cabinet door and walked my way back inside the building to warm my hands.

I was just thinking – could it be that those terminals can get loose after all of those warm and cold weather cycles, year in and year out? Must be.

I felt like I had taken a shot of espresso – that kept me going now.

#### See If It Checks Out Right

Moment of truth: let's see if this transmitter is still the "door-controlled" type.

While the transmitter was ON, I tried to close the building door in different ways, from "being careful not to wake the baby-up" to having a "dialog with my parents as a teenager" (make the door shout, huh).

The transmitter did not flinch. Looked like progress to me!

So I turned all the lights out, headed out of the door and closed it one last time. I hopped into my pick-up truck, closed the gate and drove my way down the mountain.

#### Lesson Learned

I needed to stay awake while driving in the middle of nowhere, so unless I hit a deer crossing the road, I went back to the question, "what really happened back there?"

**Figure 1** shows the simplified air flow inside the building, including the metal conduit and the beam transformer cabinet at the back of the building. This is the simplified block diagram I came up with in order to see what was going on.

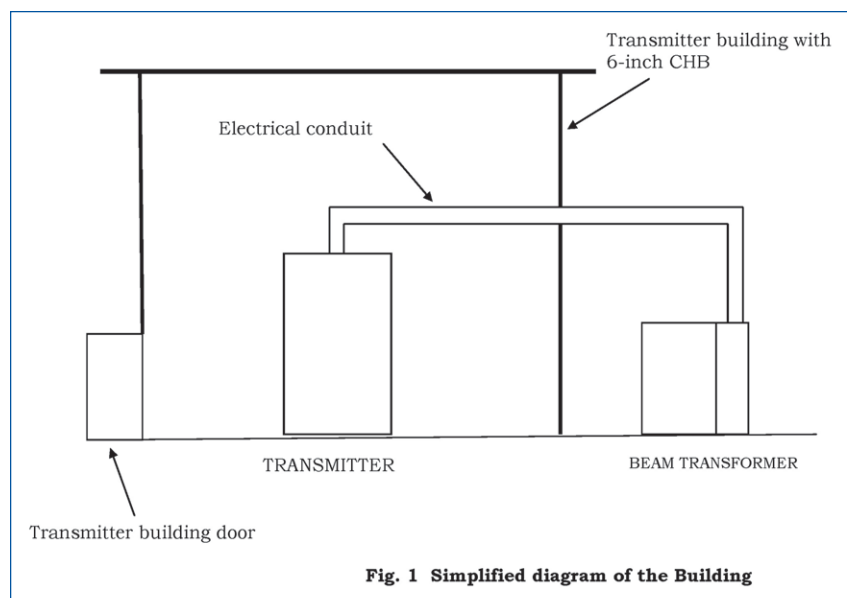

Fig. 1 Simplified diagram of the Building

Recalling my Physics, the conduit acted like a Venturi tube. The air was pushed from the inside of the building through the smaller conduit tube when the door was closed fast enough. Since the Beam transformer cabinet was also closed, and its door was lined on the edges with rubber grommet for weatherproofing, the sudden air pressure pumped into that cabinet caused the not-so-tight connection on the terminal strip to momentarily open the HV interlock system, thereby causing the transmitter to trip off. Now that makes more sense to me than someone playing a prank on me.

"What a beautiful sunrise!" as I get ready to get breakfast before bed.

*Rolin Lintag is Asst. Chief Engineer for KRON 4 in San Francisco, California*

**More than JUST a SIGN**

103.7 KISS FM ON AIR

JAYS GoVideo! In Prog

1010 WINS ALL NEWS ALL THE ON A

A+E NETWORKS ON AIR

RECORDER

AIR-2

ON AIR

44220

**CUSTOM  
COLOR  
FONT  
LOGO  
LETTERING  
DESIGN**

**TITUS  
TECHNOLOGICAL  
LABORATORIES**

[WWW.TITUSLABS.COM](http://WWW.TITUSLABS.COM)



# Sicon-8 Internet & Voice Remote Control



## The CircuitWerkes Sicon-8 Remote Monitor & Control

- Uses Dial-up, Internet Web server or free Sicontroller Software!
- 8 channels of metering, status and control (expandable to 32) and up to 5 alarms per channel.
- No accessories necessary to control your site right out of the box.
- Auto-ranging, auto-calibrating meters make setup a snap.
- Includes: Function scheduler, auto-logging & alarm reporting.



## Internal Web Server



## Free Sicontroller Software

The Sicon-8 lets you control your site via Internet with its internal Web server, via telephone, auto-answering cell phone or with our free software. Setup is a breeze using the Sicontroller software that also includes scripting, e-mail alerts, multi-site management, virtual metering & much more!

# Web-Based Remote Controls w/Streaming Audio Option

Introducing the SiteSentry4 (4 channel remote control), SiteSentry2 (2 channel remote control) & WAM-2 audio monitor

- Web enabled remote controls with 6 relay outputs & 2 status inputs on all units.
- All units detect Stereo or Dual Mono Silence (Independantly adjustable channels).
- User-programmed relays (DPDT) close automatically or via Web control
- All products include onboard temperature sensor
- Internal logging with onboard e-mailing.
- Supports DDNS services and Netbios names
- Upgradable firmware. Keep your product current with downloadable updates!
- Streaming audio option encodes Ogg-Vorbis & decodes mp3 or Ogg-Vorbis.

### SiteSentry4



### SiteSentry2



### WAM-2

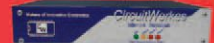

# Remote Broadcasting Solutions

Discover more online at [www.circuitwerkes.com](http://www.circuitwerkes.com)



## MicTel Mic/Line to Telephone Interface

- Outputs & Inputs for telephone handset, cellular phone or balanced line level at up to +10dBm.
- Operates up to 36+ hours on two 9V alkaline batteries.
- High quality, user-switchable, internal limiter prevents clipping.
- External power input with silent, auto-switching battery backup.
- Individual gain controls for send, receive & headphones levels.



## Unattended Dial-Up Broadcasts with the DR-10

- The DR-10 is a Dial-Up remote control with balanced, telephone audio input & output that can control many automation systems or your audio console for unattended remote broadcasts.
- Our Silencer™ option removes control tones from the audio path.
- Use the DPDT relays to insert the phone audio directly into the program path when necessary, especially for emergencies.



## TelTap Pocket-Sized Manual Telephone Coupler

- Can be used as a phone tap or a passive manual telephone coupler.
- Send or receive telephone audio.
- Compact size & low cost makes the TelTap a great addition to your remote kit for main or backup capabilities.

# Lots More CircuitWerkes Problem Solvers

- Transcon-16 - Move up to 16 contact closures from room to room over an audio cable
- DT-232 - Turns DTMF sequences into user-programmed serial outputs & action steps.
- FSK Encoders, decoders, tranceivers and contact-to-FSK encoders/decoders.
- SUB-03 Subaudible tone decoder and SEN-6 Subaudible encoder.
- HC-3 telephone autocoupler and AC-12 rack of autocouplers
- DTMF-16 and DS-8 DTMF tone decoders.

Find Full product info & downloadable manuals online at [www.circuitwerkes.com](http://www.circuitwerkes.com). 352-335-6555



## Old Ain't Bad (Part 1) Rebuilding a Simpson 260 Meter

by Tommy Gray – CPBE CBNE

For those of us who have been around the block a few times, what I am about to mention is something that is no doubt very familiar. These days everyone relies on some kind of nice digital multimeter that is auto-ranging, etc., for electronics measurements. The common multi-meter usually known as a VOM (Volt-Ohm-Milliamp meter) has capabilities to measure AC and DC voltage, Current, and Resistance. Others, usually called an LCR meter (standing for inductance-L, Capacitance-C, and resistance-R), measure things like the inductance of a coil, choke, etc, as well as capacitance, etc.

I personally do a lot of RF work, usually on AM and FM transmitters. Working with a lot of older and even vintage transmitters sometimes is better done with vintage test equipment. The one piece of equipment I am going to talk about for the next few issues, is a very common VOM called the Simpson 260. This meter has been for years the mainstay of many an engineer's tool kit. They can measure just about anything in an older transmitter from rectifier stacks (checking for shorted or open rectifiers, or stacks) to even measuring audio levels with the dB scale found in the old Simpsons. I keep one or more of these little jewels around the shop and usually in the car for use in transmitters. They are not seen very much these days, but you can easily find units that range from quality units, to those that

are only good for spare parts, to some really great ones that require very little but a fresh set of batteries.

The last time I was looking for a "new" Simpson, I found tons of them available on Ebay™ for just a few bucks. The great thing about them is that they are easily maintained and calibrated. Full schematics for them are available several places on the Internet, totally free. Having rebuilt and recalibrated numerous Simpsons, I want to share a few tips that will help you to come up with a good working unit without a lot of cash outlay, and without a lot of work. Once you have your unit refurbished, you can use it the next time you want to check a rectifier stack, or just about anything else. I would *not* recommend using it to make on-board measurements on circuit boards, for the most part, as these usually require good high-impedance meter to prevent loading the circuit.

The unit pictured here is the latest one I am in the process of rebuilding to complement another technical vehicle's tool array. I got this one for \$30 off EBay in "sort-of" working fashion. Now I usually try to avoid units that have circuit board damage as they might be a lot more trouble to resurrect.

This particular meter is a "Series 5." I personally prefer a Series 5 or later. There are a few differences I don't care to elaborate on, but just get a 5 or higher and you should be good.

### Where to Start

When you get your new meter the first thing to do is to open it up and remove any old batteries. The biggest point of failure with these, and many other pieces of older gear, is that someone stores them with the batteries still in them and, after a while, they leak and wreak havoc on the insides of the meter – many times to the point of trashing them beyond repair.

The Simpson meters carry several different complements of batteries. Some may have AA and D cells in combination. Others may have 9V and AA as their power. After removing any remains of the old batteries, check all the contacts for corrosion. You might find a very hard bluish residue on the silver plated contacts, or it might be white depending on the type of battery it had inside. I find that the blue corrosion seems to me the hardest to remove. Several of the contacts can be carefully extracted for easy cleaning. Others have wires soldered to them that may have to be removed first.

The clips shown on page 36 were removed from the top corners and are in the middle of a 4-battery chain of AA cells. They had no wires to remove and simply slipped out of the case with a little nudge.

(Continued on Page 36)



# A little extra for good measure

The combination of MR-PRO and XL2 offers you **extra flexibility and extra performance** providing a complete and easy-to-use audio measurement solution.

### MR-PRO

The MR-PRO is a versatile reference grade analog audio source generating both standard and user-stored signals at extremely low distortion. It also includes some remarkable additional features including readout of the impedance and phantom voltage of connected devices, as well as a cable test/signal balance function.

- Sine waves, Pink & White Noise
- Sweeps, both stepped and continuous; programmable
- User stored signals and signals for polarity and delay testing
- +18 dBu output at -96 dB distortion



MR-PRO



XL2 (with M4260 microphone)

### XL2

A high performance audio analyzer and acoustics analyzer together in one efficient battery-powered package. Designed to close the gap between handheld and benchtop instruments in performance and features, it functions as an audio/distortion analyzer, with frequency counter; octave and 1/3 octave real time analyzer, sound level meter, FFT spectrum analyzer, RT60 reverberation analyzer, polarity tester, delay time analyzer and optionally, as an STI-PA speech intelligibility analyzer.

- Live Sound Solutions
- Installations and Venues
- Broadcast and Studios
- Environmental and Community Noise Measurements

### Incorporating:

- High (-100 dB) audio performance
- Ergonomic package with brilliant hi-res backlit display
- Multi-parameter Sound Pressure Level Meter
- RTA and high resolution FFT spectrum analyzers
- Balanced and unbalanced audio inputs
- Monitor speaker, headphone output, tripod mount and shock jacket
- WAV file recording for later reference or post-analysis
- Data & setup memory storage and recall on micro SD card

**INTI**  
AMERICAS INC.

PO Box 231027  
Tigard, Oregon 97281 USA  
503-684-7050  
www.minstruments.com  
info@ntiam.com



www.aldena.it  
aldena@aldena.it



The original ALDENA ALP0802712 log periodic antenna  
is always better than a copy

Suitable for  
FCC Custom  
Directional  
Pattern

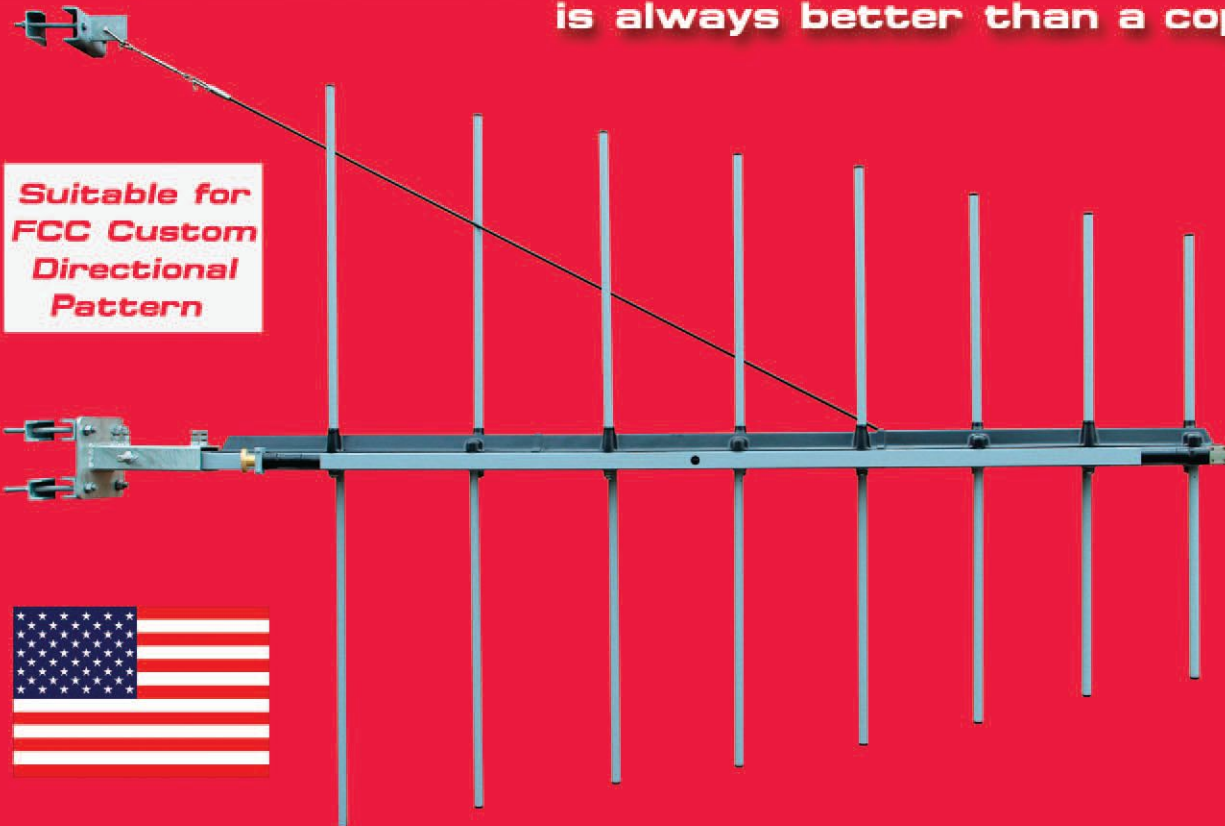

TELECOMUNICAZIONI  
ALDENA s.r.l.

Via A. Volta, 13  
20090 Cusago (MI) ITALY  
Tel. +39.02.90390461  
Fax +39.02.90390475

<http://www.rfspecialties.com>

# ALTRONIC RESEARCH INC.

Performance By Design



## RF DUMMY LOADS for ALL YOUR APPLICATIONS

- AIR-COOLED
- HD
- HDTV
- WATER-COOLED



**ALTRONIC RESEARCH INC.**

P.O. Box 249 Yellville, Arkansas 72687 870-449-4093 Fax: 870-449-6000  
E-mail: [info@altronic.com](mailto:info@altronic.com) Web Site: <http://www.altronic.com>





# Monitors and Meters

– Continued from Page 34 –

You will notice that the one on the right which had the white residue on it came a lot cleaner with a simple brushing than did the one on the left that had the blue stuff.



I will continue to clean these up with a combination of baking soda and water, and later silver cleaner. I will polish them up as best I can, then using a great product called "Cool-Amp" silver plating powder (cool-amp.com), I will finally re-plate them and they will look almost like new.

There are several more battery terminals in these Simpson units that you need to inspect and, if necessary, clean and/or repair. Many of the units such as the one I am rebuilding, use a combination of batteries as I mentioned. This one has 4 AA's and one D cell. You can see in the schematic just where they are used in the circuit.

Once you have cleaned up all your internals, being careful not to tamper with any adjustable resistors, etc., you are ready to pop in a new set of batteries and see if the unit you have will work. Please note here that I highly recommend that you use alkaline cells for better life. I would also recommend that you try to get good quality cells and change them on a regular basis, to prevent your meter from sustaining damage again. This is true for all your meters not just the trusty Simpson. How long has it been since you changed out the batteries in your meters? Well that is probably too long!

The Simpson has many really neat features that make it a great little meter for things like transmitter work. Say for example you want to test a rectifier stack. With most smaller or digital meters, it may or may not work well enough to tell if you are looking at a bad one or not. With the Simpson, the available power it has will allow you to tell most times if you are looking at a defective stack, without having to test each individual diode in the stack. One thing I especially like are the -D.C./+ D.C. switches. You can connect the leads to the rectifier, then just switch the knob between + and - to see a front to back ratio. Now I realize that you can do this with most modern meters, but where is the fun with that! The Simpson is good for a lot of other things as well. You should also note that there is a dB scale at the bottom of the meter face. You can check audio levels with the meter by simply setting the switch to AC, and choosing an appropriate voltage setting. Now keep in mind that the meter movement is heavily damped, so it is probably better for reading tones, etc., but it will allow you to see if there is audio on a line without having to drag out other equipment.

It has inputs to read DC current up to 10 Amps, and AC and DC voltage scale up to 5000 Volts. Now I personally prefer to use a high voltage probe for such measurements. Although I never tried, you could feasibly use the meter

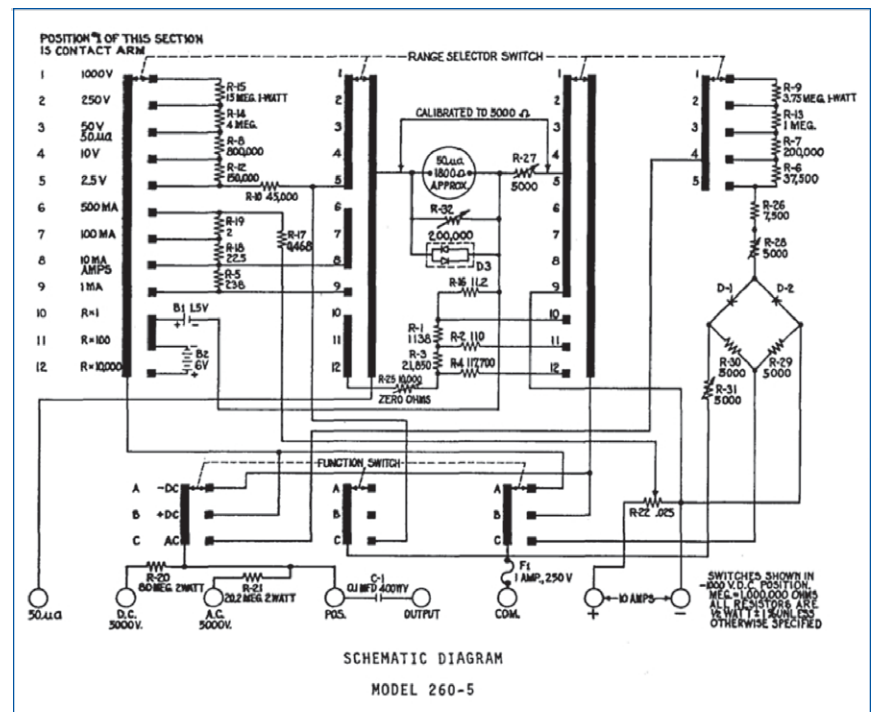

direct, though I would suggest clipping the leads on with power off and not touching them while taking a reading.

In the next installment, I will get into calibrating your meter to assure good accuracy, and a few actual measurements with the meter giving you examples of how you might use yours for field work. So now, you need to go on-line, or into your storeroom if applicable, and dig out an old Simpson meter and get ready for a little fun with an "Old Timer."

Tommy Gray is President/CEO of "Broadcast Engineering & Technology LLC", a Consulting and Contract Engineering Firm with offices in the Houston, TX area, and North LA area. [www.BEandT.com](http://www.BEandT.com)

## AM Ground Systems Co.

[www.amgroundsystems.com](http://www.amgroundsystems.com)

1-877-766-2999

PHYSICAL AM SITE SERVICES

CONSTRUCTION

EVALUATION

REPAIR

SAMPLE, FEED & CONTROL LINE LOCATION, REPLACEMENT & REPAIR

MOM MODELING PREPARATION WORK

SERVING THE TECHNICAL AND CONSTRUCTION NEEDS OF AM BROADCASTERS FOR OVER 25 YEARS

- Has your AM station lost coverage?
- Is your AM ground system over 30 years old?
- Has your ground system been damaged or vandalized?
- Base impedance or DA pattern unstable?
- Dramatic system or range changes in wet-to-dry conditions?

All of the above are indicators of hidden ground system problems that may be reducing your coverage.

SAMPLE TOROID RETROFIT SOLUTIONS AND SAMPLE LINE REPLACEMENT FOR METHOD-OF-MOMENTS DA PROOFING

Contact us today for a no obligation quote on any of our services.

877-766-2999

[eng@amgroundsystems.com](mailto:eng@amgroundsystems.com)

WE EASILY ACCOMMODATE COMPRESSED TIME-LINE PROJECTS.

Reliable, On-time Installation Firm Quotes Quality Workmanship

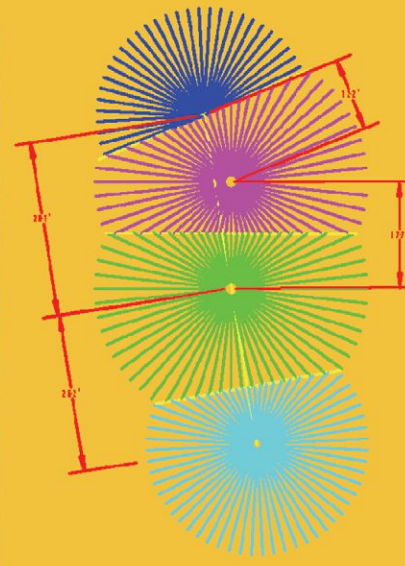



# LOW PROFILE MIC BOOMS: *No Springs Attached* (Microphone/Shockmount Optional)



AMB22-4MOT \$399



AMB16-4 MINI MOT \$399



HMB14-4MOT \$299



HMB8-4-MINI-MOT \$299



AMB-22-4 \$350



AMB16-4 MINI \$350



HMB14-4 \$250



HMB8-4 MINI \$250



AMB-22-4E \$299



AMB16-4E MINI \$299



HMB14-4E \$199



HMB8-4E MINI \$199



STUDIO ITEMS INC.

[www.studioitems.com](http://www.studioitems.com)



**DH 1-piece Antenna Sizes Available**  
From .6m to 5.0m

**DH Sectional Antennas Available:**  
1.8m ~ 2.4m ~ 2.7m ~ 3.0m  
3.7m ~ 4.2m ~ 4.5m ~ 5.0m

**Mount Options:**

Fixed Az-El, Polar Tracking, Horizon to Horizon Tracking  
Fixed & Dual-Powered Gibraltar Az-El

Dual-Powered Gemini Az-El

For More Information: [dhsat@mhtc.net](mailto:dhsat@mhtc.net)

***DH Is The Industry Standard!***

For over 35 years, our 1-piece antenna has outperformed the rest! The 4-piece, 3.7m has the same accuracy because we use 8 computer generated templates and attach them to the back prior to cutting the antenna. This allows for ...

Superior Quality    Quick Delivery  
Easier Installs    Cheaper Shipping

Fits Into Service Elevators For Roof Installs



**Our New  
4 or 8-Piece  
Freight  
"Shippable"  
Antenna**



**US Commercial  
Radio Network Is  
Moving To AMC-18!  
Call For Your New  
Antenna!**



***DHSatellite.com ~ 800-627-9443***



## Successful Troubleshooting

by Dave Dunsmoor

It seems troubleshooting is oftentimes a bit of a backwards process. You often can spend a lot of time checking all the things that *could* be the problem – but are not – just to finally locate the one thing that is the problem. It sure would be nicer to find the thing that *is* the problem *first*, then check all the other things if they seemed like they ought to be looked over, just for caution's sake.

Well, short of my developing some extrasensory powers, I know that finding every problem in the first place I look is not likely to happen anytime soon. So how about eliminating many of the possible problems at the source – at installation time? Poor installation technique has to be the most common source of problems I have encountered, anywhere. And I am not limiting this to the initial installation; I am talking about every time I go into a piece of equipment, whether to repair or just to look. Actually, anything I do (or fail to do) can be considered part of the installation.

We all know that electrical connections have to be tight in order for the equipment to function correctly. But is “tight” all there is to it? And, what really is “tight?” (I am not talking about just-short-of-breaking-it tight, I am talking about tight enough to make good electrical bond, and to stay that way.) Here are a few things I have learned over the years that have greatly lessened the number of times I have had to track down intermittent problems that were traceable to poor mechanical connections. I would like to be able to tell you that I was so clever that I thought these things all by myself, but that is not usually the case.

### Solid Connections

First, many rack mount processors, distribution amps, transmitters, etc., use the basic screw terminal strip for I/O connectivity. Most times they will stay tight forever, but I have had, on occasion, found them to have loosened up. Temperature changes and vibration are the primary causes here. To prevent this, firmly press the terminal clear to the right barrier as you are tightening the screw/nut and that ring/spade terminal will stay there forever. At least that is the theory as presented to me by Boeing Aerospace QC engineers many years ago.

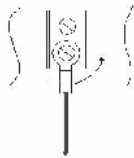

#### Incorrect Terminal Lug Installation

The problem here is that movement of the terminal lug is possible, either by fingers, tools, etc. bumping the lug or even by vibration. Then the problems start, intermittent at first, followed by an outage.

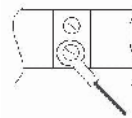

#### Correct Terminal Lug Installation

Here the terminal is held firmly against the barrier strip's insulating fence as the screw is tightened, and cannot work loose, nor can it be wiggled loose by accidental bumping. A small issue, but it has saved the day.

Phenolic, Teflon, bakelite, insulation material.



#### Wrong Assembly Method

The “weakest link” in the tightness of this electrical connection is the insulating material itself. Notice that the nuts (and therefore the terminal lug) are tight only as long as the insulating material is under compression tension. As this assembly ages, the insulating material (and especially if it is Nylon, Teflon or similar) will compress, or “cold flow” allowing the electrical connection to loosen. If it is a high current circuit, it will heat and aggravate the condition. If it is a high voltage circuit, it will arc. If it is a low voltage circuit, it will get noisy. All conditions are detrimental to the operation of the circuit.

Phenolic, Teflon, bakelite, insulation material.

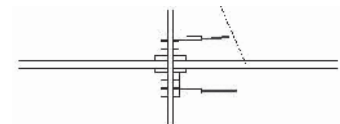

#### Correct Assembly Method

Notice here two nuts (tightened to each other) on each side of the insulation material are making the mechanical connection. This connection method is independent of the tightness of the nuts to the insulator, and will maintain its integrity forever. A third nut is then used to secure the electrical terminals.

Figure 1

Another variation on this is the stud through the insulator type connection. Usually this will be in a high current or RF connection. Either way, we do not want the electrical connections coming loose. One most important thing to remember when making this type of connection is to be sure the electrical connection integrity is not relying on mechanical connections where a compressible material is partially responsible for the tightness of the connection. (Continued on Page 40)



# fuhgeddaboutit!

Admit it; you'd love to forget all about your FM antenna. You'd be perfectly happy if it were to spend decades out of sight, out of mind, and out of your budget. You just want it to work; day in, and day out.

We understand. Shively designs antenna systems to work flawlessly. Year after year. At any site. Under any conditions. For any power level. Happily, in the background.

FM First. This was Ed Shively's vision in 1963, when he founded the company; and over 50 years later, we're still doing our best to be absolutely forgettable.

## Shively Labs®

A Division of Howell Laboratories, Inc. Bridgton, Maine 04009 USA

Call Toll-Free: (888) SHIVELY  
Or visit us on the Web at: [www.shively.com](http://www.shively.com)  
- An Employee-Owned Company since 1995 -



# Quality *FM & TV* Antenna Systems



SLANT-V  
DIRECTIONAL

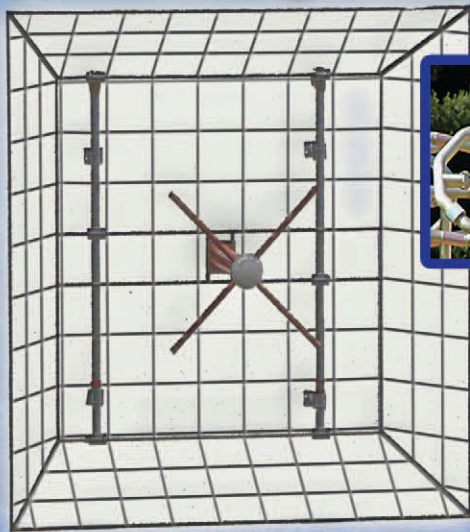

FM PANEL



POWER-TILLER



POWER-TILLER  
WITH RADOME

PSI is dedicated to designing and manufacturing the highest quality product. Working diligently with station engineers, consultants and outside vendors ensures that each project is completed to the customer's satisfaction.

Wide range of antenna models are available at all power levels, directional and non-directional, multi-station and more.

Additional products include..

Transmission Line

Combiners

Filters

Turnkey Systems



## Propagation Systems, Inc.

Phone: (814) 472 - 5540

Email: [sales@psibroadcast.com](mailto:sales@psibroadcast.com)

Fax: (814) 472 - 5676

[www.psibroadcast.com](http://www.psibroadcast.com)



## Smart Technology, Even Smarter Value.

*Innovation has never been this reliable.  
Reliability, Performance, Consistency...All the qualities  
you have come to expect from the Industry Leader.*

### 7/8" EIA COAXIAL SWITCH

- High port-to-port isolation
- Low VSWR
- Compact design
- Can be operated manually
- Highest power handling capacity available
- LED & mechanical position indicator

When power levels change, but confidence in your remote control system cannot, go with the company that has delivered Peace-of-mind to engineers for over six decades.

Learn why so many broadcasters rely on MYAT.

1-201-684-0100 | [www.myat.com](http://www.myat.com)





– Continued from Page 38 –

In **Figure 1**, notice how the terminal is tightened by a jamb nut up against the nut holding the stud in place. The jamb nut is torqued to the holding nut on both sides of the insulation material. Properly done, this kind of connection does not rely upon the holding nuts being tight in order for the electrical connections to be firm.

The insulating material (fiberglass in this example) may give over the years, but as the jamb nuts are tight against the holding nuts and are tensioned by locknuts, the electrical connection integrity is maintained. If the terminal were placed directly against the fiberglass and a single nut tightening the entire assembly, it would eventually work loose and become a problem.

## Rechecking Connections

It is always my preference to go through a new installation and recheck all connections, whether using nuts or terminal strips, and generally, if they are checked again after a season of heating and cooling (about a year later), I feel they will be good for many years. Nevertheless, it is always a good idea to check the various connections every year or so.

This goes for *all* the connections from the service panel through the entire path to the equipment – terminal strips, outlets, circuit breaker screws, everything. Loose connections can mean heat buildup, and more heat means looser connections – the cycle continues until there is a failure.

## Proper Wire Size

And do not forget that matching the proper wire type and size for a given terminal type and size makes for a more permanent connection. For example, most terminal ends are not designed to be used with solid wire. They will work, but will

probably develop an intermittent connection after a while. On the other hand, you can buy terminals designed for solid wire – they are identified by the ribs inside the ferrule where the wire fits. These terminals will also work fine on stranded wire.

Of course, once you have the right type terminal ends, the right size wire also is important. However, when you just do not have a small enough terminal for the wire at hand, one workaround is to use some “filler,” more pieces of the same gage wire layered in with the actual wire, enough to make the whole bunch approximately the same size as would normally be used for the terminal being used.

There are some actual charts designating how many of which gage wires are needed to properly fill the terminal ferrule. Again, this is an aerospace specification and has to do with gas-tight connections, not over stretching the brazed seam in the ferrule and so on, but for our purposes, close works just fine.

## Clean Grounds

We have been talking about tight connections, but there is another major factor that makes up the “second half” of a good connection: clean wire and terminals. Sure, new terminal ends and new wire are usually clean, but how many times do you have to make a connection to an aluminum chassis? This will (almost) always be a ground connection, and a solid ground connection is necessary for stable operation of any equipment.

There are several ways to make connections to aluminum, the most common being a machine screw and washers and the holding nut, with the terminal being held by the pressure exerted by the nut, and the assembly process outlined above for stud connections applies here as well.

One thing to note is that for aluminum to be considered “clean” enough for a good low loss connection, it takes a little work with a stainless brush to clean the oxide around the connection point. And where does one find such a brush? At the local welder’s supply – they are used for cleaning aluminum of all oxides prior to TIG welding.

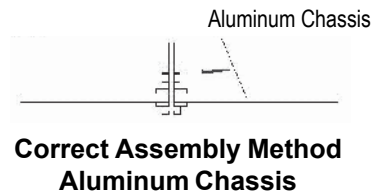

When the aluminum is cleaned, it helps keep the connection very low loss when the connecting hardware is properly torqued. Ground connections can then be added, or removed and replaced without disturbing the actual ground integrity thereafter. The stainless brush treatment is also valid for the areas where various aluminum chassis parts are connected to each other. Any thing done to improve the ground connection is likely to result in less trouble in the future.

This applies primarily to intermittent problems type of trouble, but is also very applicable to lightning-induced current type of trouble. If all the grounds are at the same potential when a great deal of current is flowing through them, all else being equal, this particular equipment will experience less damage than one with poor ground connections throughout. Generally .001 Ohms is considered to be a good connection resistance.

This low a resistance value can be difficult to obtain, and even more difficult to accurately measure. I have used milliohm meters to determine the resistance of connections as well as Fluke Low-Ohms Ohmmeters. The milliohm meters use dual point probes with very high current on one set of points, and measurement detection on the other set to determine resistance values.  $R=E/I$ , and with lots of current, R is easier to accurately determine.

You can do the same by running a lot of current through a connection, and measuring the voltage across the connection, but that is usually too much trouble for the benefit gained. Just remember to brush the connection points with a stainless brush and it will be fine. – Radio Guide –



Available in stock from  
Broadcast Depot, Call: 800-313-7592  
[www.devabroadcast.com](http://www.devabroadcast.com)

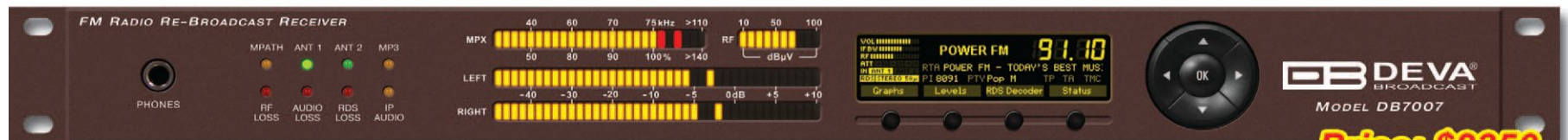

**Modulation Monitors • Rebroadcast Receivers • RBDS Encoders • Broadcast Tools**



## Twice the I/O Density per Rack Unit



### Tight on rack space? We can help.

Logitek's AoIP engines can accommodate up to 128 channels of I/O in two rack units or 240 channels in only four units - twice the density of the closest competitor. We can save rack space in other ways, too -- you can eliminate outboard microphone preamps, processors and profanity delays because those functions are included in the JetStream Mini and JetStream Plus platforms. Operations that used to require a large rack of equipment for just one studio can now be boiled down to a half-rack that fits on top of or underneath your studio furniture.

For more information, visit [logitekaudio.com/audio-routers](http://logitekaudio.com/audio-routers).

## Intelligent design...

# STX 10



The new STX 10, is the world's first 10 kW transmitter intelligently designed to offer the perfect combination of audio quality, reliability, redundancy, serviceability and efficiency, in an amazingly compact design! No other 10kW transmitter can match the design, feature set, and BE tradition of providing the best value.

**Small** - 19" (48cm) W x 29" (74cm) D x 38.5" (98cm) H.

**Efficient** - Greater than 70% AC to RF.

**Redundant** - All hot-pluggable and hot swappable power amplifier modules and power supplies and a redundant cooling system.

**Connected** - Superior Graphical User Interface that allows remote control.

**Serviceable** - All important parts and assemblies can be accessed from the front and the rear access points.



Broadcast Electronics • 4100 North 24th Street • Quincy, Illinois 62305-3606 U.S.A.  
Telephone: (217) 224-9600 • E-Mail: [bdcast@bdcast.com](mailto:bdcast@bdcast.com) • [www.bdcast.com](http://www.bdcast.com)



# Small Market Guide

## Buyer Beware Even in Small Market Radio

by Roger Paskvan

'Tis the season of giving but ... giving away too much can destroy your radio station. Trade at a radio station, in the wrong hands, is a dangerous thing.

Not too long ago, our business acquired a new radio property in a small town. This was a ma and pa type radio station that had been in the community forever and they wanted to retire from the daily rat race of broadcasting. The books looked great and they were making a respectable profit—all seemed to be up board and in proper order. A local accounting firm confirmed the statements and gave us the blessing to go ahead with a sale.

After the paperwork was over, what did we get into? The station was full of ads and sounded normal on the air. The books showed monthly billing and reasonable balances. What could be wrong with that? Our first day at the new property was met by filing cabinets that were missing documents—the previous owners had taken the file drawers on several of the filing cabinets. This looked strange but we didn't think too much of it.

A closer look at the books revealed billing irregularities with less than half of the revenue ever collected. The bookkeeper simply said this is what I was told to do and I've done it this way for years. Apparently the station was trading out a lot of things and paying for them with ads on the air.

After about a week of intense studying, it became painfully clear that there were two sets of books—the one the part time bookkeeper kept and apparently the real information was in the missing file cabinet drawers. A phone call to the previous owner was left as “disconnected” and later learned they had skipped the state with no forwarding address. We had been had, and the money was paid in full already with the FCC blessing.

Over the next month, the reality of how a radio station can get into a situation like this unfolded. Topping the list was a \$3,000 gas station bill for a radio station that had no vehicle. There were drug store bills that exceeded several thousand dollars, including makeup, drugs and food. We also found real estate contracts for the previous owner's home that was being traded out. There were even two new cars traded out in full, and of course a new boat with its traded payments. This station even had a thousand dollar grocery bill conveniently charged to the station. Eventually the local merchants realized that their friend, the previous owner, had left town and these shady trade deals now became cash bills sent to the station. We had the foundation of a real problem!

The classic was the \$3,000 gas bill. We later learned that the gasoline was the work of the owner's 17 year

old son. In our discussions with the gas station owner I asked, “How can a station have such a huge gas bill since there is no station vehicle.” They all just looked at the floor.

After repeated queries, one person said, “Put it this way, his son was real popular in high school.” I still didn't get it. I said what does his high school have to do with it?” They laughed, with one saying, “At 3:30 each day there was a wagon train of cars lined up at our pumps and his kid just waves them by and charges their gas to the station. It is a good deal for us, a better deal for them, and we get ads on the radio. This has been going on for years!” I said, “Didn't any of you see any fraud in this situation?” (No answer.)

Most of these bad trade deals eventually got resolved with a reduced percentage of the bill and some legal help. The scares from this held for quite some time and many merchants refused to do business with us. The previous owner was careful to put all contracts in the station name and fled the state making it difficult to prosecute.

So what can we all learn from an eye opening experience like this. Carefully check out the trade, have a non-local accountant, preferably from out of the area, look at the books. Check for irregularities, interview employees before you sign the dotted line. If things look too good to be true, heed the warning. Get out before you own the problem.

I'm sure there are many stories like this one across small markets in the country—maybe some that make this look good. Remember, buyer beware.

Roger Paskvan is a Professor of Mass Communications at Bemidji State University, Bemidji, MN. You may contact him at: [rpaskvan@bemidjistate.edu](mailto:rpaskvan@bemidjistate.edu)



### FM TRANSMITTERS FROM 150W TO 60kW

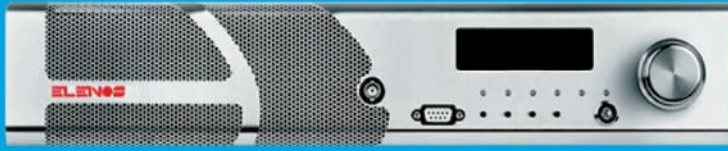

**ETG Indium Low Power**  
150W to 2kW in 2RU



**ETG Indium Medium Power**  
3.5W to 5kW in 4RU



**ETG Indium**  
SOLAR RENEWABLE  
150W & 500W in 2RU

**What makes ELENOS different?**  
Icefet & Planar technology means reduced heat and cooler operation!  
ELENOS designed and built power suppliers means more reliable and always in stock!  
Front Panel Setup means no PC required to get you on the air!  
Free 24/7 telephone support in English from ELENOS Certified Support Staff in Miami!



Call Us at 1-855-305-305-8  
Shop online at [305broadcast.com](http://305broadcast.com)  
email [info@305broadcast.com](mailto:info@305broadcast.com)  
Your Source for Broadcast Equipment



The world's finest Broadcast Audio Consoles, Networking, Recording and Processing.





Studio quality Audio and Video IP solutions and superior audio quality for telephones calls.





IP-based transmitter remote control featuring full color LED touch screen for On-Site Monitoring and Control.





Radio & TV Broadcast software solutions with advance flexibility and rock-solid performance for On-Air, Traffic, Scheduling, Logger, Newsroom and more.





2561 NW 74 Avenue #16, Miami, FL 33122  
Toll-Free: +1 855 305 3058 Phone: +1 305 406 3560  
[info@305broadcast.com](mailto:info@305broadcast.com) | [305broadcast.com](http://305broadcast.com)





# RF is good for you!



[www.rfspecialties.com](http://www.rfspecialties.com)

Check our website for the office nearest you.

## TRANSCOM CORPORATION

Serving the Broadcast Industry Since 1978

Visit Our Website – [www.fmamtv.com](http://www.fmamtv.com)

Send your e-mail requests to: [transcom@fmamtv.com](mailto:transcom@fmamtv.com)

### Fine Used AM & FM Transmitters & New Equipment

<b>AM</b>	10 kW	1988	Nautel ND10 - Solid State
	10 kW	2001	Nautel XL12 - Solid State
	<i>Please see our current listings on our website.</i>		
	55 W	2000	Harris DIGIT™ Exciter
<b>FM</b>	3.5 kW	2000	Harris Z3.5CD, Solid State
	3.5 kW	2006	Harris Z3.5CD, Solid State
	1.3-3 kW	2006	Harris Z6HD Tri-Mode
	5.0 kW	1995	Harris HT5CD
	5.0 kW	1992	BE FM5B
	7.5 kW	2007	Harris Z7.5CD, Solid State, Single Phase
	10.0 kW	2002	Harris Z10CD - Solid State
	20.0 kW	2002	Harris ZD20CD - Solid State
	21.5 kW	1990	Continental 816R2B
	25.0 kW	1982	Harris FM25K with DIGIT
	30.0 kW	1988	Harris FM30K- <i>*Special Sale Price*</i>
35.0 kW	1991	BE FM35B	
<i>Please see our current listings on our website.</i>			

#### Used Misc. Equipment:

Bird Model 8936, 10kW Air-Cooled RF Load  
Harris N+1 Controller

#### Exciters:

Harris DIGIT™  
Continental 802B  
New - 30W Synthesized



*Please go to our website for updated listings. Retuning and testing available – call for quote!*  
**OMB STL systems for radio, complete with antenna and cable for under \$5,000!**

2655 Philmont Ave, Ste 200, Huntingdon Valley, PA 19006  
800-441-8454 • 215-938-7304 • Fax: 215-938-7361

How to get the best out of crowded sites?



Get the best RF combiners and filters. Bext has it all.

888 239 8462



## ECONCO

### Rebuilt Power Tubes



Approximately One Half the Cost of New

**3,000 Hour Unconditional Guarantee**

Call for Your Quotation



Phone: 530-662-7553 • Fax: 530-666-7760  
Toll Free: 800-532-6626

[www.econco.com](http://www.econco.com)

1318 Commerce Ave, Woodland, CA 95776



# Service Guide Radio Equipment Products and Services



**MOORETRONIX**  
BROADCAST & INDUSTRIAL ELECTRONICS

## Our 15<sup>th</sup> Year

Our client list continues to grow. Thank you for your confidence and equipment purchases.

### We Re-Condition

Pacific Recorders BMX I-II-III, AMX, ABX and RMX, Stereo-Mixer and Mixer News-Mixer products.

### We Have

Replacement Wind Screens and Blast Filters for the SM-5B microphone.

### We Repair & Re-Crystal

STL Transmitters, STL Receivers, and RPU equipment.

See the "News-Update" page at our website.

Tel: 800-300-0733 Fax: 231-924-7812  
[WWW.MOORETRONIX.COM](http://WWW.MOORETRONIX.COM)  
E-Mail us at: [rmoorej@comcast.net](mailto:rmoorej@comcast.net)

## TRANSMITTING CAPACITORS

MICA-VACUUM-CERAMIC



**SURCOM ASSOCIATES, INC.**  
(760) 438-4420  
[LINK@SURCOM.COM](mailto:LINK@SURCOM.COM)

## TOWER SIGNS

[antennaID@msn.com](mailto:antennaID@msn.com)  
E-MAIL FOR FREE PDF CATALOG

### FCC TOWER SIGNS

FCC ASR - CAUTION - DANGER - RESTRICTED SIGNS  
ADD YOUR CONTACT NUMBER & WORDING TO ANY SIGN  
NO ADDITIONAL COST

ANTENNA TAG SETS 4 EACH & NUMBERED  
RED GUY WIRE MARKER BALLS YELLOW GUY WIRE GUARDS

### ANTENNA ID PRODUCTS

610-458-8418 [www.antennaID.com](http://www.antennaID.com)



**V-Soft COMMUNICATIONS®**  
R.F. Communications Software and Engineering Consulting

### The Leader in Broadcast Engineering Software!

- Create stunning "real-world" coverage maps, interference studies, and population reports with Probe 4™
- AM Pro 2™, used daily by FCC engineers, performs skywave and groundwave allocation studies and AM coverage mapping
- Find STL broadcast auxiliary and Part 101 microwave frequencies and generate PCN letters with Microwave Pro™
- Map FM stations and find upgrade possibilities using FCC minimum separations and contour-to-contour methods with FMCommander™

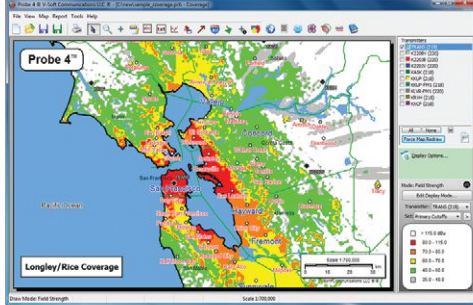

[www.V-Soft.com](http://www.V-Soft.com) - [info@v-soft.com](mailto:info@v-soft.com) - 1-800-743-3684



[www.LightnerElectronics.com](http://www.LightnerElectronics.com)

From our Facility to yours | Design & Integration | Repairs & On-Site Service Calls

**LIGHTNER ELECTRONICS** [www.lightnerelectronics.com](http://www.lightnerelectronics.com)  
Toll Free 1-866-239-3888 | Shop online [www.broadcastavsales.com](http://www.broadcastavsales.com)

## BROADCAST WORKS

### Full Service Broadcast Engineering

- Project Management - Studio Build Outs
- Transmitter Sites - IBOC Installation
- Automation Systems - STL & RPU Repairs
- Full Service Shop - Emergency Equipment Rental
- 24/7/365 Tech Support

We can team up with your engineer to supply extra manpower for big projects – or we can see your project through turn-key.

Serving Broadcasters for over 12 years.  
888-509-2470 • [www.broadcastworks.com](http://www.broadcastworks.com)

## Doug Vernier

Telecommunications Consultants

- FCC Applications for AM, FM, TV, DTV, LPTV, STL
- Upgrade and Due Diligence Analysis
- Frequency Searches
- Site Relocations
- Propagation Prediction with Custom Mapping
- Demographic Analysis
- Directional Antenna Design



We use V-Soft Software!  
[www.v-soft.com](http://www.v-soft.com) [consulting@v-soft.com](mailto:consulting@v-soft.com) 800-743-3684



## AM-FM Transmitters

Pre-Owned – Tuned and Tested to Your Frequency

[www.Besco-Int.com](http://www.Besco-Int.com)  
Rob Malany – Owner

321-960-4001 • [sales@Besco-Int.com](mailto:sales@Besco-Int.com)

## M. Celenza

Communications Consultant

FM • LPFM • AM • DTV • STL • Translators

Preparation of Applications, Amendments, Channel Studies, New Allocations, Relocations, Interference Studies, and Coverage Maps

Call: 631-965-0816

41 Kathleen Crescent, Coram, NY 11727  
[mssccommunications@yahoo.com](mailto:mssccommunications@yahoo.com)



## DANGER

Old Safety Sign. High Liability!  
Replace Immediately!

**RF Signs.com**

- ANSI Z535.2 Compliant
- Easy to order

## Chris Scott & Associates

Visit our website [www.scott-inc.com](http://www.scott-inc.com)

Ph: (270)781-5301  
Fax: (270)781-1232  
Bowling Green, Kentucky



NRSC Loop Antenna



AM-FM Notch Filters



# Service Guide Radio Equipment Products and Services

## Technalogix FM Transmitters & Translators

50 watts TO 5,000 watts with world class reliability & quality  
 Features include, Remote Control, Fold-back, RDS, Stereo Generator, AGC control, Auxiliary input for SCA, 2 year Warranty, Broadband across FM Band, Input for MPX, L&R Analog, and Mono. Built in North America, Fast delivery. Complete line of FM and Television Antennas, Transmission line & Connectors.

Pricing and Delivery Contact **Jimmie Joynt** at 972.473.2577 or [jjsbp@msn.com](mailto:jjsbp@msn.com)



**RF PARTS**  
 COMPANY  
 From Milliwatts to Kilowatts<sup>SM</sup>

Eimac • Amperex • Svetlana • M/A-Com  
 Motorola • Toshiba • Philips • Mitsubishi

Se Habla Español • We Export

**800-737-2787**  
 760-744-0700 Email: [rpf@rfparts.com](mailto:rpf@rfparts.com)  
[www.rfparts.com](http://www.rfparts.com)

## Consulting Professional Engineers

### ● Expert Witness Testimony

- FCC Applications
- Frequency Searches
- Co-location Studies
- Coverage Modeling & Maps
- Interference Analysis Studies
- RF Exposure Studies & Reports
- Custom Map Preparation

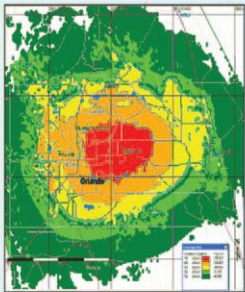

**Call us now to discuss your project needs.**

**352-367-1725**

**RFEngineers, Inc.**  
[alex@rfengineers.com](mailto:alex@rfengineers.com)

## TLM-1 TOWER LIGHT MONITOR

Total Monitoring for Older Lighting Systems

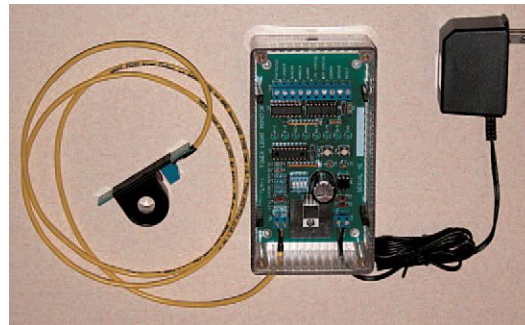

A microprocessor based system designed to monitor the status of FAA type A incandescent tower lights.

- Individual alarms for photocell, flasher, beacon & marker.
- Status outputs for lights on/off and beacon on/off.
- LED indicators for each alarm and status output.
- Opto-isolated fail-safe outputs for each alarm.
- Easy setup – one button calibration.
- Installs at the circuit breaker panel.
- Available through broadcast distributors.

**FM Services**

[www.towermonitor.com](http://www.towermonitor.com) • 336-667-7091

## COMMERCIAL RADIO COMPANY

BROADCAST SALES & SERVICE



**10% OFF FIRST ORDER**

*with mention of this ad*

Broadcast service since 1960

**Specializing in hard to find transmitting parts:**

- ✓ Mica transmitting capacitors
- ✓ Oil filled capacitors
- ✓ Ceramic RF capacitors
- ✓ Fixed and variable vacuum capacitors
- ✓ Resistors, Rheostats & Potentiometers
- ✓ Ceramic standoff insulators
- ✓ RF contactors

802.226.7582 (Ph.) | 802.226.7738 (Fax)  
 P.O. Box 43 | Cavendish, VT 05142  
[www.commercialradiocompany.com](http://www.commercialradiocompany.com)

# Radio-Classifieds.com

- Buy or Sell Your Used Equipment
- Place as Many Ads as You Like
- **FREE!** – There's Never Any Charge



Home Register Login Submit ad Search

**Radio-Classifieds.com** Latest 20 ads

Please register or log in.

Antennas [0]	Codecs & AoIP [0]	Internet & Stream [0]	STL, RPU, TSL [0]
Audio Amplifiers [0]	Computers & IT [0]	Microphones [0]	Satellite Gear [0]
Audio Delay [0]	Consoles & Mixers [0]	Monitors & Rcvrs [0]	Speakers & Phones [0]
Audio Editing [0]	Directional Gear [0]	Phone & Hybrids [0]	Timers & Clocks [0]
Audio Processing [0]	EAS Gear [0]	RDS, RBDS, SCA [0]	Tools & Test Gear [0]
Audio Routing [0]	Exciters & Gens. [0]	Recorder & Player [0]	Towers & Coax [0]
Audio Storage [0]	Furniture & Racks [0]	Remote Control [0]	Transmitters [0]
Automation [0]	Grounding & Surge [0]	RF & HV Equip. [0]	MISC OTHER [0]



## Broadcast Devices SWP-300 RF Site Controller

Broadcast Devices, Inc. BDI announces a new product for the RF site industry, the SWP-300 RF Site Controller. The SWP-300 RF Site Controller is designed to provide complete web enabled remote control of an RF site.



The system provides direct connection to motorized RF switches and to the company's popular DPS-100D True RMS Power Meter series. Complete transmitter control and interlock management is provided by a single connector. 16 additional control outputs, 8 status inputs and 4 analog inputs are provided. When DPS-100D power meters are interconnected, forward and reflected power, temperature and transmission line pressure are displayed without the need to scale or setup analog inputs for this purpose.

A web interface is provided that is compatible with BDI's Stack Graphical User Interface. A simple setup program is supplied to label command buttons, status inputs and analog inputs. Accessories offered include pre made motorized RF switch interface cable for direct plug and play connection to most RF switches offered. Pricing: \$2,895.00 Availability: 30 days after receipt of order For more information about this product and other BDI audio products please contact Bob Tarsio at: [bob@broadcast-devices.com](mailto:bob@broadcast-devices.com) (914) 737-5032.

For more information: [www.broadcast-devices.com](http://www.broadcast-devices.com)

## DM Engineering Mic-Pod

The new Mic-Pod is an ideal solution for remote broadcasts, talk studio applications, podcasts, or whenever you just need a mic OFF-ON switch on the fly.



### The Mic-Pod features:

- Large LED differentially lighted Mic-On and Mic-Off, long life silent reed type push buttons.
- Cough-mute function integrated with Mic-On button.
- Control buttons may be ordered with front panel (MP-FB), or top surface mounting (MP-TB) at no extra cost.
- Remote control of Mic On-Off function with a logic low or contact closure.
- LED Mic-On status indication on the rear of the enclosure.
- XLR connectors for Mic in and out.
- Rear panel terminal block for Solid State Relay drive voltage, continuous or flashing, to control ON-AIR or RECORDING signs, or an external LED indicator.
- 9VDC universal input power supply is included.

For more information: [www.dmengineering.com](http://www.dmengineering.com)

## ESE GPS-Based ES-410 Frequency Standard

ESE introduces the ES-410 a GPS (Global Positioning System) based frequency standard that generates a stable source of 10 MHz and 1 PPS using GPS satellites as a reference.



The unit provides 10 MHz in both Sine Wave and Square Wave (5 volt logic) form. Four Sine Wave and four Square Wave outputs are provided. The 1 PPS output is a 50% duty, 5 volt logic signal, positive-edge coinciding with the UTC seconds change. An ESE TC90™ Time Code output is also provided for driving remote time displays. Two front panel LEDs indicate when the ES-410 is locked to GPS and when power is supplied to the unit. A USB interface allows configuration of the Time Zone and other parameters, and outputs the time.

The ES-410 is now available and ready to ship.

For additional information please contact ESE or Monica Trotter / Marketing @ 310-322-2136.

For more information: [www.ease-web.com](http://www.ease-web.com)

TIME TO SYNCHRONIZE

**ES-185E/NTP6 GPS Master Clock**

Accurately generate time code with ESE's Master Clock via the 12-channel GPS receiver and output multiple types of Time Code, SMPTE-LTC/EBU, ESE, IRIG-B, ASCII (RS-232 & USB), and an extremely accurate 1PPS signal. Further reliability with dual battery back-up, and new control panel software. ESE's NTP6 feature provides an NTP server compatible with the latest version of Internet Protocol, IPv6. You can also easily interface with new or existing computers, automation and clock systems.

Visit [www.ease-web.com](http://www.ease-web.com) for all your time synchronization needs.

[www.ease-web.com](http://www.ease-web.com)  
+1-310-322-2136

### Remote Reboot of AC Powered Devices

**Stackley Devices LLC**

(609) 647 9677

**RemOutlet Reboot Mini**

**\$179**

Adjustable Power OFF Time

[www.RemOutlet.com](http://www.RemOutlet.com)

**Style and affordability from the industry leader.**

Custom furniture • Full integration services • RF services

**GRAHAM STUDIOS**  
Broadcast Furniture

(866) 481-6696 • [graham-studios.com](http://graham-studios.com)

# WE FIX

# MARTI GEAR

## (844) 549-2646

## www.martirepair.com



# FINAL STAGE



## RADIO ROUNDUP

### The Radio Guide Event Register

Email your dates and info to: [radio@rconnect.com](mailto:radio@rconnect.com)

#### 2017 CES Conference

January 5-8, 2017  
Convention Center – Las Vegas, Nevada  
[www.ces2017.org](http://www.ces2017.org)

#### 2017 NRB Convention

February 27- March 2, 2017  
Nashville, Tennessee  
[www.nrbconvention.org](http://www.nrbconvention.org)

#### NAB 2017 Spring Convention

Convention Center – Las Vegas, Nevada  
April 22-27, 2017  
[www.nabshow.com](http://www.nabshow.com)

#### NATE Unite 2016

February 27 - March 2, 2017  
Fort Worth, Texas  
<http://natehome.com/annual-conference>

#### Texas Association of Broadcasters (TAB)

August 9-10, 2017  
Renaissance Austin Hotel  
[www.tab.org/convention-and-trade-show](http://www.tab.org/convention-and-trade-show)

#### NAB Radio Show

September 6-8, 2017  
Austin, Texas  
[www.radioshowweb.com](http://www.radioshowweb.com)

## Radio Guide Advertiser Info – November-December 2016

### Advertiser - Page

Aldena - 35  
Altronic - 35  
AM Ground Systems - 36  
Arrakis - 17  
Audio Science - 13  
Bay Country - 4  
BEXT - 43  
Bohn/Marti Repair.com - 46  
Broadcasters General Store - 31  
Broadcast Devices - 19  
Broadcast Electronics - 41  
Broadcast Software Intl. - 21  
CircuitWerkes - 33  
Coaxial Dynamics - 22  
Comrex - 5  
Davicom - 4  
DaySequerra - 29  
Deva - 40  
DH Satellite - 37  
DM Engineering - 47  
Econco Tubes - 43  
Elenos/305 Broadcast - 42  
ESE - 46  
GatesAir - 23  
Graham Studios - 46

### Website

[www.aldena.it](http://www.aldena.it)  
[www.altronic.com](http://www.altronic.com)  
[www.amgroundsystems.com](http://www.amgroundsystems.com)  
[www.arrakis-systems.com](http://www.arrakis-systems.com)  
[www.audioscience.com](http://www.audioscience.com)  
[www.baycountry.com](http://www.baycountry.com)  
[www.bext.com](http://www.bext.com)  
[www.martirepair.com](http://www.martirepair.com)  
[www.bgs.cc](http://www.bgs.cc)  
[www.broadcast-devices.com](http://www.broadcast-devices.com)  
[www.bdcast.com](http://www.bdcast.com)  
[www.bsiusa.com](http://www.bsiusa.com)  
[www.circuitwerkes.com](http://www.circuitwerkes.com)  
[www.coaxial.com](http://www.coaxial.com)  
[www.comrex.com](http://www.comrex.com)  
[www.davicom.com](http://www.davicom.com)  
[www.daysequerra.com](http://www.daysequerra.com)  
[www.devabroadcast.com](http://www.devabroadcast.com)  
[www.dhsatellite.com](http://www.dhsatellite.com)  
[www.dengineering.com](http://www.dengineering.com)  
[www.econco.com](http://www.econco.com)  
[www.305broadcast.com](http://www.305broadcast.com)  
[www.es-web.com](http://www.es-web.com)  
[www.gatesair.com](http://www.gatesair.com)  
[www.graham-studios.com](http://www.graham-studios.com)

### Advertiser - Page

Henry Engineering - 2  
Inovonics - 1, 27  
Kay Industries - 47  
Logitek - 41  
Michael Patton - 47  
Mega Industries/MCI - 28  
Mooretronix - 44  
Myat - 39  
Nautel - 7  
NTI - 34  
OMB - 20  
Phasetek - 47  
ProAudio.com - 30  
PSI (Propagation Systems) - 39  
Radio Systems - 26  
RF Specialties - 43  
SCMS - 11  
Shively - 38  
Smarts Broadcast Systems - 15  
Stackley Devices - 46  
Studio Items - 37  
Tieline - 9  
Titus Labs - 32  
Transcom - 43  
Wheatstone - 3, 24, 25, 48

### Website

[www.henryeng.com](http://www.henryeng.com)  
[www.inovon.com](http://www.inovon.com)  
[www.kayind.com](http://www.kayind.com)  
[www.logitekaudio.com](http://www.logitekaudio.com)  
[www.michaelpatton.com](http://www.michaelpatton.com)  
[www.mcibroadcast.com](http://www.mcibroadcast.com)  
[www.mooretronix.com](http://www.mooretronix.com)  
[www.myat.com](http://www.myat.com)  
[www.nautel.com](http://www.nautel.com)  
[www.minstruments.com](http://www.minstruments.com)  
[www.omb.com/en](http://www.omb.com/en)  
[www.phasetekinc.com](http://www.phasetekinc.com)  
[www.proaudio.com](http://www.proaudio.com)  
[www.psbroadcast.com](http://www.psbroadcast.com)  
[www.radiosystems.com](http://www.radiosystems.com)  
[www.rfspecialties.com](http://www.rfspecialties.com)  
[www.scmsinc.com](http://www.scmsinc.com)  
[www.shively.com](http://www.shively.com)  
[www.smartsbroadcast.com](http://www.smartsbroadcast.com)  
[www.stackleydevices.com](http://www.stackleydevices.com)  
[www.studioitems.com](http://www.studioitems.com)  
[www.tieline.com](http://www.tieline.com)  
[www.tituslabs.com](http://www.tituslabs.com)  
[www.fmamtv.com](http://www.fmamtv.com)  
[www.wheatstone.com](http://www.wheatstone.com)

## No 3-phase power? No Problem!

Operate any 3-phase broadcast transmitter from a 1-phase utility supply!



- Turn any location into a 3-phase site within hours!
- Save thousands \$\$ on utility line extensions
- Recommended by leading transmitter manufacturers
- True 3-phase, not open delta
- Over 1500 Radio & TV installations worldwide
- Rotary design stores energy and rides-through line transients far better than electronic devices.

If you have ANY questions about 3-phase electric power for your broadcasting application, do yourself a favor and call Kay Industries first!



South Bend, IN 800-348-5257  
Fremont, CA 877-348-5257

The World Leaders in Single to Three-Phase Power Conversion

## PHASETEK INC.

### Custom Phasing Systems

Phasetek, Inc. is dedicated to provide the broadcast industry high quality AM Phasing and Branching systems, Antenna Tuning units, Multiplexers, and RF components.

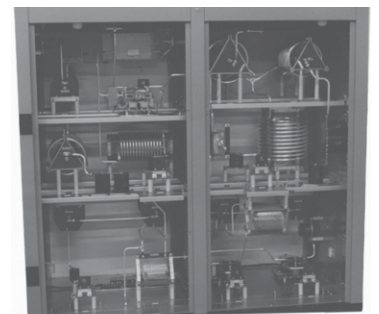

Phone: 215-536-6648  
[sales@phasetekinc.com](mailto:sales@phasetekinc.com)  
[www.phasetekinc.com](http://www.phasetekinc.com)

## DO WE HAVE A FLASHER FOR YOU!

NO, NOT THAT ONE ..... THIS ONE!

### THE STUDIO HOTLINE PHONE FLASHER SERIES

THE FIRST PHONE FLASHER, ALERT AND DOOR INDICATOR SYSTEMS THAT ARE DESIGNED EXCLUSIVELY FOR THE BROADCASTER, WITH THE FOLLOWING FEATURES:

- \* Distinctive color multiple ultra-brite wide angle LED flashers and distinctive audible alerts for both phone, alert or door
- \* Single line stand-alone units and multi-line systems available with up to 12 lines in and up to 5 display indicator modules
- \* Audible alerts muted by contact closure or logic low
- \* Driving voltage output provided for the DME Solid State Relay Pack for lighting incandescent lamps
- \* Adjustable volume for audible alerts (Off-Low-High)



And the best part is the price!

Single Line Units: \$98.00  
Multi-Line Units: 4 line \$178.00  
8 line \$208.00  
12 line \$238.00

For details on these and other innovative products for the broadcaster, call us or visit us on the web at:  
[www.dengineering.com](http://www.dengineering.com) 1-800-249-0487  
2174 Chandler St. Camarillo, CA 93010 805-987-7881

ENJOY THE SOUND!



## MICHAEL PATTON & ASSOCIATES

[MICHAELPATTON.COM](http://MICHAELPATTON.COM)  
BATON ROUGE 225-752-4189  
[MIKE@MICHAELPATTON.COM](mailto:MIKE@MICHAELPATTON.COM)

EQUIPMENT REPAIRED/RETUNED/REBUILT  
AN ALTERNATIVE TO FACTORY SERVICE AT REASONABLE RATES

- ✓ AM & FM TRANSMITTERS (UP TO 50KW)
- ✓ TRANSMITTER MODULES, BOARDS, & ASSEMBLIES
- ✓ ORPHANS: HARRIS, OMNITRONIX/LPB, MARTI, ENERGY-ONIX
- ✓ POTOMAC & OTHER ANTENNA MONITORS
- ✓ EXCITERS, STLs, AUDIO & MIC PROCS, R/C UNITS, ETC
- ✓ SOLID STATE FM POWER AMPS

OTHER ODD GEAR?  
CALL US AND SEE!



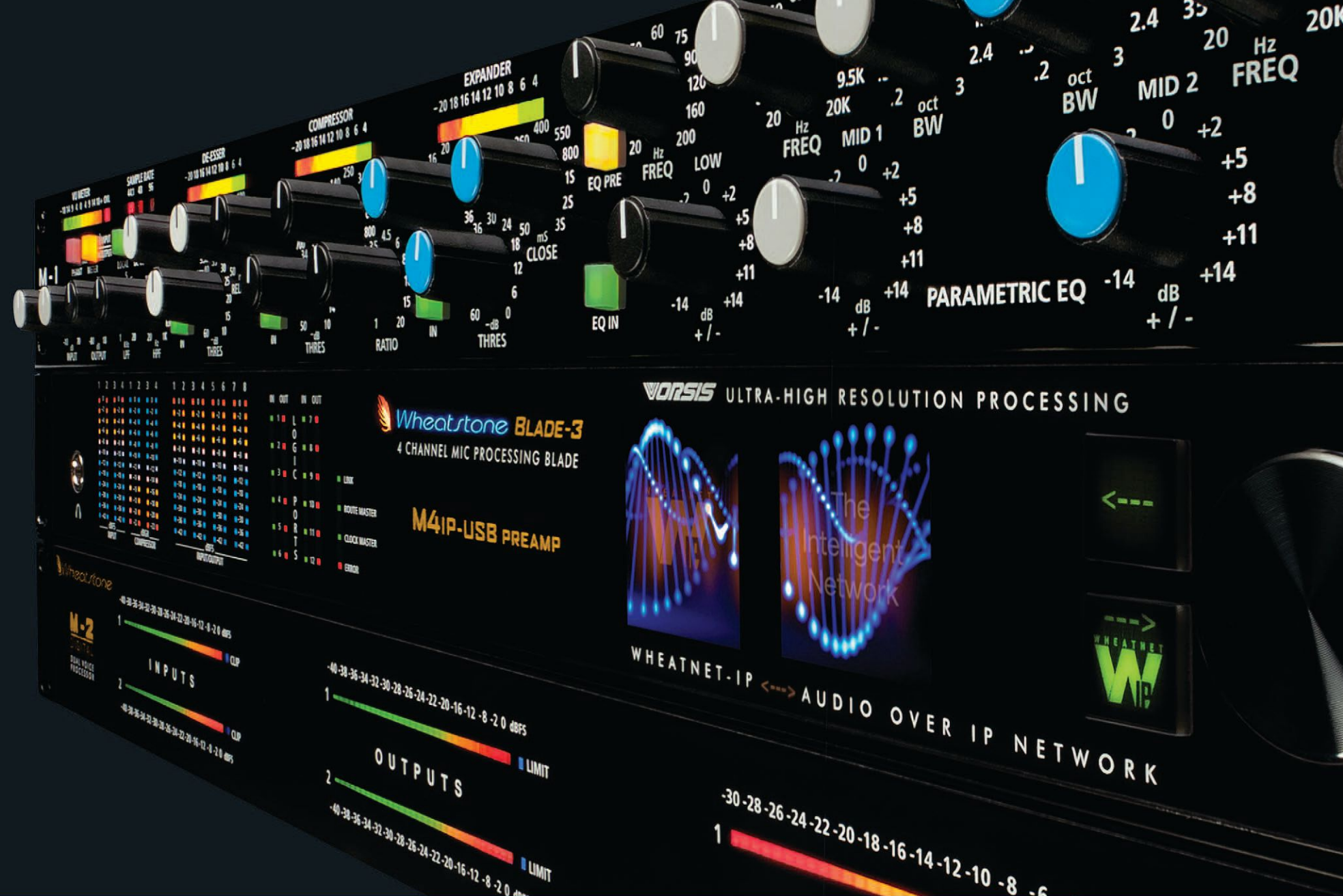

## Make Them Sound Great

Push your talent's voice beyond the limits and dominate the airwaves

Wheatstone Voice/Mic processors give you everything you need to make voices grab listeners by the ears.

For our SQ (Super Quiet) mic pres, we emulated and hot-rodded legendary studio preamps to sound incredible for modern radio.

Our compressors, limiters, & EQs are maximized for vocal smoothness, allowing your talent to stand out on-the-air.

Wheatstone's Graphical User Interfaces give you deep, intuitive control to tweak our world-class presets and save those you create.

The result? Voices that can sound superhuman.

### Wheatstone M-Series Voice/Mic Processors

**M-1:** single channel with knobs and buttons • **M-2:** dual channel with multiband compression • **M4-IP USB:** four-channel networkable BLADE-3

Learn more at [wheatstone.com/superhuman-voices](http://wheatstone.com/superhuman-voices)

