

Radio Guide

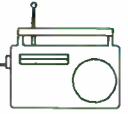

Radio's Technology Forum

July 1995

The Great Guide Contest

For the last five years, Rita has badgered me to clean out my shop. Well, that day has come (through no fault of my own), and those old circuit cards, components and miscellaneous pieces of equipment are destined for the Radio Guide "prize box."

It's hard to say if these items are prize or punishment, but they are free to the winners of our first annual Great Guide contest. I didn't have time to shoot some photos, so you'll have to let your imagination do the job. Here are the prizes:

- 1st — A Tellabs 4008 Program Amp With Case
- 2nd — A 4CX15000A Tube (can be rebuilt)
- 3rd — A Miller 1mHz Frequency Standard
- 4th — A "Million" 2 & 3-wire Molex Connectors
- 5th — Ten "Wall-Warts" of Various Voltages
- 6th — 100-foot Aviation Orange Extension Cord
- Last — Ye Olde Scrap Box (contents unknown)

In as many words as you think it takes, tell us about the worst on-the-job "disaster" you've ever had. It has to be more-or-less related to radio engineering, and if you are reading this now, you're automatically obligated to enter the contest. Oops — you're too late!

Just mail, fax or e-mail your entry by, let's say, August 21st. All prizes will be awarded . . . to someone! I've selected (coerced) a few engineers to be our contest judges. Actually I told them that if the prizes weren't awarded, they would be receiving one of them in the mail.

If, for some unforeseen reason, we don't receive any entries by deadline, I'll be randomly selecting Radio Guide subscribers to receive the prizes. It could be you, so protect yourself by entering now! Here's where/how to send it:

INTERNET E-Mail — 71203.2341@Compuserve.com

COMPUSERVE E-mail — 71203,2341

— OR —

Radio Guide
Mail to: 511 18th St. SE
Rochester, MN 55904

FEATURE OF THE MONTH

TASCAM PA-20 MK II Dual Power Amp
BIG POWER FOR A LITTLE PRICE

For maximum flexibility, the PA-20 MK II is equipped with both XLR balanced and RCA

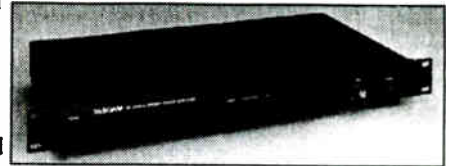

unbalanced input connectors. At 25 watts per channel, it excels in control room and production studio applications.

ABG Special Price **\$189⁰⁰**

Please call today!

MAIN SALES OFFICE
2342 S. Division Avenue
Grand Rapids, Michigan 49507
Phone: 800-999-9281
Fax: 616-452-1652

SOUTHEASTERN SALES OFFICE
200 Fareway Drive, Suite 2
Smithfield, North Carolina 27577
Phone: 800-369-7623
Fax: 919-934-8120

WESTERN SALES OFFICE
P.O. Box 1638
Palmdale, California 93550
Phone: 800-858-9008
Fax: 805-273-3321

For 35 years
AUDIO
broadcast group inc.

YOU MAY ALSO REACH US ANYTIME VIA ELECTRONIC MAIL
cServe: 75371,144
internet: support@abg.com

Inside This Issue

A Hot Console (guest editorial)	2
Some Satellite Basics	3
NRSC: The New Proof	4
Studio Relocation	7
Murphy Was an Optimist	8
Telco American and BET EBS Mods	9
Battery Operated Mic Preamp	10
Contract Recordkeeping	11
TFT "E-Alert" EBS Modification	11
Universal's Satellite Guide	12
Product Page (JK Audio)	13
Radio Guide Supporting Advertisers	14

Radio Guide

July 1995

Volume 7, Number 7

The Radio Forum

From George Whitaker — Arlington, TX

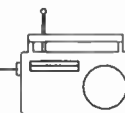

Radio Guide Publication

Raymond Topp (*editor and publisher*)

511 18th Street SE, Rochester, MN 55904

Phone: 507-280-9668

Fax: 507-280-9143

Our Contributing Technical Writers

George Whitaker - Arlington, TX

3505 Daniel, Arlington, TX 76014

Phone: 817-468-2586

John Bredesen - KLCC, Eugene, OR

3120 Nob Court, Eugene, OR 97405

Phone: 503-485-6869

Gordon Carter - WFMT, Chicago, IL

34 North Madison Ave., LaGrange, IL 60525

Phone: 312-565-5032

Andy Butler - Broadcast Electronics Inc.

P.O. Box 3606, Quincy, IL 62305

Phone: 217-224-9662

Frank Berry Ph.D.

190 112th Ave. N, #708

St. Petersburg, FL 33716

Phone: 813-577-0041

How to Submit Tech Tips

By BBS: Call our BBS at 507-280-4045, and leave your tech tips, info and articles.

By Disk: Send your tech tips and information on a 3.5" or 5.25" double, or high density floppy disk, in ASCII format.

By Compuserve: Leave E-Mail files to Radio Guide at Compuserve ID — **71203,2341**

By INTERNET: Leave E-Mail files to Radio Guide at Internet ID — **71203.2341@Compuserve.com**

A "Hot" Console

Recently I was called to a station where I learned some things I want to share with you about heat sink compound. The station took a lightning strike and the console power supply had blown a couple of voltage regulators, as well as a number of IC's scattered throughout the board. The station manager had called a local guy first and he had put in new regulators. But, he decided that he was in over his head and he left with the console still inoperative.

When I arrived, I found that the regulators (there were four of them for the four different voltages used) would heat up and shut off from thermal shut-down. After tracing down, and replacing, a number of shorted IC's and transistors, I had the console operating.

However, the +6 volt regulator was still running hot. The console would run OK for a while and then shut down. Giving it a minute or so of cool-down time would bring it back up and it would operate for an hour, or maybe five hours. Then, the regulator would shut down again.

I carry with me an industrial type thermometer for checking things like exhaust stack temperature. So, I placed the thermometer on the regulator to see what its temperature was running. This gave me a way to find out what was really happening.

The regulator was running about 140°. As the temperature in the room would vary a few degrees, the regulator would reach 145°. At this temperature, the built-in thermal shut-down would kick in, and the console would quit. I was convinced that I still had an IC somewhere drawing too much current and causing the regulator to operate on the ragged edge.

I went through every board again and could find nothing wrong. Then I decided to look at the regulator itself. I discovered that the guy before me had replaced the regulator without adding heat sink compound. All of us have done this at one time or another because the third rule of radio says, "Whatever I need is wherever I'm not." I had always wondered how much difference that awful, messy, gooey, stuff really made.

I got some heat sink compound and redid the regulator with the compound properly applied. Boy, did I get a surprise. The temperature immediately dropped to 120°. Instead of a five degree tolerance level for room temperature variance, I now had a 25° tolerance. The console began to operate as it should and I found out how much difference that goo really makes.

Radio Guide (ISSN 1061-7027) is published monthly, 12 times a year, by Media Magazines Inc., 511 18th Street SE, Rochester, MN 55904.

All material contained in Radio Guide is copyright 1995 by Media Magazines Inc., and may not be reproduced or stored in any form without the written permission of the publisher.

Some Satellite Basics

George Whitaker — Arlington, Texas [817-468-2586]

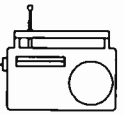

Stations have been using satellite fed signals for some years now and there have been some changes along the way. We started out using only analog signals in the C-band and LNA's were the only low noise amplifiers available. Now there are a number of different transmitting and receiving formats, and the LNB has supplanted the LNA as the unit of choice. Let's take a look at some of the terminology and some of the changes that have come about.

The LNA

LNA stands for Low Noise Amplifier. Specially manufactured and selected transistors are used to create an amplifier that will amplify the minute signals received from a satellite without adding an appreciable amount of noise of their own. LNA's have the disadvantage of having their output at the same frequency as the received signal. In C-band, this is 3.7 to 4.2 GHz. Now, remembering that the higher the frequency, the greater the attenuation of the signal in a given cable, you can see why 1/2-inch, or larger cable is always used on an LNA installation. On an LNA system, the signal at the input of the receiver is the same as the signal leaving the satellite.

The LNB

The development of the Low Noise Block Converter, or LNB, allowed the use of smaller cable, usually RG-6. The incoming frequency is beat against a local oscillator inside the LNB to produce an output of 950 to 1450 MHz. This intermediate frequency is low enough that cable attenuation is much less and, therefore, smaller cable and longer runs can be used. The only problem I have encountered with this system is that you need to make sure you place the dish where it is not pointing past your STL transmit dish, because an STL operates in the 950 MHz band and may cause interference.

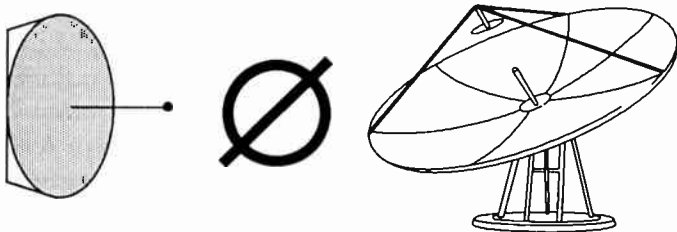

This is not a big problem unless the dish is actually pointed in the direction of the STL dish. They won't cause interference if they are off to the side. However, I did encounter one situation where it caused considerable grief.

Inside the receiver itself, the 950 to 1450 MHz signal is beat against the receiver's local oscillator to produce an intermediate frequency in the 70 MHz band. This is the frequency that is actually tuned by the receiver.

The Dish

The parabolic dish is merely a collector, or concentrator, of the signals coming from the satellite. The actual antenna is the small cross, or tubing, sticking up inside the LNA (or LNB). The inside of the LNA(B), is a tuned cavity, and the placement of the antenna in this cavity is critical for proper operation. Therefore, you should never poke around on the antenna as the movement of just a centimeter or so can make the difference between working and not working.

The Receiver

Today's receivers are generally made in sections to allow more versatility in tuning the different channels we need. The first stage is always the tuner itself. This supplies the power, through the cable center conductor, to the LNA, or B. It takes the incoming signal and tunes the transponder selected. Now, remember that each transponder is a group of frequencies. Therefore, the output of the transponder tuning section is a block of frequencies that are present on that particular transponder. These appear as a 70 MHz band intermediate frequency (actually still a group of frequencies) or, if we are after subcarriers, as a video signal with all of its subcarriers still included. This is usually labeled "baseband" or "unclamped video." The first stage, usually a card within the card cage, will supply one of these two items (70 MHz or baseband video) to the following stages. This signal is generally looped through the other cards in the cage and terminated at the last card in the daisy-chain.

The cards that follow the transponder tuning stage will be the ones that actually tune the specific SCPC, subcarrier, or digital channel that is desired. Each card will generally tune one specific frequency from the baseband or 70 MHz IF that is presented to it. This is why you can have a receiver that can simultaneously tune several different channels on the same transponder. Each card is responsible for selecting one program channel from the group of frequencies presented to it by the first stage transponder tuning.

All Radio Guide paid subscriptions have been converted to free lifetime status.

NRSC: The New “Proof of Performance”

George Whitaker — Arlington, Texas [817-468-2586]

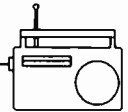

Years ago, all stations had to do an annual “proof of performance” in which the audio response, distortion, and other parameters were measured. This P.O.P. also included, for AM stations, a check on harmonics and other “out of band” emissions.

Today, the prevailing view is that competition will make a station keep its audio in good shape. The rules deal only with the part of the station that might cause interference. Therefore, the new “proof of performance” deals solely with the RF emissions. Like the old P.O.P., these measurements are required annually for all AM stations.

FM stations are not subject to this requirement. However, something many stations are not aware of is the fact that FM stations are required to do emissions measurements any time they install a new transmitter, exciter, or make other major changes in the RF chain.

Before we take a look at how the new P.O.P is done, lets review the rules that require this. The first rule, 73.44, spells out what will be done and the second rule specifies when you will do it.

73.44 AM TRANSMISSION SYSTEM EMISSION LIMITATIONS

(a) The emissions of stations in the AM service shall be attenuated in accordance with the requirements specified in paragraph (b) of this section. Emissions shall be measured using a properly operated and suitable swept-frequency RF spectrum analyzer using a peak hold duration of 10 minutes, no video filtering, and a 300 Hz resolution bandwidth, except that a wider resolution bandwidth may be employed above 11.5 kHz to detect transient emissions. Alternatively, other specialized receivers or monitors with appropriate characteristics may be used to determine compliance with the provisions of this section, provided that any disputes over measurement accuracy are resolved in favor of measurements obtained by using a calibrated spectrum analyzer adjusted as set forth above.

(b) Emissions 10.2 kHz to 20 kHz removed from the carrier must be attenuated at least 25 dB below the unmodulated carrier level, emissions 20 kHz to 30 kHz removed from the carrier must be attenuated at least 35 dB below the unmodulated carrier level, emissions 30 kHz to 60 kHz removed from the carrier must be attenuated at least $(5 + 1 \text{ dB/kHz})$ below the unmodulated carrier level, and emissions between 60 kHz and 75 kHz of the carrier frequency must be attenuated at least 65 dB below the

unmodulated carrier level. Emissions removed by more than 75 kHz must be attenuated at least $43 + 10 \log$ (power in watts) or 80 dB below the unmodulated carrier level, whichever is the lesser attenuation, except for transmitters having power less than 158 watts, where the attenuation must be at least 65 dB below carrier level.

(c) Should harmful interference be caused to the reception of other broadcast or non-broadcast stations by out of band emissions, the licensee may be directed to achieve a greater degree of attenuation than specified in paragraphs (a) and (b) of this section.

(d) Measurements to determine compliance with this section for transmitter type acceptance are to be made using signals sampled at the output terminals of the transmitter when operating into an artificial antenna of substantially zero reactance. Measurements made of the emissions of an operating station are to be made at ground level approximately 1 kilometer from the center of the antenna system. When a directional antenna is used, the carrier frequency reference field strength to be used in order of preference shall be:

(1) The measured non-directional field strength. (2) The RMS field strength determined from the measured directional radiation pattern. (3) The calculated expected field strength that would be radiated by a non-directional antenna at the station authorized power.

Section (e) of this rule simply says that stations were exempted from having to make these measurements until June 30 of 1994 so long as they had installed an NRSC package in their transmitting chain. Therefore I am not reproducing it here.

The time period for making these measurements is set forth in 73.1590. For brevity in this article I am going to simply say TV for the sections dealing exclusively with television.

73.1590

(a) The licensee of each AM, FM, and TV station, except licensees of Class D non-commercial educational FM stations authorized to operate with 10 watts or less output power, must make equipment performance measurements for each main transmitter as follows:

(1) Upon initial installation of a new or replacement main transmitter.

(2) Upon modification of an existing transmitter made under the provisions of 73.1690. Modification of transmission systems, and specified therein.

NRSC: The New Proof

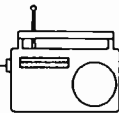

(continued from page 4)

(3) *Installation of AM stereophonic transmission equipment pursuant to 73.128.*

(4) *Installation of FM subcarrier or stereophonic transmission equipment pursuant to 73.295, 73.297, 73.593 or 73.597.*

(5) *TV*

(6) *Annually, for AM stations, with not more than 14 months between measurements.*

(7) *When required by other provisions of the rules or the station license.*

(b) *Measurements for spurious and harmonic emissions must be made to show compliance with the transmission system requirements of 73.44 for AM stations, 73.317 for FM stations, and 73.687 for TV stations. Measurements must be made under all conditions of modulation expected to be encountered by the station whether transmitting monophonic or stereophonic programs and providing subsidiary communications services.*

(c) *TV*

(d) *The data required by paragraphs (b) and (c) of this section, together with a description of the equipment and procedure used in making the measurements, signed and dated by the qualified person(s) making the measurements, must be kept on file at the transmitter or remote control point for a period of 2 years, and on request must be made available during that time to duly authorized representatives of the FCC.*

Although it is not mentioned in the rule, there is also a question on the current license renewal form that asks about these measurements. You have to certify that the terms of the applicable rules have been met.

Now let's see what all of this means to the individual station.

Section (a) specifies the equipment to be used. This is the part that makes doing these tests expensive. In checking around for an analyzer, we found that it is impossible to acquire an analyzer that will meet the bandwidth and peak hold requirements for less than \$10,000. The lowest priced model Tektronix had was the 2712 which, in combination with the plotter used to print the report, came to right at \$13,000.

I have talked to a number of people across the country who are telling me that they are using military surplus or lesser analyzers such as the Tektronix 2710. The 2710 can be used with certain factory options. However, by the time you get the necessary options, the cost is about the same as the 2712. Some of the descriptions given to me of the

equipment used, and the methodology reported to me, leads me to believe that a number of stations around the country think they have complied, when an inspection would reveal equipment or methodology deficiencies sufficient to negate the results.

The second part of section (a) allows for the use of specialized measurement equipment such as the Delta "Splatter Monitor." This is a reasonable choice for a station that already owns a field strength meter, such as the Potomac FIM 41, which is capable of reading the harmonics. An FIM 21 or Nems Clark (RCA), will not meet the requirements as they can not measure high enough to check the harmonics.

The Delta monitor, as it comes, will not meet the requirements of distance, bandpass, or harmonics. It is made to connect directly to the transmitter and the rules require readings at a kilometer. By the time you buy the monitor and the necessary accessories to meet the rules, they are actually around \$5000. If, however, you have to purchase a new FIM 41 (around \$5000) to get the harmonic reading, you are back up to the \$10,000 range. Any way you choose to go, the equipment to do these measurements, bought today, is going to run around \$10,000 minimum.

Again, I have talked to stations who informed me that they had a monitor attached to their transmitter and measured all the time. Therefore, they are sure they are in compliance. However, all they are proving is that they have not read the rules.

Section (d) tells us that the measurements should be made at approximately 1 kilometer from the center of the antenna system. This spot should be selected to stay away from power lines, water towers, or any other object that would possibly skew the readings. In the case of a directional antenna, it should be in a major lobe. Although the rules don't specify this, two different FCC field inspectors suggested to me that we make this our practice.

Whether you are using a field strength meter or a spectrum analyzer, the reference field strength will probably be method (1) or (2). If it is easy to go non-directional, you might want to use method (1). Method (2) simply means that you take the reading in the major lobe, either on the spectrum analyzer or the FIM, and use it as reference. On a spectrum analyzer, WYSIWYG. If you are using a field strength meter, such as the FIM 41, you will want to switch your meter function to log, and then tune up to the first, and then second harmonic, listening as you go for any other "out of band" emissions. The RMS field strength is what the meter will be reading when you read the fundamental, so it becomes your reference under methods one and two.

(continued on page 6)

NRSC: The New Proof

(continued from page 5)

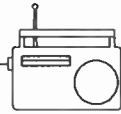

If you are into masochism, or otherwise enjoy doing things the hard way, you can use method (3) and calculate the expected field strength.

Now let's see what we are to get from these procedures. Take a look at Figure 1. This is a plot of the NRSC portion of the test. I have drawn lines to represent the approximate limits. As you can see, this station passed with flying colors. Now, take a look at Figure 2. This station passed, but barely. The indication to me is that station #2 needs to check their equipment. I did not make the measurement on station #2, Dave did. However, he tells me that they sounded terrible and the plot reflects the fact that the overall quality is bad.

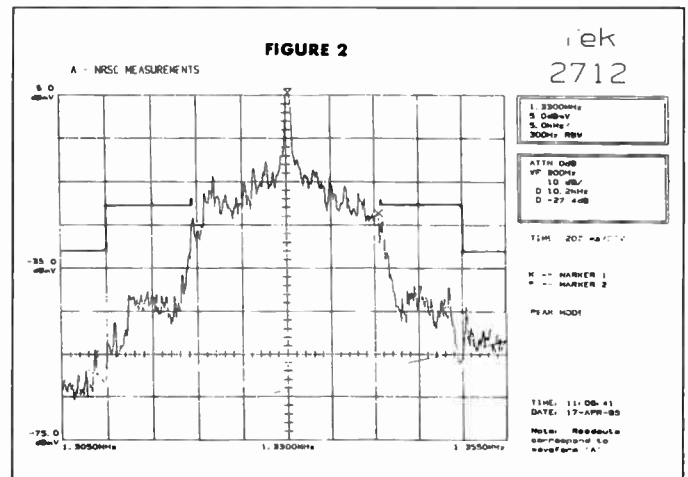
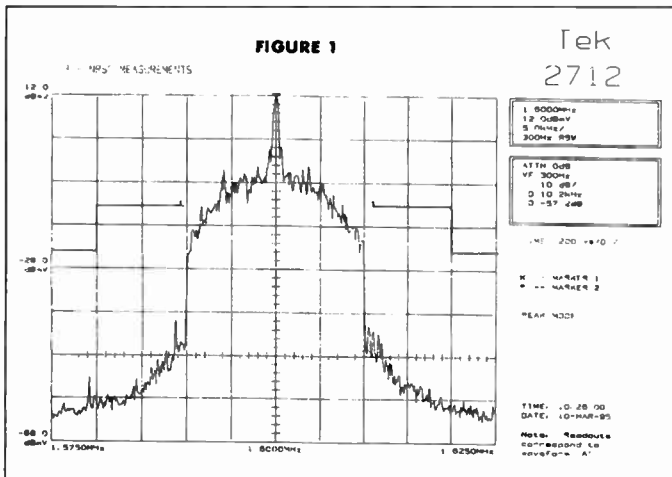

creased in a commensurate amount to the reference. Unless they tracked exactly with the reference, you can disregard them. This can quickly eliminate many of the questionable pips. Any that are left should be checked and identified with a scanner or the audio section of the analyzer, if it has a speaker built into it. Any other stations that show in the printout are generally easy to identify because they will be at 10 kHz intervals and, if they are close, will have the shape of the NRSC mask.

I usually list each of these in the "comments" of the report, although it is not necessary. I also list any other pips that are above the limit for the station I am checking and describe how I determined that they were not emanating from the station. In metro areas, such as Dallas, the man-made background noise is higher than the limit of the station. In these cases I just make a note of it. If I can't read the station, neither can the FCC.

In the second portion of the test we want to take a look at emissions beyond 75 kHz from the carrier. The rules say that this should be 80 dB, or $43 + 10 \log(\text{power in watts})$, below the unmodulated carrier; whichever is the lesser amount. Taking an example of this: We have a 500 watt station; what is the limit for beyond 75 kHz? $500 \log$ is 2.698, times 10 is 26.98, plus 43, equals 69.9 dB. Therefore, the limit for a 500 watt station is, in round numbers, 70 dB below carrier instead of 80 because 70 is the smaller of the two numbers.

If you have a calculator with scientific functions, the sequence is 500, push the "log" button, times 10, equals, plus 43. This sequence, of course, may not apply to all calculators; but, it does for the one I have and the one Dave carries. Mine cost less than \$30 and Dave's is built into his watch, so you don't need an expensive calculator.

When the measurement is made, a loop antenna allows you to check some of the unknown, questionable, pips on the screen by turning the antenna until your reference drops, then seeing if the unknown pips increased or de-

Now, what about the area that is under another station in the reading? For example, in Figure 1 we are looking at a station on 1540 and the stations at 1600 and 1480 cover up part of the spectrum where "out of band" emissions might possibly fall. If you don't find anything wrong with the part you can see, then you can reasonably assume that the part you can't see is OK. If there was significant radiation under one of the other area stations, they would be complaining about it. I have discussed this with FCC representatives in Dallas, Los Angeles, and Washington. They are going to see the same thing on their analyzer that you see on yours. They would not make four or five stations shut down, just to look at one. If you have a real problem, it would show up in the areas that can be seen, or someone would be complaining.

Dave and I have done measurements from coast to coast, and the vast majority passed easily. The key to this test series, as well as competitiveness in the marketplace, is to keep your equipment adjusted for proper levels. Overdriving is the real killer of good performance.

Studio Relocation

Andy Butler — B&G Consultants, Annandale, Virginia [703-739-5474]

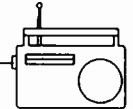

Studio relocations, triggered by the recent spate of ownership changes, have suddenly thrust many engineers into the role of property manager, facility designer and project coordinator. Unfortunately most engineers only get to design a few facilities during a career, so common mistakes are repeated in many facilities. From the school of hard knocks, here are some thoughts on getting it right.

Avoid thinking of air studios and production rooms as offices with equipment. You will come closer to a design that supports the real needs of the users if you consider studios as “stages.” They really are the location where talent performs. Our job is to make certain that the facility is comfortable and provides all of the tools they need (or *think* they need) to perform at their best. Consider how the performer will “feel” as you layout their space. Will “the stage” be a comfortable place to spend four to six hours working at “warp speed” every day? As you consider compromises to reach the necessary budget numbers, be sure that you can justify your decisions from a performer’s viewpoint, not just the technician’s or the book keeper’s.

The most crucial consideration for the entire operation is space. I have never heard anyone say “man, I wish this studio was smaller” or seen anyone who’s office was “just too damn big.” A good device to use is a “space invoice.” This is a formal design procedure that compiles a list of every function performed in a given space, lists the space necessary to perform the tasks, then compares that list against the facility layout to make sure each function is adequately served.

Interestingly enough, when most people are asked to prepare a task list for the space invoice they will leave out at least half of the jobs that they face during an operating day. If the facility goes into service without correction, those oversights turn into constant, inescapable irritations that severely limit performance. Adding more space is incredibly expensive so the users suffer and the engineers take constant abuse. Remember, your two-person morning show can turn into a five-person zoo at the drop of a program consultant. The incremental cost of including an extra thousand or so square feet is tiny compared to expanding an existing room.

Space is critical, but the facility also has to support a logical work flow. A radio station is a programming production system that combines people, machines and material to create an On-Air service. Consider all of the complex interactions that take place in your station(s) every day before you start dropping offices and studios onto a floor plan. Just a little bit of “human engineering”

will make sure you have a darn good reason before you put the traffic office on the other side of the building from the air studio! Also remember that non-program activities such as sales and promotion really are integral parts of station operations. If you figure them into the flow from the beginning, it will pay enormous dividends.

The whole building is a technical plant. Gone are the days when offices only needed lights and a phone. With computer networking, telecommunications and other electronic enhancements, the “common office” requires almost as much wiring infrastructure as a studio. The good news is these pressures have made architects and contractors much more aware of the need for easy cable access. The bad news is that most of that access has been gained by sacrificing structural integrity that used to provide at least minimal levels of sound isolation and electrical shielding. That is annoying in a regular office but can be disastrous when the newsroom, production rooms and air studios (not to mention the stereos in all of the offices) are cranked up all at the same time.

Keep a watchful eye on every single penetration through walls, ceilings or floors in the design, construction and installation phases! [When the HVAC designer mentions “plenum ceilings” hit them with something very large! That technology is great for a doctor’s office, but a radio station needs good, heavy, well insulated return ducts!]

Radio Stations operate twenty four hours a day. This is no problem if the station(s) are in a standalone building, but most operations can’t afford that level of up front expense so they look to commercial space in existing multi-purpose buildings. This puts special requirements on building security staffs and physical plant. A simple example is air conditioning. To meet environmental regulations and save money, most building HVAC system operate during normal business hours, cycling way back at night and on weekends. Solving this problem can require complicated negotiations with everyone from local code enforcers to the building owners. After the talking is over, you still have to figure out how to house an auxiliary system, in a location that wasn’t considered when the building was built, and then make sure it works correctly with the original building system. Make sure that there is easy 24-hour access for staff and guests. A dedicated door with key-card or touch-pad activated electronic locks preserves security while saving an enormous amount of staff hassle in the long term.

Those are some general ideas to help you get started. Next time we’ll continue with a list of specific does and don’ts that will make your studios the best stage in town.

Murphy Was an Optimist

Gordon Carter — C.E., WFMT, and Owner, Professional Audio Services [312-565-5032]

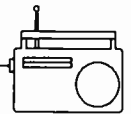

For a number of years I have been interested in the teachings of the great philosopher by the name of Murphy. Perhaps you have heard of his Law of the Perversity of Matter which states “Whatever can go wrong, will, and at the most inopportune time.” After the week I have just had, I think I can safely say that Murphy was an optimist. Let me explain.

The radio station I work for is in the process of preparing to move. We are moving to a new wing of a building that houses our sister TV station. While some of the interior finish work still remains to be completed, the shell of the wing is done. The new wing has been built on the site that used to house two satellite receive dishes for the TV station and a transmit and receive dish for our radio station and network. The dishes were moved to various points in the parking lot until the building was done, and then they were to be moved to the roof of the building. This week was the big move to the roof.

Another part of this equation is a transfer of ownership of the radio satellite dish and the installation of some new electronics relating to it. Most of the new equipment arrived in the last two weeks, except for a few items that we were able to borrow for the interim.

The schedule as it related to my work was as follows:

Monday — move 10 meter TV receive dish and set up a temporary dish for the radio uplinking.

Tuesday — finish move of the 10 meter dish and begin moving the radio dish.

Wednesday — finish moving the radio dish and complete the electronics change.

Of course, all of this is complicated by the fact that the radio dish is in use 24 hours a day with only short openings for testing and down time. By now you have probably guessed that all did not go according to schedule.

Monday began with the dish movers arriving along with the rented crane. The dish movers ordered a 35 ton crane to handle the long reach required by the setback from the edge of the roof. The crane that arrived was a 20 ton unit. They tried to make the best of a bad situation but were unable to move the large dish completely on Monday.

Also on Monday the electricians were to connect the primary power for the uplink power amplifiers and move the uninterruptable power supply (UPS) to its new location. When they looked at the power connections on the power amplifiers, they were confused. We had ordered 110 volt single phase power since that is what the UPS puts out. We were provided with 208 split phase on the power amplifiers. Off to the telephone.

At the same time we were expecting some BNC connectors for the ends of our RG-11 IF cable. We used RG-11 to minimize losses since the IF run is about 200 feet. They were to arrive Monday. They didn't. Back to the phone. They should arrive first thing Tuesday morning.

Monday afternoon the temporary portable uplink arrived, right on schedule. Maybe something was going to go right today. No such luck. On the way to our location, the metal cover for the electronics assembly had come off. It was somewhere along the Pennsylvania Turnpike. No big deal since it was only for protection. However, we found out that the cover was necessary to maintain proper cooling and air flow through the unit. We had to whip up a temporary cover to keep things cool. As the dish was being set up, we found that some of the cables had not been packed with the system. Also, the 20 Amp circuit breaker for the air conditioner kept popping. Of course, this was the beginning of the longest and hottest stretch of weather for the year so far.

Deal with the problems one at a time. We increased the breaker, found some cables, and made the cover and taped it in place with some gaffers' tape. At about the same time we had a half hour window to bypass the UPS and remove it from its former location. The person we needed to contact for a clearance on one signal on the uplink was out to lunch. We missed the window.

As the transportable uplink operator tried to set up and test the dish, more problems crop up. First he had problems finding the satellite. Another two and a half hours gone. Then one of his upconverters did not work. More delays. We finally decided to wait until Tuesday morning to get it all working.

Along comes Tuesday. Today the proper crane arrives, the testing of the portable continues okay, but the BNC connectors did not show up again. Back to the phone.

By mid-afternoon we had the only window for the day to change to the temporary dish and try to remove the UPS again. This time it all works. Less than a half hour later the dish movers begin to disassemble our radio dish. It is not until late in the day that we get any word back about the power problem with the power amplifiers. Also, the BNC connector supplier doesn't seem to be returning their phone calls from our dealer. Late in the day the power amplifier manufacturer decides to send out a technician to change the primary power. It is more than a simple jumper change and will take most of the day. Is Wednesday okay? Even later we get word on the BNC connectors . . . next morning.

(continued on page 9)

Murphy Was an Optimist

(continued from page 8)

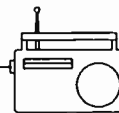

Wednesday morning comes and the power amplifier technician arrives to do his work. He will have to work around the electricians who are a day behind as well. However, the BNC connectors do not arrive. Back to the phones again. After a few more phone calls, we find out that the supplier really didn't have the connectors and nothing had been shipped after all. Our dealer does some more phone calls for us and finds half of the connectors we need for the project, in stock in town (this is Chicago after all). All we have to do is go get them. It will take about 2½ hours to go get them. We have to get the moved dish operating today since other aspects of the move have been done and passed the point of no return for at least part of the operation. Late in the day the connectors arrive and we get it all working (what we can) by 7:30 p.m. The rest of the connectors are in stock in North Carolina and will be drop shipped to us by overnight air so we have them first thing in the morning. Everything is powered up, but the UPS is not installed and the power wiring is only temporary. The electricians will finish tomorrow.

Thursday morning arrives but the connectors do not. Back to the phone. By this time we have already kept the transportable dish a day longer than anticipated. We need to get the rest of the operation moved today for a number of reasons. We continue with the various work related to it, while waiting for word on the connectors. About 1:00 p.m. we get a call from the dealer who asks to conference us. As I listen to the supplier, I can't believe my ears. He says he can't have them ready for pick up until 4:30 p.m. Remember, we are talking about only five BNC connectors. Some crazy story about entering everything in the computer. I

can't take any more and tell the dealer to call me back when they get it all resolved. To make a long story a bit shorter, we get the connectors in our hands about 4:30 p.m. We have a window beginning at 6:00 p.m. to do the final move. Put a few people to work on the connectors and keep your fingers crossed.

The connectors are on by 6:00 p.m. and we continue the move. We get it all sort of working by the deadline but find a loose connection two minutes before air time. We didn't have time to fix it right, so a clip lead does the trick. Audio levels are a bit of a guess, but it works on time.

Friday brings a new day. One program canceled on the uplink at the last minute gives us the longest opening of the week — three hours. During that time we tidy up all the levels, fix the loose connection, and call it done. Everything is working and installed, just two days late and with lots of aggravation.

I thought you might enjoy this story, since it shows that you are not alone when things go wrong. It is a bit like what I do when I start feeling bad about the work I need to do on my house (it's only about 100 years old). I go out and rent the movie "The Money Pit." It can always be worse.

Now you can have a chance to help me feel better. Do you have a story that can top this one, about how things go wrong? If so, send it to Radio Guide. It doesn't have to be long or fancy. We will even help clean it up a bit. For sending it in you will be entered in the annual Great Guide Contest. The winners will receive something from the Radio Guide "prize box," and you may even get your article printed. Good luck!

More about on the contest on page 1 . . . editor

Telco American and B.E.T. EBS Modifications

Ray Topp — editor

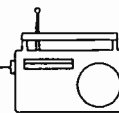

Here's a few more EBS conversion tips, I discovered in the last few weeks.

TELCO American EBS Unit

For the decoder, C7 is 2.2 uF tantylum. Change this to a 1.0 uF tantylum or polystyrene capacitor.

On the encoder, C12 is 1 2.2 uF tantylum. Change this to a 1.0 uF tantylum or polystyrene capacitor.

Some tweaking may be required.

B.E.T. EBS Unit

The B.E.T. uses 556 timers for the encode and decode circuits. Changing C-34 from 10 uF to 4.7 uF should change the decode, and changing C-38 from 27 uF to 10 uF will bring the encode tone to 7.9 seconds. Picking just the right 10 uF capacitor should get the encode tone to exactly 8 seconds.

Credit goes to Compuserve's Broadcast Professionals Forum (BPFORUM) for these two conversions.

Battery Operated Microphone Preamp

Frank Berry, Ph. D. — St. Petersburg, Florida [813-577-0041]

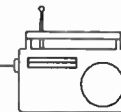

I am the official “Design Dude” for my employer, WTVT Television, Tampa. When WTVT needs a piece of equipment that is not readily found on the open market at a reasonable price, they ask me to create it. This is one my creations. It took me a couple of hours to build.

A few weeks ago, the News Director requested that our Engineering Department come up with some kind of battery operated amplifier that would bring a microphone up to +4 balanced line level, with enough reserve to run the amplifier for a few days before the battery had to be changed. The amplifier also had to produce low distortion and a flat audio response to 15 kHz.

With a pencil and legal pad in hand, I sat down and devised a simple little circuit using a single 2N2222 transistor, and a 5532 (or 1458) op-amp, power by a 9-volt battery.

I’ve also included a “POWER ON” LED. The LED goes dark when the battery voltage falls below 7.9 volts, indicating that the battery is getting weak.

The Circuit

The amplifier’s microphone input is not balanced. I have found it unnecessary to use balanced microphone inputs, unless the microphone cables are excessively long.

In this case, if you must run long cables, insert the amplifier close to the microphone and feed line-level output of the amplifier into the long cables.

The first stage of the microphone amplifier is an NPN 2N2222 transistor, This stage had an input impedance of 15,000 ohms and provides nearly 35 dB of gain to the non-inverting input of one of the amplifiers in the 5532 op-amp. The amplifier gain is controlled by a potentiometer in the negative feedback loop. The output of this amplifier feeds one side of the balanced output. It also feed the inverting input of the second amplifier within the 5532. This amplifier is a unity-gain phase inverter, which feeds the other side of the balanced output.

The LED “POWER ON” Indicator

I wanted an indication that the amplifier was on. I also wanted an indication that the battery was supplying adequate voltage for the amplifier to produce an out put of +4.

The “POWER ON” LED samples the battery voltage through a 1K current limiting resistor and a 6.8 volt zener diode. using this zener, the LED will extinguish when the 9-volt battery voltage drops below 7.9 volts. Below this operating voltage, the amplifier will not have adequate headroom and will begin to clip some of the audio peaks.

Battery Operated Microphone Preamp

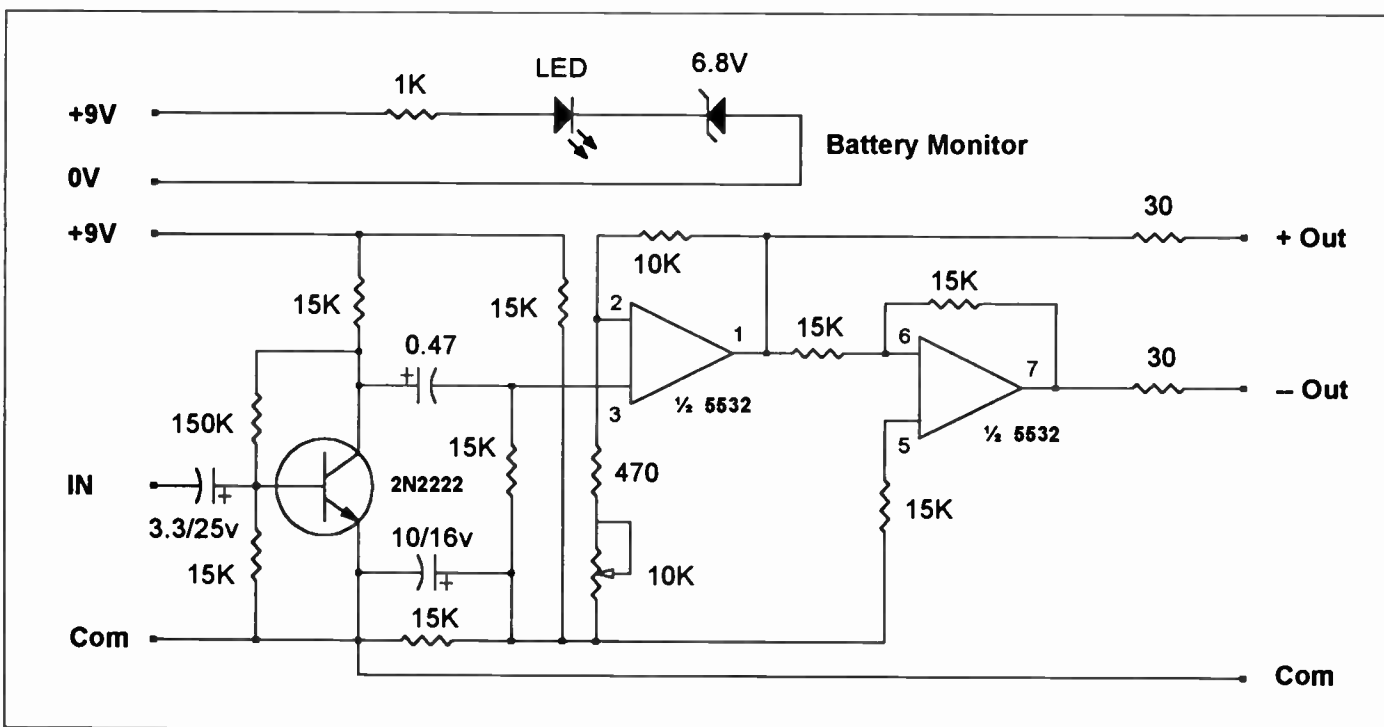

Contract Recordkeeping

Troy Langham — Radio Technical Group, Tulsa, Oklahoma

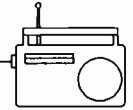

As your contract engineering business grows, you will find that the paperwork grows like mad! Next to the FCC legal, the IRS Legal and Billing come next in head time. I would like to share some of my systems for getting the billing, and some of the other, done.

My business had grown to having a part-time engineer and an almost full-time technician working with me. In just one day, we may do business with as many as 16 clients, especially during thunderstorm season.

My two other guys are very good at keeping written records of the work they do. I, however, do not share this gift. After trying various ways of making it easy to write it all down, I gave up. Radio Shack has a nice little micro cassette recorder for about \$30. This has been my salvation. When I arrive at a work site, I simply record the client's billing name, and the date and time.

When the work is finished, I dictate to the little recorder the end time, and what was done, as well as some notes on what still needs to be done. I can do all this while driving to the next job site, and still eat my lunch and keep a hand on the wheel.

At the end of the week, I take out the tape, put in a fresh one, and try and talk my wife into transcribing the recording. On those days (that she does), I am home free. But if I have to do my own, I fire up the word-processor and go at it for an hour or so. I file the tapes for later reference, keeping about six months on hand at any one time.

The document I create in my word-processor is the master work history for the business for any one month. Each paragraph is a description of the work done for a client on such and such date. I keep it by date, not client. When the guys turn in their work reports (along with demands for money . . . jees), I take the written reports and type them in by date and customer as well.

When the end of the month, and billing, rolls around, I simply open the master files, as well as an open window on the word-processor. I then copy and paste the paragraphs for one client to the open window. Once through the month, and I have a document for that client. I do this for each client until I have the master document broken up into little ones that I give to each client, along with the bill.

Let me mention that I am running Microsoft Word 6.0 for Windows. This is the best word-processor I have used in years. Not only can I have many documents open at a time, for working down the master list, but it has one of handiest drawing programs I have seen. I have found that most drawing that I used to do in my DAC program I can now do in half the time, in Word. For those complex, multi-layer drawings, I still fire up my Design CAD, but not for just a little document, such as a relay panel.

Once I have all the customer records printed out for the month, I enter them into my invoicing program. I am currently using Quick Books, from Intuit. It has an unlimited list of items that I can hot-key into the invoice, and it also takes care of statements, client lists, and aging. It allows me to track my A/P by client, so I do not forget to charge for some COD package that I wrote the check for. For a \$100 program, I like it, although the search engine is a little weak. However, I always find what I'm looking for, and the backup is easy to do.

This is not intended to tell you how to run your business, just how I am doing mine, at present. One day I might find the time to apply all those FORTRAN and PL2 computer hours I racked up in college, to code up my own database/invoicing/payroll program.

That will happen about the time I can take a four week vacation.

TFT "E-Alert" EBS Modification

Randall Rocks — Rocks Broadcast Engineering, Billings, Montana [406-245-6716]

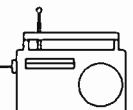

Yes, friends, another EBS modification. This one is for the TFT model #8020 "E-Alert" EBS receiver. This unit is in the form of a table-top, encode-only, fixed-tuned radio receiver TFT manufactured a while back. Its function is to decode an incoming EBS two-tone alert and un-mute itself.

Remove the three Phillips screws from the rear of the receiver, and remove the rear cover. This exposes the

component side of the PC board. Next, remove the volume control knob (small Phillips head); now the PC board will snap out of its enclosure.

Locate C-25, a 47 uF electrolytic capacitor (all components are clearly marked on the PC board). Replace it with a 20-22 uF, 35 volt tantalum capacitor. This will now provide a decode time threshold of about 4 seconds.

THAT-1

Telephone Handset Audio Tap

by **JK Audio**™



Simply connect **THAT-1** between your telephone and handset jack.



CONVENIENCE

- No batteries needed!
- RCA type jacks
- Easy hook-ups with your tape recorder, amplifier or mixer
- Measures 3.7" x 1.6" x 1.3"
- Customer satisfaction guaranteed

PERFORMANCE

- Sends and receives audio signals using the modular handset jack
- Mic/Line button enables you to either talk or play a recording down the telephone line without changing cables
- Durable, diecast aluminum construction
- FCC approved

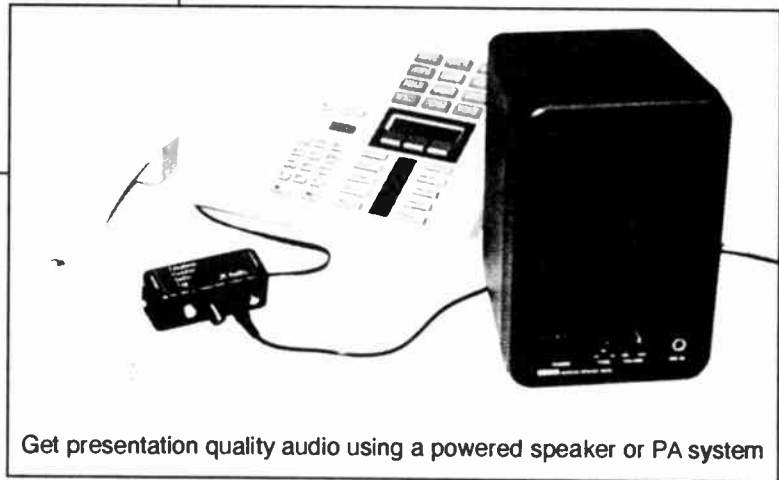

Prices and specifications are subject to change without notice.

Line Input: RCA phono jack, 250 mV RMS, 20 k ohms impedance.
Line Output: RCA phono jack, 100 mV RMS, 2800 ohms impedance.

Works with analog and digital PBX, ISDN, and single line telephones.

Price \$150.00

For information call:

1-800-JKAUDIO

1-800-552-8346

JK Audio

Quality products for the professional broadcast industry

2701 N. 45th Road, Sandwich, Illinois 60548 815-786-2929

HE HALL Electronics

706 Rose Hill Drive
Charlottesville, VA 22901

This Months Engineering Problem Solvers

ITC Cart Machine OEM & Update Components
Updates:

HE Cap. Board - Replaces old FP Power Supply Capacitors in ITC & other Cart Machines. Complete kit includes all hardware.

SP, WP, & RP Models  \$ 39
3D Model \$ 49

HE Replacement Audio Card Stereo \$ 229
Mono \$ 199

HE Replacement 3 Tone Detector Card \$ 159

O.E.M. Parts

Mag-Head (MEC) longlife tape heads Stereo \$ 99
for ITC & most other models Mono \$ 75

Top bearing for ITC 3D model  \$ 65
Standard Motor bearings \$ 20

ITC SP, WP, RP Capstan Motors - Brand New \$ 175
Dialite Start, Stop, Etc switch (Bezel & Lens not included) \$ 5

Call us for the Best New & Completely Rebuilt Equipment!
(804) 984-HALL (4255) Fax: (804) 984-FAXX (3299)

UNIVERSAL SCPC

NEW
Receiver!

XE-1000



SCPC BROADCAST AUDIO RECEIVER

New, affordable, frequency-agile receiver, direct channel entry by keyboard, selectable companding 1:1, 2:1, 3:1, wide/narrow bandwidth, de-emphasis selectable, 950-1450 MHz, line output 600 ohms, muting, transponder agile, LNB power supply, 50-channel memory, full baseband output, high-quality audio. Every needed feature at a sensible price (lowest in the industry). Write or call for full information on this quality receiver—the answer for your station. Networks call for prices.

Phone: (614) 866-4605 Fax: (614) 866-1201

UNIVERSAL ELECTRONICS, INC.
Communications Specialists
4555 Groves Road, Suite 12 Columbus, OH 43232

*ERI - Trusted since 1943
for Proven Performance in
ANTENNA - FILTER
LAMBDA™ MOUNTING
TOWER-INSTALLATION*

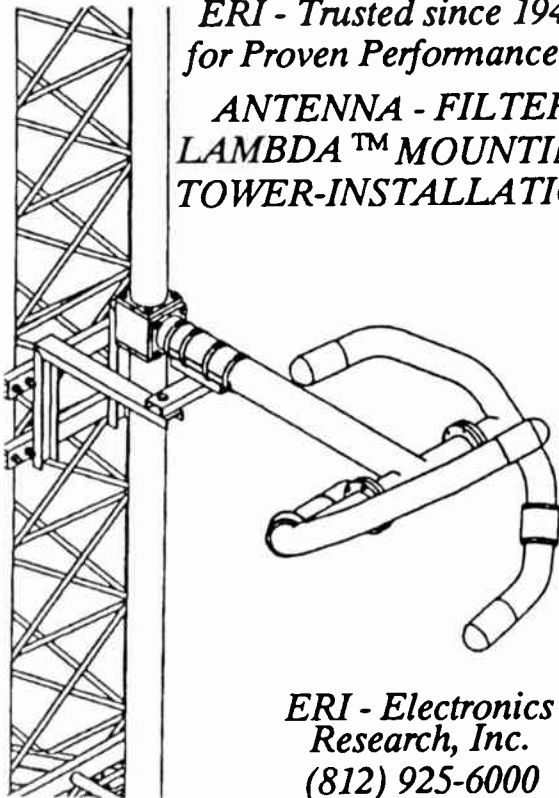

*ERI - Electronics
Research, Inc.
(812) 925-6000*

Commercial Radio Company

Duttonsville School Dr., Cavendish, VT 05142
Phone 802-226-7582 Fax 802-226-7738



Transmitter Parts
RCA - Gates
Collins/Continental



Mica Transmitting Capacitors: Sangamo, CD, Sprague, Aerovox, Acushnet types: CM-15, CM-20, CM-25, CM-30, HT, HK, AT, AK, F1, F2, F3, 30B, E, 1996, 291, 292, 293, 294 & G5.

Fixed and Variable Vacuum Capacitors: Jennings, Dolinko & Wilkins, Mounting brackets and flanges. Vacuum relays.

Oil Filled Filter Capacitors: Plastic Capacitor Corp., 600 to 40 kV, 1 mFd to 30 mFd with special mounting brackets. Non-PCB oil capacitor replacements are available for most transmitters.

Ceramic RF Capacitors: Centralab, Jennings, Sprague, High Energy, 5 kV to 40 kV.

Variable Transmitting Capacitors: E.F. Johnson Co., Cardwell Condenser Co., insulated shaft couplings as used in phasors, variable transmitting capacitors.

Weschler-Westinghouse: RF ammeters, 0-0.5 amps through 0-50 amps, internal and external thermocouples, expanded and linear or square-law scales. Sizes are 3 & 4 inch, round and square. Special meters are available.

RCA: Transmitter, phasor and antenna tuning unit parts.

ULTRAMOD® . . . UM2000

FM STEREO MODULATION SYSTEM



- The UM2000 is a complete FM processing and stereo generating system featuring:
- Dual band, stereo AGC and peak processors of exceptional clarity.
- Digitally synthesized stereo generator with separation exceeding 60dB at 1kHz, and typically 55dB at 15kHz.
- Dual composite outputs for feeding main and auxiliary transmitters or STL's. Very affordable.

WHY PAY MORE ... AND GET LESS?

HINAT HINDES inc

42 Elaine Street, RR1, Thompson, CT 06277
203-935-9066 203-935-9242

Econco

Rebuilt Power Tubes

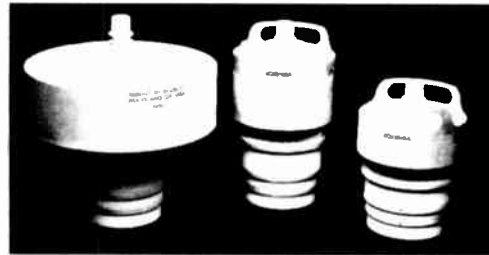

Approximately
One Half the Cost of New

Call for Our Price List

Econco

1318 Commerce Ave., Woodland, CA 95695
800-532-6626 Canada 800-848-8841

FCC Rules on Kahn POWER-side™

Motorola tried to deny broadcasters the right to increase coverage by using SSB — Kahn POWER-side™ equipment. But the FCC specifically ruled that the "Kahn POWER-side system ... may continue to be operated ..." as a mono improvement system. So you can now use POWER-side with Kahn independent sideband exciters to immediately increase coverage to listeners using any and all type of AM receivers.

Federal Communications Commission FCC 93-485:

21. Kahn "POWER-side" Operation. Several parties express concern over the continued acceptability under our rules of operating using the Kahn POWER-side AM single-sideband system. POWER-side operation, as distinct from Kahn stereo operation, involves an AM transmitter with two independent sidebands, containing identical program material, but with intentional level and frequency response differences. This system is implemented with a Kahn independent sideband stereo exciter and is claimed to have certain advantages for reception with monophonic receivers, particularly in adjacent-channel interference situations. CTI and Furr argue that adoption of the proposed standard would prohibit such an implementation. Motorola maintains that the Kahn POWER-side mode of operation is not stereophonic and questions its legality under the present rules.

22. Our AM rules do not include a definition of the term "stereophonic." However, generally accepted definitions of stereo service infer two or more channels of audio information designed to produce an audio "image" when demodulated by an appropriate receiver. On this basis, we find that stations employing the Kahn POWER-side system are not subject to the provisions of the stereophonic transmitting standard adopted herein and may continue to be operated, provided that the program material fed to both channels of the exciter is identical in content.

POWER-side™

PROBLEMS

Adjacent Channel Interference
Antenna Null Distortion
Co-Channel Interference
Power-Line Re-Radiation
Building Re-Radiation
Receiver Tuning
Low Fidelity Home Radios
Co-Channel Beat
Selective Fading

SOLUTION!

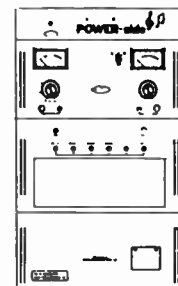

(516) 222-2221

POWER-side™

The solution to many of
AM radio's most serious
technical problems.

*From the developers of the AM STEREO system
that isn't afraid of the dark, and will let you drive right past FM Stereo.*

Kahn Communications, Inc.

222 Westbury Avenue, Carle Place, NY 11514

