

Radio Guide



Radio's Technology Forum

May 1994

It's Time to Get Serious

We've published four issues of the "new" Radio Guide now, and I've only got one request — where are *your* tech tips?

For the past few months, the Radio Guide has been published at eight pages. We'd like to increase that page count to allow room for additional tech tips and information. Unfortunately, we can't do that unless I can convince you that your tech tips are just as important as the ones you've already seen in print.

By now, I think you probably realize that Radio Guide tech tips can be of any length or subject. What you may not know, is that you don't need to be some sort of "expert" or "guru" to submit your tips, and have them published.

As a broadcast engineer, you are as qualified as anyone to help others with your experiences and solutions to problems. Please don't keep that knowledge to yourself.

The information on page 2 will tell you how to go about delivering your tech tips to us. Remember, the Radio Guide exists to help you solve technical problems, and the more tech tips we receive, the better we can do that.

If you have any questions about submitting your tech tips to Radio Guide, please give me a call at (507) 280-9668. We can work together to get your ideas into print.

Radio Guide BBS

The Radio Guide BBS has been changed to a private BBS for Radio Guide subscribers. As of April 15th, the Radio Guide BBS was changed to allow complete access only to those readers who have entered a paid subscription to this Radio Guide publication.

Those of you who have a paid subscription to the Radio Guide need only call the BBS and sign up. We will verify your subscription and grant you complete BBS access right away.

This change was made to allow Radio Guide readers easy, personal access to Radio Guide for direct submission of technical tips and information. It will also allow us to make available, on-line, a valuable technical data library, for the exclusive use of our subscribers.

The Radio Guide is a technology forum in print and structuring the BBS as a part of that forum will enhance our ability to communicate with each other and to distribute technical information to those who have elected to become an important part of this publication. *Ray Topp*

AUDIO BROADCAST GROUP INC.

A new beginning for an Industry standard!
Now with 3 sales offices to more efficiently provide all your broadcast equipment needs.

MAIN SALES OFFICE

2342 S. Division Avenue
Grand Rapids, Michigan 49507

Phone: 800-999-9281

Fax: 616-452-1652

SOUTHEASTERN SALES OFFICE

200 Fareway Drive, Suite 2
Smithfield, North Carolina 27577

Phone: 800-369-7623

Fax: 919-934-8120

WESTERN SALES OFFICE

P.O. Box 1638
36956 Desert Willow Drive
Palmdale, California 93550

Phone: 800-858-9008

Fax: 805-273-3321

For Over 32 Years



Inside This Issue

Moving Day (editorial)	2
Idiot Proof Remotes	3
Connections Made Easy	3
VRC-2000 Audio Monitor	3
Measuring Audio Impedances	4
Otari MX5050 Noise Fix	5
Gates H-Series Tube Life Mod.	5
Transmitter Blower Balancing Act	6
Save Time on Remotes	6
Technics SL1200 Display Fix	6
Retuning RPU's With Little Equipment	7
Cleaning Keyboards	7
TX Site AC Power Check	7

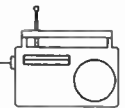

Business, Production & Ad Copy

Raymond Topp — Publisher

511 18th Street SE
Rochester, MN 55904
Phone: 507-280-9668
Fax: 507-280-9143

Technical Editorial & Copy

George Whitaker — Editor

3505 Daniel
Arlington, TX 76014
Phone: 817-468-2586

Radio Guide BBS

Technical Information and Services

24 hour-a-day operation
300-2400 Baud — 8,N,1

Phone: 507-280-4045

How to Submit Tech Tips and Articles

Radio Guide welcomes your comments, letters, articles and Tech-Tips for publication.

By BBS: Call our BBS at 507-280-4045, and leave your tech tips, info and articles as a private message or file for the Sysop.

By Disk: Send your tech tips and information on a 3.5" or 5-1/4" double or high density floppy disk, in ASCII format, to: George Whitaker, at 3505 Daniel, Arlington, TX 76014.

By Letter: We also accept clean, typewritten or printed manuscripts mailed to the above address.

— **Articles should be 750-1000 words** —

— **Tech-Tips should be 200-500 words** —

All "Tech Tipsters" receive a *Radio Guide* calculator.

Radio Guide (ISSN 1061-7027) is published monthly, 12 times a year, by Media Magazines Inc., 511 18th Street SE, Rochester, MN 55904.

All material contained in Radio Guide is copyright 1994 by Media Magazines Inc., and may not be reproduced in any form without the written permission of the publisher.

Moving Day

Two more weeks. As I write this, I have two more weeks left to be Chief Engineer for KRVA in Dallas. After that, it will be **Radio Guide**, Practical Radio Communications, and technical consulting. Leaving the security of a regular, fairly good paycheck with reasonable benefits gets somewhat scary. However, it will allow much more time for communicating with the fellows who help to keep the broadcasting business going.

As I have mentioned in times past, one of the most enjoyable things about this job is being able to visit with other engineers and learn from them. The phone calls and letters are always valuable to me personally. Every Tech-Tip that comes in is like a visit to that person's station. To me it is a real hoot.

Anyway, by the time you read this I will be out of KRVA and working in the **Radio Guide** office in Arlington Monday thru Wednesday instead of just one day a week, as it is now. You may reach me at (817) 468-2586. Please note that this is a relatively new phone number and is actually the office number. The old number that was in earlier issues of **Radio Guide** gave my home number. If you call that one, you will probably wind up talking to my wife, who actually is pretty knowledgeable of engineering matters, having worked with me for a number of years before my last son was born and she started staying home with him. At any rate, if you wish to speak to me, please call the office number.

Send your Tech-Tips to the Arlington address and share your information with the industry. We appreciate it, and so do the other engineers out there.

George

Subscribe to:

Radio Guide

Subscriptions are \$24⁰⁰ per year.

**Send a check with your order,
or we will invoice you, if needed.**

Radio Guide

**511 18th Street SE, Rochester, MN 55904
Phone 507-280-9668 Fax 507-2809143**

Idiot-Proof Remotes

Craig Jerome — WAVW, Ft. Pierce, FL

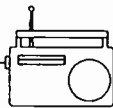

Remote broadcasts are a fact of life that most engineers could live without. However, the challenges they present can also be exciting. Many times the engineer gets the blame when the people at the studio give him false, or no, information, and the remote goes awry. Craig gives us some tips for:

Almost Idiot Proofing Remotes

In my many years in broadcasting, I have set up hundreds of remote broadcasts. For the most part set-up is easy. One thing I would always have trouble with, though, is the jock at the studio listening to the incoming remote signal. It never failed — the jock would tell me the signal sounded fine until the first remote break. We also had trouble with what receiver the remote was coming in on; I had four possible channels available at a given time.

I use Marti remote gear, so one day I sat down with the receiver manuals and found that the remote connector has numerous functions that would help my staff. The CR-10 has a signal strength DC output. I connected each of my receivers to an unused channel on my Burk ARC-16 remote control system. I then had a reading that helped in checking signal strength.

I also noted there was a relay closure for squelch. When we would fire up a transmitter, the squelch on that particular receiver would open, and close the relay contact. I connected the closure to a free status input on the remote control. This alerted the jocks, back at the studio, which receiver was in use.

For those of you who have receivers back at the studio, you have an extra function available that may make remotes even simpler. If you do not use the encode function on the Marti system, you can replace the slide switch for the encode function on the transmitter with a momentary pushbutton. Each time you push the encode switch at the remote site, the encode relay will close in the CR-10. Using a light, this will attract attention back at the studio. You could also connect a cart deck to the relay output so the jock at the remote site can start a song or spot set. I found this works well for sporting events.

Check your equipment manuals for pin-outs.

Components & Rebuilding Services

*Rebuilding service for most audio equipment
Tascam and Otari authorized service
Tape heads for most cart machines in stock
Lots of new and used audio and RF components*

HE HALL
Electronics

Phone (804) 974-6466
Fax (804) 974-6450

Connections Made Easy

Clif Glasgow — KROP, Brawley, CA

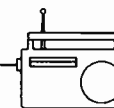

Clif has come up with several tips for us in the past and this time has some helpful information about where to get, and how to use, some of the newer innovations. If you don't have a Mouser catalog, you can call (800) 346-6873. And now:

Connections Made Easy

Interconnections and interface seem like the biggest, most frequent jobs around the station. In my combo, guys before me have used everything from Cinch-Jones and 1/4" phone to RCA and Molex mini's. Barrier strips and crimp lugs are still the most prevalent, but I have to carry two sizes of Molex tools, too. Somebody got into PC terminals, the ones that bind down on the wires if you have a micro phillips head. I like punch blocks myself. However, lately I've had to make up an inordinate number of split, mix, loss and matching passive resistor pads. I stumbled onto the Augat 2SV series of connector blocks. These are the compression type with the little levers like you find on the back of Zephyrus satellite equipment. No connectors needed; just strip the wire, insert and close the little lever — well, most of the time.

They're called the 2SV Screwdriverless series by Mouser Electronics and come in packages of 2, 3, 4, and 5 positions with 0.2" spacing on the PC pins so they fit into most 0.1" spaced pre-punched perf board. There's just enough pin to solder to, with or without copper clad boards, and not enough to bother cutting. They're 0.45" high, rated to 20A and take #18 to #24 wire. Best of all, from Mouser, up to 25 units, they range from \$0.54 to \$1.34.

VRC-2000 Audio Monitor

Doug Stromberg — Waden, MN

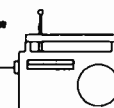

Here comes a "slapper" from Doug. I use Gentners at all of my transmitters in Dallas and once again found myself slapping my forehead and saying, "Why didn't I think of that?" He has a cheap, easy way to get the audio on his:

VRC-2000 Audio Monitor

I have installed a total of 5 Gentner VRC-2000 remote control systems. At each site, I have used an old portable radio as a permanent audio monitor. By connecting the audio output from the Gentner to the volume control of the radio, you have an inexpensive, high volume audio monitor which can be left on-site. Of course the signal from the detector of the radio is disconnected. Because transmitter sites are noisy places, this makes programming the remote so much easier than trying to listen through the receiver of the telephone set.

Measuring Audio Impedances

George Whitaker — Editor

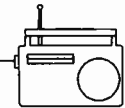

Most of the time we take for granted the manufacturers statement that a 600 ohm input or output is a true statement. However, in the real world, they seldom are as labeled. A correct impedance match will allow the best transfer of energy from one circuit to another, and ultimately, the best fidelity. Here is a look at:

Measuring Audio Impedances

Measuring the output, or input, impedance of a piece of equipment is not particularly hard. It just requires a little bit of set-up and paying attention to what you are doing.

For our example we are going to assume that we want to measure the output impedance of a console.

The equipment necessary is an audio generator, an AC voltmeter, (I use my Simpson 260) and a 2,000 ohm pot with a handful of clipleads.

Figure 1 shows the equipment set-up. Place the pot across the input to the meter. Note that the wiring is such that the pot is going to be used as a variable resistance and is not going to be wired as a potentiometer.

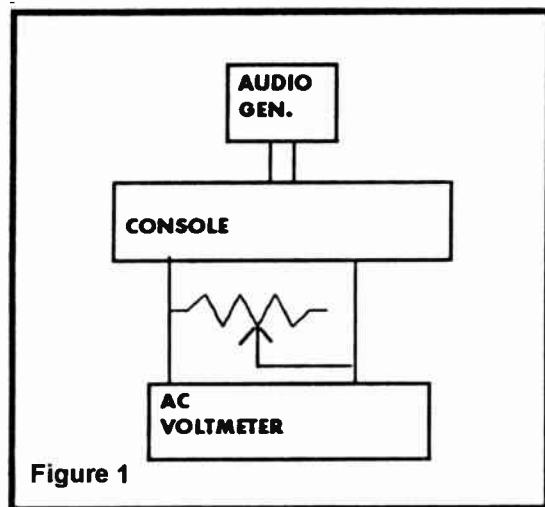

Figure 1

Set up the equipment as shown in Figure 1, except that we want to leave the variable resistance out for the first measurement.

The voltmeter will be connected to the console with nothing else connected to the console output. Then set your Simpson to the 2.5 VAC scale, or if you are using another meter, set it to the scale that can read 1 volt with the greatest accuracy. Set the tone generator to 1,000 Hz and bring up the level on the console until the voltmeter reads 1 volt.

You can ignore the meters on the console, as what they read is of no consequence to us. However, if they are not reading somewhere between 50% and full scale, then something is wrong.

Once you have established the tone at 1 VAC output, then put the variable resistance across the meter input and adjust it until the meter reads 0.5 volt. This corresponds to a 6 dB drop in the signal level.

Being careful not to move the setting of the wiper, you then remove the variable resistance and measure it on an Ohmmeter. The reading you get is the actual output impedance of that console at 1,000 Hz.

Now we know the impedance, so, what next? Well, let's consider some examples.

First, let's assume that the resistance measured 400 Ohms. This means that we are 200 Ohms shy of what it should be. Therefore, we will add this to bring it up to 600. Since we are dealing with a balanced circuit, we will need to add 1/2 of the required resistance in each leg. Place a 100 Ohm resistor in series with each side of the console output. This can be done easily by using a 2 screw terminal block as shown in Figure 2.

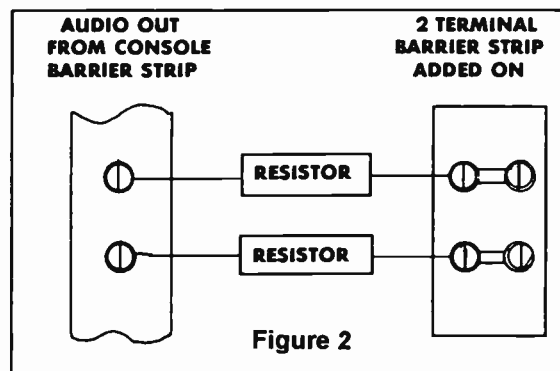

Figure 2

Note that resistors have a fairly large tolerance for value and you should measure a group of them to find ones that will most nearly add to the internal impedance to bring it up to 600. Let's look at another example and you will see what I mean.

Let's suppose this time that the variable resistance read 345 Ohms. This means we need to add 255 Ohms. Since we need to keep it balanced, each leg would need 127.5 Ohms. The nearest standard value to this is 120 Ohms. However, due to the tolerances in manufacturing, a 10% resistor could be anywhere from 108 to 132 Ohms and still be considered a 120 Ohm resistor. Therefore, if you take a handful of 120 Ohm 10% resistors, you will probably find a couple that will measure very near the 127.5 we are seeking.

Again, if you take the 127.5 Ohms in each leg, plus the internal impedance we measured, you get $127.5 + 127.5 + 345 = 600$.

(continued on page 5)

Audio Impedances

(continued from page 4)

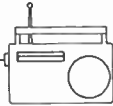

Now lets suppose that the variable resistance read 650 Ohms. In this case you can use a parallel resistance to bring the impedance down. However, in my personal experience, I have found that most outputs tend to be lower than 600.

To measure *input* impedance, use the equipment set-up shown in Figure 3.

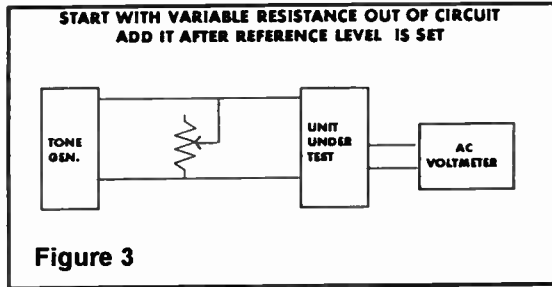

Figure 3

First, disconnect everything else from the input terminals. Connect an AC voltmeter across the output terminals and then feed a tone into the unit at a level such as to give you a convenient output reference level (1 volt is handy). Try not to disturb the controls on the equipment if it is set for normal operation. However, if it is a compressor of any kind, the compression function must be disabled according to the manufacturer's instructions. If you need more gain to get a convenient reference, use the output adjust to get a meter reading of 1 VAC. Note its original setting and after you are through you can return the unit to its original output level.

Understand that what we read on the AC voltmeter is not critical, it just needs to be some reading that we can conveniently divide in half. I would suggest 1 or 2 volts.

Once you have established the reference level, you then place a 2K to 5K pot, used as a variable resistance, across the

input terminals. Adjust the pot until the reference level drops to one half of its original reading. If you had a 1 volt reference you would adjust the pot until you had a 1/2 volt reading on the meter.

Then remove the pot from the circuit and measure with an Ohmmeter the value of its resistance. This is your input impedance.

Let's assume that we measured 1,500 Ohms. Again, the object is to bring this to 600. Since we measured more than 600, a resistor in parallel is called for. A handy formula for figuring the size of the required resistor is shown below.

$$R_{\text{PARALLEL}} = \frac{1}{.00167 - \frac{1}{\text{The input impedance you measured}}}$$

Plugging in the numbers from our example gives us:

1.	2.	3.
$\frac{1}{1500} = .000667$	$.00167 - .000667 = .001$	$\frac{1}{.001} = 1000$

A 1,000 Ohm resistor across the input will give us a 600 Ohm impedance as shown in Figure 4. Thank Heaven for pocket calculators.

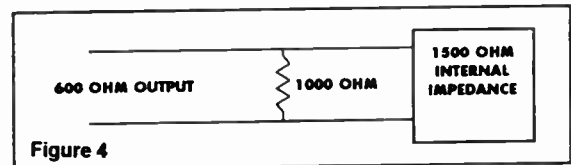
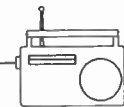

Figure 4

These methods will provide for proper impedance matching between pieces of professional equipment such as consoles and compressors or tape machines. However, note that this is all passive components and to match consumer gear to pro gear requires active components such as the Match-Box.

Otari MX5050 Noise

Del Dayton — Mendota, IL



At one station, a strange intermittent noise problem developed with both of the Otari machines. The noise was similar to the "crackling" of a bad semiconductor and only occurred during the record mode (yes it was placed on tape).

To make a long story short, I traced the problem to the tiny "record" switching relays in the bottom of the deck's electronics. They had become dirty. After delicately removing the clear, plastic covers from the top of the relay, I cleaned them with a good non-residue contact cleaner. I had to use a good burnishing tool on one of the relays, however.

Although, this got both machines working again, I do recommend replacing these relays as a permanent fix.

Gates H-Series Mod

George Whitaker — Editor



At our Ft. Worth transmitter site we use a Gates H-series transmitter, and had been replacing the 807's frequently.

We then took the removable lower front panel to a machine shop and had them cut a hole to fit a muffin fan directly over the 807's in the RF driver. Since the panel has to be removable, you'll have to add a power outlet, or a plug of some kind, inside the transmitter to allow for unplugging the muffin fan when you take the panel off. Since adding the fan, we have been getting 3 to 6 times the life on the 807's.

It just blows directly in on the 807's. However, depending on your circumstances, you might want to build a filter holder on the fan housing.

A Balancing Act

John Bredesen — KLCC-FM, Eugene, OR

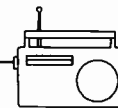

Having run into a situation similar to the one John describes in this tip, and winding up very frustrated, I was glad to learn something about:

Balancing a Blower

After moving our Continental 816R-4 to a new building, I noticed an annoying vibration which was traced to the centrifugal blower which cools the final tube. I suspected that something had fallen into the blower squirrel cage, but an inspection showed that not to be the case. Nothing appeared out of order.

Many times blower wheels will have small balance weights attached to a fin(s), but I didn't see evidence of any, such as scratches or areas where dust hadn't accumulated.

What to do? Calls to shops that specialize in balancing rotating devices quoted prices of \$50 and up, and turnaround times of several days. Additionally, they wanted the entire motor/blower assembly delivered to their shop.

The pros do the job with electronic vibration sensors attached to the device to be balanced, in this case the blower/motor assembly. These sensors in turn trigger a strobe light each revolution which "freezes" the blower and clearly shows up the markings which were placed on the wheel at the beginning of the test. The blower is stopped and a weight is added at the spot indicated by the testing setup and the test is done again. Weights are added or removed in small increments as needed until a smooth, vibration free blower is obtained. The weights used for blower wheels are simply small "U" shaped pieces of metal which are pressed over individual fins as needed. Centrifugal force holds them in place even better.

The solution I used wasn't elegant, but it produced a smooth running blower. It consisted of the trial and error

installation of various size Tinnerman clips on the fins of the blower wheel. (A Tinnerman clip is a "U" shaped piece of stamped metal, which is a self holding nut. It's slipped over the edge of a piece of sheet metal through which a clearance hole has been punched or drilled. You may have seen them on some relay racks in lieu of threaded screw holes for mounting equipment.) I emphasize the trial and error aspect of the project. The ear, and a hand placed on the stationary housing of the blower substitute for the electronics. If the blower wheel is marked off in quadrants with a magic marker when you start, it's easier to keep track of where you have been, as far as the trial and error placement of the clips is concerned.

There are three variables in the process:

1. *The weight of the clip(s)*
2. *The radial location of the clip(s), and*
3. *The front to back location of the clip(s).*

The latter may need a word of explanation. By front to back location, I'm referring to where along a particular fin the clip is located. It's not necessarily enough to know where in a 360 degree radial location the added weight is needed. Good dynamic balance acknowledges, additionally, that the added weight may be needed anywhere along the axial length of the rotating part. Start by placing the weight in the middle of the fin you've selected, but be prepared to shift it along that fin if you really want to get vibration as low as possible.

A couple of caveats: 1. This process will require a lot of on-off cycles for the motor, which we did with the transmitter on-off control. We removed the fuses in the filament circuit and second cooling motor so they wouldn't be subjected to the constant cycling. 2. Obviously, install the clips from the inside of the wheel and be careful that they fit snugly onto the fin so they don't come loose and get thrown into the tube socket.

Save Time on Remotes

Jon Book — WOC-AM, Davenport, IA

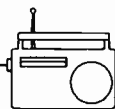

If you ever go out on a remote site and call the studio for a Marti check, you'll probably end up with many different versions of what a signal sounds like.

With three radio stations in one complex, things do get a bit busy and an extra person is not always in the budget. My direct replacement for that extra person is the Marti Tester, which is rather simple and to-the-point.

Install an Elgin station coupler, or any telco dial-up unit to a regular telephone line and feed the input to the coupler from your Marti audio signal. When you are on the road, you call the studio dial-up unit and monitor the signal.

Technics SL1200 Fix

Del Dayton — Mendota, IL

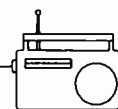

One station I worked for had a problem with speed variations in their turntable. I noted the "display" brightness would vary in intensity when the turntable speed varied. I, unfortunately, did not have a set of prints with me, but decided to look into the problem anyway.

It took some digging to get to the components but, after careful disassembly, my suspicions of a power supply problem were confirmed. The problem was a defective series-pass transistor (TR7) in the 5 volt supply.

You will be happy to note that the transistor used, crosses into most any "replacement" brand (even Radio Shack).

Retuning With Little Equipment

John Hutson — Continental Electronics, Dallas, TX

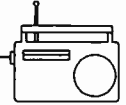

One day while visiting at the Continental plant here in Dallas, John mentioned to me about using a scanner to retune remote pick-up gear. I found it somewhat fascinating and asked him to share this with our readers. Here is the poop on:

Retuning With Little Equipment

If you have ever had the need to change frequency on 2-way or Marti gear, you may have thought you needed a synthesizer or communications monitor to do the job. It is possible to do an acceptable job with nothing but a scanner, a wattmeter, and a VOM.

The first step is to get the receiver local oscillator and its multipliers working. Most high-band units multiply a receiver LO crystal by 3 and UHF units multiply by 9 or 12. (Example: A 161.7 receiver which has a 10.7 IF needs a 151.0 injection frequency. $151/3 = 50.3333$ which is the crystal frequency.) Put the scanner on 151.0 and peak the oscillator and multipliers for the strongest signal on the scanner. You may also have to adjust the crystal trimmer until the LO signal is on frequency.

Next, we are going to use the local oscillator in the scanner for a signal generator to tune the RF stages in the receiver. My scanner (a Regency R1080) has a 10.7 IF and uses high side injection on low band and low side injection on high band and UHF. So, to get a signal on 161.7 MHz, add 10.7 and set the scanner to 172.4 MHz. Lay a wire over the scanner, stick it in the receiver's antenna connector, and tune the RF stages for maximum signal, moving the scanner farther away as necessary to reduce the signal as the receiver is tuned.

Some receivers use very sharp cavity resonators in the front ends and will not pass a signal very far off in frequency.

I have been successful in this case by removing slugs part way through the filter and putting the wire laying over the scanner through the hole and tuning the filter a little at a time. After peaking everything connect the receiver to the antenna and fine tune everything with an off-air signal. This is necessary because the piece-of-wire antenna we are using does not present a good 50-Ohm source.

Transmitters are usually much easier. Just put a dummy load and wattmeter on it and tune everything for maximum. (Just make sure you are not tuning any harmonic trap slugs!) If you are changing frequency so far that the transmitter will not put out any power at all, try putting an ammeter in the 12 volt B+ lead and start with the oscillator and first multiplier and simply tune everything for peak current.

Before long, you should see output. If this doesn't work, set the scanner on the desired transmit frequency, and starting with the oscillator, tune for maximum the same way you did with the receiver's local oscillator. Even if only the oscillator is working you should be able to hear its harmonic on-frequency.

The last step is often ignored, and that is to tune the modulator coil (which you have already peaked for RF) for best symmetrical audio. Put a tone through the transmitter and a scope across the scanner speaker and tune for best looking audio. If you have neither tone generator or scope, whistle into the mic and tune for least audible distortion.

A word of caution is in order. Do not depend on the local oscillator in the scanner to zero-beat the transmitter's frequency. It isn't accurate enough. A base station on 450 MHz is only allowed a bit more than 1100 Hz frequency error. FCC rules aside, with 12.5 kHz channel spacing, if you are outside limits, you can seriously interfere with your neighbors. Use a known accurate counter or communications monitor for this.

Cleaning Keyboards

Richard Egan — WIZM, LaCrosse, WI

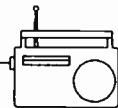

Our computer keyboards are constantly exposed to dirt, dust, and occasionally, coke and coffee. Sometimes a replacement is called for, but I've had good results cleaning a keyboard by submerging it.

It sounds crazy, but it works. Fill a big tub with hot water and your favorite detergent, and plunge it in. Follow this with a distilled water rinse to help get rid of dissolved minerals in the water. Rinsing with alcohol helps get rid of some water and also helps speed the drying time. I usually allow the keyboard to air-dry for at least a week. Running a fan or setting it over an air duct may save a few days.

TX Site Power Check

Mark Young — WJON, St. Cloud, MN

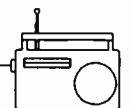

Here's a very simple tech tip for telling if the AC power is really out at a remote transmitter site.

I ran the AC power to the coil of a 120 VAC relay. When the power is on, the relay is energized, and the phone line is connected to my dial-up remote control, through the relay contacts.

When the power goes out, the relay is de-energized, and the phone line is transferred to a standard phone set that is left off the hook. If the transmitter is off, and you get a busy signal upon calling the transmitter site, it's a pretty good bet that the AC power is out.

Your Radio Guide Sponsors

The Following Manufacturers Support Your Radio Guide

ULTRAMOD® .UM2000 FM STEREO MODULATION SYSTEM



- The UM2000 is a complete FM processing and stereo generating system featuring:
- Dual band, stereo AGC and peak processors of exceptional clarity.
- Digitally synthesized stereo generator with separation exceeding 60dB at 1kHz, and typically 55dB at 15kHz.
- Dual composite outputs for feeding main and auxiliary transmitters or STL's.
- Very affordable.

WHY PAY MORE ... AND GET LESS?

HNAT HINDES Inc

42 Elaine Street, RR1, Thompson, CT 06277
203-935-9066 203-935-9242

ERI - Trusted since 1943
for Proven Performance in
ANTENNA - FILTER
LAMBDA™ MOUNTING
TOWER-INSTALLATION

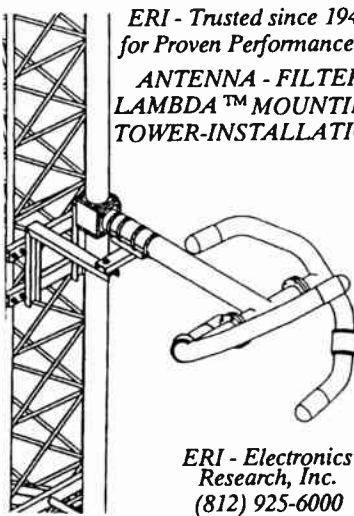

ERI - Electronics
Research, Inc.
(812) 925-6000



Econco Rebuilt Power Tubes

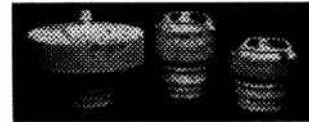

Approximately
One Half the Cost of New

Call for Our Price List

Econco

1318 Commerce Ave.
Woodland, CA 95695
800-532-6626 Canada 800-848-8841

RAM SS9200

On-Air Console

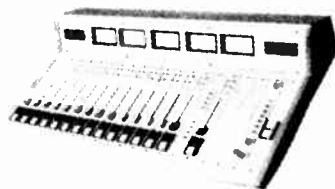

FEATURES

- Stereo PGM and AUD buses
- PGM and AUD mono sum output
- Two telephone mix minus busses
- Active high performance balanced mic & line inputs
- Solid state audio switching
- Remote control and tally facilities
- Conductive plastic faders
- Three station solid-state intercom
- Solid state high level input selectors
- Universal module positioning
- VCA controlled monitor facilities

RAM Professional Broadcast Products

Call Toll-Free — USA: (800) 779-7575 — Canada: (800) 433-2468

Commercial Radio Company

Duttonville School Dr., Cavendish, VT 05142
Phone 802-226-7582 Fax 802-226-7738



Transmitter Parts

RCA - Gates - Collins/Continental



Mica Transmitting Capacitors: Sangamo, CD, Sprague, Aerovox, Acushnet types: CM-15, CM-20, CM-25, CM-30, HT, HK, AT, AK, F1, F2, F3, 30B, E, 1996, 291, 292, 293, 294 & G5.

Fixed and Variable Vacuum Capacitors: Jennings, Dornko & Wilkins, Mounting brackets and flanges. Vacuum relays.

Oil Filled Filter Capacitors: Plastic Capacitor Corp., 600 to 40 kV, 1 mFd to 30 mFd with special mounting brackets. Non-PCB oil capacitor replacements are available for most transmitters.

Ceramic RF Capacitors: Centralab, Jennings, Sprague, High Energy, 5 kV to 40 kV.

Variable Transmitting Capacitors: E.F. Johnson Co., Cardwell Condenser Co., insulated shaft couplings as used in phasers, variable transmitting capacitors.

Weschler-Westinghouse: RF ammeters, 0-0.5 amps through 0-50 amps, internal and external thermocouples, expanded and linear or square-law scales. Sizes are 3 & 4 inch, round and square. Special meters are available.

RCA: Transmitter, phaser and antenna tuning unit parts.

Northeast Broadcast Labs Now Has a Midwest Office



NORTHEAST
BROADCAST LAB

Dave Seavy, Rochester, MN,
now serving this region:

Minnesota — Iowa — Wisconsin
North Dakota — South Dakota
Michigan — Illinois
Nebraska — Wyoming — Montana

Phone 507-281-1200
Fax 507-282-8549

FCC Rules on Kahn POWER-side

Motorola tried to deny broadcasters the right to increase coverage by using SSB — Kahn POWER-side™ equipment. But the FCC specifically ruled that the "Kahn POWER-side system ... may continue to be operated ..." as a monoimprovement system. So you can now use POWER-side with Kahn independent sideband exciters to immediately increase coverage to listeners using any and all type of AM receivers.

See FCC Order ⇨

Federal Communications Commission FCC 93-485

21. Kahn "POWER-side" Operation. Several parties express concern over the continued acceptability under our rules of operating using the Kahn POWER-side AM single-sideband system. POWER-side operation, as distinct from Kahn stereo operation, involves an AM transmitter with two independent sidebands, containing identical program material, but with intentional level and frequency response differences. This system is implemented with a Kahn independent sideband stereo exciter and is claimed to have certain advantages for reception with monophonic receivers, particularly in adjacent-channel interference situations. CTI and Furr argue that adoption of the proposed standard would prohibit such an implementation. Motorola maintains that the Kahn POWER-side mode of operation is not stereophonic and questions its legality under the present rules.

22. Our AM rules do not include a definition of the term "stereophonic." However, generally accepted definitions of stereo service infer two or more channels of audio information designed to produce and audio "image" when demodulated by an appropriate receiver. On this basis, we find that stations employing the Kahn POWER-side system are not subject to the provisions of the stereophonic transmitting standard adopted herein and may continue to be operated, provided that the program material fed to both channels of the exciter is identical in content.

POWER-side™

PROBLEMS

- Adjacent Channel Interference
- Antenna Null Distortion
- Co-Channel Interference
- Power Line Re-Radiation
- Building Re-Radiation
- Receiver Tuning
- Low Fidelity Home Radios
- Co-Channel Beat
- Selective Fading

SOLUTION!

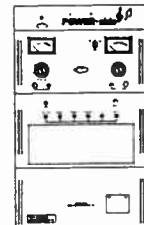

POWER-side-
The solution to many of AM radio's most serious technical problems



(516) 222-2221

From the developers of the AM STEREO system that isn't ahead of the dark and will let you drive right past FM Stereo

222 Westbury Avenue, Carle Place, NY 11514