

Radio Guide

Radio's Technology Magazine

Volume 3 Issue 6

Ray Topp - Editor

June 1990



511 18th Street SE
Rochester, MN 55904

Address Correction Requested



"GORILLA WARFARE" ...

... BRING THEM OUT OF THE JUNGLE!



The all NEW SERIES 6000 from THE EXPRESS GROUP is made to handle the "Monkey Business."

- Non-splitting, Non-marring, high impact corner guards.
- Unique edging system at base of cabinets to prevent chipping.
- High impact, high grade, laminates
- Solid void-free birch plywood construction

TAME YOUR SAVAGE BEAST with ... THE BEST OF THE BEST.

Call or write The Express Group today for our new free color brochure, that includes all 6 of our Fine Furniture lines.



The Express Group

3518 3RD AVE., SAN DIEGO, CA 92103 • (619) 298-2834 • FAX (619) 298-4143

World Radio History

Radio Guide

- Contents -

June-1990

Volume 3 Issue 6

- 4 More After This
- 6 Garage Door Remote
- 8 SBE National News
- 10-11 Tube Topics
- 12 Marti RTP-30 Tech Tip
- 14 Specification Guide
- 15 NFR Is On The Air
- 16 Radio Guide Forum
- 17 Squeaky (clean) CD
- 18 Transmitter Tips
- 19 Loss of Audio Alarm
- 20 Headphone Amplifiers
- 21 Tower Inspection List
- 22-29 DA Antenna Systems
- 30 Tech Programs Disk
- 32-33 Tips From The Field
- 34-35 Cracked Tubes in CSI
- 36 ITC Tertiary Slowdown
- 37 CSI 25 kW Tuning
Protect Your Meter
- 38-41 Product Guide
- 42-51 Equipment Guide
- 54 Broadcast BBS List

We Need Your Pictures

Send a color photo of
your studios or transmitter
site to Radio Guide.

We'll select one each
month and print it on the
cover. Let's see what you've
done at your station.

... Editor

SPOIL YOUR LISTENERS.... Not Your Audio

Pure Sonic Integrity-99.997% Distortion Free



FX 50 Exciter

No matter what your format is... no matter which processing you run; your entire system is no better than your exciter. So why limit the potential of your signal? Join the hundreds of broadcasters that have already realized what a difference the FX 50 can make. Call BE now at 217-224-9600.



**BROADCAST
ELECTRONICS INC.**

4100 N. 24th ST., P.O. BOX 3606, QUINCY, IL 62305, (217) 224-9600, TELEX: 250142, FAX: (217) 224-9607

CCA

Evolution

CCA has delivered more than 3,000 Broadcast Transmitters over the past 25 years. For 25 years our designs have been refined and improved. The result is the Evolution of the world's most perfected, most tested, most reliable, Radio Transmitter

**Grounded Grid Triode
Longest Tube Life
Auto Power Control
VSWR Power Foldback
Single Phase Optional**

CCA Electronics

P.O. Box 426

Fairburn, GA 30213

(404) 964-3530 Fax (404) 964-2222

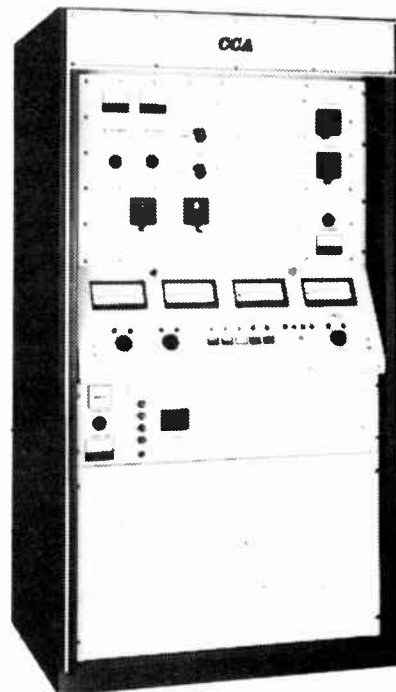

More After This!

Comments on the New Radio Guide

Ray Topp - Editor/Publisher

The New Radio Guide

As promised, here's the "new" **Radio Guide**. A new size, a bit more color, and more pages. Yet, still much of what you've always been getting.

Technical information on older equipment cannot be all that **Radio Guide** is about. We all know that there is much more to radio engineering than just the nuts & bolts. Yet, we also know that, in the end, it usually comes down to that.

This does not mean we'll be eliminating the nuts & bolts technical information at all! It's as I've said in the past two issues, the new **Radio Guide** will be something more, not something less. We're all fond of saying that if something's not broke, don't fix it. That's something I have taken to heart since the very first issue of **Radio Guide**. That doesn't mean it can't be improved.

What **Radio Guide** will do, is to cover the entire Radio Engineering spectrum. What **Radio Guide** won't do, is to try to cover the latest news of broadcasting -- you know where to get that. Still, the problem remains that many station engineers simply do not feel part of the whole and are, at times, treated with less than the respect a professional deserves.

Some say, get an attitude and a tie. I say that a person can't make intelligent decisions without good information. If a publication intends to serve the engineering community, it had better address these problems by giving its readers hard "nuts & bolts" practical information regarding their professional lives as engineers. **Radio Guide** will do that!

It's Not Older -- It's Better

There are those in the manufacturing segment of the broadcasting industry who say that **Radio Guide**

Radio Guide June-1990 Page-4

deals too much with the used equipment market. I say that once a piece of equipment is turned on -- it's used! That is, in fact, what **Radio Guide** has been about for over two years. We solicit and publish all articles on "used" gear, whether it's one day old or 20 years old.

We should not concern ourselves with the age of the equipment in use. If it is in operation and is used to generate revenue for the station, then it is an integral and essential part of that station's business. As such, it deserves the maintenance and attention that any important segment of a business would, to keep that business functioning smoothly. **Radio Guide** will help you with that!

The New Structure

This is how we've structured **Radio Guide**. We will always publish the technical information you need to help you do your job. We will not concern ourselves with the age of that equipment but, rather, that solving problems is all of our concerns. We will still, as before, solicit and publish all of your technical articles, hints, kinks, construction projects, and special test procedures.

What we will add is letters to the editor, SBE news, new product information, an expanded classified ad section, and FCC technical texts and releases. Most importantly, we will add the information that you need to help you develop yourself professionally.

Call Us

As always, this direction has been taken in direct response to your suggestions. Now, more than ever, we need to hear from you regarding these changes and what you would like to see from **Radio Guide** in the future.

Transmitter Mods

Take Care

On page 10 & 11 of the April issue of **Radio Guide** was an article on "The Care and Feeding of CCA Transmitter." It has been brought to our attention that we should have made people aware of the impact such modifications may have on type acceptance of the transmitter. As CCA pointed out to **Radio Guide**, a transmitter is approved as manufactured, and not as it may be modified in the field.

Many engineers have undoubtedly modified transmitters in the field, and they seem work just fine. But have any of them taken the time to do spurious/harmonic measurements with a spectrum analyzer? Even then, can the transmitter really be considered to be type approved if it has been modified in the field? In a future issue, **Radio Guide** will provide information regarding field modification of transmitters . . . *Editor*

Radio Guide

Volume 3 Issue 6 April 1990
Publisher: Ray Topp

SALES

Dale Tucker
4318 Kingswood Dr.
Concord, CA 94518
(415) 686-1538

EDITORIAL

Ray Topp
511 18th St. SE
Rochester, MN 55904
(507) 280-9668

Radio Guide is published monthly by Rochester Radio Publishing. Copyright 1990, all rights reserved.

Free subscriptions are available to all people involved in radio broadcasting and allied fields. Send name and address or any changes to Radio Guide at the above address.

All letters and copy submitted to Radio Guide are assumed to be for publication, unless notified otherwise.

Look for this name on the cart...

Audiopak's new molded-in logo and Quality Assurance Seal are your guarantee of genuine Audiopak performance—the consistent reliable performance that's made Audiopak the #1 choice of demanding broadcasters worldwide. They count on the proven performance of original-design Audiopak casings and the longevity and quality of Audiopak tape. For every application and every cart machine made Audiopak carts are "true blue" dependable, cart after cart after cart—accept no substitutes.



The cart the world counts on, cart after cart after cart.



15131 Triton Lane, #108
Huntington Beach, California 92649
Tel (714) 898-7224

...Look for this name on the carton.

There's no substitute for good value, friendly service and fast delivery, either. We give you all three, plus the genuine Audiopak carts you need—workhorse" A-2s, "stereo" AA-3s and "CD-ready" AA-4s. So be sure to order "the carts the world counts on" from a source you can count on: Broadcast Cartridge Service, Inc.

Garage-Door Remote

A Remote Cart Control for Those Important Times

By George Zema, Engineering Supervisor - KFRC
San Francisco, California (415) 986-6100

It's happened to all of us at one time or another. You're walking through the station and there's dead air. You scurry to the studio and see the jock arriving at the same time. It seems Mother Nature called and he or she thought there was enough time to get the job done and return to the studio before the song ran out.

Here's a device that will allow the jock or weekend board operator to leave the studio, for whatever reason, and still be able to start the next cart. It's all based on something that almost everyone has used, or will use -- a garage door opener.

You'll need to find a store that will sell you just the receiver, its power supply, and a remote control; otherwise you'll have to buy the whole package, motor and all. Each receiver is different in how it talks to the outside world but, ultimately, you're going to want a dry set of N.O. (normally open) contacts.

Some will be at a barrier strip on the receiver, and some will need to have wires attached to the solder pads on the circuit board. You may need to cut a trace that supplies the voltage to the motor's relay through the contacts of the receiver's relay. Again, what you want are the dry N.O. contacts.

Some units have a plug-in-the-wall transformer that supplies the necessary 24 VAC, and some have the transformer on board. It's best to have the plug-in type because you'll be burying the receiver in the ceiling, and it would be better to run a low voltage there, than 120 VAC.

Find a centrally located spot where you can put the receiver. Ideally, it should be hidden above the ceiling tiles, if they're easily removed or replaced. Wherever you put it, remember that you'll be running wires from there to the studio, so make it easy. The N.O. contacts go to the remote start

pins, either at the cart machine, or, in the case of our Pacific Recorders console, at the logic connector at the back of the board. These connections can be made in parallel with your normal start connections. Doing it this way, allowed us to take advantage of the timer reset circuitry at the same time.

The receiver's 24 VAC power supply is powered by a plug-strip located at the console area. Run wires from the power supply to the receiver.

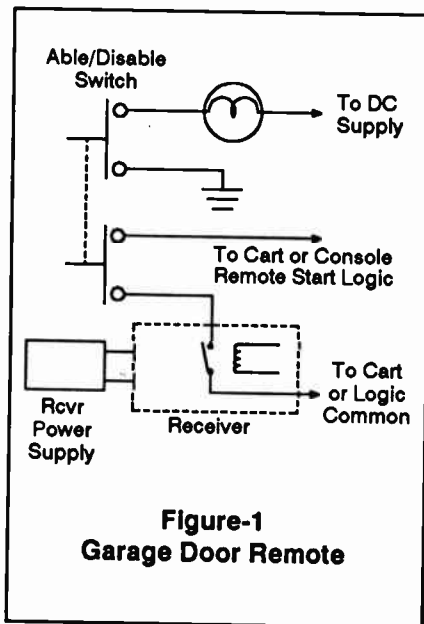

Figure-1
Garage Door Remote

As with the N.O. contacts, you may find a barrier strip that will accept the 24 VAC, or you may need to solder directly to the pads on the receiver board.

For our installation, I took the wires from the N.O. contacts and the 24 VAC, and terminated them into a Molex connector so, if need be, the receiver board could be taken into the shop for repair. Next, you'll need to pick up some DC to run the Able/Disable lamp that's part of the alternate-action switch. The Able/Disable switch prevents accidental starts.

Load cart. That cart's pot *must be up!* Yes, that seems elementary, but you'd be surprised. Press the Able/Disable button. When the cart *before* this one starts, that's when you can leave. Take the garage door remote control with you and, when you hear the song end, press the remote control which will start the cart. Upon returning to the studio, release the Able/Disable button.

Before committing to a receiver location, temporarily hook up a cart machine and go to the different places an operator may need to go. This includes going into the bathrooms, sitting where they'll sit, and trying the remote control. Go to the lobby, the shop, master control -- in short, every conceivable spot in the station.

You'll want to know how far from the receiver they can be so that there are no surprises. If you're having a problem with carts not cueing, take care of that before you install this system, since the previous cart's pot will still be up. Murphy's Law will guarantee a cart will run through while the jock is . . . indisposed.

If there is no house PA system at your station, and there are no plans to get one, buy a little portable radio that they can take with them when they leave the studio. We use this system for record-to-record transitions and *never* out of a network newscast. Yes, it's tempting to think you're going to get five minutes plus a three minute record, but you can count on the network to feed an unannounced frequency response test 30 seconds after the newscast ends. One last thing: It couldn't hurt to use Teflon coated wiring for your ceiling runs. This should satisfy most local fire codes.

We've been using this system at KFRC for almost four years, and the only failures were caused by the operators either not using the Able/Disable switch or not having the cart's pot up.

An interview with "Orbie," the Orban Dalmatian.

HOME: San Francisco, California

PROFESSION: Orban Products spokes-dog.
(Eat your heart out Spuds!)

AGE: 35 (that's 5 in human years).

QUOTE: "Orban has a passion for quality that is exceptional among companies today."

PROFILE: Reliable, versatile and technically outstanding (like Orban products).

ON ORBAN: "Orban maintains the highest technical standards and delivers the most thoughtfully engineered audio processors on the market. Reliable products, purpose-built and backed by great customer service. That's dogged perfection!"

FAVORITE PRODUCTS: "Compressor/Limiters, De-Essers, Stereo Synthesizers, Parametric Equalizers, Spatial Enhancers, Programmable Processors and of course, the OPTIMOD. The entire line is unsurpassed in quality."

FAVORITE SONG: "You Ain't Nothing but a Sound Dog."



orban

a division of AKG Acoustics, Inc.

1525 Alvarado Street
San Leandro, CA 94577 USA
Tel: (1)415/351-3500
FAX: (1)415/351-0500

LISTEN TO THE DIFFERENCE.

Compressor/Limiters, De-Essers, Stereo Synthesizers, Parametric Equalizers, Transmission Processors



SBE National News

SBE Convention Information - SBE/Defense Dept. Certification



SBE Convention

"The Ennes Workshops"

The special one day long Ennes workshops will be conducted by factory-trained instructors who will be utilizing the identical equipment that SBE members use. Here is a brief outline of the SBE Ennes Workshop schedules.

C-Quam AM Stereo

presented by Delta Electronics

Medium and High Power FM Transmitters

presented by Varian-Continental Electronics

RF Technology Session

presented by Harris/Allied Electronics

S-VHS ENG and Production

presented by the Andrew Corporation

Satellite Communication

presented by Mitchell Vo-Technical School

Management for Engineers

presented by the Cupka Corporation

Don Markley RF Workshops

presented by Don Markley and Associates

The 1990 Ennes Workshops will address these and many other important issues at the SBE National Convention which is being held in St. Louis October 4-7, 1990.

Radio Guide June-1990 Page-8

SBE Convention Update

The SBE announced the convention to be held in St. Louis, October 4-7, will have 3-1/2 days of intensive technical seminars covering both Television and Radio. This is a brief description of the papers scheduled.

State of the Broadcast Industry

Several papers from national presenters set the stage for the conference.

The Regulatory Front

Officials from the FCC and FAA will be on hand to answer attendee questions.

Radio Technology

Important sessions on how to apply new techniques that will help facilities become more efficient. Another half day session showing how computers and new antennas can improve station coverage.

Advanced Television Systems

Learn how to plan for the modernization and renovation that stations must undergo. In this half day session on HDTV and ADTV you will learn the techniques necessary to put attendees and their facilities in control of their future.

New Television Technology

Here is where the attendee will learn how to apply the new technologies such as graphics, transmitters, terminal equipment, and fiber optics.

Preparing for Disaster

Don't wait for disaster to strike to prepare your station. Experts surviving the San Francisco earthquake and Hurricane Hugo will share their experiences in protecting their stations.

Night Owl Sessions

Thursday and Friday Night-Owl sessions provide a casual atmosphere for continued discussions. The ever-popular Audio Processing Session will take place Thursday evening. Learn how NRSC and digital processing apply to making your station sound better. The Friday Night-Owl session will look at management techniques. This is where the attendees will learn how to manage themselves and others to become more productive.

SBE/Defense Dept. Certification

The SBE and the DANTES (Defense Activity for Non-Traditional Educational Support) are discussing the feasibility of using the SBE Certification Program in the U.S., Military Services. Andrew Byes, the Manager of Program Development for DANTES, views part of the SBE program as being used to certify members prior to their discharge. The Services want their members to be certified and thus more readily employable.

DANTES has testing centers throughout the world so that the certification program would become available to service members at overseas locations as well as within the continental United States.

The SBE administers a certification program with four levels of engineering achievement. They are: SBE Broadcast Technologist, SBE Broadcast Engineer, Senior Broadcast Engineer, Professional Broadcast Engineer.

Used Equipment Extravaganza!

All items available three ways (unless otherwise noted)

**STRICTLY AS-IS
GUARANTEED WORKING CONDITION
COMPLETELY REMANUFACTURED**

If you don't see what you need, call. Chances are we have it or know where to get it!

* means item is not available remanufactured. All shipping FOB Dallas, Texas.

All items except AS-IS carry 10 day money-back guarantee.

Automation:

Cetec 7000 Level 1: \$1000-\$4500
Cetec 7000 Level 2: \$1500-\$5500
Cetec I/O Cards: \$150-\$350
Gates SC-48: \$50-\$200*
Harris System 90: \$500-\$4000
Harris I/O Cards: \$50-\$250
IGM 500 System: \$300-\$1500
Schafer 902.5: \$1000-\$3250
Schafer 903: \$1200-\$4000
Schafer 903E: \$1500-\$5000
Schafer I/O Cards: \$50-\$250
Schafer I/O Cables: \$25-\$75
SMC RP1000: \$500-\$2000
SMC 3060: \$500-\$2000
SMC ESP-1: \$750-\$2500
SMC DP1: \$200 (for parts only)

Multi-Cart:

IGM Go-Cart(78): \$1200-\$3000
IGM Instacart(48): \$2500-\$7500
ITC DELTA III (3) Mono: \$2600
Schafer Audiofile I: \$1250-\$4200
Spare Module: \$300-\$1200
Schafer Audiofile II/A: \$1500-\$4800
Spare Module: \$500-\$1500
Support Module: \$500-\$1000
SMC581(Dual): \$50-\$400
SMC 721 (Dual): \$200-\$900
250 Carousel (24): \$500-\$1850
350 Carousel (24): \$750-\$2150

Single Cart Decks:

Audi-Cord Stereo R/P: \$550-\$1100
Audi-Cord A Mono Play: \$150-\$600
Harris Criterion R/P Mono \$250-\$750
ITC WP Mono: \$850
ITC RP Stereo: \$1600
SMC 790 Mono Record: \$350-\$850

Reel-To-Reels:

Ampex 352-2: \$150*
ITC 750: \$300-\$850
ITC 750 R/P Mono: \$400-\$1100
MetroTech 523: \$100-\$300*
Revox A-77: \$100-\$850
Schafer-Teac: \$50-\$300*
Scully 270: \$100-\$850
Scully 255: \$250-\$850
Scully 280B: \$350-\$1200

Logging:

Computer List & Load for Schafer
903: \$400-\$1200
Logging Printers (see Printers)
Schafer/Cetec Encoder: \$300-\$1200
Schafer/Cetec VEL Cards: \$200-\$600

Remote Controls:

Cetec 7000: \$125-\$300
Schafer 900 Series: \$50-\$250

Printers:

Anadex: \$50-\$300
Axion: \$50-\$400
Extel AF/AH-11R: \$100-\$400
Extel Paper Winder: \$50
TI Silent 700: \$50-\$400

CRT Terminals:

Beehive: \$50-\$300
Lear Siegler: \$50-\$300
Others: Call

Miscellaneous:

CRL SPP-800: \$250-1000
CRL AM-4 Mono: \$750-\$2750
Equipment Racks: \$50-\$400
IGM 25 Hz Sensors: \$50-\$200
Ramsa WR-500 Console: \$500
Schafer M-52C : \$50-\$300
Schafer Time Gates: \$200-\$750
SMC TS-25 Tone Sensor: \$100-\$300
TFT 760 EBS System: \$300-\$900
TT Preamps: \$50

bsi
Broadcast Automation, Inc

The Only Name in Broadcast Automation You Need To Know...

Call Toll Free (800) 336-8004 or FAX (214) 380-0823

4125 Keller Springs Suite 122 Dallas, Texas 75244 (214) 380-6800

Tube Topics

The Care & Use Of Power Tubes From The Publication *Tube Topics* - by Econco

The complete pamphlet "Tube Topics" may be ordered free of charge from Econco. Call (800) 532-6626.

Basic Design

A vacuum tube consists of a vacuum envelope containing various electronic elements used to emit, control and collect a flow of electrons. A filament or cathode provides a source of electron emission. Up to three grids: the control, screen and suppressor grids control the flow of electrons within the tube. A plate or anode collects the electron flow. Electrical energy, which is not transferred to the load, is converted to heat at the anode.

Emitter Types

The electron emitters in vacuum tubes are either directly heated or indirectly heated. The tube types we are concerned with in this booklet are directly heated, filamentary types.

Operating techniques which are proper for filamentary tubes, are not necessarily correct for tubes with indirectly heated cathode emitters. In particular, the operation of cathode types at reduced heater voltage can be destructive to the tube.

Filament Designs

Directly heated tubes have either spiral, parallel bar, hairpin, or mesh filament structures.

The spiral filament structure (Fig. 2) consists of one or two strands of wire which are spiral wrapped around a central support rod. They are found in older, lower power designs. Spiral filaments are subject to sagging and shorting between the turns.

The hairpin structure (Fig. 3) is found in the majority of tubes currently installed. It consists of a number of par-

allel elements bent into the shape of a hairpin. The hairpin filament support structures have built-in spring compensation for the thermal expansion of

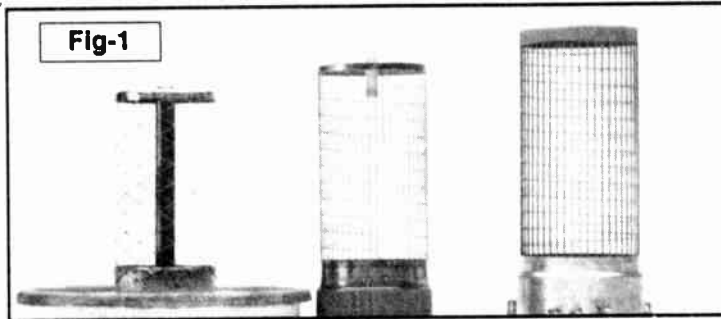

Fig-1

the filament. These filament structures can have all voltages applied without filament warm-up. Tuning will drift slightly, due to relative movement of the tube elements as they reach thermal equilibrium, but there is no danger of shorting. Some tube designs require surge current limitation for the filament, when initially turned on. This protection should be provided for by the equipment manufacturer and should not be bypassed.

Mesh filaments (Fig. 4) are composed of filament wires woven to form

closely spaced structure. This allows higher stage gain, increased efficiency and higher frequency operation.

The mesh structure relies on thermal expansion of the rigid upper filament support structure to compensate for thermal expansion of the filament. Mesh filaments require slower warm-up as the thin, low mass filament wires come to temperature immediately as voltage is applied. As they heat, they expand and, until the more massive and slower-to-heat support structures reach their operating temperature to compensate for this expansion, the filament wires warp in and out. A warped filament greatly increases the possibility of a thermal grid-to-filament short. Proper operation of the filament, as detailed in the section titled "Filament Operation," is vital to long life and stable operation of filamentary tubes.

Grids

Grid structures are generally formed of wires spot-welded together to form a circular structure which completely surrounds the emitting surface of the filament (Fig. 1). The grid controls the flow of electrons from the filament. Grids are coated with various materials compounded to suppress the emission of electrons from the grid. If emissions of electrons from the grid is uncontrolled, it can result in high distortion or runaway of the tube.

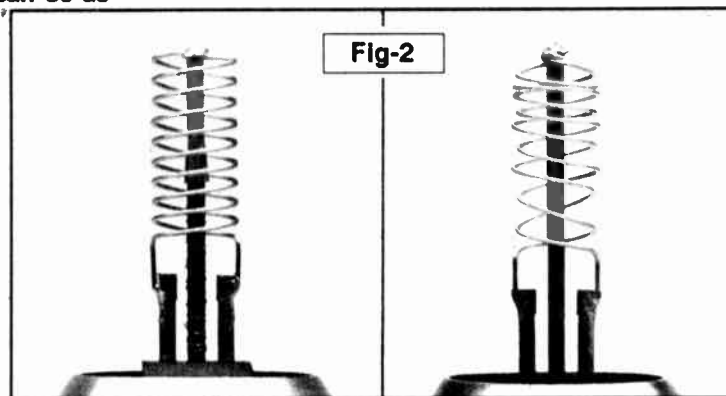

Fig-2

a basket-weave filament structure. The wire joints are spot-welded or diffusion bonded at the intersections. Mesh filaments are being designed into most new tube designs due to the belief that a mesh filament permits a denser more

(continued on page-11)

Tube Topics (Continued)

Anodes

Anodes are copper cylinders or drawn cups which collect the flow of electrons within a tube. They have air cooling fins or water cooling jackets brazed to their exteriors in order to remove the heat generated by the power not transferred to the load.

Plating

The external parts of tubes are plated with nickel or silver. Tubes which go into sockets should be silver plated. The soft silver provides a better contact interface than the much harder nickel. It deforms slightly under contact pressure, providing greater contact area. Silver plating has a dull, whitish cast whereas nickel has a hard metallic appearance.

Nickel is very resistant to discoloration due to heat at normal tube operating temperatures, while silver will tarnish easily. Often, the heat patterns on silver plated tubes are helpful in problem analysis. If a nickel plated tube shows any sign of heat discoloration, a significant cooling or operational problem exists.

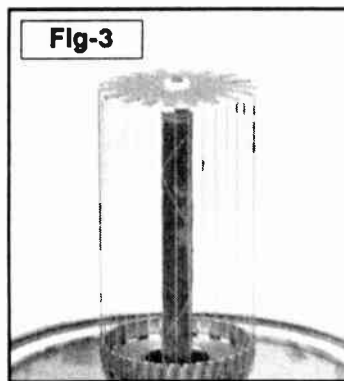

Hairpin Filament Structure

Current path is up one leg, across the top and down the adjacent leg

Nickel will not discolor until it reaches a temperature much higher than a tube will reach under normal operating conditions. If a nickel plated tube discolors, abnormal operating conditions are present.

Safety

Power tubes are installed in equipment that may have lethal electrical voltages present. The high voltage access panels should be installed, and interlocks should be operating and never bypassed. High voltage cabinets should be equipped with a directly grounded shorting bar and should be used to ground all high voltage areas before reaching into them.

Proper design requires that all high voltage circuits have bleeder resistors to bleed off any residual charge to ground when the equipment is turned off. Discharge by these bleeder circuits may take several seconds.

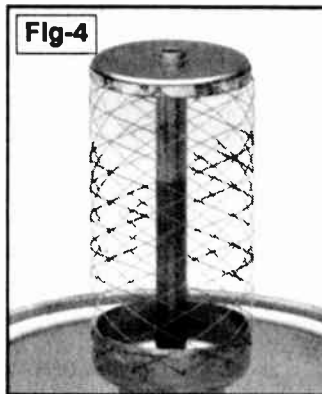

Mesh Filament Structure

Current path is from base, up through mesh filament, across top and down through center support rod

ECONCO

*Now in our 20th year
providing quality rebuilt tubes.*

These are a few of
the tubes we rebuild:

3CX2500F3

3CX3000A7

3CX3000F7

4CX5000A

4CX15,000A

4CX3000A

WE BUY DUDS.

WE ALSO REBUILD REFLEX KLYSTRONS.



ECONCO
1318 COMMERCE AVENUE
WOODLAND, CA 95695
Phone 916-662-7553

OUTSIDE CA 800-532-6626 EXT. 30
FROM CANADA 800-848-8841
TELEX 176756
Fax 916-666-7760

Marti RPT-30 Tech Tip

By Eddy Carrell - Marti Electronics
Cleburne, Texas (817) 645-9163

A common technical question we get here at Marti Electronics concerns the input level adjust of the RPT-30 transmitter.

If you have ever purchased a new remote microphone or headset sports mike to use with your RPT-30, and all of a sudden had more microphone input level than before, with virtually no control over the input level, there is good reason for that happening.

RPT-30 microphone input was designed around a typical output mike level of -68 dB. However, newer mikes, as well as many of the newest headset mikes have an output of nearly -50 dB. Since the input pot is a 25K linear taper, it can only handle about 10 dB of extra mike input. A mike that's 15 to 20 dB hotter than the circuit is designed for, causes the mike preamp to overload and distort when the pot is barely opened.

If you are using a newer style remote mike or headset mike with high output, we have a cure for this annoying distortion. The solution is to permanently pad the input to the mike preamp with a handful of 2,200 ohm resistors.

This will require you to remove the preamp board (800-251) from the RPT-30 chassis. First remove the knobs and hardware from the four level control pots on the front panel. Here is the tricky part: The Neutrik mike connector has a small hole near the center, in addition to the three pin receptacles. This hole contains a tiny locking mechanism. Use a small (.075" wide) flatblade screwdriver, insert the tool into the hole and turn it slowly until the screwdriver engages the connector lock. Go slow and use care, or you will break it! Turn the screwdriver counter-clockwise about 1/8 of a turn until the mike insert releases. Do all four connectors then gently push the black plastic inserts out of the metal shells while simultaneously pushing the gain adjust pots inward until the board releases from the front panel. Now you can remove the board and change the resistors.

The resistors in question are 570 ohm 5% and are numbered R2, R3, R9, R10, R16, R17, R25, and R26.

Replace these with 2,200 ohm resistors of the same tolerance. This will give you a 10 dB pad on the mike input and protect the preamp from overloading with the hotter mike, yet will still allow you to use any of your other lower output mikes without penalty. Now reinstall the board and be careful when you lock the Neutrik connectors so that you don't break the lock mechanisms.



CRL SPOTLIGHT

Converting to the NRSC Standard? Want to Improve Coverage of Your Station?



CRL's AM2 audio processing system is a COST EFFECTIVE way to convert your station to the NRSC standard, and in many cases improve your coverage as well. The two unit system consists of a two-band AGC unit with our dynafex® single ended noise reduction circuitry (AGC-400) followed by our tri-band peak modulation controller (PMC-450). Split studio and transmitter sites? Use the AGC unit at the studio and the limiter at the transmitter! An adjustable presence band boost lets you augment vocal clarity and punch. A patented overshoot corrected low-pass filter ensures maximum modulation control. Low frequency tilt correction circuits plus adjustable asymmetry levels assure compatibility with all transmitter types. Suggested retail price is only \$3195. Our TWO WEEK TRIAL PROGRAM will prove to you how sound of an investment the AM2 mono system is. Call or write us NOW for details.

CRL SYSTEMS
CRL Systems
2522 West Geneva Drive
Tempe, Arizona 85282 U.S.A.
(800) 535-7648 (602) 438-0888
TELEX: 350464

WHY YOU SHOULD PAY MORE FOR LESS.

**New Name-
Same Great Cart!**
The ITC Cart II Cartridge, formerly ScotchCart® II

Less phase jitter caused by poorly tracking tape, because the naturally lubricated concave guides gently position the tape and allow the cartridge machine to perform critical guidance.

Less tape noise and signal loss with our 100% laser-inspected, high output, low noise tape which delivers better frequency response and keeps signal-to-noise ratio high, harmonic distortion low.

Less wow and flutter or stop cue overshoot, because there's no rotating hub to wear out, warp or rattle.

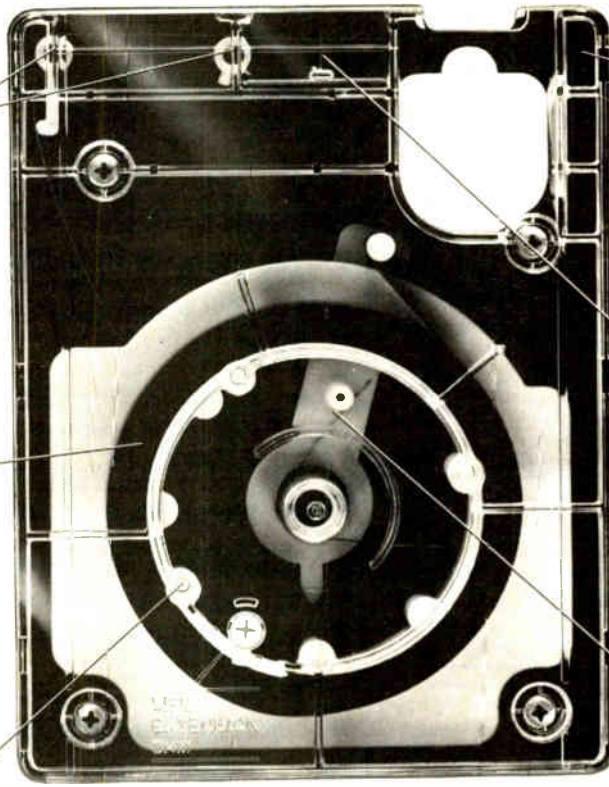

The ITC Cart II Cartridge, formerly ScotchCart® II

Less chance of the cartridge cracking or breaking, because the tough polycarbonate cover withstands repeated use and abuse.

Less head wear, tape steering and modulation noise, because there aren't any pressure pads to add friction.

Less chance of tape destruction, because our patented dynamic tension control system ensures proper tape-to-head contact, and provides constant tension to control looping and prevent twisting.

With broadcast cartridges, like everything else, you get what you pay for. With ITC Cart II cartridges, you get a revolutionary design that delivers trouble-free operation, superb sound quality and a life expectancy that's second to none.

We have renamed the cartridge due to trademark considerations, but only the name has changed, the cartridge and tape are the

same. New name, same great cartridge and performance.

For a complete listing of ITC Cart II dealers, call ITC toll-free at 800-447-0414 (in Illinois, call collect 309-828-1381.) Or write to ITC at P. O. Box 241, Bloomington, IL 61702-0241.

Because a cheaper cartridge may be more trouble than you can afford.

Specification Interpretation

A Guide to the Fine Art of Specifications

*From Mel Crosby - Sequoia Electronics
Los Gatos, California (408) 866-8434*

Manufacturers have developed a special language used in proclaiming the virtues of their products. Ordinary language does not seem to do justice to the many wonderful things they make for us. Sometimes these virtues cannot be completely understood by the average person unless he or she has the anointed translation. Here is your guide to knowledge.

NEW	Different color from previous design
ALL NEW	Parts not interchangeable with previous design
EXCLUSIVE	Imported product
UNMATCHED	Almost as good as the competition
DESIGN SIMPLICITY	Costs cut to the bone (manufacturer's costs)
FOOLPROOF OPERATION	No provision for any adjustments
ADVANCED DESIGN	The advertising person doesn't understand it
IT'S HERE AT LAST	Rush job -- nobody knew it was coming
FIELD-TESTED	Manufacturer lacks test equipment
HIGH ACCURACY	Unit on which all parts fit
DIRECT SALES ONLY	Manufacturer had big argument with distributor
YEARS OF DEVELOPMENT	Finally got one that works
UNPRECEDENTED PERFORMANCE	Nothing we had before ever worked <u>this</u> way
REVOLUTIONARY	It's different from our competitors
BREAKTHROUGH	We finally figured out a way to sell it
FUTURISTIC	No other reason why it looks the way it does
DISTINCTIVE	A different shape and color from the others
MAINTENANCE-FREE	Impossible to fix
RE-DESIGNED	Previous faults are corrected (we hope)
HAND-CRAFTED	Assemble machines are operated without gloves on
PERFORMANCE PROVEN	Will operate through the warranty period
MEETS ALL STANDARDS	Ours -- not yours
MICRO-PROCESSOR CONTROLLED	Does things we can't explain
ALL SOLID STATE	Heavy as hell
BROADCAST QUALITY	Gives a picture and makes noises.
LATEST AEROSPACE TECHNOLOGY	One of our techs recently laid off by Boeing
HIGH RELIABILITY	We made it work long enough to ship it
HIGH ACCURACY SURFACE TOLERANCES	Feels smooth
BUILT TO PRECISION TOLERANCES	Finally got it to fit together
SMPTE BUS COMPATIBLE	When completed, will be shipped by Greyhound
NEW GENERATION	Old design didn't work -- this one should.
MIL-SPEC COMPONENTS	Got a deal at the government surplus auction

NFR Is On The Air

An Update on Noise Free Radio

The Federal Communications Commission has authorized WQYK(AM), Seffner, Florida to conduct on the air tests of NFR or Noise Free Radio. WQYK(AM) 1010 kHz, 50 kW-D, 5 kW-N, DA-2 is licensed to Infinity Broadcasting.

According to George Yazell, P.E. retired, who developed NFR, the basic theory is to frequency modulate the carrier of a standard (AM) broadcast transmitter with narrow band FM. This is in addition to the normal AM program.

In the WQYK(AM) tests, a standard FM exciter generates a carrier on 101.0 MHz with 100 kHz deviation. This wide band FM signal is compressed in a frequency divider (divide by 100) to the WQYK carrier frequency -- 1010 kHz, with a deviation of only 1 kHz. This signal replaces the crystal oscillator signal in the WQYK transmitters.

A standard AM radio receives the amplitude modulation, but does not respond to the NFR signal. When received on a specially designed AM/FM/NFR receiver, the signal is expanded 75 times and then converted to 10.7 MHz with 75 kHz deviation. When injected into the IF amplifier of the FM portion of the receiver, the signal is processed and demodulated by the same circuits used to receive standard FM.

NFR is a method of compressing the normal 200 kHz wide FM broadcast signal to a bandwidth of only 2 kHz so it can be transmitted on the standard AM band. Then, expanding the narrow 2 kHz signal to a wide band 200 kHz signal in the receiver, it can be used to reproduce a hi-fi, "noise free, FM sound."

FCC authorization for the tests states, "Initial analysis indicates that this proposal offers the prospect of significant technical advancement and benefit to the AM broadcast

service, such that the public interest would be served by allowing you to test the proposed system under rigorous real world broadcast conditions."

Dr. Frank Berry, CE of WQYK, reports excellent audio quality. A spectrum analyzer showed occupied bandwidth, with simultaneous AM and FM modulation, well within the bandwidth limits of FCC Rules.

For further information:

Frank Berry, PHD - WQYK(AM)
Box 20087 St. Petersburg, FL 33702
(813) 224-0183

George Yazell, PE retired
P.O. Box 8086
Lakeland, FL 33802
(813) 682-2270

Don't Retire that Old Executive ... Retrofit!

With Broadcast Devices' field proven 10-minute retrofits you can make your old sturdy Harris Executive console perform like today's top of the line. These affordable retrofit electronics are modern plug-in replacements for the old technology mic preamps and line amps. They also will retrofit other Harris consoles including the Diplomat, President and Ambassador series. It makes good sense to retrofit -- you save thousands over the purchase of a new console and studio redesign, improve your sound and eliminate the maintenance headaches that cause embarrassing downtime. If you ever plan to sell your console, our retrofits can dramatically increase its resale value. Contact Broadcast Devices or your local broadcast distributor today for more details.

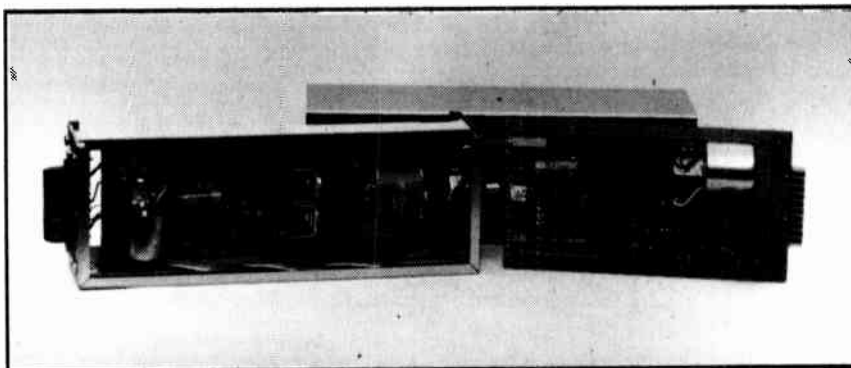

Suggested list prices: Line amp: \$360
Mic Preamp: \$165

Coming soon: Retrofit modules for the Harris Stereo Statesman, Gateway II and Dualux II series consoles!

Affordable solutions for the broadcaster ...

5 Crestview Avenue Peekskill, NY 10566 (914) 737-5032

bdi Broadcast Devices, Inc.

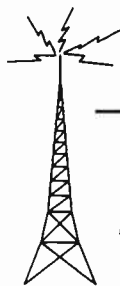

Radio Guide Forum

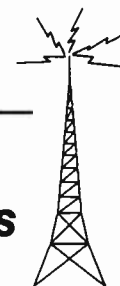

Letters and Questions From Radio Guide Readers

Call For Timers

Ben L. Umberger - WNLT
Clearwater Florida
(813) 446-0957

I would like Radio Guide to make a "call" for timer ideas. Of course, virtually all stations need cart timers that count up in minutes and seconds, resetting to zero when the next cart is started.

There may be stations out there who have adapted inexpensive digital clocks to serve as reset timers.

OK readers, consider the "call" made, and send those circuits in to Radio Guide. . . Editor

Mac Remote

Stu Engelke - WZZD
Lafayette Hill, Pennsylvania
(215) 828-6965

Has anyone used a Macintosh computer to remote control a broadcast transmitter? I'd like to.

Non-Pol Cap Sub

Bruce Sherman - KUSK
Prescott, Arizona
(602) 778-6770

Another possible replacement for the non-polarized capacitor, is the metalized polyester film type. These are available in a wide variety of values and voltages, as type ECQ-E(F), from Digi-Key Corporation. We've found that they work well in monitor horizontal circuits. I don't know how well they will work in audio circuits, but it is worth a try.

**If you have questions
on equipment problems,
send them to Radio Guide.**

Ode to the XLR

Bill Spitzer - WLS Communications
Rapid City, South Dakota
(605) 343-6986

Let me set you straight at the outset, this isn't going to be a history of the ubiquitous XLR connector. It's just a plain and simple, out and out bitch! Maybe it's also a pet peeve of yours as well.

It's not difficult to understand how the XLR has been bastardized by our industry. In the beginning, it was almost unheard of for a radio engineer to wire up an un-balanced connection. Even if it did happen, practically every input and output used a transformer. Subsequently, nobody really gave a hoot which wire went to pin-2 and which went to pin-3 (we can be grateful that pin-1 has remained the same over the years -- namely, ground).

With the advent of stereo, polarity suddenly took on a new meaning. Even if the equipment had transformers, a "rolled pair" no longer meant a cigarette. It now became important to keep those XLR connectors consistent. But in some stations (and, alas, to many manufacturers), this meant assigning pin-2 "low" and pin-3 "high." This may be the same logic that caused Ford Motors to create the Edsel.

It was all too obvious that, sooner or later, a "standard" would need to be developed. Without much hullabaloo, the IEC did just that in 1975. Maybe that's the problem -- there wasn't any hullabaloo! Not one engineer I've spoken to was aware that there was a standard. While I don't speak to all that many, most of them just said, "Well, I thought everybody did it this way." Now, get this; it didn't matter which way these guys wired that XLR connector -- they all thought "everybody did it this way."

Granted, the IEC standard has only been in effect for a measly 15 years. However, even our relatives across the "big pond" have accepted the IEC standard as a British standard since 1981 (BS5428). And in 1983, ANSI also took on the IEC standard (PH7-102).

Now the good news and the bad news. Some of you will need to change your ways in order to get in step with us righteous soles that were never wrong. Yes, many of us can throw out our chests with the same feeling of omnipotence that the Irish have every March 17th and the Texans have all year. The IEC 268 STANDARD makes pin-2 "high" and pin-3 "low." In other words, in a balanced configuration, pin-2 is positive, and pin-3 is negative. In an un-balanced XLR, pin-2 is positive (the only signal you've got), and pin-3 becomes ground.

OK, that's enough backslapping. Let's role up our sleeves and get to work. (Besides, did it ever occur to you that the folks at the IEC just flipped coin -- and we could have been the "other guys?") Now is the time. While we're still hot and on a roll. Get the paper. Get the pencil. Get the lead out! Write to those that aren't in the know. Especially those manufactures that are still wiring XLR connectors backwards. You probably have your favorites, so get with it.

Some of you AM mono folks that are snickering at this would do yourselves a big favor by joining in this effort. How do you think there will ever be an AM Stereo standard for you to go to, if we can't even get compliance with the standards that are already on the books?

Questions or comments? Send them to Radio Guide. . . Editor

Squeaky (clean) CD

By Keith O'Brien - WJRH
 Easton, Pennsylvania
 (215) 559-9917

Many of the consumer lens cleaning disks are not worth the money. Most of the time they will not remove all the grime from the lens, and the brushes can even knock the lens out of alignment. A more effective way to clean nicotine build-up, and the like, from the lens is to open the player up, and gently remove any contaminants with a cotton swab and rubbing alcohol.

Constant handling of CD's by DJ's can cause severe scratches that cause the disc to skip on the best of players. One of the best ways to remove a scratch is to use toothpaste or car polish (any very mild abrasive will do), and gently buff out the scratch with a lint-free cloth. Be sure that, when you are buffing, you are moving from the inner radius to the outer radius of the disc. Don't buff in circular motions! Although this method is not foolproof, it will remove many of the scratches that you may encounter.

If you wish to clean your CD's, don't try to use the consumer CD cleaning kits. A quick and easy way to clean a large amount of CD's is to fill a bucket with water and add a small amount of mild dish detergent, such as "Ivory." Take one CD at a time, duck it under the water and rub it gently with your fingers (once again, no circular motions). Remove the disk from the water and quickly dry it with a lint-free cloth. Don't worry, the water will not harm the CD.

**You've seen it . . .
 What do you think?
 We need your comments
 and suggestions!**

**Fax them to
 (507) 280-9143**



POWER-side™

PROBLEMS

- Adjacent Channel Interference
- Antenna Null Distortion
- Co-Channel Interference
- Power-line Re-Radiation
- Building Re-Radiation
- Receiver Tuning
- Low Fidelity Home Radios
- Co-Channel Beat
- Selective Fading

SOLUTION!

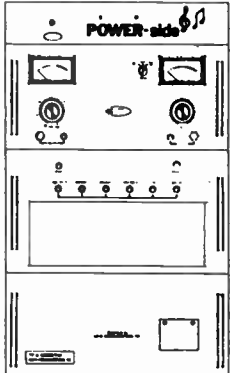

POWER-side™
 The solution to many of AM radio's most serious technical problems



*From the developers of the AM STEREO system that isn't afraid of the dark
 and will let you drive right past FM Stereo*

425 MERRICK AVENUE, WESTBURY, NY 11590 • (516) 222-2221

LPTV Sideband Suppression Notch Filters & Video Aural Combiners

Reduce sideband radiated power & meet FCC transmitter standards.

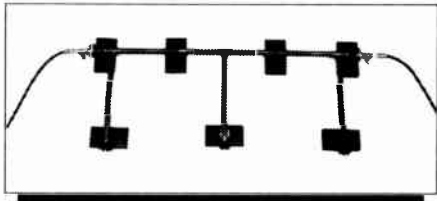

**Full Details In Bulletin #15
 Ask For Our FREE Catalogs!**

Request BTV/87 which describes TV/FM/MMDS Broadcast Filters and Combiners for service radio bands

Catalog BTV/87

Need A Special Filter? Call Us Today!
"We Make Filters In A Hurry For Customers In Trouble!"

Microwave Filter Co., Inc. • 6743 Kinne St. • E. Syracuse, NY 13057
 Toll Free(US/Can.): 1-800-448-1666 • Collect(NY/AK/HI): 315-437-3953
 FAX: 315-463-1467 • Telex: 249-613



Puts your signal in it's place!

If you need a quality antenna, you need: **JAMPRO ANTENNAS, INC.** The really experienced one for over 30 years.

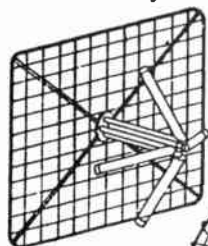

JAHD CP
Arrowhead
Screen Dipole

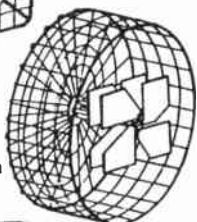

JSDP CP Spiral
Broadband Antenna

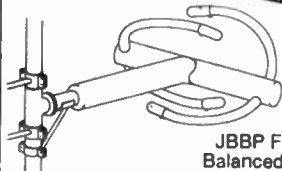

JBBP FM Antenna
Balanced Excitation

JAMPRO is the world leader in custom-designed, directional, CP antennas.

- With over 1600 of our penetrators delivered, more stations have penetrated their market.
 - Our custom-made directional antennas are operating world wide.
 - Full-scale antenna measurements on **JAMPRO's** all-year, all-weather test range.
 - We custom-make tower structures to duplicate your's, for optimum results.
 - Ask about **JAMPRO's** low-power educational packages.
- Give us your requirements and see how fast we produce.

JAMPRO Antennas, Inc.

6939 Power Inn Road
Sacramento, CA 95828
(916) 383-1177 • Telex: 377321
FAX (916) 383-1182

Transmitter Tips

False Readings & Blown Rectifiers

By Russ Erickson - RF Product Manager
Broadcast Electronics (217) 224-9607

When doing troubleshooting on a transmitter, remember that the volt meters on the front of the transmitters can sometimes be deceiving. This is because the sample voltage derived to drive the meter is taken prior to entering the PA cavity.

The first time it happened to me was on an RCA BTF-10E, but it could certainly happen on just about any grid-driven tetrode PA.

There was an indication of screen voltage on the front panel multimeter. The problem was, the voltage sample was taken prior to entering the PA. So, although I was getting a meter indication, there was no voltage getting to the screen. The only way you could verify this is by taking the voltage measurement at the feed-thru cap going into the PA, after ohming out the circuit from the screen grid to the cap to insure continuity.

It can also happen on the grid bias supply. You have probably noticed the change in state of the grid bias with and without grid drive. For example, on a 30 kW transmitter, the bias can change from -200 volts to -250 volts with drive applied. If you notice no change in the grid bias between filaments-on and plates-on, there is an open circuit after the point where the grid bias voltage is sampled.

Always take your scheduled filament voltage readings at the base of the tube socket, as recommended by the manufacturer. If your transmitter does not use a true RMS reading iron vane filament voltage meter, you could inadvertently adjust the filament too high or too low, causing the tube to de-carburize too rapidly, or to become a "getter," where the filament becomes poisoned by contaminants. Always try to maintain your filament voltage within +/- 3% of nominal.

Do you know what is inside those large rectifier stacks (large epoxy sealed blocks with solder or screw terminals)? Picture a series string of diodes with a resistor and capacitor in parallel with each diode (for RC compensated rectifiers). That's it! The manufacturer then puts that assembly in a shell and fills the shell full of epoxy.

If their voltage rating is exceeded, they will usually blow a hole in the case at the ends of the rectifier. If there is a hole blown through the case at the center, it generally means the current rating was exceeded. This may help you determine if you have an AC line problem (peak voltage exceeded), or a transmitter power supply problem (excessive current draw due to a short).

QEI QEI QEI QEI QEI

WHY QEI?

24 Hours.



Our 24 hour
service hotline
number is
609-728-2020.

Call us toll free at
800-334-9154 for all

the facts on QEI "New Reliables"
FM transmitters from 1kw to 30 kw.

QEI CORPORATION
ONE AIRPORT DRIVE • P.O. BOX D
WILLIAMSTOWN, N.J. 08094

TEL (609) 728-2020 • FAX (609) 629-1751

QUALITY • ENGINEERING • INNOVATION

Loss of Audio Alarm

A Circuit for Dead-Air Detection

By David P. Woodcock - WNBC

Madison, Wisconsin (608) 271-1025

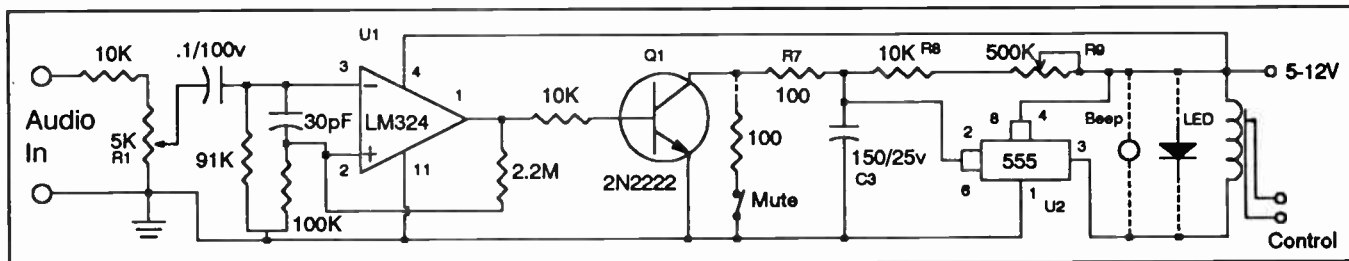

Sometimes an operator at our station may be doing production work in another studio while a taped program is being aired. This operator may be the only person on duty and may not know when there is "dead air" from a mechanical problem with a tape machine or a splice, causing a tape machine to stop.

I have built several of these alarms to put into the production studios. The input to the circuit is fed from the output of my modulation monitor. That way, it detects loss of audio from any cause.

R1 adjusts the gain of the alarm circuit. This sets the turn-on threshold of Q1. U1 is a quad op-amp. (A 741 or 748 can also be used, but you'll need a negative voltage with these.)

Q1 is any medium gain NPN transistor and acts as a discharge path for C3, through R7, when there is audio present. R9 adjusts the charge time of C3, through R8 and R9. This adjusts the delay time of the alarm.

U2 is a 555 timer which turns on when C3 reaches two-thirds of the supply voltage. You can also add a mute switch if you are going to use a beeper alarm, by adding a 100 ohm resistor connected to the collector of Q1 and going to a switch with one side connected to ground.

An LED, beeper alarm, or relay may be connected across pins 3 and 4 of U2.



CRL SPOTLIGHT

Converting to the
NRSC Standard?
Want to Improve Coverage
of Your Station?



CRL's new PMC 450 AM Limiter is a cost effective way to convert your station to the NRSC standard, and in many cases improve your coverage as well. The PMC 450 consists of a gated input compressor followed by an NRSC compliant tri-band limiter section. An adjustable presence band boost augments vocal clarity and punch. A patented overshoot corrected low-pass filter ensures maximum modulation control. Low frequency tilt correction circuits plus adjustable asymmetry levels assure compatibility with all transmitter types. Suggested retail price is only \$1850. Our two week trial program will prove to you how sound of an investment the PMC 450 is. Call or write us for details.



CRL Systems

2522 West Geneva Drive
Tempe, Arizona 85282 U.S.A.
(800) 535-7648 (602) 438-0888
TELEX: 350464

Headphone Amplifiers

Inexpensive Headset Amplifiers Using 5532 Op-Amps

By Hal Schardin - WCCO

Minneapolis, Minnesota (612) 464-7587

A couple of years ago, WCCO was looking for a multiple headset amplifier. Many times WCCO will take a program on the road, and it is necessary to provide headsets for announcers, guests, producers, and engineers. It is also necessary for each individual to be able to control his or her own headset level.

Little power is needed

Initially, the output of a PA system was bridged to provide the headset feed, but on some remotes, the level would get ducked to prevent feedback. Also, separate 8 ohm pots tend to get noisy real quick.

For most remotes, 600 ohm phones are used. Little real power is needed to drive these headsets, as the transducer is next to the ear -- and today's "cans" are much more efficient than their predecessors.

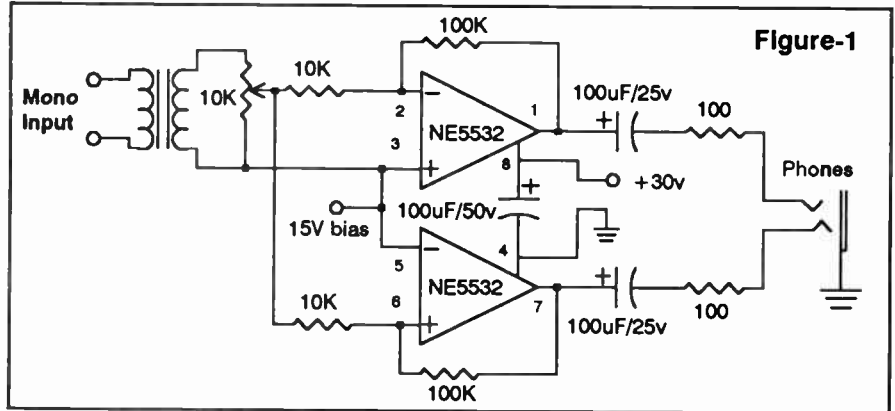

Now I hear a lot of you saying the NE5532 was never meant to be a power amp. Yes, that's true, but I say the proof is in the pudding, and we have not had one of those chips fail yet. The 100 ohm resistors in series with the outputs limit the current, should a mono plug become inserted into a stereo jack (they also limit the level to low impedance headsets).

Figure-1 shows a mono setup using a transformer to accommodate a balanced input. This is the setup we have used at remote locations to provide headset backcue. Yes, you can use an op-amp to provide active balancing. However, I've encountered better common mode rejection with a transformer, in this sort of application.

Figure-2 shows a stereo unbalanced setup. There is very little real difference between Figures 1 and 2, so you should be able to figure out a balanced stereo or unbalanced mono configuration.

I've shown the power supply circuits I've used. I've used an existing 24 VDC supply in one application (the only need was to generate a VCC/2 point for bias). The AC supply shown (Figure-3) was used to power five headset amps in the remote application mentioned earlier.

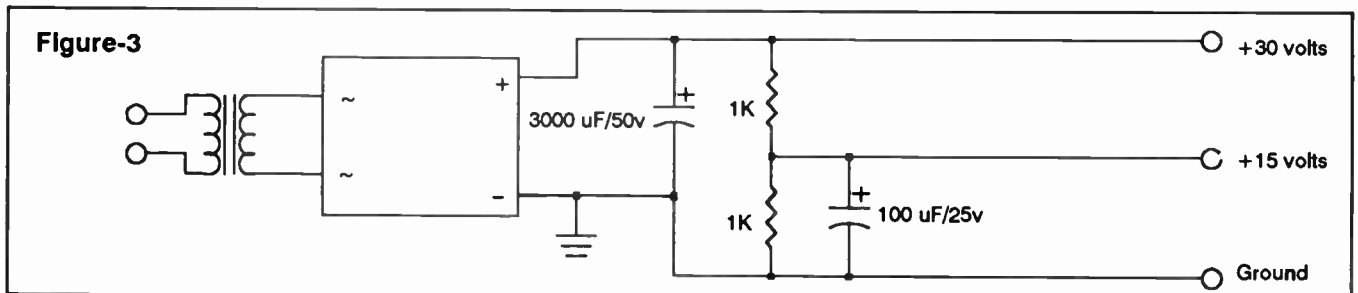
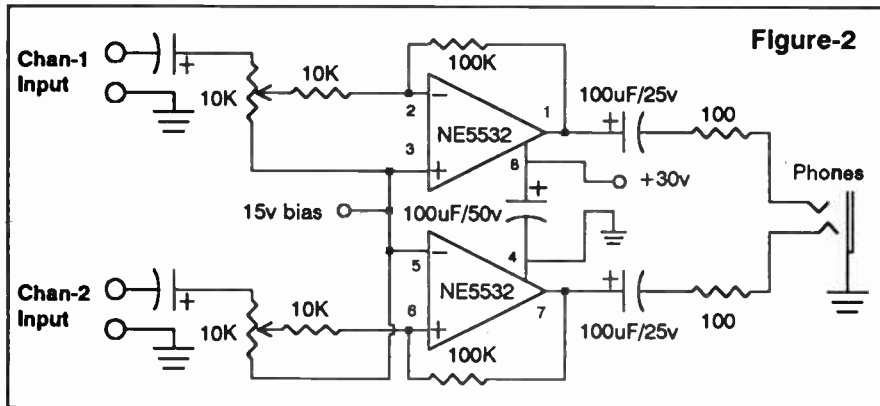

Tower Inspection Check List

From Broadcast Communications
Verona, Wisconsin (608) 845-6755

Structure

Bent or fractured cross members
Loose or missing bolts
Broken or cracked welds
Signs of unusual stress
Tower twisted or distorted
Condition of galvanizing & paint
Signs of rust, pitting, etc.

Grounding System

Clamps, straps or grounding wires
All connections secure
Lightning rod at top of tower
Any signs of arcing

Guy Wires

Any broken guy wire strands evident
Any rust or deterioration noted

Guy wire connections:

- pre-forms
- clamps
- both

Condition of thimbles and shackles
Condition of preforms/cable clamps

Lighting System

Manufacturer of system
Number of beacons out
Number of obstructions out
Condition of beacon lenses
Condition of colored beacon liners
Beacon parts in need of replacement
Condition of obstruction lenses/parts

Obstruction lenses are:

- flanged
- threaded

Signs of moisture in fixtures

Fixture drain holes clean

Fixture lenses clean

Gaskets greased

Electrical wiring

- conduit/wiring secure to tower
- junction box parts needed
- condition of junction box
- condition of breathers

Insulators

Cracked, chipped or broken

Condition of base insulator

Signs of arcing

Antenna/transmission lines

Condition of antenna hardware
Condition of antenna grounding
Physical damage to antenna and line
All bolts and connector secure

Line pressure leaks

Transmission line chaffing, or wear

Line grounding kits

Line brackets/wire ties secure

Line slippage

FM Harmonic Low Pass Filters

500 - 50,000 Watts

Delivery: 30 Days (Faster For Your Emergencies)

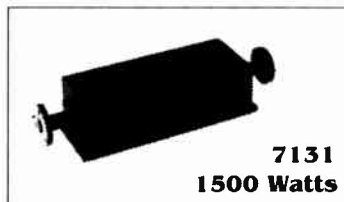
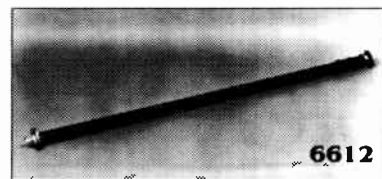
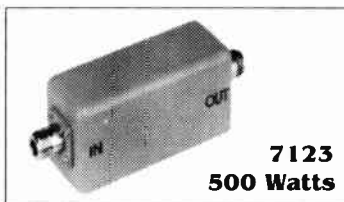

Model #	Watts
6612	6,000
6516	15,000
7772	30,000
7455	50,000

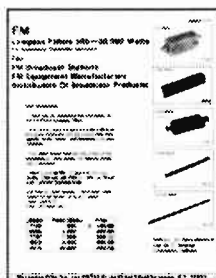

Bulletin #14

Full Details In Bulletin #14!

Also, request
BTU/87 which
describes
TV/FM/MMDS
Broadcast Filters
& Combiners for
service radio
bands.

Catalog BTU/87

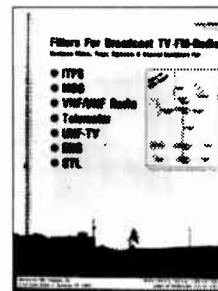

Need A Special Filter? Call Us Today!

**"We make Filters In A Hurry For
Customers In Trouble!"**

Microwave Filter Company, Inc.

6743 Kinne St. • E. Syracuse, NY 13057

Toll Free(US/Can.): 1-800-448-1666 • Collect(NY/AK/HI): 315-437-3953

FAX: 315-463-1467 • Telex: 249-613

AM Directional Antenna Systems

Construction and Setup Tips For Your Array

By *W.C. Alexander - Director of Engineering*
Crawford Broadcasting Co. (214) 445-1713

One of the most challenging and often frustrating tasks faced by the broadcast engineer is the construction and tuneup of a new or newly modified AM directional array. For many, this is an area of the engineering discipline that is farmed out to the consulting engineer -- and perhaps wisely so. Still, although a high level of expertise is required to produce the finished product, the basic setup is well within the capabilities of most competent station engineers, provided that they have a good deal of patience. By doing the basic setup themselves, station engineers can save the station a tremendous amount of money.

Site Selection

Site selection must, of course, precede all other aspects of DA setup. This facet may begin in the front seat of a real estate broker's car, touring the countryside, or it may start with negotiations with the owner of the piece of property adjacent to the station's existing antenna site so that adjoining land can be purchased to accommodate the additional tower(s), in the case of modification of an existing DA. Either way, a number of important factors must be considered.

The piece of property must be of an adequate size and shape to accommodate, not only all the towers and their guy anchors, but the ground system at a radius of 1/4 wavelength from each tower base. The ground system can be "cheated" in certain circumstances to accommodate a property boundary, but this reduces the efficiency and is generally not desirable.

Another important factor is the uniformity of the terrain on the site. A

piece of property that features elevation excursions much in excess of ten feet from the location of any one tower base location to any of the other tower base locations should be avoided.

The consistency of the soil also warrants consideration since this factor can directly affect construction costs. Sandy subsurface soil will dictate the use of larger and more expensive foundations, while rocky soil will also increase costs by requiring heavy drilling equipment to dig the anchor holes. Topsoil constitution will directly affect the time and amount of work required to install the ground system and buried transmission lines and, therefore, the cost of that part of the construction.

A geo-technical investigation of the soil conditions at the selected site is a good idea before the purchase is made. Such studies generally cost less than \$2,000 (depending on plot size and number of tests borings), and the results will provide a valuable tool in construction planning and anchor design. No station owner wants to be told that all bets are off because the backhoe operator struck groundwater 18 inches down on the new \$30,000 transmitter property!

Before construction begins, it is imperative that the locations of the tower bases be accurately surveyed and marked. A tower base that is a few feet off center can cause real grief. Most tower crews who specialize in AM DA construction will use a transit to stake at least three references off each of the surveyed base locations so that once the backhoe finished its work and the surveyor's stake is buried in a mound of fill, the sonotube and foundation forms can still be accurately placed.

When tower erection is complete, it is a good idea to have the contractor weld all the joints of at least one leg of each tower. This will make little difference initially, but twenty years down the road, when all joints are corroded, it is good to know that there is still solid electrical continuity from one end of the structure to the other.

STL and other coaxial cables attached to the towers should be electrically bonded to the supporting structure in at least three places to insure even RF current distribution along their length. In extreme cases, poorly bonded

(continued on page-23)

QEI QEI QEI QEI QEI

W H Y Q E I ?

Single Phase 30 kW.

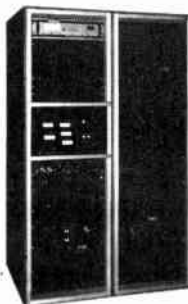

Our new FMQ 30000B is the only 30 kW transmitter available with a single phase power supply.

Call us toll free at 800-334-9154 for

all the facts on QEI "New Reliables" FM transmitters from 1kw to 30 kw.

QEI CORPORATION
ONE AIRPORT DRIVE • P.O. BOX D
WILLIAMSTOWN, N.J. 08094

TEL (609) 728-2020 • FAX (609) 629-1751

QUALITY • **E**NGINEERING • **I**NNOVATION

AM Directional . . . (continued)

transmission lines can act as independent radiating elements, causing unpredictable results to the overall system, as well as arcing and pitting of the lines.

Ground System

Ground systems for AM DA's typically consist of 120 evenly spaced radials per tower that are 1/4 wavelength long. Where these radials intersect, they will normally be bonded to a transverse copper strap. In addition, either a copperweld screen or 120 interspersed radials will be installed in the immediate vicinity of the tower base to provide additional grounding at that point.

This screen should be covered with at least two inches of a good washed gravel, and should be bonded to the same strap around the tower base as the regular ground radials. It is not necessary to bond the outer edge of the screen to the ground radials; in fact, the screen should be placed on top of the ground while the radials are buried all the way to the tower base.

Copperweld screen sections, which normally come in eight-foot sheets, should be bonded together at frequent enough intervals to insure good mechanical and electrical integrity.

Traditionally, four-inch ground strap is laid in the trench along with the transmission line to provide a ground connection between the transmitter building and each tower base/antenna tuning unit ground. However, in recent years, many installation have been cutting costs by leaving these straps out. This is entirely acceptable, since the outer conductor of the transmission line serves the same purpose.

Antenna Tuning Units

Many AM DA installations utilize "dog houses" in the vicinity of the tower bases to house the antenna tuning unit, sampling transformers, and lighting chokes. However, in recent years, free standing weatherproof cabinets have begun to replace the dog houses as the preferred enclosure. There are advantages and disadvantages to both.

The dog house provides a dry, "walk-in" environment where the station engineer can stand out of the rain and wind while taking readings and making adjustments. Some stations have even gone as far as to heat and air-condition their tuning houses and install concrete walkways between them. This is, of course, an unnecessary extravagance, but it does provide the station engineer with a cushy environment in which to work.

Otherwise, dog houses are generally high-maintenance items. Normally constructed of wood and exposed to the elements, they require periodic painting, roofing, and other repairs. In addition, they provide an attractive abode for all sorts of wildlife, from mice and snakes, to spiders, wasps and hornets. There are not many expe-

(continued on page-24)

Silence is Golden and less work with telcom c4 for RADIO and TV.



The NR system you just set and forget.

- A product of ANT Telecommunications, Inc.
- No overshooting.
- No wasting time with lining up — not even for tape exchanges.
- No pre or post echo.
- Up to 118dB dynamic range — the widest dynamic range available in any noise reduction system today.
- Applications:
 - Cartridge machines
 - STL
 - RPU
 - Reel-to-reels
 - Cassettes
- Over 15,000 channels in use worldwide.
- No breathing or pumping.

telcom c4
Silence by Design

Distributed by:

RAM BROADCAST SYSTEMS INC.

346 W. Colfax Street, Palatine, IL. 60067

New York (516) 832-8080

Chicago (708) 358-3330

Tennessee (615) 689-3000

AM Directional . . . (continued)

periences less pleasant than walking into a dark tuning house full of angry yellow jackets on a hot summer night.

Weatherproof metal enclosures, on the other hand, provide an elevated, dry environment for the tuning components, although the station engineer can get mighty wet and cold while working on them. Since these enclosures are tightly sealed, there is not usually much an insect or rodent problem, and maintenance is minimal.

Possibly the biggest advantage is cost, both initial and maintenance. Such boxes are normally supported on two steel posts set in cement near the tower base, and no slab is required.

The choice of which type of enclosure to use is probably best decided on the local climate. In temperate regions, the weatherproof metal enclosure is entirely acceptable, while in cool, rainy areas, such as the Pacific Northwest, a tuning house might be the better choice (sidewalks and air conditioning optional).

Transmitter Building

One of the easiest places to cut costs (and probably the worst place to do so) is in the design and construction of the transmitter building.

Consideration should be given to all facets of the station operation, including equipment installation, when considering a design. This means having doors wide and high enough to provide ample clearance to fork-lift in every piece of equipment as well as enough room to maneuver the equipment into place once it is inside. Once in place, the extra space will be a welcome feature for storage and work room.

Placement of the transmitter building is also important, and a great deal of savings can be realized by judicious selection of the location. Usually, if the building is located at the point closest to the egress point of the transmitter site, at the end of one of the transverse ground system straps, the shortest transmission line runs and gravel driveways will result. In addition, location of the

Radio Guide June-1990 Page-24

building a full 1/4 wavelength from the closest tower will minimize RFI problems in the building, reduce the likelihood of damage to transmitter equipment from lightning strikes to the towers, and almost always insure that the ANSI RF radiation limit is not exceeded.

For durability and low maintenance, masonry construction is preferred. A flat roof is economical and perfectly acceptable, although it is wise to make provisions for some slope, even if it is undetectable to the eye, to keep water from standing. The new single sheet "rubberized" roofing is preferable over the old tar and gravel type, for low maintenance. Most roofs come with 25 year warranties.

Provision in the slab should be made for getting transmission and sampling lines, AC cables, and ground straps from inside the building to the trenches outside. A number of four-inch, thick-wall conduit elbows installed in the slab will serve the purpose nicely. Such penetrations are easy to pull cables through, and are easily sealed when installation is complete.

Enough AC power should be provided to run all transmitting equipment simultaneously (one transmitter into the antenna and one into the load)

QEI QEI QEI QEI QEI

W H Y Q E I ?

The Longest.



Our PA tube warranty is the longest in the business — 15,000 hours.

Call us toll free at 800-334-9154 for all the facts on QEI "New Reliables" FM transmitters from 3.5 kw to 30 kw.

QEI CORPORATION
ONE AIRPORT DRIVE • P.O. BOX D
WILLIAMSTOWN, N.J. 08094

TEL (609) 728-2020 • FAX (609) 629-1751

QUALITY • ENGINEERING • INNOVATION

with the air conditioning or heating running. This will keep voltage drops to a minimum and provide an adequate safety margin for normal operation. Lightning protection for the AC mains, either in the form of one of the commercial lightning protection devices or MOV/gas-discharge devices, should be installed.

Adequate air conditioning should be provided to take care of the heat load of all transmitters and keep the building comfortably cool for all the equipment and personnel. A competent air conditioning/heating contractor can calculate the tonnage required for your installation quite accurately. Many local utilities offer rebates or reduced electric rates if you install a "heat pump" instead of regular refrigeration and heat strips. Check with your local electric service for incentives offered. Heat pumps are also considerably more efficient, further reducing operating costs.

A tight building is a clean building. Because AM transmitter sites are typically located in the open, dust, dirt and insects are a real problem. Make sure the building is designed to seal tightly, and this will result in a dust-free and bug-free environment, as well as lowered heating/cooling costs.

Finally, it is wise to install some sort of driveway improvements to provide for ingress/egress without burying your car in the mud. A lime base topped with a good quality washed gravel is relatively inexpensive and easy to maintain. Provide for a large enough paved area to park several cars, and pave all the way to the door so that no one tracks in mud.

Security

Since transmitter sites are usually remotely located, good site security is important. A good alarm system is a must for the transmitter building; however, be careful that the unit selected is not susceptible to RFI. Many commercial alarms offer RF bypass options that the installer may or may not be familiar with. It pays to check this out ahead of time.

(continued on page-25)

AM Directional . . . (continued)

The perimeter of the property should be fenced and kept locked. Signs should be posted in conspicuous places warning would-be trespassers of the consequences of unauthorized entry. High voltage and RF radiation warning signs are also useful, although all signs provide a convenient target for "Billy Bob" and his bunch of Saturday night shooters. Unfortunately, there isn't much that can be done about this. Just make sure the signs stay readable.

Perhaps one of the simplest and best forms of security that you can have is to get acquainted with the neighbors. Introduce yourself to the farmer next door and fix any RFI/TVI problems you might be causing him, at the station's expense. Offer to let him run his cattle on your land, and give him a set of keys. Not only will this often get you out of paying "rollback" taxes by keeping the property in agriculture, but the neighbor will keep an eye on things.

OST Bulletin No. 65 sets the guidelines for human exposure to non-ionizing RF radiation. Other FCC rules requires that the tower bases be fenced and locked. Check OST 65 for the radius at which your towers must be fenced, based on the worst-case condition of all the power being delivered to any one tower.

Cyclone fencing is a good, low maintenance fabric for tower base enclosure, but the FCC rules and good engineering practice dictate that such fences be grounded. Since all such fences are galvanized, electrolysis will result in corrosion over a period of time, cancelling many of the advantages of this type of fence.

Wooden "stockade" fencing does not need to be grounded but normally requires quite a bit of maintenance. Perhaps the best compromise is a high quality stockade fence constructed of treated wood and supported with steel posts. Keep all wooden components an inch or two above ground. A solid "privacy" type fence is not needed, so only half as many pickets need be in-

stalled, reducing the cost of the fences. Further savings can be realized by making the base fences an octagon or hexagon instead of a square. Gates should be equipped with lockable latches, and it is a good idea to secure them with padlocks that are all keyed the same. It is probably wise to post RF radiation warning signs, such as those sold by the NAB, on the gate of each tower base fence.

It is a good idea, although not strictly necessary, to fence all guy anchors. Cyclone fences are perfectly acceptable for this application, since they will normally be out of the very high RF field near the tower bases;

However, it is a good idea to check for RF "hot spots" around such anchor fences to make sure that the ANSI limit is not exceeded.

Initial Setup

Once construction is completed and all transmitters, phasing, tuning, and sampling equipment is installed (including control and AC wiring), preliminary array adjustment can begin. For the purposes of this discussion, it is assumed that sampling loops rather than toroidal transformers are installed at tower potential and located with an isocoil (Figure-1).

(continued on page-27)

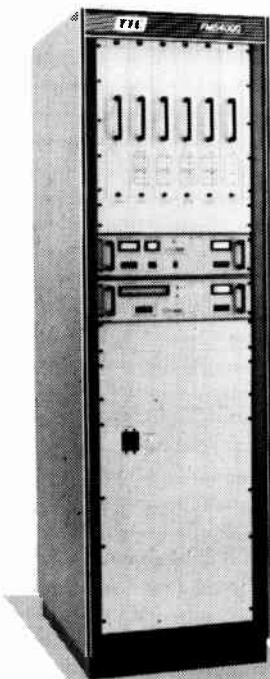

WORLD STANDARD IN SOLID STATE FM TRANSMITTERS

Solid state quality and efficiency. TTC's new FMS-Series FM Transmitters are available in 1kW, 2kW, 4kW and 8kW models. Broadband, efficient power amplifiers are transparent to the high-spec TTC Exciter.

Redundant systems for high reliability. Individual 1000 Watt plug-in amplifiers provide extremely easy service and maintenance. These transmitters remain on the air automatically—even in the unlikely event of a power amplifier failure. Exclusive "fail-on" control circuits keep the transmitter operating should a control circuit fail.

World-acclaimed TTC Model X Exciter. The Model X provides truly outstanding performance, with all distortions measuring .01% or less and FM composite signal-to-noise ratio an amazing 90dB down. Frequency response is .05dB from 20Hz to 100kHz for unparalleled loudness and clarity.

Made in U.S.A. For details on our full line of AM and FM transmitters and translators, call TTC: Television Technology Corporation, Phone: (303) 665-8000 FAX: (303) 673-9900

**The Quality
is TTC**

- 100% solid state
- Very high efficiency
- Fully automated control
- Superlative specifications
- Integral lightning protection
- Redundant power amplifiers
- Broadband—no tuning required

FIGURE 1

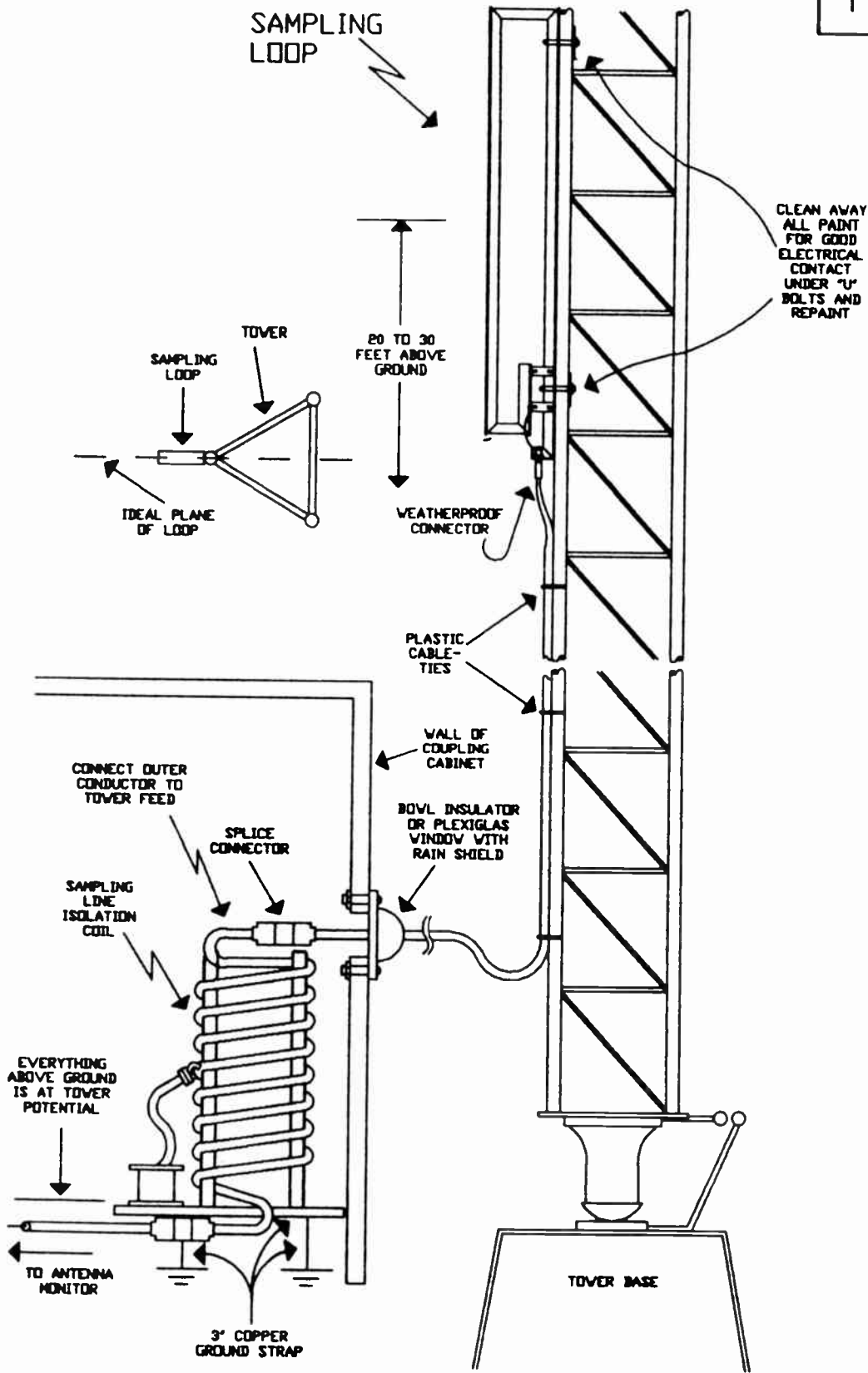

AM Directional . . . (continued)

The necessary test equipment for setup includes the following items:

1. An RF impedance bridge, such as General Radio 1606B
2. An oscillator or synthesizer, such as Potomac SD-31
3. A receiver or detector (included with SD-31)
4. An operating impedance bridge, such as the Delta OIB-1
5. An antenna monitor
6. Several equal lengths of RG-58 coax with PL-259 connectors
7. Field strength meter, such as Potomac FIM-21

Mutual Coupling

One of the first things that a station engineer can do is a very useful trick of the trade. The following test will measure the effects of mutual coupling in the power divider inductors.

Using the synthesizer or oscillator, feed the phasor at the output side of the J-plug between the input Tee-network and the power divider. The J shorting plug should be removed.

Disconnect the input tubing to the reference tower series resonant (zero phase shift) network. Connect one length of RG-58 cable between the output side of the power divider input J-plug and the reference tower input jack on the antenna monitor.

Disconnect the tubing between the power divider inductors and the phase shift networks. Connect additional lengths of RG-58 between the output of the power divider inductors and the appropriate tower input jacks on the antenna monitor (i.e. tower #1 power divider out to the tower #1 sample input, tower #2 power divider out to the tower #2 sample input, etc.).

Turn on the oscillator without modulation. You should be able to select the reference tower on the antenna monitor and set the loop current to 100% and read "0" phase.

If unable to set the loop current to 100%, the output level of the oscillator is insufficient to drive the antenna monitor. Increase the output level or use another source of drive, such as the transmitter modulation monitor jack with the transmitter operating into a dummy load.

Now select one of the other towers and note the current and phase as you vary the ratio control for that tower. Do the same for the remaining towers. Measure and plot the relative current and phase versus turns on the turns counter for all ratio controls. Remember-



Recycle Carts

to reduce
audio tape
and
cartridge
costs

Improved Tapecaster® X-100 cart loader with single lever control enables error-free loading to one-second tolerance. Long-life, heavy-duty synchronous motors and rugged all-steel chassis and top deck make X-100 the only loader you'll ever need. Among its features are:

- Adjustable tape tension
- Precision electronic timer with automatic reset
- Editall splicing block

For complete information call or write.

TAPECASTER®
a division of

 **Audiotronics, Inc.**

3750 Old Getwell Road • Memphis, TN 38118
Phone: 901-362-1350 • FAX: 901-365-8629

(continued on page-28)



You receive an important extra with every quality TTC transmitter...



We're there with Total Support if you need us. Our 24-hour Total Support Hot Line lets you call for technical, engineering, or maintenance support at any time. All our transmitters and translators are made with strict attention to quality control.

Get to know TTC and our full line of AM and FM Transmitters, made in the U.S.A.—FM from 10 Watts to 40,000 Watts, AM from 500 Watts to 50,000 Watts. For more information, call TTC: Television Technology Corporation (303) 665-8000 • FAX: (303) 673-9900

The Quality is TTC

TTC TOTAL SUPPORT

AM Directional . . . (continued)

ber, you will have to reset the reference tower reading on the antenna monitor for 100% after each change in any of the ratio controls. Note and record any interaction between ratio controls (i.e. if #3 is set for 50% and #3 is changed, does the phase shift in the other tower's power divider networks change?). There should not be any interaction, but it will be helpful later on to know if there is.

When all the above steps have been completed, set the power divider ratio controls for the appropriate ratios, note the dial settings, and leave the controls as set.

Repeat the above procedure for all patterns in the system, then reconnect all tubing removed in previous steps.

Transmission Line Lengths

This test will determine the electrical lengths of all the transmission lines in the system.

First, disconnect each transmission line at its respective ATU and leave the end open. Disconnect the phasor end of each transmission line as well. Connect the RF bridge to the input of the lines, one at a time, and by varying the frequency of the synthesizer or oscillator, determine the resonant length of the line. With the ATU end disconnected (open), a short will appear at the input end when the oscillator is set to the line's resonant (1/4 wave) frequency. Measure and note the exact oscillator frequency at which the line is resonant. Repeat for all transmission lines. It is a good idea to perform this procedure on the sample lines as well to be sure that they are of equal electrical lengths.

Once the resonant frequency of each line is known, the electrical length of each line in degrees can be determined using the following formula:

$$E_L = (F_o/F_n) \times 90^\circ$$

These electrical length values should be noted and recorded.

Radio Guide June-1990 Page-28

Preliminary Phasor Set-Up

This is a setup procedure for the phase shifting networks in the phasor. It uses the antenna monitor as a simulated load for the phasor, replacing the transmission lines and ATU's/towers.

It will be necessary to calculate the entire phase shift in each tower line (power divider, transmission line, and ATU, inclusive). Begin with the reference tower. Add the design ATU phase shift to the measured transmission line electrical length and the power divider phase shift. Remember that lagging networks and all transmission lines have negative phase shifts, and leading networks have a positive phase shift. Note and record this number. Do this for all remaining towers in the system.

Then, for all towers other than the reference tower, subtract the reference tower line total phase shift from the desired phase of the tower. This will yield the value, in degrees, to which the

Twr #	PD	Phasor	Line	ATU	Tower
1	-10	0	-110	-93	0
2	-14	-100	-110	-99	-116
3	-14	+80	-213	+80	+90
4	-14	+89	-217	-91	-26

phase shifting network in the phasor must be adjusted. Note and record this number. Perform this entire procedure for all patterns in the system. It is helpful to record these values in a table such as in **Figure-2**.

Now, as we did in the power divider test, use the RF oscillator or synthesizer to feed the phasor downstream of the input Tee network. Connect the RG-58 cables between the outputs of the phasor (where the transmission lines would normally go) and the respective antenna monitor inputs. Leave the zero phase shift network in the reference tower alone.

Adjust the phase controls of all towers, other than the reference tower, for the target phase shift, less the power divider phase shift. The resulting phase shift shown on the antenna monitor for each tower should be such that, when

added to the phase lag in the transmission line and the design phase shift in the ATU less the total phase shift in the reference tower line (including the reference tower ATU phase shift), it equals the desired total phase shift for that tower.

Note and record all dial settings. Repeat for all patterns. Disconnect the RG-58 jumpers from the phasor and antenna monitor, reconnect all transmission lines at the phasor, and connect the sampling lines to the antenna monitor. At this point, the phasor power divider and phase shifting networks should be set close to proper adjustment.

Tower Self-Impedance

Float all towers in the system by removing the J shorting plug at the output of each ATU. Measure the self-impedance of the non-directional tower with the RF bridge. Re-calculate the

Figure-2

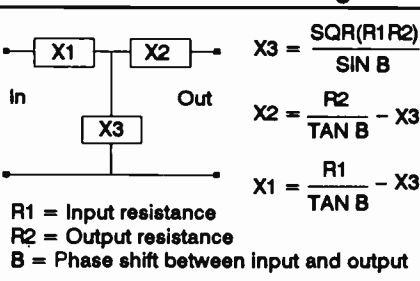

non-directional tower ATU Tee-network values using the measured self-impedance values for resistance and reactance, being careful to maintain the design phase shift in the network. Use the formula in **Figure-2**.

Note and record all tap settings. Remove the bridge and reconnect the ATU input and output J shorting plugs.

Tower De-Tuning

Configure the system for non-directional operation and feed a small amount of power (a few hundred watts should suffice) into the system from the transmitter. Adjust the sampling line iso-coils in all remaining towers for minimum induced current in those towers by connecting the field strength meter to the sampling line at the low

(continued on page-29)

AM Directional . . . (continued)

end of the iso-coil of each tower. Turn the transmitter off and set the sampling line iso-coil for the non-directional tower to approximately the same setting as the other towers (same tap position).

DA ATU Network Setup

Using the measured self-impedance values of the non-directional tower, calculate the driving point impedance off all the towers in the system for all patterns. This is a complex calculation that involves mutual coupling between towers, but it is quickly made using any of several commercial computer programs on the market. Your consultant can do it for you.

Recalculate the Tee-network values for each of the ATU's using the calculated driving point impedances and the Tee-network formulas in Figure-2 and adjust according to the new calculated values.

Reconnect the J shorting plugs in the outputs of all the ATU's. With all towers connected and the system configured for directional operation, measure the input impedance to the phasor power dividers and calculate the Tee-network values for the common point network to transform the measured to the desired impedance (usually 50-j0).

Feed a small amount of power into the phasor from the transmitter. Adjust the phasor controls to obtain the proper phase and ratio for each tower (they should be very close already). Using the operating impedance bridge (OIB), measure the driving point impedance at the output of each ATU, being careful to compensate for insertion effect with the phasor controls. Turn the transmitter off, recalculate and readjust the Tee-network values for each tower, being careful to maintain the design phase shift of each network. Note and record all taps.

Turn the transmitter back on and check the antenna monitor for proper indications of phase and ratio.

If necessary, re-measure the driving point impedance of each tower, recalculate the Tee-net values, and readjust, again recording the tap settings.

Standing Wave Ratio

Remove power and insert the OIB in the output of each transmission line at the ATU with the input J shorting plug removed, and measure the SWR. Again, be careful to compensate for the insertion effect of the bridge. The SWR should be 1.1:1 or less on the higher power towers and 2:1 or less on the lower power towers, for all patterns

It is important to present as

matched a load as possible to the transmission lines at the ATU inputs. First, the phase shifting networks in the phasor will operate in an unpredictable manner if the SWR is high, and low system SWR is important to minimize losses and maximize system bandwidth.

If the SWR is higher than it should be, either the driving point impedance of that tower was read incorrectly, the Tee-network values were not calculated correctly, or the Tee-network components were improperly adjusted. Go back and remeasure the driving point impedances, recalculate the Tee-network values, and readjust.

Phase Perfection!

The *RIGHTRACK* APC-200 Audio Phase Corrector, used as a production tool, can help you achieve optimal phase performance while dubbing from any medium. It allows you to manually optimize phase performance to give your station a consistently bright mono signal and undistorted stereo image. Material from outside sources, such as ad agencies, are never guaranteed to follow the same alignment standards. The *RIGHTRACK* allows you to electronically correct for these alignment differences . . . before they degrade your air sound.

With a built-in three frequency oscillator and L+R/L-R metering, the *RIGHTRACK* can double as convenient in-the-rack test equipment for quick verification of record and playback alignment. Used with stereo recording cart machines the *RIGHTRACK* can pre-compensate for mechanical cartridge phase error introduced by the cart itself. Contact your local distributor or Broadcast Devices today for more details.



Suggested list price: \$995

Affordable solutions for the broadcaster ...

5 Crestview Avenue Peekskill, NY 10566 (914) 737-5032

bdi

Broadcast
Devices, Inc.

Useful Technical Programs Disk

Broadcast Engineering Programs Available on Disk

By Tim McCartney - McCartney Radio Engineering
Bemidji, Minnesota (218) 751-1680

Calculations and data are available at no cost in the most recent upgrade of RF Specialties' technical program disk for engineers. While many similar individual programs are available elsewhere, "RFS" is a convenient grouping, on one disc, of the most frequently used computations.

Added to previous versions are calculations for FM/TV signal strength contours and AM T-network design. In addition, support for color monitors is added. The programs are IBM-compatible, on a 5 1/4-inch floppy disk.

Math calculations include Ohm's Law, series/parallel networks, time constants, L/R/C circuits, voltage divider circuits, transformers, decibels, frequency/wavelength, and VSWR.

An FM station's TPO or ERP can be calculated. Incorporated in the computations are relevant specifications of commonly used transmission lines and antennas.

A similar program for 950 MHz STL path quality also stores appropriate specifications of typical antennas and lines. The resulting table of computations includes antenna gain, line/connector losses, path fade margin and fresnel zones.

The RF intermodulation study enables addition and subtraction of as many as 30 frequencies. A list is provided of products falling between a specified range of frequencies selected by the user and up to the tenth harmonic range.

A distance and bearing program makes possible computations between two points on earth. By plugging in two sets of coordinates, the distance between them and direction of one from the other is calculated. Likewise, one set of coordinates and bearing suffice to compute unavailable coordinates. Distances are provided in both
Radio Guide June-1990 Page-30

kilometers and miles in two methods: the FCC flat earth and the great circle (shortest distance between two points). Printed reports are possible on about half of the calculations, typically when extensive information is the outcome.

The 1988 program is written by John Schneider of RF Specialties' Seattle office, with assistance from Bill Turney and Margaret Ralston. While John is constantly receiving suggestions for future program ideas, he currently hopes to provide an audio pad calculator in the next revision.

The disks are available free by contacting their nearest office. Or, copies may be traded since they are available for unlimited use.

QEI QEI QEI QEI QEI

W H Y Q E I ?

Free.



Our FREE spares kits include every solid state component of the transmitter, exciter and remote control.

Call us toll free at 800-334-9154 for all

the facts on QEI "New Reliables" FM transmitters from 1kw to 30 kw.

QEI CORPORATION
ONE AIRPORT DRIVE • P.O. BOX D
WILLIAMSTOWN, N.J. 08094

TEL (609) 728-2020 • FAX (609) 629-1751

QUALITY • ENGINEERING • INNOVATION

THE RF SPECIALTIES' TECHNICAL PROGRAMS DISK Version 2.04

1. Perform Electronics Math Calculations
2. Calculate an FM Station's E.R.P.
3. Plot an FM Antenna Vertical Radiation Pattern
4. Calculate Distance to an Antenna Null
5. FM/TV Signal Strength Contours
6. STL Path Attenuation
7. Intermodulation Products Calculator
8. Determine a Tower Plot's Dimensions
9. Work With Geographic Coordinates
- M. Metric Conversions
- T. Design an AM T-Matching Network
- R. Information on RF SPECIALTIES
- X. EXIT Program

Sample Printout of T.P.O.

Transmitter Output: 17.4137 KW *

Transmission Line: HJ8-50B, 3 Inch
Length of Line: 275 Feet
Line Efficiency at 101. mHz: 91.47% *
Power Dissipated In Line: 1.485 kW *
Power Input To Antenna: 15.927 kW *

Antenna Make/Model: ERI G5CPS
Number of Bays: Eleven
Polarization: Circular
Max. Antenna Power Rating: 112kW *
Antenna Gain: 6.2783 *

System E. R. P.: 100.0000 KW
* indicates specifications computed.

For Information on RFS Program Disk
Call John Schneider at RF Specialties (206) 546-6546

THE LEADERS ... from THE LEADERS

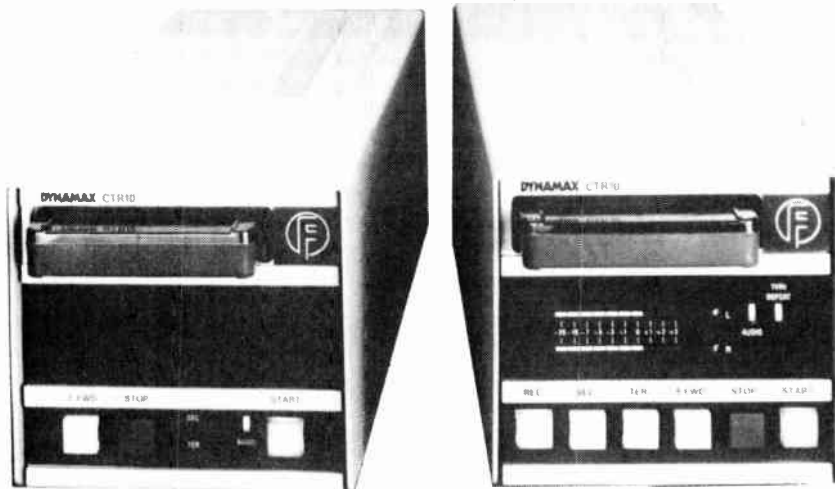

Dynamax CTR10 Series. Today's
Leading Cartridge Machines.

Available from the Leading Broadcast
Equipment Supplier.

Call today to learn more about the
Dynamax Series, and our other
equipment lines.



AUDIO

broadcast group inc.

2342 S. Division Avenue
Grand Rapids, Michigan 49507-3087

616-452-1596 800-999-9281

FAX: 616-452-1652

Popping Reception

By John McDaniel - WKZI
Casey, Illinois
(217) 932-4051

I had a problem that I could not solve for over a year and finally found a solution. Our satellite receiver is located at our transmitter site about 1/2 mile east of the city limits.

Every time the wind would blow from a certain direction, we would get a "popping" sound on our ABC satellite reception. I changed the power supply, checked all the lead-ins, and even had the local electrical coop check for loose connections several times.

I finally realized that we had left a piece of coax on our tower when we had installed a new Marti antenna and coax. We took the old piece of coax down and the popping was gone.

Magnetize or Demagnetize

By George Whitaker - KSSA
Dallas, Texas
(214) 528-1600

This is a tip from chapter 21 of my book and deals with the fact that most engineers, even rack engineers, realize that working with magnetized tools around tapes and tape machines can have very undesirable consequences.

I regularly demagnetize the tools I use by taking the cartridge bulk eraser and erasing them just as you would a cartridge. Turn the eraser on, move the tool up to the eraser, slowly withdraw the tool to arms length, and then release the button on the eraser. This will remove the magnetism from the screwdriver, pliers, or whatever.

If you desire to magnetize a tool, simply lay the tool on the eraser, turn the eraser on and off about 3 times, and you will have a magnetized item.

Cart Bearing Tip

By Jon Hunter - KBRE
Cedar City, Utah
(801) 586-5273

Why spend valuable engineering budget to have cart motors rebuilt at \$150, when you can do the work yourself with locally available parts?

All you need is a small wheel puller to remove the bearings from the shaft (available from a local auto parts store) and bearings that you can buy from the same auto parts store or bearing supply house.

For motors made by Japan Servo (SMC, ITC, etc.), you may be able to use Federal Mogul/Bower BCA bearing #38-SS or suitable cross reference. For UMC Beau motors, a larger diameter unit is needed. You may be able to use part #R6-CC. You can rebuild all the noisy motors in the plant for \$20 to \$30 each!

Battery Terminal Protection

By George Thomas - WJDX
Jackson, Mississippi
(601) 982-1062

Mr. Hartwell's article in the January Radio Guide was right on track. It brought out many items that require periodic attention on stand-by generators.

Here's a tip that my father always uses to prevent battery terminal corrosion. Remove the terminals from the battery posts. Clean and then coat both posts with a thin layer of axle grease; cover all the metal surfaces completely. Replace the terminals, tighten them securely, and cover them with the grease.

This prevents air from getting to the metal and thus inhibits corrosion. Do it to your car battery too. It'll save you lots of unnecessary post cleaning and terminal replacement.

Cart Loader

By Frederick Fess - WLRB/WKAI
Macomb, Illinois
(309) 833-5561

To reload carts, use an old reel-to-reel machine. I use an old Viking that must be about 50 years old. I took all the electronics out of the machine and, since it was so mechanical, it was very simple to adjust the tension for the cart tape.

I then set it up horizontally on the bench, put a seven-inch reel of cart tape on the supply side, and the cart spindle on the other, threaded the tape to the cart spindle, and put the machine in play while starting a timer. With the machine running at proper speed, and with some practice, I was making carts within one second of the desired time.

CD Test Tones

By Marty Acuff - WZLX
Boston, Massachusetts
(617) 267-0123

Here's a time and personnel saving tip that automates a tone oscillator for proofing phone lines, tape machines, etc. -- without the big cost of a programmable oscillator.

Use a programmable CD player with a suitable test CD, such as the Denon or NAB test discs. Just program the machine to play the desired tracks in any combination of sweep and/or step frequency runs, S/N tests and so on. Set the CD player to continuously repeat the selected tracks.

Using a prime CD player with dual D/A converters and broadcast grade outputs, you can rival the quality of a good audio oscillator.

This is a great way to transform a two-man operation into a solo project, liberating your staff to do more constructive things than "baby-sitting" an oscillator!

Motor Maint. Tip

By Don Price - WRNS
Kinston, North Carolina
(919) 522-4141

Have you ever had trouble keeping motors running smoothly and quietly? Here is a tip that works well, especially on motors with bronze sleeve bushings such as Tapcaster and others.

Disassemble the motor and thoroughly clean it with a good solvent. Then you can use a product called "Tufoil" (trade name), which was developed for combustion engines. The product contains PTFEC (Fluon), which suspends itself in oil and coats the moving parts. This product comes in 8 oz. bottles and is available at "True Value" hardware stores.

Mix 1 part "Tufoil" with 5 parts regular oil, such as 3-in-1 or equivalent, and apply a few drops to bushings and/or bearings in your motor.

I have used this on many motors and have found that they run smoother and quieter with less heat.

Equipment Guide

You send
You save
You sell

Fax it to:
(507) 280-9143

TFT-760 S/N

By Ken Willson - KVLU
Beaumont, Texas

Not only is our studio located in a campus building that screens out all AM signals, our EBS monitoring assignment is twenty miles away. Because the 760 is a little susceptible to lightning, and for aesthetic reasons (there's no overhead wires on campus), a tuned indoor loop seemed to be the best choice. Even so, there was barely enough signal to turn on the carrier light.

The audio was full of birdies and howls that virtually drowned out the monitored station. The racket was originating in the divider chain of the two-tone generator and, to a lesser extent,

from the receiver's synthesizer.

After trying the usual by-passing tricks, with no luck, I thought the problem might be a ground loop. The 760 two-tone generator has two grounds: the power connector and the front panel. It is the same for the receiver, with the addition of the antenna connector.

With the unit operating, I removed the screws holding the front panel of the two-tone generator and gently pulled it away from the chassis. All the birdies disappeared! Floating the front panel of the receiver eliminated the rest of the noise (a sort of deep warbling sound).

This fix involved a mask around the back of the two front panels and replacing the original screws with nylon 4-40's. Now I have a clean, clear, signal.

IT'S METAL!

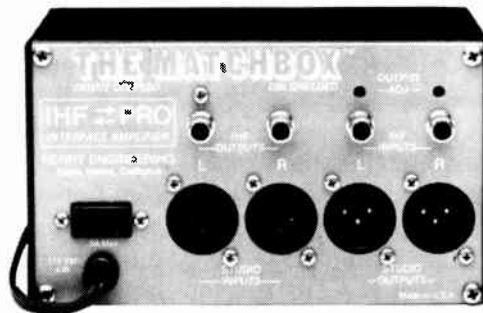

THE MATCHBOX IS IMPROVED!

The industry's most used level and impedance converter has been updated, with an all-metal chassis, gold-plated RCA connectors, and new XLR's. The metal box keeps out hum, noise, and RF. The new connectors keep the audio clean. The only thing we didn't "improve" was the price!

HENRY ENGINEERING
(818) 355-3656

We Build Solutions

ITC Tertiary Slowdown

Tertiary Relay Causes Cart Deck Speed Problem

By Paul Black - KMEL

San Francisco, California (415) 391-1061

When we built our new studios, we included a 120 VAC warning lamp in the control room, that comes on with the tertiary tones from the cart machines. We're all cart, so before a song or spot comes to an end, the lamp flashes to wake up the jock.

There's nothing special about this idea, but we came up with a strange symptom — the carts would "wow" briefly while the tertiary tone was active. Sometimes you had to listen pretty close to hear it, but we have one operator whose ears are pretty sharp, and he continued to swear it was happening.

The circuit is simple. We use ITC Deltas, and all that happens is the relay

in the machine closes a circuit, with 24 VDC on it, to ground, pulling in an external relay that turns on the light. The tones on the carts can either be steady or a series of bursts to make the light flash. The music carts are usually bursts, and those were the ones getting written up.

We finally took one cart, played it in audition on the air board and patched it down the hall to the production room so we could hear it without disturbing the jock. Sure enough, it "wowed." Typically, at the start of the tone too.

We pulled that Delta out of the air control room, took that cart, and set the whole mess up on the bench with an external relay and power supply to simulate the circuit.

Yes, it did it there too. Not only that, it did it on the spare Delta, and with various carts. It was head scratching time. A call to ITC didn't help much; they had never had any similar complaints. We were on our own.

Mystified, I was sitting there playing with everything, making the relay click, when I noticed that the digital VOM would flip its display every time the relay pulled in. The VOM was set to a low DC voltage range, and the leads were laying across the wires going to the relay.

I turned on the 'scope, put a probe near the relay wires, and turned on the tone. POW! A spike the size of Mount Everest on the display. That was it! Inductive kickback from the external relay coil was getting through to the TTL chips in the machine, via the internal relay, causing the servo motor to "burp" every time the tone came on.

I've used this circuit in several installations, but never with a machine that had so much digital control inside. Obviously, suppression was necessary.

The answer was a cap/diode across the coil. I called ITC and told them they might want to include a note in the manual, warning that external relays should be spike suppressed. I also fused the 24 volts to the coil in case one of the components shorts, to keep the house 24 VDC supply from failing.

We also have a new policy that all relays get a suppressor on them -- just in case.



SMARTS Broadcast Systems announce an affordable way to interface with satellite music services. The SMARTCASTER replaces all your carts, carousels, instacarts and other commercial sources with one low cost unit.

SMARTCASTER from **barrett associates, inc.**

BROADCAST EQUIPMENT

WE'VE JUST MADE ALL OTHER AUTOMATION SYSTEMS OBSOLETE.

For Information Call 1-800-748-5553

Are You a Writer?

Radio Guide is looking for monthly columnists.

We need writers in these areas:

RF Transmission
FM Antennas
AM Antennas
AM DA Arrays
AM Transmitters
FM Transmitters
STL/TSL Remote Ctrl.
Transmitter Audio

CSI 25 kW Tuning

By Paul Black - KMEL
San Francisco, California
(415) 391-1061

It's common knowledge that the proper way to tune a grounded-grid triode amplifier is to dip the plate current, peak the power output with the loading control and, when you achieve as much output as you can, run the tuning control slightly past resonance (the "dip" point) so you get a little rise in output with only a slight increase in plate current.

However, if you're running a CSI 25 kW rig, circulating current inside the final cavity has a nasty habit of finding an unwanted path to ground. When this happens, the breaker in the primary of the plate transformer usually goes, which means a trip to the site to reset it.

Here's a tip that seems to work with our rig. When you tune it up, run the loading control a little ways past the power output peak in a clockwise direction, and keep the dip on the plate current just barely on the high side of resonance. I was told that, the theory is, this reduces the circulating current inside the cavity to the point where the chance of arc-over is lessened.

Our rig here at KMEL seems to prefer its tuning and loading set up as stated above. It certainly arcs a lot less when adjusted this way.

Protect Your Meter

Eric Chromick - Waynesville, OH

Most DVM's and analog meters don't come with a hard case, and it's a hassle to carry spare leads, batteries and fuses around. Radio Shack's #44-1101 "Deluxe Storage Mailer" works well. If you have a large meter, or want to keep a handful of small tools from bouncing around in your briefcase, the U-matic video tape cases are great.

It takes a few minutes with a wire cutters and/or a knife to chop out the hub locks. Then you can line the case with a little spare foam, and you have a case that will hold your meter, leads, etc., and takes a lot of abuse.

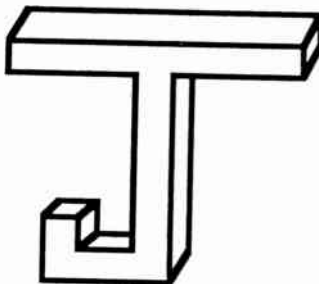

SQUARED 
TECHNICAL SERVICE

543 West 100 North
West Bountiful, Utah 84010

801-298-8515

Equipment Repair and Calibration

We service most AM/FM broadcast monitors, remote control systems, exciters, STL's, TSL's RPU's, Etc.

Give Us A Call
Check Our Rates
STL Loaner Program

Optimize — don't compromise:

If you demand optimum performance from your tape recording equipment . . . you need our services!

JRF maintains a complete lab facility insuring precision relapping and optical alignment of all magnetic recording heads and assemblies. Worn unservicable heads can be restored to original performance specifications. 24-hour and special weekend service available.

- Broadcasting
 - Mastering
 - Recording Studios
 - Tape Duplicating

New and reconditioned replacement heads from mono to 24-track . . . Many in stock.

For repair or replacement, we're at your service!



Call (201) 579-5773

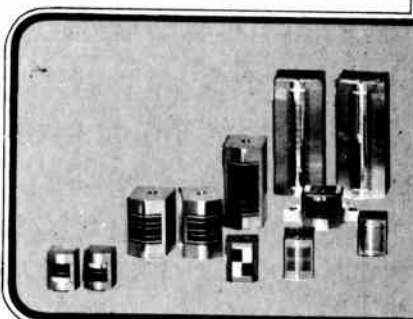

JRF/Magnetic Sciences, Inc.

Kennedy Road • P.O. Box 121 • Greendell, NJ 07839 • Telex: 325-449

New Products and Services For Your Radio Station

Call These Manufacturers and Suppliers for Information
on These Latest Products and Services

The CIA-1 Commercial Interrogation Assistant From Russco Electronics, Monitors Your Competition

Russco Electronics introduces a unique new product designed to make the job of the sales manager tremendously easier.

The Russco CIA-1 will allow the sales department to monitor the other station's commercials so much more effectively. This little black box, when connected to a cassette recorder and a radio, will start and stop the cassette recorder, recording only the speech from a broadcast.

You can extract the vital information from an eight-hour broadcast and record it on a single 45 minute cassette. The CIA-1 operates automatically, and never, never gets tired.

For more information, call
Russco Electronics
(209) 291-559
Fax (209) 291-9601

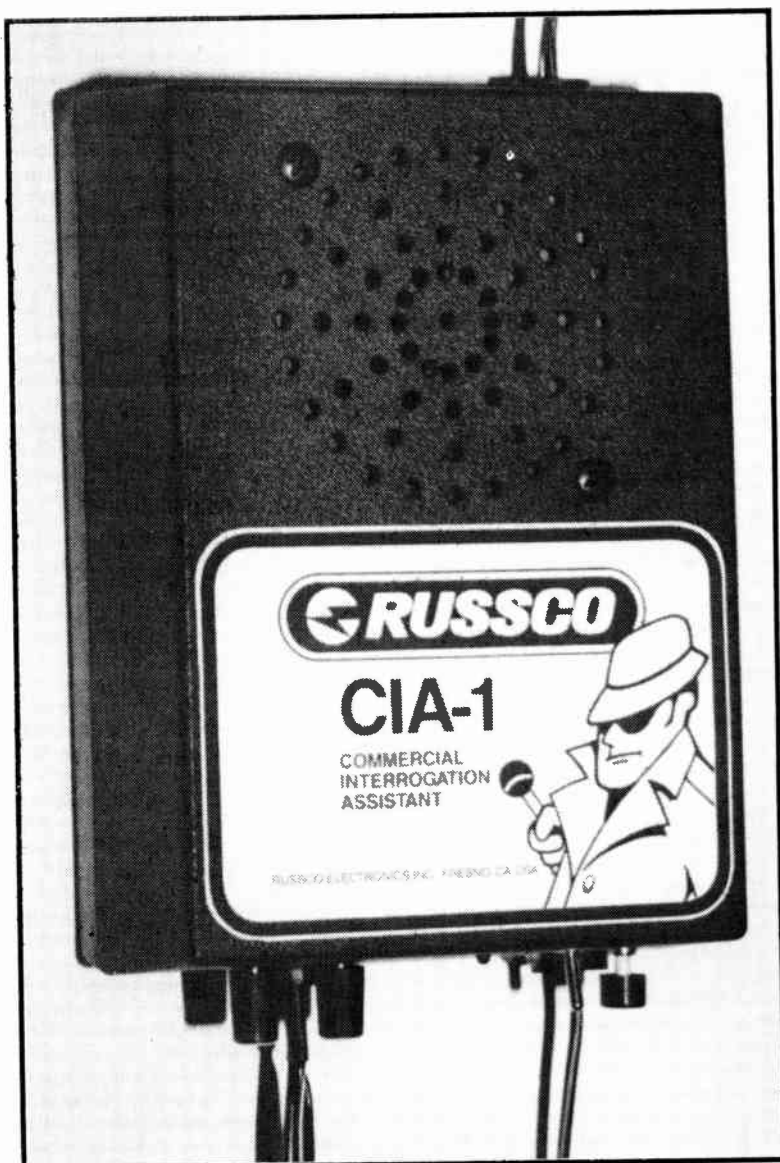

Product Guide

COMREX Multiline Frequency Extender Permits Studio Quality Remotes Using Standard Phone Lines

A compact and ruggedly portable Multiline Frequency Extender from COMREX permits transmission of high quality audio over standard telephone lines to significantly enhance the quality of remote broadcasts from anywhere in the world.

COMREX frequency extension compresses and encodes the program audio at the remote site so that it will pass within the narrower window of standard telephone lines (300-3100 Hz). It then decodes and expands the signal at the studio to recreate the full bandwidth sound for broadcast. All signal processing is done in real time so that broadcast personnel at the remote site can hear the program sent back to them with no delay.

Operation of the Multiline Frequency Extender is simple and automatic. Pushing a single button activates automatic dialing on one, two or three lines, as well as setup that includes automatic gain adjustment and line equalization for perfect transmissions. Visual display of line status as well as Touch-Tone codes used for cueing and control are also provided. The Multiline Frequency Extender may be used with one, two or three telephone lines depending on the specific broadcast situation and the audio bandwidth required.

50 Hz - 3 kHz: One Line
50 Hz - 5 kHz: Two Lines
50 Hz - 8 kHz: Three Lines

The Multiline Decoder at the studio end automatically answers each of the three lines and implements a communications protocol with the Remote/Encode to properly condition each line

so that virtually any broadcast talent can use the system readily and reliably in the field and studio.

An outstanding feature of the Multiline Frequency Extender is its incorporation of COMREX's proven multi-band telephone line noise reduction in all three operating modes (1, 2, or 3 lines). Facilities using the COMREX Multiline are achieving "satellite" quality transmission via standard telephone lines.

The Multiline Frequency Extender permits creative programming of a wider variety of remote broadcasts, that are not transmission-dependent on satellites, micro-links or dedicated lines that must normally be arranged well in advance of the broadcasts.

Included in the Multiline Frequency Extender system are: the 3XP Encoder (Remote) and 3XR Decoder (Studio) plus a compact Remote Con-

trol Console used at the studio end to facilitate dialling and cuebacks through the studio Decoder. A rugged Road Case for the Encoder is available as an option.

COMREX has been building reliable, high quality broadcast equipment for use by networks, stations and program producers since 1961 and pioneered the development of the frequency extender which was introduced in 1976.

Complete performance and price information on the Multiline Frequency Extender system is available from COMREX Corporation, 65 Nonset Path, Acton, MA 01720. Telephone (508) 263-1800. FAX (508) 635-0401.

Lynn Distler
Vice President Marketing
COMREX Corporation
Tel: (508) 263-1800
FAX: (508) 635-0401



Product Guide

TFT Combines STL Receiver & Exciter In New Reciter

TFT can increase the capabilities of many FM broadcast radio stations with its new synchronous FM broadcast system called the Reciter. Having undergone several beta tests, the Studio-to-Transmitter Link/FM Exciter was deemed "very impressive" during a three month evaluation at one of the larger radio stations in the San Francisco Bay Area.

A Technical Description

The Reciter is a single chassis equipment combining the functions of an STL Receiver and an FM Exciter using an Intermediate Frequency (IF) as the interface. By utilizing the IF to transfer the FM modulation from the STL Receiver to the Exciter, it is not necessary to demodulate the STL signal to the baseband, thus eliminating the weakest link in the FM broadcast chain. -- the STL's demodulating circuitry.

0.02% THD
85 dB SNR
55 dB Stereo Sep.
Rf Output 5-50 Watts

Stable FM Frequency

The Reciter synthesizes the IF frequency of the STL to an FM broadcast frequency.

Typically, the IF frequency from an STL Receiver is not stable enough for an FM broadcast transmitter. TFT has solved this problem with a patent pending technique which stabilizes the operating frequency of the FM transmitter well within the FCC's requirements by utilizing a unique frequency correction and stabilizing phase-locked loop circuit in order to maintain the FM broadcast frequency well within +/- 2 PPM accuracy and stability.

Solution to Boosters

The Model 8900 is a Reciter equipped with a Pilot Carrier Synchronization Module. It provides total synchronization of phase, frequency and modulation to an FM booster system regardless of the number of booster transmitter sites. The Synchronization Module generates an output frequency (88-108 MHz) which is phase-locked to the 19 kHz pilot signal. The 19 kHz

pilot is generated from a very stable frequency reference (+/- 2 PPM) deliberately introduced into the stereo generator at the studio.

Another common problem associated with booster systems is the RF signal arrival time difference between the transmitters into an overlap area. This RF delay introduces noise into the receivers. By using TFT's Model 8920 IF loop-through Digital Delay Network, a predetermined delay can be added to the RF signal which has the shorter path to the overlap area. This unit has a digitally controlled delay time and provides delay from 4 usec to 400 usec, in 0.1 usec steps.

If the Reciter is to be used as a repeater, a 63 MHz IF output is available to interface with an IF repeating STL Transmitter, such as the TFT Model 8300, to other booster sites.

For Further Information:

TFT Inc.
3090 Oakmead Village Drive
P.O. Box 58088
Santa Clara, CA 95052
(408) 727-7272
Fax (408) 727-5942



Product Guide

Shure Adds Durable, Compact L2 to Wireless Line

The L2 is available in three different versions. Model L2/58 features Shure's well-known SM58 dynamic microphone element, while Model L2/96 incorporates the condenser element used in Shure's high-performance SM96 vocal condenser microphone. A third version, L2/Beta 58, features Shure's acclaimed Beta 58 element and is available exclusively from authorized Shure Beta dealers.

Since the transmitter "heads" are easily interchangeable, any of the three elements may be used with the same L2 transmitter. The heads may be changed in seconds with no wires to solder or unplug.

Other L2 features include a durable ARMO-DUR case, separate audio mute and power switches with continuous battery indication indicator, double tuned RF output stages for spectrally pure transmission, "Mirror Image" companding for low noise and wide dynamic range, a low distortion modulated oscillator for clear audio, and a concealed audio gain adjustment switch.

David Rochman (708) 866-2542

Lee Haboch (708) 866-2534

**Shure Brothers Inc.
222 Hartrey Ave.
Evanston, IL 60202**

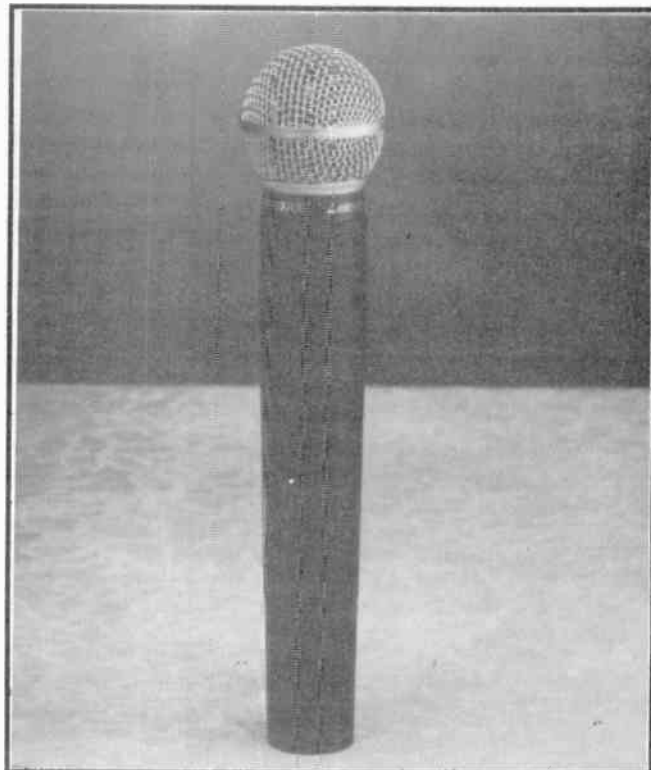
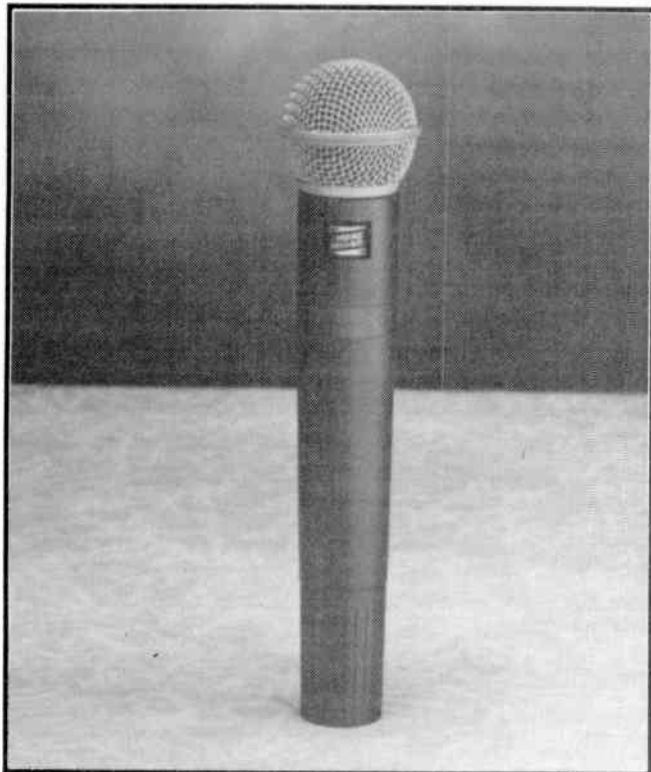

Equipment Guide

Radio's Most Effective Classified Ads

Sell Your Equipment As Easy As 1-2-3

1 - Describe your used equipment, for sale or wanted, in as many words as you feel it takes to do the job.

2 - Describe your help wanted or position wanted, again, in as many words as you feel you need.

3 - Mail or Fax your list to Radio Guide-- we'll do the rest. Your ads are always free of charge!

Fax It!



(507) 280-9143

**Equipment Guide
Box 7001
Rochester, MN 55903
Fax (507) 280-9143**

Name: _____

Station: _____

Address: _____

Address: _____

City: _____ **State:** _____ **Zip:** _____

Phone: _____

**Ad Copy Below:
(Use Extra Sheet of Paper If Needed)**

Equipment For Sale

RF meters, used and tested
Sangamo mica transmitting capacitors,
assorted sizes, large variety

Dan's Discount Radio Parts
Cavendish, VT
802-226-7582

RCA 77-DX microphone, excellent shape.

Call Jim at 914-638-6284

Stellavox SP-7 portable stereo recorder.
Similar to Nagra. 3.75, 7.5, 15 and 30 IPS,
takes 10.5" reels, with pilot tone for film
sync (defeatable). Mint condition, very
low hours. Perfect for ENG, serious music
recording, location radio work. Includes
case, reel adaptors and manuals. \$1,000
Fairchild Model 740 disc mastering lathe.
Three speed (33/45/78) 45 LB belt driven
turntable, variable pitch, with Gramplan
"D" type feedback cutterhead and match-
ing Gotham 150W amplifier. Great condi-
tion. A working system, not an old relic!
\$2,500 or best offer.

ITC 3D triple-deck stereo cart machine
with all 3 cue tones. Virtually new, less
than 100 hours of use. Also WRA match-
ing recording amplifier, also with 3 cue
tones. New condition, both units for \$2,200.
ITC premium RP stereo cart recorder
with all 3 tones. Very little usage, in excel-
lent condition, manual included. \$1,800

Hank Landsberg - Henry Engineering
503 Key Vista Drive
Sierra Madre, CA 91024
818-355-3656 Fax 818-355-0077

Gates AM mod monitor. Tube type,
model M5774. \$30

CBS Audimax 3 compressor. \$100

CBS Audimax 3S, stereo. \$200

B&W 410 distortion meter. Tube type.
\$25

Sparta 680 FM exciter. Not working,
with 6891 meter panel. \$200

Gates 88F FM frequency monitor.
\$30

McMartin TBM-3500 FM monitor.
Tube type. \$20

ITA RCFMA-1A FM RF Amp. Tube
type. \$40

McMartin TBM-2500A FM RF amp.
Tube type. \$20

Collins 900-F1 FM SCA mon. \$100

Collins 900-C2 FM stereo monitor.
\$500

CBS Volumax 410 limiter. \$100

Collins 121M-1 mono console. 8-
pots (2 in add-on chassis), tired con-
sole, use for parts, cards only?

CBS DPE-450 dynamic presence
equalizer processor. \$100

LEL SF-101 splice finder. Poor shape,
motor works, not finding splice now.
Don't buy this unless you know what
it is.

Kahn SP58-1A Symetra Peak. \$50

Technics SH-10B3 turntable base
for SP-10's. \$150

Moseley 20A234 26kHz subcarrier
generator. Card only in aluminum box.
\$30

Moseley 20A2345 26kHz subcarrier
demod. Card only in box. \$30

Ben L. Umberger - WNLT
813-446-0957

Wanted

Dead or Alive!



M30B
Transmitter

\$250 Reward



MR-30
Receiver

\$150 Reward

Marti is offering the highest
trade in ever for these two
desperadoes on RPT-30 trans-
mitters and CR-10 receivers.

Now is your opportunity to
upgrade your Marti before
the fall sports season starts.

Call Marti for details.
(817) 645-9163

Offer good on trade for RPT-30 or CR-10, 1 for 1 trade on transmitters and
receivers. Offer expires July 31, 1990

Wang 7-second digital delay. Excellent condition, with manual. \$750

Gregg mono triband processor with limiter and manuals. Excellent condition. \$1,300

Gregg AM stereo multiband processor, with extra circuit cards. \$1,800

Eventide H-949 harmonizer. Excellent condition. \$1,000

Technics SP-10 turntable. \$650

Jay White

KFQD/KWHL

9200 Lake Ours Pkwy.

Anchorage, AK 99507

907-344-9622

Tascam #10 audio console. 12 inputs, 4-channel output. Removed from service 1988. Make offer.

STL test tape. 1/2", 4-track, 7-1.2 IPS. Never used. \$55

Dick Warren

KGMG-AM/FM

5735 Kearney Villa Rd.

San Diego, CA 92123

619-560-5464

Moseley TRC-15AW. Trans. end only.

Aphex Type II Aural Broadcast Exciter.

Ampex AG-440 mono record/play reel deck.

Russco 2-speed turntables.

Jim Stanford

WYLD

2228 Gravier

New Orleans, LA 70119

504-822-1945

Broadcast Electronics 4-channel stereo console. Refurbished and ready to go. Was \$2,195 new. Now only \$445.

Ron Bronte

WWNT

Dothan Alabama

205-792-2161

205-677-3683 evening & weekends

Ampro/Scully Model 280B-FT series audio reel to reel tape recorder. 1/4" tape, 7.5 & 15 IPS tape speeds. Mono with full-track heads. New in 1978, complete with Russlang roll around cabinet. In good condition & ready for use.

Joseph F. Wilk

J&E Enterprises

2457 North Marmora Ave.

Chicago, IL 60639

312-237-2283

Schafer 903 Stereo System:

(4) Ampex 440B decks with Schafer electronics.

Extel printer

(6) Schafer cabinet racks.

(3) stereo Go-Karts (42 carts)

Full memory and 901 control unit, with keyboard.

Complete instruction manuals for system and Go-Karts.

Spare cards for Schafer Go-Karts.

Joel Gamble

KJOY

P.O. Box Y

Stockton, CA 95201

209-948-5569

Jampro JSCP-10, 10-bay antenna tuned to 93.1 MHz. \$11,000

Approx. 120 feet Andrew 3" Hellax; once each, 3-1/2" EIA flanged gas pass and gas block connectors installed. \$1,000

R. Sparks Scott

KSND

P.O. Box 10767

Eugene, OR 97440

503-686-9123

BE Sat-16. 2000 event memory, keyboard, printer, (1) Go-Kart 24, (3) 250 Carousels, (2) Instacarts, (4) equipment racks. Set up for SMN with 7 source cards.

Gary Magill - WHPA/WKMC Radio

P.O. Box 464

Holidaysburg, PA 16648

814-695-4441

(3) racks

(3) Sonomag Carousels

(1) SMC Time announce unit

Galen Gilbert

KTXJ

P.O. Box 2008

Jasper, TX 75951

409-384-6801

RCA 50A microphone. Condition unknown, make offer.

Charles Lund

Cycle Sound Productions

167 Madison St.

Waterbury, CT 06706

203-756-7761

SMC ESP-2 automation system with (4) Carousels, (2) SMC single play cart decks, and (9) Otari reel playback units with 25 Hz sensors. Make offer.

Mike Ball

KWKL-FM

Wichita, KS 67201

316-265-1065

(4) 40250 Eimac tubes. New in original boxes. On the shelf since 1984. \$100 each.

M.L. (Pete) Deets

WFHR/WWRW

P.O. Box 8022

Wisconsin Rapids, WI 54495

715-424-1300

Fax 715-424-1347

95-foot Rohn #65G Tower:

(4) 20-foot sections

(1) 10-foot tapered section (used for top section, rotor plate etc.)

1/2 of 10-foot section, used as base.

(1) guy bracket

Quantity of un-used 5/16" guy wire.

Quantity of Crosby clips.

(3) Turnbuckles.

(continued on page-45)

Quantity of Joslin fiberglass insulators.
All required bolts etc.
Call for complete details.

Clay Frlenwald
KBSG
1730 Minor Ave. 20th floor
Seattle, WA 98101
206-343-9700
Fax 206-823-7677

Orban Optimod 8000A. Mint condition,
brand new Orban capacitor kit just in-
stalled. \$1,750

George Nicholas
KXIC/KKRQ-FM
I-80 @ N. Dubuque St.
Iowa City, IA 52240
319-354-9500
Fax 319-354-9504

Harris FML-3E FM antenna. 92.1 mHz,
3-bay, 1.5588 gain H&V. Top condition,
with tower mounts, end feed. On ground.
\$2,150

Leon Halstead
KPNY-FM
#2 Elmwood Grove
Gering, NE 69314
308-635-1996
308-436-7245

ERI Signal Star FMXL-2E circularly po-
larized FM antenna. used in 2-bay, 3,000
watt operation. Tuned to 101.1 mHz. 18
months old. Installed new and replaced
due to frequency change. Complete except
for mounting brackets. Excellent condi-
tion, available now. Best bid buys.

David Winegardner - KBTN
Box K
Neosho, MO 64850
417-451-1420

ERI G5CPM/7C 7-bay center-fed FM
antenna in like new condition. Removed
by ERI crew when new antenna installed.
Tuned to 99.3 mHz, rated at 12 kW. Make
offer.

PETER DAHL CO.

Save \$\$

Heavy Duty
Replacement
Transformers, DC
Filter chokes and
capacitors for AM
& FM transmitters
manufactured by:
AEL, CCA, CSI,
COLLINS, CONTEL,
CONTINENTAL,
BAUER, GATES,
HARRIS, SINGER,
McMARTIN, GE,
RAYTHEON, RCA,
SINTRONIX, ITA,
WILKINSON.
Many other models
also available.



*FAST Delivery and
FREE Technical Support*

5869 WAYCROSS AVENUE
EL PASO, TEXAS 79924
(915) 751-2300
TELEX: 76-3861 PWDCO
FAX: (915) 751-0768



Jeff Methven or Mike Rogers
KPLT
P.O. Box 9
Paris, TX 75461
214-784-3311

Moseley 1600 remote control for sub-
carrier. Excellent condition. \$2,500

David Peschau
WKBH
505 King St. Suite 227
P.O. Box 1624
La Crosse, WI 54602
608-784-1570

(1) set of SMN Country Coast to Coast
cards. Working when removed March
1990. Fits Wegner mainframe, Model 1645,
1646, 1622 and 1683. Asking \$1,000 or
would consider trade for working SMC
Carousel or triple play cart deck.
(5) Scully reel to reel playback decks.

Holds 7 or 10-inch reels. Some need
work. As-is, make offer on all or part.

Craig Eastham
KDDA
P.O. Box 720
Dumas, AR 71639
501-382-5606

(2) Gateway II consoles.
(4) Ampex 440C tape machines.
(2) Metrotec 500 Playback only.
(1) QRK turntable with arm & Stanton
cartridge.
(2) UMC/Beau cart machines.
(1) UMC/Beau record/playback.
(1) ITC RA cart machine.
Plenty of spare parts, Entire lot - \$1,150

F. Sherwood - WPKC
P.O. Box 1330
Ft. Pierce, FL 34954
407-465-6397

5-bay Jampro JHPC FM antenna. 6-inch interbay, 3" elements for very high power. 107.3 to 107.5 mHz.

ITC Delta stereo playback cart machine.

David Sollnske
WWRM Suite 300
877 Executive Center Dr. W.
St. Petersburg, FL 33702
813-576-1073

(2) Otari ARS 1000 playback decks. Excellent condition. \$1,500 for both units.

Monty McNally - WEKC
P.O. Box 1071
Williamsburg, KY 40769
606-549-3000

300 feet of galvanized Rohn 65G tower. Guy wires, beacon, side lights. New in 1986. \$12,000 FOB on flat-bed truck.

Max Blakemore
WCVP-FM
Peachtree/Central
Murphy, NC 28906
704-837-2218

Gates Solidstatesman 5-channel console. Needs some work. Spare parts and manual included.

(2) Harris Solidstatesman AGC's and (2) Solidstatesman limiters. \$750 for all.

Buddy Womack
WBPR-FM
P.O. Box 40160 Suite 301
Myrtle Beach, SC 29577
803-236-5115

Laux analog receiver with down-converter and 6-tone decoder. Excellent shape, no longer needed. \$2,000

Jean Partridge
WCAT AM/FM
660 East Main St.
Orange, MA 01364
508-544-2321

Collins 830D-1 1kW FM transmitter on 95.3 mHz. Works fine, available July, 1990. \$1,700

4-bay horizontal FM antenna on 95.3 mHz. \$400

165 feet unsheathed 7/8" air coax. \$150
Gates BC-250GY AM transmitter on 1520 kHz. Works very well but needs new finals. Available soon. \$800

Gates Solid Statesman AM limiter. (Includes free AM transmitter above) \$800
Elmac 3CX15000H3 tube. Never used since rebuilt by Econco. \$900

Elmac 4CX15000A tube. Still makes good power. Guaranteed rebuildable. \$150

ABC Network tone decoder. \$150
Harris SCA generator boards for MS-15 or MX-15 exciter. 67kHz & 92kHz available. Perfect condition, with manual. \$300 each of \$500 for both.

Harris MX-15 FM exciter. Excellent condition, on your frequency. \$2,800

Collins 310Z-1 FM exciter. Refurbished, on your frequency. \$1,100

Kirk Harnack
Harnack Engineering
1385 Lamar Ave. Suite 5
Memphis, TN 38104
800-366-7618

Bext Model TEX-NV 20 watt exciter. 4 months old, excellent condition. Best offer over \$2,000

Collins Model 21E 5kW AM transmitter. Tuned to 1380 kHz. \$5,000 or best offer.

Thomas Edmlsson
WDKN-AM/WQZQ-FM
106 East College St.
Dickson, TN 37055
615-448-0752

Complete UPI satellite newswire system in good condition. Includes dish/LNA, Equatorial receiver, MPI printer, ribbons, etc. Working when removed from service.

Gary Peterson
KIMM & KGGG-FM
P.O. Box 8205
Rapid City, SD 57709
605-348-1100

Automation Equipment:

(1) DS-20 Audio switcher, **(1) RP-1000 brain,** **(1) time clock,** **(4) 350-RSB Carousels,** **(2) racks with doors, power supply, wiring, etc.,** Spare cards for Carousels, switcher, and brain. Extender cards, all manuals, wiring charts and schematics. All very clean and working well when pulled from service to facilitate new format. Will sell as system or as components.

Call Charlie Ferguson (GM) or Dave Dunsmoor (CE)
701-852-4646

(3) 6166A/71007 transmitting tubes. New packaged. \$1,700 each.

(7) Ramko model DC-5RA mixers. As removed. \$125 each.

(2) HP 3586B. New condition with manuals. \$3,500 each.

(1) Watkins Johnson WJ-8888A receiver. In good condition, with manual. \$1,600

(2) WJ 8888B receivers. Good condition with manuals. \$1,700 each.

(1) HP 8660 OPT 1,4,100 with 86632B. As removed. \$2,500

(1) Tek 115. Good condition. \$125

(300) Military U-matic training tapes. \$6.00 each.

(100) military Beta training tapes. \$5.00 each

Michael P. Murphy
11621 Valle Vista Rd.
Lakeside, CA 92040
619-561-2726
Fax 619-390-8611

Simpson 462-2 bench DVM
B&K 801 capacitor analyzer
DSI 5612 .1-1200 mHz counter
Leader 3060D digital storage oscilloscope. New with HP-IB interface.
Avcom PSA65A spectrum analyzer. 1 yr old, with travel case and accessories.

Dave Groth
WEOK/WPHD
P.O. Box 416
Poughkeepsie, NY 12602
914-471-1500

Harris (ERI) type 426 iso-coupler. (50KW AM to 40kW FM). FOB, make offer.

Tom B. Jones
WBAM-FM
P.O. Box 11411
4740 Radio Rd.
Montgomery, AL 36116
205-288-0150

Trade for serviceable open reel or cart machine, 2 Motorola Pulsar mobile telephones. Complete, including antennae, all brackets and wiring. Models T1680A and T1776A (rcvr RC0047). FCC types CC3325 and 3225.

R.F. Butler
KTAI-FM/TV-35
Box 178
Texas A&I University
Kingsville, TX 78363
515-595-3406

Gates Criterion I stereo cart player.
Best offer.

Edgar C. Reihl
Consulting Engineer
1715 Illinois Rd.
Northbrook, IL 60062
708-272-7125

Dismantling site. Have (5) 160-foot Pi-Rod towers, sampling loops, ATU's, lots of phasor components (7-tower DA-2), and some other stuff (dishes, etc.). All new in 1981 or later.

George Whitaker
KSSA
3500 Maple Ave.
Suite 1310
Dallas, TX 75219
214-528-1600

Elcom-Baur 605C 5kW FM transmitters. Single phase, single tube, slight shipping damage. New, never used, with exciter. \$25,000 or best offer.

FM BROADCASTERS!!

We can meet all your FM transmitter needs!!



SOLID STATE - LOW POWER

Amplifiers and transmitters are available at the popular levels of 30W, 100W, 300W, 500W, and 1KW. All units are solid state, broadband, and designed for both local and remote operation.



ONE AND TWO TUBE HIGH POWER

Medium transmitters with broadband solid state drivers and one zero bias grounded grid triode in their PA are available at 1.5KW, 3.5KW, 5.5KW, 7.5KW, and 12KW. Higher power transmitter utilizing two grounded grid triodes (one as a driver) are available at standard outputs of 15KW, 22KW, 25KW, 30KW, 40KW, and 50KW.



Energy-Onix

752 Warren Street Hudson, New York 12534
(518) 828-1690 FAX (518) 828-8476

A Wise Enterprise

Victor Michael
WHTO-FM
575A Montgomery Pike
S. Williamsport, PA 17701
717-323-8200

Telescoping heavy duty 35-foot Wilbert Mast. Model 7-30-357 with Dodge Custom Van and 12-volt compressor for mast operation. Van interior is customized with deluxe RV front seats and carpeting. Equipped with automatic transmission, cruise control, power steering, tilt wheel, air conditioning, power heavy duty disc brakes, and AM/FM stereo radio. All above in good condition. Asking \$8,000.

Sam Garfield - WYED-TV
919-553-1700

Potomac Audio Test Set. AG-51 audio generator and AA-51 audio analyzer. \$4,000 firm.

J.J. Largen
Largen Companies
1321 Pickett St.
Radford, VA 24141
703-639-4900

ERI Iso-Coupler #403
Shafer GLS 7000 unit. Complete with computer brain, Audiofile, cart machines and rack. Now on air and in use. Complete system. \$13,000

Call Jerome Hughey at 601-764-3151.
If no answer, leave message.

1 Year Old Automation for Sale

Sentry controller with PC card

(2) IGM Go-Carts (78 tray)

(1) IGM Go-Carts (24 tray)

(3) IGM Racks

Software Included

Paid \$18,000 in March-90. will sacrifice for \$12,500.

Todd Noordyk

WSHN

517 N. Beebe St.

Fremont, MI 49412

616-924-4700

Collins 830 F-1 10kW FM transmitter.
Still in operation, excellent condition, very well maintained. Installed 1965. Make offer.

D.C. Loughry

WFRB AM/FM

P.O. Box 430

Frostburg, MD 21532

301-689-8871

Collins 2-bay dual polarized, face mount FM antenna on 102.3 MHz. \$1,200
Electronic Research Inc. Type 402 Iso-Coupler on 102.3 MHz. \$600

Wallace Christensen

KLOH

West Highway 30

Box 456

Pipestone, MN 56164

507-825-4282

(2) Audio Designs 30-mixer production consoles. \$1,500 each.

(7) Pacific Recorders DI-1 digital interface units. \$40 each.

8 rows of RTS patch panels with blocks. \$200

Roy Humphrey - WLTJ

7 Parkway Center

Pittsburgh, PA 15220

412-922-9290

10-bay ERI antenna. 8 years old, center fed, low impedance, hi-power. Tuned to 106.1 MHz. \$15,000, will negotiate on shipping. Ready to deal. Ownership transfer in progress.

Joe Geoffrey

KNAN-FM

2716 N. 7th

West Monroe, LA 71291

318-387-3922

ITC Premium RP rack mount. Mono, excellent condition with low hours and manual. \$1,150

(4) ITC late model Premium SP. Mono, less than 5 years old with low hours. Rack mount with manuals. \$875

SMC MSP-1 automation system for live assist, satellite or RTR automation. 4 years old, perfect condition. \$3,400. Can include Otari ARS-1000's and ITC 3-D and SP cart machines.

Dutch Doelitzsch

WDDD

1 Broadcast Center

Marion, IL 62959

618-997-8123

Gentner VRC-1000 remote control system. Includes Qume terminal, TC100 interface, Ornitel modem, battery backup unit, terminal strip, relay panel. All in excellent condition. \$1,500 or will trade for Harris Facilities 9100 remote system.

Ted Teagarden

KELI 98.7 FM

910 West 14th St.

San Angelo, TX 76902

915-655-9879

Gates M5526 Yard console. Good working antique from 1957. Best offer over \$300 + shipping takes it.

Hewlett Packard X382A WR90 waveguide variable attenuator. 8.2-12.4 GHz, 0-50dB. Best offer over \$500 + shipping.

Hewlett Packard X375A WR90 waveguide variable attenuator. 8.2-14.4 GHz, 0-20dB. Best offer over \$150 + shipping.

Hewlett Packard X914B WR90 waveguide

moving load. 8.2-12.4 GHz, 1 watt, sliding. Best offer over \$125 + shipping.

(2) Hewlett Packard 10020A resistive divider oscilloscope probe. Best offer over \$100 + shipping.

Tektronix P6201 FET probe. DC to 900 MHz, 1X. Best offer over \$300 + shipping.

Tektronix 1015-001 S-30 Delta Standards for calibration of type 130 L-C meter. Best offer over \$300 + shipping.

Will sell all to highest bidder piece by piece or by lot.

Kelvin Schubert - KRSA

P.O. Box 650

Petersburg, AK 99833

907-772-3891 800-478-0508

Fax 907-772-4538

Martl STL-8 stereo STL

350 feet 3" coax.

J. Boyd Ingram

WBLE

Batesville, MS 38606

601-563-4664

Fax 601-563-9002

Radio Shack model 100 computer. 32K RAM, 100K floppy disk drive, bunch of software.

Radio Shack model 600 computer. Battery not so good.

Radio Shack TRP100 (battery) thermal printer.

Radio Shack CGP220 color ink-jet printer. HP 41CV. Time module, x-functions module, 821453A thermal printer, magnetic card reader, bar code wand.

Boonton (HP) 202H 54-216 MHz AM-FM RF generator. 207H Univerter provides .1-55 MHz output from above.

Heathkit IM-5248 distortion meter.

B&K model 820 capacitance meter.

B&K FET VOM (AC).

Soar model 3430 DVM, True RMS, 4-1/2 digit, auto-ranging.

Bill Weeks

530 Center St.

Newburgh, NY 12550

914-564-5837 Fax 914-566-1409

(3) UREI model LA-3A leveling amplifier. Good condition.

(2) Tape Athon 900 full track reel to reel recorders. Fair Condition.

(2) Gates CB-77 turntables. No arms.

(2) Gates Courier-70 remote mixers.

(2) Ball/Miratel air alert receivers.

(2) RCA Type OP-6 fixed remote amplifiers. Working condition.

Volumax model 4000A automatic peak controller. Good condition.

Audimax 4440A automatic level controller. Good condition.

CBS Laboratories model 4500 dynamic presence equalizer. Good condition.

Spotmaster model 5000 cart recorder. Good condition.

Rust Type 14C-3 AM monitor preamplifiers tuned to 1230 kHz. Fair condition.

Gates Attache-70 remote mixer.

Magnecord PT6 reel to reel recorder. Good for parts.

Gates CB-500 turntable. Fair condition.

Sparta-Matic Model MC-104 4-deck cart player.

McMartin TBM-3000 FM frequency monitor tuned to 102.3 MHz. Fair condition.

McMartin Accu-5 mixer. Good cond.

Modulation Sciences CP-803 composite processor. Excellent condition.

Dorrough Discriminate audio processor model 310. Fair condition.

ITC model 750 full track reel to reel recorder. Good condition.

SMC model 350-RSB stereo Carousel. Excellent condition.

Valley model 400 microphone processor. Excellent condition.

Gates M-6188 stereo Yard console with program and monitor amplifiers.

Call Steve Truex
219-722-4000

ITC RP stereo cart deck. 3 Q-tones, excellent condition. \$1,250

ITC RP mono cart deck. 3 Q-tones, excellent condition. \$1,150

ITC RA, 1kHz tone. \$450

(2) ITS RA's. 3 Q-tones. \$500 each.

Michael Brown
3740 SW Comus St.
Portland, OR 97219
503-245-4889 503-667-1230

TRANSCOM CORP.

Fine used AM & FM Transmitters
and also New Equipment

For the best deals on Celwave products
Andrew cable,
Shively & Comark antennas.

1981	CSI T3F 3 kW FM
1981	McMartin BA5K 5 kW AM
1976	RCA BTF-20E1 20 kW FM
1978	Collins 828E1 5 kW AM
1984	McMartin 3.5K 3.5kW FM
1976	CCA AM-50,000D 50 kW AM
1974	RCA BTA-5L 5kW AM
1972	Harris BC10-H 10Kw AM
1986	Harris FM 2.5K 2.5 kW FM

201 Old York Rd.
York Plaza Suite 207
Jenkintown, PA 19046

215-884-0888 or 800-441-8454

Fax No. 215-884-0738

BE 2100 RPS stereo record/playback cart deck. \$1,650.

(3) BE 2100PS stereo playback cart decks. \$950 each.

BE 3200 RP/DL mono record/playback with delay option. \$1,250

All low hours in "like new" condition.

Marti RPT-15 dual frequency UHF transmitter.

Marti CR-10-2 dual frequency UHF receiver. 450.700 and 459.925 MHz. Used on only a few remotes. \$1,700 for both.

(10) Reels Ampex 406 tape. 10-1/2" metal reels, new in factory sealed shipping carton. \$100

UMC cart splicefinder/bulk eraser. Excellent condition. \$425

Gary Jones
Southwest Mediacast Inc.
P.O. Box 229
Uvalde, TX 78802
512-367-4587

Equipment Guide

There are lots of classified ads around, but only one really does the job. List your equipment here, and watch the results.

Remember:

There's no charge
There's no word limit

Equipment Wanted

**Wanted: Orban 8000As and 8100s.
ITC Cart decks of all types.**

**Hall Electronics - John Hall
1712 Allied Street
Charlottesville, VA 22901
804-977-1100**

Wanted: Dead or alive. Pultec EQs; Fairchild & Teletronix limiters; Neumann, Telefunken, AKG, RCA, and Scheps microphones. Tube Macintosh or Marantz amps and pre-amps. Sontec, ITI, and Lang EQs. Neve or API equipment. Boxes of old tubes. UREI, Orban, United audio, dBx, and other outboard gear. Ampex ATR-102 or 104. Parts for MCI JH-110/114 recorders. Altec 604s/crossovers/Tannoy speakers. JBL 2231; Altec 288-H driver; misc. equipment of all types.

**Please call Dan Alexander
2944 San Pablo Ave.
Berkley, CA 94702
415-644-2363 - Fax 415-644-1848**

Wanted: Disc recording lathes and accessories. Audio and stereo books from 1958 to 1962. Old jukeboxes and coke machines.

**Kim Gutzke
7134 15th Ave. S.
Minneapolis, MN 55423
612-866-6183**

Wanted: Gates "UDC" or "ODC-3R" modules 25Hz detector. Should be clean and not modified. Operation OK.

**Paul Mueller
522 E. Curlew Place
Tarpon Springs, FL 34689
813-934-3466**

Wanted: Low cost used production room equipment. Stereo reel to reel playback machine, 7-1/2 and 15 IPS. Record/playback stereo cart machine. Stereo turntable. Production music and sound effects library. Old Pepper Tanner, Showcase, etc. on record.

**Larry James or Gary Webster
KAPH
315 West Ave. D
Kingman, KS 67068
800-658-1738**

**Wanted: RDC-10 AC remote control for parts.
Remote meter for Gates modulation monitor model # M-5693**

**Dave Williams
KLLV
147 Highway 140
Breen, CO 81326
303-259-5558**

Wanted: Good used 2.5 kW AM transmitter.

**Arnold Terry
WODY Inc.
Box 545
Bassette, VA 24055
703-629-5900**

Wanted: Format Sentry or similar automation controller. To be used with Satellite Music Network. Will buy or trade four Sound Workshop "Logex 8" production console.

**Dennis Thibodeaux
WHNK-FM
215 Centerview Dr.
Suite 351
Brnetwood, TN 37027
615-737-9143**

Wanted: College radio station wants to go stereo. Need stereo generator and either (1) UREI LA4 compressor or 2-channel compressor limiter.

**Bob Russo
WRRC
2083 Lawrenceville, NJ 06848
609-896-5369 (call nights)**

Wanted: Education FM station seeks donations of all kinds of audio equipment in any condition. Especially needed are stereo cart machines and stereo consoles. We are a tax exempt organization and will issue a tax deductible receipt for the value of the equipment plus shipping costs. Your help is urgently needed.

**Albert K. Nelsen or Dennis J. Wentzloff
WDNX
Route 2 Box 212
Savannah, TN 38372
901-925-9236**

Wanted: Christian radio station looking for 500 foot tower reasonably priced, plus 12-bay FM circular polarized antenna for 92.3 MHz, Need 500 feet of 1-5/8" or 3" air dielectric coax. Also looking for 5 or 10 kW FM transmitter. 103 kW FM transmitter (solid state). Radio Shack Pro-2000 scanner or other model to pick up to 1.0 GHz.

**Ken Dieble - KTJC
1207 Louisa St.
Rayville, LA 71269
318-728-4915**

Wanted: SMC 250 Carousel for parts.

**Steven Easiy
KXO AM-FM
420 Main St.
El Centro, CA 92243
619-352-1230**

Wanted: College station on tight budget needs used AC voltmeter with direct reading dB scale for calibrating equipment.

(continued on page-51)

Dan Duperron
WRUR
P.O. Box 29068
Rochester, NY 14627
716-275-7400

Wanted: Ampex #622 speaker.

Danny Rumble
602-272-5007

Wanted: Pacific Recorders and Engineering Micromax stereo cart recorder with standard NAB heads.

Hank Landsberg
Henry Engineering
503 Key Vista Dr.
Sierra Madre, CA 91024
818-355-3656
Fax 818-355-0077

Wanted: (7) blank discs with large hole, for 45 RPM cuts. Must be usable. Equipment catalogs from 40's, 50's, 60's. RCA, Gates, Presto, Collins and Mag-ncord.

Magnecord PT-8 series amplifiers. With or without speakers.

Service manual for Revox A-700 deck. Scully 7" reel snap-in hubs (2) and one 10" hub for 280-B.

Spotmaster 500 series stereo cart players. Any condition, repairable, rack or deck type.

(4) Plug-in phono preamp cards for Cetec Series-10 console.

Charles Lund
Cycle Sound Productions
167 Madison St.
Waterbury, CT 06706
203-765-7761

Wanted: Gates M6741 SCA monitor for 88F mod monitor.

Thomas Edmisson - WDKN-AM
106 East College St.
Dickson, TN 37055
615-448-0752

93 AM & FM Transmitters

We Have

All Powers
All Manufacturers
All In Stock
All Spares
All Instruction Books
All Complete

Besco Internacional
5946 Club Oaks Drive
Dallas, TX 75248
(214) 630-3600 Fax (214) 226-9416
Contact Robert Malany

World Leader in AM & FM Transmitters

Wanted: Military radio and electronics equipment.

Michael Murphy
Surplus Materials Inc.
11621 Valle Vista Rd.
Lakeside, CA 92040
619-561-2726

Wanted: Bird model 4712 Thru-Line wattmeter.

Interface BE cards for BE Sat 16-X. Instacart source cable, source cable for Go-Cart, source cable 945-6462 for SMN. 5000 watt or higher FM transmitter. Later model, solid state preferred. C-Quam AM stereo kit for CCA 1000D. (2) 4CX5000A tubes.

L.J. (Lou) Malerhofer
WTGG/WUNS-FM
101 Armory Blvd.
Lewisburg, PA 17837
719-523-3271

Wanted: 2-bay circularly polarized FM antenna close to 91.1 MHz. No de-icers, etc. needed.

Warren Wilson - KJTY
2519 NW Topeka Blvd.
Topeka, KS 66617
913-357-8888

Wanted: 3-1/8" to "N" female reducer that's reasonably priced and in working order.

ITC-750 stereo playback deck for spare. Fair to good working order.

Need 250-500W FM transmitter or power amplifier for auxillary. Have exciter. HI miles OK if in good working condition.

Kurt Browall - KTRZ
Box 808
Riverton, WY 82501
307-856-2922

Wanted: Relay interface box for Gentner VRC-1000 remote control.

I.L. Ward Jr.
WTOY
709 Bowman Ave.
Salem, VA 703-387-1480

Wanted: (3) FM antennas (6-bay or more circular) on the following frequencies: 101.5, 96.5, 107.5. Must be rated at 10kW or more.

J. Boyd Ingram
WBLE
Batesville, MS 38606
601-563-4664
Fax 601-563-9002

Business Guide

Broadcast Services
and Consultants

GOODRICH enterprises, Inc.

Parts and technical service for all
McMartin - Transmitters, Consoles, Exciters
Modulation Monitors Calibrated
Transmitter Tubes - New and Re-Built

11435 Manderson St.

Omaha, NE 68164

Phone (402) 493-1886

Fax (402) 331-0638

Telex 940103 WU PUB TLX BSN

NORTHERN MAGNETICS

CERTIFIED TAPE HEAD SERVICES

Northern Magnetics is an industry leader in the supply and service of tape heads and tape head products.

P.O. Box 16409

Minneapolis, MN 55416

Phone: (612) 333-3071

Telex: 1561238 MPS UT

FAA Repair Station # C14-57

Test Equipment

Why Buy When You Can Rent?

POTOMAC - DELTA - BIRD

Other Equipment Available

Call for Rates and Availability

Radio Resources

1-800-54-RADIO (1-800-547-2346)

(301) 859-1500

BRENTLINGER BROADCAST ENGINEERING, INC.

Charles Jayson Brentlinger
President

COMPUTERIZED REPORTS | ALLOCATION STUDIES
AM-FM-AM DIRECTIONALS-AUDIO-STL-SATELLITE COMMUNICATIONS
4338 East Acoma Drive • Phoenix, Arizona 85032 • (602) 867-0181

Consulting Communications Engineers

- FCC Data Bases
- FCC Applications and Field Engineering
- Frequency Searches and Coordination
- AM-FM-CATV-ITFS-LPTV

OWL ENGINEERING, INC.

1306 W. County Road. F,
St. Paul, MN 55112
(612) 631-1338 "Member AFCCE"

**Place Your Business Card Here
Reach All Broadcast Engineers
With Your Message**

**Call Radio Guide at (507) 280-9668
For Information on Your Space**



(802) 226-7582
FAX: 802-226-7738

COMMERCIAL RADIO COMPANY

Transmitter Parts for: RCA, Gates, Collins
Non-PCB Filter and Mica Transmitting Capacitors

DANIEL W. CHURCHILL

DUTTONSVILLE SCHOOL DRIVE
CAVENDISH, VT. 05142

Tube Rebuilding Freeland Products

- We Buy Duds -

Since 1940
Save About 50%



800-624-7626
504-893-1243
Fax 504-892-7323

Including for TV
RCA Cermolox and UHF Klystrons

FCC's Engineering AM, FM and TV Data Bases

On floppy (or) 9-track tape

Call today to request a free sample

Communication Data Inc.

6105 E. Arlington Blvd.
Falls Church, VA 22044
703-534-0034

SBE

STANLEY BROADCAST ENGINEERING

James S. Stanley

P.O. Box 24601
Tempe, AZ 85282

(602) 264-8752

DISSIPATION ARRAY® SYSTEM SPLINE BALL IONIZER™

SURGE TRANSIENT PREVENTION
CONSULTING & ENGINEERING DESIGN SERVICE



**Lightning Eliminators
& Consultants, Inc.**

6687 Arapahoe Road, Boulder, Colorado 80303
(303) 447-2828 FAX (303) 447-8122

LIGHTNING PREVENTION SYSTEMS

LIGHTNING PROTECTION AND PREVENTION SYSTEMS
FOR COMMUNICATIONS TOWER SITES.
204B Cross Keys Road, Berlin, NJ 08009
FAX 609-767-7547 • (609) 767-7209
Don't Wait Until It's Too Late!

HE HALL Electronics

THE BEST DEALS ON QUALITY
REBUILT & BRAND NEW
BROADCAST EQUIPMENT

We BUY & TRADE equipment too!
Please phone or send for our latest flyer.

10:00AM-6:00PM EST

804-974-6466
FAX 804-974-6450

1305-F Seminole Trall
Charlottesville, VA 22901

Broadcast Computer BBS's

Second Opinion BBS

24-hours
300/1200/2400/9600 baud - 8/N/1
SBE Chapter 28 news and files
414-771-3032

The Communications Exchange

24-hours
300/1200/2400/9600 baud
SBE Chapter 24 news and files
608-274-7776

Allied/RW Broadcast BBS

300/1200/2400/ baud - 8/N/1
Basic programs and ASCII files
317-935-0531

AV-Sync

24-hours
1200/2400/9600 baud - 8/N/1
Broadcast, recording, engineering files
404-320-6202

Broadcasting Computer Database

24-hours
300/1200/2400/9600
19,200 Baud Hayes/HST
Broadcast, Engineering, Ham radio,
MediaNET, On line database
713-937-9097

Network Communication System Broadcast BBS

300/1200 baud
Technical tips and schematic graphics
601-373-0160

Flamethrower Broadcast Resource

24-hours
300/1200/2400/ baud - 8/N/1
Broadcast engineering and Ham radio
804-550-3338

ICEWEB

24-hours
300/1200 baud
CATV and engineering files and
message base
608-274-8601

Broadcasters BBS

24-hours
1200/2400 baud
Broadcast/media files and msg.base
804-973-8235

Western Washington Freq.Coord

24-hours
300/1200/2400 baud
FCC coordination pgm. and data files
206-443-6170

Broadcasters Link

24-hours
Announcer/programming orientation
919-739-6150

SBE Chapter 22 (Central New York)

24-hours
300/1200/2400 baud
315-474-5070

Radio Daze

24-hours
300/1200/2400 baud
Engineering and programming
219-256-2255

KTOL Radio Point

24-hours
300/1200/2400 baud (also 14,400 HST)
206-459-4689

The Rock Board

24-hours
300/1200 baud
Music orientation
201-857-8880

Olympia Broadcasting Networks

24-hours
1200/2400 baud - 8/N/1
Fro Olympia affiliates
314-361-6688

DFW Frequency Coordination

24-hours
300/1200/2400/9600 HST
SBE Chapter 67 frequency coordina-
tion and general broadcast engineering
214-647-0670

Colorado Broadcasters

24-hours
Denver SBE Chapter materials and
Colorado frequency coordination
303-341-0129

Northern California FCC

24-hours
300/1200/2400 baud
San Francisco area frequency coordi-
nation
FidoNet 1:125/777
415-391-2657

Broadcasters BBS

24-hours
300/1200/2400 baud
Wide ranging broadcast topics
602-872-9148

Trillion

24-hours
300/1200/2400 baud
Broadcast engineering topics
616-530-0821

Videopro

24-hours
300/1200/2400 baud
Production concerns
703-455-1873

Chapter 75 SBE

24-hours
300/1200/2400 baud
Little Rock Chapter
501-753-6536

Visions infoline

General media
201-769-1779

Gannett HelpScreen

USA Today
201-525-3982

Rock and Roll Party

Broadcasters
404-982-0960

Broadcasters Forum

Broadcast info
602-395-9978

So. California Media Line

Broadcast
619-454-1629

Programmers Retreat

209-526-9987

Colorado Springs Broadcast BBS

New BBS on line
719-471-9600

Black Hole BBS

9600 Baud (HST)
419-228-7236
FidoNet 1:234/16
Amateur radio, Radio & TV engineering.

CRL Customer Service BBS

602-438-0459

Air Studio

Broadcast - Broadcasting - Amateur
Radio
313-546-7045

NRSC Conversion Products from CRL

PMC-450 Tri-Band Peak Modulation Controller



The CRL PMC-450 Tri-band peak modulation controller incorporates many unique designs originally developed for AM stereo. This unit offers state-of-the-art circuitry coupled with precise implementation of the NRSC standards for the loudest, cleanest signal on the AM dial. The PMC-450 consists of a powerful input compressor, followed by a tri-band limiter section and NRSC compliant low-pass filter. The flexible design of the PMC-450 allows it to be used as a stand alone processor, or in conjunction with various audio AGC's and pre-processors.

SMP-950 Tri-Band AM Stereo Matrix Processor



The CRL SMP-950 Tri-band AM STEREO MATRIX PROCESSOR offers state-of-the-art circuitry coupled with precise implementation of the NRSC standards for the loudest, cleanest signal on the AM dial. AM Stereo is quite different from FM and requires special techniques to provide full stereophonic fidelity while maintaining full monophonic compatibility. The CRL patented matrix processing circuitry is designed specifically to meet this criteria.

SPF-300 Standard Pre-Emphasis/Filter for AM Broadcast Transmission



The CRL Standard Pre-Emphasis/Filter contains all the functions necessary to convert virtually any monaural audio processing chain to meet the NRSC (National Radio Systems Committee) Voluntary National Standard of January 10, 1987. This transmission standard defines specific pre-emphasis and filtering requirements which are intended to help solve many of the technical concerns in AM broadcasting. The pre-emphasis curve was developed to allow receiver manufacturers to employ a complementary de-emphasis characteristic in wideband radios while improving the frequency response of narrower and medium-bandwidth radios. The filter specification, which limits transmitted audio bandwidth to 10 kHz, is intended to greatly reduce much of the interference between stations by reducing the conditions that cause "splatter" effects.

MDF-400/800 De-Emphasis/Filter for AM Monitors



The CRL Monitor De-Emphasis/Filter provides all the functions required to update any AM modulation monitor or wideband monitor receiver for the recently approved voluntary transmission standard. This allows easier setup of audio processing equipment by emulating the audio characteristic of the best-possible commercially produced radios. Additionally, the unit has features which can reduce interference typically heard in the station air monitor.

**THE
PROFESSIONAL'S
CHOICE**



CRL Systems

2522 West Geneva Drive
Tempe, Arizona 85282 USA
(800) 535-7648 (For USA Use Only)
(602) 438-0888
TELEX: 350464 FAX (602) 438-8227

GO WITH THE WINNERS.

DYNAMAX ESD 10 SERIES

*"The DYNAMAX ESD 10
Eraser/Splice Detector is
very popular with the
technical staff at WCCO-AM.
We purchased the first
one in 1987 and
now own 5 units."*

Jerry Miller
Chief Engineer

WCCO Radio, Minneapolis / St. Paul
#1 in the upper Midwest since 1924



DYNAMAX[®]
BROADCAST PRODUCTS BY FIDELIPAC[®]

Fidelipac Corporation
 P.O. Box 808
 Moorestown, NJ 08057
 U.S.A.
 609-235-3900
 TELEX: 710-897-0254
 FAX: 609-235-7779