

# RADIO GUIDE

BULK RATE  
U.S. POSTAGE  
PAID  
ROCHESTER, MN  
PERMIT 445

Address Correction Requested

A Forum for Radio Engineers  
Ray Topp Editor/Publisher (507) 280-9668

August 1989

Volume 2 - Issue 8

Copyright 1989 - Rochester Radio

511 18th Street SE

Rochester, MN 55904

## Equipment Guide For Gear

Quite a few of you are using the Equipment Guide to buy and sell your used gear. That's great! As those people have learned, the Equipment Guide really works. We don't limit the number of words you can use to describe your equipment, as other publications do. We feel that if we are going to charge for the placement of the ad, then the least we can do is to let you have your say.

When you send your classified ad in to us, please make sure you let us know how many months you wish the ad to run. Otherwise, it will run for just one month only. Remember, the used equipment market is a prime source of broadcast gear for quite a few stations. Help them out (as well as your \$elf), and send your list to us. Instructions are on the front page of the Equipment Guide section.

## DATs OK?

It seems as though they've finally gotten around to establishing a copy-code, of sorts, for DAT machines. The way I understand it, is that you can make one digital-to-digital copy of a pre-recorded DAT tape (or CD). If you try to copy the copy (digitally), you can't. Of course, you can do anything you want, in the analog domain.

This is supposed to eliminate piracy? Of course, never mind that 99.9% of the public can't tell the difference between a digital or analog copy of the original. I mean, really, we're talking zip distortion and ruler flat frequency response, any way you slice it -- A or D.

Anyone who's into pirating music, is going to circumvent the hardware anyway -- while Joe Public is most likely going to give an analog copy to his friends (it's the music, not the method).

The end result is that DAT will appear on the consumer shelves, and that's great! We all know that it's just a matter of time before recordable CDs engulf the market (probably double sided ones at that). Now, we have to wonder, is DAT too late?

## Phase Delay

Last month I asked you for various articles and tips, on what you have done at your station to eliminate (or reduce) to threat of lightning surges on the power line -- three-phase lines, in particular. I did receive a few responses, but I'm going to hold off publishing those until I get a few more. I'd like to see a few more of you let the rest of us know what you've done to shield your site against power line surges, drop-outs, brownouts -- what ever.

Maybe some of you have worked for (or with) the power company, and have some useful tidbits to share with us. Others of you may have found out, through experimentation, what works and what doesn't. Don't allow others to learn the hard way. Share that info with the rest of us, in Radio Guide.

Of course, as always, we have a constant need for any technical articles, tips, special test procedures, or construction projects. I know I sound like a broken record, but you can't ignore me, if you haven't sent in an article -- right? So get out that old Underwood, and remember, please double-space. My eyes aren't so good anymore. I think it was that screwdriver across the spark gap. Fifty kilo-whats?

## In This Issue . . .

- Page 2      Corrections - Notes - Help
- Page 3      Telco Auto Coupler
- Page 4      Advisory Alert System  
Divide and Conquer
- Page 6      Continental 816-R Gate Cards  
Limiter Bypass Circuit
- Page 7-8-9    Digital STL -- A Few Zeros
- Page 10-11    Octopus Tester
- Page 12-13    Station Woes
- Page 13      Cart Deck Delay Timer
- Page 14      Harris BC1-T Transmitter Mod.  
Continental Gate Cards
- Page 15      Almost a Nightmare



**You receive an important extra with every quality TTC transmitter...**



We're there with Total Support if you need us. Our 24-hour Total Support Hot Line lets you call for technical, engineering, or maintenance support at any time. All our transmitters and translators are made with strict attention to quality control.

Get to know TTC and our full line of AM and FM Transmitters, made in the U.S.A.—FM from 10 Watts to 40,000 Watts, AM from 500 Watts to 50,000 Watts. For more information, call TTC: Television Technology Corporation (303) 665-8000 • FAX: (303) 673-9900

**The Quality is TTC**

# TTC TOTAL SUPPORT



## Corrections - Info & Help

### Bandpass vs Notch Filter

**Edd Monskie - Hall Communications**  
Norwich, Connecticut  
203-887-1613

In the May-89 issue of Radio Guide, Conrad Troutman of WSYR talked about using bandpass filters to eliminate intermod problems on a "Marti" receiver. However, to avoid the insertion loss, you would do better to install a "notch" filter instead. You have to know the exact frequency and then get a single, double, or triple bottle version of the notch filter. Each bottle added, increases the depth of the notch. If the offending transmitter is not real close to your frequency, insertion loss is almost negligible.

The problem with the bandpass filters is that they are too broad in their bandpass. If you re-tune them for a sharper bandpass or gang several together, again for sharper bandpass, the insertion loss greatly increases. As long as you know the offending frequency, use a notch instead. The same people that make the bandpass bottle like Wacom or DB, also make the notch filters.

### RCA BTF-20E Clarification

**Joe Puma - WBEN**  
Buffalo, New York

Just a small correction of a statement on RCA BTF-20E transmitters, made by Mr. Alan Roycroft in the July-89 issue of Radio Guide.

Mr. Roycroft stated that when an SWR problem crops up, a vane moves over the face of the exciter lamp, allowing the photocell to see the lamp. He then states that when the bulb burns out, all conditions of normal appear. This is in error; he's got it 180° out of phase.

When the vane moves over the face of the exciter lamp, it cuts off the light to the photo cell (LDR), thus opening a relay and cutting off the plate voltage. Therefore, when the bulb burns out, the circuit is interrupted and the plates go off. These relay systems are then inherently fail-safe!

### Help Needed With Continental 317C

Ken Brenner, CE of WMIN in St. Paul, Minnesota, called to ask for assistance with a Continental 317C. He needs information on, and a diagram for, the solid-state replacement for K8. Give him a call at (612) 739-4433, or you can Fax him the diagram at (612) 739-4784. Let's help him out.

### So How Come You Never Write?

If you have any short tech-tips, send them in. Remember, it doesn't do anyone any good if you keep that information to yourself. Don't assume that everyone knows about your special technical tip -- so send them in!

Editor

## CRL SPOTLIGHT



Upgrade Your  
FM Stereo Generator  
... with the CRL SG-800A



Your stereo generator is an important part of your overall on the air quality. Older generators can often color your audio because they can not handle dynamically processed audio very well. The digitally synthesized CRL SG-800A produces a flawless composite baseband signal. Our unique low distortion pulse amplitude modulator ensures maximum stereo separation (60 dB typical). The SG-800A is also available with two low-pass filter options, including the new CRL DSP-1 digital low-pass filter. The price of the SG-800A starts at \$1695. Our two week trial program will let the SG-800A prove itself to you. Call or write us for details.



**CRL Systems**  
2522 West Geneva Drive  
Tempe, Arizona 85282 U.S.A.  
(800) 535-7648 (602) 438-0888  
TELEX: 350464

## SBE '89

**October 5-8**  
**Kansas City Convention Center**

The professional audio/video industry is changing rapidly. To stay ahead today, you need to know where technology is heading. Find out at the '89 SBE convention.

This year in cooperation with major manufacturers, special hands-on training sessions will be available. Other comprehensive sessions will bring you up to date on the latest developments important to your job including digital technology for

audio and video, satellite uplinking and high definition television. A seminar on worker safety is also on tap. Plus, a convention center full of the latest audio and video products.

Plan for your future now by attending the 1989 SBE National Convention and **Broadcast Engineering Conference**, October 5-8. Take in the show, and while you're in Kansas City, take in the sights!

Register now  
for the SBE  
National  
Convention!



## DA2-12 Audio Distribution Amplifier



An outstanding value at only \$435.00.  
No other DA gives you so many features for so little money.

**hnat hinders inc**

42 Elaine Street • R.R. 1 • Thompson, Connecticut 06277  
(203) 935-9066 • (203) 935-9242



# Telco Auto Coupler Circuit

By Dave Grant - WLAV Radio  
Grand Rapids, Michigan  
616-456-5461

How many times have you needed a way to couple audio to or from a phone line without spending major dollars on a factory built unit? I found myself constantly wanting such a device, but not able to find something that was less than a hundred dollars. The circuit shown here, is a versatile brainchild of my own desires. Basically, the unit offers a cheap and simple way to automatically couple audio to or from a phone line. As shown, the circuit will act as a listen line. It can be built mostly from junkbox parts and can be mounted on a relay panel or built into a small box. None of the component values are that critical. Once the circuit theory is understood, you should be able to use whatever parts are handy.

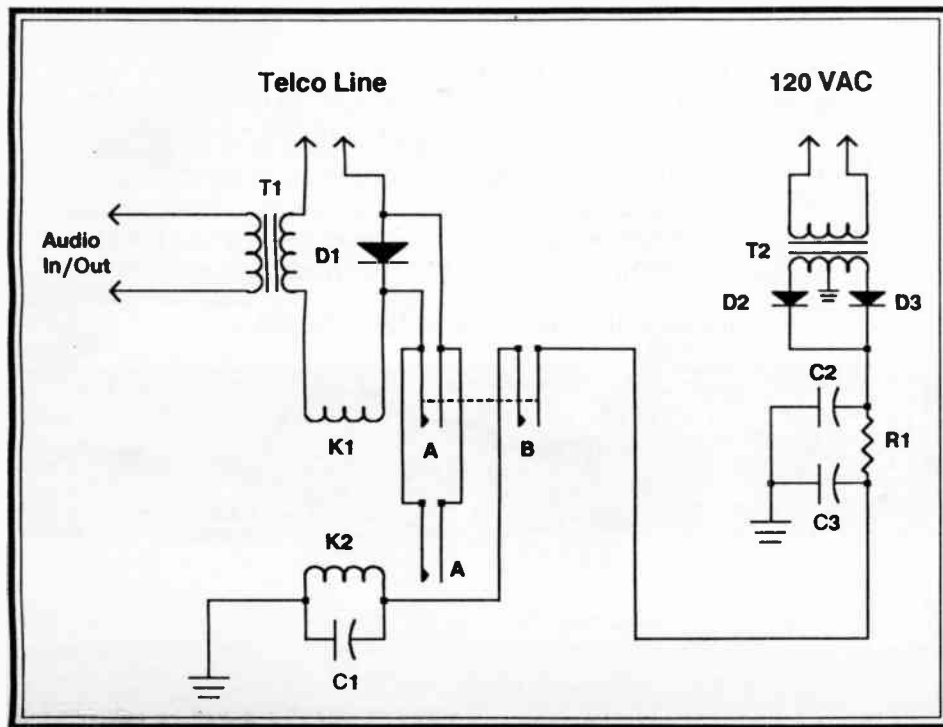

## Parts List:

- K1 & K2 = P&B R10-E1-X4 24 volt relays
- T1 = 600/600 audio transformer
- D1, D2, D3 = 1N4001 diodes
- T2 = 120 vac primary, 15 vac c.t. secondary, power trans.
- C2 & C3 = 1000 uF/50 volt capacitors
- R1 = 220 ohm, 2 watt resistor
- C1 = 220 uF/50 volt capacitor
- (Note: C1 Value may vary depending on K2)

D1 rectifies the ringing voltage, causing K1 to pulse. Contacts B of K1 cause K2 to pull in. C1 keeps K2 on for about one second, long enough for the telco central office to stop sending ringing pulses and put DC on the line. With contacts A of K2 closed, D1 is bypassed and K1 latches via the telco DC, thereby latching K2 through contacts B of K1. Audio is coupled to or from the telco line via T1. When the calling party hangs up, the central office momentarily opens the DC path. This causes the relays to drop out and re-set for the next call.

As you can see, the device locks on with the help of Ma Bell. As long as the central office provides DC, the relays will stay latched. This device is polarity sensitive. If the relays pull in as soon as you plug it in to a phone line, try reversing the leads to the phone line.

I have used this system with great success for listen lines. By adding a Radio Shack DTMF de-coder and a few more relays, you can build a simple dial-up remote control. I am currently using this for a listen line, a dial-up remote, and an auto-answer for a modem. This device has not been used or tested in areas other than Michigan Bell but I suspect most phone companies are basically the same. One note of caution: this device is not FCC registered. Hook up at your own risk.

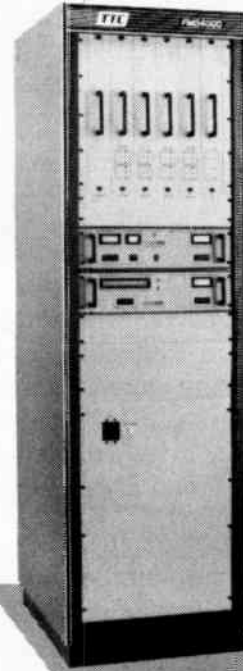

## WORLD STANDARD IN SOLID STATE FM TRANSMITTERS

**Solid state quality and efficiency.** TTC's new FMS-Series FM Transmitters are available in 1kW, 2kW, 4kW and 8kW models. Broadband, efficient power amplifiers are transparent to the high-spec TTC Exciter.

**Redundant systems for high reliability.** Individual 1000 Watt plug-in amplifiers provide extremely easy service and maintenance. These transmitters remain on the air automatically—even in the unlikely event of a power amplifier failure. Exclusive "fail-on" control circuits keep the transmitter operating should a control circuit fail.

**World-acclaimed TTC Model X Exciter.** The Model X provides truly outstanding performance, with all distortions measuring .01% or less and FM composite signal-to-noise ratio an amazing 90dB down. Frequency response is .05dB from 20Hz to 100kHz for unparalleled loudness and clarity.

**Made in U.S.A.** For details on our full line of AM and FM transmitters and translators, call TTC: Television Technology Corporation, Phone: (303) 665-8000 FAX: (303) 673-9900

**The Quality  
is TTC**

- 100% solid state
- Very high efficiency
- Fully automated control
- Superlative specifications
- Integral lightning protection
- Redundant power amplifiers
- Broadband—no tuning required

# CARTING RECORDS??



**YOU NEED SYNCHROSTART!** SynchroStart makes dubbing records or CDs to cartridge a 'one-button' operation. Produce carts that are tightly cued and consistent with **no guesswork**. Just hit the START button . . . the turntable starts, audio mutes during the start-up, then just when the stylus is precisely at the beginning of audio, audio is switched on smoothly and the cart machine starts! All automatically. Whether carts are dubbed by the PD or by the 'nighttime college kid', they'll all be **tight** and **perfectly cued** every time. In Stock.

**HENRY ENGINEERING**  
**(818) 355-3656**  
**We Build Solutions**



# Advisory/Alert System

By Michael L. Douthat, CE - KXCV Radio  
Maryville, Missouri  
816-562-1163

Here at Northwest Missouri State University we have a unique situation where a 100 kW FM station is completely operated by students. It is a real challenge to train and retrain a constantly changing staff of 15 or more people in the technical aspects of the station. I needed an advisory/alert system that would not only tell the student operators that there was something wrong that needed their attention, but would spell out in "plain English" what steps they needed to take to correct the situation.

From this challenge, came my "ultimate" advisory/alert system. The heart of this system is a Radio Shack Color Computer and a 6821 PIA interface card ordered from a company called Fraser Instrument, P.O. Box 712, Meridan, Idaho, 83642, (208) 888-5728. With these two pieces of hardware, plus a relay interface circuit, a monitor and a fairly simple basic program, you can create a system that responds to simple contact closures.

What the system is capable of from there on, is only limited by ones skill in basic programming. Our particular system, for instance, will not only tell the operator that the transmitter is off the air, but automatically raises it again, if the problem is a power outage and is restored in less than 10 seconds.

In the morning, at sign-on, the system locks out the transmitter remote control for four minutes after the filaments are turned on, to prevent prematurely applying the plate voltage to the transmitter.

The system can give any message on the screen you like, plus alert tones that can be varied in volume and frequency by a simple change in programming (or there can be a message with no alert tones).

For the system to be complete, there must already be peripheral equipment that will give you contact closures, or you must purchase or construct this also. An example of these contact closures would be an off-air alert circuit built in to your modulation monitor; some monitors have them and some do not. Your news wire may have external contacts that close when an advisory comes across. If you have three-phase power at your transmitter, you may have to purchase a device that gives you a contact closure in any or all phases are lost. And so on. . .

If you're interested in developing your own system similar to ours, I would be happy to send you a copy of the program. If you are not inclined to computer programming, give me a call and we'll work something out.

---

## Divide and Conquer

By Don Beans - WUOM  
Pinckney, Michigan

Sooner or later we all face troubleshooting. Time is of the essence. Obviously, a plan or pattern to follow will help. But it must be simple and easy to remember in those "sleepy times." The best and fastest plan I have found is - - Divide in Half. Then I ask, "Is the problem in this half or the other half." When I know, I divide that half in half, etc. With each test, I eliminate half of the system or area remaining. Looking at a table of the powers of the number 2, shows why it is fast. After only ten steps, over 1000 possibilities have been covered. Its value lies in the fact that it begins with a broad picture and sequentially narrows it to the problem cause.

One final word: make notes! Every maintenance engineer, who has been around a while, has run into a multiple-fault problem. If, at step 10, you discover you have two problems or faults, look back over your notes of the previous steps. If you see a clue back at step 5, you have just eliminated 32 possibilities, compared with no notes. A sleepy mind that remembers the results of a check incorrectly can lead down a false trail.

# NRSC-2 (?)

There appears to be confusion over the "NRSC-2" spec. Remember: *it's not a new, second standard*—just another way of looking at the original NRSC "recommendation."

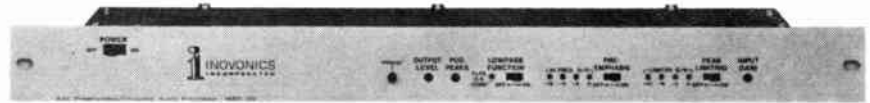

Inovonics' NRSC Audio Processor is an easy and very cost-effective means of implementing the required audio preemphasis and cutoff. Its built-in peak controller and "adaptive" preemphasis work with any existing processing to guarantee compliance with the NRSC-2 specification, *assuming a linear and "clean" RF side of the system*. Spectrum photos prove this time and again. Now prove to yourself how simple and beneficial NRSC compliance can be.

Inovonics' Model 222 - \$590

## Inovonics Inc.

1305 Fair Ave., Santa Cruz, CA 95060  
Phone: (408) 458-0552 - FAX: 458-0554



## NO VENEER OR PLASTIC, PLEASE.



COMPACT  
disc  
DIGITAL AUDIO

by  
**ALINE**

Nothing but solid oak or solid walnut will do! 40- and 80-capacity lazy susan compact disc storage cabinets in either solid oak or solid walnut.

40-capacity (D) \$79.95

80-capacity (D) \$99.95

800-622-0022

ATLANTA CHICAGO DALLAS  
LOS ANGELES RICHMOND

**ALLIED**  
Broadcast Equipment

— A HARRIS COMPANY



# 4, 6 & 8 MIXER, SINGLE AND DUAL CHANNEL STEREO, ..... \$1395 TO \$2950!!

**NOW AVAILABLE!!**  
PROGRAMMABLE, MIX/MINUS  
BUSS WITH BALANCED OUT.

The incredible, new  
**xL SERIES** audio consoles.



xL82S shown

## FIELD PROVEN

The new xL SERIES consoles utilize much of the same high performance technology that has made our audio switchers, DA's, preamps & mixers famous the world over. And, as you are reading this, these new consoles are proving themselves in numerous installations across the country. "No RF problems of any kind"... "Our sound has noticeably improved since installing your boards"... "Our people really enjoy the ease of operation"... "Would recommend your consoles to anyone that asks"... Your console actually tested out better than your spec's".

## NEW TECHNOLOGY LOWERS COSTS

Dramatic new developments in IC technology have enabled us to design these consoles with fewer components and naturally less labor. The end results are not only a significant price reduction and higher performance than previously possible but, in addition, higher reliability.

## MORE BANG FOR THE BUCK

Huge expanded scale, -40dB to +3dB, multi-colored LED VU meters (4" & readable in bright light across the room); Four individual meters on dual channel units; Switch programmable muting on each mixer and input; Nine input selects on the last channel; Mono sum output; Plug-in modules for ease of service; Optional switch programmable remote control start/stop; Remote start/stops use front panel input and output selects or input select and pot up start/ pot down stop; Double shielding for total RFI protection...and as you'll see in the rest of this ad ...much, much more.

## FOR THE SKEPTICS

Anyone can write an ad touting the virtues of their product. Well, we have always felt that we haven't passed muster until you say so. That's why all RAMKO products are shipped on a two week trial basis. You're the final judge. No ifs, ands, or buts! Simply put, if at any time within two weeks of receiving your equipment you are not entirely satisfied, or have just changed your mind, return it in like new condition. Upon verification of condition an immediate refund (less shipping charges) will be issued, for prepayment or C.O.D.s, or your account will be credited if purchased open account. What more could anyone ask? Pricing that will save you hundreds of dollars...Unsurpassed quality & performance...A no risk opportunity to prove to yourself that you get exactly what you want and everything we claim is true. And, everything we manufacture is backed by a 2 year warranty.

## DON'T DELAY

Call RAMKO RESEARCH direct or your RAMKO dealer for further information or to place your order. You have nothing to lose except perhaps some preconceived notions about how much quality *really* costs.

**TOLL FREE (800)678-1357**  
**FAX (916)635-0907**

# RAMKO RESEARCH

3501 #4 SUNRISE BLVD.  
RANCHO CORDOVA, CA 95742  
(916)635-3600

## FEATURES OVERVIEW:

1. EXPANDED SCALE VU METERS (-40dB to +3dB) multi-colored LED.
2. PLUG-IN SHIELDED INPUT MODULES.
3. MIC/LINE SELECT JUMPERS ON EACH CHANNEL.
4. MONO/STEREO FEED SELECT ON EACH CHANNEL.
5. GAIN SELECT PATCH PANEL ON EACH INPUT.
6. PROGRAMMABLE MUTING SWITCHES ON EACH INPUT.
7. NINE INPUTS ON LAST CHANNEL.
8. 2 WATT CUE AMP.
9. ROCK SOLID, SHORT CIRCUIT PROOF SUPPLY WITH LED INDICATORS.
10. MONITOR SELECT/GAIN CONTROL. Prog1/Prog2/External.
11. PHONES SELECT/GAIN CONTROL. Prog1/Prog2/External/Cue.
12. INTERNAL CUE SPEAKER.
13. VCA CONTROLLED MIXERS.
14. PADDED ARM REST.
15. MONO SUM OUTPUT.
16. PLUG-IN IC'S THROUGHOUT.
17. FOUR INDIVIDUAL PWR. SUPPLIES. Meters, Cue amp., Power amp., Main audio.
18. INSTANT ACCESS. Two, quarter turn fasteners.
19. ILLUMINATED 5 MILLION OPERATION IN/OUT SELECT SWITCHES.
20. HIGH VOLTAGE SOLID STATE AUDIO SWITCHES. Cannot be overdriven nor damaged by overvoltage.
21. EXTERNAL 20 WATT POWER AMP.
22. ON AIR LIGHTS RELAY.
23. REMOTE START/STOP OPTION. Programmable for operation from in/out select switches or mixer pot-up start & mixer pot-down stop.
24. COMPLETE INTERNAL LABELING. All labeling or in's & out's, gain adjusts, programming, levels, etc., is provided internally for easy installation.

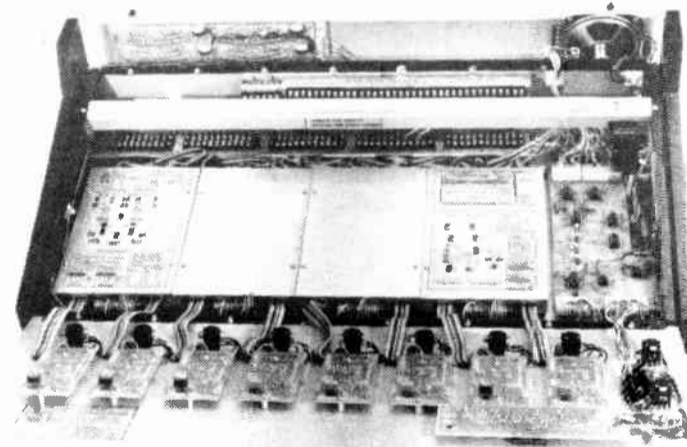

## PARTIAL SPECIFICATIONS

**INPUTS:** Two per channel except the last channel which has nine. Balanced bridging 1k ohms in mic mode & 150k ohms high level. Input #1 of each channel programmable mic thru high level. Input #1 of each channel may be strapped for mono or stereo feed.  
**OUTPUTS:** Balanced low impedance, +25dBm max into 600 ohms. May be used balanced or unbalanced. Stereo sum balanced out. Program outputs factory set for +8dBm but may be recalibrated for

any other level.  
**METERING:** Expanded scale, 4" solid state tri-color with VU ballistics. 2 each on single channel units & 4 each on dual channel models.  
**MONITOR:** Stereo, muted monitor outputs @ +4dBm. External 20 watt stereo amp included. Three position selector for PROG1, PROG2 & EXTERNAL in.  
**CUE:** Mono-sum to 2 watt internal amp & speaker and phones. Switch programmable speaker muting.  
**S/N:** Mic level in @ -50dBm & +8dBm

out; -68db. High level @ 0dBm in & +8dBm out; -75dB (typically -78dB).  
**DIST:** Below noise floor. Typically .009%.  
**RESP:** 10Hz-20kHz; ±1dB  
**CROSSTALK:** PROG1 to PROG2; -70DB.  
**SIZE:** xL4..19"W x 8.5"H x 17"D.  
xL6..25"W x 8.5"H x 17"D  
xL8..30"W x 8.5"H x 17"D  
**POWER:** 115VAC, 50/60HZ, 40W. 230VAC available at additional charge.  
**FINISH:** Polyurethane Carbide black, Linear white, Ramko Grey.

## MODELS & LIST PRICES:

xL41S	\$1395	xL81S	\$2650	LF6	Contact factory
4 mixer single channel stereo		8 mixer single channel stereo		Linear faders; Available 6/89	
xL42S	\$1650	xL82S	\$2950	LF8	Contact factory
4 mixer dual channel stereo		8 mixer dual channel stereo		Linear faders; Available 6/89	
xL 61S	\$1975	RSS4	\$225	PS230B	\$50
6 mixer single channel stereo		Remote start/stop (xL4)		230VAC power source	
xL62S	\$2375	RSS6/8	\$325		
6 mixer dual channel stereo		Remote start/stop (x16 & xL8)			



# Continental 816-R Gate Cards

By Warren Nystrom - KRDU/KOJY  
Dinuba, California  
209-486-1130

Our Continental 816 has been in service for about five years and, except for a power module failure right at the beginning, almost all our problems are/were gating card connected.

Our transmitter is about an hour and fifteen minutes away by road, in good weather. In bad, who knows. Luckily several other stations had problems and we joined in renting a helicopter at \$400 per hour.

One thing I learned was that gating cards can cause seemingly unrelated symptoms. In order of occurrence:

1. Inability to get power up to 100%
2. Blown fuses to the exciter
3. Main circuit tripped but not the PA breaker
4. PA breaker tripped
5. Dimmed building lights

After the manager got fed up with long downtimes, we ordered updated gating cards that are suppose to cure the problem. We just installed them. If they work, they're worth the cost.

It was mentioned in the April Radio Guide that faulty capacitors are usually the culprits. When replacing them, be sure to match the corresponding pairs. The exciter problem, mentioned above, was traced to a 10 mFd capacitor that only measured 4 mFd.

## Limiter Bypass Circuit

By Phillip Robillard - Robillard Communications  
Haynesville, Louisiana  
318-624-0105

This circuit is simple and straight forward. It solved a problem we had with removing either of two stereo limiters feeding our FM exciter. Our biggest problem was with alligator clips and jumper leads. Something always happened to screw up the signal going to the exciter. Let's face it, unless you have both channels feeding the transmitter, even the dumbest listener can tell the difference.

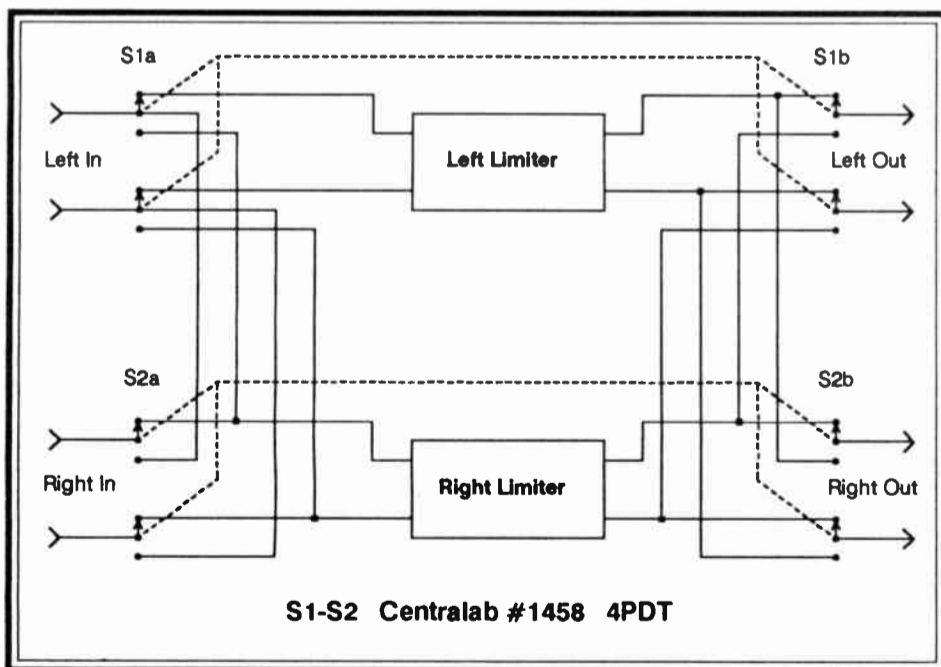

I used two Centralab #1458 4PDT switches to accomplish my mission. This way, I can switch either amplifier out of the circuit for repairs and not lose audio information. I mounted the switches on a Bud PA-1101 1-3/4 inch relay rack panel and backed it up with a Bud CB-1370 bath-tub chassis. These were held together with pop rivets, making one unit. I placed barrier strips on the back of the bath-tub chassis so that the input and output connections could be made easily.

After either amplifier or limiter is switched out, it is an easy matter to disconnect the incoming and outgoing audio wires from the rear of the defective equipment.

## SPLINE BALL IONIZER (SBI) A COST OPTIMIZED LIGHTNING PROTECTION DEVICE BASED ON STRIKE PREVENTION TECHNOLOGY

Based on 18 years of research and experience, the Spline Ball Ionizer embodies features of the famous Dissipation Array® System, reduced in size to reduce cost, but minimizing the risk and the consequences.

- Light weight.
- Low wind profile.
- Money back guarantee.
- Easy to install.
- Minimum 10 year life.

Costs Only  
\$1,450  
\$1,950 w/ chemical  
grounding

**WARRANTY**  
The SBI is guaranteed to perform as specified herein. If the customer is not satisfied with the performance within the first year, the guarantee covers a full refund, or the purchase price may be applied towards the purchase of a Dissipation Array® System which will prevent all strikes.

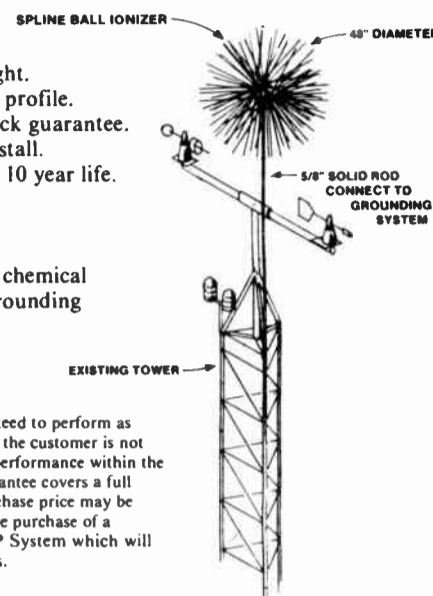

**Lightning  
Eliminators  
and Consultants, Inc.**

6687 ARAPAHOE ROAD  
BOULDER, COLORADO 80303  
(303) 447-2828 FAX (303) 447-8122  
TELEX 3791984 LEC

## -- Arrakis Authority --

"MODULAR" - - Configure to Meet Your Needs!

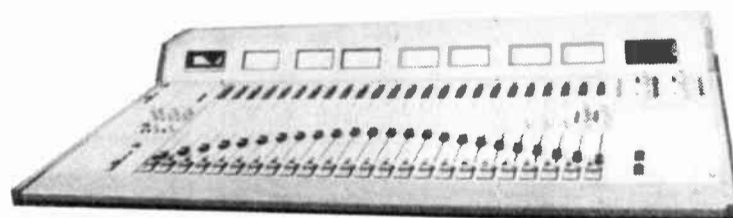

6 INPUT MODULES - UNDER \$4,000.00  
12 INPUT MODULES - UNDER \$6,000.00  
18 INPUT MODULES - UNDER \$9,000.00

Northeast Broadcast Lab proudly presents:  
The new Arrakis 12,000 Series.  
We'll help you choose the proper configuration  
to meet your present need  
and provide room for future expansion.

Get accurate advice, superior service and a paltry  
price from the Arrakis Authority. Call us today!

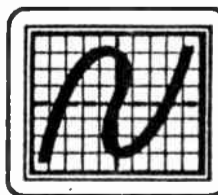

NORTHEAST BROADCAST  
LAB, INC.

Serving the Broadcast Industry Since 1961

New York P.O. Box 1179 S. Glens Falls, NY 12803 Tel: 518-793-2181 Fax: 518-793-7423	Mid Atlantic P.O. Box 565 Southampton, PA 18966 Tel: 215-322-2227 Fax: 215-953-0523	New England P.O. Box 406 Auburn, NH 03032 Tel: 603-483-1002 Fax: 603-483-2352
---	---	---

# Digital STLs - - A Few Zeros

By Tim McCartney - KBSU  
Boise, Idaho

Among many compelling reasons for radio station interest in the use of digital STLs, a few problems exist which are often ignored.

First, an overview of why the digital STL move is thriving: 1) limited 950 MHz spectrum space, 2) excellent specifications: noise, dynamic range, stereo separation, and frequency response, and 3) easier FCC licensing.

The "pseudovideo" digital systems discussed here, Sony's pulse code modulator (PCM), interfaces with a standard video signal and is transmitted in the 23 GHz band. KBSU has been using this digital STL regularly since April, 1988. Figure 1 is a block diagram of the two-hop STL.

In KBSU's application, high RF at the transmitter site renders the use of stereo generators nearly impossible. In fact, of the 13 FM stations at the site, we are alone in the attempt to make a stereo generator perform. The others all use a composite signal with the stereo generator located at the studio. We have done likewise with a redundant 950 MHz analog STL for our hop #2.

Another major problem comes during hand-offs from the Sony PCM's unbalanced, high impedance outputs to an interface amplifier and then to the stereo generator. High RF interferes during these hand-offs, resulting in unacceptable noise of about -35dB.

Experiments with RF shielding, grounding, etc., all proved to be successful only on a limited basis. And, the PCM itself is prone to total signal loss in the event that any coaxial connector is not perfectly crimped and shielded. In fact, double-insulated coax is a must in the high RF environment.

continued on page 8

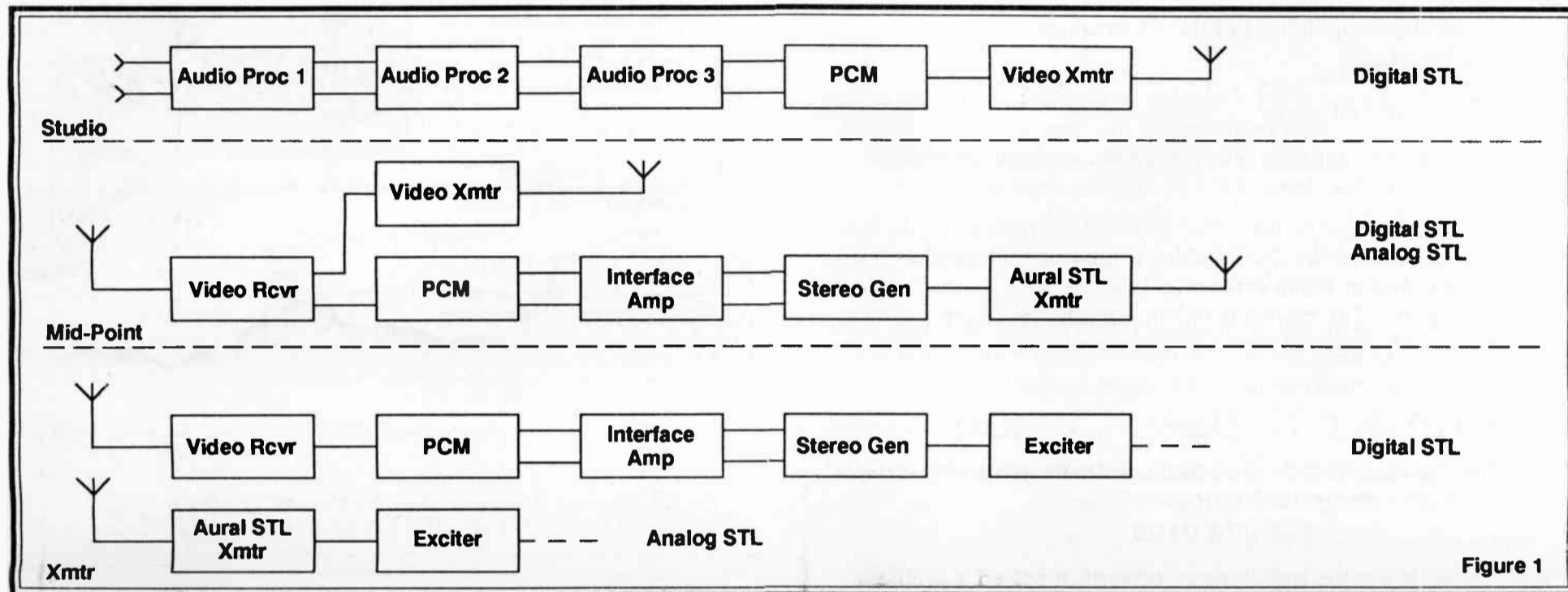

Figure 1

## Little Noisemaker.



This little gray box is about to have a big effect on the way you test your audio equipment.

No longer will you have to bother with individual tones to set proper audio levels. With Delta's SNG-1 Stereo Noise Generator you can make a variety of tests with *true* stereo noise, all at the flip of a switch.

You'll get a much more realistic view of what your equipment is doing. Whether you prefer white, pink, or USASI noise spectra, the SNG-1 provides it, in both continuous and pulsed output modes.

Say goodbye to hit or miss processor adjustments using varying program material. The award-winning SNG-1 spans the entire frequency range, so you'll cover the highs, the lows, and everything in between.

The external gate input permits an infinite variety of pulse shapes and durations so you can test your equipment to the absolute

fullest. For standalone convenience simply switch to the internal pulse mode.

With the SNG-1 you'll always get an accurate and repeatable standard to base your measurements on. And for only \$495, there's no bigger value.

To discover how the Little Noisemaker can help you in a big way, call or write today. And be sure to ask for your free copy of Delta's Noise Primer, "Employ Some Noise." Delta Electronics, Inc., 5730 General Washington Drive, P.O. Box 11268, Alexandria, VA 22312. Phone: (703) 354-3350, FAX: (703) 354-0216, Telex: 90-1963.

The Above Standard  
Industry Standard.

DELTA ELECTRONICS



©1989 Delta Electronics, Inc.



## Digital STL . . . (continued)

### Audio Processing

KBSU's audio processing equipment comes in three separate black boxes. This allows some choice when selecting the location of various equipment. Figure 1 shows KBSU's final location of each processor in relation to the digital STL.

An interesting choice is the location of Box #3 which introduces the 75 microsecond pre-emphasis. We tried locating this unit in both the studio and mid-STL points, with no differences noted. Convenience concerns kept it in the studio, however.

Since there are few similar situations at other radio stations from which to compare, it is not clear what the impact might be of inaudible digital transients feeding into audio processors. Thus it seems safer to locate all processing in front of the digital STL.

As for engineering convenience, it is most difficult to make adjustments to a stereo generator which is located at the transmitter site, miles away from the studio monitor.

### Equipment Shortages

At the present time it is impossible to purchase new PCM units, since Sony has re-allocated resources to development of the Digital Audio Tape (DAT) technology. The firm may, however, provide a similar item at a future date.

The only other competitor, dbx, is no longer producing its D/A and A/D converters (model 700), which are somewhat similar to the Sony PCM, but at a much higher price.

Any STL relying on this technology requires backup units, schematics, etc., to keep the system operational for the next few years until such a replacement item is again available.

### Uncertainty

Even if the equipment were readily available, questions must be addressed about better future options.

With spectrum space always becoming tighter, the FCC will certainly look favorably on new technologies which are spectrum efficient. For example, the 23 GHz system at KBSU occupies 10 MHz of baseband bandwidth (12 MHz minimum with rollout to 20 MHz). By comparison, the 950 MHz aural system currently uses 500 kHz of bandwidth.

Several companies have already met this challenge. Dolby poses the ironic possibility that the 950 MHz band will become home to the digital audio link of the future. Dolby can already transmit two digital 15 kHz audio channels and one narrower auxiliary channel while meeting the FCC 1990 bandwidth standard.

The new Dolby system likely will need FCC approval for any new emission type which may become the standard.

### Cost

The typical cost of a 23 GHz STL system, even if the digital converters can be found, is still typically higher than the traditional 950 MHz composite STL system.

However, for a short distance, such as KBSU's STL hop #1 of just a few hundred yards, the digital system is a few thousand dollars less. The inexpensive price of 23 GHz equipment for such short hops accounts for the savings.

### Reliability

Stations with STL paths under 15 miles usually can take advantage of digital STL systems, but must consider the impact of rain attenuation at 23 GHz.

For example, a seven mile hop in Chicago would be reliable 99.585% of the time. While that may sound acceptable, it still means that some 80 minutes per year may not be of use. And, if unreliability occurs during a rush hour downpour, the digital choice might seem like a poor one!

On the other hand, a short hop in semi-arid Boise, Idaho is reliable all but a few seconds a year. But, it happened during a heavy rain last December. A digital "roll" made the announcer sound as if

(continued on page 9)



## Optimize — don't compromise:

**If you demand optimum performance from  
your tape recording equipment . . .  
you need our services!**

JRF maintains a complete lab facility insuring precision relapping and optical alignment of all magnetic recording heads and assemblies. Worn unservicable heads can be restored to original performance specifications. 24-hour and special weekend service available.

- Broadcasting
- Mastering
  - Recording Studios
  - Tape Duplicating



**New and reconditioned replacement heads from mono to 24-track . . . Many in stock.**

For repair or replacement, we're at your service!



Call (201) 579-5773





### JRF/Magnetic Sciences, Inc.

Kennedy Road • P.O. Box 121 • Greendell, NJ 07839 • Telex: 325-449



## Mr. Popularity

In less than a year, the Harrison AP-100 has become our most popular console. The attraction of this board is more than its great looks. The affordable AP-100 has spectacular audio specifications and all the features you need to handle your most demanding programs.

Now the console you've been waiting for is ready for you. Call your Bradley professional today for a quotation and prompt delivery. Manufacturer's list price for the 12 channel model is only \$9900.



## BRADLEY BROADCAST SALES

8101 Cessna Avenue  
Gaithersburg, Maryland 20879-4177

800-732-7665 / 301-948-0650  
Fax: 301-330-7198

**Where Service and Engineering Make The Difference**



## Digital STL . . . (continued)

he had "hiccuped." By the way, this digital "rolling" can become an engineering nightmare once digital STLs have come into regular use.

For the most part, however, the digitally modulated video channel is impervious to minor rain fade of this sort.

### Licensing

KBSU had no difficulty in 1987 securing the FCC construction permit/license for the 23 GHz video link. However, the same year we applied for a similar link in the 18 GHz band and have yet to receive a decision from the Commission.

### Spectrum Use

The wide bandwidth of most video systems is not fully occupied by the Sony PCM. Thus, the remaining space is available for other operations such as analog subcarriers (see figure #2).

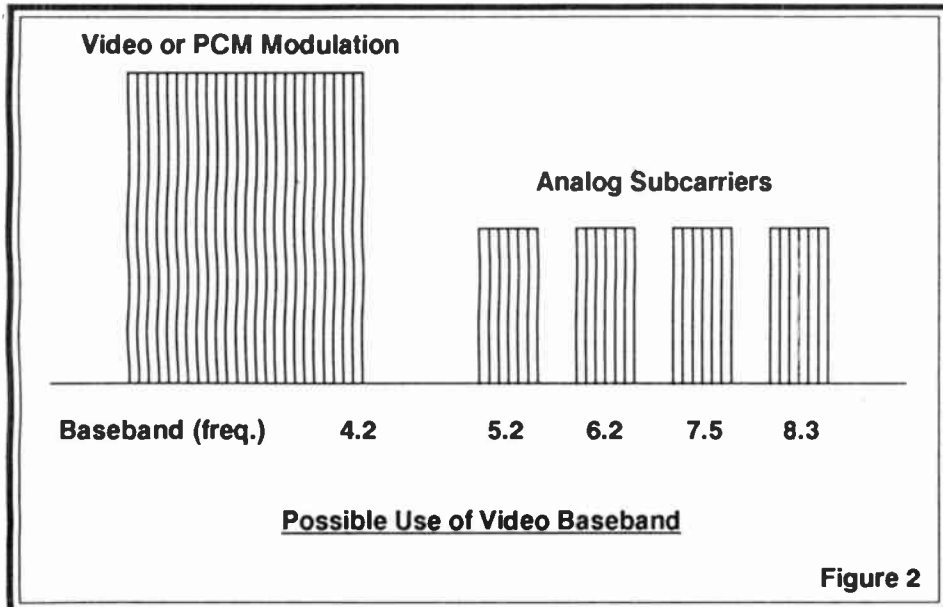

However, our attempts to use two analog subcarrier channels on the 23 GHz hop #1 failed due to high noise from unidentified interference.

### Antenna Locations

Such high-frequency systems require very short sections of waveguide. This means that the RF stages for both the transmit and receive sites are located inside the antenna structures and at typically inaccessible locations on tower masts. So, maintenance difficulties increase. The RF portions of 950 MHz systems are mostly indoors and accessible.

### Alignment

A narrower beamwidth at the higher frequencies requires a tight alignment of the two antennas. Any errors introduced by wind or lack of structural integrity amount to signal loss.

### Dropouts

Instead of a fade or a gradual degradation of signal, digital systems move quickly toward total failure. The progression is from a perfect signal, to the "hiccup," to total dropout.

Recently our digital STL dropped out completely after the 23 GHz transmitter had been momentarily disconnected from its antenna assembly. While I prepared the backup land-lines for STL hop #1, the link started working again after 20 minutes. At the time it came back into operation, I was nowhere near the equipment! I later learned that the 23 GHz receiver coaxial connection to the antenna assembly had to be removed momentarily for a quicker system reset.

This type of uncertainty about the source of problems makes one appreciate the relative simplicity of the standard 950 MHz aural system. KBSU uses its analog STL hop #2 regularly, while retaining the digital STL hop #2 for backup only. The station continues regular use of its digital STL hop #1, however.

### Digital is Coming

Nonetheless, it is clear that digital systems are in radio's future. So the sooner engineers learn to work with them and overcome their new realities, all the better.

**Yet another reason  
we sell more  
cart machines  
than anyone else.**

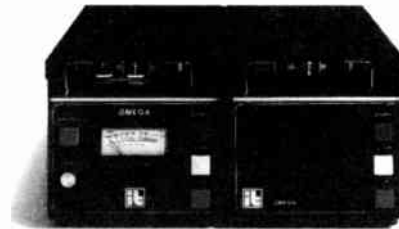

The OMEGA series. High quality performance at an affordable price.

**And here are three more.**

Our Authorized 3M Dealers

Allied Broadcast  
Equipment  
800/622-0022

Broadcast  
Services Company  
919/934-6869

Broadcast  
Supply West  
800/426-8434

3M International Tapelectronics — The World Leader in Cart Machines

©1989 3M Company

**3M**

## CRL SPOTLIGHT



**Create Personality Instantly  
. . . Just Add Voice!**

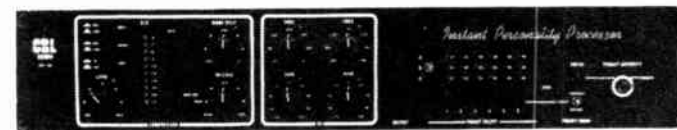

CRL's IPP-100 Instant Personality (mic) Processor is just what your station needs to enhance its personality. The IPP-100 is a fully integrated broadcast microphone processor with 18 preset memory positions. A powerful two band, parametric equalizer drives a two band compressor with adjustable band splitting. Mic or line level input and outputs, key lock security system, LED status system, and easy to use analog controls make the IPP-100 simple for anyone to use. Plus the IPP-100 features an external audio loop for special effects processors, and full remote control capability. Best yet, get all this digitally controlled power for only \$1295.

**CRL  
SYSTEMS**

**CRL Systems**  
2522 West Geneva Drive  
Tempe, Arizona 85282 U.S.A.  
(800) 535-7648 (602) 438-0898  
TELEX: 350464



# The Octopus

By Bob Schnieder - Broadcast Technical Services  
Lubbock, Texas  
(806) 798-2601

Contract engineers need to be as fast as possible when it comes to finding faulty components in Broadcast equipment. Many Navy veterans are familiar with the Octopus component tester. If you can find a copy of an Aviation Fire Control Technician 3rd & 2nd Class Petty Officers Manual, it starts on page 574.

All you need for this three hour project are three resistors and a 6.3 volt AC center-tapped filament transformer. Some leads, BNC connectors, and a small box to put it in, and you're on your way to testing circuits and components on de-energized circuits with your oscilloscope.

You will save time because you will not need to un-solder components from circuit boards. In fact, if you have a known good circuit board, the repair becomes even easier. The Octopus gives the operator a visual display of the components condition better than you can find with an ohmmeter. The display is under AC small-signal conditions which, with some practice, is a breeze to interpret on the oscilloscope.

The Octopus is designed to quickly test delicate components because it will not deliver more than one milliampere of AC current. It will test all components for shorts, opens, and will check the front to back ratios on junction components such as diodes and transistors.

Utilizing the Lissajous and combination patterns on the 'scope, the Octopus easily analyzes circuits and reactive components that defy ohmmeter analysis. You will be delighted the first time you identify a noisy potentiometer or a high resistance solder joint.

The figure 1.1 shows the schematic of the simple Octopus. You can get fancy with an on-off switch, fuse, etc., but the basic circuit is very simple.

After you build the Octopus, simply connect its vertical output to your oscilloscope's vertical input and its horizontal output to your 'scope's horizontal input. The vertical and horizontal gain control of your 'scope should be adjusted to prevent trace ends from going off the face of the 'scope. The oscilloscope must be set to the X-Y position to use the Octopus, with the horizontal sweep disabled.

Figure 1.2 shows typical oscilloscope traces. The Octopus is an AC device and you will be able to observe reactive components and Lissajous as well as front to back ratios of junction components. It is therefore unnecessary to reverse the leads. (continued on page 11)

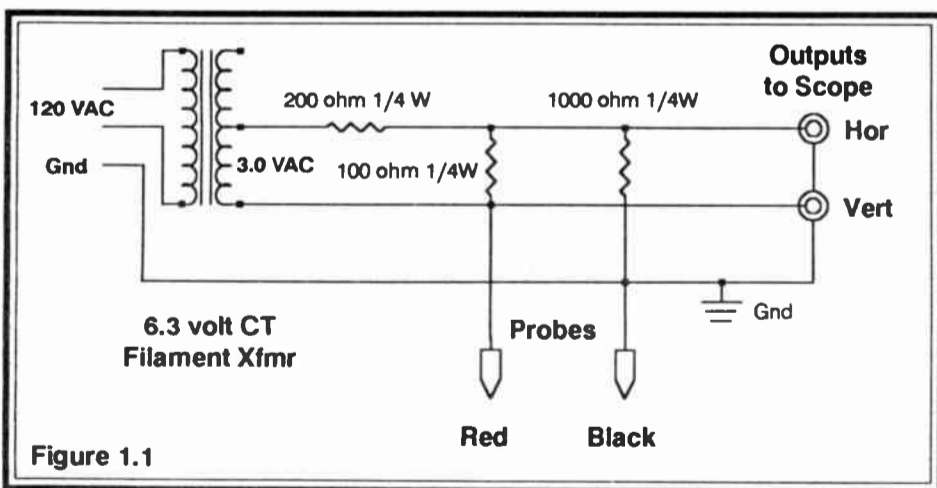

## Silence is Golden and less work with telcom c4 for RADIO and TV.



### The NR system you just set and forget.

- A product of ANT Telecommunications, Inc.
- No overshooting.
- No wasting time with lining up — not even for tape exchanges.
- No pre or post echo.
- Up to 118dB dynamic range — the widest dynamic range available in any noise reduction system today.
- Applications: Cartridge machines, STL, RPU, Reel-to-reels, Cassettes.
- Over 15,000 channels in use worldwide.
- No breathing or pumping.

**telcom c4**  
Silence by Design

Distributed by:  
**RAM BROADCAST SYSTEMS INC.**  
346 W. Colfax Street, Palatine, IL. 60067  
New York (516) 832-8080 Chicago (312) 358-3330 Tennessee (615) 689-3030

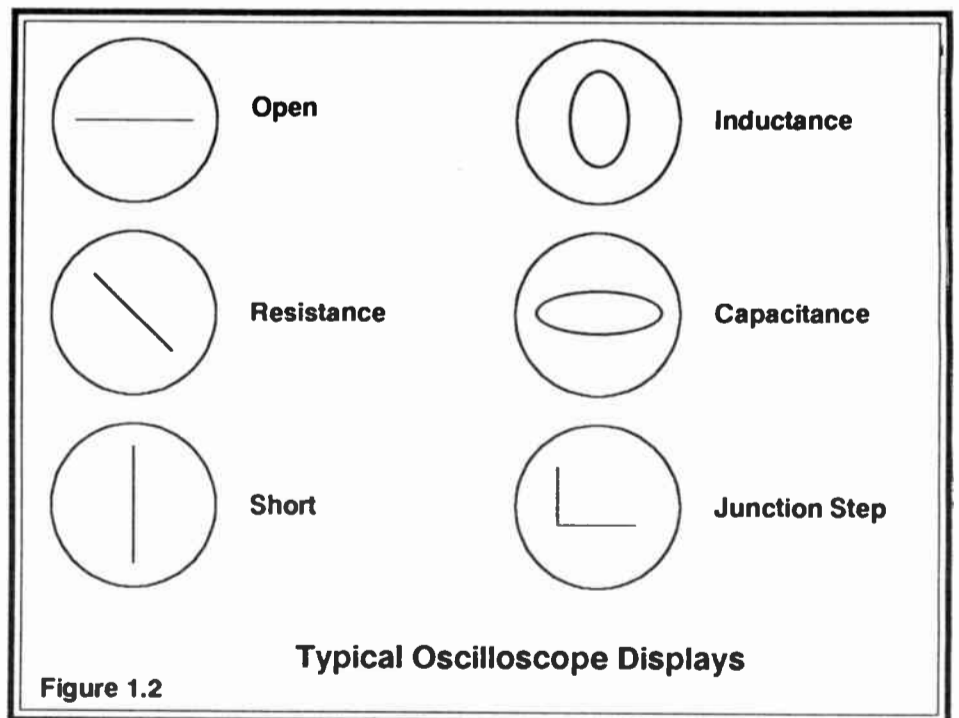

## A-MAZE high definition, Concert Hall Sound



Dramatic results in program definition, separation, loudness. Perfect solution to STL and processor headroom problems.

**hnat hinders inc**  
42 Elaine Street • R.R. 1 • Thompson, Connecticut 06277  
(203) 935-9066 • (203) 935-9242



## Octopus . . . (continued)

When checking transistors, check first from the base to one side and then from the base to the other side. Since an emitter to collector test would have to pass through two junctions in series, you will usually not get a useable result.

An ideal single junction check will produce a 90 degree step display indicating a very high front to back ratio. This simply means an open in the reverse bias direction and a short in the forward bias direction. A display that is open more than 90 degrees, is something less than perfect. The wider the angle, the less the merit of the junction. Refer to Figure 1.3.

With a little use, you will become proficient in recognizing combinations of patterns arising from grouped components. You will be able to recognize the reactance as either capacitive or inductive and analyze if the circuit is reacting correctly. When you compare to a known good board, the job becomes one that even a new technician can work with. See figure 1.4

Just a few parts from your parts box can become one of the greatest helping hands on your bench. Maybe that is why the Navy calls it an Octopus, since you will feel that it has given you many extra arms in circuit repair.

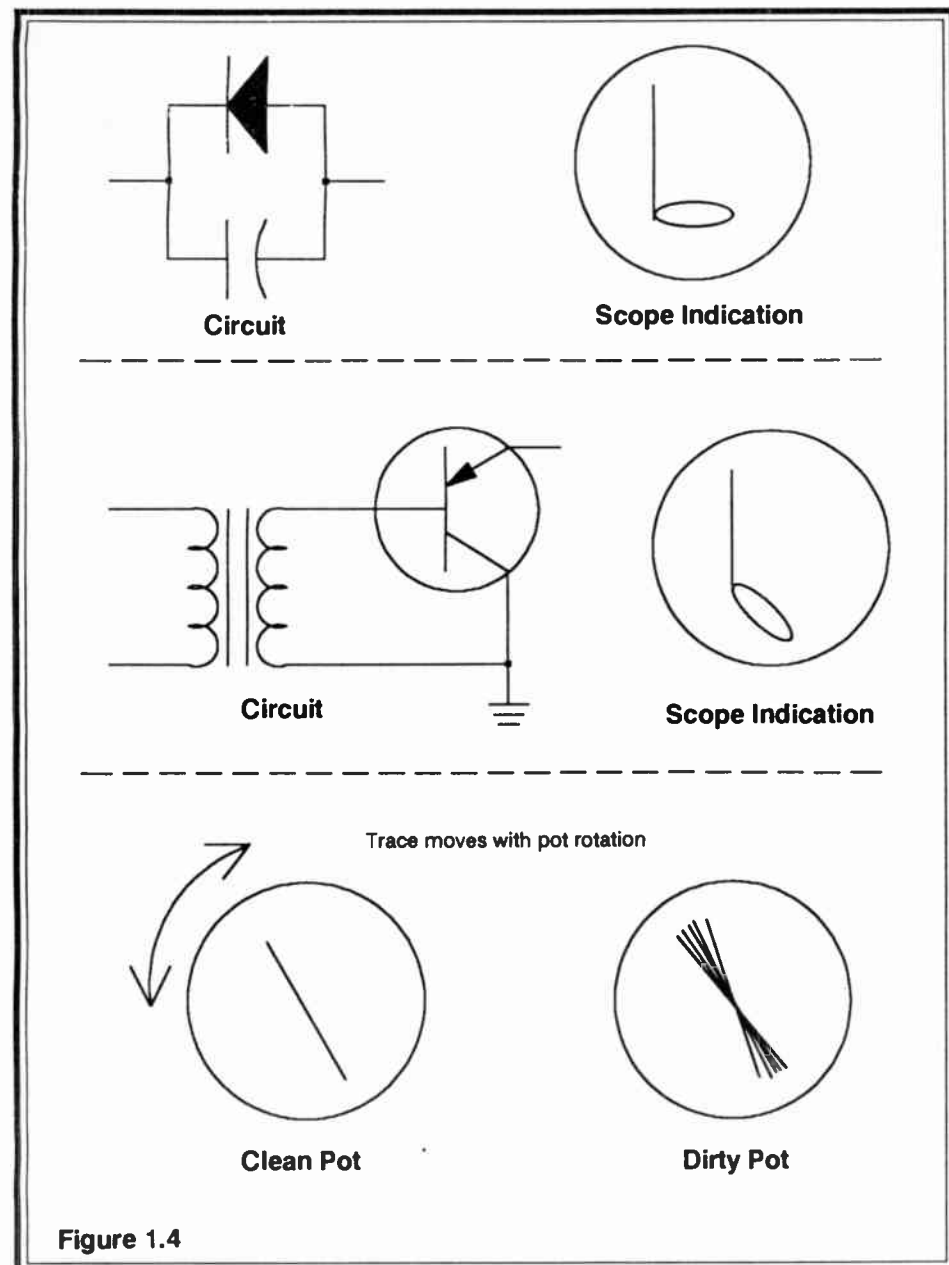
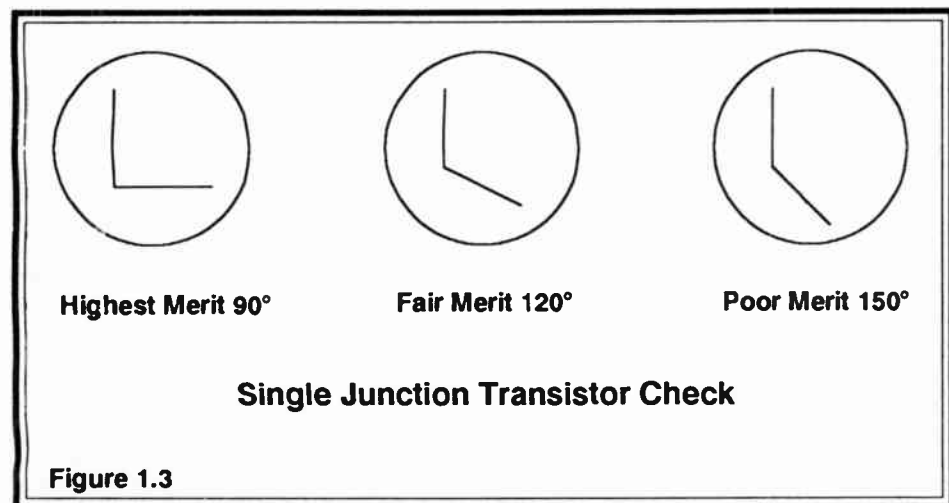

# POWER-side™

## PROBLEMS

Adjacent Channel Interference
Antenna Null Distortion
Co-Channel Interference
Power-line Re-Radiation
Building Re-Radiation
Receiver Tuning
Low Fidelity Home Radios
Co-Channel Beat
Selective Fading

## SOLUTION!

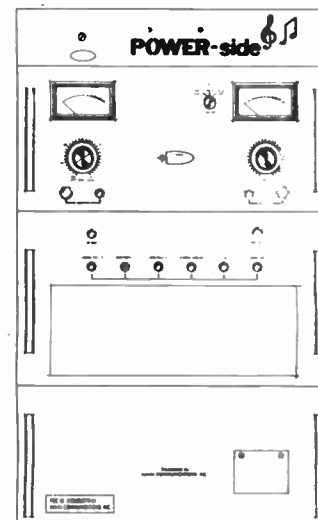

**POWER-side™**  
The solution to many of AM radio's most serious technical problems

*From the developers of the AM STEREO system that isn't afraid of the dark and will let you drive right past FM Stereo*

425 MERRICK AVENUE, WESTBURY, NY 11590 • (516) 222-2221

## IT'S OUR 15TH BIRTHDAY

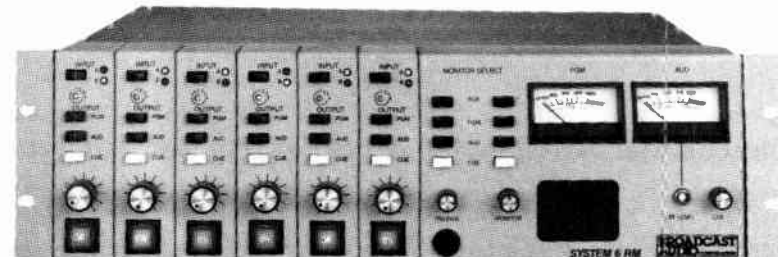

## BUT YOU GET THE PRESENT!

That's right — with the purchase of any SERIES IV, SERIES VI, or SYSTEM 6RM audio console, we'll give you a present of additional mixers, accessories, or upgrades, equal to 15% of the console base price. Select your gifts from our November, 1988 price list. Save even more with generous cash discounts!

Hurry - Our **15TH BIRTHDAY CELEBRATION** expires September 30, 1989. Big Savings and Great Sound from **BROADCAST AUDIO**. Plus, we'll still be here next year!

**BROADCAST AUDIO CORPORATION**

11306 SUNCO DR.,  
RANCHO CORDOVA, CA 95742  
(916) 635-1048



# Station Woes

By Sal A. Emma - WSLT-FM  
Ocean City, New Jersey  
(609) 399-1555

## Label Woes

Part of a recent station renovation included moving our main on-air studio and replacing the old console with a new one. When everything was installed and the job ninety percent completed, it came time to label the new console for the announcers. One morning, the station operations manager walked in and handed me a Dymo Labelmaker. He said I could use it to make labels for the new console.

"Are you out of your mind," I thought to myself? I then politely thanked him for trying to help, and informed him that we would not be using Dymo Labels on the new board. With no offense intended to the Dymo Company, there is simply something inherently offensive about those labels in some situations. They are OK for a lot of jobs, but I can't stand seeing them in plain view of everyone in the on-air studio. In addition, they leave behind a nasty glue residue when removed. When my fine managerial friend offered his assistance that morning, I still hadn't come up with an alternative.

Then, one day as I was driving along, an idea struck me like a ton of bricks (as it tends to do in this business). I procured a length of vinyl siding from the dumpster of a construction site. I trimmed it to size so that it would slide neatly under the LPB Signature Console. Then using garden variety white labels, I notated each channel function using a chisel-tip calligraphic pen.

Now, whenever we make a change in the board set-up, it's very simple to rearrange the labels. As an unexpected bonus, the chunk of siding prevents hundreds of pencils, pens, and hair balls from rolling underneath -- out of reach and tough to vacuum out.

The announcers (clever as they are) also slide their song sheets and whatever other paperwork, under the siding to hold them in one spot.

Now, whenever the PD has to train newcomers, they only have to slide the siding out from its hiding place to read the board configuration. The jocks, who have been using this system for some months, have memorized all the locations, and rarely have to slide it out at all.

## Speakerphone Woes

Being a small market station with a small market budget, we cannot afford an expensive telephone interface box. We recently purchased a standard Radio Shack Speakerphone, with separate mike and speaker elements. This worked OK for some announcers, depending on the nature of their voices. However, a few just could not seem to get the mike to actuate from three to four feet away, no matter how loud they yelled. The announcers tape their phone calls on the audition channel, with the mike and speakerphone potted up in audition; the announcers have to keep their mouths somewhere near the console mike for a quality recording. In theory, this worked very well, except that the caller always heard the announcers as though they were inside a barrel.

One idea: wire one side of the stereo mike mixer inside the board to feed the speakerphone. This works well, and there are quite a few talk radio stations around the country using this very system. However, I really did not want to modify the board and chop up the telco switches inside.

Second idea: mount the speakerphone mike near the announcer's mike. We removed the small condenser mike from the speakerphone box, and ran a piece of un-balanced shielded audio cable from the mike terminals inside the speakerphone box, up to the announcer's mike. There, we mounted the mike inside a plastic tube and attached it to the mike stand with a couple of nylon wire ties. Now, the announcer's mouth is no more than a few inches from the both mikes. To the caller, they sound just as though they are using a regular phone. The callers have always been able to hear the announcer's voice, since making this simple modification. This set-up has really improved the quality of recorded phone calls for contest winners and other actuality applications.

(continued on page 13)

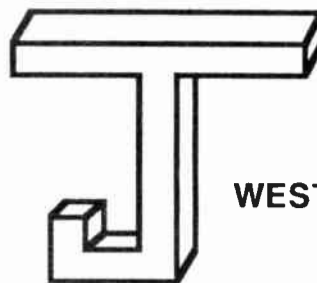

SQUARED  
TECHNICAL SERVICE

543 WEST 100 NORTH  
WEST BOUNTIFUL, UTAH 84010

801-298-8515

## EQUIPMENT REPAIR AND CALIBRATION SERVICE

WE SERVICE MOST AM/FM BROADCAST MONITORS,  
REMOTE CONTROL SYSTEMS, EXCITERS, STL's, TSL's,  
RPU's, ETC.

### GIVE US A CALL

- CHECK OUR RATES-
- TURNAROUND TIME-
- STL LOANER PROGRAM-

# ***ECONCO***

*Now in our 20th year  
providing quality rebuilt tubes.*

These are a few of  
the tubes we rebuild:

3CX2500F3

3CX3000A7

3CX3000F7

4CX5000A

4CX15,000A

4CX3000A

**WE BUY DUDS.**

**WE ALSO REBUILD REFLEX KLYSTRONS.**



ECONCO  
1318 COMMERCE AVENUE  
WOODLAND, CA 95695  
TELEPHONE 916-666-7553

OUTSIDE CA 800-532-6626 EXT. 30  
FROM CANADA 800-848-8841  
TELEX 176756  
FAX 916-666-7760



## Station Woes . . . (Continued)

### Electronic Phone Woes

Management recently installed a new phone system in the building. This system was acquired through some financial hocus pocus, and not purchased with the radio station in mind. It's an electronic system, so that each desk phone is something like a "dumb terminal" to the central brain, which hangs on the wall in the computer room. Using this system, we could no longer interface telephone audio using a QKT adapter, or any combination of transformers and capacitors, due to the lack of pure audio at the phone and the presence of hold pulses and other digital nonsense on the phone line.

The only place from which you can take pure audio on these phones is at the handset. I simply took a piece of two-conductor cable and soldered it to the handset terminals inside the phone unit at each location where the audio is needed. I then installed a cut-out switch across the transmitter, to allow the news department to record actualities without the room noises.

This audio is high impedance, so it may need a transformer to interface with some consoles. On a Marantz portable cassette recorder, it works just fine feeding the mike input, but not the "phone" input. If you want to try such connections, you may have to experiment with various inputs and impedance matching networks before you get it to work. This plan constitutes another way to make it work by spending little or no money, and we all know that the station loves its engineers when they do that.

---

## Cart Deck Delay Timer

By **Bill Meyers - WBEZ**  
Chicago, Illinois  
(312) 563-0487

Although most stations, today, are probably using electronic delay units for their talk shows, we've never had one; so we used the old "reel/reel tape delay" (two rack mounted machines and a tape loop). We found that the spacing between the recording machine and the "on-air" playback machine, happened to give us a six second delay. Since these machines were stereo, we decided to enable the program host (and guests) to remain on the air, even while a caller's audio was being "killed." This was accomplished by keeping the phone caller audio (only) on one channel, and all other program material on the second channel. These two channels were fed to a small mixer and then on to our transmitting system.

"Killing" the phone audio became a simple matter of applying a "short" (relay contact closure) across the output channel of the playback tape deck that contained the telephone audio, before it reached the mixer input.

We really wanted a controlled length of "kill" time, so that the operator was not forced to watch the clock while he held the relay contacts closed.

We selected a relay with the proper coil rating and connected it's coil in parallel with the solenoid of one of our system cart machines. The normally open relay contacts were wired across the phone caller's audio at the tape machine output, as mentioned above.

The cart machine was to be used for timing only, so a blank cart was selected. We recorded "stop tones" only, spaced 10 seconds apart. Now, simply starting the cart machine would remove the phone caller's audio from the air for 10 seconds, while our host and guests could still hear the callers remarks.

We also wanted to delegate the decision of "what to kill, and when" to the program host. We simply added a remote START pushbutton for the cart machine and placed it in front of the host and labeled it "KILL SWITCH" -- they loved it! It's a good idea to disable this remote switch during normal programming so that someone in the studio doesn't try to "find out what this switch does," thereby starting your cart (and your heart) by accident.

# The Carts You Can Count On



## From The Supplier You Can Count On

Demanding broadcasters around the world count on Audiopak broadcast cartridges for consistent response, dependable quality and outstanding reliability. High-performance tape formulations, superior coating processes and rugged, "no-maintenance" casing designs have made Audiopak the international standard. Why settle for other broadcast cartridges? Getting "workhorse" A-2s, "stereo" AA-3s or "digital-ready" AA-4s is as easy as picking up your phone.

# BSW

BROADCAST SUPPLY WEST

America's Full-Time Broadcast Supplier

**1-800-426-8434**

ORDERS • INFORMATION • SPECIFICATIONS

BSW • 7012 27th Street W • Tacoma, WA 98466 • FAX 206-565-8114



# Harris/Gates BC1-T, G and H Transmitter Modifications

By Jim Alexander - Broadcast Engineering Services  
Russellville, Arkansas  
501-968-7270

The center-tap of the RF driver tank coil, in this series of similar transmitters, is by-passed to ground through a .01 uF, 1000 volt disc ceramic capacitor. This capacitor is prone to fail during thunderstorm activity, and I have seen a number of these transmitters with connections showing frequent replacement and/or replacement with a large surplus type mica capacitor.

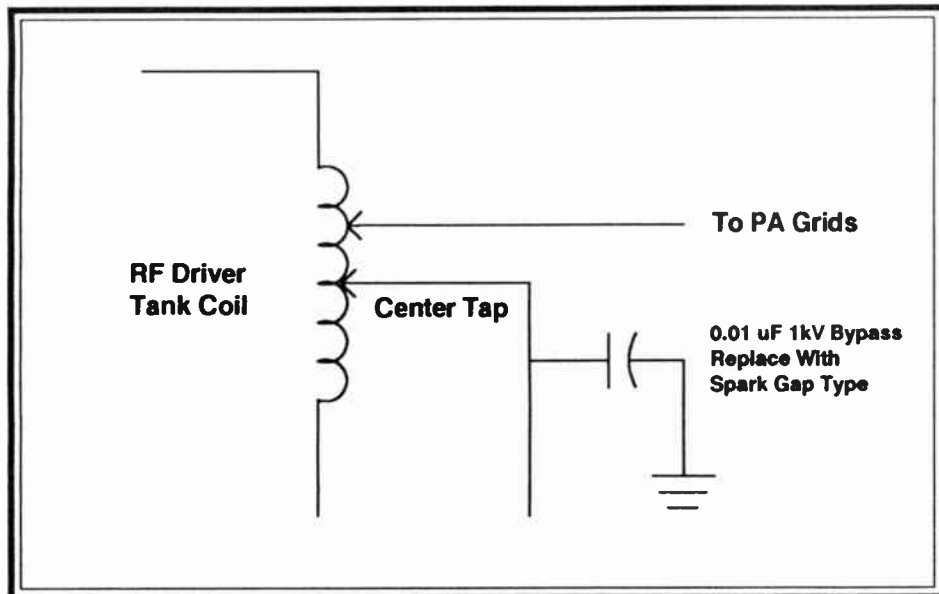

I have, for years, replaced this capacitor with a Mallory AT103A. This unit consists of a .01 uF ceramic capacitor which features a built-in spark gap in a single package. This change will normally preclude further problems with the bypass capacitor.

## Continental Gate Cards - Matched Caps

By Stephen R. Weber Jr.  
Fresno, California

Recently, I was called on to diagnose and repair a 10 kW Continental at KOJY in Dinuba. It was randomly blowing out exciter and control supply fuses and tripping the main HV breaker. As you may guess, the problem turned out to be one of the gating cards. One of the 10 mFd caps tested about 3 mFd. We installed a re-built spare card and cured all symptoms.

If you maintain one of these transmitters, I highly recommend adding an inexpensive capacitor meter to your toolbox. Even one of the ones built into some of the new digital VOMs are good enough for this. Use this unit to periodically check the three capacitor pairs on the gating boards. Also use it to check any caps you may want to use for spares or replacements for these boards.

The important thing here, according to Continental, is the value MATCH of the caps in each of the pairs, more than their absolute value. They should always match within a few percent. "Shotgun" replacement with unmatched capacitors should thus be avoided, as randomly picked electrolytics, with the terrible tolerances they have, could create more problems than you had to start with.

If you opt to replace your gating cards with a set of the new generation "capacitorless" IC gating cards (which Continental now offers), beware of a possible problem. Before you install them, check to see that the cards you receive are made of the same thickness PC board material as your original cards! One of the three sent to KOJY was thinner than the others and refused to stay in the card edge-connector properly, when inserted. There may be more like this out there somewhere.

## NRSC Conversion Special



ONLY  
\$2650.00

Why just convert  
when you can upgrade...for less

- MIC-MAZE** — STL or Telco Preprocessor  
Eliminates headroom problems
- TRI-MAZE** — Complete NRSC processing  
Including tunable cutoff frequency
- ZH-1** — Main and Auxiliary transmitter  
peak control  
For precise modulation control on both your old  
and new transmitter

No other NRSC processing package offers so  
much performance and control for so little money.

**hnat hinders inc**

42 Elaine Street • R.R. 1 • Thompson, Connecticut 06277  
(203) 935-9066 • (203) 935-9242

## Phase Perfection!

The *RIGHTRACK* APC-200 Audio Phase Corrector, used as a production tool, can help you achieve optimal phase performance while dubbing from any medium. It allows you to manually optimize phase performance to give your station a consistently bright mono signal and undistorted stereo image. Material from outside sources, such as ad agencies, are never guaranteed to follow the same alignment standards. The *RIGHTRACK* allows you to electronically correct for these alignment differences . . . before they degrade your air sound.

With a built-in three frequency oscillator and L+R/L-R metering, the *RIGHTRACK* can double as convenient in-the-rack test equipment for quick verification of record and playback alignment. Used with stereo recording cart machines the *RIGHTRACK* can pre-compensate for mechanical cartridge phase error introduced by the cart itself. Contact your local distributor or Broadcast Devices today for more details.

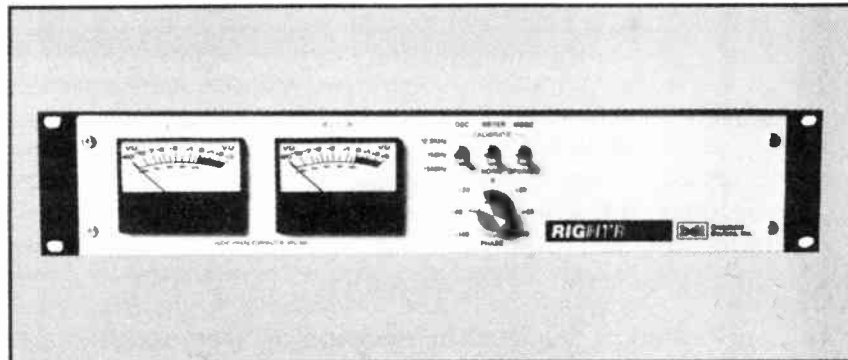

Suggested list price: \$995

Affordable solutions for the broadcaster ...  
5 Crestview Avenue Peekskill, NY 10566 (914) 737-5032

**bdi** Broadcast  
Devices, Inc.



# Almost A Nightmare

By Steve Griesbach - WOZZ-FM  
New London, Wisconsin

Here at WOZZ-FM, in New London, we have a gates FM-3G transmitter operating at 3 kW on 93.5 MHz. It began in April of 1989, at the 4:50 a.m. sign-on.

Upon inspection of our transmitter logs, I noticed that we had been operating below power until about 10 a.m. After re-tuning the transmitter (too many times to count), it still didn't improve the operation. So I consulted with our corporate engineer, and told him of the the problem, and what had been done to try to correct it.

He came up to the station about mid May, and we began our hunt. We first checked all the connections to make sure they were tight. While doing that, we noticed some masking tape on the BNC connection on the coax coming out of the exciter. Why the masking tape was there, was beyond my knowledge. While inspecting the coax for breaks and cracks, he had noticed that this was not a typical 50-ohm cable; it was 75-ohm RG-59. We switched to the auxiliary exciter and replaced the cable. Before the cable was replaced, we had an exciter output of 6-8 Watts. After the cable was replaced, the exciter was delivering about 20 Watts to the transmitter.

Was the problem solved? That was the question in our minds. The only thing to do was wait and see. Upon inspection of the next day's log, the problem was solved, but a new one had appeared -- one that hadn't been there before we changed the cable. The output power was fluctuating all day long. It wasn't a normal fluctuation, since we had to raise or lower the power every 30 to 40 minutes. The big question was, now what!?!?

We re-tuned the transmitter once again, and it cured the problem for a day or so. During the next couple of weeks, I watched the RF INPUT level to our McMartin TBM-4500A mod monitor. As the days passed, the input was slowly fell each day. The first thing to cross my mind was, "Are we losing the final tube?" So, on Friday, June 3rd, I decided to try the spare final. After sign-off, I shut off the plate, but left the filaments on.

While the transmitter was cooling, I made a visual inspection of the transmitter cabinet. During this inspection, on the underside of the PA cabinet, I noticed a red glow and some sparking -- not good! I shut the filaments off and the glow disappeared. I took a small light and looked to see where this glow was coming from. I found it came from a buss bar that connects the filament transformer to the tube filament. The first things on my mind were a loose connection or a bad transformer.

On Saturday, we took the transmitter down at 1:00 p.m. and began our search. We checked all capacitors, and those were OK. Next we took the buss bar off; it was charred. We cleaned it off, and cleaned all the connections that the bar came in contact with. We replaced a wire going to the tube, because it was melted from the heat of the glowing buss bar.

After 6 hours of repairing and cleaning, we put the transmitter back together and fired it up. What do you know -- no more glowing buss bar. After a few days of watching the transmitter meters and inspecting the logs, the problem had finally been solved. Our output power and signal quality was better than ever.

Our guess was that this problem had been going on for a while (by the looks of the buss bar). The title says it all. It was almost a nightmare. If this had continued for any longer, we could have had a transmitter fire.

## 66-block Tip

By George Mimbs III - WIKS-FM  
New Bern, North Carolina

If you're using or going to use a 66B style punch block for your station wiring, this hint may be of use.

Place the block on your copy machine and copy it! Then you've got a life size identifier for your wiring lists. You may want to enlarge it if your copy machine will do that.

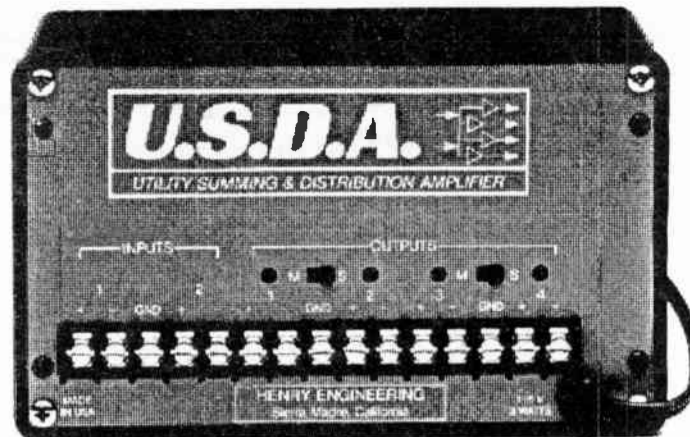

The U.S.D.A. is one of the most versatile audio tools to come along in quite a while. You can use it as a conventional 1X4 or 2X4 distribution amp. You can also *combine* a stereo input to a mono output.

It will not, however, dice, slice or make julienne fries. But then again, this is not a special TV offer. List \$195

**Crouse-Kimzey**  
C O M P A N Y

(800) 433-2105

## SCR Gate Drives

Used on Continental FM Transmitters

VPH1109D & PTR1332

- \$85.<sup>00</sup> to repair your SCR Gate Driver
- 1 Year Warranty

*With a warranty like this - why buy new?*

Quick Turnaround - Next Day Available  
Over 10 yrs Experience

We also repair - Power Monitor PCBs  
Control Circuit PCBs

(813) 932-7722

## PowerCon Electronics

Industrial Electronic Services  
9420 Lazy Lane Bldg. E-3

Tampa, FL 33614

(813) 932-7722

**Ron Radio Communications, Inc.**  
P.O. Box 201 Brightwaters, NY 11718  
"Professional Broadcast Engineers Serving the Industry..."  
**Authorized dealers for:**

- Audicord Cart Machines, Audisar Products, Belar Electronics
- Broadcast Electronics, Crushcraft Antennas, Delta Electronics
- Energy Onix FM Transmitters 100w to 60KW, Hnat Hindes
- Audio Processing, Inovonics FMX Generator & NRSC
- Processor, Jampro FM Antennas, Kintronic Phasors &
- Antenna Tuning Units, L. P. B. Consoles, Micro Controls Inc.
- (Composite STL) - \$ 5,795, MAXRAD-Antennas, Valley People
- Audio Processing, Scalla Antennas

CALL RON RADIO FOR: Frequency Searches, License Applications, Construction Permit Applications, Leasing thru DACOM Financial Services

8 0 0 - 6 6 6 - 3 5 2 5



(802) 226-7582  
FAX: 802-226-7738

**COMMERCIAL RADIO COMPANY**  
Transmitter Parts for: RCA, Gates, Collins  
Non-PCB Filter and Mica Transmitting Capacitors

DUTTONSVILLE SCHOOL DRIVE  
CAVENDISH, VT. 05142

DANIEL W. CHURCHILL

**SEARCHFM - SOFTWARE**  
Professional MSDOS Broadcast Software.  
SEARCHFM, QCHANNEL, EDFM, SEARCHTV  
With monthly FCC database pool service.

Doug Vernier, Broadcast Consultant  
1600 Picturesque Dr.  
Cedar Falls, IA 50613  
319 266-7435

**FM Study for Your PC**  
Fast, precise, and cost effective!  
Monthly data base updates available.  
Call CDI Today to Request a Free Fully Operational Demo Copy

Communications Data Inc.  
6105E Arlington Blvd.  
Falls Church, VA 22044  
(703) 534-0034

**FCC's Engineering**  
**AM, FM and TV Data Bases**  
On floppy (or) 9-track tape  
Call today to request a free sample

**Communication Data Inc.**  
6105 E. Arlington Blvd.  
Falls Church, VA 22044  
703-534-0034

**SBE** **STANLEY BROADCAST ENGINEERING**

James S. Stanley  
Engineering Consultant

P.O. Box 24601  
Tempe, AZ 85282 (602) 264-8752

**NORTHERN MAGNETICS**  
CERTIFIED TAPE HEAD SERVICES

Northern Magnetics is an industry leader in the supply and service of tape heads and tape head products.

Phone: (612) 333-3071  
Telex: 1561238 MPS UT  
P.O. Box 16409  
Minneapolis, MN 55416  
FAA Repair Station # C14-57

**BRENTLINGER BROADCAST ENGINEERING, INC.**

Charles Jayson Brentlinger  
President

COMPUTERIZED ENGINEERING REPORTS | ALLOCATION STUDIES  
AM-FM-AM DIRECTIONALS-AUDIO-STL-SATELLITE COMMUNICATIONS

4338 East Acoma Drive • Phoenix, Arizona 85032 • (602) 867-0181

**Tube Rebuilding**  
**Freeland Products**

- We Buy Duds - Since 1940 Save About 50%



800-624-7626  
504-893-1243  
Fax 504-892-7323

Including for TV  
RCA Cermolox and UHF Klystrons

**Radio Guide**  
August, 1989 Volume 2 - Issue 8  
Mail to: Radio Guide 511 18th Street SE  
Rochester, MN 55904

Fill out the information below, and then circle the number of any manufacturer from which you would like additional information.

1 - Television Technology	18 - Tom Jones Recording
2 - Henry Engineering	20 - Powercon
3 - Bradley Broadcast	21 - Hnat Hindes
4 - Inovonics	22 - Delta Electronics
5 - Ramko Research	23 - Lightning Eliminators & Cons.
6 - Dataworld	24 - Stanley Broadcast Engineering
7 - Hallikainen & Friends	25 - Communication Data Inc.
8 - Econco	26 - Northern Magnetics
9 - Kahn Communications	27 - Ron Radio
10 - 3M - ITC	28 - Owl Engineering
11 - Broadcast Audio	29 - Commercial Radio Co.
12 - CRL Systems	30 - Doug Vernier Broadcast
13 - RAM Broadcast Systems	31 - Freeland Products
14 - Broadcast Devices	32 - Brentlinger Broadcast
15 - J-Squared	33 - Crouse Kimzey
16 - Northeast Broadcast Lab	34 - JRF Magnetics
17 - Barrette Associates	

Name \_\_\_\_\_  
Company \_\_\_\_\_  
Address \_\_\_\_\_  
City \_\_\_\_\_  
State \_\_\_\_\_ Zip \_\_\_\_\_ Phone \_\_\_\_\_

**Consulting Communications Engineers**

- FCC Data Bases
- FCC Applications and Field Engineering
- Frequency Searches and Coordination
- AM-FM-CATV-ITFS-LPTV

**OWL ENGINEERING, INC.**

1306 W. County Road. F,  
St. Paul, MN 55112  
(612) 631-1338 "Member AFCCE"





## Equipment For Sale

**RF meters**, used and tested  
Sangamo mica transmitting  
capacitors, assorted sizes, large  
variety

**Dan's Discount Radio Parts**  
Cavendish, VT  
802-226-7582

**Thousands of Tape Carts**  
Scotch I and Scotch II, Aris-  
tocarts, Fidelipacs, Capitol AA4  
and A2, Mastercarts.  
50¢ to \$3.00 each, brand new to  
rebuildable condition.  
**Ampro Console**, \$1250

**Pat Martin**  
**PMA Marketing Company**  
4359 S. Howell Ave. #106  
Milwaukee, WI 53207  
414-482-2638

**CRL Audio Preparation Proc-**  
**essor AP-300**. \$500  
**CRL Spectral Energy Proces-**  
**sor SP-400**. \$700  
**CRL Peak Modulation Control-**  
**ler PMC-300**. \$500

**Dean Aamodt**  
**KBMW**  
701-642-8747

**Vacuum capacitors:** 1000pF,  
2000pF, 750pF, 500pF. All 15kV  
or greater, all used. \$150 each

**Dave Dybas**  
**Sparks Broadcast Service**  
881 Aspen Drive  
Buffalo Grove, IL 60089  
312-215-7553

**McMartin BF-25K FM transmit-**  
**ter**. 1979 model with Harris MS-  
15 exciter. Complete spare  
HVPS, transformers, reactors,  
circuit boards, etc. from stripped  
second unit. In service,  
grounded battleship at 27.5 kW.  
Available in October. No PCBs!  
Approximate price \$30,000

**Narco MK12A NAVCOM** with  
serviceable VOR head. \$350

**David Solinske**  
**WWRM**  
P.O. Box 22000  
St. Petersburg, FL 33702  
813-576-1073

**Systemation Automation Sys-**  
**tem**. Includes full week memory,  
10 Teac decks, 2 computer  
terminals with color monitor,  
Epson printer, all cables, manu-  
als, and three extra input inter-  
faces. \$10,500

**Ray Klotz**  
**KKRV**  
P.O. Box 3434  
Lake Isabella, CA 93240  
619-376-3701

**Attention: ABC Radio Sta-**  
**tions**. If you're using a Scientific  
Atlanta Satellite receiver, have I  
got a deal for you! I'll trade,  
even up, one ABC (transponder  
23) crystal, for one CBS/NBC  
(transponder 19) crystal. Also, if  
you know where I can get a  
Transponder 19 crystal without  
having to buy a whole set, let me  
know. Just give me a call at  
(701) 225-5133.

**Duane Pavlicek**  
**KDIX-AM**  
Box 1368, 119 2nd Ave. West  
Dickinson, ND 58602  
701-225-5133

## TRANSCOM CORP.

Fine used AM & FM Transmitters  
and also New Equipment

For the best deals on Celwave products  
Andrew cable,  
Shively & Comark antennas.

---

1983	CSI 25,000E, 25 kW FM
1973	RCA BTF-20E1, 20 kW FM
1978	Collins 820F, 10 kW AM
1966	Collins 21E, 5 kW AM
1970	CCA AM 10,000D, 10 kW AM
1976	CCA AM 50,000D, 50 kW AM

---

201 Old York Rd.  
York Plaza Suite 207  
Jenkintown, PA 19046  
215-884-0888

Telex No. 910-240-3856 (TRANSCOM CORP. UQ)  
Fax No.. 215-884-0738

## Mailing Lists

AM, FM & TV BROADCAST STATIONS

*Fast Service*  
*100% Accuracy Guaranteed*

Select by: Type of Station  
Transmitter Power  
Geographical Area  
Market Size  
Commercial / Educational

Cheshire or Pressure Sensitive labels

Also Available on Floppy Disks

Phone (800) 338-3264

Broadcast Mail Inc.



**Weather Check-2** weather service. Complete system for the reception of satellite delivered Weather Check-2 service. System includes Equatorial low noise converter/waveguide module, reflector/mounting frame, controller, Bonneville data receiver, manuals, and installation instructions. System is in "new" condition. Original purchase price was \$3,700. Make offer.

**Tome White**  
**WDBQ-AM/KLYV-FM**  
5490 Saratoga Road  
Dubuque, IA 52001  
319-583-6471

**Danon CD cassettes.** Hundreds, briefly used.

**Peter Palagonia**  
**KCUB/KIIM**  
575 W. Roger Road  
Tucson, AZ 85705  
602-887-1000

**RCA BTF-20E** transmitter, spare parts. Call for list.

**Dave Seavy, CE**  
**KROC-FM**  
122 South 4th St.  
Rochester, MN 55902  
507-286-1010

**TM-11-5097** noise & distortion analyzer. Military version of HP 330B. \$150 prepaid.

**B&K model 1431** scope. 10 mHz response, triggered and TV sweep. \$200 prepaid.

**Warren Arnett**  
**WBAT**  
P.O. Box 839  
Marion, IN 46952  
317-664-6239

**8-bay ERI antenna** at 101.0 mHz. Taken out of service in summer of 1989. Offer  
**Commodore Computer** with hard disk and two floppies. Offer

**Ray Eller**  
**KPRE/KBUS**  
P.O. Box 1550  
2775 NE Loop 286  
Paris, TX 75460  
214-785-1068

**RCA/Control Design System:**  
3) RCA Kartwheels (24 tray), 1) clock, 1) RCA programmer/controller, 1) printer. Complete system, needs work. Offer

2) **Technics SP-15** direct drive turntables.

1) **Audio Technical ATP-12T** tone arm.

2) **Micro-trac 303** tone arms.

3) **Audio Technical** turntable bases.

3) **ITC 850** series reel-reel decks.

**Cetec Model 2000** audio broadcast console. 8-pot, 16 inputs, good condition.

**RCA audio console.** 8-pot, 16 inputs. Good Condition.

**Make offer on all equipment.**

**Don Wolfe**  
**KRIX/KRGE**  
901 E. Pike Blvd.  
Weslaco, TX 78596  
512-968-1548

**3-bay FMLP-3 antenna** with radomes, at 105.5 mHz. Offer

**Rick Martin**  
**KWYO**  
Box 5668  
Colorado Springs, CO 80911  
719-392-4219

## Looking For A Real Bargain?

Brand New Equipment 25% - 90% Off

Only From **HE HALL**  
**Electronics**

**New ITC Delta I/IV**  
**Mono Record/Play**  
2 Available at  
\$2,495 each

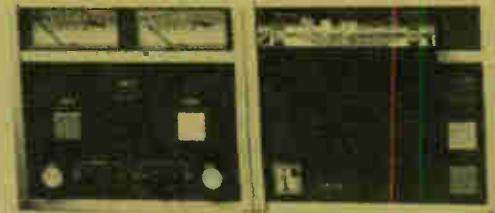

**New Harris MSP-90** tri-band agc module  
stereo strappable - \$95 each

### Also For Sale:

**CRL AM-4 Audio Processor**  
Current Model - with NRSC  
AGC-400, SEP-400, PMC-400A  
New/demo (\$4695 list)  
Now only - \$2925

**BE AX-10 AM Stereo Exciter**  
Aligned to your frequency by BE  
\$5995 (list) Now only - \$3995

**Fidelipac Dynamax CTR-112**  
Stereo Cart Player  
Demo/new - \$1595

The best deals on quality re-built  
and factory new broadcast equipment

**HE HALL**  
**Electronics**

1712 Allied Street  
Charlottesville, VA 22901

(804) 977-1100

Your Satisfaction Guaranteed

**Harris MW-50A transmitter.**  
Currently on-air on 540 kHz.  
Transmitter has been well maintained and has spares. Buyer responsible for removal. Selling due to site relocation. Available for inspection while operating, until November.

**Howard Hoffman**

**WGTO Radio**

**P.O. Box 123**

**Cypress Gardens, FL 33884**

**813-324-5400**

**50 kW, 4-tower phasor** on 540 kHz. Will sell as a system including ATUs, or for individual parts. Schematic and parts list available.

**Howard Hoffman**

**WGTO Radio**

**P.O. Box 123**

**Cypress Gardens, FL 33884**

**813-324-5400**

**Ampex 350.** 7.5 IPS, full track, cabinet mounted. \$400

**Teac A1200** reel to reel. Complete, condition unknown. \$100 or best offer

**Sparta 25-08C** 25Hz osc/filter for automation production. 2 channels. \$150 or best offer

2) **SMC 510** single cart players. Tired but operating. \$150 each or best offer

**Rek-O-Kut B16H** with tone arm. \$100 or best offer

**Oldies Tapes.** Approximately 100 on 10.5 inch NAB reels.

**Equipment operating unless otherwise indicated, FOB Loveland, CO.**

**Jim McDonald**

**Wind River Broadcast Svc.**

**329 East Third**

**Loveland, CO 80537**

**303-669-3442**

**Scientific Atlanta 6650** satellite receiver and LNC. Needs some work. \$400

**Revox A-77.** 3.75/7.5 IPS, wood case, works fine. \$400

**Meter movements.** Several sizes, shapes, and values.

**Motorola 150'**, free standing tower. Best offer

**ATU Components:**

Jennings CVHC-650, 45kV, 650pF vacuum variable for motor drive applications. \$600

Several vacuum capacitors from 50pF to 750pF, 5kV to 20kV.

Mica transmitting capacitors from .0005uF to .003uF, 5kV to 35kV, 10A to 43A.

Air wound inductors on frames. 8uH to 240uH, approximately 5" in diameter.

330uH ceramic tapped coil.

2.5mH ceramic form coil.

**Call or write for details, pricing, or list.**

**Robin O'Kelly**

**KORE-AM**

**2080 Laura St.**

**Springfield, OR 97477**

**503-747-5673**

**IGM Automation System:**

Includes Basic "A" CPU, keyboard, CRT & hard drive. 3) Instacarts, 4) ITC reeldecks, 1) Sparta carousel, 1) IGM time announce. New IGM Encoder with Televideo terminal. All cards, interfaces, maintenance kit, and manuals. Asking \$9,500

QEI 7775 ATS. Will Sacrifice.

Make Offer

**John Katz, Ops Manager**

**KJUG Radio**

**717 N. Mooney Blvd.**

**Tulare, CA 93274**

**209-686-2866**

## Blank Cassettes... Perfect for Demo Spots

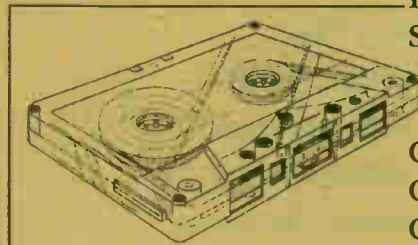

BASF Pure Chrome  
Shape Precision see-thru shell  
in quantities of:

	50	100
C-5's	\$.63 ea.	\$.55 ea.
C-10's	\$.69 ea.	\$.60 ea.
C-15's	\$.74 ea.	\$.65 ea.

Custom lengths are also available

BASF LHD Normal Bias  
Michelex German-made shells  
in quantities of:

	50	100
C-5's	\$.49 ea.	\$.42 ea.
C-10's	\$.53 ea.	\$.46 ea.
C-15's	\$.58 ea.	\$.50 ea.



PHONE: (507) 288-7711

FAX: (507) 288-4531

Tom Jones Recording Studios

220 South Broadway

Rochester, Minnesota 55904

## Beat the #1\* Killer

(\*Temperature Extremes Kill Transmitters)

**TEMPESENZ**  
Remote Temperature  
Sensor

List \$195<sup>00</sup>

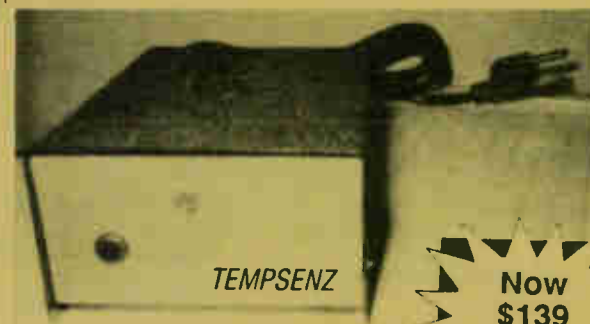

Now  
\$139

While Supply  
Lasts

- Works With Any Remote Control
- Constantly Monitors Transmitter Temperature
- Easy to Install and Calibrate



**barrett associates, inc.**

BROADCAST • AUDIO EQUIPMENT

(619) 433-5600

(800) 748-5553



# BROADCAST TUBE CATALOG

Video Camera Tubes • RF Power Tubes

Radar • Navigation • Radio Communications

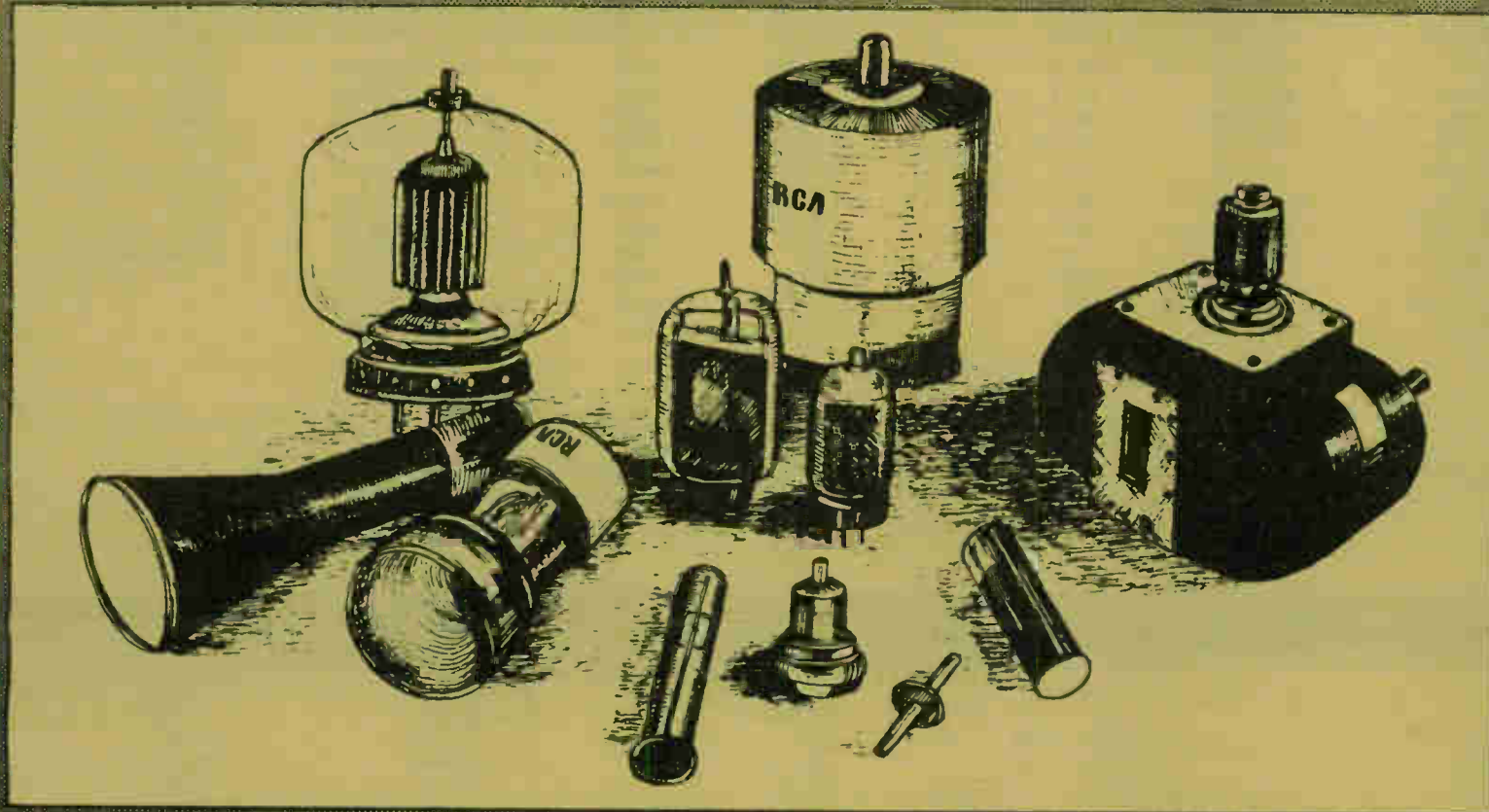

Military Systems

Marine Applications

Commercial Aviation

General Aviation

Broadcasting – Radio & TV

Telecommunications & Microwave

Mobil Communications

Ground Systems



**ARS ELECTRONICS**

ELECTRON TUBE SPECIALISTS

P.O. BOX 7323

7110 DE CELIS PLACE

VAN NUYS, CAL. 91406

PHONE: (818) 997-6200

TELEX: 215706 (ARSE)





# ARS ELECTRONICS

ELECTRONIC TUBE SPECIALISTS  
 7110 DE CELIS PLACE  
 P O BOX 7323, DEPT C  
 VAN NUYS CALIF 91409  
 PHONE (818) 997-6200  
 TOLL FREE (800) 422-4250  
 (800) 422-4277 (Calif. only)

Since 1945

Same Day Shipping

## REBUILT POWER TUBES

3CW20000A7	Call	4CX3000A	\$ 690.00	5736	\$ 515.00	6576	\$3120.00
3CW20000H3	\$1045.00	4CX5000A	785.00	5762	725.00	6696	1925.00
3CX2500A3	400.00	4CX10000D	945.00	5771/356	1400.00	6696A	1925.00
3CX2500F3	415.00	4CX15000A	1090.00	5891	3930.00	6697A	2450.00
3CX2500H3	435.00	4CX20000A/8990	1370.00	5918A	2250.00	6800	750.00
3CX3000A1	\$ 405.00	4CX35000C	\$3985.00	5919	\$2750.00	6800A	\$750.00
3CX3000F1	435.00	5CX1500A/B	590.00	5936	2480.00	6920	3720.00
3CX3000A7	490.00	356/5771	1390.00	5986A	2220.00	7121	1560.00
3CX3000F7	525.00	889RA	2090.00	6076/A	575.00	7255	660.00
3CX5000A3	1050.00	891R	1705.00	6166A/7007 RCA	2420.00	7480A	3630.00
3CX5000H3	\$1160.00	892R	\$1695.00	6420	\$1100.00	7482	\$8360.00
3CX10000A1	1325.00	5604	1760.00	6421	1550.00	7560	7150.00
3CX10000A3	1210.00	5606	910.00	6421F	1550.00	7560V	7275.00
3CX10000H3	1195.00	5606A	910.00	6422	1300.00	7900	Call
3CX10000A7	1210.00	5619	1280.00	6423	1540.00	8461	6600.00
3CX15000A3	\$1325.00	5658	\$1725.00	6423F	\$1450.00	8773A	\$2970.00
3CX15000H3	1215.00	5667	1450.00	6424	1425.00	8795	6930.00
3CX15000A7	1320.00	5668	900.00	6425	1800.00	8990/4CX20000	1375.00
3CX20000A3	1590.00	5669	1400.00	6425F	1775.00		
3CX20000H3	1600.00	5681	5700.00	6426	1590.00		
3CX20000A7	1585.00	5682	5950.00	6427	2300.00		

Prices assume the return of a rebuildable dud. If a dud must be supplied from ARS, an additional 20% of the rebuilding price will be added to the price of the tube.

## NEW POWER TUBES

2C39A	4-400C/6775	6BA6	813	5840	7558
2E26	4-1000A/8166	6BE6	872A	4876A	7580W
3-400Z	4CX250B/7203	6C4	4055	5886	7586
3-500Z	4CX250BC/8957	6CW4	4631S	5894	7587
3B28	4CX300A	6DJ8	4691	5902	7609
3CX1000A7	4CX350A/8321	6L6GC	4847	6005	7645
3CX1500A7/8877	4CX600J	6SN7GTB	5636	6012	7649
3CX2500A3/8161	4CX1000A/8168	6SL7GT	5639	6072A	7650
3CX2500F3/8251	4CX1500A	6V6GTA	5651	6080	7651
3CX2500H3	4CX1500B/8660	6X4	5654	6111	7801
3CX3000A1/8238	4CX3000A/8169	7C24/5762/7459	5670	6112	7895
3CX3000F1/8239	4CX5000A/8170	12AT7	5675	6136	7898
3CX3000A7	4CX10000D	12AU7A	5686	6146B	8106
3CX3000F7/8162	4CX1500A/8281	12AX7	5687	6201	8122
3CX5000A3	4CX20000A/8990	12AY7	5687WA	6205	8156
3CX5000H3	4CX35000C/8349	12BH7A	5702WA	6386	8791
3CX10000A1/8158	4X150A/7034	12BZ6	5702WB	6442	8792
3CX10000A3/8159	4X500A	25L6GT	5703WA	6688	8794
3CX10000H3	5CX1500A	25Z6GT	5703WB	6883B	8806
3CX10000A7/8160	5CX1500B	26C6	5718	6939	8807
3CX15000A3	5CX3000A	VA220 series	5719	7034	8890
3CX15000A7	5R4GB	VA221 series	5721	7059	8891
3CX15000H3	5U4GB	356-5771	5725	7060	8916
3CX20000A3	5Y3GT	Y572BAL	5726	7077	8976
3CX20000H3	6AK5	575A	5727	7167	8977
4-65A/8165	6AN5	673	5749	7289	8984
4-125A/4D21	6AQ5W/6005W	678	5750	7486	8986
4-250A/5D22	6AS7GA	810	5751	7543	8988
4-400A/8438	6AU6A	811A	5763	7551	9007
4-400B/7527	6AZ8	812A	5814A	7554	9011

**4,000 ELECTRON TUBE TYPES IN STOCK!!!**

**(818) 997-6200; Toll-free (800) 422-4250; (800) 422-4277 (Calif. only)**





# ARS ELECTRONICS

ELECTRONIC TUBE SPECIALISTS  
 7110 DE CELIS PLACE  
 P O BOX 7323 DEPT C  
 VAN NUYS CALIF 91409  
 PHONE (818) 997 6200  
 TOLL FREE (800) 422 4250  
 (800) 422 4277 (Calif. only)

Since 1945  
 Same Day Shipping

## GLASS & SMALL POWER TUBES

### 4-400C\*

*Amperex* incorporates heavy **thick graphite** wall **Zirconium** coated anode. Versus thin wall metal anodes. Larger thermal mass of **heavy graphite** anode absorbs high temperatures occur during tune-up or modulation peaks. **Zirconium** coating acts as a **getter** during anode temperature overloads. \*4-400C is same as 4-400A but mechanically ruggedized.

3-400Z	4-125A	5-500A	872A
3-500Z	4-400A	575	6146
4CX250B	4-400C	807	7527A
4CX250BC	4-500A	810	8122
4-65A	4-1000A	833A	2E26

## BROADCAST QUALITY CAMERA TUBES

4380	4911	P8130	P8420	P8491	XQ1085
4837	BC4917	P8131	P8421	P8496	XQ1410
4389	BC4922B,G,R	P8132	P8436	P8497	XQ1413
BC4390B,G,R	BC4923B,G,R	P8133	P8438	P8498	XQ1415
BC4391B,G,R	BC4927B,G,R	P8135	P8452	P8499	XQ1427
BC4396	BC4937B,G,R	P8142	P8453	80XQZ	XQ2170
BC4532U	BC4992B,G,L,R	P8144	P8454	83XQ	XQ2175
BC4592B,G,R	BC4993R	P8146	P8455	XQ1020R,B,G,L	XQ2177
BC4593B,G,R	BC4994G,L,R	P8147	P8456	XQ1023	XQ3070
BC4594B,G,R,L	BC7735	P8148	P8457	XQ1025	XQ3075
BC4809B	BC8134B	P8160	P8460	XQ1070	XQ3077
BC4892B,G,R	BC8480	P8161	P8461	XQ1071	XQ3410
BC4893B,G,R	BC8507	P8199	P8462	XQ1073	XQ3415
BC4894B,G,R	BC8541	P8197	P8463	XQ1075	XQ3427
BC4908B,G,R	P8022	P8400	P8474	XQ1076	XQ4500
BC4909	P8024	P8401	P8490	XQ1080	

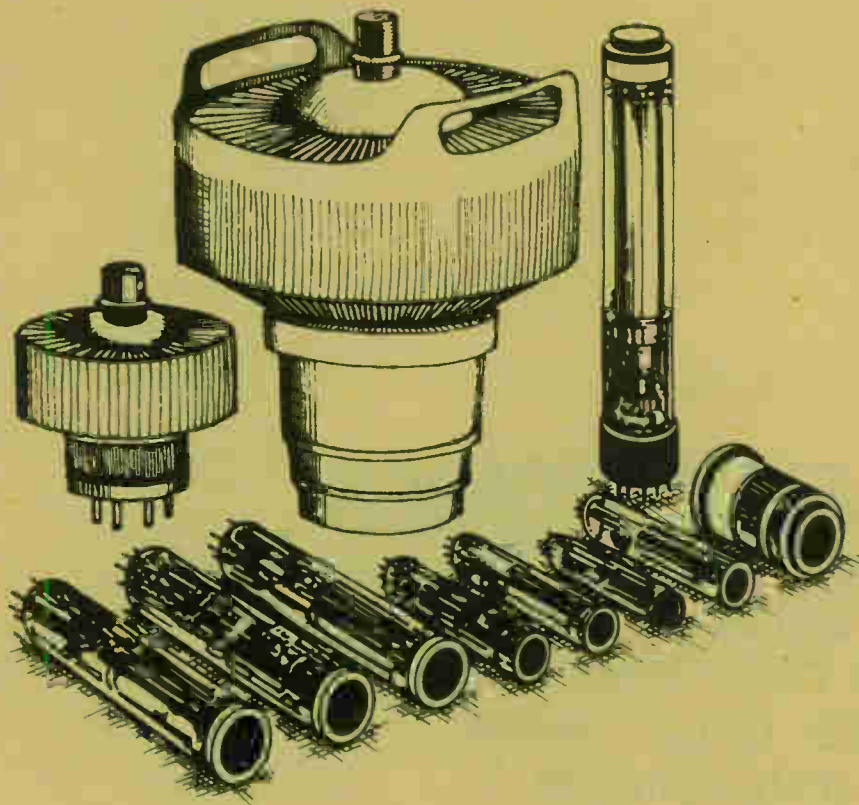

## XLR CABLE CONNECTORS

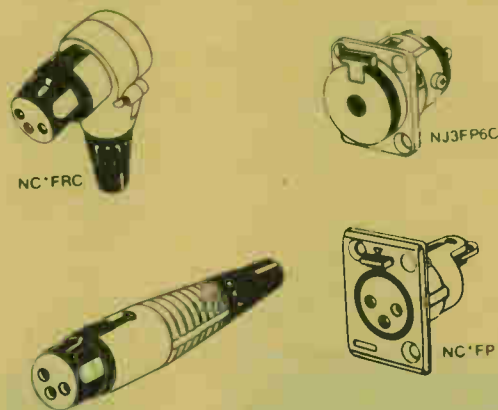

## RF & AUDIO TRANSISTORS

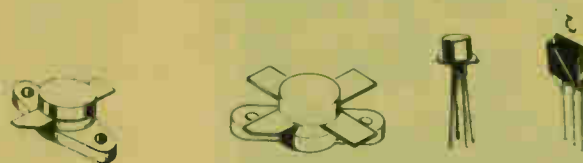

**4,000 ELECTRON TUBE TYPES IN STOCK!!!**

(818) 997-6200; Toll-free (800) 422-4250; (800) 422-4277 (Calif. only)

## Transistors, Microwave and R/F – Manufacturers' Part Numbers

B25-12	MRF454A	SD1229FL	2N5070	2N6094	2SC1765	<u>MICROWAVE DIODES</u>	
B30-12	MRF455	SD1229-1	2N5071	2N6134	2SC1946		
B40-12	MRF455A	SD1244	2N5090	2N6166	2SC1966	1N21	Series
B70-12	MRF515	SD1479	2N5108	2N6255	2SC1968	1N23	"
BAM120SR	MRF517	2N3632	2N5160	2N6256	2SC1969	1N25	"
BLW-75	MRF604	2N3839	2N5179	2N6304	2SC1970	1N82	"
BM80-12	MRF607	2N3866	2N5583	2N6305	2SC1971	1N358	"
BM70-12	MRF616	2N3866A	2N5589	2N6368	2SC1978	1N415	"
CD5919	MRF626	2N3867	2N5590	2N6370	2SC2097	1N416	"
CM80-28	MRF627	2N3868	2N5591	2N6439	2SC2099	1N446	"
DME150	MRF628	2N3870	2N5641	2N6603	2SC2100	1N630	"
DME375	MRF629	2N3871	2N5642	2N6604	2SC2103A	1N830	"
MPSH-12	MRF641	2N3872	2N5643	2SC710	2SC2237	1N831	"
MRF212	MRF644	2N3873	2N5645	2SC730	2SC2290	1N832	"
MRF215	MRF646	2N3896	2N5646	2SC731	2SC2395	1N833	"
MRF216	MRF648	2N3897	2N5829	2SC908	2SC2420	1N1838	"
MRF221	MRF901	2N3898	2N5835	2SC994	2SC2494	1N3665	"
MRF222	S15-12	2N3899	2N5836	2SC998	2SC2509	1N4294	"
MRF223	S100-12	2N3902	2N5837	2SC1011	2SC2538	1N5719	"
MRF224	S30-28	2N3903	2N5841	2SC1120	2SC2539		
MRF237	S100-28	2N3924	2N5842	2SC1121	2SC2540		
MRF243	SD1013	2N3926	2N5847	2SC1122	2SC2630		
MRF245	SD1015	2N3927	2N5848	2SC1165	2SC2694		
MRF250	SD1019	2N3946	2N5849	2SC1176	2SC2695		
MRF250A	SD1077	2N3947	2N5862	2SC1177	2SC3103		
MRF260	SD1089	2N3948	2N5941	2SC1178	2SC3104		
MRF261	SD1098	2N3959	2N5943	2SC1239			
MRF262	SD1127	2N3960	2N5944	2SC1251			
MRF264	SD1141-1	2N4072	2N5945	2SC1306			
MRF315	SD1143	2N4073	2N5946	2SC1307			
MRF316	SD1144	2N4427	2N6080	2SC1314			
MRF321	SD1200	2N4428	2N6081	2SC1509			
MRF422	SD1201	2N4429	2N6082	2SC1589			
MRF453	SD1202	2N4430	2N6083	2SC1668			
MRF454	SD1219	2N4440	2N6084	2SC1729			



## ARS ELECTRONICS

*ELECTRONIC TUBE AND LAMP SPECIALISTS*

7110 DE CELIS PLACE

P.O. BOX 7323, DEPT. C

VAN NUYS, CALIF. 91409

PHONE: (818) 997-6200

TOLL-FREE: (800) 422-4250;

(800) 422-4277 (Calif. only)



**1987 CCA FM-5000G** transmitter with exciter, like new. Perfect if you are going to 6 kW ERP. \$18,683

**1987 3-bay Shively** 6813 NPs plus coax mounts & couplings. \$3,547

**Larry Torgerson**  
WQUI-FM  
P.O. Box 5353  
2711 7th St.  
Meriden, MS 39302  
601-693-4851

**4) Andrew type 35381** tunable N jack connectors for HJ7-50A 1-5/8" line. Identical to Andrew type 87NT, with tuning screws to adjust for minimum VSWR. New in box. \$200 each or best offer.

**1) Howe 2100 Phase Chaser** phase correction unit. Excellent condition, with manual. \$600 or best offer.

**Charles Osgood, CE**  
WMWV  
P.O. Box 2008  
Conway, NH 03818  
603-447-5988

**CRL AM limiters:**

APP-400, PMC-300A, SEP-400B, SPF-300. currently in service for 2-1/2 years. Very good condition. Available in 30 days. \$2,700

**Michael Tracy, GM**  
KOAQ  
P.O. Box 1263  
Scottsbluff, NE 69363  
308-635-2690

## Equipment Wanted

**Old microphones** (working or not), WE 639A, WE 630A, RCA 77DX, Shure 556, SM33, 300, Turner 99, any Amperite mike. State condition and price in letter or call.

**Dick Igou**  
KGNB/KNBT  
1540 Loop 337 N.  
New Braunfels, TX 78130  
512-625-7311  
512-651-9352 (evenings)

**Orban 8000A Optimods**

**PMA Marketing**  
4359 S. Howell Ave.  
Suite 106  
Milwaukee, WI 53207  
414-482-2638

**Wanted: Marti RMC-15S** (high speed) studio remote control unit, whole or studio only unit, used or new.

**Guillermo Bonnet or Felix Bonnet**

WOYE-FM  
P.O. Box 1718  
Mayaguez, PR 00709-1718  
809-834-4384  
809-834-1094

## 25 KW AM Transmitter - and - 5-tower Phasor

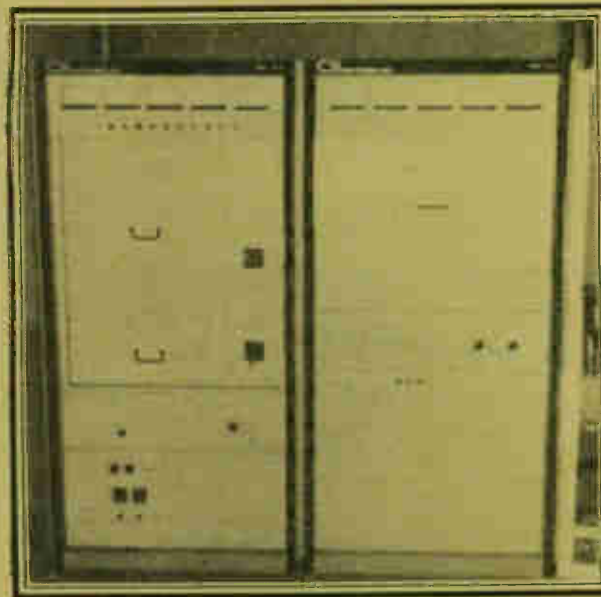

Used less than  
9 months

Operated on  
1200 kHz

External Power  
Transformer

Comes with  
or without  
Phasemaster Units

Mint Condition

### CSI 1987 Model T-25-A1

\$52,000 new

\$40,000 now

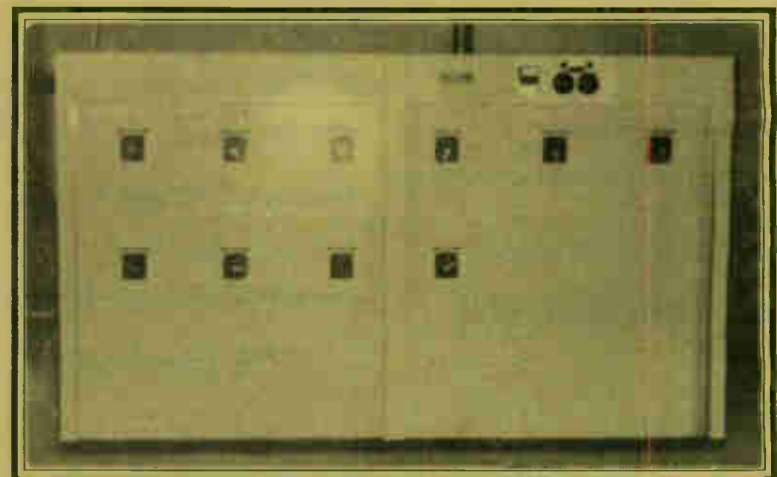

### Phasing Cabinets, 5-tower, 25 kW AM installation on 1200 kHz

\$70,000 new

\$55,000 or best offer

All equipment guaranteed to operate  
at the present location

Call **Pat Martin** now to schedule an appointment

### PMA Marketing

4359 South Howell Ave.  
Suite 106  
Milwaukee, WI 53207

**(414) 482-2638**

**Wanted: Old Programatic audio tapes.** Also seeking a Programatic system model RA-1. Need a 25 Hz tone generator.

**S.S. Wray**

**WSSW-FM**

**P.O. Box 422**

**Ashley, IN 46705**

**219-665-6427**

**Collins 20V-2 modulation transformer.**

**6-bay CP antenna, tuned or tunable to 101.7 mHz**

**Don Cook**

**Devon Broadcasting**

**5300 Martin Ave.**

**Odessa, TX 79764**

**915-362-8300 (call after 6:00 p.m.)**

**Orban 8000As and 8100s.**

**ITC Cart decks of all types.**

**Hall Electronics**

**John Hall**

**1712 Allied Street**

**Charlottesville, VA 22901**

**804-977-1100**

**Carrier current AM transmitter.** Moderately high powered, old tube type OK. College stations have lots of them. Construction details would help; if I can't find one, I can build it. State price and condition - must be repairable.

**Randal W. Howard**

**4052 W. Soledad Pl.**

**Tucson, AZ 85741**

**602-744-1150**

**640 kHz crystal for Gates 1T AM transmitter.**

**Mike Rice**

**WBOW Radio**

**Box 459**

**St. Charles, MO 63302**

**314-947-0600**

**3" or 3-1/2" air Heliac.** 350 feet or more, must be on spool and in good condition.

**Keith O'Malley**

**WNOR**

**801 Boush St.**

**Norfolk, VA 23516**

**804-623-9667**

### **CCA Electronics Inc.**

#### **Customer Service Test Technician**

Responsibilities will be to assist customers in selecting parts and in technical assistance. Send resume to:

**CCA Electronics Inc.**  
P.O. Box 426  
Fairburn, GA 30213  
404-964-3530

### **STAGOR BROADCAST SYSTEMS**

702 Lakeside Circle Drive  
Wheeling, Illinois 60090

**Stephen Gordoni**

(312) 870-1463

Broadcast Equipment  
Systems and Assistance

## **Professional Audio/Video Service/Operation Manuals**

### **Partial Listing**

Ampex	Inovonics	Scully
BGW	Javelin	Setchell Carlson
BTX	JVC	Shintron
Crown	Leader	Sigma
dBX	Magnecord	Sony
Dynair	NEC	Teac
EECO	Neumann	Tektronics
Electrohome	Otari	Tektronix
Eventide	Panasonic	Telex
GBC	Rotel	Telemation
Grass Valley Group	Sanyo	Urei
Hitachi		Wollensak

Write or call for complete list & prices

**Accurate Sound Corporation**  
3515 Edison Way  
Menlo Park, CA 94025

Phone (415) 365-2843

Fax (415) 365-3057

### **Qualified Audio Service Technician**

Challenging growth opportunity. This is a full-time position, working on tape machines and high speed duplicators. Interesting new products. Call or write to:

**Accurate Sound Corporation**  
3515 Edison Way  
Menlo Park, CA 94025  
(415) 365-2843

### **Engineering position**

Available, immediately. An excellent opportunity for a self motivated, knowledgeable Radio Broadcast Engineer, with future advancement possible. Must enjoy bench work with good test equipment, and have a good ear to assist in maintaining Houston's top AM & FM signals. Good salary, with benefits, to the right individual. Send resume, salary history, and equipment experience. E.O.E

**Errol Coker, CE - KTRH (or) John Alan, CE - KLOL**  
KTRH/KLOL Radio  
The Rusk Corporation  
510 Lovett Blvd.  
Houston, TX 77006  
(713) 526-5874



**K.E.I.**

Phone 305-771-2947  
201 N.E. 57th Street  
Fort Lauderdale, FL 33334

**M.C.I. Tape Machine - Circuit Board Repair**  
*Fast Turnaround*



# Contract Engineers Listing

This is provided as a listing service only.  
You must determine, for yourself, the technical  
qualifications of the contract engineers listed here.

Tom Becker  
Miami, Florida  
305-775-1351

Peter C.L. Boyce  
Midamerica Electronics Svc.  
New Albany, Indiana  
812-945-1209

James Boyd  
Boyd Broadcast Tech. Svc.  
Tualatin, Oregon  
503-692-6074

Mike Brown  
Portland, Oregon  
503-245-4889

Lee Freshwater  
Blue Ridge Consultants  
Flat Rock, North Carolina  
704-693-1642

Chuck Gennaro  
Wisconsin Rapids, Wisconsin  
715-423-6763

Kirk Harnack  
Memphis, Tennessee  
901-278-1306

Richard A. Hyatt  
Maine Engineering Assoc.  
Gardiner, Maine  
207-582-4192

John Morton  
Durango, Colorado  
303-247-8734

Don Musell  
Broadcast Engineering Svc.  
Mouth of Wilson, Virginia  
703-579-4461

Mark Pallock  
Marandee Broadcast Eng.  
Chatsworth, California  
818-882-9475

Ransom Y. Place III  
Westport, Massachusetts  
508-673-6831

John Ramsey  
West Hartford, Connecticut  
203-243-4703

Lee Soroca  
Soroca Electronics  
Syracuse, New York  
315-446-6106

Tom Toenjes  
Signal Specialists  
St. Marys, Kansas  
913-437-6549

Dave Wrenn  
Aiken, South Carolina  
803-649-1663

Brad Johnson  
Central California  
209-526-6277

Scott Dean  
Dean Engineering  
Fresno, California  
209-434-2358

Gary Smith  
Advanced Technical Svc.  
Abilene, Texas  
915-672-5149

James A. Chase  
Electro-Labs  
Angola, Indiana  
219-665-6427

Gary Reardon  
Ware, Massachusetts  
413-967-6156

James Droege  
Electronic Engineering Svc.  
Beatrice, Nebraska  
402-228-0780

Michelle Hunt  
Denver, Colorado  
303-469-1293

Tim Pozar  
Broadcast Engineering Cons.  
San Francisco, California  
415-695-7727

Mark Bohach  
Columbus, Ohio  
614-385-7583

Bob Ladd  
Bellevue, Ohio  
419-483-2511

Dave Hebert  
Pasco, Washington  
509-545-9672

Dave Biondi  
The Radio Service Company  
Houston, Texas  
800-444-2301

Bud Stuart  
STURADCO  
Susanville, California  
916-257-7820

Ronald J. Dot'o Sr.  
Salem, Oregon  
503-378-7024

John L. Nix  
Tower & ground systems  
Salem, Oregon  
800-321-4056

Steve Agnew  
Broadcast Technical Svc.  
Lincoln, Nebraska  
402-475-8920

Marsh Johnson Sr.  
Broadcast Operational Sys.  
Albany, Oregon  
503-928-8318

Carl Sampieri  
Sampieri Engineering  
Huntsville, Alabama  
205-830-8300

Don Roden  
Roden Engineering  
Huntsville, Alabama  
205-533-3676

Don Haworth  
Haworth Engineering  
Fargo, North Dakota  
701-237-5346

Jim Taylor  
Jim Taylor Engineering Svc.  
Augusta, Georgia  
404-738-2911

Mike Tosch  
Interstellar Broadcast Eng.  
San Diego, California  
619-576-8239

Jeff Twilley  
Ocean City, Maryland  
301-289-4545

Howard M. Ginsberg  
Communications Eng. Inc.  
Essex Junction, Vermont  
802-878-8796

Donald Frank White  
Roanoke Rapids, No. Carolina  
919-535-2599

Adam Perry  
S&B Communications Inc.  
Buffalo, New York  
716-832-7090

Thomas C. Taylor  
Total Communications Tech.  
Old Fort, North Carolina  
704-668-7977

Roger Cucci  
Techworks  
Milford, Connecticut  
203-878-3196

Harold Snure  
Calvmet Business Comm.  
Merrillville, Indiana  
219-769-4044

Dwayne Burlison & Assoc.  
Houston, Texas  
713-890-6565

Rick Cruz  
Mount Vernon, Ohio  
614-397-6440

Mark Persons  
M.W. Persons & Associates  
Brainerd, Minnesota  
218-829-1326

Hal Ross  
Air Com Communications  
Greenville, Pennsylvania  
412-588-8999

Russell Hines  
Cincinnati, Ohio  
513-721-7625

Jim Zastrow  
Zastrow Technical Service  
Mosinee, Wisconsin  
715-693-4299

Steve Holderby  
Bemsco Inc.  
Enid, Oklahoma  
405-242-7605

ACM Communications  
Napa, California  
707-257-6000

R. Michael King  
Circuit Doctors  
Frisco, Colorado  
303-668-3167

Joe Bellis  
RMF Associates  
Cape Girardeau, Missouri  
314-651-4272

Brian Walker  
Olympia, Washington  
206-438-2390

Jay Brentlinger  
Broadcast Engineering Inc.  
Phoenix, Arizona  
602-867-0181

## More Contract Engineers

Ken Bartz  
Bartz Engineering Services  
Fargo, North Dakota  
701-237-3006

Greg Blanchard  
Avila Engineering  
San Luis Obispo, California  
805-473-2396

J. Boyd Ingram  
J. Boyd Ingram & Associates  
Batesville, Mississippi  
601-563-4664

Troy D. Spencer  
Bassett, Virginia  
703-629-1161

Tom Oja  
ACM Communications  
Napa, California  
707-257-6000  
800-354-8600 (CA only)

Tom Lange  
TECS Electronics  
Kohler, Wisconsin  
414-458-1816

Lamarr Ritchie  
Lamarco Inc.  
Hazard, Kentucky  
606-476-8438

Steve Weber Jr.  
Fresno, California  
209-276-1249

John Simmons  
Simmons Communications  
Columbus, Georgia  
404-596-0265

Jim Slawson  
Broadcast Engineering  
Swainsboro, Georgia  
919-237-2011

Bill Bowin  
Bowin Engineering Services  
Galion, Ohio  
419-468-1771

Steve Gordon  
Wheeling, Illinois  
312-870-1463

Chris Scott & Associates  
Bowling Green, Kentucky  
502-781-1232

Michael G. McCarthy  
McCarthy Radio Engineering  
Mount Prospect, Illinois  
312-640-8965

J.R. Galbreath  
Broadcast Technical Services  
Colorado City, Texas  
915-728-8076

Jim Stanford  
Waco, Texas  
817-857-4296

Al Martin  
Segue Services Inc.  
Merrifield, Minnesota  
218-765-3333

Jim Stitt & Associates  
Cincinnati, Ohio  
513-621-9292

Troy Langham  
Tulsa, Oklahoma  
918-587-0941

H. Scott Blake  
Wilson's Peak Eng.  
Mount Wilson, California  
805-273-7717

Bill Spitzer  
WLS Communications  
Rapid City, South Dakota  
605-343-6986

Chris R. Holt  
San Jose, California  
408-985-9459

Bob Biermann  
Tacocca, Georgia  
404-886-4727  
404-886-1912

T. Michael Ezell  
Audiotronics Tech Service  
Dothan, Alabama  
205-793-6519

Dick Warren  
Warren Engineering  
San Diego, California  
619-279-0759

Joe DeRosa &  
Frank Bolognino  
Brooklyn, New York  
718-764-9698

Frank Baker  
Towers & Ground Systems  
503-775-3366

Paul Easter  
D&E Broadcast Services  
Corpus Christi, Texas  
512-994-0659

Bill Sutton  
Bill's RF Engineering  
Bamberg, South Carolina  
803-245-4902

Mark Sadacca  
San Bernadino, California  
714-882-2575

Gary Brown  
Broadcast Allocations  
Nashville, Tennessee  
615-662-1526

David Sanford  
St. George, Utah  
801-628-3075

Sam Garfield  
Raleigh, North Carolina  
919-870-1289

Joseph Papp  
Charleston, South Carolina  
803-884-8513

James Parkinson  
Siloam Springs, Arkansas  
501-248-1108

Joe Furjanic  
Furjanic Communications  
Monongahela, Pennsylvania  
412-379-8311

Ronald J. Meyer  
Meyer Communications  
Winterhaven, Florida  
813-293-9646

Ken Ruhland  
Central Bdcst. Eng. Group  
West Edmeston, New York  
607-847-8244

Griffen E. Dameron  
Charleston, South Carolina  
803-767-1669

Frank Hertel  
Newman-Keys Freq. Meas.  
Evansville, Indiana  
812-963-3294

Dr. Smokey King  
Amarillo, Texas  
806-335-9777

Bob Schneider  
Broadcast Technical Services  
Lubbock, Texas  
806-798-2601

Walt Gradski  
Marionics Inc.  
Toms River, New Jersey  
201-240-3119

Phillip Robillard  
Robillard Communications  
Haynesville, Louisiana  
318-624-0105

Larry Fiebig  
Cincinnati, Ohio  
513-742-3600

Peter Stohrer  
Concord, New Hampshire  
603-225-5153

Jim Trapani  
JT Communications  
Ocala, Florida  
904-236-0744

Jim Stoneback  
Mid-Atlantic states - AM only  
703-671-1037

Mark W. Crom  
Broadcast Technical Svc.  
Pequot Lakes, Minnesota  
218-568-5369

Bill Major  
Rio Rancho, New Mexico  
505-891-0719

Jeff Baker  
Technical/Design Service  
Fairport, New York  
716-258-3380

Mike Loos  
Quad City Broadcast Svc.  
Blue Grass, Iowa  
319-381-2590

Tommy Gray  
Broadcast Service Co.  
Gonesboro, Louisiana  
318-259-8835

Peter Martin  
Technical Services  
Rupert, Vermont  
802-394-7858

Don Cook  
Devon Broadcasting  
Odessa, Texas  
915-362-8300

Phil Wells  
Giant Step Enterprises  
Facility wiring/reworking  
Southern California  
619-565-8103

**To be listed here:**

**Call Ray Topp at  
(507) 280-9668**

**-- OR --**

**Send the information to:**

**Rochester Radio  
511 18th Street SE  
Rochester, MN 55904**