

# RADIO GUIDE

Attention: CHIEF ENGINEER  
KELP  
5300 EL PASO DRIVE  
EL PASO TX 79905

BULK RATE  
U.S. POSTAGE  
PAID  
ROCHESTER, MN  
PERMIT 445

Address Correction Requested

A Forum for Radio Engineers  
Ray Topp Editor/Publisher (507) 280-9668

December 1988

Volume 1 - Issue 4

Copyright 1988 - Rochester Radio

511 18th Street SE

Rochester, MN 55904

## It's Working

You are making the Radio Guide work! This month, as you can see, we are able to publish twelve pages. Our goal was to reach this point as soon as possible - - but you have helped to make that happen in half the time that I had expected.

Now, great news! Enough advertisers have delivered long term support to Radio Guide to cover costs for at least a year. You'll be seeing Radio Guide around for at least that long.

A basic purpose of advertising is to get the product information seen. No one can buy a piece of gear if they don't know it exists. Here's where you can be of help. If you feel that Radio Guide is helpful to you and is really on the right track, then let Radio Guide advertisers know about it. No - - I'm not asking you to buy or even to like their gear. That's up to you. Just take the time to let one or two know that you have seen their ads. One of the largest obstacles a fledgling publication faces is the fact that it takes a long time for the industry to believe that it actually gets read. You'd be surprised the difference you can make . . . editor

## The More ... the Better

I feel that if you create an open forum, where the engineers contribute to and direct the editorial content of the publication, then it can't miss. It's a simple idea, but we're up against some big guns, and don't think they'll ignore what's going on here. But that's fine, competition is always good for everyone. As long as it creates more technical information for the radio engineer ... well, that really should be our goal shouldn't it?

Other publications have always had the capacity to do what we are doing. Why haven't they? I'm really not certain, but perhaps there is a fear that the more you deal with technical troubles, the more you emphasize the negative. I would rather do business with a manufacturer that will stand up, admit there has been a problem, and then give me the information I need to fix it. It shows they're in the business of service, as well as sales - - and more than likely, my business will stay there . . . editor

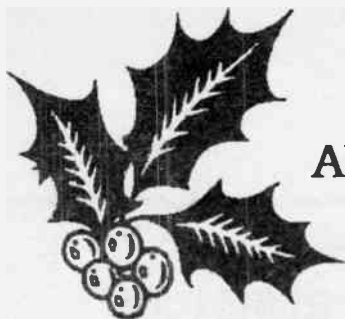

## All I Wan't For Xmas Is ...

It's time to beat the bushes again. I've written about this in every issue and will probably continue for quite a while. Are you willing to help? Radio broadcast engineering education is not a sequential learning experience. There are few text books that cover the subject and even fewer schools. If you've been at it for any length of time, you already know that it's on-the-job training most of the time. The technical information comes in bits and pieces, and many times a seasoned engineer can be quite naive about certain aspects of this industry.

My point is, don't think that your technical tips or articles are not "worthy" of publishing. I know if I were to call each one of you and ask, you would each have a technical tip or article to contribute. I can't afford to do that, so I can only hope that you will treat this as a personal invitation to contribute to this forum. We all know where to get the heavy-duty theory; it's the practical nuts & bolts info that's really in short supply.

If you'd like to help out, call me at (507) 280-9668, or write to the address at the top of the page.

Merry Christmas ... Ray Topp

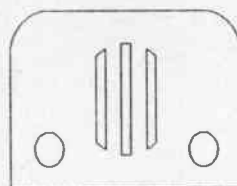
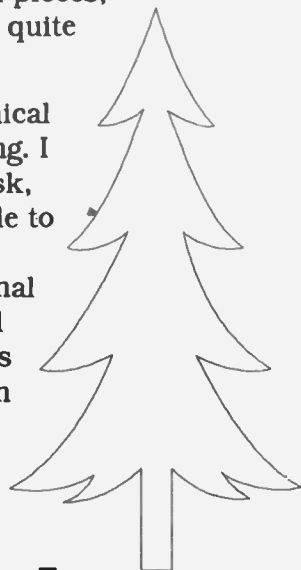

## Contents

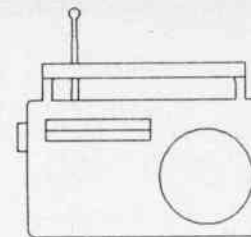

Page 2	Letters to the editor
Page 3	Cure for Henry Telecart Glitching
Page 4	More Noise Free Radio
Page 6	Who is In Control
Page 7	ITC Omega Cart Deck Fix MCI Tape Deck Tips
Page 8	Which Way Is Up ? Lattice Bridge
Page 9	McMartin BA-1K Transmitter Fix Solid State Upgrade for Continental TX
Page 10	Tips From The Field
Page 11	Contract Engineers List
Page 12	Continental 816R-4 Gate Drive Card Fix

## We Get Letters . . .

Dear Sir:

Congratulations on the start of a new forum for broadcast radio engineers. I believe the industry badly needs such a publication, especially one that will not be controlled by advertisers. Your front page commentary (RG Oct. 1988) points out that, as a fact of life, publishers cannot achieve wide distribution absent advertising.

However, having had conversations with you, I feel most comfortable that you will not allow advertisers, including me, to slant or influence either your editorials or your selection of articles and letters for publication. "technical truth" is what the industry needs, not biased sales talk.

Concerning another matter, I would point out that by providing an "open" forum you, of course, will be subjecting your readers to untested, and even occasional erroneous concepts. Even the best engineers can misspeak.

The only cure for such a problem is to set up a strict editorial board, such a provided by the IEEE. However, as a former chairman of the publications committee of the IEEE Communications Systems section, I realize that this takes a tremendous effort and also results in four to six month delays in publication. It also brings into existence yet another "engineering committee", possibly the worst invention ever unleashed on modern society.

Therefore, by providing an "open forum", you force the reader to be his or her own editor. But that isn't all bad, as long as everybody realizes that they have maintain their own vigilance as professionals.

In any case, congratulations and I wish you success in providing this new service. I intend to support, in a small way, Radio Guide by making all announcements concerning Kahn Communications promptly to your publication, understanding that there will be absolutely no bias pro or, may I pun, con. We do not offer such an arrangements to all of your competitors.

Sincerely - Leonard Kahn (Kahn Communications)

## Your Help is Needed ... and Appreciated

Although not strictly of a nuts & bolts nature, we provide space for your letters to the editor, comments, and suggestions.

If we're doing alright, let us know. If we're not serving your needs, let us know that too -- and at the same time be sure and tell us what you think needs correction, modification or expansion.

Remember, Radio Guide depends upon your suggestions for its content, direction and its very existence. You've said you've wanted it, so here it is. Please, help to create a useful technical publication.

Give me a call at (507) 280-9668 and we'll talk.

Thanks,

Ray Topp - editor

## For Your Information . . .

A new and continuing feature of the Radio Guide, is the reader-service "coupon" located on page 8. Fill in all the information asked for, and circle any advertiser's number from which you wish to obtain more information. Along with the "coupon", feel free to send a couple of technical tips you may have lying around. We can use them!

Editor . . .

## FCC Database

### ONLINE SERVICES

- 24-hour Remote Access
- AM, FM, FMTX, NCE-FM, TV, LPTV, ITFS Studies/Searches
- Terrain/Population FAA & FCC Tower Databases
- Predicted Contours
- DATAFLEX - user-specified sort/retrieval programs
- FLAG<sup>SM</sup> SERVICE - Broadcast site monitoring report

**dataworld**<sup>®</sup>

A Service of DW, Inc.

P.O. Box 30730  
4827 Rugby Avenue, Suite 200  
Bethesda, Maryland 20814  
(800) 368-5754 (301) 652-8822



## AIR-COOLED RF COAXIAL LOAD RESISTOR

OMEGALINE 6700 SERIES

**QUIET ECONOMICAL COMPACT  
PORTABLE EASY AIR DUCTING**

SPECIFICATIONS			
POWER RATINGS (CONTINUOUS DUTY)	25KW	35KW	50KW
FREQUENCY RANGE	60Hz to 240MHz		
IMPEDENCE	50-ohm NOMINAL		
RF CONNECTORS	3 1/8" EIA Flange or 3 1/8" Unflanged		
AC POWER REQUIRED	115VAC/60Hz 7.5A or 230VAC/60Hz 5A		
NOMINAL DIMENSIONS (EXCL. CONN.)	19" x 19" x 76" H 48 x 48 x 193cm	19" x 19" x 78" H 48 x 48 x 198cm	24" x 48" x 84" H 61 x 122 x 213cm
NOMINAL WEIGHT	136 lbs. - 62 kg	155 lbs. - 71 kg	235 lbs. - 107 kg
FINISH	BEIGE SPLATTER		



For FAST Delivery  
Call Toll Free 1-800-482-LOAD

P.O. Box 249, Yellville, AR 72687 (501) 449-4093

**ALTRONIC RESEARCH INC.**

For (OMEGALINE) RF Coaxial Load Resistors

Also available in water cooled models 5kw to 200kw



# Cure for "Telecart" Call Counter Glitching

By Hank Landsberg - Henry Engineering

About a year ago Henry Engineering introduced the "Telecart", a device that allows a cart machine to automatically answer a phone line and play a recorded message to the caller. Many stations use the unit for listener information services, e.g., ski reports, school closings, weather, and similar public service messages.

The Telecart has a digital call counter that registers the number of calls received. The counter advances one digit each time the machine starts, by sensing the presence of voltage on the cart machine's "remote play light" circuit. We occasionally get a call from a station using the Telecart, regarding the accuracy of the counter; the counter will sometimes count more than one digit when the cart machine starts.

The cause of the multiple-count is noise or instability on the cart machine's "remote play light" circuit. Very often, stations will use a well-worn cart machine for use with the Telecart. Since most stations have a closet full of old (tired) mono cart decks which are perfectly suitable for phone-answering, there's no need to buy a new unit. The relays are probably old and dirty; when the machine starts, the contacts "bounce" a few times and cause the Telecart counter to register two or more counts, instead of one.

Here's a quick and simple modification that will give the Telecart a substantial immunity to contact bounce and the counter-glitching it causes ... Find your copy of the instruction manual and schematic diagram of the unit. Locate R32, a 220K resistor. Now add a 0.1 uF/50 Volt ceramic capacitor in parallel with R32 (ceramic caps work best). There is no need to remove R32 from the board, just "tack" the capacitor across it. That's it!

Here's why this works: you'll note (from the schematic) that R32 is a "feedback" resistor across a pair of CMOS gates. Feedback across CMOS gates?? Yes ... each gate is inverting, and the two gates in series produce equal input and output signal states (HI in = HI out, LO in = LO out). The feedback resistor stabilizes the gates to make them somewhat immune to very fast input signal changes. If the feedback resistor were replaced by a short (or lower value resistor), the gates would "lock up", and hold themselves in either a HI or LO state indefinitely. Adding a 0.1 uF capacitor across the feedback resistor produces a "short-term short", i.e., it causes the gates to "lock up" for the duration that the capacitor is conducting. While the gates are locked, they are completely insensitive to input signal changes, e.g., noise or contact bounce.

When the cart machine stops, the capacitor is discharged through R32, and the gates are able to receive another input, which will advance the counter again.

Keep this technique in your "circuit tricks file" ... it might come in handy somewhere else down the road!

Henry Engineering will supply a 0.1 uF/50 Volt cap to any Telecart user at no charge. Just call us at (818) 355-3656 or (818) 355-0077 FAX.

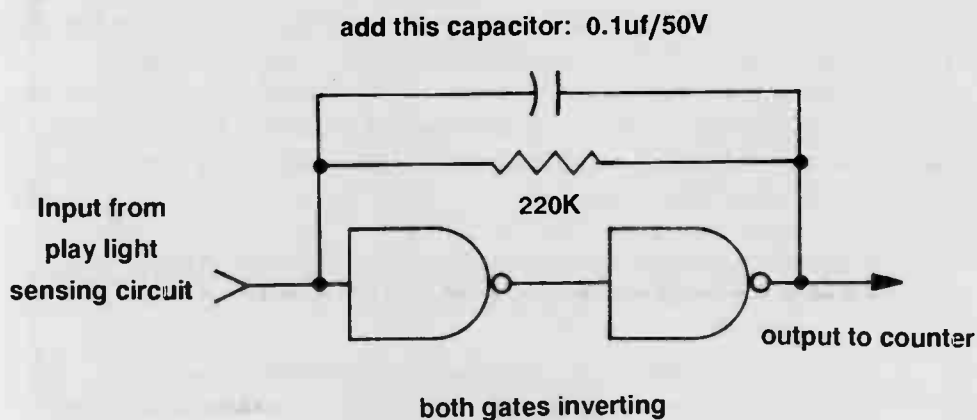

## Blank Cassettes... Perfect for Demo Spots

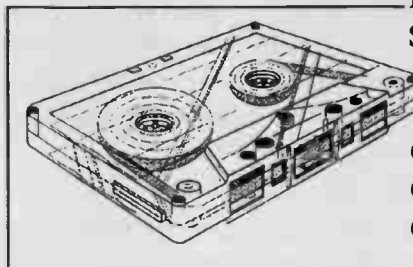

BASF Pure Chrome  
Shape Precision see-thru shell  
in quantities of:

	50	100
C-5's	\$.53 ea.	\$.46 ea.
C-10's	\$.58 ea.	\$.50 ea.
C-15's	\$.63 ea.	\$.54 ea.

*Custom lengths are also available*

BASF LHD Normal Bias  
Michelex German made shells  
in quantities of:

	50	100
C-5's	\$.49 ea.	\$.42 ea.
C-10's	\$.53 ea.	\$.46 ea.
C-15's	\$.58 ea.	\$.50 ea.



PHONE: (507) 288-7711

FAX: (507) 288-4531

Tom Jones Recording Studios

220 South Broadway

Rochester, Minnesota 55904

## Introducing The most innovative STLs on the market.

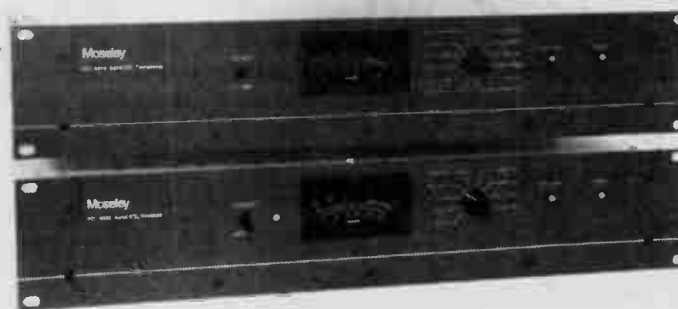

### PCL 6000 Series STLs

- Frequency agility
- Switchable monaural or composite operation
- 100 to 500 kHz channel spacing for receiver IF bandwidth
- Built-in receiver transfer circuitry
- Comprehensive front-panel metering
- Dual conversion 6020 Receiver
- Triple conversion 6030 Receiver

**Moseley**

111 Castilian Drive  
Santa Barbara, CA 93117  
(805) 968-9621 FAX: (805) 685-9638



# More "Noise Free Radio"

By George Yazell

Time flies when you're having fun - and, I'm having a ball! The first three issues of Radio Guide have produced hundreds of letters and phone calls. I met dozens of interested engineers at the Denver SBE Convention. I've been so busy answering questions and listening to good suggestions on future possibilities of NFR that I can't find time to try out some new ideas in the "laboratory".

Ray Topp, editor of Radio Guide, spread the word at the Madison Broadcast Engineering Seminar. He tells me he heard many of the same questions I've been hearing.

So, this month I'll try to reply to some of those questions and comments. I'm also preparing a book which should be off the press in about 30 days. (See my advertisement elsewhere in this issue.)

Q: "What is NFR?"

A: NFR is a method of transmitting high-fidelity, noise-free, audio through a Standard Broadcast Band AM transmitter on a frequency modulated "sub-carrier". When received on a specially designed NFR receiver, the NFR signal is reproduced by the same IF amplifier, limiter, and de-modulator circuits as used in the FM portion of the receiver. The NFR signal sounds just like FM, because it is FM!

Q: "Is it possible to have both AM and FM on the same carrier at the same time?"

A: Certainly! Motorola C-Quam Stereo uses phase modulation (another form of angle modulation, similar to FM) to transmit the L-R portion of the stereo audio program material.

Q: "If C-Quam stereo is similar to FM, why do I get noise and interference on AM stereo?"

A: There are two reasons. First, stereo requires two signals, right and left. Since the majority of AM radios in use are still mono only, the right and left audio signals are combined (L+R) and transmitted by amplitude modulation. When this signal is received on a mono AM radio, the listener hears the combined left and right audio signals. The C-Quam Stereo receiver picks up both the amplitude modulated signal (L+R) and the phase modulated signal (L-R). These signals are combined in a "matrix" circuit which restores the original left and right audio channels. Since at least half the audio signal is transmitted on AM, the stereo sound will have all the noise and interference characteristic of AM reception. In addition, the phase modulated carrier is a very "narrow band" which is no great improvement over AM. In the NFR system "narrow band" frequency modulation is used in the transmitter in order to fit the signal into the spectrum space allotted for AM, and then expanded in the NFR receiver to a "broad band" (250 kHz) channel.

Q: "You stated you used frequency multipliers to change your 430 kHz IF to 10.75 MHz. Wouldn't it be simpler to convert the 430 kHz signal to 10.75 by using a mixer and a fixed frequency oscillator on 10.320?"

A: It would be simpler, but not effective. We have a carrier on the intermediate frequency of 430 kHz which is being frequency modulated with a +/- 3 kHz deviation. We also have "sidebands" extending out at least 15 kHz on each side of that carrier. Then there may be signals on adjacent channels, 10 kHz above and below 430 kHz. That would be 440 kHz and 420 kHz. If we heterodyne our 430 kHz (swinging back and forth from 427 to 433 kHz) with a 10.320 MHz oscillator, we would have a new IF of 10.750 (swinging back and forth between 10.747 MHz and 10.753 MHz). Our adjacent channel carriers would be on 10.740 MHz and 10.760 MHz.

Now, consider MULTIPLYING the 430 +/- 3 kHz IF and its adjacent channel carriers 25 times to get 10.750 +/- 75 kHz. We now have a wide band signal and the adjacent carriers are 10.500 MHz and 11.000 MHz. That's 250 kHz between channels, instead of 10 kHz on the AM band, or 200 kHz on the FM band. That's what makes NFR possible.

Q: "I just finished reading your article in the November issue of Radio Guide and I can't go along with your theories. First, modulation of any kind, AM, FM or PM, produces sidebands removed from the carrier frequency equal to the modulation frequency. The first set of sidebands, for low modulation level at 10 kHz audio will appear 10 kHz either side of the carrier, which means you cannot pass the 10 kHz audio through a +/- 3 kHz bandwidth spectrum. Using a modulation index of 1 for a modulation frequency of 10 kHz will require a bandwidth of 20 kHz, the standard bandwidth for AM broadcasting. Won't the energy in the sidebands be the same whether it be AM, FM, or PM modulation system?"

A: There's a lot of truth in what you say, but also a few errors, and possibly a misunderstanding caused by my inability to say precisely what I mean. When I used the term 430 kHz +/- 3 kHz, I was referring to carrier frequency deviation, not bandwidth.

Please go back and check on your source for your definition of the "standard bandwidth for AM broadcasting". I think you will find that the FCC rules and regulations pertaining to spectrum utilization specify that a single tone, from 15 kHz to 30 kHz, cannot produce sideband amplitudes greater than -25 dB compared to the amplitude of the unmodulated carrier. Above 30 kHz, the sidebands have to be below -35 dB. I interpret that as authorizing bandwidth up to 60 kHz wide, providing those sidebands between 15 and 30 kHz either side of the carrier are at least 25 dB down, and even beyond 60 kHz width, providing those "far out" signals are down more than 35 dB.

AM transmitters are required to have audio frequency response of +/- 2 dB from 200 Hz to 5 kHz, and to be "proofed" out to 7.5 kHz. Even when the AM audio extends out to 15 kHz (30 kHz bandwidth), most of the energy in the broadcast signal is at frequencies well below 10 kHz. That's fortunate for radios tuned to adjacent channels just 10 kHz away.

In my opinion, we have criticized receiver manufacturers unfairly for designing radios with very selective IF stages, and an audio frequency response that cuts off at about 3 kHz. Many years ago TRF radios had a 15 or 20 kHz bandwidth. The band got crowded, so the superhet came along to improve selectivity. Early superhets had 5 kHz bandpass. Stations boosted their highs, to compensate for the sharper selectivity. Next move, more receiver selectivity, more high boost, etc., etc., etc. - - to where we are now.

NFR will not improve the sound of AM, nor allow the design of a better AM receiver. When NFR catches on and most or all AM stations are also broadcasting NFR, and most homes have NFR receiver, AM will be dropped or relegated to some narrow band type of communication or control function.

Another comment I must address is your assumption that we consider the bandwidth at a modulation index of 1. In phase modulation the modulation index is constant for all audio frequencies. In frequency modulation the modulation index is determined by dividing the deviation (frequency swing) by the modulating frequency. That's why I shall strongly suggest that if, and when we set standards for NFR we do standardize on FM without pre-emphasis! For example, a 15 kHz tone used to frequency modulate a carrier to +/- 3 kHz deviation would represent a modulation index of only 0.2. And should we decide on standard deviation of +/- 1 kHz, the modulation index of 15 kHz would be only 0.067. Look up the sidebands amplitudes for those situation on your Bessel Function charts!

Q: "How soon can we expect NFR exciters and receivers to be available?"

A: It took 20 years for FM to catch on, and it was a superior medium from the day it was introduced. I have been working on this project for just about a year. If one tired old man can get this far in a year, perhaps with 100 or so energetic young men and women working on the engineering, financial, and political stumbling blocks ahead, we just might see one or more aggressive AM stations applying for an experimental permit in 1989. The 1990 NAB convention could see four or five manufacturers featuring NFR modification kits and modulation monitors. And, for the first time we might see several receiver manufacturers on the convention floor demonstrating their new AM, FM, NFR radios! Ah so, I'll see you in Atlanta.

George W. Yazell, P.E. (retired)  
PO Box 8086  
Lakeland, FL 33802  
(813) 682-2270



# These 2 new ICs and RAMKO RESEARCH have just changed the whole concept of Broadcast Audio!!

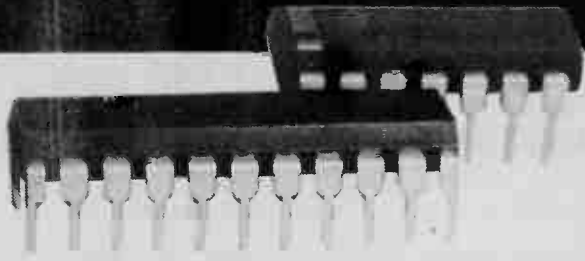

## Introducing the incredible, new, xL SERIES of professional studio equipment!

### U.S. INGENUITY

Dramatic developments in analog ICs have enabled us to develop an entirely new concept of high performance, professional studio equipment: rock solid construction; performance found only in units costing 2 to 3 times more; and pricing that will leave you simply incredulous.

### FEWER PARTS/LOWER COSTS

The ICs above are two of the latest new releases from leading US manufacturers. A new quad op amp & VCA that deliver more performance and power for package size than anything previously available. Naturally, more circuitry in a single IC means: smaller product size; increased reliability; fewer manufacturing costs; and dramatically lower prices!

### PERFORMANCE & VALUE

All of the xL series deliver performance to meet the requirements of even the most demanding professional. S/N ratios of -85dB to -90dB; distortion of 0.008% or less; and +25dBm out to mention a few of the more important specs. Value? The xL series brings a new meaning to the word "VALUE" and does it in capitals! Prices unmatched by anything else in the industry-2 year warranties-performance on the cutting edge of technology-and construction that will stand up to whatever the situation demands.

### NO RISK 2 WEEK TRIAL

You're the final judge and our trial period guarantees that you get exactly what you expect, each and every time. No and's, if's or but's. Simply put, if at any time within two weeks of receiving your order (custom equipment excluded) you are not completely satisfied or have just changed your mind, return it in like new condition. Upon verification of condition an immediate refund (less shipping expenses) will be issued, for payment in full or C.O.D.'s, or your account will be credited if purchased open account. **What more could anyone ask?** Pricing that will save you 20%-60% over any competitive product...Unsurpassed quality and performance...A no risk opportunity to prove to yourself that every claim we make is true. And, everything is backed by our 2 year warranty!

### CALL TODAY

Call RAMKO RESEARCH today or, better yet, one of our master dealers listed in this ad.. **You've nothing to lose except possibly some preconceived notions about how much quality really costs!**

CALL TOLL FREE (800)678-1357

### RAMKO MASTER DEALERS

BARRETT ASSOC. OCEANSIDE, CA (619) 433-5600	ELECTREX CO. MIAMI, FL (305) 651-5752	SOUTHERN COASTAL MARKETING PINEVILLE, NC (800) 438-6040
BROADCASTERS GENERAL STORE OCALA, FL (904) 622-9058	PROFESSIONAL AUDIO SUPPLY FORT WORTH, TX (800) 433-7668	
CAVECO EQUIPMENT CO. ONTARIO, CANADA (416) 438-6230	R.F. SPECIALTIES PITTSBURG, PA (412) 733-1994	

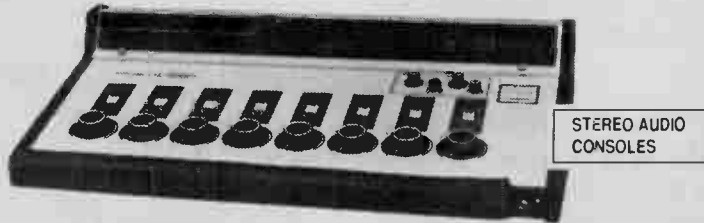

STEREO AUDIO  
CONSOLES

### 4, 6 & 8 MIXER, SINGLE CHANNEL STEREO-\$1295 to \$2850!

The new xL series of broadcast consoles redefine the term "solid state" From the beautiful exterior finish of Carbide Black, muted grey's and special xL white polyurethanes and the exceptionally long life (5 million operations), silent illuminated push button switches, thru the rock solid 1/10" thick aluminum control surface to the individually housed (double RF shielded) plug-in modules and bussing system, it will be immediately evident that nothing has been skimped on to bring you both the finest sound possible and construction that far exceeds anything else available. In short, a console that will stand up to years of use (and/or abuse), deliver performance that can only be found in the highest caliber production consoles, is a snap to install and program, and a dream to operate.

**HIGHLIGHTS:** Each mixer is programmable for mic thru line level on input A and high level on input B. Identical PROG1 and PROG2 output channels each individually or simultaneously selectable at each mixer. Huge 4" multi-color, expanded scale solid state "VU" meters. Long life faders driving special ultra low distortion VCAs for precision tracking and noise free operation. Overhead protected audio switching ICs that cannot be driven into clipping. Internally located barrier strips for ease of installation and future changes. Double module shielding, extensive bypassing, instrumentation "STAR" ground system, and RF beads for high level RF immunity. \*Four, six & eight mixers \*Single & dual output versions \*Mono mix outputs \*15 inputs/4 mixer), 19 inputs(6 mixer), 23 inputs (8 mixer) \*programmable mic/line inputs each mixer \*mic inputs programmable for stereo or mono feed \*programmable muting \*External 20 watt stereo monitor amp \*On air light's relays \*Plug-in modules \*Optional start/stop controls \*

□ xL41S (4 mixer, single channel) \$1295. xL42S (4 mixer dual channel) \$1450. xL61S (6 mixer, single channel) \$1795. xL62S (6 mixer, dual channel) \$1950. xL81S (8 mixer, single channel) \$2595. xL82S (8 mixer, dual channel) \$2850.

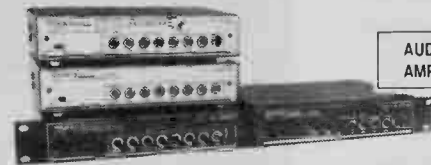

AUDIO DISTRIBUTION  
AMPLIFIERS

**DUAL CHANNEL, PRECISION AUDIO DA'S.** Two different units providing dual 1x4 or single 1x8 and dual 1x8 or single 1x16 operation. Individual output level controls, XLR input connectors, rear panel switch for independent or single feed. Standard barrier strip or optional quick disconnect phone jack output connectors. Optional outputs metering/phones monitoring available. Balanced in & out. +25dBm out max; .008% dist; 10Hz to 100kHz resp.; -85dB s/n. xL4s/8m-table top & single or dual 1 3/4" rack mount. xL8S/16M- table top & single 1 3/4" rack.

□ xL4S/8M-\$195. xL8S/16M-\$360. Call for option prices.



MINI AUDIO  
MIXERS

**6 MIXERS & UNMATCHED VERSATILITY.** Three different models with: phones monitor; master level control; expansion port; metering; phantom power; mic & line inputs on each mixer & programmable voice gating. Dual XLR & phone jack connectors on each input and barrier strip outputs. Balanced in/out. 10Hz to 20kHz resp.; .008% dist; -83dB line level & -72dB mic level s/n; +25dBm max out; UL listed supply. Table top or 1 3/4" rack. □ xL6M1(no metering or phantom pwr.)- \$190. xL6M1A (metering & 21v phantom power) - \$225. xL6M1B (metering, phantom pwr. & voice gating) - \$295 □ PS-20 (UL listed power source powers one to five units) - \$25



TURNTABLE  
PREAMPS

### STEREO, DUAL MONO & COMBINED STEREO IN ONE PACKAGE!

Precision performance with dual mono, stereo & combined stereo balanced outputs. Resp., 20Hz to 20kHz, 0.25dB; dist., 0.008%; +25dBm max out into balanced 600 ohms; -84dBm s/n; 300mv headroom. Table top or single and dual rack mount. □ xLSCM2 - \$154



MIC & LINE AMPS-  
PHANTOM POWER

**DUAL CHANNEL WITH SWITCHABLE MIC/LINE INPUTS & 21V PHANTOM POWER.** Balanced XLR inputs and balanced phone jack outputs. +25dBm max out into 600 ohms; resp., 10Hz to 20kHz, -1dB; 0.008% dist.; 72dB gain mic & 22 dB gain line; -71 dB s/nmic & -84dB s/n line. Front panel level controls. . Table top or one thru four 1 3/4" rack mount. □ xLM2L2 - \$129. PS-20 (UL listed power source powers 1 to 10 units) - \$25

\* THIS IS ONLY A PARTIAL LIST OF OVER 80 DIFFERENT PRODUCTS MANUFACTURED FOR THE BROADCAST INDUSTRY. □ AUDIO ROUTERS SWITCHERS starting at \$1273 □ STUDIO POWER AMPLIFIERS from \$99 □ MODULAR AUDIO DA'S from \$900 □ SOLID STATE METERS □ AUDIO MATCHING AMPLIFIERS \$115 TO \$174 □ MIXERS (studio & portable); COMPRESSOR/LIMITERS; and the list goes on. Call for our new catalog or specific specifications sheets.

**RAMKO RESEARCH**

3501-4 SUNRISE BLVD.  
RANCHO CORDOVA, CA 95742  
(916) 635-3500



# Who Is In Control ?

**By David Ludwig - KIWR  
Council Bluffs, Iowa**

About 11 PM I received a call from the studio that the transmitter was not acting right. The transmitter would lower, then raise power, as well as shut down and return to the air on its own. While I had the operator on the phone, he selected the power position on the remote control and pushed the lower button. The transmitter went "off air" instead of lowering the power and a few seconds later returned to the air. As he was talking, he gave me a running account of the transmitter's actions, and as he stated, he seemed to have no control of the situation. I asked him to remove the STL from the air and this allowed the fail-safe at the transmitter to remove high-voltage and keep the transmitter down.

A check of the remote control output at the studio showed that it was very stable. With this information I concluded that the problem was not at the studio.

On the way to the transmitter site I tried to piece together the lay-out of the receive remote control from the reception of the sub-carrier off the double STL hop, through the filters and finally into the demodulator. Once at the transmitter site, I took control of the transmitter and had the operator return the STLs to the air. On visual inspection, the indicator lights on the remote did indeed move in a random fashion from one location to another and on occasion would raise or lower the interface relays. A quick check of the remote control demodulators indicated a reaction to commands being sent to the unit and not the result of some bad component. The next logical step was to check the STL receiver subcarrier output. The problem became apparent at once. The multiplex channel was extremely noisy and the noise was being interpreted by the remote unit as a command to be carried out. A check of the multiplex metering did show a slight and rapid variation from side to side.

The only reasonable place to start seemed to be at the middle hop of the double STL, and hope to cut the problem into one of two possible places to begin. Once at the middle hop, I inspected the STL multiplex channel metering and incoming and outgoing signals were solid. A check of the forward to reflected power showed a slightly higher than normal VSWR but nothing to get excited about now. I decided to increase the 110 kHz injection level of the STL subcarrier from the normal 4 percent to 15 percent and returned the transmitter to the air. We now had solid control, and I gained time to sit down and try to figure this out. All I could come up with was the fact that 24 hours earlier we had a very hard rain storm of several inches. I also noticed that the "off air" signal seemed to be noisy. A check of the signal to noise ration at the transmitter output verified this. Now I had a game plan. I called the tower crew and had them inspect the antenna and transmission line of the 320 foot tower at the middle STL hop.

The STL did show a good 5 Watts output at the transmitter, but was showing only 100 milliwatts into the antenna. This was clearly not enough power output for the 20 mile hop. An inspection of the 7/8 inch connector at the antenna end, proved that the rain had deposited a full cup of water into the connector, even though it was sealed. Once the water was removed, a new connector put on and the coax dried out, we returned to normal operation.

I guess the most I learned from this problem is that when the signal gets weak from your STL, the first place it will show up, is in the multiplex channel.

## RCA BTF 5/10/20 Transmitters

We're looking for technical tips and maintenance information on the RCA BTF 5/10/20 series of transmitters. If any of you out there have any particular expertise on these boxes, let me know. Beginning in January, we will dedicate a column to a specific series of transmitters. This will be the first transmitter series covered ... editor

# POWER - side™

**The solution to many of AM radio's  
most serious technical problems**

**From the developers of the  
AM STEREO system  
"that isn't afraid of the dark"**



**425 Merrick Avenue  
Westbury, NY 11590  
(516) 222-2221**

## The Complete RF Exposure Measurement System from Holaday Industries

### Measure Both E and H Fields

ANSI RF exposure standard requires measurement of both the electric and magnetic field.

### Automatic Self-zero

Completely automatic self-zeroing eliminates drift, improves accuracy of readings.

### Recognized by Federal Agencies

Evaluated and used by NIOSH, OSHA, EPA and CDRH, as well as state, local health departments and consulting engineers.

### NBS Probe Design

Isotropic probe design originated by National Bureau of Standards.

### Displays Time Average Reading

Real-Time display of the current six minute average relates directly to the ANSI RF exposure standard. Also calculates average of user-selected test intervals. This feature is also useful for doing spatial averaging by programming appropriately timed test intervals and using constant probe velocity over a prescribed area.

Exclusive from Holaday Industries, Inc.



Model  
HI 5000SX



For more information,  
please call or write:



**HOLADAY INDUSTRIES, INC.**  
14825 Martin Drive  
Eden Prairie, MN 55344  
Telephone: (612) 934-4920  
Telex: 29-0922 FAX: (612) 934-3604



# ITC Omega Solenoid Fix

By Kevin Rupert - WORT  
Madison, Wisconsin

Recently, we have had an interesting problem with a 3M (ITC) Omega cart machine. I am wondering if any other Omega users have had the same problem.

The station which owns the machines is a small non-commercial outfit. We have two Omegas and a couple of old PD-2s. Carts are only run about once an hour for station promos and "underwriting announcements". The Omegas are about two years old.

A maintenance request came to me which said that one of the machines would not start. Checking on this, I found that the green start light would come on, but the solenoid would not pull in on the first try. After pressing "stop", the solenoid would pull in on the second try. Come back to the machine after it has been idle for about 20 minutes, and it would again repeat the failure cycle.

The factory suggested that I change the solenoid drive transistor located on the bottom of the deck. They said these sometimes get leaky. After changing this transistor, the problem continued.

Putting both Omegas on the bench, I compared solenoid drive voltage and the solenoid DC resistance. Both machines were essentially the same. I then swapped the solenoids from one machine to the other. The problem stayed with the solenoid. Even though the solenoid seemed okay, based on the resistance and mechanics, I was about to order another one.

At this point, I noticed that the solenoid plunger rests against a small rubber bumper when it is in the rest position. I pressed the plunger into the bumper and found that it had a tendency to stick. Pressing the start button at this point caused the now familiar failure of the solenoid.

A close examination of the rubber bumper showed that the adhesive which holds the rubber bumper to the deck had deteriorated. At this point, I cleaned the bumper with alcohol and with a rubber conditioner commonly used on consumer tape decks. Since we have done this, the Omega has been working perfectly.

We have always been fairly diligent about cleaning tape paths and pinch rollers. Now, we will add solenoid bumpers to our PM list!

---

## MCI Tape Deck Tips

By Johnny Bridges - WYAY  
Atlanta, Georgia

On the newer MCI tape decks, there is a circuit board beneath the tape dancer arm, which attempts to reduce wow and flutter by supplying a signal to the analog torque board, based on dancer arm movement. The actuator is a magnet, glued to an arm beneath the dancer arm. This magnet was originally fastened with rather poor glue, which sometimes comes loose and allows the magnet to move about erratically when the arm moves. Also, since the arm has some amount of mass, a ham-handed operator can re-position it by slamming the dancer arm against its stops. Either situation will result in erratic tape tension; in the worst case the machine is unusable due to jerking. The cure is simple: epoxy the magnet to the arm, then position it, such that at its center of travel, it is centered over the inductor on the pickup board.

Another insidious problem concerns the aluminum brake drums on the spooling motors. Since they are only used at power-down or a tape break, they tend to be overlooked. They have enough mass, however, to screw up the tension if they become loose enough to rattle on the motor shaft. Again, the result will be jerky tension, but of a very low order. Usually the wow and flutter is slightly out of spec, and often the spooling motor tach generator is blamed. First, try tightening the set-screws on the brake drums and see if the wow and flutter doesn't come into spec. Due to the differential expansion of the drums and the motor shafts, these loosen regularly, and re-tightening semi-annually isn't a bad idea.

## CRL SPOTLIGHT

### Upgrading Your FM Processing?



The CRL FMIG audio processing system is the perfect answer for those of you with a small budget, but a large budget need for FM processing. With the FMIG you get the market's cleanest limiter the SMP-850, followed by the SG-800A digitally synthesized stereo generator. The SMP-850 features a powerful input compressor, followed by our exclusive variable transfer function pre-emphasis limiter. Image widening stereo sound field enhance circuitry is standard equipment. The SG-800A's digital pulse amplitude modulator produces a flawless baseband stereo signal. Find out what the FMIG can do for you. We have a two week trial program available. Call or write us for details.



**CRL Systems**  
2522 West Geneva Drive  
Tempe, Arizona 85282 U.S.A.  
(800) 535-7648 (602) 438-0888  
TELEX: 350464

## A REMOTE POSSIBILITY!



Get **LOGICONVERTER** for remote control of CD players, cassette decks, or just about *anything!* LogiConverter's opto-isolated inputs and relay outputs **eliminate incompatibility** between your console and what you're controlling. It will also create a **STOP** function even if your console has 'start-only' outputs. LogiConverter will control up to four machines . . . *easily and reliably!*

HENRY ENGINEERING  
(818) 355-3656

**We Build Solutions**

# Which Way is Up?

By **Tim McCartney - KBSU**  
Boise, Idaho

We recently installed a three-inch rigid section of transmission line to mate the FM transmitter output to an RF coaxial switcher.

Before cutting into the 25-foot section, I noticed a warning on one end: "Locate this Side Towards Antenna." This advice challenged my engineering theory, since RF will not likely follow these kinds of directions. Looking for an electronic theory, I called around to knowledgeable RF engineers; there was no electronic theory to be found.

However, a plausible explanation appeared: such orientation is a technique which improves the physical strength of multiple sections stacked together.

I wrote about this in an engineering publication and received two similar responses from other engineers. All agreed that the warning is, indeed, for mechanical reasons only. One side of the rigid line section has a catch on a bullet to keep the bullet from falling out.

Undoubtedly, this design is for vertical installation, say, up a tower to the antenna. In our case, its use was horizontal, so the design consideration was not applicable. And, the section was soon cut into small pieces with a four-inch pipe cutter and hack-saw.

By the way, we never called Cablewave (the manufacturer) - - this method has been a lot more fun. And, just to play by the the clearly marked rules, the section in question was oriented in the proper direction.

## Ice Guards

Our transmitter site - - at 7,000 feet on a mountain top, needs lots of protection.

Most stations at this congested RF site near Boise, use ice guards to protect horizontal transmission line runs from falling ice. Usually these are the sections from towers to transmitter buildings.

Horizontal metal railings are mounted about six feet above the ground, with vertical ground posts anchored in the earth. The heliax, routed under the horizontal members, is thus protected from falling ice.

Since the mountains certainly have no monopoly on ice problems, it seems that ice guards would be appropriate for installation in most states. But, I don't remember seeing any before coming to Boise.

Do you have them at your stations? Are there alternative methods of protection?

# Lattice Bridge

By **Chuck Gennaro - WFHR**  
Grand Rapids, Michigan

Who hasn't, at one time or another, just paralleled feeds from say - - a network source or off-air monitor, to several different points around the station, without any isolation between them? A distribution amp would be an elegant solution, but also a rather pricey one. Something simpler may be more practical.

Enter the resistive splitter pad. A typical splitter pad is shown in figure A. It is simple and common, but only will provide about 6 dB of isolation between the outputs. When someone (accidentally) patches audio into one of the outputs, the other output will get it also - - only about 6 dB down.

A better solution is shown in figure B. Called the "lattice splitter", it has its origins with the telephone company. It has the same 6 dB insertion loss as the simple resistive splitter, but provides much better isolation of about 40 dB between the outputs. If one of the outputs is shorted, the other output is not terribly affected. A signal mistakenly applied at one of the outputs will still appear at the other output, but will be 40 dB down. Not bad for 3, 1 watt resistors.

The circuit impedance dictates the value of the resistors. With broadcast equipment, that will usually be 600 ohms. Note that a proper impedance match at the splitters terminals is necessary for best isolation.

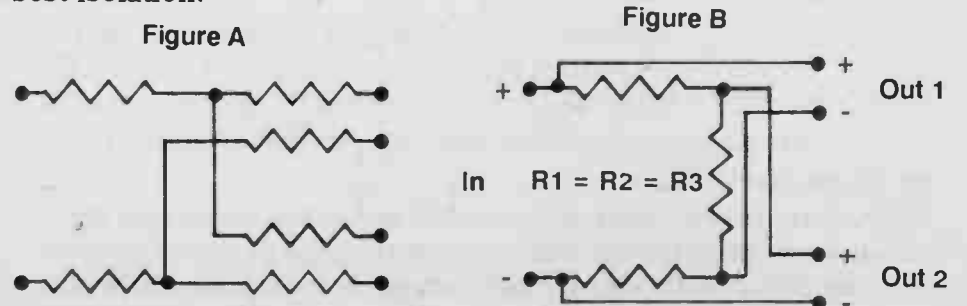

# THE "NFR" STORY

NFR is Noise Free Radio

A book covering the birth of the idea and development of a working system

A new idea for a new service for the old AM Broadcast Band

The tests that have been run and the tests yet to come

How to get in the race to be the first NFR station licensed in the USA

**\$12.00**

Includes postage & handling

Make your check or money order payable to "Noise Free Radio" and mail to:

Noise Free Radio

P.O. Box 8086

Lakeland, FL 33802

Be sure to include your name and mailing address!

Ohm's Law Formulas for DC Circuits

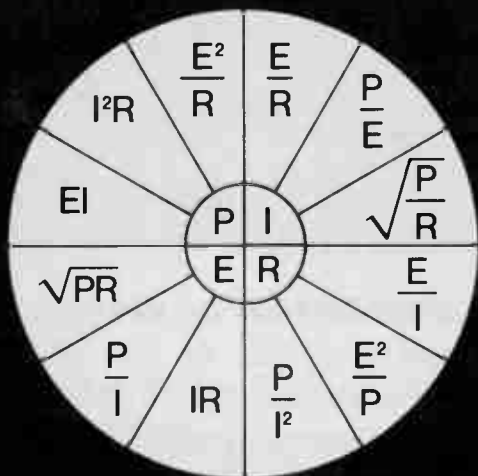

# IT'S THE LAW.

We've got Ohm's Law plus 21 other formulas you need to get the job done. For your free copy, call Delta at (703) 354-3350.

DELTA ELECTRONICS

5730 General Washington Drive, P.O. Box 11268, Alexandria, VA 22312



# McMartin BA-1K Transmitter

**By Jim Cassatt Jr. - WADV-FM**

According to the NAB Engineering Handbook, 7th edition, there are nearly 250 stations that operate with a BA-1K. So, for those 249 other stations, and everybody else, I would like to share a problem WADV had with their BA-1K.

One day in September, when the transmitter was operating at 1,000 Watts, the right modulator tube blew. After a new tube was put in the transmitter, and back on the air, everything seemed to be alright except for the plate current meter indication. When the transmitter is operating at 1,000 Watts, the plate current normally reads about 500 mA. But after this incident, the plate current meter was reading 150 mA.

The plate voltage and antenna current meter were reading normal. I even went to the base of the tower to make sure the remote antenna current meter was reading normal. The next thing that I checked were the multi-meter readings on the BA-1K. All readings were normal except for the Left Modulator Current. The meter was pinning when the reading was taken.

After this reading was taken, I realized that there was no way the tube could handle that much current (the tube was glowing normally). It was the same as the right modulator tube.

After studying the schematics and giving Charlie Goodrich a call at McMartin Industries, Charlie believed the problem was the filament transformer. He stated that the filament transformer in the BA-1K has been a common problem at other stations.

After re-ordering a new filament transformer from McMartin, we found that the new transformer is shaped differently than the original. It requires drilling new holes in the transmitter and the wiring color code is different from the old transformer. After three of us spent the night installing the transformer, the plate current reading and the L MOD readings were back to normal.

If this happens to you, don't wait! About a day after this happened, the transformer's windings kept shorting to the point where the transmitter could not operate on high power. Even though we had the transformer shipped overnight and couldn't have gotten it any sooner, there was nothing we could do but wait for the arrival of the new transformer. That's when an auxiliary transmitter would've been handy!

---

## Solid State Upgrade for Continental Transmitters

**By Tom Bosscher - WCUZ-FM  
Grand Rapids, Michigan**

Shortly after we installed our new Continental 816R2, they came out with a new exciter. It was put in place of the original, and we felt good that we had the most current and up to date transmitter available. It was not too much later that we all "discovered" the world of incidental AM noise. The 816R2 was good, but not state-of-the-art in this area. Continental saw fit to update their transmitters with a solid state wide band IPA stage to replace the dual 4CX250Bs in the older style boxes. The solid state stage does two main items: provide you with a very broad IPA stage to lower the incidental AM noise, and it eliminates replacing of the 4CX250Bs.

We were very interested in getting better AM noise from our transmitter, but the 816R2 was just purchased, and it would be rather difficult to request a new one. Then we found out that Continental was going to do something that just isn't found too much today. They were going to take care of the large existing customer base, and make available a field update for the "older" boxes. The price is very justifiable, especially when you consider that you do not need to buy a whole new transmitter.

My boss budgeted the amount of the update, along with factory field installation. We started to figure that we we could do the update ourselves, but in the end, decided to watch Dave Chenowith of Continental do it all. It was the best money spent. Yes, you might be able to put this in yourself, but this is a major update, and Dave knows the transmitter. At the time ours was done, he had updated about 40 rigs.

Does it help? Measured AM noise went from an average of 34 dB down, to about xx dB down. We have a digital paging SCA at 57 kHz on our carrier, and we were looking for as much bandwidth as possible. Now, we knew that we had made change, but was it there in the real world? Our transmitter site sits about 17 miles east of town, running 50 kW ERP at 420 feet. There is a large hill that shadows the city from the antenna about 4-5 miles east of town, and we have always had plenty of multipath. It was very noticeable after the change, that while the multipath was not gone by any measure, the pockets were not as deep or harsh. A very subjective opinion, but it was noticeable. We had a couple of unsolicited comments from staff members who had no knowledge of any change, but could tell from driving around, that something had changed.

I would really urge anyone who has any of the tube IPA series of Continentals, to look at this very cost-effective method of updating your transmitter. I am not sure exactly how far back in the lineage any one transmitter can be updated, but one phone call can tell you.

# Mailing Labels

**AM, FM & TV BROADCAST STATIONS**

**Fast Service**

**100% Accuracy Guaranteed**

Select by: Type of Station  
Transmitter Power  
Geographical Area  
Market Size  
Commercial / Educational

**Cheshire or Pressure Sensitive labels**

**Total Cost: \$66.00 per Thousand Labels**

**Phone (800) 338-3264**

**Broadcast Mail Inc.**



## Tips From The Field

Technical Tips From Around the Country

### Tower Beacon Tip

By John Lane - WWVA  
Wheeling, West Virginia

What is the problem when a tower beacon works perfectly in the day mode of a three tower DA, but does not work at all in the night DA mode? Yet, the sidelights always work.

The AC line to the beacon is shorted to the tower, causing the RF to shut down the beacon flasher. The problem was traced to a junction box containing a splice that had worked through the electrical tape, and shorted to the box. Because of the lighting transformer on the tower, either leg of the 120 VAC could short to the tower without blowing a fuse (although the white neutral wire was shorted in my case).

### Tape Tips

By Morgan "Skip" Reynolds II - WFFX-FM  
Tuscaloosa, Alabama

A couple of MX 5050BIIIs have appeared with some sort of random noise in the record circuits even with the record gain controls turned all the way down. This noise seemed to be intermittent and at times would only appear three or four minutes after a recording session began. This problem was traced to the record relays on the Record and Repro Amp Board, RL 301 and 401. These relays apparently have large contacts for the amount of current they switch, hence some oxide buildup on the contact surface would be likely.

Speaking of relays, have you ever had an ATR 700 jump into record for no reason at all, even with the Ready/Safe switches ion Safe? Try replacing Q553 on the Bias Oscillator Board.

Save your hair and put these notes in your manuals!

### Otari ARS-1000 Tip

By Steven J. Callahan - WFTI-FM  
St. Petersburg-Tampa, Florida

I've installed quite a few Otari ARS-1000 units in automation systems over the years. It is a fine playback unit and is relatively easy to troubleshoot and repair. However, this is a problem I discovered on three separately owned units in different places.

The primary symptom was an intermittent play function, which lead me initially to the play button. One would assume the play button would get a lot of operator abuse, especially with the built-in delay going from rewind or fast-forward to play. However, close examination and replacement didn't solve the problem or influence its erratic nature of occurrence. In checking closer, the main power transformer (ET-11-186) has three secondary windings (26, 28, and 5.5 VAC), and an intermittent in one of those windings was causing the erratic play function. Replacement of the transformer cleared up the problem.

## Please-We Need Your Help!

If you have any short tech-tips, send them in or better still, call me at (507) 280-9668 and we'll talk about them. Remember, it doesn't do anyone any good if you keep that information to yourself. Don't assume that everyone knows about your special technical tip. Send them in -- they'll be printed in the next issue

Editor . . .



RF Specialties of Pennsylvania

## Scotchcart II Sale

Empty	4.69	3.5 min	5.36
10 sec	4.71	4.0 min	5.54
20 sec	4.77	4.5 min	5.69
40 sec	4.82	5.0 min	5.78
70 sec	4.92	5.5 min	5.93
100 sec	5.05	6.5 min	6.22
2.5 min	5.14	7.5 min	6.41
3.0 min	5.22		

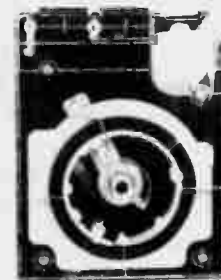

In Stock - Immediate Delivery

Minimum Quantity - 10 Carts, Single Length

## Scotch Reel-to-Reel

250-1/4-1200	7" Reel	7.10
250-1/4-2500 HPB	Hub	10.30
250-1/4-2500 R181	10 1/2" Reel	18.83
806-1/4-1200	7" Reel	6.18
806-1/4-2500 HPB	Hub	8.45
806-1/4-2500 RN	10 1/2" Reel	15.47



minimum quantity - one box

other Scotch products available - please call  
phone (412) 733-1994  
fax (412) 327-9336

RF Specialties of Pennsylvania, 121 Conneaut Drive, Pittsburgh, PA 15239



# FREE\*!

## the ENGINEER'S BIBLE

The recognized "Standard of the Broadcasting Industry," NAB 7th Edition *Engineering Handbook* is one of the most comprehensive and technical handbooks for radio and television available. This highly acclaimed and easy-to-use handbook is written for broadcasters by broadcasters and is supported by a full-time staff of NAB engineers. The text contains over 1,200 pages in a binder that lays flat and stays open.

- The NAB *Engineering Handbook* covers:
- PROCEDURES AND PRACTICES
  - ANTENNAS AND TOWERS
  - TRANSMITTERS
  - PROGRAM TRANSMISSION FACILITIES
  - PRODUCTION FACILITIES
  - REMOTE PROGRAM ORIGINATION
  - SPECIAL SYSTEMS
  - CHARTS AND GRAPHS

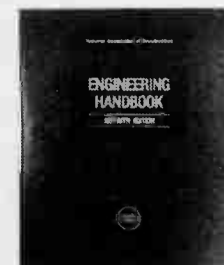

NAB 7th Edition *Engineering Handbook* is a must for everyone involved in the technical aspects of radio and television broadcasting. Allied is giving away 2 of these "standards." Enter your name in our drawing to be conducted January 8, 1989. To be eligible, simply put your name and title on your station's/company's letterhead and mail to: Dept db, P.O. Box 1487, Richmond, IN 47375. This drawing\* is open to everyone who makes broadcasting a career. Please include your business card. Winners will be notified.

Publication Date: 1985/86 Pages: 1,200 List Price: \$149.50 NAB Member Price: \$124.50

**ALLIED**  
Broadcast Equipment

ATLANTA RICHMOND  
LOS ANGELES CHICAGO  
DALLAS

1-800-622-0022



# Contract Engineers

Radio Guide will provide space here for contract engineers wishing to expand their business. To be listed here, just give me a call at (507) 280-9668.

This list is not a recommendation of any particular engineer. You will have to determine for yourself the qualifications of a particular person for the job.

Tom Becker  
Miami, Florida  
305-825-7037

Peter C.L. Boyce  
Midamerica Electronics Service  
New Albany, Indiana  
812-945-1209

James Boyd  
Boyd Broadcast Technical Service  
Tualatin, Oregon  
503-692-6074

Mike Brown  
Portland, Oregon  
503-245-4889

Lee Freshwater  
Blue Ridge Consultants  
Flat Rock, North Carolina  
704-693-1642

Chuck Gennaro  
Wisconsin Rapids, Wisconsin  
715-423-6763

Kirk Harnak  
Memphis, Tennessee  
901-529-0098

Richard A. Hyatt  
Maine Engineering Associates  
Gardiner, Maine  
207-582-4192

John Morton  
Durango, Colorado  
303-247-8734

Don Musell  
Broadcast Engineering Services  
Mouth of Wilson, Virginia  
703-579-4461

Mark Pallock  
Marandee Broadcast Engineering  
Chatsworth, California  
818-882-9475

Ransom Y. Place III  
Danbury, Connecticut  
203-798-9395

John Ramsey  
West Hartford, Connecticut  
203-243-4703

Christopher Scherer  
Miami, Florida  
305-667-5918

Lee Soroca  
Soroca Electronics  
Syracuse, New York  
315-468-5123

Tom Toenjes  
Signal Specialists  
St. Mays, Kansas  
913-437-6549

Dave Wrenn  
Aiken, South Carolina  
803-649-1663

Brad Johnson  
Central California  
209-526-6277

Scott Dean  
Dean Engineering  
Fresno, California  
209-434-2358

Gary Smith  
Advanced Technical Svc.  
Abilene, Texas  
915-672-5149

James A. Chase  
Angola, Indiana  
219-665-6427

Anyone Else ?

## Broadcast Computer Bulletin Boards

**Broadcast Computer Database**  
7 days a week, 24 hours a day  
All Baud rates (8 data, no parity, 1 stop)  
Specializes in on-line engineering programs  
David Armstrong (sysop)  
(713) 937-9097

**Network Communication System Broadcast BBS**  
300/1200 Baud rate  
Specializes in technical tips and schematic graphics  
(601) 373-0160

## A & D CARTRIDGE REBUILDING SERVICE

3380 Blakeley Avenue • Eau Claire, WI 54701  
Ph. (715) 835-7347 • Ph. (715) 835-8676

*We clean, load & pack.*

**Service within 10 work days! Work Guaranteed!**

Add 50¢ per Scotch Cart. We charge ONLY for tops, bases, and pressure pads; NOT for minor parts.

Qty.	Length	Standard Tape	High Output Low Noise Tape
_____	10 sec.	<b>2.15</b>	<b>2.25</b>
_____	100 sec.		
_____	2 min.	<b>2.30</b>	<b>2.50</b>
_____	4.5 min.		
_____	5 min.	<b>2.70</b>	<b>2.80</b>
_____	8 min.		
_____	8.5 min.	<b>2.90</b>	<b>3.00</b>
_____	10.5 min.		

**Send This Order Form - 10% OFF Your Order**

Call Letters \_\_\_\_\_ Total Carts Shipped \_\_\_\_\_  
Street \_\_\_\_\_  
City \_\_\_\_\_ State \_\_\_\_\_ Zip \_\_\_\_\_  
Telephone \_\_\_\_\_ Return Attn: \_\_\_\_\_

## ACCURATE SOUND CORP

Studio Condenser Microphone Model CR-3A

*For today's demanding digital recording needs:  
studio quality at a reasonable price...  
only \$795.00 plus \$5.00 shipping and handling.*

Try it for 10 days, you'll like it! If not, just return it.

### Features Include:

- -10 dB pad switch
- Cardioid polar pattern
- High pass filter switch
- Classic European styling
- 3-pin "Cannon" type connector
- Gold coated polyester membrane

### All accessories Included:

Fixed mount      Operator manuals  
Suspension mount      Calibration tape  
Foam windscreen      Carrying case

### Optional: @ \$179.00

DJ-601 Power Supply (good for two microphones)  
Microphone Cables (5m, 10m, 20m)



1/2 Actual Size



Accurate Sound Corporation  
3515-A Edison Way  
Menlo Park, CA 94025  
(415) 365-2843 Telex: 34 8327



# Continental 816R-4 Gate Drive Card Fix

By Mark Goff - CE - KVLT-FM  
Tulsa, Oklahoma

My Continental 816R-4 recently had the flu, and since it was such a learning experience, I thought I would share it with you.

The flu was caused by lightning that my "Power Siftor" (tm) did not sift. It caused two Gate Drive cards and one transformer (A9AR1T1) to expire. I was able to identify the "bad" cards with a procedure from Dave Chenowith at Continental (see below). After replacing the transformer and putting spare gate driver cards in, I threw the juice to it and promptly fried VR1 (blue selenium varactors across L1). Boy do they stink!. Greg Stone, at the factory, reassured me they had likely been weakened in the original lightning episode.

After cleaning up the transmitter (and myself), I ran the transmitter without VR1 (per Greg Stone) and still experienced problems getting the transmitter to make full power with the spare gate drive cards; it kept tripping the plate breaker. Jim O'Donahue of Powercon Electronics (who rebuilds gate cards - also see below), suspected that the cards, being of different date codes, may have drifted far enough away from the original specs to be a problem. I had Powercon rebuild my gate drive cards and after re-installing them (and VR1), everything is just fine.

### Test Procedure for Gate Drive Cards

1. Disconnect VR1 (5 blue over-voltage protectors that are across L1 in the rear of the center cabinet).
2. Check one card at a time. Turn transmitter on with no RF drive (mute exciter). Vary manual power control raise and lower. The plate voltage should vary up to 30% of maximum, if the card is good. (On mine, the voltage varied from approx. 30% to 80% of max.)

### Powercon Gate Cards

Since new gating cards are around \$250 each, you might be interested in a place that will rebuild, test, and guarantee cards for one year for \$75. They will also overnight them back to you for quick turnaround. Jim said that they also repair Control Circuit and Power Monitor cards.

**Powercon Electronics**  
9240 Lazy Lane Building E-3  
Dabbs Business Park  
Tampa, FL 33614  
(813) 932-7722

FCC's Engineering  
FM and TV Data Bases  
for your P.C.

Call today to request a free sample

Data for Small Systems  
Suite #236  
2020 Pennsylvania Ave. NW  
Washington, DC 20006  
(703) 276-9442

**SBE** STANLEY BROADCAST  
ENGINEERING

James S. Stanley  
Engineering Consultant

P.O. Box 24601  
Tempe, AZ 85282

(602) 264-8752

**NORTHERN**  
MAGNETICS  
CERTIFIED TAPE HEAD SERVICES

Northern Magnetics is an industry leader in the supply and service of tape heads and tape head products.

P.O. Box 16409  
Minneapolis, MN 55416

Phone: (612) 333-3071  
Telex: 1561238 MPS UT  
FAA Repair Station # C14-57

## Radio Guide

December, 1988 Volume 1 - Issue 4

Mail to: Radio Guide 511 18th Street SE  
Rochester, MN 55904

- 1 - Data World
- 2 - Altronic Research
- 3 - Tom Jones Recording
- 4 - Moseley Associates
- 5 - Ramko Research
- 6 - Kahn Communications
- 7 - Holaday Industries
- 8 - Henry Engineering
- 9 - CRL Systems
- 10 - Delta Electronics
- 11 - Noise Free Radio Book
- 12 - Broadcast Mail Inc.
- 13 - RF Specialties of PA
- 14 - Allied Broadcast Equipment
- 15 - Accurate Sound
- 16 - A&D Cartridge Service
- 17 - Data for Small Systems
- 18 - Stanley Broadcast
- 19 - Northern Magnetics
- 20 - Hnat Hlndes

Fill out the information below, and then circle the number of any manufacturer from which you would like additional information.

Name \_\_\_\_\_

Title \_\_\_\_\_

Company \_\_\_\_\_

Address \_\_\_\_\_

City \_\_\_\_\_

State \_\_\_\_\_ Zip \_\_\_\_\_ Phone \_\_\_\_\_

## AUDIO PROCESSING... hnaturally

### A-MAZE (a-maze)



#### HIGH DEFINITION IMPROVEMENT

For any existing processing chain plus ... separation enhancement.

### MIC-MAZE



#### HIGH DEFINITION MIC PROCESSING

Plus ... program gain riding: STL, AM and SCA processing.

### TRI-MAZE



FM STEREO, NRSC AM, OR TV  
THE ULTIMATE IN FLEXIBILITY AND PERFORMANCE.

**hnat hinders inc**

42 Elaine Street • R.R. 1 • Thompson, Connecticut 06277 • (203) 935-9066 • (203) 935-9242