

Sept. 1990

KDKD Radio/Barry Mishkind
2033 S. Augusta Place
Tucson AZ 85710
AZ - 857

BULK RATE
U. S. POSTAGE PAID
Permit No. 11
Winneconne, WI 54986



COMMON POINT®

A MONTHLY NEWSLETTER FOR BROADCASTERS

50 cents
per copy

Out-Of-State 800-558-0222 Distributed by Electronic Industries Inc., 19 E. Irving, Oshkosh, WI 54901 In-State 800-445-0222

DAB: The Future Of Radio Broadcasting?

Ever since NAB '90 in Atlanta one of the major topics of discussion in radio broadcasting has been DAB (Digital Audio Broadcasting). The DAB demonstration put on by the European Broadcast Union appears to have made quite an impact on broadcasters throughout the world. Many people feel that DAB will dominate the radio industry's attention to the same extent that HDTV has held the attention of TV Broadcasters in recent years.

DAB is a method of broadcasting that can deliver noise free, interference immune, CD quality audio to radio listeners in a more spectrum efficient manner than present AM/FM methods of broadcasting. Implementing this system of broadcasting without destroying the present system of AM/FM systems, in which many people have invested a considerable amount of money, is going to be a real challenge.

One idea has DAB being delivered partially via satellite and partially via terrestrial methods. Existing AM and FM stations would be allotted frequencies in the DAB spectrum and would simulcast their programming both digitally and in analog. After a number of years, when a majority of listeners would have digital receivers, standard AM and FM stations would be phased out.

At the present time DAB testing is going on in Canada while here in the U.S. CD Radio, Inc. has proposed a DAB service of 100 channels with some being delivered by satellite and some by terrestrial transmitters. Radio Satellite Corp. has filed a request to build an earth station to be

used to send ten channels of national satellite DAB programs to car radios over the same frequencies that will be used to deliver satellite paging services, data transmission and telephone service to automobiles.

In addition, Strother Communications, Inc. (SCI) of Louisiana has applied for a one-year experimental broadcast one-year experimental broadcast license from the FCC to test potential application of digital audio transmission systems. SCI proposes to test a DAB system developed by the European Broadcasting Union and the EUREKA 147-DAB system partners. Currently, the 4-6 MHz bandwidth used for the system can accommodate up to 16 separate stereo audio channels. SCI wants to examine the feasibility of all the services DAB can provide.

SCI intends to test the system in two markets, Washington and Boston, so that technical characteristics of the system can be documented and compared with current types of audio signal delivery. The firm proposes to determine the use of DAB in connection with satellite delivered signals to demonstrate DAB's capabilities for simultaneous nationwide and worldwide service. SCI also intends to experiment with DAB's ability to provide local services tailored to the needs of a specific community.

The FCC has launched an inquiry into digital audio broadcasting. The Notice of Inquiry seeks information to help the Commission develop policies regarding the possible introduction of new digital radio services.

Issues the FCC seeks comments on include the impact digital radio would have on existing audio services and how to incorporate DAB into the spectrum. The FCC also needs to determine how to best regulate DAB so that its public benefits would be most efficiently realized.

Commissioner Ervin Duggan seemed to reflect the FCC's general attitude toward DAB. "This item raises a perennial question for the FCC and for incumbent industries. Will we embrace promising new technologies with more or less open arms or will we try to discourage those technologies?" Duggan asked. "I think this whole business of digital audio broadcasting, be it by satellite or by terrestrial transmitter, clearly offers some marvelous benefits."

Spectrum and public interest questions are likely to be most contentious. According to FCC Chief Engineer Tom Stanley, the Office of Engineering and Technology (OET) has not yet begun to assess the specific spectrum possibilities for DAB. OET has been looking at possible spectrum availability of high-definition television, especially in the UHF band. Chairmen Sikes endorsed the idea of eventually setting up an advisory committee and suggest that the National Radio Standards Committee, a standards-setting organization cosponsored by NAB and the Electronics Industries Association, also serve as a good forum for DAB issues.

NAB officials who recently returned from overseas say European broadcasting officials are beginning

(Cont. to pg. 2)

Editor's Notebook



Traditionally, summertime is usually when most people take vacations. In the broadcast industry, however, it is also the time when major construction or maintenance projects are undertaken, especially where there is outdoor work involved. Warm weather in the northern tier of states comes later and leaves earlier than many of us would like, although living up here isn't really as bad as some people think. For instance, I met a cab driver at an NAB convention in Dallas a number of years who seemed to think that we lived in igloos and used dog sleds for transportation. Granted, the fact that I had left Wisconsin, where we had just received about ten inches of snow in a very late March snowstorm, and when I landed in Dallas late in the evening it was still about 70 degrees probably helped give him that impression.

At any rate, summer is usually too short for most of us to get in the vacation time we would like and still do all the outside work that has to be done. In line with that I thought it might be appropriate to offer a few suggestions on some things that should be checked at least every summer and any problem areas taken care of. You've probably run across most of these suggestions some place or other but a little refresher now and then doesn't hurt.

Have your towers inspected from top to bottom by a reputable tower company. Check things such as the paint job, lighting fixtures and associated wiring, antenna feed lines, sample loops and lines, clamps and hangers, guy wires, RPU or two-way

antennas mounted on the tower, concrete piers, base insulators (don't forget to probe the drain holes in these things.) If the station can't afford to hire a tower man to do the inspection the next best thing is to get a good pair of binoculars and do your own visual inspection.

Check all ground connections and the ground system itself (AM stations) for any broken or badly corroded connections, and re-braze them.

Clean and tighten all connections in and around the ATU shacks and tower, not forgetting such things as isolation coils, lighting chokes, feed-thu-bowls and studs and tuning/-matching network components.

The ATU shacks themselves should be checked for structural soundness as should be fences around the towers. While there are no definite specifications for fences or tuning shacks common sense will pretty much tell you whether they are in good condition. However, under the RF radiation protection requirements fences around towers have to extend out far enough so that your normal everyday "vandal" isn't over-exposed. In addition, fences and shacks must be kept locked and adequate warning signs posted warning of the dangers of high voltage and RF radiation. The FCC is getting picky about this.

Keep the whole area as clean as possible. This means keeping weeds and other vegetation cut when necessary and spiders, crickets and other pests from in and around the tuning houses. If you are in a location that can be considered "residential" you will undoubtedly find a lot of other junk laying around the vicinity of the towers. People seem to like to break beer bottles against the tower and soda cans and other types of junk manage to find their way to the surrounding area.

Many of you probably have things that you do in addition to the ones I've just listed but if you are new in the business you have a place to start.

(Cont'd from pg. 1)

to lean toward the NAB's view that digital radio should be primarily a terrestrial service.

WCCO/Minneapolis-St. Paul has broken ranks with NAB, and declared its support of CD Radio's satellite proposal. The 50kw giant, in a filing with the FCC, said the diverse offering of programming nationwide would afford the public "a choice of all of America's regional flavors." WCCO also said it and "other clear channel stations and heritage stations should be given a first opportunity or

(Cont to pg. 10)

Protect your valuable systems from all power problems. Make Shape your Clean Power Source

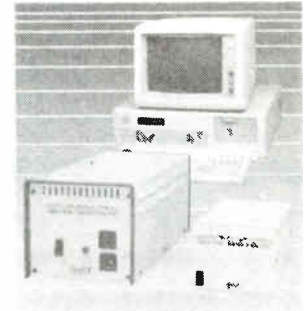

Only Line Tamer™ power products give you this unique combination of features.

- complete isolation and regulation for full protection from spikes, surges, overvolt-ages, undervoltages, lighting and noise
- cause no RFI/EMI problems
- customized units to meet unique needs and unusual applications, including mixed input and output voltages, special plugs and receptacles and kVA ratings
- maintenance-free; no unreliable circuitry
- automatic current limiting to prevent overloads and short circuits
- no step-up/step-down transformers needed.
- full one-year warranty

close out sale
on the following in stock units:

PCLT600	\$225
CLT0500AAA	\$299
CLT0750AAA	\$349
CLT1000AAA	\$449
CLT0140AAA	\$150

Electronic Industries

19 E. Irving - Oshkosh, WI 54901
Out-of-State: 800-558-0222 or
In State: 800-445-0222

NAB Announces New Report On Broadcast Technology

A wealth of information on broadcast station use of allied technologies is available from the National Association of Broadcasters in Broadcast Technology Report: A Survey of Station Technology Applications released recently.

The information was derived from a random survey of 322 television stations and 589 radio stations fielded in December 1989 and falls into seven primary categories. The categories and a sample of facts developed in each are:

1. Broadcast auxiliary services;

Fifty-one percent of radio stations and 85 percent of TV stations use studio transmitter links, an increase in both categories since 1988.

2. Station supplementary services, such as antenna tower leasing and sub-carrier services;

Twenty-nine percent of FM radio stations provide subcarrier services, down from 35 percent in 1988.

3. Telephone services (including cellular phones, pagers and fax machines); Fifty six percent of radio station lease private telephone lines, down from 67 percent in 1988. Sixty-five percent of TV stations lease private lines, the same percent as in 1988.

4. Satellite equipment;

Radio stations owned an average of 1.5 satellite dishes each, compared to 1.4 in 1988. TV stations owned an average of 3.7, compared to 3.3 in 1988.

5. Computers and software applications;

Sixty-eight percent of radio stations and 97 percent of television stations own at least one computer.

6. Broadcasting enhancements, such as AM stereo, equipment upgrades, FMX, NRSC and stereo TV; and

Eighteen percent of radio stations upgraded equipment in 1989 to the extent they needed CPs, compared to 14 percent in 1988. In television 11 percent upgraded in 1989, vs 26 percent in 1988.

7. Technological policies and opinions on upcoming developments.

Radio stations viewed digital audio technology as the "biggest development facing radio," followed by DAT, AM improvement, AM stereo and digital disc/editing. Television stations viewed advanced television as the "biggest development facing television," followed by digital video and advanced compatible TV.

Where appropriate, the data are detailed by subcategories, including (for radio) AM standalones, FM standalones and AM/FM combos, market size by population and (for television) network affiliates and independents and ADI rank.

Broadcast Technology Report is available to NAB members at \$20, and to non-members at \$40. To order, call NAB Services at (800) 368-5644 or (202) 429-5376.

NAB Publication Assists Broadcast Managers In Minimizing Accidents

To help broadcasters minimize accidents through effective loss control and risk management programs, the National Association of Broadcasters has published A Broadcaster's Safety and Loss Control Guide.

With insurance typically covering about 25 percent of total losses in an accident, the remaining costs hit the station's bottom line. Developed by the NAB Insurance Committee, the Guide addresses safety, risk management and loss control techniques for broadcast

stations. Checklists are included to help stations design programs to reduce risks and losses. Chapters include: Management overview; Safety responsibility; Safety meetings; Developing standards, procedures and rules; Communicating with your staff on hazards; Fleet safety guidelines; Accident investigation and reporting; Security and crime prevention; Protecting the general public; Property protection; How to conduct self-inspection of your station; and How to conduct periodic safety audits.

A Broadcaster's Safety and Loss Control Guide (96 pages) is available to NAB members at \$20, and to nonmembers at \$40. To order, call NAB Services and (800) 368-5644 or (202) 429-5376.

LIVE REMOTES ANY TIME . . . ANY PLACE . . .

RPT-30 FEATURES:

- 20% more output power, 52% smaller, 40% lighter.
- Subaudible encoder.
- FM compressor-limiter.
- Illuminated VU meter.
- Dual-frequency capability.
- Four balanced microphone mixing inputs, one switchable to balanced line level.
- Flashing LEDs indicate antenna VSWR problems and over-temperature conditions.
- FCC approved.
- Continuous duty-broadcast quality.

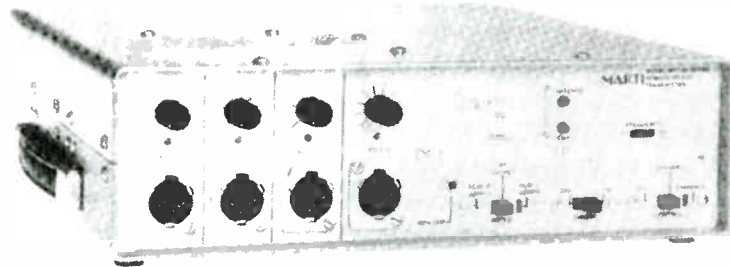

\$1695

MCS-800, Audio Companding. \$400 for RPT-30, CR-10.

. . . MARTI DELIVERS

How many times has your station missed great opportunities for promotion and revenue because an effective, broadcast quality, continuous duty, remote system wasn't in place for immediate use? Declare your independence from inflexible, re-stricted, low quality remotes by installing a high performance Marti System.

Marti has hand held portables, mobile repeaters and automatic relay stations to give you the coverage and flexibility you need. Put our 30 years experience in broadcast remote pickup equipment to work for you by calling us for assistance in planning your system.

The performance-value leader in Broadcast Equipment.

MARTI

Electronic Industries
19 E. Irving - Oshkosh, WI 54901
Out-of-State: 800-558-0222 or
In State: 800-445-0222

NAB Asks FCC to Abandon FM Directional Antennas; Measure Would Preserve the Future of FM Service

The National Association of Broadcasters, concerned about the growing interference problems on America's FM band, has asked the Federal Communications Commission (FCC) to revisit its decision allowing FM radio stations--closely positioned geographically--to use directional antennas and "contour protection" as a means to avoid interference.

In written comments to federal regulators, NAB said that a more prudent course would be for the Commission to abandon all notions of using FM directional antennas and "contour protection" in commercial FM broadcasting. Contour protection refers to the radio station's service area that can be protected from signal interference. NAB said these measures are necessary, especially in light of ongoing FCC efforts to repair the AM broadcast band--repairs that were due in part to the wide

use and, later, failure of AM directional antennas to correct interference problems.

In its comments, NAB challenged one of the FCC's fundamental arguments supporting its December 1988 decision to okay the use of FM directional antennas. Singling out the comments submitted by the National Public Radio (NPR) in another proceeding, NAB underscored NPR's assertions about the failure of both directional antennas and contour protection to avoid interference among noncommercial, educational FM station. According to NAB, NPR documented "real world" interference levels much greater than FCC projections.

This finding, NAB said, provides further support for the need to reassess the validity of the technical assumptions, particularly the concept of contour protection as a valid tool to assign FM stations in the commercial band.

NAB, along with four other parties, is seeking reconsideration of the FCC's December 1988 decision, which permitted short-spaced FM stations to use contour protection as a means to avoid in-

terference. Because it considered earlier Commission evaluations to be flawed, NAB urged the FCC in May 1990 to return to its distance separation standards for station assignments pending the results of a comprehensive technical proceeding, an effort, NAB argues, can help more accurately gauge coverage and interference levels.

SBE Employs Executive Director

The SBE has announced the hiring of Stephen L. Ingram, CAE as the organization's new Executive Director. Ingram will be responsible for: Developing new member benefits; Coordinating convention activities; Facilitating the development of a strategic plan; and Identifying new marketing opportunities.

Steve will be working from the SBE offices in Indianapolis with the current staff.

Ingram has been a professional association manager for the past eight

(Cont. to pg. 6)

STELLAR PROFESSIONAL SERIES

Here's the Remote Mixer you've been waiting for! The STELLAR SERIES TELEMOTE 321 gives you two low impedance microphone inputs and one medium impedance tape recorder input in a handy-dandy 3 pound package. What makes this tiny dynamo so unique is that it requires no batteries or any other external power source except your phone line. That's Right! The 321 works right off your dial or touch-tone phone line feed!

While you're broadcasting that important event, you can supply audio up to 3 headsets at once and control their level by a front panel pot. The audio level feeding the telephone line is controlled by a built-in limiter with the limiting action displayed by a LED bar-graph meter. The RUSSCO TELEMOTE 321 also incorporates a signal bell that allows calls originating at your station to be received at your remote location. Also, you may route the audio from a portable radio into the mixer for on-air checking with the program off the phone line. You'll like the convenient tilt-stand that doubles as a handle.

The RUSSCO STELLAR TELEMOTE 321 3 CHANNEL MIXER makes life easy for you. No batteries or AC plugs to worry about. Just hook up to your phone line and you're on the air! Don't wait any longer, order yours today!

SPECIFICATIONS:

2 Low Impedance microphone inputs (250 OHMS) 1 Medium Impedance Tape Recording input matches anything from 8 OHM Tape Recorder Output to 10 K OHMS output. 8 Inches Wide X 6 Inches Deep By 3 Inches High. Weight 3 Pounds. Case: Anodized Aluminum Cabinet with tilt up stand. Frequency response of Unit . . . 30 Hz to 15 KHz. Maximum Distortion 1 Percent.

**A STELLAR PERFORMER
YOU CAN RELY ON.**

**Price
\$649.00**

Electronic Industries
19 E. Irving - Oshkosh, WI 54901
Out-of-State: 800-558-0222 or
In State: 800-445-0222



TELEMOTE 321
3 CHANNEL
REMOTE MIXER



RUSSCO
ELECTRONICS INCORPORATED

dorrough

Introducing A Stereo Audio Signal Test Set with the Widest Range Ever Designed

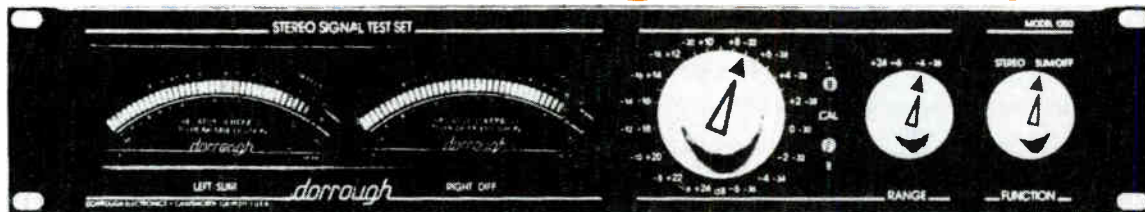

STEREO SIGNAL TEST SET

This simple and easy to operate gain set allows stereo measurements of level, balance, crosstalk, and signal-to-noise over the entire dynamic range of your system from noise floor to clipping. The solution to balanced stereo lines.

MODEL 1200

Electronic Industries
19 E. Irving - Oshkosh, WI 54901
Out-of-State: 800-558-0222 or
In State: 800-445-0222

FEATURES
Range of 100 dB
Simultaneous Peak & Average
L/R or Sum/Diff Modes
2 B scale Loudness Meters
Easy to Use

MEASUREMENTS
Signal-to-noise ratio
Program Balance
Separation
Crosstalk
Headroom

APPLICATIONS
Stereo Television
FM Stereo
Recording
Duplication
Uplink

Price
\$1650.00

FCC Confirms 24-Hour Ban On 'Indecent' Programs

The FCC has unanimously adopted a report concluding that a 24-hour ban on so-called indecent broadcasting programming is constitutional "as it would be enforced by the Commission." In 1988, Congress mandated such a round-the-clock ban to protect children ("children" now defined by the FCC as minors 17 years and younger) from indecent programming. The constitutionality of the subsequent 1988 enforcement action by the Commission was challenged by 17 media and citizens organizations, including NAB, and 24-hour enforcement was stayed by the U.S. Court of Appeals in Washington, pending judicial review.

In the report adopted, the FCC contended that the ban on indecent broadcasts conforms with the First Amendment as interpreted using the U.S. Supreme Court's "compelling government interest/narrowly tailored restriction" test applied in a recent ruling pertaining to indecent telephone calls.

The FCC cited 88,000 letters from the public in favor of such a ban, and 4,500 letters against it.

"(I believe) we'll see this (issue) taken all the way to the U.S. Supreme Court," said FCC Commissioner Sherrie Marshall at Thursday's FCC meeting. Commissioner Andrew Barrett said, simply: "This is subject to court review...and it doesn't really

matter what I think."

FCC Chairman Al Sikes ended the meeting by cautioning the press to not make more of the ban than he believes is justified. He suggested that to align it, for example, next to the recent "2 Live Crew" record ban by the courts would not be warranted.

The FCC said stations will be allowed to attempt to demonstrate if and when there is evidence showing that children are not in their market's audience during specific dayparts.

Although the Commission now defines kids as viewers and listeners up to 17 years old, an FCC spokesman acknowledged Thursday that the new definition apparently was chosen somewhat arbitrarily.

The Commission said in a news release that "based upon data collected in the FCC's proceeding, it found that children are in the broadcast audience for both radio and TV at all times of the day and night, and that alternatives such as time channeling and technological restrictions are insufficient to protect them from exposure to harmful indecent programming."

The FCC also said its definition of indecency will not change, "language that describes, in terms patently offensive as measured by contemporary community standards for the broadcast medium, sexual or excretory activities or organs", and that adults have alternative sources of indecent materials.

Singers Endorse Shure L-Series Wireless

Shure Brothers has announced the signing of several artist endorsers of the L Series Wireless and Beta Series microphone products.

On her just completed first U.S. tour, Lisa Stansfield utilized the new Shure LS24/Beta 58 hand-held wireless mic system. From the country music scene, The Judds, Patty Loveless, and Tanya Tucker are also employing L Series wireless systems.

Heavy-metal bands that have gotten on the Shure bandwagon include up and coming acts such as XYZ, Danger Danger, and Johnny Crash. All these acts, as well as multi-platinum metal band Warrant, are using L Series wireless for lead vocals.

"We are very excited about the popularity Shure Beta 58 and L Series mics are gaining among touring professionals," said Jack Kontney, Shure's manager of artist relations. "These new mics represent significant technological advancements, and we are pleased that the music industry is giving us their vote of confidence."

For more information, contact Shure customer services at 1-800-25-SHURE.

(Cont'd from pg. 4)

years and is a Certified Association Executive (CAE) by the American Society of Association Executives. Steve has been an association consultant with organizations in strategic planning, membership management and employee retention.

He serves on the Board of Directors of the Indiana Society of Association Executives and the Membership Development Committee of the American Society of Association Executives. Ingram is frequently sought as a keynote speaker on current issues in association management.

"Steve brings extensive management ability to the SBE and will be instrumental in helping the society plan strategically for our future," said President Brad Dick. "It's important for the SEB to continue the record growth we've enjoyed and take advantage of the many existing opportunities. We're looking forward to being able to provide our members with many new benefits and programs as a result of Steve's expertise."

University Sound Goes "Out To The Ball Game"

The Chicago Cubs and their cross-town American League counterparts, the Chicago White Sox, are using sound equipment manufactured by University Sound.

Wrigley Field, home of the Cubs, is outfitted with a large array of University Sound gear, and the White Sox' training camp in Sarasota, FL, installed a distributed system featuring University horns and drivers.

University equipment at the recently refurbished Wrigley Field includes 1829T CDP compression drivers; CDP 850T and FC100 horns and driver system; LR2SAT all-weather line radiators; and PA430T paging projectors. Bridgewater Custom Sound of Chicago was the Wrigley Field contractor.

The CDP 850T provides sound reinforcement throughout Wrigley Field. The PA430Ts are mounted on the front side of the press box, and the LR2SAT is utilized in a restaurant environment.

The PA430T constant directivity paging projector allows uniform coverage, fewer horns, higher intelligibility and better articulation. An omnidirectional swivel hoop system allows easy aiming in any direction. The LR2SAT all-weather line radiators contain a vertical array of three 5 by 7-inch elliptical full-range drivers connected together with a network that effectively shortens the length of the line radiator with increasing frequency.

"The sound equipment (from University) provides excellent speech intelligibility and better articulation," said a Cubs spokesman. "One of the advantages is the ease of installation. Other (University) equipment is perfect for an outdoor environment because of its weather-proof nature."

FCC Bits & Pieces

FCC Telephone Directory

The 1990 FCC telephone directory is available from the FCC's duplicating contractor, ITS. The cost is \$2.50, which includes mailing costs. Place orders by contacting ITS at 2100 M St., NW, Suite 140, Washington, D.C. 20037. Call (202) 857-3800.

Satellite Station Action

In early April, the FCC denied the licensee of WLOS-TV, Asheville, NC, the authorization to operate a defunct television station in Anderson, SC, as a satellite station. WLOS had hoped to use the facilities of former WAXA-TV in order to boost its signal toward the south.

However, the FCC rejected WLOS's plans saying that the plan would have wasted spectrum because of the significant amount of overlap between WLOS and the new satellite station.

FCC Denies License

The FCC has denied the license of KQED, Inc. for the renewal of noncommercial station KQEC, San Francisco. The FCC said the license was yanked because "KQED (Inc.) committed serious misconduct by lacking candor about and misrepresenting the reasons that KQEC-TV was off the air from January through May 1980" in an attempt to "alleviate KQED's financial problems."

However, the FCC has renewed two other stations owned by KQED Inc.-KQED, a San Francisco VHF station, and KQED-FM.

Bush Praises EBS

President George Bush has issued a video statement praising broadcast stations and networks for their voluntary participation in the emergency broadcast System (EBS). The statement is part of an EBS video training tape prepared by Durham Life Broadcasting of Raleigh, NC. FCC chairman Alfred Sikes and NAB president Edward Fritts also contributed statements praising the industry.

WORLD CLASS REMOTE

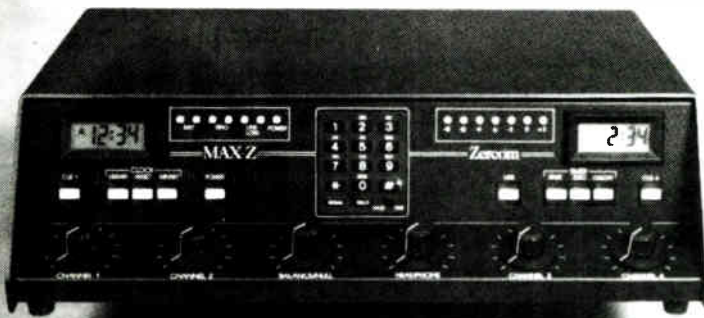

BROADCASTING

Electronic Industries

19 E. Irving - Oshkosh, WI 54901
Out-of-State: 800-558-0222 or
In-State: 800-445-0222

\$1095

plus shipping & handling

The WDET Experience

Reprinted with permission of BTP from FMX® NEWS

EDITOR'S NOTE: From time to time we plan to publish articles on the demonstrated benefits of FMX Stereo broadcasting and reception. In this premier issue of the newsletter, it seems appropriate to feature a hometown station, WDET, the first FMX Stereo broadcaster in the Detroit area.

"We have always had great expectations for FMX Stereo broadcasting here. It's amazing to hear what has been accomplished with such a modest financial investment," says Caryn Mathes, WDET General Manager. Mathes and chief engineer Malloy Farley made the decision to begin FMX Stereo broadcasting March 1988, and the system has been on the air full time ever since. Their first FMX Stereo generator was a BTP prototype unit, but after they had completely satisfied themselves on the compatibility of the system, they purchased and installed an Inovonics Model 705 generator.

It would be hard to find a more appropriate station for evaluating FMX Stereo performance with various types of programming. As at many public stations, there is some classical music and talk programming, but WDET lists its main format as jazz. That's not all, however, as the alumni magazine of station-owner Wayne State University describes it, "The very element which sets WDET apart from its local commercial competitors also distinguishes it from its public radio sister stations in other major markets. That element is an astonishing musical and cultural eclecticism — which on any given day, may incorporate sweaty Mississippi Delta blues, mournful Celtic folk songs, infectious Afro-Cuban rhythms and the chilling beat of 80's British technopop. Indeed, WDET features some musical programs on which it would not be unlikely to hear such disparate musical forms strung together in a sublime sonic medley."

The station operates on a frequency of 101.9 MHz, reflecting its heritage as a commercially-licensed station previously owned by the ALF-CIO, (The union gave the station to Wayne State in 1952.) It currently employs 14 full-time broadcast professionals, 18 part-time professionals and 7 college-level student assistants.

WDET uses an Orban 8100A audio processor and a Continental transmitter to broadcast a 79-kilowatt signal from an RCA antenna at 450 feet. It also operates the Detroit Radio Information Service for the blind and print-handicapped community on a 67-kHz subcarrier. According to the ARBITRON ratings system, WDET has an audience of over 152,000 listeners per week.

Farley accompanied the BTP engineering team during some of the coverage tests. "After a number of years on the job I feel I know this territory quite well," he said. "When we first put FMX Stereo on the air eighteen months ago, I searched the whole area looking unsuccessfully for possible trouble spots. It's a pleasure to make the rounds again, this time listening to FMX Stereo reception with the new JVC radio." The stereo coverage tests revealed interesting results. (see map) As predicted, the FMX Stereo reception contour is approximately 1.4 times as far from the transmitter as the regular stereo contour. That calculates to twice the area for FMX Stereo reception. WDET listeners with FMX car radios now can hear stereo as far away as Monroe, Ann Arbor, and Chatham, Ontario — well beyond where regular car radio's "blend" to monophonic reception.

Ann Arbor is a particularly important market because it is the home of the University of Michigan. Perhaps even more significantly FMX reception provides clearly audible benefits in numerous shadowed spots within the Detroit metropolitan area. "We could hear definite improvement in many places especially in the northwestern suburbs. That's where some of our best contributors live," said Farley. Half-jokingly, he mused also that even boaters on Lake Erie probably will be able now to receive better stereo with FMX radios. The resolute BTP engineers, moving on to other cities, decided, however to save the boating tests for another time. □

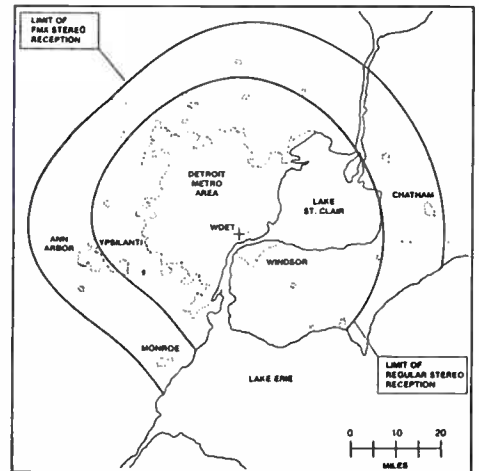

WDET automobile stereo reception.

Inovonics FM Stereo Generator (with FMX™ as a plug-in option)



\$1800.00

Inovonics' 705 is a full-featured, stand-alone Stereo Generator incorporating all necessary lowpass filtering and transmission pre-emphasis functions. The subcarrier and pilot signals are generated by digital circuitry to assure optimum performance and drift-free operation.

FMX™, the coverage-extension system developed jointly by CBS and the NAB, is available as a plug-in option which, itself, makes extensive use of digital techniques. Whether or not the FMX™ option is used, the 705 Generator remains fully compatible with existing FM broadcasting standards and practices, whether reception is in the FMX™ conventional stereo or monaural mode.



\$3670.00

With its new Model 706, Inovonics introduces a "second generation" FM Stereo Generator incorporating the FMX™ Transmission System as an easily-installed plug-in option.

The patented FMX™ System has been proven fully compatible with worldwide FM-Stereo broadcasting standards and practices. In conjunction with the FMX™ Stereo receivers now in production, FMX™ Stereo transmissions will give the broadcaster a substantial increase in his noise-free stereo coverage area.

The new Model 706 is not intended to replace the 705. Rather, it is an alternative for those situations which require additional operating and convenience features.

END-OF-SUMMER BARGAINS FOR BROADCASTERS

Microphones and Associated Equipment

Electro-Voice Pro-Line

PL-6	\$ 72.95
PL-10	196.95
PL-77	126.95
PL-80	121.95
PL-91A	58.95

Electro-Voice Broadcast

CO-90	\$106.95
RE-85	117.00
RE-10	132.00
RE-20	350.00

University Sound

US637S gooseneck mike	\$ 39.75
-----------------------	----------

Shure

SM58-LC	\$118.75
---------	----------

Audio-Technica

Pro 1A	\$ 21.95
Pro 5	103.00
Pro 7	63.25
Pro 3L	38.95
AT802	76.75
AT812	93.35
AT803A	102.50
AT801	82.50
AT835	156.75
AT853	149.95
AT855	129.95
AT857QM	157.95
AT859	126.95
AT8506 phantom power supply	99.95

Symmetrix

Model 528 microphone processor	\$405.00
--------------------------------	----------

Headphones

AKG45	\$ 41.50
Stanton 35M/HB	26.75
Stanton 30M/SR	25.85
Sennheiser HD450	65.25

Miscellaneous Audio Equipment

Henry Synchrostart	\$ 61.15
Henry Telecart	156.75
Henry USDA	156.75
Henry Mix Minus Plus	156.75
Henry Matchbox	156.75
Henry UTC turntable controller	167.95
Symmetrix 205 VU meter	174.95
Symmetrix A-220, 20-watt per channel monitor amplifier	204.95

Remote Broadcast & Associated Equipment

Audio - Technica 4462 Eng. mixer	\$863.00
Television Equipment Assoc., sports mike/headphones, dual	178.25
Television Equipment Assoc., sports mike/headphone, single	169.50
Gentner EFT900 frequency extender	699.96
YC 161 yagi	57.95
RPU xmtr crystal, 161.76 MHz	41.25
ASP whip antenna	44.10

END-OF-SUMMER BARGAINS FOR BROADCASTERS

TAPE CARTRIDGES, REEL-TO-REEL TAPE, CASSETTES AND ACCESSORIES

Fidelipac	Model #300	Mastercart	Dynamax
10 sec. - 100 sec.	\$3.25	\$4.05	\$4.50
140 sec. - 4.5 min.	\$3.65	\$4.45	\$4.98
5.0 min. - 10.5 min.	\$3.98	\$4.80	\$5.45
Audiopak	Model A2	Model AA3	Model AA4
10 sec. - 100 sec.	\$3.45	\$3.90	\$4.40
140 sec. - 4.5 min.	\$3.85	\$4.35	\$4.85
5.0 min. - 10.5 min.	\$3.95	\$4.98	\$5.85
Scotchcart			
3.5 min.			\$6.55
4.5 min.			6.85
6.5 min.			7.60
Ampex 456, 7" reels			7.25
Ampex 456, 10½" reels, NAB hub			20.25
Ampex 407, 10½" reels, NAB hub			21.40
Ampex 642, 7" reels,			6.35
Ampex 631, 7" reels			4.25
Scotch 806, 7" reel			7.05
Scotch 806, 10½ reel			9.65
Scotch 620-7/32-100 splicing tape			5.35
Bulk 10 min. cassettes			70
Bulk 90 min. cassettes			98
Bulk empty cassette cases			20
Empty 7" reels			42
7" tape reel boxes			27
Nakamichi DM-10 head demagnetizer			27.25
Handi-Mag head demagnetizer			27.55
Benjamin bulk tape eraser, hand-held			20.25
Fidelipac Model 395 hand-held bulk eraser			65.00
STL alignment/response test carts, mono/stereo, 34-FI			59.50
STL pink noise test cart, P-34-FI			68.00
STL #22-4 reel-to-reel alignment tape, ¼ track			50.00
STL #2-2 reel-to-reel alignment tape, ¼ track			50.00
STL #C-002-1 reel-to-reel alignment tape, full track			59.50
Phono Equipment			
Audio-Technica AT—12T tone arms			\$ 208.85
Technics SL-1200MK-II turntable			375.00
Shure M64A phone pre-amp			68.50
Stanton 310B phone -re-amp			219.95
Various models of phono cartridges and styli by Shure, Stanton and Audio-Technica			
Call for our low, low prices			
Miscellaneous			
TWR Lighting tower light controller, AA2-TSS			\$ 497.00
2 mfd., 8 KV. non-PCB filter capacitors			214.95
8 mfd., 3 KV. non-PCB filter capacitors			172.95
4 mfd., 3 KV. non-PCB filter capacitors			91.75
Simpson Model 1337 RF ammeters, 0-1.5 amps			55.50
0-2 amps			55.50
0-3 amps			55.50
RG213/U. 10 ft. jumpers w/N connectors			5.95

MEMO FROM METZ



by
David L. Metz

MONOLITHIC MICROWAVE INTEGRATED CIRCUITS

This month we're going to play with a truly wonderful RF device, the Monolithic Microwave Integrated Circuit (MMIC). Don't let the big name scare you! These are a RF engineers dream come true, simple cheap RF amplification devices that are very easy to use.

The MMIC is a complete wideband RF amplifier in a single chip. The ones I am experimenting with are Motorola MWA0204's. Typically they give 12 dB of gain at 500 Mhz. Band width is darned near zero to 3 gigahertz! Plus they are internally matched to 50 ohms input and output impedance.

Take a quick look at Fig. 1. It shows a complete RF amplifier that works from 1 to 3 Ghz, 50 ohms in and out. That's all there is to it. Plus if you need higher gain, additional units can be placed in series (cascaded) to attain the desired amplification.

Let's look closer at some of the devices parameters.

Gain, varies with different devices in the series and falls off with frequency. Typically 19 dB at 200 Mhz. falls off to 15 dB at 2,000 Mhz.

Noise figure, between 5 to 5 dB up to 2 Ghz. Not great for a high performance receiver front end, but perfectly fine for most other uses.

Power out, these devices are very useful for amplification in receiver local oscillator/multiplier chains and low power stages of transmitters. The MWA0204 will put out +7 dBm before serious gain compression begins.

Note in figure 1 resistor R1. It is selected to give a operating current 25 ma. with a device operating voltage of 5 volts. The following formula gives the correct value of R1 for any supply voltage.

$$R1 = \frac{\text{(supply voltage 5)}}{0.025}$$

Example:

For a supply voltage of 13.8V. 13.8 minus 5 = 8.8, 8.8 divided by .025 = 352 ohms.

Closest standard value 330 ohms or a 330 and 22 ohm resistor in series.

Also keep in mind that the low frequency gain of the devices is dependent on the value of the input and output coupling capacitors. Use at least a .1 mF at the AM broadcast band. At 1 gigahertz I'm using 100 pF successfully.

The easiest way to use MMIC's is with a printed circuit board in order to

get a good ground plain. A two stage MMIC amplifier fits easily on a 1.25" x 3" board. I did not etch mine, instead I simply cut out the insulated pads I needed with my Dremel tool. To enable the MMIC's to lay perfectly flat on the board (shortest leads) drill a 3/16" hole to serve as a well to sit the device in.

Figure 2 shows the suggested layout of the board. Since MMIC's work very well up in the microwave range, good by passing is important. I use .001 ceramic chip capacitors. They have no leads and solder flat to the board between the isolated pads. The RF chokes are some grab bag ferrite beads with four turns of # 22 wire wound on them.

Remember all the hard work of impedance matching has been done for you. All you have to do is connect ohm signal source to the input and 50 ohm load to the output. If you use these for RF amplification, tuned circuits are required only for limiting the bandpass not for matching and should be on the input side. This improves dynamic range by preventing the wide band amps from amplifying signals outside the range of interest.

Next month, some uses for the MMIC amplifier.

(Cont'd from pg. 2)

grandfathered priority on the use of the newly proposed technologies."

Eureka, CD Radio, RSC and any other group that may propose DAB services are looking forward to the next World Administrative Radio Conference (WARC), to be held in Spain in 1992. A world allocation for specific frequencies for digital audio broadcasting by satellite is on the agenda for the meeting. (Allocation of channels for local service did not make the agenda.)

NOTICE

Effective immediately
all cartridges sent in to
A.V.E. for rewinding should
now be sent to:
Electronic Industries
19 E. Irving Ave.
Oshkosh, WI 54901

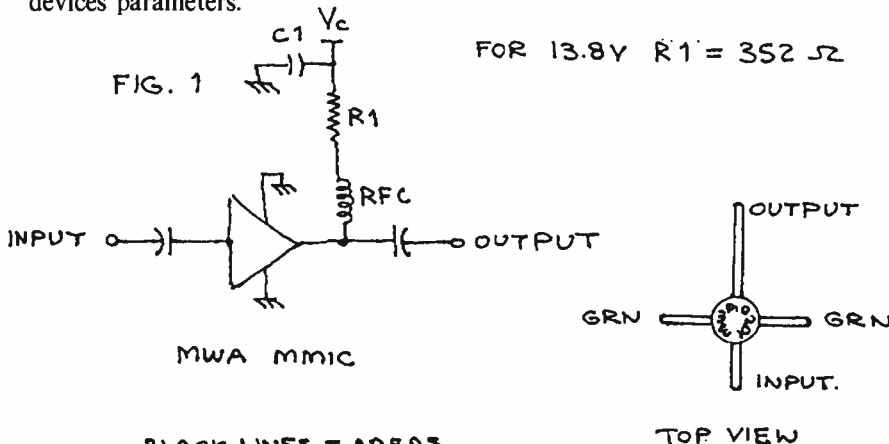

BLACK LINES = AREAS WHERE COPPER REMOVED

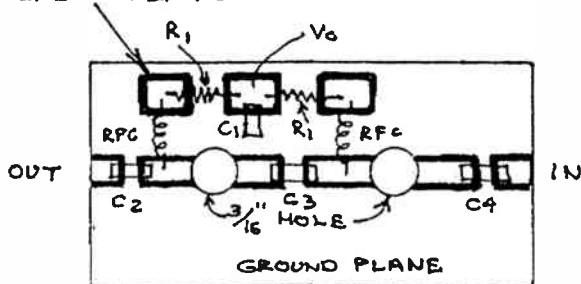

C1 .001 CHIP BYPASS
C2,3,4 CHIP COUPLING CAPACITORS

KSJO To Pay Indecency Fine

AOR KSJO/San Jose will not appeal a \$20,000 FCC indecency fine stemming from material aired by its former morning man, Perry Stone.

Explaining the decision to pay the fine without consent, KSJO GM David Baronfeld told R&R, "Frankly, we just want to get this behind us. These complaints were based on information gathered in 1988. It's ancient history."

Arguments Rejected

The FCC fine, which was announced late last month, came despite KSJO's efforts to make amends for Stone's antics. In its response to the FCC's initial inquiry, the Narragansett Broadcasting station pointed out Stone had been dismissed and it had banned "shock" humor. KSJO has issued a public apology for Stone's behavior and met with some of those who filed indecency complaints.

But in a letter notifying Narragansett of the fine, the FCC said that while KSJO's remedial actions were "perhaps ultimately effective," they were not considered when the agency weighed possible sanctions against the station. For example, Stone's dismissal was discounted by the FCC because it wasn't directly tied to one of the incidents for which KSJO was cited.

The Commission also rejected KSJO's argument that the vagueness of the FCC's indecency rules made it difficult for the station to determine whether Stone's comments, particularly those using double entendres, were indecent.

SBE Looks To The 1990s

The Society of Broadcast Engineers (SBE) has announced the initiation of a strategic planning process that will result in a formal plan to guide SBE through the 1990s.

According to SBE president, Brad Dick, "the process will be based on the recent membership survey, additional input from the current Board of Directors and the 1989 Past President's report. In addition, a focus group will be appointed to discuss the key issues facing broadcast engineers in this decade."

Dick noted that his planning process began with the 1990 member survey, "which assures that every SBE member has the opportunity to influence the society's future direction. Although other's have talked about strategic planning, those plans prevent our members having any input. My goal was to involve the entire SBE membership in the planning process. Now, we've been able to bring every member to the table and offer them the opportunity to help set our agenda. The result will be a well-conceived, accurate and successful long-

term strategic plan for SBE."

Stephen L. Ingram, CAE, Executive Director of SBE will assist the officers and directors in the development of the strategic plan. Prior to being selected as Executive Director, Ingram had worked with many professional and trade associations in developing strategic plans.

According to Ingram, "The current financial stability of the SBE is excellent. This is an appropriate time to determine the priorities of the membership and to implement the actions necessary to ensure SBE's competitive advantage for the future."

Dick reported that the target date for completion of the strategic plan will be April, 1991.

NAB Forms Digital Audio Task Force

"In accord with the policies as adopted by the NAB Radio Board of Directors, the Mission of the NAB Task Force on Digital Audio and Satellite Sound Broadcasting is to:

"1. Advise the NAB Board of Directors on the development of NAB policies regarding DAB technology;

"2. Develop recommended strategies for NAB to implement and achieve the Board policies;

"3. Analyze legal, technical, political and practical implications for DAB

(Cont. to pg. 14)

Technics SL-P370 Compact Disc Player



FEATURES

- MASH 1-bit D/A converters
- Direct track access
- Programmable to play as many as twenty tracks in any order
- Repeat of entire disc or programmed sequence
- Track skipping and fast scan (with audible output) in both directions
- Plays CD-3's without adaptor
- Display of current track number and elapsed time in track, switchable to show elapsed time

- on disc and remaining time on track or disc
- Auto-Cue to pause playback at exact starting point of next track
- Synchro-Edit for automatic dubbing on compatible cassette deck; selects tracks to fit most efficiently on both sides of tape
- Front-panel headphone jack with volume control
- Infrared remote control duplicates front-panel controls

Price
\$159.95

Electronic Industries

19 E. Irving - Oshkosh, WI 54901
Out-of-State: 800-558-0222 or
In State: 800-445-0222

FCC Cracks Down On Tower Lighting Violators

The FCC, after receiving increased reports of aircraft collisions with unlighted or improperly lighted communications towers, has begun cracking down on station compliance with tower lighting requirements.

KPSL-AM/Palm Springs, CA, was fined \$10,000 in June for failure to comply with tower lighting requirements, and the Commission says it intends to continue its close scrutiny of radio towers located near airports.

In a Public Notice (No. 3185) dated June 12, 1989, all FCC licensees were cautioned about the potential hazards to air navigation caused by improperly lighted towers.

When radio towers are greater than 200 feet in height and/or near an airport, the owner or licensee must apply for FCC issued obstruction marking and lighting specifications. During construction, temporary warning lights must be installed at the top of the structure, and at each level where permanent lights will be installed.

Licensees should ensure that their towers are marked and lighted in accordance with the specifications on their permits. Any variances must be approved by the FCC's Antenna

Survey Branch (ASB).

If a light outage occurs which cannot be corrected within 30 minutes, the local FAA Flight Service Station (FSS) must be contacted immediately. The FSS will issue a warning to pilots. The FSS must also be notified when the lights are again operational so the warning may be rescinded.

The FCC says it intends to continue to take appropriate actions, including issuance of fines and/or revocations of the station license against the user or owner of any unauthorized or improperly marked radio tower.

Tower lighting specifications are contained in Part 17 of FCC rules. An information bulletin titled "Radio Tower Painting and Lighting" (Bulletin No. FO-13) also is available at FCC local offices.

For further information, call the FCC's Antenna Survey Branch at (202) 632-7521. NAB also offers Radio and Television Towers: Maintaining, Modifying and Leasing. To order, call (800) 368-5644.

FCC Checks NRSC Compliance

Results of AM station audit by FCC's Field Operations Bureau (FOB) of check compliance with new mandatory implementation of National Radio Systems Committee

(NRSC) emission standard are "considered good news," said FOB Chief Richard Smith. FOB found 325 stations in compliance out of 374-station sample (87%). Later follow-up check of remaining 49 stations' emissions showed them to be within AM channel limitations. NRSC standard, which reduces adjacent-channel interference by limiting RF.

Broadcast News Briefs

National Public Radio has begun using Sony professional R-DAT and DASH recorders in its studios and in its field offices around the country. The equipment includes the PCM-2500 studio and TCD-D10PRO portable R-DAT recorders, PCM-3402 and 3202 two-channel DASH recorders and a PCM-3324 24-channel DASH multi-track recorders.

WNIB-FM has equipped its studios with three Tascam CD-701s. Following a demonstration by Milwaukee-based AudioLine, studio manager Bill Florian was impressed by the CD-701s features and performance. Florian said, "We wanted to get a unit that would be reliable and simple to use...they're great machines."

AC LINE SURGE SUPPRESSORS

FOR PRIMARY SERVICE PROTECTION—

EAGLE HILL Model M240 \$1650⁰⁰
208/240 V.A.C.
Single-or Three-Phase
JIC Oil-Tight Enclosure

INSTANTANEOUS PROTECTION AGAINST LIGHTNING SURGES

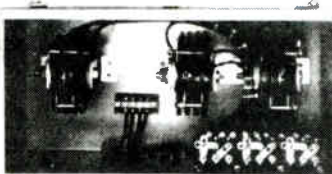

CONTINUOUS PROTECTION AGAINST TRANSIENT SURGES

EAGLE HILL Model M460 \$1980⁰⁰
380/480 V.A.C.
Single-or Three-Phase

NON-INTERRUPTING PROTECTION AGAINST SWITCHING SURGES

FOR SUB-SERVICE PROTECTION—

SMALL BUSINESSES
PROFESSIONAL OFFICES
COMPUTER INSTALLATIONS
SPECIALIZED ANALYZERS
AUTOMATIC SYSTEMS



PORTABLE PROTECTION!
Just Plug It In! Two Outlets Provided.
Handles 10, 15 or 20 Amps.
For Portable Analyzers, Chart Recorders,
Sensitive Equipment

EAGLE HILL Model SP100—10 Amp
EAGLE HILL Model SP115—15 Amp
EAGLE HILL Model SP200—20 Amp

EAGLE HILL Model M120
120 V.A.C. to
100 AMP Service

\$660⁰⁰



DISTRIBUTED BY
ELECTRONIC INDUSTRIES INCORPORATED

800-558-0222

19 E. IRVING, OSHKOSH, WI 54901

414-235-8930

DeFilippis Joins Test Center As Senior Staff Engineer

James M. DeFilippis has joined the Advanced Television Test Center (ATTC) as Senior Staff Engineer, it was announced today by Peter M. Fannon, the Test Center's Executive Director. DeFilippis comes to ATTC from Capital Cities/ABC.

DeFilippis' primary responsibility will be the engineering implementation of the state-of-the-art technical plant developed by the Test Center to permit analysis of the many new and different ways to transmitting better television pictures and sound.

ATTC Chief Scientist Charles Rhodes noted DeFilippis' contributions over the past two years as co-chair of ATTC's Test Procedures Task Force, and his active participation in the ATTC Technical Committee. "In both roles he has been instrumental in shaping our plans for testing." In announcing the appointment, Fannon said, "Jim brings to the Test Center strong experience in several fields of key importance to our work. We are pleased he will be helping ATTC create the best possible means to test these challenging new television systems."

DeFilippis joins ATTC from Broadcast Operations & Engineering at the ABC TV Network, New York City, where he has worked for the past ten years in a variety of technical development and systems engineering roles. Most recently he has been responsible for the systems engineering of the network's central switching and control facility. Earlier he participated in the development of ABC's satellite interconnection, including elements of the frequency coordination, uplink interfacing, and related RF engineering analyses.

Previously, DeFilippis worked with the Radio Systems Engineering group on both studio and network facilities, and ABC Owned Radio Stations redevelopment. This included a stint as on-site coordinator and engineering project manager for the Radio Network News Bureau in Washington, D.C.

Before joining ABC in 1980, DeFilippis held engineering positions at several stations, including AM radio outlets in New Jersey and Delaware, Columbia University's FM station, and WNET/13 television in New York.

He received his BSEE degree from Columbia University in 1980, and his MSEE from Columbia in 1990. He is a member of the Society of Motion Picture and Television Engineers, Audio Engineering Society, and the Institute of Electrical and Electronic Engineers and a New York State registered professional engineer.



\$ 1329⁰⁰

High Performance Telephone Audio With Built-In Frequency Extension.

If your format calls for a lot of telephone use, including remotes, on-air calls and interviews, Gentner's SPH-5E can simplify your operation while providing good-sounding telephone audio. The SPH-5E is a high-performance analog telephone hybrid with built-in single line frequency extension. To use the frequency extender, you press a single button. This eliminates the need for extra equipment and keeps you from tying up other console inputs for your extended remotes.

The SPH-5E provides superb telephone audio for your on-air calls and interviews. This unit's advanced analog circuitry provides the best null available in analog hybrids, keeping feedback and hollow sounding audio out of your operation. When used as a frequency extender, the SPH-5E recovers low audio frequencies that are normally lost on phone lines. This improves the bass

response of your remotes, making your announcers sound more natural on-air.*

Extra features for easy operation.

The SPH-5E was designed with simple operation in mind. You can talk with callers on-air and off-air with equal ease. The unit's CUE function toggles send audio between console mix-minus and your mic preamp. This allows you to talk to callers easily, without reconfiguring your console each time you take a call.

This feature makes it simple to set up your remotes. You can talk back and forth with the remote site off-air right until air time. Then, at the press of a button, you're sending mix-minus audio and the remote is on the air. If your console has a caller module, this process can be automated. The console will switch the send audio for you, based on whether the module is on or off.

Recording calls is easy too.

To record telephone calls, either on-air or off-air, press the SPH-5E's REC button. The unit will send both sides of the call to your tape machine, automatically starting and stopping the recorder.

No matter what the telephone requirement, the SPH-5E can give you the audio quality you want...within your budget. For ordering information, contact your favorite dealer or call Gentner at (801) 975-7200.

*A frequency extender is required on each end of the phone line. Gentner has a full line of extenders, including self-contained remote units. Call our Sales Department for details.

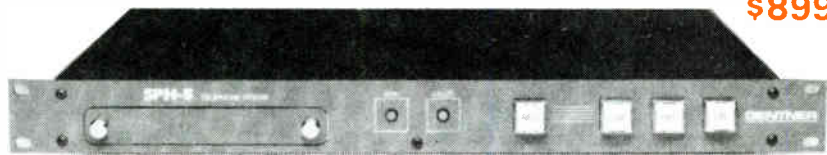

\$ 899⁰⁰

The Best Sounding Analog Hybrid You Can Buy!

If you're looking for great telephone sound without overstretching your budget, Gentner's SPH-5 is the answer. The SPH-5 is a full-featured analog hybrid that combines high quality telephone audio with operational features you'll love.

The secret to the SPH-5's great sound is Gentner's use of advanced hybrid technology. The SPH-5's unique circuitry provides the best null available in analog hybrids, keeping feedback and hollow sounding audio out of your operation. Noise and distortion are greatly reduced as well. You and your listeners will hear clean, understandable telephone audio...call after call.

The SPH-5 matches every broadcast application.

The SPH-5 is ideal for your broadcast on-air studio or newsroom. You can talk with

callers on-air and off-air with equal ease by using the unit's CUE button. When you push this button, the SPH-5 sends audio from your mic preamp down the phone line, giving you an easy, hands-free way to talk to a caller or a field news reporter off-air. Then, when you're ready to go on-air with the caller, just press the CUE button again. The SPH-5 switches back to the mix-minus feed.

If your console has a caller module, this process can be automated! The console will switch the send audio for you, depending on whether the module is on or off.

To record calls, either on-air or off-air, press the SPH-5's REC button. The unit will send both sides of the call to your tape machine and will start and stop the machine as well!

Easy, effective audio conferencing.

The SPH-5 is a cost-effective alternative to speakerphone-type audio conferencing systems. It interfaces easily with your boardroom audio system, providing full duplex telephone audio that will please everyone in the conference. The SPH-5 permits private conversations, at the press of a button, and its REC button allows you to easily record both sides of the conference.

For great telephone audio, give us a call.

Gentner hybrids can provide the solution to your daily telephone interface problems. For ordering information on the SPH-5, or to get more information on Gentner products, contact your favorite dealer or give us a call at (801) 975-7200.

Electronic Industries

19 E. Irving - Oshkosh, WI 54901
Out-of-State: 800-558-0222 or
In State: 800-445-0222

The Public Interest Should Guide Spectrum Allocation Policy, Broadcasters Tell FCC

The National Association of Broadcasters, concerned about the way the nation's airwaves might be recast in the future, criticized a federal proposal that would automatically award a "pioneer preference" to new communications services seeking radio spectrum space.

In its filing to the Federal Communications Commission (FCC), NAB said the FCC proposal would undermine "existing spectrum allocation policy emphasizing full public interest evaluation of competing needs for spectrum."

NAB said it feared the FCC's proposal would award "spectrum to possibly lessqualified applicants or to less desired services," and warned regulators against any dramatic or artificial measures that would increase the number of "unsubstantiated or premature requests for spectrum allocation."

NAB also said it was particularly concerned about "pioneer" requests for spectrum space already used by

America's TV and radio stations. "These other, newer technologies should not be encouraged to simply supplant or inhibit existing over-the-air broadcasting—a service which has a demonstrated record of success and service to the community," NAB told the FCC.

"Clearly, there are novel communications technologies planned for the near future that must be considered in the spectrum planning process," NAB said.

But, the broadcast group said, any pioneer preference policy should not displace rational spectrum allocation policy.

NAB also criticized the Commission's focus on the "profit potential" of these new communications services, calling this importance "misplaced." The FCC should instead be "more concerned over the optimum use of the radio spectrum."

In its statement, NAB said federal communication laws require FCC "accommodation of competing public interest uses of the spectrum." To measure consumer wants, NAB noted, significant market research is needed. The FCC also is obligated to determine whether existing communication technologies can do the same job as a proposed new service, NAB said.

Discounting the notion that current government policies make it difficult for small businesses to launch new communications services, NAB pointed out that technologies such as color TV, FM radio, radar, satellite and microwave communications, mobile phone service and "many more new Spectrum-using technologies" have been routinely accommodated under existing policy.

NAB chose instead to emphasize that innovation, by itself, should not be the sole criterion when weighing sweeping changes in the way the nation's airwaves are divided up.

(Cont'd from pg. 11)

technology on the existing U.S. radio broadcast industry;

"4. Determine what elements may be needed to identify new spectrum, if appropriate;

"5. Raise the awareness of the broadcasting industry on the challenges and opportunities of DAB; promote and coordinate radio broadcast industry consensus; and

"6. Monitor domestic and international DAB broadcasting activities."

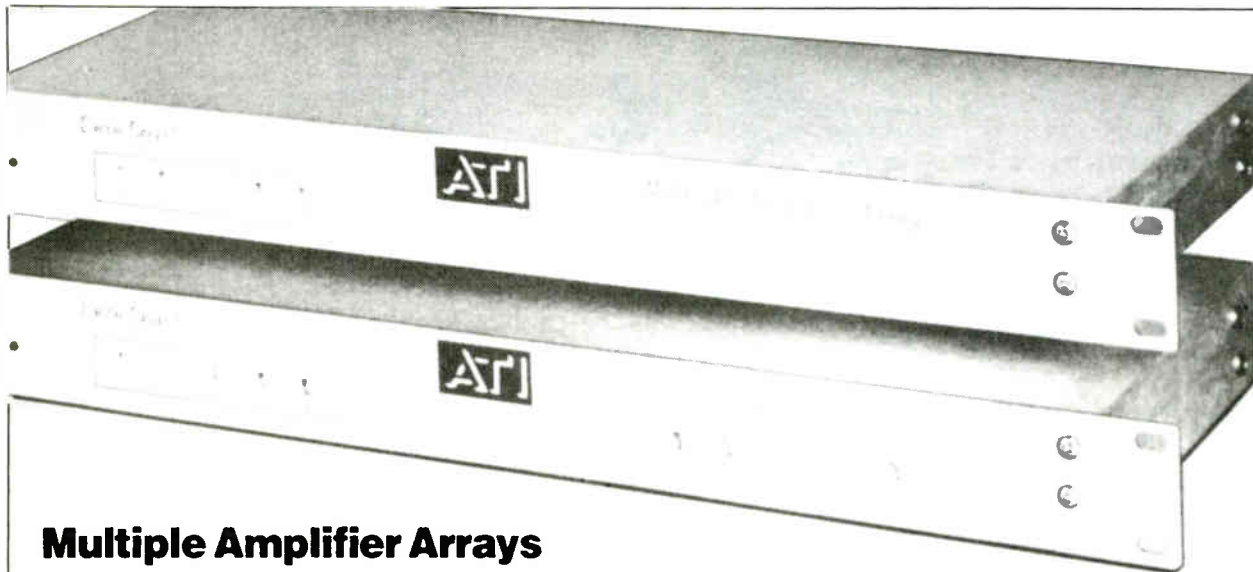

Multiple Amplifier Arrays

FROM
\$349

Four or eight channels for YOU to easily configure as Microphone, Line Buffer, Distribution and Level Matching Amplifiers. Form sum and difference networks, Interface phone lines, Drive headphones, Make a

simple Mixer or Press Box . . . just by changing jumpers. Gains to 82dB, Low noise balanced inputs. Clean + 24dBm active or transformer balanced outputs.

Configurable circuitry. . . to fit your needs.

Electronic Industries
19 E. Irving - Oshkosh, WI 54901
Out-of-State: 800-558-0222 or
In State: 800-445-0222



COMMON POINT CLASSIFIEDS

EI Classifieds

EI Classifieds are free to the readers of Common Point magazine. To place an ad type it on the acknowledgement card that comes with each issue and mail to us. We assume no responsibility for the condition of any of the equipment or services in these ads.

FOR SALE: Studiomaster, series 3 modular console; 6 stereo by 6 mono by 4 subs by 2 main outs, plus aux. return module, and regulated power supply. Excellent eq & patch points, great for 4 track rooms! \$3295 and 1 pay shipping. 509-547-9791.

FOR SALE: (4) 4-250 Eimac tubes, new in '85 in original cartons, zero hours, \$100 each. Phone 715-424-1300, FAX 715-424-1347.

FOR SALE: 100 ft., 4 inch Heliac cable; Tone Commander phone system, 6 lines/out, 40 extension; Eventide Digital Delay, 15 KHz, 7 sec; HP 650 Oscillator; HP 330 Distortion Analyzer. Call (612) 522-3628, ext. 108, Dennis Whitehead, WCTS Radio.

FOR SALE: Two Russco studio pro turntable with microtrack tonearms, \$150 each; I.T.C. R.P. mono, two tones, \$950; Two Audimax model 4450A, \$450 each. Call Bill Kuiper Jr (616) 451-9387.

FOR SALE: ITC cart machines, automation system, and RTR's. ITC premium SP's, 3-D's, and RP's in excellent condition with low hours, mono, 3-tone. SMC MSP full featured automation system, 5 years old, perfect for satellite service, live assist or full automation. Otari ARS-1000 RTR's \$1000 each. Gentner SPH-4 telephone interface. Arrakis Stereo Router switcher, 16 stereo in by 8 stereo out. All equipment in excellent condition and just taken out of service. Dutch, WDDD, Marion, IL 62959, 618-997-8123.

FOR SALE: SMC MSP Automation with: 4 Otari reel-reels, 3 SMC 350 carousels, 1 SMC 721 dual cart play backs, 3 SMC equipment racks. All real clean, on air now, available now, \$16,500; SMC 721 dual cart play back \$600; SMC 710 single cart play back, \$300; SMC 250 carousel w/random select electronics \$350; ITC RP 3 tone cart recorder, \$700; 250 reels easy listening music, all VG condition. No duplicates, \$10 per reel or offer. Jim Wenstrom, CE, WYNNE Broadcasting, 503-882-4656.

FOR SALE: 2 IGM go-cart 24 \$2500 each, 1 SMC 721 dual PB \$500, 1 SMC 710 cart PB \$250 (both SMC's in rack mount drawers). ITC stereo R/P \$1200. B&K Mod. 820 digital capacitance meter, VGC \$125. Easy listening music - 250 reels VGC no dupes \$10.00 each. Production Library (W/SFX) - mostly unopened \$250. Jim Wenstrom, CE, WYNNE Broadcasting 503-882-4656.

FOR SALE: Digimax D-1200, 9 digit frequency counter, brand new, never used, with manual. Paid \$299.95, asking \$250.00, plus shipping; Precision/Paco E-200-C RF signal marking generator, good condition with manual. \$75.00 plus UPS; Broadcast Electronics AM 400 compressor-limiter, working when removed, manual. \$225.00, plus UPS; United Transformer (1)CG-104, 10Henry, 350ma. (2) CG-44, 30Henry, 100ma, power supply chokes. \$150.00 for all, plus UPS; OHMITE, MEMCOR, IRC, high voltage, resistors, vitreous enameled, slide adjustment, 6.75 inches long, all 100 watt, various current ratings and resistances, 300 total, \$100.00, plus shipping; CCA remote control studio and transmitter units with auxiliary relay panel, \$100, plus shipping, working when removed; Tektronix model 503 scope with manual, \$100.00, plus shipping; General radio signal generator 50-250 MHZ with power supply, \$200.00, plus shipping; TOA public address amplifier model TA-958, 100 watt, \$200.00 plus shipping; Ampex 6 input mike mixer, \$150.00, plus UPS collect; Shure model SR101 series 2 audio console, 8 input, as is, \$150.00, plus UPS collect. Lloyd Spivey, Jr., Hartford, KY 42347, 502-298-3268.

FOR SALE: 1-Marti SGC-10 92KHz SCA generator (excellent); 1-Belar SCM-1 SCA mod monitor with 92 KHz (excellent); 1-XTEL AF-11R printer working, \$75; 1-XTEL AF-11R Printer for parts, \$25; 1-Marti R30/150 RPU receiver, \$200; 1-Otari ARS-1000 with SMC card, \$800; 1-Optimod 8000A, excellent, \$1,500. Contact Mark Persons, Phone 218-829-1326, FAX 218-829-2026.

BE BROADCAST ELECTRONICS INC.



FX50 FM Exciter

- Ultrastable digital modulator and digital pilot generator
- Selectable baseband equalization
- LED peak modulation display: L, R, L+R, L-R and composite signals
- Floating 50 ohm output drives long coax
- Full remote control, optically isolated control and status lines
- Delay-equalized audio low pass filters provide minimum overshoot without clippers or other non-linear devices



FS30 Stereo Generator

- THD and IMD less than 0.003% typical for true CD sound
- Unmatched 93 dB S/N typical for widest dynamic range
- 60 watt MOSFET output power to drive even the largest transmitter
- Stand-alone 60 watt FM transmitter
- Advanced linear modulated oscillator for unparalleled performance
- Computer-optimized phase locked loop greatly improves low frequency response
- Completely broadband for transparent performance
- Functional front panel controls with LCD displays

BY PURCHASING BOTH THE FX 50 AND FS 30

FX 50 FM Exciter \$6,295.00
 FS 30 Stereo Generator \$2,595.00
 Total List Price \$8,890.00

NOW JUST \$8400.00

SAVE 5%

LIMITED TIME OFFER

OFFER EXPIRES OCTOBER 1, 1990

FLUKE

70 Series Analog/Digital Multimeters

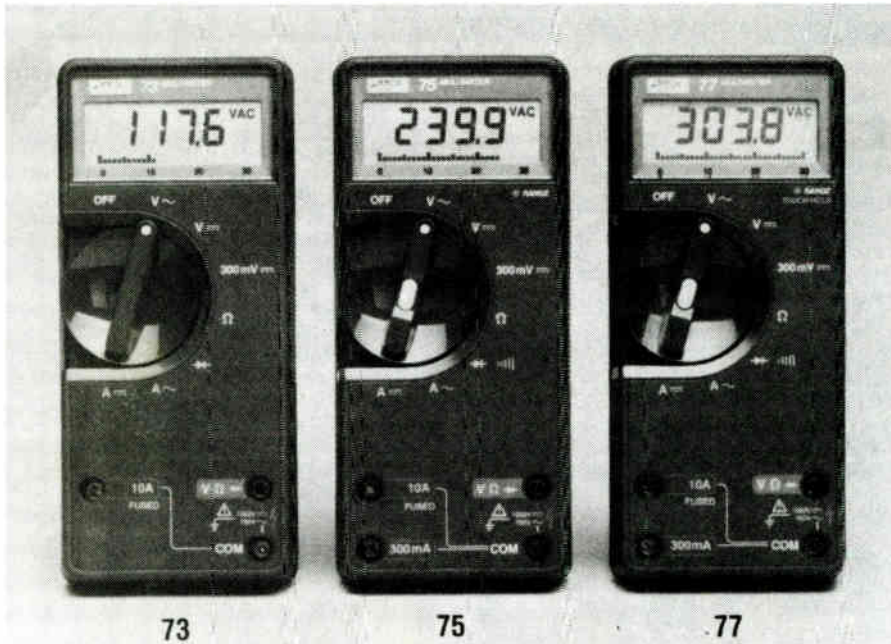

**Feature-Packed Handheld Meters
Provide Unbeatable Performance and Value**

- 3½-digit, 3200-count display
- 31-segment analog bar graph
- Single rotary dial to select all functions
- Autoranging and automatic polarity selection
- Battery-saving "Sleep Mode" powers-down display if you forget
- Tough, textured case resists drops and rough handling
- Touch Hold® (Fluke 77)
- UL 1244 listed
- Made in U.S.A.



These digital multimeters with analog bar graph displays take advantage of the latest advances in microcircuit technology to provide uncompromising quality and capabilities. The result is a series of high-performance meters with combined features never before available, even on more expensive instruments.

Operating any of the Fluke 70 Series multimeters is exceptionally simple. Choose the function you want, connect the test leads, and the meter automatically selects the correct range.

Analog/Digital Display

The high-resolution 3200-count digital display delivers better accuracy than conventional 3½-digit DMMs. A 31-segment bar graph reacts 10 times faster than the numerical display, making peaking and dipping adjustments easy.

Fast Autoranging

Simply choose a function and the meter automatically selects the range with the greatest accuracy and resolution. Symbols on the liquid crystal display show what function is being measured and the range of measurement.

Range Hold (Fluke 75 and 77)

Touching the range hold button once prevents the meter from changing ranges. Pushing the button again changes the range, and holding the button down for a couple of seconds restores the "Autorange" function. Repetitive go-no-go checks are accomplished much faster using range hold.

Audible Continuity/Diode Test (Fluke 75 and 77)

A continuous audible tone provides a fast check for continuity of current paths having 150 ohms or less. A brief tone indicates a voltage drop of about 0.6 volts, the normal forward bias for semiconductor devices passing about 500 µA.

Touch Hold® (Fluke 77)

This feature allows automatic measurements while watching probes and circuits. The meter captures the measurement, beeps, and locks it in the display until you're ready to view it. It automatically updates with each new measurement.

Standard Equipment

All 70 Series meters are packaged with a pair of safety-designed Fluke TL70 right-angle test leads, operator's manual, battery and spare fuse. The multipurpose C70 holster is included with the Fluke 77.

Basic Accuracy

(% of reading + number of digits)

	73	75	77
DC Voltage	0.7% + 1	0.5% + 1	0.3% + 1
AC Voltage	3% + 2	2% + 2	2% + 2
Ohms	1% + 1	0.7% + 1	0.5% + 1
DC Current	2% + 2	1.5% + 2	1.5% + 2
AC Current	3% + 2	3% + 2	3% + 2

Battery Life

2000 hours typical.

Three Year Warranty

One year guaranteed calibration.

Size

1.12" H x 2.95" W x 6.55" L
(28mm H x 75mm W x 166mm L)

Weight

12 oz.
(0.34 kg)

Order

Fluke 73 Multimeter	\$ 79.00
Fluke 75 Multimeter	\$119.00
Fluke 77 Multimeter/ with Holster	\$159.00
C70 Holster	\$ 14.00
C50 Compact Soft Case	\$ 15.00

Electronic Industries

19 E. Irving - Oshkosh, WI 54901
Out-of-State: 800-558-0222 or
In State: 800-445-0222