

Dec. 1987

Happy Holidays

KFXX Radio/Barry Mishkind
3222 S. Richey
Tucson AZ 85713
AZ - 857

BULK RATE
U. S. POSTAGE PAID
Permit No. 11
Winneconne, WI 54986

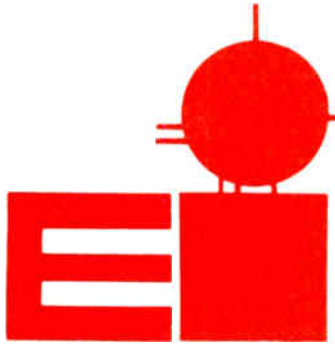

COMMON POINT®

A MONTHLY NEWSLETTER FOR BROADCASTERS

50 cents
per copy

Out-Of-State 800-558-0222 Distributed by Electronic Industries Inc., 19 E. Irving, Oshkosh, WI 54901 In-State 800-445-0222

CDs on Carts: A Capitol Idea

by Joseph Kempler, Dir Tech Mktg
Capitol Magnetic Products

Los Angeles CA...Many radio stations are broadcasting music programs directly from CDs. Those which broadcast primarily from cartridges copy their CDs onto carts, just as have always done with vinyl LPs.

There are some quality-conscious engineers and PDs who are somewhat uneasy about the sound quality of such copies, reasoning that a broadcast cartridge cannot properly reproduce what is contained on a CD.

In many respects they are quite correct. Many cartridges which use older types of tape and plastic parts with grossly deficient guiding means certainly can't do justice to a CD, or even to a good LP.

Carts challenge CD sound

These sacrifices in sound, while quite common, need no longer be accepted. Newer carts are available with many superior features. Several years ago, Capitol Magnetics took on the challenge of producing such state-of-the-art products.

The design goal required that the audible sound quality in an A-B comparison between a CD and a cartridge copy recorded from that CD be essentially identical, so neither the golden ears at the radio station nor the home listener could tell the two apart. Such quality would remain over the entire normal life of the cartridge.

Undeniably, this was quite a tall order, but I believe it has been successfully met by Capitol Magnetic's AA-4 broadcast cartridge.

The key to meeting this goal, of course, was the development of a new

tape which not only faithfully reproduces a CD, but also is virtually free from any perceptible noise, distortion, dropouts and other garbage.

The goal was accomplished at a tape speed of 7.5 ips without resorting to such exotic materials as chromium dioxide, metal powders and the like which, while capable of high performance, are totally incompatible with any of the present cartridge recorders/reproducers.

Passes listening tests

Is such a tape possible? If the acceptance criteria were to be established by laboratory measurements comparing a CD to a copy made on a tape, particularly in dynamic range capabilities, the answer is no. No analog recording on tape can match the 100 dB dynamic range of a CD without some fancy compression--expansion methods.

Fortunately, though, in the real world of music, the true measure of sound quality is the subjective perception by ear and not by meter. The design goal was to be met by subjective listening.

This is entirely fair, since it has been demonstrated in many critical auditions and blind tests that music reproduced from a good-quality tape with a flat response of about 40 to 16,000 Hz and SNR of about 60 dB will quite accurately reproduce the music contained on a CD.

Of course, tape alone cannot do it; a high-quality recorder/reproducer is certainly required to bring out the best that the tape is capable of.

A practical tape meeting these requirements is Capitol Magnetics SGS-4 tape, developed specifically

for the AA-4 cartridge. This cartridge was introduced to broadcasters in a series of "hands-on" demonstrations by recording the cartridge from a CD and simultaneously playing both back in a A-B comparison. Hundreds of audio professionals reported no audible difference.

The SGS-4 is a premium-quality tape made from a pure ferric oxide and operates at normal ferric bias levels.

Getting the contents of a CD on and off the tape is but a small part of the overall problem facing the broadcast cartridge designer.

If this were to be accomplished on a reel-to-reel recorder/reproducer, it would have been the end of the story; doing this in a cartridge is an entirely different matter. There were quite a few additional obstacles to overcome.

Consider, for instance, that a 10 minute cartridge containing 375' of tape and would in an endless coil less than 3 1/2" in diameter is continuously sliding on itself over its entire length and must run flawlessly for numerous passes.

Motion must take place with very low wow and flutter to meet broadcast standards, without transfer of the graphite lubricant to the oxide side of the tape, which would cause dropouts or depositing on the heads, where it would cause high-frequency losses.

Thus, in addition to the excellent magnetic properties, a good cartridge tape must be backcoated with a suitable lubricant which meets all of these requirements. The lubricant in the SGS-4 is the same one used in Capitol Magnetics' A-2 and AA-3 carts.

cont. to pg. 3

MARTI

RPT-15-2 Transmitter VHF-UHF

PORTABLE & REMOTE MOBILE



Model RPT-15-2 is a compact **15 watt transmitter** designed for portable and mobile remote broadcast service. It delivers the maximum power allowed by the FCC for airborne remotes such as traffic reports. The RPT-15-2 has a built-in power supply for operation on 115 V AC. It will also operate on an external 12-14 volt DC supply.

Standard features include a dual frequency and subaudible encoder for use with Marti mobile repeaters and automatic repeaters. All this plus famous Marti broadcast quality and continuous duty operation.

Mfg. list \$975.00 **CALL FOR BSW PRICE**

Model CR-10

Rack Mt. VHF or UHF base station receiver.
Single Frequency Dual Frequency

\$950.00

\$950.00

RADIO SYSTEMS



RADIO SYSTEMS PA-1 STEREO PRE-AMP

PA-1

242.00

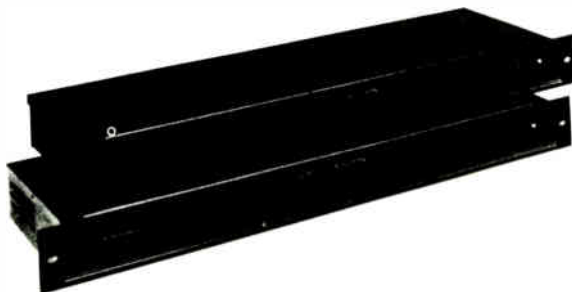

RADIO SYSTEMS DISTRIBUTION AMPLIFIERS

The DA-8 provides 8 mono outputs and the DA-16 provides 8 stereo or 16 mono outputs

Model DA-8
Model DA-16

289.00
359.00

NAB Testifies on Reimposition of Three-Year Rule

NAB Pres. Eddie Fritts testified before House Telecommunications Subcommittee Wednesday on legislation (HR.1187) to reimpose three-year anti-trafficking rule repealed by FCC in '82. Providing an overview on controversy for subcommittee members, Fritts said those broadcasters supporting reimposition of anti-trafficking "do so out of concern that the supposed turbulence in ownership of broadcast properties jeopardizes the entire range of 'public interest' programming provided by...licensees." Fritts said this concern assumes the recent rise in transfers of broadcast properties is "fueled by speculators who trade in stations indiscriminately [and] results in licensees more concerned with maximizing property value and reducing programming costs than with public interest responsibilities."

Those who oppose reimposition of rules believe that public service to the local community and broadcast property values are not mutually exclusive, but are directly intertwined, Fritts said. "These broadcasters believe public service provided by a station enhances the value of that broadcast property." He said the thinking of some in Congress seems to be that three-year rule would strengthen a broadcaster's public service efforts. "The basic economic fact is that a well run, profitable station better serves the public and is worth more to a prospective purchaser than a fly-by-night operation. The best, most successful stations are built, in part, on a strong commitment to the communities they serve." (NAB is still considering the proposed legislation and has not yet taken formal position on HR. 1187.)

Also testifying last week was NAB Board member L. Lowry Mays, Clear Channel Communications, San Antonio. Mays opposes HR. 1187 and said reimposition of three-year rule will not cure alleged deficiencies. Rather, "I believe the rule, when it was in effect, hampered the ability of station owners to serve their communities and created serious practical problems in the operation of a broadcast business."

EDITING PENCILS

WHITE CHINA
MARKERS
PACKAGE
OF 12

\$9.45

KFAX Radio/Barry Mishkind
3222 S. Richey
Tucson AZ 85713
AZ - 857

BULK RATE
U. S. POSTAGE PAID
Permit No. 11
Winneconne, WI 54986

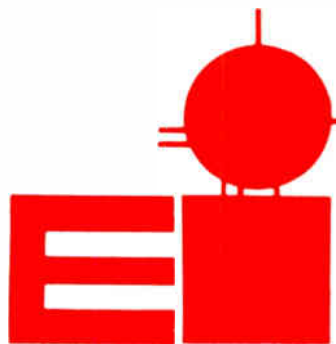

COMMON POINT®

A MONTHLY NEWSLETTER FOR BROADCASTERS

50 cents
per copy

Out-Of-State 800-558-0222 Distributed by Electronic Industries Inc., 19 E. Irving, Oshkosh, WI 54901 In-State 800-445-0222

CDs on Carts: A Capitol Idea

by Joseph Kempler, Dir Tech Mktg
Capitol Magnetic Products

Los Angeles CA...Many radio stations are broadcasting music programs directly from CDs. Those which broadcast primarily from cartridges copy their CDs onto carts, just as have always done with vinyl LPs.

There are some quality-conscious engineers and PDs who are somewhat uneasy about the sound quality of such copies, reasoning that a broadcast cartridge cannot properly reproduce what is contained on a CD.

In many respects they are quite correct. Many cartridges which use older types of tape and plastic parts with grossly deficient guiding means certainly can't do justice to a CD, or even to a good LP.

Carts challenge CD sound

These sacrifices in sound, while quite common, need no longer be accepted. Newer carts are available with many superior features. Several years ago, Capitol Magnetics took on the challenge of producing such state-of-the-art products.

The design goal required that the audible sound quality in an A-B comparison between a CD and a cartridge copy recorded from that CD be essentially identical, so neither the golden ears at the radio station nor the home listener could tell the two apart. Such quality would remain over the entire normal life of the cartridge.

Undeniably, this was quite a tall order, but I believe it has been successfully met by Capitol Magnetic's AA-4 broadcast cartridge.

The key to meeting this goal, of course, was the development of a new

tape which not only faithfully reproduces a CD, but also is virtually free from any perceptible noise, distortion, dropouts and other garbage.

The goal was accomplished at a tape speed of 7.5 ips without resorting to such exotic materials as chromium dioxide, metal powders and the like which, while capable of high performance, are totally incompatible with any of the present cartridge recorders/reproducers.

Passes listening tests

Is such a tape possible? If the acceptance criteria were to be established by laboratory measurements comparing a CD to a copy made on a tape, particularly in dynamic range capabilities, the answer is no. No analog recording on tape can match the 100 dB dynamic range of a CD without some fancy compression-expansion methods.

Fortunately, though, in the real world of music, the true measure of sound quality is the subjective perception by ear and not by meter. The design goal was to be met by subjective listening.

This is entirely fair, since it has been demonstrated in many critical auditions and blind tests that music reproduced from a good-quality tape with a flat response of about 40 to 16,000 Hz and SNR of about 60 dB will quite accurately reproduce the music contained on a CD.

Of course, tape alone cannot do it; a high-quality recorder/reproducer is certainly required to bring out the best that the tape is capable of.

A practical tape meeting these requirements is Capitol Magnetics SGS-4 tape, developed specifically

for the AA-4 cartridge. This cartridge was introduced to broadcasters in a series of "hands-on" demonstrations by recording the cartridge from a CD and simultaneously playing both back in a A-B comparison. Hundreds of audio professionals reported no audible difference.

The SGS-4 is a premium-quality tape made from a pure ferric oxide and operates at normal ferric bias levels.

Getting the contents of a CD on and off the tape is but a small part of the overall problem facing the broadcast cartridge designer.

If this were to be accomplished on a reel-to-reel recorder/reproducer, it would have been the end of the story; doing this in a cartridge is an entirely different matter. There were quite a few additional obstacles to overcome.

Consider, for instance, that a 10 minute cartridge containing 375' of tape and would in an endless coil less than 3½" in diameter is continuously sliding on itself over its entire length and must run flawlessly for numerous passes.

Motion must take place with very low wow and flutter to meet broadcast standards, without transfer of the graphite lubricant to the oxide side of the tape, which would cause dropouts or depositing on the heads, where it would cause high-frequency losses.

Thus, in addition to the excellent magnetic properties, a good cartridge tape must be backcoated with a suitable lubricant which meets all of these requirements. The lubricant in the SGS-4 is the same one used in Capitol Magnetics' A-2 and AA-3 carts.

cont. to pg. 3

NEW!

CARTING RECORDS??

YOU NEED SYNCHROSTART!

SynchroStart takes the guesswork out of carting records by **synchronizing** your turntable and cart machine. Perfectly cued carts every time with one-button ease. Automatic *audio muting strips off cue burn* for clean intros!

- Works with *any* cart recorder
- Audio start-muting for *two* turntables
- Mute-delay adjustment for *each* TT.



Electronic Industries Inc.

In Wis. 800-445-0222

Out of State 800-558-0222

In stock **\$395⁰⁰**

Editor's Notebook

It is with distinct pleasure that we welcome back this issue Dave Metz, who has been missing from Common Point a couple months now. This issue's installment is part III of "Building A Skimmer." Dave recently moved to New York and has finally gotten settled down to the point that he can start cranking out some more great articles.

It's Christmas time again so all of us here at Electronic Industries, Mims, myself, Mike and all the rest, wish you and yours the most blessed holiday season ever! Merry Christmas to everyone.

Eagle Hill PSA Adaptor

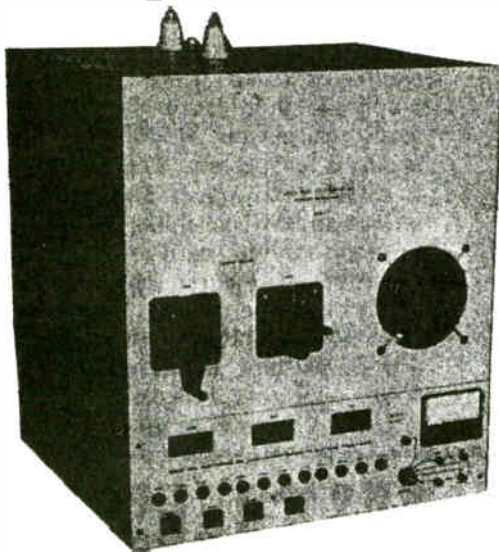

- Normal Transmitter Readings - No Internal Changes Needed
- Normal Monitor Readings Plus FCC Required Readings for Absolute Power
- Operate With Authorized Power As Low As One Watt
- FCC Authorized And Field Proven For Over A Year
- Adds Up To 150 Hours "Prime" Time Each Year

DISTRIBUTED BY

ELECTRONIC INDUSTRIES INCORPORATED

19 E. IRVING, OSHKOSH, WI 54901

OUT-OF-STATE
800-558-0222

800-445-0222



DIGITAL FREQUENCY COUNTER

D1200
D510

280.00
169.00

COMMON POINT READINGS

Metz 3
Persons 6



MEMO FROM METZ



by
David L. Metz

Memo From Metz "Building A Skimmer" Part III

The last section of our skimmer is a circuit that's been around so long, that I'm almost ashamed to present it. It's the classic op-amp balanced out-put stage. I've used this version for years, and had nothing but good success with it.

It's basically two inverting op-amp amplifiers in series. The second amp producing a output 180 degrees out of phase with the first. The result is a balanced line output.

I've chosen a 10,000 ohm input impedance since 10K is just about the standard now. It makes the stage a bridging input that will not load down the out-put of the state (cassette deck) that drives it.

The choice of op-amp can be most anything. I've been using the National LF-356 series for their low noise and wide bandwidth. In older designs, I've used the 4558 dual op-amp. If all your driving is a phone line, it's higher noise and lower bandwidth are fine.

Note that there are plenty of new op-amps on the market that might be even better choices than the LF-356. Always test your choice in real world conditions. That is, driving a long piece of twisted pair (capacitive load). Pay attention to the distortion at high output levels above 10,000 hertz.

Now about the circuit. R1 sets the input impedance. Don't go much higher or the capacitive reactance of the circuit will start to roll off the highs (I know, I tried 100K first). R2 sets the gain of the stage, the higher R2's value, the more gain. Remember this in case you need some additional amplification.

cont. to pg 6

cont'd from pg. 1

"In the real world of music, the true measure of sound quality is the subjective perception by ear and not by meter."

Cartridges too, being made of plastic and subject to molding tolerances, warping, stress relief and such, are not well suited for effective tape guiding and can easily degrade stereo phase and high-frequency response. Demanding precise tape guiding from molded plastics would be foolish, or at least unrealistic.

Machine-guide tape

A much more practical-yet very simple-design concept developed by Capitol Magnetics does not allow the cartridge to do any tape guiding. All the AA-4 cartridge must do is store the tape, feed it to the record/playback head with specified

Technics



Model SL-1200 MKII
Quartz Controlled
Direct Drive

The Broadcasters
Complete Turntable

SPECIAL \$349.00

holdback tensions and then take it up again. Tape guiding is done by the machine only, with no interference from the cartridge.

No special electrical adjustments are necessary to optimize the AA-4 to copy a CD or any other demanding music source. Bias settings for AA-4 are not overly critical; the adjustments recommended by the cartridge recorder manufacturers are fine.

We advise, however, that you correctly set the record equalization so that overall record/playback frequency response is as flat as the recorder is capable of. The nominal, maximum record level for the SGS-4 tape is 250 nWb/m, but going over by 1 to 3 dB on peaks will usually do no harm.

Having done this, put a hot CD in your player, copy it on the AA-4 cart and switch back and forth between the CD and the cartridge. If it doesn't sound like the CD, the problem is not in the cartridge.

Once recorded, this high level of performance, including the stereo phase, should remain unchanged for the life of the recording.

If you are among those skeptical broadcasters who are still uneasy about entrusting that great sounding CD to a broadcast cart, try copying it on AA-4 and prove to yourself how good a cartridge can sound.



Aglow with Love

As the warmth of holiday candles light the season, may every heart be warmed by the glow of good friends.



ELECTRONIC
INDUSTRIES

MARTI

RPT-15-2 Transmitter VHF-UHF

PORTABLE & REMOTE MOBILE



Model RPT-15-2 is a compact **15 watt transmitter** designed for portable and mobile remote broadcast service. It delivers the maximum power allowed by the FCC for airborne remotes such as traffic reports. The RPT-15-2 has a built-in power supply for operation on 115 V AC. It will also operate on an external 12-14 volt DC supply.

Standard features include a dual frequency and subaudible encoder for use with Marti mobile repeaters and automatic repeaters. All this plus famous Marti broadcast quality and continuous duty operation.

Mfg. list \$975.00 **CALL FOR BSW PRICE**

Model CR-10

Rack Mt. VHF or UHF base station receiver.

Single Frequency

Dual Frequency

\$950.00

\$950.00

RADIO SYSTEMS



RADIO SYSTEMS PA-1 STEREO PRE-AMP

PA-1

242.00

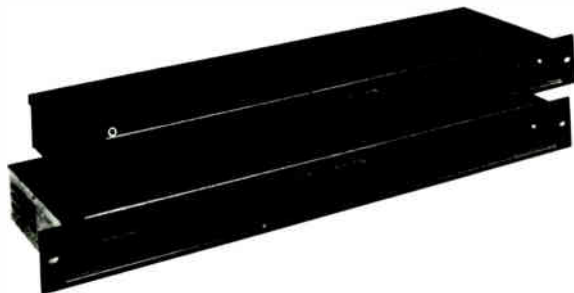

RADIO SYSTEMS DISTRIBUTION AMPLIFIERS

The DA-8 provides 8 mono outputs and the DA-16 provides 8 stereo or 16 mono outputs

Model DA-8 **289.00**
Model DA-16 **359.00**

NAB Testifies on Reimposition of Three-Year Rule

NAB Pres. Eddie Fritts testified before House Telecommunications Subcommittee Wednesday on legislation (HR.1187) to reimpose three-year anti-trafficking rule repealed by FCC in '82. Providing an overview on controversy for subcommittee members, Fritts said those broadcasters supporting reimposition of anti-trafficking "do so out of concern that the supposed turbulence in ownership of broadcast properties jeopardizes the entire range of 'public interest' programming provided by...licensees." Fritts said this concern assumes the recent rise in transfers of broadcast properties is "fueled by speculators who trade in stations indiscriminately [and] results in licensees more concerned with maximizing property value and reducing programming costs than with public interest responsibilities."

Those who oppose reimposition of rules believe that public service to the local community and broadcast property values are not mutually exclusive, but are directly intertwined, Fritts said. "These broadcasters believe public service provided by a station enhances the value of that broadcast property." He said the thinking of some in Congress seems to be that three-year rule would strengthen a broadcaster's public service efforts. "The basic economic fact is that a well run, profitable station better serves the public and is worth more to a prospective purchaser than a fly-by-night operation. The best, most successful stations are built, in part, on a strong commitment to the communities they serve." (NAB is still considering the proposed legislation and has not yet taken formal position on HR. 1187.)

Also testifying last week was NAB Board member L. Lowry Mays, Clear Channel Communications, San Antonio. Mays opposes HR. 1187 and said reimposition of three-year rule will not cure alleged deficiencies. Rather, "I believe the rule, when it was in effect, hampered the ability of station owners to serve their communities and created serious practical problems in the operation of a broadcast business."

EDITING PENCILS

WHITE CHINA
MARKERS
PACKAGE
OF 12

\$9.45

NAB Backs Overhaul of FCC's One-To-A-Market, Duopoly Rules

WASHINGTON, June 19. -- The National Association of Broadcasters said the Federal Communications Commission should eliminate its one-to-a-market rule and relax its duopoly rule for AM. The Commission has proposed relaxing both rules.

The one-to-a-market rule prohibits the common ownership of commercial radio and television stations in the same market. The duopoly rule prohibits ownership of two or more commercial stations in the same service in the same market (where there is overlap of the 1 millivolt per meter contours).

NAB Group Radio Committee Chairman Joseph I. Dorton, president, Sky Broadcasting, Detroit, MI, said, "Studies show that the number of media outlets has increased dramatically, which calls for a reexamination of these rules. By dropping its one-to-a-market rule and fine tuning its duopoly rule, the FCC could give a tremendous boost to AM radio."

In comments filed with the FCC, NAB said that developments in the communications marketplace mandate a paring back of these restrictions, especially as they relate to AM radio. As examples, it cited the growth in the number and types of competing media voices and the potential benefits the public would derive from combined station operations.

While the Commission has focused on the benefits of elimination of the one-to-a-market rule for AM stations, NAB said that the diversity in both large and small markets provides justification for the rule's elimination to permit any combination of outlets. For example, NAB said an owner should be permitted to own an AM-FM/VHR in the same market. It said the FCC should allow stations to realize the inherent economic benefits from efficiencies made possible from joint ownership which could be passed on to the public in the form of additional public service.

Regarding duopoly, NAB said AM is no longer the dominant radio service that it was at the time of the inception of the duopoly rule and that by relaxing it many of AM's problems may be remedied by improving the service's competitive status. However, since the 1mV/m standard does not adversely affect the FM service, NAB said it does not support changes to the FM duopoly rule at this time.

NAB serves a membership of

more than 4,900 radio and 930 television stations, including all the major networks.

NRSC Announces New AM Broadcast Standards Proposal

ANAHEIM, CA, -- Additional voluntary standards to further reduce interference on the AM band were proposed Sept. 10th by the National Radio Systems Committee (NRSC).

The standards would mask unwanted radio-frequency emissions and complement the NRSC standards now being implemented by AM stations to improve their audio and adhere to a uniform 10 kHz bandwidth. Currently, undesired RF emissions from AM stations can cause interference to other stations on nearby frequencies. However, stations that implement and properly operate with NRSC's current audio and bandwidth standards without making further modifications.

NRSC, a joint committee sponsored by NAB and the Electronic Industries Association, announced the RF emission standard today at NAB's Radio '87, the Management, Programming, Sales and Engineering Conference being held through September 12 at the Anaheim Convention Center.

NAB Radio Board Chairman Jerry R. Lyman, president, RKO Radio, New York, NY, said, "Together with the NRSC audio standard adopted earlier this year, adoption of the new emission limitation standard will virtually eliminate AM splatter interference, resulting in a significant technical improvement in the AM band as a whole."

Citing a 1986 NAB technical report on AM overmodulation showing that "meeting Federal Communications Commission overmodulation limits is no guarantee of a clean signal," the NRSC proposal tightens out-of-band emission limitations for AM stations and assures an absence of "splatter" AM interference. The NRSC established a six-month public comment period.



audio-technica.



Model ATP-12T

Time for a tone arm upgrade? Now is the time to buy one of the best selling tone arms in broadcast. The ATP-12T features adjustable weights, removable headshell and offers minimum tracking error.

Mfg. list \$195.00 \$155.00 ea.

Buy 2 or more \$149.00 ea.



AT 8410A

Universal shock mount with clothespin clamp. Fits most sizes and shapes of microphones. A must if you use spring loaded mic booms. The AT 8410A reduces most of all transient noise generated by the boom. Buy several and save.

Mfg. list \$34.50 \$29.50

2 or more \$24.50 ea.



audio-technica.
Microphones

UniPoint™

AT 857
\$139.95



AT 8055
\$52.95

MINIATURE
OMNIDIRECTIONAL



AT 801
ELECTRIC CONDENSER
\$78.95



AT 812
UNIDIRECTIONAL
\$92.95

PERSONS' POST SCRIPTS

by Mark Persons



SBE Convention Successful

The second annual Society of Broadcast Engineer's National Convention in St. Louis, Missouri November 10, 11 & 12, 1987 was a huge success. There were 1800 pre-convention registrants with an unofficial 3000 engineers attending plus wives and exhibitors. This is reported to be double last year's totals.

I found St. Louis a friendly city in spite of its baseball team's loss to the Minnesota Twins in the recent World Series. Well known Minnesota boy and speaker, Wally Johnson, P.E. was unable to attend because he was undergoing knee surgery at Mayo. Wally is a former chief of the Broadcast Bureau now in private practice and is a tireless international radio frequency treaty negotiator. He has worked long and hard looking out for the interests of our country as the RF spectrum is carved up.

John Battison did a good job lining up technical speakers for the convention sessions. Separate radio and television presentations were held simultaneously to make maximum use of the attending engineer's time.

Three of the radio talks dealt with the next NRSC (National Radio Systems Committee) AM audio pre-emphasis and 10 KHz low pass filter standard. All comments were positive. No one that I saw or heard from was opposed to the standard. Many stations have reported greatly improved air-sound as a result of instituting the standard. Delta Electronics showed a prototype of a Splatter Monitor that dramatically

shows on a meter and speaker how second adjacent channel interference is reduced when an NRSC filter is switched into a transmitting system. The Delta Splatter Monitor also has an incidental phase detector which can be used to adjust neutralization and tuning in all AM transmitters. I like this process to that of adjusting synchronous AM noise in FM transmitters. Many engineers have been ignoring these finer points of tuning. Poorer audio quality is the result of their lack of experience or thoroughness. Delta's chief design engineer, Tom Wright, said he is seeking input from broadcasters before they go into production of the Splatter Monitor. He said Delta marketing is targeting the price at under \$2,000.00.

Another technical innovation shown, I believe for the first time, was a DAT (Digital Audio Tape) recorder from Sony. It uses a helical scan head on a 3/16" reel to reel tape cartridge. The cost is only \$5,000. However, it is a consumer oriented system and does not have good cue capabilities like a cart or open reel to reel. ITC/3M has the only true broadcast digital cart machine on the market at this time.

The SBE reported a 16% growth in membership this past year. They are also playing an increased role in frequency coordination. One entire morning at the conference was devoted to the subject. The SBE also held certification exams for members one day as well.

Steve Brown, chief engineer of WLTE-FM in Minneapolis, was moderator for a "Nuts and Bolts" engineering session that was well attended and received. Nuts and Bolts in an interchange of ideas between broadcast engineers on problems and solutions.

Probably the most important speaker was Alex Felker, who is the new head of the FCC's Mass Media Bureau. My initial reaction to his talk was good. However, he disappointed many in the audience by not taking a stand on the AM Stereo issue. He said rulemaking proceedings to name a single AM Stereo system as the national standard might take two years. It was pointed out to him that we have already waited five years under the "marketplace" approach and that most broadcasters and receiver manufacturers are still taking a "wait and see" approach. Lack of a standard has and will continue to hinder AM and AM Stereo. Canada, Australia, and Brazil have officially adopted C-QUAM as their national AM Stereo standard. The United States should too.

The next annual SBE Convention

will be in Denver in September, 1988. John Battison will again plan the technical program.

Editor's Note: Mark Persons was a speaker Tuesday afternoon at the SBE Convention. His topic was station maintenance and it was very well received.

Daytimer's Advisory

FCC decision on granting Class III AM daytimers new nighttime operating authority (at or near lowest post-sunset power) is now expected in October. However, FCC is determining extent to which effective date of action might have to be delayed -- by several weeks -- due to international notification requirements.

Cont'd from pg. 3

The 22PF capacitor across R2 and R5 rolls off the gain of the op-amp at super sonic and RF frequencies. This eliminates some RFI and oscillation problems. Use a good quality silver mica or polyester cap here. It has to have short leads and low reactance at RF.

C1 & C2 block any DC voltage from the o-amps being sent out on the line. Remember the input is DC, so check the offset voltage of what evers going to drive this circuit. The larger C1 & C2 are, the better the low frequency performance. Theoretically they should be non-polar, but I've only used polarized ones.

Some purists might even want to experiment with bypassing C1 & C2 with say .22 metallized polyester capacitors to lower high frequency distortion.

R3 & R6 give the op-amps some current limiting in case of a short on the line and also isolate the amps from some of the lines capacitive reactance. Check your op-amps current capacity to determine the proper value.







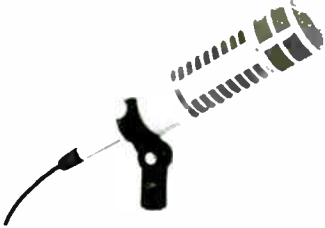

Do not use ferrite beads for RFI suppression on the output side of the amps. At line level and current, I've had serious distortion caused by the little ferrite cores magnetically saturating. If you have a problem with RFI, save the beads for the inputs (damned little current there) and use air wound RF chokes and .001 coaxial bypass capacitors for the outputs.

One last note, some cassette decks have pretty puny power supplies. Don't be afraid to add some good quality 100 to 2,200 MFD filter caps or additional regulation if required.

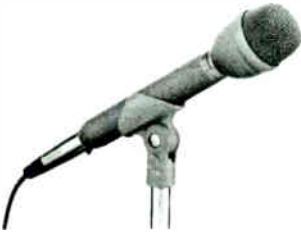
Next month if I find all my notes, we'll start build a cart machine. -

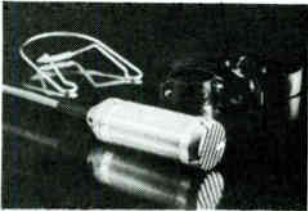
cont. to pg. 12

YOUR HEADQUARTERS FOR ELECTRO-VOICE PROFESSIONAL MICROPHONES

 <p style="margin-left: 20px;">RE18 Shock-mounted Variable-D® Cardioid</p> <p style="text-align: right; margin-right: 20px;">\$204.00</p>	<p style="margin-left: 20px;">RE20 Variable-D® Cardioid</p> <p style="text-align: right; margin-right: 20px;">\$360.00</p> 
 <p style="margin-left: 20px;">644 SOUND SPOT® DUEL-Z DYNAMIC</p> <p style="text-align: right; margin-right: 20px;">\$188.00</p>	<p style="margin-left: 20px;">RE15 VARIABLE-D® SUPER-CARDIOD</p> <p style="text-align: right; margin-right: 20px;">\$189.00</p> 
 <p style="margin-left: 20px;">RE50 Omnidirectional Noiseless, Hand-held</p> <p style="text-align: right; margin-right: 20px;">\$108.00</p>	<p style="margin-left: 20px;">RE55 Omnidirectional</p> <p style="text-align: right; margin-right: 20px;">\$179.00</p> 
 <p style="margin-left: 20px;">RE85 Noiseless Lavalier</p> <p style="text-align: right; margin-right: 20px;">\$109.00</p>	<p style="margin-left: 20px;">635A Omnidirectional</p> <p style="text-align: right; margin-right: 20px;">\$74.00</p> 
PROFESSIONAL CONDENSER MICROPHONE SYSTEMS	
 <p style="margin-left: 20px;">CO15P Omnidirectional System</p> <p style="text-align: right; margin-right: 20px;">\$219.00</p>	<p style="margin-left: 20px;">CS15P Single-D Cardioid System</p> <p style="text-align: right; margin-right: 20px;">\$190.00</p> 
 <p style="margin-left: 20px;">658L CARDIOD DYNAMIC WITH SWITCH</p> <p style="text-align: right; margin-right: 20px;">\$47.69</p>	<p style="margin-left: 20px;">PROFISSIONAL MICROPHONE MIXER</p> <p style="text-align: right; margin-right: 20px;">\$374.00</p>  <div style="margin-top: 10px;"> <p>Features</p> <ul style="list-style-type: none"> • 4 mic or line inputs • Phantom power • Peak Limiter • AC/DC power • Headphone amplifier • 1 khz tone oscillator • balanced inputs/outputs </div>

10% OFF With 3 Mikes Or More

ELECTRONIC INDUSTRIES INC.

IN WIS. 800-445-0222

OUT OF STATE 800-558-0222

Common Point/Dec. 1987
Page 7

Nortronics Clearance End of The Year

QTY	DESCRIPTION	PRICE
2	NS-1001 Heads	24.10
1	NS-1401 Heads	40.40
2	NS-2000 Heads	40.40
2	NS-2002 Heads	40.40
1	NS-2051 Heads	45.45
1	NS-2051D Heads	45.45
2	NS-2056 Heads	45.15
1	NS-2057D Heads	45.15
1	NS-3201 Heads	29.15
1	NS-3202 Heads	29.15
1	NS-3251 Heads	37.00
2	NS-5230A Heads	11.35
2	NS-5410 Heads	79.20
2	NS-5411D Heads	79.20
1	NS-5703 Heads	84.80
1	NS-5751 Heads	90.65
1	NS-5751D Heads	90.65
1	NS-5753 Heads	90.65
2	NS-5800 Heads	9.60
2	NS-6103 Heads	59.55
1	NS-6127 Heads	42.75
3	NS-7605 Heads	2.80
1	NS-7655 Heads	10.80
2	NS-8206 Heads	93.30
2	NS-QK114 Mounting Assy.	34.75
2	NS-QM230 Eraser	18.87
2	NS-8702 Heads	25.55
3	NS-9100 Heads	60.50
5	NS-9101 Heads	60.50
1	NS-9113 Heads	62.30
1	NS-9203 Heads	68.50
2	NS-9204 Heads	68.50
2	NS-9207 Heads	68.50
1	NS-9213 Heads	68.50
2	NS-9222 Heads	67.75
1	NS-9223 Heads	67.75
2	NS-9226 Heads	67.75
2	NS-CH3NB Contactor Head	32.35
1	NS-QM-704 10 pack	8.00
2	NS-QM-702 10 pack	8.00
2	NS-QM-703 10 pack	8.00
1	NS-QM-333 Splicer	2.60
1	NS-QM-527 Splicer Tabs	box 9.00
2	NS-CC-70 Plug	6.50
3	NS-CC-77 Connector	8.20
4	NS-TC-54 Clips	13.15
2	NS-TC-191 Clips	26.45
1	NS-QK-18 Mounting Assy	2.65
1	NS-QK-19 Mounting Assy	2.65
1	NS-QK-38 Mounting Assy	2.30
2	NS-QK-66 Mounting Assy	2.30
5	NS-QK-74 Mounting Assy	4.75
2	NS-QK-79 Mounting Assy	3.70
4	NS-QK-93 Mounting Assy	3.70
4	NS-QK-94 Mounting Assy	14.40
6	NS-QK-95 Mounting Assy	6.95
15	NS-QK-102 Mounting Assy	7.45
1	NS-QM-102 Head Cleaner	6.60
3	NS-AT-210 Alignment Tape	7.74
2	NS-QK-701 Bias Oscillator	61.95
1	NS-QM-380 Head Degausser	20.30

Sescom Clearance 1/2 Price End of The Year

QTY	DESCRIPTION	PRICE
6	SJ-32J0005 Solid Control	3.83
2	SJ-35J0001 Knob	.76
2	SJ-37J0001 Control	.76
6	SJ-58J0002 Octal Socket	2.22
2	SJ-66J0092B Transformer	69.42
2	SJ-C-2 Compressor	45.51
1	SJ-HP-1 High Pass Filter	37.60
4	SJ-IL-7 Transformer	33.00
2	SJ-LA-4 Line Amp	85.00
1	SJ-LP-1 Low pass Filter	38.66
4	SJ-MIC-4 Microphone	41.83
1	SJ-MIC-5 Microphone	40.00
1	SJ-MLD-1 Mic Line Driver	129.00
1	SJ-NAB-2 Tape Pre-Amp	33.00
1	SJ-NAB-3 Tape Pre-Amp	33.00
1	SJ-PA-2 Power Amp	74.00
2	SJ-PA-3 Power Amp	83.50
3	SJ-PH-2 Magnetic Phono Pre-Amp	33.00
2	SJ-PS-1 Power Supply	56.17
2	SJ-SA-2 Pre-Amp	33.00
2	SJ-SF-1 Shelving Filter	33.00
2	SJ-SWO-2 Oscillator	45.77
4	SJ-TC-2 Tone Control	23.33
6	SJ-MI-8 Audio Transformer	26.00
3	SJ-MI-22 Audio Transformer	26.00
2	SJ-MI-53 Audio Transformer	19.50
1	SJ-MI-59 Audio Transformer	9.34
6	SJ-MI-69 Audio Transformer	24.50
2	SJ-MI-71 Audio Transformer	19.81
1	SJ-MI-75 Audio Transformer	24.50
2	SJ-MI-76 Audio Transformer	24.50
5	SJ-MI-82 Audio Transformer	30.75
6	SJ-MI-83 Audio Transformer	30.75
1	SJ-MI-93 Audio Transformer	24.50
1	SJ-MI-94 Audio Transformer	24.50
6	SJ-MI-112 Audio Transformer	24.50
1	SJ-RP-3 Audio Transformer	40.00



CS-91

This is a professional headset designed specifically for live remote broadcasting such as sports events. The dynamic boom microphone allows full freedom of head movement while the circumaural ear cushions screen out unwanted background noise. The omnidirectional pattern of the microphone enhances the "live" flavor of the broadcast. Audiometric type receivers resist shock and are stable in all kinds of weather. Complete with push-to-cough switch and clothing clip.

73.1400 Remote control authorizations.

(a) An AM, FM, or TV station transmission system may be operated by remote control using the procedures described in 73.1410.

(b) No authorization from the FCC is required to operate the transmission system of an AM station operating with a nondirectional antenna, FM station, or TV station by remote control. Authority to operate an AM station using a directional antenna system by remote control is obtained using the following procedures:

(1) An application for a construction permit to erect a new directional antenna or make modifications in an existing directional antenna, subject to the sampling system requirements of 73.68, may request remote control authorization on the permit application FCC Form 301 (FCC Form 340 for noncommercial educational stations).

(2) A licensee or permittee having a sampling system in compliance with the provisions of 73.68(a) must request remote control authorization on FCC Form 301-A, and submit information showing that the directional antenna sampling system has been constructed according to the specifications of 73.68(a).

(3) A licensee or permittee of a station not having an approved directional sampling system in compliance with the provisions of 73.68(a) must request remote control authorization on FCC Form 301-A, and submit information showing that the directional antenna is in proper adjustment and further showing the stability of the antenna system during the 1-year period specified in Section II of Form 301-A.

(c) Whenever a remote control point is established at a location other than at the main studio or transmitter, notification of that remote location must be sent to the FCC in Washington, D.C. within 3 days of initial use of the point. This notification is not required if responsible station personnel may be contacted at the transmitter or studio site during hours of operation when the remote control operator is elsewhere.

73.1410 Remote control operation.

(a) Broadcast stations operated by remote control must provide at remote control points sufficient control and operating parameter monitoring capability to allow technical operation in compliance with the Rules applicable to that station and the terms of the station authorization. AM stations that are required to change modes of operation during the

broadcast day must provide sufficient redundancy to assure that such mode changes actually occur.

(b) The remote control system must be designed, installed, and protected so that the transmitter can be activated or controlled only by licensed transmitter operators authorized by the licensee.

(c) The remote control and monitoring equipment must be calibrated and tested as often as necessary to ensure proper operation.

(d) The remote control system must be designed so that malfunctions in the circuits between the control point and transmitter will not cause the transmitter to be inadvertently activated or to change operating modes or output power.

(e) Whenever a malfunction causes loss of accurate indications of the transmitter operating parameters, use of remote control must be discontinued within 3 hours after the malfunction is first detected. If the station is found to be operating beyond the terms of the station authorization and such malfunction cannot be corrected by remote control, station operation must be immediately terminated.

(f) AM stations may use amplitude or phase modulation of the carrier wave for remote control telemetry and alarm purposes. FM stations may use aural subcarriers and TV stations may use either aural subcarriers or signals within the vertical blanking interval for telemetry and alarm purposes. Use of such remote control signals must be in accordance with the technical standards for the particular class of station.

NAB to Pursue Radio-Only License Renewal Reform

NAB Exec Committee has decided to halt NAB's push for TV license renewal reform, but pursue radio-only legislation. NAB Joint Board Chairman Wally Jorgenson, Jefferson-Pilot Communications, Charlotte, NC, told reporters last week: "It's a very important issue, but we're not about to give away the store to get it [in trade-off for compromises on other items]." In Oct. 6 letter to renewal reform House author Al Swift (D-WA), NAB Pres. Eddie Fritts said NAB "deeply appreciates your personal efforts to achieve a consensus [on your draft compromise proposal]. But, on balance, there

appears to be general agreement among our Board of Directors that the compromise proposal would not be in the overall interests of the industry."

In urging Swift to pursue radio reform, Fritts said "the inherent differences between radio and TV and the plethora of AM and FM stations... dictate different standards and requirements for these diverse media outlets." Later, on Capitol Hill, Swift told reporters he's not interested in radio-only bill at this time.

NRSC Standard Stations - From West Palm Beach to Golden Gate

Louis Maierhofer, GM of WKMC, Roaring Spring, PA, tells NAB TODAY that while "quite a few radio stations are setting the pace in their home markets" with the new NRSC Standard for AM stations, "we have difficulty making local news because several newspapers look on us as competitors and because they favor the glamour of TV news. We submitted a news release and 'lo and behold, we received coverage." Maierhofer suggests other stations may score on similar news releases if they take time to send press material to all their dailies and weeklies. NAB salutes these stations who have reported their adoption of NRSC Standard in past several days:

KTAN, Sierra Vista, AZ; KDES, Palm Springs, CA; KCBS, San Francisco; WDCQ, Cape Coral, FL; WEAT, West Palm Beach, FL; WGGA, Gainesville, GA; WKBF, Rock Island, IL; KADR, Elkader, IA; KICI, Lake Charles, LA; KTIB, Thibodaux, LA; KAUS, Austin, MN; WNYR, Rochester, NY; WSPD, Toledo, OH; CHIN, Toronto, Ontario; KYW, Philadelphia; WPPA, Pottsville, PA; WRCP, North Providence, RI; WCSC, Charleston, SC; WGCD, Chester, SC; KIAT, Houston; WINA, Charlottesville, VA; WFAX, Falls Church, VA; KAIE, Tri Cities, WA; WAUK, Waukesha, WI.

E.I. Spotlights On NEW PRODUCTS



Power Controller

Delta's APC-1 Automatic Power Controller measures a sample of the transmitter output power and, by interconnection to the transmitter's Raise/Lower power controls, causes adjustments to be made to keep operation well within the FCC limits.

Originally designed to provide a means for stations to operate under ATS rules, most recently the APC-1 has been used to provide automatic power control to older FM transmitters.

Use of the APC-1 eliminates the worry of under-or over-power operation due to tube aging or power line fluctuations, says the company.

The APC-1 lists for \$1750.



Console

Broadcast Electronic's new Mix Trak 90 modular console was designed purely as an on-air radio console.

Users can choose either a twelve or eighteen channel mainframe and equip it with a wide variety of modules and options.

With the optional Source Sequencer, console operators can "program" a series of events that can be activated at the touch of a switch.

Available modules include both microphone and line input modules, each with Penny & Giles linear faders, VCA gain control, Hall Effect switches and balanced patch points.

ENG Stereo Microphone

AKG ACOUSTICS—The C-522 ENG stereo microphone is designed primarily for hand-held use by field reporters. Acoustically tuned to transmit the voice clearly, the mike's wide frequency range also makes it suitable for music recordings. The C-522 ENG contains two cardioid condenser capsules, with a 90-degree opening angle, in close proximity to each other. The X/Y technique allows for the quick action required in outdoor reporting. Balanced weight distribution provides comfortable long-term handling. The electronics and transducer are elastically suspended and isolated from the housing and connector to prevent handling and cable noise. (Circle 102)

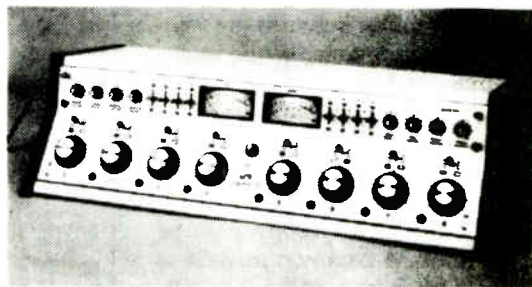

Console

LPB's new Signature III audio consoles include six, eight, 10 and 12 mixer dual mono and stereo consoles.

Signature III consoles offer a more modern look in the familiar "form factor" of prior Signatures. Knobs and VU meters are all new.

The consoles offer three inputs per mixer, rotary Shallco step or optional Penny & Giles faders, plug-in modules, LED peak indicators, switchable mic gain, all transformer inputs and outputs and RFI immunity.



Unidirectional Condenser Lavalier

SHURE BROTHERS—The SM84 professional-quality unidirectional condenser lavalier microphone is designed for demanding broadcast and sound reinforcement applications to solve ongoing problems of extraneous sound bleedthrough and to permit more gain before feedback. Shure engineers modified the performance of the SM83 omnidirectional lavalier condenser mike by developing a supercardioid pickup pattern to reject unwanted peripheral sounds. The specially tailored frequency response is retained to overcome the chestresonance phenomenon. (Circle 107)

Two-way Communication System

AUDIO-TECHNICA—The Audio-Technica Modu-Comm two-way communication system, first introduced in the AT4462 stereo field production mixer, has expanded with the introduction of two support products: the AT4522 Modu-Comm decoder and the AT4512 Modu-Comm headset. When used with the AT4462 mixer, the AT4522 decoder allows full duplex communications with on-air talent over a single conventional microphone cable. The AT4512 headset allows the mixer operator to monitor the program audio signal and communicate with the on-air talent. (Circle 106)

Ball, Berle to be Inducted Into Broadcasting Hall of Fame

WASHINGTON, Oct. 2. -- Lucille Ball and Milton Berle have been named television recipients for the National Association of Broadcasters' Broadcasting Hall of Fame Award. Radio recipients will be announced following NAB's semi-annual Board of Directors meeting in January.

The award was established in 1976 to recognize those individuals who have made significant contributions to the radio industry. It was expanded to include television at the August meeting of NAB's Executive Committee. Ball and Berle will be inducted at the television luncheon during the Association's annual convention April 9-12 in Las Vegas. The radio inductees will be honored at the radio luncheon.

NAB Television Board Vice Chairman and Convention Committee Co-Chairman Margo Cobb, vice president/general manager, W1.BZ-TV, Bangor, ME, said, "It is a pleasure to honor Lucille Ball and Milton Berle for the numerous contributions they made to television while it was in its infancy and continuing on into its mature years. They are true industry pioneers."

Four-time Emmy Award winner Ball's "I Love Lucy" became an instant hit when it premiered in October 1951. Three generations have grown up with their favorite redhead, enjoying her three successful comedy series and their re-runs. She came to television following a successful movie career and to date has made more than 80 pictures. In addition to a number of TV specials, she also has starred in the successful radio show "My Favorite Husband" and on Broadway in "Wildcat."

Berle, widely known as "Mr. Television," made his screen debut at age five with Charlie Chaplin, and his radio debut in 1928 with Rudy Vallee. He was a top vaudeville and cafe entertainer and became television's first giant when on June 8, 1948 he launched the "Texaco Star Theatre." As a result, "Uncle Miltie" was born and Tuesday nights at 8:00 became a national institution. He continued on television in a succession of shows and won an Emmy nomination for his dramatic performance in "Doyle Against the House." He also has written more than 400 songs.

NAB serves a membership of more than 5,000 radio and 940 television stations, including all the major networks.

NAB/BFM Release 1987 Report On Radio Compensation, Benefits

WASHINGTON, -- The National Association of Broadcasters and the Broadcast Financial Management Association have published the 1987 Radio Employee Compensation and Fringe Benefits Report.

It contains 34 different tables based on revenue categories, station type (AM fulltime, AM daytime, FM and AM/FM), and categories of market population. Each table contains the average and median base salary for 12 different department heads as well as their average and median annual bonus. Also included in each table are average, median and average starting salaries for 12 different support staff positions.

NAB Radio Board Chairman Jerry R. Lyman, president, RKO Radio, New York, NY, said, "Although the response to the survey is less than we would like it to be, the figures give station management a general idea of compensation being paid in the various markets."

The average and median compensation for sales staff, as well as the percent of stations using each of eight different compensation methods also are in the tables. The final area in each table is fringe benefits information including average number of paid holidays and paid sick days as well as the amount of vacation offered.

Of the 8,837 stations on the air during May 1987, 1,433 facilities representing 2,075 stations completed the survey. This results in an estimated response rate of 23.5%. Because of the low response rate, care should be taken when interpreting the data.

Findings include that, as of March 31, 1987, chief engineers had an average salary of \$23,792, program directors \$25,162, operations directors \$25,970, and on-air personalities \$17,445. In the sales area, account executives averaged \$24,043 in salary, bonuses and commissions from April 1, 1986 through March 31, 1987, and general sales managers' compensation package averaged \$44,097 during that period.

The report is available from NAB Station Services at \$40 for members and \$80 for nonmembers. Call (800) 368-5644 for ordering information.

EI Want Ads

EI Want Ads are free to the readers of Common Point Magazine. To place an ad, simply write it on the Acknowledgement Card that comes with each issue and mail card.

WANTED TO SELL

Two Carousels, Best Offer. M. Lange, WZDM, 1309 Old Orchard Rd., Vincennes, IN 47591. 812-886-5012.

McMartin B910 Exciter with stereo card and some spares on 102.9 MHz. \$1,000 P. Jellison, WBL.Y/WAZU, 117 S. Fountain, Springfield, OH 45502. 513-324-5643.

Rust Remote Control unit, Best Offer. M. Lange, WZDM, 1309 Old Orchard Rd., Vincennes, IN 47591. 812-886-5012.

ERI 25kw Iso-Coupler on 102.9 MHz. Can be re-tuned. \$2,000. P. Jellison, WBL.Y/WAZU, 117 S. Fountain, Springfield, OH 45502. 513-324-5643.

Audio Metrics S-220 tone arm, new, but not packaged, \$29.95 as is. Call E.I. 800-558-0222 or 800-445-0222.

Tellabs 4425 Dual Repeat Coil Card, New, \$44.00. Call E.I. 800-558-0222.

STL Azimuth & Level Set Test Cart, 12,500 Hz, NAB format, stereo, Audiopak A-2 cart, new, \$15.00. Call E.I. 800-558-0222.

STL Q Track Test Cart with primary, secondary and tertiary tones at standard level, 500 ms. bursts, Audiopak A-2 cart, New, \$20.00. Call E.I. 800-558-0222 or 800-445-0222.

Bud RC-7758 casters, extra-heavy-duty type for Bud Series 60, 2000, and Concorde cabinet racks, ball bearing 3/4" wheels of hard tread composition, 200 lbs. load rating, 4-hole mtg. \$6.00 each. Call E.I. 800-558-0222. (6 left).

Broadcast Electronics 5302 3-deck momo playback with cue tones, new, \$3150 Call E.I. 800-558-0222.

Why Risk The Stock Market?

Invest in choice real estate in Wisconsin's vocation paradise. Property has 4 plus acres rolling farmland over-looking beautiful Cedar Valley, bordering Kewaunee River. Fully carpeted 5 bedroom Innshruck chalet built into hill! with 2 stories, full length L-shaped deck facing valley, 1 story faces entryway. 2 full baths. 3 bedrooms up, 2 down, large living room, family room with bar on lower level, 3 patio doors to resplendant beauty outside..from master bedroom, from living room and family room to view Cedar Valley at lower level. Bow windows, bi-fold door closet space, built in vacuum, 2 1/2 car drive thru garage with openers, Geo thermal assisted heating and cooling, Jenaire grill range and convection oven; air filter, Magnificent view from master bedroom; family room large enough for full size pool table with cozy hearth and fireplace. Convenient breakfast bar in kitchen. Apple trees; wonderful natural attraction for deer and every species of bird imaginable. Here is your opportunity to have your cake and eat it to! Just \$99,000. Located at Rural Rt. 3, Kewaunee, 5 min. from City of Kewaunee, 20 min. from Door County, 25 min. from Green Bay. Call toll free in Wisconsin 1-800-445-0222 ask for Bob or 414-722-9464 evenings or weekends.

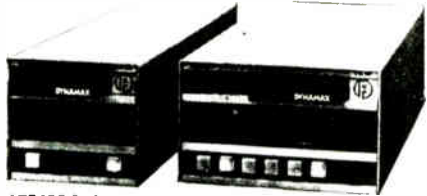

CTR100 Series

Dynemex CTR100 Series Cartridge Machines

Operational

- CARTSCAN System—automatic activation of elevated level, aux, mono* and matrix* modes
- All front panel switches illuminated
- Fast forward
- Motor speed continuously variable from 1.875 to 30 ips from external reference
- Cue tone tracking within $\pm 30\%$ of preselected speed
- Front panel diagnostics
- On-board test oscillator

Mechanical

- Playback units— $1/2$ rack width
- Record/play units— $1/2$ rack width
- $1/2$ " anodized tool plate deck
- Brushless variable speed 3 phase DC servo motor with electrolyzed nonmagnetic stainless steel shaft and permanently lubricated ball bearings, strappable for 3.75, 7.5 and 15 ips
- Micro-adjustable tape guides

Electrical

- Crystal controlled reference for all internal functions
- 144kHz bias oscillator
- Audio transformerless circuitry
- All power supplies regulated
- 110/220V 50-60Hz operation

50% OFF in stock units

CTR112 A size stereo play 1199.00

CTR124 B size stereo record/play 1999.00

AUDI-CORD CORPORATION



Model E-25

Audiocord - the company that gives you more for your money, with extremely high quality products at less cost.

For performance and reliability you can depend upon, invest in Audiocord.

E-25 STEREO RP **\$1299.00**

20% OFF in stock units

cont'd from pg. 6

BALANCED OP-AMP OUTPUT STAGE

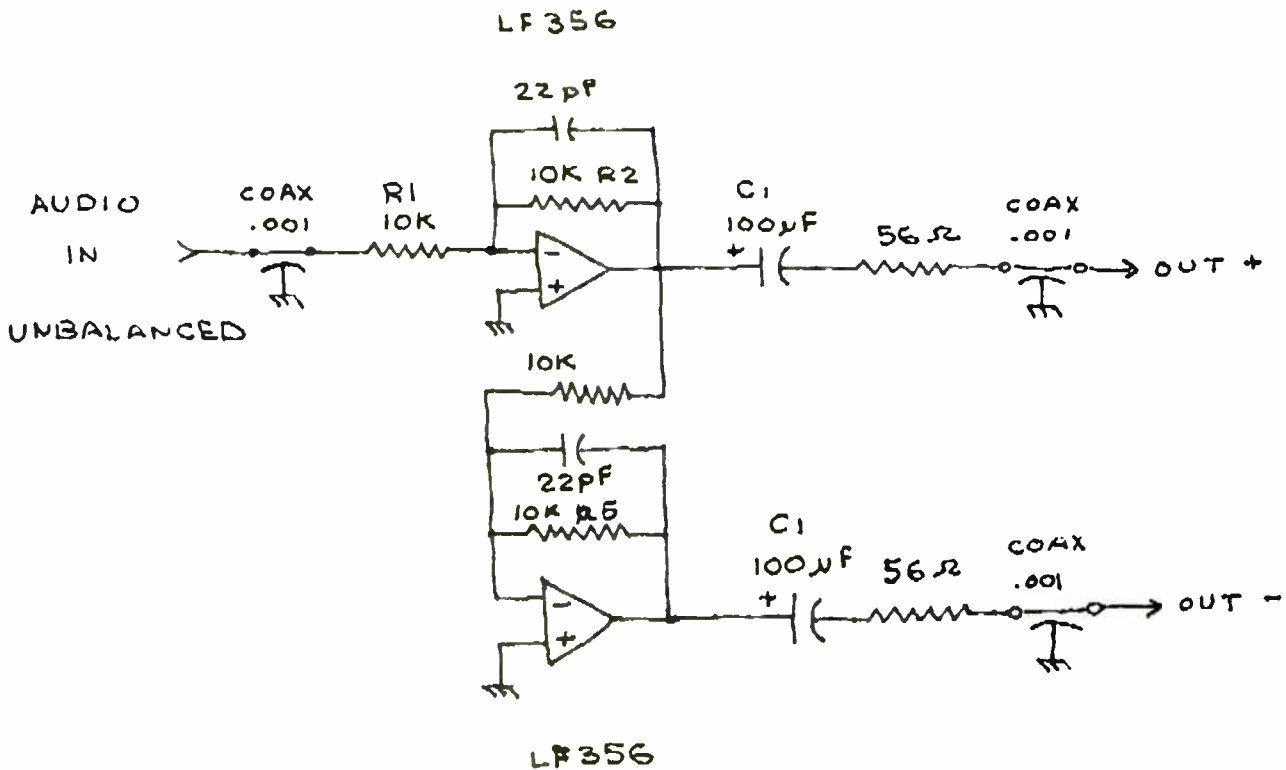

New NRSC Stations.. From Charlotte to Rapid City

EI congratulates the following AM stations which have recently adopted the new NRSC Standard:

KABL, San Francisco; KSTC, Sterling, CO; WLVS, Gainesville, FL; WPLP, St. Petersburg, FL; WDAE and WAMA, Tampa; WGAU, Athens, GA; WSLE, Bremen, GA; KWMT, Fort Dodge, IA; KXZZ, Lake Charles, LA; WTIK, New Orleans; WZON, Bangor, ME; WMPC, Lapeer, MI; KBMW, Breckenridge, MN; KSTP, Minneapolis/St. Paul; WFOR, Hattiesburg, MS; WBT, Charlotte, NC; WAGR, Lumberton, NC; WLWL, Rockingham, NC; WDCR, Hanover, NH; KNED, McAlester, OK; WFBG, Altoona, PA; WHP, Harrisburg, PA; WALO, Humacao, PR; KTOQ, Rapid City, SD; KKBO, Houston; WWIS, Black River Falls, WI; WIXK, New Richmond, WI; CIFX, Winnipeg, Manitoba.

KLRA, Little Rock, AR; KABC, Los Angeles; KDON, Salinas, CA; KGO, San Francisco; KVEN, Ventura, CA; WPGC, Washington, DC; WQBA, Miami, FL; WBSR, Pensacola, FL; KWIK, Pocatello, ID; WPRS, Paris, IL; WGDM, Marion, IN; WXAM, Buffalo, KY; WWGT, Portland, ME; WCCM, Lawrence, MA; WHFB, Benton Harbor, MI; WCXI, Detroit; KXGN, Glendive, MT; WRNA, China Grove, NC; WGBR, Goldsboro, NC; WKBC, N. Wilkesboro, NC; KHAS, Hastings, NE; KOGA, Ogallala, NE; WTSN, Dover, NH; WFIN, Findlay, OH; KTIK, Pendleton, OR; WMGW, Meadville, PA; KDKA, Pittsburgh; WSKI, Montpelier, VT; WFLS, Fredericksburg, VA; WCMS and WGH, Virginia Beach; WDUZ, Green Bay, WI; WTSO, Madison, WI; CKNX, Wingham, Ontario.

NAB Urges FCC to Adopt NRSC Standard for AM Stations

NAB has petitioned FCC to adopt transmission portions of National Radio Systems Committee (NRSC) Standard for AM broadcasting. In NAB's petition seeking FCC Rule-making, NAB asked FCC to amend Sect. 73.44 of FCC Rules to include NRSC preemphasis curve and NRSC Standard 10 kHz audio bandwidth characteristic. NASB said adoption of NRSC Standard would "reduce interference on the AM band, increase useful AM service areas and encourage production of higher-fidelity AM receivers." NAB has led industry campaign to encourage AM stations to adopt NRSC Standard for more than a year. NAB Exec Committee believes new rule would enhance implementation of NRSC adoption nation-wide. NAB urged FCC to "assign the highest priority" to adopting the rules change.

ORBAN

THE INCOMPARABLE AM OPTIMOD



The OPTIMOD AM is an integrated audio processing system for AM radio, including compression, program equalizer. It supplies very high average modulation, exceptional fidelity, and freedom from processing artifacts to yield FM like sound from typical radios.

Model 9100A/1 Mono	
Mfg. list \$3,995.00 Now Only 3,599.00
Model 9100A/2 (Cahn) 5,499.00
Model 9100A/2-C (C-Quam) 4,999.00

IN STOCK UNITS ONLY



TELEX COMMUNICATIONS, INC.

FMR-50 Receiver with WT-50 Belt-Pack Transmitter, WLM-50 Electret Lavalier Microphone and WHM-500 Condenser Handheld Microphone/Transmitter



FMR-50 Wireless Microphone Receiver

- Signal remains crisp for distances of 500' or more
- Operates on high band frequencies between 150 and 186MHz.

WLM-100/WLM-200 Electret Lapel Microphone

- Omnidirectional
- Silver or black
- Anti-noise cord
- Lemo corrector-foam wind screen and three styles of mounting clips available.

WT-200 Belt-Pack Transmitter

- Roughly the size of a cigarette pack
- Sensitivity switch
- Phantom power
- Connectorless battery terminals
- Battery test circuit
- Separate on/off switches for RF and audio.

WHM-410 Dynamic Handheld Transmitter

- Cardioid dynamic
- No switches are provided which prevents a user from inadvertently turning "off" the microphone.

WHM-500 Handheld Condenser Microphone/Transmitter

- Separate on/off switches for audio and RF
- Two wind screen styles and two 4.5V batteries are provided
- Superb rejection of handling noise
- Ideal for the vocalist because of a tailored frequency response.

Model 5300B Three Deck

Looking for a heavy duty, three deck machine for A and B sized carts? Then check the 5300B! The 5300B is rugged, full featured cart machine. The advanced mechanical design employs an internal bulkhead for accurate deck and capstan positioning. Other features include removable upper decks, direct drive synchronous motor, reliable solid state solenoid switching, superb Phase Lok IV head brackets, FET muting, active cue tone filters, and rear panel LED service aids.

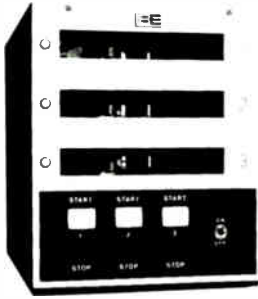

(A & B Size)

One Left! Special Price \$3150.00



WEATHER RADIO

Model CRW

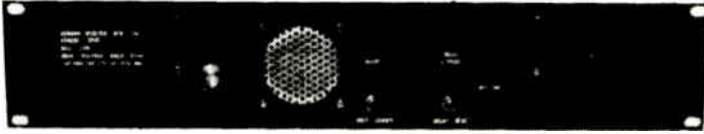

Price \$475.00

Sensitivity .28 microvolts for 12 dB quieting. All 3 frequencies. Alert tone demutes receiver, closes relay and gates audio to 600 ohm rear terminals. Another set of rear terminals has continuous 600 ohm audio output. Double conversion crystal controlled, crystal filter in first I.F., ceramic filter in second I.F. Dual gate MOS FET front end. 50 ohm coaxial input. Adjacent channel (± 25 kHz) down to 70 dB. 19" rack mount, 3 1/2" H, all metal enclosure. In stock—available for immediate delivery.

In Wisconsin
800-445-0222

Electronic Industries Inc.
19 East Irving - Oshkosh, WI 54901

Out-Of-State
800-558-0222

AM Daytimer Pre-Sunrise Rules Amended Uniform 6:00 am Sign-On Permitted

Interim pre-sunrise rules put in place earlier this year have been modified and adopted by the FCC. All AM daytime stations may now begin daily pre-sunrise operations at 6:00 am local time with a maximum power of 500 watts and a minimum power of 10 watts. The power level to be used must be determined by an interference study which is the responsibility of each station. For co-channel clear channel stations, the daytimer must only demonstrate no interference to clear channel ground wave primary contours. Existing PSA rules still apply with regard to limitations on interference to foreign stations. Applications for PSA operation must be supported with appropriate technical showings to demonstrate that interference will not occur.

While current PSA's often specify very low power, it is still possible to get significant coverage. One technique, often overlooked, is the use or establishment of an auxiliary transmission facility closer to the most important part of the daytimer's service area. FCC Rules permit use of an auxiliary transmitter for PSA transmissions. For instance, such a site located at the studio in the center of town, or in an ethnic target area, might cover far more people with 10 watts that would receive services from a main transmitter site 5 miles from town. It is even possible to adapt an existing two-way tower in town to a "folded unipole" to inexpensively radiate the signal, according to unipole manufacturer I.B.A. Technology, Inc.

ENERGY-ONIX

The Energy-Onix MK-25, 25 KW FM Broadcast Transmitter that is presently being installed at Radio Station WXYX reflects the basic features of the new line of FM broadcast transmitters offered by Bernie Wise's newest transmitter manufacturing enterprise.

An many broadcasters know, Bernie was the founder of both ITA and CCA Electronics. His basic designs are now incorporated in thousands of FM transmitters.

The MK-25 reflects this experience and provides the broadcaster with an extremely reliable transmitter with considerable reserve in power output capability, low operating expense, an understandable modern control system, a form factor which reflects ease of accessibility and utilization of standard parts available from local distributors.

The basic RF chain consists of a 20 watt, solid state, synthesized exciter, which operates at only five watts output. This unit drives a solid state broadband amplifier which can produce 300 watts, but only 150 watts are required in this application. The solid state amplifier drives a 3CX3000A7, zero bias triode which is housed in its own RF box and which can produce 4 KW, but is only used for 1700 watts. The final stage, a 3CX15000A7, can produce 35 KW and really loafs when producing 25 KW. Its output efficiency is 80% and thus its plate dissipation is only 6125 watts.

The transmitter contains two independent blower systems. Both units, like all other standard parts, can be replaced from local distributors. The driver cabinet blower produces 230 CFM when only 25 CFM is required, while the PA blower produces 680

CFM when 275 CFM is necessary. This conservative cooling, together with the utilization of filament regulated transformers and low dissipation, assures the user of three to five years of tube life.

The control system utilizes modern CMOS circuitry which are insensitive of RF or transients. The control panel indicates the status of all interlocks and operational controls. The system can be operated automatically or in a manual mode. The automatic mode requires the application of only the start switch. The system incorporates an overload recycling system which recycles four times at high power and then tries once more at low power. The control system, in addition to having a VSWR protection, also contains a "fold back" circuit which prevents a mismatch from producing a reflection in excess of a preset value. It also contains an automatic "Raise-Low" control system which maintains the transmitter power output constant independent of line voltage variations. (This circuit is overridden when the VSWR exceeds a preset level.) The control system may be operated from either a local or remote position and automatically restores itself to operation in the event of a power outage. The delay in re-applying plate voltage is related to the off time. Thus, interruptions of a few seconds will not cause the transmitter "to wait" two minutes for adequate filament pre-heating.

The MK-25 is the only zero bias triode FM broadcast transmitter available which indicates the grid and plate currents of the vacuum tubes which meters at DC ground potential. In addition to these meters, the MK-25 incorporates (4) directional couplers, (2) plate voltmeters, (2) filament voltmeters, (1) line voltage meter and an elapsed time meter.

The final feature which should delight all chief engineers are the two override panels which can be used in the unlikely event of a malfunction of the control system. These override panels can only be operated when "unlocked" by a special key. They contain individual override switches for every major control.



FIDELIPAC®



400 Tape Eraser

- Erases tapes up to 1" • Removable aluminum guide pin • High current horsepower-rated switch • Thermally-protected core
- Scuff-resistant top • Skidproof feet

400 Tape Eraser **\$105.95**

DYNAMAX COBALT™ Broadcast Cartridge

Introducing Dynamax Cobalt. A new generation of tape cartridge. Loaded with broadcasting's first cobalt tape.

The Dynamax Cobalt cartridge shell is constructed of high-grade engineering plastic for more strength.

greater heat stability and better dimensional accuracy.

Inside, our new Dynamax Cobalt tape provides the extra headroom necessary when carting CD's. And your spots, jingles and in-house production take on added punch.

Dynamax Cobalt outperforms all other broadcast tape cartridges in the following critical areas:

Longer service life without user adjustments

New cartridge design, cartridge materials and cross linked urethane tape binders combine to give you the world's longest lasting NAB "AA" tape cartridge. Tape tension build-up is kept to a minimum, thus prolonging service life.

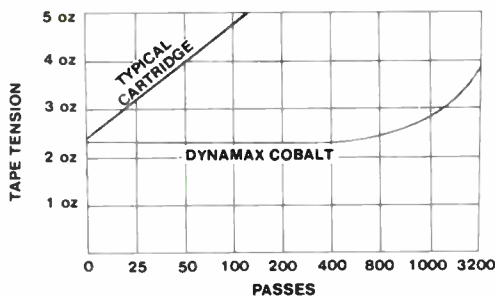

Extended high frequency response

The increased coercivity of Cobalt gives you greatly extended high frequency sensitivity, with no bias change required over conventional high output tapes, and no need for complex electronic processing systems. You'll notice new sparkle even on older machines.

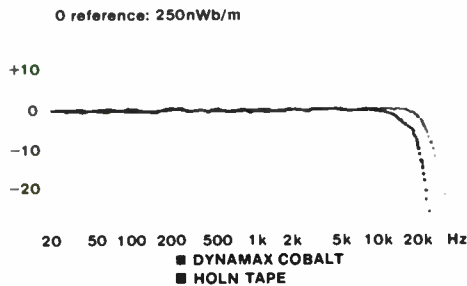

Greater high frequency headroom

Our proprietary blend of cobalt-encapsulated ferric particles provides more than 2dB of additional headroom where you need it—at upper midrange and high frequencies. So CD's sound like CD's, and your spots and jingles will sizzle.

MAXIMUM UNDISTORTED OUTPUT LEVEL AT 10 KHZ

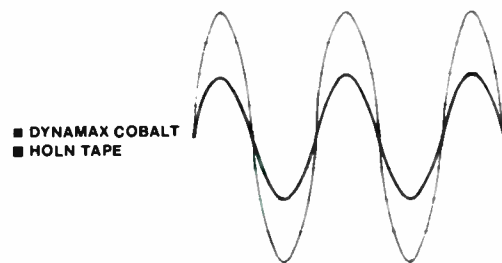

Lower flutter and distortion components

A new modified acrylic resin cartridge housing and debris-trapping pressure pads vastly reduce scrape flutter and phase jitter. These new materials provide cleaner running tape, longer tape life, greater strength, superior heat stability and more precise overall dimensional accuracy.

DIN PEAK WEIGHTED FLUTTER



Superior phase uniformity

Fidelipac, the inventor of the stereo cartridge, refines technology. Dynamax Cobalt cartridges agree in phase within tighter limits than any other "AA" cartridge, and stay that way over a long service life.

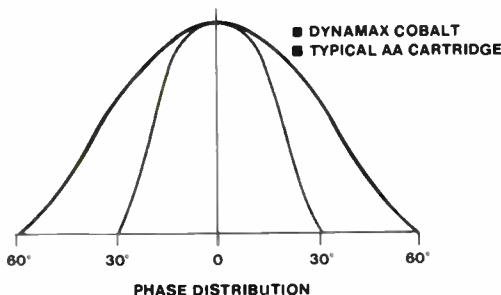

Reduced head and capstan wear

Fidelipac pays special attention to the problem of tape abrasion, so you don't have to. Dynamax Cobalt contains a combination of lubricants which actually reduce head and capstan wear in comparison to ordinary tape.

AFTER 2000 HOURS OF OPERATION
TAPE HEADS SHOWN 2.5X ACTUAL SIZE

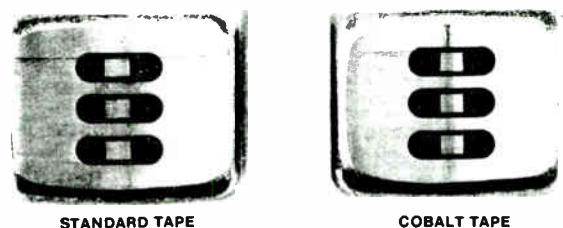

DYNAMAX COBALT™ Broadcast Cartridge

Fine tuning the broadcast cartridge with 30 years of proven experience

- New feature with Dynamax Cobalt
- Proven Fidelipac technology

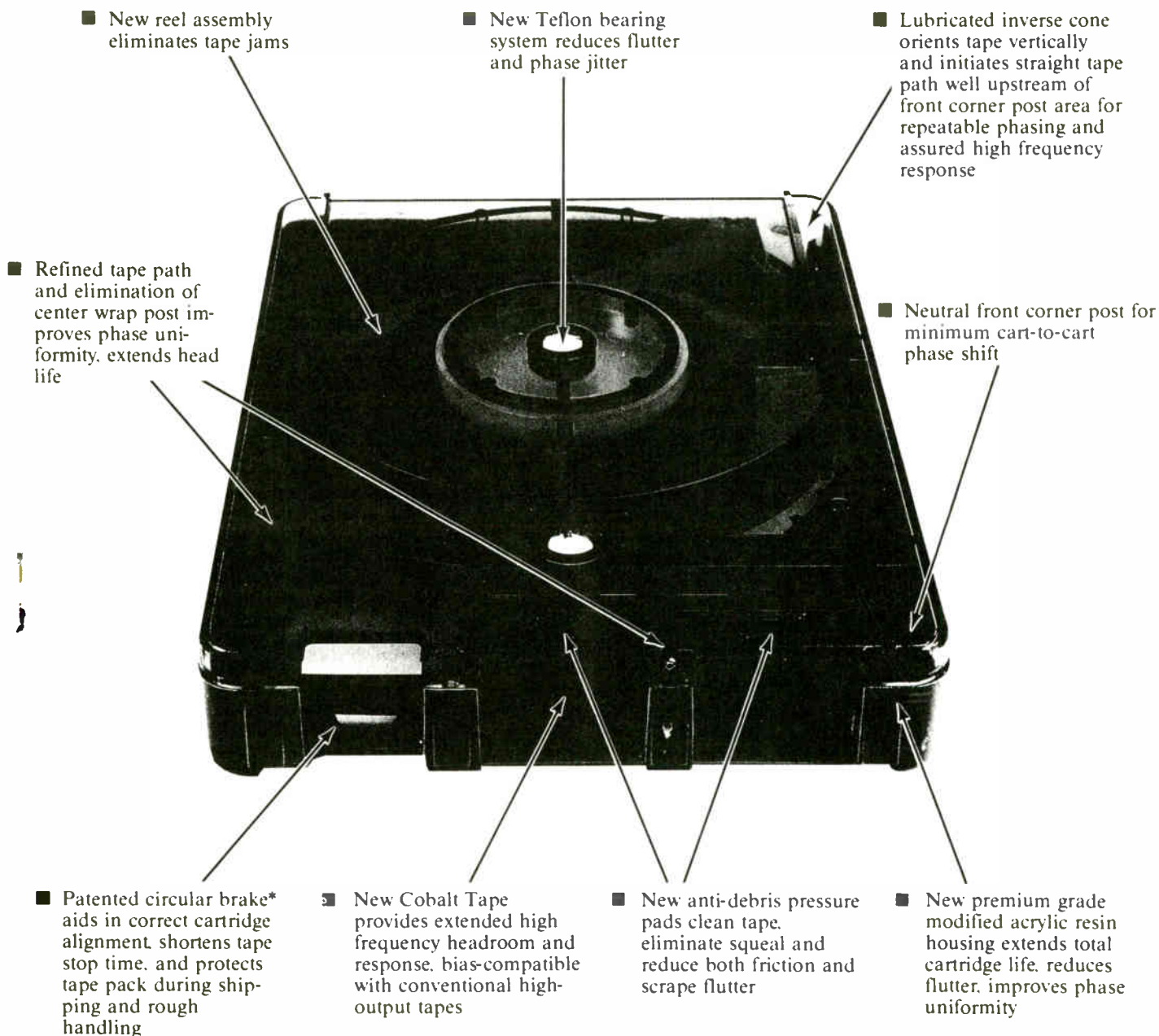

CALL

ELECTRONIC INDUSTRIES

19 EAST IRVING - OSHKOSH, WI 54901

IN WISCONSIN

800-445-0222

OUT-OF-STATE

800-558-0222

*U.S. Patent No. 4,148,443