

D'APPOLITO DISCUSSES ACCUTON'S SYSTEM ONE

SEVEN: 1996

US \$7.00

CANADA \$8.00

Speaker Builder

THE LOUDSPEAKER JOURNAL

Charles Pike

BUILD A BARREL OF 9Hz BASS

Koonce & Wright

BUILDING THE LOW-COST 3-WAY MIRACLE SPEAKER

Bill Waslo

TIME, FREQUENCY, PHASE & DELAY

The Honeycuts

CHOOSING CROSSOVER INDUCTORS

GONZALEZ & COLIN V. MONCRIEFF ON
CAPACITOR PERFORMANCE CLAIMS



The Best Capacitors for Your System

Miracle of New SETI

Audio manufacturers report the new **SETI sounds better than expensive film-and-foil caps and oil-filled caps. Yet SETI costs far less** (pricing is competitive with metallized polypropylene).

SETI brings out music's **natural liquid beauty**, so recordings sound more like **real live music** (you hear the same sonic magic from some single ended triode power amps). SETI™ (SET InfiniCap) actually sounds **better** (more musically natural) than the straight wire bypass reference!

New InfiniCap Signature

They said it couldn't be done, so we did it — InfiniCap's unique technology (pats pend) in a film-and-foil design. This is the ultimate in sound, when only the very best will do. [.01μF stock; other values OEM custom]

Critics Judge InfiniCap®...

- A high end speaker system manufacturer:
"InfiniCap does amazing things for our speaker! It's far better than all other capacitors. Compared to Hovland MusiCap, InfiniCap is more transparent, open, faster, and more dynamic, with better separation of instruments and their harmonics, better inner detail, better stereo imaging with a wider stage — and bass that's richer with more weight, yet also tighter, faster, and better defined."
- Another high end speaker system manufacturer:
"SETI surpasses MultiCap RTX and Hovland MusiCap. It gives us the **most music**, with the blackest background."
- A leading high end mfr of tube and solid state electronics:
"SETI gives us the **most realistic, natural music we've ever heard!** The difference compared to MultiCap is astounding, just amazing, night and day! SETI is the **biggest parts improvement we've ever heard!** It sounds so good that your reaction is emotional; we're giddy and swept away! SETI is fast and detailed but not hard, and it gets music's harmonic textures right. There's **no sense of reproduced sound**; it's just like **hearing real live music.**"
- Another high end manufacturer of tube electronics:
"The only other cap even close to SETI is the Audio Note Copper Foil in Oil, at **8 times SETI's price!**"
- Doug Blackburn, engineer, audio writer (his article in Stereo-ophile satirized pseudo-physics in high end audio), & regular contributor to Positive Feedback & The Audiophile Network:
"I found a great sounding new cap — unbelievable sounding actually. I used to think [a highly regarded multiple section film and foil cap] sounded pretty good, but these InfiniCaps are unreal."
- "I tried them in various locations in my equipment — power supply bypasses, in the audio signal path, etc. *Unreal* sound quality. These InfiniCaps make [the multiple section film and foil cap] sound **broken!** I'm **not kidding!** The difference is **very large.**"
- Prominent audio retailer Peter Litwack, Music by Design:
"In a high end preamp we replaced very expensive MultiCaps (\$77) with an InfiniCap (\$19). **Ecstasy!** This preamp came stock with MultiCap's best efforts, the deluxe film-and-foil PPFX-S and RTX series. To get good sonics at the coupling cap, the preamp designer found it necessary to use an array of 3 MultiCaps: 5μF PPFX-S, externally bypassed by .47μF PPFX-S, bypassed by .01μF RTX. That's 30 deluxe MultiCap sections in parallel."
"We replaced this whole \$77 MultiCap array with a single 4μF InfiniCap (\$19). No external bypasses on the InfiniCap. **This single InfiniCap, at 1/4 the price, thoroughly eclipsed the whole optimized array of MultiCaps!** Clearly, infinity is far better than 30."
"InfiniCap took this preamp to a whole new level. Bass became deeper, more articulate, and much less soggy. The stereo space expanded dramatically, extending way beyond the room walls and wrapping around the room, almost like surround sound. Really wild! Also, musical instruments themselves became better articulated and more lifelike, with better resolution revealing their subtle resonances. Overall sound became cleaner and faster, even using InfiniCap's ruggedized version with no external bypasses. Wow! InfiniCap is a home run in every way!"
- Litwack's evaluation has since been independently confirmed — by the preamp manufacturer himself, who has now changed his product from deluxe MultiCaps to SETI.

Also: New Wonder Solder UltraClear™

The world's best sounding solder makes your system sound twice as expensive!

Write to: **TRT** — Tomorrow's Research Today, 408 Mason Rd, Vista CA 92084 USA

Fax/voice mailbox: 619-724-8999

LMS Loudspeaker Measurement System

Solution!
New!
Version 3.6

At last, there is a complete and affordable analyzer system that provides quality data suitable for real electro-acoustic engineering purposes. The LMS system provides a vast array of powerful computer based features which are specifically focused on the unique requirements of loudspeaker development and QC production testing.

Whether your application is professional audio, consumer stereo, car stereo, or contract installation, LMS is the perfect tool for development and testing of loudspeaker systems.

No other measurement package today provides as many outstanding features and capabilities at such an incredible price!

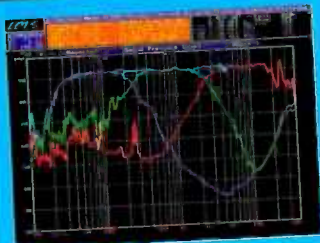

SPL Response

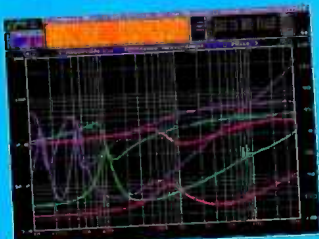

Impedance Curves

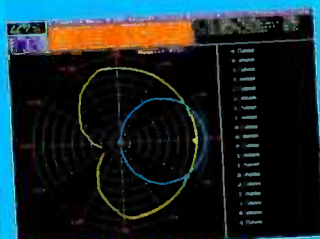

Nyquist Real/Imaginary



Polar SPL Response

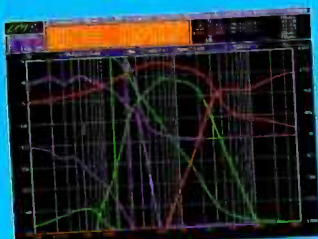

Network Transfer Functions

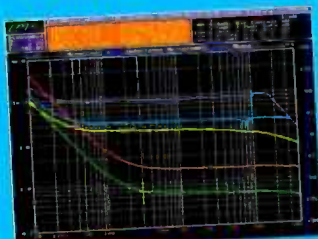

Inductance/Capacitance

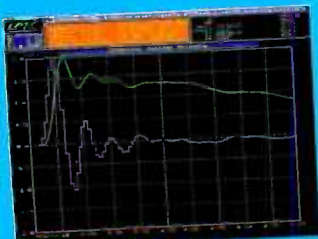

Impulse/Step Response



System Utilities and Features

The system software provides a host of powerful utilities and processing features which enable the user to perform many complex and tedious tasks easier than ever before. Unlike most other analyzer software which is oriented towards single curve use, LMS handles multiple curve display and operations with a versatile 20 entry library database.

- ✓ Curve library system for multi-curve operations
- ✓ Macro programming of operation for QC testing
- ✓ Standard and user selectable Frequency Ranges
- ✓ Relative and Absolute PASS/FAIL Compare
- ✓ Import and Export Data to ASCII files
- ✓ Speaker Parameter Generation
- ✓ SPL/Z Combo Conversion
- ✓ Nyquist Plot Conversion
- ✓ Polar Plot Conversion
- ✓ Tail Slope Correction
- ✓ Multi-Curve Averager
- ✓ RLC Meter

Analyzer System Specifications

- ✓ Full Length IBM PC Slot Card, 8 Bit PC Slot
- ✓ Oscillator: Continuous or Gated Swept Sine Wave
- ✓ Osc Maximum Output: +16dBm (5Vrms)
- ✓ THD: 0.015%, 20Hz-20kHz
- ✓ Frequency Resolution: 200 steps/decade, Log
- ✓ Filters can track Osc frequency by any ratio
- ✓ SPL Measurement Range: 35-125 dB-SPL
- ✓ Video graphics support: VGA, EGA, CGA, HGA
- ✓ Calibrated 8mm Electret Mic with Preamp
- ✓ Mic Frequency Range: 10Hz-40kHz
- ✓ Osc Attenuator Range: 60dB in 0.25 dB Steps
- ✓ Osc Frequency Range: 10Hz-100kHz
- ✓ Dual State-Variable Filters: LP/HP/BP/BR
- ✓ System Signal to Noise Ratio: 90dB
- ✓ XLR Interface: Osc out, Bal Input, Mic Input
- ✓ 360 Page Manual with Application Notes

Processing Operations

The LMS software provides a host of powerful post processing features which enable the user to perform complex mathematical operations on curve data quickly and easily.

- ✓ Scaling, Smoothing Curves
- ✓ Minimum Phase Transform
- ✓ Group Delay Transform
- ✓ Addition, Subtraction
- ✓ Multiplication, Division
- ✓ Frequency Div/Mul
- ✓ Invert, Square Root
- ✓ dB to Linear Conversion
- ✓ Inverse FFT

Call Today for a free Demo Disk! Tel: (503) 620-3044

International Dealers: **Argentina:** Interface SRL (54-1)741-1389/ **Australia:** ME Technologies 61(0)65-50-2254/ **Austria:** Audiomax 49(0)71-31-162225/ **Belgium:** Belram 32(0)2-736-50-00/ **Brazil:** SDS Equipamentos 55(0)11-887-7597/ **Canada:** Gerraudio 416-696-2779/ **China:** HiVi Research (852)2-556-9619/ **Denmark:** Finland: A&T Ljudproduktion 46(0)8-623-08-70/ **France:** Belram 32(0)2-736-50-00/ **Germany:** Audiomax 49-71-31-162225/ **Indonesia:** Ken's Audio 62(0)21-639-5806/ **Italy:** Outline snc 39-30-3581341/ **Korea:** Sammi Sound: 82(02)463-0394/ **Luxembourg:** Belram 32(0)2-736-50-00/ **Malaysia:** AUVI 65-283-2544/ **New Zealand:** ME Technologies 61-65-50-2254/ **Norway:** A&T Ljudproduktion 46(0)8-623-08-70/ **Philippines:** Dai-Ichi 632-631-6276/ **Poland:** Inter-Americom 48(22)43-23-34/ **Singapore:** AUVI 65-283-2544/ **Spain:** Audio Stage Design 34(94)620-27-47/ **Sweden:** A&T Ljudproduktion 46(0)8-623-08-70/ **Switzerland:** Good Vibes Ltd. 41-56-82-5020/ **Taiwan:** Gestion Taycan Intl 886-2-562-3883/ **Thailand:** AUVI 65-283-2544/ **The Netherlands:** Duron Audio 31-41-80-15583/ **UK(England):** Munro Assoc 44(0)171-403-3808.



LinearX Systems Inc/7556 SW Bridgeport Rd/Portland, OR 97224 USA/TEL: (503)620-3044/FAX: (503)598-9258
World Radio History

©1995 Product and Trademark names are the property of their respective owners.

Good News

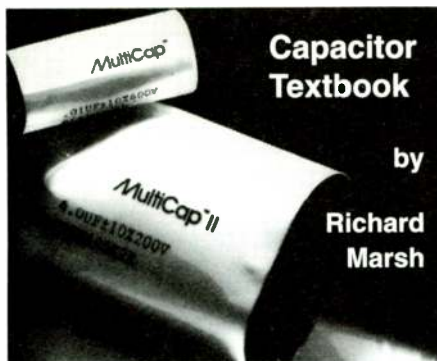

Capacitor Textbook

by

Richard Marsh

Q: What is the difference between the Segmented Capacitor design and the patented MultiCap?

A: Performance & Construction!

Segmented Capacitor: This old design now appearing as a "new" audio cap seems to offer multiple sections. But there are important differences between this and the patented, true multiple-bypass MultiCap.

Design: The segmented cap is designed for "fail safe" AC power applications. When one segment fails, the overall capacitance decreases, but the cap itself continues to function. When all the segments have failed, the cap must be replaced.

Construction: The segmented cap is a metalized-film design, constructed of extremely thin aluminum applied in equi-distant strips to the dielectric. This is then wound into a capacitor of random-value segments.

Result: (1) Multiple internal resonances at random frequencies = increased parasitics = audible distortion.

(2) Poor quality materials, not designed for audio use, invite shorts, increase ESR, greatly decrease both performance and life of the capacitor.

(3) No film & foil construction possible.

Patented MultiCap: The metalized and film & foil MultiCaps, designed for audio, are constructed of thick polypropylene or polystyrene, with a thick layer of metal. Individual capacitors of equal value are divided off as the overall capacitor is being wound on a special, proprietary machine. Each bypass is a specific ratio of the desired overall capacitance.

Result: Accuracy & musicality! A single resonance, at a frequency well above audio range + excellent materials & construction = low ESR and other parasitics = lowest distortion & highest resolution.

NOW EXCLUSIVELY FROM

reliable capacitors

Tel: 310-946-8577 Fax: 944-7494
www.capacitors.com

Reader Service #69

☞ QUITE A LEGACY

Legacy Audio introduces the Classic loudspeaker system, for various audio and home-theater applications. The Classic offers dual 10" woofers in a sixth-order alignment, a 7" Kevlar driver with graphite frame, and push/pull ribbon tweeter comprised of a 1¼" linen dome and a 30-ounce magnet. Enclosed in a 42" wooden tower and backed by a ten-year warranty, this audio system boasts a frequency response of 22Hz-30kHz, 4Ω impedance, and 91dB sensitivity at 2.83V/m. Legacy Audio, 3021 Sangamon Ave., Springfield, IL 62702, (800) 283-4644, FAX (217) 744-7269, <http://www.legacy-audio.com>.

Reader Service #101



■ ON-SITE SPEAKER DESIGN

True Image Audio invites you to visit its site on the World Wide Web to obtain new product information, special promotions, and a link to other areas of interest to the audiophile. The company recently reduced the price of its Speaker Design Toolbox, available as MacSpeakerz for use on a Macintosh computer or as WinSpeakerz for Windows 95 systems.

A demo version of the loudspeaker-design application software may be downloaded from the website. True Image Audio, 349 W. Felicita Ave., Ste. 122, Escondido, CA 92025, (800) 621-4411, FAX (619) 480-8961, <http://members.aol.com/spkrtools>.

Reader Service #102

■ PROBLEM-SOLVER EQ

Parasound's R/EQ-150 is a compact, two-channel, five-band room equalizer. It is designed to assist custom-audio installers in correcting acoustically awkward rooms—such as ceramic-tiled kitchens, plushly furnished dens, or those with poorly placed in-wall or ceiling speakers. At 8½" W x 2" H, the R/EQ-150 has five ½-octave bands with ±8dB boost, an EQ-bypass switch, and output-level control. Parasound Products, Inc., 950 Battery St., San Francisco, CA 94111, (800) 822-8802, FAX (415) 397-0144.

Reader Service #103

■ CLASSIC COMEBACK

Now 15-years old, the Quad ESL-63 returns to the US market in high-end audio specialty stores. This electrostatic loudspeaker's floor-standing design measures 36" high by 26" wide, accented by a curved frame, transparent black grille, burnished wood end pieces, and matte-black pedestal. Radiating as a dipole and mounted in an open frame, the ESL-63's full-range diaphragm is one-tenth the thickness of a human hair, coated with conductive material, negatively charged, and located between two perforated metal stators for maximum responsiveness. Distributed by Mission Electronics Inc., 400 Matheson Blvd. East, Unit 31, Mississauga, ON L4Z 1N8, Canada, (800) 838-7955, FAX (905) 507-0797.

Reader Service #105

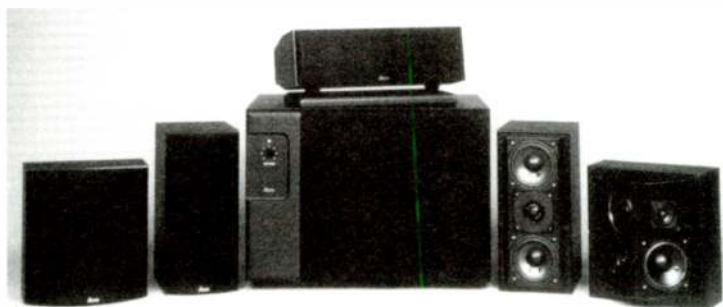

☞ DOLBY UPGRADE

Atlantic Technology has upgraded the home-theater System 250.1 to meet the greater power, bass, and surround demands of Dolby Digital. The system incorporates three speakers: model 251.1 LR front-channel, model 253.1 C center-channel, and model 254.1 SR full-range surround. Models 251.1 LR and 253.1 C each have a 4" mid-woofer with a long-throw voice coil, ¾"-thick cabinet walls, and heavy-duty crossovers. The 254.1 SR surround speaker allows the localization of rear-channel sounds and boasts a frequency response of 80-20kHz at ±3dB, a front baffle with two ½" tweeters and two 4" woofers, and phase-inverted twin-pole driver configuration. Atlantic Technology International, 343 Vanderbilt Ave., Norwood, MA 02062, (617) 762-6300.

Reader Service #104

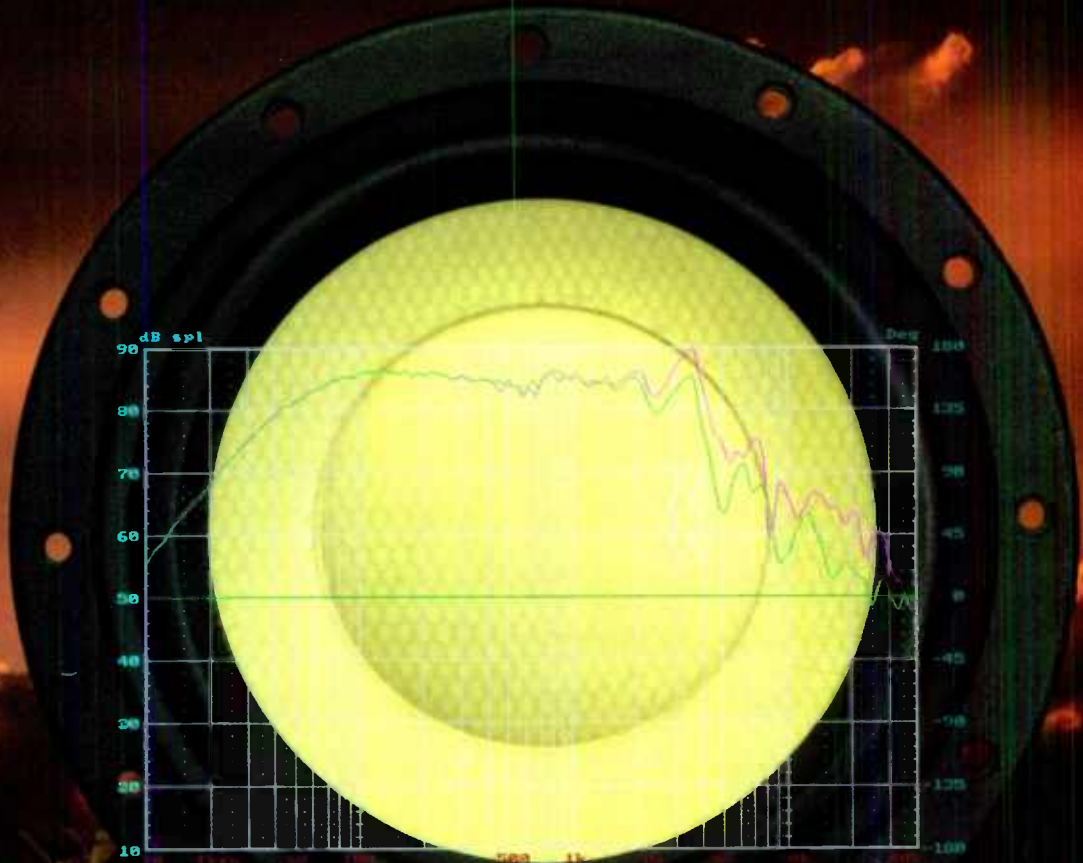

D6G

*Nominal Impedance(Z):*5Ω
*Resonance Frequency(Fs):*47Hz
*Sensitivity(E):*85dB
*Voice Coil Diameter:*76 mm
*DC Resistance(Re):*4.5Ω
*Voice coil Length:*14.5mm
*Force Factor(BL):*6.5N/A
*Linear Excursion(Xmax):*5.5mm
*SUSPENSION COMPLIANCE:(Cms):*690μM/N
*Mechanical Q Factor(Qms):*5.3
*Electrical Q Factor(Qes):*0.54
*Total Q Factor(Qts):*0.49
*Moving Mass(Mms):*16.3g
*Effective Piston Area(Sd):*109cm²
*Equivalent Air Volume(Vas):*11.6L

Hi-Vi RESEARCH®

100 SPY COURT, MARKHAM, ONTARIO L3R 5H6
 TEL:001-905-475-3100, FAX:001-905-475-8226

THIRD GENERATION CLASS-D POWER AMPLIFIERS

Reliable, high-efficiency switching amplifiers have come of age...

LGT is an OEM manufacturer of high performance audio amplifiers, either turnkey with a full feature set, or as pre-fabricated PCB assemblies. The high efficiency of Class-D is available in several configurations and output levels. Heatsinking requirements on all models are minimal. Contact Terry Taylor for full details and a developer kit.



Turnkey 500WRMS subwoofer amp with full feature set... ready to drop in your enclosure.

LGT SWITCHING TECHNOLOGIES

©1996 LGT

910 Creekside Road • Building A • Chattanooga, TN 37406 • Email: acoustical@aol.com

Tel: 423-622-1505 Fax: 423-622-1485

Reader Service #79

About This Issue

Speaker enclosures come in all shapes and sizes, but have you ever mounted a driver in a barrel? **Charles T. Pike** takes this unusual approach and explains how the advantages outweigh the disadvantages in "9Hz in a Barrel" (p. 8). This project, which uses a 55-gallon polypropylene drum, features one of the easier-to-build enclosures we've seen in a while. And the results are enjoyable low-frequency responses you can live with.

When you design loudspeakers, phase and signal delay are important to consider, but few of us are really comfortable with these concepts. In answer to reader questions, **Bill Waslo** provides a short tutorial entitled "Time, Frequency, Phase, and Delay" (p. 12) and defines these phase-response terms.

Now that we've selected the drivers and design for our three-way system ("A Modest-Cost Three-Way Speaker System, p. 20), it's time to begin construction. In part 2, **G.R. Koonce** and **R.O. Wright** present detailed illustrations, with plenty of construction and assembly tips, to guide you through the process and ensure good-sounding, good-looking finished boxes.

Family togetherness extends into the speaker-building world as the father and son team of **Richard** and **Erin Honeycutt** offers guidelines on how to choose inductors for crossover networks ("Inductors for Crossover Networks," p. 36). You'll discover that their advice on choosing components for passive crossovers debunks many of the traditional beliefs we've held about inductors.

Also in this issue, we've devoted plenty of space to answering reader questions and comments (*SB Letters*, p. 50, and *Ask SB*, p. 46). And be sure to check out "Tools, Tips and Techniques" (p. 62) for a simple modification that improves the clarity of a Vifa tweeter.

Speaker Builder (US ISSN 0199-7929) is published every six weeks (eight times a year), at \$32 per year, \$58 for two years; Canada add \$8 per year; overseas rates \$50 one year, \$90 two years; by Audio Amateur Corporation, Edward T. Dell, Jr., President, at 305 Union Street, PO Box 494, Peterborough, NH 03458-0494. Periodicals postage paid at Peterborough, NH and an additional mailing office.

POSTMASTER:

Send address change to:
Speaker Builder, PO Box 494
Peterborough, NH 03458-0494

Speaker Builder®

The Staff

Editor and Publisher

Edward T. Dell, Jr.

Contributing Editors

Joseph D'Appolito **Robert Bullock**
Richard Campbell **John Cockroft**
David Davenport **Vance Dickason**
Bruce Edgar **Gary Galo**
G.R. Koonce **Richard Pierce**
Bill Waslo

Vice President

Karen Hebert

Dennis Brisson Assistant Publisher

Swain Pratt Associate Editor

Courtney E. Howard Assistant Editor

Karen Chivallati Editorial Assistant

Linda Cardone Graphics Director

Diane Luopa Assistant Graphics Director

Joan Ahern Production Assistant

Gary Duke Production Assistant

Laurel Humphrey Marketing Director

Robyn Lasanen Circulation Manager

Doris Hamberg Customer Service Supervisor

Advertising Rates & Schedules

Peter B. Wostrel National Advertising Director

Linda M. Guyette Advertising Sales

Barbara Morris Advertising Assistant

(603) 924-7292 FAX (603) 924-6230

The peculiar evil of silencing the expression of an opinion is, that it is robbing the human race; posterity as well as the existing generation; those who dissent from the opinion, still more than those who hold it.

JOHN STUART MILL

Speaker Builder is published eight times a year in the interest of high-quality audio reproduction.

Legal Notice

Each design published in *Speaker Builder* is the intellectual property of its author and is offered to readers for their personal use only. Any commercial use of such ideas or designs without prior written permission is an infringement of the copyright protection of the work of each contributing author.

Subscription Inquiries

A one year subscription costs \$32. Canada please add \$8. Overseas rate is \$50 per year.

To subscribe, renew or change address write to the Circulation Department (PO Box 494, Peterborough, NH 03458-0494) or telephone (603) 924-9464 or FAX (603) 924-9467 for MC/Visa/Discover charge card orders. E-mail: audiotech@top.monad.net.

For gift subscriptions please include gift recipient's name and your own, with remittance. A gift card will be sent.

Editorial Inquiries

Send editorial correspondence and manuscripts to *Speaker Builder*, Editorial Dept., PO Box 494, Peterborough, NH 03458-0494. E-mail: audiody@top.monad.net. No responsibility is assumed for unsolicited manuscripts. Include a self-addressed envelope with return postage. The staff *will not* answer technical queries by telephone.

Printed in the USA. Copyright © 1996 by Audio Amateur Corporation
All rights reserved.

Speaker Builder

THE LOUDSPEAKER JOURNAL

VOLUME 17 NUMBER 7

NOVEMBER 1996

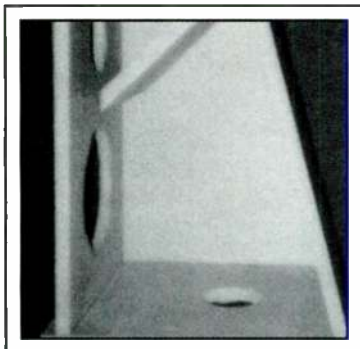

20

8 9Hz in a Barrel

BY CHARLES T. PIKE

12 Time, Frequency, Phase, and Delay

BY BILL WASLO

20 A Modest-Cost Three-Way Speaker System, Part 2

BY G.R. KOONCE and R.O. WRIGHT

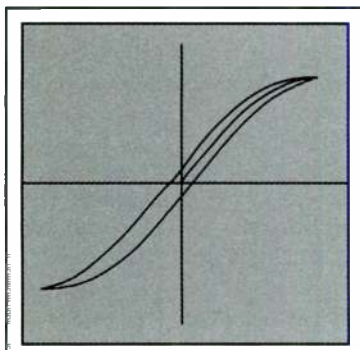

36

36 Inductors for Crossover Networks

BY RICHARD and ERIN HONEYCUTT

DEPARTMENTS

4 GOOD NEWS

46 ASK *SB*
BY JOE D'APPOLITO

50 *SB* MAILBOX

59 CLASSIFIED

60 AD INDEX

62 TOOLS, TIPS, & TECHNIQUES
BY LARRY VAN WORMER

KEEP IN TOUCH

EDITORIAL — Send letters, questions, and comments to: Speaker Builder, Editorial Dept., PO Box 494, Peterborough, NH 03458 USA, FAX (603) 924-9467, E-mail: audiody@top.monad.net.

Be sure to reference the issue, title, author, and page number of the article or letter in question; and if you request an answer from an author, please include a self-addressed envelope (and your FAX number and/or E-mail address, if applicable), with a loose stamp or postal coupon.

Due to the volume of correspondence, we cannot personally acknowledge or respond to each letter or query. All letters to the editor will be considered for publication unless you indicate otherwise. *Speaker Builder* reserves the right to edit your letters or technical queries for length and clarity.

Author guidelines are available by sending a self-addressed envelope with loose postage to the above address.

CIRCULATION — For subscriptions, renewals, back issues, or address changes, write to the Circulation Department (PO Box 494, Peterborough, NH 03458) or call (603) 924-9464 or FAX (603) 924-9467. E-mail: audiotech@top.monad.net.

ADVERTISING — Address advertising inquiries and information requests to the Advertising Department, Audio Amateur Corporation, PO Box 494, Peterborough, NH 03458-0576, voice (603) 924-7292 or 1-800-524-9464, FAX (603) 924-6230.

OLD COLONY SOUND LAB — For product information and ordering, contact Old Colony Sound Laboratory, PO Box 243, Peterborough, NH 03458-0243, voice (603) 924-6371 and (603) 924-6526, FAX (603) 924-9467.

9HZ IN A BARREL

By Charles T. Pike

This article describes an easy-to-build subwoofer that has a low-frequency cutoff of 9Hz. After completing my previous article ("A 16Hz Subwoofer," *SB* 4/94, p. 26), I had a Radio Shack 15" Model 40-1301 woofer without an enclosure, and since I find nothing more inspiring than having a driver without a home, I started thinking about enclosure designs. I did not want to build a copy of my previous design because it takes up a lot of space and it's more fun trying something new.

The first approach I considered was mounting the speaker in the wall of my family room with the back open to a 2000ft³ storage area under my living room. *Figure 1* is a printout from the BassBox 5.1 computer program showing the calculated sound pressure level (SPL) as a function of frequency (top), maximum acoustic power (center), and impedance (bottom) for the Radio Shack woofer mounted in a 2000ft³ infinite-baffle enclosure. Although the frequency response could be corrected, as pointed out in my previous article, the maximum SPL is limited at frequencies below 50Hz by the driver cone excursion.

OTHER APPROACHES

Since this approach did not seem too promising, I decided to look at alternatives. A fourth-order bandpass enclosure is normally divided into two sections, with a sealed volume in back of the speaker and a ported volume in front. All of the output then comes from the port. In examining bandpass enclosures, it occurred to me that if you were to replace the rear sealed box on a fourth-order bandpass enclosure with an essentially infinite baffle, it should be possible to extend the low-frequency response.

The top graph in *Fig. 2* shows the calculated frequency response of such a system with a bandpass response that extends from

8.9–45Hz at the 3dB down points! In addition, the center graph in *Fig. 2* shows that the maximum output is not limited by speaker excursion for frequencies above about 16Hz.

Of course, there is a price to pay for this good low-frequency response: a loss in efficiency. As shown in *Fig. 2* (top) the maximum SPL is 83dB at 2.83V RMS input. However, at 100W, the maximum input power of the speaker, the output would be about 103dB, which I think is more than adequate.

CONSTRUCTION

You can calculate the optimum volume for the ported section of the enclosure with the

formulas given by Jean Margerand ("The Third Dimension: Symmetrically Loaded," *SB* 6/88, p. 29) or by using the Quick Box computer program. For this design, the volume is about 210 ltr. To simplify construction (and since it would be out of sight under the house), I decided to use a 55-gallon drum—almost exactly the correct volume.

I chose a 55-gallon polyethylene insecticide tank because it is easier to cut than a steel drum. On one end of the tank you must provide a flange for mounting the speaker. Cut a 16" square out of 3/4" plywood or particleboard, with a 13 5/8" hole for the speaker. Bolt it to the tank with 8 × 10–24 flat-head bolts countersunk to provide a smooth

Loudspeaker Parameters

—General Information—
Company: Radio Shack
Model: 40-1301
Note/SN:

—Mechanical Parameters—

Fs = 20.0 hertz
Qms = 6.450
Vas = 21.000 cu.ft
Cms =
Mms = 4.003 oz
Rms =
Xmax = 0.347 in
Sd = 133.0 sq.in
Dia = 13.0 in

—Electrical Parameters—

Qes = 0.485
Re = 5.6 ohms
Le = 1.0 mH
Z = 8.0 ohms

—Combination Parameters—

BL =
Pe = 100.0 watts
Qts = 0.450
ηo = 0.955%

—Multiple Drivers—

Number = 1
Single
Wiring: single
NetZ =
NetRe =
NetSens =

Box Parameters

Custom Closed Box
Vc = 2,000.000 cu.ft
Fc = 20.1 hertz
F3 = 38.2 hertz
Qtc = 0.433
Fill = none

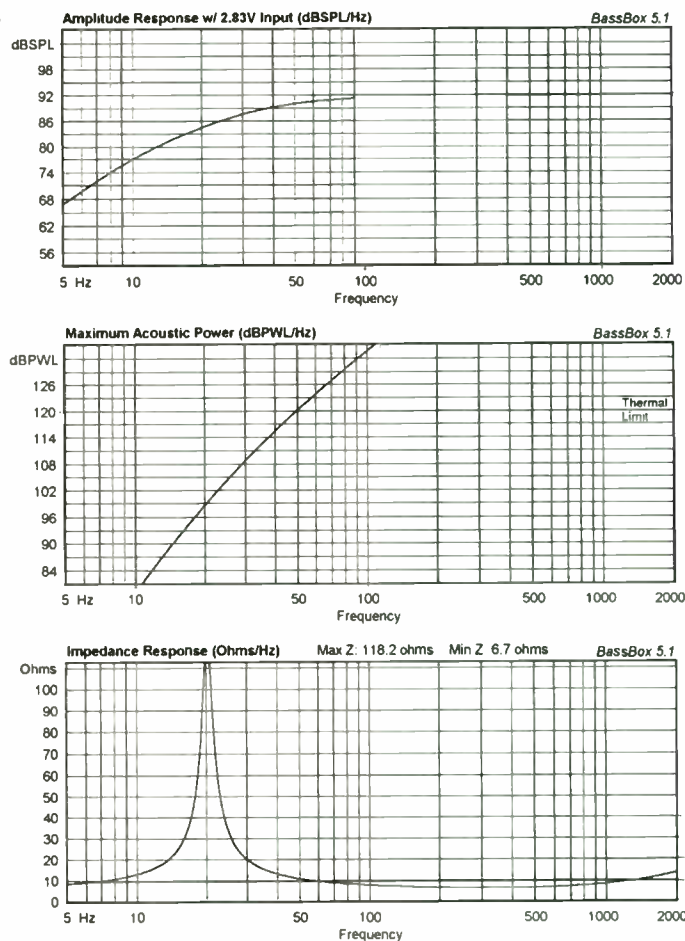

FIGURE 1: Calculated speaker performance in infinite baffle.

ABOUT THE AUTHOR

Charles Pike, a long-time audio enthusiast and music lover, designs and builds his own loudspeakers and amplifiers. He is primarily interested in music of the baroque and classical periods. He has an MS in Physics from Fairleigh Dickinson University and is professionally occupied in designing lasers for military applications.

mounting surface for the speaker.

If you use plywood for the flange, make sure to fill with wood putty any voids that might make air leaks. Use floor-tile cement between the flange and the drum to make a tight seal. *Photo 1* shows the flange installed on the drum and *Photo 2* the flange with the speaker mounted.

Using 3/4" plywood or particleboard, make the port duct 17" long, with inside dimensions of 5" x 5 1/4". Provide a small flange for bolting the port duct to the drum wall. Cut a 5" x 5 1/4" hole in the rectangular protrusion where the drain is located in the bottom of the tank, and attach the duct using screws and floor-tile cement for an airtight seal. *Photo 3* shows how the duct is fastened to the drum.

Then stiffen the drum with two lengths of perforated plumbing strapping from your

local hardware store, tensioned with small turn-buckles. Plug the small hole in the cover with a screw or silicone sealant. *Photo 4* shows the completed system, and *Photo 5* shows it installed under my living room.

TESTING

In using a drum for the enclosure, I was concerned as to whether it would be rigid

enough. It does vibrate somewhat in use, but the frequency response (*Fig. 3*) measured with a Panasonic P9932 microphone (which J. D'Appolito indicated is flat to 10Hz [letter in *SB 3/94*, p. 66]) agrees within 1dB with the computed curve.

Figure 4 shows the impedance, which also agrees well with the computed curve. It is interesting that fourth-order bandpass enclosures seem to follow the old rule of thumb that the port should be adjusted to make the height of the two impedance peaks approximately equal.

I measured the near-field SPL at the port output to be 111dB at 2.83V RMS input. D. B. Keele¹ gives the following relationship for calculating the near-field sound

Loudspeaker Parameters

-General Information-

Company: Radio Shack

Model: 40-1301

Note/SN:

-Mechanical Parameters-

Fs = 20.0 hertz

Qms = 6.450

Vas = 21.000 cu ft

Cms =

Mms = 4.003 oz

Rms =

Xmax = 0.347 in

Sd = 133.0 sq.in

Dia = 13.0 in

-Electrical Parameters-

Qes = 0.485

Re = 5.6 ohms

Le = 1.0 mH

Z = 8.0 ohms

BL =

Pe = 100.0 watts

-Combination Parameters-

Qts = 0.450

ηo = 0.955%

Sens = 92.00 dB (2.83 V)

-Multiple Drivers-

Number = 1

Single

Wiring: single

NetZ =

NetRe =

NetSens =

Box Parameters

Band-Pass Vented Box

Fill = none

-Rear chamber-

Vb1 = 2,000.000 cu.ft

Fb = 20.1 hertz

F3 = 8.9 hertz

-Front chamber-

Vb2 = 7.345 cu ft

Fb = 20.0 hertz

F3 = 44.8 hertz

Ports = 1 (other)

Area = 25.00 sq.in

Lv = 19.62 in

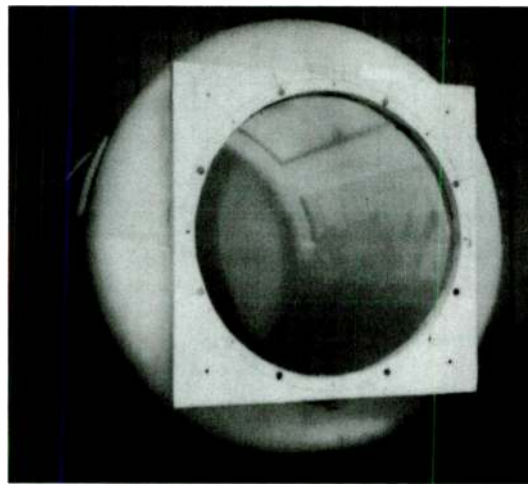

PHOTO 1: Speaker mounting flange.

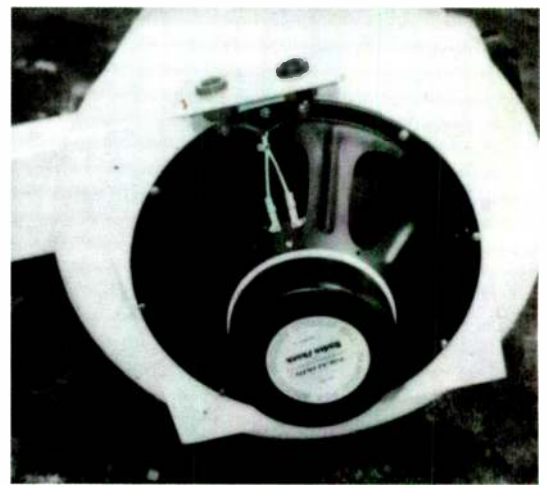

PHOTO 2: Speaker mounted on flange.

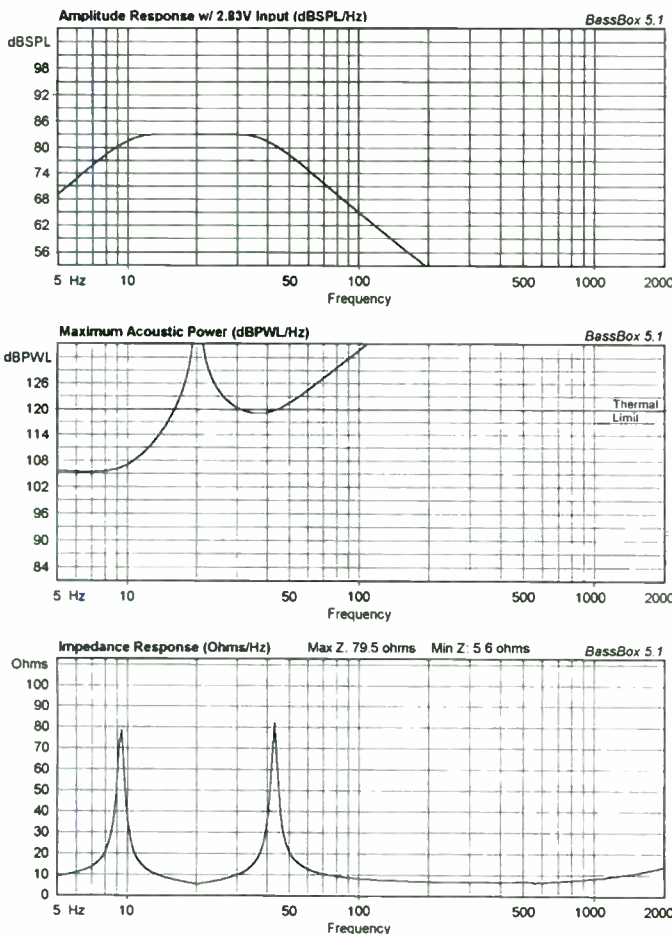

FIGURE 2: Calculated speaker performance in modified fourth-order bandpass enclosure.

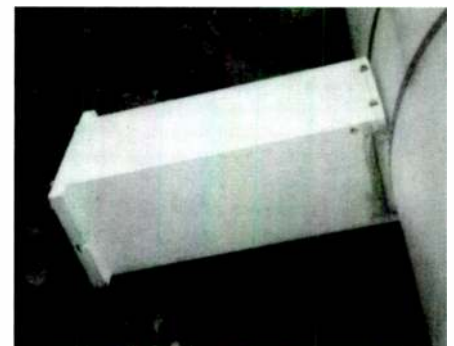

PHOTO 3: Duct mounting.

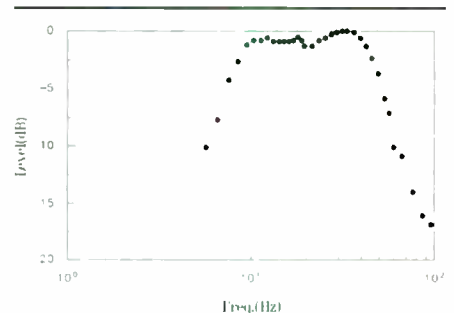

FIGURE 3: Measured frequency response.

pressure from the far-field value for a source radiating into a hemispherical space: $P_n = P_f(2r/a)$, where P_n is the near-field sound pressure, P_f the far-field pressure, r the distance from the source to the measurement point, and a the radius of the source.

Dividing by the 0dB reference pressure, then taking the logarithm of both sides and

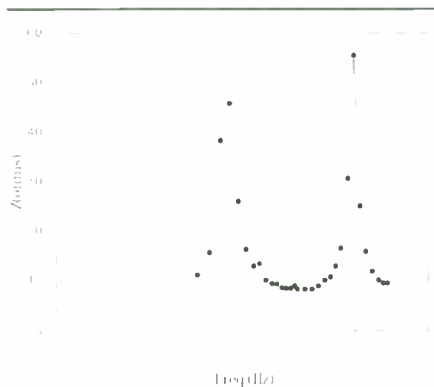

FIGURE 4: Measured impedance.

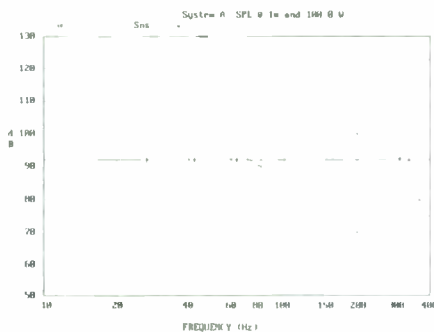

FIGURE 5: Frequency response of system calculated with Bandpass Boxmodel.

rearranging terms, we get: $SPL(f) = SPL(n) - 20\log(2r/a)$, where $SPL(f)$ is the far-field sound pressure level and $SPL(n)$ the near-field. Take a as the radius of a circle with the same cross-section area as the port. Then, if you let $r = 1m$, the calculated SPL at 1m with 2.83V RMS input is 82dB, which agrees very well with the 83dB given by the computer model. The testing seemed to indicate that the system performed almost exactly as expected.

CROSSOVER

Figure 5 is the computed response of the system using Bandpass Boxmodel, showing it predicts a port resonance at about 300Hz. Some sort of a crossover is therefore required to suppress this peak. I used the same circuit given in my previous article (SB 4/94), with the $0.1\mu F$ capacitors—which determine the crossover frequency—changed to $0.033\mu F$. This rolls off all frequencies above 60Hz at an 18dB/octave rate.

LISTENING TESTS

This subwoofer is connected to the right channel of my system, and a modified version of my 16Hz subwoofer is connected to the left. They are driven by an 80W-per-channel amplifier that I designed and built.

Recordings such as Jean Guillou's performances of Bach's Toccata and Fugue in D

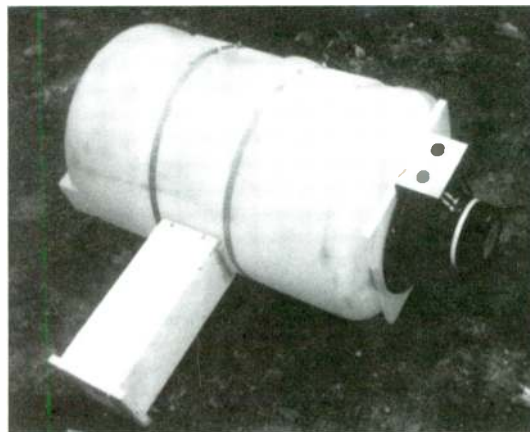

PHOTO 4: Completed system.



PHOTO 5: System installed.

Minor on Dorian DOR-90134 and Mussorgsky's Pictures at an Exhibition on Dorian DOR-90117 are truly thrilling to listen to page 58

The Industry's Finest Connectors.

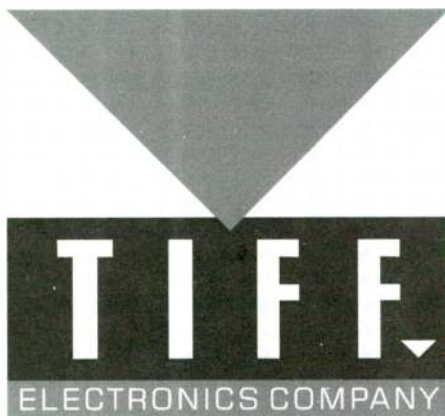
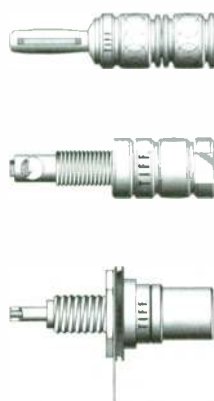

TIFF Electronics Company • 44 Pearl Pentecost Road / Winder, GA 30680 • (770)867-6300 / 2713 (Fax)

ORCA Design & Mfg Corp.
1531 Lookout Drive
Agoura, CA 91301 - USA
tel: (818) 707 1629
Fax: (818) 991 3072

by
FOCAL

ORCA is bringing to you from France a whole new and exclusive line of fine drive units specifically designed by Kimon Bellas, ORCA, and by Gilles Brun, FOCAL SA. Why ACCESS ?

Well think of ACCESS as "entry level", "first step". In clear, these drive units have been designed in such a way that any beginner using no other measuring instrument than a set of good ears should have 100% success designing his first system. Indeed most of these units will do great without any X-over part, or at the most with a single inductor. Now don't be fooled, nothing is more difficult to engineer than a drive unit that is easy to use. Experts do know that. And expert designers will be the first ones to dive into the ACCESS catalog !

Also, think of ACCESS as "affordable". That maybe was the toughest challenge for us: to bring you this degree of performance and ease of use at the cost of ordinary paper cone units. We did not cut corners, we cut cost through good engineering. All units feature the finest hand coated paper cones (still an art at FOCAL), alloy cast frame and, needless to say, the legendary quality of FOCAL craftsmanship. The same hands who are making the world renown FOCAL drive units are making your ACCESS drive units.

Makes sense to you ? Call ORCA for your catalog. It includes full description of each unit, large scale curves and graphs, all parameters, and two computer simulated bass response for each ACCESS unit.



- ACCESS 4A Quick, high definition 4" midrange. Wide bandwidth (up to 12 KHz !). A natural and easy match for a highly transparent tweeter. . You pick the frequency and you pick the slope !
- ACCESS 4B Potent & detailed 4" midbass. Clean up to 7 KHz. Very robust low end. Ideal for mini audio-video systems and very small size high quality speakers.
- ACCESS 5A Efficient 5" midrange. Smooth. Superb definition. It needs a good 91-92 dB tweeter for an effective match. Great for surround systems and for high quality high output 3-way designs.
- ACCESS 5B Solid 5" midbass, in the FOCAL tradition. Gentle roll-off around 4 KHz. Like most other ACCESS units, it can be used both in sealed and in vented cabinet designs.
- ACCESS 6A Efficient (92 dB +) and transparent 6" midrange. A single inductor might be all you need to get the quintessence of this beautiful drive unit.
- ACCESS 6B Surprising weight in the low end, which is powerful and well defined. This little woofer does not seem to be much embarrassed by any signal.
- ACCESS 7A Extremely smooth 7" midrange/ midbass. Excellent prospect for a simple efficient 2-way bass reflex , It can also be used in surround systems main speakers, with or without a subwoofer.
- ACCESS 7DB Outstanding 7" dual voice coil midbass. Powerful, crisp and efficient, this drive unit will play anything your amplifier will throw with panache and relentless enthusiasm.
- ACCESS 8A Very efficient (93 dB +) 8" midrange/ midbass. One of the truly rare 8" that can be used in 2-way designs. You will need a very good and efficient tweeter to match this unit (at least 92 dB/W/m)
- ACCESS 8DB Outstanding 8" dual voice coil midbass. Efficient, smooth and crisp sounding it is also capable of handling large dynamics and true low frequencies with the authority of a much larger woofer.
- ACCESS 10A Impact & dynamics (94 dB/W/m). If a 10" midbass can make it to the tweeter range, this is the one. Its nearly perfect roll-off will allow direct wiring without filtering. Rare unit for 2-way 10" designs !
- ACCESS 10B Deep and musical 10" woofer. Ideal for medium size 3-way systems , with one of the 4", 5" or 6" ACCESS midranges. A classic.

TIME, FREQUENCY, PHASE, AND DELAY

By Bill Waslo

Signal theory is a topic that intimidates many audiophiles, who generally have a good grasp of the concept of time and feel comfortable discussing frequency, but consider phase and signal delay to be magical quantities in some sort of esoteric alchemy, understandable only with great effort and through extensive mathematical abstraction. In this article I will attempt to present a relatively simple treatment of these subjects, with emphasis on their importance in loudspeaker design and testing.

MEANINGS

First, I want to clarify the meaning of time-domain data and frequencies. Time-domain data is any quantity that varies with time, which in the case of loudspeakers is usually a sound-pressure or signal voltage. Music, as viewed on an oscilloscope (*Fig. 1*), is an example, as are the various other signals (impulses, MLSs, sweeps, tone bursts, and noise) used in loudspeaker tests.

You might think that frequency is another word for pitch, describing the notes of a musical scale, but for this discussion, frequency is a parameter relating only to sine-wave-like signals. The output of very few musical instruments approximates a sine-wave shape. While you may hear a pitch when listening to an acoustical sinusoid (a sine-wave-like waveform), a note from an instrument such as a piano is not a single sinusoid but a combination of many. In most cases, the note is identified with the lowest strong sine-wave frequency present, but in some cases you can hear a pitch corresponding to a low frequency that isn't even there to any appreciable degree.

WAIT TILL THIS SINE WAVE IS FINISHED

The sine wave upon which this concept of frequency is based is a special repeating time-domain signal. An ideal sine wave is forever; it has no beginning or end. It (along with its phase-shifted alter-ego, the cosine wave) has a specific value at any given time.

To minimize the confusion, I'll refer to points in time using numbers to indicate positions. "Time = 0" doesn't mean "the beginning of time," but just some convenient reference point, with all previous time denoted in negative seconds and all later time in positive seconds.

Mathematical sine waves and cosine waves have a maximum size (amplitude) of 1. The frequency of these waves is a measure of how many times per second the basic sine-wave shape repeats itself. If the waveform cycles only a finite number of times and then stops, it is not a sine wave.

Cosine waves and sine waves are identical except for a phase or time shift of 90° , which means $90/360$ (or one-fourth) of the basic waveform. At time = 0, sine waves have a value of 0 and cosine waves a value of +1. Cosines rather than sines are generally used in discussions of Fourier theory.

FIVE-MINUTE FOURIER THEORY

J.B.J. Fourier (1768–1830) was a mathematician and physicist who showed that any time-domain signal can in principle be made from a sum of sized and delayed cosine waves. This means that you could, at least in theory, put a great number of cosine waves through a network that adds the voltages (shifted and amplified) together at each point

in time, and duplicate any possible time-domain signal at the output.

Each individual cosine wave varies over time between positive and negative values, and the summation at any point can therefore be positive, negative, or zero (*Fig. 2*). If you are uncomfortable with the idea that your treasured recording of Beethoven's Ninth Symphony could be duplicated with just a bunch of sine-wave generators, I should mention that it would require an infinite number of them; this is an abstract theory, you see.

The Fourier transform, used in many signal analyzers, essentially breaks a time-domain waveform into its component cosine waves. The transform does this by revealing the size and phase position required of the cosines at each frequency to reconstruct the original waveform.

As an example of Fourier summation, a square wave contains cosine waves (delayed and sized) only at the frequencies that are odd multiples of the repetition rate. *Figure 3* shows a limited selection of the first five odd harmonics summing up to make a fair approximation of a square wave.

The classic nonrepeating waveform is the impulse, which has a value of 0 everywhere except at time 0, when it is at plus infinity. These idealized spikes don't happen in real life, of course, yet they are central to the concept of frequency response. If you could take all the cosine waves at all possible frequencies, all with the same amplitude of 1 and all defined at the same time = 0, and play them simultaneously, they would sum to form this impulse.

Another way of stating this is that the

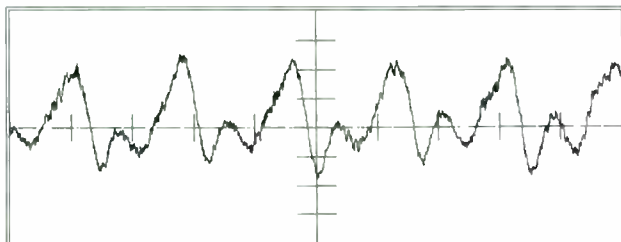

FIGURE 1: A time-domain plot of a sound signal. X-axis is time, Y-axis is sound pressure.

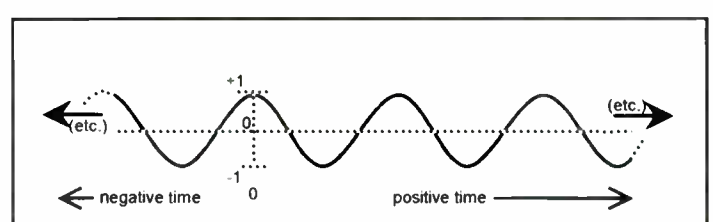
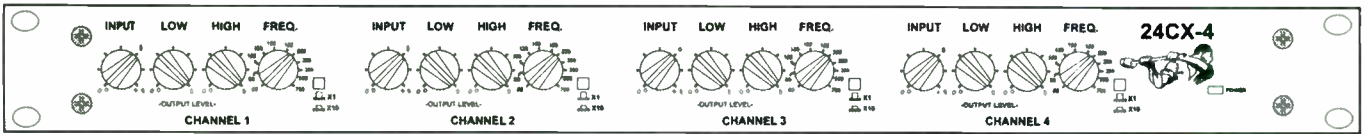

FIGURE 2: A cosine wave oscillates for all time and varies between positive and negative values.



Electronic Crossovers

24CX-2 Stereo 2-Way

24CX-4 Stereo 3-Way

- 24CX-2 is used for BI-AMP and the 24CX-4 is used for TRI-AMP systems or Surround Sound BI-AMP.
- 4th order State Variable Linkwitz-Riley Filter design. All outputs in phase at crossover point.
- 24dB per octave crossover slopes for greater driver protection than with 12db and 18db per octave types.
- Flat summed electrical response throughout the crossover region.
- Zero lobing error (polar pattern tilt) throughout the crossover region.
- Automatic 3-way operation on Models 24CX-2 and 24CX-4 or independent two or four channel 2-way operation.
- Integral security cover.
- Polypropylene capacitors are used throughout the signal path, active filter section, and even the power supply.
- The input/output connections used are high reliability 2mil GOLD phono plug connectors.

24CX-2/4 electronic crossovers represent the latest in state-of-the-art design and manufacturing technology. Innovative electrical and mechanical design concepts and implementation have resulted in a product of superior performance expected of units selling for several times the 24CX-2/4 price.

A 4th order Linkwitz-Riley type of crossover does not guarantee flat summed response. Flat summed response of the low and high frequency outputs of the 4th order Linkwitz-Riley crossover is made possible by using precision

1% metal oxide film resistors, selected capacitors, and the industry's only precision matched and selected 1% four-gang Frequency Range potentiometer. No matter where the control is set, you will get flat summed response, not just the end positions where some products are specified.

High Slew-Rate, Low Noise, Bi FET operational amplifiers guarantee the finest in sound quality and overall electrical performance.

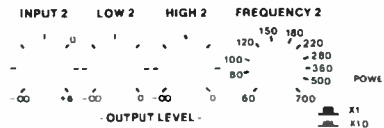

SPECIFICATIONS

Crossover Filter Type

4th Order Variable Linkwitz-Riley design, 24 db/octave slopes.

Frequency Range

x1 60 Hz to 700 Hz
x10 600 Hz to 7.0 kHz

Slew Rate

RL=2 kohms 9 v/usec.
CL=0.01 uFd+/-2.5 v/usec.

Total Harmonic Distortion

RL 2 k ohms

Low Freq Output

.005% THD
20-9 kHz @ +8 dBu (1.95 volts)

High Freq Output

.01% THD
60 - 20 KHz @ +8 dBu (1.95 volts)

Maximum Output Level

RL 2 kohms
+21 dBu (6.2 volts)
@ .05% THD 20 - 20 kHz

Maximum Output Current

25mA peak @ 250C

Maximum Voltage Gain

+6 dB Hum and Noise
(20 Hz - 20 KHz)
Av = 0 dB fc = 800 Hz

Low Frequency Section

a. Output Attenuator
@ -infinity-104 dBu
b. Output Attenuator
@ 0 dB -96 dBu

High Frequency Section

a. Output Attenuator
@ - infinity 104 dBu
b. Output Attenuator
@ 0 dB 90 dBu

Signal to Noise Ratio

108 db

Input Impedance

Noninverting Unbalanced

20 kohms

Output Impedance

300 ohms

Controls

Input Level:

Continuously variable from +6db gain to 90 db attenuation

Output Level:

Continuously variable from 0 db (unity) gain to 96 db attenuation

Crossover Frequency:

Adjustable from 60 Hz to 900 Hz on the X1 range 600 Hz to 9kHz on the X10 range

Power Source:

U.S. & Canadian Models 120 v AC, 60 Hz

Power Consumption

12 VA

Dimensions (WXHXD)

19 inches x 1.75 inches x 7.5 inches with security cover

Net Weight

both models 8 pounds

0dBu = 0.775 v rms

Also available in 1/4 " phone or XLR Balanced Line

Model 24CX-2 \$425.00

Model 24CX-4 \$525.00



ORDER INFORMATION: All orders will be shipped promptly, if possible by UPS. COD requires a 25% prepayment, and personal checks must clear before shipment. Adding 10% for shipping facilitates shipping procedure; residents of Hawaii, and those who require Blue Label air service, please add 20%. There is no fee for packaging or handling. We will accept MasterCard or VISA on mail or phone orders.

MADISOUND SPEAKER COMPONENTS
8608 UNIVERSITY GREEN
P.O. BOX 44283
MADISON, WI 53744-4283 U.S.A.
TEL: 608-831-3433 FAX 608-831-3771
e-mail madisound@its.com
Web Page: http://www.its.com/madisound

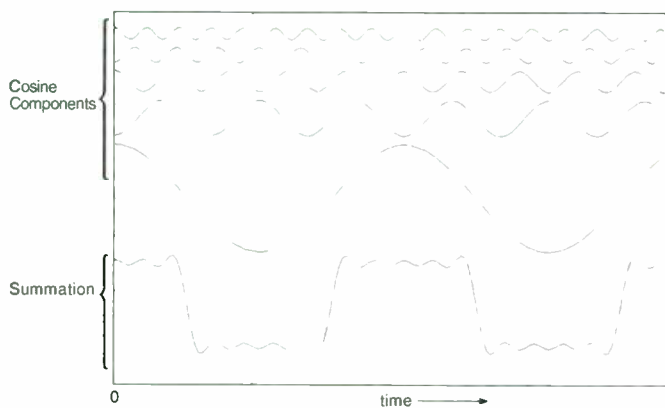

FIGURE 3: Five shifted and sized cosine components summing to form a coarse square wave.

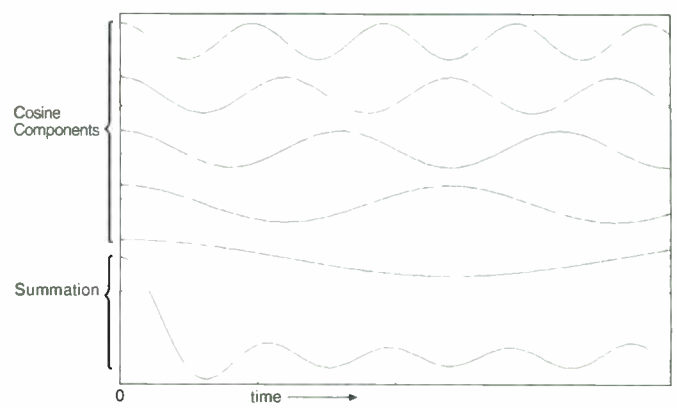

FIGURE 4: Five components of an impulse and their summation. Only at time 0 do they all stack up.

impulse has equal contributions from all frequencies, with all these at zero phase shift (where phase refers to that of a *cosine* waveform). A system that could pass this waveform would have a perfectly flat frequency response in magnitude and phase.

ZERO TO INFINITY

You can envision the construction of an impulse from cosines as follows: since all these cosine waves have zero phase shift, each is equal to 1 at time 0. Therefore, the sum of all the infinite number of cosine waves at time 0 will be the sum of an infinite number of 1s.

At non-zero times, however, some cosine waves (extending up through infinite frequency) have positive values, some negative, and some zero. At times other than 0, the positives will balance out the negatives, with zero as the resulting sum (note that this is not meant to be a proof, but merely a conceptual aid). *Figure 4* shows several equal-sized, zero-phase cosine-wave sections summed to demonstrate how the impulse takes shape.

Because the impulse contains all frequencies phase-aligned at equal levels, an approximation of it makes a very handy test signal. If you feed a bandwidth and size-limited impulse through a system, all its component cosine waves might come out the other side with their sizes changed and their phases shifted. This change is called the frequency response of the system (a frequency-domain representation). The changes to each cosine wave consequently affect the shape of the impulse as it passes through the system, forming what is known as the impulse

response (a time-domain representation).

You could apply cosine or sine waves of each frequency, one at a time, to measure the frequency-response characteristic of a system and tally the curve up on a frequency-by-frequency basis. But you can use the *impulse* to do it all at once, assuming you can perform the Fourier transform to analyze the cosine components after they pass through the measured system. A real-world version of the impulse, finite in size and bandwidth, is often used to measure the frequency response of loudspeakers with devices such as the basic IMP.

The reason you go to all this trouble to define any signal as a collection of cosine waves is so you can make unified descriptions of predominantly linear systems such as loudspeakers, which modify signals. If you can describe how a linear device modifies cosine waves of any frequency, you need not measure the separate characteristics of square-wave response, triangle-wave response, or Beethoven's Ninth Symphony response. The full frequency response, including phase and magnitude data, or, equivalently, the impulse response, contains the information needed to mathematically determine how a system will treat any waveform within its dynamic range.

GOING THROUGH A PHASE

The concept of phase tends to confuse a lot of speaker builders and audiophiles, but it's really very simple. The phase shift of a cosine wave is, first of all, a relative measurement defined in relation to an unshifted cosine wave. Scale the size of the wave in question (make it bigger or smaller in height) so that its maximum value is +1. Then see how far to the right or left you must move it to make it match the reference cosine wave.

Phase is always a comparison between two cosine waves of the same frequency. If the reference isn't specified, you can usually assume it to be that at the input of a mea-

sured system, or else a spectrum where all cosines are aligned at a reference time. You don't measure phase shift in seconds, but in portions of a cosine-wave cycle. This is the first main difference between phase shift and delay. While delay is measured in units of time, i.e., seconds, the units used for phase shift are radians or degrees (there are 2π radians—or 360° —per cycle).

But because the sine or cosine waves are eternally repeating, a funny thing happens: shifting a wave backward or forward one full cycle of 360° (or any whole number of cycles) gives the same result as not shifting it at all. As a result, you can make any shift possible within a phase change of one cycle. This is so because you are dealing only with cosine waves of a single frequency. As long as you are using a single-frequency waveform for measuring a speaker, you cannot tell whether the shift is x° or $(360 + x)^\circ$; there is no difference at all between the two.

DELAY SHIFT

Delay, on the other hand, is how far in *seconds* you must shift a waveform to the left on a typical oscilloscope plot to get it to align with a reference unshifted waveform (usually the input signal). If your waveform for analysis is a simple cosine wave, you can still get there by shifting only within whatever time equals 360° .

The actual phase shift corresponding to a given time shift will depend on the frequency of the cosine wave. For instance, if the frequency were 1/360th of a Hertz, each cycle of the wave would last 360s, and a 1s delay would correspond to 1° of phase shift ($360^\circ/360$). A delay of 6min. would correspond to a phase shift of 360° , the same as no phase shift at all. However, the same 6min. delay for a 1/1440 hertz waveform (each cycle being 1440s), would correspond to 90° .

But most waveforms are not single-frequency waves but are, in Fourier theory, col-

ABOUT THE AUTHOR

Bill Waslo (BSEE, Univ. of Cincinnati) is an RF design engineer with a midwest engineering firm. With his wife, Carol, he also runs Liberty Instruments, developer of IMP, IMP/M and Liberty Audiosuite analyzer systems. His interests include music, loudspeaker design, signal processing, reading, and gardening.

**S
p
e
a
k
e
r

C
o
m
p
o
n
e
n
t
s**

AIRBORNE
LA PASSION DU HAUT-PARLEUR
AUDAX

DYNAUDIO[®]

ETON

LPG



morel

Peerless

scan·speak

seas

vifa



SOLEN INC.
4470 AVENUE THIBAUT
ST-HUBERT, QC J3Y 7T9
CANADA

Tél.: (514) 656-2759

Fax: (514) 443-4949

Catalogue 1996 • \$ 8.00

Solen crossover
components catalog included



*Music
Forever*

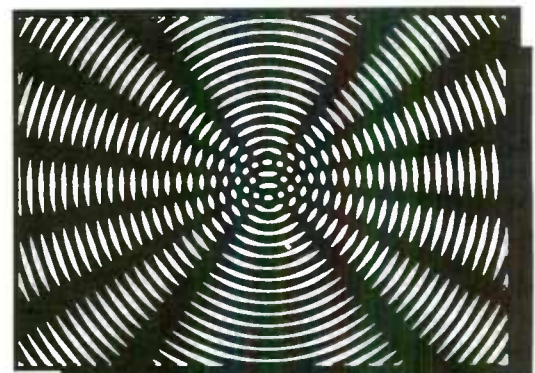
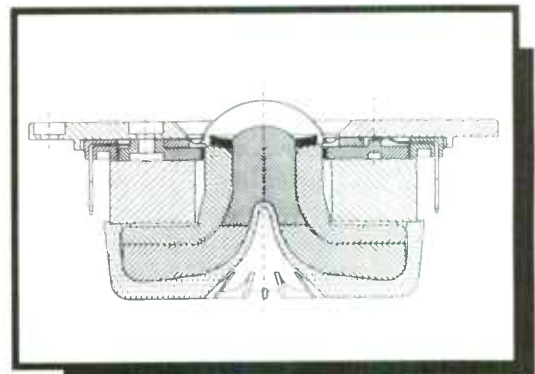

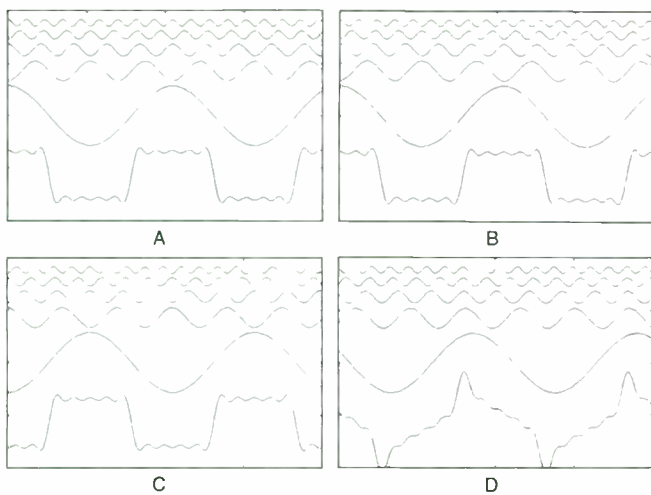

FIGURE 5: The first five components of a square wave and their sum, after various uniform phase shifts ($a=0^\circ$, $b=360^\circ$, $c=180^\circ$, $d=65^\circ$). Shifts that are not integer multiples of 180° distort the shape.

lections of cosine waves. These complex waveforms may not repeat at all, and if they do, will not repeat at the same rate as each component cosine wave. So delay is not such an ambiguous quantity for such a complex waveform.

Delay, however, can be rather hard to define if the waveform is warped by a magnitude response or is phase-shifted in such a way that its shape doesn't come out resembling the original. This is usually the case for loudspeakers, most of which do not have equal delay at all frequencies (even if the frequency-response magnitude might be essentially flat), consequently altering complex waveform shapes.

This perhaps highlights the reason that the concept of delay is often confusing. In an impulse plot, delay is difficult to determine except in systems which alter waveforms only in horizontal (time) position. Those trying to find the reference plane of a loudspeaker driver by looking only at its impulse response often are unsuccessful because the output doesn't look like the input. Using frequency response and phase data, however, you can easily find delay for one frequency, but only if you already know that it doesn't amount to more than one period of that frequency. Otherwise, the phase at that frequency alone cannot tell you the delay.

PHASE DISTORTION VS. LINEAR PHASE

Whether phase distortion as generated in existing loudspeaker systems is audible is a subject of some controversy. You would probably agree that an imagined pathological system that delayed, for instance, mids and highs by only microseconds, but bass frequencies by several months, would

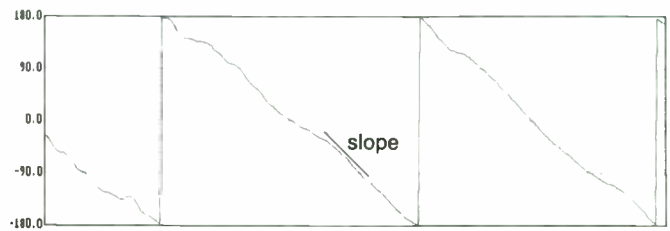

FIGURE 6: A phase response in "linear frequency" format. The group delay at each frequency is proportional to the downward slope of the curve, and is relatively uniform throughout this range.

certainly have an audible delay characteristic. But less-severe delay errors may or may not be such a problem, and the dividing line is not clearly known.

If you are designing a speaker and

wish it to have ideal waveform replication, what do you look for in the phase response? Do you want a speaker that has the smallest delay possible? One that imparts the same phase shift at all frequencies? One that has flat "group delay"? Or one that shows no curving sections in a plot of phase versus frequency? Just what does an ideal phase characteristic look like?

Delay itself is what audio playback is all about. When you listen to your recording of Belafonte at Carnegie Hall, there is a delay of over thirty years at work on that signal! In speaker measurements, the amount of delay you get depends on the distance from the speaker to the measuring microphone. Remember, sound travels about 17ms; you get an additional delay of about 1ms for each foot of speaker-to-mike spacing. In short, the true phase response of a microphone or speaker depends on just how far away you measure it! (It has meaning only if you specify some reference plane.) So there would seem to be little motivation to pursue minimum delay in a speaker design.

How about constant phase shift? You can shift each component cosine wave by a constant phase angle, although the result may not be what you expect. If you shift each component by 360° or any integer multiple thereof, you will, of course, not change any of them and will therefore not change the complex waveform. If you shift by 180° , you will invert the waveform (turn it upside down)! But if you shift by, say, 65° , what do you get?

Figure 5 shows the result of shifting the first five components of a square wave by 0° , 360° , 180° and 65° . Note that the basic shape of the wave is preserved for all except the last. Shifting all the cosine com-

ponents of a complex waveform by angles that are not integer multiples of 180° usually results in severe waveform distortion! So equal phase shift at all frequencies is generally not desirable from the standpoint of waveform fidelity.

What you want for ideal waveform replication is not a response without delay nor with a constant phase shift versus frequency, but with constant *delay* versus frequency. This is known as a uniform delay or "linear phase" characteristic.

GROUP DELAY

The same delay applied to all frequencies means that the phase shift will be different for different frequencies. In fact, you can express the phase shift of a linear-phase system as being proportional to frequency (remember that each phase angle has many aliases: you can add or subtract any integer multiple of 360° to each angle value without changing it).

A frequency response with uniform magnitude (the "dB" part) and which imparts the same delay to all frequencies will preserve waveform shape. If magnitude or delay is not flat, however, the delay is difficult to determine because the shape of a complex (multifrequency) test signal is changed by the system being measured. And phase shift or delay is rather ambiguous if you consider single cosine waves in isolation.

One way to deal with this impasse is to consider the cosine components at closely spaced frequencies and their phase shifts in relation to each other as they pass through the system. In other words, look at how the phase shift changes for small changes in frequency. This leads to a definition of what is called "group delay," mathematically defined as the negative rate of change of phase versus frequency.

On a plot of phase versus *linear* frequency (Fig. 6), this is the "slope" or downward steepness of the phase curve (the sharp upward edges are a result of phase ambiguity where -180° is equated to $+180^\circ$). A uniform, waveform-preserving phase response will have a constant value of this slope over the entire curve.

But beware! The phase-response curves shown by most measurement systems (including IMP and Liberty Audiosuite) are normally given in log-frequency format. A plot of a uniform delay system, other than one with zero delay, will then show a line for which the downward slope gets steeper as frequency is increased, because more frequencies are crunched together toward the right side (Fig. 7).

In such a plot, a response with a phase-shift line that tilts downward without a bend in it would actually have a nonuniform delay. Figure 8 shows an overlaid LAUD phase plot for successively increasing uniform delays. The same kind of phase wrapping will occur from the delay that's added by moving a measuring microphone back from a speaker.

Recognize also that constant group delay does not guarantee uniform time delay. A uniform time delay will exhibit constant group delay, but the opposite is not necessarily true. For example, remember the shift of each cosine component by 65° shown in Fig. 5d. The phase response of a system bringing about this shift could be represented by a straight line at 65° . The slope of that curve, and therefore the group delay of such a system, is a constant zero. Yet you saw that the resulting waveform distortion definitely indicates nonuniform time delay.

TIME DELAY

A uniform time delay implies that you could remove delay from the phase response to achieve a horizontal line at 0° (which means no delay). If you can't get to a straight horizontal line by removing delay, or if the horizontal line you then achieve is at some angle other than 0° , the system being measured will exhibit waveform distortion. So, it seems that a way to determine whether a delay is constant over a band of frequencies is to work backwards and see whether removing some constant delay will get you to 0° everywhere within that band.

To remove delay at a given frequency, take the time delay being tried (in seconds) and multiply it by 360 times the frequency. Do this for each data frequency and add the result to each raw phase angle (in degrees), remembering that you can also add or subtract 360° as many times as necessary at each point to reduce the answer to within $\pm 180^\circ$. Do this for various delay values until a best approximation of a straight line is reached.

That isn't very practical to do by hand. It is much easier to simply apply a known complex waveform to the system and see whether it passes through uncorrupted in the time domain. That is the motivation for square-wave or triangle-wave testing.

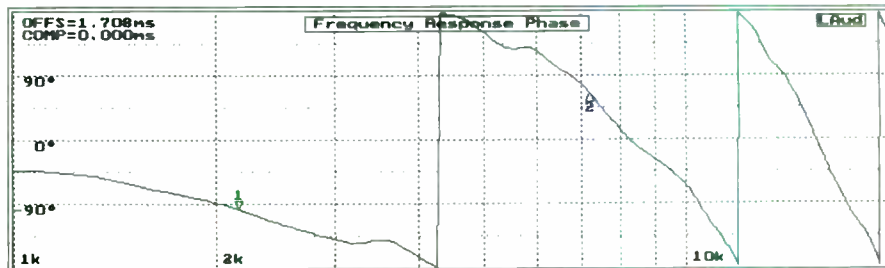
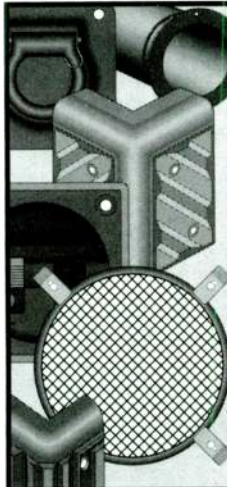

FIGURE 7: The same phase response as in Fig. 6, but in log-frequency format. The curve appears to bend more at higher frequencies because of the nonlinear display format, even though the group delay is relatively constant.



If you build it, it will rock.

TCH offers you the ability to combine state-of-the-art speaker components to design and build your own custom loudspeakers. So whether your speakers will rock concert halls, disco floors or living rooms, TCH has over 500 items in stock and ready for immediate delivery.

1-800-291-0389

TCH

- Handles
- Corners
- Speaker Grills
- Casters
- Speaker Carpet
- Clamps
- Jack Dishes
- Feet
- Grill Cloth
- Plugs & Jacks
- (\$50 min. order)



1705 Broadway, Buffalo, NY 14212 Fax: 716-892-4302
2955 Congressman Lane, Dallas, TX 75220

Reader Service #48

Speaker Builder 7/96 17

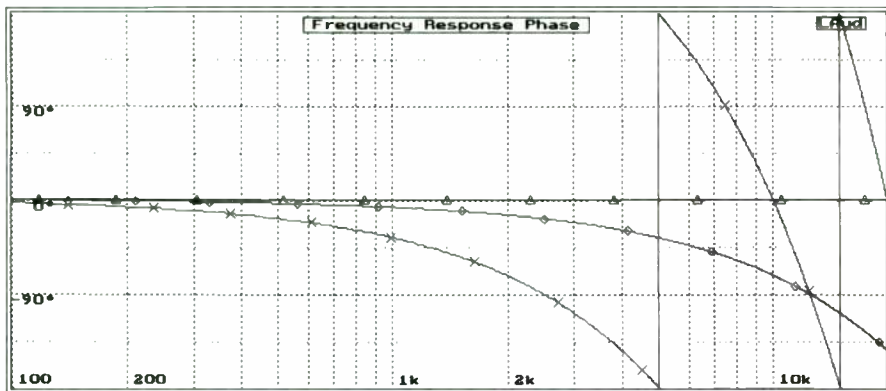

△ ideal phase and zero delay ◇ 20 microseconds delay × 100 microseconds delay

FIGURE 8: An ideal linear-phase characteristic in log-frequency format with different amounts of delay.

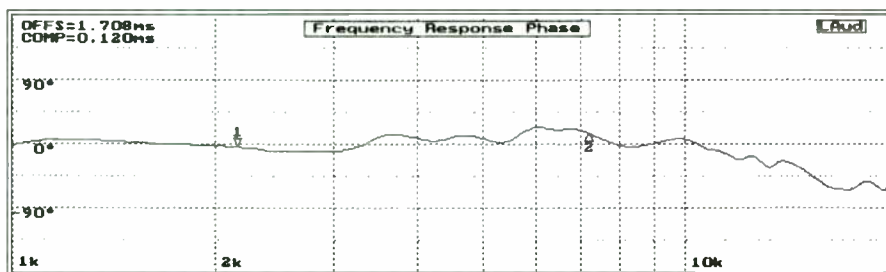

FIGURE 9: The phase response of Fig. 7, with time delay ("COMP") removed via computer to resemble a horizontal line. The line is near 0°, so this speaker essentially has a linear-phase characteristic over the range (1–10kHz).

However, even though such simple time-domain testing may tell you that there is waveform distortion, it won't clearly indicate whether any problem uncovered is due to frequency-response magnitude or phase error. In addition, it is difficult to conduct meaningful square-wave tests on loudspeakers, because you cannot remove the effects of the room reflections or echoes that also strongly alter the shapes of the reproduced periodic waveforms.

APPROXIMATION BY COMPUTER

With IMP- or LAUD-generated quasianechoic responses, you can easily remove delay mathematically using the computer until the best approximation to a straight line is achieved on the plot over the frequencies of interest (Fig. 9). You can do this by trial and error without much effort. If the line is then essentially near 0° (if at 180°, you can reverse the speaker leads), the delay of the speaker is uniform, and complex waves made up of these frequencies will pass phase aligned.

Of course, the magnitude of the frequency response must also be flat to achieve waveform integrity. In IMP or LAUD, fixed amounts of delay can be subtracted from or added to a phase plot by using the [F9] key.

You can get a close starting value for the amount of delay to remove by measuring the distance from the speaker to the mike and multiplying that value in feet by 0.886 (or the value in meters by 2.91). The result is the number of milliseconds it took for the signal to reach the mike after it left the speaker. For this to be valid (in the case of IMP and LAUD), the measurement should be made with a "Cal" normalization from the signal at the crossover input (in dual-channel mode for LAUD).

You should also set the first time marker to a placement of "1" before doing any transformations, so that the time window includes the entire time of flight. (For further information about normalization, time markers, windows, and measurement devices, see the series of IMP articles in *Speaker Builder* issues 1, 2, 3, 4, and 6 of 1993, the IMP Guide, or the Liberty Audiosuite manual.)

I should again mention that for good sound reproduction you probably do not need such extremely uniform phase-response or waveform-shape integrity. It is not unusual to find that the phase curve of a very good speaker straightens only over short portions of the audio band and often away from 0°, revealing a nonuniform delay. The degree of phase distortion that is tolerable before it affects audible sound quality is another subject altogether.

FerroSound

The Solution Is Loud And Clear™

FerroSound ferrofluid retrofit kits for tweeter, midrange and compression drivers are now available through the Parts Express catalog. The generic tweeter kit contains a low viscosity ferrofluid in sufficient quantity for most 1" and smaller dome tweeters. Application specific kits for popular professional compression drivers are available for the following models:

Manufacturer	Model
B & C	DE-16
	DE-45
	DE-75
Electro Voice	DH-1A
	NDYM-1
Radian	450, 455
	4450, 4455
	735, 750
	4735, 4750
Eminence	1" exit

**CALL TOLL
FREE**

Parts Express Customer Service

1-800-338-0531





THE SPEAKER WORKS, INC.
 1021 E. Camelback Rd.
 Phoenix, AZ 85014
 (602) 230-0344 FAX (602) 230-8533

vifa

QUALITY DANISH LOUDSPEAKERS

vifa

D19TD-05-08 ¾"

- High Loss Diaphragm
- Magnetic Fluid
- High Power Version
- Good Dispersion

Specifications

Impedance 8Ω
 Resonance 1700Hz
 Frequency Range ... 3-20KHz
 SPL 1/W/1/M 89DB
 Power Handling 80W
 Voice Coil 19mm
 Magnet 3.7 oz.



\$11.69 ea.

P17WJ-00-08 6½"

- Also in 4 ohm
- Magnesium Basket
- Mineral Filled Polycone
- High Damping Surround
- Very Smooth Response

Specifications

Impedance 8Ω
 Resonance 37Hz
 Frequency Range ... 5000Hz
 SPL 1/W/1/M 88DB
 Power Handling 120W
 Qts 0.35
 Vas 34.7 LTR
 Voice Coil 32mm
 Magnet 14.6 oz.



\$33.93 ea.

D25AG-35-06 1"

- Aluminium Diaphragm
- Magnetic Fluid
- Double Chamber
- Flexible Voice Coil Braids

Specifications

Impedance 6Ω
 Resonance 850Hz
 Frequency Range ... 1.5-35KHz
 SPL 1/W/1/M 89DB
 Power Handling 100W
 Voice Coil 25mm
 Magnet 8.5 oz.



\$26.00 ea.

P21WO-20-08 8"

- Magnesium Basket
- Mineral Filled Polycone
- High Temp Voice Coil
- Very Smooth Response

Specifications

Impedance 8Ω
 Resonance 28Hz
 Frequency Range ... 25-4000Hz
 SPL 1/W/1/M 91DB
 Power handling 150W
 Qts 0.33
 Vas 113 LTR
 Voice Coil 40mm
 Magnet 24.6 oz.



\$47.52 ea.

SHIELDED SPEAKERS

D19TD-03-08 ¾"

- High Loss Diaphragm
- Additional Magnet
- Good Dispersion

Specifications

Impedance 8Ω
 Resonance 1400Hz
 Frequency Range ... 4-20KHz
 SPL 1W/1M 90.5
 Power Handling 50W
 Voice Coil 19mm
 Magnet 7.4 oz.



\$13.40 ea.

Specifications

Impedance 8Ω
 Resonance 54Hz
 Frequency Range ... 54-5000KHz
 SPL 1/W/1/M 88DB
 Power Handling 70W
 Qts 0.35
 Vas 12 LTR
 Voice Coil 25mm
 Magnet 12.1 oz.

M13SG-09-08 5"

- Magnetically Shielded
- Very Smooth Response
- High Damping Surround
- Paper Cone



\$31.52 ea.

ANY QUESTIONS? — CALL US

We accept VISA - Mastercard - Check — No C.O.D.
235 PAGE CATALOG \$10.00 (USA only)

A MODEST-COST THREE-WAY SPEAKER SYSTEM, PART 2

By G.R. Koonce and R.O. Wright

At the end of Part 1 (SB 6/96), I spoke of the design program we used to give us the proportions and detailed dimensions of the enclosures for our three-way system. Now I'll continue with the actual construction.

BOX CONSTRUCTION

Figure 26 shows side and front views of the box. Note that width always refers to a measurement from left to right, height from top to bottom, and depth from front to back. Note also that "box left" refers to the side of the box on your left as you face its front—the same as the position of the "left" speaker of a stereo pair.

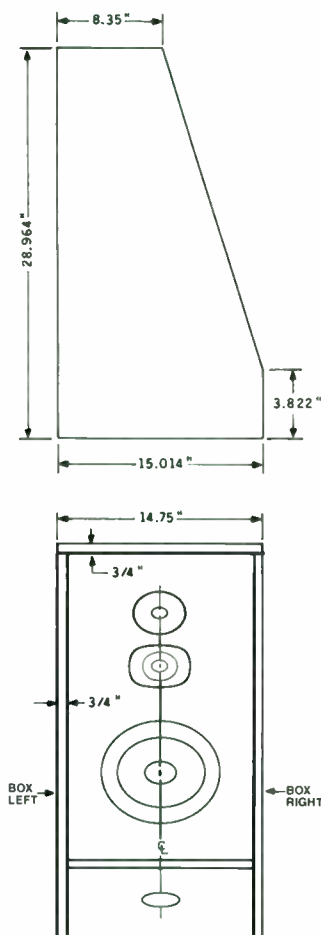

FIGURE 26: Front and side views of enclosure.

The front panel, back, midrange top, midrange bottom, and bottom are all the same width, so if you cut them all with the same saw settings, the box will fit together well even if you don't quite achieve the design width. This is what I call a construction-tolerant design!

I can't carry or easily cut a full 4' x 8' sheet of 3/4" particleboard, so I had the lumberyard cut it into 8'-long strips. With the construction of four boxes in mind, I purchased four sheets of the best particleboard and had them cut each one into two strips 13 1/4" wide, with a strip about 21+ inches wide left over. It should take less than two sheets of particleboard and some additional pieces of thinner material (for the crossover packaging) to build a pair of these boxes. Guides for designing your own box will be shown in Part 3.

CONSTRUCTION ORDER

I constructed the boxes as follows, working on all four at the same time. Cut the pieces for the front panel, back, midrange top, midrange bottom, and bottom all to the same width. Figure 27 shows the dimensions of each piece of the basic enclosure. I initially made the midrange top about 1/4" too deep, and also left the midrange bottom long in depth, with only one end cut at an angle for later fitting. I cut the cabinet top and sides later to ensure a better fit.

Photo 3 shows all the final pieces sitting on a side board to help you visualize how the parts fit together. The 2 x 2 had not been installed on the front panel when I

took this photo. You should install it after assembling the sides to the front panel and bottom. Photo 3 clearly shows that both the woofer and midrange chambers have only their sides parallel. It also indicates the very tight tolerances needed on the midrange and tweeter locations to ensure proper fitting of the midrange top.

MAKING THE FRONT PANEL

The next step is to fabricate the front panel. It is easy to get confused here: the end cut at a 90° angle goes at the bottom, and the back (interior) face of the panel is longer. Figure 28 shows the front-panel layout with all measurements from the bottom, so they are true on both the back and front faces. If your 2 x 2 is not 1.6" high by 1.5" deep,

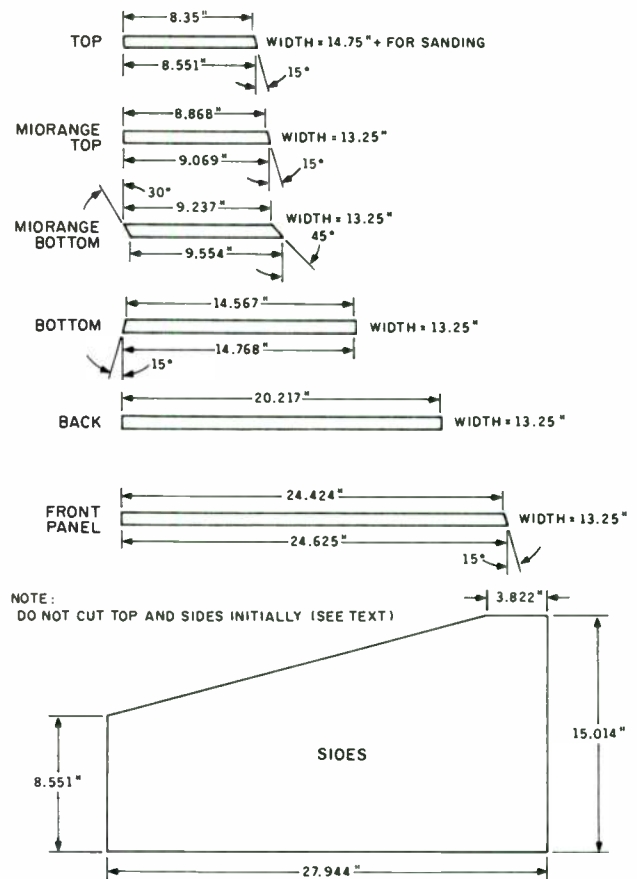

FIGURE 27: Basic drawing of all pieces of 3/4" particleboard in cabinet.

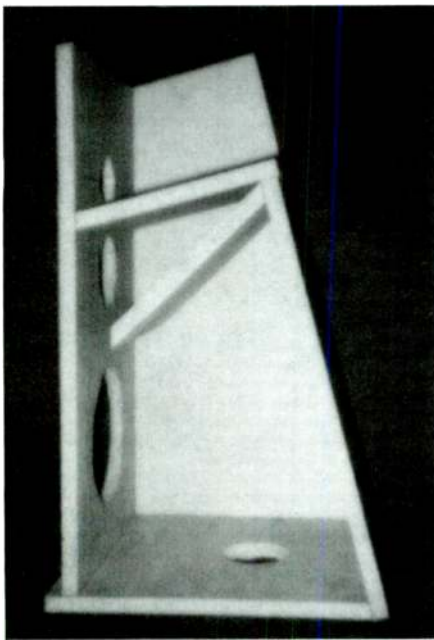

PHOTO 3: Basic layout of panels to construct enclosure.

you will have to make some adjustment.

As noted near the end of Part 1, the tweeter position is raised 1/16" higher than on the test front-panel design to prevent the back of the rather deep SEAS tweeter from touching the midrange top board. You should check this tolerance later, and, if necessary, grind a slight notch to prevent a possible rattle condition. I did not need to do this on any of the four boxes, but it is tight.

You must mark on the front panel the positions of the three driver holes and of the 2 x 2. Also mark the positions of four nail holes for attaching the midrange top, and four more for affixing the 2 x 2. I assembled my boxes with 1 5/8" tempered steel panel nails (made by ELCO), which you cannot drive into good particleboard without first drilling holes for them (I used a #51 drill).

If these nails bend, they easily break off,

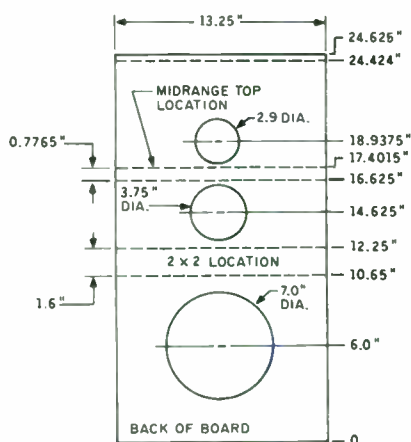

FIGURE 28: Layout of front panel.

and since they are ridged, they will tear up the particleboard if you try to pull them out. If a nail breaks I recommend you drive the remainder in flush, then drill and install a new nail nearby. Drill the nail holes for the 2 x 2 straight in (at right angles to the surface), but keep in mind that dowels fit into the 2 x 2, so space the nails to avoid the dowel holes (see Fig. 31).

You must drill the nail holes for the midrange top at an angle of 15° to the front-panel surface. (You need to be able to drill holes at 15° and 30° angles for this project. See drilling jig in *Photo 8* and discussion later.) My experience has shown that you get better accuracy if you drill the angled holes from the side of the board that mates with the other board. Start the drill vertically to make a small dent (to prevent the drill from walking along the board surface); then set the board to the desired angle and drill the hole.

DRIVER HOLES

Next, cut the driver holes using a circle cutter (fly cutter) in the drill press. I do not recess drivers into the front panel, as I feel it weakens this critical mounting interface and is not needed because of the front panel treatment described later. Again, the tweeter and midrange hole locations are quite critical. The tweeter hole must have notches for the terminals, and space gets tight here, because the Audax tweeter requires two notches 180° apart, while the SEAS needs one large notch. There is no room between the tweeter hole and the midrange top board, so you cannot put any of these notches at the bottom of the hole.

You have to be careful here, or you won't be able to properly place the two sets of screw holes needed, as the two tweeters don't have the same screw-hole centers. *Photo 4* shows back and front views of a finished front panel. Mount the SEAS tweeter rotated slightly counterclockwise from having its top two screws on a horizontal line, while you mount the Audax rotated slightly clockwise, with the SEAS notch serving as one of its notches, and the opposing notch cut slightly above the center line. Take plenty of time here. I recommend making a cardboard template that fits both tweeters and then transferring the dimensions to the front panel.

I cut the notches with a Roto Mite cutter

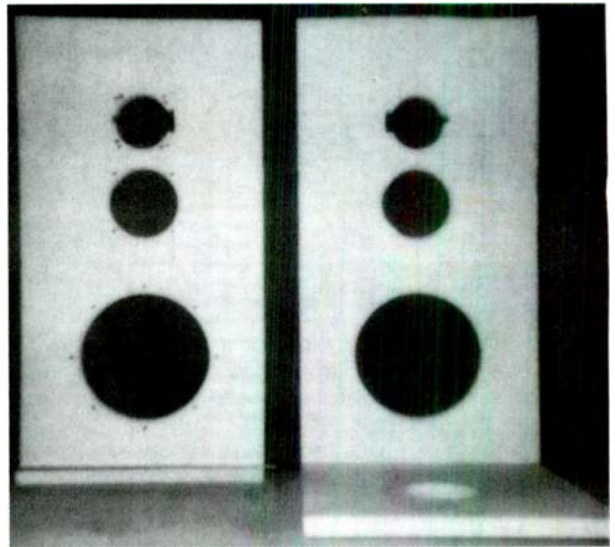

PHOTO 4: Front and rear views of front panel—bottom assembly.

and its 1/4" solid carbide bit (#RZ250), both available from Trendlines (American Legion Hwy., Revere, MA 02151, 800-767-9999). I did the final fitting by hand filing to be sure each tweeter type would fit into each front panel. I drilled eight screw holes (#48) for the two tweeter types, mounting them with #6 x 1/2" sheet-metal screws, which I find work better in the face of particleboard than normal wood screws. *Photo 4* shows the arrangement of these eight holes.

With the hole sizes shown for the midrange and woofer, it is necessary to file a small chamfer on the front edge of each to get the drivers to fit in flush with the front panel. I mounted both the midrange and woofer with #8 x 5/8" sheet-metal screws into #43 holes. The wire terminals tend to restrict the rear of the cone, so I mounted both drivers with the terminals facing the top, which is the most restricted area of each chamber. I believe the driver has to "breathe" on the back for the front to work properly, so I always relieve the rear edge of the driver mounting hole. For the sake of maximum stiffness and mounting strength, I do not like to relieve too much material behind the mounting screws and, thus, relieve only the area not blocked by the driver frame. To do this, I set the midrange and woofer into their holes and mark on the back of the front panel the correct areas to relieve.

I perform the reliefs with a router. For the midrange-top relief, I used a 3/8"-radius bit, but did not cut to full depth. You want to set the bit so it will not cut into the area of the front panel where the midrange top attaches. For the other three midrange reliefs, I used 3/8" radius and full depth. The four woofer reliefs were done with a 1/2"-radius bit, but not quite to full depth.

Photo 5 is the best picture I could get of

SILVER STREAK

Silver Streak is the ideal interconnect for all "up-scale" audio applications. It will deliver years of exacting audio performance, that gets you closer to the "being there" experience.

SilverStreak incorporates many advanced KIMBER KABLE technologies, as found in our most costly reference models. Proven tri-braid—VariStrand™ cable geometry, advanced metallurgy and custom Teflon™ dielectrics, synergistically combine to deliver superior performance in a package that's modestly priced.



The heart of SilverStreak features a single AG VariStrand™ conductor, fabricated from hyper-pure silver.

The ground plane is comprised of twin TCSS conductors with all Teflon™ dielectrics.

UltraPlate™ RCA connectors feature precision machined craftsmanship for perfect fit and peak performance.

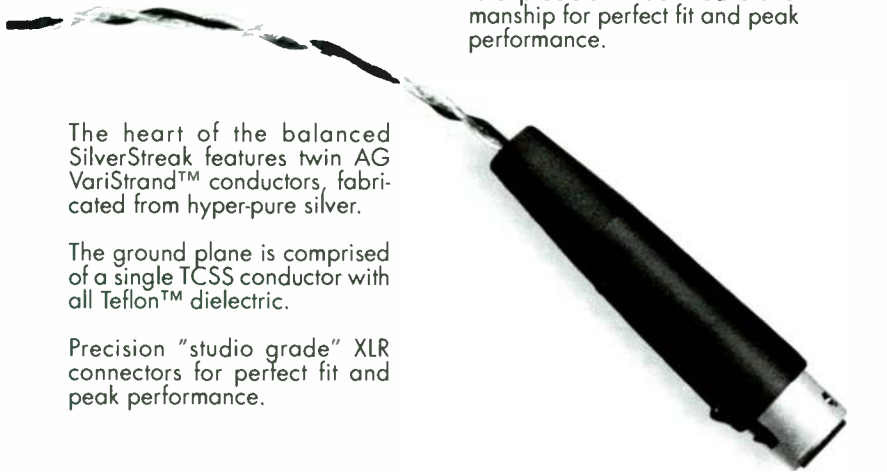

The heart of the balanced SilverStreak features twin AG VariStrand™ conductors, fabricated from hyper-pure silver.

The ground plane is comprised of a single TCSS conductor with all Teflon™ dielectric.

Precision "studio grade" XLR connectors for perfect fit and peak performance.



2752 S 1900 W • Ogden Utah 84401
801-621-5530 • Fax 801-627-6980
www.kimber.com

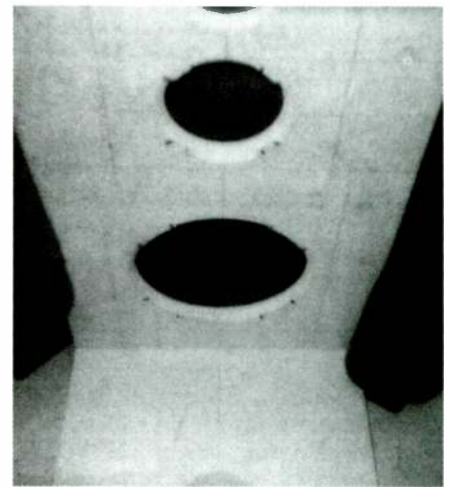

PHOTO 5: Front panel reliefs on midrange and woofer holes.

these reliefs. Building systems with small drivers over many years has shown me that these reliefs are important to get the system to the maximum level of which the drivers are capable, so please do not omit them, even if you must file them by hand.

BOTTOM FABRICATION

The next step is to fabricate the bottom board. Note that the right-angle cut is at the front, and the upper face is the shorter one. Refer to *Photo 3*. *Figure 29* shows the bottom-board layout. Mark the 3/4" set-back of the front panel and mark and drill the nail holes to attach this board to the front panel. Then mark the position of the port duct and make the hole. My finished boxes indicate that the diameter of the port duct could be slightly larger (maybe 1/4") than mine, but if it's too large, it will end up too close to the back board when you tune the enclosures.

Mating the front panel to the bottom board seems simple to do, but my experience has shown this to be the most critical assembly of the entire box! You must fasten the front panel and the bottom exactly at right angles in two planes. Apply glue to the bottom of the front panel and then clamp the front to the bottom board using a C-clamp hooked into the woofer hole. As shown on

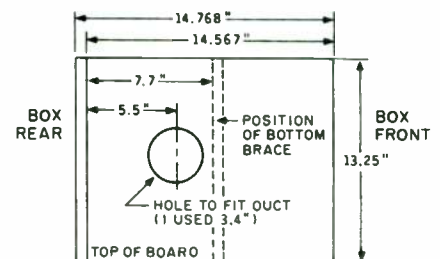
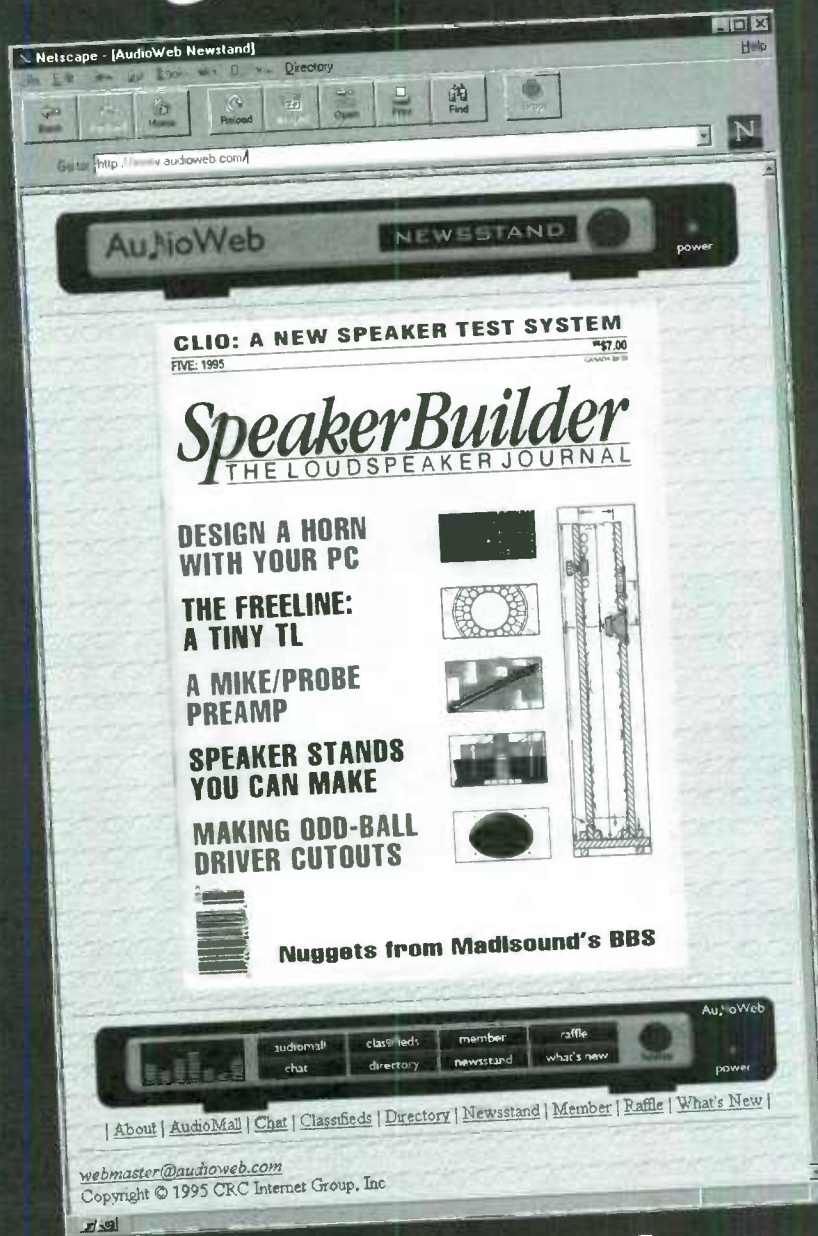

FIGURE 29: Layout of bottom board for enclosure.

Reader Service #65

Speaker Builder is on the Internet!

AudioWeb™



www.audioweb.com

For advertising and editorial information, please contact:

AudioWeb
c/o CRC Internet Group, Inc.
230 Sherman Avenue
Berkeley Heights, NJ 07922
908.464.7307
info@audioweb.com

the left in *Photo 4*, verify with a carpenter's square that the front panel is truly at right angles to the side of the bottom. Then nail the two pieces together. By adjusting the position of the C-clamp in the woofer hole, you can "pull" the front panel so you're sure it stands at right angles to the bottom board. Then let this assembly dry.

FABRICATING THE SIDES

You can use the L-shaped front panel and bottom assembly as a template to mark the sides of the box on the wide strip left over from cutting the particleboard sheets. *Figure 30* shows the basic layout of the side boards. Cut out the side boards, making the pairs the same size, even if the boxes are slightly different. Then mark the position of each mating box part (inside and out) on each side board.

Locate and drill the nail holes for the front panel, bottom, midrange top, and back. This includes a hole for a 2" (coated) sinker nail (#46 drill) into the end of the 2 x 2 that you will mount on the front panel. I did not at this point drill the nail holes for the midrange bottom or the braces that mate with the side, as they are hand fitted and may not come out exactly as shown in *Fig. 30*.

Now glue and fasten one side to the front panel/bottom assembly with just a few nails

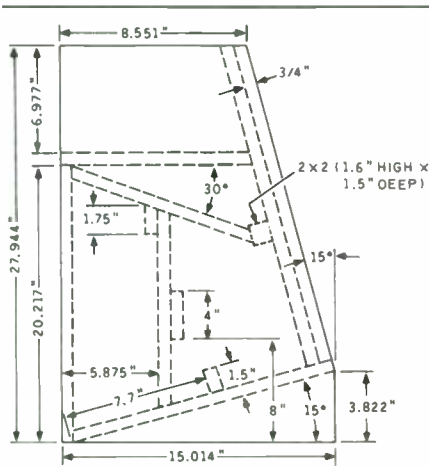

NOTE: SHOWS ALL PIECES INTERFACING WITH SIDE BOARDS. ALL ARE 3/4" THICK PARTICLE BOARD EXCEPT 2 x 2. DO NOT DRILL SIDE BRACE HOLES INITIALLY.

FIGURE 30: Layout of side board for enclosure.

and verify that the back and midrange top will fit properly. Next, glue the second side and fix it in position with long wood clamps. If the box stands properly without rocking, finish nailing the sides to the front panel and bottom board. Drive all the nails in the sides below flush so you can sand the boxes if you wish; what you do will depend on how you plan to apply a finish to the enclosures.

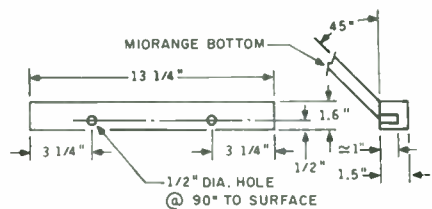

NOTE: MIORANGE BOTTOM BOARD COVERS $\approx 1.06"$ ON 2 x 2 BACK FACE.

FIGURE 31: Details of 2 x 2 brace for front panel.

Figure 31 shows the details of preparing the 2 x 2 braces for installation. Cut them so they fit rather tightly and then install them. Next, set in the midrange top, mark it, cut it to proper depth, and drill the necessary nail holes for attaching it to the back. Pass the midrange wire (#18 Zip cord) through the midrange top to the crossover (CO) area behind the tweeter, choosing a place where no nail from the side board will penetrate the wire. I recommend placing the wire hole 3" in from the back of the midrange top and 1" in from its side. I had used a location in 1/2" from the side; but, when I got to CO construction, this position caused an interference problem. I knotted the wire on the inside and seal it with lots of RTV.

Verifying that the back will fit properly and that the midrange top mates at the correct

MCM AUDIO SELECT™

- 6 1/2" Fiberglass Cone Shielded Woofer
- Woven Fiberglass Cone
- High Compliance Rubber Surround
- Rounded Over Front Steel Basket
- 35Hz-10KHz Response
- 8ohm, 40W/80W RMS/Peak Capacity
- Magnetically Shielded for Home Theater Use

Save **28%** Speaker Builder Readers Only!

You must supply this special price code: **SB34**
#55-1640
Reg. \$17.95...Sale **\$12.95**

High Performance Good Looks Great Price!

MCM Electronics is the undisputed leader for supplying top quality speaker components at unbeatable prices. Take advantage of this tremendous offer, available for a limited time, only to Speaker Builder readers.

Call today to order, or for your free catalog...

1-800-543-4330

Authorized Original Parts Distributor
Panasonic
Quasar / Technics

RCA / **3M**
Premier Distributor

Price effective November 12 through December 28, 1996



MCM ELECTRONICS®
850 CONGRESS PARK DR.
CENTERVILLE, OH 45459
A PREMIER FARNELL Company

Hours: M-F 7 a.m. - 9 p.m., Sat. 9 a.m. - 6 p.m. EST.

Fast delivery from distribution centers near Reno, NV and Dayton, OH.

CODE:SB34

Reader Service #11

Reader Service #32 →

RAVEN

HIGH EFFICIENCY PURE RIBBON TWEETERS

ORCA is sincerely proud of introducing these exceptional high frequency transducers from France. The RAVEN tweeter is a true ribbon tweeter, possibly the purest transducer available today. In a dome tweeter the signal is carried through the voice coil wire, and the sound is radiated by the dome attached to the voice coil. Here, the carrier of the electrical signal and the radiating diaphragm are one and the same part: the ribbon itself. Furthermore, the RAVEN ribbon is 100% pure conductive material, no metalized film. To have an idea of the high frequency performance of the RAVENS, imagine that the moving mass here is about 30 times less than a high quality dome tweeter. The music comes through effortless, almost immaterial. The special and massive NeFeB magnet of the RAVENS is five times more powerful than a conventional magnet. The result: the RAVEN R1 is capable of 118 dB peak with no measurable distortion (R2: 120 dB). At 10WRMS, that is continuous power now, R1 reaches 105 dB with less than 1% distortion, and R2, 107 dB. The RAVENS come with a specially designed matching transformer (very low distortion, low loss and wide bandwidth) for optimum coupling with your power amplifier. Now look carefully at the decay of these units !

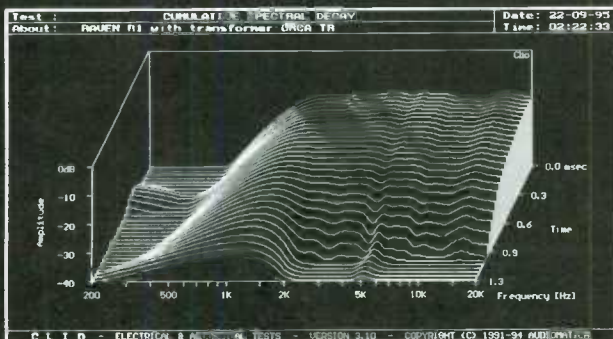

RAVEN R1
KGS 1.14
LBS 2.5
92 x 80 mm
3.63 x 3.15 in.
Moving mass:
0.0061 g
0.0002 oz.
dB/W/m 95
2 KHz to 40 KHz

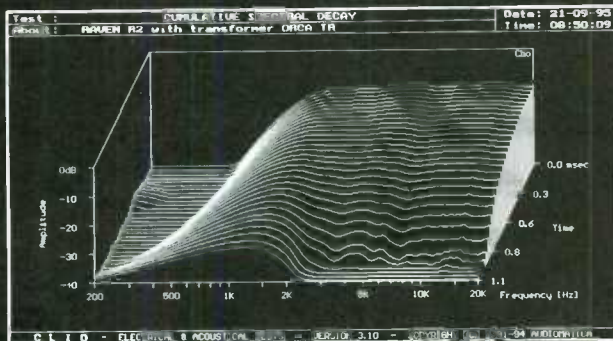

RAVEN R2
KGS 2.22
LBS 4.9
166 x 76 mm
6.54 x 2.99 in.
Moving mass:
0.013 g
0.0005 oz.
dB/W/m 98
2 KHz to 40 KHz

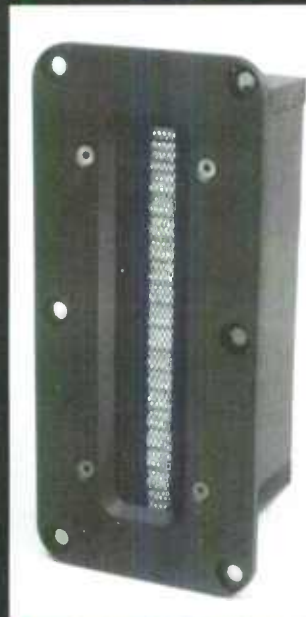

RAVEN TRANSDUCERS are distributed worldwide exclusively by **ORCA Design & Manufacturing Corp.**
1531 Lookout Drive, Agoura, CA 91301 - USA
TEL (818) 707 1629 FAX (818) 991 3072
E-Mail: orcades@aol.com
OEMs, stocking distributors and importers inquiries welcome. Goods now in stock in America.

point with the front panel, fix the midrange top in place. Install the wire as noted above, leaving plenty of length each way.

SEAM FILLETS

I advise that you fillet all seams in the construction to ensure air-tight joints and prevent edge buzzing or rattling. I have used many substances for the fillets over the years, but the best I have found is the same glue (Titebond II) I use for assembly. If the joint is not tight, the glue will continue to seep into it until it is. Drying and rechecking takes a bit of time, but you should continue to add a small bead of glue along the joints

until it hardens on top, verifying that the joint is sealed.

In placing the glue fillets on the assembled portions of the box, try to avoid areas where braces or other items will later be installed, so you can fit them in more easily. Pay special attention to the midrange chamber, since you will soon close it up, and reaching in through the midrange mounting hole to fillet seams is difficult. When the box is finished, be sure to fillet the seams on the outside of the bottom and front panel.

FINISHING THE MIDRANGE CHAMBER

The next step is to fabricate the midrange

bottom board. At the front, this fits against the back of the 2 x 2 brace, flush with its top edge, and against the midrange top just flush with the back board. The front-to-rear 1/2" dowels will interfere with the midrange bottom, so you must cut notches in the bottom at the appropriate positions. Also, to attach the midrange bottom to the 2 x 2, drill three nail holes in the 45°-angle cut of the front edge, making these holes perpendicular to the plane of the cut edge. The rear of the midrange bottom is not nailed until you install the back.

Once you install the midrange bottom board, you will no longer have access to the midrange chamber, so the damping material for that chamber must be fabricated before you fasten in the bottom. I was worried about strands of the fiberglass damping material I use getting into the midrange driver via its vented magnet, so I wrapped all the fiberglass mats for this area in old grille cloth. See *Photo 6* to clarify the following description.

Tear 6" x 17" strips of (nominal) 3 1/2" fiberglass into two equal half-thicknesses. Placing two such strips side by side, wrap them in grille cloth, creating a finished 12" x 17" mat. Sew the mat closed along the seam and at each end with heavy thread, at one end doubling the grille cloth over and sewing it to make a lip four layers of cloth thick. This is the end you later staple to the front of the midrange top board.

Next, make a cardboard template of the side surface of the midrange chamber, and from this a paper template for measuring the cover of a full thickness 3 1/2" fiberglass mat cut to fit the side. Then staple the large fiberglass mat to the front of the midrange top. *Photo 6* shows on the left an inverted box with one of the side mats set in. The center box shows the large mat stapled in place. Now poke the midrange wire and the loose end of the large mat through the midrange hole to get them out of the way, and install the midrange bottom.

Use lots of glue on the sides, as it is almost impossible to fillet the inside of these seams through the midrange mounting hole. Now drive the nails into the 2 x 2, clamp the midrange bottom up tight against the midrange top, verify that the back will fit in properly, and then install the nails through the sides. After the glue dries, fillet the midrange-bottom seams, including the one where it meets the midrange top. This last fillet will require you to file clearance on the inside top of the back board so it will fit in properly.

When filleting the seam where the midrange bottom meets the 2 x 2, you need to avoid the holes and notches for the front-to-back dowels. Now, working through the

* CAR SPEAKER SYSTEM

* IN-WALL SPEAKER

* TWEETERS

**COST DOWN!!
COST DOWN!!
COST DOWN!!**



Separate/Component Car Speaker System
4", 5 1/4", 6 1/2"

Dome Tweeter @ USD0.79

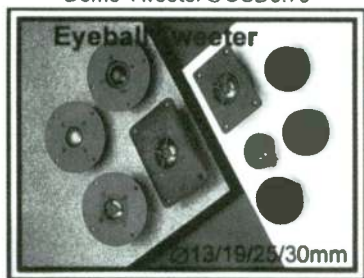

Surface/Angle/Flush
Mounting Kits



Pot-Light Style/Square In-Wall

- ⊗ Best choice for cost saving effectively.
- ⊗ Most professional manufacturer for speakers.
- ⊗ Available for OEM design and free 1997 catalogues.

Forgings INDUSTRIAL CO., LTD.

P.O. BOX 1823, TAIPEI, TAIWAN, R.O.C.
TEL: 886-2-585-3316/7 FAX: 886-2-594-2708
ATTN: Ms. Su Lien

Reader Service #52



MADISOUND CUSTOMER APPRECIATION 10% OFF EVERYTHING SALE!

In appreciation of your continued support for Madisound, we would like to offer you a 10% discount on everything in our inventory. This offer is good for the month of December, 1996.*

** This offer is applicable to Retail sales only and excludes all speaker kits, Leap designs, sales items and cannot be combined with any other discounts.*

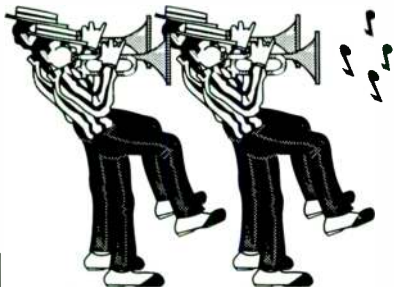

MADISOUND SPEAKER COMPONENTS
8608 UNIVERSITY GREEN
P.O. BOX 44283
MADISON, WI 53744-4283 U.S.A.
TEL: 608-831-3433 FAX: 608-831-3771
e-mail: madisound@itis.com
Web Page: <http://www.itis.com/madisound>



▶ You must mention this offer when placing your order. ◀

midrange mounting hole, poke the large fiberglass mat into proper position and put some glue along the lower front edge to keep it in position. Then glue the outer surfaces of the side mats and push them into position. The side mats serve to lock the large mat into position. This finishes the midrange chamber.

SIDE BRACES

The next step is to install the braces that stiffen the top (midrange bottom), bottom, and sides of the woofer chamber (Fig. 32 and Photo 7). To make the two side

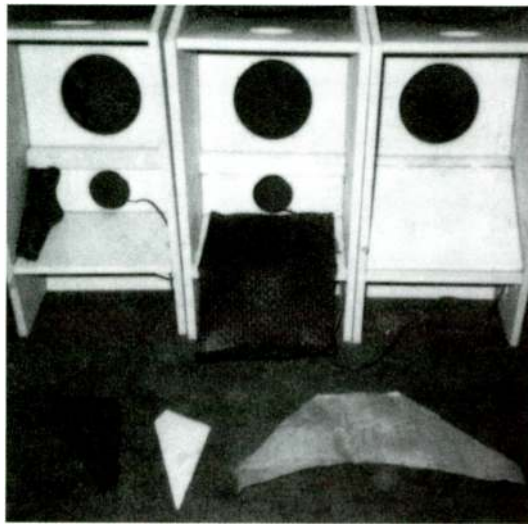

PHOTO 6: Midrange box construction and damping mats.

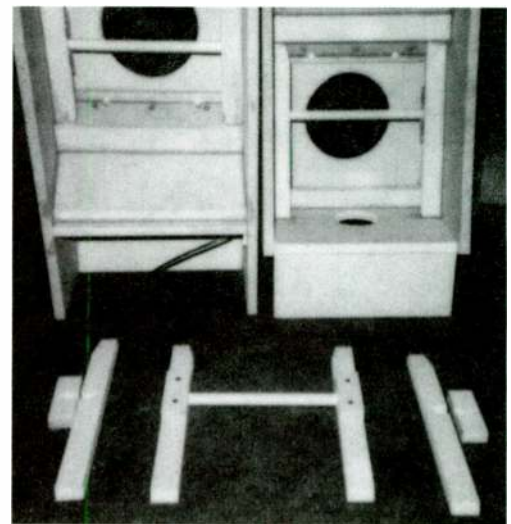

PHOTO 7: Woofer box side-bracing parts.

you can use the triangle-shaped sections cut from the side boards to convert them from rectangles to their final shape. The braces will not be full width for their entire length, but this is no problem. Install the bottom brace first, $\frac{1}{2}$ " in front of the port hole and perpendicular to the bottom board. Drill holes and drive nails into this brace through the bottom and sides. The remaining braces do not mate with this one.

Fitting the side braces is painful hand work. They do not have to be in the exact position shown, but you don't have a lot of clearance between the side-to-side dowel and the woofer magnet. The braces go in vertically, parallel to the back. Once the side braces are cut to fit and you've made the top brace with the two #36 holes drilled, install all three pieces, clamping the tops of the side braces to the top brace. Then drill the two #36 holes into the midrange bottom board, mark the dowel location 10" up from the bottom of the box, and mark the brace locations inside the box.

Now remove the pieces, drill the dowel holes and the dowel clamping-block-attachment screw holes, and put the through-bore and countersink on the top brace. The flat Irwin bits will drill the holes for these dowels in particleboard with no problem, straight in or at an angle. These holes, about 1" deep, are at the interface of the brace and the clamping block. Drill the necessary nail holes in the box sides and then install all three parts permanently, along with the $\frac{3}{4}$ " dowel (about 12" long) and the dowel clamping blocks.

BACK BRACES

The back braces are a bear. Figure 33 shows the dimensions, with the layout shown in Photo 8. Put the dowels in the 2 x 2 and mark the dowel-hole locations on the fitted

back brace—about 10 $\frac{7}{8}$ " up from the inside bottom edge of the boxes. Remember that these dowel holes go in at a 15° angle. Once you've finished the back braces and dowel clamping blocks, cut the $\frac{1}{2}$ " dowels to the proper length (about 8 $\frac{11}{16}$ " and assemble all parts in the boxes.

Mark the positions where the braces fit best on the midrange bottom and the box bottom—about $\frac{3}{4}$ " from the inside edge of the side boards. Drill nail holes in the bottom board and toe-nail holes in the 30°-cut faces of the back braces at the top. Then install both back braces, making sure they will sit tightly against the back board when it is installed. Be sure to drive the toe-nails at the top in flush so the back will fit. Also, file

grooves along the sides of the $\frac{1}{2}$ " dowels where they go into the 2 x 2, so glue will not prevent their insertion.

After the glue has dried, fit the back board in temporarily. I did not think I could support the back braces sufficiently to drive nails into them, so I drilled three holes for #6 x $1\frac{1}{2}$ " flat-head particleboard screws in each side of the back. You should also mark the back for nails into the bottom board (angled up at 15°) and into the midrange bottom board (down 30°), being careful to avoid existing nail locations.

Photo 8 shows an upright and an inverted box with the back braces installed. Also shown at the left front of the picture is the 15° drilling jig for the drill press. The remov-

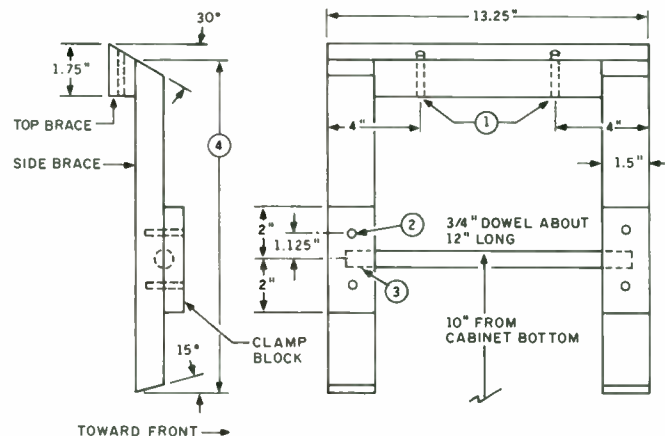

- NOTES: ① DRILL INITIALLY #36. IN FINAL PREPARATION DRILL TO #12 AND COUNTERSINK FOR #8 x 2" FLAT HEAD PARTICLE BOARD SCREW.
 ② INITIAL DRILL #36. DRILL CLAMP BLOCK #13 AND COUNTERSINK FOR #8 x 1 1/4" FLAT HEAD PARTICLE BOARD SCREWS.
 ③ 3/4" HOLES FOR DOWEL DRILLED APPROXIMATELY 1" DEEP.
 ④ SIDE BRACES CUT TO FIT: OVERALL LENGTH IS ABOUT 14" SO START LONGER. IF BRACE NOT FULL WIDTH FOR ENTIRE LENGTH PUT NARROW END AT TOP.

FIGURE 32: Details of all pieces involved in side bracing woofer box.



PHOTO 8: Woofer box back braces and damping material.

able dowel across the top of the jig allows drilling at 30° when the board is properly positioned. Also shown is a back board with the wire installed on the cabinet's left side, down 3" from the top of the board and in 1" from the side.

THE WOOFER BOX

We were unable at the time to obtain a second pair of woofers, so from this point construction continues on only two boxes. Line the woofer boxes with fiberglass as follows. Cover the bottom board with nominal 3/2" fiberglass in three areas: in front of the bot-

tom brace, behind the bottom brace, and outside the back braces, but here stopping about 2" from the back of the box. This leaves the port area clear, and the gap at the rear allows room to place fiberglass on the back.

Cover each side with nominal 3/2" fiberglass both in front of and behind the side braces, but again leave about 2" from the cabinet rear uncovered.

At the top of the woofer box, cover the bottom side of the 2 x 2 with 1/2" fiberglass, wrapping it around the 2 x 2 up over to the dowel area. (This fiberglass is really 1/2" thick and is sold as wrap-around insulation for pipes.) Then use the nominal 3/2" fiberglass from the 2 x 2 to the top brace and from that brace back to 2" from the cabinet rear. Cover the fiberglass from the top brace to the front panel with

grille cloth to keep fibers from getting into the woofer.

The right side of *Photo 8* shows the box at this point of construction. Next, cut three strips of fiberglass to cover the back board (avoiding the back braces), but do not install them yet. Now drill the needed holes in the back board, including countersinks for the screw holes, glue the

board and nail and screw it in. (Don't forget the woofer wire before you install the back.)

With the box on its back, reach in through the woofer hole and fillet the inside back seams (the back is later filleted on the outside also). With the interior fillets done, install the last three strips of fiberglass through the woofer hole, poking them under the existing fiberglass on the sides, top, and bottom to hold them in place while the glue sets. (I initially used rubber cement to glue the fiberglass, but we discovered it came loose when the boxes were shipped. You should use a stronger glue or, alternatively, the approach described by R.O. Wright in Part 3.)

CROSSOVER PARTS

At this point, the box is complete except for the CO parts and the top board. *Figure 34* shows the dimensions of the parts for the Zobel board, and *Fig. 35* the parts to fabricate the CO board. The two 15/16" holes in the rear of the Zobel board (*Fig. 34*) serve as finger holes to permit handling and to allow

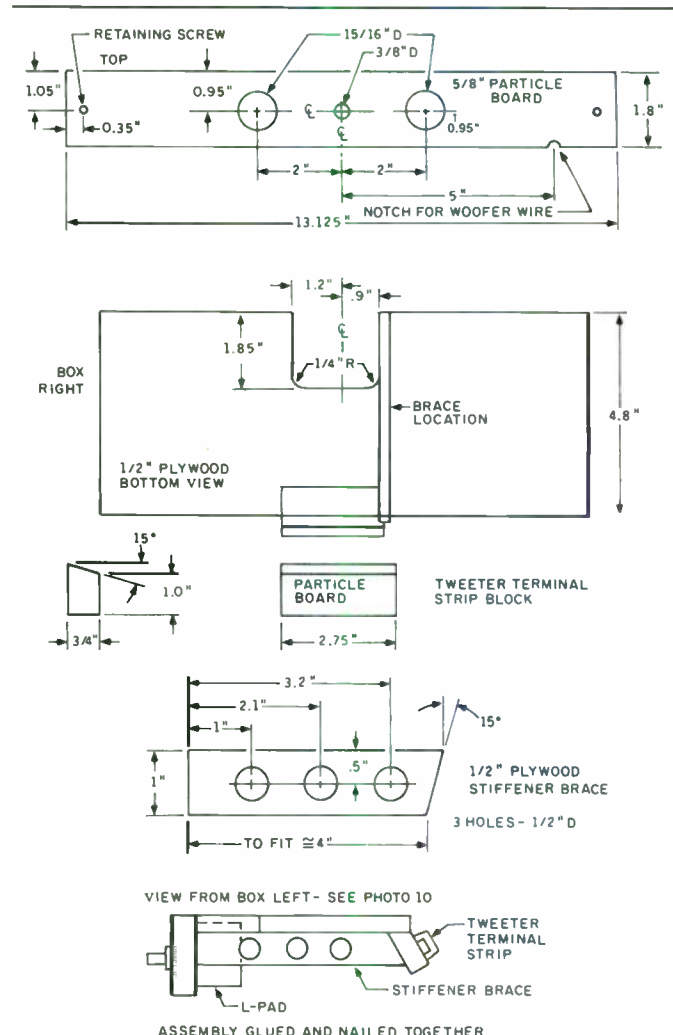
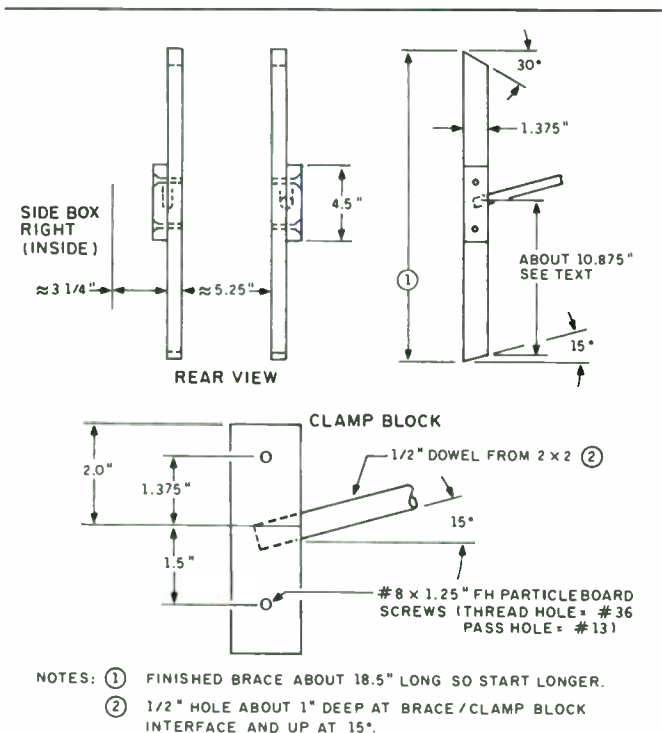

FIGURE 33: Details of all pieces involved in back bracing woofer box.

FIGURE 34: Details of all pieces used to construct the Zobel board.

air flow, as this board holds several resistors. Do not omit these "finger" holes or the holes shown in the Zobel-board stiffener.

Photo 9 shows the pieces of the boards. At the right front are the three pieces that build the Zobel board (I added a fourth stiffener piece later), and at center front are

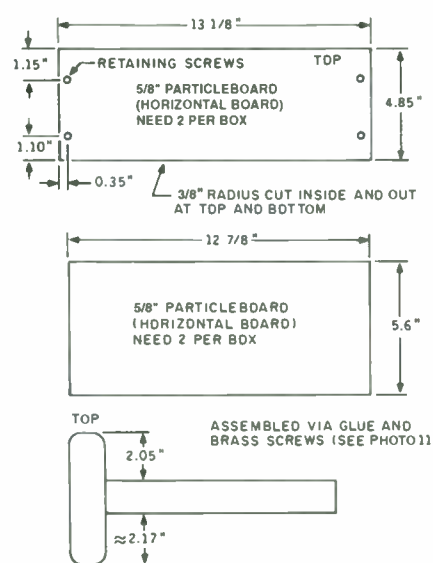

FIGURE 35: Details of all pieces used to construct the crossover boards.

the two pieces that form the T-shaped CO board, of which two are needed per box. On the left are finished Zobel and CO boards, with the only components mounted being the L-pad and tweeter terminal strip on the Zobel board.

The E-shaped pieces (Fig. 36) are screwed to the enclosure sides to hold the boards as shown in the box at the right rear of the photo. Note the foam tape covering the groove faces. The box at the left rear shows how it appears with the boards installed.

TIGHT QUARTERS

The approach does provide easy access to the tweeter L-pad and a quick and convenient way to change the tweeter and CO. If the distance from the upper surface of the midrange top to the upper edges of the sides is not at least 6.9", you may never get the COs packed in this area and should use a different approach. Even with 6.9" available, the space was so tight that I was forced to make the horizontal portion of the Zobel board out of 1/2"-thick plywood rather than

5/8" particleboard. The plywood was then so lively that I added a stiffener from the vertical board to the small block for the tweeter terminal strip to damp the board so it would not ring.

After fabricating the parts needed for packaging the COs, cover the slide grooves in the E-shaped holders with 1/16" single-sided foam tape, including the front edge of the short (bottom) E leg. Place additional foam tape on the inside faces of the vertical boards, on both the Zobel and CO, to make

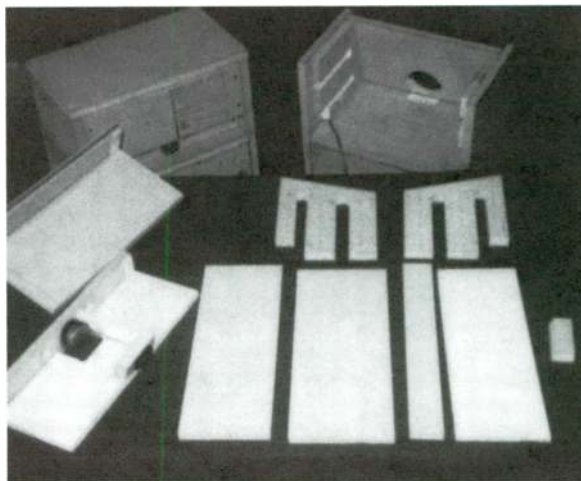
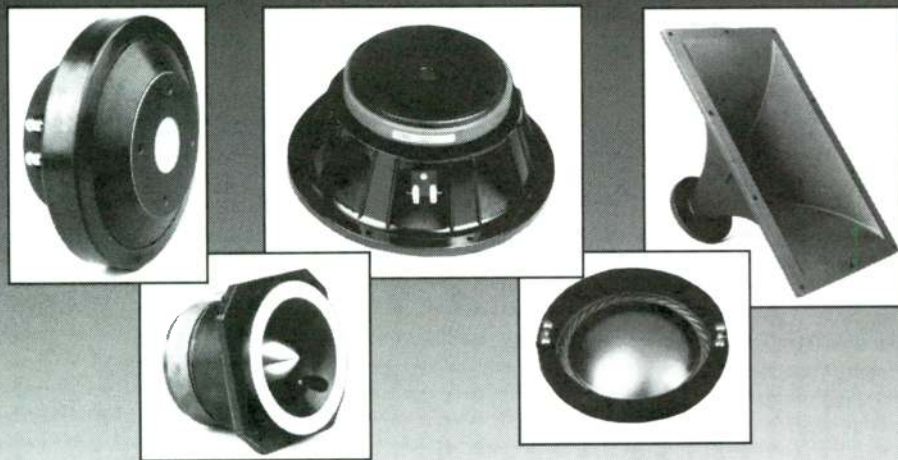

PHOTO 9: Pieces used to package and mount crossovers.

The Source for Pro Sound Speaker Builders



Loudspeakers, Drivers, Horns, Tweeters, Crossovers, Hardware, Connectors... and much, much more!
Image delivers virtually every component for the speaker builder.
See for yourself. Call or FAX for your FREE catalog today!

- EMINENCE**
Loudspeakers, Drivers,
Diaphragms and Recone Kits
-
- Electro Voice**
Recone Kits
-
- McCauley**
Loudspeakers & Drivers,
-
- Acoustician**
Drivers, Horns, Tweeters,
Diaphragms & Crossovers
-
- Waldom**
Audio Products
Hardware, Connectors, Etc.



5235 W. 65th Street • Unit D • Bedford Park, IL 60638
1-800-552-1639 • Phone (708) 563-4950 • FAX (708) 563-4956

INTRODUCING

Peak Instrument Co.™

THE WOOFER TESTER™

QUICKLY AND
ACCURATELY
MEASURES:
Fs, Qms, Qes,
Qts, Vas, Bl,
SPL @ 1W/1m,
Mmd, Cm, and Rm
IN MINUTES!



UNBELIEVABLE
INTRODUCTORY OFFER!

\$199⁹⁵

PLUS SHIPPING

#SB-390-800

Peak Instrument Company proudly introduces "The Woofer Tester". Just ask any loudspeaker engineer, and they will tell that the only way to design enclosures of the correct size and tuning is to measure the Thiele-Small parameters for the actual drivers to be used. The reason? Manufacturers' published specs can be off by as much as 50%! But until now, measuring the parameters yourself required expensive test equipment and tedious calculations, or super expensive measurement systems (\$1,200 to \$20,000). The Woofer Tester changes all that. Finally, a cost effective, yet extremely accurate way to derive Thiele-Small parameters, in only minutes! The Woofer Tester is a combination hardware and software system that will run on any IBM compatible computer that has EGA or better graphics capability and an RS232 serial port. The Woofer Tester will generate the following parameters. Raw driver data: Fs, Qms, Qes, Qts, Vas, Bl, SPL @ 1W/1m, Mmd, Cm, and Rm. Sealed box data: Fsb and system Q. Vented box data: Fsb, ha, alpha, and Q loss. The Woofer Tester system includes hardware, test leads, serial cable, AC wall adaptor, detailed instructions, and software. Distributed exclusively by Parts Express, Dayton, OH.

◆ 30 DAY
MONEY BACK
GUARANTEE

◆ 1 YEAR
WARRANTY

◆ SAME DAY
SHIPPING



**Parts
Express™**

CALL TOLL FREE
1-800-338-0531

340 E. FIRST ST., DAYTON, OH 45402-1257 ◆ PHONE: 937-222-0173 ◆ FAX: 937-222-4644
WEB SITE: <http://www.parts-express.com> ◆ E-MAIL ADDRESS: xpress@parts-express.com

Source
Code: SBM

sure there will be no contact between particleboard pieces to cause a buzz problem; this is clearly visible in *Photo 9*. Then clamp the E-shaped pieces into position on the box sides and verify that the boards fit without interference.

Finally, screw the E-shaped mounts into the sides. This violates one of my basic rules, as they were not glued or filleted, so a potential for buzzing existed. I wanted to be able to move them if need be, and if a buzz resulted, I planned to reinstall them with a thin sheet of damping material clamped between them and the cabinet sides. No problem developed here, however.

FINISHING THE BOX

You can now cut out the top board, making it a bit wider than the measured dimension so you can sand it smooth. Drill holes for nailing the top to the sides and front panel (at 15° angle), then glue and nail it on and fillet it on the inside. Drive the nails in to below flush. The construction is now complete. Now, you should do whatever is needed to finish the box. I sanded the outside faces and painted the bottom diffuser area with flat black paint.

Builders have finished boxes of this type by painting them, veneering them, laminating them with Formica®, or wrapping them

with stick-on vinyl. As for grille cloth, this design intends for you to staple it right on the front of the box and cover the staples with thin trim strips, but this would prevent tweeter changes. If you want to be able to change the tweeter, you can fasten the grille cloth to a very shallow removable frame.

Also, if you object to the exposed particleboard edges at the bottom, you can install a bottom board. I have experienced no sonic change with this, but it makes future retuning of the woofer very difficult unless the board is removable or contains a hole aligned with the port.

DRIVER INSTALLATION

Solder the woofer and midrange to the pre-installed wires and fix them in place using Moretite putty-like material to obtain an airtight seal. These drivers are then removable in case you want to play with the damping material in their chambers. To the tweeter, solder wires of sufficient length to allow it to sit on the top of the box and still be connected to the terminal strip on the front edge of the Zobel board. These pigtails should terminate in space lugs, as you will not want to have to remove the terminal-strip screws to change tweeters. The tweeters do not need an air-tight seal to the front panel, so you can install them dry.

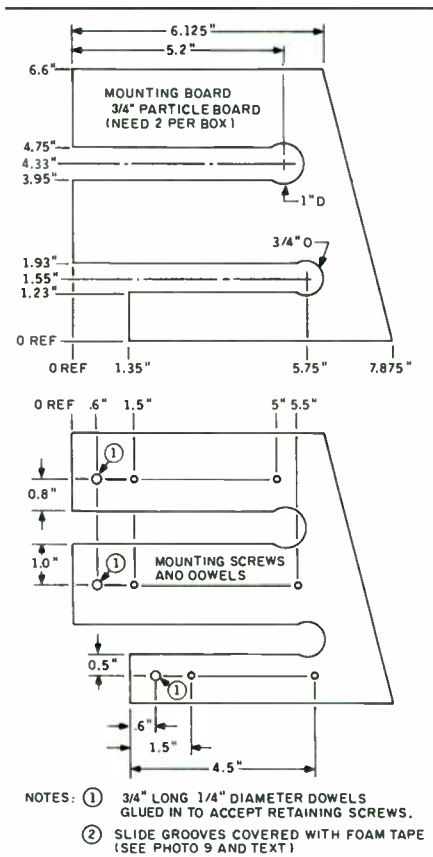
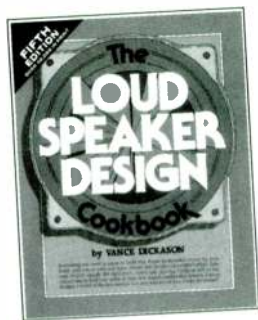

FIGURE 36: Details of the E-shaped pieces.

From the editor of VOICE COIL, Vance Dickason . . .
two of the most comprehensive books on loudspeakers ever produced. From an extensive primer on loudspeakers to the advanced techniques for using computer-aided design, these two volumes provide powerful tools for those wishing to build technically outstanding, satisfying loudspeaker systems.



The Loudspeaker Design Cookbook

Fifth edition of world's best-selling loudspeaker book. How Speakers Work; Enclosures; Drivers; Crossovers; Testing; CAD Software Reviews; Home Theater, Car Audio; much more. Softcover, 5E 1995, 165 pp., 8.5 X 11, ISBN 1-8825-8010-9. BKAA2-V \$34.95 (shipping weight- 2 lbs.)

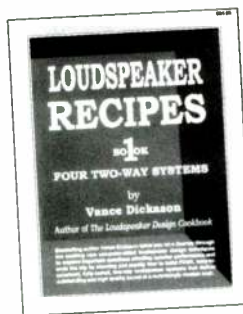

Loudspeaker Recipes: Book One

Computer-aided speaker design techniques for four two-way systems as examples of any system you wish to design. Dickason identifies issues, explores compromises, rationalizes solutions in real projects. Valuable insight even if you don't use CAD. Softcover, 1994, 112 pp., 8.5 X 11, ISBN 1-8825-8004-4. BKAA30 \$24.95 (shipping weight- 2lbs.)



OLD COLONY SOUND LABORATORY

PO Box 243, Dept. B96 • Peterborough NH 03458 • USA
 Tel 603-924-6371 FAX 603-924-9467 Email: auditech@top.monad.net

Qty.	Part#	Description	Price Ea.	Total Price
				\$
			Subtotal	\$
			Shipping*	
			Handling	\$ 2.00
			Total Order	\$

Name		
Street		
City	ST	Code
Card No.	Expire Date	
TEL or FAX	Today's Date	

**We accept checks in US\$ drawn on a US bank
 Visa Mastercard Discover American Express**

* Shipping Table (Based on total shipping weight of items ordered):

Wt. in Lbs.	Domestic (UPS Ground)		Canada (Air)	Overseas (Surface)	Overseas (Air)
	1-3	\$5.00	\$ 8.50	\$11.00	\$23.00
4-6	\$5.50	\$12.50	\$17.00	\$39.00	
9	\$6.00	\$16.00	\$23.00	\$56.00	
10-12	\$7.00	\$20.00	\$29.00	\$68.00	
20 +	Call for a quote.				

Introducing . . .

PERFORMER'S *Audio* Awesome Sound

Gearing Up for

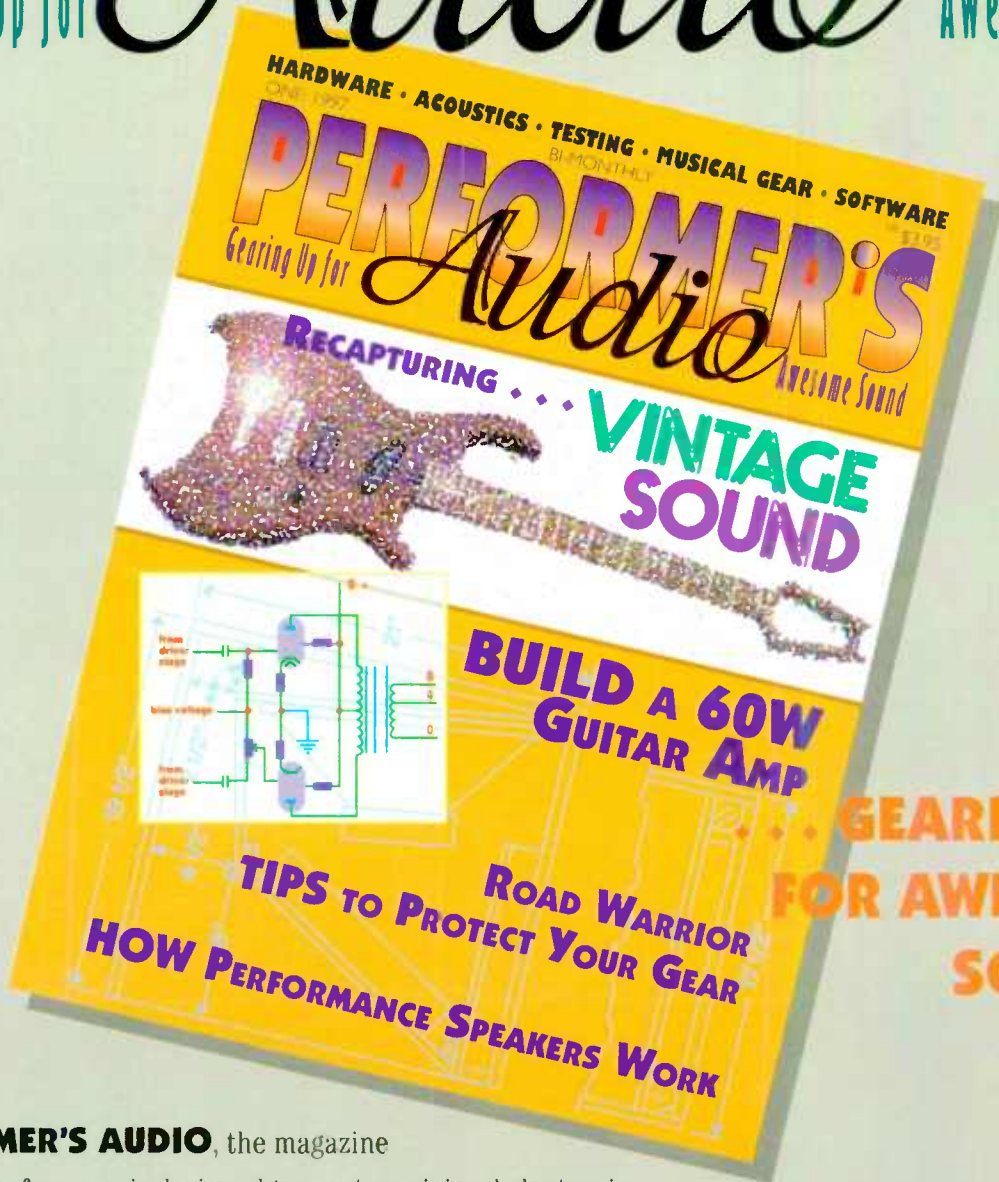

GEARING UP FOR AWESOME SOUND!

PERFORMER'S AUDIO, the magazine for music performers, is designed to meet musicians' electronic needs. Unlike other music magazines, **Performer's Audio** tackles the nitty-gritty of performance audio issues. Whether you perform in public and/or record your own music, **Performer's Audio** will make you sound better. You'll discover how to get the most out of every piece of your equipment, optimizing the audio performance of your system.

You'll find it all in the pages of **Performer's Audio**: mikes, preamps, speakers, studio consoles, portable mixers, instruments and stage gear. If it contains electronics, it'll be covered here.

PERFORMER'S AUDIO WILL UNCOVER the guts of your electronic equipment, walking you through the steps it takes to improve your sound—from the power supply to the cabling system to the amps and mikes to the speakers, mixers and recording gear.

IF YOU'RE SEARCHING for information on tube-driven or solid-state musical gear, or if you need software for scoring and arranging compositions or the latest on acoustic or testing applications, **Performer's Audio** will bring you state-of-the-art designs and mods to meet all of your performance needs.

LOOK INSIDE...

You'll find articles written . . .

for performers **by performers . . .**
who understand your technical needs — both on the stage
and in the studio.

BUILD-IT-YOURSELF PROJECTS

- Amps & Preamps
- Synthesizers
- Signal Processors
- Drum Machines
- Digitizers AND MORE!!!

ALL projects include . . . schematics, . . . parts lists, . . . tube selections . . . AND assembly instructions

FIELD-TESTED DESIGNS . . . that rival more expensive commercial units

CIRCUIT & WIRING SCHEMES . . . that will boost your system's performance

DESIGN MODIFICATION . . .

troubleshooting and repairs of your equipment

TIPS . . . on getting the most out of your tube amplifier

PRACTICAL TWEAKS . . . to turn your sleeper amp into a great-sounding unit

SIMPLE TRICKS . . . tips and tutorials for better equipment performance

MODS of stock guitar amps

WHO SHOULD BE READING PERFORMER'S AUDIO?

- Sound Engineers
- Music Directors
- Enthusiasts
- Recreational Musicians
- Beginning Performers
- Serious Musicians
- Music "Techies"
- Weekend Warriors
- Vintage-Amp Lovers
- Club Band Members

If you're on this list, **PERFORMER'S AUDIO** is your **NEW** magazine!

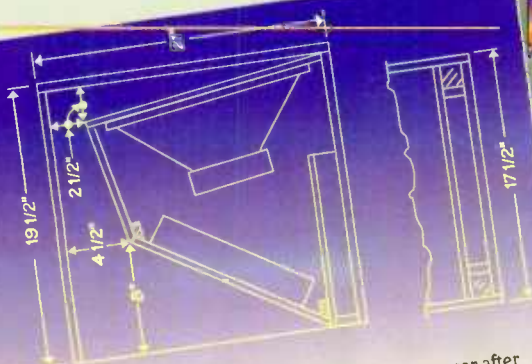

It's 2 A.M. You've just finished packing up your gear after a gig and are heading out to your pickup truck in the parking lot. It's raining. The drive home is 30 miles, and you pray that your bass bins won't be totally waterlogged before the night is over.

The drums have cases for protection, and your electronics are safely sealed in roadcases, but what about your speakers? At best, all that separates your costly drivers from the elements are flimsy vinyl covers. If you'd like to change this situation, I can show you how to build good roadcase protection for your speakers.

(From **The Road-Warrior Subwoofer**, by Bill Fitzmaurice)

INTAGE SOUND

... a characteristic of the late '50s and early '60s guitar amps. Just as a 1959 Les Paul Gibson that originally sold for \$350 can now fetch up to \$25,000, an old Fender Bassman of the same period might now sell for four times its original price.

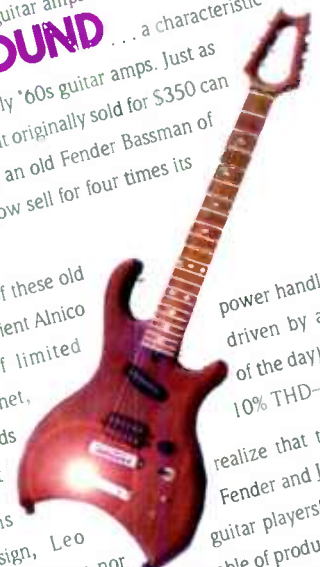

What was the magic of these old amps? Imagine inefficient Alnico magnet drivers of limited power in an open-back cabinet, even by standards of the time. Few musicians ran with about as much power as Fender and Jim Marshall, were neither audio engineers nor guitar-amp designers. Leo Fender and his team were crude affairs incapable of producing clean, full-range response. But while their inherent distortion and speaker coloration made their amps worthless for quality sound reproduction, those same sonic shortcomings applied to an electric guitar's signal were responsible for defining the sound of a generation.

...we have known that single-ended guitar amplifiers sound better than push-pull ones. This is because a push-pull amplifier produces only odd harmonics when clipping. Most guitar amplifiers are built as push-pulls because you can very easily modify a push-pull amplifier to give a single-ended characteristic. By removing the signal from one of the output tubes, you can convert your amplifier to single-ended. One output tube works as an output tube and the other works as a current generator to prevent the output transformer from saturating. With this simple modification, you can continually change your plifier from push-pull to single-ended operation.

(From **Build Your Own Guitar Mini-Cab**, by Bill Fitzmaurice)

SAMPLE ARTICLES FROM THE PREMIERE ISSUE

For a long time now

...we have known that single-ended guitar amplifiers sound better than push-pull ones. This is because a push-pull amplifier produces only odd harmonics when clipping. Most guitar amplifiers are built as push-pulls because you can very easily modify a push-pull amplifier to give a single-ended characteristic. By removing the signal from one of the output tubes, you can convert your amplifier to single-ended. One output tube works as an output tube and the other works as a current generator to prevent the output transformer from saturating. With this simple modification, you can continually change your plifier from push-pull to single-ended operation.

(From **Modify Your Push-Pull Guitar Amp**, by Rickard Berglund)



I discovered a **cheap & easy** way for guitar players to sample single-ended sound with almost any output and power transformer. In my design, the output pentode runs single-ended "ultralinear" mode. The center tap of the output transformer's primary is connected to the screen for a louder guitar amp.

Single-ended musical instrument amps have a "musicality" that is great for guitar but horrible when overblown in playback (hi-fi) amps. The sound of this amp is not hi-fi. It adds a dark, pleasant thickening from significant amounts of harmonic distortion, no feedback, and iron distortions (with apologies to Kondo San, iron is bad).

In this article, I help you choose cathode and plate resistors for both guitar and hi-fi. You'll have the ability to kludge any amp.

(From **Guitar Amp Refinements**, by Daniel Patrick Coyle)

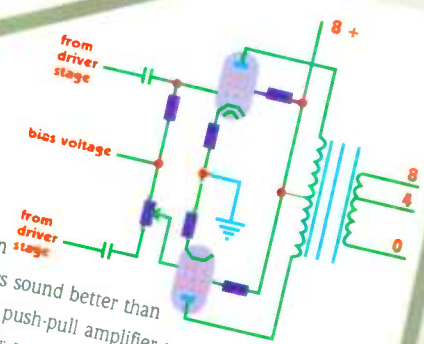

PERFORMER'S AUDIO is brought to you by *Audio Amateur Corporation*, a pioneer of high-quality DIY audio publishing for over 27 years. Joining consumer audio publications—*Audio Amateur*, *Speaker Builder* and *Glass Audio*—**PERFORMER'S AUDIO** will provide the best in articles and resources to help you through your DIY projects.

By now you can see that **PERFORMER'S AUDIO** is for the do-it-yourselfer.

It's for musicians like you who derive satisfaction and enjoyment from tackling a project from start to finish. It's for helping you whether you're upgrading your equipment, modifying a circuit or just trying to understand what's behind your best performance

sound. It's a practical guide to working with every piece of equipment you own—to get you the best possible sound without spending a small fortune. Performer's Audio emphasizes "how to build" as well as "how to buy" with savvy!

Take the plunge

into the truly satisfying world of great electronic gear.

Send for your premiere issue of **PERFORMER'S AUDIO** and be ready to take your performance to new heights.

Fax or mail-in the form below to reserve your premiere issue of **PERFORMER'S AUDIO**. We'll enter your charter subscription at the low rate of \$19.97 for one year (that's six issues). You'll save over 15% off the newsstand price and you'll be sure to receive each issue as soon as it's published.

Don't miss the EXCITING FIRST ISSUE! Subjects include:

- BUILD A 60W GUITAR AMP**
- ROAD WARRIOR TIPS TO PROTECT YOUR GEAR**
- CHOOSE THE RIGHT MONITORS FOR THE STAGE**
- GUITAR AMP MODS: WHY SINGLE-ENDED IS BETTER**
- RECAPTURING VINTAGE SOUND**
- HOW PERFORMANCE SPEAKERS WORK**

FOR ADVERTISING RATES, SCHEDULES & INFORMATION CONTACT PETER WOSTREL AT 1-800-524-9464.

YES! Enter my charter subscription to **PERFORMER'S AUDIO** at the low introductory rate of \$19.97 for 1 year (six issues). When the invoice comes, I'll pay it and continue to receive issues or if I decide it's not for me, I'll write "cancel" on the invoice and return it. I'm under no further obligation and my satisfaction is guaranteed!

SAVE ME MORE \$\$\$ Sign me up for the two-year introductory rate of \$34.97 (12 issues). I'll save over 25% off the newsstand price! I'll receive the same guarantee of satisfaction.

CANADA / MEXICO: ADD \$6 PER YEAR.
OVERSEAS RATES: \$32, 1 YR; \$56, 2 YRS.

NAME

STREET & NO.

CITY

STATE

ZIP

COUNTRY

PERFORMER'S
Audio
Creating By The Audio Magazine Guild

PERFORMER'S AUDIO, PO Box 876, Peterborough, NH 03458-0876 USA.
Phone: 603-924-9464 Fax: 603-924-9467
E-mail: audiotech@top.monad.net

VISIT OUR WEB SITE AT www.audioxpress.com!

World Radio History

**YOUR FAX ORDER TO:
603-924-9467**

PERFORMER'S AUDIO
PO Box 876
Peterborough, NH
03458-0876 USA.
Phone: 603-924-9464
Fax: 603-924-9467

Design Your Listening Room With Software From



AIRR (Anechoic in Room Response) SoundBlaster Sound Card Speaker Response Software Julian J. Bunn

NEW FROM SWITZERLAND! AIRR is a program that offers a cheap alternative to loudspeaker measurement for owners of PCs equipped with a SoundBlaster¹⁶ or compatible sound card. Based on the principle of pulse generation of the loudspeaker followed by Fast Fourier Analysis, AIRR features full color real-time plotting of both the digitized pulse received by the microphone and the frequency response of the loudspeaker system. The AIRR display itself can be "captured" into a PC Paintbrush (PCX) file, which may then be included as graphics in a document.

The AIRR software includes operating instructions combined with on-line help and a sample file containing microphone response data. AIRR requires a PC equipped with a SoundBlaster 16 soundcard (or compatible); VGA screen with at least 640 x 480 resolution; microphone (usually supplied with the sound card, although a calibrated microphone such as Old Colony's Mitey Mike is often desired); and loudspeaker to test. Math coprocessor not required. Shipping weight: 1 lb.
SOF-AIR \$49.95
SOF-ARDEM Demo Only \$5.00

Modes For Your Abodes Joseph Saluzzi

This unique program helps acousticians and audiophiles in designing listening rooms or better understanding a room's sonic character. MODES is a menu-driven, user-friendly program that rapidly generates and prints out axial, tangential, and oblique modes, as well as predicts axial coincidences.

Its database summary screen provides a convenient, rapid means of running multiple calculations and comparing many room sets. Supports standard text printing. IBM PC or compatible, MS-DOS 5.0+, 604K RAM, 1Mb free disk space. From SB 6/92, 1-2/93. Article reprints included. Shipping weight-each version-1 lb.
SOF-ABO \$25.00
SOF-ABO1 Requires Windows 3.1+ \$49.95
SOF-ABO2 Requires Windows 95 \$49.95

Visual Ears Software for Windows - KB Acoustics

Visual Ears allows the audio enthusiast to enhance system performance by minimizing standing wave and boundary reflection problems with proper speaker and listener placement. In most cases, room problems can be reduced to satisfactory levels, at a prime listening position, without resorting to obtrusive acoustical control devices. The program features many enhancements:
* Slanted or Cathedral Ceilings.
* Drag and Drop for the listener and speakers.
* Supports Woofer/Satellite systems and considers the crossover.
* Supports 3 Way systems and considers the crossover.
* Provides 1/3 octave averaging.
* Uses high speed 32-bit algorithms written in C.
* Models system low frequency roll-off.
* Saves multiple set-ups in a single file.
* A multiple file capability is useful for dealers who are setting up customers' rooms.
* Operates in either Imperial or Metric mode.
Requires Windows 3.1 or 95, VGA monitor and mouse. Shipping weight: 1 lb.
SOF-VER \$89.95

The Listening Room For IBM Sitting Duck Software

This interesting program predicts standing wave modes in small rooms and is designed for positioning speakers—and the listener—in such a way as to minimize standing wave effects and other room-generated influences. It allows for a full range of speaker and listener movement in 3D space and continuously updates a standing wave Pressure versus Frequency display.

IBM 256K RAM; DOS 2.11+; CGA, EGA, VGA, or Hercules graphics required. Shipping weight: 1 lb.
SOF-TLR1 \$47.50

The Listening Room For MAC Sitting Duck Software

Like the popular PC version, this program for the Macintosh allows you to interactively position listener and speakers in your listening room, although this is now accomplished using the Macintosh "dragging" graphics technique. The program actively displays the magnitudes of standing waves, as well as the effects of (now up to 124) early reflections on the direct response. Several features have been added, notably local optimization of listener and/or speaker positions to maximize, minimize, or smooth the standing wave patterns. This MAC version also enables you to model the woofer low frequency limit and slope, and produces high-resolution output including multiple graph overlays. Requires 512k RAM. Shipping weight: 1 lb.
SOF-TLR2 \$67.95

Yes! Please send me _____ \$ _____



*Shipping _____
Handling \$ 2.00
Total Order \$ _____

NAME _____

STREET _____

CITY _____ STATE _____ ZIPCODE _____

*Shipping By Weight:

Weight in Lbs.	Domestic (UPS)	Canada (Air)	Rest of World	
			Surface	Air
1 - 3	\$ 5.00	\$ 8.50	\$ 11.00	\$ 23.00
4 - 6	\$ 5.50	\$ 12.50	\$ 17.00	\$ 39.00

OLD COLONY SOUND LABORATORY

PO Box 243, Dept. B96
Peterborough NH 03458 USA
Tels. 603-924-6371, 603-924-6526 Fax 603-924-9467

MC/VISA/DISCOVER # _____ EXPIRE _____

TEL/FAX _____ TODAY'S DATE _____

• Mastercard • Visa • American Express • Discover • Check or Money Order in US Funds Drawn on US Bank •

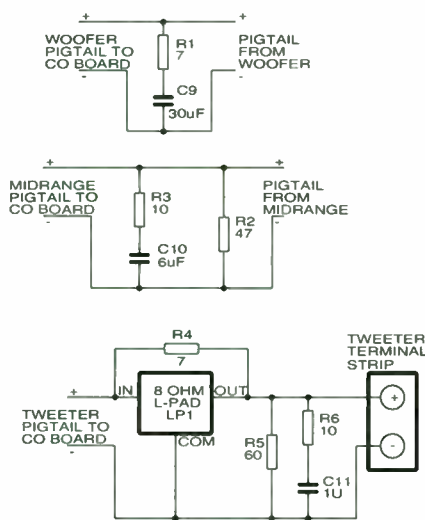

FIGURE 37: Schematic for components packaged on Zobel board.

WOOFER TUNING

Next, tune the woofer. Start with a duct tube 8" long and proceed to cut it off until you obtain the desired impedance-curve minimum (f_m), assuming this should match the computed box-tuned frequency (f_b). Remember to stand the box up on the floor when checking the tuning; standing it near the edge of a workbench will not yield the correct results.

For my woofer A, the desired f_m was 38.6Hz, and the final duct was 5¼" long. For woofer B, the values were $f_m = 37.6$ Hz and length = 6.0". If you do not plan to measure your drivers to establish an f_m value, I would go with a 3"-diameter duct about 5.5" long. (The second pair of boxes with the newer woofers required 3"-diameter ducts of 6½" and 6¾" length and I now recommend a length in this range.) Note that setting f_m typically does not result in quite the desired (same) f_b .

The system performance just does not

change that quickly with small tuning variations, which is good, since environmental variations will move the tuning around anyhow. If you insist on spikes on the bottom of the box, they should be in place during the tuning process. I have no idea whether they would affect the sound, as I have never tried lifting the diffuser off the floor.

DAMPING THE FRONT PANEL

The ¾"-deep grille frame and covering grille cloth can have adverse effects on the clarity of the system's high-frequency response; detailed discussion and test results will be shown in Part 3. Covering the front panel with damping material greatly reduces these effects and removes the need to attempt to set the drivers flush into the front panel. I, thus, cover the front panel with ½" fiberglass, the 6"-wide kind made for wrapping pipes. *Photo 12* shows a front view of the enclosure with this covering.

ZOBEL-BOARD PACKING

At this point in construction, the box could be played, so I breadboarded the COs and tried them. I was happy with the sound; no changes were needed in the CO values developed via the baffle and breadboard tests.

Wanting to proceed slowly, I packed only the Zobel-board components. *Figure 37* shows the schematic for the Zobel board, and *Table 4* lists the component values. *Photo 10* shows the layout I used in trying to maintain minimum inductance in the wiring. The pigtailed should be long enough to allow pulling the CO board all the way out when they are attached. The pigtailed end in terminal lugs for attachment to the barrier terminal strips on the CO boards. I used spade lugs so I could disconnect the wires without removing the terminal-board screws.

I played the systems with the installed Zobel boards and the COs still in breadboard fashion. I could detect no difference in the sound quality. Note that a notch must be filed in the bottom edge of the Zobel board's vertical face to allow clearance for the woofer wire. I soldered the woofer and midrange wires directly to the Zobel board, as there is no reason to make it removable.

CROSSOVER BOARDS

Next, I packaged the two CO boards for each system. *Figures 38* and *39* are, respectively,

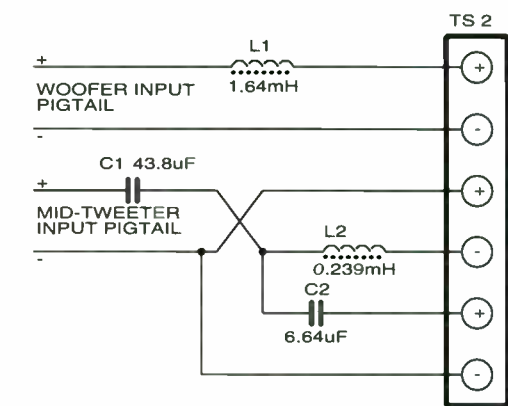

FIGURE 38: Schematic for components packaged on first-order crossover board.

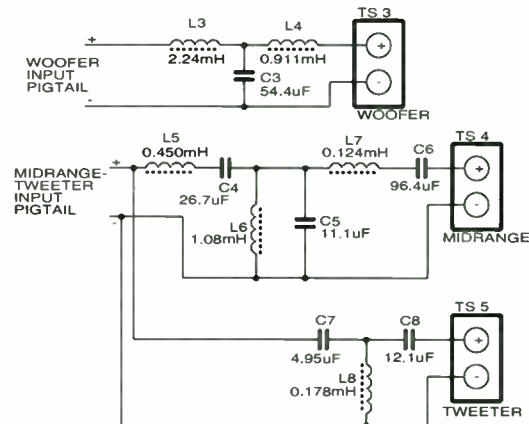

FIGURE 39: Schematic for components packaged on third-order crossover board.

the first- and third-order CO-board schematics, and *Table 5* lists the component values for both. I used large film capacitors for these COs for two reasons: I wanted to be sure there was enough room for others to build the CO, and I thought from past experience that the systems sound better with the physically larger capacitors.

Photo 11 shows the top and bottom views of the two CO boards. The black stripe on the mounting board indicates the top of the structure. The first-order CO is easy to package, and I mounted all components on the top of the horizontal board to keep them as far as possible from the tweeter and the large metal shell of the L-pad. I used a single six-terminal barrier strip for this CO board to provide terminations for the three pigtailed from the Zobel board. I used two input pigtailed, one feeding the woofer and the other the midrange and tweeter to allow biwiring if desired. The length of these pigtailed depends on where you plan to locate the amplifier input terminals.

Again, I recommend minimum-inductance wiring practice; see *SB 5/90*, p. 26, for information on this. Remember that with the first-order CO the midrange is wired so that

TABLE 4

ZOBEL BOARD PARTS

(All capacitors are plastic-film units of 100V or greater.)

UNIT	VALUE	HOW PART WAS IMPLEMENTED
C9	30μF	Parallel 10 + 10 + 10
C10	6μF	Parallel 5.6 + .47 (selected)
C11	1μF	1μF selected
R1	7Ω	5Ω @ 10W series 2Ω @ 11W
R2	47Ω	47Ω @ 5W
R3	10Ω	10Ω @ 7W
R4	7Ω	3Ω @ 5W series 4Ω @ 5W
R5	60Ω	47Ω @ 5W series 15Ω @ 10W (selected)
R6	10Ω	10Ω @ 7W
LP1	8Ω	L-pad marked 15W, 1.64" diameter, ¾" threaded mounting collar.
TS1	2 terminal	Terminal barrier strip—#5 screws, overall 1.4" long × 0.85" wide.

when the pigtail is connected, the midrange polarity is inverted.

The third-order CO board is a bear. I spaced the coils as best I could to keep them away from the coils on the opposite side, from the tweeter, and from the L-pad on the Zobel board right below the CO board. With the large film capacitors, this board gets full. The woofer LP and tweeter HP are on the bottom of the board, and the midrange BP occupies the top. Again, use minimum-inductance wiring practices and the two input pigtails. The pigtails from the Zobel board terminate on three individual two-terminal barrier strips, the woofer and tweeter on the bottom and the midrange on the top.

CROSSOVER PROBLEMS

The first-order CO board was installed, and there was no change in the sound as far as I could determine. That was not the case when I tried the third-order CO board. I noticed a slight increase in sibilance, generally caused by an excess of energy in the 4kHz range, which is the upper CO frequency. Certainly the speakers were not perfect before this, but I believe I heard a change, and I now preferred the sound with the tweeters set about 1dB lower in level.

I examined and measured the third-order CO boards, but all components were correct and were the same ones used in the breadboarded CO listening. ROW reports that coil crosstalk will cause the effect observed, and this may indeed be the problem, but I

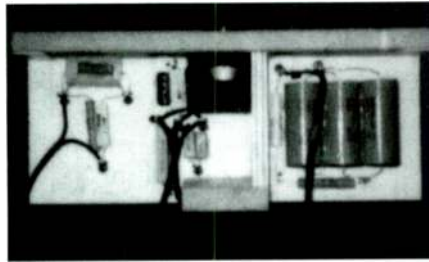

PHOTO 10: Bottom view of finished Zobel board.

have measured side-by-side ferrite bobbin core coils and found them rather immune to this. I tried sliding the CO board back to see if the L-pad was interacting with a coil (these coils are more sensitive to interaction with items off the end than off the side), but that made no difference. I pursued the mystery no further.

For the best sound, I recommend that you do not pack the third-order CO as I did. There was also cabinet-top vibration, which is not good. This is a result of the CO packaging not providing room for a stiffener on this board. If you were to package the first-order CO on the bottom of the board (keeping inductors away from the tweeter and L-pad) instead of the top, you could put a brace on the cabinet top board. But you would then have to package the third-order CO outside of the box.

Perhaps a design with a pedestal at the bottom to house the CO would be a better approach. I plan to investigate this problem

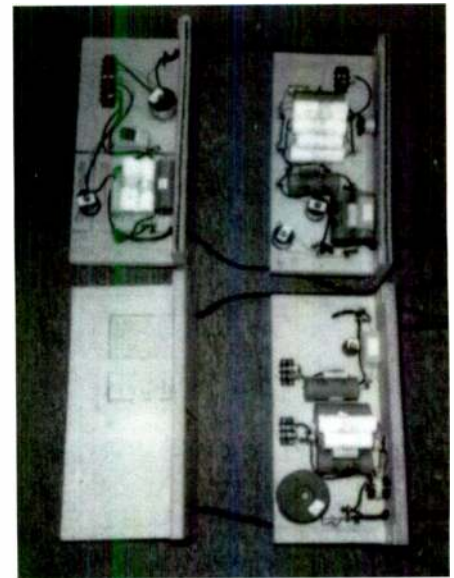

PHOTO 11: Top and bottom views of finished crossover boards.

on the second pair of boxes and will report a solution if I find a good one. I also think more experimentation with the third-order CO component values could further smooth performance in the region of the upper CO frequency. (Follow-up work in this area will be reported in Part 3.)

Photo 12 shows a front and back view of the finished boxes. Amplifier input is via a barrier terminal strip mounted on the back of the box. I provided a jumper to tie together the two CO pigtails for single-wire drive, which was how I did all my listening.

Part 3 of this series will cover grille effect and final testing, guides on designing your own enclosure, continued work on the second pair of boxes, and discussion of the system's sonic quality. R. O. Wright and Ed Dell will also describe their experiences listening to these systems.

TABLE 5

PARTS LIST FOR BOTH CROSSOVER BOARDS

(All capacitors are plastic-film units of 100V or greater.)

UNIT	VALUE	HOW PART WAS IMPLEMENTED
C1	43.8μF	parallel 15 + 15 + 10 + selected cap
C2	6.64μF	parallel 5.6 + .47 + .47 (selected)
C3	54.4μF	parallel 10 + 10 + 10 + 25 (selected)
C4	26.7μF	parallel 10 + 10 + 2.5 + selected cap
C5	11.1μF	parallel 10 + 1 + .47 (selected)
C6	96.4μF	parallel 25 + 25 + 25 + 10 + 10 + selected cap
C7	4.74μF	two small selected caps in parallel
C8	12.1μF	parallel 10 + 2.5 (selected)

Note: 25μF capacitors were purchased as 10μF and 15μF soldered in parallel.

(All inductors wound on ferrite [or powdered iron] bobbin cores.)

UNIT	VALUE	RDC Ω	WIRE	CORE HEIGHT & DIAM. IN INCHES
L1	1.64 mH	0.23	#18	0.99 × 1.38 (wound up 1.4)
A bigger core would be better.				
L2	0.239 mH	0.08	#18	1.08 × 1.13 (dewound 0.35)
L3	2.24 mH	0.27	#18	1.31 × 2.44 (dewound 3.0)
L4	0.911 mH	0.22	#20	1.07 × 1.11 (dewound 1.0)
This should have bigger wire and thus lower Rdc.				
L5	0.45 mH	0.10	#18	1.07 × 1.11 (dewound 0.5)
L6	1.08 mH	0.24	#20	1.07 × 1.11 (wound up 1.0)
L7	0.124 mH	0.09	#20	1.1 × 1.09 (dewound 0.35)
L8	0.178 mH	0.13	#22	0.73 × 0.86 (dewound 1.0)
TS2	6 terminal	Terminal barrier strip - #5 screws		
TS3	2 terminal	Terminal barrier strip - #5 screws		
TS4	2 terminal	Terminal barrier strip - #5 screws		
TS5	2 terminal	Terminal barrier strip - #5 screws		

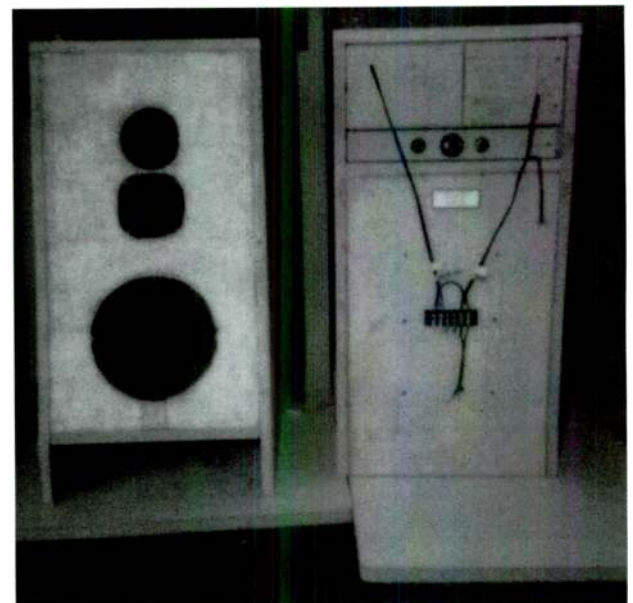

PHOTO 12: Front and back views of finished enclosures.

INDUCTORS FOR CROSSOVER NETWORKS

By Richard and Erin Honeycutt

A passive crossover network used to be considered a simple thing: just hook up a capacitor in series with the tweeter and an inductor in series with the woofer, and you have it. What size capacitor? Try $1/2\pi fR$. What kind of capacitor? A nonpolar electrolytic. How about the coil? Oh, about a pound of #18 wire jumble-wound on a toilet-paper roller. Stick a bolt through the middle to mount it.

As my previous article "Caps for Passive Crossovers" (*SB* 3/92, p. 34) demonstrated, the traditional advice about capacitors was poor. You should begin by selecting the proper order of the filter. Then you choose whether or not to Zobel the speakers. Using software or formulae from *The Loudspeaker Design Cookbook*, you can determine component values. Finally, you select a polyester or polypropylene capacitor, or, if you must use 'lytics for financial reasons, you parallel them with polys.

The traditional advice about inductors was even worse than that for capacitors. To show you why, I must first review some basics.

INDUCTOR BEHAVIOR

Inductance is the property of a conductor that resists a change in current. If you connect a coil in series with a battery and a switch and then throw the switch, the current in the inductor does not immediately rise to maximum. Instead, the current exponentially approaches the maximum value, which you can find with Ohm's Law.

How long it takes the current to reach maximum is determined by the inductance of the coil and the resistance of the connecting wires, the switch contacts, and the battery itself. The more inductance, the more time delay. Inductance is measured in henries, and crossover inductors are usually in the millihenry range.

ABOUT THE AUTHOR

Richard Honeycutt was assisted on this article by his son, Erin, 19, a physics major at Wake Forest University, who has been assisting with sound-system installations since he was eight and helping to build speaker systems for commercial installation since the age of 13. Erin is also an amateur radio operator whose interests include music, basketball, and one special young lady.

If you apply AC to the coil, the current tries to change all the time, and the inductor opposes that change. An inductor's opposition to the flow of AC is called the inductive reactance, X_L , and this depends upon the value of the inductance and the frequency of the AC. (At higher frequencies, the current is trying to change faster, so the inductor offers more opposition.) The formula is $X_L = 2\pi fL$.

Any piece of wire has inductance. When you wind the wire into a coil, the inductance increases, with the final value being approximately proportional to the square of the number of turns in the coil. You can reduce the number of turns necessary to yield a given inductance by inserting a magnetic core into the center of the coil.

A perfect inductor would have inductive reactance, but no resistance. How closely an inductor approaches no-resistance behavior is described by its quality factor, or Q. (The concept is the same as speaker Q: a ratio of power stored to power dissipated under certain conditions.)

The Q of a coil is given by: $Q = X_L/R$. Since a magnetic core reduces the number of turns needed for a coil of a given inductance, adding the core also increases the Q, all other things being equal. All other things, however, are not equal. To see why, you must look at the magnetic behavior of various materials.

PERMEABILITY FACTORS

Based on their behavior in a magnetic field, materials fall into three groups. When inserted into a magnetic field, some materials, called diamagnetic, very slightly weaken the field. A second group of materials, called paramagnetic, will very slightly strengthen a magnetic field. Finally, the third kind, ferromagnetic materials, will greatly strengthen the magnetic field.

The factor by which a given material changes the field is called its permeability. A material having a permeability of 1 would have no effect on a magnetic field—it would be truly nonmagnetic. Actually, there is no such material, but diamagnetic materials such as copper (permeability = 0.999) and

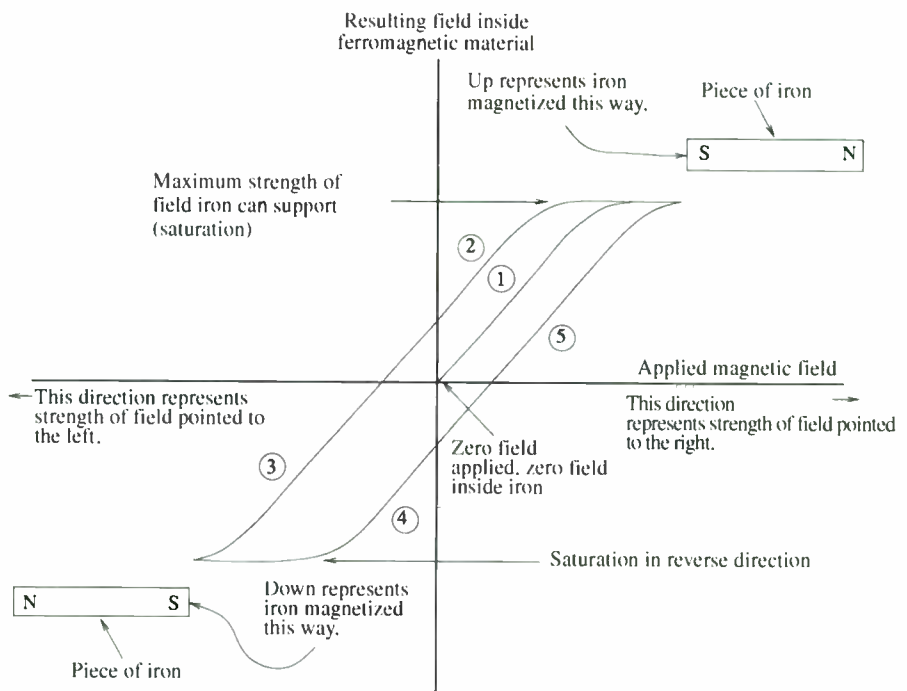

FIGURE 1: The hysteresis loop for a ferromagnetic material.



FIGURE 2: Hysteresis loops for soft iron (left) and hard iron (right).

paramagnetic materials such as air (permeability = 1.0000004) come so close that they are often called nonmagnetic.

The ferromagnetic materials, on the other hand, have permeabilities significantly greater than 1. Iron, for example, is in the 200–1000 range, nickel is about 100, and Mumetal (an alloy of nickel, chromium, copper, and iron) is close to 20,000. There are also a number of ferromagnetic ceramics, called ferrites, that have significant permeabilities.

HYSTERESIS LOOP

A material's permeability is not constant, but depends upon the strength of the field in which it is placed. *Figure 1* shows a graph of the magnetic flux density inside a material plotted against the applied external field. Such a graph is called a hysteresis loop. The explanation of the curves is as follows:

1. The iron is initially unmagnetized. As the

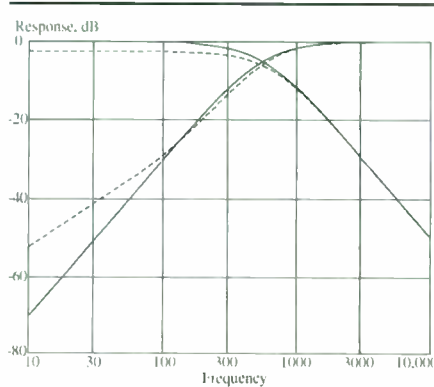

FIGURE 3: Comparison of second-order crossovers with low- and high-Q coils; (—) filter with high-Q coils; (---) filter with low-Q coils).

magnetic field is applied and increased, the field inside the iron increases to its maximum possible level.

2. The iron holds some magnetism as the field is reduced, even to zero.

3. The applied field's polarity is reversed, but some reverse field is needed to bring the field inside the iron down to zero. As the strength of the reversed field increases, the iron becomes magnetized in the reverse direction. The field inside the iron increases

Digital Storage Oscilloscope For \$189.95 ???

And much, much more!
O-Scope I turns PC-ATs into DSO, Spectrum Analyzer, Frequency Counter, DVM. DC-50KHz

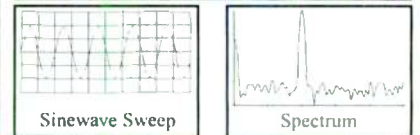

Actual O-Scope I Captured Signals

For Orders and Inquiries Call: 1-800-980-9806
For Technical Assistance: 1-713-777-0401

Allison Technology Corporation
8343 Carvel, Houston, TX 77036
FAX and BBS 1-713-777-4746

SOLEN

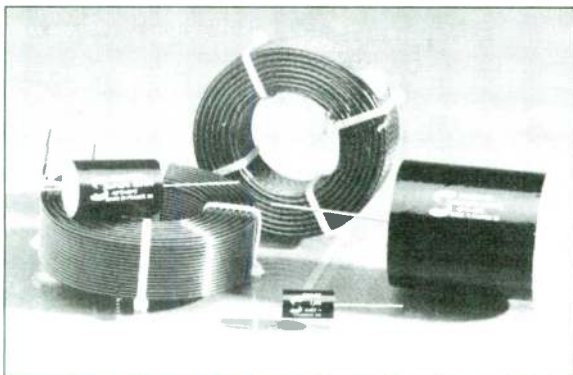

SOLEN INC.
4470 Ave. Thibault
St-Hubert QC J3Y 7T9 Canada
Tel: 514-656-2759 Fax: 514-443-4949

CROSSOVER COMPONENTS CATALOG

HEPTA-LITZ INDUCTORS

Air Cored Inductors, Litz-Wire Perfect Lay Hexagonal Winding
Values from .10 mH to 30 mH
Wire Sizes from 1.3 mm (16 AWG) to 2.0 mm (12 AWG) 7 Strands

STANDARD INDUCTORS

Air Cored Inductors, Solid Wire Perfect Lay Hexagonal Winding
Values from .10 mH to 30 mH
Wire Sizes from 0.8 mm (20 AWG) to 2.6 mm (10 AWG)

FAST CAPACITORS

Fast Capacitors, Metallized Polypropylene
Values from 0.10 μ F to 300 μ F
Voltage Rating: 630, 400, 250 VDC

CROSSOVER & SPEAKER PARTS

Metalized Polyester Capacitors, 1.0 μ F to 47 μ F, 160 VDC
Non Polar Electrolytic Capacitors, 22 μ F to 300 μ F, 100 VDC
Power Resistors 10 W, 1.0 Ω to 82 Ω , 8 Ω L-Pads,
Gold Speaker Terminals, Gold Banana Plugs, Gold Binding Posts,
Crossover Terminals, Port Tube & Trim Ring, Grill Fasteners,
Car Speaker Grills, Screws, Nylon Ties, Speaker Books, Etc.

until the maximum value is reached with the reversed polarity.

4. As the applied field is reduced, the field strength inside the iron decreases, but the iron still has some internal field even when the applied field is zero.

5. If the external field is now applied again with the original polarity, then increased, the field inside the iron will also be returned to its original polarity and increased.

There are two features of particular interest about a hysteresis loop. One is that above a certain applied field level, the field inside the material no longer increases. This condition is called magnetic saturation. In a coil

core, the applied field results from current in the windings. Thus there is a maximum current that can be applied before saturation occurs. At saturation, the field inside the core, and thus the inductance of the coil, becomes a nonlinear function of the coil current. The result is distortion.

MAGNETIC MEMORY

The other feature is that reducing the applied field does not cause the internal field to drop to zero. This "magnetic memory" is what makes permanent magnets possible. A hard-iron material that would make a good permanent magnet would have a fairly

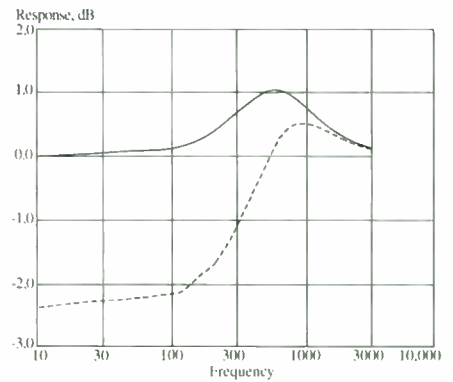

FIGURE 4: Composite response of second-order crossovers using low- and high-Q coils; (— filter with high-Q coils; --- filter with low-Q coils).

square hysteresis loop, meaning that the material could be magnetized to saturation, and would stay magnetized almost at that level even when the external field was removed. Soft-iron materials used in coil and transformer cores have skinny hysteresis loops, meaning that they do not retain much magnetism, but more nearly follow the intensity of the applied field. *Figure 2* illustrates this difference.

Soft-iron cores have skinny hysteresis loops and high saturation levels. Also, they enter saturation gradually. Unfortunately, iron is conductive, so that the alternating magnetic field caused by AC in the coil induces circulating currents in the core material. These "eddy" currents cause the core to heat up, and whenever heat is produced in an electric circuit, an equivalent resistance is present somewhere. In this case, the heating effect of the eddy currents appears as a resistance in parallel with the inductance of the coil, reducing the Q.

Breaking up the conducting mass into small regions reduces the eddy currents. Therefore, transformer cores are made of thin pieces of iron laminated together with an insulating varnish. Going one more step, you can further reduce the eddy currents by grinding the iron into filings and gluing them together with insulating epoxy.

Finally, you can use ferrite cores. Ferrites, being ceramic material rather than metal, are nonconductive and hence have no eddy currents. There are two problems with ferrites, however. The first is that you need a larger core than iron requires in order to avoid saturation. The second is that ferrites saturate more abruptly, causing more severe distortion.

AIR-CORE COILS

On the other hand, air-core coils do not have eddy-current problems, nor do they saturate. But since they require many more



THE WORLD'S MOST RESPECTED HI-FI MAGAZINE

SUBSCRIBE TODAY AND GET THE NEXT 12 ISSUES FOR

\$65.00 USA \$75.00 CANADA

Please send me the next 12 monthly issues of Hi-Fi News and record Review from the next available issue.

Mr/Mrs/Miss/Ms _____

Address _____

Apt# _____

City _____

State _____ Zip _____

METHOD OF PAYMENT

Check enclosed (US dollars and drawn on a US bank)

Please charge my Visa Mastercard American Express

Account No. _____ Exp.date _____

Signature _____ Date _____

Please bill me

Return to Hi Fi News & Record Review, PO Box 384, Avenel, NJ 07001

FOR FASTER SERVICE USE YOUR CREDIT CARD AND CALL TOLL FREE

☎ 800-688 6247

AA41

turns of wire, the wire's resistance lowers the Q. Figure 3 shows the performance of a second-order crossover made, first, with a nearly ideal coil (Q = 1256), and second, with a low-Q coil (Q = 5, typical of a high-inductance air-core coil). Attenuation of a 20Hz signal to the tweeter is reduced from 58dB with the high-Q coil to 45.4dB with the low-Q one.

You can see the effect upon response and crossover frequency more clearly in Fig. 4. The low-Q coil produces a 2.3dB flat loss in the woofer output, and moves the crossover frequency up 6Hz. You must also consider the cost of the additional copper wire required by the air-core coil. So which kind of coil is best?

THE TESTS

I tested seven different 4mH coils in various ways, resulting in nine different configurations. The coils were:

- An air-core coil wound with 16-gauge wire and rated by the seller at 500W;
- Two 2mH 14-gauge air-core coils in series, each rated at 800W;
- A 16-gauge equivalent copper-foil air-core coil rated at 350W;
- An 18-gauge iron bar-core coil rated at 250W;
- An 18-gauge laminated-iron bar-core coil rated at 250W;
- A 16-gauge ferrite-core spooled coil rated at 500W;
- A 16-gauge ferrite-core toroid with a 1cm² core cross-section, power not rated.

TABLE 1

MEASUREMENTS OF INDUCTANCE AND Q OF VARIOUS COILS

COIL	L (mH) (120Hz)	L (mH) (1kHz)	Q (120Hz)	Q (1kHz)
16-gauge air-core, original	4.71	3.99	4.72	4.65
16-gauge air-core, brass screw	4.72	3.99	4.74	4.65
16-gauge air-core, steel screw	4.89	4.01	4.57	4.44
16-gauge air-core, modified*	2.4	2.41	3.01	18.1
Two 14-gauge, air-core	4.07	4.04	4.2	15.6
Two 14-gauge, brass screw	4.07	4.04	4.2	15.6
Two 14-gauge, steel screw	4.41	4.27	4.2	14.3
copper foil, air-core**	4.03	3.91	3.46	16.1
18-gauge iron-bar-core	3.99	3.99	4.25	30.3
18-gauge laminated-iron bar core	4.05	3.9	7.25	21.7
16-gauge ferrite spool	3.93	3.91	13.16	71.4
19-gauge toroid	4.01	3.98	10.2	71.4

* See text

** Actually rated at 3.9mH

In addition, I tested two of the air-core coils with a brass mounting screw and then with a steel mounting screw in the center of the coil.

INDUCTANCE AND Q

The first test measured the inductance and Q of each coil at 120Hz and at 1kHz, using a Hewlett-Packard 4261A LCR meter (Table 1).

The inductance of a perfect coil would not change with frequency. Real coils, however, have distributed interwinding capacitance that causes the inductance to decrease somewhat as frequency increases. In fact, a

real coil will have a self-resonant frequency at which the interwinding capacitance resonates with the inductance. Above this frequency, the coil is a capacitor. (For all the coils tested, the self-resonant frequency is well above the 50kHz limit of measurement.) Also, the core losses in a magnetic-core coil will cause the inductance to decrease at higher frequencies.

The first and fifth rows in the table reveal a curious thing: although the 14-gauge coil has nearly constant inductance (within 0.75%) from 120Hz-1kHz, the 16-gauge coil does not. Since the coils were constructed nearly identically, I looked more closely

CFAC™
Copper-Foil Air-Core Inductors
Precisely Designed For Precision Audio Transducers, Driver Crossovers, Networks.

"I'm confident that the CFAC Inductors provide an interesting alternative for high-end manufacturers to consider in their quest for sonic truism."
Vance Dickason, Editor
Voice Coil, Nov. 94

"The CFAC Inductor far exceeds anything I have used in the past."
Arnie Nudell, President
Genesis

"They are, simply, the best..."
Robert Grost, President
Unity Audio

Available At:
Michael Percy, CA
Tel: (415)669-7181
Speaker City USA, CA
Tel: (818)846-9921
Parts Express, OH
Tel: (800)338-0531
Handmade Electronics, PA
Tel: (610)432-5732
The Parts Connection, ONT.
Tel: (905)829-5858

For Catalog: Solo Electronics, 2462 Tripaldi Way, Hayward, CA 94545, USA.
Tel: (510)887-8016 Fax: (510)887-1657

Reader Service #40

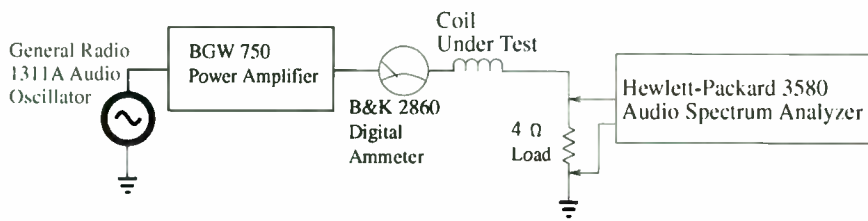

FIGURE 5: Test setup for distortion measurements.

and discovered that the 16-gauge coil was actually wound on a square iron tube, so that it was not an air-core coil at all, even though it was advertised as one! When I removed the tube, the inductance dropped by some

40%, but it no longer varied significantly with frequency.

Mounting the coils by means of a brass screw through the middle would provide a small amount of eddy-current damping, but

this was too small to measure. Apparently this mounting method is acceptable. A steel screw, however, significantly increased the inductance of the coils, as you would expect.

The inductance of the copper-foil air-core coil varied more with frequency than did the traditional round-wire coils. This variation—about 3%—could be marginally significant in some designs.

CONSTANT INDUCTANCE

Surprisingly, the iron-bar-core coil had the most constant inductance of any magnetic-core coil. Very likely this was because of the method of construction. The core in this coil was exactly the same length as the winding, which does not provide very effective flux linkage of the core.

The laminated-bar core extended beyond the ends of the coil by about an inch. This would make the core more effective in reducing the number of turns needed, but would also make the core characteristics more noticeable when you compare inductances at different frequencies. Both of the ferrite-core coils had very stable inductances.

As mentioned earlier, Q depends directly upon X_L , which is proportional to frequency. Q depends inversely upon R , which depends upon frequency only to the extent that non-perfect cores are used. (At higher frequencies, skin effect causes Q to decrease, but this effect is not important at audio frequencies. At 20kHz, skin effect would make at most a 1dB difference in the performance of a crossover coil. Much malarkey is bandied about concerning skin effect by people who have never investigated it—or who hope the audio consumer has not.)

You would therefore expect the Q of a coil to increase with frequency, and it did for all of the coils except the original 16-gauge "air-core" coil. This lack of variation in Q was another clue that something was strange about this unit. Of the air-core coils, the 14-gauge combination had the highest Q at 120Hz, while the modified 16-gauge had a higher Q at 1kHz. A high Q is one of the reasons for using a magnetic core, and as theory predicts, the iron- and ferrite-core coils do offer improvements in this respect.

HARMONIC DISTORTION

Since magnetic-core coils provide higher Q than air-core coils, the next question is how much you pay for that improvement in terms of increased distortion. To make a distortionless magnetic-core coil, the core material must have a perfectly linear hysteresis curve, and there must be no "magnetic memory." In other words, the curve would have to be infinitely skinny. Also, the material would have to be operated well below its saturation magnetization.

Increase your electronics know-how and skills

The speed and intensity with which electronics penetrates our daily lives at home, at work, or in our car, tends to make us forget that we **can use electronics creatively** by building designs with a practical application and having the satisfaction of a successfully finished project. *Elektor Electronics*, which is distributed all over the world, can help you achieve these goals. Throughout the year, the magazine features original construction projects, informative articles and news on the gamut of electronics, science & technology, book reviews and information on new products. The past 11 issues contained 80 major and 97 minor construction articles, 21 articles of an educative or instructional nature, and 10 articles dealing with Science & Technology.

If you wish to increase your electronics know-how and skills, take out an annual subscription to *Elektor Electronics* by writing or faxing to

**World Wide Subscription Service Ltd
Unit 4, Gibbs Reed Farm
Pashley Road, Ticehurst
East Sussex TN5 7HE, England**

Telephone +44 580 200 657; Fax +44 580 200 616

You will then have the convenience of having the magazine delivered to your home, and the peace of mind that you will not miss any issue. The current rate for an annual subscription (11 issues) is \$US 57.00 (post paid – airspeeded).

There are also a number of *Elektor Electronics* books geared to the electronics enthusiast – professional or amateur. These include data books and circuit books, which have proved highly popular. Two new books (published November 1993) are *305 Circuits* and *SMT Projects*. Books, printed-circuit boards, programmed EPROMs and diskettes are available from

**Old Colony Sound Lab
PO Box 243, Peterborough NH 03458
Telephone (603) 924-6371, 924-6526
Fax (603) 924-9467**

Audiophile Sweepstakes

Enter and win one of these exciting prizes!

Simply complete and mail the reader service card in this issue or the coupon below and you will be automatically entered in our third and biggest yet, Audiophile Sweepstakes:

GRAND PRIZE

Our grand prize winner will receive a pair of **Electra-Print Audio 130EP Single-Ended Monoblocks** to drive his new **Edgarhorn System 80 horn system!**

Each monoblock uses a matched pair of Svetlana 911-3's and an exclusive dual tuned choke power supply to deliver 30 Watts of clean, reference-quality power. The design is reminiscent of the old McIntosh 75s.



A breakthrough in horn folding technology has allowed the utilization of a JBL 5" monitor woofer on a 5' long 80Hz bass horn. This high performance horn system is ideal for use with low power single ended triode amps. Unlike most other horn systems it can be used in small listening rooms.

FIRST PRIZE

The Audio Alchemy DDS Pro CD Transport

This new dual-chassis transport has the advanced new Pioneer "stable platter" CD transport system and offers both I²S & SPDIF digital output. This unit comes complete with full-function remote and detachable AC mains cord with integrated line filtering.

SECOND PRIZE

The Davidson-Whitehall StoraDisc™ Library Series LS-360 CD storage unit

This unit, given an A+ rating in the December 1995 issue of *Audio* and chosen as *CD Review's* top choice in a 60 product comprehensive comparison, stores 360 CDs with a non-slip surface that holds even a single CD upright. This fine furniture-quality storage unit is a perfect balance of function and elegance. From Davidson-Whitehall of Atlanta.



3 THIRD PRIZES

Three of our readers will receive a \$100 gift certificate from **International Audio Group** towards the purchase of the renowned **Sowter transformers**. Choose from a large selection of standard design push-pull or single-ended output, power, electrostatic loudspeaker, moving coil, or line transformers or custom design your own!

25 FOURTH PRIZES

The Audio Glossary
by J. Gordon Holt

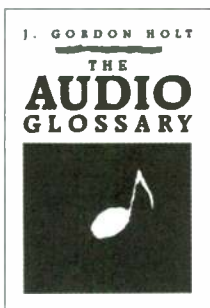

This sweepstakes is void where prohibited by law. All entries must be postmarked by December 31, 1996. Multiple entries are allowed and encouraged. Employees and relatives of employees of Audio Amateur Publications are ineligible for this sweepstakes. One entry per envelope please.

Name: _____

Address: _____

City: _____

State: _____

Zip: _____

Please enter my name in the Third Audiophile Sweepstakes

I'd like information from the advertisers in the following magazine(s):

Speaker Builder

Issue # O#4 O#5 O#6 O#7 O#8

Glass Audio

Issue # O#4 O#5 O#6

Reader: Please circle the reader service number as seen at the bottom of an advertisement in the magazine(s) about which you want information. For more, please see card in the magazine.

1	2	3	4	5	6	7	8	9	10
11	12	13	14	15	16	17	18	19	20
21	22	23	24	25	26	27	28	29	30
31	32	33	34	35	36	37	38	39	40
41	42	43	44	45	46	47	48	49	50
51	52	53	54	55	56	57	58	59	60
61	62	63	64	65	66	67	68	69	70
71	72	73	74	75	76	77	78	79	80
81	82	83	84	85	86	87	88	89	90
91	92	93	94	95	96	97	98	99	100

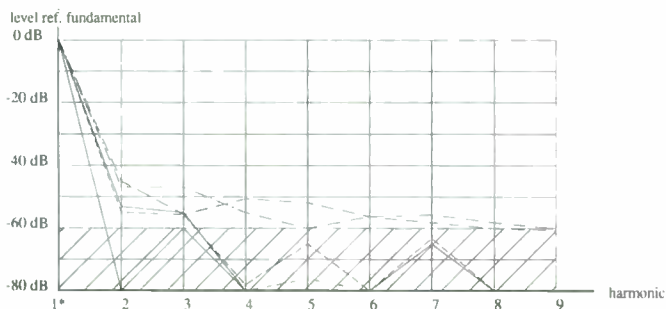

FIGURE 6: Distortion measurements for air-core coils; (—) 16-ga. air-core coil, original**; (—) two 14-gauge coils in series; (---) 16-gauge coil with steel screw; (— · —) 14-gauge coils with steel screws; (— · · —) 16-gauge air core, modified**; (— · — · —) copper-foil, air-core). Note: Shaded area represents equipment noise/distortion floor. *—fundamental; **—see text.

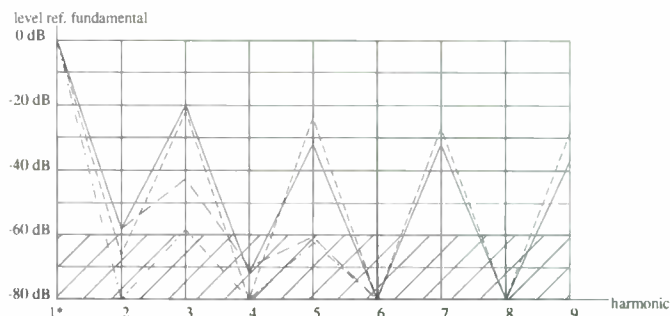

FIGURE 7: Distortion measurements for ferromagnetic-core coils; (—) ferrite bobbin core; (—) iron bar-core coil; (---) ferrite toroid coil; (— · —) laminated bar-core). Note: Shaded area represents equipment noise/distortion floor. *—fundamental.

Real magnetic core materials do produce distortion. To see just how much, I used the test setup of Fig. 5. This allowed me to feed each coil with a known current at whatever frequency I chose, and examine the output for distortion products. For the first test, I applied a 7A sine wave to the dummy load resistor, and found the resulting harmonic levels to be below -60dB, or 0.1%.

Then I applied the 7A sine wave to each coil; the results are graphed in Fig. 6 for the air-core coils, and in Fig. 7 for the magnetic-core coils. You might argue for varying the

applied current according to the power rating of each coil. However, none of the power ratings included a speaker-impedance specification, nor is the current in a crossover coil the same among different coils in different orders of crossovers, even with a given speaker. Thus, using a standard current for all tests seemed more fair. (The variation in distortion with current is examined later.)

STEEL EFFECTS

Notice in Fig. 6 that only the coils mounted with steel screws had distortion components

above the measurement threshold of the test equipment. In other words, as you would expect, air-core coils do not produce significant distortion, although a small amount of distortion (about 0.1–0.5 %) is added if the coils are mounted using steel screws.

In Fig. 7, you see that the story is very different for ferromagnetic-core coils. The only one of these that had really low distortion was that using a laminated-iron core. Although this coil was rated at only 250W, it introduced no significant distortion. Second-best was the iron-bar-core coil, which intro-

...if you value musical involvement over sonic fireworks, the C/BD-2000 should be at the very top of your "must-audition" list.

- Robert Harley on the C/BD-2000 Belt Drive CD Transport.
Stereophile, May 1996.
Vol. 19 No. 5

...if you buy any \$2,000 converter without first auditioning the Parasound, you'll never know just how much musical performance is possible at this price.

- Robert Harley on the D/AC-2000 Ultra D-A Converter.
Stereophile, April 1996.
Vol. 19 No. 4

(Just a reminder that most Parasound dealers will be open by 10:00 a.m. tomorrow.)



PARASOUND

950 Battery Street • San Francisco, CA 94111
(415) 397-7100 • Fax (415) 397-0144



duced about 0.16% second harmonic and 0.7% third harmonic. The ferrite-core coils were awful, providing about 10% third-harmonic distortion.

Defenders of truth and justice will be quick to point out that the test was unfair to ferromagnetic-core coils, since these are known to have a saturation point, and the 7A test current would represent almost 400W into an 8Ω load. Therefore, I measured the distortion in these coils again, this time varying the test current. The results are plotted in Fig. 8.

Notice that the ferrite-core toroid's distortion was off the scale, and the other ferrite-core coil showed a distortion of 5% just below 3A, corresponding to 72W into 8Ω. The 1% distortion level for that coil occurred well below 2A (36W). (Notice that the equivalent power figures would be only half as large if a 4Ω load were used.)

DISTORTION VS. FREQUENCY

Since there is some interplay between distortion levels and eddy currents, and eddy currents are frequency-dependent, I measured the distortion versus frequency. The results are shown in Fig. 9.

As you can see, frequency did affect THD differently for the three coils shown. As before, the distortion levels for the air-

core coils were below the measurement floor, and those for the ferrite-core coils were off the top of the scale.

Harmonic distortion is not the only kind, and certainly is not the most objectionable. Intermodulation (IM) distortion results whenever two or more signals are applied to a non-linear system. The result is that sum and difference frequencies are produced. Since these frequencies are not harmonically related to the signal, they can sound more or less like out-of-tune instruments. IM between two closely-spaced tones imparts a warbling sound. Either way, the effect is quite unpleasant.

IM distortion is audible at levels far lower than those at which you perceive harmonic distortion. I tested the IM distortion of the crossover coils by applying two tones to each: a 50Hz tone at 4.4A and an 80Hz at 10dB lower. I used the spectrum analyzer to measure the 130Hz sum and 30Hz difference frequencies. Table 2 shows the results.

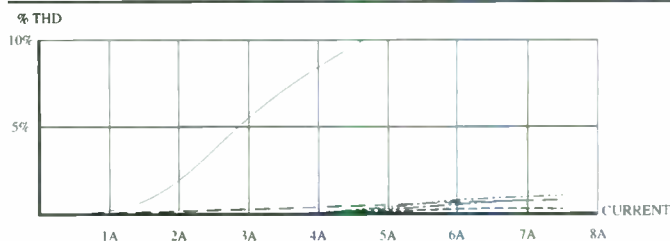

FIGURE 8: Distortion of coils vs. current (— ferrite-core coil; --- iron bar-core coil; ···· 16-gauge air-core coil original; -·-· 14-gauge air-core coils in series; -·-·- 14-gauge coils with steel screws). Note: toroid distortion was >10% even at 1.5A. Coils not shown had distortion <0.1% at all current levels.

Notice again that the ferrite-core coils were the worst, with IM levels above 5%. The iron-core coils had IM below 0.5%, and the air-core coils could be coaxed into producing IM distortion only if a steel screw was used to mount them.

CONCLUSIONS

The coils tested had nominal values of 4mH, a value I chose so I could purchase units of the same inductance in as wide a variety of construction types as possible. Low-inductance coils are generally available solely as air-core types, and you can obtain very large ones only in the iron-core variety.

You would typically use the 4mH value

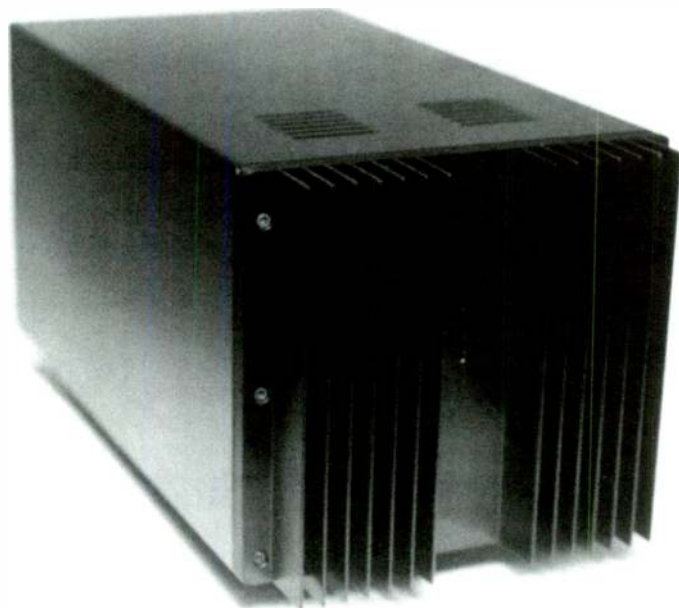

MONO BLOCK

An amplifier with an attitude!

AMPLITUDE

Class A/AB, dc coupled, amplifier with J-fet input in a cascoded differential voltage gain stage. Starting at \$395.00 ea.

MENISCUS

2575 28th St. S.W.
Wyoming, MI 49509
619-534-9121
fax 616-534-7676

email meniscus@iserv.net

1981 A Testing Unit for Speaker Parameters • Variable-Volume Enclosure • Thiele/Small Theory, Pt 1-3 • Easy to Make Enclosure Using Concrete Blocks • The Tractrix Horn: Good Dispersion From an Old Design • Diffuser Port for Small Boxes • Mini-Speaker Made From PVC Tubes • Closed vs. Vented Box Efficiency • Interview with P.G.A.H. Voigt • Dual 8" Symmetrical Air Friction Enclosure • Thiele/Small Calculator Computation • Thiele/Small Parameters for Passive Radiators •

1982 Transmission Line Theory • Thiele/Small Sixth-Order Alignments • The Quad 63 • Table Saw Basics • AR-1 Mods • Active Crossover and Phase • Three Transmission Line Speakers • A Beginner's First Speaker • How Passive Networks Interact with Drivers • Horn Loaded Heil • Phase Correcting Active Crossover • Wind Your Own Inductors • Series and Parallel Networks • High Performance Corner Speaker • Using Zobel's to Compensate for Driver Characteristics •

1983 Building the Two-Way Dynaudio • A Crossover That Offsets Speaker Impedance • Using a Calculator for Box Design • Choosing a Calculator • A Simple Peak Power Indicator • A Small Horn Speaker • Audio Pulse Generator • How to Use Speaker Pads and Level Controls • An Easy-to-Build Voltmeter for Speaker Measuring • Nomograms for Easy Design Calculations • Interview with KEF's Raymond Cooke • Build a Simple Wattmeter • A New Type of Speaker Driver •

1984 Build an Aligned Satellite/Woofer System • BOXRESPONSE: A Program to Calculate Thiele/Small Parameters • Casting with Resins • A Phase Meter • An Interview with Ted Jordan • Building the Jordan-5 System • Self-Powered Peak Power Indicator • Closed Box Design Trade-offs • How to Build Ribbon Tweeters • Build a Dual Measurement Impedance Meter • A High-Power Satellite Speaker System • Build and Use a White/Pink Generator • Sound Pressure Level Nomographs •

1985 OUT OF PRINT, some single issues still available at \$7 each •

1986 The Edgar Midrange Horn • Sand-Filled Stands • Crossover Networks: Passive and Active • 5-sided Boxes • A 2 x 4 Transmission Line • The Free-Volume Subwoofer • Notch Filters • By-Wiring the LS3/5A • A Push/Pull Constant Pressure System • Current and Power in Crossover Components • The Unbox (Egg) • Upgrade Speakerlab's S-6 Crossover • Measure Speakers with Step Response • A Gold Ribbon System • A Visit with Ken Kantor • A Tractrix Horn Design Program • Reviews: Audio Concepts "G"; Seven TL Midranges; Focal's Model 280; the Audio Source RTA-ONE.

1987 A Compact TL Woofer • Frequency Response and Loudspeaker Modeling, Pt 1-3 • A Manual Coil Winder • The Model-One Speaker • Designing a Listening Room • A Sixth-Order Vented Woofer • Tapered Pipe Experiments • Visiting Boston Acoustics • A Vented Compound System • The Octaline • Spreadsheets for Speaker Design • In Memoriam: Richard Heyser, Pt 1-2 • Using Non-Optimum Vented Boxes • Building Speaker Stands • Evaluating Driver Impedance Compensation • Tuning Bass Reflex • Six Woofers Compared • Bullock on Passive Crossovers: Alternate Bandpass Types • Fast, Easy Filter Calculations • A Mobile Speaker • Polk 10 Mod •

1988 Electronic Turns Counter • Two-Way Design • Minimus-7 Mod • Dome/Midrange/Tweeter Array • Plotting Complex Impedances • A Driver Design Primer • A Cabinet Primer • Tuning Up Old Systems • Low-Cost AR-3 Upgrade • Electronic Time Delay • Enclosures Shapes and Volumes • Minimum-Phase Crossovers • Spot Sound Absorbers • How to Add a Subwoofer • The Swan IV System • Sub-Bass Power Boosting • The Unline: A Short TL • Active Filter Computer Design Program • Low-Cost Two-Way Ribbon • Amp-Speaker Interface Tester and Construction Plans • The QB₃ Vented Box is Best • A Pentagonal Box System • Keith Johnson Profile • Sheathed Conductor ESL • A Symmetrically Loaded System, Pt 1 • Ceramic Enclosure • Inductance Measuring Technique • Polk 10 Mods •

1989 (4 Issue Set: VERY LOW STOCK) The Audio Laboratory Speaker System • A Passively Assisted Woofer • Digital Filter Tutorial • The Listening Arc Alignment • Small IC Power Amp & Crossover • Easy Surround Sound • Building Speaker Spikes • An Isobarik in a Thunderbird • Sheetrock Cabinetry • A Great Speaker • Servo Control • AR-1 • Sent, Safe Muting System • Equalizing a Klipsch Control • Test Switcher • Visiting the Klipsch Kingdom • Rehab for Kitchen Music • Spreadsheet Design • A Subwoofer/Satellite System • Impedance Measurement as a Tool • Practical Passive Radiators • A Symmetrical Dual Transmission Line, Pt 1 • The Microline • A Voice Coil Wheatstone Bridge • Tweeter Q Problems •

1990 Acceleration Feedback System • Cylindrical Symmetrical Guitar TLs • Compact Integrated Electrostatic TL, Pt 1-3 • Minimus-7 Super Mod • The Show (Bass Horn) • A Small Two-Way System • Helmholtz Spreadsheet • Heresy Upon a (Klipsch) Heresy • Beer Budget Window Rattler • Contact Basics • MDT Mini-Monitor Speaker System • Titanium + TPX + Polypropylene = Fidelity • Tom Holman, Skywalker, and THX, Pt 1-2 • Bud Box Enclosure • Klipschorn Throat Riddle • Modular Three-Way Active Speaker • CD Speaker System • SPEAKER DESIGNER Software • Symmetrical Isobarik • Novice Crossovers • Triamplified Modular System • Magnetic Crosstalk in Passive Crossovers • Mitey Mike Loudspeaker Tester • Symmetrical Loading for Auto Subwoofers • Improved Vented Box with Low Q_{rs} Drivers • BOXMODEL Woofer System Design Software • Four Eight By Twos • Dynaco A-25 Mod • Klipschorn Throat Revisited •

1991 Students Building Systems • Servo Subwoofers • An Apartment TL • L-R Crossover for the Swan IV • More or Less Power • New Guidelines for Vented Boxes • The Pipes • Macintosh's Wave and Sound Programs • Creating Professional Looking Grilles • Octaline Meets D'Appolito • Using Radar to Measure Drivers • Deep Bass for GMC • PSpice LF Response Calculating • Pipe and Ribbon Odyssey • The Delac S-10 • Infrared Remote Volume Control • Backloaded Wall Horn Speaker • Mod for the Minimus 7 • Simplifying Cabinet Assembly • Fibrous Effects on TLs • The DOALS • Loudspeaker Cable • Speaker to Ear Interface • Speaker Sensitivity to Errors in T/S Parameters • TL Speaker Evaluation • Cable and Sound • Kit Reports: Little V; Audio Concepts' Sub-1 •

1992 Rumreich on Box Design & Woofer Selection • MLSSA • Double-Chambered Reflex by Weems • Active Crossover and Delay • Electrical Circuit Bandpass Enclosure • A Dreadnaught System (satellite swivels) • Designing Real-World Two-Way Crossovers • 20-foot Ribbon Dipole Speaker • Biamping the Sapphire II • Capping Passive Crossovers • A High Quality Speaker Cabinet • 1/3-Octave Noise Source • Disappearing Loudspeaker • The A&S Soundoff Winner, Pt 1-2 • Alignment Jamming • Marc Bacon's "Danielle", Pt 1-2 • Double-Chambered Isobarik Bass • Ferguson's Pickup Installation • Electronic Counter for Coil Winding • Oakley on Speaker Placement • Making Your Room Hi-Fi, Pt 1 • More on Dust Caps • Spreadsheet for Nonoptimum Vented Box Design • Acoustic Resistance Tuned Enclosure •

1993 Waslo's IMP, Pt 1-3 • Quasi-Monotonic Vented Alignments • Making Your Room Hi-Fi, Pt 2-3 • A&S Soundoff Winner, Pt 3 • Flexible Dipole Woofer • The Spline • Stalking F_s • A Bi-Structural Enclosure • A Sixth-Order T/S Subwoofer Design • Speaker Enclosure Screws • Electric Bass Tri-Horn • Prism V Satellite/JBL Subwoofer, Pt 1-2 • Fitduct: Program for Designing Duct Software • Compact Coincidental Point Source Speaker • IMP: Measuring T/S Parameters • KIT REPORT: Rockford's Beginner Software/Driver Paks • SOFTWARE REPORT: Low Frequency Designer 3.01 • Three Affordable Measurement Microphones • Two Ways to Realize a Dream • Matching Driver Efficiencies • Two-Woofer Box System • Designing a Dual Voice Coil Subwoofer • SOFTWARE REPORT: Blaubox 1.2 • Tale of Three Speaker Projects • A&S Sound-off 1992 • Monolith Horn • Orbiting Satellites • Real-World Three-Way Crossovers • The Simplex • Living with a Speaker Builder • The IMP Goes MLS •

There's More 

Please send me the following back issues of Speaker Builder

- | | | | |
|------------------------------------|------------------------------------|------------------------------------|------------------------------------|
| <input type="checkbox"/> 1995 \$32 | <input type="checkbox"/> 1994 \$32 | <input type="checkbox"/> 1993 \$25 | <input type="checkbox"/> 1992 \$25 |
| <input type="checkbox"/> 1991 \$25 | <input type="checkbox"/> 1990 \$25 | <input type="checkbox"/> 1988 \$23 | <input type="checkbox"/> 1987 \$20 |
| <input type="checkbox"/> 1986 \$20 | <input type="checkbox"/> 1984 \$18 | <input type="checkbox"/> 1983 \$18 | <input type="checkbox"/> 1982 \$18 |
| <input type="checkbox"/> 1981 \$18 | | | |

SHIPPING BACK ISSUES

UPS: Domestic ground service by value of order:
 Less than \$60.00 - \$4.50 \$131.00-220.00 - \$8.50
 \$61.00-130.00 - \$6.50 \$221.00+ - \$10.50

Canada: Add \$6.00 per year.

Foreign Air: Europe add additional 40% of total order. **Total Magazines** _____
 Other destinations: 50% of total order. **Postage** _____

Foreign Surface: Add additional 20% of total order. **TOTAL ENCLOSED** _____

Rates subject to change without notice. All remittance in US \$ only drawn on a US bank. Make checks payable to Audio Amateur Corp.

- Check or Money Order Discover MC VISA

DISCOVER/MC/VISA NO.	EXP. DATE
NAME	ACCOUNT NO.
STREET & NO.	
CITY	STATE ZIP

Speaker Builder

Post Office Box 494, Dept. B96, Peterborough, NH 03458-0494
 (603) 924-9464 FAX (603) 924-9467

Answering machine for credit card orders only—before 9:00 a.m., after 4:00 p.m. and weekends
 Please have all information plus MC/VISA available.

% THD at 4.7 amperes

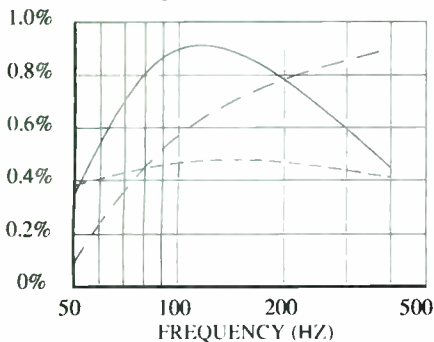

FIGURE 9: Distortion of coils vs. frequency; (— iron bar-core coil; — — — 16-gauge air-core coil with steel screw; - - - 14-gauge air-core coils with two steel screws).

in crossovers operating in the low hundreds of Hz, which was also appropriate, given the 120Hz and 1kHz test frequencies for measuring the inductance and Q with the H-P

TABLE 2

IM DISTORTION OF SELECTED COILS

COIL	% IM DISTORTION
16-gauge air-core, with steel screw	0.451%
Two 14-gauge air-core/steel screw	0.287%
Two 14-gauge air-core/2 steel screws	0.321%
18-gauge iron-bar-core	0.257%
16-gauge ferrite spool	6.34%
19-gauge toroid	5.05%

bridge. But, you'd expect the mechanisms for producing the distortion to affect lower- or higher-inductance coils similarly.

The conclusions seem pretty clear: ferrite-core coils are not suitable for crossovers. Air-core coils have vanishingly low distortion, but their Q is nothing to brag about. Iron-core coils behave somewhere between the other two categories, with laminated iron-bar cores perhaps the best compromise between low distortion and high Q.

Finally, the expensive copper-foil air-core coil, while offering by far the best Q of the air-core group at 1kHz, actually had a lower Q at 120Hz. So there is no ideal coil for crossovers. But by using the results given in this report judiciously, maybe you can reduce yet another source of distortion in your speaker systems.

Start a Family Business From Your Home!



Free Special Report Now Available:

Get 3 hours of cassette tapes plus complete detailed information on the 40+ best home businesses that a couple or individual can run from their home with a computer. Learn from the experts, Computer Business Services, Inc. (CBSI), the world's largest resource for in-home computer business services. This free report tells you • What's working—where • Which businesses allow you to keep your present job • What your costs will be • And much more! *Learn how individuals like yourself are running successful businesses from their homes.*

Get FREE Cassettes and Special Report!

Call 1-800-343-8014, ext. 4542

CBSI, CBSI Plaza, Ste. 4542, Sheridan, IN 46069

Use this convenient list to request the products and services that you need *fast*. Don't forget to mention *Speaker Builder!*

COMPANY	PRODUCT	FAX
Acoustic Technology Int'l	Hi-End Drivers	(905) 475-8226
Allison Technology Corp.	O-Scope II	(713) 777-4746
Audio Classics, Ltd.	Audio Classics, Ltd.	(607) 865-7222
Gasoline Alley L.L.C.	Acoustasheet	(913) 827-9337
Harris Technologies	BassBox and X*over	(616) 641-5738
Kimber Kable	Speaker cables, interconnects, etc.	(801) 627-6980
LinearX Systems, Inc.	LMS	(503) 598-9258
Markertek Video Supply	Unique & Hard-To-Find Accessories	(914) 246-1757
Morel Acoustics USA	Loudspeaker Drivers, Car Speakers	(617) 277-2415
Newform Research, Inc.	5", 8", 15" & 30" Ribbon Kits	(705) 835-0081
Solo Electronics	CFAC Inductor	(510) 887-1657
Technologie MDB	Focal, Cabasse, Kits	(514) 635-7526
The Speaker Works, Inc.	Vifa	(602) 230-8533
True Image Audio	WinSpeakerz & MacSpeakerz	(619) 480-8961

Speaker Builder

BACK ISSUES Continued

Sanctuary Sonics • Modular Active Crossovers • A Full-Range Open-Baffle System • An Evolving Magnepan MG-1 • Low-Frequency AC-To-DC Converter • A Compact Bass Guitar Speaker • Measuring Speaker Impedance Without a Bridge • The Dynapleat • The Danielle II • The Birdhouse: A Sound-Reinforcement Subwoofer • The Linear-Array Sound System • A Revised Two-Way Minimonitor • Exploring the BUF 124 with Pspice • Signet's SL280B/U • Time Response of Crossover Filters • Converting Radio Shack's SLM To Millivolt Use • Acoustic Distortion and Balanced Speakers • Microphone Response Correction with IMP • More About the Birdhouse Bandpass • A 16Hz Subwoofer • D.H. Labs Silver Sonic Cables • The System III Loudspeaker • Exploring Loudspeaker Impedance • IMPcycling • The Linear-Array Chronicles • Book Report: Loudspeaker Recipes, Book One • The Woofer Test • A Large Ribbon You Can Build • Loudspeakers, A Short History, Pt 1-2 • Absolute SPL Sensitivity Measuring with IMP • The Damping Factor: One More Time • Cliffnotes for Loudspeaker University • Software Report: The Listening Room for Macintosh • Book Report: The Theory and Design of Loudspeaker Enclosures • A 15" Transmission Line Woofer • Inductor Coil Cross Talk • Quick Home Theater on a Budget • Silk Purses: A Two-Way Salvage Design • Audio Phase Inductor •

The T-Rex Minisubwoofer • High Quality Use of Motorola's Piezo Driver, Pt 1 • The Achilles: A Two-Way Automotive Transmission Line • Driver-Offset-Related Phase Shifts in Crossover Design, Pt 1-2 • The Linear-Array Chronicles, Pt 3 • From Sad to Sparkle: A SAAB Story, Pt 1-2 • A Compact Two-Way PA, Pt 1-2 • The Baekgaard Crossover Technique • Rebuilding the KLH-9 Power Supply • KIT REPORT: Audax of America A652 • Satellites For a New System • Box Models: Benson Versus Small • PRODUCT REVIEW: Sapphire III Reference Monitor • The Spline Sidewinder Woofer • Focused Arrays: Minimizing Room Effects • A Flexible Four-Way System • Extending IMP: A Program Set • CD REVIEW: My Disc From Sheffield Lab • The Freeline: An Open-Pipe Transmission Line • Computer-Aided Bass Horn Design • A Mike/Probe Preamp For Sound-Card Measurements • Four-Poster Speaker Stands • Mining For Gold On the Madisound BBS • SOFTWARE REVIEW: CLIO Test System • The Waveguide Path to Deep Bass, Pt 1-3 • Stereo Bass: True or False? • A Morning Glory Midrange Horn • Testing a Simple Focused Array • PRODUCT REVIEW: LinearX's pCRTA • A Self-Powered Subwoofer for Audio/Video • Your Car's (and Living Room's) Bass Boost • Driver Temp and T/S • SOFTWARE REPORT: SoundBlaster 16 • A Push-Pull Planer Speaker Quest • PC Sound Overview • Design a Three-Way TL with PC AudiLab, Pt 1 • PRODUCT REVIEW: Audio Control C-101 • SOFTWARE REVIEW: Electronics Workbench •

Ask SB

SPEAKER PLACEMENT

Although not many things in life are rocket science, I believe speaker building is. Once you consider all the factors and the problems to be overcome, it's amazing speakers sound as good as they do. One of the major problems is the room effect on the sound. Bill Waslo's article on focused arrays and minimizing room effects ("Focused Arrays: Minimizing Room Effects," *SB* 4/95, p. 10) was very interesting and provoked me to write.

D'Appolito configurations appear to be the way to go for numerous reasons. I have seen polar-axis response graphs for systems in which the interdriver spacing is two-thirds wavelength, but many times this spacing is difficult to achieve due to a high crossover point and large tweeter size (some almost 5" in diameter). What do the response graphs look like when the distance is greater than one wavelength? Also, what if the phase difference between the woofers and tweeter(s) is 45° rather than 0° and 90°?

Many audio/video speakers, especially THX certified systems, have two or three tweeters between the woofers, 3k crossover frequencies, and obviously don't meet the

basic D'Appolito requirements. Their stated purpose is to narrow the vertical response, although some people contend that this causes them to have inferior room response and sound less musical.

I wonder whether the reason that some favor planar and ribbon speakers is because of their restricted vertical, and maybe horizontal, response, as well as their random reflections from the floor, ceiling, and side walls. We could build small speakers, and sit close, to minimize many problems.

I still haven't recovered from the first time I saw the Accuton Reference System One line array by Joe D'Appolito (*Fig. 1*). This masterpiece of audio indulgence included three Accuton tweeters, four Accuton midranges, and six Focal 5K013L woofers stacked from floor to ceiling in a three-way configuration.

In light of Mr. Waslo's comments, it would appear that such a system could benefit from superior vertical dispersion, a large sound-wave launch area (different issue), and random room reflections. Leaning the cabinets would increase the randomness of the reflections, but might prove difficult, as

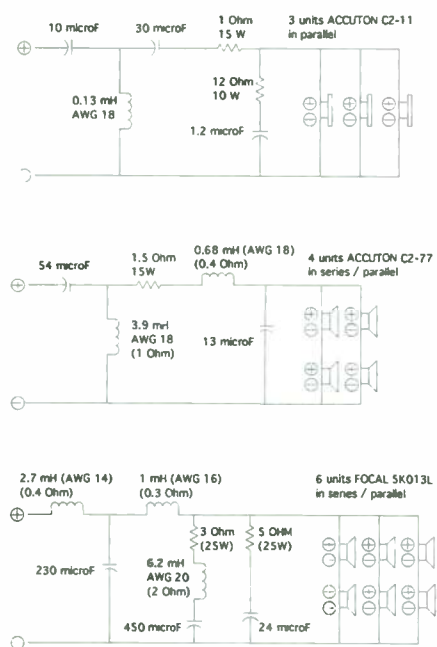

FIGURE 1: Accuton Reference System One.

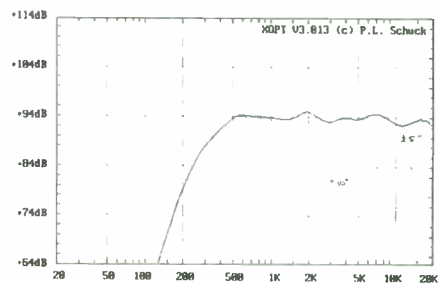
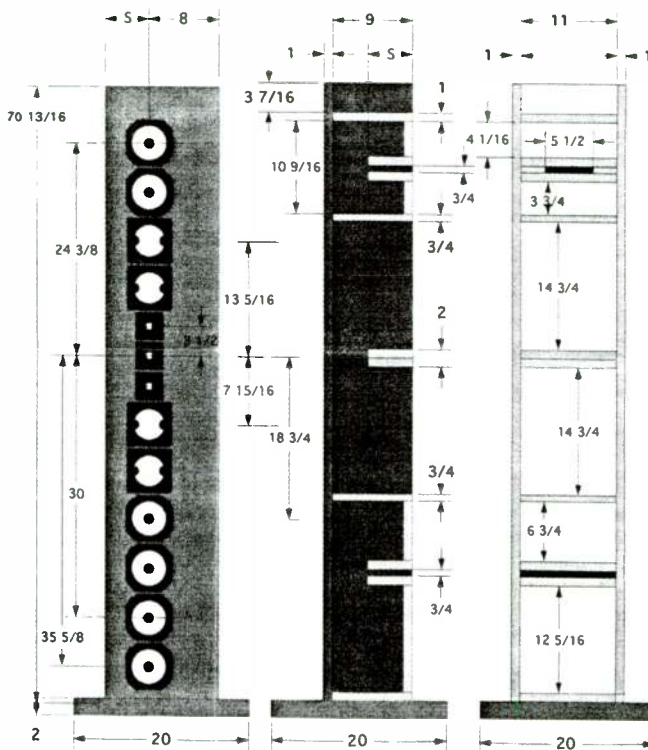

FIGURE 2: Midrange/tweeter response plots.

would the vertical off-axis response of such a system.

Robb Hayes
Newcastle, OK

Contributing Editor Joe D'Appolito responds:

There are so many drivers in this system that I had to design it in two stages with the old software: LF/midrange and midrange/tweeter. Figure 2 is a plot of the response of the midrange/tweeter combination (four C277s and the three C211s). The solid line is the on-axis response (relative to the center tweeter), while the dotted lines show the responses in the vertical direction at +5° and +10° off-axis.

First, we see that the response degrades rather rapidly off-axis. Along the +5° axes, the spread of the tweeter array produces a sharp null at about 9kHz along the +10° lines, while the four spaced midrange units produce a broader null around 2.5kHz. These response curves do not change very much for horizontal angles of +30°.

This shows that long line arrays tend to focus all the acoustic energy

SALE! PLUS FREE ADHESIVE!

MARKERFOAM™ ACOUSTIC FOAM GIANT 54" x 54"



Immediate Shipping

2" Reg. \$29.95 Now \$19.99 • 3" Reg. \$39.95 Now \$29.99. **KILL NOISE QUICK!** High performance, full-size sheets of super high density Markerfoam. EZ mount. Blue or gray. Super-effective sound absorption for studios. Markerfoam offers best value, looks professional & is proven in studios worldwide. Request Foam Buyers Guide/Catalog, specs & free samples today.



MARKERTEK JUMBO SOUND ABSORB BLANKETS

Heavy-duty 72"x80" padded blankets absorb sound wherever they're hung or draped. Fabulous for stage, studio and field use. Top professional quality at a super saver price! Weight: 6 lbs. Black. \$19.99

MARKERTEK BLADE TILES™ HIGH PERFORMANCE - LOW, LOW COST!!!

America's best acoustic tile value only from Markertek!

\$3.49 per tile, 16"x16"x2", charcoal or blue
\$4.49 per tile, 16"x16"x3", charcoal or blue
\$5.49 per tile, 16"x16"x4", charcoal.



MARKERSTIK™ FOAM ADHESIVE

FREE with any foam purchase in this ad! Limited offer. A \$4.00 per tube value.



SONEX

All the colors and sizes plus great prices!

FREE

America's most unique catalog featuring 320 pages of over 6,000 exclusive and hard-to-find supplies for Pro Audio, Broadcast Video, Audio Visual & Multimedia production.

MARKERTEK™ VIDEO SUPPLY

4 High St., Box 397, Saugerties, NY (USA) 12477
800-522-2025 • Fax: 914-246-1757
World Wide Web: <http://www.markertek.com>

Reader Service #10

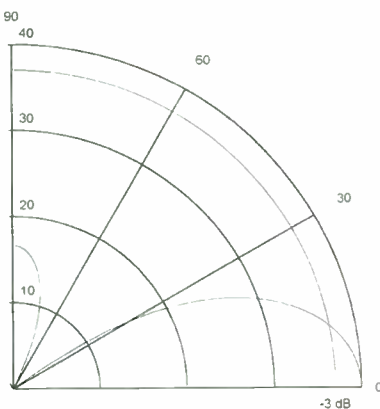

FIGURE 3: Vertical polar response of MTM array at two-thirds wavelength spacing, $\phi = 0^\circ$.

forward into a narrow vertical range. The center tweeter was set at typical seated listening height. The curves indicate that, for best response, the listener should be within the $\pm 5^\circ$ envelope.

For the MTM array, Figs. 3-10 show a sequence of vertical polar-response plots for various interdriver spacings and phase angles (ϕ). All plots assume point-source drivers. The effect of driver polar response will be limited to vertical angles of 45° or more for typical crossover frequencies and mid-bass drivers of 6" diameter or less.

GO AHEAD

Ask top engineers and music lovers worldwide what capacitors they choose for their ultimate designs.

— H O V L A N D —

MUSICAP®

The most naturally revealing capacitor. Film and foil polypropylene construction - optimized for fine speakers and vacuum tube electronics. Precision made in the USA.

Values from .01 μ F to 10 μ F.

Listen and compare for yourself.

UPGRADE NOW

"If you want see-thru, high definition, detail and listenability, try the Musicaps."

Joe Roberts, SOUND PRACTICES, ISSUE 6

To order contact one of the following:

- Welborne Labs 303-470-6585
- The Parts Connection 800-769-0747
- A & S Speakers 510-685-5252
- Allpass Technologies, Inc. 407-786-0623
- Anchor Cross Co., Japan, 81-3-3203-5606
- SJS Electroacoustics, England 44-1706-823025
- Tang Hill International Ltd., 886-2-5813605
- Audio Kinetik Pte. Ltd., 65-339-9789
- OEMs contact Hovland Company at :
ph 209-966-4377 • fax 209-966-4632

Reader Service #73

Why Contact ACI Today?

Sapphire III: *Component of Exceptional Merit, awarded by Bound for Sound, 1995, 1996*

"I recommend them without reservation" Gary Galo, Speaker Builder

"Fully recommended" Ken Duke, The Sensible Sound

Titan Powered Subwoofer: Stereophile Recommended Component, *The powered sub that does justice to music and Home Theater.*

You love music, ACI has provided "Sound that satisfies"... Since 1977, *Guaranteed!* NEW VLS Series (Virtual Line Source), B-Flat Wallspeaker, Assembled speakers, Complete systems, NEW B-Flat II Co-axial Wallspeaker, Home Theater *done right*, Jaguar, Spirit, Shadow, EAM, NEW AV2 Shielded Center Channel, Parts Kits, NEW Cast-frame DV12 woofer, NEW Push-Pull, Magnetic-Planar line source drivers, (PPMP), 200-20K without crossovers, DH Labs Silver Sonic cables, Lasting value, guaranteed!

Visit us at: <http://www.audioc.com>

ACI, Division of Audio Concepts, Inc. 901 S. 4th Street, La Crosse, WI 54601

Phone: (608) 784-4570 Fax: (608) 784-6367

Reader Service #6

Speaker Builder 7/96 47

LEARN Speaker Reconing

Recone your own speakers
Save Money, Make Money

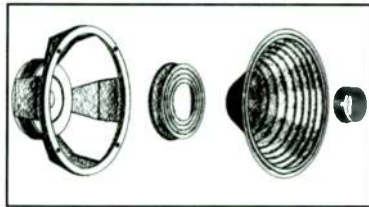

NO MORE SECRETS

This comprehensive video has taught hundreds to perform this task and now you can learn too. WVS also supplies parts.

Phone: 219-424-5463 / Fax: 800-997-3266

\$39.95

Check, Money
Order, Visa, MCI

WVS

1502 N. Harrison
Ft. Wayne, In 46808

Reader Service #66

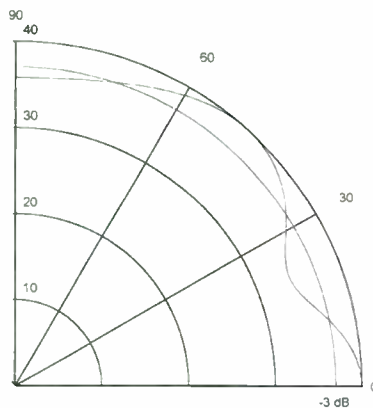

FIGURE 4: Phi = 90°.

Figures 3–6 are for the different phase angles at the two-thirds wavelength spacing. Figure 3 shows the results for $\phi = 0$. Notice that the array produces a strong forward lobe with a -3dB width of about $+8^\circ$. With a sharp null at 50° and a greatly attenuated vertical lobe, this is rather ideal for most home environments.

In Fig. 4, $\phi = 90^\circ$ which defocuses the array. There are no nulls, only a rippling of the response. (The MTM array is often placed horizontally when used as a center channel speaker in home theater applica-

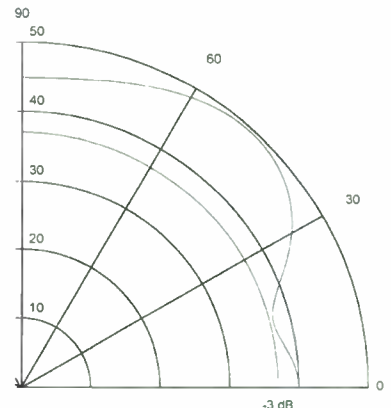

FIGURE 5: Phi = 120°.

tions. Figure 4 suggests that odd-order (90°) networks in this application will achieve the best horizontal dispersion.)

Now for the surprise! Figure 5 shows the polar response for $\phi = 120^\circ$, which is the phase angle between drivers using Small's parallel sum-to-one network. Notice that the off-axis response peaks almost 10dB at $+45^\circ$! You should not use interdriver phase angles greater than 90° with the MTM array.

I know of no crossover network that produces the interdriver 45° phase angle, but if there were one, it would look like Fig. 6.

We're pleased to announce an increase... in frequency, that is!

After 27 years of high-quality DIY audio projects and articles, we're increasing the frequency of *Audio Amateur* to **6** BIG ISSUES per year! If you've enjoyed projects like the Zen amplifier and its family, the recent series of articles on regulators for high-performance audio or any of our other state-of-the-art audio information,

you'll be happy to see what we have in store for you in 1997. Two more issues filled with the kind of technology you're seeking. Two more issues of projects for you to build!

We're sure you'll be pleased with the changes we are making to *Audio Amateur* (soon to be known as *Audio Electronics*) so we've made this offer too good to refuse. Join us and experience the difference. As always, your satisfaction is guaranteed and you may cancel at any time and receive a refund on all unmailed issues.

1 YEAR (6 issues) \$28 CANADA ADD \$6

2 YEARS (12 issues) \$50 CANADA ADD \$12

Payment: REMIT IN US \$ DRAWN ON A US BANK ONLY Check or Money Order VISA Mastercard Discover

CARD NO

EXP DATE

NAME

Audio Amateur & Electronics

PO Box 576, Peterborough, NH 03458-0576 USA

Phone: 603-924-9464 Fax: 603-924-9467

E-mail: audiotech@top.monad.net

STREET & NO.

CITY

STATE/PROV.

ZIP/POSTAL

COUNTRY

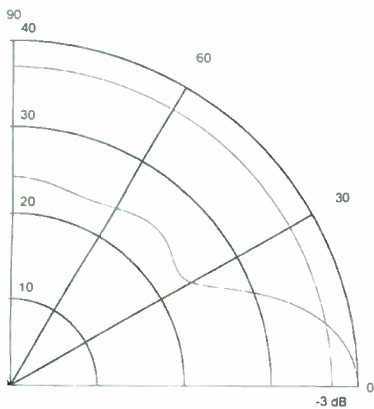

FIGURE 6: $\Phi = 45^\circ$.

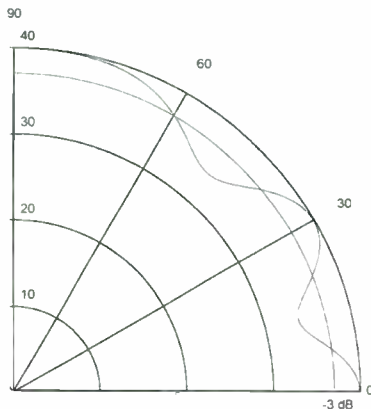

FIGURE 9: One wavelength spacing, $\Phi = 0^\circ$.

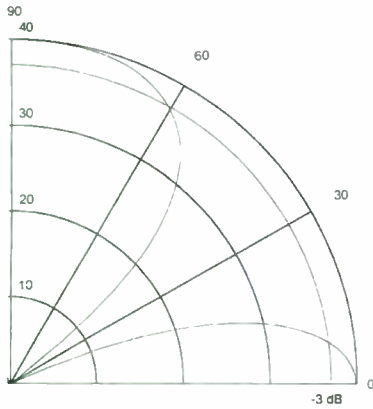

FIGURE 7: One wavelength spacing, $\Phi = 0^\circ$.

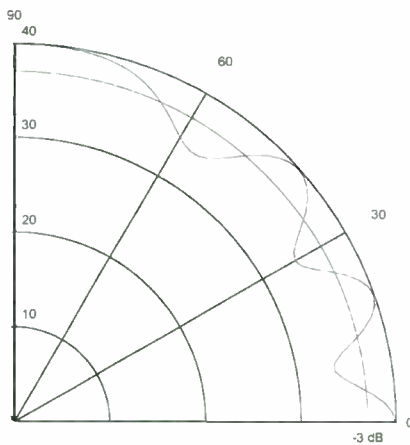

FIGURE 10: One-and-a-half wavelength spacing, $\Phi = 90^\circ$.

For the effect of interdriver spacing, refer to Fig. 7, which shows the response for $\Phi = 0$ and $D =$ one wavelength. The off-axis null has moved down to 30° , but worse is the major off-axis lobe at 90° , which is as strong as the on-axis response. At 90° off-axis the drivers are exactly one wavelength apart and therefore add directly. At $D = 1.5$ wavelengths (Fig. 8), the major off-axis lobe has moved down to $+40^\circ$ off-axis.

When $\Phi = 90^\circ$, the effect of interdriver spacing is not as critical. The array is still

defocused. The major effect of increased spacing is to put more ripples in the polar response (Figs. 9 and 10).

Incidentally, Morel (414 Harvard St., Brookline, MA 02146, 617-277-6663, FAX 617-277-2415) has a new line of compact soft dome tweeters that are only a little over 2" square. These tweeters seem ideal for the MTM array, as they allow much closer placement of the mid-bass drivers and can be crossed over at relatively low frequencies. ▶

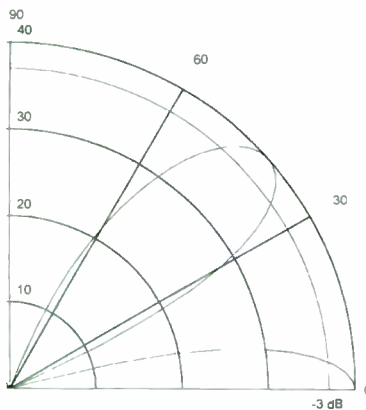

FIGURE 8: One-and-a-half wavelength spacing, $\Phi = 0^\circ$.

**OF NOTE IN
Glass Audio**

Issue 5, 1996

- A 15W SE Power Amp With 6C33C-B
- Improved Vacuum-Tube Models for SPICE Simulations
- Direct-Coupled Mu Stage
- World Class Fit and Finish
- Filament Power and Performance of the 2A3
- Enhanced-Mode Operation

MAHOGANY SOUND

The Transmission Line Specialist
P.O. Box 9044
Mobile, AL 36691-0044
334-633-2054

Acousta-Stuf

The Very Best Damping Material For Speaker Systems. It Produces Deeper Bass, Cleaner Mids, And Greater Dynamic Range. Acousta-Stuf Costs \$9.50 Per Pound UPS Paid.

Q&ETLD

Quick & Easy Transmission Line Speaker Design Booklet & LOTUS 1-2-3 Software. Learn How To Design Optimizes 1/4 Wavelength TL Speakers. Q&ETLD Costs \$8.95 Plus \$2.05 P&H.

Acousta-Tubes

Round Paper Tubes For Building Cylindrical Speaker Enclosures.

Please Note Our New Address & Area Code

Call Or Write For A Free Catalog

Reader Service #9

VACUUM STATE ELECTRONICS

The SuperCables Cookbook
by Allen Wright

I believe cables are crucial to sound quality, and 10 years of research brings 188 pages (+130 pix) about making your own. Using only regular tools and readily available materials, these 35 interconnects, speaker cables and AC cords will sonically better the hi-priced commercials — and at a fraction of their cost! There's 23 pages of supporting theory, and we also offer kits...
\$US40-£27-\$AUD50-DM60 includes surface post (airmail DM20 extra) VISA/MC welcome.

USA: Ph/Fax: (415) 492 0728 (FSpiritEd@aol.com)
UK: Fax: (01734) 845933
Australia: Ph ++ 61 2 9344 3358
All other areas: Allen Wright/VSE, Einsteinstr.129, 81675 Munich, Germany. Ph/Fax ++49 89 477415 (100240.2562@compuserve.com)

Reader Service #61

SB Letters

CEPSTRUM CORRECTION

The graphic denoted as Figure 3 in Bill Waslo's "Reflecting on Echoes and the Cepstrum" (*SB* 5/96, p. 20) was incorrect; rather, the figure should have appeared as follows:

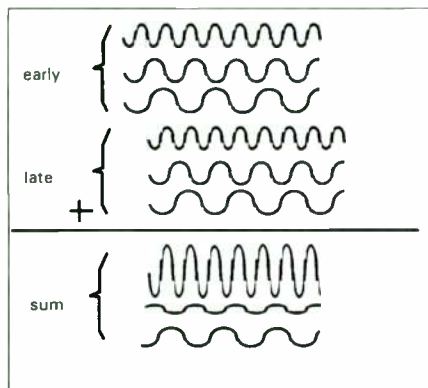

FIGURE 3: Sum of delayed sine-wave packets.

ELUSIVE TL DESIGN

David Field's article, "T-Rex: A Quarter-Wavelength Reflex Transmission Line" (*SB* 4/96), contains a good deal of common sense and touches on some of the many sore points

of TL design, which nag those who have spent even a little time with these beasts. Part of the problem, as Field points out, is the chameleon-like nature of TL systems. By varying the length of the line, the cross-sectional area, the amount and type of stuffing, and the placement and number of chambers, you can force the system to behave like a bass-reflex box, a sealed box, a variously damped acoustic wave-guide, an aperiodic system, or practically anything else you want!

The only point in Field's excellent article that is a bit confusing concerns the stuffing material's influence in the line, which decreases the resonant mode peaks' amplitude and shifts their frequency. The shift in frequency is downward and occurs because the stuffing slows the speed of sound within the line; but it does so depending upon frequency. In other words, the lower the frequency, the greater the effect. Any calculations, and expectations, for a quarter-wave TL are valid only with an empty line and at one specific frequency.

The driver Q_{ts} is another variable. Old-line TL designers still prefer high-Q drivers, while Field advocates low-Q units. Alex Thornhill and I, however, obtained our best results with mid-Q woofers. I suspect good results are obtainable across a wide range of driver types if the units are matched correctly to the line. The plethora of component variables makes TL design a constantly

moving target, and keeps the TL a bastion of "cut-and-try" speaker design.

I am surprised at the lack of attention paid to a very interesting piece of TL research done by Juha Backman from the acoustics laboratory at the University of Technology in Helsinki, Finland. Backman's paper, translated as "A Computational Model of Transmission Line Loudspeakers," was presented at the 92nd AES Convention in Vienna, March 1992, and is available as Preprint #3326 by phoning (212) 661-2355. The paper looks at many TL configurations—from the traditional TL of A.R. Bailey to modern, dual-ported designs—and presents informative graphs showing the effects of stuffing density and fiber diameter. It is a "must-read" for the serious TL enthusiast.

Robert J. Spear
Accokeek, MD

ACOUSTIC-MASS EFFECTS

Joe D'Appolito, answering Jay Doherty as to why *Boxmodel* and *Topbox* give different results for the same driver ("Mailbox," *SB* 5/96), brought up acoustic-mass loading as it affects the driver parameters used in design. I wish to echo Joe's response, while including additional comments.

Acoustic-mass loading seems to be understood by only a minority of speaker design-

BassBox 5.1

Design low-frequency loudspeaker enclosures fast and accurately with BassBox software. Uses both Thiele-Small (f_s , Q_{ms} , V_{as} , η_0) and Electro-Mechanical (Q_{es} , Q_{ms} , CMS , MMS , RMS , BL) parameters with equal ease.

for Microsoft® WINDOWS™

Box Design Software with huge loudspeaker database.

- ◆ Easy to use
- ◆ On-line help
- ◆ Hi-res mode
- ◆ Low price

Design Types:
Optimum Vented
Extended Bass
Custom Vented
Band-Pass with Double or Triple Chambers
Passive Radiator
Optimum Closed
Custom Closed
All designs can use multiple woofers (including Isobaric)

Built-in Test Procedures:
Test and calculate loudspeaker parameters*
Test and calculate passive radiator parameters*

*Requires basic test equipment: sine wave generator, frequency counter, power amplifier, 1 kohm resistor, voltmeter, ohmmeter, test box.

Design Options:
Small and large-signal analysis. Examine one loudspeaker in several different boxes or ... Examine several different loudspeakers in the same box.
6 graphs: normalized amplitude, 2.83-V amplitude, acoustic power, impedance, phase and group delay.
Advanced vent calculator.
Advanced box dimension calculator w/ 18 volume shapes.
Accepts loudspeaker measured acoustic response.
Accepts automobile or listening room interior acoustic response.
Use English or metric units.
Save and recall designs.

\$99.00

plus \$6.00 S&H (Canada +\$7.00) (Overseas +\$13.00)

Tel: 616-641-5924

Fax: 616-641-5738

Email: 72674.514@CompuServe.com

Harris Technologies, Inc.

P.O. Box 622
Edwardsburg, MI
49112-0622 U.S.A.

Also available:
X-over 2.1 passive crossover program for Windows.
X-over calculates the component values for 1st, 2nd, 3rd and 4th-order 2-way and 3-way networks, load compensating networks and L-pads. Regular price: \$39. (\$29 if purchased with BassBox.)

Minimum System Requirements:
MS-DOS 5.0, Microsoft Windows 3.1 & compatible computer (386 or better CPU with at least 4 MBytes of RAM), 7.5 MBytes of free hard disk space, 1.44 MByte 3.5" disk drive and mouse.
Harris Technologies reserves the right to make changes without prior notice.

ers, including some who write enclosure-design programs. I read about this subject, originally, in N. W. Maclachlan's book, *Loudspeakers*—published by Dover, but now out of print. Maclachlan derives the concept of acoustic-mass loading from principles using solutions to the acoustic-wave equation, but also provides an intuitive justification for the concept.

You could imagine measuring the resonant frequency of a loudspeaker in outer space, where there is no air, no acoustic waves, and no acoustic-mass loading. This measurement is the mechanical resonant frequency. Back in the atmosphere, you can measure the resonant frequency with the speaker mounted in the middle of an infinitely long pipe having an inside diameter the same as the speaker's active diameter. According to the wave equation, the speaker will have the same resonant frequency in the latter case as it did in outer space.

On the other hand, when measured in free air—or in an open or sealed enclosure—the speaker's mass will have increased after compensating for stiffening effects of air trapped in the enclosure. The explanation is that acoustic-mass loading is caused by the velocity of the air particles in a wave, in which a component is not parallel to the direction the diaphragm is moving. In other words, whenever air particles can move sideways relative to the diaphragm's motion, the acoustic mass will increase.

The acoustic-mass loading, which must be added to the mechanical mass of the diaphragm to find its total mass, must be known and added in for each condition of measurement—in free air, or in an enclosure. The value in an enclosure depends on its size and whether you consider the outer or inner surface of the diaphragm. Suitable equations for these calculations are given in *Acoustics* by Leo L. Beranek (available from Old Colony Sound Lab as #BKAC5 for \$44.95, plus S/H).

Dr. Victor Staggs
Orange, CA

CAPACITOR CONFLICT

I would like to reply to Mr. Moncrieff regarding his response to my letter (*SB* 2/96, p. 51) about his claims for the InfiniCap (that other caps "smear music by a million to one"). He said that I "succumbed to a common mistake (even among engineers), confusing two different kinds of delay and smearing." Well, Mr. Moncrieff, first of all, I am an engineer, and more importantly, I am well aware of the smearing type of delay, known as non-constant group delay vs. frequency, or phase distortion.

Years ago I presented a paper at the Boston Audio Society on the audibility of phase distortion, and more recently I did research on this with precision all-pass networks, listening to live-miked acoustic transients through headphones. Both experiments showed a maximum audibility when the group-delay variation was centered near 200Hz. But about 1ms of delay smearing

was needed in order to barely hear the transient blurring, and the pulse distortion was clearly visible on a scope (unlike nonlinear distortion, the threshold of which eludes visual observation).

So, if Mr. Moncrieff would publish a scope photo of the alleged "infinite number of different-looking waveforms" distorted by a "conventional capacitor," or would

Ribbons
from
5" to 30"



New Technology *For Pure* Ribbon Systems *Audio or* **5 Channel**

Our monopolar, minimal acoustic profile Ribbons deliver large panel transparency and detail in more practical, more dynamic and easier to drive speaker systems. From the *R5-1 to No Holds Barred*, they offer precision without fatigue and unsurpassed soundstaging. These Ribbons lower the price of admission to high end fidelity and open up the future for painless system upgrading. Step up to Ribbon clarity and sweetness for **\$486 to \$2550** per pair delivered factory direct in North America. 30 day "Let's Be Sure" guarantee. 5 year warranty. Ask for our comprehensive Info Pack with full systems, kits, glowing international reviews and system design and room setup tips.

Newform Research Inc.
P.O. Box 475, Midland
Ontario Canada L4R 4C3
Tel: (705) 835-9000
Fax: (705) 835-0081
Visit our large website.
<http://www.barint.on.ca/newform/>



Reader Service #25

SPEAKERWORKS

"SPECIALISTS IN THE ART OF SPEAKER REPAIR"

FACTORY AUTHORIZED SERVICE:
Advent, B-I-C, Bozak, EPI, RTR,
Cerwin-Vega, JBL Home & Pro

**Speaker parts & adhesives,
cones, spiders & dust caps**

**3 Way Crossovers Circuit
Breaker Gold Plated Binding
Posts \$19.95 each!**

**Replacement grilles for Altec,
B-I-C, Cerwin-Vega, JBL & Marantz**

**Refoam kits available for 4", 5-1/4",
6-1/2", 8", 10", 12", & 15" speakers
- only \$29.95 (JBL slightly higher)**

**Special Closeout on rebuilt DYN
Audio Drivers: MR 17.75, W30-100,
W24-100, W17-75. BELOW COST!**

We Buy Dead Speakers: Altec, E-V & JBL



1-800-526-8879



NO CATALOG AVAILABLE
CALL US FOR HARD TO FIND DISCONTINUED PARTS
4931 A-1 South Mingo / Tulsa, Oklahoma / 74146

send me an InfiniCap sample so I can observe the effect, then I will be happy to be "enlightened."

Mr. Moncrieff further claimed that a million-to-one inductance variation through various paths in a cap "could smear music all the way down to 2Hz," assuming a self-resonant

frequency of 2MHz typical for "ordinary" caps around 1 μ F.

Now, he states that delay is proportional to L, but this is only true in an L-R (1st-order) circuit. But a wound capacitor is primarily a distributed L-C circuit, with very low resistance. The delay in an L-C network varies as \sqrt{L} , not L. So the 2MHz resonance with the assumed million-to-one inductance variation would have a possible effect only down to 2kHz, not 2Hz.

Let's look at some physics. The length in a wound cap is around 100', which has an electrical delay of 100ns (one wavelength at 10MHz), while 2Hz has an (electrical) wavelength of 93,000 miles! For a 100' maximum path length to influence 2Hz is analogous to hearing a 1/2-second echo from any acoustic structure whose maximum dimension is 0.0014'!

Sure, one could imagine 560' of one-millionth-inch diameter tubing crammed into a dust particle, giving a 1/2-second acoustic delay. But the laws of physics have something to say about energy—how much of that echo would you hear (with 1000 to 1,000,000dB of loss in the tubing)?

Since my first letter, I have measured some components (Fig. 1). For example, I tested a relatively "ordinary" capacitor—a Siemens (I think, from its logo, although what I had ordered was a Chateauxoux) part #PB1000MKP-FC 10 μ F polypropylene. The self-resonant frequency was 131kHz, the series inductance 148nH, and the series resistance 0.0175 Ω . Although the resonance was lower than the 2MHz I mentioned (appropriate for smaller caps), the square-wave response, with either high- or low-pass configuration with a resistor, was as perfect

an exponential decay as you could hope to see on the scope over the full audio range, with no variety of distorted waveforms.

A speaker I recently designed, using these caps, sounds excellent, as clear as the midrange alone with no crossover. Note that the inductance of that cap, 148nH, is only about that of a 1' speaker cable. This is because even though the cap's wound length may be 100', the two plates are so close that their magnetic induction nearly cancels, as in any good transmission line.

I also measured a "regular" wire-wound, sand-cast 3.3 Ω 25W resistor, a Colher CW 25E (\$0.60). Its inductance was 24nH, causing a 20kHz phaseshift of 0.05°. The impedance rose by 1dB at 11MHz. Now, in the catalog with this resistor is also a "noninductive" unit, for \$1.80. Those who can hear above 11MHz should use this one! (Sorry, I couldn't "resist" that!)

By the way, how is it so easy to hear the

**Exclusive
Distributor of
Acoustic Research
&
NHT Parts**

ARNHT

Complete in-house service:
We can test and "bring back to life"
AR and NHT speakers and equipment
using original components.



800-225-9847 FAX: 508-478-9816
17A Airport Drive
Hopedale, MA 01746

Reader Service #55

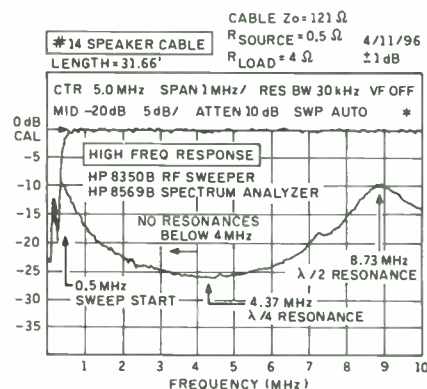
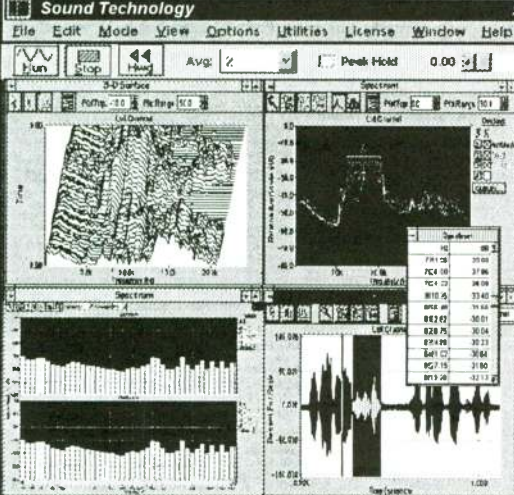

FIGURE 1: Reader Colin's component measurements.

Sound Technology **Spectra Series PC-Based SoftTest**

File Edit Mode View Options Utilities License Window Help

Avg: 2 Peak Hold: 0.00 0.00



Transform Your PC Into A Powerful Spectral Measurement System

Sound Technology, Inc. leader in test & measurement for the past twenty-seven years is pleased to introduce the next generation in Windows-based data acquisition and dynamic testing.

Spectra SoftTest - easy to use, fast, advanced, real-time Windows interface; Spectra was designed for you! Our new 32-bit modular architecture runs 200% faster than 16-bit programs and allows add-on options and future enhancements to be added...

Equip yourself with our latest SoftTest to meet all your testing requirements. To test drive a fully functional version, download a copy from our BBS, visit our Web Site or call one of our Sales Engineers today to find out how our revolutionary Spectra Series can help you solve problems faster and increase your productivity

• SpectraRTA v1.32 • SpectraPRO v3.32
• SpectraPLUS v3.16 • SpectraLAB v4.32

Affordable Data Acquisition from \$395 to \$4995

Stopped Real Time 44100 Hz, 16 bit, Stereo FFT: 65536 pts Blackman



SOUND TECHNOLOGY
Instrumentation & Automation
1400 Dell Avenue Campbell, CA 95008
FAX: 408-378-6847 BBS: 360-779-6846

Call Now To Order 1-800-401-3472

Web: soundtechnology.com Email: info@soundtechnology.com



Reader Service #20

"astounding" improvement of a cap when even the best recordings are made through microphone and other electronics, most of which probably don't have "audiophile" capacitors?

I don't mean to belittle quality. As an engineer and an avid musical-reproduction researcher, I certainly appreciate the admirable pursuit of perfection in Mr. Moncrieff's capacitors and other fine components. But regarding the astrophysical claims made in ads, would some non-market-vested entity with audio wisdom please conduct careful double-blind scientific comparisons, using ruthlessly perceptive and politically incorrect listeners, and publish the results?

Perhaps if *Consumer Reports* hired some audio engineers, the Boston Symphony, and a few Tibetan Buddhist monks who can hear the sound of one capacitor plate charging....

Dennis Colin
Barnstead, NH

J. Peter Moncrieff responds:

Two facts are indisputable. InfiniCap's design is different from other capacitors, and so is its sound (as confirmed by numerous independent evaluators). As a research scientist, I believe in cause and effect, not mysticism. Thus, the correct explanation for InfiniCap's different sound has to be its different design.

Most engineers are also open-minded scientists, but Mr. Colin's comments remind me of the letters one sees in other magazines, where a vociferous minority of engineers argue that different cables with the same LCR can't possibly sound different, that

amplifiers with the same frequency response can't possibly sound different, or that we can't possibly hear differences when employing a signal that's already been corrupted by miles of poor cables, poor capacitors, phase rotations, and so on.

These engineers were taught a limited set

of rules, which only partially describe a limited set of phenomena. From this circumscribed basis, they argue a priori about what can't exist in the real world. That's a perversion of science and the scientific method that should have disappeared with the church elders telling Galileo what couldn't

SPEAKER CITY, U.S.A.

PROUD TO DISTRIBUTE
EXCLUSIVELY
in Southern California

vifa

excellence from Denmark

OTHER HIGH END LINES INCLUDE:

SCAN-SPEAK

FOCAL
technologie d'avant-garde



DYNAUDIO®

LA PASSION DU HAUT-PARLEUR
AUDAX



1996 Catalog Now Available

Call today
to receive your copy

115 S. Victory Blvd., Burbank CA 91502
(818) 846-9921 FAX (818) 846-1009

Reader Service #27

FOCAL

AUDAX

AEON

SPEAKERS

QUALITY DRIVERS & MORE

ERSE
ELECTRONICS

ACCUTON

etc.

ORCA CONNECTORS

**We Offer A Complete Line Of Kits
Also Specializing In Speaker Repair**

2730 W Thomas Rd.
Phoenix, AZ 85017
Phone (602) 272-6696

Request a **FREE** catalog

FAX (602) 272-8633

(Mntn Std Time)
10:00 AM-7:00 PM Weekdays
10:00 AM-5:00 PM Saturdays

Reader Service #71

Speaker Builder 7/96 **53**

DEFLEX[®]
SPECTRA **acoustic**
Dynamics **PANELS**

The simplest and most cost effective way to upgrade your existing system

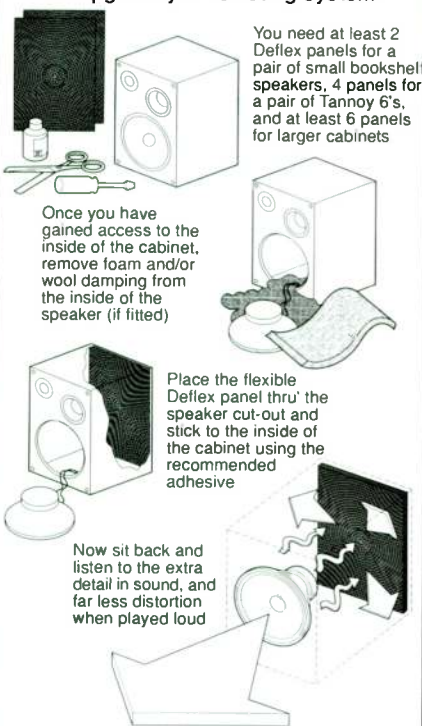

You need at least 2 Deflex panels for a pair of small bookshelf speakers, 4 panels for a pair of Tannoy 6's, and at least 6 panels for larger cabinets

Once you have gained access to the inside of the cabinet, remove foam and/or wool damping from the inside of the speaker (if fitted)

Place the flexible Deflex panel thru' the speaker cut-out and stick to the inside of the cabinet using the recommended adhesive

Now sit back and listen to the extra detail in sound, and far less distortion when played loud

What the experts have to say...

"...a marked improvement was obvious from the first few bars of REM's *Automatic for the people* album..."
Hi-Fi News & Record Review - March 1994

"...Deflex panels seemed to give greater tightness and control, improved internal clarity, and pitch definition - all without deadening the sound in any way..."
Audiophile - January 1994

"...the result was sharper imaging, wider dynamics and a more natural sound..."

CHOICE VERDICT
 Sound Quality
 Value for money
Hi-Fi Choice - January 1994

"...But one thing for sure - the Deflex panels are no gimmick. They work..."
Audio Video - November 1994

Some Of Our Other Products:

- *MIT MultiCaps... Better selection and the best prices anywhere!
- *InfiniCap, Solen, SCR/AEON, Rel-Cap, etc., premium grade film capacitors.
- *Kimber, Cardas, MIT, XLO, Acrotec, ultra high performance chassis wires.
- *Non-inductive wirewound and power resistors from Mills, Caddock, others
- *SOLO Copper Foil Air Core Inductors for no-compromise crossover designs.
- *Cardas, Edison Price, Vampire, XLO, binding posts, banana plugs, etc.

Send for **FREE** catalog today!

MICHAEL PERCY AUDIO
 P.O. Box 526
 Inverness, CA 94937
 (415) 669-7181 Fax (415) 669-7558

Reader Service #21

possibly be. There are more things in heaven and earth than are dreamt of in these engineers' philosophy, or in their limited set of engineering rules.

A research scientist openly accepts the world as it really is, and tries to explain it. New theories may be needed to explain empirical evidence. We don't use old theories to argue a priori that real empirical evidence can't exist. I (and other research scientists in audio) routinely evaluate audible differences and what causes them. We have discovered sonically significant factors and phenomena that would make these engineers' hair curl.

A scientist's job is to learn by opening new paths in new directions. Maybe our training schools are to blame for teaching engineering rules as if they were horse's blinders—so some engineers blindly follow the old straight and narrow path, while zealously refuting the existence of new real-world phenomena all around them.

In his zeal, Mr. Colin even repeats in his second letter the same principal blunder I pointed out in his first letter—conflating two types of delay. He bases his argument on the propagation delay of a 2Hz wavelength, which he then paints as absurd. But propagation-delay smear in a conventional capacitor is only 1000:1, not 1,000,000:1—as pointed out in our ad and in my response to Mr. Colin's first letter (so 2Hz is an irrelevant straw man).

I'm happy to debate someone who's open minded, rational, and who listens and learns. But I wouldn't even hire as an engineering assistant someone who repeats the same principal blunder, or who sets up phony straw men to sarcastically knock down.

Mr. Colin and I have an interesting disagreement about the other kind of delay, caused by inductance smear, which is 1,000,000:1 in a conventional capacitor. He assumes that any adverse effect of this inductance would arise only from altering the capacitor's internal self-resonant frequency (a \sqrt{L} phenomenon), while I assume that it could also arise from the higher inductance paths interacting with the external circuit to which the capacitor is connected (this effect is proportional to L , not \sqrt{L}).

We each could make a case, depending on the circuit application of the capacitor. But Mr. Colin overlooks the fact that, even if I were to grant him this point completely, we'd still be looking at conventional capacitors smearing music above 2kHz (instead of above 2Hz), and there's plenty of music above 2kHz, including the spectral

region where the ear is most sensitive.

Mr. Colin's best point is a challenge to measure the phenomenon of signal time smearing, to prove the nexus between InfiniCap's different design and its different sound, and to prove that this nexus is related to time smearing of a signal. As most readers know, Mr. Colin's sine-wave sweep LCR/Z capacitor test is irrelevant to measuring such time smear, so his a priori speculations that this phenomenon can't exist or can't be heard are likewise irrelevant.

Mr. Colin's test is irrelevant because only a single, simple sine wave is input at any one time, because the output is measured as an average amplitude over time, and because the output at any one instant is the sum of all the different paths through the capacitor arriving at that instant. Thus, this measurement can't see the time-smear effects of the different paths, it can't evaluate time-smearing effects upon a complex signal, and it can't observe instantaneous amplitude (so it can't even see time smear).

But there is a test that is relevant: take a snapshot of real music. Music provides a complex signal input, and the instantaneous snapshot can observe time-smearing phenomena. Real music is also the only test signal that really matters, for we use our capacitors to listen to music, not sine waves.

If the scope shows the same kind of time-smearing differences that are predictable from InfiniCap's different design, and the same kind of time-smearing differences that independent evaluators hear, then we as research scientists have a pretty ironclad case against any old-fashioned engineers who still say that the earth can't revolve around the sun.

We know that a trumpet's sound is very revealing of sonic differences in audio. This trumpet's waveform consists of positive spikes, each about 75µs wide. Within the overall waveform of each spike, there are numerous little peaks and valleys. These details give the trumpet sound its brassy texture; they make it sound real.

The left waveform (Fig. 2) is the original trumpet waveform, measured through a straight wire from an M&K RealTime CD,

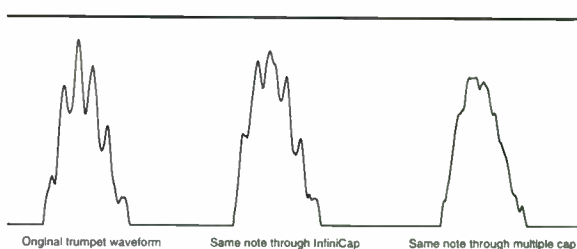

FIGURE 2: Waveform of a trumpet note (left). The same note measured through InfiniCap (center) and through a multiple capacitor (right).

on a 1MHz 16-bit sampling scope. Notice all the little peaks and valleys that make the trumpet sound real.

The center waveform is precisely the same instant of trumpet note, measured through InfiniCap. Notice that every one of the little peaks and valleys is still represented, and in

reasonable approximation to the original. The brassy texture of the trumpet is preserved and transparently revealed, so the music sounds real.

The right waveform is precisely the same instant of trumpet note, measured through a multiple capacitor with ten coaxial sections (which is hypothetically better than a conventional capacitor with only one section). Notice that the subtle musical information represented by all those little peaks and valleys has been virtually wiped out. Some energy from each little peak has been delayed and smeared in time, diminishing that peak and filling in the little valley following. So the music signal has been time-smeared into an averaged waveform. This trumpet waveform has lost the subtle texture that makes it sound real.

Bi-amping???

Use the XVR-1 Platform.

- High resolution, musically accurate.
- 6, 12, 18dB/octave HP and LP filters.
- Bass EQ stage for subsonic filtering and sixth-order bass reflex systems.
- 1% MF resistors and PPN capacitors.
- Large regulated lo-ESR power supply.
- 10MHz. Bipolar/JFET gain stages with 25 V/uS slew rate and 0.0006% THD.
- Passive first-order High Pass option.
- Precise Compact Electronic Crossover.

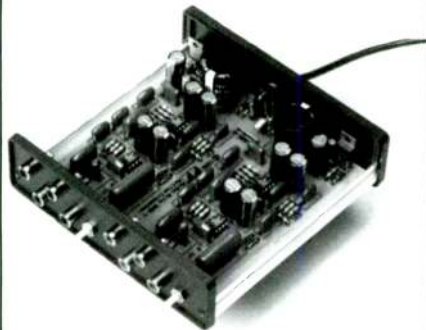

Audio Arts

RD 2 Box 3502
Wernersville PA 19565
610.693-6740
audioarts@prodigy.com

Reader Service #47

AND, MOREOVER...

Referencing Dennis Colin's letter, and J. Peter Moncrieff's response ("Mailbox," SB 2/96, p. 51), I would also like to hear a credible explanation for the InfiniCap ads. These very ads are what I use as an example for what gives the high end a bad name.

The ad claims that small delays in "ordinary" capacitors are sonically significant. Dennis Colin correctly points out that these delays are at least 100 times smaller than those of conventional loudspeakers. In fact, the difference between the high-frequency phase shift of two otherwise-excellent loudspeakers is often 100 times that introduced by even the worst capacitors.

Mr. Moncrieff's argument about the "lagging waveforms corrupting the main (earli-

est) version" is nonsense. His idea is that a conventional capacitor divides the signal into many copies, and recombines them after delaying each copy by different amounts. This would be a problem if the delays differed by, say, -180°; but, as Mr. Colin notes, this application deals with delays on the

COOL SYSTEM IDEAS FROM DRIVER DESIGN

A tight little 6-liter vented minimonitor with the V5/12R 5-1/4" midbass plus your favorite 90-dB tweeter! Xover 3.0-3.5 KHz

A sweet but tough 10-liter sealed-box surround/satellite with the V6/20 6-1/2" midbass and your favorite 89 dB tweeter! Xover 2.5-3.0 KHz

A high-powered compact 96-dB stage cluster with four V6/20s and a Peerless 100HT horn tweeter! Xover 3.0 KHz

THERE'S SO MUCH YOU CAN BUILD WITH DRIVER DESIGN SPEAKER COMPONENTS! JUST CALL AND ASK US HOW!

Free applications assistance for your design ideas using Driver Design components

Driver Design
The American Alternative

Phone: 510-370-1941
E-mail: DDL111@AOL.COM

Reader Service #42

Technologie

MDB

Affordable Excellence from Canada
L'excellence Abordable du Canada

Now featuring the new FOCAL Hi-Fi and Audio-visual kits, with three compact speaker kit models and a center channel plus four brand-new column speakers! Advanced technology including dual voice-coil drivers, sandwich Kevlar and Polyglass cones, flat ribbon voice coils, concave dome tweeters with phase plugs, tioxid domes, Axon capacitors, high-quality inductors, and more!

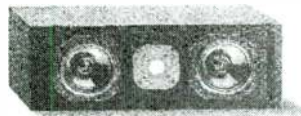

Technologie MDB

Recently relocated at: 40 Marsolet, St. Constant, Québec J5A 1T7 Phone (514) 891-6265 Fax (514) 635-7526

Reader Service #18

Speaker Builder 7/96 55

order of 0.6° at 20kHz. Combining a 0.6° phase-shift signal with a “wildly different” one, having 0° phase shift, will not corrupt the signal by any significant amount.

Mr. Moncrieff claims that his customers can hear significant benefits from substituting InfiniCaps, which is what he calls “hard

empirical evidence.” It certainly is possible that the InfiniCaps’ construction produces audible benefits. He fails, however, to address Mr. Colin’s complaint against the advertisement: how can the delay caused by a capacitor be audibly significant when the delays already present in the audio chain—comprising microphone to recording medium, to loudspeaker, to ear—are much more so?

Other advertisements may be equally misleading, but the InfiniCap ads are especially onerous. They use such ambiguous and emotional phrases as “smears music by a factor of 1,000,000:1.” I know where the 1,000,000:1 figure originates, but what does it mean to “smear music?”

Ralph Gonzalez
<gonzalez@crab.rutgers.edu>

J. Peter Moncrieff responds:

My previous response to Dennis Colin’s second letter generally suffices to address Ralph Gonzalez’s concerns here. It’s worth noting that Mr. Gonzalez, like Mr. Colin, confines his “it’s a small problem” critique to only one kind of delay, propagation delay. But our ad prominently states that inductance-delay smear is a worse problem than this propagation-delay smear.

Indeed, the various length propagation paths shown in our first diagram were conceived primarily as a pedagogical stepping stone. The reader could then visualize, using our second diagram, how different length paths have drastically disparate inductances, constituting a worse problem. Similarly, the sentence “this time smears your music, so it sounds...” was originally

in the text which described the second and worse problem, but was moved to the first section to help readers grasp the concept of time smear, aided by the disparate paths shown in their simple linear form instead of their convoluted three-dimensional form.

Colin and Gonzalez ask for the dismissal of an entire advertisement based on the charge that it calls propagation delay a small problem. That’s neither scientific nor fair, since the ad itself states that it is the lesser problem.

Ironically, Mr. Gonzalez—unlike Mr. Colin—says that he understands the derivation and concept of the 1,000,000:1 ratio, among disparate inductances and various paths through a conventional capacitor. Why does Mr. Gonzalez limit his critique to only propagation delay, the lesser problem? Surely, he must recognize the importance of the worse problem discussed in our ad: some paths, with a million times higher inductance, output a version of the music signal with a million times slower rise time than the version output by the shortest paths. If that isn’t worthy of being called music smearing, what is?

STICKY SITUATION

I need to clean some speakers. I think soda spilled on the speakers and one of them seems stuck. The cone moves, but very slowly—as though there is sugar around it. Is there anything that I can do?

James Banfield
banfield@mainlink.net

Perhaps Martha Stewart is reading this and will offer a reply.—Eds.

PREMIUM CROSSOVER NETWORKS HIGH POWER 12DB PASSIVE

YOU’VE DESIGNED BUILT AND LOADED
YOUR ENCLOSURES
WITH HI QUALITY SPEAKERS.
YOU HAVEN’T SPARED ANY EXPENSE,
YOU’VE SPENT TIME AND MONEY
LET CROSSTECH AUDIO’S
PREMIUM HI POWERED
CROSSOVER NETWORKS
FINISH OFF THE JOB
DO IT YOUR WAY. THE RIGHT WAY!
CUSTOM FREQUENCIES NOT A PROBLEM

CROSSTECH AUDIO INC.

30 Francine Lane Staten Island N.Y. 10314
Phone (718) 370-8399 Fax (718) 370-8297

Reader Service #85

The Speaker Design Toolbox®

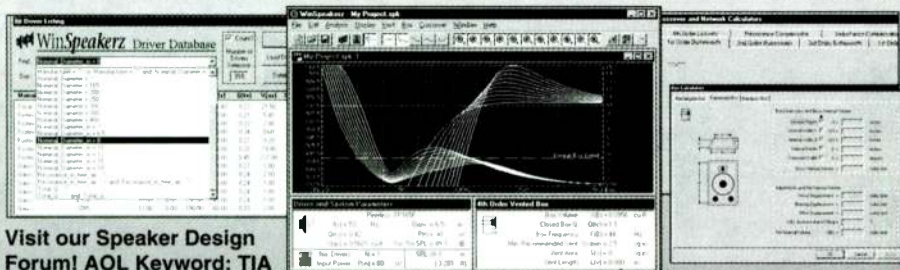
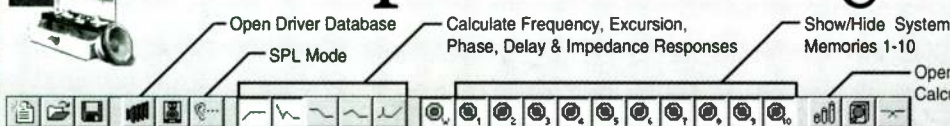

Visit our Speaker Design Forum! AOL Keyword: TIA

True Image Audio® 349 WEST FELICITA AVE., SUITE 122, ESCONDIDO, CA 92025 • email: TIA Sharon@aol.com
• Phone: 1-800-621-4411 • Fax & INTL Inquiries: 619-480-8961



Speaker Designers!
Visit Our Web Site For More Information on
The Speaker Design Toolbox®!
Download Your Demo Today!

<http://members.aol.com/spkrtools>

only \$199!
30 Day MBG



ACCUTON by THIEL & PARTNER

Pure ceramic concave dome drive units, from super tweeter to midbass

The new line of ACCUTON is a true breakthrough in high technology applied to speakers. For the first time ever you can build an all ceramic system, from tweeter to low frequency! All ACCUTON diaphragms are made of pure Al₂O₃ in the alpha crystal lattice (corundum) through a unique patented process. This ultra hard material provides high internal sound velocity and pure piston behavior, which transcribe into very low distortion and virtually no coloration. The ACCUTON ceramic units are among the purest transducers ever made, at any price. For a detailed catalog with specs and curves, as well as system designs, please contact ORCA. For supply, contact our stocking distributors.

ORCA Design & Manufacturing Corp.: 1531 Lookout Drive, Agoura, CA 91301. TEL (818) 707 1629 FAX (818) 991 3072
A & S Speakers, California. TEL (510) 685 6400 FAX (510) 603 2724 Speakers ETC, Arizona. TEL (602) 272 6696 FAX (602) 272 8633. ZALYTRON, New York. TEL (516) 747 3515 FAX (516) 294 1943. MDB Technologie, Canada. TEL (514) 891 6265 FAX (514) 635 7526. W.A.R., Australia. TEL 61 9 445 2422 FAX 61 9 445 2579.

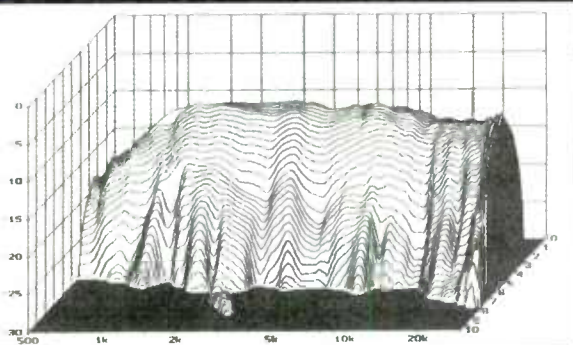

C2-12 Super tweeter US\$ 180.00

Efficient (close to 90 dB) 1 in. concave dome high frequency unit. Liquid cooled. Very wide band (2.5 to 30 KHz). Low Fs (700 Hz). It can be used in 2 or 3-way designs with a large variety of crossovers. One of the very finest tweeters available today. This is where the super hard ceramic dome shines the most: the break up mode happens well above the audible range.

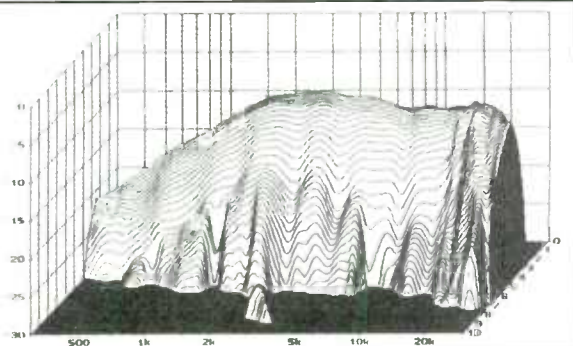

C2-23 Tweeter US\$ 220.00

Efficient (close to 90 dB) 1-3/16 in. concave dome tweeter. Liquid cooled. Wide band (1.7 to 23 KHz). Very low Fs (350 Hz). The ideal tweeter for 2-way designs. The ceramic dome keeps the upper resonance still above the audible range, and at the same time the tweeter can meet just about any midrange or midbass unit where it best performs

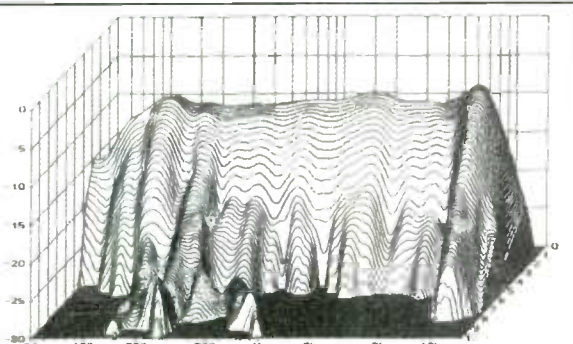

C2 79/6 Midrange US\$ 260.00

Beautiful 3 1/2 in concave dome midrange. Liquid dampened. Extremely wide band (200 to 6 KHz). Very low Fs (96 Hz). This outstanding unit covers perfectly the human voice (200 to 2000 Hz). Near perfect piston functioning warrants very low distortion and virtually no coloration over the whole spectrum. Designed to work well in a small tubular sub-enclosure.

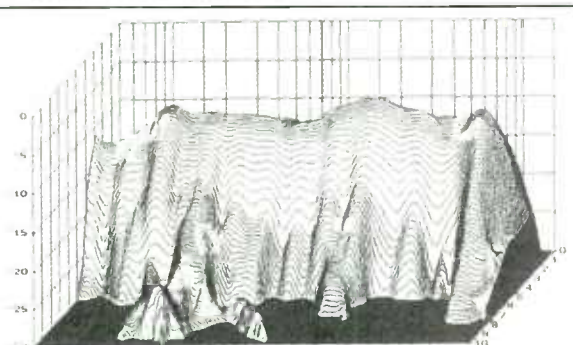

C2-88 Midbass US\$ 270.00

The first true midbass using a ceramic concave dome diaphragm. High-loss rubber surround. Wide band (40 Hz to 4 KHz). This 3-1/2 in. is an amazing bass unit and at the same time a remarkable midrange, working as a pure piston over its range. This will give the designer an extraordinary degree of freedom. Ideally suited for D'Appolito configurations.

Acoustasheet® Damping Material



TYPICAL TRANSMISSION LOSS

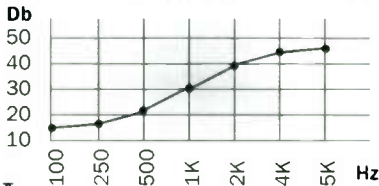

Improve the imaging and clarity of your speakers by reducing cabinet resonance and baffle diffraction. Transform the acoustics of your listening room. Make your car whisper quiet. Goodyear Acoustasheet will do all this for only \$2.48 per sq. ft. (10 min.) plus \$5 handling. It's a 4' wide, 1lb. per sq. ft. loaded vinyl with 1/4" acoustic foam lamination.

GASOLINE ALLEY, L.L.C.
1700 East Iron, Salina, KS 67401
1.800.326.8372



Reader Service #81

ELECTRONIC COMPONENTS

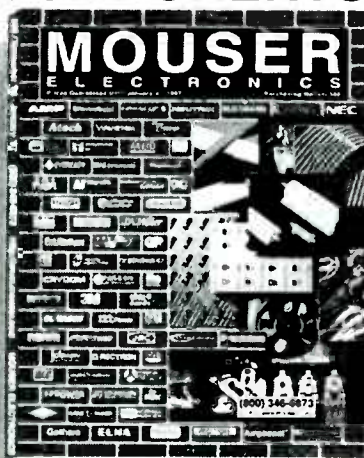

Call for your **FREE 332**
page catalog **TODAY!**

- 68,138 Products
- 128 Manufacturers
- All Orders Ship Same Day
- No Minimum Order

800-992-9943 FAX: 817-483-0931
<http://www.mouser.com> sales@mouser.com

958 North Main St., Mansfield, TX 76063

Reader Service #30

HELP WANTED

[We encourage readers who may have information on the following topics to correspond directly with these letter-writers.—Eds.]

I have a pair of Infinity Quantum 5s. I like the speakers, but have had them for a long time. How can I upgrade the sound? Can the components of the crossover be replaced? What about tri-amping? Should I say good-bye to them and build replacements? If so, could you recommend a design; perhaps one from *SB*?

Steve Tatum
784 Dexter Drive
Broomfield, CO 80020

I want to rebuild a pair of JBL Century K100 speakers, a consumer version of the 4311 studio monitor, with serial numbers 115665A and 115666A and manufactured in approximately 1973. I would rewire the speakers, eliminating the presence and brilliance controls from the circuit; install new binding posts; and replace or update the crossover network. Does anyone have any advice on how to do it?

Stephen M. Middleton
PO Box 1511
Foley, AL 36536
(334) 971-1111, FAX (334) 970-1116

9Hz in a Barrel
from page 10

ten to. Reference Recordings' "Pomp & Pipes" RR-58CD is spectacular, but most of the music is not to my taste. Many Telarc recordings are also spectacular. A good sampling is "Organ Blasters" CD80277.

If you want an inexpensive and easy-to-build subwoofer that really extends the frequency response of your system to sub-audible frequencies, this design will satisfy your needs.

References

1. D.B. Keele, "Low-Frequency Loudspeaker Assessment by Nearfield Sound-Pressure Measurement," *Loudspeaker Anthology, Vol. 1*, JAES 1980.

SOURCES

- | | |
|---------------------------------|--|
| Speaker | Radio Shack 40-1301 |
| 55 gal. drum | Northern Hydraulics
PO Box 1499, Burnsville, MN 55337
(800) 533-5545 |
| BassBox 5.1 | Harris Technologies
PO Box 622, Edwardsburg, MI 49112
(616) 641-5924 |
| Quick Box and Bandpass Boxmodel | Old Colony Sound Lab
PO Box 243, Peterborough, NH 03458
(603) 924-6371 |

LIQUIDATION!

TW60A TWEETERS...SOLD OUT!...THANK YOU!
SILVER LEAD WIRE...SOLD OUT!...THANK YOU!

GRILLES:

- | | |
|---|--------|
| 23" x 13 1/8" fiberboard foam covered, with 12" opening | \$1.00 |
| 25" x 12 7/8" molded plastic frame, brown grille cloth | \$1.00 |
| 26 1/4" x 15" molded plastic frame, brown grille cloth | \$1.00 |
| 6.5" dia. black wire mesh grilles w/mounting bracket | \$1.00 |
| 6.0" dia. black wire mesh grilles w/mounting bracket | \$1.00 |
| 5.0" dia. black wire mesh grilles w/mounting bracket | \$1.00 |

CROSSEVERS:

- | | | |
|-------|-----------------|---------|
| C X-1 | 2 Way Crossover | \$9.00 |
| CX-18 | 3 Way Crossover | \$18.00 |
| CX-24 | 2 Way Crossover | \$15.00 |

Cones, voice coils, spiders, dust caps, whizzer cones, surrounds, gaskets, ferrite magnets (demagnetized), adhesives, crossovers, inductors, L-pads, magnet wire, horns, drivers, speakers 6" thru 15", tweeters, cabinet handles/corners, wire mesh grilles.

Complete list available.

International Sales & Engineering

P.O. Box 750, Hwy 77 & FM 511
Olmito, TX 78575-0750
PH: 210-350-5555
FAX: 210-350-5574

WE GET RID OF WHAT YOU DON'T WANT!

D.I.Y. NEW FOAM KITS

SPEAKER PLACE

1-800-NEW-FOAM
1-800-362-6624

Speaker Repair & Replacement Parts
Nationwide Service Since 1979

D.I.Y. NEW FOAM KITS

Please have your measurements/size info ready when you call.

REFOAM-RECONE
Woofers · Mid Ranges
Tweeters
Crossovers · Grill Cloth
Horns · Voice Coils
Books & Accessories

No Catalog Available

VISA MasterCard AMEX Discover
3047 West Henrietta Road • Rochester, NY 14623
1-716-427-8136

email **NEWFOAM@msn.com**

Reader Service #84

Classifieds

TRADE

STATE-OF-THE-ART PASSIVE CROSS-OVERS featuring Hovland MudiCaps. Software available, free design guide. **ALLPASS TECHNOLOGIES, INC.**, 2844 Charmont Dr., Apopka, FL 32703-5972, (407) 786-0623.

ELECTROSTATIC

KITS PARTS TRADE SECRETS
save \$\$\$ building, repairing, modifying ESLs
CATALOG/START-UP MANUAL—\$5.00
DAVID LUCAS
924 HULTON ST. OAKMONT, PA 15139

THE BEST MUSIC YOU MAY NEVER HEAR. Free catalog. **CREATIVE MUSICIANS COALITION**, Dept. GBM, 1024 W. Wilcox Ave., Peoria, IL 61604, (800) 882-4262.

PAIR DYNACO MKIII, absolutely mint condition, \$395; JVC Stereo Integrated Amp A-X400, excellent condition, \$190; manuals included. Place orders and make payments to: **GÖSTA BERLING**, Box 132, Nakusp, BC V0G 1R0, CANADA, phone/FAX (604) 265-3175.

Audio and industrial parts for the D-I-Y or equipment builder.

Some of the brands Handmade stocks:

RelCap MultiCap, Cardas, Kimber, Solo inductors, Solen, Golden Dragon, Nichicon Muse, Edison-Price, Hammond, Belden, Allen-Bradley, Caddock, low cost, very high quality silver wire and many others.

For a copy of catalog 1996-1997, send \$2.00 (US) or 5 IRC's (from your Post Office) to:

Handmade Electronics

P.O. Box 9114

Allentown, PA 18105-9114 USA

ELECTROSTATIC electronics, transformers, Mylar®, information. From author **ROGER SANDERS**, (505) 759-3822.

NEW!! SILVER SONIC digital interconnect cables are now available, 75Ω coax & 110Ω AES/EBU balanced; state-of-the-art performance, affordable prices. For information, contact **D.H. Labs**, PO Box 31598, Palm Beach Gardens, FL 33420-1598, phone/FAX (561) 625-8998.

FOR SALE

Pair Electro-Voice EVM-15L woofers, new, \$165. Darren, (561) 625-8998.

Two Ongaku Audio Note power transformers; new, never been used; \$175 each, asking \$125. Two Audio Note chokes 10H 200mA, new \$65, asking \$40 each. Ashby, (954) 723-5225.

Heathkit IO-4540, 5MHz single-trace oscilloscope, asking \$100 shipped. I would like to trade my Dynaco ST-70 with Van Alstine driver modification for a Bryston power amp. Greg Nawrocki, 21 Indiana St., Kitchener, ON N2H 2A4, CANADA, (519) 745-1579, gnawrock@ionline.net.

POLYPROPYLENE CAPS

4 MFD 200v REL-CAP	\$ 70¢/each
6 MFD 200v REL-CAP	\$1.25/each
8 MFD 200v ULTRA-CAP	\$1.50/each

Send SASE for list of other capacitors available.

APEX Jr.

3045 Orange, La Crescenta, CA 91214
(818) 248-0416 • (818) 248-0490 FAX

Bitwise Music Systems D/A, \$995; Reference Line 1 MKII remote passive preamp, mint condition, \$850; set of three aluminum cones, 1.5" diameter x 1.5" tall, bolts, \$19; pair JVC HSW1101-01A ribbon-leaf tweeters, enclosures, crossovers, \$50; pair Techniques EAS-10TH 400A ribbon-leaf tweeters, enclosures, crossovers, \$95. Steve, (203) 397-3888 in Connecticut.

Liberty Instruments' Audiosuite v1.16, complete systems, ready to install and run. Includes Echo DSP soundcard, calibrated microphone, microphone preamp, all cables and probes, manual and software, mint condition, hardly used, six months old, \$475. Upgradeable to v2.0 for \$100. Henry Lugg, (510) 837-7817.

Seeking a good home: pair Peerless 1727 woofers, \$100; pair Peerless 1858 woofers, \$90; pair Focal 7N412 DBs, \$50, (two pair with curves); Adcom 2535 (4 x 60W or 2 x 60W plus 1 x 200W, level controls); \$360, all unused and in mint condition. Also, N.E.W. A-20.1 Class A amp, \$450. Duke, (504) 486-7943.

HIGH END AUDIO

Equipment • Parts • Manuals

BUY-SELL-TRADE-REPAIR

Since 1979

HUGE Inventory, FREE list!

AUDIO CLASSICS, LTD.

8-5 M-F **607-865-7200**

Fax: 607-865-7222

E-mail: info@audioclassics.com

See our list at: www.audioclassics.com

PO Box 176SB, Walton, NY 13856

Two pair Music Posts, \$25; (R/L pairs) Audio Quest panel-mount RCA connectors, \$8; Noble pots, two 20k and one 25k, \$8 each; TI 486DX2-80 CPU, \$15; video capture card, \$45; VESA IDE cache controller card, \$20; VESA graphics accelerator card, \$20. Dan Patten, dpatten@dasengr.com, (801) 225-8577.

Pair JBL 2440 horn drivers (same as 375); pair JBL 2328 horn adaptors; pair Altec 291A drivers; pair Altec N-800-D crossovers; pair Altec 421 15" woofers, pair Altec 808-8B drivers; pair EAW horns, fit 802/808 drivers; pair large Community horns fit 2440/41; Van Alstine Model I rack-mount solid-state preamp. David, (914) 688-5024.

WANTED

Owner's manual for EICO Scope model 425, original or copy. Call Dave collect, (518) 399-3798.

Altec 838 or 820, Laguna, Carmel, or any other corner speaker; 604, 605, 601 coaxials. Tannoy Red or Gold monitors; Jensen CX-222, G-600, G-610; other corner and coaxial/triaxial speakers. Sonny, (405) 737-3312, FAX (405) 737-3355.

Photocopy of schematic/service manual of 3M-Minicom Division 6100A audio test set. Single partridge OTF UL2. Willie, Toronto, CANADA, (416) 251-3007.

WELBORNE LABS

200 PAGE CATALOG and DESIGN MANUAL OF HIGH QUALITY AUDIO KITS and SUPPLIES!!!
We've got Vacuum Tube and mosfet Amplifiers, Linestages Phonostages, Active Crossovers, Power Supplies, AC Line Conditioners and many other Audio Kits and Schematics

Parts and Supplies

Hovland MusiCaps, Kimber Kaps, MIT MultiCaps, Solen WIMA and Wonder InfiniCaps; Caddock, Holco, Mills and Resista resistors; Golden Dragon, NOS RAM Labs, Sovtek and Svetlana tubes, Cardas, DH Labs, Kimber Kable Neutrk, Vampire and WBT connectors and wire, Alps, Noble and stepped volume controls; Enclosures, Books and other Supplies for DIY'ers International Orders Welcome. For our Catalog and Manual, send \$12 (US/Canada) \$18 (International) or call (303) 470-6585, fax (303) 791-5783 or e-mail to: wlabs@ix.netcom.com with your Visa/Mastercard.

WELBORNE LABS

P.O. Box 260198, Littleton, CO 80126-0198
Visit our Website for more info <http://www.welborneilabs.com>

CLASSIFIED



INFORMATION

Four types of Classified Advertising are available in **Speaker Builder**:

FOR SALE: For readers to sell personal equipment or supplies.

WANTED: Help readers find equipment or services.

TRADE: For any business or private party selling equipment, supplies or services for profit.

CLUBS: Aid readers in starting a club or finding new members. Specific guidelines apply to *Club* advertising. Please write to the Ad Department for terms. Don't forget, include a #10 self-addressed stamped envelope.

PRICING

All advertising is \$1.50 per word, \$10 minimum per insertion. Deduct 5% for a 8x contract. Please indicate number of insertions. Payment **MUST** accompany ad. *No billing for word classified advertising.*

AD COPY

A word is any collection of letters or numbers with a space on either side. *No abbreviations*; please spell out all words. Count words, not letters. Ad copy should be clearly typed or printed. Illegible ads will be discarded.

SUBSCRIBERS

Receive *free For Sale and Wanted* ads, 50 word maximum, each additional word \$.20, \$10 minimum. For *Club* ads, follow instructions at the bottom of the Clubs listings. Please submit only one ad per category per issue.

Please include your name, address, and telephone number. If *TRADE* please indicate number of insertions on the ad. All free ads are run only once, and then discarded. *Ad questions, copy and copy changes cannot and will not be answered on the phone.* All correspondence must be in writing addressed to:

Speaker Builder
Classified Department
PO Box 494

Peterborough, NH 03458-0494

Ad Index

ADVERTISER	PAGE	ADVERTISER	PAGE
AB Tech Services	52	Orca	
ACI	47	Access	11
Acoustic Technology Int'l	5	Accuton	57
Allison Technology Corp.	37	Raven	25
Audio Arts	55	Parasound Products, Inc.	42
AudioWeb	23	Parts Express Int'l, Inc.	
Computer Business	45	Peak Instruments Woofer Tester	31
Crosstech Audio, Inc.	56	Audax/Parts Express Team	CV3
Driver Design Limited	55	Reliable Capacitor	4
Elektor Electronics	40	Solen Inc.	
Ferrofluidics Corporation	18	Crossover Components	15
Forgings Industrial Co.	26	Speaker Components	37
Gasoline Alley L.L.C.	58	Solo Electronics	39
Harris Technologies	50	Sound Technology, Inc.	52
Hi-Fi News/Record Review	38	Speakers, Etc.	53
Hovland Company	47	Speaker City	53
IAR-TRT	CV2	Speaker Works	51
Image Communications	30	Speaker Workshop	48
Int'l Sales & Engineering	58	Speaker Works Inc., The	19
Kimber Kable	22	TCH	17
Kustom Isolation Supports	60	Technologie MDB	55
LGT Technologies	6	TIFF Electronics Co.	10
LinearX Systems, Inc.	3	True Image Audio	56
Madisound		Vacuum State Electronics	49
Customer Appreciation Sale	27	Zalytron Industries Corp.	61
Electronic Crossovers	13		
Mahogany Sound	49	CLASSIFIEDS	
Markertek Video Supply	47	Apex Jr.	59
McFeely's	62	Audio Classics, Ltd.	59
MCM Electronics	24	David Lucas, Inc.	59
Meniscus	43	Handmade Electronics	59
Michael Percy Audio	54	Welborne Labs	60
Morel Acoustics USA	CV4		
Mouser Electronics	58	GOOD NEWS/NEW PRODUCTS	
New Foam	58	Atlantic Technology International	4
Newform Research, Inc.	51	Legacy Audio	4
Old Colony Sound Lab		Mission Electronics	4
LDC/Recipes	32	Parasound Products, Inc.	4
Speaker Software	33	True Image Audio	4

Kustom
Isolation
Supports



Kustom Isolation Supports, 73-63 Bell Blvd., Suite 3P, Bayside, NY 11364, Fax: 718-776-2139

ZALYTRON

Focus on Focal!

OPEN SEASON ON FOCAL FOR THE SPEAKER BUILDER BARGAIN HUNTER

FOCAL is pretty secretive about whom they supply with their famous drive units (and Kimon Bellas the FOCAL importer sounds like a locked bank vault when you ask him about it), but if you visit any high-end show, you see an awful lot of FOCAL drive units by many very respected speaker manufacturers. Well these high end OEMs, like any manufacturer on earth need to change models and change drivers. Sometimes only the paint of the frame changes, sometimes a little stiffer spider ... That is how you create very attractive obsolete product. When the French woke up from their traditional August siesta, we made an offer to FOCAL: ZALYTRON would take all these brand new OEM drives (with the usual warranty) they had on their shelves if they would sell it to us ... at an appropriate price. We would be hard pressed to print here that we made a killing, just see for yourself in the ZALYTRON tradition, we pass the benefit of our good deals directly to our customers. If this reads like the D.I.Y. dream list it simply is. If only these OEMs could keep changing models...

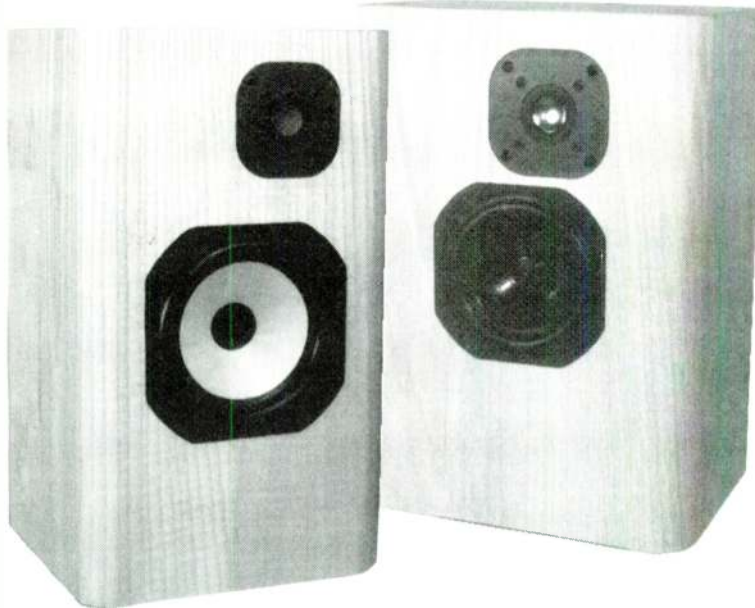

BLOWOUT PRICES ON FOCAL SPECIALS

ITEM	PIECES	PRICE	ITEM	PIECES	PRICE
T90TI.....	48	\$35.00	10K617H	34	\$139.00
T120TI02.....	96	50.00	10V617	20	110.00
T124TD	62	50.00	165 C Kit	50	135.00
T120ZLT	200	50.00	W21B.....	30	60.00
4C211	112	39.00	IF YOU WANT TO SPEND EVEN LESS, WE HAVE THESE BLOWOUTS		
4C212	100	39.00	SEAS P17RCY / 4 OHM		\$29.00
4C228G.....	24	45.00	SEAS CA17RCY.....		29.00
5NZLT	250	45.00	SEAS 382 1" Aluminum Tweeter		15.00
6C211S	198	39.00	AUDAX HT130FO		26.00
6C211S1	270	39.00	AUDAX HT130G6.....		20.00
6P211S	108	35.00	AUDAX HT170G2.....		21.00
7CZLT	300	45.00	AUDAX HT110GO Uncoated		15.00
AUDIOM 8/2	10	169.00	AUDAX HT130MO		15.00
8C012DBG	89	60.00	3.3 MFD MYLAR CAPS 250V.....		3/\$1
8K515	10	75.00			
8K511DB	8	80.00			
Audiom 10/2	10	169.00			

ZALYTRON INDUSTRIES CORP.

469 JERICHO TURNPIKE, MINEOLA, N.Y. 11501

TEL. (516) 747-3515

FAX (516) 294-1943

Our warehouse is open for pick-up 10AM to 6 PM daily, Saturday 10 AM to 5 PM
UPS orders shipped same day • Minimum order \$50.00

Call or Write for your Latest Catalog mailed FREE in USA. Canada \$5 P&H, Worldwide \$10 P&H

Tools, Tips & Techniques

MODIFYING VIFAS

Since they first came out, I have been using the Vifa "silk-dome" tweeters, especially the D27TG-35-06, for the cheaper speakers I build. I consider them a very good value. However, they definitely don't have the clarity of more expensive models, such as the Dynaudio Esotec, which I have also used in several sets of speakers. Specifically, the Vifas aren't as clear as the Esotecs at any

power level, and their sound "hardens up" much sooner as power levels increase.

MODIFYING THE VIFA

Even so, they are very good for the money, so I thought it might be worthwhile trying to modify them to see if I could at least narrow the gap. After trying a number of mods, I came up with one that is easy, simple, and quite effective.

A comparison of the Vifa with the Esotec shows that the most obvious physical difference is the structure that dissipates the backwave. The Esotec has a number of sophisticated design features to do this, but the Vifa does not (quite understandable at its price).

If you take the back off one of the Vifas, you find that the bore in the pole piece is empty, and the only measure taken to dissipate the back wave is a simple layer of felt in the back chamber. By contrast, the Esotec has a bore that is stuffed, along with a more sophisticated back-chamber shape.

I decided to see if adding stuffing to the Vifa would help its clarity. It did. Before-and-after SPL checks (I use a Mitey Mike) show that a couple of small peaks, which seem to be due to cavity resonance, almost vanish. Listening tests show a significant improvement in clarity, and less "hardening" at higher outputs. No, it's still not as good as an Esotec, but it's a lot closer.

THE PROCEDURE

I have modified about 20 tweeters now, at almost no cost, and have evolved the following simple procedure. (For those who worry about such things, yes, I'm sure it would void any warranty on the tweeters.) Just be careful to protect the dome while you're working on the tweeter. Beyond dome damage, though, I don't see how anything could easily go wrong.

Remove the back chamber, which is easiest to do by cutting into its plastic edge, just

against the magnet, with a hacksaw blade. That provides a space that lets you pry off the chamber (use a screwdriver blade—gently!). The chamber comes off fairly easily, and there is nothing delicate you might damage in the immediate area. Next, simply place the tweeter face down on a clean table top. Since the dome is recessed, this position actually protects it from damage.

Now stuff the pole-piece bore. I use polyester batting, contained in a fine tulle netting, which is very cheap at any fabric store. The actual amount of stuffing is not critical. I have tried a wide range of stuffing densities. If you make it very dense, the tweeter resonance drops, but there's no need to go that far. I now put in just enough stuffing so it will stay securely in place, using the following steps:

- Roll a plug of the polyester approximately 1" long, with a diameter larger than the bore, and center it in a patch of the netting about 3" square.
- Shape the netting around the polyester into a small cylinder. Gently insert the end of the cylinder that is closed by the netting into the bore until you feel it pressing against the tweeter dome. (It's not difficult. The dome is quite strong from that direction. If you watch the dome as you are doing it, you can see it move outward very slightly.)
- Pull the plug back about 1/8", then cut off any polyester that is still protruding from the bore. Leave the netting that protrudes, since it will act to stop the plug from moving, once the back is in place.
- Replace the back with a bit of glue to hold it in place (I use silicone seal).

That's it! I consider the mod very worthwhile, since it does make an easily audible difference for almost no cost.

Larry Van Wormer
Port Elgin, ON, Canada

Our Samples Are Better Than

FREE!

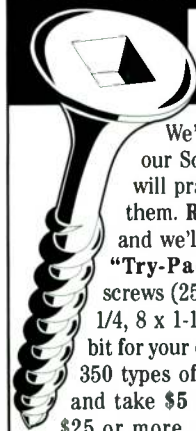

We're so sure you'll love our Square Drive Screws we will practically pay you to try them. Return this ad with \$5 and we'll send you our famous "Try-Pack" Sampler of 100 screws (25 each of #8 x 5/8, 8 x 1-1/4, 8 x 1-1/2 and 8 x 2), a driver bit for your drill, our catalog listing 350 types of Square Drive screws, and take \$5 off your first order of \$25 or more, or \$10 off your first order of \$50 or more! (Limited time offer. Available in USA only.)

"We tried a box of 1-3/4" #8 prelubricated flat heads with nibs from McFeely's, which quickly became our favorite fastener." Speaker-Enclosure Screws, Robert J. Spear and Alexander F. Thornhill, *Speaker Builder*, 2/94

© 1996 McFeely's All Rights Reserved

McFEELY'S
SQUARE DRIVE SCREWS

PO Box 11169 • Dept SB6F
Lynchburg • VA • 24506-1169

Reader Service #83

A WINNING TEAM

LA PASSION DU HAUT-PARLEUR

AUDAX

&

Parts Express™

HIGH DEFINITION AEROGEL DRIVERS



Parts Express carries over 50 different Audax products, **in stock and ready to ship!** Audax has more than sixty years experience in designing and producing high quality woofers. They make extensive use of very sophisticated loudspeaker software that measures the transducer through F.F.T analysis. This has helped them to develop a new cone material called High Definition Aerogel. These exciting drive units from Audax incorporate a new breakthrough in loudspeaker cone technology. The cone is made of a unique acrylic polymer gel with a blend of Kevlar and carbon fibers embedded into it. This results in an ultra light and extremely rigid cone that produces outstanding clarity, precise imaging and unequalled sonic definition. Developed for no compromise high end designs, these drivers feature a die cast Zamak chassis, venting under the spider for superior transient response, high compliance rubber suspension, edge-wound copper voice coil on a fiberglass reinforced Kapton former, phase plug, and gold plated terminals. The results of this technology, combined with careful subjective acoustical evaluation, are some of the finest bass/midrange units produced in the world today. Parts Express is proud to offer you these outstanding drivers. For more information on our entire line of Audax products, or to order your copy of our free catalog, call our sales staff toll free today.

FREE CATALOG
CALL TOLL FREE
1-800-338-0531

340 E. FIRST ST., DAYTON, OH 45402-1257
PHONE: 937-222-0173 ♦ FAX: 937-222-4644
WEB SITE: <http://www.parts-express.com>
E-MAIL ADDRESS: xpress@parts-express.com



Visit Our Website!

<http://www.parts-express.com>

- ◆ Play the *Audio/Electronics Trivia Contest*
- ◆ Get on the *Interactive Audio Talk Forum*
- ◆ Check out our *Closeout Bin*
- ◆ *Electronics Industry Search Engine*
(Add your own link)

Source
Code: SBM



High-Tech Audiophile Loudspeakers

For Further Information Please Contact:

morel
acoustics USA

414 Harvard Street
Brookline, MA 02146

Tel: (617) 277-6663

FAX: (617) 277-2415



Typical Double Magnet Woofer Cross Section