

Win An Edgarmhorn
See Sweepstakes, p. 55

HOW TO CHOOSE A GOOD CROSSOVER COIL

SIX: 1996

US \$7.00

CANADA \$8.00

Speaker Builder

THE LOUDSPEAKER JOURNAL

**BUILD THIS
EXTRAORDINARY
LOW-COST
THREE-WAY**

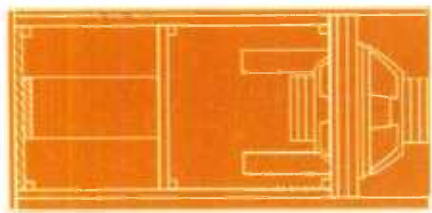
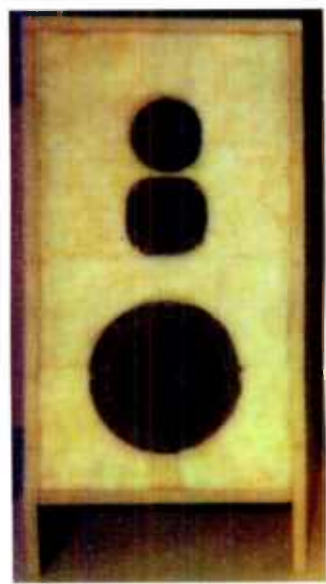

**A BIG 15"
SUBWOOFER**

**SHOULD WOOFERS
POINT DOWNWARD?**



**STROBOSCOPIC CHECKS
ON SPIDER ACTION**

CHEAP, ULTRA HIGH QUALITY SPEAKER CABLES



The 3 Best Capacitors for Your Speakers

Miracle of New SETI

Audio manufacturers report the new **SETI sounds better than expensive film-and-foil caps and oil-filled caps. Yet SETI costs far less** (pricing is competitive with metallized polypropylene).

SETI brings out music's **natural liquid beauty**, so recordings sound more like **real live music** (you hear the same sonic magic from single ended triode power amps). SETI™ (SET InfiniCap) actually sounds *better* (more musically natural) than the straight wire bypass reference!

Original InfiniCap

Since its debut last year, the original InfiniCap® has been acclaimed as the most accurate, revealing capacitor — far superior to 10 section multiple caps and even premium film-and-foil caps.

New InfiniCap Signature

They said it couldn't be done, so we did it — InfiniCap's unique technology (pats pend) in a new film-and-foil design. This monster is the absolute ultimate in capacitor sound, when only the very best will do.

Critics Judge InfiniCap...

- A high end speaker system manufacturer:
"InfiniCap does amazing things for our speaker! It's far better than all other capacitors. Compared to Hovland MusiCap, InfiniCap is more transparent, open, faster, and more dynamic, with better separation of instruments and their harmonics, better inner detail, better stereo imaging with a wider stage — and bass that's richer with more weight, yet also tighter, faster, and better defined."
- Another high end speaker system manufacturer:
"SETI surpasses MultiCap RTX and Hovland MusiCap. It gives us the **most music**, with the blackest background."
- A leading high end mfr of tube and solid state electronics:
"SETI gives us the **most realistic, natural music we've ever heard!** The difference compared to MultiCap is astounding, just amazing, night and day! SETI is the **biggest parts improvement we've ever heard!** It sounds so good that your reaction is emotional; we're giddy and swept away! SETI is fast and detailed but not hard, and it gets music's harmonic textures right. There's no sense of reproduced sound; it's just like hearing real live music."
- Another high end manufacturer of tube electronics:
"The only other cap even close to SETI is the Audio Note Copper Foil in Oil, at 8 times the price!"
- Doug Blackburn, engineer, audio writer (his article in Stereo-ophile satirized pseudo-physics in high end audio), and regular contributor to Positive Feedback and The Audiophile Network:
"I found a great sounding new cap — unbelievable sounding actually. I used to think [a highly regarded multiple section film and foil cap] sounded pretty good, but these InfiniCaps are unreal."

"I tried them in various locations in my equipment — power supply bypasses, in the audio signal path, etc. *Unreal* sound quality. These InfiniCaps make [the multiple section film and foil cap] sound **broken!** I'm **not kidding!** The difference is **very large.**"

- Prominent audio retailer Peter Litwack, Music by Design:
"In a high end preamp we replaced very expensive MultiCaps (\$77) with an InfiniCap (\$19). *Ecstasy!* This preamp came stock with MultiCap's best efforts, the deluxe film-and-foil PPFX-S and RTX series. To get good sonic results for the coupling cap, the preamp designer found it necessary to use an array of three MultiCaps: 5µF PPFX-S, externally bypassed by .47µF PPFX-S, bypassed by .01µF RTX. That's 30 deluxe MultiCap sections in parallel."
"We replaced this whole \$77 MultiCap array with a single 4µF InfiniCap (\$19). No external bypasses on the InfiniCap. **This single InfiniCap, at 1/4 the price, thoroughly eclipsed the whole optimized array of MultiCaps!** Clearly, infinity is far better than 30."
"InfiniCap took this preamp to a whole new level. Bass became deeper, more articulate, and much less soggy. The stereo space expanded dramatically, extending way beyond the room walls and wrapping around the room, almost like surround sound. Really wild! Also, musical instruments themselves became better articulated and more lifelike, with better resolution revealing their subtle resonances. The overall sound became cleaner and faster, even using InfiniCap's ruggedized version with no external bypasses. Wow! InfiniCap is a home run in every way!"
- Litwack's evaluation has since been independently confirmed — by the preamp manufacturer himself, who has now changed his product over to the new InfiniCap SETI.

Also: New Wonder Solder UltraClear™

The world's best sounding solder is effectively **free** — and it makes your speaker system sound twice as expensive! Ask for a sample and prove it for yourself.

Write to: **TRT** — Tomorrow's Research Today, 408-d Mason Rd, Vista CA 92084 USA
Fax/voice mailbox:619-724-8999 <http://members.aol.com/trtwonder> e-mail: trtwonder@aol.com

Electroswitch

*Note for note...
the sound starts
at the switch*



At Electroswitch, we enhance sound where it starts – at the switch. That's saying quite a lot, because we offer you the industry's widest selection of compact analog switches for sound equipment.

To get the finest, purest sound from today's analog speakers, amplifiers, tuners and musical instruments, you need a rotary switch. Digital switches simply don't cut it. Electroswitch gives you a hit parade of custom switch solutions and standard rotary switches – in 2-48 positions with 1-60 poles, and ratings from milliamps to 11 amps at 125 VAC. And we deliver your switches when you need them, with lead times from stock to 3 weeks.

Want the very best sound your high performance equipment can deliver? Start at the switch... Electroswitch.



For more information call us
TOLL FREE at 1-888-ROTARYS (768-2797)
or fax us 1-800-909-9171.



ELECTROSWITCH
ELECTRONIC PRODUCTS

UNIT OF ELECTRO SWITCH CORP.
P.O. Box 41129, Raleigh, NC 27604

(919) 833-0707 Fax (919) 833-8016

E-mail: sales@electro-nc.com

Reader Service #16

World Radio History

New! LEAP
Version 4.5

LEAP

Precision Development Tools for Precision Loudspeaker Designs

LEAP System Response Prediction

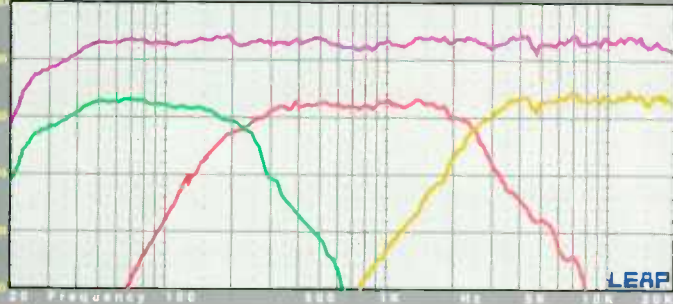

Actual System Response Measurement

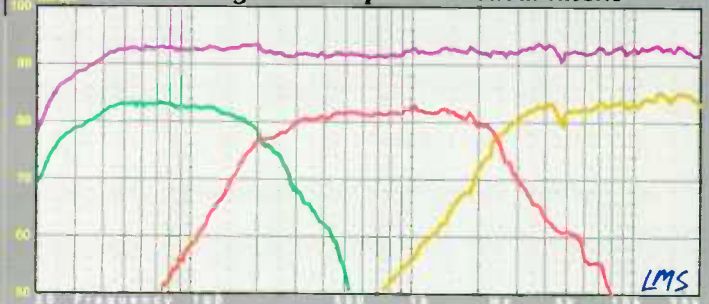

The Art and Science... of loudspeaker system development today has become more complex than ever before. Competition is tough, and to compete each design must perform to the best of its ability, and make the most out of every dollar's worth of transducer cost. The simple approach of choosing a combination of seemingly appropriate transducers coupled with ordinary networks and filters, has given way to a painstaking process of meticulously blending selected transducers in combination with carefully devised and matched crossover designs.

Similar Workshops available, call for details.

LEAP (Loudspeaker Enclosure Analysis Program) is a complete full range analysis package which provides virtually all of the tools necessary to develop precision loudspeaker systems, for today's demanding audio markets. Whether your applications are consumer audio, car stereo, professional audio, or custom esoteric marvels, LEAP provides the power, flexibility, and accuracy to investigate every possible design permutation. The open architecture and broad spectrum of features provided will dramatically reduce your development time, while improving the quality of the final result... and demonstrates why LEAP has become the #1 choice of professional loudspeaker designers world-wide!

Advanced Transducer/Enclosure Simulations

- ✓ Sealed, Vented, Bandpass, PR Simulations with multiple speaker/ port capability.
- ✓ Large signal analysis of TempVC, and Non-Linear BL/ Ports/ Compliance.
- ✓ Acoustic Parallel or Acoustic Series (Isobaric) Driver Mounting.
- ✓ Port Standing Wave resonance modeling.
- ✓ Frequency Dependent Revc and Levcc modeling.
- ✓ Library storage of 36 transducer parameters, and over 24 enclosure parameters.
- ✓ Generic transducer modeling of electro-dynamic, ribbon, and piezo devices.

Advanced System Analysis Features

- ✓ Use simulation or imported actual measured SPL/Z data.
- ✓ 3-Way crossover system modeling, and more.
- ✓ Time offset between transducers.
- ✓ Active or Passive based crossovers.
- ✓ Hilbert-Bode transform for deriving phase.
- ✓ 22 Passive components per xover section.
- ✓ 16 Active filter blocks per xover section.
- ✓ Passive Network Optimizer for single/system response.
- ✓ Active Filter Optimizer for single/system response.
- ✓ Frequency ranges from 1Hz to 100kHz.

Printer/Output Formats

When you wish to produce a hardcopy output of your finished designs and graphical data, LEAP supports a large number of printer standards, and even supports numerous desktop publishing graphic formats in both black & white and color! Portrait/Landscape orientations in any custom size and aspect ratio are user controllable.

- ✓ IBM/Epson 8 Pin Dot Matrix
- ✓ Epson 24 Pin Dot Matrix
- ✓ HP LaserJet Series Printers
- ✓ HPGL Compatible Plotters
- ✓ PostScript EPS/TIF B&W,Color
- ✓ AI-Adobe Illustrator B&W,Color
- ✓ NEC 24 Dot Matrix
- ✓ TOSHIBA 24 Dot Mat
- ✓ HP DeskJet 500C
- ✓ PostScript Printers
- ✓ DXF AutoCAD
- ✓ TIFF, BMP, PCX Plot

Development Utilities

- ✓ Quick Cabinet Box Designer
- ✓ Conjugate Network Designer
- ✓ Wire Table Calculator
- ✓ Multi Curve Averages
- ✓ Import Data from ASCII Files
- ✓ Crossover Network Designer
- ✓ Spkr Parameter Measurement
- ✓ Voltage/Current/Imp Calculator
- ✓ Motor Constants Calculator
- ✓ Export Data to ASCII Files

Extensive Documentation

The two volume manual set comprises almost 1,000 pages of documentation which thoroughly covers the operation of the program and provides numerous examples of how to maximize your use and understanding of the program's many features. The Reference Manual describes all graphs, menus, commands, and their operation. This manual explains the unique and special non-linear speaker and port models, as well as proper use of the optimizers, importing data, and the many other utilities. The Application Manual provides many exciting examples showing how to use the powerful features of the system in a combined manner to perform both simple and complex design tasks. Both novice and experienced users alike will find this information invaluable for exploiting the full power of the system. Additional information is also provided on loudspeaker measurements, design tips, filter calculations, and complete crossover system development for both passive and active based systems.

- ✓ 502 Page Reference Manual
- ✓ 436 Page Application Manual

Call for a free Demo Disk!
TEL: (503) 620-3044



LinearX Systems Inc 7556 SW Bridgeport Road Portland OR 97224 USA Tel: (503) 620-3044 Fax: (503) 598-9258

International Dealers: AgentIna:Interface SRL (54-1)741-1389/Australia:ME Technologies 61(0)65-50-2200/Austria:Audiomax 49(0)71 31-162225/Belgium:Belram 32(0)2-736-50-00/Canada:Gerraudio 416-696-2779/Denmark:Finland:A&T Ljudproduktion 46(0)8-623-08-70/France:Belram 32(0)2-736-50-00/Germany:Audiomax 49(0)71 31-162225/Indonesia:Ken's Audio 62(0)21 639-5806/Italy:Outline snc 39-30-3581341/Korea:Sammi Sound:82(0)2)463-0394/Luxembourg:Belram 32(0)2-736-50-00/Malaysia:AUVI 65-283-2544/New Zealand:ME Technologies 61-65-50-2254/Norway:A&T Ljudproduktion 46(0)8-623-08-70/Philippines:Dai-ichi Denshi (63) 2631 69-80/Poland:Inter Americom 48(22)43-23-34/Singapore: AUVI 65-283-2544/Sweden:A&T Ljudproduktion 46(0)8-623-08-70/Switzerland:Audiomax 49-71-31-162225/Taiwan:Gestion Tay ran Intl 886-2-786-3468/Thailand:AUVI 65-283-2544/The Netherlands:Duran Audio 31-41-80-15583/UK(England):Munro Assoc 44(0)171 403-3808.

Good News

▷ MIGHTY CABLES

MIT's iconn™ Interchangeable Connector System eliminates the need to buy new cables or modify existing ones to new equipment. MIT cables, housed in gray jackets, feature a basic Pin Base connector at each end, accommodating spring-loaded and threaded terminals.

Connectors available with the iconn system are gold-plated and include regular banana, economy spade, regular spade, and large spade. Music Interface Technologies, 13620 Lincoln Way, Ste. 320, Auburn, CA 95602, (916) 888-0394, FAX (916) 888-0783.

Reader Service #106

■ CD-ROM MAGAZINE

Elektor Electronics' CD-ROM, the *CD-Elektuur/Elektor 1995*, contains all articles—except news columns—published in the 1995 issues of the magazine. The CD-ROM offers an overview of 11 issues and allows you to view individual articles in a choice of four languages—English, Dutch, French, and German. Individual circuit diagrams, illustrations, and PCB layouts may be exported from the CD to other programs for adaptation and use. Elektor Electronics Publishing, PO Box 1414, Dorchester, UK DT2 8YH, (+44) 1305 250 995, FAX (+44) 1305 250 996.

Reader Service #103

■ CATCH THE SPIRIT

Absolute Zero, the latest addition to Soundcraft's line of Spirit console speakers, is a compact near-field monitor rated at 75W RMS. Absolute Zero utilizes a 30mm voice coil in its woofer, while the soft-dome tweeter is driven by a 25mm ferrofluid-cooled voice coil. The long-throw 170mm LF driver and vented cabinet with a large rear port extend LF response and allow unrestricted bass, even at high listening levels. Spirit by Soundcraft, Inc., 11820 Kemper Rd., Auburn, CA 95603, (916) 888-1488, FAX (916) 888-0480.

Reader Service #107

■ NEW SIMULATION VERSION

Interactive Image Technologies' Electronics Workbench Version 5.0 is SPICE-based software that simulates the behavior of analog, digital, and mixed circuits. Available in 10 different languages, Version 5.0 offers analyses for transient, AC sweep, DC operating point, Fourier, distortion and noise; schematic editing; graphical waveforms and autoscaling graphs; a library of analog components, device models, digital components, and ICs; and the import and export of standard SPICE netlists. Interactive Image Technologies Ltd., 111 Peter St., Ste. 801, Toronto, ON, Canada M5V 2H1, (416) 977-5550, FAX (416) 977-1818.

Reader Service #102

■ MONAD MINI

Probe Audio Labs' Monad two-way mini-monitor loudspeaker may be used in hi-fi and home-theater environments. The Monad boasts a frequency response of 50Hz–20kHz, 8Ω nominal impedance, and efficiency of 88dB/1W/1m. Available in black or natural oak-veneer finish, the monitor sports three drivers: a 6½" magnetically shielded mid/bass, a 1" silk dome tweeter, and one ¾" rear-firing tweeter. Probe Audio Labs, 10223 NW 53rd St., Sunrise, FL 33351, (954) 749-7344.

Reader Service #109

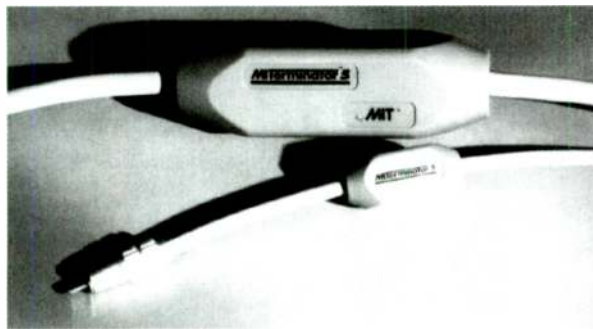

■ TO SEAL AND PROTECT

Abilene Research & Development, makers of Texturelac leather finish for speakers, announces the relocation of its main office to Royal Oak, MI. The company has added three low-VOC clear topcoats to its product line, which includes satin, semi-gloss, and high-gloss non-yellowing finishes. Designed to protect and seal painted surfaces, these environmentally friendly glazes air dry within one hour. Abilene Research & Development, 803 N. Main St., Royal Oak, MI 48067, (810) 545-8042, FAX (810) 545-8833.

Reader Service #101

■ THE ULTIMATE CONNECTION

D.H. Labs, maker of interconnect and speaker cables, introduces the new Ultimate XLR connector. While the contact pins of conventional XLR connectors are made from brass, those of the Ultimate XLR are constructed of OFHC copper. Nickel-free gold-plating is laid over the base metal to prevent corrosion. D.H. Labs, PO Box 31598, Palm Beach Gardens, FL 33420-1598, phone/FAX (561) 625-8998.

Reader Service #104

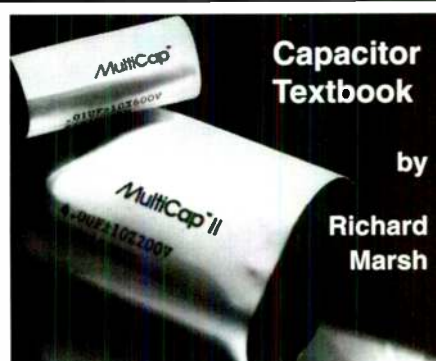

Capacitor Textbook

by

Richard Marsh

Q: *What is the difference between the Segmented Capacitor design and the patented MultiCap?*

A: *Performance & Construction!*

Segmented Capacitor: This old design now appearing as a "new" audio cap seems to offer multiple sections. But there are important differences between this and the patented, true multiple-bypass MultiCap.

Design: The segmented cap is designed for "fail safe" AC power applications. When one segment fails, the overall capacitance decreases, but the cap itself continues to function. When all the segments have failed, the cap must be replaced.

Construction: The segmented cap is a metalized-film design, constructed of extremely thin aluminum applied in equi-distant strips to the dielectric. This is then wound into a capacitor of random-value segments.

Result: (1) Multiple internal resonances at random frequencies = increased parasitics = audible distortion.

(2) Poor quality materials, not designed for audio use, invite shorts, increase ESR, greatly decrease both performance and life of the capacitor.

(3) No film & foil construction possible.

Patented MultiCap: The metalized and film & foil MultiCaps, designed for audio, are constructed of thick polypropylene or polystyrene, with a thick layer of metal. Individual capacitors of equal value are divided off as the overall capacitor is being wound on a special, proprietary machine. Each bypass is a specific ratio of the desired overall capacitance.

Result: Accuracy & musicality! A single resonance, at a frequency well above audio range + excellent materials & construction = low ESR and other parasitics = lowest distortion & highest resolution.

NOW EXCLUSIVELY FROM

reliable capacitors

Tel: 310-946-8577 Fax: 944-7494
www.capacitors.com

Reader Service #69

Good News



◉ SMALL BUT POWERFUL

Miller & Kreisel Sound designed its S-150THX® 5.1 multichannel discrete digital monitor for today's advanced home-theater Dolby Digital AC-3® systems. M&K's Phase-Focused crossover, featured in the S-150THX, combines analyses for time-domain, frequency-domain, and point-in-space (3-D, in-room response). Delivering musical sound quality in a small package, the enclosure measures 12½" H × 10½" W × 12" D and incorporates front-baffle foam treatments and integral mounts on the back-baffle. Miller & Kreisel Sound Corp., 10391 Jefferson Blvd., Culver City, CA 90232, (310) 204-2854, FAX (310) 202-8782.

Reader Service #108

■ CC3 IN A PRISM

B & W Loudspeakers' CC3 is a sub-compact center-channel speaker housed in the company's PRISM enclosure system. PRISM slot-ported and magnetically shielded cabinets incorporate a fourth-order vented design with injection-molded front and rear baffles, an inner surface comprising dozens of tapered pyramids, and molded cross-braces. With a 1" soft-dome tweeter and a pair of 4" mid/bass drivers, the CC3 achieves an 8Ω nominal impedance, 60Hz–20kHz output at ±3dB, and a sensitivity rating of 91dB/1W/1m. B & W Loudspeakers of America, 54 Concord St., North Reading, MA 01864-2699, (508) 664-2870, (800) 370-3740, FAX (508) 664-4109.

Reader Service #110

▷ ALPHA EXPANSION

PSB Speakers' Alpha series of home-theater loudspeakers has expanded to include three new versions: the Alpha^{A/V}, Alpha Mini, and Alpha Mite. All three units employ a two-way bass-reflex design, 14mm (½") polycarbonate dome tweeters, woofers with treated fiber cones, video and magnetic shielding, and a black or dark cherry enclosure with grille. Each design achieves 6Ω nominal impedance and runs at 60W RMS input power (program). PSB International Inc., 633 Granite Ct., Pickering, ON, Canada L1W 3K1, (800) 263-4641, FAX (905) 263-4633.

Reader Service #111

■ HOW SUITE IT IS

Liberty Instruments announces Version 2 of Liberty Audiosuite (LAUD), a DSP-card-based measurement system for loudspeakers and audio equipment. The PC-compatible package comprises both hardware and software to provide MLS- and sinewave-based transfer functions, impedance measurements, a dual-channel oscilloscope, FFT and RTA spectrum analyzer, and harmonic-distortion analyzer. This upgraded version further includes a script processor and real-time 1/3- and 1/6-octave analyzer, while performing pass/fail testing, automatic input-level adjustments, and display scaling. Liberty Instruments, Inc., PO Box 1454, West Chester, OH 45071, phone/FAX (513) 755-0252, Internet: www.libinst.com. Also available as #SOF-LAU from Old Colony Sound Lab, PO Box 243, Peterborough, NH 03458, (603) 924-6371, FAX (603) 924-9467.

Reader Service #105



The Industry's Finest Connectors.

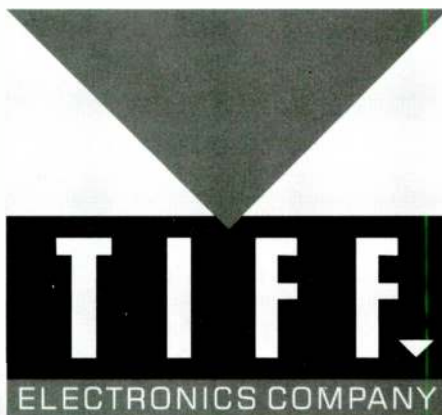

TIFF Electronics Company • 44 Pearl Pentecost Road / Winder, GA 30680 • (770)867-6300 / 2713 (Fax)

Reader Service #72



ACCUTON

by

THIEL & PARTNER

Pure ceramic concave dome drive units, from super tweeter to midbass

The new line of ACCUTON is a true breakthrough in high technology applied to speakers. For the first time ever you can build an all ceramic system, from tweeter to low frequency! All ACCUTON diaphragms are made of pure Al₂O₃ in the alpha crystal lattice (corundum) through a unique patented process. This ultra hard material provides high internal sound velocity and pure piston behavior, which transcribe into very low distortion and virtually no coloration. The ACCUTON ceramic units are among the purest transducers ever made, at any price. For a detailed catalog with specs and curves, as well as system designs, please contact ORCA. For supply, contact our stocking distributors.

ORCA Design & Manufacturing Corp. 1531 Lookout Drive, Agoura, CA 91301. TEL (818) 707 1629 FAX (818) 991 3072
A & S Speakers, California. TEL (510) 685 6400 FAX (510) 603 2724 Speakers ETC, Arizona. TEL (602) 272 6696 FAX (602) 272 8633. ZALYTRON, New York. TEL (516) 747 3515 FAX (516) 294 1943. MDB Technologie, Canada. TEL (514) 891 6265 FAX (514) 635 7526. W.A.R., Australia. TEL 61 9 445 2422 FAX 61 9 445 2579.

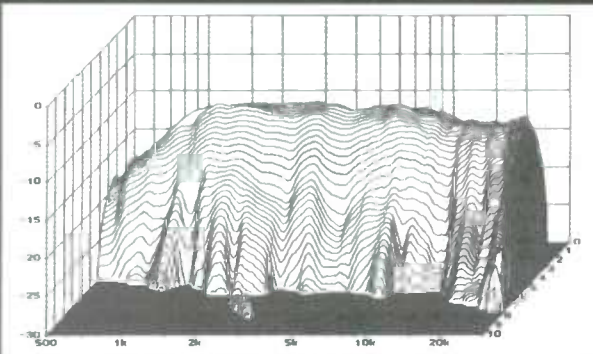

C2-12 Super tweeter US\$ 180.00

Efficient (close to 90 dB) 1 in. concave dome high frequency unit. Liquid cooled. Very wide band (2.5 to 30 KHz). Low Fs (700 Hz). It can be used in 2 or 3-way designs with a large variety of crossovers. One of the very finest tweeters available today. This is where the super hard ceramic dome shines the most: the break up mode happens well above the audible range.

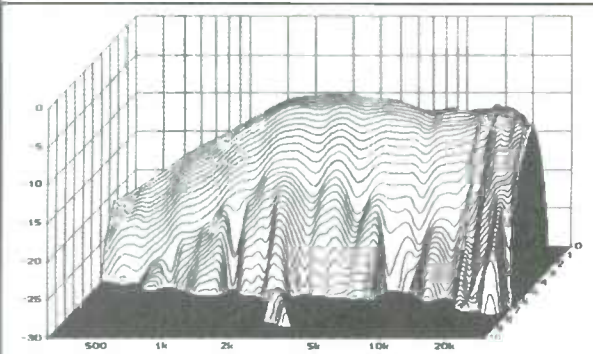

C2-23 Tweeter US\$ 220.00

Efficient (close to 90 dB) 1-3/16 in. concave dome tweeter. Liquid cooled. Wide band (1.7 to 23 KHz). Very low Fs (350 Hz). The ideal tweeter for 2-way designs. The ceramic dome keeps the upper resonance still above the audible range, and at the same time the tweeter can meet just about any midrange or midbass unit where it best performs.

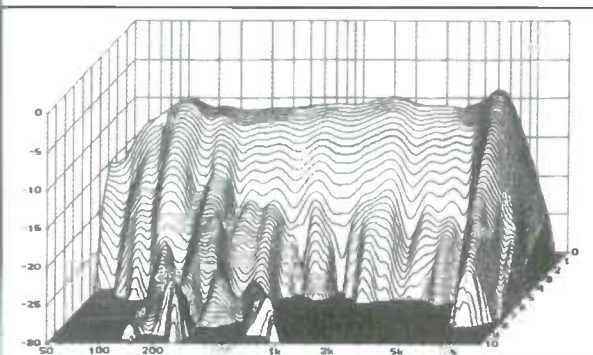

C2-79/6 Midrange US\$ 260.00

Beautiful 3-1/2 in. concave dome midrange. Liquid dampened. Extremely wide band (200 to 6 KHz). Very low Fs (96 Hz). This outstanding unit covers perfectly the human voice (200 to 2000 Hz). Near perfect piston functioning warrants very low distortion and virtually no coloration over the whole spectrum. Designed to work well in a small tubular sub-enclosure.

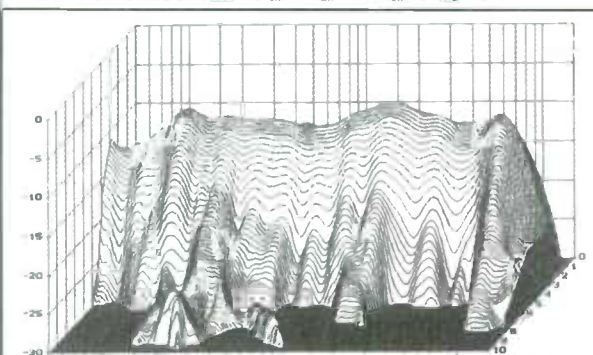

C2-88 Midbass US\$ 270.00

The first true midbass using a ceramic concave dome diaphragm. High-loss rubber surround. Wide band (40 Hz to 4 KHz). This 3-1/2 in. is an amazing bass unit and at the same time a remarkable midrange, working as a pure piston over its range. This will give the designer an extraordinary degree of freedom. Ideally suited for D'Appolito configurations.

THIRD GENERATION CLASS-D POWER AMPLIFIERS

Reliable, high-efficiency switching amplifiers have come of age...

LGT is an OEM manufacturer of high performance audio amplifiers, either turnkey with a full feature set, or as pre-fabricated PCB assemblies. The high efficiency of Class-D is available in several configurations and output levels. Heatsinking requirements on all models are minimal. Contact Terry Taylor for full details and a developer kit.



Turnkey 500WRMS subwoofer amp with full feature set... ready to drop in your enclosure.

LGT SWITCHING TECHNOLOGIES
©1996 LGT

910 Creekside Road • Building A • Chattanooga, TN 37406 • Email: acoustical@aol.com

Tel: 423-622-1505 Fax: 423-622-1485

Reader Service #79

About This Issue

In the first of a three-part series, speaker experts **G.R. Koonce** and **R.O. Wright** document the development of their multidriver project ("A Modest-Cost Three-Way Speaker System, Part 1," p. 10). Not just another three-way design, this one is noteworthy for its low cost, simplicity and sound quality.

Not all woofers are designed to be downloaded; there are several factors you should consider first. **Andy Lewis** measures the effects of speaker orientation and answers the question, "Should You Download Your Woofer?" (p. 26).

In his appropriately-named Aftershock Subwoofer restoration project, **Philip Abbate** demonstrates how to turn some vintage drivers into a moving subsonic experience ("The Aftershock Subwoofer," p. 34).

How good are iron-core coils and how do they affect system performance? **Roger Russell's** comprehensive coil-distortion tests take the guesswork out of choosing which ones to use in passive crossover networks ("Quality Issues in Iron-Core Coils," p. 44).

Tom Perazella offers an up-close-and-personal look at cone movement with some fascinating photos in "Low-Cost Stroboscopic Spider Analysis" (p. 54).

Finally, *Speaker Builder* invites you to participate in an experiment to test directionality. Does the amount of oxygen and alignment of crystals in the manufacture of wire make a difference? See "SB Mailbox," p. 60.

Speaker Builder®

The Staff

Editor and Publisher

Edward T. Dell, Jr.

Contributing Editors

Joseph D'Appolito **Robert Bullock**
Richard Campbell **John Cockroft**
David Davenport **Vance Dickason**

Bruce Edgar **Gary Galo**
G.R. Koonce **Richard Pierce**

Bill Waslo

Assistant Publisher

Karen Hebert

Dennis Brisson Managing Editor

Swain Pratt Associate Editor

Courtney E. Howard Editorial Assistant

Linda Cardone Graphics Director

Diane Luopa Assistant Graphics Director

Joan Ahern Production Assistant

Laurel Humphrey Marketing Director

Robyn Lasanen Circulation Manager

Doris Hamberg Customer Service Supervisor

Advertising Rates & Schedules

Peter B. Wostrel National Advertising Director

Linda M. Guyette Advertising Sales

Barbara Morris Advertising Assistant

(603) 924-7292 FAX (603) 924-6230

The peculiar evil of silencing the expression of an opinion is, that it is robbing the human race; posterity as well as the existing generation; those who dissent from the opinion, still more than those who hold it.

JOHN STUART MILL

Speaker Builder is published eight times a year in the interest of high-quality audio reproduction.

Legal Notice

Each design published in *Speaker Builder* is the intellectual property of its author and is offered to readers for their personal use only. Any commercial use of such ideas or designs without prior written permission is an infringement of the copyright protection of the work of each contributing author.

Subscription Inquiries

A one year subscription costs \$32. Canada please add \$8. Overseas rate is \$50 per year.

To subscribe, renew or change address write to the Circulation Department (PO Box 494, Peterborough, NH 03458-0494) or telephone (603) 924-9464 or FAX (603) 924-9467 for MC/Visa/Discover charge card orders. E-mail: audiotech@top.monad.net.

For gift subscriptions please include gift recipient's name and your own, with remittance. A gift card will be sent.

Editorial Inquiries

Send editorial correspondence and manuscripts to *Speaker Builder*, Editorial Dept., PO Box 494, Peterborough, NH 03458-0494. E-mail: audiody@top.monad.net. No responsibility is assumed for unsolicited manuscripts. Include a self-addressed envelope with return postage. The staff *will not* answer technical queries by telephone.

Printed in the USA. Copyright © 1996 by Audio Amateur Corporation
All rights reserved.

Speaker Builder (US ISSN 0199-7929) is published every six weeks (eight times a year), at \$32 per year, \$58 for two years; Canada add \$8 per year; overseas rates \$50 one year, \$90 two years; by Audio Amateur Corporation, Edward T. Dell, Jr., President, at 305 Union Street, PO Box 494, Peterborough, NH 03458-0494. Periodicals postage paid at Peterborough, NH and an additional mailing office.

POSTMASTER:

Send address change to:
Speaker Builder, PO Box 494
Peterborough, NH 03458-0494

Speaker Builder

THE LOUDSPEAKER JOURNAL

VOLUME 17 NUMBER 6

OCTOBER 1996

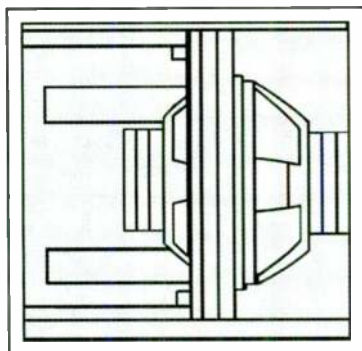

34

10 A Modest-Cost Three-Way Speaker System, Part 1

BY G.R. KOONCE AND R.O. WRIGHT

26 Should You Download Your Woofer?

BY ANDREW R. LEWIS

34 The Aftershock Subwoofer

BY PHILIP E. ABBATE

44 Quality Issues in Iron-Core Coils

BY ROGER RUSSELL

54 Low-Cost Stroboscopic Spider Analysis

BY TOM PERAZELLA

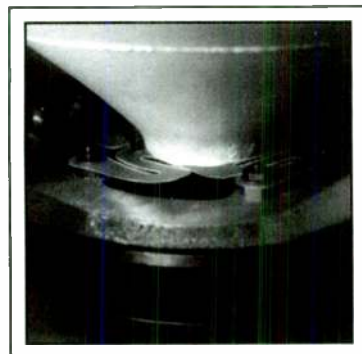

54

DEPARTMENTS

5 GOOD NEWS

58 BOOK REPORT

THE LOUDSPEAKER DESIGN COOKBOOK, FIFTH EDITION
REVIEWED BY ROBERT BULLOCK

60 SB MAILBOX

66 TOOLS, TIPS & TECHNIQUES

BY JOHN DAY

68 CLASSIFIED

69 CRAFTSMAN'S CORNER

BY GERALD H. JONES

KEEP IN TOUCH

EDITORIAL — Send letters, questions, and comments to: Speaker Builder, Editorial Dept., PO Box 494, Peterborough, NH 03458 USA, FAX (603) 924-9467, E-mail: audiody@top.monad.net.

Be sure to reference the issue, title, author, and page number of the article or letter in question; and if you request an answer from an author, please include a self-addressed envelope (and your FAX number and/or E-mail address, if applicable), with a loose stamp or postal coupon.

Due to the volume of correspondence, we cannot personally acknowledge or respond to each letter or query. All letters to the editor will be considered for publication unless you indicate otherwise. Speaker Builder reserves the right to edit your letters or technical queries for length and clarity.

Author guidelines are available by sending a self-addressed envelope with loose postage to the above address.

CIRCULATION — For subscriptions, renewals, back issues, or address changes, write to the Circulation Department (PO Box 494, Peterborough, NH 03458) or call (603) 924-9464 or FAX (603) 924-9467. E-mail: audiotech@top.monad.net.

ADVERTISING — Address advertising inquiries and information requests to the Advertising Department, Audio Amateur Corporation, PO Box 494, Peterborough, NH 03458-0576, voice (603) 924-7292 or 1-800-524-9464, FAX (603) 924-6230.

OLD COLONY SOUND LAB — For product information and ordering, contact Old Colony Sound Laboratory, PO Box 243, Peterborough, NH 03458-0243, voice (603) 924-6371 and (603) 924-6526, FAX (603) 924-9467.

A MODEST-COST THREE-WAY SPEAKER SYSTEM, PART 1

By G. R. Koonce and R. O. Wright

This three-part article will describe the rather serpentine path to the development of a moderately priced three-way system. In addition to creating a system that sounds good, your efforts can provide a learning experience. We will tell you how we developed the system and constructed the initial prototypes.

We designed the system to accept two different 1" dome tweeters, so in just a few minutes you can change the tweeter and compare the sound of your favorite music as

played by a hard (aluminum) or soft (fabric) dome. The project also has two physically interchangeable crossovers (COs), a first-order and a third-order. This is an ideal way to compare the differences in imaging that COs can make with no physical changes in the acoustic system.

The cost of the system is modest, as the drivers are all less than \$40 each. The woofer is an 8" unit produced by Eminence (DJ840/8). (The DJ840/8 designation is an Eminence in-house number that we will use

throughout the article. This woofer is available from Madisound as the Eminence #8253, and we have tested samples of it to verify compatibility. The other drivers are available from Madisound and other companies—see Sources.) The midrange driver is a SEAS 4.5" open-back (MCA11RC), and the two tweeters are the Audax TW0-25MO soft dome and the SEAS 25TAC/G hard dome.

the sensitivities are so high that they force you to use horns for the midrange and tweeter, or else go to biamping."

ROW: "That would not be a problem if one driver did the whole frequency range."

GRK: "If you can find such a driver, I will build the box and we will write it up for *Speaker Builder!*"

For over a year ROW sent me a variety of drivers. I rejected them all through tests or listening as not up to the job. I noted near the end that a little cheating was going on, as I opened one box and was greeted by a coaxial driver with built-in crossover. This, too, was rejected.

We finally agreed that a single driver would not do, and decided on a two-way system with a simple crossover. The basic goals were as follows:

1. -3dB response limits from about 40Hz-16kHz, the typical upper limit for a 1" dome tweeter
2. A reasonably sized woofer box of, say, less than 2ft³
3. All drivers to be fairly low-priced and available to anyone
4. Drivers to be used as manufactured, with no home modifications
5. A simple crossover that others can duplicate without having complex measurement capability.

THE TWO-WAY SYSTEM WOOFER RESULTS

To meet the 40Hz lower -3dB point with any reasonable power capability, we needed a driver of 8" or more. The box requirement of less than 2ft³ indicated an 8" woofer was the best bet. We investigated a variety of low-cost 8" woofers and selected the DJ-840 as the best candidate. Tests of a pair showed they would meet our goal of -3dB at 40Hz

ABOUT THE AUTHORS

G.R. Koonce and R.O. Wright are both retired engineers—electrical and mechanical, respectively—who have long worked in the development of speaker systems. Mr. Koonce has built speakers as a home hobby for about 40 years, and Mr. Wright has spent about the same length of time working with speakers for the professional ranks.

TABLE 1

DJ840/8 WOOFER SPECIFICATIONS

Nominal impedance	8Ω			
Voice-coil diameter	2"			
Magnet weight	38 oz			
RMS electrical power	100W maximum (unverified)			
Measured data on two samples and catalog data:				
	Unit A	Unit B	Catalog	Units
f_s	35.1	33.5	32-35	H _z
Q_{ES}	0.36	0.37	0.35	
Q_{MS}	8.08	7.65	6.97	
R_e	6.04	6.20	6.4	Ω
V_{AS}	1.45	1.60	1.92	ft ³
SPL	88.9	88.4	90.1	dB/W/m

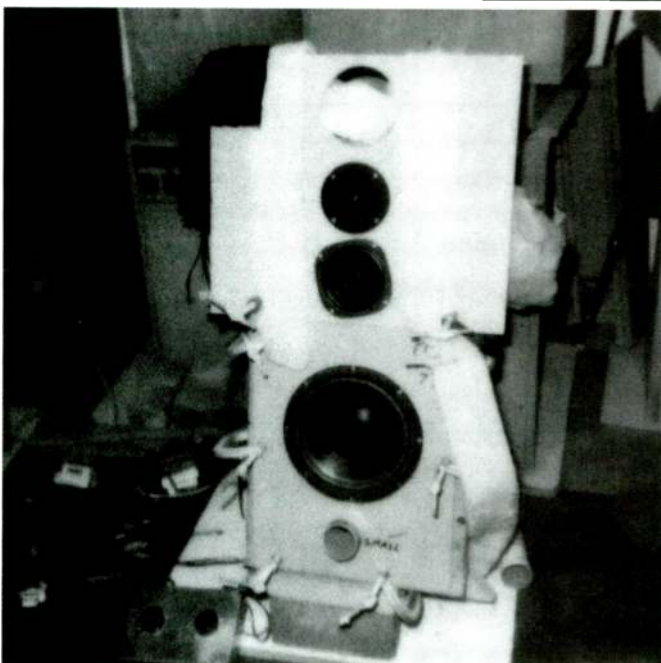

PHOTO 1: Three-way breadboard system.

IT ALL BEGAN...

This project started several years ago with a phone conversation between R.O. Wright (ROW) and myself (GRK) that went something like this:

GRK: "I wish there were more low Q drivers with a low resonance."

ROW: "I can get you all you need from the professional ranks."

GRK: "Yes, but

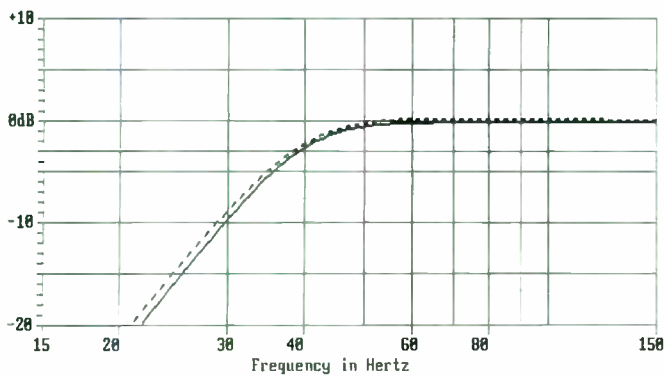

FIGURE 1: Small-model predicted woofer response in 1.1ft³ vented box.

in a vented box slightly over 1ft³ (Fig. 1).

We also evaluated the woofers to establish their upper-end frequency performance. Figure 2 shows the performance of the DJ-840 woofer. It starts to show ripples at about 1kHz, and we deemed it usable to about 1.5kHz in a two-way system. Also shown in Fig. 2 is the performance with a third-order 1.5kHz low-pass (LP) crossover; note that the performance holds up well off-axis to at least 30°.

We listened to the woofer in a breadboard vented box of slightly under 1ft³ with a small two-way system doing the rest of the audio band. Since we found the sound quality good, we adopted the DJ-840 as our woofer. Now our problem was to find a tweeter to go with it. Table 1 shows the DJ-840 data.

TWEETER RESULTS

The catalogs listed some new low-resonance 1" dome tweeters that might be usable down to 1kHz. We purchased three tweeters in pairs for study (Table 2). Figure 3 shows the frequency response for these in the 6' baffle (see sidebar, Testing Approach). None were really usable to 1kHz; the summary catalog pages had misled us in this regard. From reading the detailed data sheets, it became clear that a lower frequency limit of about 2.5kHz was what the manufacturers had in mind.

The Audax TW025V2 tweeter does go below 1kHz, but has a nasty dip in the 1.5kHz region that made its use questionable. Since it was clearly no better than the Audax TW025MO unit, had a lower sensitivity, and was 4Ω, we dropped it from further consideration. We listened to the Audax TW025MO unit (hereafter simply called the Audax tweeter) and the SEAS tweeter in a system and found them acceptable, although they sounded different, as one has a soft dome and the other hard. We decided that since they had similar imped-

ances and close to the same sensitivity, we would use both for the two-way system.

FRONT-PANEL DEVELOPMENT

One major problem when you design a multidriver system is the effect of driver offset (drivers not located similarly in height and in depth on the front panel) on the performance of the system in the region of the crossover frequency. To investigate this effect, you must determine the driver spacing on the cabinet's front panel.

I insist on putting a brace above the woofer to stiffen the front panel. Thus the two drivers cannot be mounted so they nearly touch. I arrived at a minimum spacing of 7.5" center-to-center for the two drivers and made a test insert for the 6' baffle that provided this spacing. I mounted the woofer and tweeter in line vertically, with the tweeter at the top.

BAFFLE TESTS AND CO-DEVELOPMENT—TWO-WAY SYSTEM

It was clear that we were going to be pushing both drivers in terms of their frequency-response capabilities, so we decided to use a third-order electrical CO. We set the ini-

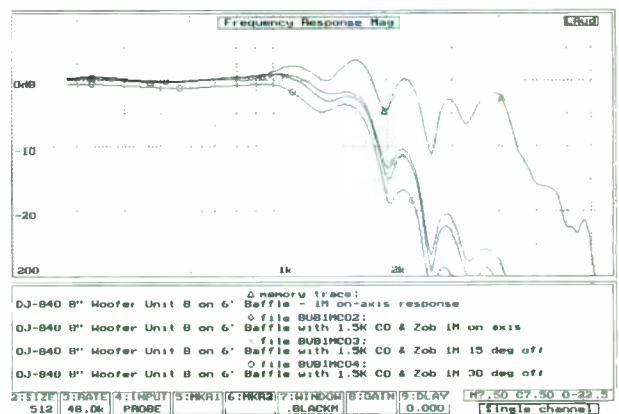

FIGURE 2: Woofer acoustic response on- and off-axis with 1.5kHz crossover.

tial CO frequency point at 1.5kHz. Tests indicated that the driver responses were causing the acoustic responses to deviate from the electrical CO responses.

To get a reasonable total response for the driver pair, it was necessary to modify the CO component values from the design values to correct for the driver responses and impedances. We did this and measured the

TABLE 2

1" DOME TWEETER TYPES

Type #	1	2	3
Maker	Audax	SEAS	Audax
Model	TW025MO	TAC25/G (H400)	TW025V2
Measured f _s	930-950	600-610	720-740
Manufacturer's ratings:			
f _s	900	660	600
SPL dB/W/m	92	91	87
Dome material	textile	aluminum	textile
Nominal Z _n	8	6	4

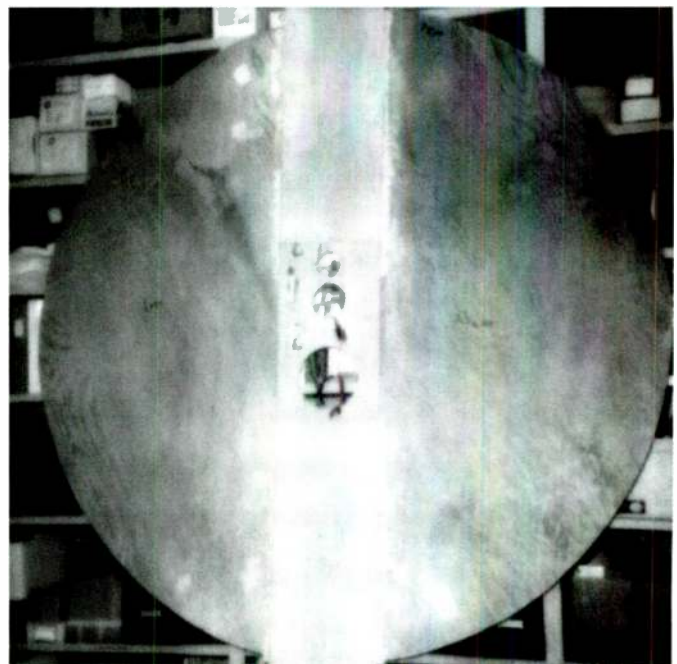

PHOTO 2: Six-foot test baffle with three-way system insert.

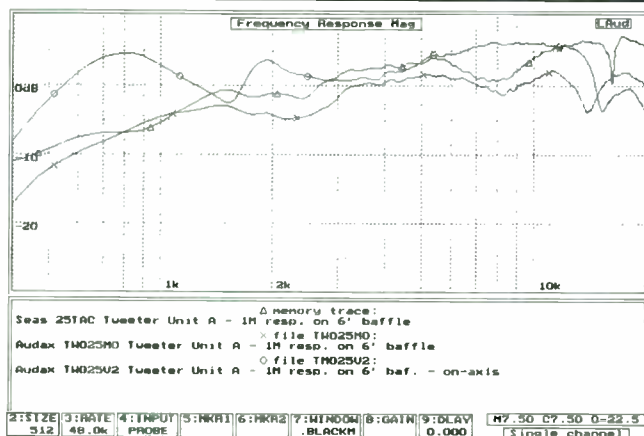

FIGURE 3: Acoustic responses for three tweeter types measured at 1m.

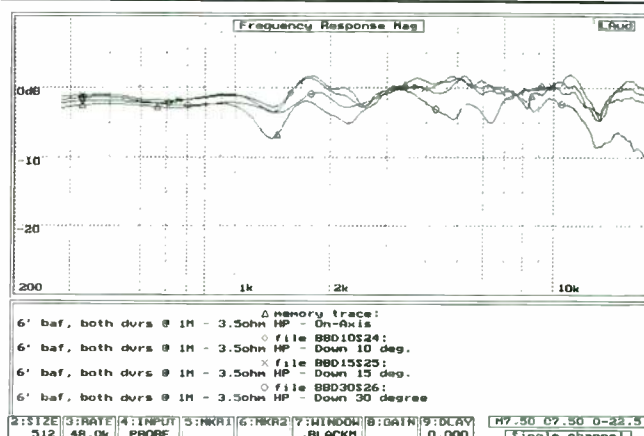

FIGURE 4: Summation response for two-way system at various angles.

resulting performance at various vertical angles off the tweeter axis with the Audax tweeter (Fig. 4).

Note that “up” refers to an angle above the tweeter (away from the woofer) and “down” refers to moving toward the woofer. This measured response was quite good, and the system was breadboarded and sounded good when listened to on an axis of about 10° down. While a lot of testing and listening effort was spent on the two-way system, we decided not to build it because:

1. The modifications to the CO to flatten the summed response caused the system input impedance to dip to about 2.4Ω in the 2kHz range. The removal of this dip resulted in inferior performance.
2. We were really pushing the tweeters too far in terms of their low-frequency power-handling capability.
3. We were factoring the driver responses and impedances into the CO design, and we doubted that others building the system would get the same summation response.

4. Victor Staggs informed us that his design, which factored in the tweeter performance, had changed with tweeter aging.

THE THREE-WAY SYSTEM

We now had tested lots of drivers, yet had no practical system. I was not sure the world needed another low-cost, moderate-performance three-way system, but ROW pointed out that we had low-resonance tweeters, and that if we could get a midrange driver with low resonance and wide frequency response, perhaps we could develop a three-way system with a first-order CO.

This was a worthwhile goal, so we began searching for an acceptable midrange. With our present woofer and tweeters, we thought that to make a first-order CO possible, the CO frequencies would have to be about 600Hz and 4kHz. The midrange would then have to cover more than this span, with acceptable impedance and frequency response.

It turned out that good-sounding, wide-band, low-cost midrange drivers are rather scarce. We evaluated four midrange drivers

for this project (Table 3). Figure 5 shows the acoustic responses of types 1–3. Initially, we selected the drum midrange, type 2, but I thought we could do better. Brian Kane of Madisound suggested using the SEAS MCA11RC, and while I was a bit worried that it was short on sensitivity, testing and listening showed it to be a great match with our other drivers, so it became the midrange for this project. Its sensitivity is such that it runs with the woofer without padding.

FRONT-PANEL DEVELOPMENT

The SEAS midrange is open-backed, so it needs a chamber behind it. SEAS offers a low-cost plastic chamber, but it is so small that it would raise the resonance too high for this project, so we rejected it. The front-panel design must therefore allow not only a brace above the woofer, but also a midrange enclosure. Figure 6 shows the minimum front-panel spacings we arrived at. We built a test insert with these spacings (Photo 1). You can use either the SEAS or the Audax tweeter with this insert.

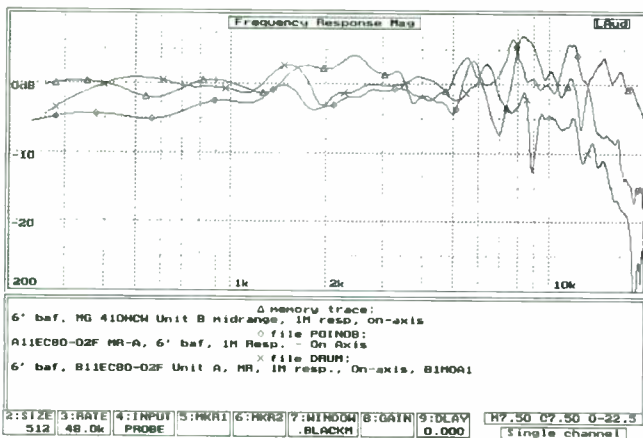
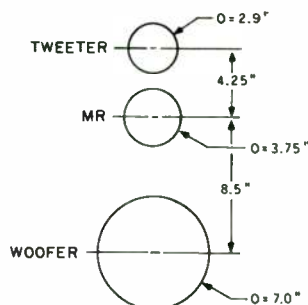

FIGURE 5: Response of midrange types 1–3 at 1m.



NOTES:
NOTCHES WERE CUT TO ALLOW MOUNTING EITHER TWEETER.
ALL HOLES ON SAME VERTICAL LINE.

FIGURE 6: Driver spacings for three-way test front panel.

BAFFLE TESTS AND CO-DEVELOPMENT—THREE-WAY SYSTEM

The idea of a first-order CO was interesting, but it was doubtful our drivers would support first-order acoustic CO responses. We therefore decided to develop and test both a first-order and third-order CO. Since they both had to support two tweeter types with

**S
p
e
a
k
e
r

C
o
m
p
o
n
e
n
t
s**



scan·speak

seas

vifa



SOLEN INC.

4470 AVENUE THIBAUT
ST-HUBERT, QC J3Y 7T9
CANADA

Tél.: (514) 656-2759

Fax: (514) 443-4949

Catalogue 1996 • \$ 8.00

Solen crossover
components catalog included



*Music
Forever*

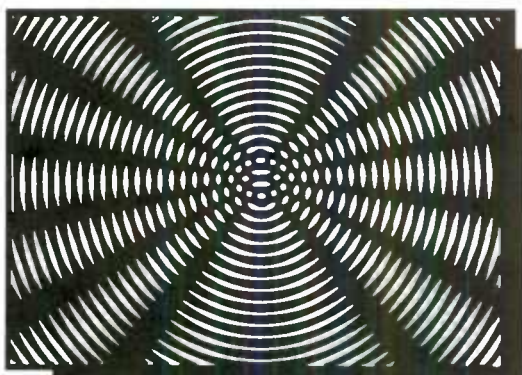
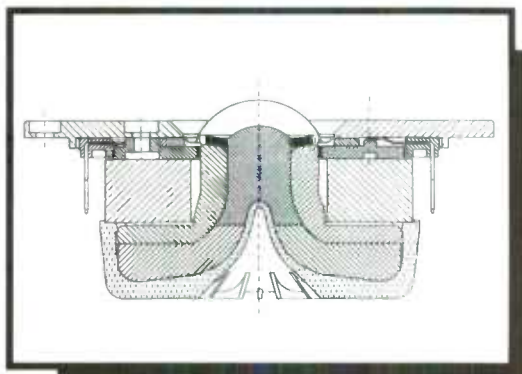

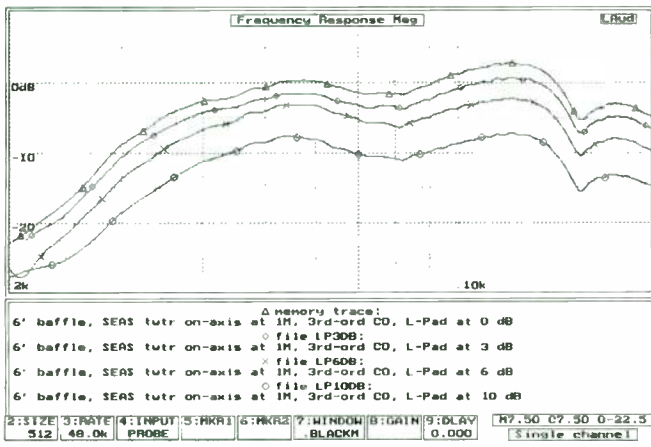

FIGURE 7: Response of SEAS tweeter with various L-pad settings—third-order crossover.

differing sensitivities, we had to apply some tricks to the design.

We easily handled the difference in tweeter sensitivities by including an L-pad on the tweeter. I normally will not use L-pads, as they are very dangerous to the health of the tweeter. ROW feared that a low-cost L-pad might add sufficient inductance to the tweeter circuit to cause a significant loss of high-frequency response. Figure 7 shows the acoustic response of the SEAS tweeter (without Zobel) with various L-pad settings and a third-order high-pass (HP) filter. There is no indication that the presence of the L-pad harms the tweeter response.

TWEETER IMPEDANCES

We investigated the impedances of both tweeter types and developed a compromise Zobel that worked for both. This resulted in impedances of about 6Ω for each type. Using an 8Ω L-pad directly would result in a CO load on the HP section that changed too much with L-pad setting.

It is possible to correct an 8Ω L-pad to 6Ω at a single padding value (see L-pad sidebar for equations), and we did this for a padding value of 3dB. Note that all padding values used in this work refer to the L-pad working with an 8Ω load. They were read off the calibrated scale for the L-pads (*SB* 3/81, p. 30).

Figures 8 and 9 show the input impedance to the two tweeter types for various L-

pad settings, with the L-pad corrected to 6Ω at 3dB padding, and with the compromise Zobel. We considered the results satisfactory for use with a 6Ω HP CO design. The midrange driver does not need padding, but the first-order CO requires the tweeter and midrange to have the same impedance, so we Zobel and shunt-padded the midrange to give 6Ω.

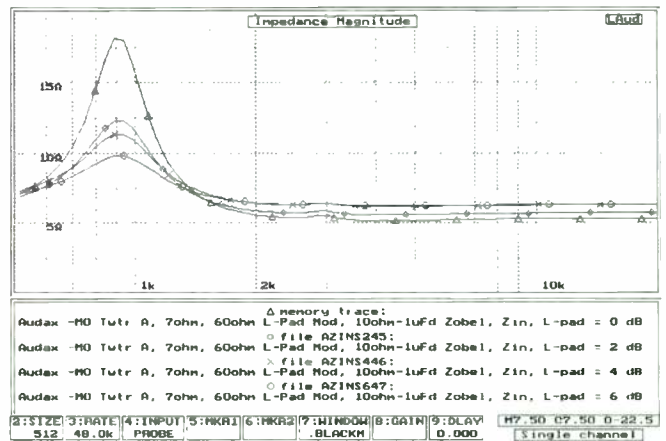

FIGURE 8: Z_{in} to Audax tweeter with Zobel versus L-pad setting.

TABLE 3

FOUR MIDRANGE DRIVERS

Type #	1	2	3	4
Maker	Pioneer	Pioneer	MG	SEAS
Model	A11EC80-02F	B11EC80-02F	410HCW	MCA11RC (H143)
Type	Open back	Drum	Open back	Open back
Measured f_s	105	340	170	120
Manufacturers' ratings:				
f_s	70	320	/	140
Nominal size	4.5"	4.5"	4"	4.5"
Nominal Z_{in}	8Ω	8Ω	8Ω	8Ω
SPL dB/W/M	90	94	91	89
Usable frequency range (Hz)	70–15k	320–6k	120–19k	400–5k

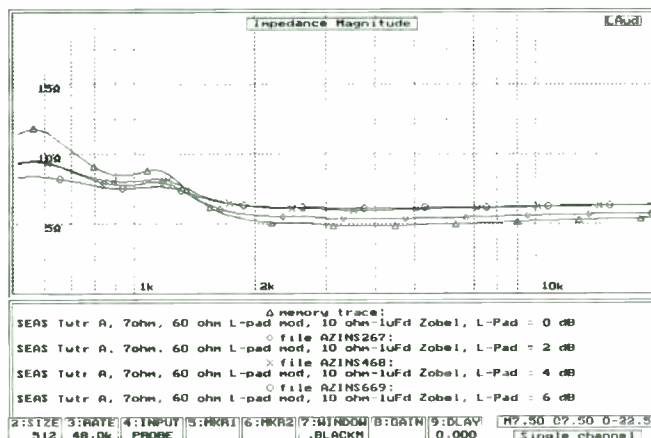

FIGURE 9: Z_{in} to SEAS tweeter with Zobel versus L-pad setting.

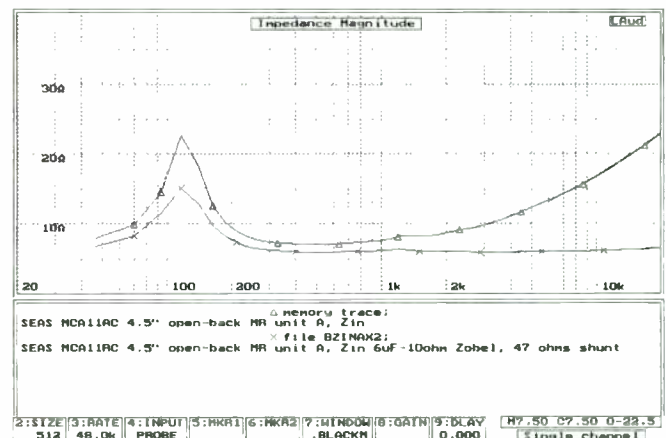

FIGURE 10: SEAS midrange Z_{in} bare and with Zobel and padding.



THE SPEAKER WORKS, INC.
 1021 E. Camelback Rd.
 Phoenix, AZ 85014
 (602) 230-0344 FAX (602) 230-8533

vifa

QUALITY DANISH LOUDSPEAKERS

vifa

D19TD-05-08 ¾"

- High Loss Diaphragm
- Magnetic Fluid
- High Power Version
- Good Dispersion

Specifications

Impedance 8Ω
 Resonance 1700Hz
 Frequency Range 3–20KHz
 SPL 1/W/1/M 89DB
 Power Handling 80W
 Voice Coil 19mm
 Magnet 3.7 oz.



\$11.69 ea.

P17WJ-00-08 6½"

- Also in 4 ohm
- Magnesium Basket
- Mineral Filled Polycone
- High Damping Surround
- Very Smooth Response

Specifications

Impedance 8Ω
 Resonance 37Hz
 Frequency Range 5000Hz
 SPL 1/W/1/M 88DB
 Power Handling 120W
 Qts 0.35
 Vas 34.7 LTR
 Voice Coil 32mm
 Magnet 14.6 oz.



\$33.93 ea.

D25AG-35-06 1"

- Aluminium Diaphragm
- Magnetic Fluid
- Double Chamber
- Flexible Voice Coil Braids

Specifications

Impedance 6Ω
 Resonance 850Hz
 Frequency Range 1.5–35KHz
 SPL 1/W/1/M 89DB
 Power Handling 100W
 Voice Coil 25mm
 Magnet 8.5 oz.



\$26.00 ea.

P21WO-20-08 8"

- Magnesium Basket
- Mineral Filled Polycone
- High Temp Voice Coil
- Very Smooth Response

Specifications

Impedance 8Ω
 Resonance 28Hz
 Frequency Range 25–4000Hz
 SPL 1/W/1/M 91DB
 Power handling 150W
 Qts 0.33
 Vas 113 LTR
 Voice Coil 40mm
 Magnet 24.6 oz.

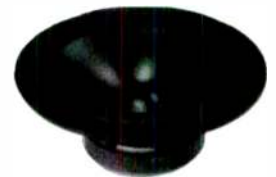

\$47.52 ea.

SHIELDED SPEAKERS

D19TD-03-08 ¾"

- High Loss Diaphragm
- Additional Magnet
- Good Dispersion

Specifications

Impedance 8Ω
 Resonance 1400Hz
 Frequency Range 4–20KHz
 SPL 1W/1M 90.5
 Power Handling 50W
 Voice Coil 19mm
 Magnet 7.4 oz.



\$13.40 ea.

M13SG-09-08 5"

- Magnetically Shielded
- Very Smooth Response
- High Damping Surround
- Paper Cone

Specifications

Impedance 8Ω
 Resonance 54Hz
 Frequency Range 54–5000KHz
 SPL 1/W/1/M 88DB
 Power Handling 70W
 Qts 0.35
 Vas 12 LTR
 Voice Coil 25mm
 Magnet 12.1 oz.

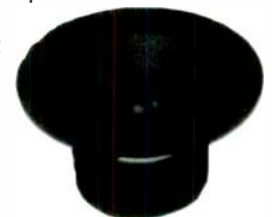

\$31.52 ea.

ANY QUESTIONS? — CALL US

We accept VISA - Mastercard - Check — No C.O.D.
235 PAGE CATALOG \$10.00 (USA only)

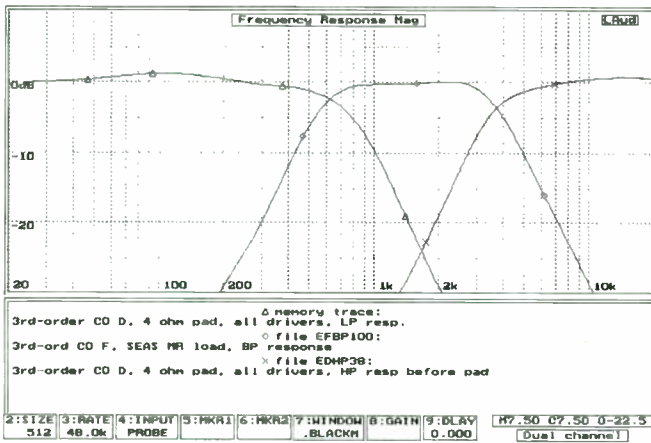

FIGURE 11: Electrical responses of LP, BP, and HP sections with third-order crossover and actual driver loads.

Figure 10 shows the basic midrange driver input impedance and the resultant

impedance with the Zobel and shunt resistor. The result is nearly a 6Ω load for the

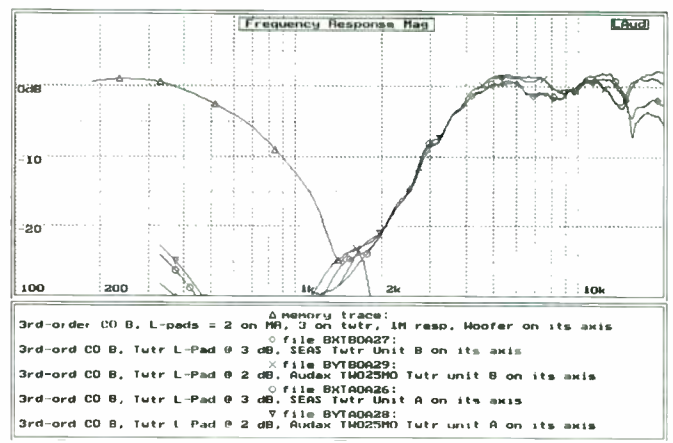

FIGURE 12: Acoustic responses for woofer and four tweeter samples with third-order crossover.

TESTING APPROACH

We generated the test data presented in this article via Liberty Audiosuite. We mounted the drivers near the center of a 6'-diameter wooden baffle (Photo 2) that allowed anechoic measurements solid down to below 400Hz and usable to at least 200Hz. We kept the measurement distance greater than three times the span of the drivers to ensure a valid far-field measurement.

The measurement microphone was a 33"-long unit, flat within ±0.5dB over the range 200Hz–20kHz. (Note that data acquired before 7/10/95 was taken with an uncorrected microphone that showed a peak less than 2dB in the 8k–15kHz frequency range.)

Every attempt was made to ensure

anechoic measurements. We applied no smoothing to any of the acoustic test results in this work; they show all the nasties that existed. Note that “up” refers to measurements made off-axis above the reference axis, and “down” to those below the reference axis. For a single driver, the reference axis was the driver center line; for the two-way system, it was the tweeter center line; and for the three-way system, it was the midrange driver center line.

A minimum of acoustic data is provided on the finished systems, since my test room simply does not support echo-free testing of a structure the size of the finished enclosure. Impedance data for the finished systems is provided.

CO bandpass (BP) output down to about 300Hz. The third-order CO we used is the Bullock positive-polarity bandpass all-pass design with transposed midrange topology (SB 2/85, p. 26). This all-pass CO has slight rises in the total power response, with corresponding slight dips in input impedance at the two CO frequencies.

The transposed BP topology has a voltage gain of unity. Using the cascaded BP topology would have resulted in about a 2dB rise in available midrange sensitivity, but the cascaded topology causes a dip in input impedance throughout the midrange band, and I have always thought the transposed topology sounded better.

ELECTRICAL OUTPUTS

Figure 11 shows the measured electrical LP, BP, and HP outputs from the third-order CO with the driver loads, including Zobel and the paddings described above. These are really quite good, almost matching the performance with resistive loads because of the low midrange and tweeter resonant frequen-

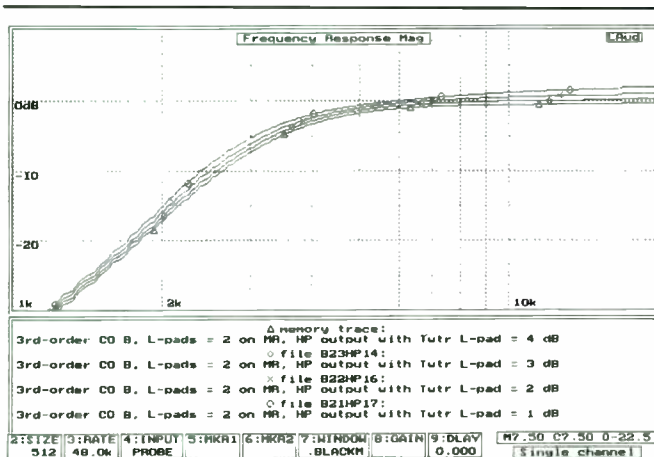

FIGURE 13: Electrical HP output driving SEAS tweeter versus L-pad setting with third-order crossover.

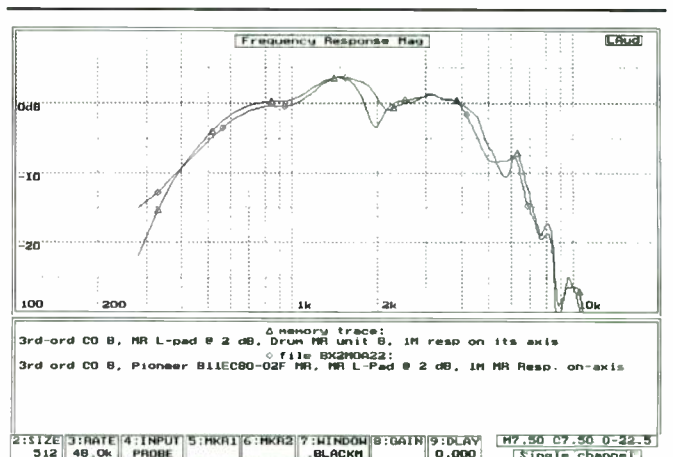

FIGURE 14: Response of both type 2 drum midranges with third-order crossover.



MADISOUND'S WITCHES' BREW OF WICKED SPEAKER SAVINGS

QTY	Description	Price
1,000	Sreco 10 ohm 25 watt Resistor , sand cast wire wound, 10%, 12mm x 13mm x 64mm	10/ \$3.00
6,000	Mallory 1.33µfd Mylar capacitor , 250V, 10%, 25mm L x 11mm Ø, Axial 43mm leads	10/ \$2.00
500	IC 2.0µfd Mylar capacitor , 250V, 10%, 32mm L x 11mm Ø, Axial 41mm leads	10/ \$2.00
1,000	Siemens 2.2µfd Mylar capacitor , 250V, 5%, 20mm x 10mm x 31mm, PC mount	10/ \$3.00
1,500	Wima 3.3µfd Polypropylene cap. , 160V, 10%, 31mm L x 16mm W x 34mm T, PC mount	\$1.00 each
2,000	Hitachi 4.7µfd Mylar cap. , 100V, 10%, 30mm L x 7mm W x 13mm T, Axial 13mm leads	10/ \$4.00
19,000	Elpac 5.0µfd Mylar capacitor , 50V, 10%, 30mm x 10mm x 7mm, Axial 53mm leads	10/ \$4.00
1,700	Roederstein 6.8µfd Polycarbonate cap. , 63V, 10%, 30mm x 10mm Ø, Axial 41mm leads	\$0.90 each
300	T.I. 1300µfd Electrolytic capacitor , 100V, 5%, 71mm x 30mm Ø, Axial 42mm leads	\$4.00 each
60	Sledgehammer 2.7mH Steel Bobbin Inductor , 15 awg, .166 DCR, 64mm Ø x 44mm T	\$8.00 each
700	Audax DW50M 4 ohm tweeter , 94dB, Fs 2050, 45 Watt, 14mm direct drive poly dome with diffuser, 50mm round flange with no mounting holes, mounting ring and wedge mount available separately. We recommend a 12dB crossover of 6.8µfd & 0.15mH coil	\$5.50 each
2 pair	Audax TP1X2P0 1" x 2" HD-3P dome tweeter , Gold ion deposited piezo electric polymer film direct-radiating dome, includes 6dB 6K x-over with Solen cap and transformer	\$300 / pair \$130+ below cost
90	Seas 25TA/D H533 1" aluminum dome tweeter with diffuser, 6 ohm, Fs 1000 Hz, 91dB, 60 watts, 4" Ø flange, 3" cut out. Great for frequencies above 3K, smooth to 20K	\$15.00 each
370	Phenolic Ring tweeter , 4.25" Ø flange with metal grill & 10oz magnet	\$5.00 each
160	Seas 25TAFN/QG 1" aluminum dome tweeter with metal grill and neodymium magnet, 6 ohm, Fs 1800 Hz, 89dB, 100 watt, 64mm square flange, fits in Audax wedges	\$19.00 each
180	LPG 26TSP 1" titanium dome tweeter with cropped flange, chambered back, metal mesh grill, 8 ohm, Fs 730 Hz, 90dB, 100 watt. Very smooth to 25kHz.	\$18.00 each
100	Peerless 821214 2" dome midrange , textile dome, chambered back, Fs 298, 89dB, 200W @1kHz, 134mm flange with a 106mm cutout, smooth response to 5kHz	\$28.00 each
136	Vifa C11WG-09-08 4.5" woofer , coated paper cone, rubber surround, vented pole piece, 8 ohm, Fs 72Hz, 85dB, 30 watt, Vas 4.2 liters, Qts .40, frequency response from 100Hz to 10kHz. Nice for small Sat.	\$15.00 each
95	Seas P11RC H454 4.5" woofer , Poly cone, rubber surround, cast frame, 8 ohm, Fs 55 Hz, 84.5dB, 60 watt, Vas 5.3 liters, Qts .34, frequency response from 75Hz to 7kHz. Great as woofer or midrange.	\$25.00 each
48	Peerless 1667 5.25" Paper cone woofer , cast frame, rubber surround, 8 ohm, Fs 58 Hz, 88dB, 80 watt, Vas 12.4 liters, Qts .425, F3 of 65Hz in .3 cf vented (1.5"Ø x 3.7"L) or 100Hz in .25 cf sealed. Like the KO40	\$23.00 each
150	Vifa C17WG-07-04 6.5" 4 ohm woofer , coated paper cone, foam surround, vented pole piece, Fs 51Hz, Qts .54, Vas 26 liters, 50 watt, 88dB, 3mm x-max, F3 of 75Hz in 10 liters sealed.	WOW only \$10
<p>OKAY! So you wouldn't take them at \$14 each, so we made a mistake and bought something you're not all excited about. I hope you can find uses for them at this price and help to restore our confidence in making these large purchases of surplus items.</p>		
104	Peerless 2622 8" Poly cone woofer , foam surround, 8 ohm, Fs 26 Hz, 90dB, 100 watt, Vas 168 liters, Qts .37, F3 of 50 Hz in 1 cubic foot sealed and stuffed enclosure, nice choice for a small 2-way	\$25.00 each
150	Famous maker 8" woofer , paper cone, foam surround, 8 ohm, 90dB, Fs 41 Hz, Qts .37, Vas 36 liters, 50 watt, F3 of 47Hz in .9 cubic foot with 2" Ø port by 3.6" long	\$14.00 each
80	Eminence T1040 10" Paper cone woofer , cloth accordion surround, 40oz magnet, 2" VC, 92dB, 150 watt, Fs 24Hz, Vas 240 liters, Qts .34, F3 of 52 Hz in 2 cf sealed or F3 of 38 Hz in 3 cf vented (3"Ø x 5"L)	\$30.00 each
85	Stanford Acoustics 12" Paper cone woofer , treated paper cone, rubber surround, 2" voice coil, 90dB, Fs 14 Hz, Vas 695 liters, Qts .24, F3 of 40Hz in 3 cubic feet sealed or 30Hz in 4 cf vented, 3" Ø x 7" L	\$39.00 each

Offer expires January 1, 1997



MADISOUND SPEAKER COMPONENTS
8608 UNIVERSITY GREEN
P.O. BOX 44283
MADISON, WI 53744-4283 U.S.A.
TEL: 608-831-3433 FAX: 608-831-3771
e-mail: madisound@itis.com
Web Page: <http://www.itis.com/madisound>



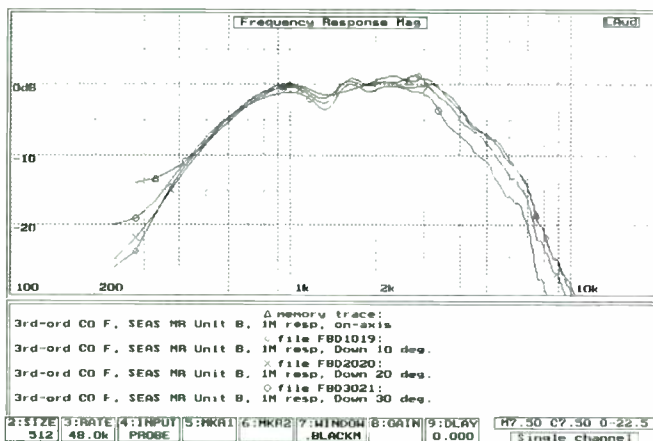

FIGURE 15: Acoustic response of SEAS midrange versus angle with third-order crossover.

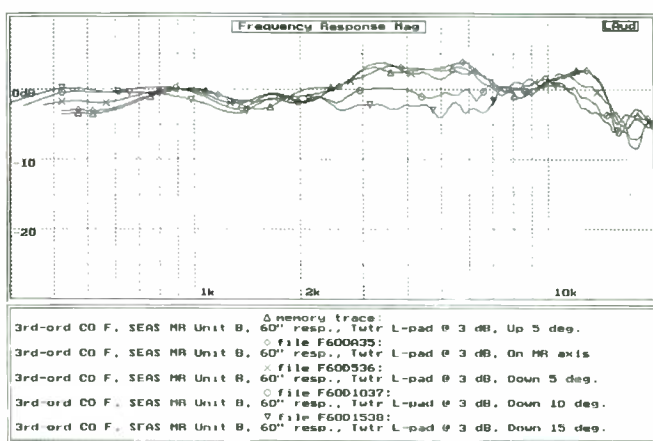

FIGURE 16: Summed response with third-order crossover from up 5° to down 15°.

cies. Note that while the CO frequencies are 600Hz and 4kHz, the BP response narrows to about 600–3.5kHz, which I will explain shortly.

Figure 12 shows the acoustic LP response for the woofer and the acoustic HP responses for two each of the SEAS and Audax tweeters, indicating the CO does work for both tweeter types and that the tested pairs match quite well. Figure 13 shows that the HP response (SEAS tweeter load) tracks well with L-pad settings over the expected range (about 3–4dB padding).

The mismatches and wiggles in the acoustic BP response for the two drum midranges (midrange type 2) prodded us to search for a new midrange (Fig. 14). Note that the electrical BP response was from 600–4kHz. Similar tests with the SEAS midranges indicated that the acoustic BP response was wider than the electrical BP on the upper end. The BP section was redesigned only to cover 600–3.5kHz to correct for this effect. Figure 15 shows how well the resultant acoustic response of the

SEAS midrange holds up over a considerable listening angle.

COMBINED PERFORMANCE

The total span of the three drivers in the 6' baffle is about 19" from the bottom of the woofer to the top of the tweeter. Since any acoustic measurements of combined performance must be done from a distance exceeding three times this span, we selected a value of 60". At this test distance, my room will not support anechoic tests even down to 400Hz at certain listening angles, so in some of the following curves you will note that the low end of the response is truncated.

For the three-way system, the listening-angle reference is the midrange axis, up again meaning toward the tweeter, and down meaning toward the woofer. Figure 16 shows the measured acoustic response of the three-way system (SEAS tweeter) for every 5° of listening angle from up 5° to down 15°. I think the performance over this range is quite good. The woofer-to-midrange CO is not even detectable, while

the midrange-to-tweeter CO is bounded by a tight box.

Remember that there is no smoothing applied to these curves; they show all ill effects. It was doubtful that we could match this performance with the enclosure added. Figure 17 shows the acoustic response for every 10° from on-axis to down 20°; it is clear that we start getting into trouble by down 20°. The box will be designed for a listening angle of about down 5°.

I became very worried about the tweeter protection with a first-order CO, so we used a slightly modified CO configuration, called the cascaded two-way first-order CO, which offers some added tweeter protection (Fig. 18). This consists simply of two first-order two-way COs put in cascade. L1 and C1 split the signal at 600Hz, then C2 and L2 split the first HP output at 4kHz for the true BP and HP output. The advantage is that below 600Hz the tweeter goes to a second-order HP response for increased protection.

This CO does require the tweeter and

midrange to have the same impedance, which explains why we did this. We will henceforth refer to the cascaded two-way first-order CO simply as the first-order CO. In Fig. 19, which shows the measured performance of this CO with dummy loads, note how the tweeter HP goes to second-order at low frequency. Figure 20 shows the electrical LP, BP, and HP out-

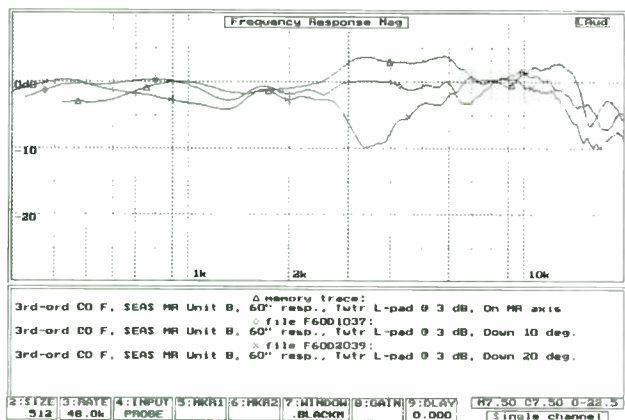

FIGURE 17: Summed response with third-order crossover from on-axis to down 20°.

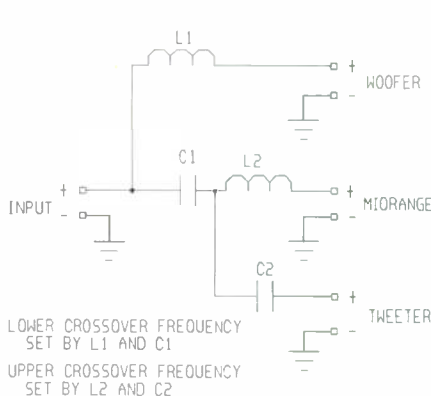
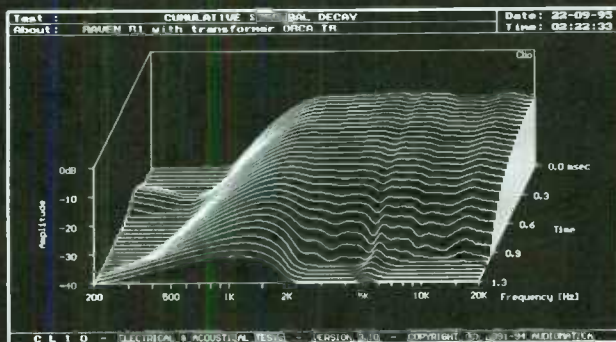

FIGURE 18: Schematic for basic cascaded two-way first-order crossover.

RAVEN

HIGH EFFICIENCY PURE RIBBON TWEETERS

ORCA is sincerely proud of introducing these exceptional high frequency transducers from France. The RAVEN tweeter is a true ribbon tweeter, possibly the purest transducer available today. In a dome tweeter the signal is carried through the voice coil wire, and the sound is radiated by the dome attached to the voice coil. Here, the carrier of the electrical signal and the radiating diaphragm are one and the same part: the ribbon itself. Furthermore, the RAVEN ribbon is 100% pure conductive material, no metalized film. To have an idea of the high frequency performance of the RAVENs, imagine that the moving mass here is about 30 times less than a high quality dome tweeter. The music comes through effortless, almost immaterial. The special and massive NeFeB magnet of the RAVENs is five times more powerful than a conventional magnet. The result: the RAVEN R1 is capable of 118 dB peak with no measurable distortion (R2: 120 dB). At 10WRMS, that is continuous power now, R1 reaches 105 dB with less than 1% distortion, and R2, 107 dB. The RAVENs come with a specially designed matching transformer (very low distortion, low loss and wide bandwidth) for optimum coupling with your power amplifier. Now look carefully at the decay of these units !



RAVEN R1

KGS 1.14
LBS 2.5
92 x 80 mm
3.63 x 3.15 in.
Moving mass:
0.0061 g
0.0002 oz.
dB/W/m 95
2 KHz to 40 KHz

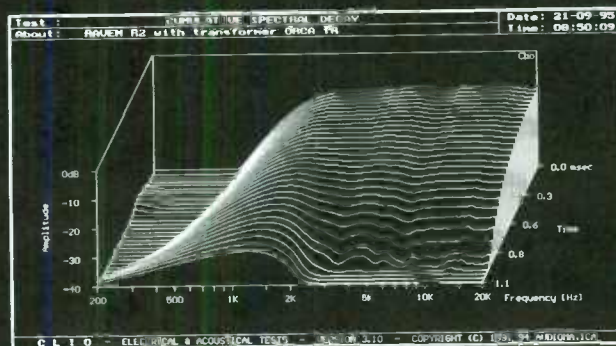

RAVEN R2

KGS 2.22
LBS 4.9
166 x 76 mm
6.54 x 2.99 in.
Moving mass:
0.013 g
0.0005 oz.
dB/W/m 98
2 KHz to 40 KHz



RAVEN TRANSDUCERS are distributed worldwide exclusively by **ORCA Design & Manufacturing Corp.**
1531 Lookout Drive, Agoura, CA 91301 - USA
TEL (818) 707 1629 FAX (818) 991 3072
E-Mail: orcades@aol.com
OEMs, stocking distributors and importers inquiries welcome. Goods now in stock in America.

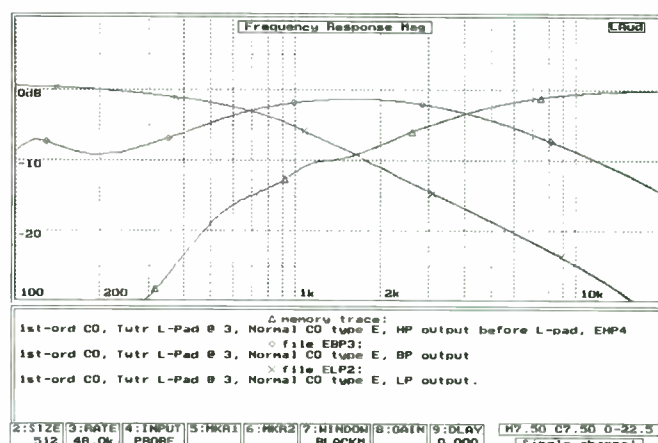
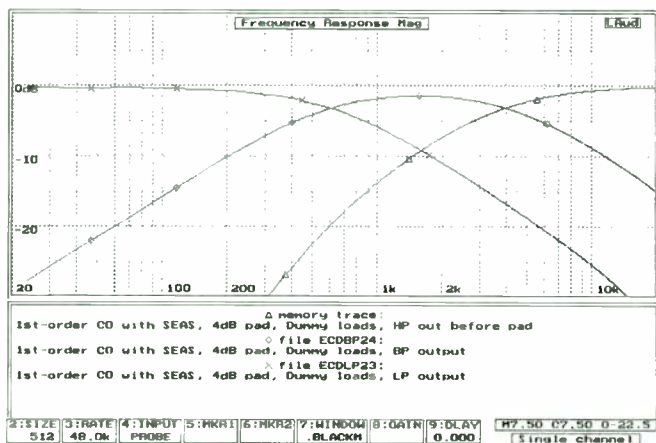

FIGURE 19: Performance of cascaded two-way first-order crossover with dummy loads.

FIGURE 20: Electrical responses of LP, BP, and HP sections with first-order crossover and actual driver loads.

puts with the drivers as loads. It is clear that the first-order CO is bothered much more by driver-impedance variations than was the third-order CO.

Figure 21 shows the acoustic responses for the first-order CO with drivers on their own axis. We were definitely not getting an accurate acoustic first-order CO with these drivers. I believe a major improvement could be made here by using complex Zobel's (see *SB 5/94*, p. 28, and *4/95*, p. 24) to limit the destructive effects of the midrange driver and tweeter resonant impedance rises. Such Zobel's must be designed for the individual drivers (with the midrange in its final enclosure) and so were outside the goals of this project.

DRIVER-OFFSET EFFECTS

In his clever approach to effects of driver offset on various two-way CO types, Bruno Carlsson (see *SB 1/95*, p. 26 and *2/95*, p. 26) shows that the first-order CO with drivers having the same polarity is very sensitive,

while performance with one driver inverted is much better. Testing certainly verified this result. Figure 22 shows the total acoustic response of the three drivers (SEAS tweeter) hooked up at normal polarity at various listening angles. Listening tests verified that the performance is terrible.

If the midrange is connected with inverted polarity (Fig. 23), then each CO pair has one driver inverted, and the offset effects are greatly reduced. I played with the first-order CO component values with no major improvement. I also tried a straight first-order all-pass CO, and it was even worse. Since the first-order CO requires only four components, we carried it on this project, but it is nowhere nearly as accurate as the third-order CO. The first-order CO is wired with inverted midrange polarity. Again, the optimum listening angle is in the down 5°–10° range.

Breadboard tests (Photo 1) in monaural using a down 5–10° seated listening angle indicated the third-order CO to be very

smooth and accurate. I judged sound quality to be consistent between seated and standing listening and over a wide angle from side to side. The first-order CO with the midrange inverted sounded musical, but showed some change between seated and standing listening. The first-order CO with normal midrange polarity was terrible, with the lower midrange sound missing at most vertical listening angles. Note that the breadboard system did not match the design front-panel driver spacings.

In general, the listening tests agreed well with the baffle-measured data; however, the first-order CO with inverted midrange sounded better than I had expected from the tests. The data showed that the third-order CO performance was to a great extent free from effects of the impedance or driver response. This means that others building the system should get almost the same performance we did. The first-order CO is not well isolated from driver effects, but should be tolerant of mild variations.

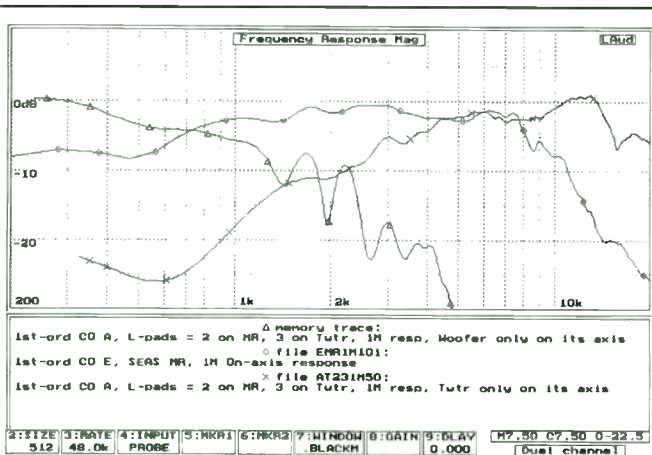

FIGURE 21: On-axis acoustic responses for drivers with first-order crossover at 1m.

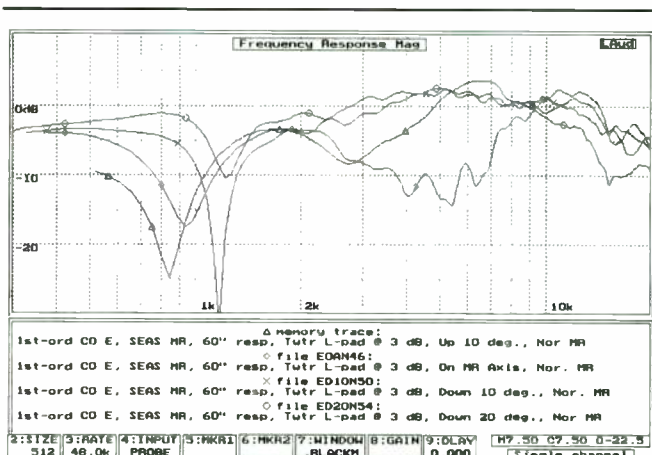

FIGURE 22: Summed responses for first-order crossover—normal midrange polarity.

ZALYTRON

Focus on Focal!

OPEN SEASON ON FOCAL FOR THE SPEAKER BUILDER BARGAIN HUNTER

FOCAL is pretty secretive about whom they supply with their famous drive units (and Klmon Bellas the FOCAL importer sounds like a locked bank vault when you ask him about it), but if you visit any high-end show, you see an awful lot of FOCAL drive units by many very respected speaker manufacturers. Well these high end OEMs, like any manufacturer on earth need to change models and change drivers. Sometimes only the paint of the frame changes, sometimes a little stiffer spider ... That is how you create very attractive obsolete product. When the French woke up form their traditional August siesta, we made an offer to FOCAL: ZALYTRON would take all these brand new OEM drives (with the usual warranty) they had on their shelves if they would sell it to us ... at an appropriate price. We would be hard pressed to print here that we made a killing, just see for yourself in the ZALYTRON tradition, we pass the benefit of our good deals directly to our customers. If this reads like the D.I.Y. dream list it simply is. If only these OEMs could keep changing models...

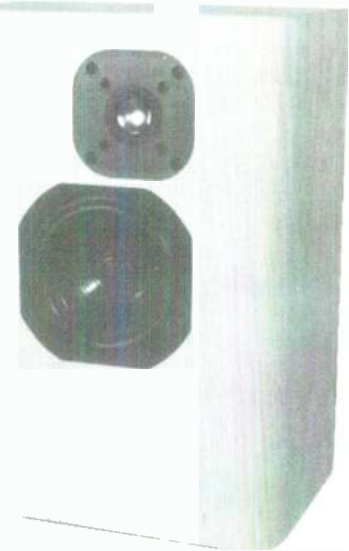

BLOWOUT PRICES ON FOCAL SPECIALS

ITEM	PIECES	PRICE	ITEM	PIECES	PRICE
T90T1.....	48	\$35.00	10K617H	34	\$139.00
T120TI02.....	96	50.00	10V617	20	110.00
T124TD	62	50.00	165 C Kit	50	135.00
T120ZLT	200	50.00	W21B.....	30	60.00
4C211	112	39.00	IF YOU WANT TO SPEND EVEN LESS, WE HAVE THESE BLOWOUTS		
4C212	100	39.00	SEAS P17RCY / 4 OHM		\$29.00
4C228G.....	24	45.00	SEAS CA17RCY.....		29.00
5NZLT	250	45.00	SEAS 382 1" Aluminum Tweeter		15.00
6C211S	198	39.00	AUDAX HT130FO		26.00
6C211S1	270	39.00	AUDAX HT130G6.....		20.00
6P211S	108	35.00	AUDAX HT170G2.....		21.00
7CZLT	300	45.00	AUDAX HT110GO Uncoated		15.00
AUDIOM 8/2	10	169.00	AUDAX HT130MO		15.00
8C012DBG	89	60.00	3.3 MFD MYLAR CAPS 250V		3/\$1
8K515	10	75.00			
8K511DB	8	80.00			
Audiom 10/2	10	169.00			

ZALYTRON INDUSTRIES CORP.

469 JERICHO TURNPIKE, MINEOLA, N.Y. 11501

TEL. (516) 747-3515

FAX (516) 294-1943

Our warehouse is open for pick-up 10AM to 6 PM daily, Saturday 10 AM to 5 PM
UPS orders shipped same day • Minimum order \$50.00

Call or Write for your Latest Catalog mailed FREE in USA. Canada \$5 P&H, Worldwide \$10 P&H

BOX DESIGN REQUIREMENTS

The problem is now to develop a box for the system that does not distort the performance too much from what the baffle tests and breadboard listening showed was available. The requirements for the box are as follows:

Front Panel

Maintain the driver spacings used in the testing and provide a seated listening angle of around down 5°. To maintain the same sound quality as heard in the breadboard tests, you should keep the woofer relatively low in the box and maintain the overall box width near the breadboard value of 13.5".

Woofer

Woofer design shows that you need a net volume of 1.1ft³. Based on an estimate for volume lost to the woofer and the port duct, and allowing a 5% overvolume for bracing, you need a design gross volume of about 1.2ft³.

Midrange

To give the first-order CO a chance, you want to keep the midrange resonance as low as possible; hence, you need a relatively big midrange chamber.

Tweeter

Many tweeters are heavy masses with thin mounting plates. I believe that they will move slightly if exposed to acoustic pressure, and with the short wavelengths and slight tweeter diaphragm motions involved, this hurts the tweeter clarity. Therefore I place the tweeter outside the woofer and midrange boxes.

Port

I am a firm believer in the diffuser port (*SB* 2/81, p. 16, and 2/91, p. 45), which lowers the air velocity at the front of the port and puts it outside the area covered by the grille cloth. I also think the bass sounds better than with a conventional port. Generally, the diffuser port allows you to use a larger-diameter port duct, something we both think is important.

Crossover

It has to go somewhere, and I prefer to have it external to the acoustic portions of the box so it does not affect box volumes, is not subject to acoustic pressures, and can be easily modified. With this project, there are two CO designs you must make interchangeable for comparison purposes. You should also make the L-pad on the tweeter easily accessible.

Bracing

As noted above, I insisted on a front-panel brace that is just above the woofer. Cutting holes in the front panel and then bolting large masses into them makes the panel the most likely to give trouble and therefore the area in need of the most attention. My engineering training won't let me mount the woofer compliantly; I want it tied tightly to the front panel and the panel made rigid around the woofer.

Resorting to thick material for the front panel is an approach I don't like. I believe part of what results in "slow" bass is energy stored in the woofer box. The more mass you put into the walls, the more energy they can store. I prefer reasonable wall thickness with the braces necessary to create a stiff structure.

I also do not like to set the drivers flush into the front panel, as I believe it weakens it at this critical juncture. I handle the fact that the drivers are not flush-mounted in another way, which I'll describe later.

For this project, all panels are 3/4" particle-board. The most important braces you can provide in an enclosure are those tying the opposite walls together so that the box cannot "balloon" with acoustic pressure. The best way to lose all bass punch (i.e., make slow bass) is to fail to tie the two sides or the front and back of the woofer box together.

The simplest way to do this is to tie the opposite surfaces together with wooden dowels that terminate near the stiffening braces

for those walls. For this project, I included dowels from the front panel to the back wall and between the side walls. I would also like to have a dowel between the top and bottom, but the diffuser port and driver depth make this nearly impossible, so you should keep the top and bottom of the woofer chamber relatively small.

Building Limits

There is no sense designing a box you can't build. My building skills are fairly limited, so I build in a way that is tolerant of cutting mistakes. I would rather have no parallel walls in the woofer box, but I can't cope with cutting the angles required to build a pyramid-shaped box. I try to minimize the number of parallel walls while limiting the box to simple angle cuts; i.e., all cuts that are not on a rectilinear X-Y grid on the board's surface are vertical cuts, and all cuts at an angle other than 90° are on the X-Y grid. This makes cutting the boards much easier with a table or radial-arm saw.

Grille Frame

One of my construction limitations is that I can't build grille frames. Thus I make them part of the basic box structure by setting the front panel back a little from the front of the box. I can then simply staple the grille cloth right on the front of the box and cover it with some form of trim strips.

If you want to use another approach, you will have to modify my box design. Based on physical measurements of the drivers, I thought it best to set the front panel back 3/4" so as to have the grille cloth as close as possible to the panel, yet still protect the drivers.

ACTUAL BOX DESIGN

I wrote a BASIC program to design the enclosure. The back of the box is vertical and the top horizontal (*Fig. 24*). The front panel and bottom board are also at right angles to one another, but tipped to provide

for the diffuser at the bottom and to slant the front panel for the proper listening angle. A 2 x 2 board is mounted on the back of the front panel just above the woofer.

The midrange enclosure has a horizontal top mating with the front panel between the midrange driver and tweeter, and a midrange bottom runs from the back of the 2 x 2 front-panel brace to the top of the midrange box at the

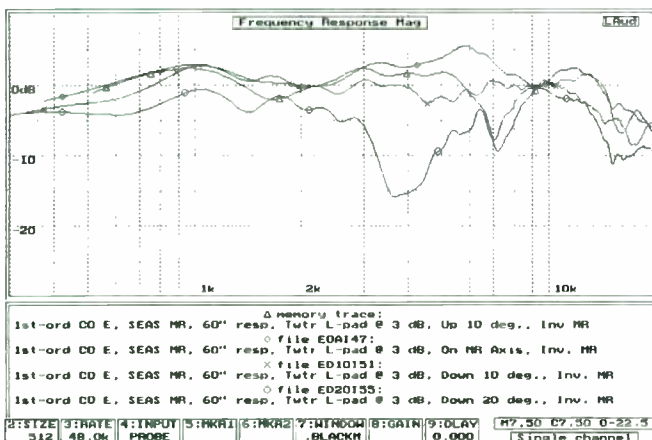

FIGURE 23: Summed responses for first-order crossover—inverted midrange polarity.

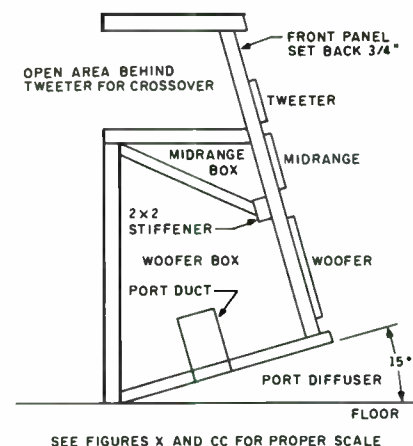

FIGURE 24: Basic internal configuration of box to be used.

DDS•Pro

The New Reference in Digital Playback

Now's your chance to get on the bus... the I²S bus ◀

The first transport to offer the I²S bus digital data output format providing a jitter-free link to Alchemy's DTI•Pro32 or DDE v3.0

Features the new-generation Pioneer "Stable Platter" based engine

All clock signals are generated via a proprietary, high-accuracy, ultra-low jitter (2 pS) internal master reference oscillator

External power supply utilizes four separate transformers and employs 12 low-impedance regulators/buffers to provide filtered, low-noise DC

S/PDIF data – clocked to a master reference oscillator for jitter-optimized output – is provided via BNC coaxial and AES/EBU (standard), or ST glass (optional)

Controller and display interface are each enclosed in their own shielded environments; chassis is resonance damped for additional isolation

Complete with full-function remote control and detachable AC mains cord with integrated line filtering

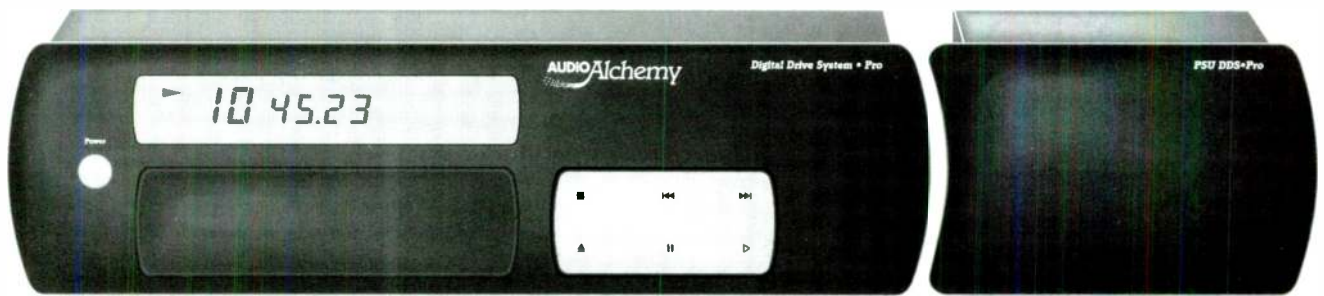

DDS•Pro Digital Drive System
Compact Disc Playback Transport

AUDIOAlchemy

31133 Via Colinas, Suite 111 • Westlake Village, CA 91362 • VOX 818 707.8504 • FAX 818 707.2610
Call for a local dealer near you.

© 1996 Audio Alchemy, Inc. DDS, DTI and DDE are trademarks of Audio Alchemy, Inc.

World Radio History

DEFLEX[®] acoustic PANELS

SPECTRA Dynamics

The simplest and most cost effective way to upgrade your existing system

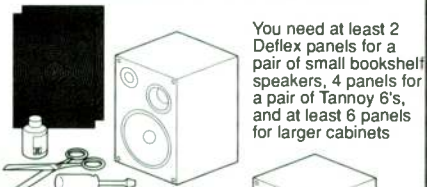

You need at least 2 Deflex panels for a pair of small bookshelf speakers, 4 panels for a pair of Tannoy 6's, and at least 6 panels for larger cabinets

Once you have gained access to the inside of the cabinet, remove foam and/or wool damping from the inside of the speaker (if fitted)



Place the flexible Deflex panel thru' the speaker cut-out and stick to the inside of the cabinet using the recommended adhesive

Now sit back and listen to the extra detail in sound, and far less distortion when played loud

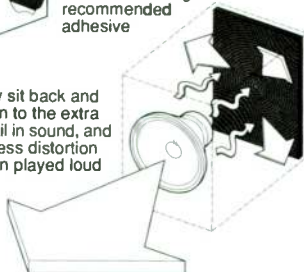

What the experts have to say...

"...a marked improvement was obvious from the first few bars of REM's *Automatic for the people* album..."
Hi-Fi News & Record Review - March 1994

"...Deflex panels seemed to give greater tightness and control, improved internal clarity, and pitch definition - all without deadening the sound in any way..."
Audiophile - January 1994

"...the result was sharper imaging, wider dynamics and a more natural sound..."
CHOICE VERDICT

Sound Quality
 Value for money
 Hi-Fi Choice - January 1994

"...But one thing for sure - the Deflex panels are no gimmick. They work..."
Audio Video - November 1994

Some Of Our Other Products:

- *MIT MultiCaps... Better selection and the best prices anywhere!
- *InfiniCap, Solen, SCR/AEON, Rel-Cap, etc., premium grade film capacitors.
- *Kimber, Cardas, MIT, XLO, Acrotec, ultra high performance chassis wires.
- *Non-inductive wirewound and power resistors from Mills, Caddock, others
- *SOLO Copper Foil Air Core Inductors for no-compromise crossover designs.
- *Cardas, Edison Price, Vampire, XLO, binding posts, banana plugs, etc.

Send for FREE catalog today!

MICHAEL PERCY AUDIO
 P.O. Box 526
 Inverness, CA 94937
 (415) 669-7181 Fax (415) 669-7558

Reader Service #21

back. All this results in the woofer box having only its sides parallel, and makes the midrange chamber a triangular box with small parallel ends. Thus the midrange box is a very stiff structure supporting the front panel.

Early results from the computer program indicated the slant needed for the front panel

8Ω L-PAD MOD

Over a small range of padding, the modified L-pad will be quite accurate in both attenuation and resistance. You must first establish the actual load resistance (R_L and less than 8Ω) and the nominal padding value (PdB) that you will use. You then place a resistance (R_1) across the 8Ω L-pad from input to output and a resistance (R_2) in shunt with the load. Refer to Fig. 25.

PdB = nominal padding value in positive dB

$K = E_{out}/E_{in}$ ratio for PdB padding

R_s = series resistance of L-pad at PdB padding

R_p = parallel resistance of L-pad at PdB padding

R_L = actual load resistance used

R_{in} = input resistance to modified network = R_L at PdB padding

R_1 = resistance added input to output on L-pad

R_2 = resistance added shunting load

$K = 10^{PdB/20}$

$R_p = 8 \times K / (1 - K)$

$R_s = 8 \times (1 - K)$

$R_1 = R_s \times R_L / (8 - R_L)$

$R_2 = R_p \times R_L / (8 - R_L)$

An example of using an 8Ω L-pad with a 6Ω load in the area of 3dB padding:

PdB = 3dB and $R_L = 6\Omega$

$K = 10^{3/20} = 0.7079$

$R_p = 8 \times 0.7079 / (1 - 0.7079) = 19.392\Omega$

$R_s = 8 \times (1 - 0.7079) = 2.336\Omega$

$R_1 = 2.336 \times 6 / (8 - 6) = 7.009\Omega$

$R_2 = 29.392 \times 6 / (8 - 6) = 58.177\Omega$

When the L-pad is set to 3dB, the actual padding is 3dB and $R_{in} = 6\Omega$.

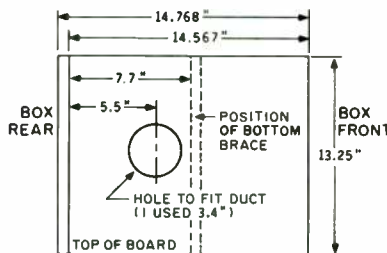

FIGURE 25: Schematic for L-pad modification.

was greater than I had initially estimated, requiring more height on the panel. I therefore had to increase the driver spacings from those I had used in testing: the woofer to midrange center-to-center up from 8.5" to 8.625", and the midrange to tweeter up from 4.25" to 4.3125". Even with these increases, tolerances for attaching things to the front panel were tight.

Two options were available for locating the CO, which consists of two parts. One portion (called the Zobel board) contains the L-pad, Zobel, and padding resistors, and is used with either CO. The second part (called the CO board) is the first-order or third-order CO. One option is to put a portion of the CO in a pedestal below the port diffuser, but I settled on a configuration that extends the height behind the tweeter and puts both CO portions in this area. (Part 2 of this article will deal further with the crossover boards and components.)

INPUT AND OUTPUT

The input to the design program includes the front-panel dimensions, the woofer and midrange positions, the desired woofer volume, the actual 2×2 brace size and its location on the front panel, and the front-panel height in the tweeter area. The program output the size of the various boards, the midrange box volume, the various box dimensions, and the listening angle, which was based on an ear height of 42" back 10' from the midrange driver.

I judged that a vertical height of 6.9" was needed to package the CO. We ran the design program with input data to provide this distance. The resulting design used for this project showed the final listening angle to be down 3.9°. After sketching the box, I concluded I could use a duct up to about 8" long, and that an inside diameter up to about 3.0" was safe.

Part 2 will describe the details of the project's construction.

SOURCES

Liberty Instruments, Inc.
 PO Box 1454, West Chester, OH 45071
 513-755-0252

Kim Girardin
 Homer Rd., Winona, MN 55987

Madisound Speaker Components
 University Green, Madison, WI 53744-4283
 608-831-3433

Trendlines
 American Legion Hwy., Revere, MA 02151
 417-767-9999

Martin Sound Products, Inc.
 Alpha Park, Cleveland, OH 44143-2297
 216-442-2286

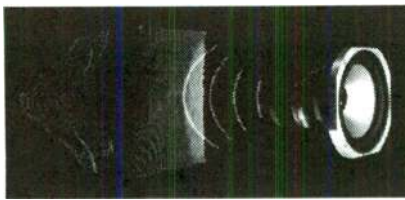

DEFLEX

ACOUSTIC PANEL TECHNOLOGY

TECHNICAL SPECIFICATION

	<i>Standard Panel</i>	<i>Sub-woofer Panel</i>
Material.....	Advanced polymer	Advanced polymer
Colour.....	Charcoal grey	Charcoal grey
Surface emulation.....	Spherical concave	Spherical concave
Defined radius - nominal.	200 mm	300 mm
Focal point - nominal.....	100 mm	150 mm
Thickness at centre.....	5 mm (maximum)	12 mm (maximum)
Max. edge thickness.....	12 mm	12 mm
Overall dimensions.....	280mm x 210mm	340 mm Diameter
Density / hardness.....	1.36 / < 15° A	1.36 / < 15° A
Rebound resilience.....	< 15%	< 15%

GENERAL DESCRIPTION

Deflex acoustic panels have excellent performance characteristics.

The polymer is specially formulated to absorb shock and vibration, thus minimizing cabinet resonances.

The surface emulation has been carefully designed to help eliminate standing waves.

The energy inside the enclosure is controlled - NOT ABSORBED.

"...A marked improvement was obvious from the first few bars of REM's *Automatic for the People* album..."

"...Vocals took on a air of presence that was stunning compared to what had gone before..."

"...Rhythm was more definite and seemed to 'glue' the musical experience together..."

HI FI News & Record Review - March 1994

"...The special surface pattern reduces standing waves to cure boxiness and resonance without killing the vitality of the sound..."

"...expect tighter cleaner bass, crisper articulation, and an increase in liveliness without loss of control..."

"...The result was sharper imaging, wider dynamics and a more natural sound..."

HI-FI Choice - January 1994

"...Deflex panels seemed to give greater tightness and control, improved internal clarity, and better pitch definition - all

" THE ONLY CURE FOR BOX NOISE AND STANDING WAVES "

CURRENT PRICE LIST

Standard Panel @ \$ 11.00 each
 Sub-woofer Panel @ \$ 20.00 each
 We recommend Weldbond as an adhesive.
 Trade inquires welcome!

MADISOUND SPEAKER COMPONENTS
 8608 UNIVERSITY GREEN
 P.O. BOX 44283
 MADISON, WI 53744-4283 U.S.A.
 TEL: 608-831-3433 FAX: 608-831-3771
 e-mail: madisound@itis.com
 Web Page: <http://www.itis.com/madisound>

SHOULD YOU DOWNLOAD YOUR WOOFER?

By Andy Lewis

Some audio systems include a woofer pointing toward the floor. This technique is sometimes referred to as *downloading* or *downfiring* the speaker. Listeners describe the sound of these systems in glowing terms, as if there were an inherent advantage to mounting a woofer in this way. They fail to specify, however, what this advantage is.

After considering this subject, I realized that I had many questions:

- Can this design technique offer better bass with a given woofer?
- Is a downfiring woofer really a selling point?
- What are its disadvantages?
- How far above the floor should I raise the bottom of the enclosure?
- Will a carpeted surface have an effect on its performance?

I decided to perform some simple tests to answer these questions.

DOWNLOADED SYSTEM

Figure 1 shows a traditional, or standard, system with the woofer oriented vertically and affixed to a panel. Figure 2 shows a woofer mounted facing down, or downloaded, and the enclosure supported by non-specific "feet," separating it from the floor. Figure 3 shows the same downloaded system on a carpeted surface, to see what effect this might have on a system's performance.

In these illustrations, the enclosure is a simple sealed box, but in practice, the horizontal orientation is used in sealed, vented, and other systems. Although the measurements presented here are outside the discussion of primary loading methods (sealed versus ported, for example), we will see that positioning a woofer downward can affect your choice of enclosure type.

Three effects of downloading a woofer are: (1) an apparent change in the moving

mass of the cone assembly, (2) a change in the damping characteristics (Q) of the driver, and (3) displacement of the cone assembly due to the force of gravity on the cone mass. While there may be other changes in performance, these three effects lend themselves to easy analysis.

MASS AND DAMPING

When a woofer "fires" into a restricted air space, as in the throat of a horn or in a downloaded system, the result is what horn theorists refer to as a "high pressure-low velocity" situation. This is a fancy way of saying that the air in the vicinity of the cone is moving (wind), instead of merely acting as a medium for traveling waves (sound). As a pressure front travels the length of a horn, of course, it undergoes a gradual transformation to a high velocity-low pressure condition, or sound wave.

In a downloaded system, no provision exists for this gradual transformation from moving air to sound wave. Instead, it is abrupt and unpredictable. We do know, however, that air has mass, which, when moving in conjunction with the speaker's cone, could have the effect of increasing the apparent moving mass of the driver. Horn designers, in fact, often calculate the volume of the air chamber behind their diaphragm expressly to compensate for the added air mass being "dragged" by the cone.¹ In a simple downloaded system, I had expected the result of this added mass to be insignificant, but this was not the case.

Also, as the speaker pushes air back and forth between the bottom of the downloaded system and the floor, energy is lost to friction. Frictional energy losses (damping) in the driver are expressed as Q_{MS} , and Q_{ES} for electrical damping. You would expect this new loss, when added to the soup, to cause a lowered Q_{MS} , which would in turn lower Q_{TS} . A carpeted surface under the speaker might tend to increase this loss and lower Q_{MS} still further.

SETUP

I figured that information about changes in mass and damping would be easy to express in numbers. I chose to measure the effects on

the driver itself, and once I quantified and expressed the effects as a change in the parameters of the driver, then extending them to a finished downloaded system would become no more difficult than in a vertically oriented system. You could simply use these

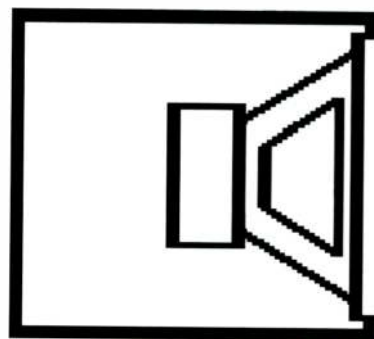

FIGURE 1: Standard vertical configuration.

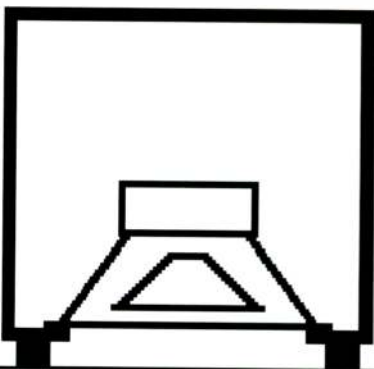

FIGURE 2: Downloaded (horizontal) system.

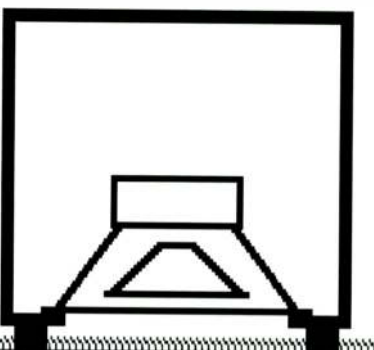

FIGURE 3: Downloaded system over carpeted surface.

ABOUT THE AUTHOR

Andy Lewis lives in Englewood, CO, with his wife Lori and two sons, Corey and Collin. He learned some physics at Hastings College, plays drums professionally in the Denver area, and has a consequent interest in bass guitar speakers. He can be reached by E-mail at Dadbag@aol.com.

amended driver parameters and proceed with a design in the usual way.

Since each design has its own problems, the changes in effective driver parameters would provide an easy way to extend the results into your finished system. Consequently, I chose to measure without an enclosure. I simply mounted a speaker to a baffle, oriented the baffle in different ways, and performed measurements in each position.

I chose an old Electro-Voice 12" woofer I had pulled from an ancient Knight 3-way system. It has a fairly low-moving mass (41gm) and a fairly high Q_{TS} (in excess of .5). These characteristics would make any changes in damping and effective mass more apparent as I made my measurements, as the effects of downloading the speaker would have a larger effect relative to the speaker's inherent mass and damping. A woofer with high-moving mass or a very low Q_{TS} would be less affected on a relative basis than this somewhat underdamped woofer with its low moving mass.

I mounted the woofer in the center of a piece of $\frac{3}{4}$ " particleboard scrap, about 20" x 30" (Photo 1). I soldered a length of zip cord to the terminals, so I could then make my measurements at the end of the zip cord, rather than at the speaker terminals themselves. This would allow me to move the speaker/baffle assembly to different positions as I made the different measurements without adding any wire. Any measurements of Q made with my fixed length of zip cord would reflect the presence of this wire in the



PHOTO 1: Vertical speaker baffle.

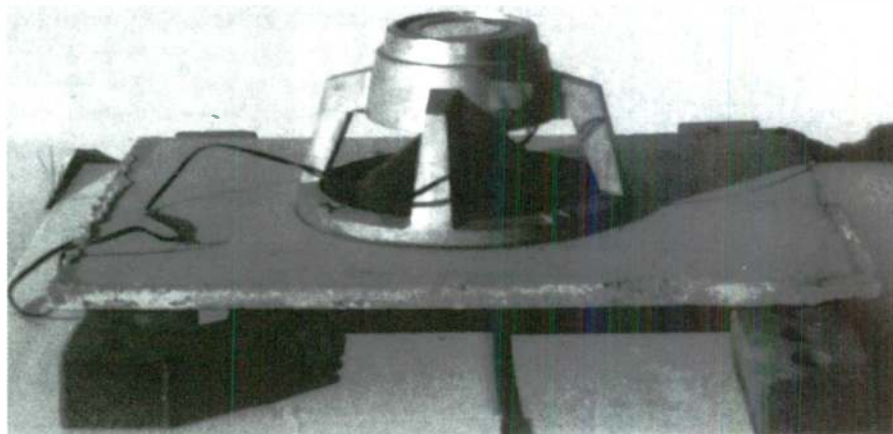

PHOTO 2: Test setup using bricks.

circuit, but the results would be reliable for purposes of comparison.

I could then orient this speaker/baffle assembly in different ways to measure the effects of downloading the woofer. With the speaker placed in different positions, I could isolate the effects of downloading the speaker as I measured the Q and resonance of the woofer.

TESTS

I performed tests with the speaker/baffle assembly in six different positions:

1. With the baffle standing vertically, as in a standard system (Photo 1). This would be the control, against which I would compare other scenarios.
2. With the baffle suspended woofer-down on bricks placed on their sides, one at each corner, with the baffle about $3\frac{1}{4}$ " above a concrete surface. This is the first downloaded scenario.
3. With the baffle suspended woofer-down on bricks lying flat, one at each corner, with the baffle about $2\frac{1}{4}$ " above a concrete surface (Photo 2). This is the second downloaded scenario.
4. With the baffle suspended woofer-down on $2" \times 2"$ blocks, one at each corner,

with the baffle about $1\frac{1}{2}$ " above a concrete surface (Photo 3). This is a more extreme downloaded scenario.

5. With the baffle suspended woofer-down on $2" \times 2"$ blocks, one at each corner, with the baffle about $1\frac{1}{2}$ " above a $\frac{1}{2}$ " thick carpeted surface (Photo 4).

6. With the speaker oriented vertically, but with a mass of modeling clay added to the cone's moving mass, to simulate a mass of moving air, and as a consequence remove frictional loss. This is explained in greater detail below.

These first four positions measure the increasing effects as the baffle is lowered toward the floor. As the tests were run, I hoped a pattern might emerge that would provide a "feel" for what to expect from the downloading technique.

In each of the six positions, I connected a standard impedance-measuring setup and measured the damping (Q_s) and resonance frequencies (f_s). The resonant frequency, of course, is the frequency of maximum impedance in the bass region. Q_{MS} , Q_{ES} , and Q_{TS} figures are derived from impedances measured at several frequencies. I use the standard derivation found in most popular texts.

While these tests give us a generalized

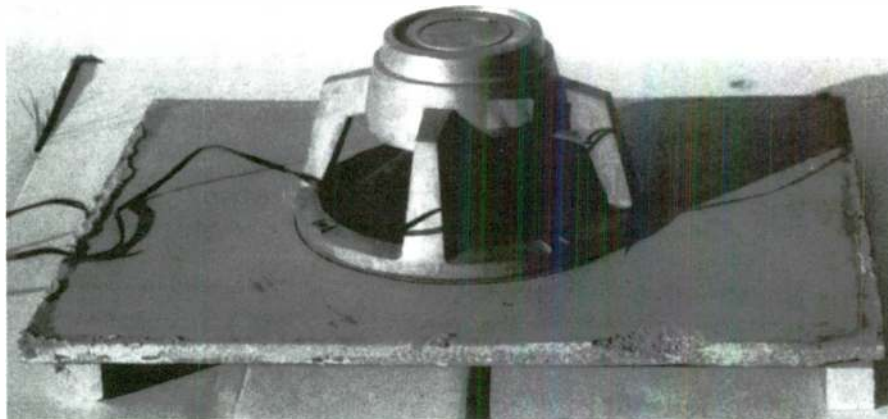

PHOTO 3: Lowering the baffle on blocks.

idea of the effects of downloading, it is important to realize that they should be performed with a setup that more closely approximates the finished system (with a more realistic baffle size and an enclosure). Otherwise, unpredictable results could occur.

RESULTS AND INTERPRETATION

Table 1 shows the measurement results. Please note that column 8, "EBP," lists the calculated "Efficiency Bandwidth Product," which is simply the ratio of f_s to Q_{ES} , for the speaker in each position. This refers to the popular, and very concise, method for evaluating whether a speaker is better-suited for a sealed or vented enclosure.² A rule of thumb states that an EBP around 50 indicates the driver will probably be better-suited to a sealed enclosure, while a value of 100 places the speaker in a vented system.

Interestingly, the change in resonance as the baffle is lowered toward the floor is dramatic. For example, going from 38.3Hz to 33.2Hz represents a change of about 13%! We know that the compliance of the woofer's suspension is unchanged, so the change in resonance must be due to the mass of the air in the vicinity of the cone, as it moves with the cone. We can, in turn, calculate the mass of this air for each test scenario.

An accepted test exists for determining the compliance and moving mass of a driver. When a known mass (such as a lump of modeling clay) is artificially added to a speaker's cone, the resonance is obviously lowered. The amount by which the frequency of resonance changes reveals the speaker's inherent moving mass. If we already know the cone's actual mass, however, we can determine the mass added to the cone.

ADDED MASS

A woofer's moving mass, the change in resonance, the speaker's original resonance, and the known mass of the clay (or air, in this case) are related by the following equation³:

$$M_{MD} = M' / [(f_s / f'_s)^2] - 1 \quad (1)$$

where:

- M_{MD} = the woofer's moving mass
- M' = added test mass of clay (air)
- f_s = speaker's natural resonance
- f'_s = lowered resonance with test mass added.

If we know the speaker's true moving mass, we can determine the mass of the moving air:

$$M' = M_{MD} \times [(f_s / f'_s)^2] - 1 \quad (2)$$

- where:
- M' = the effective mass of air moving with the cone.

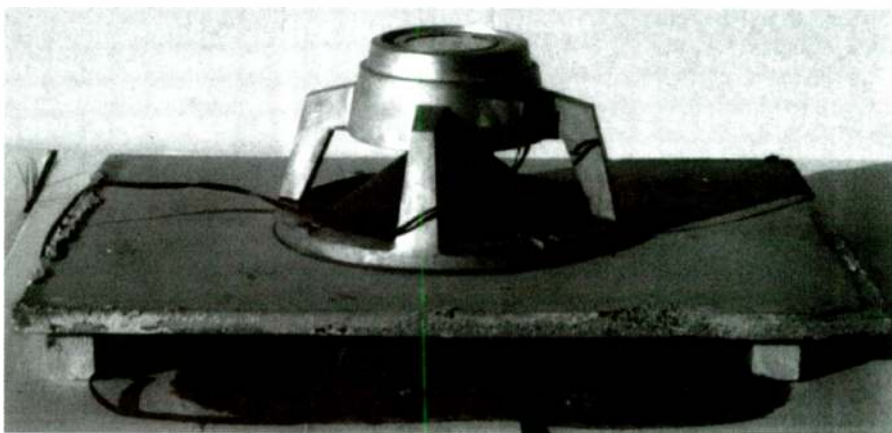

PHOTO 4: Testing the effects of a carpeted surface.

I made these calculations for each of the downloaded test scenarios, using an M_{MD} of 41gm and the relevant quantities in Table 1, and entered in column 7 the apparent mass that has been added to the cone in each case. As the enclosure is lowered toward the floor, the amount of air under the baffle decreases, but the amount of air which apparently moves with the cone increases! I was surprised by the amount the speaker's resonance changed in these tests.

When referring to masses of air, I find it interesting to consider the actual physical volume of the air in question. How much air represents a gram of mass? A typical figure for the density of air at sea level is 1.29×10^{-3} gm/cm³. The volume of a gram of air, then, would be the inverse of this figure, or 775. A gram of air occupies about 775cm³ of space, or about three quarters of a liter!³

Within the context of this downloaded setup, this allows us to calculate, more or less, the volume of air under the speaker actually moving with the speaker's cone. If we multiply the mass of the air moving with the cone (6.99gm, column 7, 2¼" bricks) by the volume per mass (775cm³/gm), we get a figure of 5417cm³, effectively about 5.4 liters of moving air.

Q AND DAMPING

With regard to damping (Q_s), I expected to see a clear decrease in the figures for Q_{MS} as the woofer was lowered. The extra friction should tend to lower the Q_{MS} of the driver as the air is pushed and pulled through the restricted air space. As a general rule, when friction goes up, Q goes down! As Q_{MS} decreases, Q_{TS} decreases as well.

The test results, however, seem to contradict my expectations. Column 4 shows that unless carpet is added under the system to increase friction, the relationship between downloading and Q_{MS} is unclear at best. In fact, the Q_{MS} figures in the vertically oriented system and the very low (1½") example change only from 5.70 to 5.71. The interim examples seem to gyrate somewhat, and no clear pattern occurs.

As friction is increased with the addition of a carpeted surface, Q_{MS} decreases when compared to scenario 4. From earlier experiments, I noticed that adding mass to a speaker's cone generally has the effect of raising both the Q_{MS} and Q_{ES} of a driver. Could it be that the Q_{MS} -lowering tendency of the air friction was being overwhelmed by the Q_{MS} -raising effect of the additional moving mass of the air?

TABLE 1

MASS AND Q TEST DATA							
TEST #	ORIENTATION	F_s (Hz)	Q_{MS}	Q_{ES}	Q_{TS}	G_{MS} AIR	EBP
1	Vertical	38.3	5.70	0.651	0.584	N/A	58.8
2	On 3½" bricks	37.3	5.90	0.676	0.607	2.23	55.2
3	On 2¼" bricks	35.4	5.77	0.683	0.611	6.99	51.8
4	On 1½" blocks	34.5	5.71	0.738	0.653	9.53	46.7
5	1½" blocks, carpet	33.2	5.11	0.749	0.654	13.56	44.3
6	Added mass vertical	34.4	6.09	0.753	0.670	N/A	45.7

TABLE 2

AIR LOADING VS. ADDED MASS							
TEST #	ORIENTATION	F_s (Hz)	Q_{MS}	Q_{ES}	Q_{TS}	G_{MS} AIR	EBP
4	On 1½" blocks	34.5	5.71	0.738	0.653	9.53	46.7
6	Added mass vertical	34.4	6.09	0.753	0.670	N/A	45.7

ORCA Design & Mfg Corp.
1531 Lookout Drive
Agoura, CA 91301 - USA
tel: (818) 707 1629
Fax: (818) 991 3072

ACCESS

by
FOCAL

ORCA is bringing to you from France a whole new and exclusive line of fine drive units specifically designed by Kimon Bellas, ORCA, and by Gilles Brun, FOCAL SA. Why ACCESS ?

Well think of ACCESS as "entry level", "first step". In clear, these drive units have been designed in such a way that any beginner using no other measuring instrument than a set of good ears should have 100% success designing his first system. Indeed most of these units will do great without any X-over part, or at the most with a single inductor. Now don't be fooled, nothing is more difficult to engineer than a drive unit that is easy to use. Experts do know that. And expert designers will be the first ones to dive into the ACCESS catalog !

Also, think of ACCESS as "affordable". That maybe was the toughest challenge for us: to bring you this degree of performance and ease of use at the cost of ordinary paper cone units. We did not cut corners, we cut cost through good engineering. All units feature the finest hand coated paper cones (still an art at FOCAL), alloy cast frame and, needless to say, the legendary quality of FOCAL craftsmanship. The same hands who are making the world renown FOCAL drive units are making your ACCESS drive units.

Makes sense to you ? Call ORCA for your catalog. It includes full description of each unit, large scale curves and graphs, all parameters, and two computer simulated bass response for each ACCESS unit.



- ACCESS 4A Quick, high definition 4" midrange. Wide bandwidth (up to 12 KHz !). A natural and easy match for a highly transparent tweeter. . You pick the frequency and you pick the slope !
- ACCESS 4B Potent & detailed 4" midbass. Clean up to 7 KHz. Very robust low end. Ideal for mini audio-video systems and very small size high quality speakers.
- ACCESS 5A Efficient 5" midrange. Smooth. Superb definition. It needs a good 91-92 dB tweeter for an effective match. Great for surround systems and for high quality high output 3-way designs.
- ACCESS 5B Solid 5" midbass, in the FOCAL tradition. Gentle roll-off around 4 KHz. Like most other ACCESS units, it can be used both in sealed and in vented cabinet designs.
- ACCESS 6A Efficient (92 dB +) and transparent 6" midrange. A single inductor might be all you need to get the quintessence of this beautiful drive unit.
- ACCESS 6B Surprising weight in the low end, which is powerful and well defined. This little woofer does not seem to be much embarrassed by any signal.
- ACCESS 7A Extremely smooth 7" midrange/midbass. Excellent prospect for a simple efficient 2-way bass reflex , It can also be used in surround systems main speakers, with or without a subwoofer.
- ACCESS 7DB Outstanding 7" dual voice coil midbass. Powerful, crisp and efficient, this drive unit will play anything your amplifier will throw with panache and relentless enthusiasm.
- ACCESS 8A Very efficient (93 dB +) 8" midrange/midbass. One of the truly rare 8" that can be used in 2-way designs. You will need a very good and efficient tweeter to match this unit (at least 92 dB/W/m)
- ACCESS 8DB Outstanding 8" dual voice coil midbass. Efficient, smooth and crisp sounding it is also capable of handling large dynamics and true low frequencies with the authority of a much larger woofer.
- ACCESS 10A Impact & dynamics (94 dB/W/m). If a 10" midbass can make it to the tweeter range, this is the one. Its nearly perfect roll-off will allow direct wiring without filtering. Rare unit for 2-way 10" designs !
- ACCESS 10B Deep and musical 10" woofer. Ideal for medium size 3-way systems , with one of the 4", 5" or 6" ACCESS midranges. A classic.

ANOTHER TEST

This apparent conflict between two opposing consequences of downloading the woofer suggested the last test scenario, in which the woofer is oriented vertically, but with extra mass added to the cone to simulate a mass of moving air. By artificially lowering the effective f_s to the point of resonance in the downloaded example, you can effectively remove the frictional loss and measure the effects of added mass independently of the air friction.

Because the speaker is not firing into a restricted air space in this added-mass test, the friction of creating wind under the baffle is removed. Additionally, if you used a test mass similar to one of the previous downloaded examples, this added-mass test could isolate any Q_{MS} -decreasing effect of air friction associated with the woofer's downloading itself. I chose the third downloaded setup (#4) to simulate in this fashion. I simply added the modeling clay to the cone to decrease the resonant frequency to the desired point and to simulate the mass of the added air in the equivalent downloaded setup.

With the speaker oriented vertically and the correct mass added to the cone, I performed the (#6) test (Table 2). The #4 and #6 figures for f_s don't quite match, due to the

limitations of the accuracy of my work and equipment. A difference between 34.4Hz and 34.5Hz is probably less than my measurement error itself, and I chose to ignore it.

But, when you compare the results of these two tests, the frictional loss in test #4 does appear to lower Q_{MS} substantially. When the frictional loss is removed, as in test #6, Q_{MS} is increased from 5.71 to 6.09. In the downloaded system, with the loss in place, Q_{TS} is decreased from .670 in test #6 to .653 in test #4. I characterize this change as substantial. Apparently, the frictional loss associated with downloading itself is significant; however, it tends to be obscured by the more influential effect of an increase in effective moving mass, resulting in a general increase in Q_{TS} when a woofer is downloaded.

EFFECT OF DISPLACEMENT

A woofer in its position of equilibrium, or zero excursion, in a standard vertical orientation (Fig. 4) normally is manufactured with its voice coil centered in the magnetic gap (note the position of the voice coil as indicated by the arrow). One effect of mounting the speaker face-down (or face-up) is that the earth's gravitational field exerts a force on the moving system of the unit, which tends to pull the voice coil out of its centered posi-

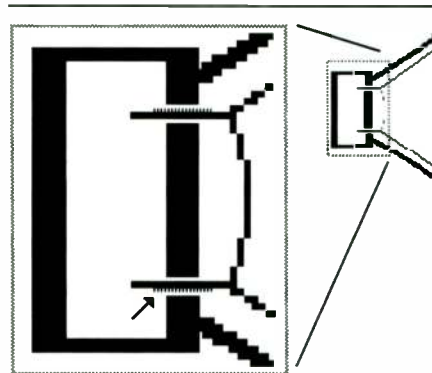

FIGURE 4: Voice coil centered in gap in vertically oriented mounting.

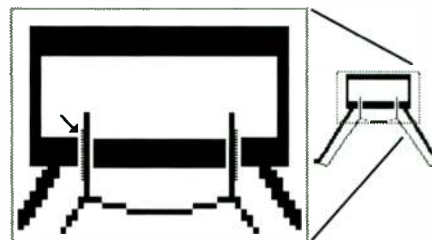

FIGURE 5: Voice coil pulled from center position when mounted horizontally.

tion. Figure 5 shows a driver face-down, with the inset showing the voice coil slightly displaced from center (arrow).

The magnetic field of the speaker's magnet is concentrated in the magnetic gap. The turns of wire that make up the voice coil are immersed in this field. As electrical current passes through the voice coil, the magnetic field exerts a force on each turn of wire. The equation describing the force on a conductor in a magnetic field is:

$$F = Bli \quad (3)$$

where:

F = force on the conductor

B = magnetic field strength

l = length of the conductor immersed in the magnetic field

i = electrical current in the conductor

You can see from this equation that when Bl remains constant, force is proportional to current. The length of the conductor in the field, in the special case of a loudspeaker, is equal to the length of each turn of wire times the number of turns in the gap. As long as the number of turns remains constant, the " Bl product" will be a constant as well, and the speaker will work as it should, with force on the voice coil in direct proportion to current through the wire voice coil.

In extreme situations, when a speaker is required to reproduce signals with long woofer excursions, a voice coil will sometimes move far enough to exceed the length of the windings. This over-excursion causes

FerroSound

The Solution Is Loud And Clear™

FerroSound ferrofluid retrofit kits for tweeter, midrange and compression drivers are now available through the Parts Express catalog. The generic tweeter kit contains a low viscosity ferrofluid in sufficient quantity for most 1" and smaller dome tweeters. Application specific kits for popular professional compression drivers are available for the following models:

Manufacturer	Model
B & C	DE-16
	DE-45
	DE-75
Electro Voice	DH-1A
	NDYM-1
Radian	450, 455
	4450, 4455
	735, 750
	4735, 4750
Eminence	1" exit

**CALL TOLL
FREE**

Parts Express Customer Service
1-800-338-0531

**Parts
Express™**

the number of turns of wire in the gap to be reduced from that when the driver is in its equilibrium position (Fig. 5). When this happens, the BI product is reduced, because as the number of actual turns decreases when excursion is long, the effective length of wire in the field decreases.

As the BI product decreases, the force on the voice coil is no longer in direct proportion to input current, and the performance of the motor is nonlinear, i.e., distortion or breakup occurs. The X_{MAX} parameter describes one-way linear excursion limit.

Small and others⁴ have described "displacement-limited power handling" in terms of the volume of air displaced at maximum linear excursion:

$$P_{AR} = f_3^4 \times V_D^2 / (3 \times 10^8) \quad (4)$$

where:

- P_{AR} = displacement-limited power handling
- V_D = volume of air displaced at maximum linear excursion
- f_3 = 3dB down point

In turn,

$$V_D = X_{MAX} \times S_{SD} \quad (5)$$

where:

- X_{MAX} = maximum linear excursion
- S_{SD} = cone area

Consequently,

$$P_{AR} = f_3^4 \times (X_{MAX} \times S_{SD})^2 / (3 \times 10^8) \quad (6)$$

Actual displacement-limited power handling is proportional to the square of X_{MAX} , so any reduction in X_{MAX} will have a disproportionate effect on actual system power handling. As gravity exerts a force on the speaker's moving assembly, and the voice coil is in turn displaced from its centered position, power handling can be reduced.

POWER-HANDLING REDUCTION

Gravity's force on a speaker's moving assembly is equal to the mass of the moving system times the acceleration due to the earth's gravitational field:

$$F_{MD} = M_{MD} \times g \quad (7)$$

where:

- F_{MD} = force on the moving system in dynes
- M_{MD} = the speaker's moving mass in grams
- g = acceleration due to the earth's gravity
= $9.80 \text{ m/s}^2 = 9.80 \times 10^2 \text{ dyn/gm}$

SILVER STREAK

Silver Streak is the ideal interconnect for all "up-scale" audio applications. It will deliver years of exacting audio performance, that gets you closer to the "being there" experience.

SilverStreak incorporates many advanced KIMBER KABLE technologies, as found in our most costly reference models. Proven tri-braid—VariStrand™ cable geometry, advanced metallurgy and custom Teflon™ dielectrics, synergistically combine to deliver superior performance in a package that's modestly priced.



The heart of SilverStreak features a single AG VariStrand™ conductor, fabricated from hyper-pure silver.

The ground plane is comprised of twin TCSS conductors with all Teflon™ dielectrics.

UltraPlate™ RCA connectors feature precision machined craftsmanship for perfect fit and peak performance.

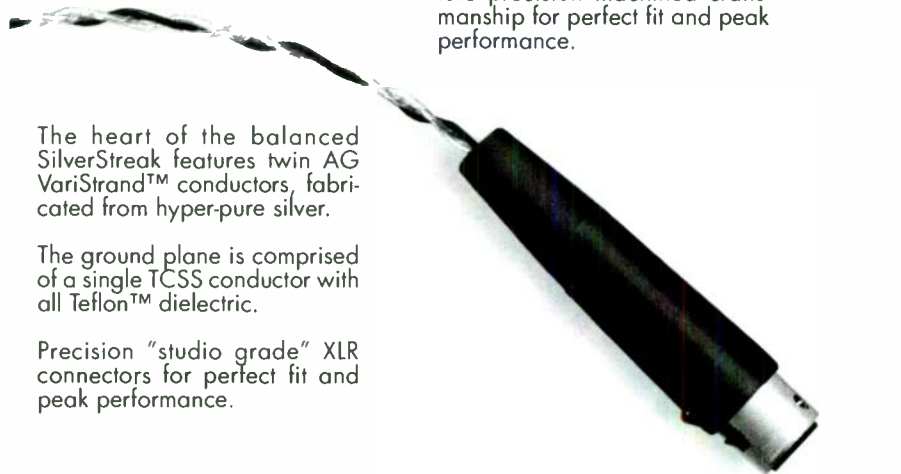

The heart of the balanced SilverStreak features twin AG VariStrand™ conductors, fabricated from hyper-pure silver.

The ground plane is comprised of a single TCSS conductor with all Teflon™ dielectric.

Precision "studio grade" XLR connectors for perfect fit and peak performance.

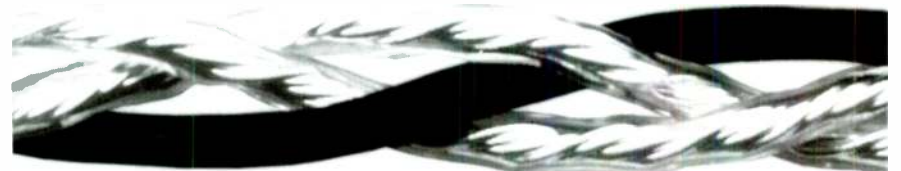

 **KIMBER KABLE**

2752 S 1900 W • Ogden Utah 84401
801-621-5530 • Fax 801-627-6980
www.kimber.com

Reader Service #65

Speaker Builder 6/96 31

Displacement due to gravity then will be equal to the downward force on the cone times the compliance of the speaker's suspension:

$$D_G = F_{MD} \times C_{MS} \quad (8)$$

where:

D_G = displacement due to gravity in cm
 C_{MS} = speaker compliance in cm/dyn

Amended X_{MAX} would then be equal to the original linear excursion minus displacement due to gravity.

$$X_{MAX}' = X_{MAX} - D_G \quad (9)$$

where:

X_{MAX}' = amended linear excursion limit

Since displacement-limited power handling is proportional to the square of X_{MAX} , the factor relating vertical and downloaded power-handling figures will be equal to the square of the ratio of the two:

$$P_{AR}' / P_{AR} = (X_{MAX}' / X_{MAX})^2 \quad (10)$$

where:

P_{AR}' = amended displacement-limited power handling.

TABLE 3

POWER-HANDLING REDUCTION IN SEVERAL DRIVERS

DRIVER	M_{MD} (gm)	F_{MD} (dyn)	C_{MS} (m/N)	C_{MS} (cm/dyn)	DISP (cm)	X_{MAX} (cm)	X_{MAX}' (cm)	P_{AR}' / P_{AR}
Audax HM100XO	3.23	3165.4	0.00225	0.00000225	0.0071	0.23	0.2229	0.939
Peerless 1599	12.2	11956	0.00015	0.00000015	0.0018	0.3	0.2982	0.988
Eton 11-580	23	22540	0.000094	0.000000094	0.0021	0.4	0.3979	0.989
Audax PR300MO	33	32340	0.000264	0.000000264	0.0085	0.44	0.4315	0.962
Dynaudio 30 W-100	35.2	34496	0.000121	0.000000121	0.0042	0.8	0.7958	0.990
Madisound 12204	106	103880		0.00000048	0.0499	0.6	0.5501	0.841
Audax PR380MO	115	112700	0.000062	0.000000062	0.0070	0.38	0.3730	0.964
Madisound 15254	160	156800		0.00000048	0.0753	0.55	0.4747	0.745

Using these equations, along with a speaker's mass and compliance data, you can then see what effect gravity can have on power handling in a downloaded system. Without linear-excursion data (X_{MAX}) for my old Electro-Voice, I used the manufacturer's data for several drivers to calculate the anticipated loss in linear excursion and displacement-limited power handling (Table 3).

In the event you need to determine your own figures, here is the simple mathematical relationship between mass, compliance, and resonant frequency:

$$f_s = 1 / [2 \times \pi \times (M_{MD} \times C_{MS})^{1/2}] \quad (11)$$

You can derive compliance from figures provided for resonance and moving mass:

MCM AUDIO SELECT™
8" Carbon Fiber Woofer
 • Woven Carbon Fiber Cone
 • High Compliance Rubber Surround
 • Rounded Over Front Steel Basket
 • 24Hz-5KHz Response
 • 8 ohm, 75W/150W RMS/Peak Capacity

Save **30%**
 Speaker Builder Readers Only!



You must supply this special price code: **SB33**
 #55-1550
 Reg. \$34.95... Sale **\$24.50**

High Performance Good Looks Great Price!

MCM Electronics is the undisputed leader for supplying top quality speaker components at unbeatable prices. Take advantage of this tremendous offer, available for a limited time, only to Speaker Builder readers.

Call today to order, or for your free catalog...

1-800-543-4330

Authorized Original Parts Distributor
Panasonic
Quasar / Technics
REG / GE
 Premier Distributor

Price effective October 8 through November 23, 1996



MCM ELECTRONICS®
 650 CONGRESS PARK DR.
 CENTERVILLE, OH 45459-4072
 A PREMIER Company

Hours: M-F 7 a.m. - 9 p.m., Sat. 9 a.m. - 6 p.m. EST.

Fast delivery from distribution centers near Reno, NV and Dayton, OH.

CODE:SB33



$$C_{MS} = 1 / [(2 \times \pi \times f_s)^2 \times M_{MD}] \quad (12)$$

Make sure you use consistent units. For example, in Table 3 I converted m/N in column 4 to cm/dyn in column 5. This information indicates that the effects of gravity on voice-coil centering range from significant to inconsequential. The two woofers most affected (the two Madisound models) both exhibit high-moving masses and high compliances, as you'd expect.

Keep in mind that these calculations are parameter related, and indicate nothing about the relative quality of any of the units listed. They may, however, provide an insight into their relative usefulness for downloading.

As a rule of thumb, when evaluating a woofer's suitability for downloading, high mass and compliance are your enemies, if high power handling is a consideration. A high figure for a speaker's X_{MAX} is your friend, as gravitational displacement will be smaller compared with the original X_{MAX} .

CONCLUSIONS

These tests demonstrate that downloading a woofer can change a woofer's apparent parameters. As a system is oriented horizontally and lowered toward the floor, the driver's frequency of resonance decreases due to an apparent increase in moving mass, as air in the cone's vicinity moves with the cone itself. This added mass results in an increase in driver Q_{TS} , which the frictional loss associated with the movement of this air somewhat mitigates.

As the speaker designer, you can anticipate a moderate increase in effective Q_{TS} and a decrease in apparent f_s when you download a woofer. The best conditions involve a woofer with a somewhat low Q_{TS} or one with a somewhat high inherent f_s . In practice, this would suggest a speaker with an EBP that needs to be decreased, or that might become more useful through a reduction in EBP. In addition, using such a system over a carpeted or other "lossy" surface can significantly affect damping, and can lower Q_{TS} , or at least reduce the increase in Q_{TS} .

REFERENCES

1. Abraham B. Cohen, *Hi-Fi Speakers and Enclosures*, Hayden Book Company, 1968, pp. 248-249.
2. Vance Dickason, *Loudspeaker Design Cookbook*, Marshall Jones Co., Third Edition, 1987, p. 5. Attribution to Small.
3. David B. Weems, *How to Design, Build and Test Complete Speaker Systems*, Tab Books, 1978, pp. 73 and 75.
4. Richard Small, and Margolis, "Personal Calculator Programs," *JAES*, June 1981, p. 422.

From this look at the effects on mass and damping, it is clear that to proceed with a design of this type without some careful consideration could produce a system that does not operate as intended. If you capriciously apply this technique to a woofer without accounting for its effects, you'll be working with design goals that could be vague, and achieve an unpredictable result. When carefully used, however, downloading can change effective driver parameters in special cases, i.e., when the driver could be helped by a lower f_s , higher Q_{TS} , or lower EBP.

Another effect of downloading is that the force of gravity tends to pull the voice coil from its centered position, resulting in a decrease in maximum linear excursion for the driver and a decrease in displacement-limited power handling. This effect will vary in importance from woofer to woofer, and will be most harmful in drivers exhibiting high compliance, large moving mass, and short inherent linear-excursion capability. Be sure to evaluate the effect gravity will have on the woofer before choosing your driver.

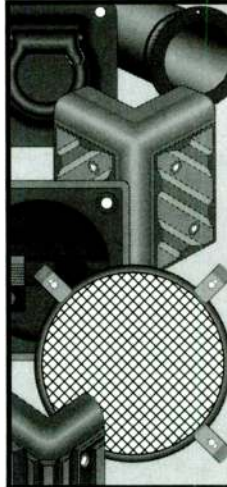

If you build it, it will rock.

TCH offers you the ability to combine state-of-the-art speaker components to design and build your own custom loudspeakers. So whether your speakers will rock concert halls, disco floors or living rooms, TCH has over 500 items in stock and ready for immediate delivery.

1-800-291-0389



1705 Broadway, Buffalo, NY 14212 Fax: 716-892-4362
2955 Congressman Lane, Dallas, TX 75220

- Handles
- Corners
- Speaker Grills
- Casters
- Speaker Carpet
- Clamps
- Jack Dishes
- Feet
- Grill Cloth
- Plugs & Jacks
- (\$50 min. order)



THE AFTERSHOCK SUBWOOFER

By Philip E. Abbate

One night I was screening the *True Lies* laserdisc at theater-reference volume. This means that the *va-room* during the THX logo at the beginning of the disc peaks at 105dB. During a very loud passage, I could swear I felt the house move. I replayed the passage and was convinced that what I felt was in the movie. I mentally noted the time.

I found out the next day that there had been a 2.7 aftershock on the Northridge fault at that moment. Using this information to calibrate the sensation, I predict that my subwoofer (*Photo 1*) could mask a 2.0 Richter-Scale quake at the epicenter—thus the name Aftershock.

My Aftershock subwoofer uses two re-coned, 15" Altec Lansing 421-8H bass speakers in a 111-ltr vented Isobarik cabinet. The Woofer Wizard Subwoofer Crossover (*SB 6/92*, p. 16, Old Colony PN KF-7A) sums left, right, and preamp outputs into a mono feed that rolls off the highs starting at 60Hz, and the lows starting at 18Hz. A vintage Yamaha M4 power amplifier delivers 120W to each driver's 8Ω load. The Wizard's underdamped 20Hz high-pass filter adds 9dB of gain at 20Hz to effect a sixth-order system that cranks out a full 108dB at 20Hz in my living room when placed appropriately in a corner.

A BLAST FROM THE PAST

My circa 1970 Altec woofers (*Photo 2*) are typical of many models from past years and some that are currently manufactured for the professional stage. When a friend dusted them off and showed them to me, I fell in love with them. When he gave them to me, I almost fainted. He knew I would somehow make these beauties sing again.

Everything about the speakers is heavy

ABOUT THE AUTHOR

Phil Abbate, a registered professional electrical engineer, was inspired to build his first speaker cabinet in 1969 when his uncle introduced him to John Karlson, designer of the Karlson enclosure. Phil Abbate's Karlson cabinets were the first in a long line of folded and straight horn speakers built for live-music production and reinforcement. Having taken a break from audio to raise two children and earn B.S. and M.S. degrees, he refound his first love when he discovered *Speaker Builder* three years ago.



PHOTO 1: Aftershock complete.

duty. They weigh 26 lbs each; I can flick the dust cap with my finger without phasing it. Comparing these drivers with today's typical hi-fi models would be like comparing a 1970 Coupe de Ville to a Ford Festiva.

The 421's heavy cast-aluminum frame minimizes energy transfer to the enclosure, and the 1" lip facilitates mating of the two drivers in a face-to-face Isobarik configuration—outside of the enclosure! The driver uses a massive aluminum nickel cobalt (alnico) magnet. The force field this magnet develops, in conjunction with the underhung 3" edgewound aluminum voice coil, makes this a very efficient driver.

The large top plate assures that the voice coil stays in the gap throughout the X_{MAX} excursion, providing superior linearity and low distortion because the coil is always driven by a constant magnetic field. Also, since the coil is totally enclosed by a large amount of steel and the speaker has a rear-vented pole piece, the driver unit has good thermal stability, high power handling (200W all day long), and dynamic capability. The fabric surround keeps the system aligned despite the force the motor can exert, and it should last longer than the generations of Star Trek.

COLLECTING THE FACTS

Initial tests revealed an open voice coil in one of the 421s. I decided to attempt to

design an enclosure with one speaker and then repair the second if necessary. I located Altec Lansing in Oklahoma (of all places) and found out that ElectroVoice had absorbed its pro-audio division. Steven Upchurch, an original Altec employee from California, was kind enough to provide me with the specifications for the 421-8H and its near twin, the 421-LF. He told me that if I wasn't satisfied with the 421-8H, I could re-cone the blown speaker with 421-LF parts, which would fit the 421-8H frame.

I measured my working 421-8H's Thiele/Small param-

eters using the constant-current method as described in *Bullock on Boxes* (from Old Colony, PO Box 243, Peterborough, NH 03458, 603-924-6371, FAX 603-924-9467, #BKAA8). The factory specifications, my measurements, and the averages I used for input into the modeling programs appear in *Table 1*.

PRELIMINARY DESIGN HOMEWORK

To design a box of appropriate size, I used my 421-8H's f_s and Q measurements with



PHOTO 2: Altec 421 drivers.

TABLE 1

SPEAKER PARAMETERS

REF:	1	2	3	4	5	6
f_s	31.5	27.5	44.23	34.4	34.7	34.5
V_{AS} (1)	361	569	258	139	181	80*
Q_{TS}	0.25	0.25	0.4341	0.47	0.524	0.497
Q_{ES}	0.27	0.28	0.534	0.548	0.61	0.579
Q_{MS}	2.6	2.75	2.323	3.29	3.71	3.5
X_{MAX} (mm)	13.	13.	13.	13.	13.	13.
SD (cc)	858	858	858	858	858	858
R_E (Ω)	5.5	5.5	5.3	5.1	5.1	5.1

1 = Factory, 421-8H
 2 = Factory, 421-LF
 3 = My 421-8H
 4 = First 421-LF recone

5 = Second 421-LF recone
 6 = Values plugged into BoxModel

* Average/2 used as Isobarik V_{AS}

the 361-ltr V_{AS} supplied by the factory as input to Ralph Gonzalez's LMP box program (shareware downloaded from the Madisound BBS). LMP determined that the size of an optimal SBB4 aligned ported box was 303 ltr for an f_c of 71Hz and an f_3 of 72Hz.

LMP also suggested larger, refrigerator-size boxes for other ported alignments, which in my estimation would yield equally disappointing bass. LMP predicted that a 204-ltr closed box would have a poor f_c of 44.2. Looking at the massive driver and doubting LMP's prediction, I confirmed

LMP with Boxmodel V2.1 (Old Colony SOF-MOD3B5G) and concluded that the 421-8H would not produce sufficient quantities of bass under 30Hz to satisfy my subwoofer requirements.

What bothered me most was that my f_s and Q measurements were significantly different from Altec's specs, which made me also suspect its V_{AS} specification. I thought the drivers' Thiele/Small (T/S) parameters might have changed in use or in its ten-year hibernation three miles from a Southern California beach. I just couldn't believe that this beautiful massive driver was unable to

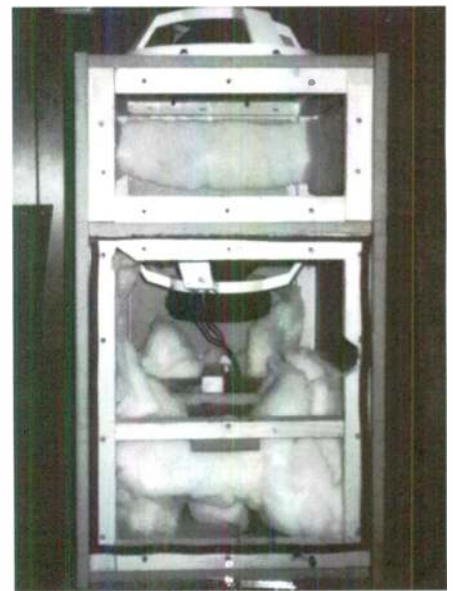

PHOTO 3: Prototype design.

produce more low bass than the 8" Focal drivers currently in my system.

At this point, I decided that since I had not yet invested any money, I could afford to buy a 4' x 8' piece of MDF, build the largest box possible from it, measure V_{AS} , and listen to this driver. The prototype box (Photo 3) would be 166 ltr and measure 18" x 24" x 33".

The Source for Pro Sound Speaker Builders



Loudspeakers, Drivers, Horns, Tweeters, Crossovers, Hardware, Connectors... and much, much more!
 Image delivers virtually every component for the speaker builder.
 See for yourself. Call or FAX for your FREE catalog today!

image
COMMUNICATIONS

5235 W. 65th Street • Unit D • Bedford Park, IL 60638
 1-800-552-1639 • Phone (708) 563-4950 • FAX (708) 563-4956

EMINENCE
 Loudspeakers, Drivers,
 Diaphragms and Recone Kits

Electro Voice
 Recone Kits

McCauley
 Loudspeakers & Drivers,

Acoustician
 Drivers, Horns, Tweeters,
 Diaphragms & Crossovers

Waldom
 Audio Products
 Hardware, Connectors, Etc.

I continued to wonder what would happen to my design by plugging the factory specs for the 421-LF into Boxmodel using a constant 166-ltr volume and evaluating closed-box and various ported and Isobarik alignments. My Isobarik evaluation assumed I would compound-load the two drivers face to face, and that V_{AS} for the pair would be half the average of the two V_{AS} figures.

At this point, I must admit, I had not realized what a sixth-order alignment could do for me, so the best I could do was synthesize a couple of Isobarik ported alignments with the 166-ltr box that extended to 20Hz. The output level was attenuated about 9dB at 60Hz and falling rapidly. I reasoned that, since I would cross over the subwoofer below 60Hz and the Altecs' efficiency was relatively high, I would be able to realize a believable 20Hz sound-pressure level out of a 166-ltr box.

At the time I was designing my 166-ltr prototype box, I was intrigued by Matt Federoff's birdhouse ("The Birdhouse: A Sound Reinforcement Subwoofer," *SB* 2/94, p. 36). Matt's Carvin driver was similar to my Altec. Augspurger's recommendation that bass enthusiasts interpolate the designs in his article ("More About The Birdhouse Bandpass," *SB* 4/94) influenced me to make

a modular prototype box approximately the same size as Federoff's. What's more, the modular design of my box would be suitable for measuring V_{AS} .

PROTOTYPE ENCLOSURE

With Aftershock's modular enclosure, I could experiment with the Altecs in a variety of configurations. The enclosure had a 55-ltr chamber and a 111-ltr chamber with removable side covers, and a baffle board with a hole in the center to fit an Altec, dividing the enclosure into two sections. The outside end of the 55-ltr section eventually evolved into a second baffle, with a hole cut to fit an Altec.

The test enclosure enabled me to measure V_{AS} , which appears in *Table 1*. My experimental configurations are listed below.

- Fifth-order bandpass with a sealed 55-ltr box firing into a 111-ltr ported enclosure, and a sealed 111-ltr enclosure firing into a 55-ltr ported enclosure.
- Sixth-order bandpass with both the 55 and 111-ltr ends ported.
- Sealed 55, 111, and 166-ltr enclosures.
- Ported 111, 55, and 166-ltr enclosures.
- Ported Isobarik with 111-ltr volume and the 55-ltr volume acting as a compression chamber.

Since Aftershock was going to a cutoff below 70Hz, I figured that configurations with the rear of the Altec firing out into the room or into an uncovered chamber would not sound much different than the typical subwoofer configuration with the front of a driver firing into a wall or the floor.

CONSTRUCTION

I used the butt-joint, screw, glue, and batten construction technique to build the prototype (*Photo 3*). I ripped kiln-dried 2" x 4" studs into three equal strips on the radial-arm saw and used them for the battens. All the sides were anchored to the battens with screws piercing the 3/4" medium-density fiberboard (MDF).

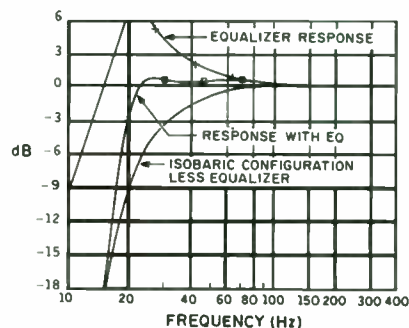

FIGURE 1: Sixth-order design.



MONO BLOCK

An amplifier with an attitude!

AMPLITUDE

Class A/AB, dc coupled, amplifier with J-fet input in a cascoded differential voltage gain stage. Starting at \$395.00 ea.

2575 28th St. S.W.

MENISCUS

Wyoming, MI 49509

619-534-9121

fax 616-534-7676

email meniscus@iserv.net

I cut the panels for the box with a 7.25" circular saw because the wood was too large to control on the radial-arm saw table.

To assemble the prototype, I laid the two largest pieces (32" x 18") across the sawhorses and clamped glue-coated battens to the sides, 3/4" from the four edges. Once I'd set a batten with clamps, I flipped over the MDF sheet and screwed it to the batten with 2" drywall screws. I also installed a batten for attaching the parting baffle.

Next I cut the three 24" x 18" pieces. I selected one as the parting baffle, cut the speaker hole in it with a jig saw, and installed T-nuts so I could easily remove and replace the driver. I installed two battens 3/4" from the edges of all three of these pieces on the 24" sides. I then glued and screwed the two 18" x 24" sides and the 18" x 24" parting baffle to the two 32" x 18" pieces. I glued and screwed the 24" x 32" back to the framework of battens, which completed the box except for the side covers. All the screws pierced the MDF, anchoring it to the battens.

I attached the removable side covers with T-nuts, laying the covers into the cabinet and drilling slightly undersized pilot holes through the covers into the battens to be sure the holes registered with the T-nuts.

Removing the covers, I held each T-nut behind the batten and threaded an oiled 1/4" cap-head screw with a washer on the cap side into the T-nut. I tightened the cap-head screw with an allen wrench, pulling the T-nut into the undersized pilot hole and thus seating it into the batten. When all the T-nuts were seated, I attached a 1/2" strip of adhesive-backed, open-cell weather strip to the batten to seal the cabinet when I installed the side covers. Finally, I sealed all of the internal batten joints with 100% silicon sealant.

INITIAL TESTS

I installed the original 421-8H in the center baffle and sealed the side cover of the 111-ltr chamber. I then measured the original 421-8H's T/S parameters in the sealed box so I could calculate V_{AS} using the closed-box method described in paragraph 8.70 of Vance Dickason's *The Loudspeaker Design Cookbook*.

Before taking serious measurements, I swept the cabinet with sine waves from 15Hz to 1kHz to check the test box for rattling or buzzing noises. I also checked for air leaks using a 30Hz tone to excite the cabinet, and running the flame of a lighter along all the joints. Since the flame was not disturbed, I was sure there were no air leaks. I found f_c

TABLE 2

BOXMODEL INPUT PARAMETERS

F_S	35.4Hz	V_B	111
V_{AS}	80.0 ltr	F_B	25.5
Q_{ES}	0.579	Filter order	second
Q_{MS}	3.500	Cnr	20Hz
R_E	5.1 Ω	Dmp	0.4587
S_D	858	Vent diameter	10.6cm
P_E	200W	Vent length	29.9cm
X_{MAX}	7.1mm		
Q_{AS}	28		
Q_{LS}	14		
Q_{PS}	28		

with the box sealed, remeasured the Q_s in the box, and calculated V_{AS} .

I couldn't wait to listen to the speaker, so I rigged up a 12dB/octave LP crossover using a handy 13mH choke and 75 μ F capacitor, and connected the sealed cabinet and crossover across the left-channel output from my amplifier. The sub's output was 3dB more efficient than the pair of Focal 8V01/4 and T90Ti 91dB+ satellites, but subjectively no bass extension was added to the soundstage.

I decided to port the enclosure to squeeze some low bass out of the subwoofer and measure V_{AS} with the vented-box method to

HIGH PERFORMANCE ELECTRONIC CROSSOVER NETWORKS THESE COMPONENTS AVAILABLE FULLY ASSEMBLED OR AS KITS

XM9 Crossover Network • 24 dB/octave slope • fourth-order constant-voltage design • Outputs in phase • Low noise • Controls on circuit board or panel • Settable crossover frequency from 20-5,000 Hz.



XM16 Crossover Network • 48 dB/octave slope • Eighth-order constant-voltage design • Outputs in phase • Low noise • Controls on circuit board or panel • Settable crossover frequency from 20-5,000 Hz.



XM26 Tube Electronic Crossover provides smooth tube audio, fourth-order design, 24 dB/octave slope, for both channels. Includes time-delayed power supply for long tube life and no transients during power-on/power-off. Plug-in frequency modules set crossover between 20 and 5,000 Hz. Quality components throughout. (Shown with cover removed.)

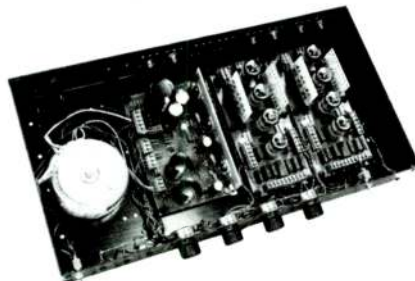

PS24 Open Frame Power Amplifier Power supply with toroidal power transformer, rectifier, and one or two PM21, PM22, or PM23 (MOSFET) Power Amplifier Modules—all in one compact, power package!



PM21 and PM22 Power Amplifier Modules provide 75 watts RMS into 8 ohms • Complementary Darlington output stage • Integrated-circuit driver circuit • Over-current and over-temperature protection • Class A or Class AB operation. (PM22 shown.)

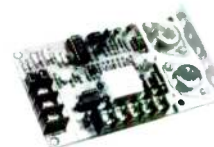

WRITE NOW FOR FREE LITERATURE ABOUT THESE AND OTHER MARCHAND PRODUCTS

SEND YOUR NAME AND ADDRESS TO: MARCHAND ELECTRONICS, INC.
P.O. Box 473 • WEBSTER, NY 14580 • PHONE (716) 872-0980 • FAX (716) 872-1960
Web Page: <http://www.marchandelec.com> E-mail: phil@marchandelec.com

confirm my closed-box method measurements. To port the enclosure, I removed the side cover and used my radial-arm saw to cut a hole $\frac{1}{16}$ " smaller than the 3" diameter shipping tube I intended to use as the port.

I used a razor to scribe a line around the shipping tube $\frac{3}{4}$ " from the end, and peeled off layers of cardboard until the end of the tube would fit into the hole in the baffle. The uncut end butted up against the baffle, sealing the hole. My initial experiments had the tube on the outside of the cabinet to facilitate rapid adjustments and A/B testing. I used a pair of 5"-long 3"-diameter tubes to measure F_{1H} , F_{1M} , and F_{1L} , and calculated V_{AS} using the vented-box method. As I suspected, the average measured vented/closed box results for V_{AS} (Table 1, ref 3) were very different—fortunately for the better—from those specified by the manufacturer.

I used my new V_{AS} value and Boxmodel to calculate suitable vent lengths, and tried various arrangements of bandpass designs, but was not satisfied with the sound. Using the signal generator, I could generate 110dB SPL at 25Hz in a standing wave peak, but while this sub was connected to the same amp that was driving my satellite, there was no apparent extension to the sub bass—just an increase in volume of the mid bass, which was completely rolled off at around 40Hz.

NEW LIFE

I called Eddie's Re-Coning Service (840 Cypress Ave., Los Angeles, CA 90065, 213-221-3714) and talked with Chico, who had been re-coning speakers at Eddie's since the business opened. He listened to what I wanted to do to the speaker and said, "Trust me—you will like it when I'm done!" He re-coned

the blown 421 with the cone/surround (Waldom pn w5758) and spider kit for the 421-LF, as both the 421 and 421-LF use the same voice coil.

The cone on the 421-LF is heavier than that of the 421-8H's, and the suspension is not as stiff. A popular misconception these days is that a very light cone is necessary to attain adequate speaker speed. In general, this is true, but the transient response of woofers with heavy cones, coupled with very large and powerful magnets, can attain the same speed as lighter cones coupled with less powerful magnets.

I broke in my new re-coned speaker by running 20Hz through it for a day. It measured as far from the factory 421-LF specifications as the 421-8H did (Table 1, ref. 4). Some Boxmodel plots I ran with the measured parameters looked much more promising than the previous plots.

I used Boxmodel to align the enclosure with the 421-LF. The new speaker and alignment were much better, but it still was not what I wanted.

BIAMPING AND EQUALIZATION

I decided that I needed to biamp the system to achieve my goal. I removed a 90W amplifier from a powered subwoofer and used it on the 421-LF in the 111-ltr ported prototype cabinet. The powered subwoofer amplifier allowed me to sum left and right channels and adequately roll off the highs. It also let me compensate for the efficiency differences between the sub and the satellites.

I liked the resulting big, powerful bass and listened to it for weeks. Eventually becoming critical of the sound, I felt the extreme low registers were lingering longer

than the signal was present at the source. This was especially evident on TKO, track 8 on Dave Grusin's *Migration* CD (GRD-9592). I suspected that something other than the low-pass filter, L/R summing, and gain control was responsible for the improvements I heard. I decided to measure the transfer function of the powered subwoofer amplifier.

The input-to-output measurements revealed some serious (+14dB @24Hz) shelving EQ was being applied below 70Hz. There was no apparent rolloff other than the amplifier's inability to work to DC. Now that I knew equalization was responsible for my success, I noticed in *Stereophile* articles that top-of-the-line Infinity, B&W, and Genesis speakers used active bass equalization, and that with Boxmodel I could design systems using B6 alignments.

I synthesized the design shown in Figure



PHOTO 4: Aftershock in position.

BassBox 5.1 for Microsoft WINDOWS™

Design low-frequency loudspeaker enclosures fast and accurately with BassBox software. Uses both Thiele-Small (F_s , Q_{ms} , V_{AS} , η_0) and Electro-Mechanical (Q_{ES} , Q_{MS} , CMS , MMS , RMS , BL) parameters with equal ease.

Copyright © 1996 by Harris Technologies. All rights reserved worldwide. BASSBOX is a trademark of Harris Technologies. Other trademarks are the property of their respective companies. Computer and loudspeakers not included.

Box Design Software with huge loudspeaker database.

- ◆ Easy to use
- ◆ On-line help
- ◆ Hi-res mode
- ◆ Low price

Design Types:
 Optimum Vented
 Extended Bass Custom Vented
 Band-Pass with Double or Triple Chambers
 Passive Radiator
 Optimum Closed
 Custom Closed
 All designs can use multiple woofers (including Isobaric)

Design Options:
 Small and large-signal analysis. Examine one loudspeaker in several different boxes or... Examine several different loudspeakers in the same box. 6 graphs: normalized amplitude, 2.83-V amplitude, acoustic power, impedance, phase and group delay. Advanced vent calculator. Advanced box dimension calculator w/ 18 volume shapes. Accepts loudspeaker measured acoustic response. Accepts automobile or listening room interior acoustic response. Use English or metric units. Save and recall designs.

Built-In Test Procedures:
 Test and calculate loudspeaker parameters*
 Test and calculate passive radiator parameters*
*Requires basic test equipment: sine wave generator, frequency counter, power amplifier, 1 kohm resistor, voltmeter, ohmmeter, test box.

\$99.00

plus \$6.00 S&H
(Canada +\$7.00)
(Overseas +\$13.00)

Tel: 616-641-5924
Fax: 616-641-5738
 Email: 72674.514@CompuServe.com

Harris Technologies, Inc.
 P.O. Box 622
 Edwardsburg, MI
 49112-0622 U.S.A.

Also available:
X-over 2.1 passive crossover program for Windows.
X-over calculates the component values for 1st, 2nd, 3rd and 4th-order 2-way and 3-way networks, load compensating networks and L-pads. Regular price: \$39. (\$29 if purchased with BassBox.)

Minimum System Requirements:
 MS-DOS 5.0 Microsoft Windows 3.1 & compatible computer (386 or better CPU with at least 4 MBytes of RAM), 75 MBytes of free hard disk space, 1.44 MByte 3.5" disk drive and mouse.
 Harris Technologies reserves the right to make changes without prior notice.

I by entering the parameters in Table 2 into Boxmodel. Rather than build an electronic crossover, I bought Dan Ferguson's Subwoofer Wizard, tuned it by injecting a 20Hz signal (you can use the signal from any of the test CDs if you don't have a signal generator) and adjusted the frequency pot until the output peaked. I then adjusted the damping pot for the maximum (9dB) gain.

I connected the output to one channel of a Yamaha M4 power amp and auditioned the system. The sound was much more extended and controlled than with the shelving equalizer from my commercial subwoofer amplifier. I could now hear the individual plucks on TKO. I attribute the improvement to the high-pass action of the B6 alignment and the application of the EQ to only the lowest frequencies. The Subwoofer Wizard also had a steeper rolloff on the high end, which made it much more difficult to hear the placement of the subwoofer's location in the room.

To complete the biamping, I installed capacitors in series, with the input to the power amplifier driving the left and right satellite speakers. I determined the capacitor value using the reciprocal of $(2\pi) \times$ (crossover frequency) \times (amp input Z), assuming the specified input impedance of the amplifier was accurate. I fine-tuned the value by measuring the amplifier output and noting the -3dB power point at 70Hz. I matched the 70Hz -6dB filter by adjusting the LP control on the Subwoofer Wizard to 50Hz with a test tone and finding the -3dB point.

I then fine-tuned the crossover by ear. I tweaked the filters until I could turn up the volume without the 8" Focal 8V01/4 woofers bottoming out and the subwoofer putting out incredible bass. A great test for low bass is the title track of Bela Fleck's "Flight of the Cosmic Hippo" (Warner Bros. 9-26562-2). At this point I was satisfied, and over the next couple of months I listened to my CD collection, caught up on my laserdisc movie watching, and found the perfect location for the subwoofer.

IN SEARCH OF THE SWEET SPOT

My criteria for locating the subwoofer in my listening room were:

- to minimize perceptual localization of the sub-bass emanations;
- to maximize the excitation of all room modes so as to have as many standing wave peaks at as many frequencies in as many places as possible;
- to find a location my family could live with.

I read Tom Nousaine's "Subwoofer Secrets" article (*Stereo Review* 1/95, p. 97)

and decided I would place my sub in my two favorite listening positions and then walk around the room, determine the hottest spots, and try the subwoofer there. Nousaine's theory is that the generation of standing waves would reciprocate as the listening position and the subwoofer were exchanged, and exciting my room this way seemed to work.

Using a bass warble-tone CD track, I found the best spot in the room was in front of the main entrance to my house. When my wife came home and saw this, her patience evaporated and she said, "Either your subwoofer goes, or I go!" (I'm gonna miss her.)

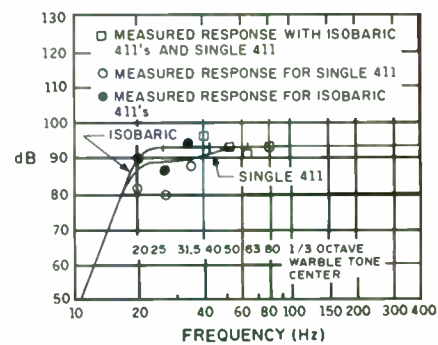

FIGURE 2: SPL predictions and measurements.

IN STOCK

quality \ 'kwäl - et - ē \ noun

- An inherent and essential feature or element:
exhibiting a degree of excellence and superiority.
syn. see Mouser Electronics

Call for your
FREE 332
page catalog
TODAY!

67,092 Products
126 Manufacturers

All Orders Ship Same Day



- Passive Components
- Semiconductors
- Electromechanical
- Connectors/Cable
- Surface Mount and Through Hole

MOUSER[®] ELECTRONICS

800-992-9943

FAX: 817-483-0931

<http://www.mouser.com>

sales@mouser.com

958 North Main St., Mansfield, TX 76063

Reader Service #30

Speaker Builder 6/96 39

I tried a corner at the rear of the room, and for a while I thought I could tell the sound was coming from the corner. However, after surprising several people who listened to the system without knowledge of the subwoofer or its location, I was convinced there was no problem (Photo 4).

COOL SYSTEM IDEAS FROM DRIVER DESIGN

A tight little 6-liter vented minimonitor with the V5/12R 5-1/4" midbass plus your favorite 90-dB tweeter! Xover 3.0-3.5 KHz

A sweet but tough 10-liter sealed-box surround/satellite with the V6/20 6-1/2" midbass and your favorite 89 dB tweeter! Xover 2.5-3.0 KHz

A high-powered compact 96-dB stage cluster with four V6/20s and a Peerless 100HT horn tweeter! Xover 3.0 KHz

THERE'S SO MUCH YOU CAN BUILD WITH DRIVER DESIGN SPEAKER COMPONENTS! JUST CALL AND ASK US HOW!

Free applications assistance for your design ideas using Driver Design components

Driver Design
The American Alternative
 Phone: 510-370-1941
 E-mail: DDL111@AOL.COM

Reader Service #42

ISOBARIK

I returned to the re-coning shop and left the working Altec 421-8H also to be re-coned as a 421-LF. I installed the second 421-LF in the end of the 55-ltr chamber (Photo 2). This resulted in one Altec's rear, loaded by the 111-ltr ported enclosure, firing into the 55-ltr chamber, and the second Altec's front firing into the dacron-lined 55-ltr chamber, with its rear facing outward. The 55-ltr chamber was sealed to form an Isobarik or constant-pressure zone between the two speakers that were driven out of phase. I used Boxmodel again, with the values shown in Table 1, reference 6, to design new porting for the Isobarik box (Fig. 2).

I tested the response with the *Stereophile* test-CD warble tones and a Radio Shack SPL meter, and the measured results were as good as Boxmodel's prediction (Fig. 2). The Isobarik implementation notably increased the dynamic response as well as the bass extension, which was probably due to halving the V_{AS} . This let me align the system at a lower frequency, and the dynamic increase was probably due to the doubling of the power, since I was now running two 120W amplifiers into two 8Ω voice coils.

With Aftershock in the corner, my Radio Shack meter registers 108dB at the

listening position with the 20Hz warbles from the test CD before my M4 amp begins to clip. I was so pleased that I moved the ports inside the box, stuffed it with dacron, and listened to this configuration for several months.

REMODELING

I decided to remodel the prototype to improve its look. I needed to eliminate the second chamber, make a baffle strong enough to mount both the Altecs face-to-face, thicken the box to reduce cabinet reso-

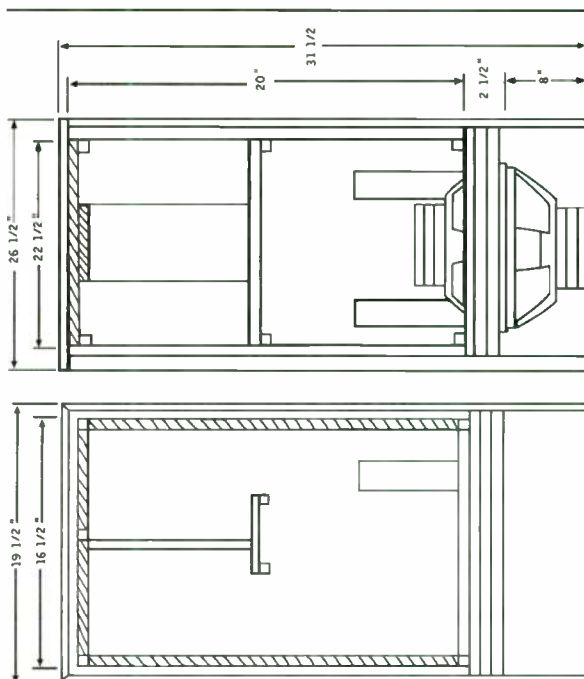

FIGURE 3: Adding more MDF.

Sound Technology **Spectra Series PC-Based SoftTest**

File Edit Mode View Options Utilities License Window Help

Play Stop Avg: 2 Peak Hold 0.00 0.00

Transform Your PC Into A Powerful Spectral Measurement System

Sound Technology, Inc. leader in test & measurement for the past twenty-seven years is pleased to introduce the next generation in Windows-based data acquisition and dynamic testing.

Spectra SOFTest - easy to use, fast, advanced, real-time Windows interface; Spectra was designed for you! Our new 32-bit modular architecture runs 200% faster than 16-bit programs and allows add-on options and future enhancements to be added.

Equip yourself with our latest SOFTest to meet all your testing requirements. To test drive a fully functional version, download a copy from our BBS, visit our Web Site or call one of our Sales Engineers today to find out how our revolutionary Spectra Series can help you solve problems faster and increase your productivity.

- SpectraRTA v1.32
- SpectraPRO v3.32
- SpectraPLUS v3.16
- SpectraLAB v4.32

Affordable Data Acquisition from \$395 to \$4995

Dynamic Testing For The Real World

- Dual Channel FFT (up to 65K)
- Decimation, Overlap, Triggering
- Octave scaling from 1/1 up to 1/24
- Real-Time, Record, Post Process
- Spectrum, RTA, Phase, Time Series
- 256 Color 3-D Spectrogram, 3-D Surface - Waterfall Views
- Distortion Analysis
- THD, THD+N, IMD, SNR, MultiTone
- Real/Complex Transfer Functions
- Frequency, Phase, Impedance Plots
- Coherence, PSD, Integration
- Advanced Signal Generation
- Dynamic Data Exchange (DDE)

Stopped Real Time 44100 Hz 16 bit, Stereo FFT: 65536 pts Blackman

SOUND TECHNOLOGY
 Instrumentation & Automation
 1400 Dell Avenue Campbell, CA 95008
 FAX: 408-378-6847 BBS: 360-779-6846

Call Now To Order 1-800-401-3472

Web: soundtechnology.com Email: info@soundtechnology.com

VISA
MasterCard

Reader Service #20

nance, permanently close up the side covers, and beautify the cabinet with red-oak veneer and trim strips.

I decided to have the second layer of MDF overlap the baffle enough to cover the protruding Altecs. The driver end was open, facing the wall in the corner. The design would also support standing Aftershock on end, with the speaker pointing downward on an added 2" x 4" frame stand.

Working on a sheet of scrap carpet to prevent damaging the cabinet, I cut the 55-ltr chamber and the parting baffle out of the prototype using a jig saw. I flattened the MDF and batten surface where the parting baffle had been with a belt sander using 36-grit paper. I cut three new 18" x 24" MDF sheets, cut the holes for the speaker and ports in each, and recessed the inside piece to accommodate the binding posts for the inside speaker. I floated each baffle onto the prototype box with the technique described in the next section. When the new baffles were glued up, I installed T-nuts and glued and caulked the port tubes.

MDF FLOATERS

I bonded the three baffle boards and a second layer of 3/4" MDF onto the prototype using Franklin Titebond Aliphatic Resin as the primary agent. In a variation of the method described by Spear and Thornhill ("A Prize-Winning Three-Way TL," *SB* 1/93, p. 44) to attach the 3/4" MDF, I used screws rather than clamps to hold the second layer in place while the glue dried.

I smoothed all uneven protrusions and enhanced the bonding surface by belt-sanding the test cabinet. To ensure continuous bonding of the two layers of MDF, I coated both of them with resin. To prevent the two sheets of MDF from floating while I installed the first screws, I drilled pilot holes in the outside layer and cleaned off all chips from the inside surface prior to applying the resin. These holes located the second sheet on the test box and also prevented the additional drywall screws—installed without the aid of pilot holes—from pulling the second layer of MDF away from the first.

All of the 3/2" drywall screws used to attach the second layer of MDF pierced both layers and pulled them into the battens. After securing the edges of the new MDF panels to the battens, I installed several 1 1/4" screws in the centers of the panels to pull the layers together while the glue dried (Fig. 3).

FINISHING TOUCHES

Veneering: Considering veneer and formica too expensive, I decided to cover Aftershock with a \$14 sheet of 1/8" red-oak plywood. I needed to veneer only the top, front, and two sides of the cabinet. I ignored waste in

favor of aesthetics when deciding how to cut up the 4' x 8' oak sheet (Fig. 4). The sheet consisted of six laminated strips that made three similar patterns along the 8' length. I wanted one of the patterns to run through the center of Aftershock's top and then continue down the front piece. Each side would also contain the same pattern, facing in the same direction as the top. I marked the areas to be cut with 1" overlap on each dimension, and ripped them out with a jig saw. After cutting each piece, I marked its orientation on the inside to aid me when laminating it. On the bottom, I used a scrap of 1/8" mahogany door skin.

I sanded the sides lightly, vacuumed them clean, and did the same for the veneer pieces. I coated the veneer and cabinet surfaces with Elmer's Latex Contact Cement.

Using three scrap MDF strips as stand-offs along the width of the cabinet, I registered the veneer panel on the strips so there was even overlap at each edge of the cabinet. Then I removed one of the end stand-offs and pushed the veneer into the cabinet with a piece of carpet fastened to a 3/4" MDF scrap. I removed the other standoff strips and pressed the sheet until it was completely laminated to Aftershock. To ensure that the edges of the veneer were

Liberty Audiosuite

version 2 now available

Fast, programmable, and very cost-effective Audio Analyzer system for Engineering and Production Test/Control

Call or fax for brochure and free DEMO disk

Visit our web site at www.libinst.com

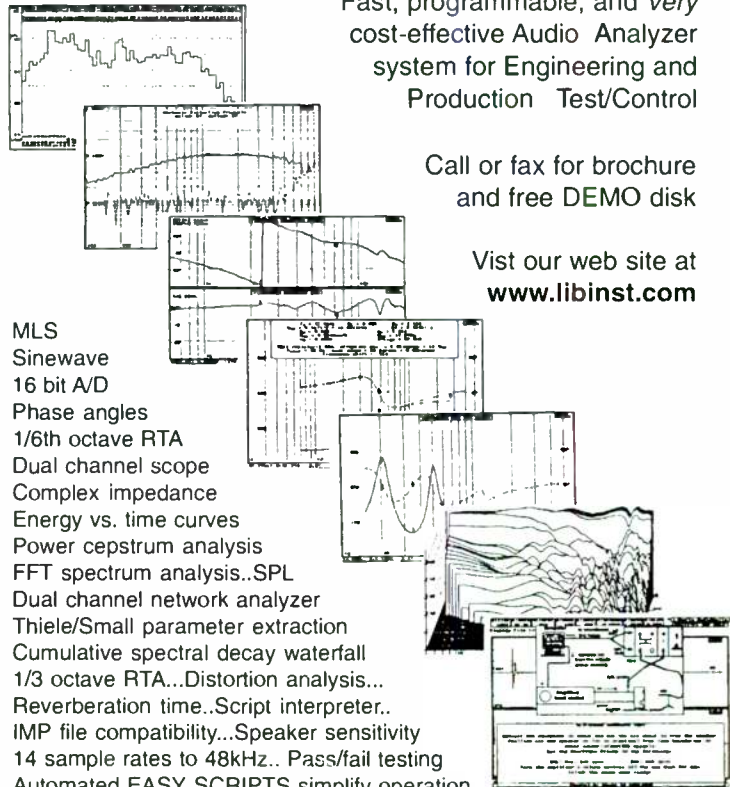

- MLS
- Sinewave
- 16 bit A/D
- Phase angles
- 1/6th octave RTA
- Dual channel scope
- Complex impedance
- Energy vs. time curves
- Power cepstrum analysis
- FFT spectrum analysis..SPL
- Dual channel network analyzer
- Thiele/Small parameter extraction
- Cumulative spectral decay waterfall
- 1/3 octave RTA...Distortion analysis...
- Reverberation time..Script interpreter..
- IMP file compatibility...Speaker sensitivity
- 14 sample rates to 48kHz.. Pass/fail testing
- Automated EASY SCRIPTS simplify operation
- Measure capacitors/inductors..DOS or Windows
- Acoustic distance.....Step response.....'Cycling measurements.....
- Microphone calibration files..Automatic input gain...Quasi-anechoic..
- Distortion visualize..MERGE math&editing...Automatic display scale.
- ASCII file exporting..... Direct+port sum.....Progressive averaging..

Liberty Instruments, Inc.

**P.O. Box 1454, West Chester, Ohio
45071 USA Phone/Fax (513) 755-0252**

bonded to Aftershock, I hammered the carpet-covered MDF around the edge.

After laminating each panel, I used my router with a roller-bearing edging-trimmer bit to make the veneer flush with Aftershock's edge. To avoid splintering the veneer, I moved the router along the surface from right to left. When all four edges were done, I sanded with 100-grit paper from the center of the cabinet outward to smooth the edge. This was important, since rough edges could catch in the carpet when I worked on the other side.

Trimming: If I had to start over, I would follow Spear's and Thornhill's advice and

align the second layer of MDF so I could use sections of 1" hardwood board for the trim strip. Instead, I butted the corners of the 3/4" MDF where the trim strip was to be installed (Fig. 5). Once the 1/8" panel was glued into place, this required a 7/8" trim strip. Unfortunately, that meant I had to find a 15/16" red-oak board instead of a standard 1" board (which measures exactly 3/4") to cut the trim strips from. I sanded a slight chamfer on the inside edge of the trim strips so they would center themselves flush to the two side edges.

Finishing: Before installing the veneer, I painted the baffle flat black. With the veneer

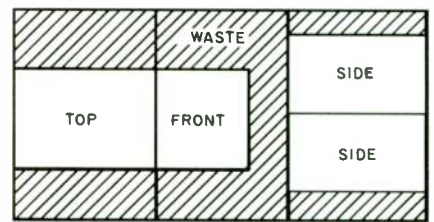

FIGURE 4: Getting the wood pattern right.

and trim completed, I sanded and then stained Aftershock with two coats of MinWax #245 Golden Pecan wood finish, applied four hours apart. Twenty-four hours later I applied three coats of MinWax fast-drying clear-satin polyurethane. I waited four hours between applications to sand, vacuum, and recoat.

BACK IN BUSINESS

When the finishes were dry, I installed a piece of closed-cell foam rubber on the rear of the enclosure, opposite the baffle, and fastened a sheet of AC foam to the brace to prevent reflections from bouncing out of the cabinet through the cones. I lined the entire box except for the baffle with 1" of Dacron blanket batting and loosely stuffed the cabinet with about 2 lbs of AC Stuff. I installed one Altec magnet in and the other out and secured them with eight 3 1/2" cap-head machine bolts.

The inside speaker connects to the amplifier's speaker cables through 2-inch-long banana jacks in the baffle, with the connections to the banana plugs supplied by 12-AWG monster cable. The outside speaker is connected directly to the amplifier's 12-AWG speaker cable. I checked the seal between the two drivers with my lighter, driving both speakers with a 30Hz in-phase tone. There were no air leaks.

I reversed the leads on the outward facing speaker, and Aftershock was in service again. I could not detect any significant difference in sound through changing the

to page 65

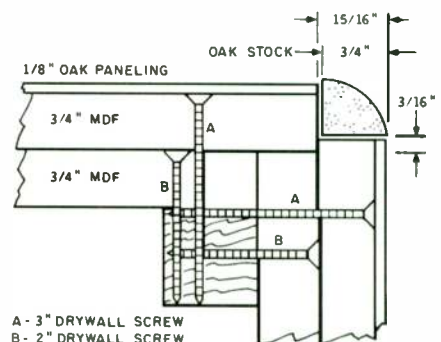

FIGURE 5: Joint section.

HI-FI NEWS & RECORD REVIEW

THE WORLD'S MOST RESPECTED HI-FI MAGAZINE

SUBSCRIBE TODAY AND GET THE NEXT 12 ISSUES FOR

\$65.00 USA \$75.00 CANADA

Please send me the next 12 monthly issues of Hi-Fi News and record Review from the next available issue.

Mr/Mrs/Miss/Ms _____

Address _____

Apt# _____

City _____

State _____ Zip _____

METHOD OF PAYMENT

- Check enclosed (US dollars and drawn on a US bank)
 Please charge my Visa Mastercard American Express

Account No. _____ Exp. date _____

Signature _____ Date _____

Please bill me

Return to Hi Fi News & Record Review, PO Box 384, Avenel, NJ 07001

FOR FASTER SERVICE USE YOUR CREDIT CARD AND CALL TOLL FREE

800-688 6247

AA41

Speaker Builder is on the Internet!

AudioWeb™

Netscape [AudioWeb Newsstand]

File Edit View Go Bookmarks Options Directory

Back Forward Home Reload Stop Print Find

Go to: <http://www.audioweb.com/>

AudioWeb NEWSSTAND power

CLIO: A NEW SPEAKER TEST SYSTEM
FIVE 1995 \$7.00

SpeakerBuilder
THE LOUDSPEAKER JOURNAL

DESIGN A HORN WITH YOUR PC

THE FREELINE: A TINY TL

A MIKE/PROBE PREAMP

SPEAKER STANDS YOU CAN MAKE

MAKING ODD-BALL DRIVER CUTOUTS

Nuggets from Madlsound's BBS

audiomall classifieds member raffle
chat directory newsstand what's new

AudioWeb power

| About | AudioMall | Chat | Classifieds | Directory | Newsstand | Member | Raffle | What's New |

webmaster@audioweb.com
Copyright © 1995 CRC Internet Group, Inc.
1995

www.audioweb.com

For advertising and editorial information, please contact:

AudioWeb
c/o CRC Internet Group, Inc.
230 Sherman Avenue
Berkeley Heights, NJ 07922
908.464.7307
info@audioweb.com

World Radio History

QUALITY ISSUES IN IRON-CORE COILS

By Roger Russell

If you plan to use iron-core coils in a passive crossover network, the quality of those coils can make or break the sound of your speaker system. This article describes a method you can use to measure coil distortion as well as conduct an effective listening test. Then it's easy to tell which ones to use.

I selected various types of coils from well-known suppliers to see how they would perform. Some iron-core coils are surprisingly good up to very high power, while others are very good up to moderate power. A few are not acceptable at all.

EXPENSIVE COPPER

Why even consider using iron-core coils when there are air-core coils and even active crossovers that don't have a core distortion problem? First, there's the problem of cost. Active crossovers are expensive, and they also require one or two extra power amplifiers to drive the remainder of the system.

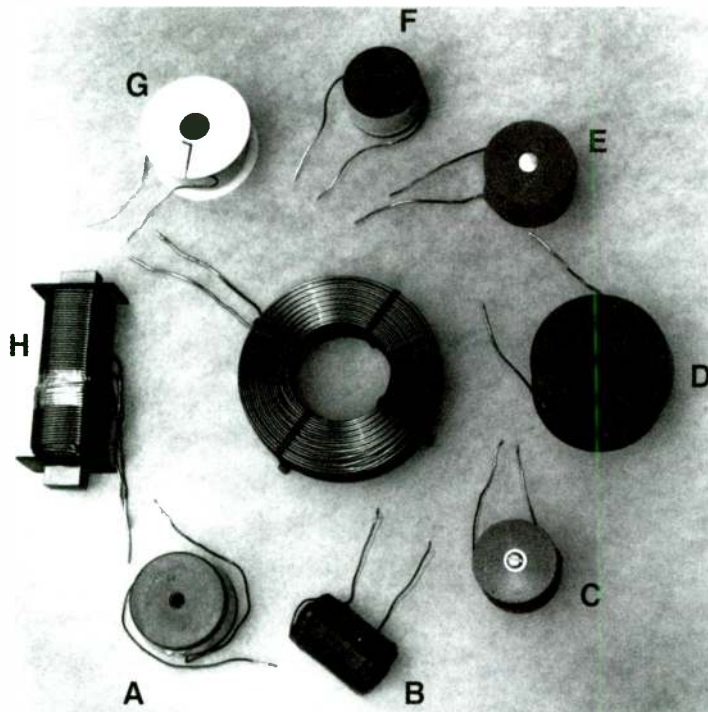

PHOTO 1: The group of coils used for the tests (identified in Table 2).

Air-core coils are also costly because copper wire is expensive, and they require more turns of heavier wire to give the same inductance and DC resistance (DCR) as comparable iron-core coils. Large-inductance air-core coils can also be very big and

heavy. Moreover, if you use a third- or fourth-order network for the woofer, you need two series coils, requiring even lower DCR for each one. Adding a simple, low-cost iron core can reduce the amount of expensive copper wire needed. Figure 1 shows how you can reduce the number of turns of wire for the same inductance by inserting an iron core in the center of an air-core coil. At 3mH, for example, you can reduce 425 turns to 280. Figure 2 shows that the corresponding weight of the wire is reduced from 0.575lb to 0.33lb. A further benefit of adding the iron core is that at 3mH it reduces the DC resistance from 1.38Ω to 0.87Ω, as shown in Fig. 3.

Iron cores come in a variety of sizes, shapes, and materials.

There are plain cylindrical "slugs" and I-shaped (bobbin) cores, usually made by the sintering process, which squeezes iron powder or granules under high pressure into a desired shape. There are also laminated cores made with layers of thin iron strips. Finally, there are toroid cores.

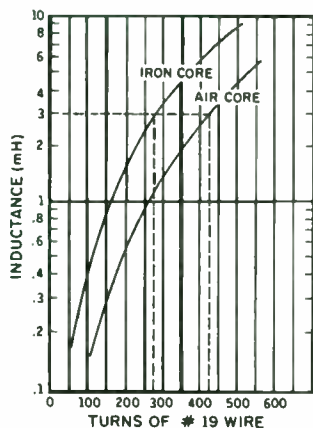

FIGURE 1: Graph of inductance versus turns of wire. Adding an iron core reduces the number of turns from 425 to 280 for a 3mH coil.

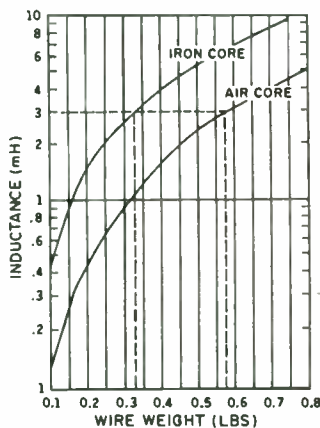

FIGURE 2: Graph of inductance versus wire weight. Adding an iron core reduces the wire weight from 0.575 to 0.33 lbs for a 3mH coil.

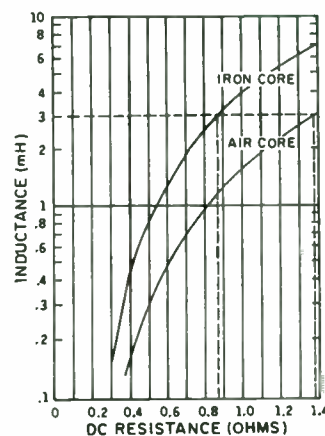

FIGURE 3: Graph of inductance versus coil DCR. Adding an iron core reduces the DCR from 1.38 to 0.87Ω for a 3mH coil.

The disadvantage of iron-core coils is that the material used can become saturated. As the core approaches saturation, distortion increases more rapidly. The type of core material, its shape, and the current levels that pass through the coil determine how soon the saturation will occur.

THE TEST SETUP

You can measure coil distortion using the test setup shown in Fig. 4. An oscillator drives a low-distortion power amplifier. Although it isn't mandatory, you can use a frequency counter for accurate and repeatable settings of the oscillator. A high-wattage load resistor replaces a speaker, and you connect the coil you're testing in series with the resistor. A distortion analyzer connected across the resistor then measures the coil distortion.

ABOUT THE AUTHOR

Roger Russell has a degree in electrical engineering from Rensselaer Polytechnic Institute. He has written several articles about loudspeaker design, testing, and other audio devices. Several patents have been awarded for some of his designs. He is a member of the Audio Engineering Society and the International Society for General Semantics. His interests range from stereo sound to photography, new-age music, computers, and science fiction.

The power amplifier you use for the coil test should be the one you plan to use to drive the finished speaker system. Be sure your amplifier can deliver the necessary sustained sine-wave power for the time it takes to make each distortion test. It's a good idea to check with the manufacturer first. You can check for clipping in case the power amplifier is overdriven by connecting an oscilloscope across the power-amplifier output.

Be certain to use heavy hookup wire between the coil, load resistor, and amplifier. I used about ten feet of #12 speaker wire. The value of the load resistor you select should be the same as the nominal impedance of the system in which you plan to use the coil. I use an 8Ω, 100W resistor, placed in a container of water to keep it cool.

You can make a form (Table 1) to select the powers and voltages you plan to use. The measurements you make should start at 1W and proceed in convenient steps up to the maxi-

TABLE 1				
SAMPLE FORM				
COIL _____	DATE _____			
INDUCTANCE _____mH	TYPE _____			
DCR _____ OHMS	WIRE SIZE _____			
PWATTS	V1	%-20Hz	%-100Hz	%-250Hz
1.13	3			
3.13	5			
7.03	7.5			
12.5	10			
28.1	15			
50	20			
113	30			
200	40			
313	50			
450	60			
613	70			

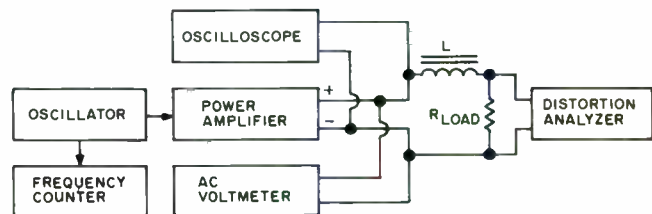
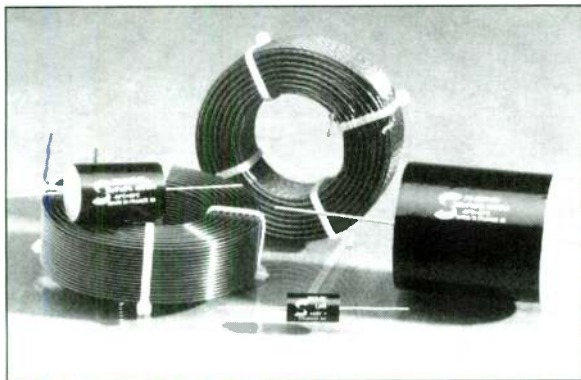

FIGURE 4: Block diagram for the distortion-test setup. L is the coil to be tested.

SOLEN



SOLEN INC.
 4470 Ave. Thibault
 St-Hubert QC J3Y 7T9 Canada
 Tel: 514-656-2759 Fax: 514-443-4949

CROSSOVER COMPONENTS CATALOG

HEPTA-LITZ INDUCTORS

Air Cored Inductors, Litz-Wire Perfect Lay Hexagonal Winding
 Values from .10 mH to 30 mH
 Wire Sizes from 1.3 mm (16 AWG) to 2.0 mm (12 AWG) 7 Strands

STANDARD INDUCTORS

Air Cored Inductors, Solid Wire Perfect Lay Hexagonal Winding
 Values from .10 mH to 30 mH
 Wire Sizes from 0.8 mm (20 AWG) to 2.6 mm (10 AWG)

FAST CAPACITORS

Fast Capacitors, Metallized Polypropylene
 Values from 0.10 μF to 300 μF
 Voltage Rating: 630, 400, 250 VDC

CROSSOVER & SPEAKER PARTS

Metalized Polyester Capacitors, 1.0 μF to 47 μF, 160 VDC
 Non Polar Electrolytic Capacitors, 22 μF to 300 μF, 100 VDC
 Power Resistors 10 W, 1.0 Ω to 82 Ω, 8 Ω L-Pads,
 Gold Speaker Terminals, Gold Banana Plugs, Gold Binding Posts,
 Crossover Terminals, Port Tube & Trim Ring, Grill Fasteners,
 Car Speaker Grills, Screws, Nylon Ties, Speaker Books, Etc.

GO AHEAD

Ask top engineers and music lovers worldwide what capacitors they choose for their ultimate designs.

H O V L A N D

MUSICAP®

The most naturally revealing capacitor. Film and foil polypropylene construction - optimized for fine speakers and vacuum tube electronics. Precision made in the USA.

Values from .01µF to 10µF.

Listen and compare for yourself.

UPGRADE NOW

"If you want see-thru, high definition, detail and listenability, try the Musicaps."

Joe Roberts, SOUND PRACTICES, ISSUE 6

To order contact one of the following:

- Welborne Labs 303-470-6585
- The Parts Connection 800-769-0747
- A & S Speakers 510-685-5252
- Allpass Technologies, Inc. 407-786-0623
- Anchor Cross Co., Japan, 81-3-3203-5606
- SJS Electroacoustics, England 44-1706-823025
- Tang Hill International Ltd., 886-2-5813605
- Audio Kinetik Pte. Ltd., 65-339-9789
- OEMs contact Hovland Company at :
ph 209-966-4377 • fax 209-966-4632

Reader Service #73

SALE! PLUS FREE ADHESIVE!

MARKERFOAM™ ACOUSTIC FOAM GIANT 54" x 54"

Immediate Shipping
2" Reg. \$29.95 Now \$19.99 • 3" Reg. \$39.95 Now \$29.99. **KILL NOISE QUICK!** High performance, full-size sheets of super high density Markerfoam. EZ mount. Blue or gray. Super-effective sound absorption for studios. Markerfoam offers best value, looks professional & is proven in studios worldwide. Request Foam Buyers Guide/Catalog, specs & free samples today.

MARKERTEK JUMBO SOUND ABSORB BLANKETS
Heavy-duty 72"x80" padded blankets absorb sound wherever they're hung or draped. Fabulous for stage, studio and field use. Top professional quality at a super saver price! Weight: 6 lbs. Black. \$19.99

MARKERTEK BLADE TILES™

HIGH PERFORMANCE - LOW, LOW COST!!!
America's best acoustic tile value only from Markertek!
\$3.49 per tile, 16"x16"x2", charcoal or blue
\$4.49 per tile, 16"x16"x3", charcoal or blue
\$5.49 per tile, 16"x16"x4", charcoal.

MARKERSTIK™ FOAM ADHESIVE
FREE with any foam purchase in this ad!
Limited offer. A \$4.00 per tube value.

SONEX

All the colors and sizes plus great prices!

FREE America's most unique catalog featuring 320 pages of over 6,000 exclusive and hard-to-find supplies for Pro Audio, Broadcast Video, Audio Visual & Multimedia production.

MARKERTEK VIDEO SUPPLY

4 High St., Box 397, Saugerties, NY (USA) 12477
800-522-2025 • Fax: 914-246-1757
World Wide Web: <http://www.markertek.com>

Reader Service #10

imum power safely available from your amplifier. Figure 5 shows the relationship of voltage and power for four different values of load resistance. This is derived from the formula $V=\sqrt{PR}$, where V is the voltage at the power-amplifier output terminals, P is the power in watts, and R is the load resistance in ohms.

You can then use the AC voltmeter to indicate the corresponding power level you need when running the test. Since I own a McIntosh MC7300 that I can connect for 600W in mono operation, I was curious to see what the coils would do, both at "normal" and extra high power.

The coils I chose all had about the same value of inductance, which allows a better comparison of the various types of core and construction. When making the test, be careful not to place the coil on a metal surface, which could affect the test results. I placed mine on a wooden test bench.

Coil distortion doesn't remain the same at all frequencies. You can use several test frequencies, starting at 20Hz for the lower limit. Figure 6 shows the upper test-frequency limit for four different values of load resistance. This comes from the formula $L = R/(2\pi f) \times 1000$, where L is the inductance in millihenries (mH), f is the frequency in hertz, and R is the load resistance in ohms.

For example, the upper limit for a 5mH coil and an 8Ω load is 250Hz, the actual crossover frequency for these component values in a first-order network. I selected 100Hz as an intermediate frequency. You can choose other test frequencies if you so desire.

TEST RESULTS

Figures 7-15 show the distortion curves for each of the nine coils at the three different test frequencies. The solid line is 20Hz, the dashed line is 100Hz, and the dotted line is 250Hz. Coils A - E have the highest distortion. The curves for coil F are noticeably different.

The horizontal portion, up to 50W, is not due to the coil, but is the lower limit of my test equipment. Below 50W, this coil's dis-

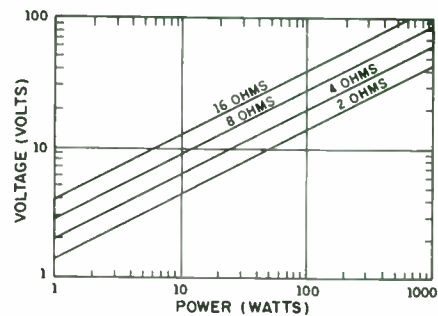

FIGURE 5: Voltage and power conversion chart for 16, 8, 4, and 2Ω load resistors.

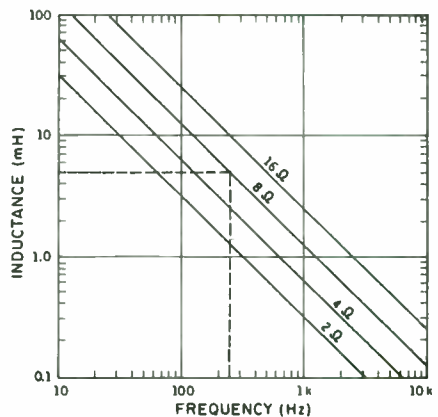

FIGURE 6: Inductance versus upper-frequency test limit for 2, 4, 8, and 16Ω load resistors.

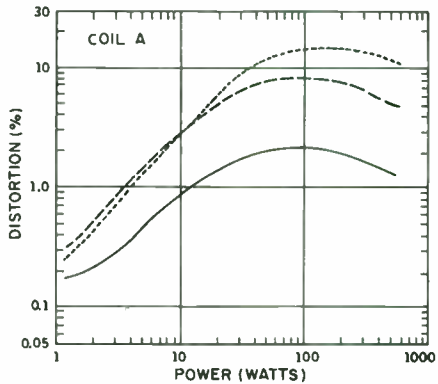

FIGURE 7: Coil A. This graph (and those in Figs. 8-15) measure distortion versus power at three test equipment frequencies. The solid line is 20Hz, the dashed line is 100Hz, and the dotted line is 250Hz.

TABLE 2

RAW DC TEST SUPPLY PARTS LIST

COIL	IND	DCR	WIRE	TYPE	COST	NAME	SOURCES
A	5.0	0.37	18	iron bobbin	\$10.50	AMS	MCM 50-690
B	5.0	0.42	18	iron slug	8.69	AMS	MCM 50-395
C	5.0	0.37	18	iron bobbin	8.89	Feron	MCM 50-1025
D	5.0	0.27	16*	iron bobbin	11.70	Sledgehammer	Madisound SHS
E	4.7	0.241	16*	iron bobbin	8.92	Feron (low dist)	Zalytron
F	5.0	0.39*	18	iron bobbin	6.50	Super ferrite	Meniscus(custom)
G	5.0	0.80	18	iron slug	6.65	MHL	Madisound MHL
H	5.0	0.242	15	laminated bar	12.00	Sledgehammer	Madisound SLS
I	4.7	0.56	14	air core	20.76	Perfect Lay	Zalytron

*measured

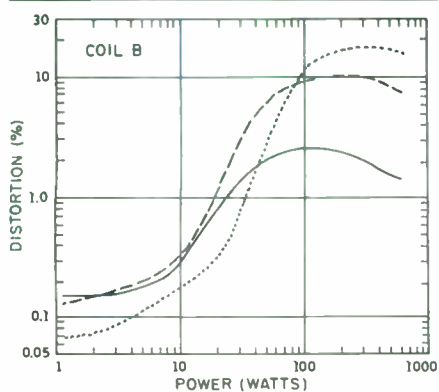

FIGURE 8: Coil B.

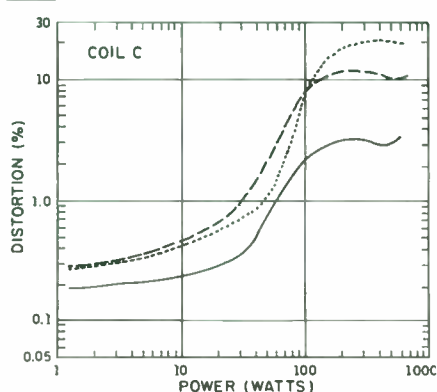

FIGURE 9: Coil C.

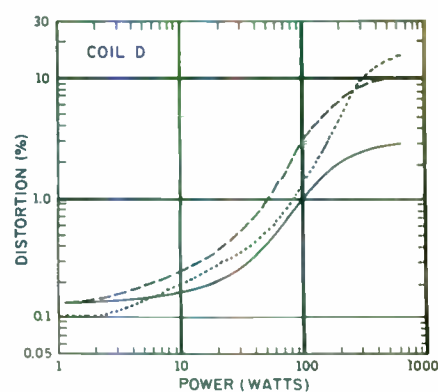

FIGURE 10: Coil D.

tortion could be far below that of coils A through E, and even G. F's distortion rises more rapidly, however, compared to the others, and is just as high as coils A through E at very high power.

Coil G's distortion remains relatively low, even at high power. Coils F and G have the lowest price in the group, and H, with the lowest distortion of all the iron-core coils, is the most expensive—except for I, an air-core coil that has no measurable distortion. The curves for coil I show the limit for my test equipment through the whole power range. I included it for com-

parison and in case anyone has doubts about distortion in air-core coils! The fact that distortion in coils A, B, and C increases to a maximum and then decreases slightly is caused by the initial permeability of the core material increasing and then decreasing.

Figure 16 shows a typical spectrum of distortion components measured on a 1/10-octave analyzer. This one is for coil C at 260Hz, driven with 100W. The distortion products are all odd harmonics, indicating top and bottom waveform symmetry. The total harmonic distortion is 8%. This coil is advertised as having a 300W power rating

and being "virtually free of distortion."

Table 2 shows the specifications as advertised by the suppliers, with the coils listed in the order of overall decreasing distortion.

LISTENING FOR DISTORTION

How much distortion can you actually hear? Although much emphasis is currently placed on electronics having .01% or .001% distortion, the plain truth is that such low distortion is completely inaudible. Several sources^{1,2,3,4} indicate that under ideal conditions with pure tones, a threshold as low as 0.1% to 0.25% can be detected. With

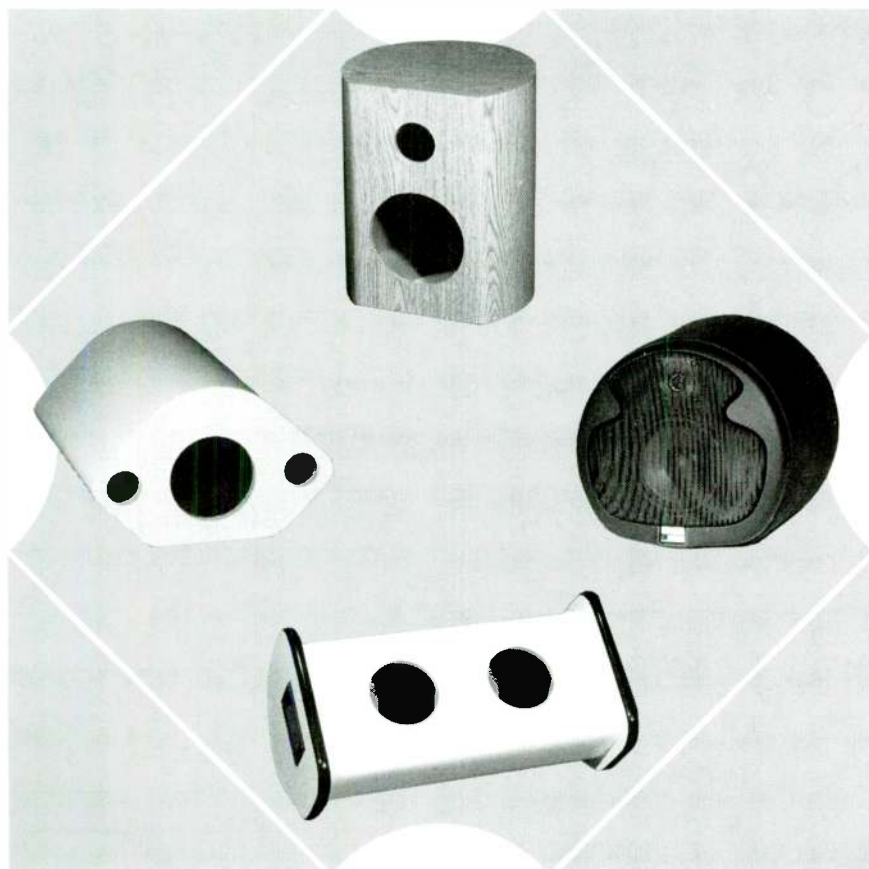

Throw us a curve.

Give us your curves, your bases, your molded plywood shapes, and we'll make them for you out of our paper tubes. Our unique, Cubicon construction is a sturdy, light-weight, cost effective alternative to expensive, time-consuming, fabrication. So go ahead, throw us a curve. We seldom strike out.

Cubicon Corporation
10176 Corporate Square Drive
P.O. Box 28745
St. Louis, MO 63146-1245
Phone: 314/567-0667
Fax: 314/567-0046

SPEAKERWORKS

"SPECIALISTS IN THE ART OF SPEAKER REPAIR"

FACTORY AUTHORIZED SERVICE:
Advent, B-I-C, Bozak, EPI, RTR,
Cerwin-Vega, JBL Home & Pro

Speaker parts & adhesives,
cones, spiders & dust caps

3 Way Crossovers Circuit
Breaker Gold Plated Binding
Posts \$19.95 each!

Replacement grilles for Altec,
B-I-C, Cerwin-Vega, JBL & Marantz

Refoam kits available for 4", 5-1/4",
6-1/2", 8", 10", 12", & 15" speakers
- only \$29.95 (JBL slightly higher)

Special Closeout on rebuilt DYN
Audio Drivers: MR 17.75, W30-100,
W24-100, W17-75. BELOW COST!

We Buy Dead Speakers: Altec, E-V & JBL



1-800-526-8879



NO CATALOG AVAILABLE

CALL US FOR HARD TO FIND DISCONTINUED PARTS

4931 A-1 South Mingo / Tulsa, Oklahoma / 74146

BIG BASS FOR SMALL, SINGLE-ENDED AMPS

*Put 2 Altec 515B woofers in this horn loaded box
and enjoy great bass!*

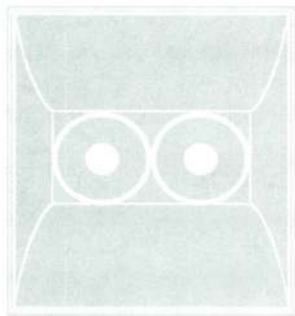

- Only 5 pairs to sell!
- 48" H x 34" W x 24" D
- \$400/pair plus shipping
- Color: gray, woofers not included

**STOP RECEIVING AND
TRANSMITTING R.F. AND
DIGITAL NOISE!**

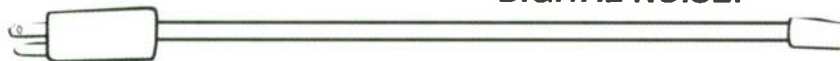

- Integral R.F.I. filter, 6½' long, shielded
- Standard IEC jack cut off for hard wire application
- Shielded 18 gauge, 3 conductor with R.F.I. filter powercords
- Your Toroidal power transformers will efficiently pass any R.F. coming in on your power core to their secondaries, 6 amps max.
- \$25 each, shipping paid.

V. VOGT 330 S.W. 43rd St. #247, Renton, WA 98055 FAX: 206-251-0636

Reader Service #2

music, the threshold can be as low as 1%.

Perhaps the best way to decide is to do your own listening comparison with the coils you have chosen. You perform the test using a sine-wave oscillator, AC voltmeter, power amplifier, and oscilloscope. There are two ways to proceed.

You can connect a switch into the speaker line, as shown in Fig. 17. This will give you an instant comparison between the coil you intend to use in series with the driver versus a direct connection to the driver. There may be some slight listening differences, because the response will change with and without the coil, but this normally will be minor compared to the sound of the core distortion.

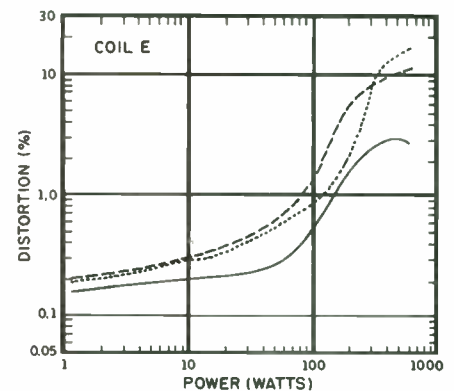

FIGURE 11: Coil E.

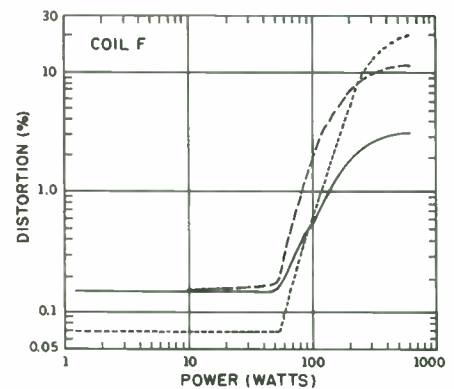

FIGURE 12: Coil F.

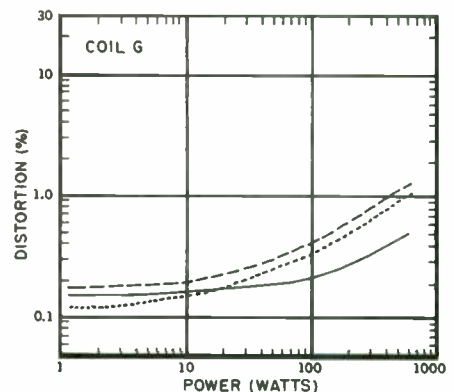

FIGURE 13: Coil G.

As an alternative, you could do the listening test as shown in Fig. 18. This will give you a little more control by switching between the test coil and an air-core coil of similar value. Having no distortion, the latter can keep the frequency response of the woofers about the same as it would be with the iron-core coils, so the amplitude of the harmonics relative to the fundamental will stay about the same.

In these tests that use a sine-wave oscillation,

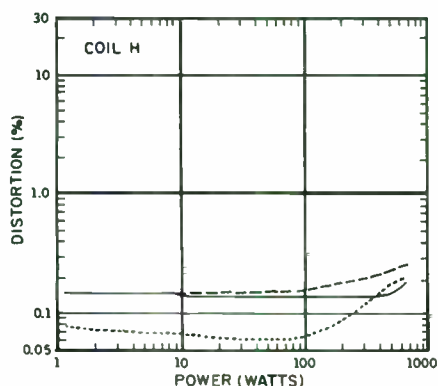

FIGURE 14: Coil H.

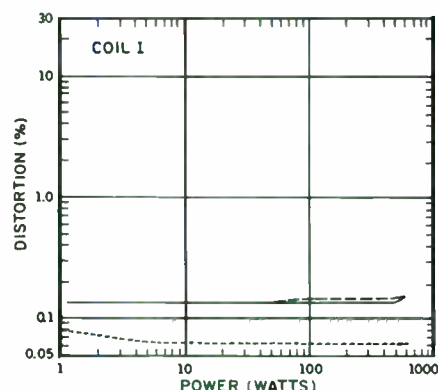

FIGURE 15: Coil I.

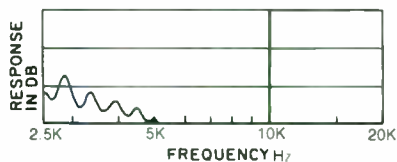
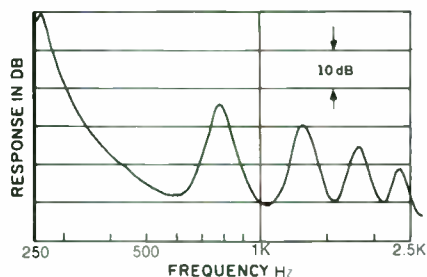

FIGURE 16: Distortion spectrum of coil C at 100W. Total harmonic distortion is 8%. The manufacturer rates this coil for 300W of power.

tor, there is some risk of damaging the driver you plan to use, since some driver power ratings are for music and not sine wave. Check with the driver manufacturer before applying too much sine-wave power.

You can hear the distortion products more easily by standing at a point in the room where the fundamental of the test frequency cancels due to room reflections. This may not be the way controlled hearing tests are done in a research lab, but it certainly is appropriate and typical for us in home listening environments. The listening position in typical living rooms has nulls at several low

frequencies, allowing you to hear distortion products more easily.

DETECTING DIFFERENCES

You can choose several different frequencies for the listening test. I selected 100Hz. Start at 5 or 10W. If you can hear a difference from one switch position to the other, reduce the power until you can still just hear it clearly. This, then, will be the maximum acceptable power for that coil. If you can't hear a difference, increase to 15W, then 20W, and so on, until you can clearly hear a difference. Be careful not to exceed the maximum

* CAR SPEAKER SYSTEM * IN-WALL SPEAKER * TWEETERS

**COST DOWN!!
COST DOWN!!
COST DOWN!!**



Separate/Component Car Speaker System
4", 5 1/4", 6 1/2"

Dome Tweeter@USD0.79

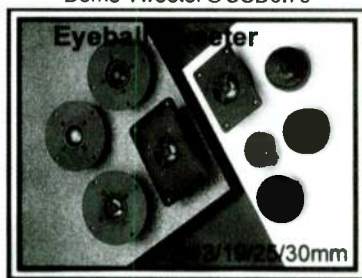

Surface/Angle/Flush
Mounting Kits



Pot-Light Style/Square In-Wall

- ⊗ Best choice for cost saving effectively.
- ⊗ Most professional manufacturer for speakers.
- ⊗ Available for OEM design and free 1997 catalogues.

Forgings INDUSTRIAL CO., LTD.

P.O. BOX 1823, TAIPEI, TAIWAN, R.O.C.
TEL: 886-2-585-3316/7 FAX: 886-2-594-2708
ATTN: Ms. Su Lien

power for your driver, as the coil you are testing may not have audible distortion for the power you have available. At higher power levels, coil-distortion measurements can be much safer than listening tests.

Coil A's distortion was clearly audible at only 2W. Coil B was clearly audible at 15W, C at 20–25W, and D at 30–35W. At 50W, all four coils sounded very distorted. Coil E became clearly audible at 60W, and F at 80–90W. Although F's distortion is exceptionally low at low power, there may be no audible benefit, for reasons I'll discuss shortly. Coil G became audible at 500–600W, and H was not audible at 600W.

You shouldn't take this listening test to mean that the speaker system you use has no distortion. It simply means that any increase in distortion could or could not be heard using the driver you have selected. Because I wanted to listen at high power, I used the woofer section of my McIntosh XR290 speaker system, which has four low-distortion 12" drivers mounted in a 10ft³ sealed box. At the highest powers, even the four woofers had significant distortion. However, if I had used a single 12" driver, the extremely high distortion would have interfered with the test. The voice coil might even have bottomed or burned out.

DISTORTION LIMITS

Certainly, the coil distortion should not be audible compared to the driver distortion. References to other sources,^{1,2,3,4} the distortion measurements, and the listening tests suggest that a distortion between 0.5 and 1.0% is the maximum allowable. Then, your choice depends on either the maximum power available from the power amplifier, or the power rating of the drivers you use, whichever is lower.

If, for example, your woofer or mid-range driver is rated at 100W, then coils E and F are marginal and G and H are the best choices. However, if the amplifier you use with these drivers is rated at only 50W, then coils E and F would be acceptable as well.

COIL DC RESISTANCE

DC resistance is another concern for a crossover coil. How high or low should it be? If DCR for woofers is too high, it can result in significant loss of power delivered to the woofer. As a point of practical reference, the crossover-coil DCR should normally be less than 1/10 of the nominal speaker impedance. This would be a maximum of 0.8Ω for an 8Ω driver, and 0.4Ω for a 4Ω driver. Using coils with lower DCRs is conservative and certainly won't hurt, but the cost can be higher and the improvement is questionable.

To make a comparison, coil G, at about half the price of coil H, has a DCR of 0.8Ω, the highest in the group, as well as reason-

Increase your electronics know-how and skills

The speed and intensity with which electronics penetrates our daily lives at home, at work, or in our car, tends to make us forget that we **can use electronics creatively** by building designs with a practical application and having the satisfaction of a successfully finished project. *Elektor Electronics*, which is distributed all over the world, can help you achieve these goals. Throughout the year, the magazine features original construction projects, informative articles and news on the gamut of electronics, science & technology, book reviews and information on new products. The past 11 issues contained 80 major and 97 minor construction articles, 21 articles of an educative or instructional nature, and 10 articles dealing with Science & Technology.

If you wish to increase your electronics know-how and skills, take out an annual subscription to *Elektor Electronics* by writing or faxing to

**World Wide Subscription Service Ltd
Unit 4, Gibbs Reed Farm
Pashley Road, Titchhurst**

**East Sussex TN5 7HE, England
Telephone +44 580 200 657; Fax +44 580 200 616**

You will then have the convenience of having the magazine delivered to your home, and the peace of mind that you will not miss any issue. The current rate for an annual subscription (11 issues) is \$US 57.00 (post paid – airspeeded).

There are also a number of *Elektor Electronics* books geared to the electronics enthusiast – professional or amateur. These include data books and circuit books, which have proved highly popular. Two new books (published November 1993) are *305 Circuits* and *SMT Projects*. Books, printed-circuit boards, programmed EPROMs and diskettes are available from

**Old Colony Sound Lab
PO Box 243, Peterborough NH 03458
Telephone (603) 924-6371, 924-6526
Fax (603) 924-9467**

TEST EQUIPMENT

Bruel & Kjaer 4133 microphone
Fluke 45 dual display multimeter
General Radio 1521-B graphic level recorder
General Radio 1304-B oscillator
General Radio 1564-A sound & vibration analyzer
General Radio 1650-A impedance bridge
Goldstar FC-2130 frequency counter
Hewlett-Packard 333A distortion analyzer
Hewlett-Packard 200CD oscillator
Instek OS-622 dual trace oscilloscope
McIntosh MC7300 power amplifier (connected for 600W mono)
McIntosh XR290 speaker system (woofer section with no crossover)

REFERENCES

1. M. Lazenby, "How Little Distortion Can We Hear," *Wireless World*, (Sept. 1957): 435–440.
2. P. Milner, "How Much Distortion Can You Hear," *Stereo Review*, (June 1977): 64–68.
3. P. Fryer, "The Audibility of Distortion in Loudspeakers," *Stereo Review*, (Aug. 1977): 68–71.
4. J. Moir, "Just Detectable Distortion Levels," *Wireless World*, (Feb. 1981): 32–38.
5. H. Fletcher, *Speech and Hearing*, D. Van Nostrand Company, Princeton, NJ (1929).
6. G. Augspurger, "The Damping Factor Debate," *Electronics World*, (Jan. 1967).
7. F. Toole, "Damping, Damping Factor, and Damn Nonsense," *Audio Scene*, (Feb. 1975): 16–17.

ably low distortion at both low and high power. Coil H has a DCR of 0.24Ω , one of the lowest in the group, and has even lower distortion. The difference in DCR between the two coils is 0.56Ω . Figure 19 shows the

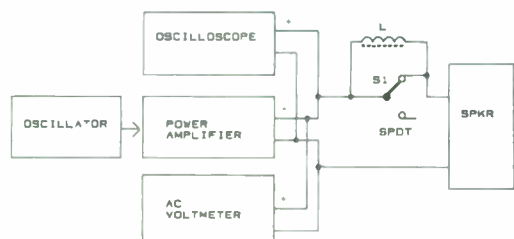

FIGURE 17: Block diagram for listening test. At each power level, you can instantly switch from the iron-core coil to a direct connection to the woofer. The speaker response will not remain the same.

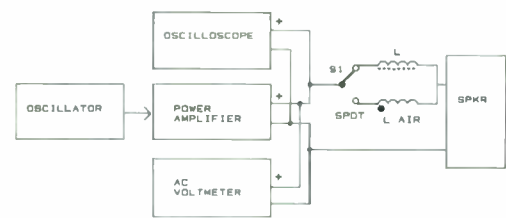

FIGURE 18: Block diagram for listening test. At each power level, you can instantly switch from the iron-core coil to a no-distortion air-core coil of the same inductance. The speaker response will remain the same.

response of an 8Ω woofer in a sealed enclosure, first with coil H in series (upper curve) and then with coil G in series (lower curve). The change in response is $1/2\text{dB}$ or less. The reason for this small difference, of course, is that most of the DC resistance in a speaker system is in the woofer voice coil.

Typically, an 8Ω woofer has a DCR of 7.2Ω and a 4Ω woofer has a DCR of 3.2Ω . The greatest response difference between the two curves is in the areas of 20Hz and 100Hz. This is where the impedance of the woofer, shown in Fig. 20, is near its lowest value, and where the crossover-coil DCR could be a significant part of the system impedance.

SPEAKER-LOCATION EFFECT

How significant is this small change in response? To put it in perspective, look at the response measured at the listening position in a listening room. Locating a speaker on the floor in a corner of the room gives a maximum low-frequency output.

Moving it from the corner against the wall on the floor reduces the

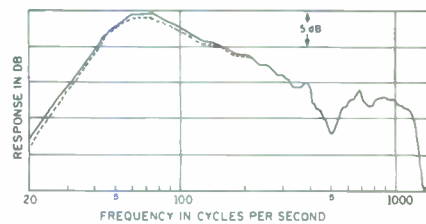

FIGURE 19: Response of coil H, having 0.24Ω DCR (upper curve), and coil G, having 0.8Ω DCR (lower curve).

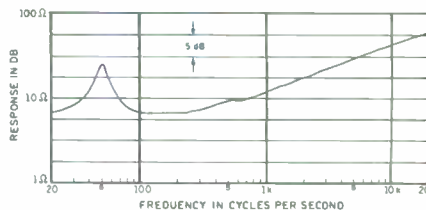

FIGURE 20: Impedance curve of the 8Ω woofer in a sealed enclosure used for the response curves in Fig. 19.

bass by 3dB. Sliding the speaker up the wall reduces the bass by another 3dB. Moving it out away from all reflecting surfaces reduces bass output by still another 3dB. In addition, low-frequency response can change by as much as 10–15dB due to room reflections that cause low-frequency reinforcement and cancellation.

...if you value musical involvement over sonic fireworks, the C/BD-2000 should be at the very top of your "must-audition" list.

- Robert Harley on the C/BD-2000 Belt Drive CD Transport.
Stereophile, May 1996.
Vol. 19 No. 5

...if you buy any \$2,000 converter without first auditioning the Parasound, you'll never know just how much musical performance is possible at this price.

- Robert Harley on the DIAC-2000 Ultra D-A Converter.
Stereophile, April 1996.
Vol. 19 No. 4

(Just a reminder that most Parasound dealers will be open by 10:00 a.m. tomorrow.)



PARASOUND

950 Battery Street • San Francisco, CA 94111
(415) 397-7100 • Fax (415) 397-0144



Fletcher⁵ suggests the minimum perceptible change in intensity level for a pure tone at 100Hz is 0.6dB at higher levels, and greater than 5dB at low levels. Again, a listening test might help. Select a low-DCR coil similar to coil E or H. You could connect a $\frac{1}{2}\Omega$ resistor in series with the woofer and switch it in and out to see if you can hear the difference. Use the setup in Fig. 21. Again, be certain to use heavy speaker wire, making the connections very tight or soldering them.

You can try the listening test at normal and high listening levels, using pink noise or program material as well as pure tones. This time, you could have a friend do the switching for you without telling you whether the

resistor is in or out, but just saying it's position A or position B. Then see if you can hear the difference. I could hear no difference with either $\frac{1}{2}$ or $\frac{3}{4}\Omega$ in series. The small change in DCR for the two different coils does not significantly affect the damping factor of the system.^{6,7}

SMALLER-VALUE COILS

The cost of iron-core crossover coils with smaller inductance values may not be as significant compared to air-core coils. The transition area can be in the vicinity of 1mH or so, depending on the manufacturer's pricing. You can then use smaller-value air-core coils economically, unless there is a particular need for very low DCR.

In mid-range and tweeter circuits, a resistor is often used in series with a crossover coil to reduce the Q of the circuit or attenuate the output of the speaker. You may not need a low-resistance coil at all. A neat trick is to wind the coil with wire of smaller diameter so the series resistance is included in the coil DCR. This eliminates a part in the crossover and also cuts down on the coil size and weight. You can use wire as small as #28 and still handle up to 3A of current.

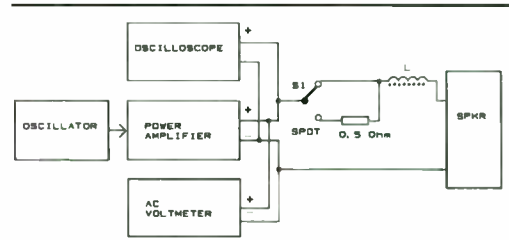

FIGURE 21: Block diagram for the series DCR listening test. You can instantly switch to compare any listening difference with and without a $\frac{1}{2}\Omega$ resistor in series with a low DCR coil. A normal or high listening level can be used.

SUMMARY

By using the procedures described in this article and knowing the test results for a sample group of coils, you can see the value of testing the coils you plan to use with your favorite speaker system. All iron-core coils are not the same. Some can offer both very good performance and considerable savings, even at high power. Others can provide excellent value depending on the power levels you plan to use. A few should be avoided completely. Without making these tests, you might blame distortion on the drivers, the amplifier, the cabinet design, or even the cabinet construction, without becoming aware that the cause may lie in the coils. ▶

SOURCES FOR IRON CORE COILS

Madisound Speaker Components
8608 University Green, PO Box 44283
Madison, WI 53744-4283
(608) 831-3433, FAX (608) 831-3771

MCM Electronics
650 Congress Park Drive, Centerville, OH 45459-4072
(800) 543-4330, FAX (513) 434-6959

Meniscus Audio
2575 28th St. S.W., Wyoming, MI 49509
(616) 534-9121, FAX (616) 534-7676

Zalytron Industries Corp.
469 Jericho Turnpike, Mineola, NY 11501
(516) 747-3515, FAX (516) 294-1943

Why Contact ACI Today?

Sapphire III: *Component of Exceptional Merit, awarded by*
Bound for Sound, 1995, 1996

"I recommend them without reservation" Gary Galo, Speaker Builder
"Fully recommended" Ken Duke, The Sensible Sound

Titan Powered Subwoofer: Stereophile Recommended Component,
The powered sub that does justice to music and Home Theater.

You love music, ACI has provided "Sound that satisfies". . . Since 1977, Guaranteed!
NEW VLS Series (Virtual Line Source), B-Flat Wallspeaker, Assembled speakers, Complete systems, NEW B-Flat II Co-axial Wallspeaker, Home Theater *done right*, Jaguar, Spirit, Shadow, EAM, NEW AV2 Shielded Center Channel, Parts Kits, NEW Cast-frame DV12 woofer, NEW Push-Pull, Magnetic-Planar line source drivers, (PPMP), 200-20K without crossovers, DH Labs Silver Sonic cables, Lasting value, guaranteed!

Visit us at: <http://www.audioc.com>

ACI, Division of Audio Concepts, Inc. 901 S. 4th Street, La Crosse, WI 54601

Phone: (608) 784-4570 Fax: (608) 784-6367

Audiophile Sweepstakes

Enter and win one of these exciting prizes!

Simply complete and mail the reader service card in this issue or the coupon below and you will be automatically entered in our third and biggest yet, Audiophile Sweepstakes:

GRAND PRIZE

Our grand prize winner will receive a pair of **Electra-Print Audio 130EP Single-Ended Monoblocks** to drive his new **Edgarhorn System 80 horn system!**

Each monoblock uses a matched pair of Svetlana 911-3's and an exclusive dual tuned choke power supply to deliver 30 Watts of clean, reference-quality power. The design is reminiscent of the old McIntosh 75s.

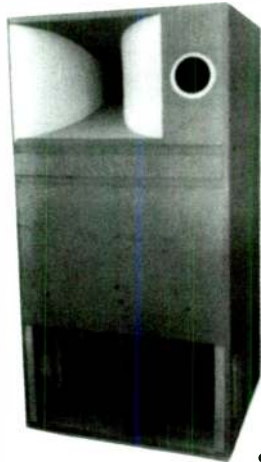

A breakthrough in horn folding technology has allowed the utilization of a JBL 5" monitor woofer on a 5' long 80Hz bass horn. This high performance horn system is ideal for use with low power single ended triode amps. Unlike most other horn systems it can be used in small listening rooms.

FIRST PRIZE

The Audio Alchemy DDS Pro CD Transport

This new dual-chassis transport has the advanced new Pioneer "stable platter" CD transport system and offers both I²S & SPDIF digital output. This unit comes complete with full-function remote and detachable AC mains cord with integrated line filtering.



SECOND PRIZE

The Davidson-Whitehall Storadisc™ Library Series LS-360 CD storage unit

This unit, given an A+ rating in the December 1995 issue of *Audio* and chosen as *CD Review's* top choice in a 60 product comprehensive comparison, stores 360 CDs with a non-slip surface that holds even a single CD upright. This fine furniture-quality storage unit is a perfect balance of function and elegance. From Davidson-Whitehall of Atlanta.



3 THIRD PRIZES

Three of our readers will receive a \$100 gift certificate from **International Audio Group** towards the purchase of the renowned **Sowter transformers**. Choose from a large selection of standard design push-pull or single-ended output, power, electrostatic loudspeaker, moving coil, or line transformers or custom design your own!

25 FOURTH PRIZES

The Audio Glossary
by J. Gordon Holt

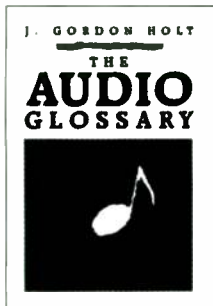

This sweepstakes is void where prohibited by law. All entries must be postmarked by December 31, 1996. Multiple entries are allowed and encouraged. Employees and relatives of employees of Audio Amateur Publications are ineligible for this sweepstakes. One entry per envelope please.

Name: _____

Address: _____

City: _____

State: _____

Zip: _____

Please enter my name in the Third Audiophile Sweepstakes

I'd like information from the advertisers in the following magazine(s):

Speaker Builder

Issue # O#4 O#5 O#6 O#7 O#8

Glass Audio

Issue # O#4 O#5 O#6

Reader: Please circle the reader service number as seen at the bottom of an advertisement in the magazine(s) about which you want information. For more, please see card in the magazine.

1	2	3	4	5	6	7	8	9	10
11	12	13	14	15	16	17	18	19	20
21	22	23	24	25	26	27	28	29	30
31	32	33	34	35	36	37	38	39	40
41	42	43	44	45	46	47	48	49	50
51	52	53	54	55	56	57	58	59	60
61	62	63	64	65	66	67	68	69	70
71	72	73	74	75	76	77	78	79	80
81	82	83	84	85	86	87	88	89	90
91	92	93	94	95	96	97	98	99	100

LOW COST STROBOSCOPIC SPIDER ANALYSIS

By Tom Perazella

Since the early days of experimentation with electronic flash, one of the most interesting applications has been stop-motion or "stroboscopic" analysis. Dr. Harold Edgerton has been called the father of electronic flash, and he received popular recognition by photographing subjects such as milk droplets striking a pool of milk and bullets penetrating apples.

However, as entertaining as these subjects might have been, the greatest benefit is that it allows researchers to visualize repetitive motions otherwise imperceptible because of their high speeds. Compared to some of the other techniques for analyzing speaker components, the relatively inexpensive stroboscope provides a surprisingly good overall view of what is happening to a spider. Before covering the specifics of this technique for driver analysis, a review of the principles involved may be helpful.

EYE RESPONSE

One basic limitation of human vision is that you cannot discern the details of motion that occurs at frequencies higher than 30Hz. At higher frequencies, the eye integrates the motion into a "blur" of a certain visual density. The higher the frequency, the more uniform that density, and its value is a function of the density and size of the moving object in relation to the background.

For example, if you rapidly spin a white disk with small radial slits in front of a dark background, the slits will appear almost as light as the white segments of the disk. If the slits are then enlarged to the point where only narrow white segments remain between them, the spinning disk will appear dark. The density, or conversely, the apparent brightness at any point of the disk is a function of the time integral of light reflected from the disk at that point. The eye continuously integrates light from all points, resulting in the blurring effect.

STOP MOTION

To prevent this blurring, you can limit the time that light strikes a moving object while in a specific position. The electronic flash is an ideal device to accomplish this lighting control. Instead of a constant production of

light, the flash device stores electrical energy and then discharges it very rapidly through a gas-filled tube, resulting in a very bright flash of light in a short time period.

If the duration of the flash is sufficiently short, the amount of the object's movement is inconsequential. If its movement is periodic, you can arrange to fire the flash at the same point in each period, with the visual result of "freezing" the motion. This can be especially valuable in observing a distortion of the object at a point of high stress in the period.

SLOW MOTION

As valuable as observing a particular point in the period can be, it is sometimes useful to observe the complete range of movement or distortions that can occur in an object during the whole period. By adjusting the time between firings of the strobe to be longer or shorter by some fixed amount in relation to the period of the object, the illumination will occur at a different point in the period with each flash. The result is that the object

appears to be moving in slow motion. The closer the period of the flash to the period of the object, the slower the motion appears.

THE STROBOSCOPE

The stroboscope is an electronic flash optimized for stop-action work in several key areas as follows:

- The duration of the flash is very short, much shorter than a typical photographic flash. Special circuitry and flash tubes make this short duration possible.
- Stroboscopes generally have a narrow angle of illumination. This is necessary to concentrate the lower light levels produced at short flash durations onto a specific area of interest.
- In addition to an external sync, there is an internal time base to trigger the flash in a stable, repetitive manner.

USING A STROBOSCOPE

To get the best results from a stroboscope, you must take account of several factors:

1. The reflectance of the subject relative

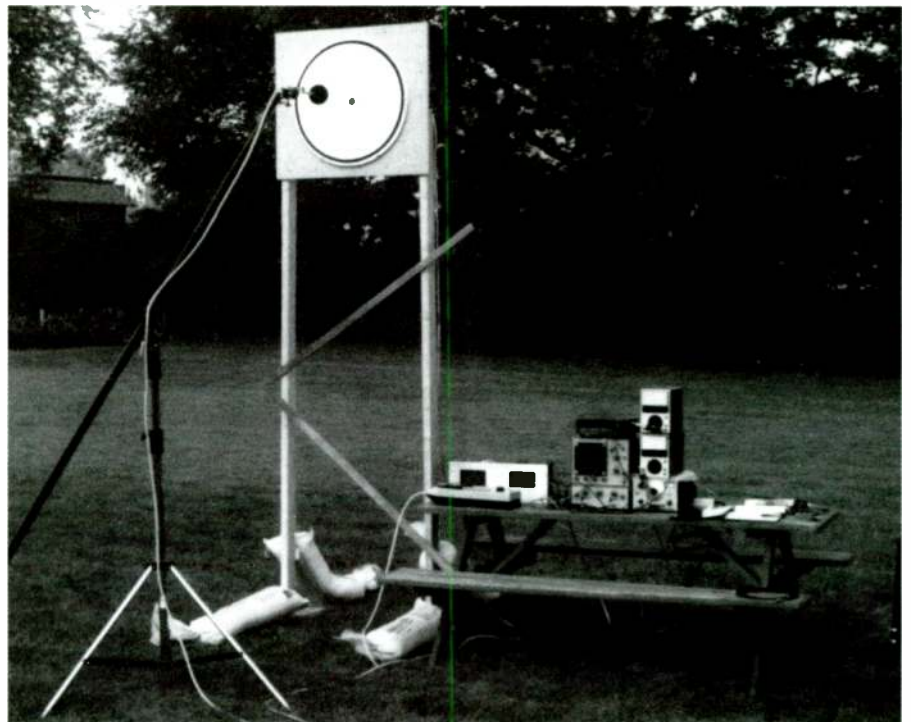

PHOTO 1: Test setup for 24" woofer.

NOW IN PRINT!

ULTIMATE AUTO SOUND:

Your Guide To Heaven On Wheels

"In today's world, if you want a high-fidelity sound system in your car, you are expected to pay a lot of money. The good news is that if you follow the plans in this book you won't have to." —from the Preface

YOURS FOR ONLY \$29.95!

Dan Ferguson is a practical, hands-on expert with years of experience in upgrading vehicle sound systems. He doesn't do this for a living—he's a construction engineer who became tired of the wimpy sound he was hearing in his truck commuting every morning and evening, and wasn't about to pay the big bucks installers were asking to make it better.

What Dan offers is a practical, proven method to upgrade your car or truck's sound system so that it produces excellent music. This is not a guide to paint-peeling, ear-destroying thunder on wheels. It simply upgrades the system in your vehicle so it sounds as good as what your stereo produces at home.

The book deals with the specific problems of various vehicle formats from small pickups to large sedans to hatchbacks. A wealth of information about specific problems is scattered throughout the book as well as solid advice on what the novice modifier should and should not do in upgrading certain vehicles. Dan suggests various paths to achieve success as well as sources for all the supplies, parts, drivers and even replacement door panels.

Best of all, the book is anything but dry theory. The information is solidly backed by hands-on experience in hundreds of vehicles of a very wide variety. The sources listed put you in touch with vendors the author has found reliable and who offer the best buys on what you need for better sound. There are also phone numbers for hand-holding support should you need it.

If you love good sound and want it in your personal transport, *Ultimate Auto Sound: Your Guide to Heaven on Wheels* is the help you need to achieve that goal, and help you do it for the smallest possible investment of cash. **Order yours today!**



CALL OR WRITE TODAY FOR YOUR FREE COMPLETE LISTING OF OCSL PRODUCTS!

Here is my order form, with BKAA37(s) described above totaling US\$ _____

I am also including my appropriate shipping charge as follows:

USA surface, add 7% to order. Shipping _____
Other surface, add 14%.
USA second day, add 14%. Handling **2 00**
Other air, add 25%.

Total Order US\$ _____

NAME _____

STREET _____

CITY _____ ST _____ ZIP _____

MC/VISA/DISCOVER # _____ EXP. DATE _____

TELEPHONE OR FAX (CIRCLE) _____ TODAY'S DATE _____

Mastercard Visa Discover Check or Money Order in US Funds Drawn on US Bank

Tels. 603-924-6371, 603-924-6526 Fax 603-924-9467



OLD COLONY SOUND LABORATORY

PO Box 243, Dept. B96
Peterborough NH 03458-0243 USA



PHOTO 2: Microphone position used for testing.



PHOTO 4: "S"-shaped spider construction.

to the background. The greater the difference, the more visible the motion. If you're viewing a light object, use a dark background, and vice versa. The basic product-photography trick of outlining the edges of dark objects with chalk can help in differentiating the object from the background.

2. Use appropriate lighting levels. Visual observation is not too critical, since the eye has a very broad range of light acceptance. However, if the contrast ratio between the object and background is too great, the eye will have difficulty. This ratio is even more important when using photographic or video capture, as these media are more limited in accepting ranges of brightness.

3. Adjust the viewing or photographing angle to best show the motions in question. The eye and camera are most sensitive to movements perpendicular to the axis of vision. Conversely, motions along the viewing axis are the most difficult to discern. If motions occur in multiple planes, try to view them from various angles.

4. Position the light to take maximum advantage of surface textures and contours. The more oblique the lighting in relation to surfaces, the more prominent textures and contours become. The changes of lighting on these surfaces help the brain process visual changes into the perception of motion.

5. There is an optimum range of perceived speed. You should adjust the stroboscope so

that the viewed motion is slow enough to see details, yet not so slow that the overall motion is not readily apparent.

A CASE STUDY

The versatility of the stroboscope is illustrated by an analysis of an audible anomaly that appeared while I was testing a 24" woofer. The manufacturer of this driver claimed an f_s of 13Hz, but MLSSA analysis indicated it was 27Hz. The manufacturer was skeptical of MLSSA analysis and asked for testing of the driver in an open environment. To satisfy the manufacturer's objections, I conducted tests the old-fashioned way, i.e., making point-by-point measurements in an open field. *Photo 1* shows my test setup.

I measured using a Bruel & Kjaer type 2209 sound-level meter feeding a digital voltmeter, two analog voltmeters, and an oscilloscope. *Photo 2* shows the mike position in relationship to the driver. Test results were within experimental tolerances of those achieved with MLSSA. During the tests, however, when drive levels exceeded 2V RMS at 27Hz, I noticed a howling at higher frequencies. The scope trace confirmed a higher frequency component on top of the

base frequency. *Photo 3* shows the resultant waveform from an input of 5V at 27Hz.

I measured relative acoustic outputs at 31.5Hz and 500Hz using the Bruel & Kjaer 1613 octave filter set attached to the 2209 sound-level meter. Relative levels at a 12" mike-to-driver distance and a 6V drive at 27Hz were 111dB at 31.5Hz center frequency, and 82dB at 500Hz center frequency.

A study done by Eric Busch of DLC Design states that the sensitivity of the ear at 27Hz is approximately 50dB below that at 200Hz. Unfortunately, data for the 500Hz center frequency was not available in that study, but extrapolating from other studies, the difference would be even greater at the higher frequency. The measured 29dB difference, when compared to the greater than 50dB sensitivity of the ear at 500Hz, confirms the degree of audibility of the higher frequency component.

At first, I suspected cone breakup. To see if this was the case, I used a stroboscope to view the cone motion with the same drive conditions. No breakup was apparent.

SPIDER SCRUTINY

The spider was the next area I examined. This particular driver had a spider style popular years ago. It appeared to be machined from a sheet of glass/epoxy material in such a way that four S-shaped fingers connected the base of the cone to the basket. *Photo 4* shows that construction.

To view the spider in motion, I positioned a stroboscope so that part of the light struck the spider itself and part was reflected from the white cone material, resulting in partial direct and partial backlighting. I observed the spider's motion while applying signals at 27Hz at various voltages, adjusting the stroboscope to yield an optimum perceived motion as described above.

Since I had not worked with this type of

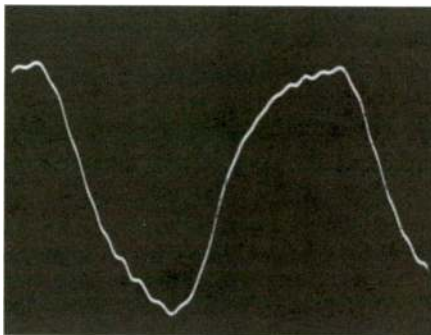

PHOTO 3: Waveform at a 5V level at 27Hz. Note the high-frequency component.

ABOUT THE AUTHOR

Mr. Perazella is the Director of Information Systems for a national retailer of professional photographic equipment headquartered in the midwest. Prior experience includes work as a criminalist in the San Diego and Long Beach (CA) crime labs and director of marketing for a photographic wholesale distributor. In addition to speakers, Mr. Perazella has designed commercial high-powered electronic flash equipment as well as numerous pieces of audio electronics for his own use.



PHOTO 5: The driver at rest before the test.



PHOTO 8: The cone continuing its outward movement with the spider still leading.



PHOTO 11: The cone moving significantly inward with the tip of the spider staying outward.



PHOTO 6: The cone in a rearward portion of its stroke with the tip of the spider also rearward.

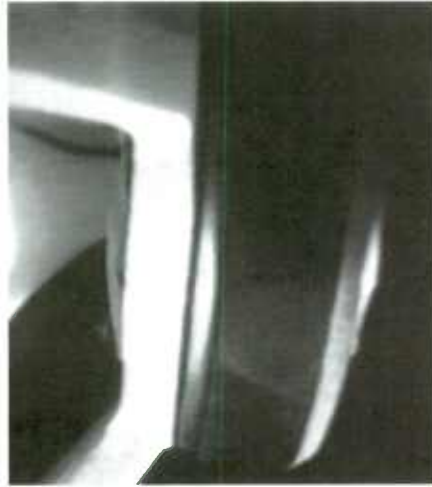

PHOTO 9: The cone continuing to move outward with the tip of the spider slowing down.



PHOTO 12: The cone moving again toward the front with the tip of the spider moving backward.



PHOTO 7: The cone moving outward with the tip of the spider actually leading the cone movement.



PHOTO 10: The cone further outward with the tip of the spider moving backward.

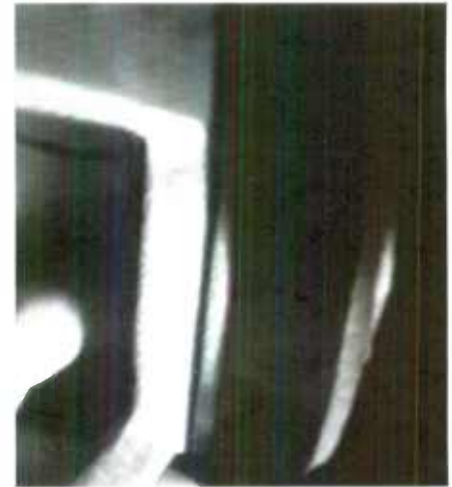

PHOTO 13: Using a finger to damp the oscillations of the spider.

spider construction before, the results were quite surprising. As the spider traveled through the center part of its range of movement, the tip of the "S" portion fluttered back

and forth at a frequency higher than the fundamental. In addition to this flutter, I noted a torsional vibration in the spider sections, also at a higher frequency.

RECORDING THE EVIDENCE

The next step was to record this motion on video so the results could be sent to the man-
to page 65

Book Report

THE LOUDSPEAKER DESIGN COOKBOOK, FIFTH EDITION

Reviewed by Robert Bullock, Contributing Editor

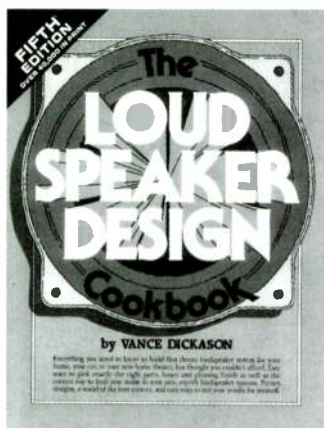

The Loudspeaker Design Cookbook, Fifth Edition, by Vance Dickason, published by Audio Amateur Press, \$34.95, available from Old Colony Sound Lab, PO Box 243, Peterborough, NH 03458-0243, (603) 924-6371. FAX (603) 924-9467.

Since *The Loudspeaker Design Cookbook (LDC)* was first reviewed in *Speaker Builder* in 1987, four subsequent editions have appeared, as well as translations into German and Portuguese. Such widespread interest justifies this review of the latest edition.

The first sentence of *LDC* states that it "aims to describe the operation, application, and measurement of electrodynamic loudspeakers and their associated enclosures and crossover networks." That this is an accurate thumbnail description of the book's scope

explains why I consider it to be the best available loudspeaker-design reference. Speaker-building novices should not take any steps without a copy to refer to. Because Vance Dickason has done such a fine job, this review will be mainly a description of the contents of *LDC*. The following chapter

headings give a good indication of the coverage of the work.

1. HOW LOUDSPEAKERS WORK
2. CLOSED-BOX LOW-FREQUENCY SYSTEMS
3. VENTED-BOX LOW-FREQUENCY SYSTEMS
4. PASSIVE-RADIATOR LOW-FREQUENCY SYSTEMS
5. TRANSMISSION LINE LOW-FREQUENCY SYSTEMS
6. CABINET CONSTRUCTION: SHAPE AND CONSTRUCTION
7. MID- AND HIGH-FREQUENCY DRIVERS: APPLICATION AND ENCLOSURES
8. PASSIVE AND ACTIVE CROSS-OVER NETWORKS

First published in 1958, *Audio Measurements* by Norman Crowhurst is a complete compendium of measurement and testing techniques for audio reproduction equipment with discussions of all the instruments needed to use them. Not surprisingly, it has a simplicity and clarity which are the hallmark of Crowhurst's writing.

After clearly explaining how to measure and detailing all the equipment needed to do so, he leads the reader step by step through all the types of audio reproduction equipment a reader is likely to have, including amplifiers, transformers, preamps, turntables and changers, tonearms and cartridges, tape recorders, and microphones. Crowhurst's *Audio Measurements* belongs in every audio hobbyist's library—and most especially so if the hobbyist is a tube enthusiast.

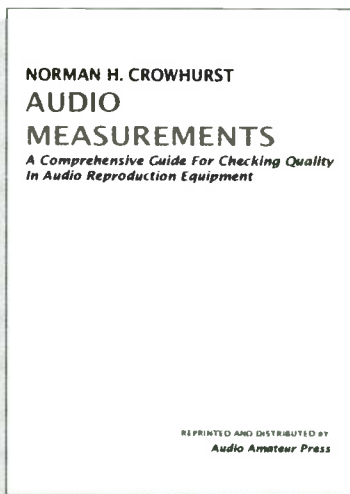

#BKAA41

JUST \$12.95!

*SHIPPING:
7% USA
14% Other Surface
25% Other Air

*Shipping \$12.95
Handling 2.00
Total Order \$

Yes! Please send me #BKAA41 @ \$12.95



OLD COLONY SOUND LABORATORY
PO Box 243, Dept. B96
Peterborough NH 03458 USA
Tel. 603-924-6371 • 603-924-6526 • Fax 603-924-9467

• MC • Visa • Discover • Check/money order USS US bank • make checks payable to: Audio Amateur Corp. •

NAME _____
STREET _____
CITY _____ ST _____ CODE _____
CARD NO. _____ EXPIRE _____
TELEFAX _____ TODAY'S DATE _____

- 9. LOUDSPEAKER TESTING
- 10. CAD SOFTWARE FOR LOUDSPEAKER DESIGN
- 11. HOME THEATER LOUDSPEAKERS
- 12. CAR AUDIO LOUDSPEAKERS

The first chapter is a thorough discussion of the anatomy of an electrodynamic loudspeaker driver and how it acts to produce sound. It also briefly discusses acoustic power requirements in typical listening rooms and how they affect driver selection.

The next four chapters are devoted to the design and performance of the low-frequency portion of a system, each one starting with a bit of history on the particular design covered in that chapter. The first of these—on closed boxes—discusses not only the basic design methods but also box filling, multiple-driver configurations, thermal behavior, equalized alignments, bandpass systems, and variovents. Of particular interest is an empirical discussion of box filling—something I have seen nowhere else.

The chapter on vented boxes contains a thorough discussion of various alignment types and includes extensive design tables for them. With sufficient study, this material should enable anyone to make an informed design choice. The chapter has a good discussion on accounting for box losses, and it also

covers vent behavior and tuning, vent-driver interaction, box stuffing, equalized vented boxes, and vented-box bandpass systems.

The chapters on passive radiators, transmission lines, and cabinet construction are somewhat shorter, but they still contain complete design information and cover additional topics such as the augmented passive radiator and alternative transmission-line design procedures. I am glad to see that *LDC* stresses that desirable passive-radiator responses usually require a PR that is substantially more compliant than the system driver. This is readily verified from models, but is rarely mentioned when the subject of passive-radiator design arises.

Chapter 6 discusses the important considerations in mounting midrange and high-frequency drivers. Included are such matters as midrange enclosures, driver spacing, and effective baffle design.

Chapter 7 on crossover networks is among the longest in the book. The treatment of passive crossovers is quite thorough as far as the standard networks are concerned, and quite a few design formulas are included for various types of two- and three-way networks. This chapter also discusses elementary impedance and response equalization networks. Active crossover networks are justifiably deemed beyond the scope of *LDC*, but it supplies several useful references. Overall, the chapter is an excellent introduction to crossovers and contains an extensive list of references for those who care to pursue the subject in greater depth.

Next is a chapter on loudspeaker testing. It covers not only the basic topic of determining Thiele/Small driver parameters, but also frequency-response measurements, phase measurements, enclosure-vibration measurements, and measurement microphones.

Chapter 9 consists of descriptions of the many loudspeaker design and analysis software programs available.

The book culminates in two chapters on topics that are currently of widespread interest: home theater and car audio. The material on home theater discusses the audio requirements of such systems and describes the THX and Dolby systems. The chapter on car audio concentrates on contrasting speaker performance in a lossy closed field (auto passenger compartment)—as opposed to a free field (large listening space)—and designing a system with good center-channel imaging.

In summary, I believe this book is of great value for anyone involved in designing and building loudspeaker systems. Its broad and thorough coverage of the basic concepts makes it an ideal reference for both the beginner and the experienced designer, and its extensive list of references should make it useful to even the most expert designer. 

Buy-Sell-Trade

Clean, Tested, Guaranteed
High End & Vintage Audio

Equipment, Manuals, Parts - Since 1979

Featuring products from: Accuphase, Accurus, AR, Adcom, Air Tight, Altec, Apogee, Aragon, Audio Alchemy, Audio Control, AudioQuest, Audio Research, B&K, B&W, CAL, Cardas, Carver, Cary, Classe, conrad-johnson, Counterpoint, Crown, dbx, Dahlquist, Denon, Dunlavy, Duntech, Dynaco, Farichild, Fisher, Golden Tube, HK, Hafler, Heath, Infinity, JBL, Jensen, Joseph Audio, KEF, Klipsch, Krell, Levinson, Lexicon, Magnepan, Magnum-Dynalab, Marantz, Martin-Logan, McIntosh, Mesa, Perreux, Phase Linear, Platinum, PS Audio, Proac, Procead, Quad, Rotel, Rowland, Sequerra, Spectral, SOTA, Soundcraftsman, Sound-Lab, Stax, Sunfire, Tandberg, Tannoy, Theta, Thiel, VAC, VTL, VPI, Vandersteen, Velodyne, Wadia, Western-Electric, Wilson & many more.

AUDIO CLASSICS

Limited

FREE condensed catalog!

8AM-5PM ET M-F

607-865-7200

Fax: 607-865-7222

www.audioclassics.com

34 Gardiner Place, Post Office Box 176SB,
Walton, NY 13856

Reader Service #77

LEARN Speaker Reconing

Recone your own speakers
Save Money, Make Money

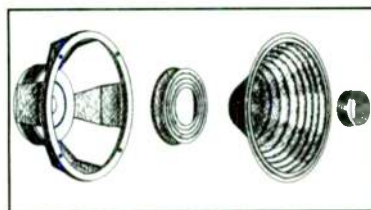

NO MORE SECRETS

This comprehensive video has taught hundreds to perform this task and now you can learn too. WVS also supplies parts.

Phone: 219-424-5463 / Fax: 800-997-3266

\$39.95

WVS

Check, Money
Order, Visa, MC

1502 N. Harrison
Ft. Wayne, In 46808

Reader Service #66

Digital Storage Oscilloscope For \$189.95 ???

And much, much more!

O-Scope I turns PC-ATs into DSO, Spectrum Analyzer, Frequency Counter, DVM. DC-50KHz



Sinewave Sweep

Spectrum

Actual O-Scope I Captured Signals

For Orders and Inquiries Call: 1-800-980-9806
For Technical Assistance: 1-713-777-0401

Allison Technology Corporation
8343 Carvel, Houston, TX 77036
FAX and BBS 1-713-777-4746

SB Mailbox

VOLUNTEERS WANTED

Belden has been making professional audio cable for almost 100 years. As part of our determination to learn as much as we can about audio cables, we are interested in investigating the quality of performance of audio cables called "directionality."

Directionality is an attribute that pertains to the direction of flow of audio information in the cable. Some people believe that the sound quality of audio differs depending on the direction of signal flow through the cable, that one direction yields sound quality that is preferable to the other, and that this is related to the way the cable is created in the manufacturing process.

As the Technology Development Manager at Belden, I felt we should investigate this attribute. In discussions with our engineering staff we came up with a simple double-blind experiment that should satisfy most of the concerns of critical musical listeners. The goal of the experiment is to determine whether or not there is a correlation between "direction" in which the cable is manufactured and the quality of audio information flow in the cable.

We would like to invite readers to participate in this experiment. Those interested must send a card, letter, or fax volunteering to participate in this experiment by the end of the November to:

Belden Wire & Cable
Stephen H. Lampen
Technology Development Manager
2200 US Hwy. 27 S.
Richmond, IN 47374
FAX (317) 983-5825 or (317) 983-5294.

Be sure to clearly mention my name, Stephen Lampen, and that you want to be part of the Audio Directionality Test.

We are seeking 100 volunteers, each of whom will receive ten pieces of single-conductor polyethylene-jacketed wire approximately 5' long. The wire ends will be tagged with numbers chosen at random. Belden will maintain a master log of the "direction" each wire was drawn during manufacture, copies of which will be furnished to David Moulton, of David Moulton Professional Services, who has volunteered to be the third-party judge of the results.

The experimental task for each participant will be to audition the ten pieces, substituting the test piece for the positive lead from your amplifier to the positive connection for one speaker. This may be done at your convenience, and according to your preference, over a period of two months. During this time, you will try to determine in each piece of wire which "direction" you prefer.

Each participant should complete the answer sheet provided with the test wires and mail it in its post-paid envelope to David

Moulton Professional Services, Groton, MA, for tabulation and statistical analysis. This should be completed within 60 days (two months) after receipt of the test wires. The wires do not need to be returned.

David Moulton Professional Services provides neutral testing services devoted to the audio field. Mr. Moulton has no professional opinion regarding cable directionality nor any vested interest in such a question. Mr. Moulton will tabulate the received answer sheets and correlate them with Belden's master log. He has no previous connection with Belden and was nominated for this position by Ed Dell, editor of *Speaker Builder*. Using normal statistical techniques, he will prepare an analysis of the correlation between preference and directionality, which in turn will be presented to Belden Wire & Cable, which will conduct its own statistical analysis of the results. All results will be made public to interested parties.

Speaker Builder will publish the test results in a future issue. Belden reserves the right to present these results at some appropriate convention or trade show. Should there be a significant group of testers whose perception of direction correlates positively, we expect to continue the investigation with these individuals. Our goal for such research is to develop a positive correlation between measured physical qualities and directionality.

True Image Audio

The Speaker Design Toolbox®

Open Driver Database Calculate Frequency, Excursion, Phase, Delay & Impedance Responses Show/Hide System Memories 1-10

SPL Mode Open Vent Calculator

FREE! WinSpeakerz 95 Demo **FREE!** MacSpeakerz Demo

Speaker Designers!
Visit Our Web Site For More Information on
The Speaker Design Toolbox®!
Download Your Demo Today!

<http://members.aol.com/spkrtools>

only \$199!

30 Day MBG

Visit our Speaker Design Forum! AOL Keyword: TIA

True Image Audio® 349 WEST FELICITA AVE., SUITE 122, ESCONDIDO, CA 92025 • email: TIA Sharon@aol.com
• Phone: 1-800-621-4411 • Fax & INTL Inquiries: 619-480-8961

Reader Service #29

Thank you in advance for your help with this experiment.

Stephen H. Lampen
Technology Development Manager
Belden Wire & Cable

Speaker Builder is pleased to be involved in this unique experiment and encourages reader participation. We wish that those readers who decide to take part in the directionality test will commit to it seriously, keep an open mind, and respond in a timely manner. We consider it a credit to both the magazine and its dedicated, knowledgeable readers to be approached to participate in this test, which attempts to address the question of directionality without bias.—Eds.

TUBULAR EXPANSION

I couldn't find the values for the capacitor used as a crossover in Richard Carlson's article, "Tubular Speakers" (SB 4/96). I also cannot locate the placement of the sound port or the tweeter. A small diagram with values, placement, and assembly would have taken little space and clarified much. I am anxious to build two pairs of these for my office and workshop.

Carlos Alvarez
Winder, GA

Dick Carlson responds:

My sincere apologies for excluding tweeter and crossover information from my article. I cannot imagine why I overlooked such an important aspect of the system, other than pure haste.

To the point, each of the tubes employed an Audax TW010F1 10mm polymer-dome tweeter. The manufacturer recommends a first-order crossover frequency at 6kHz; yet, since I did not intend for the system to be played at extreme levels, I opted for a 5kHz crossover frequency. All loudspeaker components have an impedance of 8Ω, so I used a Mylar 10% polyester film capacitor rated at 3.9μF based on the calculations of X-over 2.0 (Fig. 1). Should you decide on a different tweeter, the values will be affected. Although I did not employ a coil for the woofer, Fig. 1 shows 0.25mH coil would have worked nicely.

Concerning the placement of the tweeter, I used a 1/2"-thick strip of plywood as a tweeter baffle. It is cut to the length of the tube, less baffle thickness at each end, and glued flush with each baffle. Before doing this, I cut a hole at the approximate center of the strip for the tweeter. After mounting the drivers, I routed the wires to the drivers and, using

Tweeter: Audax TW010F1

Z = 8.0 ohms
Re = 5.5 ohms
Le =
Qms =
Qes =
Sens = 90.0 dB (1 watt)
Number = 1
NetZ = 8.0 ohms
NetRe = 5.5 ohms
NetSens = 91.6 dB (2.83 V)

Woofer: Madisound 5102-B

Z = 8.0 ohms
Re = 5.7 ohms
Le = 0.23 mH
Qms = 2.330
Qes = 0.440
Sens = 89.1 dB (2.83 V)
Number = 1
NetZ = 8.0 ohms
NetRe = 5.7 ohms
NetSens = 89.1 dB (2.83 V)

Crossover Network Components

Frequency 5000 Hz
2-way 1st-order Butterworth
C1 = 3.98 μF
L1 = 0.25 mH

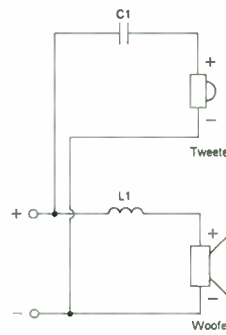

FIGURE 1: Passive-crossover design for tubular speakers.

electrical tape, secured the wires to the tube for appearance and to prevent vibrations.

You will really enjoy the full-bodied sound of these loudspeakers, as I did for many months. Beware, you will receive numerous comments on the speakers, so be prepared to tell your story over and over again.

APERIODIC MYSTERY

I am interested in building an aperiodic enclosure. I have found only bits and pieces of information in various magazines and books, which mainly talk in generalities and offer no concrete information.

I understand that a purely resistive membrane allows air to escape the enclosure. What is meant by "purely?" Is the box just large enough to enclose the speaker? What about tuning? Are there any mathematical equations involved in this design? Can a response be predicted or is it all trial and error?

What is the membrane made of and how much do you compress it? Does the com-

pression thickness affect the tuning or the response? Is there a formula for surface area to the membrane?

John Rose
Saugus, CA

Although there are vendors who sell a type of cover for an aperiodic opening in the rear of closed boxes, very little in the way of formal investigative work has been done on this interesting format.

In the 1960s, Dynaco imported many hundreds of thousands of their A2 aperiodic speakers made for them by SEAS, but Dynaco's production manager confessed years later that the design was totally empirical, without any proven scientific theory as to why or how it works. The speaker was highly popular and many still survive.—E.T.D.

WAVEGUIDE ALTERNATIVES

Thanks very much for sharing your waveguide enclosure configuration in your three-part "The Waveguide Path to Deep Bass" (SB 6, 7, 8/95). I was also struck by the synchronicity of finding the letter from J. David Keener on the page opposite the end of your article. Reading your waveguide article, I kept wondering, "Why didn't he try PVC pipe?"; then, Mr. Keener's letter prompted me to suggest the idea.

Four-inch sewer pipe is a perfect match for the 4" RS-1022 speakers from Radio Shack and 6" pipe works nicely with 6 1/2" drivers. Hot-melt glue is great for attaching the drivers to the PVC, allowing you to glue pipe to the front and back of a driver, putting it directly in the waveguide. Using elbows and tees, as Mr. Keener mentions, you can easily create configurations and change them in a matter of minutes.

Use this convenient list to request the products and services that you need fast. Don't forget to mention **Speaker Builder!**

COMPANY	PRODUCT	FAX
Allison Technology Corp.	O-Scope II	(713) 777-4746
Driver Design Limited	V5/12R - HOUR/6 - V6/20-CUSTOM	(510) 370-1941
Electroswitch	Lever & Rotary Switches	(919) 872-8875
Harris Technologies	BassBox and X'over	(616) 641-5738
Hi-Vi Research	Hi-End Drivers	(905) 475-8226
Kimber Kable	Speaker cables, interconnects, etc.	(801) 627-6980
Liberty Instruments, Inc.	LIBERTY AUDIOSUITE VER.2	(513) 755-0252
LinearX Systems, Inc.	Leap	(503) 598-9258
Markertek Video Supply	Unique & Hard-To-Find Accessories	(914) 246-1757
Meniscus	Monoblock	(616) 534-7676
Morel Acoustics USA	Loudspeaker Drivers, Car Speakers	(617) 277-2415
Solen Inc.	Speaker & Crossover Components	(514) 443-4949
Speaker Works, Inc., The	Vifa	(602) 230-8533
True Image Audio	WinSpeakerz & MacSpeakerz	(619) 480-8961
V. Vogt	Antique Audio	(206) 251-0636

SOLD OUT

1981 A Testing Unit for Speaker Parameters • Variable-Volume Enclosure • Thiele/Small Theory, Pt 1-3 • Easy to Make Enclosure Using Concrete Blocks • The Tractrix Horn: Good Dispersion From an Old Design • Diffuser Port for Small Boxes • Mini-Speaker Made From PVC Tubes • Closed vs. Vented Box Efficiency • Interview with P.G.A.H. Voigt • Dual 8" Symmetrical Air Friction Enclosure • Thiele/Small Calculator Computation • Thiele/Small Parameters for Passive Radiators •

1982 Transmission Line Theory • Thiele/Small Sixth-Order Alignments • The Quad 63 • Table Saw Basics • AR-1 Mods • Active Crossover and Phase • Three Transmission Line Speakers • A Beginner's First Speaker • How Passive Networks Interact with Drivers • Horn Loaded Heil • Phase Correcting Active Crossover • Wind Your Own Inductors • Series and Parallel Networks • High Performance Corner Speaker • Using Zobel's to Compensate for Driver Characteristics •

1983 Building the Two-Way Dynaudio • A Crossover That Offsets Speaker Impedance • Using a Calculator for Box Design • Choosing a Calculator • A Simple Peak Power Indicator • A Small Horn Speaker • Audio Pulse Generator • How to Use Speaker Pads and Level Controls • An Easy-to-Build Voltmeter for Speaker Measuring • Nomograms for Easy Design Calculations • Interview with KEF's Raymond Cooke • Build a Simple Wattmeter • A New Type of Speaker Driver •

1984 Build an Aligned Satellite/Woofers System • BOXRESPONSE: A Program to Calculate Thiele/Small Parameters • Casting with Resins • A Phase Meter • An Interview with Ted Jordan • Building the Jordan-5 System • Self-Powered Peak Power Indicator • Closed Box Design Trade-offs • How to Build Ribbon Tweeters • Build a Dual Measurement Impedance Meter • A High-Power Satellite Speaker System • Build and Use a White/Pink Generator • Sound Pressure Level Nomograms •

1985 OUT OF PRINT, some single issues still available at \$7 each •

1986 The Edgar Midrange Horn • Sand-Filled Stands • Crossover Networks: Passive and Active • 5-sided Boxes • A 2 x 4 Transmission Line • The Free-Volume Subwoofer • Notch Filters • By-Wiring the LS3/5A • A Push/Pull Constant Pressure System • Current and Power in Crossover Components • The Unbox (Egg) • Upgrade Speakerlab's S-6 Crossover • Measure Speakers with Step Response • A Gold Ribbon System • A Visit with Ken Kantor • A Tractrix Horn Design Program • Reviews: Audio Concepts "G"; Seven TL Midranges; Focal's Model 280; the Audio Source RTA-ONE.

1987 A Compact TL Woofer • Frequency Response and Loudspeaker Modeling, Pt 1-3 • A Manual Coil Winder • The Model-One Speaker • Designing a Listening Room • A Sixth-Order Vented Woofer • Tapered Pipe Experiments • Visiting Boston Acoustics • A Vented Compound System • The Octaline • Spreadsheets for Speaker Design • In Memoriam: Richard Heyser, Pt 1-2 • Using Non-Optimum Vented Boxes • Building Speaker Stands • Evaluating Driver Impedance Compensation • Tuning Bass Reflex • Six Woofers Compared • Bullock on Passive Crossovers: Alternate Bandpass Types • Fast, Easy Filter Calculations • A Mobile Speaker • Polk 10 Mod •

1988 Electronic Turns Counter • Two-Way Design • Minimus-7 Mod • Dome/Midrange/Tweeter Array • Plotting Complex Impedances • A Driver Design Primer • A Cabinet Primer • Tuning Up Old Systems • Low-Cost AR-3 Upgrade • Electronic Time Delay • Enclosures Shapes and Volumes • Minimum-Phase Crossovers • Spot Sound Absorbers • How to Add a Subwoofer • The Swan IV System • Sub-Bass Power Boosting • The Unline: A Short TL • Active Filter Computer Design Program • Low-Cost Two-Way Ribbon • Amp-Speaker Interface Tester and Construction Plans • The QB₃ Vented Box is Best • A Pentagonal Box System • Keith Johnson Profile • Sheathed Conductor ESL • A Symmetrically Loaded System, Pt 1 • Ceramic Enclosure • Inductance Measuring Technique • Polk 10 Mods •

1989 (4 Issue Set: VERY LOW STOCK) The Audio Laboratory Speaker System • A Passively Assisted Woofer • Digital Filter Tutorial • The Listening Arc Alignment • Small IC Power Amp & Crossover • Easy Surround Sound • Building Speaker Spikes • An Isobarik in a Thunderbird • Sheetrock Cabinetry • A Vented Speaker • ARV Conforming • R-1 • Silent, Safe Muting System • Equalizing the Klipsch Crown II • A Test Switcher • Visiting the Klipsch Kingdom • Rehab for Kitchen Music • Spreadsheet Design • A Subwoofer/Satellite System • Impedance Measurement as a Tool • Practical Passive Radiators • A Symmetrical Dual Transmission Line, Pt 1 • The Microline • A Voice Coil Wheatstone Bridge • Tweeter Q Problems •

1990 Acceleration Feedback System • Cylindrical Symmetrical Guitar TLs • Compact Integrated Electrostatic TL, Pt 1-3 • Minimus-7 Super Mod • The Show (Bass Horn) • A Small Two-Way System • Helmholtz Spreadsheet • Heresy Upon a (Klipsch) Heresy • Beer Budget Window Rattler • Contact Basics • MDT Mini-Monitor Speaker System • Titanium + TPX + Polypropylene = Fidelity • Tom Holman, Skywalker, and THX, Pt 1-2 • Bud Box Enclosure • Klipschorn Throat Riddle • Modular Three-Way Active Speaker • CD Speaker System • SPEAKER DESIGNER Software • Symmetrical Isobarik • Novice Crossovers • Triamplified Modular System • Magnetic Crosstalk in Passive Crossovers • Mitey Mike Loudspeaker Tester • Symmetrical Loading for Auto Subwoofers • Improved Vented Box with Low Q_{TS} Drivers • BOXMODEL Woofer System Design Software • Four Eight by Twos • Dynaco A-25 Mod • Klipschorn Throat Revisited •

1991 Students Building Systems • Servo Subwoofers • An Apartment TL • L-R Crossover for the Swan IV • More or Less Power • New Guidelines for Vented Boxes • The Pipes • Macintosh's Wave and Sound Programs • Creating Professional Looking Grilles • Octaline Meets D'Appolito • Using Radar to Measure Drivers • Deep Bass for GMC • PSpice LF Response Calculating • Pipe and Ribbon Odyssey • The Delac S-10 • Infrared Remote Volume Control • Backloaded Wall Horn Speaker • Mod for the Minimus 7 • Simplifying Cabinet Assembly • Fibrous Effects on TLs • The DOALS • Loudspeaker Cable • Speaker to Ear Interface • Speaker Sensitivity to Errors in T/S Parameters • TL Speaker Evaluation • Cable and Sound • Kit Reports: Little V; Audio Concepts' Sub-1 •

1992 Rumreich on Box Design & Woofer Selection • MLSSA • Double-Chambered Reflex by Weems • Active Crossover and Delay • Electrical Circuit Bandpass Enclosure • A Dreadnaught System (satellite swivels) • Designing Real-World Two-Way Crossovers • 20-foot Ribbon Dipole Speaker • Biamping the Sapphire II • Capping Passive Crossovers • A High Quality Speaker Cabinet • 1/3-Octave Noise Source • Disappearing Loudspeaker • The A&S Soundoff Winner, Pt 1-2 • Alignment Jamming • Marc Bacon's "Danielle", Pt 1-2 • Double-Chambered Isobarik Bass • Ferguson's Pickup Installation • Electronic Counter for Coil Winding • Oakley on Speaker Placement • Making Your Room Hi-Fi, Pt 1 • More on Dust Caps • Spreadsheet for Nonoptimum Vented Box Design • Acoustic Resistance Tuned Enclosure •

1993 Waslo's IMP, Pt 1-3 • Quasi-Monotonic Vented Alignments • Making Your Room Hi-Fi, Pt 2-3 • A&S Soundoff Winner, Pt 3 • Flexible Dipole Woofer • The Sipline • Stalking F₃ • A Bi-Structural Enclosure • A Sixth-Order T/S Subwoofer Design • Speaker Enclosure Screws • Electric Bass Tri-Horn • Prism V Satellite/JBL Subwoofer, Pt 1-2 • Fitduct: Program for Designing Duct Software • Compact Coincidental Point Source Speaker • IMP: Measuring T/S Parameters • KIT REPORT: Rockford's Beginner Software/Driver Paks • SOFTWARE REPORT: Low Frequency Designer 3.01 • Three Affordable Measurement Microphones • Two Ways to Realize a Dream • Matching Driver Efficiencies • Two-Woofers Box System • Designing a Dual Voice Coil Subwoofer • SOFTWARE REPORT: Blaibox 1.2 • Tale of Three Speaker Projects • A&S Sound-off 1992 • Monolith Horn • Orbiting Satellites • Real-World Three-Way Crossovers • The Simplex • Living with a Speaker Builder • The IMP Goes MLS

There's More

Please send me the following back issues of Speaker Builder

- | | | | |
|------------------------------------|------------------------------------|------------------------------------|------------------------------------|
| <input type="checkbox"/> 1995 \$32 | <input type="checkbox"/> 1994 \$32 | <input type="checkbox"/> 1993 \$25 | <input type="checkbox"/> 1992 \$25 |
| <input type="checkbox"/> 1991 \$25 | <input type="checkbox"/> 1990 \$25 | <input type="checkbox"/> 1988 \$23 | <input type="checkbox"/> 1987 \$20 |
| <input type="checkbox"/> 1986 \$20 | <input type="checkbox"/> 1984 \$18 | <input type="checkbox"/> 1983 \$18 | <input type="checkbox"/> 1982 \$18 |
| <input type="checkbox"/> 1981 \$18 | | | |

SHIPPING BACK ISSUES

UPS: Domestic ground service by value of order:
 Less than \$60.00 - \$4.50 \$131.00-220.00 - \$8.50
 \$61.00-130.00 - \$6.50 \$221.00+ - \$10.50

Canada: Add \$6.00 per year

Foreign Air: Europe add additional 40% of total order. **Total Magazines** _____
 Other destinations: 50% of total order. **Postage** _____

Foreign Surface: Add additional 20% of total order. **TOTAL ENCLOSED** _____

Rates subject to change without notice. All remittance in US \$ only drawn on a US bank. Make checks payable to Audio Amateur Corp.

- Check or Money Order Discover MC VISA

DISCOVER/MC/VISA NO.	EXP. DATE
NAME	ACCOUNT NO.
STREET & NO.	
CITY	STATE ZIP

Speaker Builder

Post Office Box 494, Dept. B96, Peterborough, NH 03458-0494
 (603) 924-9464 FAX (603) 924-9467

Answering machine for credit card orders only—before 9:00 a.m., after 4:00 p.m. and weekends
 Please have all information plus MC/VISA available.

I have been playing with transmission-line enclosures for a few years. Using PVC pipe convinced me that you can get truly great bass from a transmission-line enclosure. In fact, after trying plastic pipe, which is easy to work with and should be suitable for waveguides as well, I swore to never build another wooden cabinet.

TLs are woefully inefficient: the driver's back wave adds nothing to the sound, as with closed-box or vented enclosures. TLs can reproduce really low notes, but not with real authority. The best results seem to come from using drivers with higher sensitivities; otherwise, you cannot fully appreciate what these wonderful enclosures can do for your music.

Given the waveguide articles and audio-testing software now available, useful empirical data on how TLs behave in real life when varying drivers, lengths, types and density of stuffing, and configurations is plentiful.

Doug Jones
72614.3525@compuserve.com

Contributing Editor G.R. Koonce responds:

Most readers who responded to the waveguide article recommended construction via round piping. At the time of my experimental double-ended waveguide investigation, I wanted a structure that had adjacent location of the two output ports and could handle one or two drivers of various size and mounting-hole arrangement. The only way I could see to accomplish this was with particle-board construction.

Certainly, if you know the final dimensions for what you want to build, the round pipe would offer simplified construction, greater wall stiffness, and less risk of air leakage. In waveguide work, the required pipe diameter is not set by the driver's nominal diameter, but by a combination of the driver's physical and electrical characteristics.

The transmission-line (TL) structures that Mr. Jones is experimenting with are, indeed, single-ended waveguides when used with little or no stuffing. I believe testing would show that the unloaded side of the driver cone makes a contribution to the total system output, which must be considered. In many TL applications, the woofer is used to a frequency above the range controlled by TL effects. For a flat response, the whole structure must be designed for a sensitivity that matches the driver's reference efficiency; i.e.,

SPEAKER CITY, U.S.A.

PROUD TO DISTRIBUTE
EXCLUSIVELY
in Southern California

vifa excellence from Denmark

OTHER HIGH END LINES INCLUDE:

SCAN-SPEAK

FOCAL
technologie d'avant-garde

Versa
ronics

DYNAUDIO®

POLYDAX
SPEAKER CORPORATION



1995 Catalog Now Available

Call today
to receive your copy

115 S. Victory Blvd., Burbank CA 91502
(818) 846-9921 FAX (818) 846-1009

Reader Service #27

Speaker Builder

BACK ISSUES Continued

1994 Sanctuary Sonics • Modular Active Crossovers • A Full-Range Open-Baffle System • An Evolving Magnepan MG-1 • Low-Frequency AC-To-DC Converter • A Compact Bass Guitar Speaker • Measuring Speaker Impedance Without a Bridge • The Dynapleat • The Danielle II • The Birdhouse: A Sound-Reinforcement Subwoofer • The Linear-Array Sound System • A Revised Two-Way Minimonitor • Exploring the BUF 124 with Pspice • Signet's SL280B/U • Time Response of Crossover Filters • Converting Radio Shack's SLM To Millivolt Use • Acoustic Distortion and Balanced Speakers • Microphone Response Correction with IMP • More About the Birdhouse Bandpass • A 16Hz Subwoofer • D.H. Labs Silver Sonic Cables • The System III Loudspeaker • Exploring Loudspeaker Impedance • IMPcycling • The Linear-Array Chronicles • Book Report: Loudspeaker Recipes, Book One • The Woofer Test • A Large Ribbon You Can Build • Loudspeakers, A Short History, Pt 1-2 • Absolute SPL Sensitivity Measuring with IMP • The Damping Factor: One More Time • Cliffnotes for Loudspeaker University • Software Report: The Listening Room for Macintosh • Book Report: The Theory and Design of Loudspeaker Enclosures • A 15" Transmission Line Woofer • Inductor Coil Cross Talk • Quick Home Theater on a Budget • Silk Purses: A Two-Way Salvage Design • Audio Phase Inductor •

1995 The T-Rex Minisubwoofer • High Quality Use of Motorola's Piezo Driver, Pt 1 • The Achilles: A Two-Way Automotive Transmission Line • Driver-Offset-Related Phase Shifts in Crossover Design, Pt 1-2 • The Linear-Array Chronicles, Pt 3 • From Sad to Sparkle: A SAAB Story, Pt 1-2 • A Compact Two-Way PA, Pt 1-2 • The Baekgaard Crossover Technique • Rebuilding the KLH-9 Power Supply • KIT REPORT: Audax of America A652 • Satellites For a New System • Box Models: Benson Versus Small • PRODUCT REVIEW: Sapphire III Reference Monitor • The Simpline Sidewinder Woofer • Focused Arrays: Minimizing Room Effects • A Flexible Four-Way System • Extending IMP: A Program Set • CD REVIEW: My Disc From Sheffield Lab • The Freeline: An Open-Pipe Transmission Line • Computer-Aided Bass Horn Design • A Mike/Probe Preamp For Sound-Card Measurements • Four-Poster Speaker Stands • Mining For Gold On the Madisound BBS • SOFTWARE REVIEW: CLIO Test System • The Waveguide Path to Deep Bass, Pt 1-3 • Stereo Bass: True or False? • A Morning Glory Midrange Horn • Testing a Simple Focused Array • PRODUCT REVIEW: LinearX's pCRTA • A Self-Powered Subwoofer for Audio/Video • Your Car's (and Living Room's) Bass Boost • Driver Temp and T/S • SOFTWARE REPORT: SoundBlaster 16 • A Push-Pull Planer Speaker Quest • PC Sound Overview • Design a Three-Way TL with PC AudioLab, Pt 1 • PRODUCT REVIEW: Audio Control C-101 • SOFTWARE REVIEW: Electronics Workbench •

the same situation as for a vented or closed box. If the woofer is only used above the frequency range where resonant effects dominate, it is possible to obtain increased sensitivity over the bare driver. I encourage Mr. Jones to write up configurations he has found to perform well for the benefit of all readers.

AD INDEX

ADVERTISER	PAGE
ACI	52
Acoustic Technology Int'l	70
Allison Technology Corp.	59
Audio Alchemy, Inc.	23
Audio Classics, Ltd.	59
AudioWeb	43
Crosstech Audio, Inc.	65
Cubicon Corporation	47
Driver Design Limited	40
Electroswitch	3
Elektor Electronics	50
Ferrofluidics Corporation	30
Forgings Industrial Co.	49
Harris Technologies	38
Hi-Fi News/Record Review	42
Hovland Company	46
IAR-TRT	CV2
Image Communications	35
Int'l Sales & Engineering	65
Kimber Kable	31
Kustom Isolation Supports	69
LGT Technologies	8
Liberty Instruments, Inc.	41
LinearX Systems, Inc.	4
Madisound	
Halloween Specials	17
Deflex	25
Marchand Electronics, Inc	37
Markertek Video Supply	46
McFeely's	69
MCM Electronics	32
Mahogany Sound	66
Meniscus	36
Michael Percy Audio	24
Morel Acoustics USA	CV4
Mouser Electronics	39
Old Colony Sound Lab	
Audio Measurement	58
Ultimate Audio Sound	55
Velleman Tube Kits	61
Orca	
Accuton	7
Raven Transducers	19
Access	29
Clio	67
Parasound Products, Inc.	51
Parts Express Int'l, Inc.	CV3
Reliable Capacitor	5
Solen Inc.	
Crossover Components	13
Speaker Components	45
Sound Technology, Inc.	40
Speaker City, U.S.A.	64
Speaker Works	48
Speaker Works, Inc., The	15
Speaker Workshop	59
TCH	33
TIFF Electronics Co.	6
True Image Audio	60
V. Vogt	48
Welborne Labs	68
Zalytron Industries Corp.	21
CLASSIFIEDS	
Audio International, Inc.	68
Apex Jr.	68
David Lucas, Inc.	68
Decade Engineering	68
Welborne Labs	68
GOOD NEWS/NEW PRODUCTS	
Abilene Research & Development	5
B&W Loudspeakers of America	6
D.H. Labs	5
Elektor Electronics Publishing	5
Interactive Image Technologies	5
Liberty Instruments, Inc.	6
Miller + Kreisel Sound Corp.	6
Music Interface Technologies	5
Probe Audio Labs	5
PSB International, Inc.	6
Spirit by Soundcraft, Inc.	5

AS I WAS SAYING...

To continue my response to Thomas H. Eberhard's letter (*SB* 5/96, p. 54), the latest version (1.1.0) of Mac SLM[®] lets you save the measurement as a text file, enabling its importation into a spreadsheet, analysis, or graphics program. I sent Mr. Eberhard an upgrade version and user's manual. As it turns out, he had not received the printed manual with his order, which is necessary to experience the program's full potential.

Along the same vein, I give H. Donn Hooker (*SB* 5/96, p. 58) some sympathy regarding MathCad.[®] I use version 3.1 for consulting and personal projects, such as designing the DSP filters in Mac SLM. You should first read the book and then practice using the program. Quite powerful in some ways, MathCad is weak in optimization and in the facilities provided by the Maple[®] subset.

Beware that some impedance measurements are normalized by the impedance of free air, which radically changes the system of units. ▶

Dr. Victor Staggs
Orange, CA

Aftershock Subwoofer

from page 42

phase. Removing the 55-ltr chamber and thickening the walls made Aftershock sound a little more solid; however, the response measured the same as it did before the overhaul.

SUMMARY

If you can get your hands on some old professional bass-instrument or sound-reinforcement speakers, take a little time to restore them, analyze what you have, and use the knowledge available in *Speaker Builder*, you may surprise yourself with incredible results and save yourself a ton of money. Warning: if you live in Southern California, watch one of those PBS specials on earthquake-proofing your house and take the precautions before putting your Aftershock into service, or you may hear some crashes that were not in the original soundtrack! ▶

Spider Analysis

from page 57

ufacturer. I used a Sony MVC5000 video camera for this session, utilizing the composite video output available to drive both a monitor for real-time viewing and a VCR for recording. I used several different levels and recorded the results. Frame grabs from the video showing representative results are shown in *Photos* 5-13.

As you can see from the photos, there were significant motions at frequencies higher than the fundamental. These vibrations, coupled to the air both directly and through the base of the cone, were quite audible.

To confirm this spider motion as the source of the errant sounds, I conducted another basic test using the stroboscope to visualize the results. I again fed the test signal to the driver, and, while watching the vibration of the spider under the stroboscope, I placed my index finger on a point of one leg where it was attached to the basket. I then moved my finger up the spider until the strobe showed that the vibrations were damped, all the while listening for changes (*Photo* 13). The reduction in the high-frequency anomalies was consistent with the reduction of vibration I noted. Since I subjected only one of the four legs to this test, the anomalies were not totally removed, but the effect was clear.

In summary, a stroboscope can show motions in drivers that you cannot see with the naked eye. Additional advantages include its moderate cost, its portability, and the fact that you can use it with a wide range of objects. A little care in basic lighting techniques greatly enhances visual results, extending the range of objects that can benefit from this technique. ▶

PREMIUM CROSSOVER NETWORKS HIGH POWER 12DB PASSIVE

YOU'VE DESIGNED BUILT AND LOADED
YOUR ENCLOSURES
WITH HI QUALITY SPEAKERS.
YOU HAVEN'T SPARED ANY EXPENSE,
YOU'VE SPENT TIME AND MONEY
LET CROSSTECH AUDIO'S
PREMIUM HI POWERED
CROSSOVER NETWORKS
FINISH OFF THE JOB
DO IT YOUR WAY. THE RIGHT WAY!
CUSTOM FREQUENCIES NOT A PROBLEM



30 Francine Lane Staten Island N.Y. 10314
Phone (718) 370-8399 Fax (718) 370-8297

Reader Service #85

LIQUIDATION!

TW60A TWEETERS...SOLD OUT!...THANK YOU!
SILVER LEAD WIRE...SOLD OUT!...THANK YOU!

GRILLES:

23" x 13 1/8" fiberboard foam covered, with 12" opening	\$1.00
25" x 12 7/8" molded plastic frame, brown grille cloth	\$1.00
26 1/4" x 15" molded plastic frame, brown grille cloth	\$1.00
6.5" dia. black wire mesh grilles w/mounting bracket	\$1.00
6.0" dia. black wire mesh grilles w/mounting bracket	\$1.00
5.0" dia. black wire mesh grilles w/mounting bracket	\$1.00

CROSSOVERS:

C X-1	2 Way Crossover	\$9.00
CX-18	3 Way Crossover	\$18.00
CX-24	2 Way Crossover	\$15.00

Cones, voice coils, spiders, dust caps, whizzer cones, surrounds, gaskets, ferrite magnets (demagnetized), adhesives, crossovers, inductors, L-pads, magnet wire, horns, drivers, speakers 6" thru 15", tweeters, cabinet handles/corners, wire mesh grilles.

Complete list available.

International Sales & Engineering

P.O. Box 750, Hwy 77 & FM 511
Olmito, TX 78575-0750
PH: 210-350-5555
FAX: 210-350-5574

WE GET RID OF WHAT YOU DON'T WANT!

Reader Service #56

MAHOGANY SOUND

The Transmission Line Specialist
P.O. Box 9044
Mobile, AL 36691-0044
334-633-2054

Acousta-Stuf

The Very Best Damping Material For Speaker Systems. It Produces Deeper Bass, Cleaner Mids, And Greater Dynamic Range. Acousta-Stuf Costs \$9.50 Per Pound UPS Paid.

Q&ETLD

Quick & Easy Transmission Line Speaker Design Booklet & LOTUS 1-2-3 Software. Learn How To Design Optimizes 1/4 Wavelength TL Speakers. Q&ETLD Costs \$8.95 Plus \$2.05 P&H.

Acousta-Tubes

Round Paper Tubes For Building Cylindrical Speaker Enclosures.

Please Note Our New Address & Area Code

Call Or Write For A Free Catalog

Reader Service #9

Tools, Tips & Techniques

A CHEAP, HI-TECH CABLE

In recent years, controversy has raged about the presence of audible differences in speaker cables, interconnects, and even amplifiers. A major factor influencing cable performance is total resistance, which reduces the damping of the amplifier/speaker combination, causing frequency-response variations. Less resistance has less of an effect. A larger wire diameter has less resistance for a given length than a smaller one. The greater the length of wire, the greater the resistance.

WIRE FEATURES

Skin effect is a diameter- and frequency-dependent property of the wire, which adds an inductive-type roll-off to the high frequencies. You should minimize this effect within the audio band by using small-gauge, individually-insulated Litz wire. The geometric layout of these small wires affects mutual inductance and self-inductance. Long parallel runs of closely-grouped small wires exhibit high inductance, whereas a tightly-twisted pair has both low inductance and high capacitance.

Insulation forms the dielectric of a capacitor, while the two wires alternately form positive and negative plates. When the potential across this capacitor crosses zero, the capacitor will discharge back into the signal path. A slow discharge is audibly more disruptive than a rapid one, since the longer discharge duration represents a lower spectrum in the frequency domain.

Even just a little storage of the musical peaks can wreak havoc on the low-level detail when discharged back into the signal path, even at a minute fraction of the original amplitude. A Teflon® dielectric, which discharges more rapidly than any other, can keep this zero-crossing energy release to such a short duration that its frequency is inaudibly high, thus avoiding noticeable

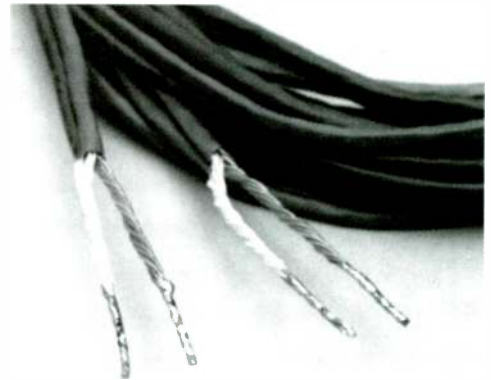

PHOTO 1: Multiple twisted pair of speaker cables.

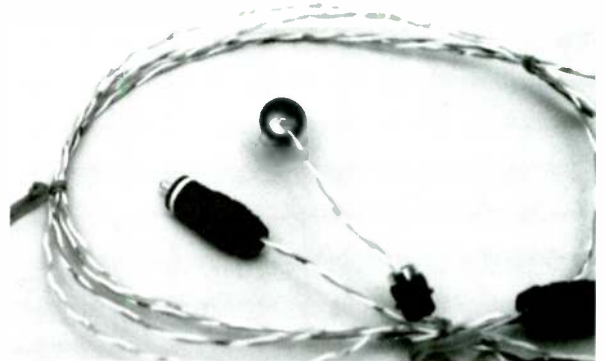

PHOTO 2: Interconnects.

degradation of the signal.

Characteristic impedance is calculated as the square root of cable inductance divided by cable capacitance, and expressed in ohms. A cable with a characteristic impedance of 8Ω will most efficiently serve an 8Ω speaker load. Ideally, this match should be within 20% for best power transfer and minimal reflectance of the signal to the source. When the source and load are mismatched with the transmission line, the line can support resonances that are comparable to the standing-wave pattern of multiple echoes between parallel walls.

Most speaker wire does not match well to an 8Ω load and even less so to the 0.1Ω output impedance of a typical power amplifier. This mismatch at source and load can cause an unfavorable situation in which electrical reflections are set up in the line.

DREAM CABLE

With all of this in mind, an optimal speaker cable that minimizes foreseeable pitfalls and matches characteristic impedance to the 8Ω load of most loudspeakers is conceivable. The model could then be easily transposed for 4Ω , 6Ω , and 16Ω speakers. Speakers with a constant impedance would benefit the most from line matching, but other design considerations should reap like benefits. An equivalent gauge of AWG 14–16 should give an adequately low total resistance for most applications.

Multiple twisted pairs of small-gauge Teflon-insulated, high-purity copper wire, calculated to provide the desired 8Ω characteristic impedance and minimal skin effect, would be such a multipurpose cable (*Photo 1*). This dream cable would require specialized production facilities and, thereby, would be expensive to make—perhaps costing over \$50 per foot. The only way to reduce the cost would be to mass-produce the cable on an industrial scale, as is done with the digital trunk line for computer installations.

Incidentally, the digital trunk line for computer networks is rated to 110MHz and consists of four twisted pairs of 24-gauge high-purity, Teflon-insulated copper wire. How many runs of this cable would you need for a workable equivalent gauge? Eight twisted pairs would equal a 15-gauge pair, with a characteristic impedance of 9Ω .

So, you would need a double run of category 5 Plenum-rated digital trunk line to get eight twisted pairs. For the double run, the cost would be a dollar a foot, which is as much as Radio Shack's knock-off of Monster cable. On the other hand, a 1,000' spool costs only \$240*. Obviously, I stacked the deck on this one. The point is that good speaker wire is available at low cost.

Ideally, sound is extremely detailed, spacious, dynamic, and free of grain. It is somewhat dependent upon the impedance curve of speakers with which it is mated. Speakers with a very high impedance across the midrange and high-end, such as a two-way design incorporating a series resistor on the tweeter for level matching, may sound better with a single run of twisted pairs with a 19Ω characteristic impedance.

In this case, the equivalent gauge is 18, so keep the runs under 8'. By the same token, four runs can be compiled for an equivalent gauge of 12 and a characteristic impedance of 4.75Ω .

PREPARING THE WIRE

The important factor here is "sweat equity," or the amount of work required. Four runs of four twisted pairs of 24-gauge wire per channel gives 128 little wire ends to strip, segregate, and solder for one pair of 12-gauge

cables. If even one of the ends is mistakenly bunched with the opposite polarity bundle, the amplifier will immediately short out and die, unless the protection circuit works really well. Testing with an ohmmeter first is a very good idea.

Twisted pairs are color-coded, and the positive of each is easily distinguishable from its negative mate. Remove kinks in the runs of wire before twisting and soldering. "Electrician's scissors" are good for stripping the wire ends, but have the salesperson at your local electrical-supply store show you how. There is a touch and a technique to the procedure.

I should mention that a single twisted pair can be extracted from a length of cable to make an exceptionally clean, detailed, transparent interconnect (*Photo 2*). With a characteristic impedance of 75Ω , it can also serve as digital interconnect. As such, it should be terminated with good-quality RCA plugs. Shop around for gold-plated and Teflon-insulated plugs.

John Day, MD
Austin, TX

* The best price we could find is \$199 for a 500' spool.—E.T.D.

US\$ 995
CLIO no direct in ORCA
Audiomatica
Only CLIO is like CLIO
Professional electro-acoustic measurement system
generator: MLS/sine/square/burst/noise/ + any pre-defined stimulus
analyzer: any signal present at CLIO inputs, frequency and time.
Don't be fooled by the price! This is not your usual soundcard/quick-hacked-soft combo with hash on the side and a sad look on your interface! This is a unique SYSTEM, designed, engineered and implemented as a system by AUDIOMATICA, one of the finest team of audio engineers today (also known SOFIA, the first ever PC controlled vacuum tube curve tracer!). What you get here is a true professional quality electro-acoustic lab working as a precision 16 bit A/D, D/A audio front-end to your PC. It is sophisticated but it is also fun to use: very elegant "Windows-like" screens, all mouse-operated or easy key strokes, as you wish. Here a scope looks like a scope, an RTA like an RTA! CLIO comes complete with precision calibrated microphone and mounting hardware, pro quality cables and interconnects, sealed disk, and a fantastic manual written in plain English by professionals (we thought we had to precise that). The numerous illustrations actually match your screen! Sounds good enough? Each CLIO comes with one hour of free tech support (if ever you need it) from none else but our great friend Dr. Joseph D'Appolito himself. In fact since we sent Joe his CLIO so that he can assist you on the telephone, he told us that CLIO is becoming the measurement system he is using the most. We believe there has never been a better offer made to the D.I.Y. or for that matter to the savvy professional.
If you want our 8p info pamphlet, a demo disk or to order CLIO at this time: ORCA 1531 Lookout Dr, Agoura, CA 91301 TEL (818) 707 1629, FAX (818) 991 3072. Faster than that? CLIO is also waiting for you @ <http://www.mclink.it/com/audiomatica/clioeng.htm>

Reader Service #34

Speaker Builder 6 96 67

Classifieds

TRADE

ELECTROSTATIC

/// KITS /// PARTS /// TRADE SECRETS ///
save \$\$\$ building, repairing, modifying ESLs
CATALOG/START-UP MANUAL—\$5.00
/// DAVID LUCAS ///
924 HULTON ST, OAKMONT, PA 15139

STATE-OF-THE-ART PASSIVE CROSS-OVERS featuring Hovland MusiCaps. Software available, free design guide. **ALLPASS TECHNOLOGIES, INC.**, 2844 Charmont Dr., Apopka, FL 32703-5972, (407) 786-0623.

WELBORNE LABS

200 PAGE CATALOG and DESIGN MANUAL OF HIGH QUALITY AUDIO KITS and SUPPLIES!!!

We've got Vacuum Tube and mosfet Amplifiers, Linestages Phonostages, Active Crossovers, Power Supplies, AC Line Conditioners and many other Audio Kits and Schematics.

Parts and Supplies

Hovland MusiCaps, Kimber Kaps, MIT MultiCaps, Solen WIMA and Wonder InfiniCaps; Caddock, Holco, Mills and Resista resistors; Golden Dragon, NOS RAM Labs, Sovtek and Svetlana tubes; Cardas, DH Labs, Kimber Kable Neutrik, Vampire and WBT connectors and wire; Alps, Noble and stepped volume controls; Enclosures, Books and other Supplies for DIY'ers, International Orders Welcome. For our Catalog and Manual, send \$12 (US/Canada) \$18 (International) or call (303) 470-6585, fax (303) 791-5783 or e-mail to: wlab@ix.netcom.com with your Visa/Mastercard.

WELBORNE LABS

P.O. Box 260198, Littleton, CO 80126-0198

Visit our Website for more info: <http://www.welbornelabs.com>

THE BEST MUSIC YOU MAY NEVER HEAR. Free catalog. **CREATIVE MUSICIANS COALITION**, Dept. GBM, 1024 W. Wilcox Ave., Peoria, IL 61604, (800) 882-4262.

NEW!! SILVER SONIC digital interconnect cables are now available, 75Ω coax & 110Ω AES/EBU balanced; state-of-the-art performance, affordable prices. For information, contact **D.H. Labs**, PO Box 31598, Palm Beach Gardens, FL 33420-1598, phone/FAX (561) 625-8998.

SUBWOOFER ELECTRONICS

Decade's new SUB-II OEM amplifier kit offers low cost and a powerful list of features:

- High Output Power: 100W (4Ω), 60W (8Ω)
- Low-Frequency Boost Equalizer (Switched)
- Very Low Standby Power Consumption
- No Adjustments Required
- Small Size; PCB is only 1.8x5.5 inches
- Two Layer Glass-Epoxy Circuit Board
- Engineering Assistance for Small Mrs

With Decade's OEM kits, your electronic design is done. You supply power transformers, metal work, and assembly labor. Contact us for more information.

Decade Engineering

2302 5th St. NE, Salem, OR 97303

73054.1755@compuserve.com

503-363-5143 • fax: 503-399-9747

WE RE-CONE all home, auto, pro and vintage speakers. Re-foam kits, \$10. **TRI-STATE LOUD-SPEAKER**, www.nauticom.net/www/speakers, (412) 375-9203.

ELECTROSTATIC electronics, transformers, Mylar®, information. From author **ROGER SANDERS**, (505) 759-3822.

FOR SALE

Pair ScanSpeak 18W-8544, \$120 plus shipping. Regis, (412) 368-8019.

Pair Altec 604-8K, \$675; pair Altec 288-8K, \$400; pair JBL 375, \$700; pair JBL 2410 pro-version of LE-175, \$225; pair JBL 2344 bi-radial 1" studio monitor horns, \$200; pair JBL HL91 horn/lens, \$150; crown D-150A amplifier, \$225; Altec 921 15", \$100. Kent Elliot, phone/FAX (913) 677-1824, before 9 p.m. (CST).

Two Ongaku Audio Note power transformers, new, never been used, \$175 each, asking \$125. Two Audio Note chokes 10H 200mA, new \$65, asking \$40 each. Ashby, (954) 723-5225.

Pair Audio Art 12" subwoofers, \$160, assorted midranges and tweeters, make offer. \$5,000 worth of car audio equipment. David, phone/FAX (502) 561-8289. Are you looking for possible trades?

Pair Focal 7K011BBL bass-midrange drivers, used in Focal kits: Compact B400, Aria Z, 133, 233, 333; \$125 plus shipping. Cary SLA-70B Signature (oil caps) 60W/channel tube amp, mint condition, (\$1,800) asking \$1,300 plus shipping. Mr. Willes, (800) 227-6121, weekdays (9-5).

Pioneer Elite SP91D surround-sound processor, mint cond., box/manual, (\$1,000) asking \$500; Madisound 24CX4 stereo, 3-way crossover, 4th-order Linkwitz/Riley design, variable frequency selection, very good, box/manual, (\$525) asking \$250. Leigh, (352) 378-7485 ans machine.

Pair Dyna Mark IIs, \$300; single Dyna Mark III, Boak mod, new, played five hours to ensure operation, \$250, all plus shipping. Paul Leo, 103-10 Queens Blvd. 5H, Forest Hills, NY 11375, (718) 459-5443.

Klipsh Cornwall speakers. Sell whole for \$400 or by component. William Brown, (505) 257-3672.

Pair University S9 "Classic" horn system components: pair C15W 15" woofers, pair T30/Cobraflex horn midrange units, pair T60/HF-206 horn supertweeter units, pair N-3B 3-way crossover networks, and plans for cabinet of University's best-ever horn system. All in excellent condition, \$650 or best offer. Tom, (910) 885-9436 or FAX (910) 885-2883.

Acoustat Monitor 3 electrostatic speakers with servo-charge tube amps, original owner, capacitor upgrades and new beige grille cloth, \$995 or best offer. Prefer pickup in Boston metro area, shipping and packing extra. Gil, (603) 883-6411.

Complete set of *Speaker Builder* 1980-1995, \$250. Kent Johnson, (303) 989-8272.

POLYPROPYLENE CAPS

4 MFD 200v REL-CAP	\$ 70¢/each
6 MFD 200v REL-CAP	\$ 1.25/each
8 MFD 200v ULTRA-CAP	\$ 1.50/each

Send SASE for list of other capacitors available

APEX Jr.

3045 Orange, La Crescenta, CA 91214
(818) 248-0416 • (818) 248-0490 FAX

Preeminence Reference Line 1 Mk II Silver remote passive preamp, \$875; Luxman T-02 tuner, mint condition, review unit, \$250; Alchemy VAC phono preamp and power supply, \$175; pair Eminent Technology LFT-speakers, new 1995, boxes, manual, \$675. Steve, (203) 397-3888.

Pair ScanSpeak 18W-8546 6½" Kevlar® mid-bass drivers, \$205; pair ScanSpeak D2905/ 9300 1" soft-dome tweeters, \$105. Brand new, ordered too many; matched pairs. Ed, (206) 562-9848 (PDT), prices are 25% off most mail orders.

WANTED

Adcom, Altec, ARC, Bryston, Carver, Cello, Decca, Denon, Duntech, Dynaco, Final, Fisher, Fourier, Component, Krell, Marantz, McIntosh, Onkyo, Passlab, Patrician, Paragon, Phase Linear, Hafler, Harbeth, Hartsfield, HQD, Infinity, Jadis, Jensen, Levinson, Luxman, QUAD, Nakamichi, RCA, Rogers, Spectral, Sunfire, Tannoy, Threshold, UTC, Victor, Wadia, Westlake, Western Electric, WAMM. John, (408) 737-2980, FAX (408) 735-1426.

Citation 7.0. Leigh, (352) 378-7485, or machine.

Microphones: RCA, Sony, WE, Neumann, AKG, Shure, E-V; working or not. Trade my rare NOS tubes for mikes. Also want UREI and tube limiters/compressors. Mike States, Box 81485, Fairbanks, AK 99708, phone/FAX (907) 456-3419.

ScanSpeak Drivers, D2905-9000, 13M-8636, and 18W-8545. Regis, (412) 368-8019.

ENGINEER R&D

Audio International, Inc., an aerospace electronics firm serving the corporate aviation industry and specializing in cabin entertainment and cabin control systems is seeking candidates for the Research and Development department.

The successful candidate will be performing design in the areas of analog and digital electronics, and embedded software. Experience in video and audio, including speaker design, is a plus. Experience with DSP and FPGA'S is desirable.

Five years of experience is required.

Interested candidates should forward their resume to:

Audio International, Inc., Human Resources
7300 Industry Drive
North Little Rock, Ar. 72117



Craftsman's Corner

MINI SUBWOOFER

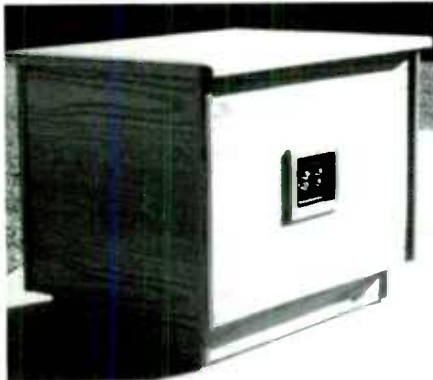

PHOTO 1: The author's subwoofer enclosure includes a 3/4" oak top and 1/4" plywood sides. It is powered by a 65W individual amp and features 6 1/2" Madisound 8Ω speakers.

My neighbor, Burr Coffelt, and I constructed two mini T-Rex subwoofers ("The T-Rex Minisubwoofer," *SB* 1/95, p. 10), because he very much liked the sound of my subwoofer, which has a single 12" woofer. Also, I wanted a smaller one.

We contacted Madisound Speakers for their evaluation of a change from the 4Ω speaker in the original T-Rex to 8Ω, in order to be compatible with their house speakers. We were then able to use the 6 1/2" mid-bass drivers, as in the original T-Rex design, and simply constructed two each from medium-density particleboard, using the Madisound connection blocks. We discussed crossovers, amplification, and other design considerations at great length, but knowing the sound would be similar to my existing 12" speaker subwoofer, we chose to loop the sound through a separate amplifier and a separate equalizer to control both volume and bass response. The resulting sound is magnificent.

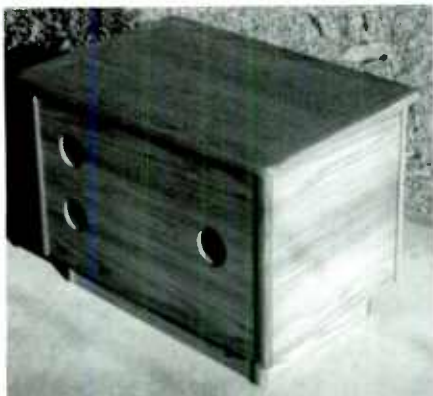

PHOTO 2: This attractive speaker unit also makes a perfect end-table.

HOME IMPROVEMENT

Burr, who happens to be a master carpenter, designed the end-table concept. Using 3/4" red oak for tops and 1/4" oak plywood surfacing on all sides, he constructed each unit to the height of our respective homes' furniture. The box is a nice addition to the livingroom and a source of an incredibly

mellow bass sound.

We discovered, however, that if your room is carpeted, you might encounter difficulty running wires to the speaker unless it is situated close to the amplifier.

Gerald H. Jones
Yuma, AZ

Kustom Isolation Supports

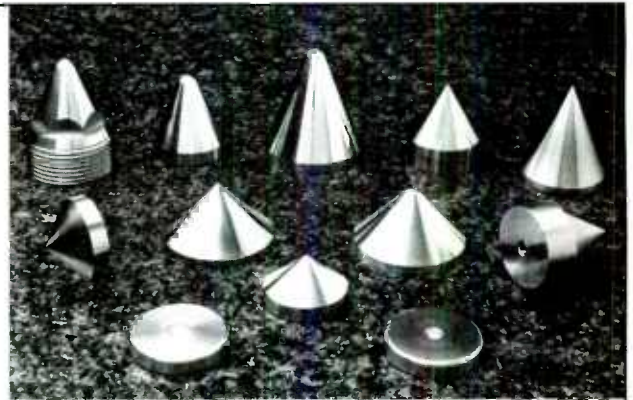

Kustom Isolation Supports, 73-63 Bell Blvd., Suite 3P, Bayside, NY 11364, Fax: 718-776-2139

Reader Service #80

STATEMENT OF OWNERSHIP, MANAGEMENT AND CIRCULATION (Required by U.S.C. 3685.) Date of Filing, Sept. 30, 1996. Title of Publication: **SPEAKER BUILDER**. Frequency of issue: Eight times a year (every six weeks.)

Annual subscription price \$32. Location of the headquarters or general business offices of the publishers: 305 Union St., Peterborough, NH 03458-0494. Publisher: Edward T. Dell, Jr., PO Box 494, Peterborough, NH 03458-0494. Managing Editor: Dennis Brisson. Owner: Audio Amateur Corporation, PO Box 576, Peterborough, NH 03458-0576. Stockholders owning or holding 1 percent or more of the total amount of stock: Edward T. Dell, Jr., PO Box 576, Peterborough, NH 03458-0576. Known bondholders, mortgages or other securities: None.

	Average # copies each issue during preceding 12 months	Single issue nearest to filing date
Total # copies printed	16,563	17,000
Newsdealer sales	2,542	2,341
Mail Subscriptions	9,590	8,079
Total paid circulation	12,132	10,420
Free distribution complimentary	1,074	2,180
Total Distribution	13,206	12,600
Office use, leftover	2,703	4,400
Return from News agents	654	0
Total	16,563	17,000

I certify that the statements made by me above are correct and complete. Publication No. 529-310. Edward T. Dell, Jr., Publisher

Our Samples Are Better Than

FREE!

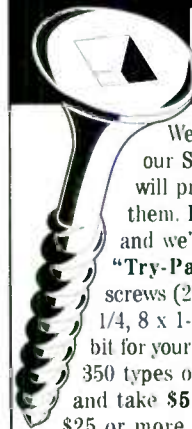

We're so sure you'll love our Square Drive Screws we will practically pay you to try them. **Return this ad with \$5** and we'll send you our famous "Try-Pack" Sampler of 100 screws (25 each of #8 x 5/8, 8 x 1-1/4, 8 x 1-1/2 and 8 x 2), a driver bit for your drill, our catalog listing 350 types of Square Drive screws, and take **\$5 off** your first order of \$25 or more, or **\$10 off** your first order of \$50 or more! (Limited time offer. Available in USA only.)

"We tried a box of 1-3/4" #8 prelubricated flat heads with ribs from McFeely's, which quickly became our favorite fastener." Speaker-Enclosure Screws, Robert J. Spear and Alexander F. Thornhill, *Speaker Builder*, 2/94

McFEELY'S
SQUARE DRIVE SCREWS

PO Box 11169 • Dept SB6F
Lynchburg • VA • 24506-1169

Reader Service #83



D6G

*Nominal Impedance(Z):*5 Ω
*Resonance Frequency(Fs):*47Hz
*Sensitivity(E):*85dB
*Voice Coil Diameter:*76 mm
*DC Resistance(Re):*4.5 Ω
*Voice coil Length:*14.5mm
*Force Factor(BL):*6.5N/A
*Linear Excursion(Xmax):*5.5mm
*SUSPENSION COMPLIANCE:(Cms):*690 μ M/N
*Mechanical Q Factor(Qms):*5.3
*Electrical Q Factor(Qes):*0.54
*Total Q Factor(Qts):*0.49
*Moving Mass(Mms):*16.3 g
*Effective Piston Area(Sd):*109cm²
*Equivalent Air Volume(Vas):*11.6L

Hi-Vi RESEARCH®

100 SPY COURT, MARKHAM, ONTARIO L3R 5H6
TEL:001-905-475-3100, FAX:001-905-475-8226

Dedicated To Quality



Parts Express is dedicated to bringing serious speaker builders the finest products currently available. We have recently become a distributor for Linear X and now carry their superb loudspeaker design program, LEAP Version 4.5, plus the outstanding LMS loudspeaker measurement system. We are also very pleased to announce that Parts Express is now an authorized distributor for Morel Acoustics. Morel's unique vented magnet system and large diameter Hexatech voice coils provide smooth frequency response, high power handling, and astonishingly low levels of distortion. We also carry the high performance line of drivers from Audax, featuring the revolutionary High Definition Aerogel and Carbon Fiber cone materials. For high quality crossover networks, we stock Solen polypropylene capacitors, 14 gauge air core inductors from ERSE, Solo copper foil air core inductors, and Monster Cable speaker wire. Our software programs for enclosure design include BassBox 5.1, Quick Box from Sitting Duck Software, and Loudspeaker Architect 2.01 from N.A.M.E. Call now for your copy of our FREE 228 page catalog and to get the details on these and many other quality products.



Parts Express

CALL TOLL FREE

1-800-338-0531

CATALOG

340 E. First St., Dayton, Ohio 45402-1257, Phone: 513-222-0173, Fax: 513-222-4644

SOURCE CODE: SBM

Reader Service #19

World Radio History



Made
in
England

High-Tech Audiophile Loudspeakers

For Further Information Please Contact: **morel acoustics USA**
414 Harvard Street
Brookline, MA 02146
Tel: (617) 277-6663
FAX: 1603 237 2456



Typical Double Magnet Woofer Cross Section

Reader Service #1