

BALANCE AND DISTORTION TRADEOFFS

FOUR: 1994

US \$7.00

CANADA \$8.00

Speaker Builder

THE LOUDSPEAKER JOURNAL

de LANGE:

**TIME AND
CROSSOVER
FILTERS**

CARRINGTON:

**MODS FOR
RADIO SHACK
SL METER**

WASLO:

**MANAGING
MIKES WITH
IMP**

PIKE:

**BUILD A
SIXTEEN I
WOOFER**

AUGSPURGER:

**BANDPASS &
BIRDHOUSE**

WAYLAND:

**BISCUITS FOR
BETTER JOINTS**

DOES U.S. PATENT LAW NEED REVISION?

New!
LEAP

Version 4.5

LEAP

Precision Development Tools for Precision Loudspeaker Designs

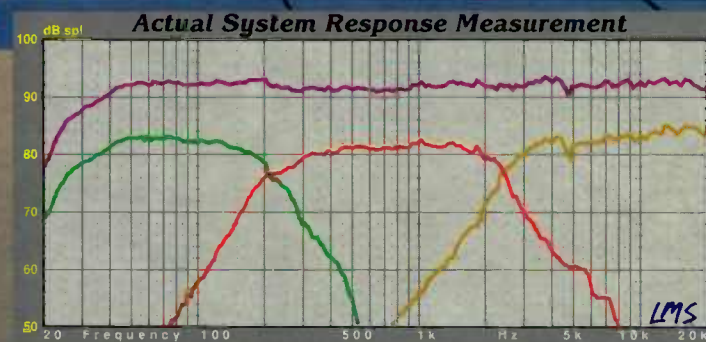
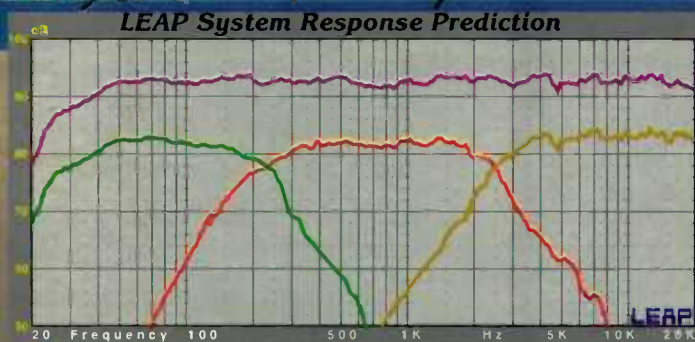

The Art and Science... of loudspeaker system development today has become more complex than ever before. Competition is tough, and to compete each design must perform to the best of its ability, and make the most out of every dollar's worth of transducer cost. The simple approach of choosing a combination of seemingly appropriate transducers coupled with ordinary networks and filters, has given way to a painstaking process of meticulously blending selected transducers in combination with carefully devised and matched crossover designs.



LEAP (Loudspeaker Enclosure Analysis Program) is a complete full range analysis package which provides virtually all of the tools necessary to develop precision loudspeaker systems, for today's demanding audio markets. Whether your applications are consumer audio, car stereo, professional audio, or custom esoteric marvels, LEAP provides the power, flexibility, and accuracy to investigate every possible design permutation. The open architecture and broad spectrum of features provided will dramatically reduce your development time, while improving the quality of the final result... and demonstrates why LEAP has become the #1 choice of professional loudspeaker designers world-wide!

Advanced System Analysis Features

- ✓ Use simulation or imported actual measured SPL/Z data.
- ✓ 5-Way crossover system modeling, and more.
- ✓ Time offset between transducers.
- ✓ Active or Passive based crossovers.
- ✓ Hilbert-Bode transform for deriving phase.
- ✓ 22 Passive components per crossover section.
- ✓ 16 Active filter blocks per crossover section.
- ✓ Passive Network Optimizer for single/system response.
- ✓ Active Filter Optimizer for single/system response.
- ✓ Frequency ranges from 11Hz to 100kHz.

Printer/Output Formats

When you wish to produce a hardcopy output of your finished designs and graphical data, LEAP supports a large number of printer standards, and even supports numerous desktop publishing graphic formats in both black & white and color! Portrait/Landscape orientations in any custom size and aspect ratio are user controllable.

- ✓ IBM/Epson 8 Pin Dot Matrix
- ✓ Epson 24 Pin Dot Matrix
- ✓ HP LaserJet Series Printers
- ✓ HPGL Compatible Plotters
- ✓ PostScript EPS/TIF- B&W,Color
- ✓ AI-Adobe Illustrator B&W,Color
- ✓ NEC 24 Dot Matrix
- ✓ TOSHIBA 24 Dot Mat
- ✓ HP DeskJet 500C
- ✓ PostScript Printers
- ✓ DXF AutoCAD
- ✓ TIFF, BMP, PCX Plots

Extensive Documentation

The two volume manual set comprises almost 1,000 pages of documentation which thoroughly covers the operation of the program, and provides numerous examples of how to maximize your use and understanding of the program's many features. The Reference Manual describes all graphs, menus, commands, and their operation. This manual explains the unique and special non-linear speaker and port models, as well as proper use of the optimizers, importing data, and the many other utilities. The Application Manual provides many exciting examples showing how to use the powerful features of the system in a combined manner to perform both simple and complex design tasks. Both novice and experienced users alike will find this information invaluable for exploiting the full power of the system. Additional information is also provided on loudspeaker measurements, design tips, filter calculations, and complete crossover system development for both passive and active based systems.

- ✓ 502 Page Reference Manual
- ✓ 436 Page Application Manual

Advanced Transducer/Enclosure Simulations

- ✓ Sealed, Vented, Bandpass, PR Simulations with multiple speaker/ port capability.
- ✓ Large signal analysis of TempVC, and Non-Linear BL/ Ports/ Compliance.
- ✓ Acoustic Parallel or Acoustic Series (Isobaric) Driver Mounting.
- ✓ Port Standing Wave resonance modeling.
- ✓ Frequency Dependent Rise and Level modeling.
- ✓ Library storage of 36 transducer parameters, and over 24 enclosure parameters.
- ✓ Generic transducer modeling of electrodynamic, ribbon, and piezo devices.

LinearX Systems Inc
7556 SW Bridgeport Rd
Portland, OR 97224 USA
Tel: (503) 620-3044 Fax: (503) 598-9258

Call for a free
Demo Disk!
TEL: (503) 620-3044

LINEAR X

• Seminars/Workshops available call for details

International Dealers: Argentina: Interface SRL (54) 1-778-2713/Australia: ME Technologies 61(0)65-50-2200/Austria: Audiomax 49(0)71-31-162225/Belgium: Belram 32(0)2-736-50-00/Brazil: SDS Equipamentos 55(0)11-887-7507/Canada: Ge Audio 416-596-2779/China: Rhythmic Industrial 86(7620)562-0111/Denmark: Finland: A&T Ljudproduktion 46(0)8-623-08 70/France: Belram 32(0)2-736-50-00/Germany: Audiomax 49-71 31 162225/Indonesia: Ken's Audio 62(0)21-380-2118/Italy: Outline snc 39-30-3581341/Korea: Sammi Sound: 82(02)463-0394/Luxembourg: Belram 32(0)2-736-50-00/Malaysia: AUVI 65-283-2544/New Zealand: ME Technologies 61 65 50 2254/Norway: A&T Ljudproduktion 46(0)8-623-08 70/Poland: Inter Americom 48(22)43-23-34/Singapore: AUVI 65-283-2544/Spain: Audio Equipment Services 34(94)681-81 20/Sweden: A&T Ljudproduktion 46(0)8-623-08 70/Switzerland: Audiomax 49-71-31-162225/Taiwan: Gestion Taycan Intl 886-2-562-3883/Thailand: AUVI 65-283-2544/The Netherlands: Duran Audio 31-41-80-15583/Turkey: Silver Productions 44(0)722 336221/UK(England): Munro Assoc 44(0)71 379 7600.

Good News

⇒ CIRCUIT GUARDIAN

Protect your circuit boards and electronic parts from moisture, static, corrosion, and pollutants with a new nontoxic spray from Circuit Guard International (Ontario, CANADA). Circuit Guard™ protects, without altering resistive, capacitive or inductive components. Contact Circuit Guard International at (905) 509-2647, or (800) 365-5030.

Reader Service #104



↻ CANON FIRES SALVO

Canon has recently showcased two new speakers, the S-30 and S-35. Designed for use with audio and audio/video systems, including home theater, these models feature curved acoustic mirrors for what Canon claims is a stereo

image up to six times larger than a conventional speaker. Canon, One Canon Plaza, Lake Success, NY 11042, (516) 328-5145.

Reader Service #102



■ THE SIBLINGS' SPEAKER

Clair Brothers introduces the R-4 Series III three-way speaker system, featuring a directional mid-range baffle system. The new design, according to the company, delivers high intelligibility and trans-

parent sound. Clair Brothers Audio Systems, PO Box 396, Litzitz, PA 17543, (616) 695-5948, FAX (616) 695-7623.

Reader Service #115



← **Reader Service #36**

■ THE CHAMELEON HF

Galaxy Audio designed the Chameleon to blend into your home audio surroundings. This compact, yet full-range, monitor speaker is compatible with virtually all amps and is available from Galaxy Audio, 625 East Pawnee Avenue, Wichita, KS 67211, (316) 263-2852, FAX (316) 263-0642.

Reader Service #117

↻ STICKY BUSINESS

Hemon React 727 Acrylic Structural Adhesive bonds to a variety of materials, including metals, glass, and ceramics, in many applications. You can apply this easy-to-use, fast-acting thixotropic paste, which you can use with any of three

■ GENELEC GOES HOME

Genelec, long recognized by audio producers and engineers for its professional studio products, introduces a line of loudspeakers for the custom home theater market. The nine models range from a compact, biamplified, two-way design to a large three-way design with a massive triamplification system. Genelec, distributed by QMI, 25 South Street, Hopkinton, MA 01748, (508) 435-3666, FAX (508) 435-4243.

Reader Service #109

Hemon activators. No curing action takes place until the parts are mated. Hemon Manufacturing, 121 Tech Drive, Sanford, FL 32771, (407) 322-4000, (800) 527-0004, FAX (407) 321-9700.

Reader Service #103



■ LOSING A VOICE

By purchasing ServoDrive design and manufacturing rights, Quantum Sound hopes to change the face of low-frequency audio reproduction. Replacing the voice coil with the servomotor drive increases linear excursion and the overall efficiency of the loudspeaker

system, thus enabling the ServoDrive to handle large low-frequency peaks without damage or sonic compromise. Quantum Sound, 3453 Commercial Ave., Northbrook, IL 60062, (616) 695-5948, FAX (616) 695-7623.

Reader Service #114

↻ NO FLIES ON THIS SPEAKER

Bullfrog introduces the PR1510, a three-way trapezoidal loudspeaker system designed for main PA use and full-range instrument applications. The Bullfrog cabinet houses a double-ported 15" bass speaker and two woofers. Bullfrog, 1503 Prairie Ave., South Bend, IN 46613, (616) 695-5948, FAX (616) 695-7623.

Reader Service #105

Speaker Builder (US ISSN 0199-7920) is published every six weeks (eight times a year), at \$32 per year, \$58 for two years; Canada add \$8 per year; overseas rates \$50 one year, \$90 two years; by Audio Amateur Publications, Inc., Edward T. Dell, Jr., President, at 305 Union Street, PO Box 494, Peterborough, NH 03458-0494. Second-class postage paid at Peterborough, NH and an additional mailing office.

POSTMASTER:

Send address change to:
Speaker Builder, PO Box 494
Peterborough, NH 03458-0494

Good News



☛ B&W LAUNCHES NAUTILUS

Featuring a radical snail-like design, the Nautilus speaker boasts a high price tag (\$35,000/pair) as well as high-quality music reproduction. The manufacturer claims its smooth contours produce the most diffraction-free baffle surfaces yet devised. B&W, 54 Concord St., N. Reading, MA 01864, (508) 664-2870, (800) 370-3740, FAX (508) 664-4109.

Reader Service #118

■ FREE FOR THE ASKING

Simply by calling (800) 833-8575, you can receive a free brochure, "The Power of the Platform," which gives prospective users a detailed overview of Techron's TEF 20 Systems for sound system test and analysis. For more information about TEF applications, contact Techron, PO Box 1000, Elkhart, IN 46515, (219) 294-8300, FAX (219) 294-8329.

Reader Service #116

■ PCB DESIGN AID

Baas Electronics of The Netherlands has released version 4.92 of its popular, low-cost PCB design package Layo1, which speeds up off-line design rule checking, component dragging, and printing check plots. Compatible with many schematic capture packages, such as OrCAD, Layo1 is available from Old Colony Sound Lab, PO Box 243, Peterborough, NH 03458, (603) 924-6526, FAX (603) 924-9467.

Reader Service #112

■ CABLE SANS DISTORTION

Alpha-Core offers a new speaker cable, the Goertz MI (matched impedance), which eliminates distortion—regardless of run length—between amplifier and speaker. The compact cable design features low inductance and high capacitance for a difference anyone can hear in a comparison test, according to Alpha-Core, 915 Pembroke St., Bridgeport, CT 06608, (203) 335-6805, FAX (203) 384-8120.

Reader Service #110

■ A SOUND TEST

The Sheffield/Coustic Test and Demonstration Disc is an audio reference compact disc to help you test and fine-tune both home and mobile audio systems. You can evaluate system sonic performance and accuracy and make appropriate adjustments with the specially designed test tracks. Cooustic, 4260 Charter St., Vernon, CA 90058, (213) 582-2832, (800) 227-8879, FAX (213) 582-4326.

Reader Service #113

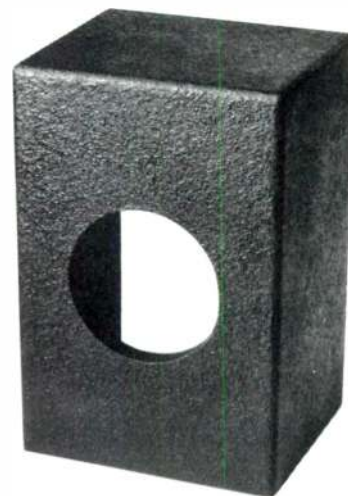

☛ TEXTURED LOOK

Give your speaker boxes a finished look of leather, stucco, stone or pebble with the Texturelac paint finish from Abilene Research and Development Corp., PO Box 294, Hewlett, NY 11557, (516) 791-6943, FAX (516) 791-6948. You can apply your choice of textured pattern—which dries to a hard, mar-resistant finish within 15-30 minutes—with a conventional spray gun.

Reader Service #101



☛ BOOKSHELF SPEAKERS

Design Acoustics presents two new full-range video-shielded loudspeakers, the PS66 and PS88, featuring a compact size and high performance well-suited for home theater applications. Design Acoustics, 1920 Enterprise Parkway, Twinsburg, OH 44087, (216) 425-8222, FAX (216) 425-9339.

Reader Service #106

■ HONE YOUR DESIGN SKILLS

You can improve your speaker-building skills with the Loudspeaker Design Information Series (LDIS) beginning June 1994 and published eight times a year. The course, targeted for beginners and audiophiles, teaches the latest in speaker-building technology and sound reproduction techniques. For more information, contact Technologie MDB, 5445 de Lorimier, Suite 108, Montreal, Quebec H2H 2C3, (514) 526-8851.

Reader Service #107

☛ TWEETER ON TOP

The B&W Matrix HTM is designed for several home theater applications: as a center channel, left or right front monitor, or as a surround speaker. The cabinet design, which incorporates B&W's zero magnetic field technology, eliminates stray magnetic flux that could induce video-image distortion in monitors/TVs. B & W, 54 Concord St., N. Reading, MA 01864, (508) 664-2870, (800) 370-3740, FAX (508) 664-4109.

Reader Service #111

■ A POWERHOUSE AMP

The PA9 monoblock power amplifier is available from Sentec America (Route 9, Stockport, NY 12172, (518) 828-8490). This Class A/B amplifier, developed with an optimized signal path which the manufacturer claims produces the most coloration-free signal possible, is compatible with a variety of speakers.

Reader Service #108



FOCAL
technologie d'avant-garde



AUDIOM 15VX Polyglass 15" subwoofer

for your free copy of the complete FOCAL catalog: call or write Focal America, Inc.
1531 Lookout Drive, Agoura, CA 91301. USA. TEL: (818) 707-1629 FAX: (818) 991-3072

Copper-Foil Air-Core Inductor™

Extremely Designed For Precision Audio Transducer/Speaker Driver Crossover Network.

"The CFAC Inductor far exceeds anything I have used in the past."

"Gone are the colorations I previously attributed to various drivers. It is now obvious that the colorations were in fact caused by interior inductor."

**Arnie Nudell, President
Genesis**

"CFAC Inductor is a product that have advanced the state-of-the-art, providing me with a product that is the most sonically pure component available. They are simply, the best...."

**Robert Grost, President
Unity Audio**

PRODUCT HIGHLIGHT

FEATURES

Low DC resistance
High precision coil reactance
Uniform current density
Minimized Skin Effect resistance up to 100kHz
Made in USA.

CFAC INDUCTOR™. ELIMINATE SKIN EFFECT

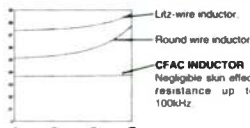

Skin Effect Resistance
Skin Effect will cause the inductor resistive load increase, power loss, non-uniform current density in the conductor, signal amplitude decrease and phase delay. Sound quality will be degraded. The ultra-thin structure (0.003" thick) of the CFAC INDUCTOR is specially designed to minimize the Skin Effect.

AVAILABLE AT:

MICHAEL PERCY
BOX 526
INVERNESS
CA 94930
TEL (415)669-7181
FAX (415)669-7558

HANDMADE ELECTRONICS
1825 ROTH AVE.
ALLEN TOWN
PA18104
TEL (215) 432-5732

SONIC FRONTIERS
760 PACIFIC RD., #19
OAKVILLE, ONTARIO
CANADA L6L 6M5
TEL (416) 847-3245
FAX (416) 847-5471

FOR A COMPLETED WHITE PAPER, PLEASE CALL TEL: (510) 887-8016
OR WRITE TO: SOLO ELECTRONICS, 2462 TRIPALDI WAY, HAYWARD, CA 94545, USA. FAX: (510) 887-1857

Reader Service #40

Speaker Builder

The Staff

Editor and Publisher
Edward T. Dell, Jr.

Contributing Editors
Joseph D'Appolito Robert Bullock
Richard Campbell John Cockroft
David Davenport Vance Dickason
Bruce Edgar Gary Galo
G.R. Koonce

Director of Outside Projects & Personnel
Karen Hebert

Dennis Brisson Managing Editor
Brenda Baugh Assistant Editor

Glenn Galloway Graphics Director
Production Assistant
Diane Luopa

Laurel Humphrey Circulation Director
Circulation Assistants
Pat Kavenagh Robyn Lasanen

Advertising Rates & Schedules

Martha L. Povey National Advertising Director
Laura Brown Advertising Assistant
(603) 924-9464 FAX (603) 924-9467

The peculiar evil of silencing the expression of an opinion is, that it is robbing the human race; posterity as well as the existing generation; those who dissent from the opinion, still more than those who hold it.

—JOHN STUART MILL

Speaker Builder is published eight times a year in the interest of high-quality audio reproduction.

No material in *Speaker Builder* may be used in any form without the written permission of the publisher.

Subscription Inquiries

A one year subscription to *Speaker Builder* is \$32. Canada please add \$8. Overseas rate is \$50 per year.

To subscribe, renew, or change address write to Circulation Department or call (603) 924-9464 or FAX (603) 924-9467 for MC/VISA/Discover charge card orders.

For gift subscriptions please include gift recipient's name and your own, with remittance. A gift card will be sent.

Send circulation and editorial correspondence to *Speaker Builder*, PO Box 494, Peterborough, NH 03458-0494. No responsibility is assumed for unsolicited manuscripts. All manuscripts must include a self-addressed envelope with return postage. The staff *will not* answer technical queries by telephone.

Printed in the USA. Copyright ©1994 by Audio Amateur Publications, Inc.
All rights reserved.

About This Issue

Is existing patent law stifling the entrepreneurial spirit in the US? Editor/Publisher **Ed Dell** ascends his editorial soapbox to address this question and summons audiophiles to become involved.

Dewald de Lange shares with *SB* readers his extensive crossover network time studies and concludes that, in some circumstances, time responses enjoy an advantage over frequency responses when considering crossover filters (p. 10).

C.L.P. Carrington's clever circuit modification shows how to expand the usefulness of a Radio Shack SLM (sound level meter). By adding a switch you can choose between regular operation and an accurate millivolt testmeter to measure speaker response (p. 12).

Similar speakers fed the same inputs will deliver the same performance, right? Not necessarily, according to *SB* author **Don Jenkins**. After putting different speakers through their paces, this super sleuth reveals the results of his investigation in "Acoustic Distortion and Balanced Speakers," p. 14.

Measuring gear doesn't have to be expensive to be accurate...especially if you use **Bill Waslo's** versatile brainchild, IMP (Impulse response Measurement and Processing). In their most recent adventure, Bill Waslo uses the IMP to computer-correct an inexpensive microphone for unerring speaker results.

After reading our 2/94 article about Matt Federoff's "Birdhouse" design, **George Augspurger** was incredulous. So, Augspurger, a noted loudspeaker authority, decided to look closer at this unusual bandpass design and shares his findings in "More About the Birdhouse Bandpass," p. 22.

Charles Pike always dreamed of achieving "just clean, pure bass that I could feel as well as hear." He recently realized this goal with a 16Hz subwoofer solution detailed on p. 26.

Visiting **Bob Wayland's** Woodworking World, we discover the secrets of biscuit joinery, an easy way to make strong, eye-pleasing joints for more creative projects.

In the Tools, Tips & Techniques department, airman **Steven Crosby**, recently involved in the airdrop of supplies over Bosnia, shares his interesting design of a dual-volume test box.

Also, contributing editor **Gary Galo** examines a new line of high-performance speaker cables from D.H. Labs.

Speaker Builder

THE LOUDSPEAKER JOURNAL

VOLUME 15 NUMBER 4

MAY 1994

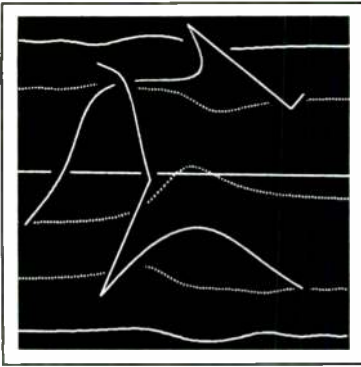

10

10 Time Response of Crossover Filters

BY DEWALD P. DE LANGE

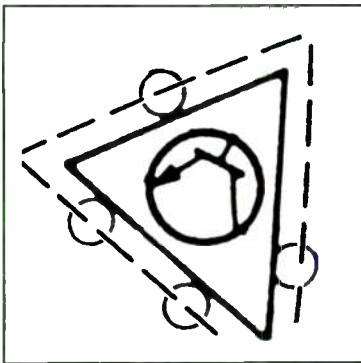

12

12 Converting Radio Shack's SLM to Millivolt Use

BY C.L.P. CARRINGTON

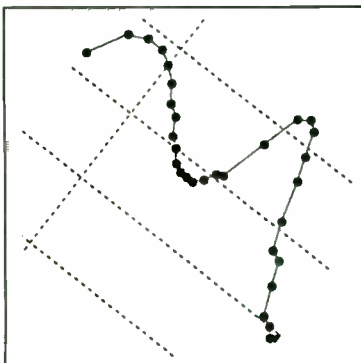

26

14 Acoustic Distortion and Balanced Speakers

BY DONALD JENKINS

18 Microphone Response Correction with IMP

BY BILL WASLO

22 More About the Birdhouse Bandpass

BY G.L. AUGSPURGER

26 A 16Hz Subwoofer

BY CHARLES T. PIKE

42 PRODUCT REVIEW:

D.H. Labs Silver Sonic Cables

BY GARY A. GALO

DEPARTMENTS

3 GOOD NEWS

9 EDITORIAL Patent Perils and Purviews

32 WAYLAND'S WOOD WORLD
BY BOB WAYLAND

38 TOOLS, TIPS & TECHNIQUES
BY STEPHEN A. CROSBY

48 SB MAILBOX

57 CLASSIFIED

62 AD INDEX

MW 114-S

Neodymium Magnet DPC Cone 4" Woofer

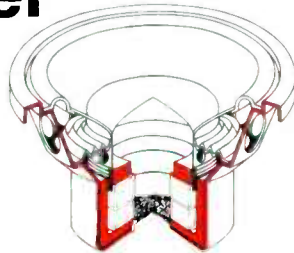

Specification

Overall Dimensions	Ø118mm (4.64") x 58mm (2.29")
Mounting Baffle Hole Diameter	Ø95mm (3.75")
Magnet System	Pot Type, Vented, Neodymium Magnet
Nominal Power Handling (Din)	150W
Transient Power - 10ms	800W
Voice Coil Diameter	54mm (2.125")
Voice Coil Type/Former	Hexatech Aluminium
Frequency Response	55-7000 Hz
FS - Resonant Frequency	65 Hz
Sensitivity 1W/1m	87 dB
Z - Nominal Impedance	8 ohms
RE - DC Resistance	5.6 ohms
LBM - Voice Coil Inductance @ 1kHz	0.47 mH
Magnetic Gap Width	1.25mm (0.050")
HE - Magnetic Gap Height	6mm (0.236")
Voice Coil Height	12mm (0.472")
X - Max. Linear Excursion	3mm
B - Flux Density	0.88T
BL Product (BXL)	6.75
Qms - Mechanical Q Factor	2.32
Qes - Electrical Q Factor	0.36
Q/T - Total Q Factor	0.31
Vas - Equivalent Cas Air Load	3.18 litres (0.113 cu. ft.)
MMS - Moving Mass	7.00gm
CMS	807µm/n
SD - Effective Cone/Dome Area	53cm ² (20.86 sq. in.)
Cone/Dome Material	DPC (Damped Polymer Composite)
Nett Weight	0.500 kg

Specifications given are as after at least 45 minutes of high power, low frequency running, or 24 hours normal power operation.

The 114-S is the first of Morel's new generation of woofers, featuring a powerful Neodymium magnet system which provides increased sensitivity, lower Q_t and reduced distortion. For a 4" driver it is unique in having a large 54mm (2.125") diameter Hexatech aluminium voice coil.

Benefits of this large voice coil diameter include a very high power handling capacity and lack of sound level compression. In addition, it allows the use of a very shallow cone profile. Coupled with the use of Damped Polymer Composite cone material and a rubber surround, this provides excellent dispersion (off-axis response), resistance to cone break-up (even at high sound pressure levels) and lack of colouration.

Frequency and phase response are very flat, while the roll-off is very smooth. The MW 114-S may be used either as a bass-mid range in 2-way systems, or as a mid-range in multi-way systems.

The vented magnet system is encased within a steel chassis, which improves efficiency and shields the magnet, virtually eliminating stray magnetic fields. The MW 114-S is ideal not only for high quality hi-fi, but also TV, video and surround-sound applications.

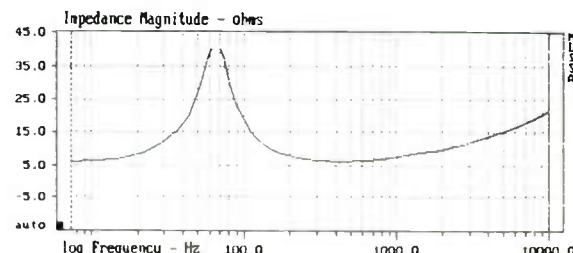
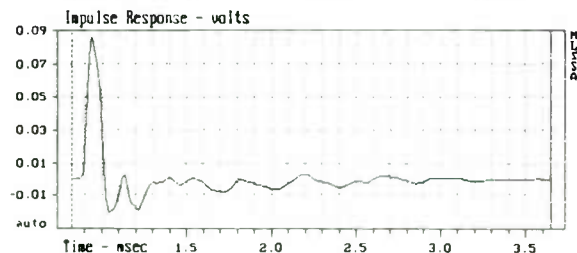
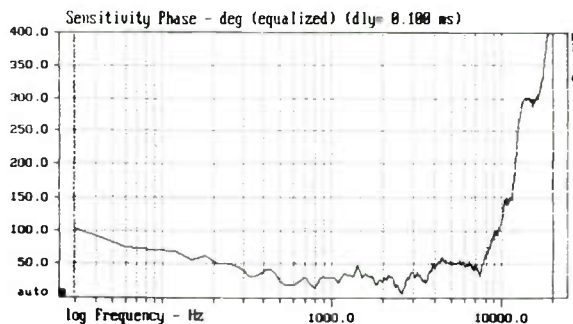
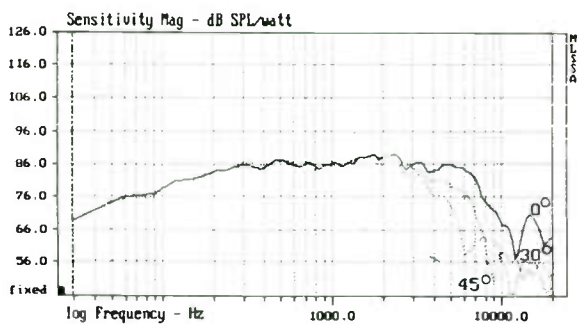

Morel operate a policy of continuous product design improvement, consequently specifications are subject to alteration without prior notice.

World Radio History

high fidelity
range

morel (u.k.) ltd.

11 Foxtail Road,
Nadon Rd. (Ransomes)
Industrial Estate,
Ipswich, IP3 9RT
England
Tel: (0473) 719212
FAX: (0473) 716206

morel
acoustics usa

414 Harvard Street
Brookline, MA 02146
Tel: (617) 277-6663
FAX: (617) 277-2415



Editorial

Patent Perils and Purviews

The United States patent statutes have, in my opinion, a serious case of schizophrenia. On the one hand, a patent must fully describe the device itself and also explain clearly how it works. The patent is in public domain, that is, it is not copyright-protected and must be, and is, available to the public. Copies of any US patent are readily available from the patent office for \$1.50. (The Commissioner, Office of Patents and Trademarks, Class 179 and 181, Acoustical Devices, Washington, DC 20231.)

On the other hand, any individual who builds the actual patented device, for his own use only, is considered by the law to be infringing the patent. Strictly speaking the builder need not sell a copy or market it, or make one for his neighbor to run afoul of the letter of the present law.

Considerable case law, however, has held that experimental construction of a patented device is not an infringement until it is put to some commercially valuable use. As early as 1850 a case was decided stating that use of a patented machine to satisfy the curiosity of the builder does not constitute infringement.

This matter came up in early April when I received George Augspurger's response to Matt Federoff's article, "The Birdhouse," which appeared in *SB* 2/94. I was more than a little pleased to read that author Augspurger considers Federoff's work "...an original design ideally suited to the author's requirements."

I have included Mr. Augspurger's commentary and findings in his article beginning on page 22. Augspurger also noted the relationship of Federoff's device to a patent held by Bose Corporation (4,549,631), although Federoff's chambers are tuned exactly opposite to those in most commercial systems, including those manufactured by Bose Corporation.

Two weeks later I received notification from a Boston law firm that the Bose Corporation considered the Federoff article to infringe their patent and that by publishing the article I, as publisher, was "actively inducing infringement" of it. Our legal counsel have replied citing one of a long list of case law decisions.

"(p)ublication of information about a patented product or method does not constitute active inducement unless accompanied by other activity such as sale of material capable of infringing use. The patent itself is published and must contain full disclosure

of how to make and use the invention." Chisum, *Patents*, Sec. 17.04(4) (footnotes omitted).

The issue of experimental use of a patented device goes much deeper than being able to build something out of curiosity. If such restrictions are enforced, or are legally actionable, then they inevitably have a chilling effect on innovation, technical exploration, and discovery of further device variations. A patent may not fully explore all that is possible with a specific, legally protected device. Federoff's Birdhouse is dubbed "unique" by one of the most respected authorities on loudspeaker patents in the United States. Is the purpose of a patent to prevent further exploration of the possibilities of a formula or an invention?

The United States has, for over a decade, been falling far behind both Germany and Japan in the number of individuals who apply for and hold patents. One reason is that both countries actively encourage and sometimes fund the inventive efforts of individuals. In the US most of the patents are granted to corporate owners whose R&D produce the discoveries.

At this time a Senate Committee is actively considering an overhaul of the patent law. This might be a good time for amateurs of all stripes to make known their views on experimental use of patented devices. If you agree with me that a clarification of this issue is an important matter, write to: Senator DiConcini, Chairman, Senate Judiciary Subcommittee on Patents, Copyrights, and Trademarks, Washington DC 20510, (202) 224-8178.

A special notice concerning the Federoff article appears in a box below. I commend it to your attention.

The patent mentioned in that notice, 4,549,631, covers forms of multiple port, two-chamber loudspeaker systems. If you'd like a copy of it, send us a 9 x 12 self-addressed envelope with 50¢ US postage (or three International Postal Coupons) and we'll supply one. I have consulted with a number of experts in the loudspeaker field about this patent and some are convinced that others may have published such designs before the Bose patent was granted on October 29, 1985. Our attorneys tell us that if such prior art exists it may be presented to the Patent Office with a request for a reexamination of the originality of the claims.

Speaker builders will certainly hold, as I do, that any patent holder is entitled to the full benefits of his or her discovery. But the patent system was founded not only to protect the rights of the inventor, but to make the benefits of the invention available to all citizens. This patent use issue has hung, like a sword of Damocles, over the heads of any amateur who loves to explore technologies. I believe its revision is in the best interests not only of amateurs like ourselves, but of America's economic health and well being, as well.—E.T.D.

NOTICE

Bose Corporation of Framingham, Massachusetts, have notified Audio Amateur Publications, Inc. of Bose's position that the loudspeaker system described in *Speaker Builder*, Issue 2, 1994, pages 36-40, titled "The Birdhouse: A Sound-Reinforcement Subwoofer" by Matthew Federoff, infringes U.S. Patent No. 4,549,631, which Bose Corporation owns.

TIME RESPONSE OF CROSSOVER FILTERS

By Dewald P. de Lange

If the individual outputs of the drivers in a two- or three-way system were to be combined, the result should be a replica of the original input signal. In this article the combined response of the crossover filters only is considered, i.e., driver response is taken as ideal (although the distortion it causes is probably the overwhelming factor). Speaker-system designers appear to exclusively use SPL-frequency response to analyze crossover networks.

FREQUENCY RESPONSE

This type of analysis relies on the fact that any arbitrarily shaped signal can be built up from sinusoidal waves of various amplitudes and frequencies. If sine waves of all frequencies proceed through a crossover network with a constant amplitude and time delay, it follows that other, more complex input signals will retain their original shape. The SPL-frequency response consists of magnitude and phase.

The phase is usually converted to a quantity more directly related to time, namely phase delay (phase over frequency) or, more commonly, group delay (the rate at which the phase changes with frequency). Designers then aim for an SPL-frequency response that has a flat magnitude and a flat group delay. This method is fine if these quantities are indeed flat. When they are not, however, it is hard to imagine how seriously a real signal will be affected.

TIME RESPONSE

Time responses provide a more direct indication of what a crossover filter does to real signals. Of the two common time test signals, impulse and unit-step, the latter is used here. The step response indicates what the edges of a low-frequency square wave would look like.

A two-way crossover network is used for

ABOUT THE AUTHOR

Dewald de Lange resides in Cape Town, South Africa. He obtained a B. Eng. (electronics) degree from the University of Stellenbosch. He has mostly worked in the radio frequency field. He recently wrote a basic speaker system design program.

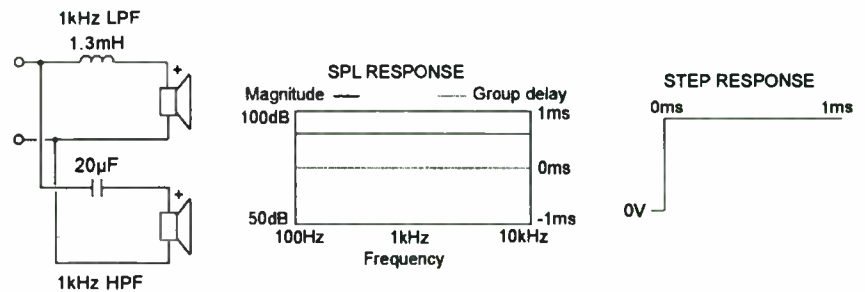

FIGURE 1: First-order crossover filter response.

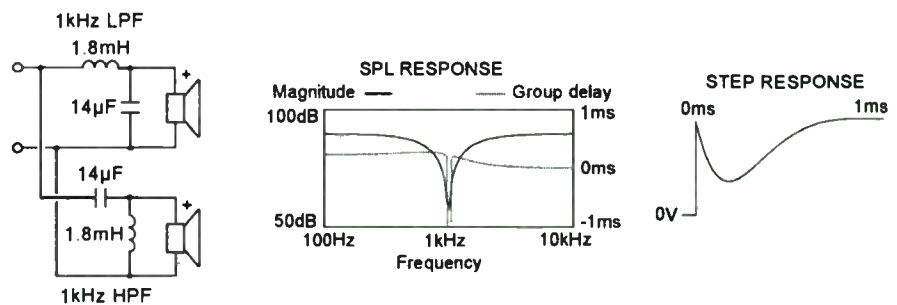

FIGURE 2: Second-order Butterworth crossover filter response.

simplicity in this article. The responses shown are all derived by computer simulations. The SPL graphs are "on axis," being the response straight in front of the speaker system.

The simplest crossover filter is a first-order one, as illustrated in Fig. 1. As can be seen from the middle graph, the combined frequency response has a flat SPL magnitude with zero group delay, which is exactly what

we want. (Zero group delay implies a constant phase shift against frequency, which would not be a constant time delay, unless the phase is zero, which it is). On the right the output step response is also a perfect replica of the input step.

In Fig. 2 we have a second-order low- and high-pass filter, both with the same cutoff frequency. At this cutoff frequency the out-

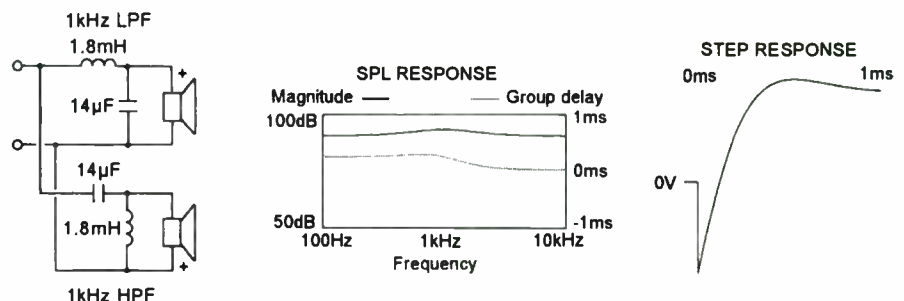

FIGURE 3: Second-order Butterworth crossover with reversed tweeter polarity.

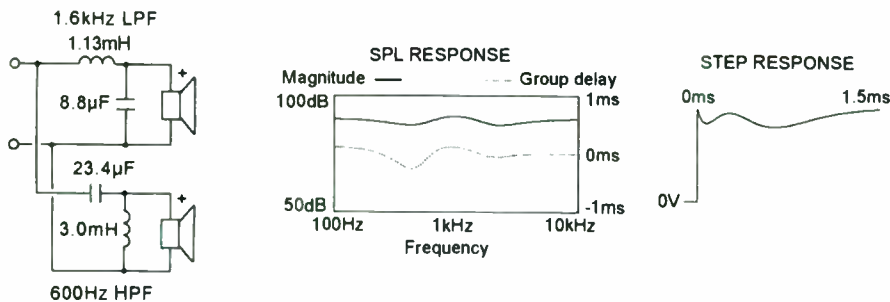

FIGURE 4: Second-order Butterworth crossover with overlapping cutoff frequencies.

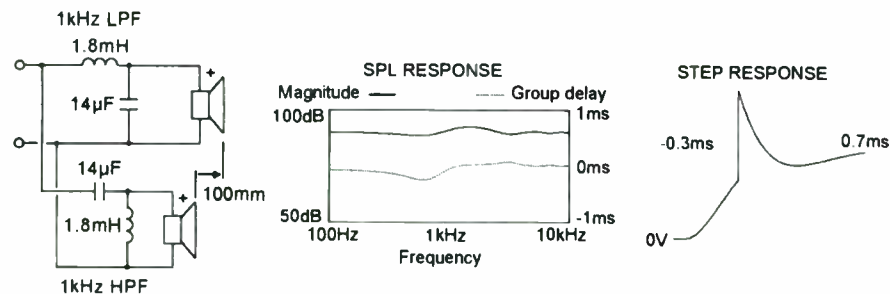

FIGURE 5: Second-order Butterworth crossover with woofer offset.

put from the low-pass filter is out of phase with that from the high-pass filter. The result is a combined output of zero, as can be seen from the dip in the amplitude response. At this frequency there is also a sharp dip in the group delay response, because the phase changes from -90° below the cutoff frequency to $+90^\circ$ above it.

In principle the dip in the amplitude response means the speaker system would produce no sound at 1kHz and the filters must be modified in some way. Before we take a look at possible mods, note that the step response, instead of a flat line after the step, has a dip. The initial spike comes from the high-pass filter. A slight delay occurs before the low-pass filter comes into action. The combined result is the distorted step response shown. The literature contains a suggested method for eliminating the null in the frequency response of a second-order filter, namely to reverse the polarity of one driver (e.g. the tweeter). The two outputs should now be in phase. Figure 3 indicates the result.

The bulge in the SPL magnitude at 1kHz

is compensated for by moving the cutoff frequencies of the two filters apart. However, the step response indicates a fundamental problem, not apparent from the frequency response. As the polarity of tweeter is now reversed, it produces a negative spike.

Another way of addressing the null in the frequency response would be to overlap the low-and high-pass filters (Fig. 4). The SPL response is now continuous, except for ripples of a few decibels. The step response also shows an improvement. However the overlapping slopes now provide little improvement in attenuation over a first-order filter.

Finally, one might consider moving the woofer forward, which largely removes the dip in the SPL magnitude (Fig. 5). The step response is not totally unexpected, with the low-pass filter output appearing before the spike from the high-pass filter.

Third-order Butterworth crossover filters have the advantage that their outputs sum to a flat magnitude response, as shown in Fig. 6. The uneven group delay indicates that the

Continued on page 56

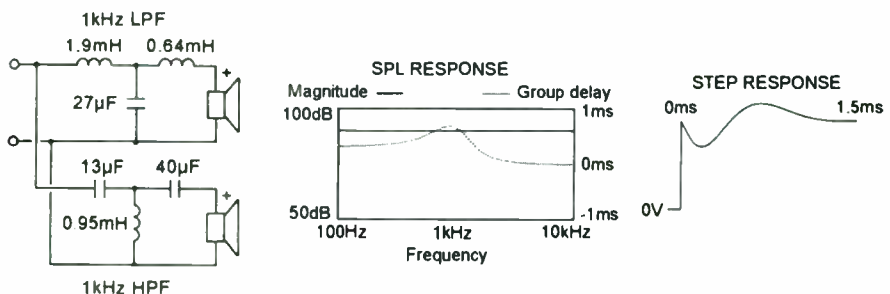

FIGURE 6: Butterworth third-order crossover filter response.

YES, IT REALLY EXISTS!

High-End Technology made in Germany



This driver delivers a genuine full-range 360° dipolar output, is currently available as OEM and/or with the ArtNOISE custom-built cabinet.

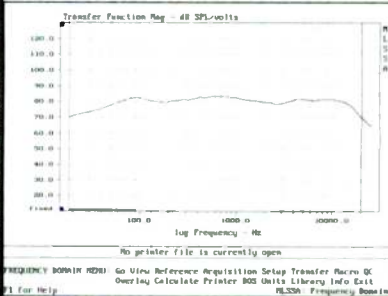

These measurements are taken without any form of filtering. Frequency Range: -6 dB at 70 Hz, from 150 Hz to 16 kHz $\pm 2,5$ dB, -3,5 dB at 16 kHz and above.

Resonance Frequency:	91 Hz
Coincidence Frequency:	220 Hz
Dipole Resonance Fre.:	6 kHz
Sensitivity:	87 dB/W/m
Output Characteristic:	360° toroidal
Impedance:	Z(1kHz)=4 Ω
Nominal Power Handling:	120 W
Frequency Range:	(see above)

Distributor enquiries welcome.
Fax (0 11) - 49 - 69 - 4 94 09 63

GERMAN PHYSIKS

HIGH END TECHNOLOGY

Postbox 10 26
D - 63 506 Hainburg
Germany

Reader Service #42

CONVERTING RADIO SHACK'S SLM TO MILLIVOLT USE

By C.L.P. Carrington

Until I read Joseph D'Appolito's article "Mitey Mike" (*SB* 6/90, p. 10), I used a borrowed Shure Equalisation Analyser to make measurements on the speakers I built. However, the one-octave bandwidth of the analyzer and the 3dB incremental display limited the equipment's usefulness for the analysis I wanted.

Mitey Mike proved highly satisfactory when used in conjunction with Dick Crawford's Warbler (*TAA* 1/79, p. 22). The results were so good, in fact, that I built another measurement system for a friend who is equally enthusiastic about speaker building (probably more so; he has embedded concrete LF horns in the cellar of the home he constructed!).

Having built the Mitey Mike and Warbler, I looked around for an economical mV testmeter to use with them, but without success. My friend used a Radio Shack sound level meter (Cat. No. 33-2050) for balancing his system, which I reckoned could be modified to provide the mV testmeter we sought. Radio Shack includes a schematic diagram in the instruction booklet, which facilitated the modifications.

MINIMAL MOD

My aim was not to rebuild the sound level meter but to modify it, minimally, in such a way that it could still be used as originally intended. Accordingly, I provided a line input to Q1 through an SPCO switch that would select either the SLM microphone or the line input. I achieved this by cutting the printed circuit between C1 and the "CAL" potentiometer VR1; *Photo 1* shows the location of the track to be cut.

With the meter switched to "C" weighting, measurements made by connecting an audio oscillator to the top of VR1 indicated that for 0dB on the 120 scale to correspond to 0.775V (i.e., 0dBm), some attenuation would be required. On this basis, the most sensitive position (60dB) would equate to 0.775mV (-60dBm). I detected a fall-off in response at the low and high ends of the 20Hz-20kHz passband.

To carry out the modifications, mount an SPDT miniature toggle switch (RS 275-625) and RCA phono socket (RS 274-852) in the side of the rear housing—the switch 1/2" from the

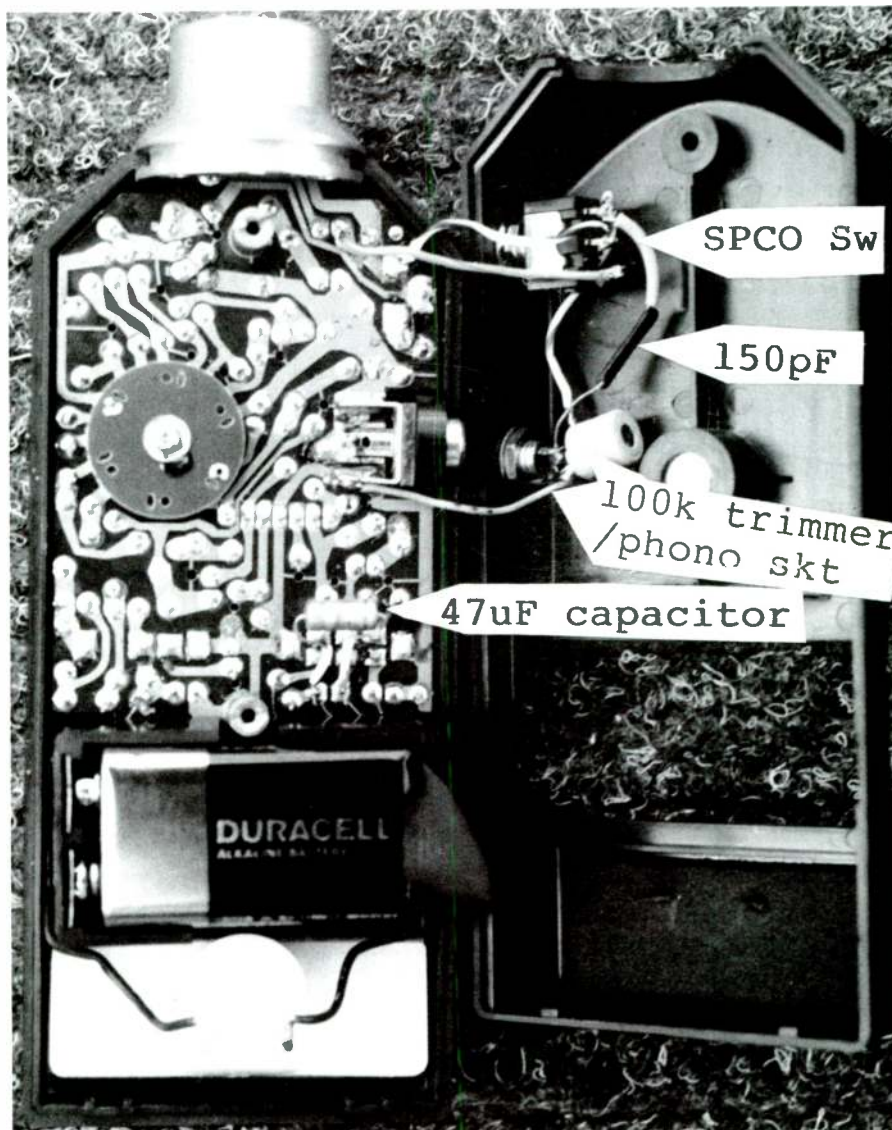

PHOTO 1: The modified Radio Shack sound level meter.

cutout for the "output" socket in the direction of the microphone and the socket 1/2" on the other side of the cutout. Both should be mounted halfway up the side of the housing (*Photo 1*).

Using a scalpel or craft knife, cut the copper track leading from C1, in line with the metal pillar. (With the sound level meter lying face down, as shown in *Photo 1*, this track is just to the right and below the microphone; it is the fourth track to the right of the pillar.)

Solder a wire to the track near C1 (the half of the track nearest the microphone) and connect this to one side of the SPDT switch. Connect the other end of the severed track to the center pole of the switch so that with the switch thrown in the direction of the SLM microphone, the meter will operate as before, i.e., as a sound level meter.

Connect a wire from the solder tag, retained by the nut of the phono socket, to the

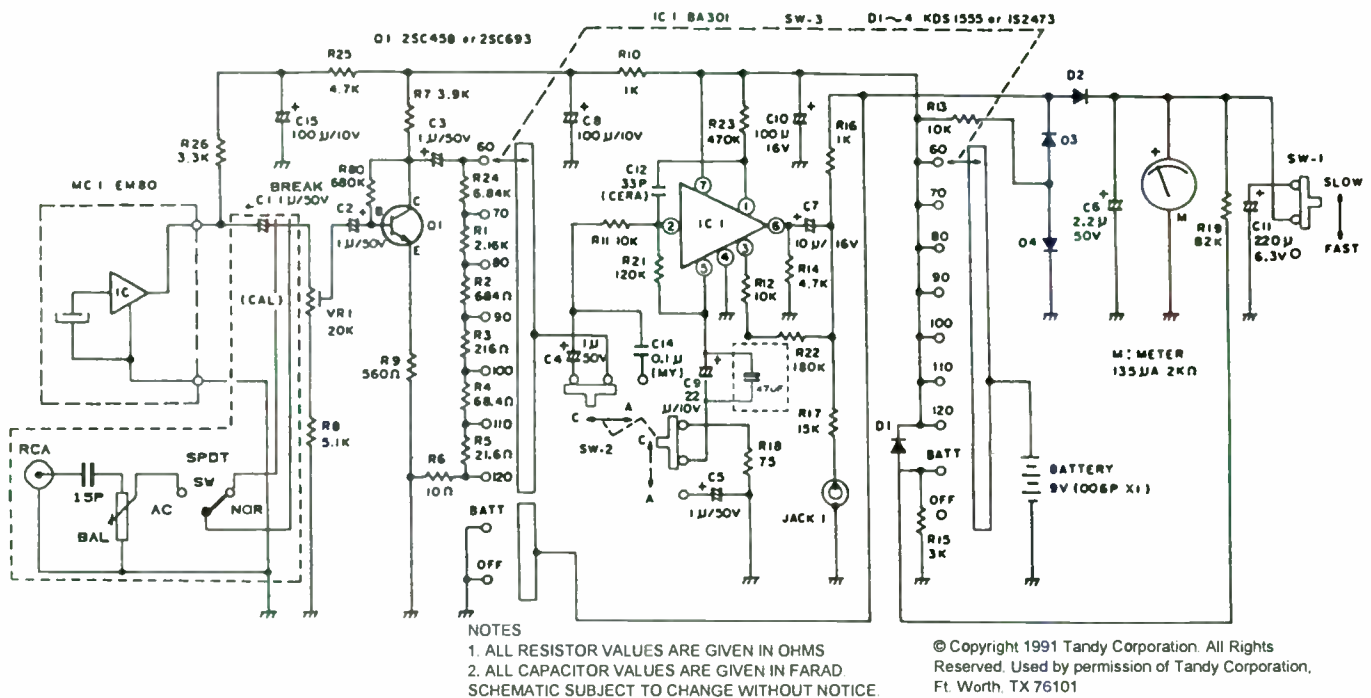

FIGURE 1: Schematic for the Radio Shack sound level meter, with modifications.

U-shaped piece of metal grounding the "output" socket. Connect a 100k trimmer resistor (RS 271-284 would probably do) across the RCA phono socket, and connect the wiper of the trimmer to the free side of the SPDT switch. When the switch is thrown in the direction away from the microphone, the "input" line socket should now be connected to the amplifier, via the trimmer.

DECLINE AND FALL-OFF

An accurate audio-signal generator will facilitate the calibration. Connect the generator

to the "input" socket with the switch thrown to put this in circuit. Feed a 0dBm (0.775V) signal at 1kHz into the input, switch the meter to the 120 scale, adjust the trimmer for 0dB (at about the midpoint [electrical] of the trimmer), and switch to 20kHz. If you see any fall-off in reading, shunt the top half of the trimmer by a small capacitor to compensate.

The two meters I modified differed in sensitivity; you may need to proceed by trial and error. Start by connecting a 150pF capacitor from the input socket to the wiper of the trimmer (or to the side of the SPDT switch

connected to this point). If you're lucky, the 20kHz level will now correctly read 0dB. If it reads high, reduce the capacitor to, say, 120pF. If it reads low, increase the capacitor. It may be worthwhile to buy a trimmer capacitor (RS 272-1336) and adjust it for the correct reading. By judicious mounting, this could be accommodated within the enclosure.

Switch to 20Hz. You will note a minor fall-off in reading on the meter; you can correct this by shunting C9 with a 47µF capacitor. Six soldered connections are in line to the

Continued on page 56

BassBox™ 5.0

for Microsoft WINDOWS™

Design speaker boxes fast and accurately with BassBox software. Accepts both Thiele-Small (Fs, Qts, Vas, η) and Electro-Mechanical (Qes, Qms, Cms, Mms, Rms, Bl) parameters with equal ease.

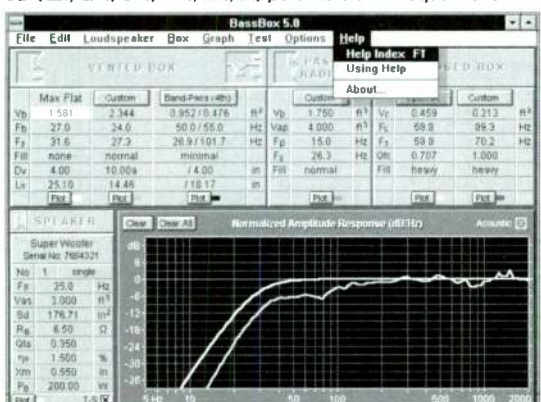

Copyright © 1994 by Harris Technologies. All rights reserved worldwide. BassBox is a trademark of Harris Technologies. Other trademarks are the property of their respective companies.

Driver Database with over 1,000 drivers.

- ◆ Easy to use
- ◆ On-line help
- ◆ Large driver database
- ◆ Low price

Design Types:

- Maximally Flat Vented
- Extended Bass Vented
- Custom Vented
- Band-Pass Vented
- Passive Radiator
- Optimum Closed
- Custom Closed
- Multiple Woofer designs (including Isobaric)

Built-In Test Procedures:

- Test and calculate loudspeaker parameters*
- Test and calculate passive radiator parameters*

*Requires basic test equipment: sine wave generator, frequency counter, power amplifier, 1 kohm resistor, voltmeter, ohmmeter, test box.

 **\$99.00**

plus \$4.00 S&H
(Canada +\$6.00)
(Overseas +\$12.00)



Tel: 616-641-5924
Fax: 616-641-5738

Harris Technologies
P.O. Box 622
Edwardsburg, MI
49112-0622 U.S.A.

Also available:
X-over 2.0 passive cross-over program for Windows.
X-over calculates the component values for 1st, 2nd, 3rd and 4th-order 2-way and 3-way networks, load compensating networks and L-pads. **Regular price: \$29.** (\$19 if purchased with BassBox.)

System Requirements:
MS-DOS 5.0, Microsoft Windows 3.1 & compatible computer (IBM® PC w/ 386SX or better), 1.44 MByte 3.5" disk drive and mouse. 4 MBytes RAM recommended.

Harris Technologies reserves the right to make changes without prior notice.

ACOUSTIC DISTORTION AND BALANCED SPEAKERS

By Donald Jenkins

Designers of sound systems pay a great deal of attention to the matching, balancing, and phasing of components in their quest to achieve optimal performance. They will measure and analyze electrical characteristics of the components and give careful thought to the design and construction of the speaker enclosure.

But what about the question of speaker-to-speaker acoustic balance? Do supposedly identical speakers actually deliver the same performance when energized with the same inputs? The results of my investigation show that in some cases what are considered equal acoustic systems may in fact display large acoustic dispersion over a small frequency range.

The test that I devised measured speaker (that is, voice-coil) current, which I took to be a linear indication of acoustic power. If the two speakers are constructed in the same way and mounted in similar enclosures, an identical input voltage to each should produce equal currents at a given frequency; if the speaker currents are equal, the speakers' outputs are considered equal. Of course, a better way to assess speaker output is to measure the actual cone displacement, but for speakers installed in enclosures that is hard to accomplish.

So for purposes of this test I have assumed that equal currents in the same design produce equal displacements.

In this steady-state test, I measured the RMS value of the current over a range of frequencies. I used a ten-second linear frequency sweep from 20–175Hz at a constant input voltage to the speaker, keeping the sweep-frequency range intentionally narrow.

Figure 1 shows a standard plot of imped-

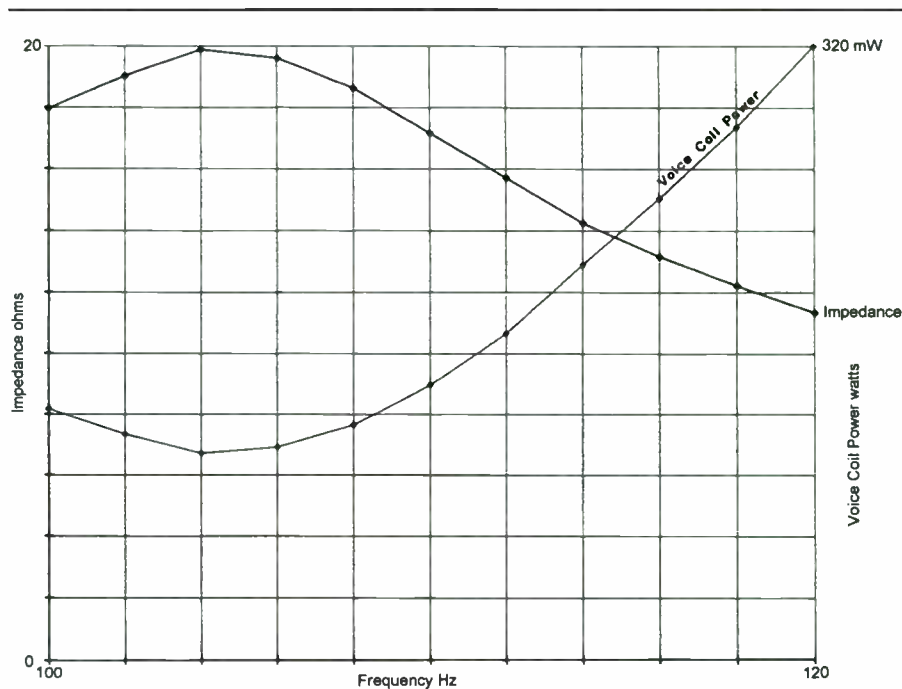

FIGURE 1: Impedance versus frequency; Sony APM-215/Heath W-5M.

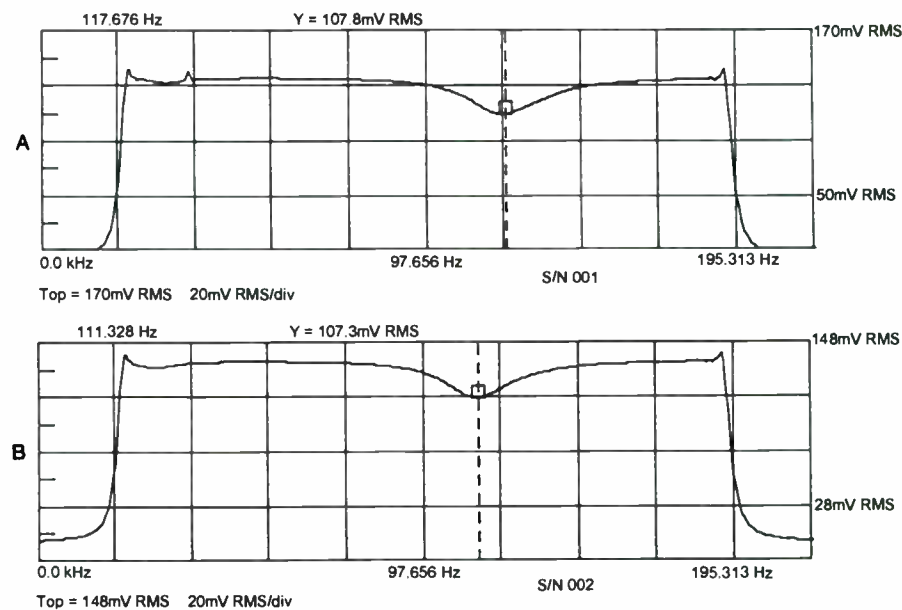

FIGURE 2: Slow-sweep spectra of a "matched" set of Sony APM-215 speakers: a. speaker A; b. speaker B.

ABOUT THE AUTHOR

Don Jenkins is a retired engineer from the aerospace business, and is now consulting part time. He considers the study of amplifiers strictly on the hobby side of his interests. The "professional" side is concerned with rocket propulsion system design and development, with some activity on the projection technology committee of the SMPTE.

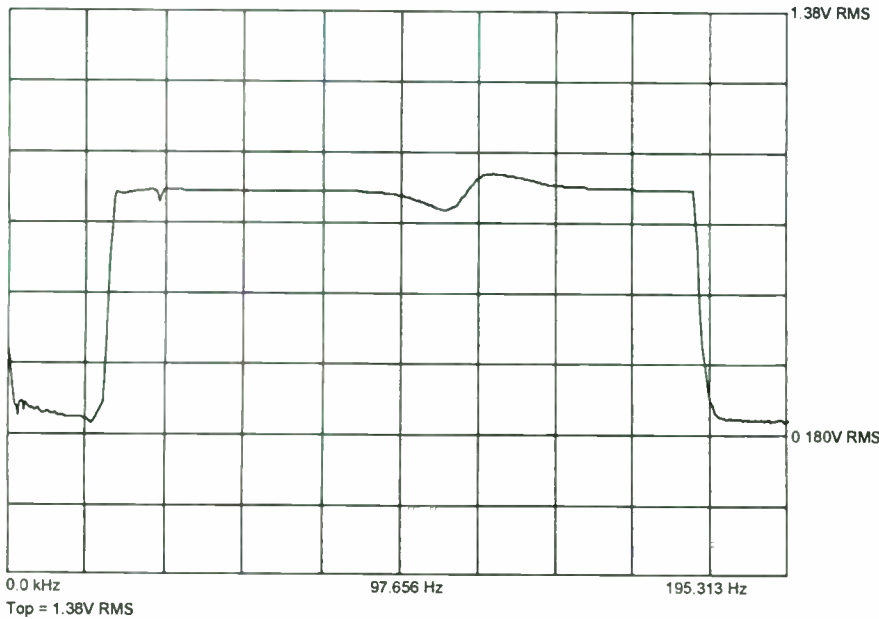

FIGURE 3: Ratio of the two curves, S/N 001 to S/N 002, for the Sony APM-215s. The plot is derived by line-by-line division across the test spectrum.

ance versus frequency for a typical set of speakers mounted in an enclosure. At greatest impedance, speaker current is lowest. I have defined acoustic dispersion as the dif-

ference in output currents at the same input frequency.

The speaker unit I used in this test was a SONY APM-215. It has three small drivers

built into a bookshelf-type cabinet and is designed to be used with its companion amplifier, the Model TA-215. Note that the speaker current is lowest at about 104Hz.

Figures 2a and 2b show the slow-sweep spectra of a "matched" set of these speakers. The spectra are similar. Figure 3 shows the ratio of the two curves, S/N 001 to S/N 002, derived by line-by-line division across the test spectrum. The resultant curve is the difference, therefore the acoustic distortion, that results from equal inputs to the two speakers. It reaches a maximum of about 6% in the 100-120Hz frequency range.

This means the same input to these speakers would result in as much as a 6% difference in acoustic output at those frequencies. It also means that a small frequency shift could actually shift the relative amplitude from one set of speakers to the other. As a result, any stereo separation in this range would not only be lost but would actually be channel-reversed.

This explains why I used such a narrow band of frequencies in the test. The mismatch phenomenon is greatest at the resonant points of the speaker/enclosure/crossover network assembly, since this is the frequency range in which the rate of change in the impedance is greatest. Achieving a true match of all these elements is clearly quite difficult.

Headphone Amplifier Module

All you need is ± 15 Volts and Ground, and you can add a great sounding headphone amp to your system.

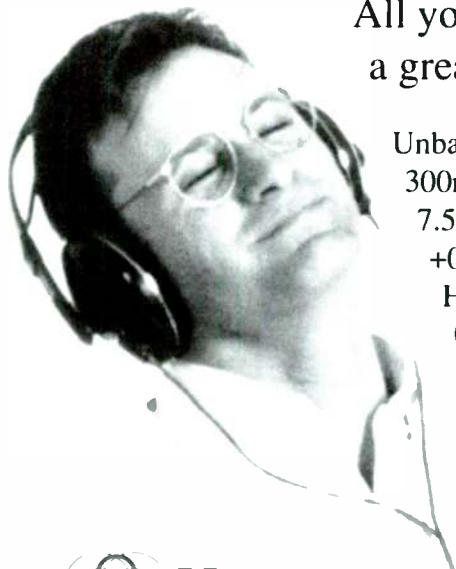

- Unbalanced Line Inputs
- 300mWatt Rated Output Power
- 7.5 Ohm Output Impedance, DC Coupled Throughout
- +0db, -3dB 20Hz to 20KHz Frequency Response
- Headphone Audio Image Correction Filter
- 0.03% +0.05% THD 70Hz to 20KHz
- 90dB S/N Ratio

For 8-Page information booklet, comprehensive spec sheet, and competent technical advice about headphone amplification call HeadRoom at (406)-587-9466.

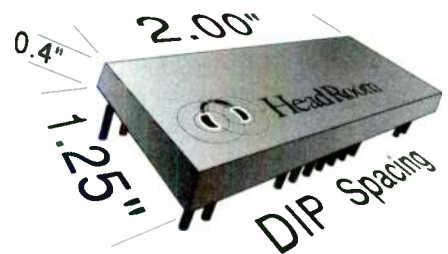

DESIGN TOOLS THAT SPEAK YOUR LANGUAGE!

For years loudspeaker builders have been waiting for this. Affordable software programs to design and simulate your special speaker system. Programs you don't have study on, but are ready to use immediately.

NETCALC is the state of the art crossover design program using an **interactive** or **automatic optimizer**. And with its **graphical** speaker editor and network editor you can easily enter your data.

BOXCALC \$99 DOS software for enclosure design of closed and ported designs, including a database of 1200 drivers

NETCALC \$149 DOS software for crossover design, optimization and system simulation

Dutch Elektor 'Luidspreker Special'
"We recommend NETCALC without restrictions, only to play with it is worth it"
 Together with BOXCALC

"An ideal combination to compute and simulate practically every aspect"

Voice Coil (Oct. 1993)
"...NETCALC offers a lot of features for not much money"

ORDER INFORMATION:

To order a copy of BOXCALC or NETCALC please send a personal or bank check in US \$. The software will be delivered by airmail, postage is included. Dealer inquiries are welcome.

ARIBA

Baroniehoeve 32
 5244 HZ Rosmalen
 the Netherlands
 FAX + 31 4192 15841 (24h)

Reader Service #43

Mahogany Sound

2610 Schillingers Rd. #488
 Mobile, AL 36695
 (205) 633-2054

TRANSMISSION LINE SPECIALISTS

Q&ETLD

QUICK & EASY TRANSMISSION LINE SPEAKER DESIGN is a new booklet that is a must for TL fans. It offers a step-by-step design procedure that really works. All you need is a calculator with a square root key, and imagination. There is also a computer diskette for use with Lotus 123, and a 6 1/2" 2-way TL project called *The Mini Monolith TL*.

Q&ETLD is \$8.95 postage paid.

ACOUSTA-STUF

ACOUSTA-STUF is absolutely the best sound absorption fiber for transmission lines. You should order one pound per cubic foot of enclosure.

ACOUSTA-STUF costs \$8.95 per pound, UPS paid.

WRITE OR CALL FOR A FREE CATALOG

Reader Service #9

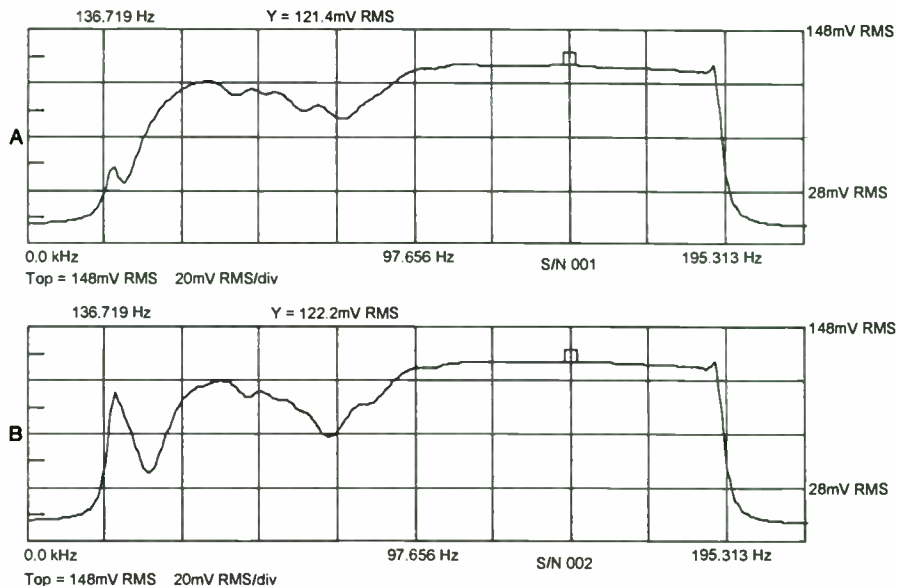

FIGURE 4: Slow-sweep spectra of a "matched" set of Heath SS-1/-1B speakers: a. speaker A; b. speaker B.

To see whether this response was unique to my Sony speakers or is typical of any two matched speaker units, I compared them with two Heath SS-1 and SS-1B units. Each of these units consists of four speakers in two cabinets with crossover networks.

These two assemblies proved to be even more divergent in input. Figures 4a and 4b are the two sweep spectra, and Fig. 5 is the ratio plot. For these units, peaks in acoustic distortion are in the 20Hz range and have an

amplitude as high as 100%; there is also distortion of about 32% near 75Hz. Here too, a slight shift in frequency will result in apparent channel shift.

The results of these tests show that this type of unsymmetrical acoustic distortion will probably occur with any two speaker sets used for discrete channel reproduction. Whether or not this unbalance is discernible to the listener is the next question. Critical listening tests might provide an interesting answer.

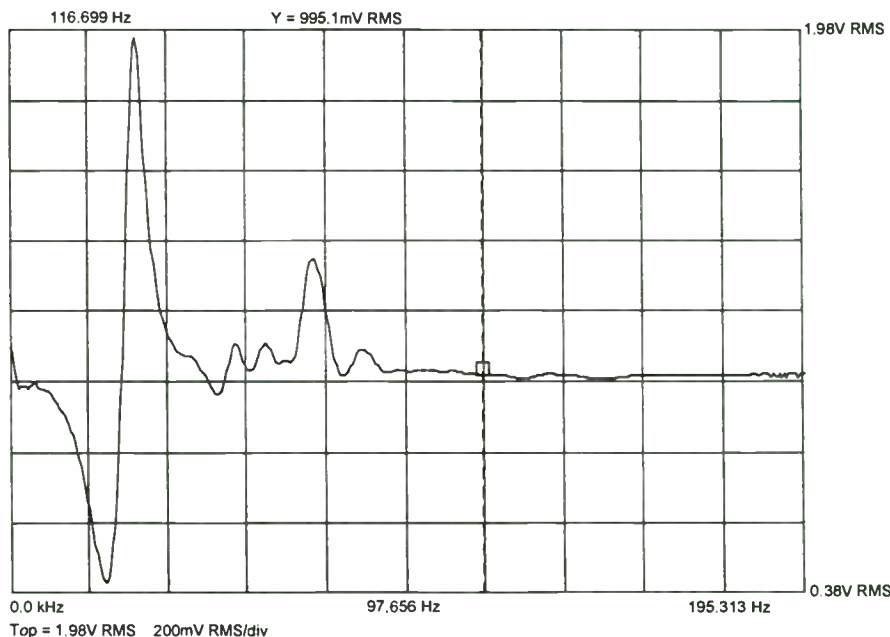

FIGURE 5: Ratio of S/N 001 to S/N 002 for the Heath SS-1/-1Bs.

NEW FOR 1994

The *Q-3* incorporates the proven Vifa P17WJ with the new 26mm D27TG silk and fabric dome tweeter. The D27 has a lighter and better controlled diaphragm than typical cloth domes. A tuned cavity, and linear response faceplate add to the technology Vifa designed into this driver to compete with other fine Danish tweeters. Response has been favorable to this new addition to the Vifa line.

The crossover is computer optimized as a forth order Linkwitz-Riley type. Text-book formulas could not produce the values used in this effective circuit. The designer and Brian Smith of A&S worked to overcome problems such as the nasality and "honk" associated with some bass-mids, and the brightness and sibilants associated with many dome tweeters. The use of LMS and LEAP together, with careful listening, have refined the *Q-3* into a very musical two-way speaker with excellent bass, mid-range tonal balance and smooth, extended highs.

The *Q-3* overcomes many of the problems associated with DIY projects and less sophisticated commercial systems. The enclosure features a computer-optimized, third-order (slightly modified QB3) alignment. In this design, both enclosure tuning and the natural resonance of the bass-mid are below the -3dB point of the system. This alignment provides better transient response and less colorations than conventional forth-order vented designs. To reduce cabinet resonances, and further improve bass clarity, the inside walls of the enclosure are covered with two layers of Black Hole Pad. Careful use of other materials completes the damping of the cabinet.

The *Q-3* is -3dB at 49 Hz and -10dB at 35 Hz., but may be combined with matching subwoofers. These computer-optimized modules incorporate the new Vifa M26WR 10 inch woofer and will extend the system response down to 26 Hz.

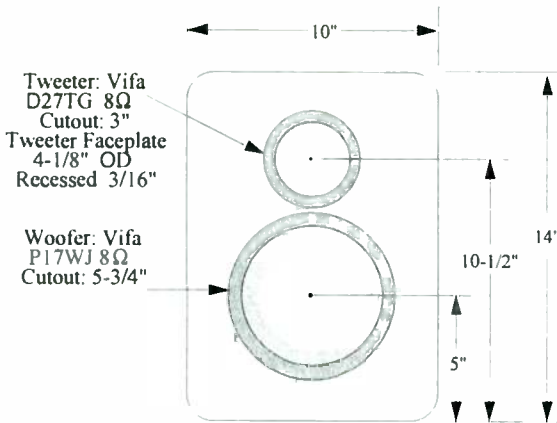
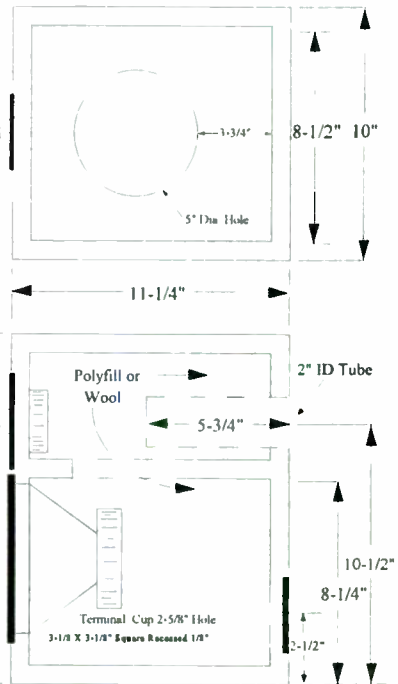

Prices:	
<i>Q-3</i> Kit	
W/ Enclosure	\$389
WO/ Enclosure	\$229
Subwoofer Kit	
W/ Enclosure	\$519
WO/ Enclosure	\$339

Tweeter: Vifa D27TG 8Ω
Cutout: 3"
Tweeter Faceplate
4-1/8" OD
Recessed 3/16"

Woofer: Vifa P17WJ 8Ω
Cutout: 5-3/4"

The *Q-3*

Designed by Jay Adamson

A&S
speakers

3170 23rd Street; San Francisco, CA 94110

Telephone: (415) 641-4573 Fax: (415) 648-5306

MICROPHONE RESPONSE CORRECTION WITH IMP

By Bill Waslo

Loudspeaker measurement accuracy is greatly affected by your microphone. A cost-effective microphone of known characteristics can achieve very accurate results. It can also remove any requirement for an expensive, flat measurement microphone. One advantage to using a computer system for measuring and processing is that known, linear effects, like microphone response and sensitivity, may be digitally corrected with little effort.

Even without correction the little microphone capsule used with IMP (as well as in Mitey Mike and others) has quite good characteristics. But better results can be automatically obtained when correction data is provided to the IMP or IMP/M software. (Note: the P9932 capsule used in IMP and Mitey Mike was discontinued. The P9939 (WM60) capsule has been found to be a good substitute.)

It is easy to get confused with terminology here, so let me make a few distinctions. "Cal" in the IMP system refers to the normalization process that eliminates response errors resulting from the electronic test equipment. "Correction" refers to the process that eliminates response errors due to the microphone—usually accomplished with the help of microphone calibration data (as it is called in the world beyond IMP). Beware of confusing "cal" with "calibration." Within this article, the microphone calibration data is called "correction data."

JUST SAY WHEN

There are several ways to determine how and when to apply microphone correction. An obvious approach is to apply the correction curve whenever you desire. But this adds yet another thing for you to keep in mind during

a system measurement. If your lab is like mine, you probably don't need more complication in your work.

The alternative IMP provides is saving a record of the input from which time data was acquired. If the data is taken from the microphone input, IMP assumes the measurement is acoustically based and that the correction should be applied. This tag, which defines the source as a microphone, is also attached to any frequency responses transformed from the time data. Of course, when exceptions to these rules are desired, there are menu options under [* Display Mic_correction]. These options allow you to force a time or frequency domain data set to be treated as either acoustic or nonacoustic.

The correction is actually applied only to frequency-response data, and then only when a "cal" is, or has been, performed on the data.

Remember: an IMP "cal" refers to the process of normalizing the spectrum at a speaker's output with what is at its input. The frequency response yielded is independent of the IMP pulse shape or amplification/filter effects. Microphone correction is done only with cal as a practical matter. If you need rapid, noncritical results, you may not want to wait the extra time required to apply the correction to each FFT result; and, the response rolloff from pulse shape and anti-aliasing filters is usually greater than that of the IMP microphone. Therefore, microphone correction is of little value without cal application.

Although this arrangement is complicated to describe, it is easy to use. Just have the microphone correction data available and loaded into the IMP software. IMP will apply it when appropriate. When both microphone correction and system cal are applied, a small "m"



FIGURE 1: Simple attenuator for Mitey Mike to reduce sensitivity with IMP.

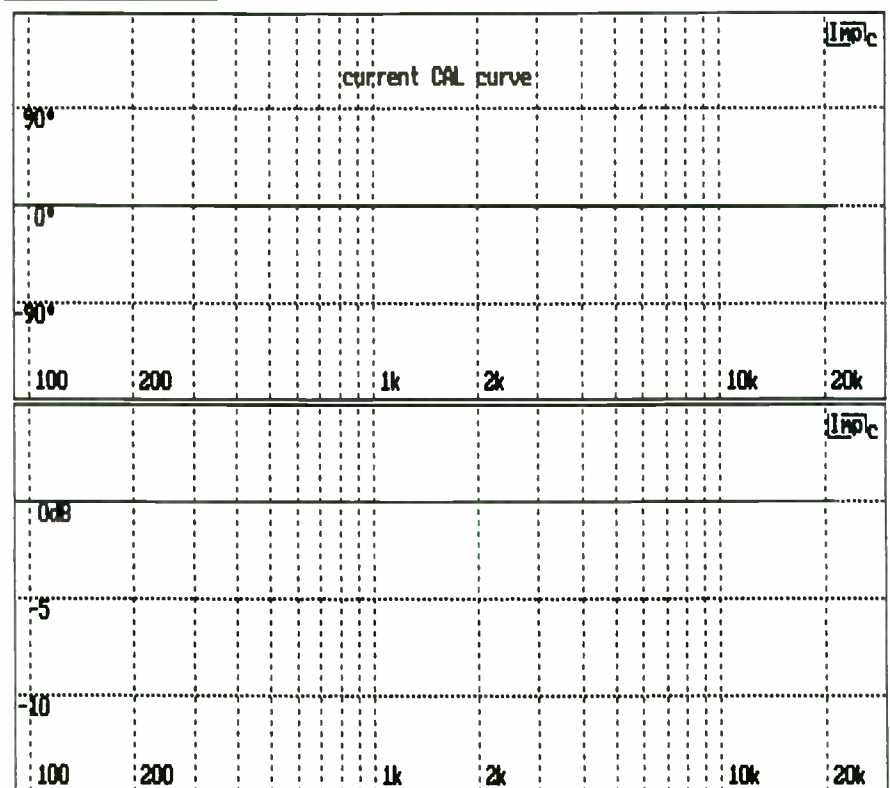
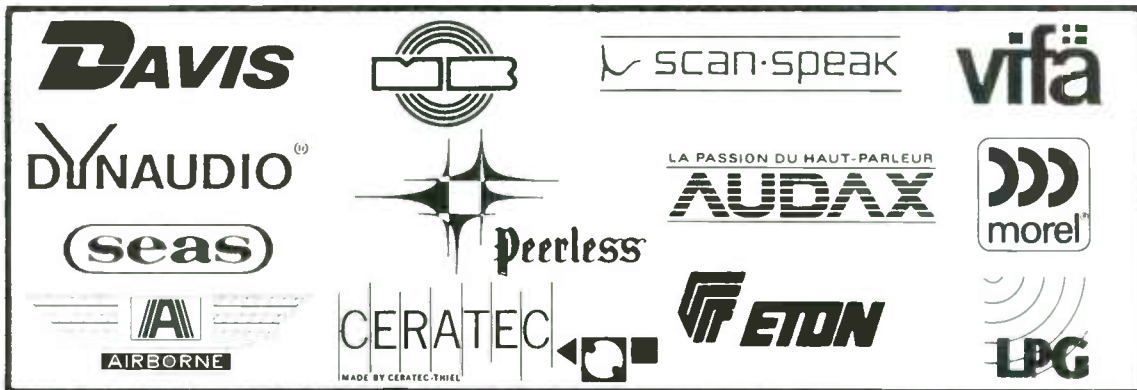

FIGURE 2: A "flat" dummy cal curve.

SOLEN SPEAKER COMPONENTS



CROSSOVER, SPEAKER COMPONENTS



FAST CAPACITORS

Metallized Polypropylene (Non-Polarized)
 Values from 1.0 mfd to 200 mfd.
 Voltage Rating: 250 VDC / 150 VAC

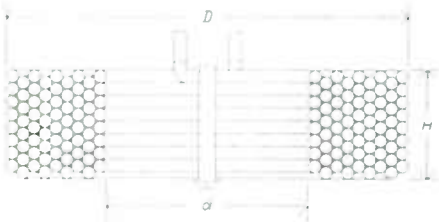

SOLEN INDUCTORS

Perfect Lay Hexagonal Winding Air Cored
 Values from .10 mH to 30 mH
 Wire sizes from #20 AWG to #10 AWG



HEPTA-LITZ INDUCTORS

Seven Strands Litz-Wire Constructions
 Values from .10 mH to 30 mH
 Wire sizes from #16 AWG to #12 AWG

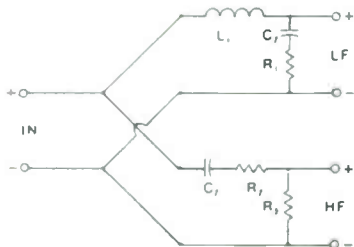

SOLEN CROSSOVERS

Custom Computer Design
 Passive Crossover for Professional, Hi-Fi and
 Car Hi-Fi, Power up to 1000 Watt

CROSSOVER, SPEAKER PARTS

Gold Speaker Terminals, Gold Banana Plugs
 Gold Binding Posts, Crossover Terminals
 Power Resistors, Mylar Capacitors,
 Bi-Polar Capacitors, Plastic Grille Fasteners,
 Nylon Ties, Car Speaker Grilles, Speaker Books,
 Speaker Kit Brochure, Miscellaneous Parts



SOLEN INC.
 4470 Thibault Ave.
 St-Hubert, QC J3Y 7T9
 Canada
 Tel.: (514) 656-2759
 Fax: (514) 443-4949

**COMPUTER AIDED DESIGN FOR
 ENCLOSURE AND CROSSOVER
 AVAILABLE TO CUSTOMER**

Catalog \$6.00 refundable.

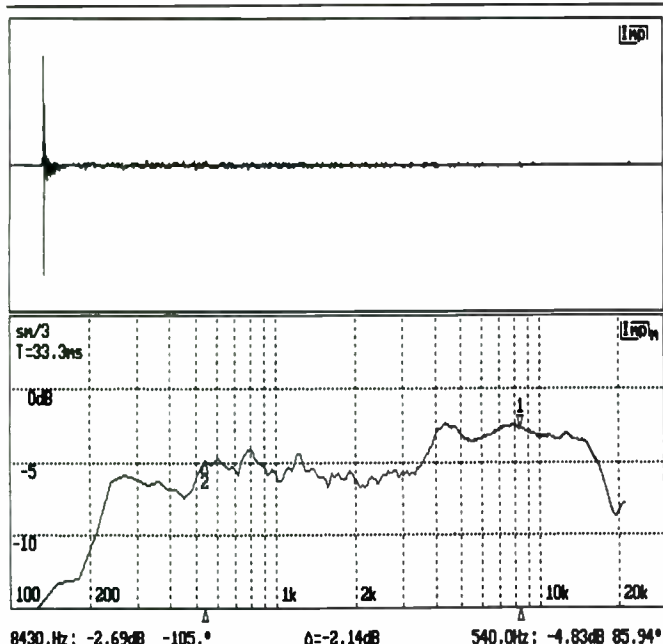

FIGURE 3: Corrected for response for Mic only (using flat Cal).

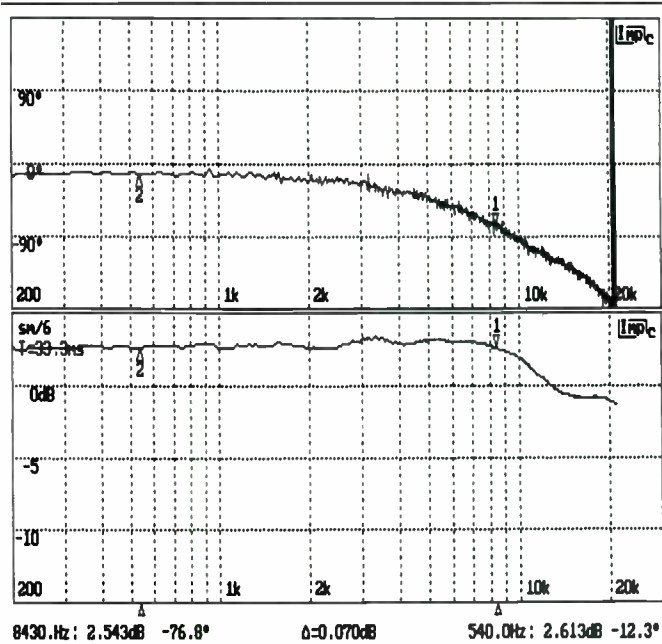

FIGURE 4: The correction data (response curve) for the WM60 sample mike.

will appear by the IMP logo. A small "c" by the logo indicates that only cal has been applied.

One further note: in IMP, the microphone correction is used only with the higher sample rate. The capsules commonly used are much better for low-frequency performance than for the high-frequency end of the audio spectrum. In addition, conventional memory use in IMP is already approaching maximum. Therefore, correction data below approximately 1kHz is not usually needed.

NAILING DOWN A REFERENCE

Of course, the correction cannot be applied at all if it is not available and loaded into the computer in a compatible way. Several options are available, depending on cost, effort, and the level of precision you require.

The easiest and cheapest route is to use the "TYPMIC.DAT" correction file provided with the IMP software. This will generally get you very close, within about a decibel flatness, according to a quick comparison of five P9932 capsules. If you wish to have more accurate results, or if absolute sensitivity levels are an issue, you will need measured data for the individual capsule you use.

Several microphones with calibration data from sources such as Old Colony and Josephson Engineering are available. Use an electret condenser type, not a dynamic microphone. The bias current supplied from the IMP microphone input is undesirable in a magnetic circuit. You may, with some microphones, have to adapt connectors to match IMP's input. If your microphone's output impedance is not very low, you may have to modify the correction data sensitivity to account for

the 2.21kΩ loading of IMP's microphone input as well. (This should not be a problem with Mitey Mike.)

The cal data on your microphone might be in disk or paper form. The format required by IMP for microphone disk-based data is described in two places. Refer to the "IMP-READ.ME" file of version 1.21 or to the Help files in version 2.00 and above. Don't despair if you have only a paper graph or frequency list. You can enter the data into an ASCII file using any of a number of common text editors. Just follow the specified format. IMP interpolates its required values from the frequency points provided—so the correction resolution is determined by the number of points you wish to enter. If phase data is not provided, just neglect it. IMP will assume the phase correction is zero—not likely to be very far off below about 15kHz.

When you are finished, name the new file with a ".DAT" extension (example: MYMIC.DAT). Then copy it into the directory from which you run IMP. Go to [* File Micdat], load, and you are ready to go.

DIY CORRECTION FILES

Another approach is to borrow a calibrated microphone and use IMP to generate your own correction data for your capsule. A microphone calibrated this way will be less direct in its calibration pedigree. (It's one more step away from the initial standard, and some error can be expected to be introduced at each step.) It does have the advantage of providing do-it-yourself satisfaction, however. This can be done efficiently, but will require some care, a little trickery, and some explaining.

One problem that arises in this process is gross differences between microphone output levels. If absolute sensitivity is not required, just use IMP's microphone level control for compensation. But, if you need to determine sensitivity also, you must keep track of the attenuation. The easiest method is to attenuate the higher-output microphone down close to the level of the lower-output microphone.

For example, to attenuate Mitey Mike down near the sensitivity of the bare IMP capsule (as powered from the IMP module), a resistor of 10.0kΩ can be installed. Positioned in series with the hot lead at the IMP module microphone input, this provides 15dB attenuation. This resistor should be installed with connectors, so that it can be included without permanent modification to either IMP or the Mitey Mike (Figure 1).

MITEY MIKE ATTENUATOR

If you use such an attenuator, be sure to adjust the sensitivity value of the correction data for the high-output microphone accordingly. That way, IMP is aware of the change. (Make a separate file of the correction data for such use.) For instance, for a 10.0k resistor used with a Mitey Mike, divide by 5.656 the number preceding the expression "mV/Pa" in the first line of the correction data file. In this instance, 15dB = 20*log(5.656).

You'll need a speaker with reasonably flat response, preferably within 10dB over the desired correction frequency range. IMP will measure the speaker with both microphones and will use the data from the corrected microphone. Then IMP will calculate the correction curve for the unknown microphone based on the differences in the measurements.

This step-by-step procedure will enable you to generate a correction file. Menu directions apply to the IMP/M version of the software:

1. Make a dummy cal file. That way, you can trick the program into applying only the microphone data to a curve. (Microphone correction can only be applied when cal-ing.) Take any non-cal'd impulse response of high RATE and large size, such as the simulated pulse the IMP program shows when first started. A size of 1,024 or 2,048 should be OK. FFT all of it. (In the time curve before FFTing, put marker 1 at 1 and marker 2 at SIZE.) Declare the curve as "cal" using [* Transform Set_cal]. Then, by the key sequence [* Display Mic_correction Freqdata No], tell the program the response is non-acoustic. Set delay to zero (via F9), and the frequency response GAIN (F8) to 0dB. Do [* Transform Cal]; i.e., cal it with itself. You should get a straight line of 0dB and 0° phase (Fig. 2). Declare this line as your new cal data by [* Transform Set_cal] again. You might want to save this cal curve ([File Save fCal_file]) under the name "Flat," so you don't have to go through this again.

2. Make sure that the proper Microphone Correction file for your calibrated microphone is loaded in via [File Micdat].

3. Use your calibrated microphone to make an acoustic-only measurement of a loudspeaker that has reasonable response. (MLS is definitely preferred.) This measurement may be anechoic (echoes edited out) or not, as you like. The valid correction curve will extend lower if echoes are included. Including echoes, however, makes repeatability of microphone placement more critical. If you include echoes, you may want to deaden the area around the speaker and microphone by spreading blankets or pillows. Doing so minimizes high-frequency reflections and gets a smoother curve.

Do not use a probe "cal" procedure with this measurement. FFT and then cal this curve using the dummy cal data. This ensures that only the microphone correction is applied to its frequency response when the "Flat" cal is used. Declare this modified curve as the new CAL using [* Transform Set_cal]. This is the speaker's response under arbitrary but controlled conditions—corrected for microphone response, but *not* for IMP pulse shape or filtering (which need not be dealt with in this procedure). This curve will show significant rolloff above 15kHz because of the lack of a proper cal (Fig. 3).

Carefully note the exact position of the

calibrated microphone capsule in space. You will need to position your new microphone, as accurately as possible, in this same spot.

4. Replace the microphone with the new mike for which you wish to derive a response curve. Mount it in the same way and at the same point as the reference microphone. Then measure the impulse response of the same speaker under the same conditions of amplifier gain and IMP control settings.

5. Tell IMP not to use microphone correction data by the command sequence [* File Micdat]. Then type "none." FFT and "Cal" the new response. This divides the curve using the new microphone with the curve using the corrected reference microphone. The result is the correction curve for the new microphone.

6. The true differences between the responses should tend to be relatively wideband (i.e., no hash or fine ripples), because the microphone diaphragm lacks the high Q for narrow-band effects. Any such narrow ripples you see are apt to be due to differences in microphone placement affecting echo-induced cancellations—usually narrow-band effects. You will induce little error and get more coherent results by just smoothing these

Continued on page 56

(Sudden)

IMPACT™

"POWERED SUBWOOFER" "KIT"

Driver: 2 x 12" ECLIPSE
Alignment: 3 cu. ft. 6th order vented
Amp.: 200 Watts into 4 ohm
Resp.: 16 - 100 Hz
X-over: 55 Hz or 90 Hz , 12dB/oct.
Adjustable gain
Adjustable phase
Cabinet: Oak veneers and solids,
27.5"x16"x16", "Spiked"
Introductory price: \$600.00

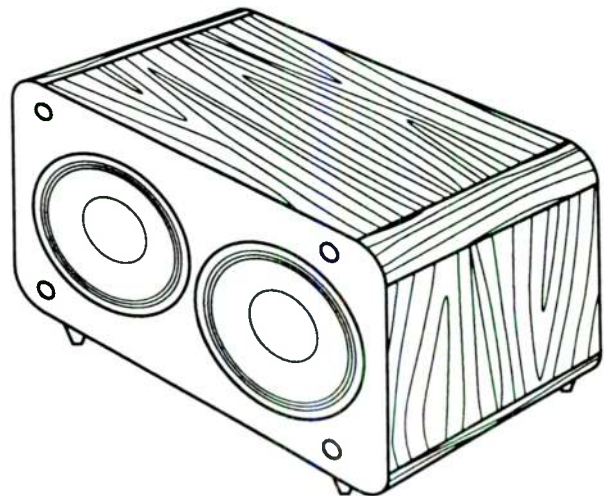

MENISCUS

2575 28th St. S.W. #2
Wyoming, MI 49509
(616) 534-9121
Fax (616) 534-7676

Make your day - order one today!

MORE ABOUT THE BIRDHOUSE BANDPASS

By G.L. Augspurger

In *SB 2/94* ("The Birdhouse: A Sound Reinforcement Subwoofer," p. 36) Matt Federoff details an unusual bandpass design. After a quick glance at the article my reaction was, "This can't be right."

The article describes a tandem, double-tuned bandpass system with a 105-liter chamber tuned to 90Hz and a 65-liter chamber tuned to 30Hz. To the best of my knowledge this is a first. Commercial tandem designs always tune the smaller chamber to the higher frequency. The original Bose patent (4,549,631) sets forth a preferred range of resonance frequencies as

1.5:1 to 2:1, with corresponding subchamber volumes of 1:2 to 1:4.

The author apparently obtained his published response curve from Bullock's bandpass program. I ran a quick simulation with my own computer model and got an almost identical curve (*Fig. 1*). My model also confirms that output in the passband is almost 5dB greater than the rated sensitivity of the woofer.

WHAT'S GOING ON HERE?

The overlaid impedance and cone excursion curves give a hint, but it took several addi-

tional computer comparisons before the situation became clear.

Let's start with the basics. A good first step in synthesizing a double-tuned bandpass system is to find a practical vented box alignment for the loudspeaker in question. *Figure 2* shows 1W, 1m response of the PS-15C woofer in a 250-liter box tuned to the speaker's free-air resonance of 35Hz. Low frequency output is about 95dB with the -3dB frequency at vent resonance.

To transform this box into a double-tuned bandpass system with a comparable low-fre-

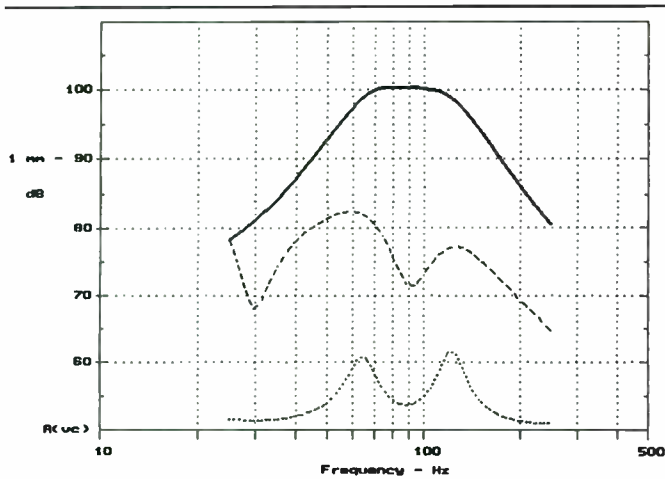

FIGURE 1: PS-15C in 65/105 liter Federoff bandpass box.

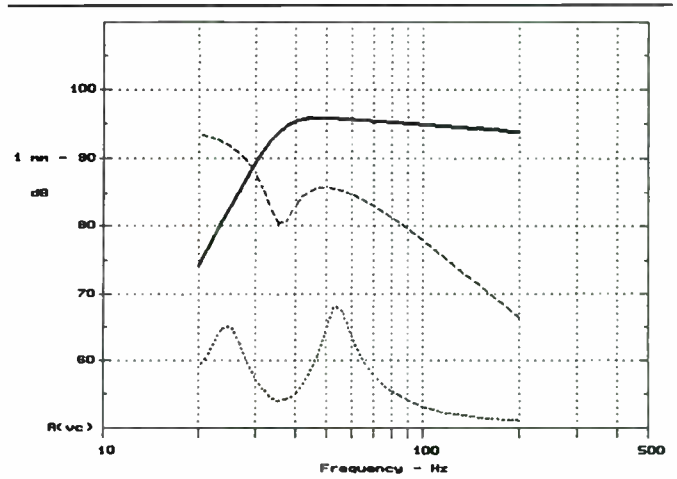

FIGURE 2: PS-15C in 250-liter, 35Hz vented box.

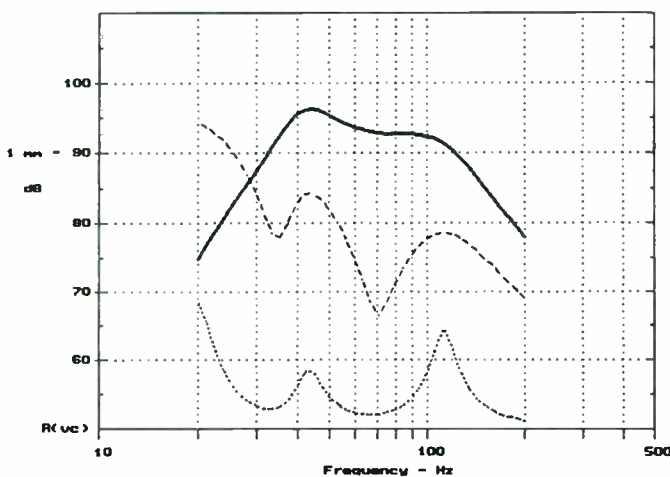

FIGURE 3: PS-15C in 65/185 liter double-vented bandpass box.

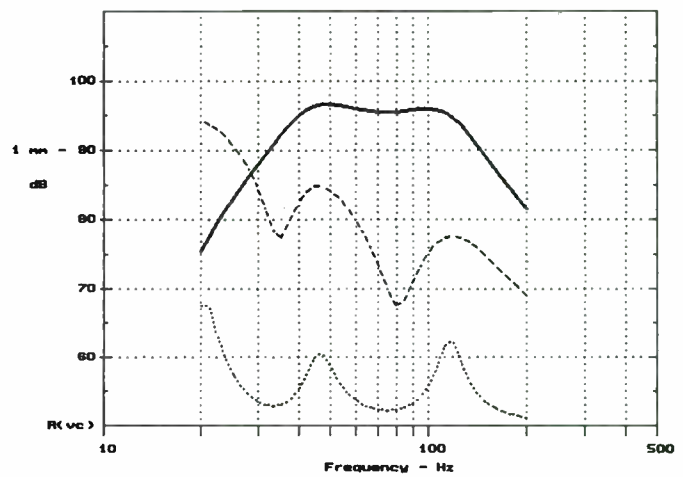

FIGURE 4: PS-15C in 70/180 liter double-vented bandpass box.

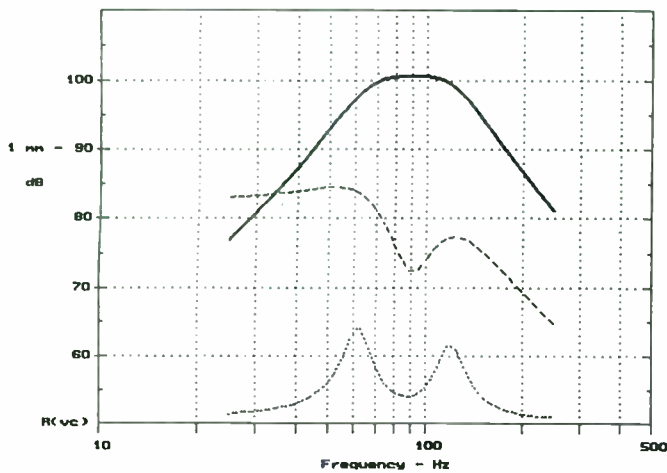

FIGURE 5: PS-15C in 65-105 liter sealed-vented bandpass box.

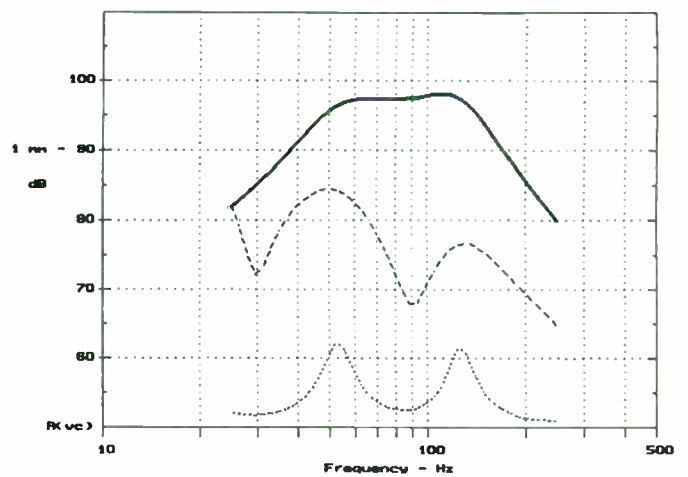

FIGURE 6: PS-15C in 65-105 liter reverse-tuned Federoff bandpass box.

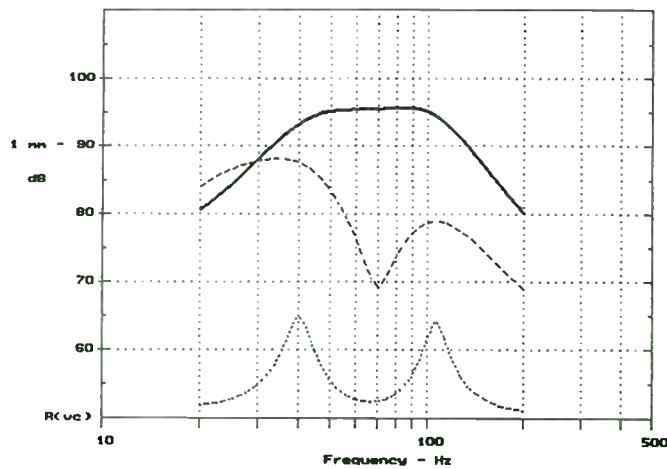

FIGURE 7: PS-15C in 80/170 liter Federoff bandpass box.

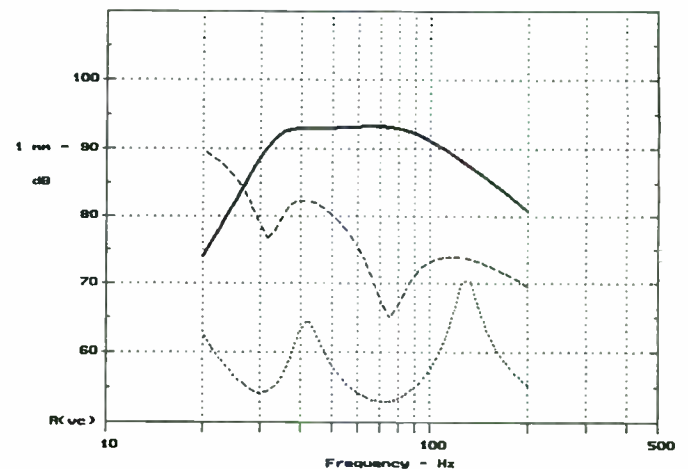

FIGURE 8: JBL E140 in 35/135 liter double-vented bandpass box.

quency band edge, we can divide the box into 65- and 185-liter subchambers, a ratio of roughly 3:1. Keeping the lower vent resonance at 35Hz, you can then tune the smaller chamber an octave higher. *Figure 3* shows the predicted result...not great, but not bad for starters. A little more twiddling with computer models suggests that a better subchamber ratio is 70 liters and 180 liters, which delivers a nearly symmetrical bandpass curve about 1.5 octaves wide centered near 70Hz (*Fig. 4*).

Not satisfied with these figures, Mr. Federoff wished a super-punchy system with response maybe an octave wide centered at about 90Hz. His starting point was the single-tuned, sealed-vented bandpass system

analyzed by Margerand. With a 65-liter sealed chamber and a 105-liter-vented chamber tuned to 90Hz, such a system delivers the performance of *Fig. 5*. Hmm, the only real difference between this and *Fig. 1* is reduced cone amplitude below 60Hz because of the clamping effect of the second vent.

THE DESIGN IN QUESTION

The Federoff "Birdhouse" functions as a hybrid system, with one port delivering useful sound and the other controlling out-of-band cone excursions. In other words, an original design ideally suited to the author's requirements.

His system has another interesting property.

The computer model predicts that somewhat broader bandwidth with correspondingly less efficiency will result from simply reversing the tuning frequencies, as in *Fig. 6*.

Although Federoff's design offers the advantage of controlled cone excursion, anyone wishing to build such a system is advised to omit the second vent for two reasons: First, you can use Margerand's published tuning alignments (*SB 6/88* and *1/89*, "The Third Dimension: Symmetrically Loaded, Parts I and II"); and second, the sealed-vented bandpass configuration is in the public domain. A double-vented system, on the other hand, no matter how the vents are tuned, may be an

ABOUT THE AUTHOR

George L. Augspurger is the author of numerous articles and technical papers. He also contributes regularly to the *Patent Reviews* published by JASA and reprinted by JAES. Mr. Augspurger is a member of the Acoustical Society of America, United States Institute for Theatre Technology, and a fellow of the Audio Engineering Society. Formerly with James B. Lansing Sound, Inc., Mr. Augspurger devotes his full time to Perception Inc., a consulting office specializing in architectural acoustics and sound system design.

About the Figures

Acoustic output, cone excursion, and relative impedance are plotted logarithmically on each graph.

The dark, heavy curve represents one-watt, one-meter response with standard (hemispheric) acoustic loading.

The dotted curve near the bottom of each graph is impedance relative to voice-coil resistance. For example, a point 6dB above

the bottom of the graph is twice the DC resistance of the voice coil, a point 10dB above the bottom is 3.15 times DC resistance, and so on.

The dashed curve shows one-watt cone excursion. 90dB is equivalent to one millimeter peak excursion, or 2 mm peak-to-peak. A point at 82dB is therefore 6dB below 1 mm, or 0.5 mm.

A Quality Texture Look

Without Laminating Costs and Labor!

Designed For Use On Speaker Cabinets

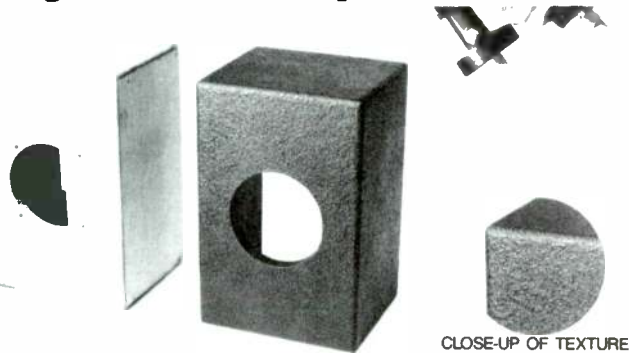

RESTORES OLD WORN OUT SURFACES

TEXTURELAC Spray finish produces a three-dimensional look that resembles a pebble, stucco or leather texture. It can be handled within 15 minutes of spraying and eliminates most sanding, spackling or extra paint operations. Dries to a hard mar-resistant and washable finish.

—Can reduce production spray room material and labor costs by 70 percent or more—

TEXTURELAC Is formulated for use on all wood, and composition woods, plastics and metal castings. It is available in most colors.

For a trial order or swatch panel of **TEXTURELAC** with descriptive literature call or write:



Abilene Research and Development Corp.

PO Box 294, Hewlett, NY 11557 • (516) 791-6943 • FAX (516) 791-6948

Reader Service #33

infringement of the Bose patent (Page 9 for a related editorial.)

A HAPPY WOOFER

For hi-fi or home theater applications, the low-frequency cutoff should be lowered still farther to about 35Hz. To keep the PS-15C happy, a larger box is required. *Figure 7* shows a 250-liter hybrid system with an 80-liter chamber tuned to 70Hz and a 170-liter chamber tuned to 15Hz. Again, the lower vent resonance only affects cone excursion and can be omitted.

As a useful comparison, *Fig. 8* shows the theoretical performance of a "Bose-type" double-vented system operating over roughly the same range from 35–100Hz. A more efficient loudspeaker such as a JBL E140 can deliver similar bandwidth and efficiency in a 170-liter box because both vents contribute useful output. The situation is analogous to the efficiency difference between corresponding sealed and vented box alignments.

As Matt Federoff emphasizes, if you want to play with bandpass response analysis you need a good computer modeling program. However, by using the information in his manuscript and then interpolating between the systems described here, you should achieve a variety of useful bandpass outputs from the PS-15C woofer.

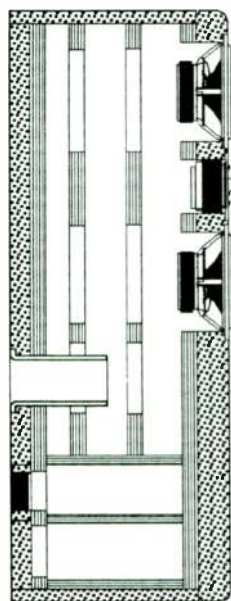

Rhythm

The most refined full range loudspeaker kit ever offered to the audiophile. Made in the USA of US and Danish components and featuring:

- **SCAN-SPEAK** D2905 1" Fabric Dome Tweeter.
- **SCAN-SPEAK** 18W/8544 7" Kevlar® Woofers.
- **SPRAGUE** High Frequency Metallized Polypropylene Film Capacitors.
- **Ultra-CAP** Bypass Capacitors.
- **OHMITE** 1% Precision Power Resistors
- **10 AWG Music Coil** Hex-Laid Inductors.
- All crossover components **hand matched to 1%**.
- QB3 Partition Vented, Aperiodically Braced Cabinet with 2¼" Composite Front and 2" Rear.
- Sand-Filled lower chamber.
- External, independently housed crossover.
- Frequency response: 57 Hz - 20 kHz ± 3 dB.
- Sensitivity: 89.5 dB, 2.83V, 1m in 4π.
- Available as a **Woodworker's Kit**, with pre-veneered cabinet flats, or as a **Complete Kit**.

For a complementary copy of our complete catalog, including drivers, crossover components, cabinets, stands, cables, accessories, publications, and **all 10** of our High Performance Loudspeaker Kits, please give us a call or drop us a line.

North Creek Music Systems

PO Box 1120, Old Forge, NY 13420
Voice/Fax (315) 369-2500.

Reader Service #17

\$2.00 FOR FREE!

PLUS

**Old Colony Sound Lab's
1994 CATALOG
ON DISK!**

If you are a subscriber to *Speaker Builder*, in the near future you will automatically receive a copy of Old Colony's 1994 catalog of great audio products—books, kits, components, software, test CDs, cable, accessories, and much more!

HOWEVER, if you would like to get your catalog now

— instead of in a month or two —

JUST SEND US \$3.00!*

We'll send YOU our new catalog on IBM 5¼" DS/HD or 3½" DS/DD disk (please specify) PLUS an Old Colony credit for \$2 MORE THAN YOU SEND!

SO, ACT TODAY

TO SEE OUR GREAT

NEW PRODUCTS TOMORROW!

OLD COLONY SOUND LAB

PO Box 243, Dept. B94

Peterborough NH 03458 USA

(603) 924-6526 FAX (603) 924-9467



Check or money order in US funds drawn on US bank, Mastercard, Visa, or Discover.

*\$5.00 from outside the USA. Price includes postage. Credit card orders must total at least \$10.00 to avoid service fee.

Reader Service #8

Vifa and Madisound Introduce a New Standard of Autosound Woofers

8" WOOFER

vifa

M22WR-19-04

Special Features:

- Long Stroke, Low Reflexion, Magnesium Basket
- Very Stiff Paper Cone
- Low Damping Rubber Surround
- Magnet system with 2" VC and Large Vent
- Optimized as Car Subwoofer

Price \$60.00

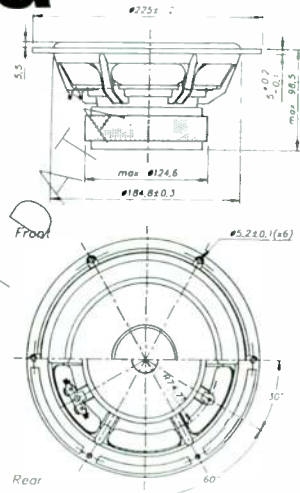

Nominal Impedance [ohm]	4
Nominal Power (IEC 268-5) [W]	150
Music Power (DIN 45500) [W]	200
Frequency Range [Hz]	45-1000
Sensitivity (1W,1m)/(2,83V,1m) [dB]	85/88
Effective Cone Area [sq.cm]	224
Voice Coil Resistance [ohm]	3.2
Voice Coil Inductance [mH]	0.9
Operating Power [W]	12.6
Voice Coil Diameter/Height [mm]	50/19
Air Gap Height [mm]	8
Moving Mass (incl. Air) [g]	35
Free Air Resonance [Hz]	48
Force Factor, B*1 [T*m]	6.4
Magnet Weight [g]/[oz]	1062/37.4
Qms	3.44
Qes	0.87
Qts	0.70
Vas [ltr]	20

8" WOOFER

vifa

M22WR-29-04

Special Features:

- Double 2" Voice Coil in Large Vented Magnetsystem
- Long Stroke, Low Reflexion, Magnesium Basket
- Very Stiff Paper Cone
- Low Damping Rubber Surround
- Optimized as Car Subwoofer

Price \$63.00

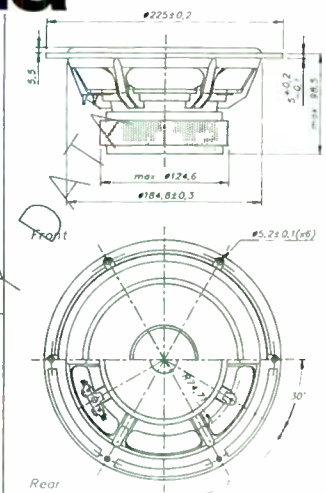

Nominal Impedance [ohm]	4
Nominal Power (IEC 268-5) [W]	150
Music Power (DIN 45500) [W]	200
Frequency Range [Hz]	45-500
Sensitivity (1W,1m)/(2,83V,1m) [dB]	84/87
Effective Cone Area [sq.cm]	224
Voice Coil Resistance [ohm]	3.4
Voice Coil Inductance [mH]	0.85
Operating Power [W]	16
Voice Coil Diameter/Height [mm]	50/19
Air Gap Height [mm]	8
Moving Mass (incl. Air) [g]	42
Free Air Resonance [Hz]	47
Force Factor, B*1 [T*m]	6.9
Magnet Weight [g]/[oz]	1062/37.4
Qms	3.70
Qes	0.81
Qts	0.66
Vas [ltr]	19

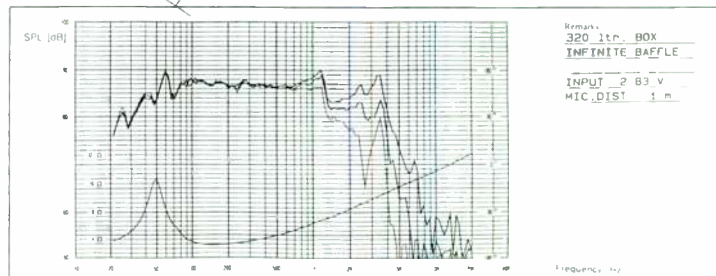
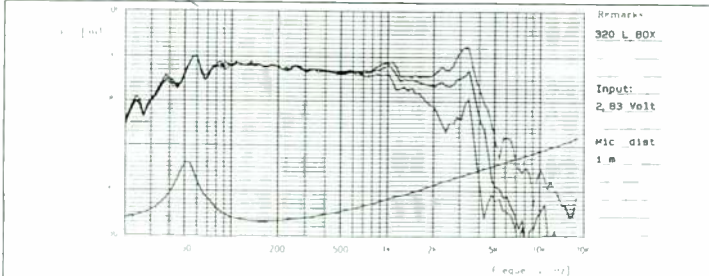

10" WOOFER

vifa

M26WR-19-04

Special Features:

- Long Stroke, Low Reflexion, Magnesium Basket
- Very Stiff Paper Cone
- Low Damping Rubber Surround
- Magnet system with 2" VC and Large Vent
- Optimized as Car Subwoofer

Price \$68.00

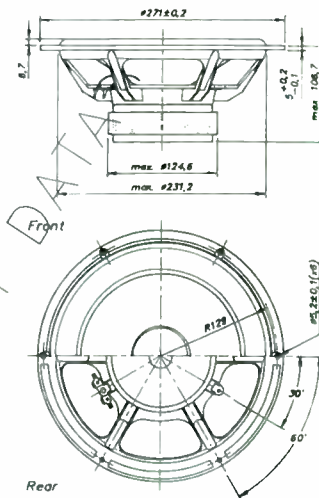

Nominal Impedance [ohm]	4
Nominal Power (IEC 268-5) [W]	150
Music Power (DIN 45500) [W]	200
Frequency Range [Hz]	40-1000
Sensitivity (1W,1m)/(2,83V,1m) [dB]	87/90
Effective Cone Area [sq.cm]	337
Voice Coil Resistance [ohm]	3.2
Voice Coil Inductance [mH]	0.95
Operating Power [W]	8.1
Voice Coil Diameter/Height [mm]	50/19
Air Gap Height [mm]	8
Moving Mass (incl. Air) [g]	41
Free Air Resonance [Hz]	44
Force Factor, B*1 [T*m]	6.4
Magnet Weight [g]/[oz]	1062/37.4
Qms	3.65
Qes	0.84
Qts	0.69
Vas [ltr]	53

10" WOOFER

vifa

M26WR-29-04

Special Features:

- Double 2" Voice Coil in Large Vented Magnetsystem
- Long Stroke, Low Reflexion, Magnesium Basket
- Very Stiff Paper Cone
- Low Damping Rubber Surround
- Optimized as Car Subwoofer

Price \$71.00

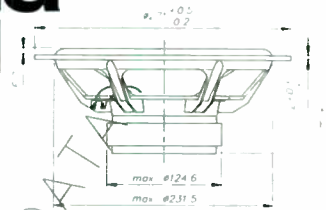

Nominal Impedance [ohm]	4
Nominal Power (IEC 268-5) [W]	150
Music Power (DIN 45500) [W]	200
Frequency Range [Hz]	40-500
Sensitivity (1W,1m)/(2,83V,1m) [dB]	86/89
Effective Cone Area [sq.cm]	337
Voice Coil Resistance [ohm]	3.4
Voice Coil Inductance [mH]	0.88
Operating Power [W]	10
Voice Coil Diameter/Height [mm]	50/19
Air Gap Height [mm]	8
Moving Mass (incl. Air) [g]	50
Free Air Resonance [Hz]	40
Force Factor, B*1 [T*m]	6.9
Magnet Weight [g]/[oz]	1062/37.4
Qms	4.08
Qes	0.80
Qts	0.67
Vas [ltr]	55

Ordering Information: All speaker orders will be shipped promptly, if possible by UPS. COD requires a 25% prepayment, and personal checks must clear before shipment. Add 10% for shipping charges. Residents of Alaska, Canada and Hawaii, and those who require Blue Label air service, please add 25%. There is no fee for packaging or handling, and we will refund or bill you to the exact shipping charge. We accept Mastercard or Visa on mail and phone orders.



Madisound Speaker Components
 (8608 University Green)
 P.O. Box 44283
 Madison, WI 53744-4283 U.S.A.
 Voice: 608-831-3433
 Fax: 608-831-3771

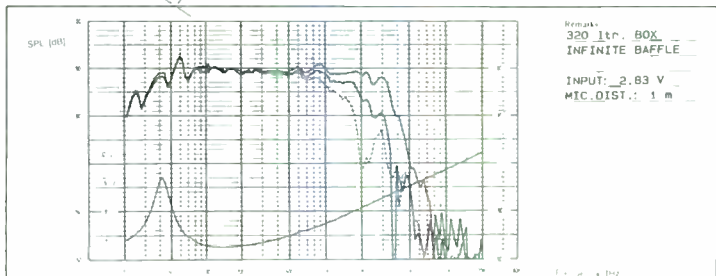
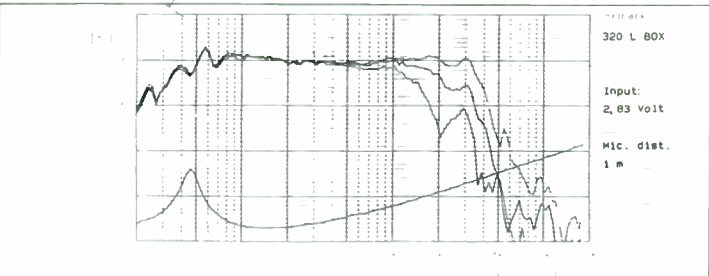

A 16HZ SUBWOOFER

By Charles T. Pike

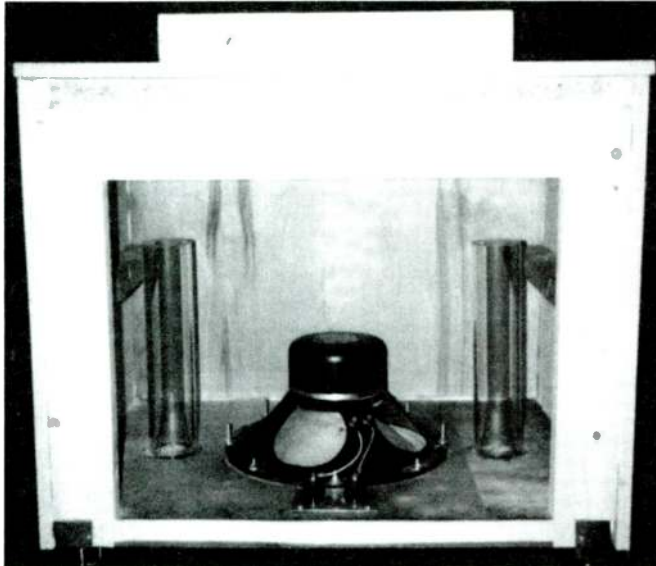

PHOTO 1: Loudspeaker box with back panel removed.



PHOTO 2: Bottom view of enclosure (mounted on casters) showing the placement of two ducts in relation to driver.

Ever since I became interested in audio, I've wished to build a speaker system to realistically reproduce the lowest notes (16Hz frequency) of the 32-foot stop of a pipe organ. Using loudspeaker drivers mounted in an infinite baffle or sealed enclosure, you would require too many 15" or 18" drivers capable of large excursions, however, to achieve flat response to 16Hz at realistic volume levels. I needed an alternative to this conventional, but expensive and bulky, approach.

If you tune a vented enclosure to the lowest frequency to be reproduced, the port will

radiate most of the sound, and cone excursion will be greatly reduced. The price you'll pay for arbitrarily choosing the box tuning frequency is uneven frequency response.

Figure 1 shows a 15" woofer's frequency response (tuned to 13Hz and calculated with the QUICK BOX computer program) in a 10 ft³ vented enclosure. The frequency response rolls off at about 3dB/octave below 300Hz. Since this rolloff can be electronically corrected, however, the maximum SPL produced is more important. Figure 2 shows the maximum SPL calculated using the BOXRESPONSE computer program and predicts that an SPL of 100dB can be produced at 16Hz (which is adequate for satisfying reproduction).

A SOLUTION UNFOLDS

I used a 15" Goodmans Audiom 955 woofer, which I purchased 30 years ago. At the end of the article I suggest a currently available alternative driver which should work as well or better than the Goodmans. Figure 3 depicts an impedance curve of the Goodmans driver, while Table 1 lists the Thiele/Small parameters for this woofer calculated using the formulas in Vance Dickason's *The Loudspeaker Design Cookbook (LDC)*.¹

The V_{AS} was calculated from the compliance, which I determined by measuring the displacement of a small weight on the speaker cone. The measured frequency of the 32Hz impedance peak in the final enclosure and the BOXRESPONSE calculation confirmed the accuracy of these numbers. The speaker's free

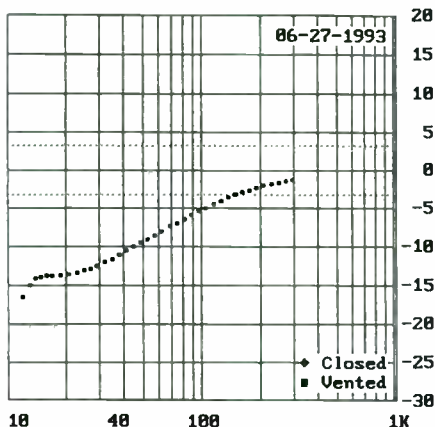

FIGURE 1: Frequency response of 15" woofer in 10 ft³ box.

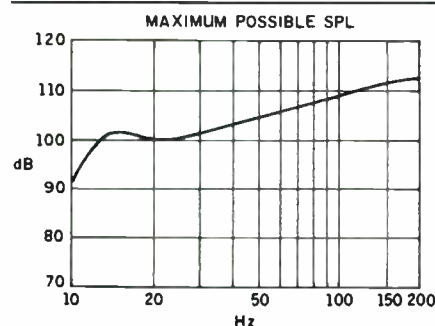

FIGURE 2: Maximum SPL produced by 15" woofer in 10 ft³ box.

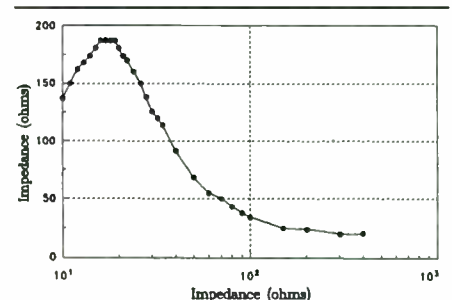

FIGURE 3: Impedance curve for Goodman's 15" woofer.

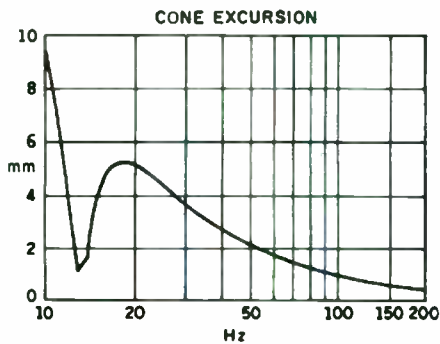

FIGURE 4: Cone excursion for 15" woofer.

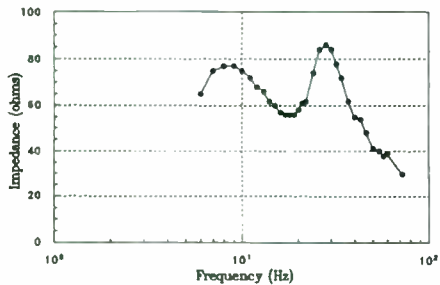

FIGURE 5: Impedance curve for 15" woofer in lossy box.

air resonant frequency was originally 25Hz, but the suspension has loosened over the years and reduced it to the present value of 16Hz.

I used these parameters to determine the results of Figs. 1 and 2. In Fig. 4, which shows

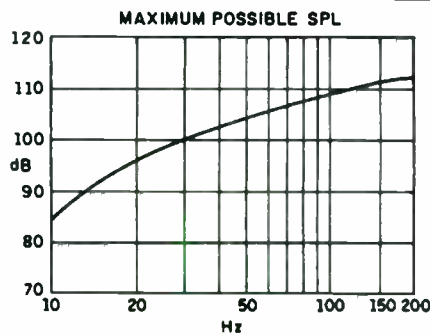

FIGURE 6: Effect of losses on maximum SPL.

the BOXRESPONSE cone excursion results, the peak cone excursion of about 5mm is well within the limits of the cone suspension.

I originally mounted the woofer in a cabinet formed by enclosing the space under the stairs leading to my family room. After I installed the woofer, I measured the impedance as a function of frequency, but no peak due to the vent tuning was evident. Air leaks severely reduced the QI of the cabinet. I crawled inside the cabinet with a caulking gun and a roll of duct tape to seal every crack and opening I could reach. Figure 5 shows the improvement.

Using the formulas in the LDC and the Mathcad computer program, I calculated the value of QI as a disappointing 1.4. Figure 6 shows the maximum SPL reduced by about 9dB at 16Hz from the value in Fig. 2, which

PARTS LIST

SUBWOOFER ELECTRONIC CROSSOVER

REF	DESCRIPTION
Capacitors	
C1-C8	100N 5%, 50V film
C9	2,200µF, 35V aluminum electrolytic
Resistors	
R1, 4, 5, 10, 13	82.5k 1% ¼W metal film resistor
R2, 11	7.5k 1% ¼W metal film resistor
R3, 6, 7, 12, 15, 16	39.2k 1% ¼W metal film resistor
R8, 17	49.9Ω 1% ¼W metal film resistor
R9, 18	1k 1% ¼W metal film resistor
R19	1.6k 5% 1W carbon
R20	100k 1% ¼W metal film resistor

Semiconductors

U1	TL074CN
U2	TIP120
D1	1N4148
D2	1N4001
Z1	1N5338

Miscellaneous

K1A,B,C	Relay, 2PDT, 24V coil (see text)
	Perforated circuit board
	Gold-plated phono connectors
	±15V regulated power supply
	Chassis box

was calculated assuming a combined Q of 33. I realized that the only way to get good performance was to build a separate enclosure for the subwoofer.

THE PLAN

To achieve a high QI, your loudspeaker enclosure must be free of air leaks, the walls

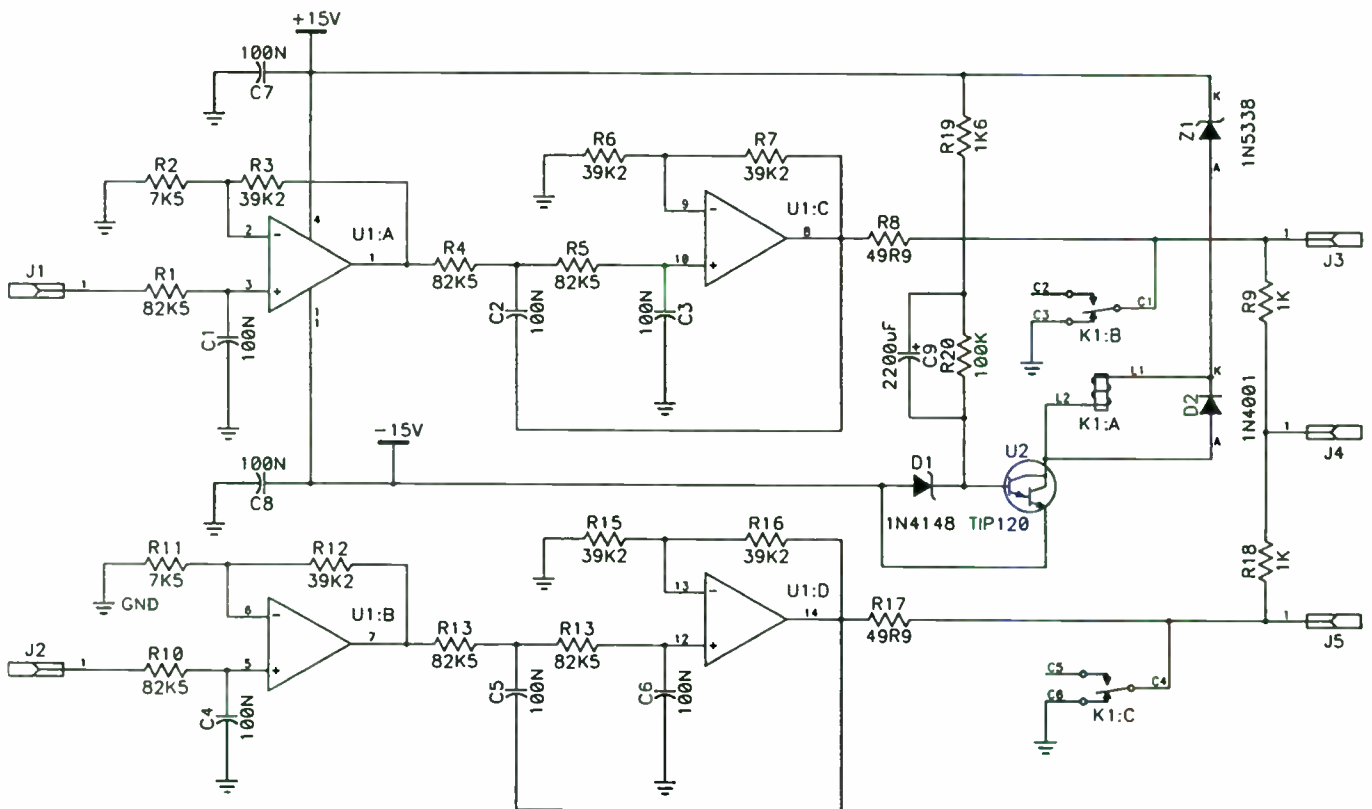

FIGURE 7: Schematic of electronic crossover.

must be rigid, and no damping material should be used. The lowest major box resonance occurs at a frequency with a wavelength twice the longest box dimension. In my design the lowest resonance happens at about 200Hz, which is well above the recommended crossover frequency. Therefore, I don't need to include damping material to control cabinet resonances.

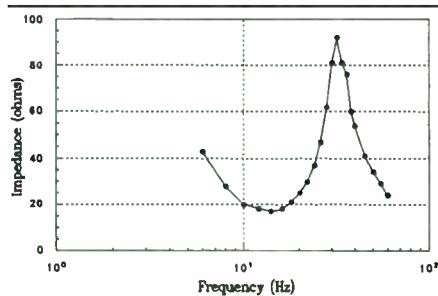

FIGURE 8: Impedance of final system.

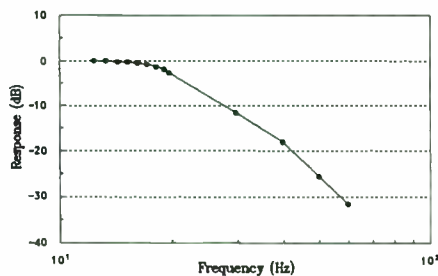

FIGURE 9: Frequency response of electronic crossover.

Using the "alignment" suggested in this article, you will reduce system efficiency when you decrease the volume of the enclosure. Also, you will require a longer tuning duct, which will be more difficult to fit inside the box. I chose a 10 ft³ volume as a compromise between efficiency and size. The overall outside dimensions of the cabinet are 33.5" long by 27.5" deep by 26.5" high—small enough to fit through a normal doorway and, since it is mounted on 2" casters, easy to move. The casters space the bottom of the cabinet 2.5" from the floor, making the total height 29"—a convenient level for use as a table.

To ensure rigidity, I constructed the top, bottom, and front of the cabinet from a 1.75" thick exterior or "solid core" door, which had served as our kitchen table for many years. The other three walls are constructed of 0.75" particleboard braced with an edge-mounted 2 × 3 across the middle of the ends and a similarly mounted 2 × 4 on the back. Since the door's core is a sawdust and glue mixture, which has a porous surface, I used RTV silicone rubber to cement all joints for air tightness. Also, to get a good grip in the door, I used 3.5" deck screws to hold the joints together.

Use 2 × 4s to frame the opening for the

removable back panel as shown in *Photo 1*. The back panel on top of the enclosure in *Photo 1* shows the position of the 2 × 4 stiffening cleat. I centered the driver face down in the cabinet's bottom panel to take advantage of room boundary coupling. You can do this without worrying about diffraction because the frequencies the loudspeaker is handling are larger than the thickness of the panel. At 40Hz the sound wavelength (at sea level) is about 28', or almost 200 times the panel thickness.

To tune the cabinet to 13Hz, I installed two ducts—with an inside diameter of 2.75" and a 0.25" wall thickness—on each side of the driver (*Photo 2*). I rounded the ends of each 16"-long plastic tube to a radius equal to the tube's wall thickness. The subwoofer is free of any "chuffing" noises even when driven at high levels at subaudible frequencies.

The input connectors are Superior Electric Co., 50 amp Supercon connectors, which some readers may consider overkill, but unlikely to ever cause any problems. I finished the enclosure by covering it with charcoal gray cabinet carpet cemented in place with a multipurpose floor covering adhesive.

A HANDY SAFETY PRECAUTION

I designed the electronic crossover (*Fig. 7*) with the aid of the *Active-Filter Cookbook*.² It is an 18dB/octave low-pass filter, which is 3dB down at 20Hz. Since the first op amp stage in most designs serves as a buffer for a passive 6dB/octave filter section, you can easily modify this design by adding R2, R3, R11, and R12 to bring the subwoofer output up to the level of other loudspeakers. I've provided two inputs, J1 and J2, for the right and left channel stereo signals. The corresponding outputs for driving a pair of subwoofers are J3 and J5. The outputs are summed using the 1k resistors, R9 and R18, and connected to J4 for driving a single subwoofer.

Since operational amplifiers' output can fluctuate widely on turnoff, I have provided a simple protection circuit to prevent damaging your amplifiers or speakers. When you turn on the power, the Darlington transistor, U2, turns on by the current through the 1.6k resistor, R19, and the capacitor, C7. When the voltage is high enough, relay K1 is pulled in and the outputs are active. Capacitor C7 then charges up almost to the 30V difference between the supply rails, and U2 stays turned on by the current through the 100k resistor, R20.

When you turn off the power, the rail voltage drops, and U2 turns off almost immediately by C7, which has a time constant of 220s in parallel with R20. Relay K1 then drops out and the outputs are shorted. I recommend, however, that you turn on the crossover before the subwoofer power amplifier and turn it off after the power amplifier is shut off.

Because of the protection circuit's sensitivity to voltage fluctuations, the power supply should be regulated. I have not included a schematic of the ±15V power supply, since many suitable designs have been presented in *TAA* and other resources. The electronic crossover should be preceded by a buffer with an output impedance of about 1k or less to avoid affecting the electronic crossover performance.

CROSSOVER CONSTRUCTION

I built the electronic crossover on a Radio Shack or Vector predrilled board with solder pads for mounting components. The latest version uses ¼W 1% metal film resistors for all resistors except R19, which is a 1W 5% carbon resistor. The capacitors, C1 to C8, are Panasonic P-series 2% tolerance polypropylene capacitors, and C9 is a 35V electrolytic. The quad op amp, U1, is a Texas Instruments TL074CN. The relay, K1, is 4PDT with gold-plated contacts and a 24V DC coil with a resistance of 650Ω (many manufacturers offer similar units). The input and output connectors are also gold-plated to avoid oxidation. The straightforward layout should present no problem for experienced amateurs.

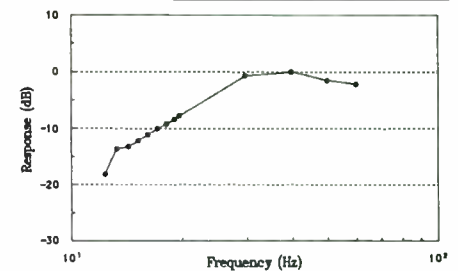

FIGURE 10: Frequency response of final system without electronic crossover.

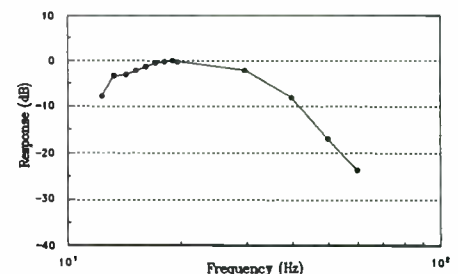

FIGURE 11: Frequency response of final system with electronic crossover.

TESTING

I used the following test equipment: a modified Hewlett-Packard Model 200 audio oscillator calibrated with a Continental Specialties Model 5001 counter-timer in the period mode; the AC millivoltmeter section of a Heathkit Model IM-22 Audio Analyzer; a Triplet Model 650-SC AC voltmeter, which was calibrated at 60Hz by a Keithley Model 130 digital multimeter; a Radio Shack sound level meter (cat. no. 33-

ZALYTRON

SPECIALS FROM FOCAL

How can one be sure to please his customers? It's very simple: you go to the best supplier of the highest quality drive units, you offer him a deal that he cannot refuse, you work the technical with the best people in the business, and you put your money where your mouth is. That's exactly what we did: we went to Focal, asked Kimon Bellas to work the technical details and made a deal on a large volume of a special order for Zalytron.

So What do we have here?

- **FOCAL tweeter:** T120 ZLT fiberglass inverted dome with foam suspension, massive magnet with double back plate, and dual vent.
- **4" FOCAL midrange:** 40111, cast frame, curvilinear profile impregnated paper cone, rubber surround, super clean impulse, ideal from 250 Hz and up it goes to a real 10 KHz! Easy job on crossover.
- **4" FOCAL midbass:** 4C212, cast frame, semi exponential coated paper cone, negative rubber surround, sharp impulse here also, and real muscle too! Will work in 2-way + sub. Nice roll-off around 2-3 KHz.
- **6" FOCAL midbass:** 60211S, new low profile 6" frame, latex damped paper cone, Neoprene surround, 4 layers VC. Ideal for potent 2-way, easy to cross over.
- **7" FOCAL High efficiency midrange/midbass:** 7V513, cast frame, Polyglass cone with phase plug, coated foam surround. Edge-wound flat copper wire VC on Kapton former, massive magnet structure. An explosive high power midrange, more than 93 dB/W/m. Detailed and elegant it is the rare find for tube amp. aficionados!



4C111



6C211S

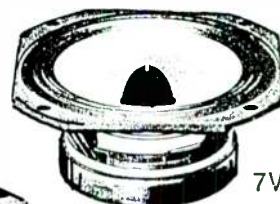

7V513



4C212



T120ZLT

	4C111	4C212	6C211S	7V513	T120ZLT
DCR	6.16	6.78	3.10	6.83	6.0
Fs	81.72	72.80	41.37	46.81	-
Qes	0.482	0.58	0.389	0.250	-
Qms	2.851	2.33	6.114	2.91	-
Qts	0.412	0.47	0.362	0.28	-
Vas (L)	4.14	4.82	29.92	33.81	-
L (mH)	0.24	0.48	0.5	0.55	-
dB/W/m	88.56	86.8	89.2	93.25	93.5
VC length	7.2	12.4	11.5	13	-
Gap height	5	4	4	6	-
PRICE	\$39	\$39	\$39	\$79	\$69

ZALYTRON INDUSTRIES CORP.
469 JERICHO TURNPIKE, MINEOLA, N.Y. 11501
TEL. (516) 747-3515 FAX (516) 294-1943

Our warehouse is open for pick-up 10AM to 6 PM daily, Monday thru Saturday
 UPS orders shipped same day • Minimum order \$50.00
WRITE OR CALL FOR ALL YOUR SPEAKER NEEDS OR INQUIRIES

TABLE 1

T/S PARAMETERS FOR GOODMAN'S AUDIOM 955 WOOFER

PARAMETER	VALUE	UNIT
f_s	16	Hz
V_{AS}	900	L
R_E	15	Ω
Q_E	0.1	
Q_M	1.2	
Q_{TS}	0.09	
Cone Area	730	cm^3
Efficiency	97.5	dB/W
Power Rating	50	W

2050); and a Panasonic WM-063T microphone cartridge in a home-built microphone.³ (Panasonic has since replaced the WM-063T with the WM-60AT.)

Figure 8 illustrates an impedance curve of the completed system. The 92 Ω impedance peak at 32Hz and the 17 Ω null (which approaches the driver's 15 Ω DC resistance) at the box tuning frequency of 13Hz indicate that the QI of the cabinet is high. Using BOXRESPONSE and inserting different values until I matched the measured impedance of 17 Ω at the box resonance, I estimated the value of QI to be 20. The formulas in *The Loudspeaker Design Cookbook* produced a value of about 15, so I was able to confirm my results. Figure 9 is the frequency response of

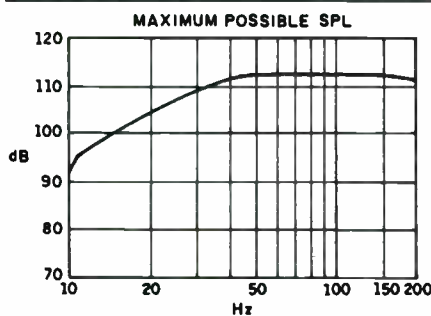

FIGURE 12: Maximum SPL for Radio Shack woofer in 10 ft³ enclosure.

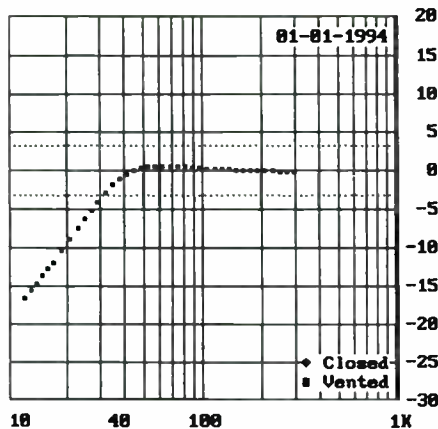

FIGURE 13: Frequency response of Radio Shack woofer in 10 ft³ enclosure calculated by QUICK BOX.

the electronic crossover, which agrees with the design predictions.

I measured the frequency response with both the home-built microphones using the Panasonic WM-063T cartridge and the Radio Shack sound level meter. The speaker input voltage was 5.7V RMS maximum, which is equivalent to 2W RMS into the loudspeaker's nominal 16 Ω impedance. I placed the microphones on the floor under the center of the speaker system. The Radio Shack meter response rolled off below 20Hz relative to the Panasonic cartridge.

After examining the Radio Shack meter schematic, I noted that a 1 μ F capacitor is used for interstage coupling to the 10k Ω resistance of the attenuator. This results in a high-pass filter characteristic, which is 3dB down at 16Hz and explains the difference in measurements.

Therefore, my measurements using the Panasonic cartridge are plotted in Fig. 10, which shows the system's frequency response without the electronic crossover. Although the slope of the rolloff is steeper than predicted, the total 13dB drop in output is about the same. When combined with the crossover response, the system is 3dB down at 15Hz and 35Hz, as shown in Fig. 11.

FEEL THE BEAT

While some may argue that it is impossible to reproduce frequencies with a wavelength longer than twice the largest room dimension, I have not found this to be true. Room modes will not enhance the output at these frequencies, but reproduction is still possible. During testing I found a 14Hz resonance in my house's structure, which caused the walls to shake and an outside door to rattle. Since the floor of my family room is a concrete slab, the energy which caused the walls to vibrate had to be acoustically coupled.

My listening material for testing included the CDs on the Dorian label by J. Guillou and on Telarc by M. Murray, and the recording of Saint-Saens' Symphony No. 3 on Philips #412 619-2 conducted by Edo de Waart with J. Guillou as organist. The subwoofer extended my system response to the lowest CD frequen-

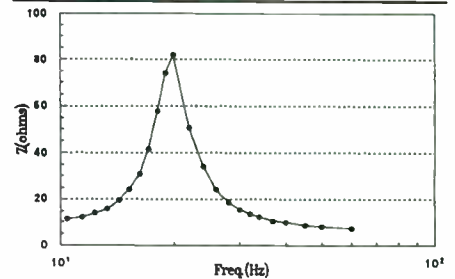

FIGURE 14: Measured impedance of Radio Shack #40-1301 woofer without enclosure.

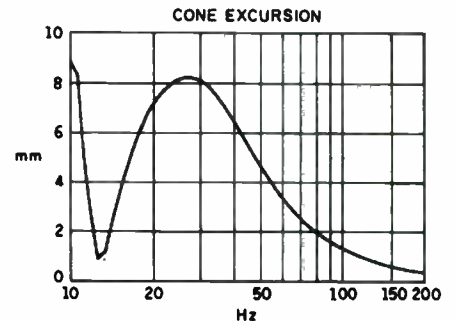

FIGURE 15: Peak cone excursion required by Radio Shack woofer calculated by BOXRESPONSE.

cies with room-shaking authority. No audible evidence of distortion was apparent; just clean, pure bass that I could feel as well as hear. The subwoofer also enhanced my enjoyment of laserdisc films such as "Last of the Mohicans," "The Empire Strikes Back," and "The Adventures of Baron Munchausen."

AN EXCELLENT ALTERNATE

Based on availability and the specifications listed in Table 2, I selected the Radio Shack 15" woofer catalog no. 40-1301 to test as an alternate to the Goodmans driver. I was particularly impressed with the X_{MAX} of 18mm (peak-to-peak), which is one of the highest values I have encountered. The maximum SPL this woofer generates using the suggested approach is approximately the same as the Goodmans woofer as calculated with BOXRESPONSE (Fig. 12). As shown in Fig. 13, the QUICK BOX-calculated frequency response—and, consequently, the perform-

TABLE 2

RS 40-1301 15" WOOFER SPECIFICATIONS

PARAMETER	DATA SHEET	MEASURED	UNITS
f_s	20	20	Hz
V_{AS}	594		
R_E	5.6	5.6	Ω
Q_E	0.485	0.45	
Q_M	6.45	6.1	
Q_{TS}	0.45	0.42	
X_{MAX} (peak-to-peak)	18		mm
Cone Area	856	856	cm^3
Efficiency	90	92 (calculated)	dB/W
Power Rating	100		W

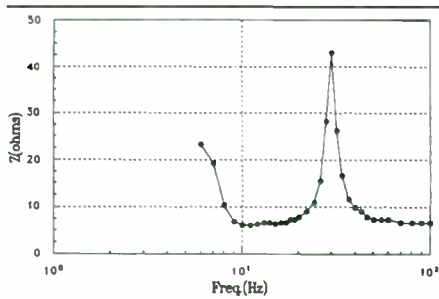

FIGURE 16: Measured impedance of Radio Shack woofer in subwoofer enclosure.

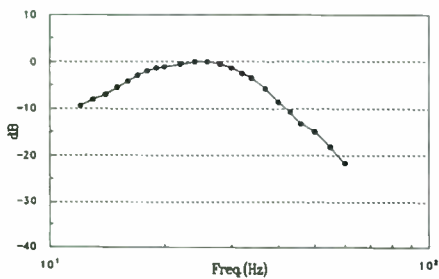

FIGURE 17: Measured frequency response of Radio Shack woofer in subwoofer enclosure.

ance—is similar to the measured response for the Goodmans woofer.

After purchasing the woofer, I measured the impedance as a function of frequency, as shown in Fig. 14. I then calculated the Q_{MS} and Q_{ES} and present them in Table 2. The similarity between my measured values and the Radio Shack values is excellent and probably within the experimental error of my measurements. Radio Shack has done an excellent job of quality control on this unit. Figure 15 shows that the required peak excursion is less than the 9 mm peak excursion limit of the Radio Shack woofer.

Since the Radio Shack woofer has a slightly larger cone than the Goodmans woofer and

requires a 14" baffle hole rather than 13", I fabricated an adapter flange with a 14" hole from 3/4" plywood. Figure 16 depicts an impedance curve of the subwoofer with the Radio Shack woofer installed. By substituting values into the BOXRESPONSE until I matched the 43Ω impedance peak, I estimated a Q of 8 for the enclosure. Although the Q is lower than with the Goodmans woofer, the maximum SPL of 100dB at 16Hz matches.

I measured the frequency response, shown in Fig. 17, using the same conditions and equipment as used for the Goodmans woofer. At 16Hz the response is down 4dB, which is excellent performance considering that the

Radio Shack woofer costs less than what I paid for the secondhand Goodmans woofer 30 years ago.

CONCLUSION

I have presented a general approach to the design of subwoofers capable of reproducing the lowest octave of the audio spectrum at realistic levels in a home environment. The design includes an enclosure tuned to the lowest frequency to be reproduced and an electronic crossover to flatten the frequency response. Although I refer to two specific design examples, you could use this approach to extend the bass response of a variety of drivers. ▶

SPEAKER CITY, U.S.A.

vifa

excellence from Denmark

EXCLUSIVE

SOUTHERN CALIFORNIA DISTRIBUTOR

OTHER HIGH END LINES INCLUDE:

scan-speak

polydax
SPEAKER CORPORATION

FOTAL
technologie d'avant-garde

versa
ronics

DYNAUDIO®



**VIFA 8" TREATED
PAPER SUBWOOFER
M 22WR-09-06**

6Ω
150W RMS
88dB - 1W/1m
2" diameter VC

F_s - 30Hz
Q_{TS} - .33
V_{AS} - 55 L
Freq. range 30Hz - 1kHz



115 S. Victory Blvd., Burbank CA 91502
(818) 846-9921 FAX (818) 846-1009

**CALL
FOR
PRODUCT
AVAILABILITY**

SOURCES

Mathsoft, Inc.
201 Broadway
Cambridge, MA 02139
Mathcad

Old Colony Sound Lab
PO Box 243
Peterborough, NH 03458
QUICK BOX, BOXRESPONSE, The Loudspeaker Design Cookbook, Active-Filter Cookbook, Mitey Mike test microphone

REFERENCES

1. V. Dickason, *The Loudspeaker Design Cookbook*, (The Marshall Jones Co., 1987; Audio Amateur Press, 1991).
2. D. Lancaster, *Active-Filter Cookbook*, (Howard W. Sams & Co., 1975).
3. J. D'Appolito, "Mitey Mike: For Loudspeaker Testing," *SB* (6/90): 10ff.

Reader Service #27

Speaker Builder / 4/94 31

Wayland's Wood World

BISCUIT JOINTS

By Bob Wayland

All too often, we try to make screws correct for poor craftsmanship and planning when we make enclosures. Shoulders aching and hands sore, we leave unsightly screw heads and plugged holes, most evident in exposed corner joints. As I mentioned in my column on power tools (*SB* 2/93, p. 54), biscuit joiners are a wonderful and easy way to make joints. Let's explore this topic in a bit more detail.

A biscuit joiner is essentially a small motor with a right-angle drive coupled to a 4" saw blade, which makes a shallow cut on each side of the pieces to be joined. This cut accepts a flat, football-shaped biscuit of compressed birch. When the biscuit is inserted into the glue-filled cut, it quickly swells to form an incredibly strong bond. If you start gluing soon after making the biscuit cut, your joint will be stronger ("Sticking Together," *SB* 2/94, p. 46). You can easily make adjustments for perfect alignment before the glue sets.

When purchasing a biscuit joiner, consider one of the newer designs featuring a rugged front fence that can be accurately aligned and

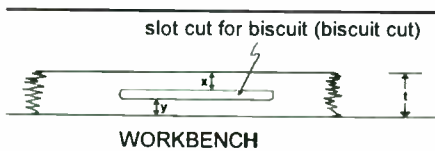

FIGURE 1: Centering your cut.



PHOTO 1: Standard-size biscuits for use with biscuit joinery.

will hold your settings without the need of extra clamps. Expect to pay about \$200. A useful additional feature is a dust/chip catcher. These little devils can produce prodigious quantities of chips. A number of woodworker supply houses offer a 12-tooth blade to replace the standard 6-tooth ones supplied with the joiners. The claim is that you get a cleaner cut.

The biscuits come in three different sizes (*Table 1; Photo 1*). If you're building several enclosures (or a large one), buy the biscuits in 1,000-piece lots. For the same price—about \$20 plus S&H—you can buy a mixed bag of 250-#0, 250-#10 and 500-#20. (You can also buy exotic special-order biscuits at a premium, without gaining any appreciable advantage.)

All the biscuits fit into the standard 5/32-inch-wide slot cut by the joiner. If the relative humidity in your area is consistently high, store the biscuits in zip-lock bags to slow the



PHOTO 2: Adjusting the depth of cut on the biscuit joiner.

absorption of moisture, and add activated charcoal for extra protection.

Before you start, set the depth of cut on the joiner. Then cut along the long dimension of

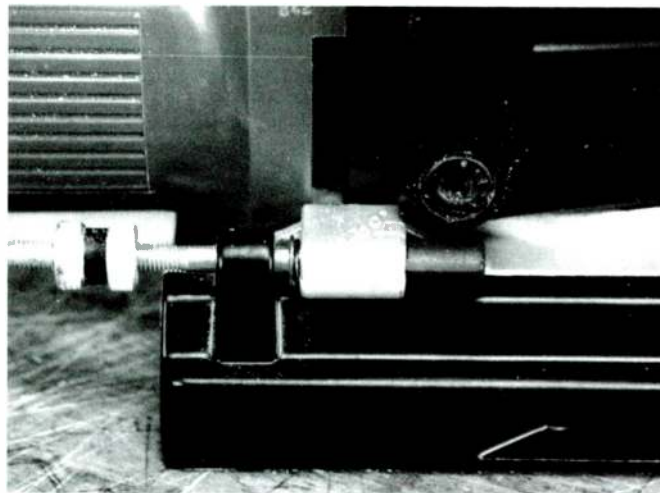

PHOTO 3: Biscuit-size adjustment on Freud JS100 Joiner.

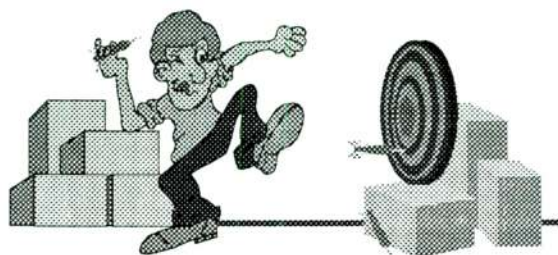

PHOTO 4: Adjusting to center the slot cut. Notice the clamps holding the fence firmly in place.

Technologie

MDB

Affordable Excellence from Canada



WANT TO IMPROVE YOUR CHANCES OF SUCCESS IN SPEAKER BUILDING?

Try the

LOUDSPEAKER DESIGN INFORMATION SERIES

Developed by Marc Bacon and published by Technologie **MDB** the LDIS is *the only speaker design course in the world that combines theory and hands-on practice in a structured series of topics.* It uses a combination of easy-flowing text, cassettes, FOCAL drivers, AXON crossover components, software, and experiments to teach the latest in speaker-building technology and sound reproduction techniques, yet requires only a basic knowledge of algebra as a prerequisite. Beginning in June 1994, the LDIS will be published eight times each year for a total of 24 units and will be revised every three years to ensure that it incorporates the industry's most recent developments. The writing style is aimed at beginners, yet the course contains a wide enough base of knowledge to satisfy the most seasoned audiophile. Course contents are given below:

Unit	Subject	Unit	Subject
1	Music, Physics, and the Perception of Sound	13	Determining Driver Parameters
2	Dynamic Loudspeakers, part 1 -- Woofers	14	Objective Measurement of Loudspeakers
3	Dynamic Loudspeakers, part 2 -- Midranges and Tweeters	15	Subjective Measurement of Loudspeakers
4	Low Frequency Analysis -- Closed Boxes	16	Architectural Acoustics
5	Low Frequency Analysis -- Vented Boxes	17	Professional Sound Systems -- part 1
6	Low-Frequency Analysis -- Passive Radiators	18	Professional Sound Systems -- part 2
7	Low-Frequency Analysis -- Bandpass Enclosures	19	Computerized Crossover and System Design
8	Low-Frequency Analysis -- TL's, Labyrinths, Aperiodic Devices and Horns	20	Surround Sound and Home Cinema
9	Cabinet Construction and Damping	21	Woodworking and Cabinetmaking
10	Mid and High-Frequency Enclosure Design	22	Advanced Speaker Design -- An introduction to active crossover theory
11	AC Circuit Analysis	23	Advanced Speaker Design -- Diaphragm Radiator Theory and Performance
12	Passive Crossovers and Response Shaping Circuits	24	Advanced Speaker Design -- Putting it all together. A rational design approach to achieving optimum performance in hobbyist or low volume production.

How to order:

Call our sales office to receive free information and an order form. Average cost is \$39.95 U.S. currency per unit. You will receive units as they are published, and may choose to stop at any time as required by your time or budget, then start again at will and work at the rate you choose until you catch up to publication dates. Those who complete all 24 units will receive a handsome personalized engraved plaque attesting to their achievement and the right to a 10% discount on all Technologie **MDB** products with **no limit on total amount** for six months from the date of completing the course.

Technologie MdB

Focal/Cabasse/Accuton/SEAS/Morci/SCR/Axon/Black Hole/Atelier Audio/Intertechnik/Top Box/Kits by Marc Bacon

Sales:

5445 de Lorimier, Suite 108, Montreal, Quebec H2H 2C3

Telephone: (514) 526-8851 9:00 A.M. to 5:00 P.M. EST

After-hours "hot line" (514) 891-6265 6:30-8:00 P.M. EST weekday evenings and 9:00-12:00 A.M. Saturdays

Administration and Engineering:

4000 Terrasse Jean XXIII St. Hubert, Quebec J4T 3L6

Fax: (514) 443-5485

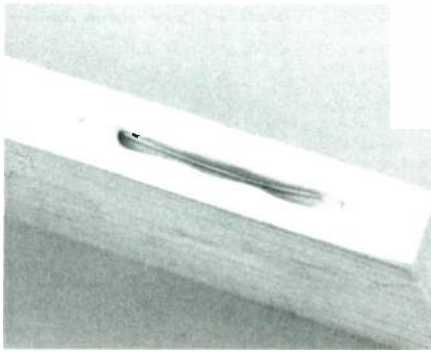

PHOTO 5: Proper amount of glue for a biscuit slot.

a #20 biscuit so that exactly one-half is left. Using this test biscuit as a gauge, adjust the joiner's depth of cut just a bit deeper than the half biscuit (Photo 2). Most machines have a stepped index to allow switching from one biscuit size to another without resetting the depth each time (Photo 3). Make a test cut and insert the test biscuit to make sure it just fits.

A FEW GOOD JOINTS

This column covers the two most commonly used joints for speaker builders: the edge-to-edge and butt joints. Once you have mastered these techniques, you'll be able to handle even the most difficult biscuit joinery.

All biscuit joiners have an indexing system that allows you to center your cut precisely. This is usually a clearly defined mark on the housing, both top and bottom and on the fence. To quickly cut only the slots needed, simply align these marks with marks on your work. The cutting is made by pushing the cutting head into the edge of the material. Quick and simple!

First, decide on the biscuit spacing along the joint. Place a biscuit at each end with its center line about 2" from the end, then space the remainder about every 6-8" between the two. For normal cabinet construction, this is good practice. Since the pressure levels generated within an enclosure impose special requirements, however, I normally leave a biscuit length between each.

Usually, there is never a whole number of biscuits' lengths along any joint and you will need to expand or contract the spacing as appropriate. Using a try-square or a framing square, draw a line perpendicular to the glue line at the midpoint of each biscuit. Don't fret about where the midpoint is; the main thing is that the line is in the same place on both sides of an aligned joint.

EDGE-TO-EDGE JOINTS

Set the fence to place the biscuit slot on the center line of your board's thickness. Here is another of woodworking's little secrets: if the cut is always relative to the same surface,



PHOTO 6: Spreading the glue in a slot with a palette knife.

TABLE 1
BISCUIT SIZES

SIZE #0	DIMENSIONS (in inches)
#0	1 ³ / ₄ × 5 ⁵ / ₈
#10	2 ¹ / ₈ × 3 ⁴ / ₄
#20	2 ³ / ₈ × 1

centering won't have to be exactly "dead on." (Some woodworkers don't worry about centering the cut. I think this introduces unnecessary potential for stress buildup.) As a good approximation for centering your cut, consider Fig. 1. For the cut to be centered $x = y$ and

$$2x + \frac{5}{32} = t \text{ (thickness of board),}$$

or for $t = \frac{3}{4}$ ", $x = \frac{19}{64}$ or about $\frac{5}{16}$ ".

Now adjust the fence so the position of the cut will be in the center of the board's thickness (Photo 4). Many biscuit joiners are made with the distance y fixed, however. For edge-to-edge joints, centering the cut is worth the effort (this isn't possible with butt joints). Support the joiner's base firmly with shims,



PHOTO 7: Aligning and clamping the pieces together: corner joint.

to ensure getting the correct distance x for a centered cut. If your fence is strong enough, and will accurately remain in adjustment, let the fence support the joiner without shims.

As an alternative, set your fence for the thickness t with the base as one reference surface and the position of the fence determined by the board's thickness. Your slots will be off center, but you'll be OK as long as you follow the above simple rule. Narrower boards present a problem: the distance x should always be at least $\frac{1}{4}$ ". Problems with swelling can also occur, with subsequent dimple formation if you sand or plane the surface before the swelling has subsided.

To ensure that everything goes together as you wish, dry clamp before beginning the gluing; never put glue on all surfaces before assembly. It is far simpler to make corrections before gluing.

First put glue into the slots on one of the boards and insert the biscuits (Photo 5), then spread the glue in the slot with an artist's palette knife (Photo 6). Special glue dispensers perform the whole operation in one step. Woodworkers often claim the only glue needed for the other piece is in the biscuit slots. This doesn't work for speaker enclosures—unless, of course, you want to produce a whistle. Put glue on the board face of the glue joint and in the biscuit slots of the other piece.

Next, quickly assemble the pieces and align them accurately before the glue starts to set (usually within five to ten minutes). The best guides will be the centerline guides you marked for the slots; be sure you have clamped properly (see "Putting On the Pressure," SB 1/94, p. 58). When gluing up a whole panel of boards, glue in pairs from the outside edges inward. The biscuits set up

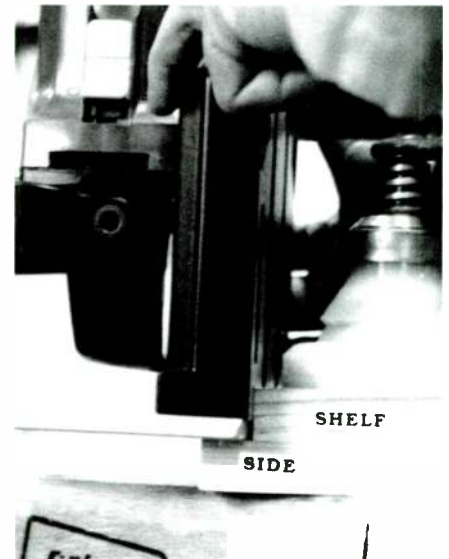

PHOTO 8: Making the vertical cut into the side piece: corner joint.

Final Liquidation Sale!

AC Components

Phone: (608) 784-4579, Fax (608) 784-6367 P.O. Box 212, La Crosse, WI 54601

	Reg Price	1-49 each	>50, each
AC Spikes	\$2.49	\$1.49	\$.99
Resistor; 20 ohm 10W, 10%	\$.45	\$.29	\$.19
Cap; 5.6 NP electro 100V Ritchie	-	\$.29	\$.19
Cap; 15 NP electro 100V Ritchie	\$.99	\$.29	\$.19
Cap; 50 NP electro 100V Ritchie	\$1.75	\$.79	\$.55
Cap; 15mfd mylar, 10%, 50V	\$3.25	\$1.29	\$.89
Cap; .22mfd IAR, 5%, 425V	\$4.00	\$2.99	-
Cap; 1mfd IAR, 5%, 425V	\$5.25	\$3.99	-
Cap; 3mfd IAR, 5%, 425V	\$9.00	\$6.99	-
Cap; 5mfd IAR, 5%, 310V	\$7.50	\$5.99	-
Cap; 10mfd IAR, 5%, 310V	\$13.75	\$9.99	-
Aircoil; 1.75mh 14ga. Oxygen free, 1%	\$13.90	\$9.99	-
Aircoil; 2mh 14ga. Oxygen free, 1%	\$14.90	\$9.99	-
Aircoil; 2.5mh 14ga. Oxygen free, 1%	\$16.90	\$10.99	-
Dacron 12 oz. bag	\$2.79	\$1.49	-
Long-hair wool, 1lb, carded, cleaned	\$11.90	\$7.99	-
Acoustical Magic™, Quart	\$16.90	\$11.99	-
Acoustical Magic™, Gallon	\$54.90	\$44.99	-
Acoustical Magic™, 5 gallon	-	\$210.00	-
AC12 poly-woofer, rubber surround	\$79.00	\$63.20	-
AC8 poly-woofer, rubber surround	\$55.00	\$44.00	-
Dynaudio Esotec 20W75	\$240.00pr	\$149.00pr	-
Focal 6V415 bass-mid	\$280.00pr	\$135.00pr	-
Vifa D26T tweeter	\$17.90	\$12.99	-
Vifa H25T High-output tweeter	\$21.90	\$12.99	-
Vifa M10MD Midrange w/chamber	\$21.00	\$12.99	-
Dynaudio D28/2 tweeter	\$62.00	\$49.00	-
Odds and ends			
13M/8640 midrange	\$65.00	\$39.00 1 only	
18W/8542 woofer	\$89.00	\$59.00 1 only	
Focal 10N511 neoflex, cast	\$100.00	\$49.00 1 only	
Ultimate grill, 10" size	\$10.00	\$3.00	
Focal T90 Rep. faceplate-coil	\$35.00	\$15.00 New	
Focal T120K Rep. faceplate-coil	\$45.00	\$15.00 Used but Okay	

We must liquidate our parts business to concentrate on meeting the demand for Audio Concepts, Inc. (ACI) speaker systems. This is the final liquidation of AC Components div., order today, quantities are very limited! Orders may be placed by mail, fax or by calling 608-784-4579. Payment by Visa/MC or Money Order. Sorry, no CODS. All sales final, non-returnable, non-refundable.

* Orders shipped within the Continental U.S. will be charged exact UPS rates plus \$3 to cover insurance, packaging and handling. To expedite shipping include 10% of your total order, plus the \$3. Any overpayment will be promptly refunded. Call for express rates and shipping charges other than Continental U.S.

* For any order with merchandise total under \$50 the handling charge is \$8.

* Shipments to a Wisconsin address require the addition of 5% sales tax after shipping charges.

* Products are guaranteed against original manufacturers defects only. Anything returned under warranty must be returned within 15 days of purchase. No returns will be accepted without prior authorization from AC Components. Soldering voids driver warranty.

All quantities are limited, order today!



PHOTO 9: Making the horizontal cut into the shelf piece: corner joint. The extra board, which acts as a support for the joiner, should be of the same thickness as the other pieces.

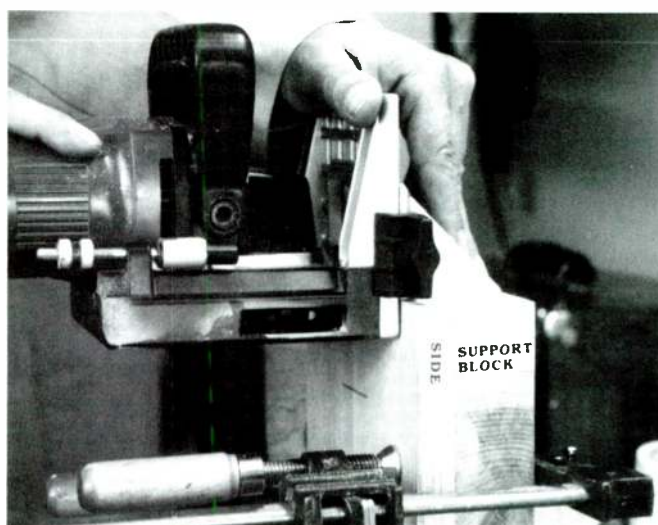

PHOTO 10: Using a support block to cut the slots into the side piece.

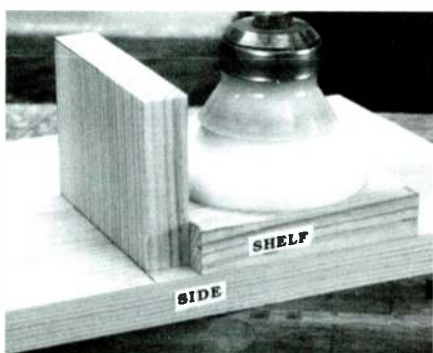

PHOTO 11: Aligning and clamping the pieces together: interior butt joint.

much faster than normal joints; with most glues, you can probably remove the clamps in about 10 to 15 minutes (see *SB 2/94*, p. 46). If time isn't critical, it's better to leave the clamps on overnight.

BUTT JOINTS

Though not very pretty, the butt joint is the simplest, and fine if your finish is to be

veneer, texture, or paint. As the name implies, you just butt one piece against another, usually at right angles, either at a corner where the sides meet the top and bottom or as a shelf within the cabinet. The corner and interior butt joints are basically made the same way, with only small differences.

The corner butt joint requires the two pieces to be exactly the same thickness. With particleboard and medium density fiberboard (PB/MDF) this should not be a problem. First, set up the side and shelf so that the cuts can have the same configuration. Using a piece of material of the same thickness as the shelf and side, clamp the two together (*Photo 7*). You shouldn't be able to feel any offset where the spacer and side meet. Be sure the shelf piece is clamped flat to the side. At each of the marked locations, align the joiner in a vertical position and make the cut (*Photo 8*). Rotate the joiner to the horizontal position, align with the mark, and make the cut into the shelf (*Photo 9*). This procedure ensures that all cuts are made relative to the outside (exposed) faces.

Another method for making the side cut is

to use a square support block (*Photo 10*). Be sure to set the fence, using the shelf as a guide.

An interior butt joint (for a shelf) is made almost the same way. Carefully mark the shelf's location, then clamp it to the side so it is flat and spaced its exact thickness below the reference line. Either use a piece of material of the same thickness as a guide (*Photo 11*), or align one edge with the reference line and then carefully rotate the shelf downward onto the side piece. Make the vertical and horizontal cuts as before (*Photos 12 and 13*).

Good joints which are not at right angles to each other are also possible. Unfortunately, most fences have fixed angles built in (usually 45° and 90°). If you wish to use these joiners, you must cut angled shims and attach them to the fence. If you expect to be making many non-right-angled joints, consider a biscuit joiner with an adjustable fence.

Biscuits having a self-clamping action used to be available, but lately I haven't been able to find a source for them. If any reader knows of one, please let me know by writing to me in care of *Speaker Builder*. ▶



PHOTO 12: Making the vertical cut into the side piece: an interior butt joint.

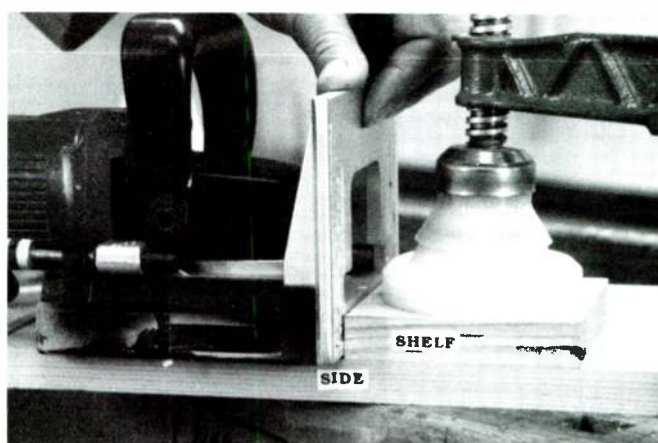

PHOTO 13: Making the horizontal cut into the shelf piece: interior butt joint.

SYNCHRON....Coincidental Loudspeakers

The dream of every loudspeaker designer is to build a speaker with a smooth frequency response and good imaging. A smooth frequency response can be obtained by careful crossover design and use of quality drivers. Good imaging poses a problem that is not so easily solved, for the sound of the woofer and the tweeter should reach the listener at exactly the same point in time. Phase correction circuitry can be added to the crossover in order to achieve better imaging, but this type of design creates a precise image only in small areas of the listening room. Now a much improved design technique is possible due to the development of neodymium tweeter magnets. Their small mass allows a tweeter to be mounted at the base of the woofer cone, very close to the woofer voice coil.

Close positioning of the driver voice coils creates true imaging for any listening position in the room, because the sound generated by the woofer and tweeter originates from a single point source. The listener hears the music synchronized, in phase, and the result is unmistakably realistic.

The woofers in Synchron loudspeakers feature cast baskets, mineral filled polypropylene cones, PVC surrounds, Kapton formers, and ferrofluid cooling. The tweeters have aluminum domes with supronyl surrounds (3/4" on the SYN-519A and SYN-619A, 1" on the SYN-825A), neodymium magnets, diffuser/dome protectors, Kapton formers and ferrofluid cooling.

SYNCHRON SYN-519A 5.25"			
Technical Data	Symbol	Value W/T	Unit
Nominal Impedance	Z	8/8	Ω
Resonance Frequency	Fs	58/1500	Hz
Power Handling (IEC)	P	25/30	W
Sensitivity (1W/1m)	E	90/90	dB
Voice coil Diameter	\emptyset	33/19	mm
DC Resistance	Re	6/5.6	Ω
Voice Coil Inductance	Lbm	50/-	μ H
X-Max peak		2/-	mm
Magnet Weight	m	.33/.008	kg
Force Factor	BL	6.5/2.5	TM
Suspension Compliance	Cms	1018/-	mN ⁻¹
Mechanical Q Factor	Qms	1.8/-	
Electrical Q Factor	Qes	0.39/-	
Total Q Factor	Qts	0.32/-	
Equivalent Air Volume	Vas	14	Ltr
Moving Mass	Mms	7.8/0.19	g
Effective Piston Area	SD	.01/-	m ²
Price Each		\$63.00	



Suggested Box Alignments		
	Sealed	Vented
VB Ltrs	3.7	6
F3 Hz	125	85
Fb Hz	-	72
Vent \emptyset	-	1.5"
Vent L	-	3.3"

SYNCHRON SYN-619A 6.5"			
Technical Data	Symbol	Value W/T	Unit
Nominal Impedance	Z	8/8	Ω
Resonance Frequency	Fs	55/1500	Hz
Power Handling (IEC)	P	30/30	W
Sensitivity (1W/1m)	E	90/90	dB
Voice coil Diameter	\emptyset	33/19	mm
DC Resistance	Re	6/5.6	Ω
Voice Coil Inductance	Lbm	47/-	μ H
X-Max peak		2/-	mm
Magnet Weight	m	.33/.008	kg
Force Factor	BL	7/2.2	TM
Suspension Compliance	Cms	803.3/-	mN ⁻¹
Mechanical Q Factor	Qms	2.1/-	
Electrical Q Factor	Qes	0.44/-	
Total Q Factor	Qts	0.36/-	
Equivalent Air Volume	Vas	20	Ltr
Moving Mass	Mms	10.3/0.19	g
Effective Piston Area	SD	.013/-	m ²
Price Each		\$68.00	



Suggested Box Alignments		
	Sealed	Vented
VB Ltrs	7.5	12
F3 Hz	105	65
Fb Hz	-	61
Vent \emptyset	-	2"
Vent L	-	3.8"

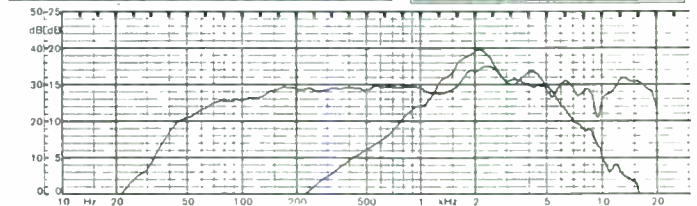
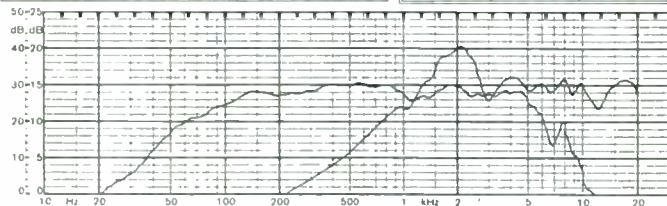

SYNCHRON SYN-825A 8"			
Technical Data	Symbol	Value W/T	Unit
Nominal Impedance	Z	8/8	Ω
Resonance Frequency	Fs	40/1500	Hz
Power Handling (IEC)	P	60/40	W
Sensitivity (1W/1m)	E	91/90	dB
Voice coil Diameter	\emptyset	42/25	mm
DC Resistance	Re	6/5.6	Ω
Voice Coil Inductance	Lbm	58/-	μ H
X-Max peak		4/-	mm
Magnet Weight	m	.567/.013	kg
Force Factor	BL	9.1/3.18	TM
Suspension Compliance	Cms	808.4/-	mN ⁻¹
Mechanical Q Factor	Qms	1.74/-	
Electrical Q Factor	Qes	0.36/-	
Total Q Factor	Qts	0.30/-	
Equivalent Air Volume	Vas	50	Ltr
Moving Mass	Mms	19.7/0.49	g
Effective Piston Area	SD	.021/-	m ²
Price Each		\$78.00	



Suggested Box Alignments		
	Sealed	Vented
VB Ltrs	11	16
F3 Hz	94	60
Fb Hz	-	54
Vent \emptyset	-	2"
Vent L	-	3.6"

Dim. mm	SYN-519A	SYN-619A	SYN-825A
A	154.5	180.3	217
B	5	5	5.5
C	77	83.3	98
D	90	90	110
E	119	145.4	187

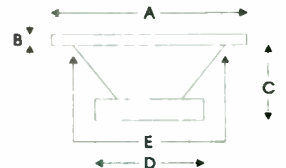

Using our anechoic chamber, Audio Precision and the Leap program, Madisound has created crossover designs for these drivers. Available on request.

Ordering Information: All speaker orders will be shipped promptly, if possible by UPS. COD requires a 25% prepayment, and personal checks must clear before shipment. Add 10% for shipping, residents of Alaska, Canada and Hawaii, and those who require Blue Label air service, please add 25%. There is no fee for packaging or handling, and we will refund to the exact shipping charge. We accept Mastercard or Visa on mail or phone orders.

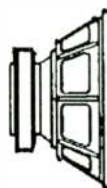

Madisound Speaker Components
 (8608 University Green)
 P.O. Box 44283
 Madison, WI 53744-4283 U.S.A
 Voice: 608-831-3433
 Fax: 608-831-3771

Dealer inquires welcome. Supronyl and Titanium domes available at 200 piece quantities.

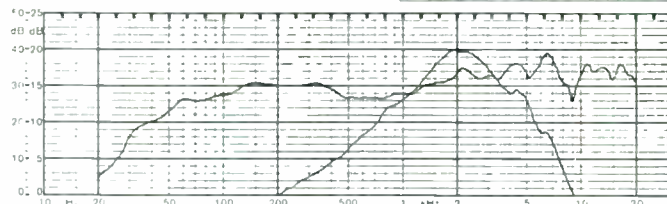

Tools, Tips & Techniques

A DUAL-VOLUME VAS TEST BOX

One of the ways to measure a woofer's V_{AS} is to mount it in a sealed enclosure of known volume and measure the shift in its resonant frequency (f_s) and electrical Q (Q_{ES}). *The Loudspeaker Design Cookbook*, by Vance Dickason (Audio Amateur Press, 1991), calls for a 1ft^3 enclosure for drivers up to 10" and a 2ft^3 box for larger ones. To avoid building and storing two separate boxes, I designed and built a dual-volume test box. The basic idea is a 2ft^3 box with a removable divider. With the divider installed, the internal volume loading the woofer is reduced to 1ft^3 .

DESIGN

I made five top pieces, one each for 6", 8", 10", 12", and 15" woofers. For increased strength, I added an inner half-wall to support the divider, rather than using shims

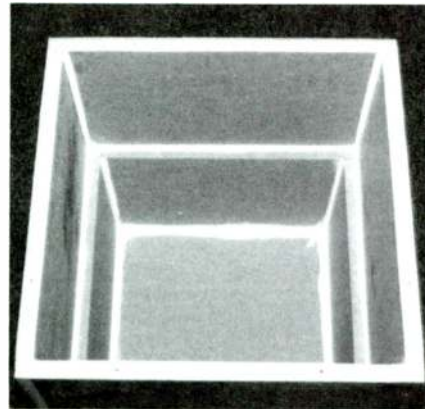

PHOTO 1: Looking down into the test box.

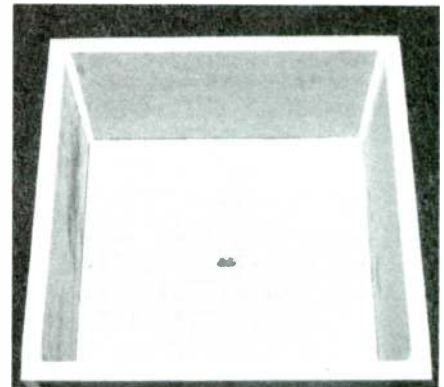

PHOTO 2: Top section of box with divider in place.

(Fig. 1); I didn't want to worry about breaking the shims in when I pushed the divider into the box. I used $\frac{3}{4}$ " thick wood (MDF) because the internal volumes came very close to their targets and I wished to minimize wall vibration. You can use the same

procedures to calculate the correct volumes with other wood thicknesses.

The first requirement was to make the top of the box large enough to mount a 15" woofer. A $16" \times 16"$ top would accomplish this, and a single sheet of wood yielded three top pieces.

Roy Allison's Famed Tweeter Now Available

Winter Sale Prices Now in Effect --- Save Big \$\$ on every Purchase

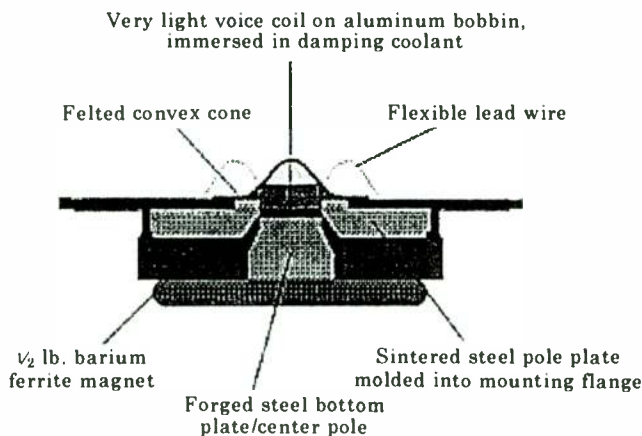

Roy Allison's Convex Dome Tweeter is world renowned for its almost perfect dispersion pattern. Edgar Villchur said of Roy Allison upon hearing this tweeter for the first time, "The student has surpassed the teacher." No other tweeter in the world creates such an even power response throughout the listening area. This is due to the pulsating hemisphere created by its unique design.

New Low Price - \$41.00 each

RDL ACOUSTICS

26 Pearl Street, #15
Bellingham, MA 02019

For Specifications and Ordering

Call 1-800-227-0390

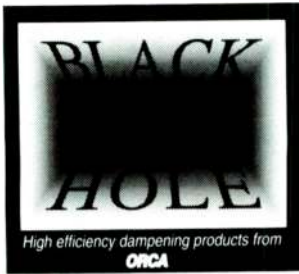

A better speaker damping material...

If you've been building speakers for some time, you know how much guesswork goes with speaker damping and stuffing. The choices seem endless: fiberglass, wool, Dacron, flat foam, convoluted foam, felt, tar, plus various "magic" compounds that you're invited to brush or pour into your new cabinets. Everyone has their own recipe, and who knows if it's a recipe for disaster? Or what effects the vapors emitted by these chemicals might have on the glues that bond your woofer surround to its cone and chassis? In this era of costly, space-age drivers and computer-assisted design, we think such risks are

totally unacceptable. So we went to work to find the ideal solution.

The problems are fairly well-known: a driver transforms electrical energy into mechanical energy. This mechanical energy is transformed into acoustical energy which is radiated to the outside of the cabinet - the useful front wave - and to the inside - the sometimes-useful back wave. Unfortunately, it is also transmitted through the frame of the driver to the cabinet itself, which acts as a very large "cone" of very small excursion. This means that the spurious resonances and vibrations of the cabinet have to be controlled in a predictable and reproducible way. That's how we came to BLACK HOLE 5 and the BLACK HOLE PAD.

First, THE PAD. It's a thin (1/16 inch) black flexible viscoelastic damping material (filled vinyl copolymer) with maximum performance between 50 and 100 degrees F (we hope that that covers the temperature range of your listening room) and excellent flame resistance - it meets UL94 V-O. Thanks to its outstanding damping characteristics, THE PAD will dramatically reduce the vibration energy stored in the walls to which it is applied.

Easy to cut and apply, THE PAD has a pressure-sensitive adhesive back: simply peel off the release paper and press hard onto a clean surface. You can use THE PAD on just about anything you suspect of vibrating: driver frames, thin panels like car doors, and, of course, the walls of your speaker cabinets. And it can be used to recess a driver without using a router: just laminate enough layers to match the thickness of the driver frame and apply to the front baffle. Finally, it is the ideal material for "constrained layer" wall construction, where two panels are laminated on each side of a damping material for optimum transmission loss. Because THE PAD has a fine grain leather finish, you can wrap an entire cabinet exterior and give it an attractive appearance at the same time!

For applications which require **maximum damping, isolation and absorption**, we've developed BLACK HOLE 5. One and 3/8" thick, BLACK HOLE 5 is a high-loss laminate that provides optimum acoustical damping performance. It consists of five layers:

Thin diamond-pattern embossing, densified with a polyurethane film surface. This unique surface layer dramatically improves the performance of the whole acoustical system, especially the lower mid-range and mid-bass frequencies where simple acoustical foam loses its effectiveness.

One-inch deep polyester urethane foam, structurally optimized for acoustical damping. Highly effective at "soaking" maximum sound energy with minimum thickness.

Barrier septum, 1/8 inch thick. Made of limp flexible vinyl copolymer loaded with non-lead inorganic fillers, it is a "dead wall" that isolates the vibrations in the walls of your cabinet from the vibrations created inside the enclosure.

Polyester urethane flexible open-cell foam, 1/4 inch thick. Thanks to special vibration-isolation characteristics, it decouples the vibrating structure (the wall) from the rest of the damping system, thus optimizing performance.

High-loss vibration damping material, same as The Pad. It is strongly bonded to the cabinet wall with pressure sensitive adhesive.

These layers are laminated using an adhesive-free mechanical and thermal process, thus optimizing performance and eliminating the risk of solvent fume damage. BLACK HOLE 5 can be used in any enclosure, as well as for acoustical panels to improve the characteristics of your listening room. **YOU PROVIDE THE MUSIC; BLACK HOLE FIVE WILL TAKE CARE OF THE NOISE!**

orca

1531 Lookout Drive
Agoura, CA 91301 U.S.A

818-707-1629
FAX 818-991-3072

AEON Cables

New from ORCA!

AX-ON (Greek axon, axis): that part of a nerve cell through which impulses travel away from the cell body. AXON 8 speaker cable combines outstanding design features with component quality usually associated with the most expensive cable. With eight AXON 1 solid-core conductors and utilizing mylar/ polypropylene construction, AXON 8 offers outstanding performance for amp-speaker connections and perfectionist internal speaker wiring. Our superb AXON 1 AWG 20 solid core conductor is also available separately. Oxygen-free and 99.997% pure, it is ideal for most internal wiring applications.

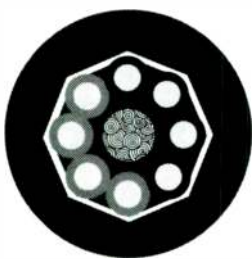

Outer insulation: UL approved TPE

Cable geometry: non interleaved spiral

Individual conductor insulation: 105 degree Celsius, UL approved PVC

Cable equivalent gauge: total - AWG 11, 2 conductors - AWG 17, 4 conductors - AWG 14

Individual conductors: solid core AWG 20 copper, long-grain and ultra-soft, free of all contaminants and oxygen.

Cable core: crushed polypropylene

Inner envelope: mylar film

Reader Service #32

CANADIAN SPEAKER BUILDERS

FREE
CATALOG OF
QUALITY
SPEAKERS
AND RELATED
COMPONENTS

QCOMPONENTS
DIRECT MAIL ORDER

638 COLBY DRIVE,
WATERLOO, ONT. N2V 1A2
PHONE: (519) 884 - 1140

CANADA ONLY PLEASE.

Reader Service #2

45,296

ELECTRONIC COMPONENTS

Whether you order 1 part or
all 45,296...MOUSER stocks
and...ships same day!!

CALL...(800) 992-9943

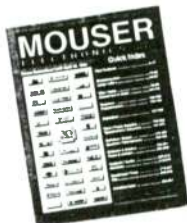

for your
FREE
CATALOG

2401 Hwy 287 N.
Mansfield, TX 76063

MOUSER ELECTRONICS

Sales & Stocking Locations Nationwide

Reader Service #30

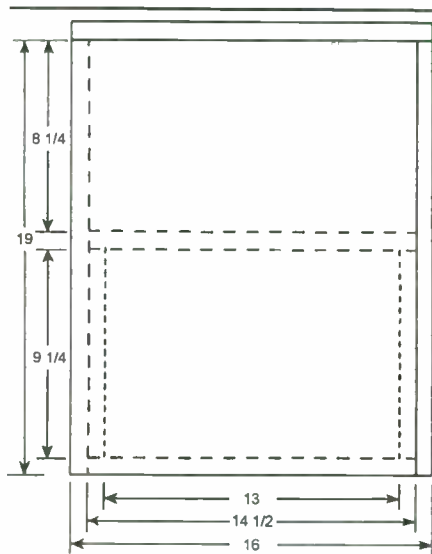

FIGURE 1: Side view of test box.

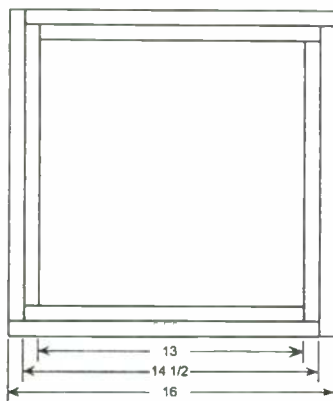

FIGURE 2: Top view with top and divider removed.

Given the size of the top piece and the thickness of the sides, I knew two of the top section's internal dimensions ($14\frac{1}{2}'' \times 14\frac{1}{2}''$). It remained only to figure out the height for a 1ft^3 volume. The internal dimensions of the top section ended up being $14\frac{1}{2}'' \times 14\frac{1}{2}'' \times 8\frac{1}{4}''$. The target volume for the top section is $1,728\text{ in}^3$ and these dimensions give you about $1,735\text{ in}^3$ —within 0.4% of the target.

To use the full 2ft^3 volume, you simply remove the divider. So when figuring the dimensions for the rest of the enclosure, remember to include the divider's volume. With the 1" divider removed, the dimensions of the top section are $14\frac{1}{2}'' \times 14\frac{1}{2}'' \times 9''$. The top section volume now equals $1,892\text{ in}^3$. The

TABLE 1

TEST BOX PARTS LIST

QTY	PART	DIMENSIONS
5	lids	$16'' \times 16''$
4	outside sides	$19'' \times 15\frac{1}{4}''$
2	bottom and divider	$14\frac{1}{2}'' \times 14\frac{1}{2}''$
4	half-sides	$9\frac{1}{4}'' \times 13\frac{3}{4}''$



PHOTO 3: My dual-purpose test box.

bottom section volume then needs $1,564\text{ in}^3$ more to equal $3,456\text{ in}^3$ (2ft^3). The dimensions I used were $13'' \times 13'' \times 9\frac{1}{4}''$ (Fig. 1), which gives you $1,563\text{ in}^3$ for the bottom section and $3,455\text{ in}^3$ total.

CONSTRUCTION

Construction of the box is rather straightforward. I used an overlapping butt joint technique (Fig. 2). The nice thing about this method is that all four side pieces are the same size. All pieces are glued and screwed together using counter-sunk flat-head wood screws, with the exception of the divider and top(s), which to facilitate removal are mounted with only pan-head wood screws (no glue).

The first step is to glue and screw together the half-sides and the bottom. Temporarily mount the divider, using screws only, to get the proper alignment of the holes; then remove it. Attach the outside sides with more glue and screws and let the glue dry overnight. Then seal all the joints in the lower section and the corners of the upper section (I used silicone caulk). Attach some sort of seal (I used weather-strip foam) along the top edge of the half-sides and outer sides. You want to avoid any leaks from the outer box or into the lower section while the divider is installed.

Finally, mount a handle (I used an eyebolt) in the center of the divider. Also round the corners of the divider so it doesn't scrape off the top section's caulking as you install or remove it.

With the divider installed, the woofer is loaded by the top 1ft^3 . With the divider removed, the woofer sees the entire 2ft^3 . I hope this design makes your testing procedures easier.

Stephen A. Crosby
APO AE 09470

1981 A Testing Unit for Speaker Parameters • Variable-Volume Enclosure • Thiele/Small Theory, Pt 1-3 • Easy to Make Enclosure Using Concrete Blocks • The Tractrix Horn: Good Dispersion Bass From an Old Design • Diffuser Port for Small Boxes • Mini-Speaker Made From PVC Tubes • Closed vs. Vented Box Efficiency • Interview with P.G.A.H. Voigt • Dual 8" Symmetrical Air Friction Enclosure • Thiele/Small Calculator Computation • Thiele/Small Parameters for Passive Radiators •

1982 Transmission Line Theory • Thiele/Small Sixth-Order Alignments • The Quad 63 • Table Saw Basics • AR-1 Mods • Active Crossovers and Phase • Three Transmission Line Speakers • A Beginner's First Speaker • How Passive Networks Interact with Drivers • Horn Loaded Heil • Phase Correcting Active Crossover • Wind Your Own Inductors • Series and Parallel Networks • High Performance Corner Speaker • Using Zobels to Compensate for Driver Characteristics •

1983 Building the Two-Way Dynaudio • A Crossover That Offsets Speaker Impedance • Using a Calculator for Box Design • Choosing a Calculator • A Simple Peak Power Indicator • A Small Horn Speaker • Audio Pulse Generator • How to Use Speaker Pads and Level Controls • An Easy-to-Build Voltmeter for Speaker Measuring • Nomograms for Easy Design Calculations • Interview with KEF's Raymond Cooke • Build a Simple Wattmeter • A New Type of Speaker Driver •

1984 Build an Aligned Satellite/Woofer System • BOXRESPONSE: A Program to Calculate Thiele/Small Parameters • Casting with Resins • A Phase Meter • An Interview with Ted Jordan • Building the Jordan-5 System • Self-Powered Peak Power Indicator • Closed Box Design Trade-offs • How to Build Ribbon Tweeters • Build a Dual Measurement Impedance Meter • A High-Power Satellite Speaker System • Build and Use a White/Pink Generator • Sound Pressure Level Nomographs •

1985 OUT OF PRINT, some single issues still available at \$5 each. •

1986 The Edgar Midrange Horn • Sand-Filled Stands • Crossover Networks: Passive and Active • 5-Sided Boxes • A 2 x 4 Transmission Line • The Free-Volume Subwoofer • Notch Filters • By-Wiring the LS3/5A • A Push/Pull Constant Pressure System • Current and Power in Crossover Components • The Unbox (Egg) • Upgrade Speakerlab's S-6 Crossover • Measure Speakers with Step Response • A Gold Ribbon System • A Visit with Ken Kantor • A Tractrix Horn Design Program • Reviews: Audio Concepts "G"; Seven TL Midranges; Focal's Model 280; the Audio Source RTA-ONE •

1987 A Compact TL Woofer • Frequency Response and Loudspeaker Modeling, Pt 1-3 • A Manual Coil Winder • The Model-One Speaker • Designing a Listening Room • A Sixth-Order Vented Woofer • Tapered Pipe Experiments • Visiting Boston Acoustics • A Vented Compound System • The Octaline • Spreadsheets for Speaker Design • In Memoriam: Richard Heyser, Pt 1-2 • Using Non-Optimum Vented Boxes • Building Speaker Stands • Evaluating Driver Impedance Compensation • Tuning Bass Reflex • Six Woofers Compared • Bullock on Passive Crossovers: Alternate Bandpass Types • Fast, Easy Filter Calculations • A Mobile Speaker • Polk 10 Mod •

1988 Electronic Turns Counter • Two-Way Design • Minimus-7 Mod • Dome/Midrange/Tweeter Array • Plotting Complex Impedances • A Driver Design Primer • A Cabinet Primer • Tuning Up Old Systems • Low-Cost AR-3 Upgrade • Electronic Time Delay • Enclosure Shapes and Volumes • Minimum-Phase Crossovers • Spot Sound Absorbers • How to Add a Subwoofer • The Swan IV System • Sub-Bass Power Boosting • The Online: A Short TL • Active Filter Computer Design Program • Low-Cost Two-Way Ribbon • Amp-Speaker Interface Tester and Construction Plans • The QB₃ Vented Box is Best • A Pentagonal Box System • Keith Johnson Profile • Sheathed Conductor ESL • A Symmetrically Loaded System, Pt 1 • Ceramic Enclosure • Inductance Measuring Technique • Polk 10 Mods •

1989 (5 Issue Set: VERY LOW STOCK) The Audio Laboratory Speaker System • A Passively Assisted Woofer • Digital Filter Tutorial • The Listening Arc Alignment • Small IC Power Amp & Crossover • Easy Surround Sound • Building Speaker Spikes • An Isobarik in a Thunderbird • Sheetrock Cabinetry • A Picket Speaker • Servo-Controlling AR-1 • Silent, Safe Muting System • Equalizing the Klipsch Cornwall • A Test Switcher • Visiting the Klipsch Kingdom • Rehab for Kitchen Music • Spreadsheet Design • A Subwoofer/Satellite System • Impedance Measurement as a Tool • Practical Passive Radiators • A Symmetrical Dual Transmission Line, Pt 1-2 • The Microline • A Voice Coil Wheatstone Bridge • Tweeter Q Problems • A Dipole Subwoofer for the Quad • Adjusting Woofer Properties • Modifying Paradigm's 7se •

1990 Acceleration Feedback System • Cylindrical Symmetric Guitar TLs • Compact Integrated Electrostatic TL, Pt 1-3 • Minimus-7 Super Mod • The Show (Bass Horn) • A Small Two-Way System • Helmholtz Spreadsheet • Heresy Upon a (Klipsch) Heresy • Beer Budget Window Rattler • Contact Basics • MDT Mini-Monitor Speaker System • Titanium + TPX + Polypropylene = Fidelity • Tom Holman, Skywalker, and THX, Pt 1-2 • Bud Box Enclosure • Klipschom Throat Riddle • Modular Three-Way Active Speaker • CD Speaker System • SPEAKER DESIGNER Software • Symmetrical Isobarik • Novice Crossovers • Triamplified Modular System • Magnetic Crosstalk in Passive Crossovers • Mitey Mike Loudspeaker Tester • Symmetrical Loading for Auto Subwoofers • Improved Vented Box with Low Q_{TS} Drivers • BOXMODEL Woofer System Design Software • Four Eight By Twos • Dynaco A-25 Mod • Klipschom Throat Revisited •

1991 Students Building Systems • Servo Subwoofers • An Apartment TL • L-R Crossover for the Swan IV • More or Less Power • New Guidelines for Vented Boxes • The Pipes • Macintosh's Wave and Sound Programs • Creating Professional Looking Grilles • Octaline Meets D'Appolito • Using Radar to Measure Drivers • Deep Bass for GMC • PSpike LF Response Calculating • Pipe and Ribbon Odyssey • The Delac S-10 • Infrared Remote Volume Control • Backloaded Wall Horn Speaker • Mod for the Minimus 7 • Simplifying Cabinet Assembly • Fibrous Effects on TLs • The DOALs • Loudspeaker Cable • Speaker to Ear Interface • Speaker Sensitivity to Errors in T/S Parameters • TL Speaker Evaluation • Cable and Sound • Kit Reports: Little V; Audio Concepts' Sub-1 •

1992 Rumreich on Box Design & Woofer Selection • MLSSA • Double-Chambered Reflex by Weems • Active Crossover and Delay • Electrical Circuit Bandpass Enclosure • A Dreadnaught System (satellite swivels) • Designing Real-World Two-Way Crossovers • 20-foot Ribbon Dipole Speaker • Biamping the Sapphire II • Capping Passive Crossovers • A High Quality Speaker Cabinet • 1/3-Octave Noise Source • Disappearing Loudspeaker • The A&S Soundoff Winner, Pt 1-2 • Alignment Jamming • Marc Bacon's "Danielle," Pt 1-2 • Double-Chambered Isobarik Bass • Ferguson's Pickup Installation • Electronic Counter for Coil Winding • Oakley on Speaker Placement • Making Your Room Hi-Fi, Pt 1 • More on Dust Caps • Spreadsheet for Nonoptimum Vented Box Design • Acoustic Resistance Tuned Enclosure •

1993 Waslo's IMP, Pt 1-3 • Quasi-Monotonic Vented Alignments • Making Your Room Hi-Fi, Pt 2-3 • A & S Soundoff Winner, Pt 3 • Flexible Dipole Woofer • The Simpline • Stalking F₃ • A Bi-Structural Enclosure • A Sixth-Order T/S Subwoofer Design • Speaker Enclosure Screws • Electric Bass Tri-Horn • Prism V Satellite/JBL Subwoofer, Pt 1-2 • Fitcut: Program for Designing Duct Software • Compact Coincidental Point Source Speaker • IMP: Measuring T/S Parameters • KIT REPORT: Rockford's Beginner Software/Driver Paks • SOFTWARE REPORT: Low Frequency Designer 3.01 • Three Affordable Measurement Microphones • Two Ways to Realize a Dream • Matching Driver Efficiencies • Two-Woofer Box System • Designing a Dual Voice Coil Subwoofer • SOFTWARE REPORT: Blaubox 1.2 • Tale of Three Speaker Projects • A & S Sound-off 1992 • Monolith Horn • Orbiting Satellites • Real-World Three-Way Crossovers • The Simplex • Living with a Speaker Builder • The IMP Goes MLS •

Please send me the following back issues of Speaker Builder

- | | | | |
|------------------------------------|------------------------------------|------------------------------------|------------------------------------|
| <input type="checkbox"/> 1993 \$25 | <input type="checkbox"/> 1992 \$25 | <input type="checkbox"/> 1991 \$25 | <input type="checkbox"/> 1990 \$25 |
| <input type="checkbox"/> 1989 \$21 | <input type="checkbox"/> 1988 \$23 | <input type="checkbox"/> 1987 \$20 | <input type="checkbox"/> 1986 \$20 |
| <input type="checkbox"/> 1984 \$18 | <input type="checkbox"/> 1983 \$18 | <input type="checkbox"/> 1982 \$18 | <input type="checkbox"/> 1981 \$18 |

SHIPPING BACK ISSUES

UPS: Domestic ground service by value of order:
 Less than \$60.00-\$4.50 \$131.00-220.00-\$ 8.50
 \$61-\$130.00-\$6.50 \$221.00+ -\$10.50

Canada: Add \$6.00 per year.

Foreign Air: Europe: add additional 40% of total order

Total Magazines _____

Other destinations: 50% of total order.

Postage _____

Foreign Surface: add additional 20% of total order.

TOTAL ENCLOSED _____

Rates subject to change without notice. All remittance in US \$ only drawn on US bank.

Check or Money Order Discover MC VISA

NAME _____ ACCOUNT NO. _____

STREET & NO. _____

CITY _____ ST _____ ZIP _____

MC / VISA NO. _____ EXP. DATE _____

Speaker Builder Magazine

Post Office Box 494, Dept. B94 Peterborough NH 03458-0494

(603) 924-9464 FAX (603) 924-9467

Answering machine for credit card orders only—before 9:00 a.m., after 4:00 p.m. and weekends
 Please have all information plus MC/VISA available.

Product Review

D.H. LABS SILVER SONIC AUDIO CABLES

By Gary A. Galo
Contributing Editor

D.H. Labs' Silver Sonic Audio Cables, D.H. Labs, 6633 Glenway Dr., West Bloomfield, MI 48322, (810) 851-1296. **T-14 Speaker Cable**. Conductors: 2 × 14AWG, silver plated oxygen-free copper, stranded. Dielectric: Pure Teflon® TFE. Capacitance: 21.5pF/ft. \$3.00/ft. **BL-1 Balanced Interconnect Cable**. Conductors: 2 × 20AWG, silver plated oxygen-free copper, stranded. Dielectric: Teflon copolymer. Shield: Foil with stranded drain wire. Capacitance: Not specified (see text). \$3.50/ft.

D.H. Labs is a newcomer to the audio cable scene, and its first products are sure to attract attention among those who believe that cables make a difference. High-end audio designers generally agree that Teflon® is the best solid dielectric material. Measurements introduced nearly fifteen years ago have shown the superiority of Teflon in critical performance areas, including dissipation factor and dielectric absorption (among other things, audio cables are capacitors).¹ D.H. Labs has recently introduced its new "Silver Sonic" cable line, including the T-14 loudspeaker cable and BL-1 interconnect (*Photo 1*).

The T-14 consists of two 14AWG conductors with pure DuPont Teflon TFE insulation. TFE is the highest grade of Teflon available. The stranded conductors are made of oxygen-free copper, and each is individually coated with silver. Silver is a superb conductor—but it oxidizes easily. To prevent this, the T-14's conductors are tightly sealed with the Teflon insulation. The T-14's silver coating has a thickness of 40μ, twice as thick as some silver coatings.

The insulated conductors are spiraled for low inductance, yet capacitance is also low—around 22pF/ft. These cables should mate

well with most amplifier/loudspeaker combinations. The center conductors are wound with a vibration-damping filler and tightly covered with a tension wrap and heavy outer jacket, making the cable virtually immune to resonances and microphonics.

The BL-1 is a fully balanced interconnect cable consisting of two insulated center conductors, plus a foil shield and a separate drain wire. The conductors are made from slow-drawn, oxygen-free copper. Each of the fine strands is individually plated with silver. The dielectric is a new Teflon copolymer. D.H. Labs' president, Darren Hovsepian, claims the new copolymer has nearly identical electrical characteristics as the pure Teflon TFE used in the T-14 loudspeaker cable.

The copolymer requires less heat in the extrusion process, however, which is advantageous when manufacturing a finely stranded cable. The overall gauge of the conductors and drain wire is 20AWG, heavier than many interconnects. The BL-1 contains vibration-damping fillers similar to those used in the T-14 speaker cable. The outer jacket is extruded under pressure, further reducing the possibility of resonances and microphonics.

I evaluated the T-14 and BL-1 cables with my biamped Audio Concepts Sapphire II/Sub1 loudspeaker system, fed with a pair of Adcom GFA-585 power amps (the Sapphire II's amp is modified) and an extensively modified Adcom GFP-565 preamp. The Sapphire II's satellites are biwired (detailed in "Bi-Amping the Sapphire II Sub-1 System," *SB* 3/92, p. 24). I fitted the T-14 loudspeaker cables with gold-plated Old Colony's fork lugs. I use Canare F-10 RCA connectors with the BL-1 cables (more on connectors below).

I had several weeks to evaluate the T-14 speaker cable before the F-10 interconnect

arrived. My existing speaker cables were AudioQuest Indigo Blue; my interconnects were made from Grado Signature Laboratory Standard Audio Cable (no longer available in bulk form). Both of the D.H. Labs "Silver Sonic" cables made a significant improvement in my system. I was enormously impressed with the increase in detail and resolution.

Soundstage reproduction is also superior to my previous cables, being larger than I'm accustomed to. The D.H. Labs cables are extremely smooth and extended in the high frequencies, with plenty of the elusive air and space, yet free of any harshness. I have found them to be extremely musical over the long haul (I've used the BL-1 interconnects for several weeks, and the T-14 speaker cables for over two months).

If the BL-1 is used in an unbalanced application (e.g., most home installations), the shield should float at one end. On the source end, connect both the black center conductor and the drain wire to the shield of the RCA connector. On the load end, leave the drain wire unconnected. In this configuration, the BL-1 has a capacitance of about 56pF/ft. I recommend using a small piece of heat shrink tubing to make sure the drain wire remains insulated on the load end of the cable. The arrows printed on the cable should point toward the load. The cable isn't manufactured with directional characteristics, but the arrows provide an easy means of identifying the load end once the cable has been fitted with RCA connectors.

If you purchase the BL-1 interconnect cable, you'll have to decide which RCA connectors to use. My current favorite is the Canare F-10 (*Photo 2*). Canare has received little attention in the audiophile community; it is best known to audio professionals, primarily for

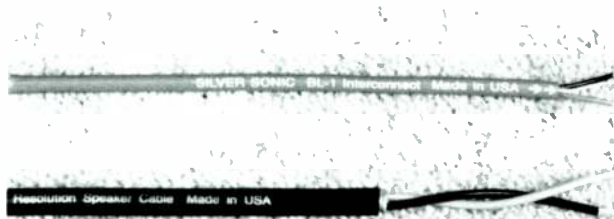

PHOTO 1: D.H. Labs' new Silver Sonic cables. From top to bottom, the BL-1 balanced interconnect and the T-14 loudspeaker cable.

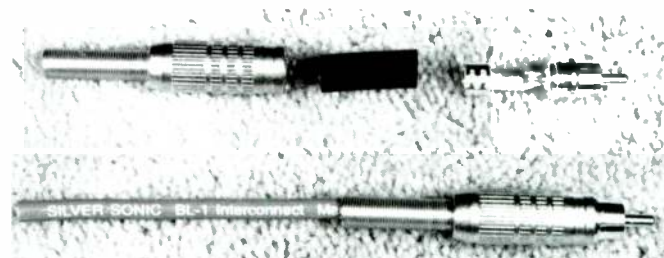

PHOTO 2: The Canare F-10 RCA connector shown disassembled, and fitted with D.H. Labs' BL-1 interconnect cable.

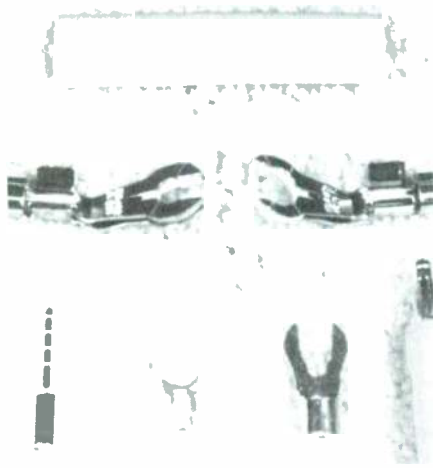

PHOTO 3: High-performance speaker cable terminations. Top, left to right: Kimber Kable's state-of-the-art PM-25 and PM-33 Postmasters, both supplied with heat-shrink tubing and Wonder Solder. Bottom, left to right: D.H. Labs' P-1 pin connector, SP-1, SP-2 spade connectors, and B-1C banana plug.

its excellent L4E6S balanced quad microphone cable. The F-10 RCA plug is a rugged gold-plated connector. The gold plating is extremely high quality, applied directly on brass. The best news is the insulator—it's

pure Teflon. Canare's catalog simply lists the generic chemical name—Polytetrafluoroethylene, which is Teflon TFE.²

At around \$3.50 each, the Canare F-10 connectors are the most economical Teflon-insulated RCA connector made. They compare favorably with high-end audio types costing several times as much—audiophiles usually pay at least four times this price for connectors of this quality.

Canare products are usually sold through pro dealers, including Hudson Audio-Video (listed below). HAVE carries many other items that might be of interest, including a wide selection of audio and video tape. Call for a free catalog; you might find enough other items to make up the \$50.00 minimum order. Canare will send you a complete list of dealers with its catalog. Check the others for minimum order info. D.H. Labs was still deciding on which RCA connectors it intended to sell at the time of writing. I recommended the F-10.

You'll also need to purchase terminations for the T-14 speaker cables. The gold-plated fork lugs sold by Old Colony work well (cat. #SCFFF, \$2.95/pair). D.H. Labs offers four different gold-plated terminators at a very reasonable cost. The SP-1 spade connector will accept 10AWG wire; cost is \$2.20/pair.

The SP-2 spade connector will accept up to 8AWG wire; cost is \$5.00/pair. D.H. Labs also offers the B-1C banana connectors and P-1 pin connectors, at \$5.00 and \$3.00/pair, respectively.

Kimber Kable recently supplied samples of its Postmaster spade connectors (Photo 3). If cost is no object, these are the best speaker cable terminations I've seen. Postmasters are plated with Kimber's proprietary Ultraplate alloy. They have a compressed silicon wafer between the contact parts, which results in a gas-tight connection with only finger-tight torque. Two sizes are available. The PM-25s fit conventional 1/4" binding posts; the PM-33s fit a 3/8" post. Cost is \$14.00/pair.

Recently I evaluated the Kimber Kable KCAG interconnects and 4AG speaker cables. These cables are made with Kimber's proprietary Silver Varistrand conductors and Teflon insulation. The interconnects are terminated with Kimber's RCA-M plugs, and the speaker cables with Postmasters. The KCAG interconnect cables cost \$350/meter pair. The 4AG speaker cables are \$100/foot. While I found the Kimber Kables *slightly better* than the D.H. Labs cables in most areas of performance, it's clear that the law of diminishing returns is at work.

The McCauley Difference

We are proud to be adding McCauley loudspeakers and drivers to our family of fine audio products.

McCauley
6000 Series Loudspeakers & Drivers

EMINENCE
Loudspeakers, Drivers, Diaphragms,
Repair & Recone Kits,

ACOUSTICIAN
Horns & Drivers

ELECTRO-VOICE RECONE KITS

Waldom Audio Products
Crossovers, Hardware &
Accessories

Waldom Repair Centers
They use all the original sources for your reconing needs.

For more information and our latest catalog, call us at 1-800-552-1639



Image Communications • 4301 W. 69th St. • Chicago, IL 60629 • (312) 585-1212 • FAX (312) 585-7847

Reader Service #22

Speaker Builder / 4/94 43

A 1m pair of D.H. Labs BL-1 cables fitted with Canare F-10 connectors will cost around \$30. The same length of Kimber KCAG with Kimber RCA-M plugs will cost nearly 12 times that amount. I think few listeners would say they were 12 times as good. Kimber's 4AG speaker cables are nearly 30 times the cost of the D.H. Labs T-14, if the T-14 is fitted with one of D.H. Labs gold-plated termina-

tions. Again, the Kimber Kables are excellent, but, in my view, nothing like 30 times as good as the D.H. Labs cable. D.H. Labs offers unprecedented value, with performance excellent even when compared to cables selling for many times the price.

Darren Hovsepian also suggests trying the BL-1 as a digital interconnect. According to his measurements, with the shield floating on both ends (i.e., disconnected), the cable's impedance is 79Ω. I made a 1m digital interconnect with this cable and Canare F-10 connectors and compared its performance to my custom-made ones (described in *Ask TAA* 2/93). The BL-1 cable produced a considerably larger soundstage than mine, and superior inner detail.

The D.H. Labs cables are easy to work with. The BL-1 interconnect is flexible enough to warrant serious consideration for internal wiring in preamps, electronic crossovers, and other low-level circuitry. The use of a drain wire/foil shield combination makes the shield connection easy. D.H. Labs is ex-

panding its dealer network, so ask for the name of a dealer near you. Old Colony Sound Lab carries both the T-14 and the BL-1 for \$2.99/foot. Both Canare and D.H. Labs have brought the cost of high-quality Teflon-based cables and connectors within reach of any serious audiophile. These products are highly recommended.

MANUFACTURER RESPONSE

I would like to thank SB and Gary Galo for reviewing our Silver Sonic audio cables. Our goal for the Silver Sonic line is to offer high-end performance at affordable prices, and we are very pleased that Gary was impressed with the performance and value of the cables.

One point that I believe would be of special interest to speaker builders is that the conductors in our speaker cable (and the interconnect) are tightly sealed in the Teflon insulation and will not oxidize over time. This is especially important for the wiring inside speaker enclosures, which cannot be easily replaced.

Also, the interconnect is now available in factory terminated lengths as well as by the spool.

Darren Hovsepian
D.H. Labs

SOURCES

D.H. Labs

6633 Glenway Dr., West Bloomfield, MI 48322
(810) 851-1296
T-14 Speaker Cable; BL-1 Interconnect

Canare Cable, Inc.

511 5th St., Unit G, San Fernando, CA 91340
(818) 365-2446
F-10 RCA Connectors

Kimber Kable

2752 South 1900 West, Ogden, UT 84401
(801) 621-5530.
Postmaster speaker connectors

Hudson Audio-Video Enterprises, Inc. (HAVE)

309 Power Ave., Hudson, NY 12534
(518) 828-2000
Canare products

Old Colony Sound Lab

PO Box 243, Peterborough, NH 03458
(603) 924-6371; FAX (603) 924-9467
dealer for D.H. Labs products

REFERENCES

1. W. Jung and R. Marsh, "Picking Capacitors," Parts 1 and 2, *Audio* (Feb. and March 1980).
2. T. Jones, *Electronic Components Handbook* (Reston Publishing, 1978): 4.

FOTAL

ACCUTON

ORCA CONNECTORS

SR

SPEAKERS

QUALITY DRIVERS & MORE

etc.

Regular

CUSTOM SPEAKER CABLES & INTERCONNECTS

AUDIO
ERSE
ELECTRONICS

INDUCTORS

polyda

SPEAKER CORPORATION

Speaker Kits Available

**We Offer State Of The Art Speaker Components and Kits
(Specializing in Speaker & Crossover Design)**

Request a FREE catalog

1828 W Peoria
Phoenix, AZ 85029
Phone (602) 944-1878 FAX (602) 371-0605

(Mtn Std Time)
10:00 AM-7:00 PM Weekdays
10:00 AM-5:00 PM Saturdays

Reader Service #38

SMT PROJECTS

Owen Bishop

This book is a practical introduction to Surface Mount Technology (SMT). SMDs (Surface Mount Devices) are miniaturized versions of traditional electronic components, soldered directly to the surface of the circuit board instead of connected by wire leads or terminal pins. Because of their small size, they are widely used in much of today's portable equipment, from calculators and camcorders to cellphones and smart cards. This volume describes the special features of SMT and how to work with SMDs on the workbench. It includes over 20 construction projects, all of which have many useful applications in and around the home and workshop. These include a warbler; blinker; passive I-R intruder detector; bicycle alarm; impatient and wailing sirens; clap switch, VHF transmitter; low-voltage AF amplifier; slave flash; hourglass timer; logic probe; digital die; mini radio receiver; two-tone (model) locomotive horn; sample-and-hold device; gunfire generator; sparking pendant; live wire detector; multi-level resistance probe; and micro microwave (with sound and light for a dollhouse, but does not cook!). PCB layouts provided, for making your own boards. United Kingdom, 1993, 174pp., 5 1/2" x 8 1/4", softbound.

BKAA29

\$14.50

CAD MUSIC AUDIO REFERENCE AND STUDIO TOOLS CD

CDCAD1

\$34.95

Contents: Reference Part—[1] Dramatic movie magic. [2] Soundscapes. [3] Monica's nylon dreams. [4] Dynamic flow. [5] Classical acoustic guitar. [6] Critical listening, *acoustic arpeggio*, 8 repeats, Q 1.8; (01) no equalizing; (02) +3dB 125Hz; (03) +3dB 250Hz; (04) +3dB 500Hz; (05) +3dB 1.0kHz; (06) +3dB 3.0kHz; (07) +3dB 6.0kHz; (08) +3dB 10.0kHz. [7] Chunky guitar jam I. [8] Chunky guitar jam II. [9] Splash in the wilderness. [10] Cave stream I. [11] Cave stream II. [12] Cave stream III. [13] Niagara Falls, falling rocks. [14] Stream. [15] Stream close up. [16] Rain and rolling thunder. [17]-[21] Grooves mix check, each approximately 2:05; funky swing, 103 bpm; silky house, 120 bpm; Minneapolis, 100 bpm; Ritz percussion, 113 bpm; L.A. beat, 104 bpm. [22] Guitar (Wah 1; Wah 2; Dance riff I A,C; Dance riff II A,C; Pick 1 A; Pick 2 C; Feedback C; C & C git stab; Metal lick; Dive bomber).

Studio Tools—[23] Left and right connection. [24] Digital zero, reference level 1kHz. [25] SMPTE code 25 fps, 8 min starts at 00:59:55:00. [26] Pink noise; 0:30 left channel; 0:30 right channel; 1:00 both channels. [27] Silence, 0:30. [28]-[30] Mastering calibration, 1kHz, 10kHz, 100Hz; 0:15 left and right channels; 1:00 both channels. [31]-[34] Frequency check, each frequency 0:15; 20, 32, 40, 64Hz; 120, 280, 420, 640Hz; 800Hz, 1.2, 2.8, 5.0kHz; 7.5, 12, 15, 20kHz. Produced by Claes Dahlström for CAD Music. Ref. #001g. Sweden, 1992, 61:03.

MCGRAW-HILL ELECTRONICS DICTIONARY

BKMH9

\$49.95

John Markus, Neil Sclater

Reflecting the explosive progress in the field of electronics, the fifth edition of this best seller is now available. Currently the only dictionary that focuses on words and phrases specific to the field of electronics—plus such related fields as engineering, the physical sciences, materials science, and computer science—this reference remains a premier source for information in all areas of electronics. From CDs and VCRs to solid-state lasers and liquid-crystal displays, rapid expansion of electronic technology has left its mark on the language. Many of the dictionary's new terms have their origin in personal computing, on-line networks, and electronic media, while others are derived from the intersection of electronics with such specialized sciences as metallurgy, biophysics, and astrophysics. More than 14,000 entries, including more than 1200 new entries and 150 new illustrations, make this an essential reference for professionals and anyone who wants a better understanding of technical articles, books, catalogs, advertisements, and new product announcements on electronic subjects. 1994, 596pp., 7 3/8" x 9 1/4", hardbound.

SILVER-PLATED HOOKUP WIRE

D.H. Labs

Lab-quality, Teflon-insulated hookup wire manufactured with annealed, silver-plated copper. Black only. Made in the USA. Purchasing options available:

MWR22BK	#22 Stranded Hookup, 25 feet	\$6.95
MWR20BK	#20 Stranded Hookup, 25 feet	\$7.95
MWR18BK	#18 Stranded Hookup, 25 feet	\$8.95
MWR16BK	#16 Stranded Hookup, 25 feet	\$9.95

AFTERTOUCH SAMPLER CASAT4 CASSETTE #4

\$9.95

Creative Musicians Coalition

Fresh sounds from independent electronic musicians with a wide variety of exceptional talents and styles enable you to experience a fascinating cross-section of the best on the electronic scene today. #ATVOL4C, 50:00.

Contents: Side One—[1] "Electric City" (from *Electric City*), Jack Poley. [2] "The Maya" (*Angels, Aliens, & Archtypes*), Mark Dwane. [3] "Globe" (*Deeper in the Dreamtime*), Robert Scott Thompson. [4] "Return of the Ancient Children" (*On Time*), Robert Newcomb. [5] "Setting Sail" (*Inner, Stellar*), Fred Becker. [6] "Capriccio No. 1, OP. 76—Brahms" (*Brahms: Neue Bahnen*), Norris Mills. [7] "Mars" (*Time and Space*), Mark Baechtle. [8] "White Browed Robin (The Aviary)" (1992 *Spring Sampler*), David Bagsby. Side Two—[1] "People Don't" (*Warm Places*), Neil Davis. [2] "Excerpt from Dot Black" (*Dot Black*), Petru Grajdian. [3] "Muladhara" (*The Seven Chakras*), D'Orlando. [4] "Solarwinds" (*Spatial Logic*), Michael Milazzo. [5] "Angelight" (*Angelight*), J.C. Sebastian. [6] "Triple Conjunction" (*Gardens*), Kelly Dowhower. [7] "The Tarn" (*Summit Approach*), Jeff Stover. [8] "Are You in the Computer?" (*Run the Gauntlet*), Hartley C. White.

AFTERTOUCH SAMPLER SPECIAL!

CASAT/S4

Creative Musicians Coalition

\$33.95

All four AfterTouch electronic music samplers (CASAT1, CASAT2, CASAT3, CASAT4), at a savings of \$5.85!

HIGH-END GOLD/SILVER/COPPER CONNECTORS

D.H. Labs

These excellent connectors are gold-plated and made from pure, high-conductivity copper. They feature a layer of silver (not nickel) under the gold plating for added corrosion resistance and improved conductivity. Can be crimped or soldered. Made in the USA. Purchasing options available:

SCSLGSP-1	#10-#14 Spade Lug	Each \$1.95
SCSLGSP-2	#8 Spade Lug	Each \$3.95
SCBNGB-1C	Single Banana Plug with Insulator Sleeve Gold-plated, 9 contacts instead of usual 4.	Each \$3.95
SCP-1	#10-#14 Pin Connector, 5/8" pin Gold-plated, solder only.	Each \$2.95

MICROPHONE MANUAL: DESIGN AND APPLICATION

BKB29

David Miles Huber

\$36.95

Written for both the beginner and the professional, this book provides the latest techniques, tools, and tips needed to keep you abreast of the ever-changing technologies of microphone design and placement and environmental acoustics. Topics covered include: the microphone pickup and its method of operation; cable/connector interfacing; single-microphone placement; stereo "miking" fundamentals, including spaced-pair, coincident, and near-coincident techniques; applied placement techniques with the music production environment, video/film media, and speech and music reinforcement; and microphone accessories. 1988, 297pp., 7" x 10", softbound.

AUDIO ENGINEER'S REFERENCE BOOK

BKB28

Michael Talbot-Smith, editor

\$159.95

This text covers a wide range of audio topics at a level equivalent to first year degree standard in electronic engineering/physics. Written by acknowledged experts in audio engineering, its contents include Basic principles; Acoustics and acoustic devices; Recording and reproduction; Digital equipment; Studios and their facilities; Distribution and audio signals; and Miscellaneous topics. United Kingdom, 1994, hardbound. IN PRODUCTION; PLEASE CHECK AVAILABILITY.

OLD COLONY SOUND LAB

PO Box 243, Department B94
Peterborough, NH 03458-0243 USA
24-Hour Lines:
Telephone: (603) 924-6371 or
(603) 924-6526 FAX: (603) 924-9467

OUR DISCOUNT POLICY

Order Value	Discount
<\$50.00	0%
\$50.00-\$99.99	5%
\$100.00-\$199.99	10%
>\$200.00	15%

Mastercard, Visa, Discover, check or money order in US funds drawn on US bank.

PLEASE BE SURE TO ADD SHIPPING CHARGES

Shipping Charge According to Destination and Method Desired (\$)

Order Value	United States		Canada		Other	
	Surface	Air	Surface	Air	Surface	Air
< \$50.00	3.00	7.50	5.00	7.50	10.00	20.00
\$50.00-99.99	4.00	15.00	7.50	15.00	20.00	30.00
\$100.00-199.99	5.00	20.00	15.00	20.00	30.00	40.00
> \$200.00	6.00	30.00	25.00	30.00	40.00	50.00

NEW THIS ISSUE



well as the enthusiastic amateur wishing to improve his techniques or the keen listener interested in gaining a better understanding of the recording medium and sound quality in general. Beginning with a look at the nature of sound itself, the reader is able to follow the progress of a recording from the acoustic environment, through selection of equipment and microphone balance techniques to the various forms of audio reproduction including disc, tape, digital magnetic, optical, and thermomagneto-optic disk recording. United Kingdom, 1991, 267pp., 5½" x 8½", softbound.

ADVANCED AUDIO PRODUCTION TECHNIQUES **BKB27** *Ty Ford* **\$28.95**

This book explains how to create concepts and use current audio technology to achieve "audio pictures" in the mind of the listener. By using visual language, charts, and graphs, the author offers a multidimensional approach to the realization of practical concepts that are the basis of good audio. Key features include interviews with award-winning audio producers; step-by-step instructions on connecting and operating equipment; clear, easy-to-understand explanations of digital theories and operations; and insight into envisioning and executing the right sound. Through use of this book, even if you do not have a strong technical background, you will be able to operate complex audio systems successfully. 1993, 148pp., 6" x 9¼", softbound.

THE ART OF THE SOUND EFFECTS EDITOR **BKB21** *Marvin M. Kemer* **\$21.95**

In this volume directed toward the film student, beginning film professional, and apprentice sound editor, the author sets forth his personal approach to sound editing, based on his years of experience with vehicles such as *Ben Hur*, *Dr. Zhivago*, and "The Man from U.N.C.L.E." In an easy-to-read, anecdotal style, he describes the responsibilities of the sound editor and the assistant sound editor, taking the reader through the various steps of the sound editing process. 1989, 107pp., 6½" x 9¼", softbound.

NEWNES AUDIO & HI-FI HANDBOOK **BKB25** *Ian R. Sinclair, editor* **\$79.95**

This is the revised and updated second edition of the previously entitled *Audio Electronics Reference Book*, which has been substantially reduced in price and now has many new contributors. The aim is to present as wide a perspective as possible of high-quality sound reproduction, including reproduction under adverse circumstances (PA and in-car), from less conventional sources (such as synthesizers), and with regard to the whole technology from studio to ear. Chapters include: Sound Waves (by Dr. W. Tempest); Microphones (John Borwick); Studio and Control Room Acoustics (Peter Mapp); Principles of Digital Audio (Allen Momington-West); Compact Disc Technology (Ken Clements); Digital Audio Recording (John Watkinson); Tape Recording (John Linsley Hood); Noise Reduction Systems (David Fisher); The LP Record (Alvin Gold); Disc Reproduction (Don Aldous); Tuners and Receivers (Hood); Preamps and Inputs (Hood); Voltage Amplifiers and Controls (Hood); Power Output Stages (Hood); Loudspeakers (Stan Kelly); Loudspeaker Enclosures (Kelly); Headphones (Dave Berriman); Public Address and Sound Reinforcement (Mapp); In-Car Audio (Berriman); Sound Synthesis (Mark Jenkins); Interconnections (Momington-West); and The Future (Sinclair). United Kingdom, 1993, 820pp., 6¼" x 9½", hardbound.

AUDIO IC CIRCUITS MANUAL BKB24 *R.M. Marston* **\$24.95**

A useful guide for the audio IC user, dealing with devices such as low frequency linear amps, dual preamps, audio power amps, charge coupled device delay lines, bar-graph display drivers, and power supply regulators. United Kingdom, 1988, 168pp., softbound.

SOUND RECORDING AND REPRODUCTION **BKB20** *Glyn Alkin* **\$19.95**

This book is an exceptionally comprehensive overview of the whole field of current audio art and technology. It contains a wealth of vital information of interest to the professional sound recordist as

EFFECTIVE AUDIO-VISUAL: A USER'S HANDBOOK **BKB22** *Robert S. Simpson* **\$42.95**

Here is a handy volume for anyone who needs to know more about audio-visual equipment and techniques. It not only discusses the traditional A-V approaches such as slide-tape, multi-image, film, and video, but also introduces the role of computer graphics and the application of interactive A-V. These varied approaches are discussed as they apply to the most commonly encountered A-V uses--business presentations, conferences, training sessions, museum exhibits, and visitors' center displays. This second edition has been extensively rewritten, with updated illustrations and new chapters on commissioning A-V programs and on computer-based multimedia. United Kingdom, 1992, 241pp., 7½" x 10", hardbound.

SOUND EFFECTS: RADIO, TV, AND FILM **BKB23** *Robert L. Mott* **\$42.95**

Created for students preparing for a career in radio, TV, or film, and professionals wishing to expand their knowledge of the field, this book offers invaluable information on the role sound plays in these media. All aspects of the craft are explored, ranging from the techniques used in Shakespeare's Globe Theatre to the challenges and expectations of today's electronic venues. The reader will learn what sound effects are, why they are used, and how they are created. Included are discussions of the history of sound effects; different types of sound effects; creating sound effects from scratch; recording sounds in the studio and field; the advantages of live sounds over tape; knowing why and when to use sound effects; Foley and the Foley stage; and recording and editing equipment. 1990, 223pp., 6¼" x 9½", hardbound.

ACOUSTICS IN THE BUILT ENVIRONMENT: ADVICE FOR THE DESIGN TEAM **BKB26** *Duncan Templeton, editor* **\$97.95**

Acoustics in the Built Environment is an invaluable work of reference for the building professional, covering all aspects of acoustics. It is unique in its range of topics: the environment, transport infrastructure, building design, building systems, and buildings in use. Each section has been contributed by an expert in the field, and presents information highly relevant to the day-to-day work of project design teams in a concise, readily accessible, and usable form. Chapters include: Environmental acoustics; Design acoustics; Services noise and vibration; Sound systems; and Technical information, comprised of both a detailed glossary and listings of equivalent, international, American, British, French, and German standards. United Kingdom, 1993, 158pp., 8¾" x 12", hardbound.

VALKYRIE LINE-STAGE PREAMP KIT

If you want to hear sound that reproduces the original as closely as possible, this hot new preamp is for you! Designed by Grayson King and introduced in the 1/94 issue of *The Audio Amateur*, the Valkyrie reveals many details that might not have been audible previously and is likely to bring to your ears much that you've been missing. Three buffers included (four possible), as well as state-of-the-art power supply. Top-quality parts throughout: Avel transformer, Panasonic caps, Roederstein resistors, Alps "Blue Velvet" pots. Article reprint included. Build it yourself to save, or buy it with the boards ready to go!

KK-13	UNASSEMBLED VALKYRIE PREAMP KIT, not including enclosure, shielding strip, knobs	\$389.00
KK-13C	UNASSEMBLED VALKYRIE PREAMP KIT, including enclosure, shielding strip, knobs	\$479.00
KK-13A	VALKYRIE PREAMP KIT WITH ASSEMBLED PC BOARDS ONLY, all other parts including enclosure, shielding strip, knobs—final enclosure assembly left to user	\$539.00

OLD COLONY SOUND LAB

PO Box 243, Department B94
Peterborough, NH 03458-0243 USA
24-Hour Lines:
Telephone: (603) 924-6371 or
(603) 924-6526 FAX: (603) 924-9467

OUR DISCOUNT POLICY

Order Value	Discount
<\$50.00	0%
\$50.00-\$99.99	5%
\$100.00-\$199.99	10%
>\$200.00	15%

Mastercard, Visa, Discover, check or money order in US funds drawn on US bank.

PLEASE BE SURE TO ADD SHIPPING CHARGES

Shipping Charge According to Destination and Method Desired (\$)

Order Value	United States		Canada		Other	
	Surface	Air	Surface	Air	Surface	Air
< \$50.00	3.00	7.50	5.00	7.50	10.00	20.00
\$50.00-99.99	4.00	15.00	7.50	15.00	20.00	30.00
\$100.00-199.99	5.00	20.00	15.00	20.00	30.00	40.00
> \$200.00	6.00	30.00	25.00	30.00	40.00	50.00

Announcing
VANCE DICKASON'S
LOUDSPEAKER RECIPES
BOOK ONE

An owner-built loudspeaker with truly dazzling performance is now within the reach of almost any reasonably intelligent constructor. Loudspeaker building, only a very few years ago, was a matter of a few hand tools and some plywood, plus some guesses as to the technical details. Our knowledge of what makes a special combination of drivers and crossover components the best possible has been growing explosively in the last decade.



Vance Dickason, bestselling author of *The Loudspeaker Design Cookbook* (over 33,000 English copies sold, with German and Portuguese versions also available) brings almost twenty years of experience, research and hands-on knowledge to this new book on designing and building four tested and proven two-way loudspeaker systems.



The best news, however, is that the directions, definitions and instructions for realizing these four demonstration systems, contain all the right questions and the clear paths to their answers which enable you to build excellent performing two-way systems with an almost endless combination of available woofers and tweeters.



Dickason shows you how to look for the right driver characteristics to be paired successfully

with the right crossover components and also how to fix any anomalies which may trouble your particular choices. Although the four two-way systems which are meticulously documented in this book, along with an outstanding general purpose subwoofer, may be built just as they are defined here, you are not limited to building these systems only.



Loudspeaker Recipes, Book 1, lays a firm groundwork, both theoretical and practical, for building as many varied and successful two-way loudspeaker systems as you wish. The book benefits from the latest techniques for computer aided design, but is also rich in proven construction practices for building practical systems. Mr. Dickason is not only a published author and Editor of *Voice Coil*, the monthly newsletter for the loudspeaker industry, a Contributing Editor for *Speaker Builder*, but also is a professional consultant and product reviewer as well.



Loudspeaker Recipes, Book 1 provides a powerful tool for any music lover who wishes to build a technically outstanding and satisfying loudspeaker system for home listening. Watch for new volumes in this series at your bookseller.

SALE! \$19.95

**IF YOU ORDER
BEFORE
PUBLICATION**

SALE!

YES! PLEASE SEND ME #BKAA30 @ \$19.95

FOR S/H INCLUDE: \$3 USA

\$5 OTHER SURFACE \$10 OTHER AIR

TOTAL AMOUNT OF ORDER \$ _____

NAME _____ TODAY'S DATE _____

STREET _____

CITY _____ ST _____ ZIP _____

MASTERCARD / VISA / DISCOVER _____ EXP. DATE _____

OLD COLONY SOUND LAB, PO BOX 243, PETERBOROUGH, NH 03458 USA
 24-Hour Tels.: (603) 924-6526 (603) 924-6371 24-Hour Fax: (603) 924-9467

SB Mailbox

BUFFER 'N SPICE

I would like to thank Dick Campbell for his kind words regarding my buffer design ("Exploring BUF 124 with PSpice" *SB* 3/94, p. 39).

Although I have access to PSpice and try to simulate all of my circuits, simulation has not entirely replaced bench testing...for two reasons. First, as Mr. Campbell points out, PSpice has problems with the cascode-complementary topologies. In some more complex configurations PSpice can't handle the circuits, giving "convergence" errors, despite the fact that the circuit is working happily on the bench. I have to do much more work with PSpice to simulate my designs reliably.

The second reason is the lack of PSpice models for the discrete devices in my circuits. IC components are now very well characterized with PSpice models, and are available from the manufacturers. However, very few discrete devices have such models.

PSpice has a model generator, with which

you can generate your own. But first you need reliable data for the devices. Unfortunately, discrete device datasheets rarely have the necessary data available. Model generation then becomes an intuitive process, very much dependent on one's experience.

Concerning Mr. Campbell's selection of devices, I have not tried these in the buffer. The 2N5457/59/60/62 have too large a spread in I_{DSS} to be applicable without testing and matching. The devices used in the original circuit are made by Toshiba of Japan, not by European manufacturers.

Erno Borbely
82205 Gilching, Germany

PC TO THE RESCUE

Is anyone trying to use low-cost PC sound boards to measure driver or box characteristics? It seems you could either use the

"recording" capabilities of the boards (with the AGC turned off) along with a test CD of various frequency tones or use the sound generation capability along with a low-cost sound meter. Perhaps you could use two sound boards—one to generate sounds and the other to record them. Maybe you could use the different methods for different measurements, for example, Thiele/Small parameters, box losses, distortion, SPL versus frequency, and so on.

Of course, the better the sound board, the better the resolution of your measurements. Today's sound boards run the gamut from \$40 to \$1,000. How can you quantize the precision of your measurements if you know the boards' parameters? I don't mind doing some programming, but I suspect that one of your editors could help me avoid some basic pitfalls along this path.

Lee Meador
Arlington, TX 76007

SpeakerBuilder

THE LOUDSPEAKER JOURNAL

A

NAME _____

STREET & NO. _____

CITY _____ STATE _____ ZIP _____

I have enclosed: Check or Money Order
 MC VISA Discover

Card No. _____ exp date _____

SUBSCRIBER SERVICES

- Check here if this is an address change
 New Subscription Renewal
 Gift (see below)
 1 Year, \$32 2 Years, \$58

Canada add \$8/year. Remit in US\$ drawn on a US bank only.
Overseas rates: \$50, 1 year; \$90, 2 years.
Rates subject to change without notice.

TELL OTHER SPEAKER BUILDERS ABOUT US!

Print their names & addresses below. We'll take care of the rest.

NAME _____

NAME _____

STREET & NO. _____

STREET & NO. _____

CITY _____ STATE _____ ZIP _____

CITY _____ STATE _____ ZIP _____

(When giving a gift subscription—fill in the recipient's name & address here.)

We try to keep our subscription process as trouble-free as possible, however, if you have a problem we want to help to correct it as soon as possible. Call or write with all the pertinent information including your account number.

Call us during business hours at (603)924-9464 or FAX us at (603)924-9467.

Our FAX machine is on duty 24 hours a day.

Speaker Builder, PO Box 494, Peterborough, NH 03458-0494 USA.

Contributing Editor Richard Campbell responds:

Your question is certainly perceptive, since it seems obvious that multimedia-type record/play PC boards can be used for general data acquisition.

I am pleased to report that the first that I have seen of this breed of software has crossed my desk and is also currently advertised in SB (see SB 2/94, p. 67). It is called "PC Audio Lab" by Microacoustics Audio Software Products (2553 Carpenter St., Thousand Oaks, CA 91362, 818-719-2566).

I am currently reviewing this product, so you'll get a chance to read about it in a future issue of SB. I can say at this time that it works very well using the SoundBlaster 16 card (the Media Vision cards can also be used) and that it has many of the functions you mention plus many more. The software talks directly to the card without the need to load specific drivers, which the card might need for other applications.

CAPACITOR GLUT?

I read with great interest Mark Seymour's article in SB 1/94 ("An Evolving Magnepan MG-1," p. 44) about adding capacitance to amplifier power supplies. I also obtained a copy of the Aug. 1980 *Audio* magazine article by Jung about this subject and now I have purchased the necessary parts to expand the capacitance of my Hafler DH120 amp from 6,600µF/channel with an additional 34,000µF/channel. Both Jung's and Seymour's articles convinced me that additional capacitance is one of the best sonic improvements to be made to any system.

I dug out the 4/91 issue of *Audio Amateur* and read the letter on p. 44 by Alan Douglas, "Megafarad Power Supplies." "Uh oh," says Douglas, additional capacitance might burn out the transformer/rectifier.

Jung and Seymour say nothing about this possibility. Although Seymour says his additional capacitance has operated well for ten years, I find myself wondering what might happen to my secondary listening system (the 120 powers a VMPS original sub and a pair of B&W DM 14s) if I go through with the extra capacitance.

Whom should I believe? Is the transformer/rectifier problem the reason that the high-end cost-no-object amp manufacturers don't offer the option of expanded capacity power supplies?

William H. Wallace
Stockton, NJ 08559

Mark Seymour responds:

You are right to be cautious about the modifications Mr. Jung and I have written about. Both warn readers of the dangers of adding capacitance without surge protection. Specifically, "Without such protection, the initial current surge will blow fuses, burn up the rectifier bridge, and degrade the transformer."

During operation, the current demand on an amplifier's power supply with an extended capacitor bank is a bit higher than without capacitance augmentation. Usually this can be handled within the rated current capability of the stock transformer and rectifier. It is

wise, however, to measure quiescent current demand with and without extra capacitance in the circuit to be sure.

The bigger danger comes when the amp is first switched on. The discharged capacitors appear as a dead short to the rectifier bridge/transformer combination. The instantaneous current demand (the "On" current spike) is huge.

Temporary insertion of a 100W wire-wound ceramic 10Ω resistor in series with the transformer limits the current surge to about 10A. This is within the current handling capability of the power transformer that came in my stock Hafler amp kit.



HI-FI NEWS & RECORD REVIEW

THE WORLD'S MOST RESPECTED HI-FI MAGAZINE

SUBSCRIBE TODAY AND GET THE NEXT 12 ISSUES FOR

\$65.00 USA \$75.00 CANADA

Please send me the next 12 monthly issues of Hi-Fi News and record Review from the next available issue.

Mr/Mrs/Miss/Ms _____

Address _____

Apt# _____

City _____

State _____ Zip _____

METHOD OF PAYMENT

Check enclosed (US dollars and drawn on a US bank)

Please charge my Visa Mastercard American Express

Account No. _____ Exp.date _____

Signature _____ Date _____

Please bill me

Return to Hi Fi News & Record Review, PO Box 384, Avenel, NJ 07001

FOR FASTER SERVICE USE YOUR CREDIT CARD AND CALL TOLL FREE

☎ 800-688 6247

AA41

JBL

JBL Professional, a preeminent manufacturer and marketer of professional audio equipment, has immediate opportunities in its Engineering and Product Development Department:

SENIOR TRANSDUCER ENGINEERING MANAGER

Candidate will conceive and develop advanced high and low frequency transducers for studio and sound reinforcement applications. Loudspeaker systems development experience also desirable. Manage and motivate team of engineers and technicians in a fast-paced and exciting technical environment.

The successful candidate will have a college degree in engineering (B.S.E.E. or B.S.M.E., M.S. preferred) and 10 years experience in loudspeaker component and system design. Management, communications, and leadership skills must be demonstrated, as well as a proven track record in developing innovative loudspeaker products.

JBL Professional is an equal opportunity employer, offers a competitive salary, a comprehensive benefits package, and the challenge of working for an industry leader. If you would like to join our team, please submit your resume, in confidence, including salary history to:

Mark R. Gander
Vice-President, Engineering
JBL Professional
8500 Balboa Blvd., PO Box 2200
Northridge, CA 91329

FOR THE CONSTRUCTOR

Ideal for desktop devices that require easily accessible controls, meters, switches, etc.

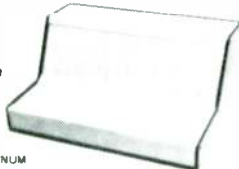

PANELS ARE .063" ALUMINUM

DUAL SLOPE METAL CABINETS		
MODEL	DESCRIPTION W x D x H x H1 x S1 x S2 x D1 (inches)	PRICE
DS-1	4 x 6 x 4 x 1.2 x 1.9 x 2.4 x 1.6	59.00
DS-2	6 x 6 x 4 x 1.2 x 1.9 x 2.4 x 1.6	63.25
DS-3	8 x 6 x 4 x 1.2 x 1.9 x 2.4 x 1.6	67.50
DS-4	10 x 6 x 4 x 1.2 x 1.9 x 2.4 x 1.6	71.50
DS-5	12 x 6 x 4 x 1.2 x 1.9 x 2.4 x 1.6	76.00
DS-6	18 x 6 x 4 x 1.2 x 1.9 x 2.4 x 1.6	81.00
DS-7	4 x 8 x 6 x 2 x 3.1 x 3.5 x 1.9	69.00
DS-8	6 x 8 x 6 x 2 x 3.1 x 3.5 x 1.9	73.00
DS-9	8 x 8 x 6 x 2 x 3.1 x 3.5 x 1.9	78.00
DS-10	10 x 8 x 6 x 2 x 3.1 x 3.5 x 1.9	82.75
DS-11	12 x 8 x 6 x 2 x 3.1 x 3.5 x 1.9	87.75
DS-12	18 x 8 x 6 x 2 x 3.1 x 3.5 x 1.9	100.75



PANELS ARE .063" ALUMINUM

- EASY TO FABRICATE
- SHIPPED FLAT
- ALL ITEMS STOCKED FOR QUICK DELIVERY
- DESIGNED FOR SMALL LOT PRODUCTION

RACK CHASSIS		
MODEL	DESCRIPTION W x D x H (inches)	PRICE
1RU5	19 x 5 x 1.75	30.85
1RU7	19 x 7 x 1.75	33.10
1RU10	19 x 10 x 1.75	35.25
2RU5	19 x 5 x 3.5	33.10
2RU7	19 x 7 x 3.5	35.25
2RU10	19 x 10 x 3.5	37.50
3RU5	19 x 5 x 5.25	41.90
3RU7	19 x 7 x 5.25	44.10
3RU10	19 x 10 x 5.25	48.30

SESCOM ALSO STOCKS HEAVY DUTY RACK CHASSIS, METAL CABINETS, EXTRUDED BOXES AND MORE! CALL OR WRITE FOR YOUR FREE 24 PAGE CATALOG



USA AND CANADA ORDERS (800) 634-3457
SESCOM, INC., 2100 WARD DRIVE
HENDERSON, NEVADA 89015 USA
TECHNICAL HELP (702) 565-3400
FAX (702) 565-4828

Reader Service #23

After 100 seconds, when the capacitor bank is charged, this resistor is bypassed (effectively removed from the circuit) by means of a time-delay relay. If you have a smaller supply in your amp you may wish to use up to 20Ω resistor, which will further damp the initial current surge but will slow the charge time of the capacitor bank.

You wonder about use of augmented power supplies in "cost-no-object" amps. First, except in the private collection of audio designers who have a target market of one, I have never seen (heard) a true cost-no-object amp.

Second, even if people do appreciate the value (\$/sonic enhancement), two other considerations rapidly become controlling: size and weight. The capacitor bank described in my SB 1/94 article occupies twice the volume of my power amp. If the devices were to be integrated, the new super-amp would be three times as large and weigh over 100 pounds.

Finally, design of commercial amps requires a balance of many design alternatives to yield the best sound for the dollar. While extension of the capacitor bank improves the sound, other design options might yield an even better product.

Large electrolytic capacitors are expensive. The ones I used came from an electronic parts surplus house at about 10% of wholesale cost. My capacitor bank, if assembled from new parts, would cost over \$1,000. If you had the extra \$1,000 you might choose a different amp to begin with.

CIRCUIT SIMPLICITY

Silva's article, "Low-Frequency AC-to-DC Converter" in SB 1/94, presents a useful idea. However, his circuit implementation seems unnecessarily complex.

I have enclosed a circuit schematic (Fig. 1) that has the functionality of Fig. A in his article, but uses only about one third the parts. All specified components are available from Digikey (701 Brooks Ave. S., Thief River Falls, MN 56701, 800-344-4539). A step-by-step look at my circuit will explain the simplifications:

Input stage: Silva uses a times-two amp with an amplitude control. All sinewave and function generators I have seen or used have more than enough voltage range, amplitude controls, and low-impedance (typically 50Ω) outputs. Therefore, I have simply deleted this stage.

However, I have used AC coupling, because many sinewave generators don't have a precise zero offset output, or have offsets that can be easily misadjusted. For the safety of the circuit and the speaker under test, it is important not to

allow DC in the speaker. Note that C1, although a large value, never sees much voltage, and only serves to block DC; therefore, it can be a cheap, low-voltage unit.

Voltage-to-current converter: Silva uses the classic Howland current pump, which is useful when the load (the speaker) must be grounded. Since no such requirement exists, a much simpler circuit is possible. Silva uses discrete components to provide the current needed to drive a speaker. I have used an inexpensive, readily available, power op amp, which eliminates more parts, and will drive the speaker at a minimum of ¼ amperes, which is more than enough.

Current monitor: Silva uses a differential amp for this purpose. Unless his voltage-to-current converter is misbehaving, he should just be able to monitor the voltage at its input. For the converter I used, the question is moot because the current-monitoring resistor connects to ground, and, therefore, current can be measured by monitoring its voltage directly—no circuitry required.

Voltage monitor: Both circuits require a differential amp. I have left out the protection diodes (which you can add, if needed) because the possibility of zapping the op amp through the 100k resistors seems low. Silva neglects to mention (an oversight?) that the resistors in this stage must match. Specifically, the ratios R4/R3 and R6/R5 should be equal to within 1° for best accuracy.

Precision rectifier: Silva uses a full-wave circuit, but the average value of the positive and negative portions of an AC waveform that has no DC offset are by definition equal. Therefore, a half-wave rectifier is sufficient if DC offset can be set suitably low. Fortunately, that is easy.

For highest accuracy, U1's offset should be trimmed to less than 0.001V DC by installing whatever value of R_{OFF} is necessary to accomplish the task, to either the plus or minus supply as required. Using a low-offset op amp for U2 keeps offset of the other stages low.

I have also chosen not to install an amplitude control before this stage because of the availability of cheap DMMs that may not read low-frequency AC well, but can provide sufficiently high resolution at DC. If you wish an amplitude control simply install a pot in series with R7, or install whatever value of R7 you like.

In the circuit I used, the filtering is combined with the rectifier for further parts savings. I used a 100k resistor instead of a 10k unit so that the filter caps could be ten times smaller. For best accuracy and lower leakage, they should be tantalum rather than aluminum electrolytics.

Supply bypassing: Silva shows no bypass

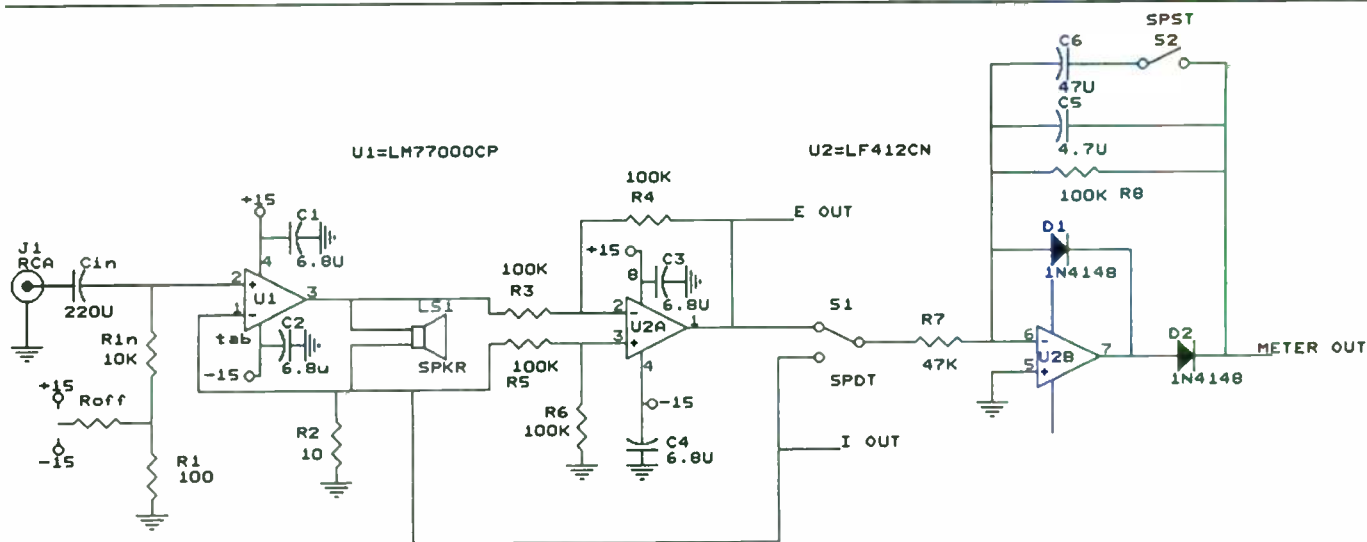

FIGURE 1: Suggested "Low-Frequency AC-to-DC Converter" circuit revision.

capacitors in his circuit. Unless the filter caps of your power supply are very close to your op amps, they must be used; otherwise, high-frequency oscillations will occur. It's good practice to include them, especially because of the low-impedance load that is being driven.

Note: A precision rectifier and filter determines the average, not the RMS, value of any AC input. Therefore, this circuit is not truly an AC voltmeter, won't give accurate absolute readings, and won't give accurate comparative readings on dynamic waveforms. It should only be used to compare static waveforms.

Roy Mallory
Bedford, MA 01730

Homero Sette Silva responds:

Thank you very much for your interest in my article in SB 1/94.

First, I developed this dedicated circuit to measure T/S parameters of loudspeakers, and not as a general-purpose measurement circuit.

Second, many of those interested in loudspeakers aren't electronics experts, but they need a precise and foolproof tool for their measurements.

Input stage: The reason for the 50k pot and the times-two op amp at the input stage was the simple (but stable) oscillator I used, with a fixed and small amplitude output. About the capacitor coupling suggested, I avoided this

due to increasing errors and great settling time, in the presence of very low frequencies.

Current-to-voltage conversion: Using a common ground to all measuring instruments (oscilloscope vertical and horizontal inputs, voltmeter, and so forth) and the device under test avoided a lot of trouble arising from wrong patching.

I'm aware about power op amps, but I don't have access to them here in Brazil. Unfortunately, Digi-key is far away.

Current monitor: The reason for a current monitor is very simple: to prevent disturbing the reference voltage drop in the sensing resistor, with low-impedance instruments or short circuits.

Voltage monitor: The lack of reference to

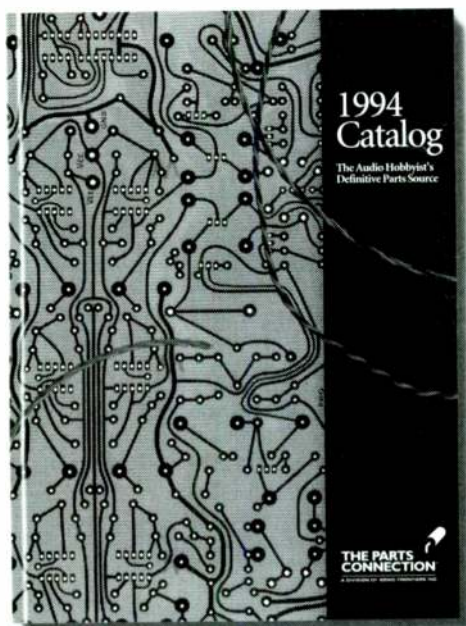

To make the most of your projects, start with the right tool.

Get connected.

Order The Parts Connection 1994 Catalog (a new division of Sonic Frontiers) to find the largest selection of audiophile-grade parts, components, upgrade/modification kits and complete kit products available in North America.

As a discerning hobbyist, you'll be inspired by the incomparable lines The Parts Connection carries, parts that are usually reserved for large, state-of-the-art manufacturers. With these components your projects will compete with the biggest names in high-end audio.



MIT MultiCap • Wonder Cap • Kimber Kap • Solo • Solen • Siemens • Hovland MusiCap • Wima
Holco • Rel-Cap • Dralonic • Vishay • Caddock • Mills • Matsushita • TKD • Noble • Cardas
Kimber Kable • Discovery • Audioquest • MIT • ClearAudio • Alps • Bourns • Shalico Attenuators
Elma • Electrosch • Nichicon • Gold Aero • RAM • Mallory • Ruby Tubes • Edison Price
Linear Technology • Motorola • Analog Devices/PMI • International Rectifier • MagneQuest
Sonic Frontiers • Pearl • Tube Sockets • WBT • Neutrik • Curcio Audio Engineering • Kits

2790 Brighton Road, Oakville, Ontario, Canada L6H 5T4

Telephone (905) 829-5858 Facsimile (905) 829-5388 Toll Free Order Line 1-800-769-0747 (U.S. & Canada)

Our 1994 catalog has new and expanded lines of precision resistors, high-quality capacitors, hook-up wire, interconnect and speaker cable, hardware, semiconductors, volume controls and connectors.

We offer discounts of up to 30% off your purchase and your order will be processed and shipped within 48 hours of receipt. Back orders are as rare as many of the parts we carry.

To receive your copy of the new 1994 parts catalog and a \$10 discount coupon good on your first order over \$100, just send \$5 along with your mailing address or call with credit card information.

THE PARTS CONNECTION
A DIVISION OF SONIC FRONTIERS INC

Reader Service #26

Speaker Builder / 4/94 51

this fact was not "an oversight," and I found it a necessity with 10% components. The same applies to the current source.

Precision rectifier: A half wave rectifier is not the best choice in the presence of very low frequencies, since the large capacitors needed to filter the AC components will result in large settling times. This fact is very annoying, when measuring Q_{15} for example, since we are always changing frequency (from f_s to f_1 and f_2).

The gain adjust provided in this block was intended to calibrate the meter or modify its readings, without changing the loudspeaker current.

About reducing the filter capacitor, I said "increasing the resistor value allows you to reduce capacitor size proportionally, but temperature effect in the diode reverse current will be of concern." With aluminum capacitors a small value resistor is wise; using tantalum is a better choice.

Supply bypass: A very good practice. Thank you for reminding me.

Note: Throughout my text you'll find references warning that the circuit discussed was not a true RMS indicator, as in "you now have an AC voltmeter calibrated to RMS readings for distortionless sinusoidal input

signals" or "Remember, this will hold only for sinusoids, since the averaging circuit is intrinsically a mean-value indicator."

DINOSAUR POWER

Some years ago I purchased a pair of Z-40 Janzen electrostatic speakers. Although technology may long have passed them by, I have an affectionate attachment to them, and had the woofers reconed last year. From time to time the internal power supply in one of them fails and begins to blow fuses.

In past years, Soundmates in Minneapolis would repair the crossover/power supply boards at no charge. Unfortunately, Soundmates seems to have vanished in the years since my last encounter with the fuse problem. Can anyone out there help me locate a schematic for the power supply or put me in touch with Soundmates, the successor to Soundmates (if any), or suggest how I can repair these remarkable dinosaurs?

Bruce M. Chassy
Champaign, IL 61821

DRIVING DANIELLE

In my article "The Danielle II" (SB 2/94, p. 24), I mentioned limitations on the use of 4K111 drivers in cabinets which permit reflection of the rear wave. This has led to reader concerns about K2 cones in general. In order to avoid confusion, I offer the following:

1. The 4K111 drivers are excellent, with transparency, dynamics, and acceleration that few drivers can match. However, they would profit from a dipole arrangement (for its open sound and lack of reflections) or a transmission line to avoid reflections through the cone. Many other small, high acceleration, thin-coned drivers, including the Polydax MDA-100, would also profit from similar treatment.

2. K2 is a unique sandwich material with a core composed of hollow glass microballs. More rigid and better damped than simple Kevlar® cones, this product from FOCAL can better define transients and resist cone breakup.

As Dickason puts it, speakers can have quite a different "timbre soup" one from another. Successful speakers have been built around cellulose, K2 sandwich, Kevlar, honeycomb, aluminum, polypropylene, polyglass, ceramic, and other cone materials. The fun of speaker building is that of making music happen, not coldly applying technical know-how.

Marc Bacon
Montreal, Quebec H2H 2C3

Increase your electronics know-how and skills

The speed and intensity with which electronics penetrates our daily lives at home, at work, or in our car, tends to make us forget that we **can use electronics creatively** by building designs with a practical application and having the satisfaction of a successfully finished project. *Elektor Electronics*, which is distributed all over the world, can help you achieve these goals. Throughout the year, the magazine features original construction projects, informative articles and news on the gamut of electronics, science & technology, book reviews and information on new products. The past 11 issues contained 80 major and 97 minor construction articles, 21 articles of an educative or instructional nature, and 10 articles dealing with Science & Technology.

If you wish to increase your electronics know-how and skills, take out an annual subscription to *Elektor Electronics* by writing or faxing to

**World Wide Subscription Service Ltd
Unit 4, Gibbs Reed Farm
Pashley Road, Ticehurst
East Sussex TN5 7HE, England
Telephone +44 580 200 657; Fax +44 580 616**

You will then have the convenience of having the magazine delivered to your home, and the peace of mind that you will not miss any issue. The current rate for an annual subscription (11 issues) is \$US 57.00 (post paid - airspeeded).

There are also a number of *Elektor Electronics* books geared to the electronics enthusiast - professional or amateur. These include data books and circuit books, which have proved highly popular. Two new books (published November 1993) are *305 Circuits* and *SMT Projects*. Books, printed-circuit boards, programmed EPROMs and diskettes are available from

**Old Colony Sound Lab
PO Box 243, Peterborough NH 03458
Telephone (603) 924-6371, 924-6526
Fax (603) 924-9467**

SOLVING EQUATIONS

I am going crazy trying to figure out the mathematical sequence in "Stalking f_3 " by Manning Redhill (*SB* 2/93, p. 24). Just above equation (1) the author indicates that the response of a fourth-order high-pass system is given by that equation.

First question: Where do you find that out? Are there some useful books to explain the responses of various systems? I make my living writing computer programs and have a degree in mathematics so they can be fairly technical.

Second, in that equation the response is given as a function of x . Does this mean that I could calculate SPL in decibels as a function of frequency (Hz) using this equation? Does the response correspond to the output of the vented box and driver? And, further, is this given as a function of frequency?

Third, equation (2) shows x as a function of f and calls x the "normalized frequency." What does it mean to "normalize" the frequency? Would my calculation (above) of SPL use f as the independent variable rather than x ? Or would it just change the units along the bottom of the graph?

Fourth, and most important, what is the little d in the equations for the α_1 shown between equations (2) and (3)? It is also used later in the discussion, but I can find no definition for it.

Lee Meador
Arlington, TX 76007

Manning Redhill responds:

1. When the magnitude of the transfer function of a high-pass filter is given (this is what equation [1] is in my "Stalking f_3 " article), then it is sufficient to examine how the function behaves when the independent variable x becomes very small. The denominator goes to 1 so it can be ignored, but the numerator goes to x^4 , which labels the filter as fourth-order. In general, if the order is n , the amplitude response drops $6n$ decibels per octave.

2. and 3. The normalized frequency x is used only as a convenience. Whenever it appears in equation (1), substitute equation (2) for it. Now you have the amplitude response $R(f)$ as a function of the ordinary frequency f in hertz. In a computer program, (a) select a frequency f in hertz, (b) use it to calculate x in equation (2), and (c) substitute x into equation (1) for the frequency response $R(f)$ of the frequency you selected. Then (d) calculate $20\text{Log}_{10}[R(f)]$ to get the amplitude response in decibels. Now go back to (a).

4. In those equations between equations (2) and (3), the symbol d stands for denomi-

ULTIMATE CABINET TO FLOOR COUPLING

Finally, State Of The Art Is Now Defined In Speaker Spike Technology. The Tiger Spikes Are The Ultimate Design For Cabinet To Floor Coupling!

- Improves Bass Response
- Increases Focus & Imagery
- Great Cabinet Cosmetics
- Aircraft Grade Stainless Steel
- Fine Thread Design
- Penetrates 3 Inch Carpet
- Speaker Drill Bit Included

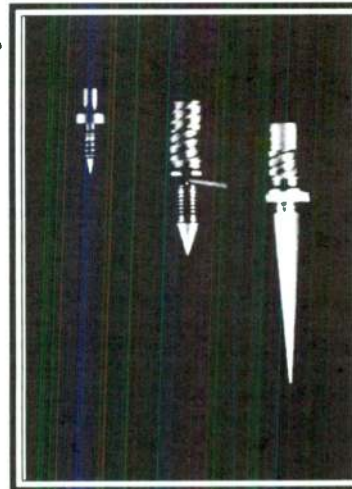

Three Models Available

TS-3 A three inch spike that penetrates three inch carpet

TS-2 Great for flat surfaces or thin carpet

TS-1 For use on platters for components

For more info call toll free

(800) 608-6574

Exclusive Audio Video Design

P.O. Box 4314 / Malibu / CA / 90265 / Fax: (310) 457-8449

Reader Service #44



Measure, Analyze & Equalize

- **10 band Real Time Spectrum Analyzer & Calibrated Microphone:** allows accurate analysis of listening room using built in digital pink noise generator
- **Integral trificated sliders:** provides highest levels of reliability for equalizer sliders
- **High-speed, low noise op-amps:** advanced components for improved sound quality
- **Digital audio switching:** provides shorter signal paths for better noise rejection
- **Sharp 18dB/octave subsonic filter:** removes power wasting, speaker damaging subsonic frequencies
- **Fully regulated power supplies:** maintains constant power levels for consistent performance and lower distortion
- **Made in USA with a 5 year parts & labor warranty**

AudioControl[®]

making good stereo sound better.[®]

Electronic Engineering & Mfg., Inc.

22410 70th Avenue West • Mountlake Terrace, WA 98043 • 206-775-8461 • Fax 206-778-3166

SHIPMENT TO FORMER SOVIET BLOC NATIONS NOW PERMITTED.

Reader Service #5

Speaker Builder / 4/94 53

JBL

PRODUCT MANAGER

JBL Product Managers function in a diverse, fast-paced environment, taking new products from concept, through development to market launch, managing all aspects of the process while working in cross-functional development teams.

The successful candidate will have a college degree in engineering (B.S.E.E. or B.S.M.E.) or related discipline and 3-5 years experience in loudspeaker acoustic design and/or mechanical/plastics design. Additionally, particular emphasis will be placed upon project and schedule management and communication skills. Familiarity with the studio and home recording markets is a benefit. Computer literacy is also required.

JBL Professional is an equal opportunity employer, offers a competitive salary, a comprehensive benefits package, and the challenge of working for an industry leader. If you would like to join our team, please submit your resume, in confidence, including salary history to:

Mark R. Gander
Vice-President, Engineering
JBL Professional
8500 Balboa Blvd., PO Box 2200
Northridge, CA 91329

ACJ 1

Active Crossover Kit

*totally modular design
class-A discrete circuitry
balanced & unbalanced i/o
2 and 3 way system capability
1st, 2nd, 3rd and 4th order networks*

a

*Jean-Claude Gaertner/Erno Borbely
design
sold exclusively through
Welborne Labs*

Call, fax, or write us for more information.
Or send \$10 for our complete 200 page
design manual and catalog featuring
other audio kits plus our full line of
audiophile quality parts and supplies.

P.O. Box 260198
Littleton, CO 80126
PH: 303-470-6585
FAX: 303-791-5783
Visa & Mastercard accepted

nator—again, a notational convenience since the grouping of the symbols $Q_1, Q_{1s}^{1/2}$ appears in the denominator of the definition of all the α 's.

A very useful, friendly book is *Analog Filter Design* by M.E. van Falkenburg, published by Holt, Rinehart, and Winston (1982). It assumes you know your way around the complex plane.

DO YOUR RESEARCH

I would like to respond to the editorial "Do We Need Postal Police?" in SB 2/94. What is an editorial like this doing in a loudspeaker journal? Please stick to the subject matter that we (the subscribers who pay for this) are entitled to. If you want a soapbox, write to the *Washington Post* or *Newsweek*.

Please do not mislead your readers with misinformation like "a government-subsidized agency." The USPS receives no tax subsidies; all revenues come from postage rates, which must rise from time to time like everything else due to inflation. Deregulating or privatizing the USPS is not the fix all people would like it to be. (Look at what happened to the trucking, airlines, and telephone industries, which are not now cheaper or in better shape.) Corporate greed can be as bad as bureaucracy.

I agree that the USPS is very poorly managed, and from the inside craft position (letter carrier) I hold, I can say this from experience (the editor cannot). Some say that we craft workers get paid too much. After seven years, I make only \$33,000/yr., although I work very hard (it is a very difficult job that may seem easy on the outside, but until you do it, don't say anything).

One of the other purposes for federal protection of postal services is to provide universal service to everyone everywhere. UPS has already gone to a two-tier rate structure (residential delivery costs more than commercial delivery). It's easy to imagine a privatized post office providing better and cheaper service in large profitable urban areas and more expensive, but worse, service in smaller or rural markets (bad for Aunt Flo living in the middle of Iowa). Changing the current postal structure would also eliminate free forwarding and free return of first-class mail, and free forwarding of second-class publications like SB.

Also, a FAX is not a letter; it is a data transmission falling under FCC laws, not postal regulations. The USPS is one of the cheapest and most efficient postal services in the world. In Germany it costs 67.2 cents for a first-class letter; Italy, 62.3 cents; Norway, 54.8 cents; Austria, 47.9 cents; Japan, 46.6

VOICE COIL

The Newsletter for the Loudspeaker Industry

Voice Coil is the monthly newsletter for the loudspeaker industry. Published on the 20th of each month and mailed first-class, it is one of the fastest and easiest ways for loudspeaker people to keep up with their ever-changing, fast-growing industry. Most experts agree editor Vance Dickason is a world class authority on the technology and significant news and advances happening in loudspeakers today.

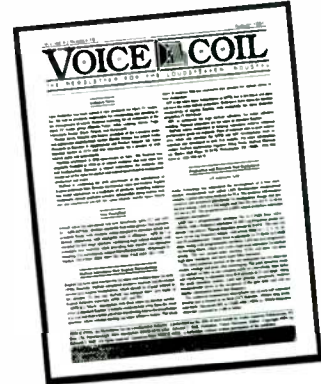

Reliable, practical information about the major changes in the loudspeaker industry is the primary priority. Published since 1987 *Voice Coil* is a collection of information from and about loudspeaker and peripheral manufacturers. It represents the most up-to-date information and developments and delivers them to you—FAST!

Each issue features new products, new patents, product reports, reviews of all the new computer aided design and test software, meeting highlights and much more.

It will be the very rare issue where you won't find something you didn't know.

YES, start my subscription to VOICE COIL

Two years @ \$90 (24 issues)

One year @ \$50 (12 issues)

Remit in US\$ drawn on a US bank. Rates subject to change without notice.

DISCOVER/MC/VISA NUMBER

EXP DATE

NAME

STREET & NO

CITY

STATE

ZIP

Voice Coil
PO Box 176, Dept. B94
Peterborough, NH 03458-0176
(603)924-9464 FAX (603)924-9467

Answering machine for credit card orders only:
before 9:00 a.m., after 4:00 p.m. and weekends.
Have all information plus MC/VISA available.

cents; Great Britain, 42.5 cents; and Canada, 34.5 cents. In some of these countries, which may only be as big as some of our states, it takes longer for delivery.

The problem with USPS is not whether it needs a police service—it does, to take care of mail fraud, bombs, illegal drug traffic, dishonest employees, and so forth. The problem is an overbloated, extremely top-heavy management structure that has four craft workers for every manager/administrator position that does not handle or move mail.

Robert J. Suryan
Seattle, WA 98155

The health and existence of these magazines depends to a large extent on USPS performance, both in handling promotional mail and second-class rules. It is very much in the interest of all readers that their postal service function well. Mr. Suryan has not provided any information of which I have not been fully aware. The fiction that the USPS has no government subsidies is belied locally when a supervisor drives to his job daily in an automobile with a "US Government" tag on it. This editor's "research" includes over 30 years of dealing with the postal service.

The services which reader Suryan mentions are nice on paper, but they do not work well and sometimes not at all. Forwarding and address correction has, in some cases, taken six months. Missorting mail is a daily occurrence, ranging from one to 50 pieces each day. Our periodicals are routinely destroyed without notice and without compensation. The postal service is the only delivery service which does not have to be fiscally responsible for destruction of property, unless the sender pays for insurance. The latter is difficult to collect and takes a lot of time and paperwork.

The people who serve the USPS are to be commended, as always, for coping with an institution that must be modified for their sakes, as well as the public's. The postal system's problems are a matter of record with almost every periodical in this country, including The Reader's Digest. Significant change in the system will benefit postal employees most of all,

PREVIEW Glass Audio

Issue 2, 1994

- Constructing Cascodes
- New Dynaco PAS Upgrade
- Lowe's Servo Bias System Revisited
- Output Transformers, Part I

and they deserve better, as do those who depend upon the system.—Ed

CAVEAT EMPTOR

I was quite excited when I read Peter Manchev's letter in *SB Mailbox*, *SB 5/92*, p. 64, telling of his experiences with an 18" Orevox Essence WC-18125 woofer. The specs looked interesting, and, when plugged into my MacSpeakerz program, yielded very promising performance graphs for a moderate-sized sealed box.

I contacted the supplier, and bought a WC-18125. Unfortunately, the actual speaker falls far short of the advertised specifications and, while it does produce a lot of subjectively impressive "boom," as Mr. Manchev enthuses, it does not go very low. The measured f_3 is 34Hz, instead of the advertised 15Hz, so that the f_B (4.3ft³) turns out to be around 48Hz, instead of the computed and anticipated value of 28Hz. So much for my dream of -3dB at 25Hz in a small box.

Moreover, since I wrote to the supplier (Goldwood Products, of Northridge, CA) about my disappointment, I have received no reply. I think *SB* readers should be warned not to buy a "pig in a poke," but when pur-

SALE! PLUS FREE ADHESIVE!

MARKERFOAM™ ACOUSTIC FOAM GIANT 54" x 54"
Immediate Shipping

2" Reg \$29.95 Now \$19.99 • 3" Reg \$39.95 Now \$29.99! KILL NOISE QUICK!
High performance, full-size sheets of super high density Markerfoam. EZ mount. Blue or gray. Super-effective sound absorption for studios. Markerfoam offers best value, looks professional & is proven in studios worldwide. Request Foam-Buyers Guide Catalog, specs & free samples today. VISA, MC, AMEX, COD, PO's, QUANTITY DISCOUNTS.

MARKERTEK JUMBO SOUND ABSORB BLANKETS
Heavy-duty 72" x 80" padded blankets absorb sound wherever they're hung or draped. Fabulous for stage, studio & field use. Top professional quality at a super saver price! Weight: 6 lbs. Black, \$19.99.

MARKERTEK BLADE TILES™
HIGH PERFORMANCE
LOW, LOW COST!
\$3.49 per tile, 16x16x2"
America's best acoustic tile value, only from Markertek!
Charcoal. Also available 16x16x3" as shown, \$4.49 each.

MARKERSTIK™ foam adhesive FREE with any Foam purchase in this ad! Limited offer. A \$5.95 per tube value.

SONEX
All the colors and sizes plus great prices!

*** Get our FREE 149-page catalog of over 6,000 exclusive and hard-to-find supplies for audio & video.**

800-522-2025 America's most unique catalog for audio & video!
FAX: 914-246-1757

MARKERTEK™
4 High St., Saugerties New York 12477 U.S.A. **VIDEO SUPPLY**

Reader Service #10

SPEAKERWORKS

"SPECIALISTS IN THE ART OF SPEAKER REPAIR"

FACTORY AUTHORIZED SERVICE:
Advent, B-I-C, Bozak, EPI, RTR, Cerwin-Vega, JBL Home & Pro

Speaker parts & adhesives, cones, spiders & dust caps

3 Way Crossovers Circuit
Breaker Gold Plated Binding
Posts \$19.95 each!

Replacement grilles for Altec, B-I-C, Cerwin-Vega, JBL & Marantz

Refoam kits available for 4", 5-1/4", 6-1/2", 8", 10", 12", & 15" speakers - only \$29.95 (JBL slightly higher)

Special Closeout on rebuilt DYN Audio Drivers: MR 17.75, W30-100, W24-100, W17-75. BELOW COST!

We Buy Dead Speakers: Altec, E-V & JBL



1-800-526-8879



NO CATALOG AVAILABLE
CALL US FOR HARD TO FIND DISCONTINUED PARTS
4931 A-1 South Mingo / Tulsa, Oklahoma / 74146

Classified

TRADE

ACT AUDIO COMPUTER SYSTEMS. Custom configurations for your design needs. Lowest prices. Ship anywhere in USA. Send your wish list, we send quote. **ACT AUDIO COMPUTER SYSTEMS**, 619 Moon Clinton Rd., Coraopolis, PA 15108, FAX (412) 264-0677. T4/94

CONTROL CABINET VIBRATIONS AT THE SOURCE: specially designed high-density speaker gasket material that is D-E-A-D. Stays resilient, adhesive backed. **KELDAMP:** 1/16" x 1/2" x 100' roll, \$48. **MEADOWLARK AUDIO**, (619) 598-3763, FAX (619) 727-6473. 5/94

AUDIO PHASE INDICATOR: Hand-held tool for engineers and enthusiasts. Bicolor LED shows "IN" or "OUT" relative phase for loudspeakers, microphones, etc. For more info, write or call **CRYSTAL LAKE DESIGNS**, PO Box 591, Crystal Lake, IL 60039, ph. (815) 455-0799. T4/94

HIGHLY ACCLAIMED AUDIO/VIDEO POWER CORD. Unique configuration serves as low frequency EMI filter. Superb audio, with pinpoint resolution of visual detail. Money back guarantee!! Phone/FAX (510) 548-5721. 4/94

10TAP AND 20TAP 10 AND 12 GAUGE AIR-CORE COILS! 10GA: 20mH 20TAP \$175; 10TAP, \$140!; 10mH 10TAP, \$125!; 5mH 10TAP, \$95! 12GA: 2mH 20TAP, \$110; 10TAP, \$75!; 1mH 10TAP, \$65! Every coil individually measured (20TAP = 210 measurements, 10TAP = 55) using Stanford Research SR715 (0.2% accuracy)! **CUSTOM VALUES AND INCREMENTS NO PROBLEM.** Send check or money order to **KIM GIRARDIN**, Box 1181, Winona, MN 55987. Will ship freight collect. Delivery in 4 to 6 weeks. T5/94

TWEETERS: 32 Philips ribbon AD21600RT8, \$50 ea.; 12 Dynaudio D28-AFSQ, \$30 ea. **JOHN ÖTVÓS**, RR# 4, Brighton, ON Canada K0K 1H0, Phone/FAX (613) 475-3633. 6/94

STATE-OF-THE-ART PASSIVE CROS-OVERS AND COMPONENTS. Custom coil winding our specialty. Free Design Guide. **ALL-PASS TECHNOLOGIES**, PO Box 453, Amityville, NY 11701, (516) 598-1320. T8/94

WIDER, DEEPER, MORE HOLOGRAPHIC SOUNDSTAGE: Room Acoustics Handbook \$14.95, Monarchy 22a DAC \$695, Level 1 Mod \$295, Digital Cable \$125, Loudspeakers from \$995. **MACH 1 ACOUSTICS**, RR# 2, Box 334A, Wilton, NH 03086, phone/FAX (603) 654-9826. T8/94

MYLAR 1/2 mil, genuine DuPont, 48" width, \$1/ft. ESL transformers. (503) 742-7640. T7/94

ELECTROSTATIC parts, supplies, exotic circuits. Free catalog. **DAVID LUCAS, INC.**, 924 Hulton Rd., Oakmont, PA 15139, (412) 828-1967, FAX (412) 828-0422. T2/95

WORLD'S LARGEST SELECTION! Home, auto and pro speakers, parts and reconing services, 200 pages! \$10 (refundable), Visa/MC, \$12. **TRI-STATE LOUDSPEAKER**, 650 Franklin, Aliquippa, PA 15001, (412) 375-9203. T5/94

FOR SALE

REK-O-KUT turntable; Audio Empire tone arm; Shure M75E cartridge; dbx NX40 noise reduction system; EICO 14W monotube amp; Heath WA-P2 monotube pre-amp; University KEN-15 horn-loaded enclosure. John Bundy, 6 Aspen St., Etna, NH 03750, (603) 643-5567.

Acoustic Research model AR-3 speaker system. Cherry wood cabinet. Very good condition, main driver has been replaced. Asking \$150. Andre, (305) 475-6116.

SPEAKER BUILDER CLASSIFIED ORDER FORM

PLEASE PRINT IN CLEAR BLOCK LETTERS OR TYPE. SPELL OUT EACH WORD. NO ABBREVIATIONS.

1	2	3	4	5	6	7	8	9	10
11	12	13	14	15	16	17	18	19	20
21	22	23	24	25	26	27	28	29	30
31	32	33	34	35	36	37	38	39	40
41	42	43	44	45	46	47	48	49	50

For Sale

Wanted

Trade, indicate number of insertions _____

For Sale ads are to *sell* personal equipment or supplies. **Wanted** ads are to *find* supplies, equipment or services. Both are "not for profit" ads and will only run once unless they are resubmitted. **Trade** ads are for any business or private party selling something for a profit.

Ad copy: A word is any collection of letters or numbers with a space on either side. **Illegible ads will be discarded.**

Price: All ads are \$1.50 per word. Deduct 5% on a 8X contract for **Trade** ads. Ten dollar minimum per insertion. **Payment must accompany ad. No billing.**

Subscribers receive *free* **For sale** and **Wanted** ads up to 50 words; .20 each additional word. Only one ad per category, per issue.

Please include your name, address and telephone number.

Please charge to my DISCOVER MASTERCARD VISA:

CARD NUMBER _____ EXP. DATE _____

Check/Money Order Enclosed

Subscription Account Number: A

NAME _____

COMPANY _____

STREET & NO _____

CITY _____

ST _____

ZIP _____

PHONE _____

Premium Parts & Accessories

The largest selection of audiophile capacitors, resistors, connectors, chassis wires in North America. MIT MultiCaps, Wonder Caps-solder-wire, SCR, Solen cap, Rel-Cap: Vishay, Holco, Caddock, Mills, Resista resistors: MIT, CARDAS, KIMBER, NIMTEC, & silver chassis wires, custom cables, SOLO foil inductors: all types of audio connectors: silver contact toggle, rotary switches & stepped attenuator kits. HEXFRED rectifiers, ANALOG DEVICES, HUBBELL hospital grade plugs & outlets. Tubes, feet, damping sheets & compounds, tools and many accessories. Extensive inventory - good prices and good service! Phone (415) 669-7181 or fax 669-7558 for a catalog. **Michael Percy, Box 526, Inverness, CA 94937**

Adcom GFA535II, \$200, NAD 2400THX, \$400, both 1 1/2 yr. old; Pioneer P-7 turntable, \$50; BSR 14-band equalizer with spectrum analyzer, pink noise, presets, remote, \$100. All pristine, boxes, papers, best offers welcome. Will ship. Jay, (410) 465-5297.

E.S.S. Hiel Air Motion tweeters. For more information, call Jerry at (415) 468-2990.

Matched MOSFETS for Pass/Thagard A75 amplifier available. Set includes all 37 (1 spare P-channel and N-channel output) IRF devices. \$175 US per channel plus shipping. Deadline for receiving your order is June 1/94. Anyone interested, please contact Nick Mastrobuono, 2086 Lakeshore, Sarnia ON Canada N7T 7H6, (519) 542-0964.

Gold Sound 424 24dB electronic crossover, \$275. Original box and manual. Call Bill, (702) 385-7170.

TWO WAYS to get the products, services and information you need from our advertisers!

1 CALL OR FAX . . .

and be sure to tell them you saw their ad in *Speaker Builder*.

Some even offer special discounts to our readers!

2 FILL OUT THE CARD . . .

Nearly every advertisement has a corresponding reader service number. Use the reader service card in this issue to request more information. *Please mail all cards within 60 days of receipt of magazine.*

Dahlquist DQ-10's, \$900/pr. or b.o.; Polk 5jr+, \$175/pr. or b.o.; original packing for both. One pair KEF B-30 in 9' T-line, \$300. Ron Meyer, 1508 Cedar Grove Plantation Dr., Savannah, GA 31419, (912) 925-2311.

FEP shrink tubing, fluorinated ethylene propylene. Vastly superior second generation Teflon, astoundingly transparent sonics, 175°C shrink temperature, very easy to work with, dielectric constant approximately .7. Mylar shrink tubing also available. Phone/FAX (510) 548-5721.

McIntosh speaker manuals and literature, SASE for extensive list; B&K technical review 1960-86 (67 issues), \$30; General Radio 1304A audio oscillator, exc., \$50; McIntosh MP14, exc., \$800; YAMAHA DSP-1, like new, \$175. Roger Russell, 366 W. Hornbeam Dr., Longwood, FL 32779, (407) 862-5143.

Four Precision T-305 woofers G.C., \$120; four Focal 8V416, \$110/pr.; \$200 the lot; Fluke #73 DMM, \$45; Mercer #9702 Digi-clamp meter/case L.N., \$50; Associated Research #2224 MEG-CHEK E.C., \$100; University N2A, N2B x-overs, \$25/pr.; E.V. Sentry IVB horn-loaded system x-overs, \$50/pr.; Soundcraftsman SE-450 EQ plus test LP, \$75. All plus shipping. Jim, (708) 425-6719.

JBL 2470 horn drivers, \$250/pr.; 2425, \$250/pr.; 2" to 1" adapters, \$50/pr.; 3106 x-overs, \$125/pr.; N-2400, \$80/pr.; horn adapters, \$25 ea.; Altec 4168C, \$125; N50188, \$80; 32C horns, \$100/pr. EV LS12 woofers, \$100/pr.; X-36 x-overs, \$30 ea.; Technics SA5550 receiver, \$125. (914) 688-5024.

JBL SR4722, excellent, \$450 ea.; TOA 385D w/15" Gauss, good, \$175 each. Jim, (516) 244-0214.

One Celestion 12" G12M type 1871 8Ω 25W guitar speaker, 1970s vintage, lightly used, \$50; six Audax TW60A tweeters with wedge mounts and 3.3μF 350V film caps, new, \$36/all; three Realistic 40-1390 ribbon tweeters, all new in boxes, \$39/all. Steve, (610) 759-3218, 5-10 PM weekdays, all day weekends, (PA).

Linkwitz system: KEF B-110, Audax HD100D25, STK-463 amps (30W/ch. ea.). 5" cubes on two black steel poles, 3-tiered base, faux granite finish, separate (dvc) woofer. Towers, T-line with T35 and M&M 5". Can send picture. Karl Rabe, Rt 4, Box 566, Pittsboro, NC 27312, (919) 542-4195.

OTL output tubes. 256AS7G, \$180. Ashby, (305) 475-5225.

One pair Dahlquist DQ20 speakers. Best offer. (718) 967-2553, please leave message.

Focal Satellites, pro built cabinet, 1 1/4" MDF, black with grilles, black hole treatment inside, external crossover in own box, gold posts, 70-20kHz ± 2dB woofer 5-K013 L tweeter T 120-K with rear chamber and impedance compensation. Below cost! \$350 US or \$450 CAN. Call Andrew, (514) 281-7954, Montreal, PQ.

WANTED

P.S. Audio PS1 with outboard power supply. Also consider APT Holman, Hafer. Shane Nicholson, (303) 443-4815, please leave message.

CLASSIFIED

INFORMATION

Four types of Classified Advertising are available in *Speaker Builder*:

FOR SALE: For readers to sell personal equipment or supplies.

WANTED: Help readers find equipment or services.

TRADE: For any business or private party selling equipment, supplies or services for profit.

CLUBS: Aid readers in starting a club or finding new members. Specific guidelines apply to *Club* advertising. Please write to the Ad Department for terms. Don't forget, include a #10 self-addressed stamped envelope.

PRICING

All advertising is \$1.50 per word, \$10 minimum per insertion. Deduct 5% for a 8x contract. Please indicate number of insertions. Payment **MUST** accompany ad. *No billing for word classified advertising.*

AD COPY

A word is any collection of letters or numbers with a space on either side. *No abbreviations*; please spell out all words. Count words, not letters. Ad copy should be clearly typed or printed. Illegible ads will be discarded.

SUBSCRIBERS

Receive *free For Sale, Wanted, and Club* advertising; 50 words maximum; each additional word just \$.20. Please only one ad per category, per issue.

Please include your name, address, and telephone number. If **TRADE** please indicate number of insertions on the ad. All free ads are run only once, then discarded. Ad questions, copy and copy changes cannot and will not be answered on the phone. All correspondence must be in writing addressed to:

Speaker Builder
Classified Department
PO Box 494
Peterborough, NH 03458-0494



The Ribbon Source

Newform Mid/Tweeter Ribbons have the musicality of electrostatics and the practicality of moving coils. These mono-polar drivers offer superb sound in all respects at a cost well below the expected audiophile price range.

Ribbons come in 4", 8", 15" and 30" and kits for most applications. We are tube friendly! Please call for specs and reviews.

Newform Research Inc.
1-705-835-9000

Custom installer, small OEM and international inquiries welcome.

LP/CD: Columbia, Sziget playing Tartini "Devil's Trill" sonata; Columbia, woodwind member of symphony orchestra playing Mozart opera arias; RCA, Eric Leinsdorf conducting Mozart's "Marriage of Figaro" overture; Odyssey, Casals as member of string quintet playing Strauss waltzes; DGG, string quartet playing Strauss waltzes transcribed by Schonberg & Webern. James Pann, (510) 223-6986, (415) 768-1234.

50-80 WPC transistorized basic amp; one Focal 10V516; pair 10" woofers; LCR meter. Jim, (708) 425-6719.

Bozak B-800 8Ω, 8" speaker; Triad HSM94 output transformer. Arthur Fisher, 100 Larkin Place, Santa Monica, CA 90402, (310) 459-0414.

Help! I'm looking to find any of the following items: Grommes model 250K mono amp; George Gott model G50D mono amp; Fisher XP-5 2-way speaker; Knight 3005 3-way speaker. Any condition ok. Cash or trade. Eric Brown, PO Box 4396, Ruidoso, NM 88345, (505) 257-3672.

REPRINTS

Available for articles, reviews, and advertisements.

Call today for details.

1-800-524-9464.

100 copy minimum

CLUBS

WANTED: SPEAKER AND AUDIO AMATEURS IN THE BRADENTON/SARASOTA/IST. PETERSBURG/TAMPA, FL AREAS. Would like to form a club and develop a lab for testing speakers/amps/preamps and passive and active crossovers or just to discuss speaker projects and ideas. Angel Rivera, Bradenton, FL 34206, (813) 792-3870.

AUDIO SOCIETY OF MINNESOTA. Now in its 15th consecutive year! Serving the many and varied interests of audiophiles in the upper Midwest. Monthly meetings, tours, audiophile concerts, special guests. For information and a sample of our latest newsletter, write ASM, PO Box 32293, Fridley, MN 55432, or call our 24-hour "Audio Hotline," (612) 825-6806.

AUDIO CLASSICS, LTD.

Buys - Sells - Trades - Repairs - Modifies.

Products listed by Class, Make, Model, Condition, Your Cost. AI=AS IS, D=Demo, EX=Excellent, F=Fair, G=Good, M=Mint, N=New. **AMPLIFIERS** Accuphase P11(M) \$1699, P102(M) \$1899, P260(M) \$995; Accurus A250(EX) \$869; Altac 1569(EX) \$399; Aragon 2004-II(EX) \$995; Audio Research Corp CLASSIC-120(EX)\$3995, CLASSIC-60(EX) \$2589, D76(EX) \$899, M100(EX) \$2999, ST70C3(EX) \$999; B&K EX442(BAL)(N) \$998, ST120(D) \$399, ST202+(N) \$799; Carver AV64(EX) \$569, TFM25(D) \$549, TFM42(D)\$589, TFM45(D) \$625; TFM55(D) \$749, TFM6CB(D) \$225, TFM75(D)\$1395; Chord SPM1200(D) \$2499; Classe DR8(EX) \$1295; Coda10(D) \$2350, 20(D) \$700; Conrad-Johnson EV2000(EX) \$3999, MF2000(N) \$1749, MF2300(N) \$2099, MF80(N) \$1199, MV100(EX)\$1950, PREMIER-8(D) \$12765; Counterpoint NATURAL(D) \$7595, SA100(EX) \$799, SA12(EX) \$699, SA20(EX) \$999, SA20A(EX)\$1399, SA220(EX) \$2199, SOLID-2(D) \$1999; Crown D40(G) \$199; Denon POA5000(N) \$999; Dynaco ST120(EX) \$119, ST400II(D)\$599, ST80(EX) \$199; Electrocompaniet AW250(D) \$499; Fisher30A(EX) \$199; Forte MODEL-7(M) \$1295; GAS SON-OF-AMPZILLA(EX)\$399; Hafler 9130(D) \$369, 9300S(D) \$999, 9500-MOSFET(EX)\$999, DH220(AI) \$299; Heathkit W5M(EX) \$399; Jadis DEFY-7(D)\$3799; Kinergetics KBA202-G(EX) \$1249; KBA75(D) \$1795; KrellKSA150(EX) \$3333, KSA250(EX) \$4295, KSA80(EX) \$1899; LevinsonML9(M) \$1699, ML11(M) \$1200, Manley EURO-35(D) \$1499; Marantz15(EX) \$395, 250M(EX) \$499, 8B(EX) \$1495; McIntosh MC2255(EX)\$2495, MC240(EX) \$1495, MC2505(EX) \$499, MC3500(G) \$6000, MC3500pr(G) \$15000, MC50 (EX) \$275, MC60pr(G) \$1699, MC7200N(EX) \$2049, MC75(G) \$899, MC754(EX) \$599; MotiMS100(EX) \$1825, OCM500(D) \$2099; Precision Fidelity M7A(AI)\$399; SAE MKIII-CM(G) \$399, P50(G) \$299. **CASSETTE DECKS:** Bang & Olufsen 5500(N) \$375; Carver TD1400(D) \$249, TD1440(D)\$249; Denon DRM170(N) \$359, DRS810(N) \$449, DRW840(N) \$399; Harman Kardon HK1000(AI) \$99, Nakamichi 550(AI) \$349; Tandberg TCD310(AI) \$125, TCD420(AI) \$209; Teac V400X(AI)\$99. **CD PLAYERS:** Accuphase DP70(M) \$2099; AMC Valve MusicCD6(D) \$549; Carver DTL100(EX) \$125, MDV500(EX) \$479, SDA370(D) \$519, SDA410(D) \$239, SDA450(M) \$299, SDA490(D)\$499; Denon DCD320(EX) \$599, DCD570(N) \$229, DCM320(D) \$199; Discrete Technology FD2040(G) \$199; Kinergetics KCD40(D)\$2195; Krell CD1(M) \$1666, CDDSP-CUSTOMI(EX) \$2295, MD10(EX)\$4995, MD20C(EX) \$3333, MD2ACI(EX) \$2169; Magnevox CD482WD\$109, CDB486(D) \$168, CDC792(D) \$197; McIntosh MCD7007(EX)\$1448; Philips CD910PBK(D) \$166, CD920(D) \$149; CDC875(D)\$199, CDC925(D) \$199; Procead PDT(M) \$749, PDT2(M)\$899, PDT3(M) \$1099; Pioneer SLP10(AI) \$149. **CD PROCESSORS:** KrellSBP32(EX) \$1599, SBP64(EX) \$3395; STEALTH(EX) \$1339, STUDIOI(EX) \$2195; Procead PDP2(M) \$499. **CROSSOVERS:** Accuphase F15L(M) \$1659; Levinson LNC2(M) \$1250. **EQUALIZERS:** Advent FBC(G) \$99; Audio Control C101-III(D)\$437, C131(D) \$999, Octave(D) \$149; Bose 901 EQ all seriesvarious condition \$99; RICHTER-SCALE(N) \$345, TEN-II(N) \$219, TEN-PLUS-II(N) \$279; McIntosh MQ101(EX) \$199, MQ104(EX) \$249, MQ107(EX) \$399; MXR 124(EX) \$149, 125(EX) \$149; Soundcraftsmen 20-12(G) \$99. **GUITAR AMPS:** Art 490(EX) \$499; Peavey MARK-III(EX) \$349; SWR BABY-BLUE(EX) \$499. **GUITARS:** Fender TELECASTER(M) \$1199; Gibson CE-CELEBRITY(M) \$1199; Kramer DUKE(EX) \$125; Pedulla MVP(M) \$999; Rickenbacker325JL(M) \$1199; Sigma CR9(N) \$250. **HEADPHONES:** GradoSR200(D) \$189; Stax LAMBDA-CLASS-MX(D) \$699, LAMBDA-SIG(DI) \$1425, SR-SIGMA(EX) \$299, SR34-PRO(D) \$179, SR84-PRO(D) \$219, SRD5(EX) \$49, SRD6(EX) \$75, SRD7-PRO(EX) \$125, SRD7SBI(D)\$159, SRDX(EX) \$150. **INTEGRATED AMPS:** AMC Valve MusicCVT3030(N) \$899; Carver CM1090(D) \$544; Dynaco SCA80(EX)\$199; McIntosh MA6200(EX) \$1099; Tandberg TIA3012A(EX) \$399. **LINE CONDITIONERS:** Counterpoint PAC15(D) \$425, PAC5(D) \$295; Tripp-Lite LC1800(EX) \$249, LC1800A(EX) \$249. **MICROPHONES:** AKG C451E(EX) \$199. **MIXERS:** Gately SM6(AI) \$160; ShureM67(EX) \$99; Sony MX777(G) \$199, MX1000(EX) \$350. **MUSICAL ACCESSORIES:** Boss DR550MKII(EX) \$179. **PHONOGRAPHS:** Victor VV-S-215(G) \$395, VVXII(G) \$395. **PRE-PREAMPS:** Accuphase C11(M) \$1399, C17(M) \$749; Advent MPR1(N) \$79; All-Test DevicesATD25(EX) \$99; Arcam HA10(EX) \$49; Audio Standards MX10A(EX) \$275; McIntosh MCP1(EX) \$275. **PREAMPLIFIERS:** AccuphaseC22(M) \$795, C202(M) \$1199; Accurus L10(EX) \$516; Adcom SLC-505(EX) \$99; Amber FF17 (EX) \$225; APT HOLMAN(EX) \$149; Athena MC1(EX) \$299; B&K PRO5(D) \$355, PRO10MC(EX) \$399; Carver C11(N) \$399, C15V(D) \$699, C16(D) \$459, C19(D) \$999, C20V(D) \$849, C5(EX) \$333; Coda 01P(D) \$2750; Conrad-JohnsonPF1L(N) \$1049; Counterpoint SA1000(D) \$999, SA3000(D) \$1799, SA5000(M) \$3595; Dynaco PAS3(AI) \$75, PAT(AI) \$79, PAT4(EX)\$99; Electrocompaniet PRAMP-II(EX) \$349; Fisher 400C(X)\$499; Hafler DH101(AI) \$99; Harman Kardon CITATION-25(G)\$299, CITATION-A(G) \$199, Jadis JPL(D) \$3395; LevinsonNo25(M) \$1250, No26(M) \$2999; Kinergetics KPA2(D) \$999; KrellKSLA(EX) \$1699, KSP7B(EX) \$1666; Luxman 5C50(G) \$299; Marantz3300(G) \$399, 3800(G) \$399, 7 (EX) \$1999, 7T (EX) \$495, THIRTY-THREE (EX) \$399; McIntosh C11(G) \$1695, C20(EX) \$1399, C22(EX) \$1999, C26(G) \$399, C27(EX) \$699, C28(EX) \$699, C30(EX) \$1099, C32(G) \$999, C36(EX) \$999, C37(EX) \$1699, CR7(EX) \$399; MTI 500-MTI(G) \$99; Precision Fidelity C8-PF(AI) \$349; PS Audio PSIV(EX) \$199; Rotel RC980BX(D) \$449; Soundcraftsmen PRO-CONTROL-3(EX) \$199, PRO-CONTROL-4(EX)\$229; SUMO HLI1(EX) \$350; Yamaha C2(EX) \$149. **PROCESSORS:** ADCSS100SL(EX) \$75; Advanced Audio DNR911(G) \$99; Advent 100(G)\$99, ADVOCATE-101(AI) \$50; Audio Pulse 2(G) \$99; AudiosourceSS-ONE(AI) \$99; Bozak 902(G) \$99; Burwen DNF1201(EX) \$379; Carver C9(EX) \$99, DPL20(D) \$349, DPL33(D) \$289, H9A(V)EX\$209; CBS 220(EX) \$49; DBX 100(EX) \$59, 142(AI) \$85, 21(EX)\$49, 222(EX) \$149, 228(EX) \$99, 3B(EX) \$299, 400(EX) \$99; Fosgate DSM3608(EX) \$449; Harman Kardon 44+(AI) \$39; McMartinLR1004C(G) \$230; Pioneer SR101(EX) \$62; SAE 5000A(EX) \$299; Shure HTS5000(EX) \$249, SR101(EX) \$299; Sound ConceptsSX80(EX) \$49; Sound Workshop 220(AI) \$199; Yamaha DSP1(EX)\$199. **RECEIVERS:** Carver HR742(D) \$459, HR772(D) \$489, HR875(D) \$849, HR895(D) \$1150; Fisher 500B(G) \$369; Harman-Kardon HK385I(EX) \$99; Kycocera R461(D) \$399; Luxman R1050(EX)\$249; Marantz 22(AI) \$49; 2215(AI) \$49; McIntosh MAC1000(EX)\$1195, MAC4275(EX) \$1195; Philips FR920(D) \$219, FR930(D)\$325, FR940(D) \$399; Scott 340(G) \$239; Tandberg TR2040(AI)\$199. **RECORD CLEANERS:** VPI HW17(D) \$649. **REMOTE CONTROLS:** Bang & Olufsen 3000(G) \$199; McIntosh CR4(EX) 675, CR7(M)\$299, CR8(EX) \$149. **SPEAKER SWITCHES:** Avid ELC(EX) \$300; McIntosh P349(M) \$250, SCR2(EX) \$149, SCR2A(EX) \$149; NilesMSA6R(N) \$480. **SPEAKERS:** Apogee CENTAUR(EX) \$1250, STAGE-SW(EX) \$1995; Audiostatic ES100(D) \$2499; BIC REALTA(D) \$899; V52(N) \$149, V52+(N) \$99, V52S(N) \$75, V62(N) \$179, V830A(D)\$499; Carver SILVER-ED(D) \$1649; Dahlquist DQ16(N) \$700, DQ18(D) \$659, (G) \$499; Harman-Kardon SX19Y(EX) \$1320; JBL4410(N) \$499; LIBRA(G) \$149; Jensen S100(EX) \$75; JM LabMICRON(D) \$595, SYMBOL-I(D) \$369; KEF 1042(D) \$1499, 1053(D) \$2999, 1072(D) \$3999, C85(D) \$639, Q10(D) \$259, Q50(D) \$599; McIntosh ML1C(EX) \$50, ML2C(G) \$999, ML4M(G)\$1500, WS200(EX) \$299, XD715(M) \$799, XR1052(EX) \$999, XR230(M) \$849, XR240(M) \$1199, XR250(EX) \$1699, XR3(N) \$749, 1-XRT18(M) \$1199, XRT22(EX) \$4800; Sound Lab PRISTINE(D)\$3200; TDL STUDIO-3(D) \$1569. **SPEAKERS-RAW:** JBL C36WX(G) \$99, D130(EX) \$149. **SUBWOOFERS:** Kinergetics SW800(D) \$3299. **SYSTEMS:** Denon D60(D) \$885. **TAPE DECKS:** Ampex 1260(AI) \$99, AG500(EX) \$299; Crown 824(AI) \$399; Revox A700(G) \$499, A77(AI) \$299. **TEST EQUIPMENT:** Audio Control R130(D) \$615, SA3050A(N) \$995; Ferrograph ATU2(EX) \$499, RTS2(EX) \$499; General Radio 1396A(EX) \$750; Hewlett-Packard1220A(EX) \$325, 5300B/5308A(EX) \$500, 8050A(AI) \$350; Hickock539C(EX) \$799, 6000A(EX) \$399; Ivie IE10A(EX) \$625; Justi-Meter-III(AI) \$199; McIntosh AA2(EX) \$749, LOAD-BOX(EX) \$199, MI3(G) \$699, MPIA(G) \$1199; Shure M615(EX) \$299; SoundTechnology 1000A(EX) \$1799, 1200A(EX) \$1585, 1400A(EX) \$500, Stereosonics JB2(EX) \$199, TONEARMS: Grado LAB-TONE-ARM(G)\$999; Kuzma REF-A(D) \$1275; SME-V(M) \$1399. **TUNER PREAMPS:** Carver CT17(D) \$579, CT29V(D) \$999, CT8(D) \$549; Hafler945(D) \$535, 945S(D) \$575; McIntosh MX110(G) \$599, MX117(EX) \$999. **TUNERS:** B&K TS108(N) \$398; Carver T11B(D) \$739; Day-Sequerra FM-REFERENCE(D) \$4800; Denon TU680NAB(D) \$575; Dynaco FM1(AI) \$49, FM3(AI) \$99; Fisher 80R(AI) \$50, 90T(AI)\$49; Magnum-Dynalab ETUDE(D) \$1459, FT-R(D) \$299, FT101AB19(D) \$749, FT101AS19(D) \$779; Marantz 10B(EX) \$3495, 112(G) \$199, 20B(EX) \$699; McIntosh MR55A(AI) \$276, MR65(G)\$599, MR65B(AI) \$150, MR66(G) \$799, MR67(EX) \$799, (G) \$699, MR71(EX) \$899, (AI) \$249, (G) \$699, MR73(EX) \$599, MR74(EX)\$549, MR75(EX) \$999, MR77(EX) \$699, MR78(F) \$899, (EX) \$1399, MR80(G) \$1399; Scott 310B(AI) \$75, 350D(AI) \$99; SherwoodS3000III(AI) \$45; Tandberg TPT3001A(EX) \$995; Vector ResearchVU1500(EX) \$99. **TURNTABLES:** Fons CQ30(EX) \$199; MarantzSLT12U(EX) \$399; Thorens TD160BC-MKII(F) \$100; VPI HW19-JR-PLUS(D) \$1499, PL(C) \$279, TNT-JR(D) \$2299.

Call 8 AM-5 PM EST Mon.-Fri. for a FREE Catalogue

POB 176 GA, Walton, NY. 13856

607-865-7200

WANTED: PRO-SOUND HOBBYISTS OR CURRENT EMPLOYEES IN SOUND REINFORCEMENT FIELD to correspond with USAF serviceman in England. Looking for equipment sources and contact with anyone who has a passion for quality reproduction of live music. Rick Diaz, PSC 41, Box 6912, APO AE, 09464.

DO YOU LIVE NEAR LAWRENCE, KS? I am a student at the Univ. of Kansas looking for other speaker builders within driving distance. I would like to exchange ideas and listen to other homebrew systems. Michael Marmor, 1520 Lynch Court #2, Lawrence, KS 66044, (913) 843-8993.

ALL PERSONS INTERESTED IN STARTING AN AUDIO/SPEAKER BUILDER CLUB IN THE SOUTHWEST MISSOURI-NORTHWEST ARKANSAS AREA, please send your name, address, phone number, and something about yourself to: Greg McKinney, 900 S. Roanoke, Apt. 2, Springfield, MO 65806.

Are You Moving

Please send us your **NEW** address at least **four** weeks in advance.
Thank you.

THOSE INTERESTED IN AUDIO and speaker building in the Knoxville-East Tennessee area please contact Bob Wright, 7344 Toxaway Dr., Knoxville, TN 37909-2452, (615) 691-1668, after 6 p.m.

ARIZONA AUDIOPHILE SOCIETY located in metropolitan Phoenix is a growing and active club in the pursuit and reproduction of recorded music. New members are welcome. Meetings are last Tuesday of each month. Receive monthly newsletter and biannual journal. Club discounts with local high-end audio dealers. Send inquiry to Arizona Audiophile Society, PO Box 13058, Scottsdale, AZ 85267, or call Bob Williams, (602) 944-5929.

THE ATLANTA AUDIO SOCIETY is dedicated to furnishing pleasure and education for people with a common interest in fine music and audio equipment. Monthly meetings often feature guest speakers from the audio manufacturing and recording industry. Members receive a monthly newsletter. Call Chuck Bruce, (404) 876-5659, or Eddie Carter, (404) 847-9296, or write A.A.S., 4266 Roswell Rd. N.E., K-4, Atlanta, GA 30342-3738.

ELECTROSTATIC LOUDSPEAKER USERS GROUP is now a world-wide network for those interested in sharing valuable theory, design, construction, and parts source information. If you are interested in building, or have built, your own SOTA ESL we invite you to join our loose-knit organization. For information, send SASE to: Barry Waldron, 1847 Country Club Dr., Placerville, CA 95667.

THE BOSTON AUDIO SOCIETY, the nation's oldest (founded 1972), seeks new members. Dues include the monthly meeting notice and our newsletter, the *BAS Speaker* (6/year). Recent issues cover Carver, a/d/s; the founder of Tech Hi-Fi, Photo CD. Plus visits from famous speaker designers, listening tests, measurement clinics, research investigations, and more. Back volumes available. Membership includes engineers, journalists, consultants, and music-loving audiophiles like yourself. For information write to PO Box 211, Boston, MA 02126-0002, USA.

THE CATSKILL AND ADIRONDACK AUDIO SOCIETY invites you to our informal meeting. Join our friendly group of audio enthusiasts as we discuss life, the universe and everything! Toobers, Tranzzeestors, vinyl canyons, or digital dots. No matter what your level of interest, experience, or preferences, you are welcome. Contact CAAS at (518) 756-9894 (leave message), or write CAAS, PO Box 144, Hannacroix, NY 12087.

THE COLORADO AUDIO SOCIETY (CAS) is a group of audio enthusiasts dedicated to the pursuit of music and audiophile arts in the Rocky Mountain region. We offer a comprehensive annual journal, five newsletters, plus participation in meetings and lectures. For more information, send SASE to CAS, 1941 S. Grant St., Denver, CO 80210, (303) 733-1613.

CONNECTICUT AUDIO SOCIETY is an active and growing club with activities covering many facets of audio—including construction, subjective testing, and tours of local manufacturers. New members are always welcome. For a copy of our current newsletter and an invitation to our next meeting, write to: Richard Thompson, 129 Newgate Rd., E. Granby, CT 06026, (203) 653-7873.

ESL BUILDERS GROUP is a new address for people who have built or want to build electrostatic loudspeakers and associated (tube) drivers, or are just interested? An answer is ensured, if you include some kind of compensation for postage and handling. Write to: Gunter Roehrich, Bühlerstr. 21, 7030 Böblingen, Germany.

THE HI-FI CLUB of Cape Town in South Africa sends a monthly newsletter to its members and world-wide subscribers. To receive an evaluation copy of our current newsletter, write to PO Box 18262, Wynberg 7824, South Africa. We'll be very pleased to hear from you.

HI-FI COLLECTOR/HOBBYIST seeks "living letters"/audio penpals from other states to correspond via reel-to-reel tape. Noncommercial strictly; make up short monologues on subjects from vintage technology, with regional FM excerpts for background or equipment samples, from personal tales of yard-sale scavenging success, repair/restoration tactics and strategies, favorite service centers, general ways to handle the burgeoning obsession with arcane hi-fi gear. All correspondence on 3", 5", 7" reels (1/4" tape) will be cheerfully answered and tapes returned via parcel post. James Addison, 171 Hartford Rd., Apt. #7, New Britain, CT 06053.

THE PRAIRIE STATE AUDIO CONSTRUCTION SOCIETY (PSACS) meets every other month. Meetings feature audio construction, design, and analyses, blind listening tests, equipment clinics, auto sound, lectures from manufacturers and reviewers. PSACS, PO Box 482, Cary, IL, 60013, or call Tom, (708) 248-3377 days, (708) 516-0170 eves.

MEMPHIS AREA AUDIO SOCIETY being formed. Serious audiophiles contact J.J. McBride, 8182 Wind Valley Cove, Memphis, TN 38125, (901) 756-6831.

LONDON LIVE D.I.Y. HI-FI CIRCLE meets quarterly in London, England. Our overall agenda is a broad one, having anything to do with any aspect of audio design and construction. We welcome everyone, from novice to expert. For information contact Brian Stenning, 081-748-7489.

ENTEC SUBWOOFERS

Simply the best

408.736.6120

Fax 408.732.8107

THE LOS ANGELES AREA LOUDSPEAKERS DESIGNERS GROUP. If you're just starting out or an experienced builder and would like to share ideas on speaker design and listen to each other's latest creations, give us a call. Geoffrey, (213) 965-0449; Edward, (310) 395-5196.

MONTREAL SPEAKER BUILDER CLUB. Meets when it can, BYOB, discussions range from speaker design and testing to equipment modification. All welcome. Contact Andrew McCree, 4701 Jeanne Mance, Montreal, PQ, H2V 4J5 Canada, (514) 281-7954.

NEW JERSEY AUDIO SOCIETY meets monthly. Emphasis is on construction and modification of electronics and speakers. Dues include monthly newsletter with high-end news, construction articles, analysis of commercial circuits, etc. Meetings are devoted to listening to records and CDs, comparing and A-B-ing equipment. New members welcome. Contact Frank J. Alles, (908) 424-0463, 209 Second St., Middlesex, NJ 08846; or Bob Young, (908) 381-6269; or Bob Clark, (908) 647-0194.

THE INLAND EMPIRE AUDIO SOCIETY—soon to become **THE SOUTHERN CALIFORNIA AUDIO SOCIETY (SCAS)**—is now inviting audiophiles from all areas of Southern California and abroad to join our serious pursuit for that elusive sonic truth through our meetings and the *IEAS* official speaker, *The Reference* newsletter. For information write or call Frank Manrique, President, 1219 Fulbright Ave., Redlands, CA 92373, (714) 793-9209.

NORTHERN VIRGINIA BUSINESS CLUB. I am interested in turning my speaker-building interests into a profitable business. So I'm organizing this business club to attract other speaker builder entrepreneurs with the same interests. Call Frank Troy, (703) 912-8226, M-F, 7:30 a.m. to 4:30 p.m.

PACIFIC NORTHWEST AUDIO SOCIETY (PAS) consists of 60 audio enthusiasts meeting monthly, second Wednesdays, 7:30 to 9:30 p.m., 4545 Island Crest Way, Mercer Island, WA. Write Box 435, Mercer Island, WA 98040 or call Bob McDonald, (206) 232-8130 or Nick Daniggelis, (206) 323-6196.

TUBE AUDIO ENTHUSIASTS. Northern California club meets every other month. For next meeting announcement send #10 SASE to Tim Eding, PO Box 611662, San Jose, CA 95161.

EXPERIENCE!

Nothing compares to being at a live musical performance...
but Audax's experience can bring you close. We use cutting
edge materials and processes—including ultra-light, rigid, maximally
damped HD-A cones—to capture the subtlety and emotion of live music.
Join the audiophiles who depend on Audax as their number one source for a complete
line of loudspeaker products, many patented worldwide. And experience for yourself what
these customers already know: Audax manufactures the highest quality loudspeaker components
in the world, giving your system an unparalleled sonic advantage. Let our expertise perform for you.

For your 1994 catalogue or list of authorized distributors, contact Polydax Speaker Corporation, the U.S. subsidiary of Audax Industries, France.

polydax
SPEAKER CORPORATION

AUDAX

POLYDAX SPEAKER CORPORATION 10 Upton Drive Wilmington, Massachusetts 01887 Tel: 508.658.0700 Fax: 508.658.0703

**BACK ISSUES OF VOICE COIL
ARE AVAILABLE!**

All back issues of *Voice Coil* are available from the first issue published in November 1987. These may be purchased for \$5 for each single issue or a one-year set may be purchased for \$40 postpaid.

Send check
with dates of issues desired to:
Voice Coil

PO Box 176, Peterborough, NH
03458-0176
MC/VISA phone orders:
(603)924-9464; FAX (603)924-9467

SPEAKER BUILDERS/AUDIOPHILES in the Milwaukee, WI area. I am a speaker builder with test gear looking to join or form an audio club. Anyone interested contact Kirk Rontti, (414) 355-7509, leave message.

IF YOU ARE an "Organ Music Lover" and like to test your audio system, **SFORZANDO** has room for a few more members. We have about 3,000 "live," on-the-spot, cassette tapes that are not available in the stores. We are happy to lend them to you via the mail. Just ask EA Rawlings, 5411 Bocage St., Montreal, Canada H4J 1A2.

**SOUTHEASTERN MICHIGAN WOOFER AND
TWEETER MARCHING SOCIETY (SMWTMS).**

Detroit area audio construction club. Meetings every two months featuring serious lectures, recording studio visits, design analyses, digital audio, AB listening tests, equipment clinics, and audio fun. Club publication, *LC, The SMWTMS Network*, journals the club's activities and members' thoughts on audio. To join or subscribe, e-mail to ad282@leo.nmc.edu, phone to (810) 544-8453 and leave your name and address on the machine, or write SMWTMS, PO Box 721464, Berkley, MI 48072-0464.

**VINTAGE AUDIO LISTENERS AND VALVE
ENTHUSIASTS (VALVE)** meets the first Sunday of every month to swap vintage audio gear, audition rare and collectible equipment, and evaluate modifications and scratchbuilt projects. Dues provide a monthly newsletter with current reviews of vintage components and modification information; vintage service data; and access to an active network of serious collectors. For information, call (206) 697-1936 or write to 1127 NW Brite Star Ln., Poulsbo, WA 98370.



AVAILABLE NOW!

TC SOUNDS makes no-compromise drivers with linear motor-structures (underhung), high-compliance linear mechanical systems, and stiff lightweight composite diaphragms. Individual T/S-parameters for 8", 10", 12", 15" (5.5" & 18" soon). Call (619) 622-1212, or FAX (619) 622-9293.

PIEDMONT AUDIO SOCIETY in the Raleigh/Durham and Chapel Hill area is meeting monthly to listen to music, demonstrate owner-built and modified equipment, and exchange views and ideas on electronics and speaker construction. Tube and solid-state electronics are of interest and all levels of experience are welcome. Kevin Carter, 1004 Olive Chapel Rd., Apex, NC 27502, (919) 387-0911.

WASHINGTON AREA AUDIO SOCIETY meetings are held every two weeks, on Fridays, from 19:00 hours to 21:30 hours at the Charles Barrett Elementary School in Alexandria, VA. Prospective members are welcome but must register in advance in order to be admitted to the meetings. No exceptions please. Call Horace Vignale, (703) 578-4929.

WASATCH AUDIO, located in Salt Lake City. Our club is interested in construction, modifications, design, and listening to music. We are looking for members and ideas for our new club. Contact Edward Aho, (801) 364-4204.

WEST VALLEY AUDIO SOCIETY. We are starting a group interested in all aspects of high performance audio. West San Fernando Valley, CA. Contact Barry, (818) 225-1341.

Factory Direct Service
Ohm
Complete Speaker Catalog
Dealer List (718) 783-1111
Ohm Brand Upgrades & Drivers
Systems: \$200 to \$7000 pr.
Ohm Acoustics Corp.
241 Taaffe Place
Brooklyn NY
11205

THE WESTERN NEW YORK AUDIO SOCIETY is an active, long-established club located in the Buffalo area. We issue a newsletter and hold meetings the first Tuesday of every month. Our meetings attract many prominent manufacturers of audio-related equipment. We are involved in all facets of audio from building/modifying to exposure to the newest high-end gear, and the chance to hear more types of music. For information, write to WNY Audio Society, PO Box 312, N. Tonawanda, NY 14120.

Ad Index

Advertiser	Page	Advertiser	Page
A & S Speakers	17	Sescom, Inc.	50
Abilene Research & Development Corp.	24	Solen, Inc.	19
AC Components	35	Solo Electronics	6
Ariba	16	Speaker City, U.S.A.	31
AudioControl	53	Speaker Works	55
Elektor Electronics	52	Speakers Etc.	44
Exclusive Audio Video Design	53	Technologie MDB	33
German Physiks	11	The Parts Connection	51
Harris Technologies	13	Welbome Labs	54
HeadRoom	15	Zalytron Industries	29
Hi-Fi News & Record Review	49		
Image Communications	43	CLASSIFIED SECTION	
JBL		Audio Classics, Ltd.	59
Professional Product Manager	54	Entec Subwoofers	60
Senior Transducer Engineering Manager	50	Michael Percy	58
LinearX Systems, Inc.	CV2	Newform Research, Inc.	59
Madisound		Ohm Acoustics Corporation	62
Synchron	37	TC Sounds	62
VIFA Woofers	25	GOOD NEWS/NEW PRODUCTS	
Mahogany Sound	16	Abilene Research & Development Corp.	4
Markertek Video Supply	55	Alpha-Core	4
Meniscus	21	B & W	
Morel Acoustics		Matrix HTM Speaker	4
MW 114-S	8	Nautilus	4
High Tech	CV4	Bullfrog	3
Mouser Electronics	40	Canon	3
North Creek Music Systems	24	Circuit Guard International	3
Old Colony Sound Lab		Clair Brothers Audio Systems	3
Catalog on Disk	24	Cooustic	4
Loudspeaker Recipes	47	Design Acoustics	4
New Products	45-46	Galaxy Audio	3
Orca		Hemon Manufacturing	3
Focal	5	Old Colony Sound Lab	4
Black Hole/Aeon Cables	39	Quantum Sound	3
Parts Express Int'l., Inc.	CV3	QMI	3
Polydax Speaker Corp.	61	Sentec America	4
Q Components	40	Technologie MDB	4
RDL Acoustics	38	Techron	4

AUDAX KIT PLANS

Speaker Kit Plans Are Now Available From Parts Express!

"Kit Plans. Build Your Own Loudspeakers" is a 25 page booklet containing plans for 7 speaker kits. The Signature Series has 4 different kits utilizing Prestige and Reference Series components and was designed exclusively by Vance Dickason, author of "The Loudspeaker Design Cookbook". The enclosures, crossovers, and components were carefully selected by Mr. Dickason and computer optimized to ensure the highest level of performance. The Classic Series was designed in house by Polydax and includes 3 easy-to-build kits that offer great sound quality at an affordable price. All of the components and accessories you need to build any of these projects are available and in stock at Parts Express.

To receive the booklet "Kit Plans, Build Your Own Loudspeakers", and a copy of the 188 page Parts Express 1994 Catalog, just send \$1.00 to cover postage and handling (\$3.00 to Canada).



LA PASSION DU HAUT-PARLEUR

AUDAX

polydax
SPEAKER CORPORATION



Please send check or money order to receive the kit plans. Be sure to include your name and complete address with zip code. Mail to:

PARTS EXPRESS INT'L.
DEPARTMENT A
340 E. FIRST STREET
DAYTON, OH 45402-1257



Made
in
England

High-Tech Audiophile Loudspeakers

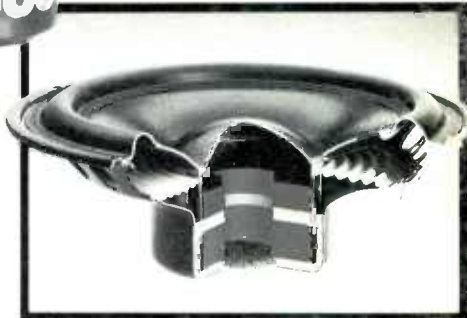

Typical Double Magnet Woofer Cross Section.

For Further Information Please Contact: **morel acoustics USA**

414 Harvard Street
Brookline, MA 02146
Tel: (617) 277-6663
FAX: (617) 277-2415

World Radio History

Reader Service #15