

Wireless Mics in Large Scale TV Productions

SOUND & COMMUNICATIONS

FOR CONTRACTORS, SYSTEM MANAGERS AND SPECIFIERS

FEBRUARY 1988



The Acoustics **ing**
White House Installs New System
for Presidential Briefings

81870 02110A7
17872
1 023C
BEAR SOUND & COMMUNICATION NS
21900 W. WINFIELD RD
TOPANGA CA 90290

Large scale concert sound reinforcement has a smaller future.

Manifold Technology™ delivers...twice the output in half the space!

Concert sound is getting smaller. System size, that is, not tour dollars! In fact, the high-level sound market is stronger than ever. But high transportation and setup costs are forcing lighter, smaller and more efficient speaker systems. While audiences demand better fidelity.

That's why we've made Manifold Technology *systems twice as loud in half the space*. The two-box, 4-way active MT-4 uses 4 (four!) drivers in each bandpass for unequalled acoustic output. Now, your system can be one quarter the size or four times as loud compared to other designs.

The MTA-42 Manifold Technology adapter combines four compression drivers without added distortion. And without the phase cancellations of Y-adapters! That's 4 supertweeter and 4 upper-midrange compression drivers on identical 60° x 40° constant-directivity horns. To complete the MTH-4 "high" box, four DL10X woofers use proprietary phase plugs to provide seamless vocals from 160-1600 Hz. The result is flawless 138-dB midbass at 1 meter!

The MTL-4 "low" box combines four 18-inch woofers in an ultra compact 36" x 36" x 30" cabinet. More efficient than horn-loaded subwoofers, Manifold Technology design prevents woofer "bottoming" even at 40 Hz with 1,600 watts input!

MT-4

Concert Sound System 50,000-Watt Array

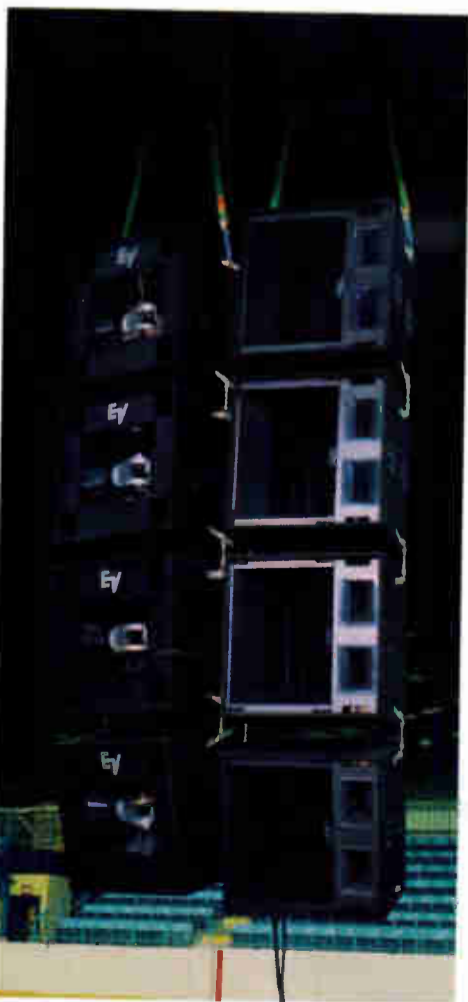

High output plus high fidelity

To produce high-level sound, most concert systems aim many horns at the same seating area. Unfortunately, this approach causes peaky frequency response, decreased sensitivity and ragged coverage patterns. With four drivers on each horn, a large-scale MT-4 system has fewer independent sources. For fewer phase-cancellation problems. Frequency response is smoother, sensitivity increased, and coverage perfectly constant.

A flying system that's second to none

MT-4 cabinets are optionally equipped with a unique two-point flying system that allows true point-source arrays. Tilt angle adjustment is easy because track positions are pre-engineered for popular array configurations. Trial-and-error guesswork is a thing of the past. Nothing is as easy as an MT-4.

You don't have to wait for the system of the future. It's here now! For a free MT-4 brochure, see your EV Professional Audio Dealer or write: Electro-Voice, Inc., Dept. SC-4, 600 Cecil St., Buchanan, MI 49107.

Circle 210 on Reader Response Card

Electro-Voice®

a MARK IV company

THE IEQ WITH Smartcurve™

Not Just Another
Programmable Equalizer
With MIDI™

The IEQ with Smartcurve™ is a programmable, high performance graphic equalizer that includes a video output. For those who wish to enjoy the video output of the IEQ, ART makes the IEQ Video Monitor.* Smartcurve™, proprietary software developed by ART gives you instant actual frequency response as easy as the push of a button. The IEQ Family consists of both the 2/3 octave and the 1/3 octave graphic equalizers. Both types come in two varieties, Controllers and Satellites. A Controller is a self-contained programmable intelligent graphic equalizer capable of controlling 15 satellites at once. IEQ Satellites are exactly the same unit except the front panel controls are eliminated.

IEQ Model Specifications: Controller & Satellite

- 128 battery backed presets
- MIDI
- Frequency Response
20Hz-20kHz ± 0.5dB
- THD - ≤ .009% @ 1kHz 0dBm typical
- Dynamic Range - ≥ 100dB typical
- Balanced inputs and outputs

*IEQ Video Monitor Features

- 19" rack mountable
- NTSC compatible monochrome monitor
- 4 Selectable inputs
- Standard RCA jacks for easy connections

It Has To Be A Work Of . . .

ART

Applied Research & Technology

215 Tremont Street
Rochester, NY 14608
(716) 436-2720
TELEX: 4949793 ARTROC
FAX: (716) 436-3942

For more information see your local dealer.

Circle 231 on Reader Response Card

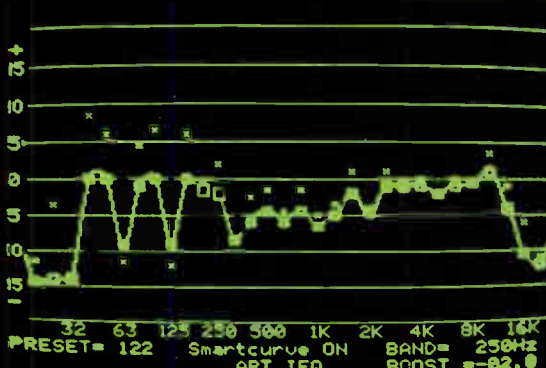
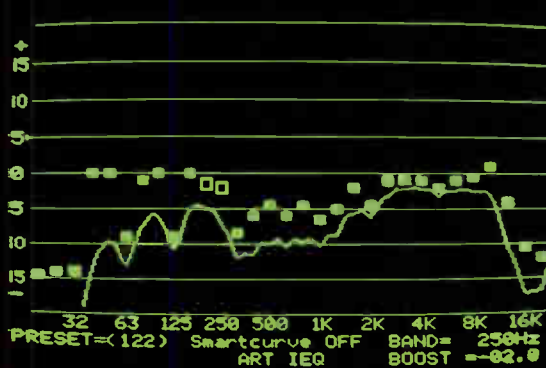
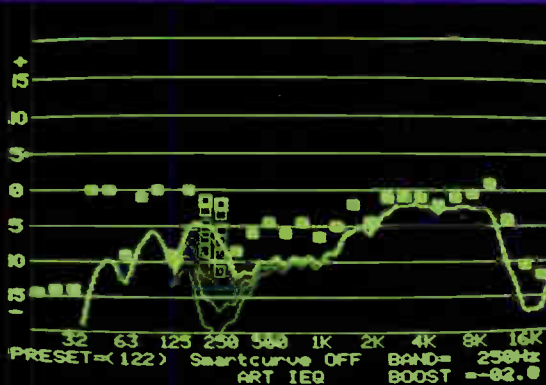

1 See the Sound

This is a video output of the IEQ as the unit is being adjusted. The sliders can be moved ± 15dB in 1/2dB steps to get the exact response you need. With the simple push of a button, complex equalization can be done in seconds with incredible accuracy.

2 Hear the Sound

The power of the IEQ readily becomes apparent as the video display plots the frequency response due to the slider settings. The IEQ offers high quality constant "Q" equalization. The video graphic display shows the correlation between the sliders and the frequency response.

3 Perfect Sound

Turn Smartcurve™ on and perfect equalization is at your fingertips. Note the difference between the second frame, (Smartcurve™ OFF) and this frame. The position of the sliders represent the actual frequency response of the EQ. Interaction between bands is virtually eliminated. Incredible! Just think, now when you adjust the EQ you get exactly what you need. The "perfect" EQ? Let your eyes and ears decide.



World Radio History



26

DEPARTMENTS

- 6 Editorial
- 8 Newsletter
- 50 Products
- 56 Datafile
- 60 Faces and Places
- 62 Rep News
- 62 Job Report
- 64 Supplies • Services • Support
- 66 Dr. Wokka
- 68 Ad Index
- 69 Classifieds
- 70 Technically Speaking

Consultant's Comments will resume in an upcoming issue; Marc L. Benningson is on sabbatical.

ON THE COVER

The Blue Cross corporate board room in Minneapolis, Minnesota, is one of the most elaborate of its kind in the U.S. The 40-person, custom-made board room is capable of conferencing on and off-site, and included the design of room acoustics, audio, lighting, video and control systems. The audio conferencing system is fully automated and concealed.

Photo by
Blumberg Communications

FEATURES

19 THE ACOUSTICS OF TELECONFERENCING by Steven J. Orfield

Steven J. Orfield discusses how to solve room acoustic problems in teleconferencing, interfacing room acoustics, frequency response, etc.

26 THE USE OF WIRELESS MICROPHONES IN LARGE SCALE TV PRODUCTIONS by Patrick Baltzell

Patrick Baltzell takes a look at how a Motorola spectrum analyzer is used to monitor the condition of wireless microphones while they are being used for large scale TV productions.

31 MIDI AND THE CONTRACTOR by Greg Prince

A round table discussion with industry leaders on how MIDI is doing in the sound and communication business.

36 HOSPITAL AND HEALTH CARE COMMUNICATIONS—FROM NOW TO THE 21st CENTURY, PART II by Ron Rosen

Rosen continues his discussion on health care communications by looking at the changing technology that's available.

42 INSTALLATION PROFILE: THE WHITE HOUSE INSTALLS NEW SOUND SYSTEM FOR PRESIDENTIAL BRIEFINGS by William M. Peterson

Peterson was the technical designer of special projects and the responsibility for this job came under his purview.

48 LAB TEST REPORT: THE ORBAN 464A CO-OPERATOR by Jesse Klapholz and Richard Feld

This month the Orban Co-Operator is put to the test.

COLUMNS

10 Theory and Application

William Thornton discusses bandwidth applications.

14 Sales and Marketing

Bill Hooper discusses market determination and how it can help your business.

53 Products in Review: A Closer Look

Gary D. Davis takes a closer look to see just how loud the Meyer UPM-1/P-1A loudspeaker system really is.

54 Book Review

Ted Uzzle sees how much power there is in "The Battery Book".

Copyright © 1988 SOUND & COMMUNICATIONS PUBLISHING, INC. Reprint of any part of contents without permission forbidden. Titles Registered in the U.S. Patent Office. Sound & Communications (U.S. P.S. 943-140) is published monthly by Sound & Communications Publications, Inc., 25 Willowdale Avenue, Port Washington, N.Y. 11050. 516-767-2500. President, Vincent P. Testa. Subscription rates: U.S.—3 years \$37.50, 1 year \$15.00. Canada and Mexico—3 years \$48.00, 1 year \$18.00. Foreign and South America—1 year \$25.00. Second-class postage paid at Port Washington, NY and at additional mailing office. POSTMASTER: Send address changes to Sound & Communications, 25 Willowdale Avenue, Port Washington, NY 11050.



THERE'S MORE TO OUR PERFORMANCE THAN MEETS THE EYE.

When the historic Royal Danish Theater in Copenhagen underwent modernization in 1983, plans called for a new sound reinforcement and stage monitor system. The designers found themselves faced with critically tight acoustical, spatial and visual requirements. Flexibility was essential: the theater needed a sound system that could deliver the full range of audio frequencies under all manner of theatrical applications, from ballet to musicals to pre-recorded accompaniment. At the same time, sight lines from every seat had to be maintained and leakage between the house and stage had to be controlled. The solution was an innovative custom design centered around standard JBL components.

JBL's exclusive Central Array Design Program (CADP) was employed to aid in designing and aiming the loudspeaker arrays. Coupled with extensive on-site testing, this resulted in a highly individualized sound

system that specifically addresses the needs and requirements of the theater. Meticulous selection of components and professional installation are reflected in the system's superior performance, which has received consistently positive reactions from the public and performers alike, ensuring that the Royal Danish Theater will go on thrilling audiences for another 100 years.

To find out how JBL can be a part of the solution to your sound problems, contact your JBL sound contractor. Whatever your loudspeaker and electronics needs, there's more to our performance. JBL.



JBL Professional
8500 Balboa Boulevard
Northridge, CA 91329

Circle 213 on Reader Response Card

World Radio History

Guest
Editorial:

Why Bother with Industry Standards?

Are there real advantages to industry standards, and if so, why do so many responsible manufacturers continue to ignore them? Let me poke this issue around for a bit and toss out a challenge or two.

I can think of at least one good reason to create and adhere to industry standards wherever possible: money. There could be significant cost reductions in *all* facets of the industry: manufacturing, installation and retail purchase. For example, a broad-based connector standard would eliminate the need for manufacturers to include redundant input/output hardware, and reducing both equipment and installation costs. Speaking of connectors, here's a good one: the U.S. signed an international agreement years ago—IEC 268—which created a polarity standard for input/output connectors. And yet to this day several large, influential U.S. manufacturers continue to ignore the standard, shipping products with reversed polarity and making installations that are much more difficult (and therefore expensive) for the contractor.

Why do manufacturers persist in ignoring the concept of standards? Apathy? Bureaucratic retardation (related to corporate ignorance)? Marketing myopia? Overinflated ego ("We're big enough to create our own standards")? Some combination of these haunts us all. I realize that conflict in creating standards is sometimes the product of simultaneous development of different technologies, such as the great VHS/BETA video format war. Trouble is, seldom does a manufacturer really gain from such a battle, and the industry as a whole loses momentum, efficiency and market growth. Could this conflict have been avoided? Something to think about.

The key to promoting industry growth and cost-effectiveness is responsibility and cooperation on the part of *every* manufacturer. We must make ourselves aware of existing standards, be watchful for areas that need standards, and then maintain a healthy and professional attitude toward cooperation. For example, our company has recently proposed a hardware standard for outboard DC power supply interconnection; no standard exists, so we research the area carefully and arrived at a cost-effective, reliable, easily-sourced solution. We've formally issued a plea to accept this format as an industry standard. However, should another manufacturer come up with a better scheme and let us know, we will happily consider changing our configuration in order to maintain a consistent standard.

My challenge to fellow manufacturers is this: if you're abusing an existing standard, make a production change—*now*. We've made countless production changes for less reasons, and they've been worth it. And if you conceive of a new standard, or areas that need standards, make your ideas known, perhaps through an existing organization such as the NSCA. Manufacturers, consultants and contractors should communicate and cooperate more aggressively to work toward a more well-defined industry from which we will all benefit. Use the trades, use the mail, use the phone...let's talk standards.

Larry Winter
V.P. Marketing
Rane Corp.

SOUND & COMMUNICATIONS

Editorial Director/Publisher
Vincent P. Testa

Managing Editor
Debra A. Pagan

Technical Editor
Jesse Klapholz

Assistant Editor
Fran Avnet

Contributing Editors
Marc Beningson, Gary D. Davis,
Ted Uzzle

Consulting Editors
Jerome J. Brookman, Chris Foreman

Technical Council
Dr. Mort Altschuler, *Professor Audiology, Hahneman University, Chief of Audiology, V.A. Hospital, Phila, PA*; Mike Biegel, *EPD Technology Corporation*; C. Leroy James, *Rees Associates, Inc.*; Richard N. Jamieson, *Jamieson and Associates, Inc.*; Russell Johnson, *Artec Consultants, Inc.*; Richard Negus, *Purcell Noppe Associates, Inc.*; William Parry, *Maryland Sound Industries, Inc.*; Daniel Queen, *Daniel Queen Associates*; Jon Sank, *Cross Country Consultants*; William R. Thornton, *Phd, PE*

Art Director
Andrew Elias

Assistant Art Director
Karen Waibel

Staff Artist
Gerard Caramannello

Typesetting
Leo Ancona, George Proper

Circulation Director
Deborah A. Droge

Advertising Director
Thomas Soevyn

West Coast Advertising Sales
Stuart Smith
(818) 769-6481

Vice President/Editorial
Judith Morrison

Editorial and Sales Office
Sound & Communications
25 Willowdale Avenue
Port Washington, New York 11050
(516) 767-2500



Sound & Communications • Music & Sound Output
The Music & Sound Buyer's Guide • Post
NSCA-TV News • NAMM-TV News • CES-TV News
The Music & Sound Retailer
Home Entertainment

YOU KNOW US FOR SPEAKERS.

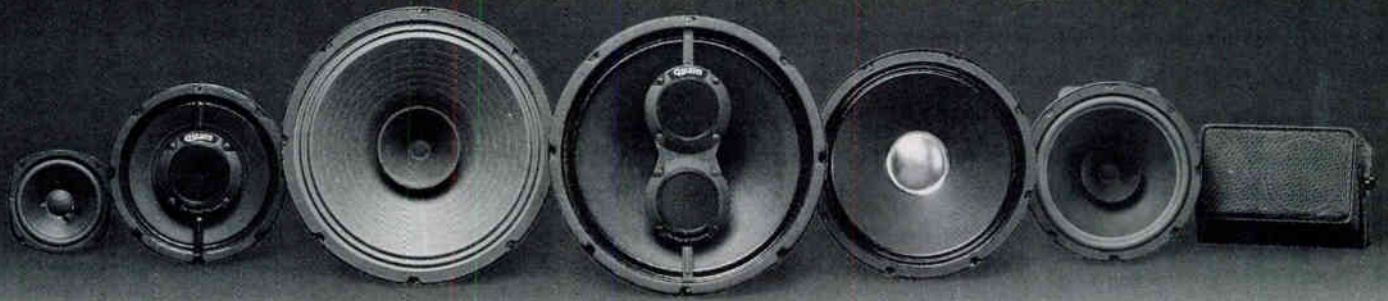

THE FACT IS, WE'RE LISTENERS.

Speakers started our business more than 50 years ago. Listening keeps us prospering today. Developing products and services you need. Continually introducing improved techniques. Providing you with the tools to be a leader in your market.

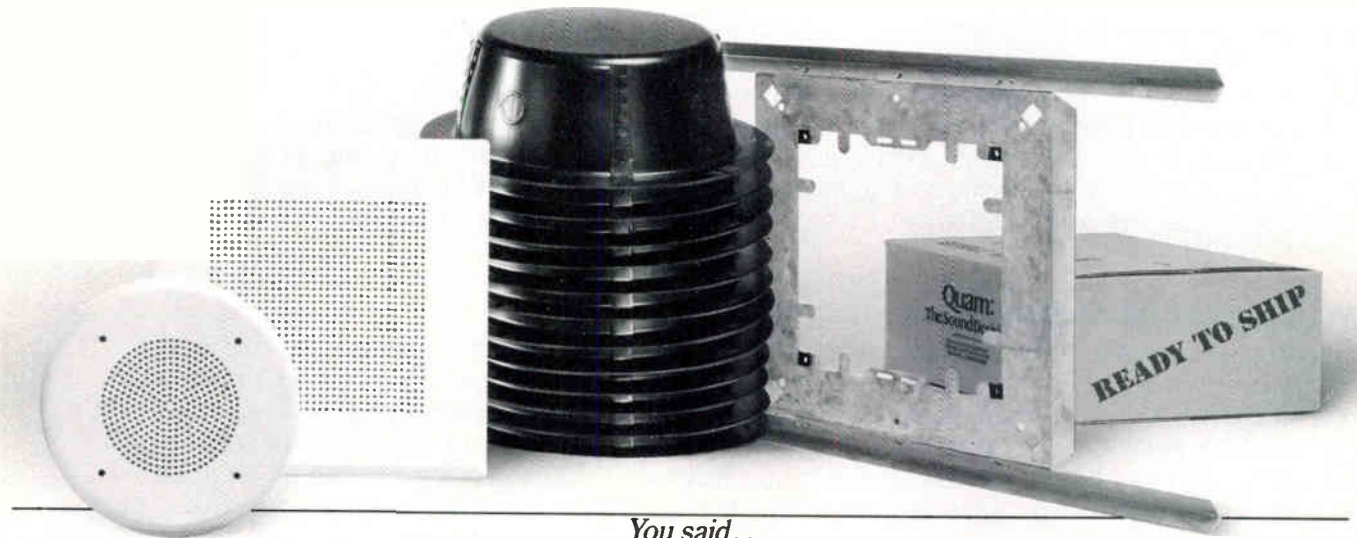

You said...

"GIVE ME BAFFLES THAT REALLY LAST."

Quam's do. The tile-matching, white powdered-epoxy finish of our full-range series of 8" and 4" baffles provides durability far superior to enamel or lacquer. They stand up to handling during shipping and installation, and maintain their fresh look.

"BACKBOXES TAKE UP TOO MUCH SPACE."

Not Quam ERD-8 backboxes. The unique, drawn design of these lightweight backbox enclosures means they nest for storage and transit—taking up one-fifth the space of traditional high-hats. More important to your customer, the one-piece, leak-proof construction of the ERD-8 backboxes results in problem-free air pletum installations with better audio response.

"MOUNTING ASSEMBLIES ON CEILING TILES TAKES TOO MUCH TIME."

The design of the Quam SSB-2 Speaker Support Bridge saves you substantial time. It eliminates the need to cut a close-tolerance round hole in the ceiling tile. Locking tabs on the bridge's center plate prevent movement during installation. And the SSB-2 accepts most of the industry's popular round or square baffles, with or without backboxes.

"I NEED IT, WHEN I NEED IT."

Quam's toll-free order line and factory inventory of over 100,000 products means you get exactly the products you want—even complete sound masking assemblies—shipped within 24 hours of receipt of your order.

So while speakers started it all, listening keeps us—and you—prospering. And we'll continue to listen—and respond to what we hear—while we refine and enhance our current products and create new ones to meet your evolving needs.

Quam: The Sound Decision Since 1930

Quam-Nichols Company • 234 East Marquette Road • Chicago, Illinois 60637 • (312) 488-5800

Circle 216 on Reader Response Card

GENTNER RESTRUCTURES FOR PROJECTED GROWTH

Russell D. Gentner, president of Gentner Electronics Corp., has announced a major restructuring of the corporation's management. The company, which formerly used a centralized marketing and sales department, has appointed directors of marketing and sales for the three major market areas served by Gentner.

According to Gentner, "Our company is approaching its product marketing in a new way. Instead of a single sales manager and a single marketing manager attempting to cover all of our markets, we are concentrating specific people on specific markets. One of the markets we will penetrate is the sound and communications industry. We are progressing very rapidly in this area and will introduce four new sound contracting products at NSCA in May."

Personnel changes at Gentner include: Elaine Jones, director of marketing and sales, sound and teleconferencing; Gary W. Crowder, director of marketing and sales, broadcast audio; John E. Leonard, Jr., president of Gentner RF Products Division, will continue management of marketing and sales to the broadcast RF market; Kelli Maag, marketing coordinator; Jennifer Jones, marketing assistant. Gentner is also in the process of hiring a director of operations to oversee the daily operations of the company including administration, office and engineering management.

SWITCHCRAFT REALIGNS MANAGEMENT GROUP

William C. Jones, president of Switchcraft, Inc. has announced a realignment of his management team within the overall Switchcraft structure. The company will now be organized into line and staff functions encompassing Seiscor Technologies, a subsidiary, and Sorensen Company, a division. The Chicago operation of Switchcraft will now be known as the Components Division. Howard L. Cohen, vice president finance for Switchcraft, will now have responsibility for all financial consolidations for the entire company.

COMMUNITY EXPANDS, ESTABLISHES SALES NETWORK IN CHINA

Community Light & Sound's part owner and director of international marketing, Christine Howze, disclosed that Community has formalized the establishment of a distribution network in the Republic of China. The distribution will be handled by Yang's Audio Visual laboratories. Managed by S. H. Yang, the company's offices are located in the capital city of Taipei. According to Howze, this new distribution network is part of an ongoing effort to increase Community's world-wide availability. "We've already established distribution in Australia, Japan, Singapore, Israel, West Germany and Sweden. In fact, while we're at AES in Paris this March we'll be looking into other countries for distribution and make ourselves available to those who are interested."

In other news from Community, the company has revealed that a major expansion of its production capabilities was made that enabled the manufacture of its CS and RS loudspeaker system to increase by 50 percent. Designed as part of a comprehensive plan to fill a projected need for a 50-75 percent greater output of these products, the expansion will additionally allow shipments to be made directly from inventory in the near future.

AES TO HOLD SIXTH INTERNATIONAL CONFERENCE

The Audio Engineering Society will hold a conference on the subject of sound reinforcement and architectural acoustics from May 5 through 7 at the Opryland Hotel

in Nashville, Tennessee. It will consist of papers and demonstrations representing the state of today's art in sound reinforcement systems.

This will be the sixth international conference organized by the AES around a single technical topic. Previous conferences dealt with digital audio, recording electronic music, and other subjects. There will be no trade exhibits at the conference, only non-commercial technical presentations.

Conference chairman is Ted Uzzle, director, market development at Altec Lansing in Oklahoma City, Okla., and *Sound & Communications* contributing editor and book reviewer. Vice chairman is Tom Roseberry, sales and marketing director for Innovative Electronic Designs, in Louisville, Kentucky.

The opening event at the conference will cover the history of sound reinforcement, and will be presented by *Sound & Communications* technical editor Jesse Klapholz. A session on computer aided sound system design is being assembled by AES international region vice president John Eargle, of JME Consulting Corp. in Los Angeles. Other sessions include new concepts in equalization and special sound systems for one-time mega-events.

AES CONVENTION TO BE HELD IN PARIS

From March 1-4, members of AES will be attending workshops and doing the can-can when the 84th AES Convention meets in Paris. Among the workshops offered: Digital Mastering, MIDI and SMPTE interface, and Sound Reinforcement. Paper Sessions will include: Loudspeakers, Audio Measurements and Digital Converters. For more information on other workshops and paper sessions contact the AES in New York at (212) 661-8528.

FOURJAY'S FOUNDER PASSES AWAY

J. Myron Fulkerson passed away recently at the age of 73 after a long fight with cancer. Myron founded Fourjay Industries, Inc. in 1956 and, though he was retired, remained as a chairman of the board until his death.

Fulkerson worked his way up the ladder, and while at Jackson Electrical Instrument Co. worked his way to president. He started Fourjay to pioneer the use of plastics and the mounting ring concept in background music speaker ceiling grilles. Through the years, he improved the line with the use of new thermoplastics and expanded into music and paging speakers. "Fulkerson was a very dynamic person and innovator in the field," said Bud Frawley, Fourjay's director of sales. "He did it his way. His motto was 'if you are going to make a product, make it right and make it labor saving.' He will surely be missed."

CONFERTECH INTERNATIONAL RECEIVES "PRODUCT OF THE YEAR" AWARD

Confertech International, Inc. was presented with one of teleconferencing's highest awards—the International Teleconferencing Association's (ITCA) "Gold Audioteleconferencing Product of the Year Award" for its Tempo-MB digital audioteleconferencing bridge. Confertech was selected from among entries submitted by some of the largest companies in the telecommunications industry. The award was given during ITCA's Sixth Annual Teleconferencing Awards Dinner held recently in Anaheim, CA, in conjunction with TeleCon VII, an industry trade show sponsored by Applied Business Telecommunications and ITCA.

by William Thornton, PH.D., PE
Thornton Acoustics & Noise

Octave Band Filters

Octave band filters are important in acoustics and their characteristics must be understood for proper use and interpretation of data.

Octave by definition, is a doubling. Each nominal center frequency of the octave filter is twice that of the one before. ANSI S1.11-1966 (R1976) specifies the characteristics in detail. The center frequencies range from 31.5 to 16,000 Hz as shown in Table I. Each one is twice the other, e.g. 31.5, 63, 125.

Bandwidth

A key attribute of octave filters is the bandwidth which increases with frequency. As the center frequency increases, so does the filter width. Each filter is twice as wide as the one before. The bandwidth is 71 percent of the nominal center frequency. The relationship among the center frequency and upper and lower limits is:

$$CF = \text{SQRT} (Fu * F1)$$

where:

CF = center frequency in Hz,
Fu = upper limit in Hz,
F1 = lower limit in Hz.

For example, the 31.5 Hz filter is 22 Hz wide whereas the 16,000 Hz filter has a width of 11,360 Hz. Notice that the lower limit is the bandwidth as shown in Table I.

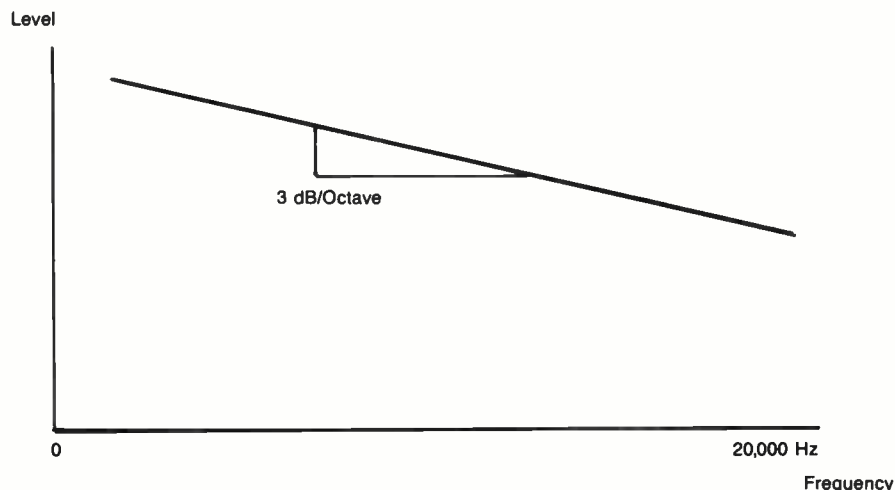

FIGURE 1

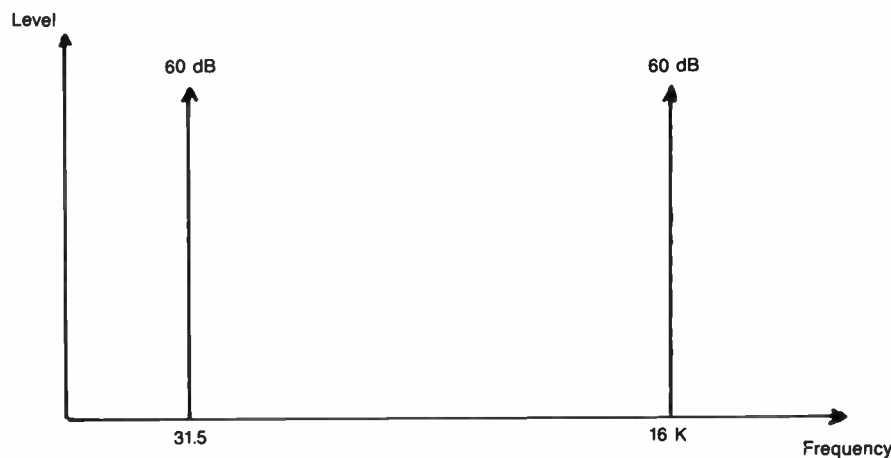

FIGURE 2

The energy in each band is affected by the bandwidth. When an octave band analysis is done, the magnitude

of the octave band sound pressure level reading is influenced by it. The reading is the result of an integration of the

Lower Limit	Center Frequency	Upper Limit
22	31.5	44
44	63	88
88	125	177
177	250	355
355	500	710
710	1000	1420
1420	2000	2840
2840	4000	5680
5680	8000	11360
11360	16000	22720

TABLE I: FILTER CENTER FREQUENCY AND LIMITS

"Hands-free" continuous wireless communications



"Q" PLUS—convenient full-duplex wireless intercom

- Eliminates trailing cables
- Operates full-duplex or simplex (push-to-talk)
- Up to six portables per system
- Interfaces with other wireless or wired intercom systems
- Long-range communications over low-noise, high-band VHF frequencies
- Installs easily...in minutes
- Many applications...
 - Stage managers and technical directors
 - On-floor crew coordination
 - Camera/lighting operators
 - Backstage conferencing
 - Production crew and setup coordination
 - Warehousing operations, including voice recognition and response
 - Public-safety
 - Sports and racing

Rugged, dependable, and easy to operate

Up to six Cetec Vega "Q" PLUS remote belt-pack wireless intercom units (portables) can communicate full-duplex through a central master station. The six portables talk continuously ("conference" style) without pushing a push-to-talk switch or without the annoying one-person-at-a-time limitations and syllable cutoffs of VOX (voice-operated) systems.

The compact Model QTR-1 portables are built to take abuse, and are housed in a welded aircraft-alloy aluminum case.

The portables are very easy to use; they have only two operating controls — a

combined on/off and headset volume control, and a push-button audio control switch.

The portables operate 8-10 hours on two inexpensive 9-volt batteries.

System audio is crisp and clear, with extended frequency response, low distortion, and audio processing for low noise.

Full monitoring with master station

The Model QX-6 master station has comprehensive provisions for control and monitoring, plus a user-programmable intercom interface and auxiliary audio inputs/outputs. Interfacing is



QTR-1 Portable (top view)

DIP-switch programmable to a wide variety of wired-intercom systems, including Clear-Com, RTS, ROH, David Clark, most "carbon mic" systems, etc.

The master station operates on 115/230 Vac, 50-60 Hz, or + 11.5 to + 24 Vdc.

For more information, contact your nearest Cetec Vega dealer or sales representative, or call 1-800-877-1771*

Cetec Vega

Division of Cetec Corporation
9900 Baldwin Place
El Monte, California 91731-2204
Telephone: 800-877-1771*
(818) 442-0782

Telex II: 910-587-3539
FAX: (818) 444-1342

*Toll free number effective February 15, 1988

Circle 215 on Reader Response Card

area under the autospectrum from the lower to upper limit. For example, if the 31.5 Hz and 16,000 Hz bands have a reading of 60 dB, there are several practical alternatives which could account for identical readings. In one case, the noise spectrum could be broad band noise similar to white noise except that the level slowly tapers off with increasing frequency as shown in Figure 1. The spectrum level decreases by 3 dB for each octave and all octave bands have the same level. (This is the reverse of pink noise which increases by 3 dB for each octave.) In a second case, two pure tones might exist with frequencies of 31.5 and 16,000 Hz where each has a magnitude of 60 dB as shown in Figure 2. A third possibility is broad band noise in the 16,000 Hz band and a pure tone in the 31.5 Hz band as shown in Figure 3.

All three of these examples yield the same readings but the noise characteristics are quite different. The first case is a fan-like noise. The second case is a complex waveform with a constantly repeating sound to it. The third case would have a deep rumble with a hiss. The spectra are quite different but all have the same readings. The annoyance value for all three would vary substantially.

Levels

How do the individual readings relate to the overall reading? The sum of the parts equals the whole. As discussed in previous articles on spectral analysis, the overall reading is the 'area under the curve.' As mentioned above, the octave band sound pressure level for each band is the result of an integration from the lower to upper limit. The areas for each octave band are added to obtain the total area under the curve of the autospectrum which gives the overall reading. The octave band sound pressure level reading is proportional to the area under the autospectrum between the limits for the band. This is portrayed in Figure 4. (Note, that if this graph were to continue up to 16,000 Hz, the set of lines would continue to be twice as wide as the one before.) The overall reading is the sum of these which is mathematically related by:

$$L_{pt} = 10 \text{ Log} \{ 10^{(L_{p1}/10)} + 10^{(L_{p2}/10)} + \dots + 10^{(L_{pn}/10)} \}$$

where:

L_{pt} = overall sound pressure level,

L_{pi} = octave band sound pressure level.

With a little thought, it is easy to realize that many combinations of spectrum shape could yield the same octave band levels and overall level. In theory, an infinite number of combinations exist. The shape of each spectrum could be altered with the single requirement that the total area under each octave band remain the same. (Pure tones are handled with a dirac delta function which is essentially a spike whose height is the level after integration.)

Summary

When working with loudspeaker

systems, the octave band filter is a useful tool. White noise is used as input to the system and the response of the speakers is adjusted with a spectrum shaper to give the desired speaker response. The octave filters are well suited for this task but not for diagnostic work. In an extreme case where very sharp room response occurs, e.g. strong room modes or standing waves with strong peaks and valleys, a narrow band filter is needed to isolate the peaks and valleys. In a measurement situation, if doubt exists, it is best to use a narrow band analyzer. Octave filters should be used in circumstances where the spectrum characteristics are known. ■

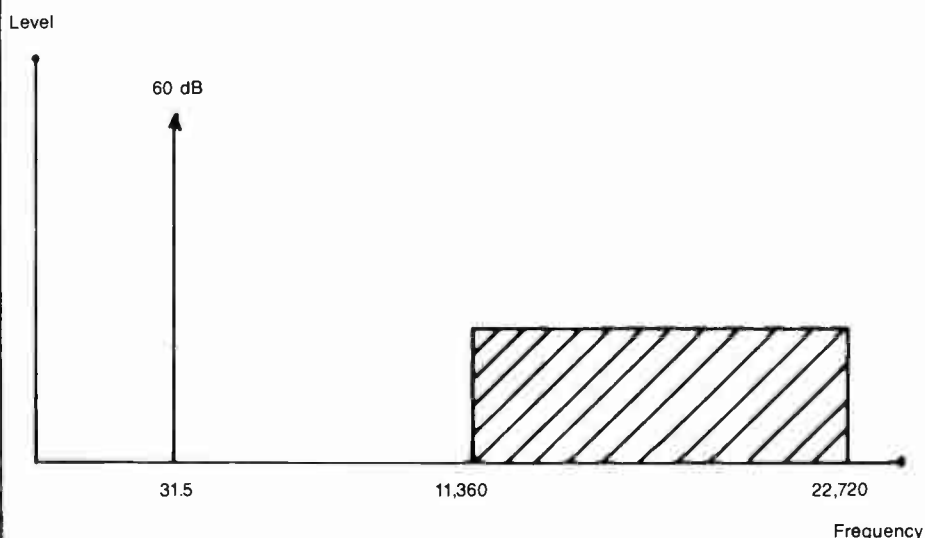

FIGURE 3

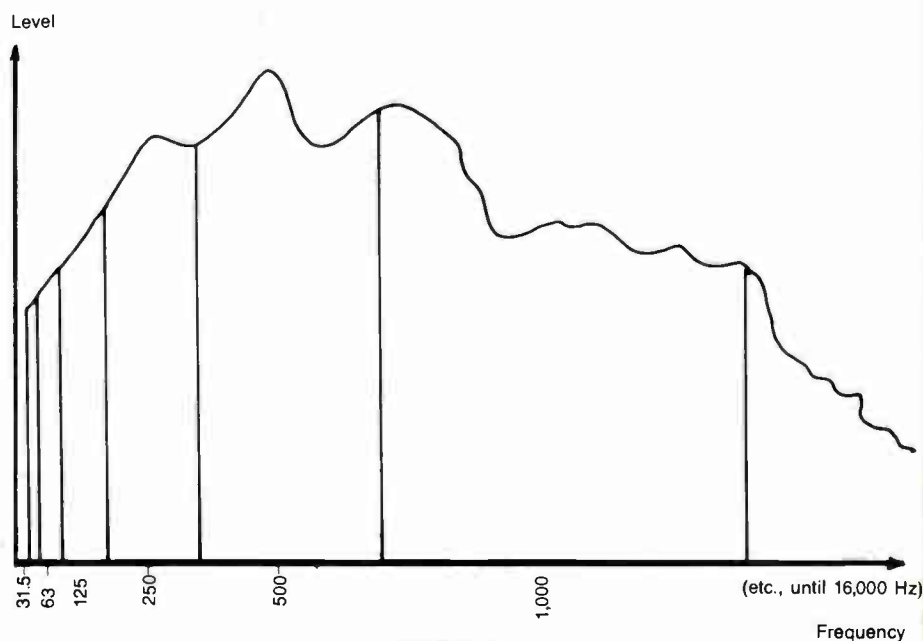

FIGURE 4

How to make your best church sound systems disappear from sight!

Actual Size
Model AT853 Unidirectional
Condenser Choir Microphone

Install Audio-Technica UniPoint® miniature studio-quality microphones

Every congregation deserves the best possible sound, whether at the service or listening to broadcasts or tape. Now you can install superior sound without bulky microphones and awkward microphone stands that intrude on the services.

New Directional Choir Microphone

Audio-Technica engineers have broken new ground with our UniPoint design that delivers studio-quality sound from tiny, inconspicuous *directional* microphones. Our new choir microphone is so small and light that it can be suspended by its own slim cable, making it virtually invisible. Yet it offers controlled pickup of only the choir, sharply reducing room noise and reverberation.

Directional models for altar, lectern, pulpit, plus lavaliers

Four other UniPoint models for use at the lectern or pulpit offer the same clarity, full range, and directional pickup control. Our comprehensive approach to church sound also includes a surface-mounted directional microphone that lies flat on altar, table, or floor. We round out the selection with directional lavalier microphones that solve acoustic problems other lavaliers can't handle. The entire line provides



Model AT871
UniPlate Boundary Cardioid



Model AT857AM
Podium Cardioid

full freedom of movement to the participants, yet the microphone is almost unseen.

Better sound is now smaller, lighter, less visible

Whether your customer's sound system is solely for sound reinforcement, or is also used for radio/TV or tape recording of the service, UniPoint microphones improve the sound quality while remaining almost invisible.

Our experts are ready to help

If you ever need help with specific installations – whether large or small – our Audio-Technica church sound experts are ready with answers to your most difficult problems. To watch your toughest church sound installation problems disappear, call or write us today.



audio-technica.

1221 Commerce Drive, Stow, OH 44224
(216) 686-2600

Circle 219 on Reader Response Card

by Bill Hooper

Market Determination

Bringing any business through start-up to an active, viable entity is certainly no small accomplishment. Many of today's most successful manufacturers and contractors can no doubt recall an early purchase order—or a local garage needing six horns and a 30 watt amplifier—just in the nick of time to complete the weekly payroll. And, it must necessarily hold true that some of tomorrow's most successful companies are right now coursing through those same formative stages.

With this wonder of a free enterprise system in which all Americans bask, the measurement of business success, most thankfully, remains the sole prerogative of the individual owner-ship. It *could* mean having a New York

Stock Exchange listing, hundreds of employees, with national, if not international customers. Success can also describe a family owned and operated entity that faithfully and profitably serves its local community—and of course, many businesses who fall between those two extremes. Certain aspects of any business are open to outside praise or criticism, but to be critical of size alone embodies impertinence and should be treated accordingly. Inside, self evaluation, however, in those wee hours of the morning, can indeed be quite constructive.

Assume a company, offering quality products—or services—has reached a point of general stability, reasonable cash flow and some reserve. But, real growth remains an elusive target. Per-

haps a strong dose of *market determination* may be in order. It can be frustrating and difficult to hit targets that are constantly moving, or somewhat out of focus. Or worse, it can be court-ing disaster to simply jump into un-defined new markets.

Market determination, as used above can have any number of definitions. In one sense, it means taking the necessary time, effort and money to best understand the external market forces that bear upon the business. In our industry, that may include the needs, logistics and even philosophies, of the targeted customer base, labor pool, sources of supply or delivery, competition and so forth.

Another definition of *market deter-mination* has to do with how compati-

REST ASSURED!

Telex Paging Mics give you a special confidence earned through fifty years of acoustic experience.

Vast experience coupled with constant product innovation and improvement has kept Telex in a leadership position within the paging market. Moreover, there is no company with a larger or more complete product offering.

- Desk Paging
- Selective Zone Paging
- Handheld Paging
- Gooseneck Paging
- Wall Plates
- Lavaliers

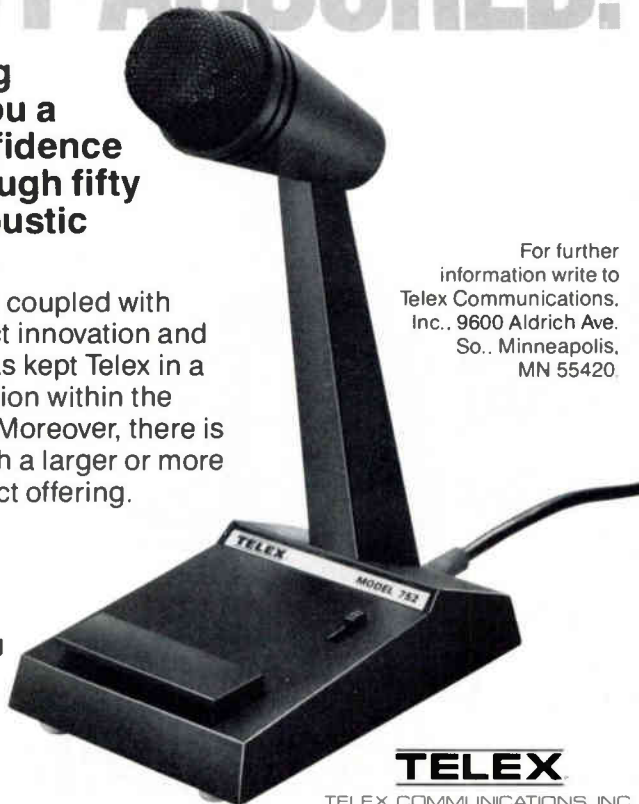

For further information write to Telex Communications, Inc., 9600 Aldrich Ave. So., Minneapolis, MN 55420.

TELEX

TELEX COMMUNICATIONS, INC.

Circle 226 on Reader Response Card

MED & TEK

NURSE CALL SYSTEMS

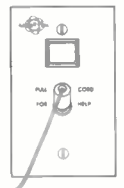
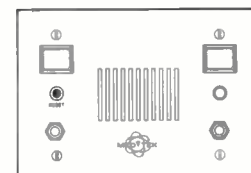
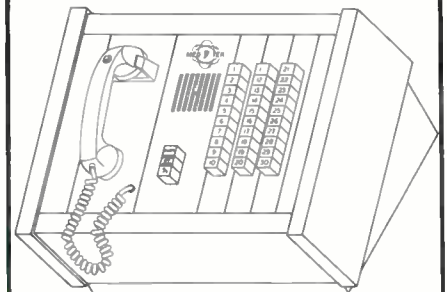

UL LISTED

VISUAL AND AUDIO/VISUAL SYSTEMS

DIVISION OF
ENGINEERED ELECTRONICS, INC.
4301 INDUSTRIAL ACCESS ROAD
DOUGLASVILLE, GEORGIA 30134
(404) 949-3290

Circle 232 on Reader Response Card

ble the present company structure may, or may not be, with potential new markets it wishes to address. This kind of internal examination requires a large degree of detachment and a most candid evaluation of each functional capability. Particular attention must be given to the costs and availability of qualified persons to guide and maintain a professional company image, as well as those who can produce acceptable levels of quality workmanship. New tooling, equipment and physical space are critical considerations, as can be the establishment of new lines of supply or delivery.

Only after critical analysis of factual findings, (these and others that will develop), can a basis begin to emerge for determining viable new market directions that can result in reasonably predictable growth. No doubt much of the time this takes, will as usual, be after normal business hours, but, a great amount of the required information is readily available—only it will need to be reviewed from a different and slightly dispassionate perspective. Most in-house subjects can be determined by consulting with employees who are the people with daily, hands-

on experience. They know what can, or cannot be done, what saves time or produces a better product. Consulting with employees gives them further reason to feel more as an important part of the business and their insightful perspectives should be highly valued.

Customers, suppliers, (even friendly competitors) can be excellent sources of external market data. Trade secrets notwithstanding the general modus operandi of most every company across the country is plainly visible. However, a little more business communication can clear a lot of road blocks. Simply put, getting goods from the end of a production line—properly installed into some end-users facility—is what our industry is all about. It would seem, therefore, frequent and in depth dialog between contractors and suppliers, particularly at the highest levels, should be strongly encouraged. That will produce much needed understandings of mutual marketing goals, mutual support of new directions and help to head off any potential collisions.

Every business has the sole privilege of developing its own particular and unique characteristics. The thrust of

this article is not to act as a text book, but rather, to encourage individual thought and action, which taken in an appropriately, factual manner, will produce growth within the industry. Undoubtedly, many more definitions will be found for my catch-word expression, *market determination*. There is, however, one final meaning I would like to apply which concerns having the courage of one's own convictions. Having at least strong, if not steadfast focus, when pursuing factually determined new markets—without trying to be all things, to all people, at all times. Whether contractor or supplier, growth and success will in great part, ultimately depend upon doing the best you possibly can—within your viably targeted markets. ■

Hooper has devoted more than 30 years throughout many levels of the sound and communications industry. He has held top managerial and executive posts with contractors, representatives and manufacturers on both coasts and draws from a deep well of organizational, administrative, marketing and technical experience.

RED

The RED digital, dynamic range of active and passive loudspeakers is the result of development work done in England and America since 1979.

RED loudspeakers have applications in: studio monitoring, public address systems, backline amplification, theatre and club P.A., audio visual presentations, location sound recording and Hi-Fi for the ultimate home systems.

RED ACOUSTICS (USA) LTD.

1231 ROTH DRIVE
LANSING, MI 48911

TELEPHONE: 517-694-3618
TELEX: 284091 RED UR

Available Internationally:

AUSTRIA:	Buhne Und Disco	0732/237086
CANADA:	Wavelength Systems	403/424-5546
DENMARK:	Sommerk ApS	02/164344
ENGLAND:	Saville Audio Visual Ltd.	0904/782782
ITALY:	Musica Pro	0532/754030
U.S.A.:	Central Music	517/882-3589
	Core Systems	713/977-9500
	Gibson Clone Comm. Inc.	517/676-5619
	IAN Comm. Group Inc.	617/658-3700
	Nathan Rahimi Associates	718/441-2696
	Tech-Stream Inc.	517/676-0186

Yamaha's newest musical instruments.

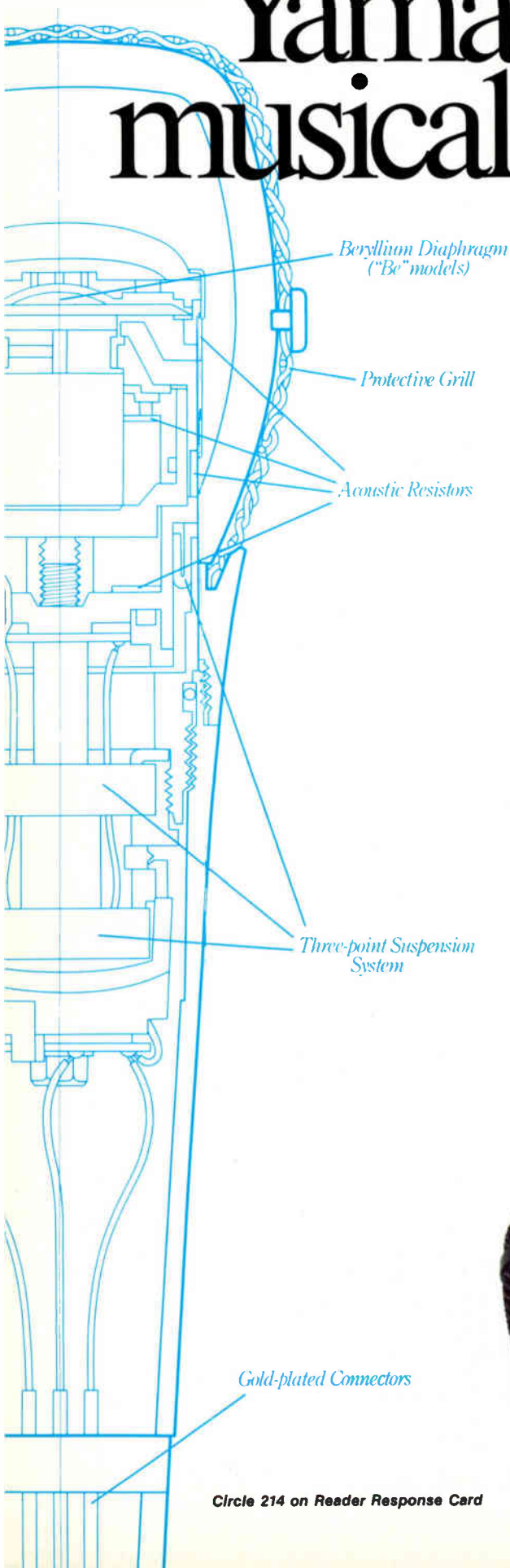

For years, Yamaha has been making musical instruments that allow performers to express what they feel. Our new line of MZ Series professional dynamic microphones continues this tradition.

The three-layer laminated beryllium film used in the diaphragms of the MZ102Be, MZ103Be and MZ105Be offers greater control over piston movement for heightened presence and accuracy throughout the entire frequency range.

Throughout the entire line, a superior acoustic damping system makes use of a mesh screen and photo-silkscreen technology. The benefits are extraordinary long-term stability and absolute uniformity. This uniformity can be especially important when matching pairs of mics for stereo.

A tight cardioid pattern provides excellent off-axis rejection for superior feedback suppression.

To reduce handling noise, all MZ mics have a unique three-point floating suspension system. And a special windscreen with three times the impact resistance of conventional types. So you know it can take a pounding.

We even use gold-plated audio connectors.

But when you listen to Yamaha MZ mics, you hear more than the result of advanced technology. You hear a one-hundred-year tradition of making music.

For complete information, write Yamaha International Corporation, Professional Audio Division, P.O. Box 6600, Buena Park, CA 90622.



YAMAHA[®]
Engineering Imagination



Circle 214 on Reader Response Card

THE ACOUSTICS OF TELECONFERENCING

by Steven J. Orfield



Over 10 years ago, as the Bell System was examining markets for new services, teleconferencing began to be seriously considered as an alternative to the process of inter-city travel for the purpose of attending meetings. While the idea of televising a meeting and its participants privately from one city to another was intriguing, there were concerns regarding the client acceptance of this type of service, and thus there also began to emerge a concern for the potential quality of the service.

Specifically, if the participation in a teleconferencing event was no more disorienting than similar participation in an on-site meeting, it was assumed that the service would be a popular one, and

much of the energy expended in developing an approach to teleconferencing was spent in this direction. This concern for user comfort and confidence was particularly well suited to the previous work of the Bell System in the area of speech intelligibility, quality and signal distortion, and thus the study of the acoustics of teleconferencing began in the 1970's as an attempt to set standards for a dedicated service provided by the Bell System. We had the privilege of working with Ray Naughton of Southwestern Bell on one of these centers in St. Louis.

In considering the problems assumed relevant to this service offering, the issues that began to achieve much of the research attention were

Above left:
The Blue Cross
Prototype Desk
Top right:
The Blue Cross
Boardroom

ROOM ACOUSTICS

Common Applications

Increasing rear wall absorption to reduce echo from the rear.
 Using reflective ceilings to support speech.
 Using corner absorption for reduction of focusing echoes.
 Carpeting of the room with moderate absorption carpet.
 Using moderate wall absorption in order to provide reverberation times within guidelines.

SOUND SYSTEM DESIGN

Crucial Questions.

What are the intended room uses?
 Who is designated to control the priority of speakers on the system?
 Is an audio technician present during the typical meeting?
 How often is the room used for off-site conferencing?
 What quality of audio is justified?

SOUND SYSTEM DESIGN

Suggestions

Limit the intended room uses.
 Limit the system control and automate it.
 An audio technician should be at important meetings.
 Normally, dedicated A-V facilities with video capability require high quality audio performance.
 Avoid the use of secondary, expensive controllers such as compression-limiters, etc.

room acoustics, sound system design, video design, lighting design, and interior architectural design. Additional questions that quickly arose in this regard were specifically aimed at microphone design and control, automated adjustment of varying signal levels from distant phone equipment, control over the possibility of two distant parties talking at once and control over the quality of reproduction of the human voice.

While the problems being studied by the Bell System were not too dissimilar to some standard conferencing problems, the need for high perceived quality and the lack of experiential cues led to more concentration on the definition and solution to these particular problems, and this work, in part, has established the background for current views of both local and remote conference facility design in the areas of room acoustics, sound system design, video design and lighting design. Although the Bell System has found limited success in the marketing of its early concept, its work generated a new look at conferencing facilities, and a background on some of the information derived will follow.

Concurrent with the consideration of the acoustics of conferencing was the emerging view that small rooms did not behave acoustically in the same ways as large rooms, and that these small rooms exhibited different types of problems. (Puetz and

Schroeder were at that center of this realignment.) Another acoustical practice emerging at this time was the use of extreme levels of sound absorption in the open plan office and the introduction of products that were used in this application.

Room Acoustics

In looking at the issues of room acoustics, I am principally considering conference rooms that are used for conventional and for broadcast conferences. With regard to room acoustics, the principal issues that needed consideration in a conferencing room were room shape; reverberation time—room absorption; background noise levels; wall, ceiling and floor attenuation performance; room resonance and echoes;

and orientation of room use.

In considering room shape, the multipurpose conference room is governed, to a large degree, by the need for sight lines to the participants, and thus, the table is generally designed in some type of a U-shape, with the presenter or moderator at the opening of the table.

Since room shape is only significant under circumstances of moderate or higher reverberation (one second or more), it is generally considered most in conference rooms which are intended to provide some natural reinforcement to the live speaker, and these room types ideally fall within the one to one and one-half second reverberation times (RT 20).

General practices in room shape in these types of rooms

(normally board type rooms of 20-60 participants) includes the use of a non-axially symmetric room, when possible, to reduce room resonance (square and equal-sided polygon rooms are problematic, with circular rooms being worst); and the use of a moderate ceiling height (10-12 feet) to reduce time delayed reflections.

Room absorption and its related reverberation effects are based on the fact that room shape problems can be reduced or eliminated by reducing the reflections from offending surfaces. Some common applications in this regard are the increasing rear wall absorption to reduce echo from the rear; using reflective (gypsum board type) ceilings to support speech; using corner absorp-

Larger Conference Room:

NC-20

Frequency (Hz)	63	125	250	500	1000	2000	4000
Level (dB)	51	40	33	26	22	19	17

Smaller Conference Room:

NC-25

Frequency (Hz)	63	125	250	500	1000	2000	4000
Level (dB)	54	44	37	31	27	24	22

Typical Background Noise Level in a Specification

Quality Office Space:

NC-40

Frequency (Hz)	63	125	250	500	1000	2000	4000
Level (dB)	64	56	50	45	41	39	38

SUPER NATURAL CONTROL



ature doesn't recognize the ISO centers on graphic equalizers. But with the GE 30 Interpolating Constant-Q Equalizer you maintain proven constant-Q filter performance between ISO centers when two sliders are activated simultaneously. Interaction and unwanted side-effects are minimized.

You'll never have to bother making decisions about boost/cut or cut-only, direct or transformer coupled outputs, terminal strips or three-pin connectors. The GE 30 gives you all these options with the push of a button. Even a steel security cover is standard.

The power of two conventional equalizers in one. Meet your acoustical challenges with the super-natural control of the Rane GE 30.



RANE

Rane Corporation
10802-47th Ave. W.,
Everett, WA 98204.
(206)355-6000.

Circle 221 on Reader Response Card

VIDEO DESIGN

Video Selection Points

Quality and brightness of the image.

Rear screen installations as opposed to front mounted projectors.

Data applications of video presentations in the future; make sure that this capability is discussed and offered to all clients, and not just to their architects.

Video is quickly overtaking slide and overhead applications.

LIGHTING DESIGN

Lighting Selection Points

Color selections in the conference facility must be based on controlled light reflectance values.

Lighting control should be via dimming and not switching.

Incandescent lighting or indirect fluorescent lighting are to be favored as ceiling mounted sources.

Glare recommendations of the IES should be carefully considered.

INTERIOR ARCHITECTURAL DESIGN

Phases

Program Development

Schematic Design

Design Development

Construction Documents

Contract Supervision

tion for reduction of focusing echoes; carpeting the room with moderate absorption carpet; and using moderate wall absorption in order to provide reverberation times within guidelines, generally applied to the wall portions above table height.

Background noise level control is a double-edged sword, in the sense that reasonable control of signal-to-noise ratio is necessary for speech intelligibility and speaker quality control, but lower background noise levels (NC or PNC) will require higher quality walls for equivalent sound attenuation from other spaces. (A 5 dB reduction in background noise requires a five point increase in STC of the wall construction for equal attenuation of outside noise. Generally, background noise in a conference facility should fall within certain noise criteria, **see charts.**)

The NC-40 Criteria is at least 15 dB higher, on average, than is most useful for the control of speech reinforcement via live talkers or audio systems operating at lower levels.

Normally, background noise is controlled via isolating the room from outside noise sources and via the use of moderate velocity air handling systems and fiberglass-lined duct work. In addition, the mixing boxes of the typical VAV (variable air volume) system are generally vibrationally isolated within the plenum, and any unusually loud HVAC sources, such as heat pumps, are specially iso-

lated and attenuated.

Sound System Design

While room acoustics are often more neglected than sound system design in conference rooms, the design of electro-acoustical systems are often more controversial. Some of the most crucial questions that must be defined prior to their design are: What are the intended room uses? Who is designated to control the priority of speakers on the system? Is an audio technician present during the typical meeting? How often is the room used for off-site conferencing? (teleconferencing) What quality of audio is justified?

Some specific audio decisions that are necessary relate to microphone system types (automated or manual), loudspeaker types and positions (local or remote), audio range (voice or full music range), signal routing (local or throughout a conference center), equalization (for feedback or for linear response), control (manual or via preset system), interface with other control issues (lighting, draperies, screen or whiteboard drop) and monitoring at speaker position (audio, video and interactive control).

At the request of Rand Olson of Blumberg Communications in Minneapolis, we recently completed with them the acoustical, A-V and lighting design of a corporate board room for Blue Cross of Minnesota, and this design process illustrates some of the issues inherent in sound sys-

tem design within this type of center. The project was the design of a 40 person board room capable of conferencing on and off-site, and it included the design of room acoustics, audio, lighting, video and control systems; the work was performed via a cooperative effort from the negotiated A-V contractor and the architect, The Architectural Alliance. Unusually, the architectural firm had on staff an interior designer with a background in industrial design, Ron May, and this, in part, determined the final quality of the facility.

The program for this facility suggested a custom boardroom with specially designed millwork and conference table, along with a high degree of architectural attention to room details. In addition, the architect and the audio dealer were sensitive to the desire to insure that the room acoustics were high enough in quality to insure live speech reinforcement for persons of normal hearing without the use of the sound system. Finally, the users of this facility were considered to be disinterested in its function and its technology in general; they were using the room for business purposes and did not want to have to consider its method of operation (technicians were not assumed to be present).

Initial discussions suggested the use of a moderately reverberant room, a dual-automated sound system, a sophisticated rear-screen video system and a very comfortable programmed lighting

system. The most difficult of these problems arose over the desire to include the automated sound system microphones and loudspeakers within the design of the conference table, and this was made more predictable by the construction of a cross-sectional table prototype by the project design. Into this prototype was installed a set of automated microphones and a set of adjacent speakers for feedback testing.

The tests suggested that the most workable control for this feedback problem was the use of a "filibuster" mode for the microphones (one mic on-line at a time) and shut down of loudspeakers for the two adjacent positions on each side of the talker, and this was how the system was installed, after discussing this with the microphone system manufacturer, Shure.

Unfortunately, there were features of the Shure AMS systems that were not noted in the literature (a discussion with the designer of the microphone system, Steve Julstrom of Shure, led to his sending out an AES article on the design parameters of the system). One of these parameters suggested that the microphone was looking for a base background sound level against which it could establish a gating criteria, and our enclosure of the microphones had apparently made them more sensitive, without our knowledge of this fact.

Having been told by the designer of the microphones that our current design would

not work well, we devised a way to set microphone sensitivity on each microphone with a RASTI system test, and the main room system was then mixed in with the local loudspeakers at the table to decrease the sensitivity of the AMS system. Finally, the house system was tested for gating of the AMS system and special equalization was applied to insure that the house loudspeaker system would not gate the AMS microphones.

While this brief example does not suggest that the use of automated microphones speakers is incorrect, it does suggest that their set-up, check-out and a tuning is often quite time consuming and should be both a contractor and consultant task and responsibility.

Some suggestions that are useful in sound system design in this type of facility are to limit the intended room uses as much as reasonably possible, in terms of talker and listener orientation. (A room that is undefined has little chance of high quality performance.); and to limit the system control and automate it whenever possible. (Don't assume that an automated system doesn't need meeting

preparation and supervision.) In addition, an audio technician should always be available at important meetings; and normally, dedicated A-V conference facilities with video capability require high quality audio performance. Also, avoid the use of secondary, expensive controllers such as compressor-limiters, etc., unless indicated by experience or audio problems and provide monitoring functions at podium positions to insure that the talker is speaking at the correct level.

Video Design

While video is not the focus of this discussion, it is important to note some crucial points with regard to video, in terms of both its quality and its interactions with acoustic issues. In this regard, the video projector typically is used in one of two mountings in the typical conference center, in the conference room or in a rear screen room. When mounted in the conference room, the projector provides its own background noise, often at a level above that of the established NC level. In order to be used properly, it normally must be mounted directly over the heads of the persons attend-

ing the meeting, and the ceiling must be low enough to allow for proper orientation to the screen (typically at 10 foot maximums for hanging projectors).

On the other hand, if a rear screen room is to be used, the acoustic attenuation of this room is important, both in terms of limited sound entering the room and in terms of isolating between adjacent rooms. We are now completing the design of the rear screen rooms for the Minnesota World Trade Center, and two rear screen rooms are placed adjacent to each other; in this case, both the wall construction and acoustical door solutions must be added to the basic design.

From the standpoint of video equipment selections, it is important to remember a number of points. First, the prime benefit that is perceived by the viewer is the quality and brightness of the image; use the best and brightest projector that falls within the budget. Second, clients perceive rear screen installations as superior to front mounted projectors, and the rear screen use allows for more subtle architectural design. Third, there will be many data applications of

video presentations in the future; make sure that this capability is discussed and offered to all clients, and not just to their architects. Fourth, video is quickly overtaking slide and overhead applications; plan for the future as well as the present and limit overhead projection expense.

Lighting Design

Lighting design is often far from the province of the audio designer, but remember that lighting and acoustical performance provides or precludes minimum architectural quality. In order that lighting systems are minimally adequate, it is important to remember that lighting levels are not the critical performance standard in this field—lighting quality and visual performance are necessary to insure that: color selections in the conference facility are based on controlled light reflectance values; lighting control should be via dimming and not switching, preferably via zoned preset systems; incandescent lighting or indirect fluorescent lighting are to be favored as ceiling mounted sources; glare recommendations of the IES (Illuminating

(continued on page 63)

EXPLETIVE ADDED: WOW

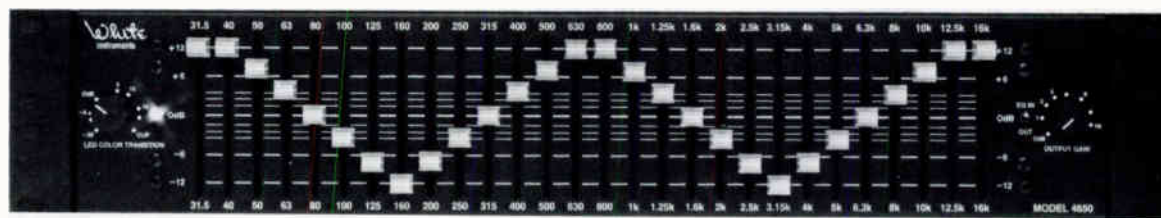

MODEL 4650 • ONE THIRD OCTAVE RC ACTIVE GRAPHIC EQUALIZER

Compare our new 4650 with any other 1/3 octave graphic in the world. It's in a class by itself! Features include: 60mm controls . . . longest you can get into a 3.5" package! Service without removing it from the rack or disturbing its EQ settings. XLR and 1/4" connectors. Best Noise spec in the business for a 1/3 octave, R-C active equalizer. Exclusive one-light metering. 10dB gain available. Legendary White Instruments quality and support! Extremely attractive price!

BOX 698 • AUSTIN, TX 78767 • (512) 892-0752 • TELEX: 776409 WHITE INST AUS



Circle 234 on Reader Response Card

THE PROJECT MANAGER/ENGINEER'S ROLE IN TELECONFERENCING

The job of a project manager has evolved greatly in the 80's. Due to the increased complexity and scope of audio and video installations, a dedicated project manager/engineer (PM/E) is usually called for. At one time it was possible for one person to call on the customer, discuss equipment needs, pick-up equipment and then return and install it. Today's installations involve changing technology and increased complexity and insight.

The first step in the project manager/engineering approach for a teleconferencing job is the site-survey of a potential order. Often this is required in association with a consultant directed project. Along with the salesman, the PM/E discusses with the customer many areas vital to a successful installation. These include overall cost considerations, system usage (overall aim of system, user profile, number of users, flexibility,

Ron Fresta
PM/E
Peirce Phelps, Inc.

traffic flow), future needs and available space. A walk-thru is carried out (for existing sites) to assess various items that will affect design consideration such as acoustics, lighting access, overall size, and common carrier interface locations. As much information as possible is gathered during the site survey. In almost every case, architectural drawings are studied to ascertain dimensions and possible construction obstacles (such as ductwork, support beams, ceiling sprinklers).

Armed with the site survey information, the PM/E sits down and works with the salesman to develop the proposal. The PM/E will first develop a theory of operation, reviewing consultant supplied drawings if applicable.

The theory of operations for a confer-

ence room requires many questions to be answered. Will it be an audio-only conference room or a video conference room? How many participants (primary and/or secondary) will require microphones? What number and types of microphones will be needed? Will the audio transmission be full-duplex with echo cancellation, half-duplex, or "speaker phone" type? When video is involved, more questions are generated. How will the signal be transmitted (full motion 768 Kb data, limited motion with 56 Kb of data or freeze frame)? Other considerations are table layout, control system (hardwired, PC based, wireless), overflow rooms and capability, echo control, user ergonomics and flexibility.

Based on the operational theory, an exact equipment list is developed. Along with this list will be cost estimates for manpower (installation, engineering,

(continued on page 63)

Courtesy Peirce Phelps

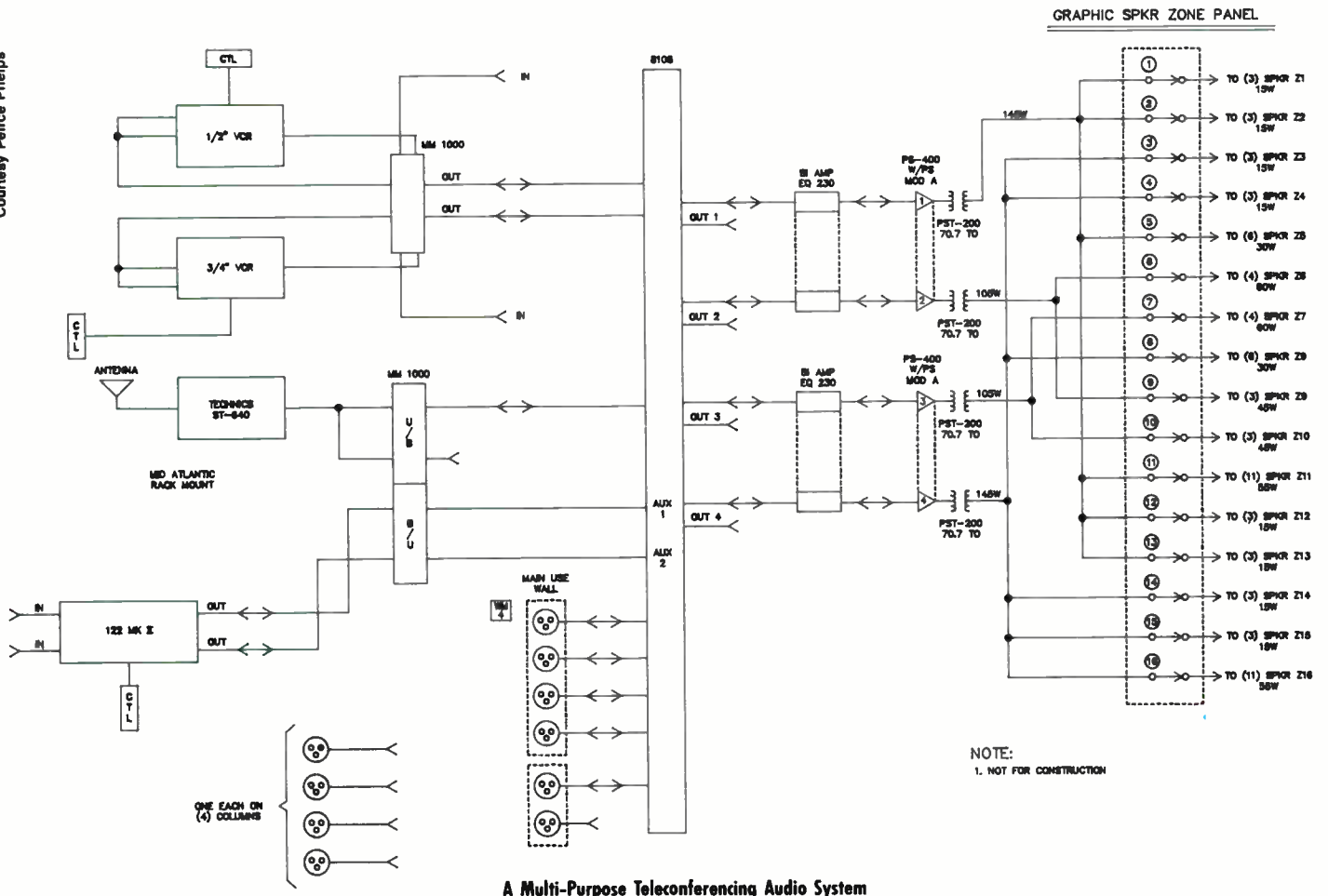

Introducing the New Generation of Wireless Microphones from HME.



All New RF Link. All New Switching Diversity. All New Packaging. And Unbeatable Sound.

HME's new Series 50 is so advanced that anything else is a compromise.

Here's just a few highlights:

A completely new RF link greatly improves the capture ratio for dropout-free performance under the most demanding conditions. Our new state-of-the-art noise-free switching diversity system has broken the price/performance barrier.

There's a new, rugged ABS body on the hand-held models, along with an advanced internal antenna with superb radiation characteristics. The new dual-frequency body pacs give you top

performance under physical as well as electrical abuse.

HME's new NRX II™ noise reduction system has to be heard to be believed. It's the only noise reduction system designed *expressly* for wireless microphones. And it's available only in HME's New Generation Series 50, both hand-held and body pac.

See your HME dealer for the final shock:

You'll find HME's Series 50 price below every other professional system. That's because we're sure every thinking professional will standardize on it.

And why not. There's nothing even close.



HME ELECTRONICS, INC.

6675 Mesa Ridge Road
San Diego, CA 92121
(619) 535-6060

**HME's New Series 50 Wireless Microphone—with NRX II™
No Equal. Nothing Close.**

Circle 220 on Reader Response Card

World Radio History

THE USE OF WIRELESS MICROPHONES IN

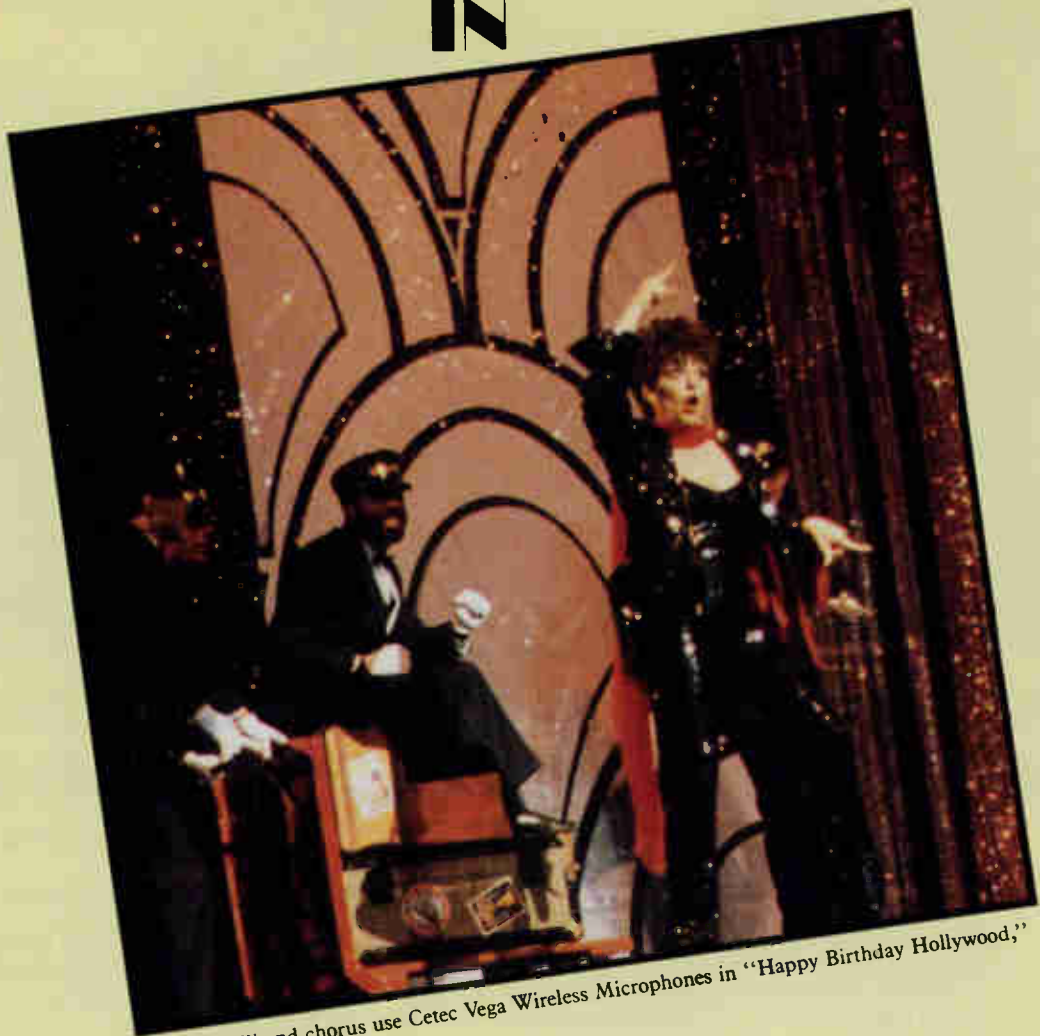

Liza Minelli and chorus use Cetec Vega Wireless Microphones in "Happy Birthday Hollywood,"
May 1987.

LARGE SCALE TV PRODUCTIONS

"...but the wireless microphones sounded fine in rehearsal—there must be something in the air." Every sound mixer who has worked with wireless or RF (radio frequency) microphones has said these or similar words to a distraught producer or manager. The dilemma is that although conditions do change for RF transmitters, there is very little that the individual sound mixer can do about them.

Of course, one can test every battery under current-drain conditions, and carefully adjust antenna positions, but, beyond that one can only keep his fingers crossed and hope. The author recalls pausing backstage—on opening-night with a crowd full of reviewers—for a moment of silence to the *RF Powers That Be* for clear skies; while 18 RF microphones wait in the wings with no defense at all against hits, pops, loose

neon connections, generators larger than life, walkie talkies, TV sub-carriers, Kryptonite, and tropical moonbeams.

Sound engineers with extensive experience using wireless microphones have usually developed some empirical rules of thumb; keep receivers six inches apart; pin flexible body pack antennas vertical on the inside of the shirt against the skin because the sweat acts as a ground plane; only use frequencies above 204 MHz in

by **Patrick Baltzell**

the presence of neon to reduce interference; etc. Every edge counts in the mysteriously invisible hostile environments of the real-world.

The high-stakes of live national broadcasting has prompted a scientific approach to these problems. The major networks in Hollywood have highly specialized equipment and technicians to insure that when a show airs live to millions of viewers around the world, such as the Grammy Awards and the American Music Awards, all precautions are taken to eliminate the "mystery" from RF microphones.

This article describes the methods by which those results are achieved in large-scale TV productions. Although not every RF microphone application has the budget for dedicated technicians, many of the setup techniques described here can be applied to permanent installations. The lower price range of RF analyzers and microprocessor-control features are currently available for less than \$5,000. These factors all contribute to bringing this technology closer to everyone involved with RF microphones. [Ed.: Competition in this field indicates more economical units in the wings.]

Frequency Coordination

After reading the script, the air mixer specifies the RF microphones which are then supplied by a rental company. [Ed.: The author's experience has been primarily with Cetec Vega.] In addition to the microphone frequencies, a minimum of four to six duplex (talk/listen) RF intercommunications belt packs for stage managers along with the base station must be considered. This is a minimum for even the simplest of shows. Often, the complex production shows require up to 18 remote PL (party-line) "drops" and three base stations each with their own frequency.

Each frequency is entered into a MS-DOS computer program (available from Cetec Vega), which calculates the degree of interference—up to the 12th harmonic—of the crystal fundamental between all of the units intended for use. The next step is to add the frequencies of local television sub-carriers, any existing transmitter frequencies in the building such as RF intercom, walkie talkies, adjacent stages with RF, or any other potential source of interference, and run the program again. If all goes well, the on-site work begins.

Set-up

The typical award show (eg., Grammy Awards, Emmy Awards) or large scale musical/variety special (i.e. Happy Birthday Hollywood) requires three to six days of set up and rehearsal. The RF crew from the network tests each receiver/transmitter combination and measures the carrier signal strength, frequency error, and frequency deviation or frequency modulation. The test system used is the Motorola 2001D Communications System Analyzer. (See Figure 1.)

The 2001D is a comprehensive measurement system incorporating many additional features such as a duplex generator, cable fault detector, and DTMF (Dual Tone Multiple Frequency) signaling for paging and mobile phone applications. It is ideally suited for live monitoring of RF microphones because it has automation and memory capabilities. Based on the Motorola 6809 microprocessor, the display-scales auto-range, data is input via the keyboard, and there are 32 non-volatile memories. This allows the technician to input the frequencies to be used.

One screen digitally displays signal strength, frequency error and deviation. (See Figure 2.) Each transmitter is opened up and adjusted to optimize or confirm factory specifications for these parameters. On one show it was determined that four body-pack transmitters had partially broken flexible-antennas—but, they still transmitted. A perfect antenna with all strands intact and tuned to the optimum length (See Figure 3) has a given amplitude against which defects are obvious—but audible manifestations can be subtle and frustrating. Typically, engineers will listen to RF microphones to choose the best ones because one may sound *harsh* and another may sound *raspy*.



Figure 1

The Motorola 2001D Communications System Analyzer.

A common misconception should be pointed out here concerning the *crackling* sound associated with neon lights alleged to be RF interference. Simply not true. The fact is that neon radiation is broadband, and interferes with the electret element in the microphone itself—regardless if the element is feeding a transmitter or not. However, loose neon connections can arc, emitting large amounts of RF energy. This interference is part of the audio signal. Therefore, any similar electret mic will amplify neon radiation.

Back at the RF setup. Throughout the rehearsals and the show, a single key-stroke on the 2001D will bring any assigned frequency up providing all pertinent data in real-time. One can easily envision a software program that would automatically scan the preset frequencies and check user defined parameters (such as carrier strength) and alert the operator when a transmitter is found that does not meet or exceed the defined value. Large production shows and Broadway musicals that operate with limited staff might be prime candidates for such a product.

Next, the transmitters are all turned off, and the signal generator section of the Motorola system is used for a test tone to check and adjust all receivers for equal gain. Included in the RF monitoring is an isolated audio-split from each receiver. The audio-splits feed a switching network driving headphones or a small speaker allowing the operator to listen to the units for intermittent mic cables or excessive handling noise. This allows cueing upcoming mics as well as those in use. The panel also contains audio mute switches for each receiver in the event squelch is broken.

After all units are operating at full capacity, the next step is to check receiver compatibility. One receiver is turned on, then each of the others is turned on one at a time to determine if there is any interference between receiver local oscillators. Any significant RF signal strength registered on a receiver's meter by turning on another receiver, with all transmitters off, is an indication of interaction. This usually is a result of leakage from one receiver through the multi-coupler back into the front end of a harmonically related receiver.

Receivers with frequencies 10.7 MHz apart or multiples of that are susceptible. Even though the condition appears to be solved when the transmitters are turned

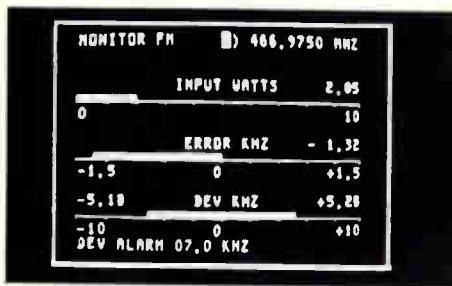

FIGURE 2

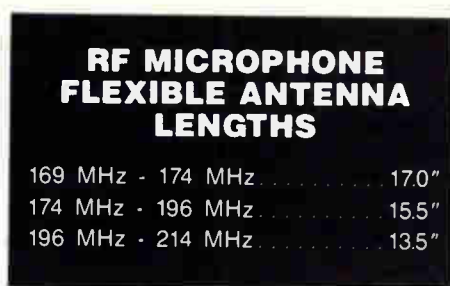

FIGURE 3

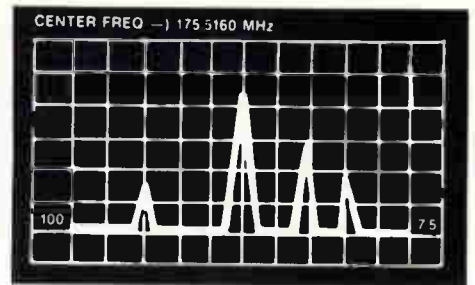

FIGURE 5

on, this situation is best avoided. If this is a problem and there are a large number of frequencies already in use, depending on the script requirements, receivers can be turned off for certain segments to avoid interference. The check to the broadcast truck for continuity and level adjustment is done with the 1 kHz tone generated and transmitted by the analyzer. Later when rehearsals begin, microphones, particularly lavaliers, will be tested for polarity to the air-mixer by comparing each against a reference and listening for cancellation.

During the set-up antenna positions are selected. The RF monitoring position must be set up in a location in the wings or the audience to provide easy visibility

to all performances. A typical antenna arrangement (See Figure 4) includes eight antennas which home-run to a custom switching network. Each of the two diversity antenna inputs is paralleled with the other receivers and comes up to the switching network. This configuration allows any of the antennas to be assigned to either of the receiver inputs.

The transmitters are "walked" throughout the areas of use including off-stage and possibly the audience seating areas. The relative carrier signal strengths are noted for each antenna and for each performance position. For example, the balcony antenna and under-stage antenna might provide the strongest signal for performances downstage near the apron.

However, the stage right introduction area is covered best by the house left and offstage right combination. Later, during rehearsals, these are refined to the point that by the time the script is finalized, the ideal antenna combinations for each performance or scene, have been selected and noted.

Performance

During the performance, one of the two analyzers and operators is dedicated to monitoring antennas. If signal strength changes, or minor interference is detected, the switching network allows off-line monitoring of any of the other antennas so that if an improvement is

(continued on page 67)

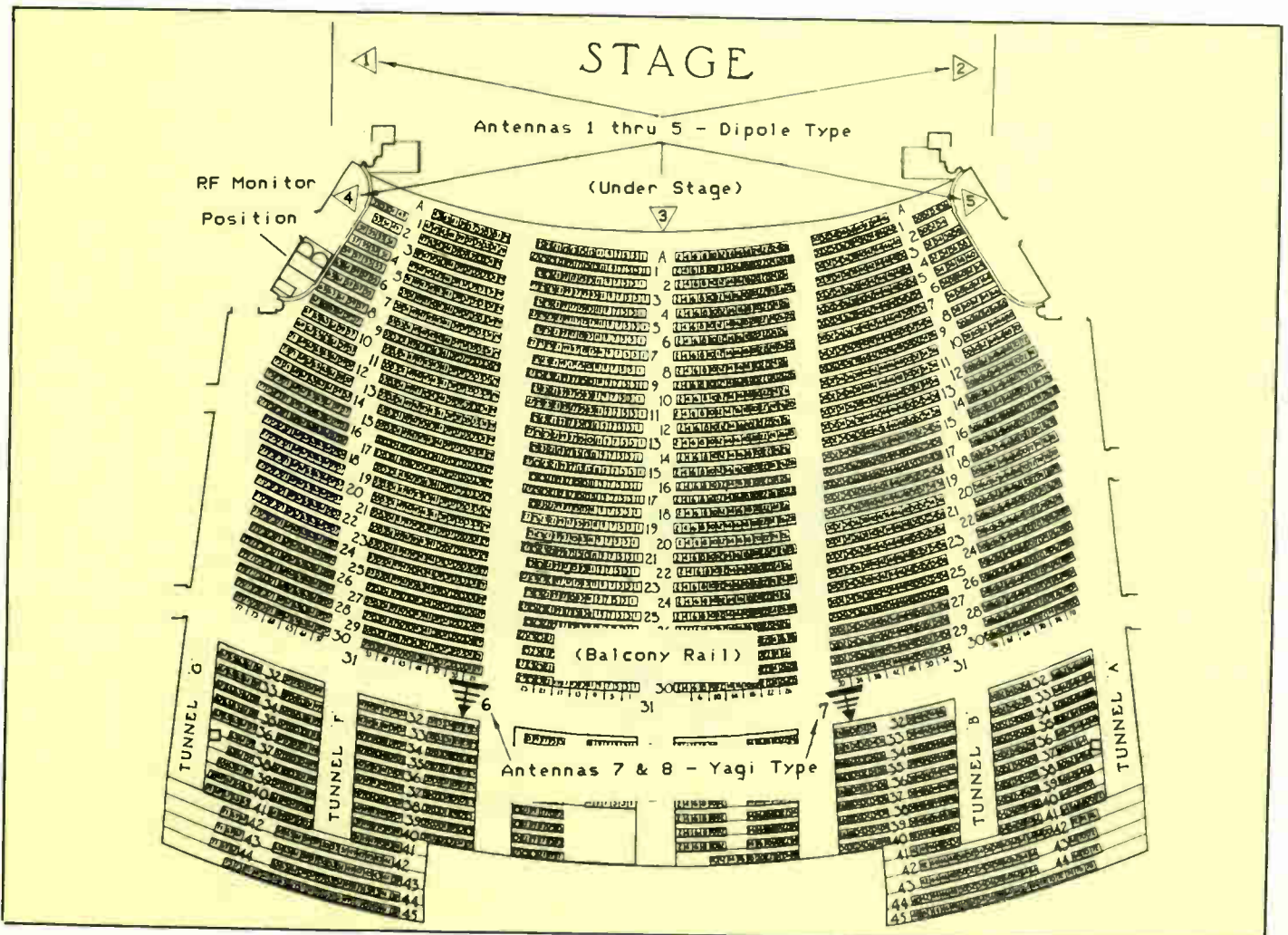

FIGURE 4



SUPERIOR PERFORMANCE ANYWHERE, ANYPLACE, EVERY TIME.

No matter how much you spend on a wireless system without selectable channels in the receiver and transmitter, you'll always be vulnerable to potentially damaging interference.

That's why the Samson Broadcast STD wireless system offers ten selectable channels in *both*. Simply dial up the ideal channel in the receiver, then select the identical channel in the transmitter

for optimal transmission quality.

We also included an exclusive Samson feature to let you see the RF level on each available frequency before you use the system. The receiver's visual "window", two five-segment L.E.D. level ladders, scans each channel for instant confirmation of the clearest frequency.

But the real benefit of Broadcast STD truly becomes apparent once

you hear the system. Samson's sophisticated "new generation" RF circuitry with dbx* noise reduction provides more dynamic headroom and the purest, most transparent audio quality available in wireless today.

The Broadcast STD Series combines these leading edge features so you *know* you're getting matchless performance. Anywhere, anyplace and every time.

Broadcast STD Series available in Hand-Held, Lavalier & Instrument Systems.

Samson Technologies Corp. 485-19 South Broadway, Hicksville, NY 11801 (516) 932-3810
TLX 284696 SAM UR FAX (516) 932-3815
In Canada: Omnimedia Corporation Ltd., 9653 Cote De Liesse, Dorval, Quebec H9P 1A3
514-636-9971

* dbx is a registered trademark of BSR North America Ltd.
© 1987 Samson Technologies Corp.

SAMSON®
WE TOOK THE WORRY OUT OF WIRELESS®

Circle 209 on Reader Response Card

As You Might Expect, No \$700 Amplifier Has Ever Equalled The Performance, Quality And Reliability Of The \$1000 BGW 7500...



Until Now!

Introducing The BGW 7500T. \$1000 Performance At A \$699 Price.

There are thousands of BGW 7500 amplifiers in the field today. In every case, our \$1000 model 7500 was chosen over a number of lower priced alternatives, for its superior quality, durability and sonic performance.

But BGW knows that you don't always have the luxury of choosing the higher quality, higher priced amplifier. Until now, the price-sensitive buyer has had no choice but to settle for a less expensive, lesser performing unit.

Not anymore. Because BGW's new 7500T amplifier delivers exactly the same performance as our legendary model 7500, at a price that goes head-to-head with any U.S. or foreign competitor—just \$699 professional list.

The model 7500T is a price/performance breakthrough. You get the same conservatively-rated 200/250 Watt-per-channel power (@ 8/4 ohms), the same performance specs—in fact the exact same amplifier design, circuitry and components as our no-compromise model 7500 — at a \$300 savings.

How did we do it? We selectively trimmed a few of the model 7500's nice but non-essential frills. The 7500T has a steel front panel instead of a fancy aluminum one, and uses cost-effective barrier strip terminations. The 7500's LED indicators are omitted on the 7500T. The lower-priced model accommodates one optional BGW internal crossover card for biamp applications, while the 7500 can take two cards. These differences aside, our new economy model is a BGW model 7500 through-and-through.

The 7500 and 7500T are the most rugged and reliable amplifiers you can buy. Inside, you'll find no trouble-prone relays and no sound-degrading IC's.

And here's an important difference between the 7500/7500T and other competitive units: Many use inexpensive MOSFET designs which require high bias, and consequently run very hot. Other brands use inadequate heat sinking. These competitive amplifiers can't live without forced air cooling.

BGW's exclusive copper header output devices don't require bias at all. We mount them directly on highly efficient heat sinks. As a result, the 7500 and 7500T run cool and efficient—so they don't require forced air cooling. And that means you can forget about replacing burned-out fans every few years.

BGW's 7500 has always been the ultimate choice for quality and dependability. Now that our 7500T gives you the same unmatched performance at just \$699, there's really no reason to settle for anything less than BGW. Call us toll-free at 1-800-252-4800 (In CA, 213-973-8090) to arrange for a demo trial.



BGW SYSTEMS INC.
13130 SOUTH YUKON AVE.
HAWTHORNE, CA 90250

ENGINEERED TO BE THE BEST

Circle 230 on Reader Response Card

S T A T E

Of The Market In

MIDI

by Greg Prince

Welcome to *Sound & Communications'* own version of *Jeopardy*. The category is The Future For '88—and Beyond—the answer is, “an advanced technology available today that more and more manufacturers are using in new products to make the sound contractor's life a little easier.”

The question is, “What is MIDI?”

The next question may be “Why MIDI?” Why, considered something

Greg Prince is a freelance writer specializing in electronics, audio and video. He has written for *Billboard*, *Backstage*, *Crain's New York Business* and *Home Entertainment*.

basically known as the province of musicians and recording people? Why not stick to what's already in use?

Well, as reported in the February, 1987, issue of *Sound & Communications* MIDI (Musical Instrument Digital Interface)—is an important standard that allows devices to communicate via hardware and software. For example, MIDI allows a computer to act as a communications and control center for complex setup and operations with archival storage on disk. And with the new MIDI equipment either on or coming to the

market, sound contractors can only benefit.

“MIDI, in this field,” said Peter Beverage, vice president of sales and marketing for Applied Research and Technology (ART), “is in the embryonic stages, quite frankly. But from what talk I have had with contractors, I can see it sure is starting to make an impact particularly in theatrical venues. It's been used in more than one, so I know it's no fluke.” It is for such theatrical jobs that ART is introducing its Intelligent Equalizer, a digitally controlled unit with full MIDI

implementation.

"It's a communications medium," said Beverage of MIDI. "For example, the Intelligent Equalizer can talk to a real time analyzer, or with it, the master controller

"MIDI, in this field, is in the embryonic stages."

**Peter Beverage
ART**

can set up a curve for a meeting room or a night club. Those are pure contractor applications, though only the theatrical contractors see an immediate need for it right now."

Attitude Adjustment

Attitude adjustment is a slow process, Beverage stressed. "In my travels, I find more contractors are more cognizant of MIDI and treat it less like a foreign language," he said.

One thing that has caused contractors to take so long in accepting it may be the name: *Musical Instrument Digital Interface*. Some just don't think it pertains to them. "MIDI should not be thought of just as a communications port," said

follow through on this point and make clear that these capabilities have come into the market."

JL Cooper is one of those suppliers that can talk about what's available with authority because the company has a variety of MIDI products. According to president Jim Cooper, one that's been out for a while is the MIDI Mation automated controlling system, found mostly in studio mixdown situations, but also in nightclubs for setups. One such venue where the MIDI Mation has been used successfully is Paris' world famous Moulin Rouge.

"What's happened is the technology has gone beyond simply receiving data from musical instruments. Now you can manipulate details of internal structure."

**Charlie Richmond
Richmond Sound
Design**

A new piece from JL Cooper, the Mix Mate, offers eight channels of self-contained automated control. It can take commands from a computer, when programmed to do the job, and control the hardware. The Mix Mate is compatible with the Apple or ST.

Cooper has found contractors' views similar to the ones Beverage came across. "The sound contractors lag behind in this area, behind the studio pro audio people," the president said. "I'd like to think there has been more acceptance by sound contractors and that there will be more in two years. Generally, contractors are a conservative lot when it comes to revamping a setup. Some just think it should be left to the sound engineers and that's just not the case."

One industry leader who said MIDI has already come further than his expectations for it is Charlie Richmond, presi-

dent of Richmond Sound Design. "I see it evolving farther than what was originally thought," he said. "We have a computer-based system, the Command Cue, to help with large sound system configurations of up to 4,000 channels. We're not dealing with sequencing here; we've taken the contractor-system programming approach and put together a custom-oriented digital delay unit, programmed by means of MIDI system-exclusive messages, that if put into the controlling system, allows you to download a complete set of parameters. This gives the user more flexibility than simply using a sequencer."

In an arena, Richmond points out, the Command Cue can be adjusted for different configurations. "Many clusters of loudspeakers need to be setup in an arena or coliseum, whether for boxing, hockey, or in bigger ones such as baseball or football," he said. "For us, that's no problem. You can call up the system in regular menu fashion and the command key sends out complete instructions for anything like volume level and delay taps."

The delay unit's MIDI system-exclusive messages orchestrate from beginning to end how the setup should go. The cue-to-cue sequencing, from one-tenth of a second to the next tenth of a second, works well for live theatre. The messages sent out to system hardware can command mixing boards, effects, sampler,

"I'd like to think there has been more acceptance of MIDI by sound contractors and that there will be more in two years."

**JL Cooper
JL Cooper
Electronics**

Beverage. "You can download a lot of information with it. Manufacturers have to

"When sound contractors see that effects can be turned on and off with ease, less expensively and not requiring two people, MIDI will make it in sound reinforcement."

**Derek Pilkington
Soundtracs USA**

etc. A single cue downloads MIDI patch-

ing information and is simply displayed.

Richmond believes products like the Command Cue can only improve life for the sound contractor. "Instead of having to flip thousands of switches, you can create cues which can accomplish all the necessary changes in a system," Richmond said. "It doesn't replace the operator, it assists the operator. What's happened is the technology has gone beyond simply receiving data from musical instruments. Now you can manipulate details of internal [architectural] structure."

Theatrical Applications

Theatrical applications are especially suited for MIDI, said Derek Pilkington, vice president of operations for Soundtracs USA. "MIDI has really found a home in Broadway productions," said Pilkington. "Mixing consoles eat up seats. With MIDI, and our PC 16 and PC 24 boards, it's all more compact. You can operate the console remote control. I don't think I'm exaggerating when I say that this has been almost a 'wish, dream' kind of thing for a long time among producers. These small mixers are the size of a three hole binder, opened up. The operator can sit in one seat and that's it. Typically, mixing consoles take up eight seats. That's \$400 in lost revenue per night at \$50 a ticket. No wonder they're so happy to see a smaller board."

Soundtracs' 16-channel board, with 32 inputs, is especially useful, said Pilkington,

"There's a good commercial market for it, but we need to do a little bit to convince commercial people that MIDI is simply another data transfer standard."

**Gerry Tschetter
Yamaha**

ton, for a show with a large number of synthesizers in the orchestra. The company also has a new accessory for the mix-

ers, an effects return module with four additional line level inputs for MIDI muting. As potential becomes clearer, Pilkington believes the technology will become more attractive to contractors.

"It's commonly not considered that much yet," Pilkington said. "But it was slow going into the recording studios, so it's not surprising that's there isn't a lot of it yet in sound reinforcement. But contractors are seeing the applications, particularly in production. When sound contractors see that effects can be turned on and off with ease, less expensively and not requiring two people, MIDI will

"More products and features are coming out but there's just not that much MIDI-controlled stuff for the sound contractor at this time."

**Dave Gonden
ADA**

make it in sound reinforcement."

Yamaha has a slew of MIDI products with sound reinforcement applications. Foremost among the new ones, according to product manager Gerry Tschetter, is the DEQ-7 digital equalizer, a dual-channel unit that fits in one rack space. Delay is also included, meaning the installer can combine delay and equalizer for under the balcony if so desired. "You can recall different settings from MIDI remote devices," Tschetter said. "You can download via MIDI program settings and store EQ curves digitally. If someone tampers with the equalization, you don't have to worry because the setting is already in storage. It's a device for uploading and downloading."

MIDI Potential

"MIDI is a growing thing and offers a lot of potential," declared Tschetter. "There's a good commercial market for it, but we need to do a little bit to con-

"More and More, MIDI is being used to control things, not at all the way outsiders might have pictured it."

**Chuck Augustowski
AHB**

vince enough commercial people that MIDI is simply another data transfer standard. MIDI-equipped devices should find a wide enough market given its economies of scale and incredible capabilities. What it seems should cost six-digit prices in reality is sold for under \$4,000."

ADA has a brand new digitally-controlled MIDI equalizer, the MQ-1. Artist relations and sales manager Dave Gonden said, "The nice thing is MIDI is really going to help. If you have our equalizer, location becomes more easily accessible. Changing settings becomes much easier. You can do it automatically, even by phone. You don't have to do it yourself."

Widespread use in the sound field is not in the near future, though, in Gonden's view. "The impact isn't there, not just yet," Gonden said. "More products

"Sound contractors will find the MIDI program changing to their liking because they will be able to call up the program they desire right away."

**Allen Wald
Alesis**

and features are coming out, but there's just not that much MIDI-controlled stuff for the sound contractor at this time."

Allen and Heath Brenell (AHB) has been working with MIDI for some four

years now, according to vice president and sales manager Chuck Augustowski. Its most MIDI-fied products are in the Sigma series of consoles used in meeting setups. Augustowski notes the consoles respond to direct MIDI signals. One example he cites is the muting control.

"We feel the industry is changing from a professional standpoint where MIDI is concerned," Augustowski said. "More and more, MIDI is being used to control things, not at all the way outsiders might have pictured it. You do have definite applications for consoles, though some seem to make things more complicated instead of easier."

**"I wouldn't say
MIDI hasn't been
discussed, but we
feel we've accom-
plished a lot with
microcomputers."**

**Tom Roseberry
IED**

Other players in MIDI include Alesis with its MIDIverb 2 signal processor. Vice president of marketing Allen Wald said sound contractors will find the MIDI program changing to their liking because they will be able to call up the program they desire right away. Roland is on the scene with the M160 and M240 rack-mounted line mixers.

On the other hand, there are sound and communications manufacturers who are staying out of the MIDI milieu. IED is one such supplier. Director of marketing and sales Tom Roseberry said microcomputers have served IED well for the last few years and no immediate plans that include MIDI are in the works. "I wouldn't say MIDI hasn't been discussed," Roseberry noted, "but we feel we've accomplished a lot with micros."

Altec Lansing is another company that just as soon go MIDIless for now. "We don't think very much of MIDI and we're working on alternatives," said Ted Uzzle, director of marketing and development. "We've studied the situation in

I Is Not Enough

**Additional copies of the
1987 BLUE BOOK
are available at \$12 each.**

Please send your check or money order to:

Circulation Department
1987 BLUE BOOK
25 Willowdale Avenue
Port Washington, NY 11050.

Major credit cards are also accepted.

**"We've studied the
situation in
enormous depth
and find we prefer
other interfaces
(than MIDI)."**

**Ted Uzzle
Altec Lansing**

enormous depth and find we prefer other interfaces. MIDI may be good for the music industry, but we don't find it very exciting. We'll stay the course."

At a minimum, MIDI is an evolving standard that gives all manufacturers a common denominator. Can you imagine if personal computers, parallel in serial interface standards, were never accepted? How would we use modems and printers? The common denominator concept allows for economic systems integration. As with any issue concerning change, there are always going to be dissenters. But the overall feeling among the manufacturers is that MIDI is here to stay in the sound reinforcement field and more is on the way. ■

In compression drivers, less distortion equals more accurate sound. Theoretically, transducer sound outputs are an exact copy of their electrical inputs. In real-world compression drivers, distortion must be minimized to satisfy the critical listener. Careful design of the magnetic circuit, voice coil and suspension components helps to reduce non-linearities which cause production of upper harmonics, multiples of the fundamental frequency. Manufacturers' data sheets typically show the level of second and third harmonic components relative to the fundamental.

However, other types of distortions can have greater significance in speech and especially in music. Subharmonic distortion components at one half, one third, etc., of the fundamental frequency are of particular concern in the output of a compression driver. Although the second and third harmonics of the frequency range may be outside the audible spectrum, the second or third *subharmonics* are in the middle of the passband where the ear is most sensitive.

No compression driver diaphragm behaves as an ideal simple piston at all frequencies; some types of "break up" produce subharmonic distortion. At Altec Lansing we solved this problem in the 288 series of compression drivers. This knowledge was applied in making the careful choices of diaphragm size and material for the Pascalite™ diaphragm assembly in the new model 299 compression driver.

The resulting engineering achievement makes the 299

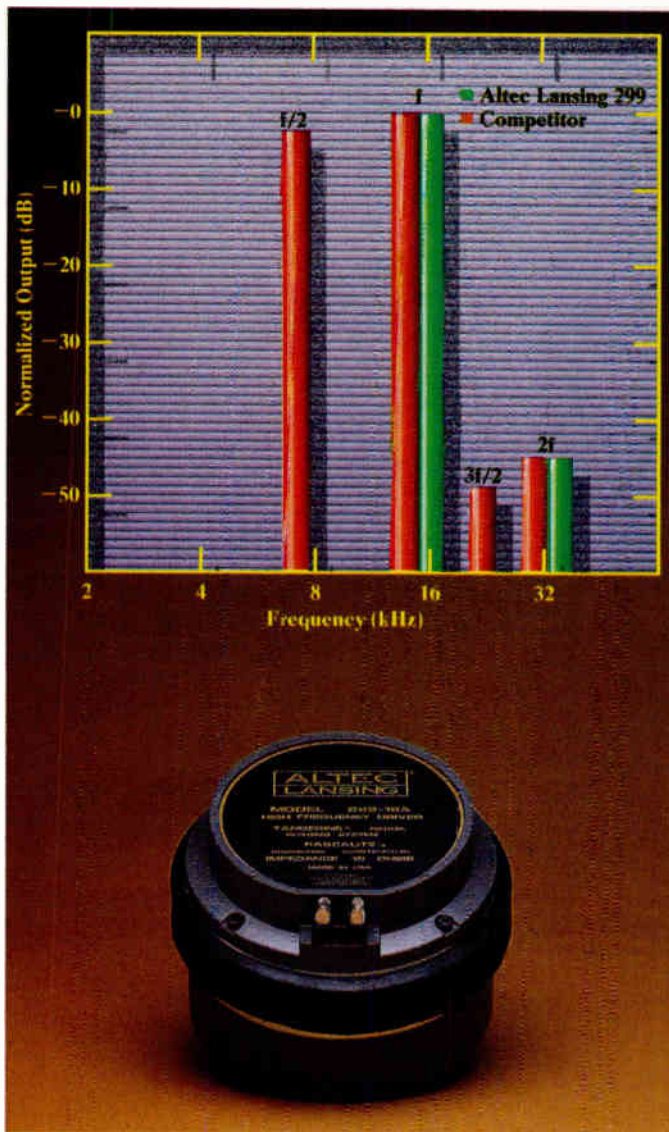

equal in acoustic output to large format compression drivers using titanium diaphragms, while minimizing the problem of subharmonic distortion.

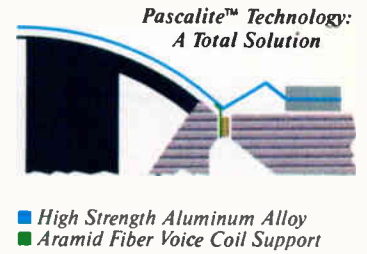

2.8" Diameter Voice Coil and Diaphragm Assembled with State-Of-The-Art Adhesive in Cutaway One-Half View Mounted in Driver

This graph, based on extensive Altec Lansing research with TEF® analysis, shows the output of a competitor's compression driver with a four-inch diameter titanium diaphragm when driven at 15.5 kHz with a modest input power level of one watt. It also shows the output of the Altec Lansing 299 Pascalite™ diaphragm driver at the same power level. The horizontal axis is frequency, while the vertical axis shows the relative amplitude of the output. At one half the fundamental frequency, the output of the competitor's driver is louder than any of its upper harmonics. This kind of spurious midband tone makes "S" sound like "SHH" and blurs musical definition. *The graph shows the subharmonic content of the Altec Lansing model 299 driver to be virtually unmeasurable.*

The benefit of lower total distortion in a compression driver is more accurate sound, and more satisfied customers and audiences.

Fact.

In Compression Drivers, Less Distortion = More Accurate Sound



P.O. Box 26105 · Oklahoma City, Oklahoma 73126-0105 USA · 405-324-5311 · Telex 160-369

© 1987 Altec Lansing Corporation

Circle 217 on Reader Response Card

World Radio History



**HOSPITAL &
HEALTH CARE
COMMUNICATIONS
Part II**

**From Now
to the
21st Century**

BY RON ROSEN

In the first part of this article (see December issue of *Sound & Communications*), we discussed the viability of the health care market as it related to our industry. It appeared that in spite of having almost reached a saturation point in the building of new hospitals, there remains an ongoing market for replacement, or retrofit of nurse call and other hospital communications—plus steady growth in the building of long term health care facilities such as nursing homes and residential care buildings.

CHANGING TECHNOLOGY

As those who are involved in the manufacturing process are only too aware, new nurse call systems do not usually spring into life in a burst of divine intervention. The gestation process is almost always fraught with anguish.

If the nursing community feels that the operation of our new whiz-bang super deLuxe computer-based master station is too cumbersome and too complex for someone untrained in electronics—if a cure is not found almost immediately for any bugs that show up in the early installations—if the communications contractor is not comfortable with the installation and/or service required and

does not care to put any effort into selling the new product to his customer—congratulations, you have just re-invented the Edsel. The corporate bean-counters and the board of directors will be less than thrilled.

Fortunately, however, most of our manufacturers are capable of learning a lesson from their own mistakes and those of their competitors. Just as domestic auto manufacturers learned that the public will not always be forced-fed whatever Detroit wants to sell, manufacturers of nurse call systems are observed as now subscribing to the form-follows-function school of design rather than function-follows-form. In recent years we have observed the emergence of a startling new philosophy; rather than have engineering anticipate what we *think* the user needs, let's talk to the user first, and find out what he wants!

A perfect example of this increased awareness can be found in a change in operation of most of the new types—particularly the micro-processor versions—in that portion of the operation known most commonly as Service Request.

Up until fairly recently, answering an audio-visual nurse call master station extinguished the corridor light outside the patient room. This presupposed excess staff loitering at the nurses station ready

to be dispatched to the patient if it was ascertained that personal attention was needed; whereas in reality chances are that the staff is already out in the patient area hard at work. How do we attract their attention to the room if we already *turned out the corridor light?*

Fortunately, most of the newer types of master stations are now equipped with Service Request buttons whereby the operator can re-illuminate the corridor light—usually with a different color—indicating that personal attention is now required. (The micro-processor having made it feasible to add an “overtime” reminder to signal the operator if the call has not been responded to and cancelled within a preset time frame.)

An example of increased awareness to the real-world needs of the user follows.

MICROPROCESSOR VS. TRADITIONAL DESIGN

Obviously, nothing has done as much to advance the technology of nurse call systems as the advent of the micro-processor. The majority of manufacturers spoken to by the author stated that a major portion, if not all of their production of audio-visual nurse call systems are microprocessor based, or that they planned to shortly introduce same.

The advantages of doing away with

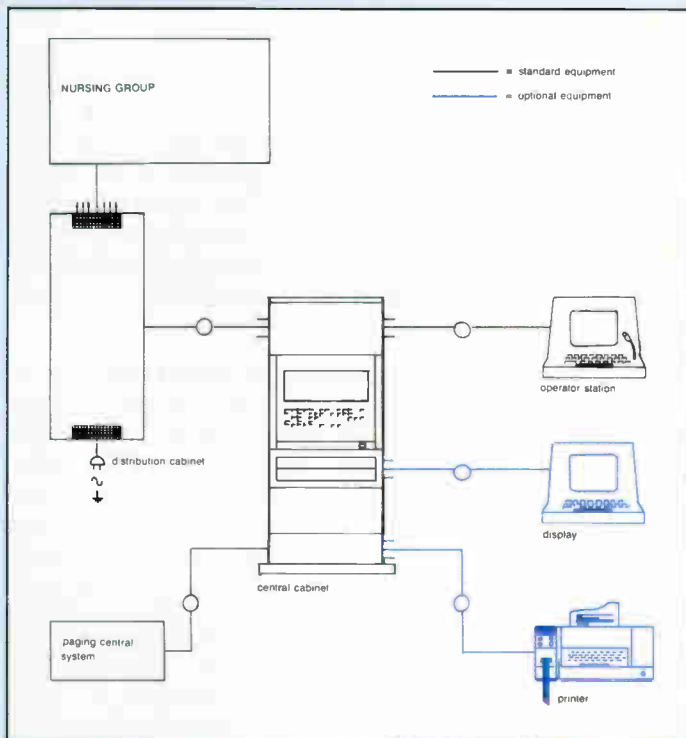

Figure 1

A typical Centralized Nurse Call System.

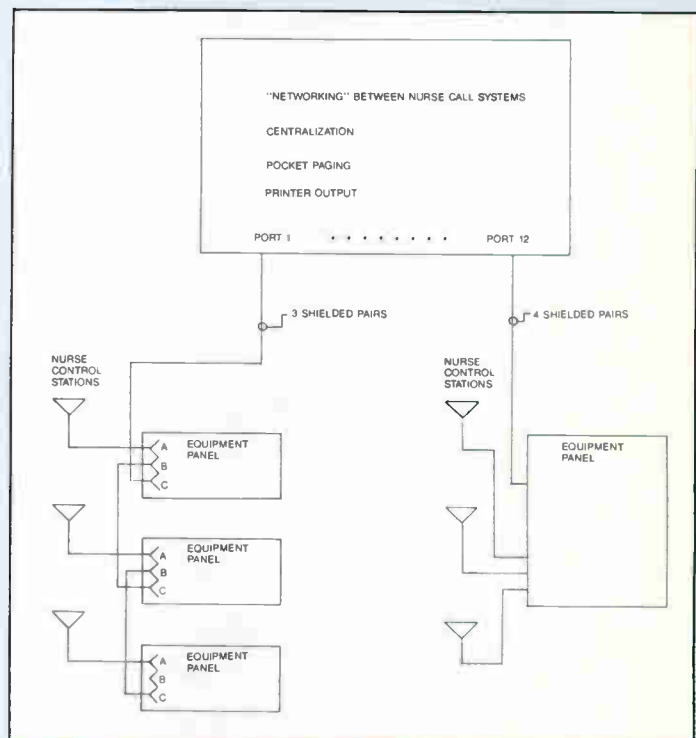

Figure 2

Networking Combiner.

Courtesy of UNIMED.

Line diagram courtesy Rauland-Borg Corp.

mechanical components thereby contributing to the longevity of the device, and the many additional features possible with microprocessor technology make this without a doubt the nurse call system of the future. Newer technology however, is not without its learning curve.

The first objection to be overcome on the part of the staff is that of "Too Complicated." The computer term "User Friendly" certainly applies here. In the traditional electro-mechanical system, nothing could be simpler than mashing down whatever button happened to light up when you heard the buzzer, and talking with the patient. Proponents of microprocessor based systems might say that their operation is even simpler, merely pick up the handset or press the push-to-talk button, the calls will sort themselves out in the order received, or in order of priority. In the real world however, nurses freely admit that they do get to mentally prioritize their patients; one may be a real pain and use the call button as though it were room service at the Waldorf, others will hardly ever call unless there is a real problem. So much for answering calls in the order received.

With a microprocessor based system a call may be picked out of the "stack" and taken out of sequence, but it does require somewhat more training—or to use hospital parlance, "In-Service"—than the old fashioned way. Fortunately, however, the population is becoming increasingly literate in the use of electronic devices due to the proliferation of more sophisticated home electronics; one cannot help but reflect on the future of the next generation as we watch a five year old blithely load and operate a V.C.R.

The other caveat in our wondrous world of microprocessors is that nemesis of computers in general—static. Many a display on a microprocessor-based Master Station has on occasion resembled an electronic pinball machine rather than a communication device. (In all fairness it must be pointed out that not all makes of microprocessor-based nurse call systems are as severely affected by static problems. Some manufacturers utilize multiplex cabling with "smart" patient stations, others prefer the logic located at the control cabinet, and opinion seems equally divided as to which technology is more prone to damage by static.)

EXPANDING THE SYSTEM

It is no secret that health care institutions are faced with a dramatic shortage of nurses and aides; many hospitals are also faced with the problem of declining revenue due to D.R.G.'s, competition from walk-in treatment centers, etc. Our industry is moving rapidly ahead with more flexible operation of the communications system, hopefully allowing better time management and increased utilization of the available skilled workforce.

Conversion of the nurse call system from an electro-mechanical device to the processing of digital information is providing expanded operation never before possible, via the ubiquitous RS-232 port.

What are some of the options with the new generation of nurse call systems?

CENTRALIZATION

Centralization of the nurse call operation usually implies a central console remotely located in a non-patient area, manned round the clock, answering all patient calls rather than have the calls answered at the nursing floor. (See Figure 1.) The console operator can handle the routine requests for information, etc., and if he or she determines that personal attention is required, will presumably locate the closest nurse or aide and inform them of the request.

Full centralization of this type, although widely used in Europe, seemed to gain only limited acceptance in the U.S., and enjoyed brief popularity from 1980-1981.

The trend at present is toward Networking, or combining, of the individual nurse call systems on each floor. (See Figure 2.) In this manner any or all of the individual systems can be "captured" by any other. This allows takeover of an area during the evening hours when staff is reduced, or any other permutation the hospital or nursing home desires for efficient operation.

WIRELESS REGISTRATION

Staff registration is highly desirable in a localized floor system to locate staff as required, and is a must in order to operate a Centralized system. Manual registration is offered by most manufacturers, but it has the disadvantage that a harried staff member is not always going to remember to push the appropriate button upon entering or leaving a room, particularly when his hands are full.

One solution offered by a couple of manufacturers is for each nurse and aide to carry a small transmitter—infrared, R.F. or some yet to be announced technology—which signals a receiver in the Patient Station that a nurse or aide

A	B	C	D	E	F	G
		04-12-2 M42	Smith.P	038	B	
01	09-30		KITCHEN			
02	12-08-3		WILLIAMS.G	045		
03	U121 02-10-1 F34		BROWN. N	032	A	PAIN
04	W252 16-15-2 M61		PETERS, K	041	B	ASP
LOCATING						
11	N182 08-13-2 F63		JONES. G. H.	037		MED. ALARM
12	N147 04-31		LAVATORY			
13	N157 05-08-2 F34		SCOTT.L	032	E	BOOK !!!!!
14	N235 13-17-1 M46		WEST.C	039	D	PILLOW
FOLLOW UP						
21	21-13-2 M43		WELLESLEY.C	047	F	BARBER
22	13-24		NURSE STATION		F	DR.048

Column A gives the line numbers
 Column B shows the receiver numbers of the nurses paged, with code letters
 Column C are the floor, room and bed numbers
 Column D gives the sex, age and the names of the parents or rooms
 Column E shows the receiver numbers of the treating doctors
 Column F gives the care level
 Column G are the notes made by the operator, or directly by medical alarm

Figure 3

The text that might appear on the screen of an operator station at a given moment.

We have many competitors. But no competition.



SENNHEISER

© 1987 Sennheiser Electronic Corporation (N.Y.)

Sennheiser Electronic Corporation (N.Y.), 48 West 38th Street, New York, N.Y. 10018 (212) 944-9440 Manufacturing Plant: D-3002 Wedemark, West Germany
PROFESSIONAL MICROPHONES • HEADPHONES • WIRELESS MICROPHONES • INFRA-RED SYSTEMS

Circle 236 on Reader Response Card

World Radio History

has entered a particular room. If immune from interference, this somewhat Buck Rogers approach might well become the standard of the future.

POCKET PAGING

There were a number of hastily formed alliances between manufacturers of nurse call systems and R.F. manufacturers when it appeared that hanging a pocket page receiver on the nurse, showing the room number and priority of the calling patient would be a great idea. The digital information received at the nurse call system was processed and passed along to the RF encoder/transmitter.

Manufacturers interviewed were

unanimous in stating that this option did not live up to expectations, and that sales of the necessary software and hardware were less than overwhelming. Still offered by some as an option, pocket paging awaits widespread acceptance by the health care community.

PRINTER INTERFACE

Here, manufacturers of nurse call systems state that they are seeing more demand. Patient census, call activity, and staff activity are easily extracted from the hard copy; the time taken to answer a call—the interval from operation of the call cord or pushbutton to cancellation by the staff at the bed or bath station—can

be a critical factor in case of lawsuit or claims of neglect, and a printed copy is invaluable.

C.R.T. DISPLAY

Offered by American Zettler, Bunting and others, C.R.T. display perhaps represents the most radical departure from traditional concept. Rather than be notified merely of the calling room and bed number, this feature allows for display of patient name plus whatever personal and medical data is deemed appropriate. (See Figure 3.)

Opinion as to the value of having this information at the Nurse Call Master is divided. Full time nurses will usually pride themselves on knowing the patients placed in their care, and will quickly associate patient with room number. It is seen as valuable to per diem and part time nursing staff.

The problem, however, seems to be entering of the information into the P.C. portion of this type of system. The floor nurse will shy away from this task, not wishing to add to an already overloaded work schedule, and may see it as a duplication of information that already exists, certainly in more detail and much more up-to-date on the patient's chart.

It would appear that better communication is needed between suppliers of various hospital systems. Patient data is often entered into the hospital mainframe computer at the time of admission, and although the technology exists to download this information to the various subsystems (as well as exchange information with other areas such as the laboratory) it seems that few are willing to take the risk of integrating the systems. Access to a constantly updated internal data bank from terminals located at the nursing stations is a reality in a number of hospitals, and perhaps it is only a matter of time before we see access of this data from a nurse call system.

In summation, it would appear that we are beginning a new generation of health care communication systems. There is a large responsibility associated with the supply and installation of systems designed to assist in the proper delivery of health care.

The supplier and contractor who remain sensitive to the needs of this rather unique customer, and who stay abreast of changing technology will find few areas as satisfying and rewarding as health care communications. ■

Ron Rosen is a freelance writer and has been both a contractor and district manager in the sound and communications industry.

CALL 800/245-4964 AND... LET YOUR FINGERS DO THE STOCKING

From Anchorage to Miami, Los Angeles to Boston and anywhere in between, if you need wire in a hurry, just call West Penn Wire. With hundreds of different types of plenum and non-plenum electronic cable in stock, we'll ship exactly what you ordered, right to your door, ... that's our promise. (Stock items shipped within 24 hours.)

Reliability, quality, service and the best price. That's what West Penn Wire is all about.

Send for our free electronic cable catalog.

WPW
WEST PENN WIRE

Washington, PA 15301
In PA 800-222-8883
FAX 412/222-6420



TOA'S WINNING HAND

THE NEW 900 SERIES PLUG-IN MODULES

Toa introduces 7 new fabulous hi-tech modules that perform wonders when incorporated into Sound Reinforcement Systems utilizing 900 Series amplifiers. The new additions to the 900 Series plug-in modules offer Voice Gate, Variable Muting, Mic and Aux Compressor features and allow the sound contractor or specifying engineer to choose from a total of 36 modules in six different categories. These modules have been designed with Toa's "install and forget" philosophy. They utilize thoroughly modern surface mount technology, provide ease of installation and increased reliability.

You can have complete confidence when specifying or installing Toa 900 Series Sound Reinforcement Products.

TOA's New Modules for The 900 Series

M-51 Voice Gate Module / M-61 Mic Compressor Module / U-12 Variable Mute Module / U-61 Compressor Module / T-02 Music-On-Hold Module / M-11 Precedence Mute Module / U-21 Remote or Remote Master Volume Module



Surface Mount Technology

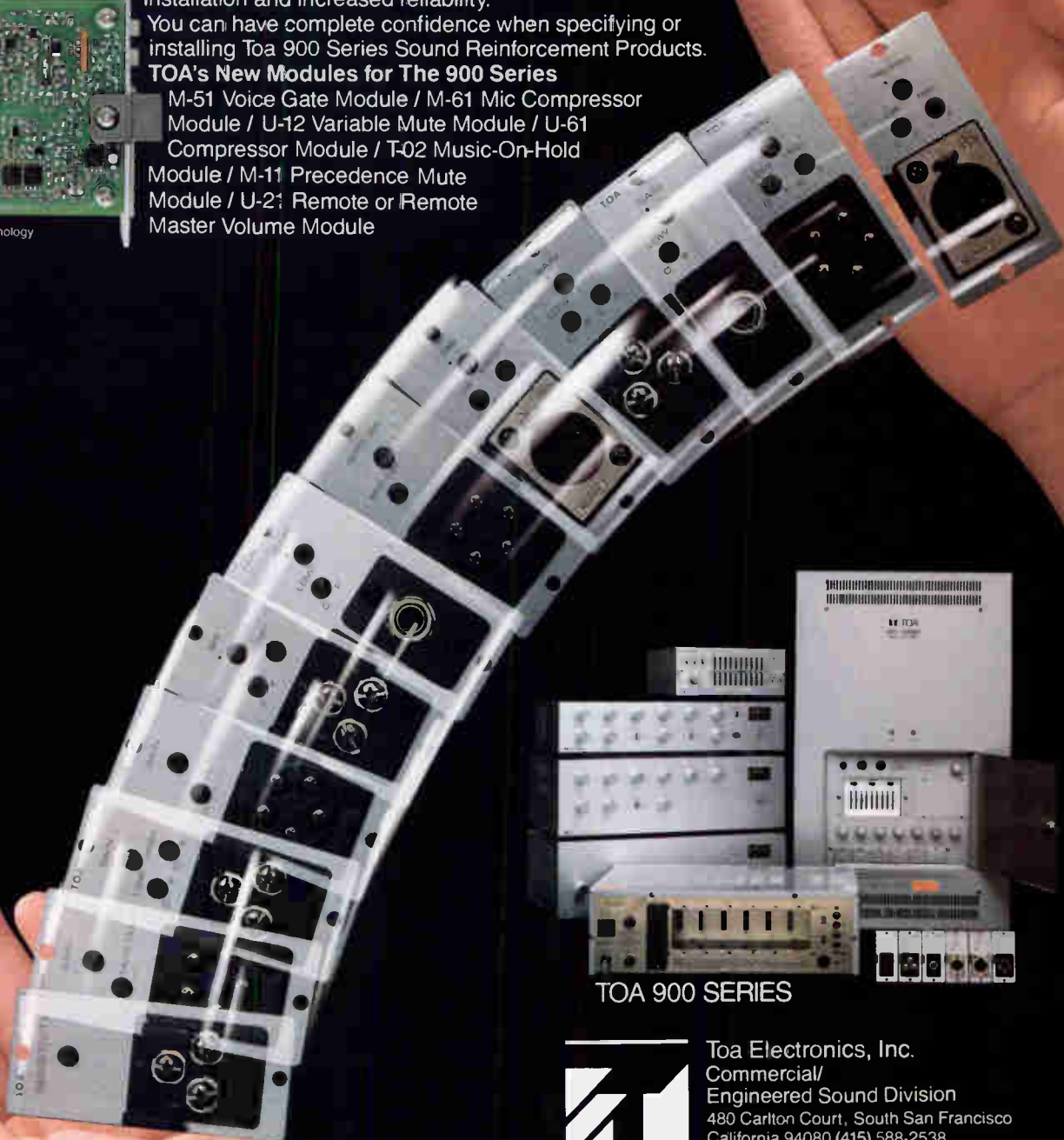

TOA 900 SERIES



Toa Electronics, Inc.
Commercial/
Engineered Sound Division
480 Carlton Court, South San Francisco
California 94080 (415) 588-2538

Toa Canada: (403) 489-5511 Edmonton or
(416) 624-2317 Toronto — Toa U.K.: (0277)
233882 Essex — Toa Europe: (040) 2506091
Hamburg — Toa Japan (0797) 71-2222

Installation Profile

by William M. Peterson
President of Professional
Sound Industries

The White for Preside

The White House Press Lobby sound system is used regularly by the President of the United States when he speaks to the press and to the country. The importance of this sound system operating daily without fail cannot be overstated. The existing Press Lobby sound reinforcement and distribution system had served the President, the White House Press Office and senior administration officials for over 16 years. But with in-

creased needs for maintenance, and with a goal of improving communications within the room, the White House Communications Agency (WHCA) issued a Request For Proposal for a new system.

The Statement Of Work (SOW) issued by WHCA requested eight switchable mic/line inputs, two separate distributed systems, a four input automatic mixing system for picking up questions from members of the press, complete patch bays, full monitoring and 100 percent

Redundancy with a single switch changeover. This redundancy requirement necessitates that there are two of nearly everything.

After careful consideration of bidders' price and technical proposals, a contract for the Press Lobby system was awarded to Professional Sound Industries (PSI), a Sterling, Virginia E, F & I (Engineer, Furnish and Install) sound contracting firm. When the system was finally installed, four men had put in a total of

House Sound System ntial Briefings



some 800 man-hours over a period of nine months. This was to become one of PSI's most challenging projects.

The Existing System

The room is 20 feet wide by 60 feet long, and has a podium at one end, a group of chairs in the center for the press, and a camera platform at the rear. The ceiling is eight feet high with 12-inch square interlocked acoustic tiles. Windows and the outside door are along one

long wall. The opposite wall is painted drywall, and the floor is carpeted. There is no additional acoustic treatment, and the room has a moderately high ambient noise level. The acoustics were not treatable within the scope of this contract.

The sound system to be replaced was straightforward. The operator, who works for WHCA, sits in front of a standard 19-inch equipment rack located six feet camera right of the podium. There was a volume knob for the podium, a

volume knob for the press question microphone, and six additional knobs to control other patchable mic or line level inputs.

The existing system worked, but suffered in a couple of areas. The press in the rear could not always hear the questions from the front rows, and the press in the front and the briefer sometimes had trouble hearing questions from the rear.

PSI, in its proposal, visualized the new



Chris Nottingham (left) and Keith Dorest of Professional Sound Industries install a sound system rack in the White House Press Lobby.

must be cut off, and the sound from the briefer must be heard through all speakers, including those in the questioning zone. Using the Industrial Research Products (IRPI) DE-4013 Voice Matic† Mixer, the operator does not have to think about turning ON or OFF mics or speakers. The mixer's briefer override option implements this feature automatically and instantaneously whenever the podium mic is activated.

In addition to reinforcement within the press lobby, there is a secondary requirement for chronicling all that goes on within the briefing. To this end, recordings are made of all press functions, and for this recording, *all* microphones must be on at *all* times.

sound system as being two separate yet integrated systems: one system for sound reinforcement within the press lobby proper to improve understanding of the questions; and a second, distributed system with both line level and 70 V sends.

Within the press lobby, eight existing four-inch Altec 405 flush mounted ceiling speakers carry the sound from the podium to the seated press. The same speakers are zoned to amplify questions

from the press. To derive maximum gain before feedback, whenever a press question mic is activated by someone asking a question, the local pair of ceiling speakers is relay-switched off.

Who's In Charge/Who's On First?

The person speaking from the podium must have control of the proceedings at all times. If the briefer should wish to override a questioner, the question mic

System Description

To accommodate this "everything at all times" requirement, we installed a second DE-4013. Using an automatic mixer keeps unwanted "noise" out of the system, and with the DE-206 Level Matic† module, we insure a consistent level no matter how many people are speaking, or how loud or soft they may

**White House Press Lobby
Sound Reinforcement and
Distribution System**

Block Diagram

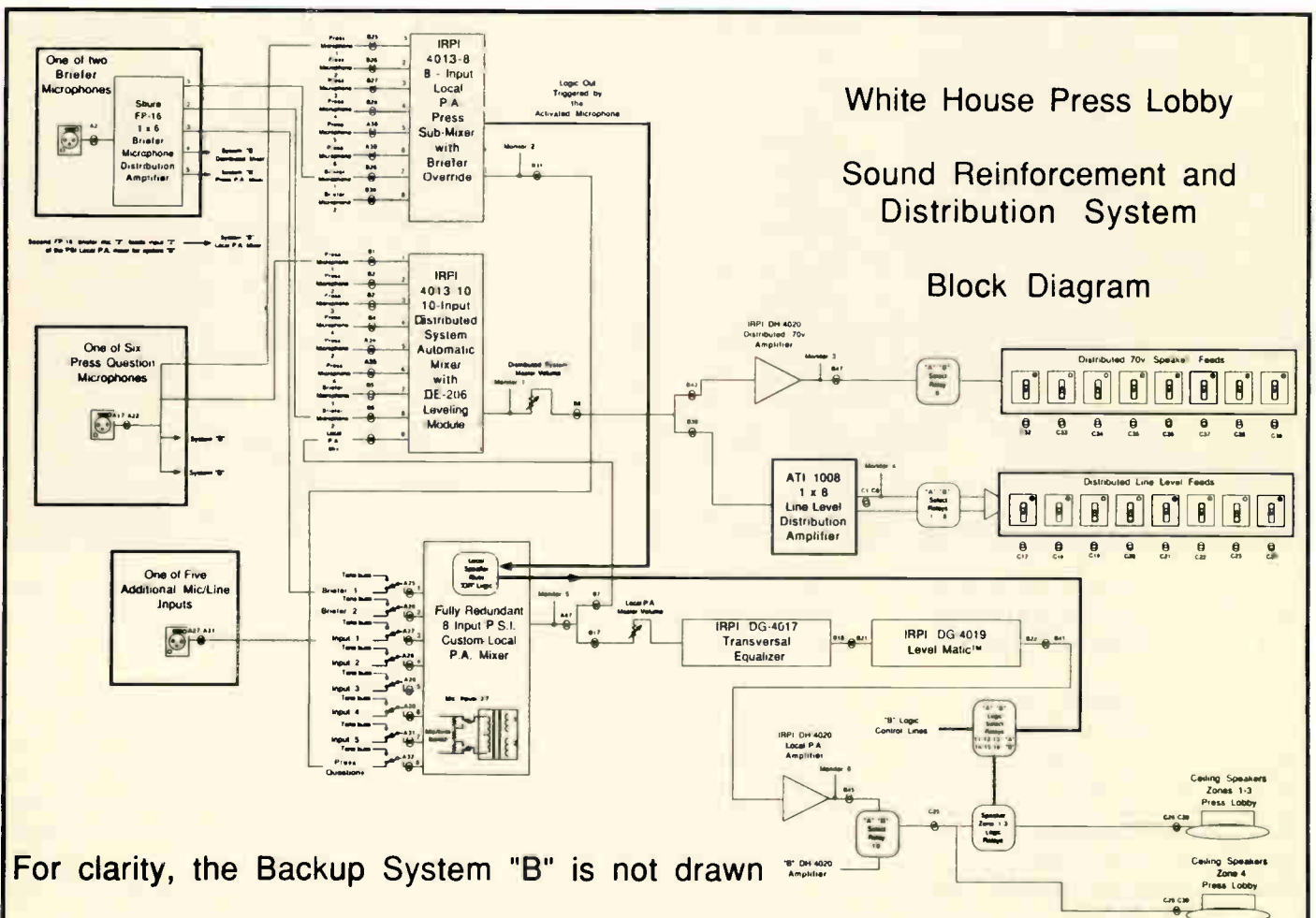

For clarity, the Backup System "B" is not drawn

Professional Sound Industries, Sterling, VA Drawn by: William Peterson

Focused.

The US690 mic puts N/DYM™ technology on the podium. Now, the most powerful innovation in dynamic microphones is available for commercial sound applications. The revolutionary N/DYM magnetic assembly means up to six dB more output—plus smooth, crisp, open sound and outstanding voice reproduction.

Typical problems of a podium mic are eliminated by the unique features of the US690. A well controlled supercardioid pattern ensures better directivity and less feedback, producing better sound in noisy environments. An effective hum-bucking coil cancels hum from lighting and other sources. Handling and mechanical noise are reduced by an effective shock mount and noiseless gooseneck. And an Acoustifoam™ pop filter eliminates explosive breath sounds and wind noise.

In short, the US690 is focused on a broad range of applications where your customers want—and need—to be heard.

The US690—pro quality in commercial sound available only from:



Circle 218 on Reader Response Card

be talking.

This second DE-4013 feeds two distributed systems, one at Line level (+4 dBm) to the recording studio, and stenographers, and one at 70 V to other speakers throughout the White House. Each of these "sends" is switch selectable and the switch status is shown with a green LED on each switch.

The amplifier requirement calls for each amplifier to be capable of supplying a minimum of 100 Watts. The IRPI DH-4020 amplifier fills every need—plenty of power, quiet (no fan), and the right size, a single rack space.

IRPI TEQ† transversal equalizers model DG-4017 and DI-4019 Level Matic automatic gain controls fill out the balance of the Industrial Research equipment. Audio Technologies 2008 distribution amplifiers are used for the line level distributed feeds, and Shure FP-16 distribution amplifiers supply the needed microphone splits. The briefer microphone is split six ways through the Shure, while the press question mics are split four ways directly into the IRPI-4013's. To allow this four-way bridging without loading the microphone, the input impedance of the 4013's is raised with a simple resistor swap.

Automatic mixers, because of their speed and flexibility, were chosen for all mixing functions. As designed with the automatic mixers, the entire system can function without an operator. The WHCA person in charge requested the custom local P.A. mixer to contain manual controls for the briefer, in addition to output from the automatic sub-mixers. The operator can choose to use these direct inputs from the briefer, or use the automatic mixer inputs, at his discretion.

Redundancy, Redundancy

To fulfill the redundancy requirement the system contains two of everything; two of both IRPI mixers, automatic gain control, amplifier, distribution amp, and two identical Local P.A. mixing consoles within a single chassis. This custom designed mixing console contains two mic pre-amps for each input, two summing amps, two headphone amps, two meters, two sets of logic controls, even two power supplies. The slide faders are dual controls, simultaneously raising and lowering a primary and back-up pre-amp for each input.

The local P.A. mixing console is completely custom engineered and incorporates 16 special miniature, high-gain,

†Registered trademark of IRPI.

The equipment rack, next to the briefer, contains a completely redundant system of a single 19 inch by 77 inch cabinet. The system includes IRPI's DE-4013 Voice-Matic, Gentner's Versapatch/66 patch bays and (detailed insert) PSI's custom Local P.A. mixer. The mixer contains VU meters and headphone outputs for simultaneous monitoring of six critical audio points in both the Primary and Backup systems.

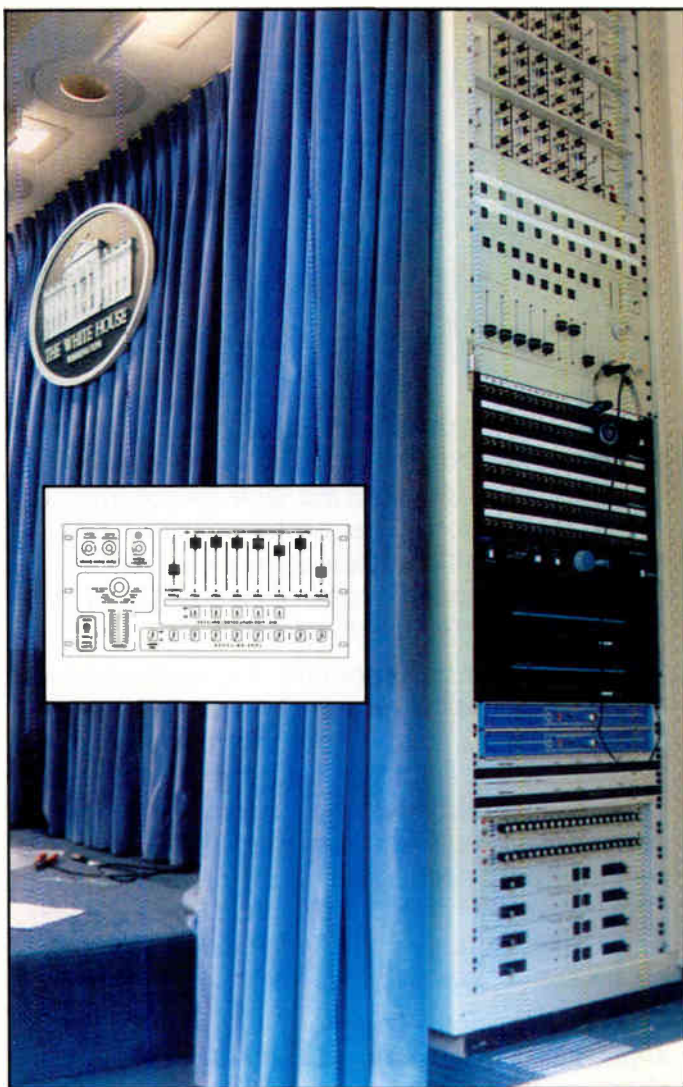

low-noise, mic pre-amp boards, eight for the primary, and eight for the backup system. For the summing amps, headphone amps, and meter circuitry another custom circuit board is used. Each output, and each group of eight pre-amps is powered from its own power supply, providing complete redundancy even within the custom mixer.

It's Logical, and, it Makes Sense

Two sets of logic circuitry are also located within the mixer to control the zone speaker switching. Each press question zone has two microphones, and if either mic is activated by someone speaking, both zone loudspeakers are automatically switched off. A simple logic OR circuit operates from the optional logic outputs provided on the rear panel of the IRPI DE-4013 mixer.

The Custom Local P.A. Mixer

Eight operator accessible slide faders are provided on the local P.A. mixer for level control. The first fader is the primary Briefer mic, the second fader is

the backup Briefer mic, and the last fader is all six press question mics through the automatic press question sub-mixer. Five additional patchable, mic/line selectable inputs accommodate sources such as the Rose Garden, Camp David, and anywhere else from which a press event may originate. Two banks of switches above the mixer individually select the distributed line-level and 70 V feeds.

If you ever wondered about the three mics in front of the President, the first two are the primary and backup Briefers, and the third goes directly to the Press. To add even more backup for the President, WHCA sends a split from their mixer containing their briefer mics to the press; and the press splits and sends their single briefer mic back to WHCA.

More Redundancy, Again

The method of system redundancy we designed for the White House is one wherein the primary and backup systems both operate all the time. Each microphone splits and drives two identical sets of electronics, operating concurrently,

right through the power amplifiers. The operator can switch through all monitor positions and verify that the audio signal is present and at the same level at six major audio points in the system. In this way, the operator will be aware if either the primary, or the backup system should experience a failure. A tone oscillator input is supplied, with switches to place a test tone into any circuit for testing and pre-use level checking.

As required in the Statement Of Work, a single switch affects the complete changeover from *Primary* to *Backup* systems, instantaneously.

There are two signal paths from the custom mixer. Audio feeds the distributed system and the local P.A. system. For each signal path there are two separate signal lines, and each system contains two identical sets of electronics.

Audio from each mixer output to the local P.A. system routes through an IRPI DG-4017 TEQ transversal equalizer, then through an IRPI DI-4019 Level-Matic automatic gain control, and finally through an IRPI DH-4020 amplifier with DH-100, 70 V output transformer to isolate the speaker lines from ground.

The distributed system has a similar lineup of mixer, automatic gain control and amplifier. From the local P.A. mixer, a signal is sent to the distributed system mixer. Each of these two IRPI DE-4013 mixers receives direct splits of the briefers and press question mics. In this way, individual volume controls can be adjusted so the distributed feed has plenty of level from all microphones. As this mixer contains an output from the local P.A. mixer, it will also contain any feeds originating from outside the press lobby which are patched into the local P.A. mixer. An IRPI DE-206 Level-Matic module is plugged into this mixer to provide a constant level signal to all the distributed sites the operator has selected.

Just One dB

To get the microphones as close to the members of the press as possible, we suspended Shure SM-62 high quality, small, cardioid dynamic mics from the ceiling. This places the mics as close as possible to the talkers while still keeping them out of the camera shot. Moving the mics a few inches closer clearly does not result in much increased gain before feedback—we calculated we could get close to another one dB. However, when you are striving to squeeze out all the amplification you can, one dB can be just that much closer to the signal level you need.

While full patch bay capabilities were

requested, the duplication of nearly every piece of equipment meant the number of patch points required would have been enormous. As it was, using the most space economical equipment for each item of electronics, we barely fit within the space confines of the rack. There was simply not enough room to patch everything.

Analyzing the patch needs, we realized that no one would ever patch around a problem during a live session. If a problem occurs, the operator switches to the backup system, and fixes whatever went wrong later. Therefore, what was needed, and what we designed and installed was a "trouble-shooting" patch bay. Plugging into a patch point allows monitoring the signal through all components prior to that patch.

Surpriiise, Surpriiise . . . !

Systems of this complexity do not work the first time you turn them on, even though the electronics are all thoroughly tested. We spent countless hours analyzing failure modes in systems; correcting every shortcoming we could think of, and the best we could hope for is to minimize the number of inevitable surprises.

The Press Lobby system held four surprises, three of which were painfully obvious. Surprise number one was that the system hummed. It didn't hum when we tested it, it didn't hum when we installed it, it only hummed when the door of the rack was closed. More specifically, it only hummed when a mic input was turned up.

When we realized the hum level increased as the door was being swung closed it was not difficult to pinpoint the cause. Moving the coiled A.C. equipment cords away from the mic lines removed the hum completely.

Our second surprise was the relays—especially the speaker zone switching relays. They clicked. No surprise there, the surprise was how *loudly* they clicked. During testing, we were comforted to hear them click. It never dawned on any of us that the President would not be comforted in quite the same way by this clicking. I left for home puzzling over how to get these relays quiet, and how to do it fast!

By the time I got to work the next morning I had come up with seven different fixes for the relays. What was deemed simplest and fastest was to remove the guts of the relay leaving the plastic housing and 8-pin plug. Inside the now empty space we installed a miniature printed circuit mount relay. This was mounted

on 18 gauge wire "legs" to the original terminal contacts. One of the legs was a 1 Watt voltage dropping resistor to lower the 24 V supply to 12 V for our smaller relay. Now there was little vibrational coupling to the case, but the package still clicked loudly.

The final step was to wrap a layer of friction tape around the outer plastic shell. This damped the re-radiation of the click from the outer shell. Plugging these modified relays into the sockets in the rack elicited the response that they "didn't work" Honestly, you had to put your ear right up against the relay to hear it click. Two down, two to go.

Surprise number three also related to the relays. When the system was used with microphones, everything worked fine. But, introducing a feed from an external source started all the speakers in the room switching on and off. Fortunately, it didn't take long to realize what the system was doing.

The sound from a given loudspeaker would be picked up by its nearest microphone. Once the automatic mixer detected a signal at the mic, it of course turned off the speaker! As soon as the speaker turned off, the mic was no longer activated, the mixer turned the speaker back on, and the whole process started again. The effect was quite cacophonous with three sets of speakers and microphones all switching on and off at random.

The solution, fortunately, was simple. Whenever the operator wishes to bring in an outside feed, he flips a switch which activates the chairman override mode on all mixers. As you recall, in our implementation of chairman override, sound comes out of all speakers at all times, and the zone microphones cannot switch on; an elegant solution requiring but a single switch and four diodes.

The final surprise didn't show up for several days. Occasionally, when a certain 70 V send switch was activated, the VU meters would go to full scale, and the audio got distorted everywhere. We could neither duplicate this condition, nor explain it. You can't hear this type of electronic feedback, as it is supersonic, but the system VU meters picked it up readily. WHCA finally traced the problem to a wire bundle containing a 70 V feed which had been improperly routed along with several mic input lines. Separating the lines as they should have been originally corrected the condition.

As we had pre-built and tested the entire rack, the actual installation of the press lobby sound system took us only a

(continued on page 68)

The Orban 464A Co-operator

by Jesse Klapholz and Richard Feld

A two-channel gated leveler/compressor/high-frequency limiter/peak clipper, in a single rack space package. That is how the 464A is described on the front cover of the manual. While its primary application is in the broadcast/production sector, it should be included in many sound reinforcement designs. Orban has enjoyed a fine reputation for well-built good-sounding signal processing gear in the broadcast environment. Hence, its immunity to stray RF, noise, and hum pickup; and audio performance are rather impressive. Quiet, good sounding signal processing that is easy to install and operate is becoming increasingly important for sound reinforcement systems in this digital era.

Basically, the unit is comprised of two independent functions per channel—AGC (automatic gain control), and HF (high-frequency) limiting/

peak clipping. AGC is maintained via a gated leveler followed by a compressor—either function may be switched off. The attack time of the leveler is approximately 200ms, and about 5ms for the compressor; the compression ratio is greater than 20:1, and all these numbers adjust dynamically. The HF section is comprised of a limiter that has a six-position frequency characteristic selector, and a peak clipper.

The two channels of the unit may be operated independently of each other in dual mode, or may be switched to track each other in stereo mode via a front-panel push-button. In this mode the leveler and compressor VCAs will track the channel requiring the greatest amount of gain reduction. While this ensures a more stable stereo image, the high-frequency limiters remain independent of the levelers and compressors.

Installation

Installation of the unit is straight forward—barrier strip and tip-ring-sleeve inputs and outputs, with pre-punched holes for an optional XLR-retrofit kit. The power ground may be isolated from the chassis ground by simply removing a strap connection on the rear panel. The inputs and outputs are all electronically balanced, and will interface with any pro gear. Output transformers are optionally available. The output level is easily set so that +3 dB on the output LEDs will correspond to full output, or safe output-level, on the device the 464A is driving. The output level and meter calibration controls are recessed behind the front-panel and are protected by a small security cover.

The controls on the unit are all easy to get to on the front panel and are easily set. The four level indicator LED banks show the gain reduction and output level simultaneously on both channels. There are HF limiting and gate threshold LEDs as well. The gate threshold may be set to avoid noise ups, pumping, and breathing often associated with this type of process. The release time characteristics may be set for either music or voice, which allows the unit to cleanly control signals with varying dynamic characteristics.

The HF limiter section has six different pre-emphasis curves which allow the unit to be tailored to the device it is protecting, or to the spectrum of the signal it is processing. Together with the clipper, which is the final block in the chain, the HF section will minimize excessive sibilance

Specifications:	Manufacturer's	Lab Test's
Maximum output:	greater than +20dBu	+21.2dBm
Frequency Response (below leveler, compressor, and HF limiter thresholds):	20-20kHz, ± 0.25 dB	20 - 20 kHz $\pm .2$ dB
Distortion (@ 15dB gain reduction, HF-limiter off)		
THD:	less than .05% @ 1kHz	.03%
	less than .1% 20-20 kHz	less than .03%
IM:	less than .05%	.04%
THD of HF-limiter/compressor:	0.02%	.02%
Noise (below output clipping threshold w/HF-limiter set for flat output):		
20 - 20kHz	85dB (90dB typical)	86dB
CMMR	NA	42dB



and protect compression drivers from excessive power; which is easy to do with the extra EQ generally applied to constant directivity type horns. An applications note is included that details this type of setup, and explains how to match the pre-emphasis curve with various driver types.

Operation

Setting the leveler is done by adjusting the input attenuation, gate threshold, and release time controls. Also, the release shape is hard or soft selectable on the front-panel. Leveling provides a slow averaging gain control that sounds most natural on signals that do not require a great deal of dynamic loudness reduction. Compression, on the other hand, affords transient control for signals that have high peak-to-average ratios, or frequent abrupt level changes.

Setting up the unit itself is simplified by knowing, in advance, the manner in which you wish to process the audio signals. Once a setup is known, the most time consuming steps are calibrating the peak output level meters, and calibrating the clipping levels. In order to accurately set these levels, an audio oscillator, and an audio voltmeter that can be referenced to 0 dBm/600 ohm (0.775V RMS) must be used. All the other settings are mostly a matter of routine and are easily set. However, it should be noted that three settings must be made prior to installation in the rack. The peak clipper and pre-emphasized outputs must be set by jumper placement on the circuit board itself.

All the controls and the output and gain reduction LEDs are easily read and set, with the exception of the power switch. Perhaps we are more swayed to the "no power switch" school, but having the AC nestled in among audio control switches with no illuminated indicator is a bit exceptional, but not a major issue. Otherwise the layout is clean and is setup with the operator in mind. The construction is rugged, and uses high-quality parts.

Comments

We found the documentation excellent—easy to read, laid out clearly and intelligently, and rather comprehensive. Included is a detailed index and more than the usual amount of drawings and schematics. Detailed parts lists as well as vendor addresses are included. Besides the operating instructions are detailed theory of circuit descriptions, and some back-up material on leveling and compression, and high-frequency limiting. Routine maintenance and trouble-shooting instructions round out the manual.

Following the manual it was easy

to set up and calibrate the unit for a given absolute output level. Running the various tests on our Sound Technology 1710 gave us no surprises at all. Test points are easily picked off the circuit board which helps a lot during such testing. For a VCA unit to keep up with minimum gain op-amp specs is rather impressive.

What we measured held through auditioning the unit. With the gate properly set, no pumping or breathing was detectable, and the leveler and compressor functions could easily be tailored to specific program sources. The HF limiter and peak clippers performed as expected. The LED bar graphs, gate LEDs, and limit LEDs all give the operator an exact picture of what is going through the unit, and exactly where the driven output device level is. In short the Co-Operator lives up to its name. Besides the obvious broadcast applications, we feel that for recording, transmission links, and sound reinforcement systems the 464A will prove both to be useful and the most economical approach replacing two to three "component" units. ■

General Specifications:

Indicators:	Four LEDs to show gating & HF limiting
Meters:	LED Bar graph: gain reduction and peak output level for each channel.
Connectors:	Barrier strip in parallel with ¼" balanced phone jacks/optional XLRs.
Dimensions:	1.75"H x 19"W x 9.625"D
Net Weight:	10 pounds
Price:	\$1,195.00

PRODUCTS IN REVIEW

ART's Master Blaster Is a Sound System

ART's Master Blaster is a sound system that is made up of a pair of enclosures, the Supercompact and Impact 1. By mating a pair of 10 inch transducers with a one inch compression driver, each coupled to a constant coverage horn, the Supercompact midrange unit seeks to eliminate the distortion associated with high sound pressure levels.

Low end frequencies are handled by the Impact 1 port loaded enclosure that features a single, sturdy 18 inch driver.

Each unit that makes up Master Blaster houses its own power supply and amplifier internally mounted on a 3 μ high, 19 inch rack. The amplifier is capable of delivering cooling of the heat sink. The Master Blaster power amp module, the size of a cigarette packet, can deliver in excess of 1,000 watts. Input signal is constantly monitored and compared with acoustic output to correct any im-

balance between amplifier and loudspeaker.

A delayed automatic level control built into each Master Blaster enclosure offers constant signal maintenance as opposed to limiting or compression of the dynamic range.

Circle 1 on Reader Response Card



Electro-Voice Introduces DeltaMax

Electro-Voice has introduced

DeltaMax, a processor controlled speaker system. Two versions of DeltaMax systems currently comprise the series—a compact 12 inch two way and a 15 inch two way.

Both systems, the 15 inch DML-1152 and the 12 inch DML-1122, are constructed of void-free birch plywood in a trapezoidal shape, forming a 30 degree wedge. An optional, three point flying system with steel-reinforced aircraft-type pan-fitting hardware allows the system to be flown in multi-cabinet arrays.

Circle 2 on Reader Response Card

Vicon Introduces Microcomputer-Based Switcher

Vicon Industries, Inc. has introduced an all-new microcomputer-based switcher. The V1504 represents a significant advance over the original V154 Switcher.

The V1504 belongs to a new generation of CCTV technology, because it is built around a microcomputer instead of the simpler microprocessor. The microcomputer provides several new functions: LEDs for all alarmed camera positions flash until acknowledged; alarm acknowledgement can be manual or automatic; auto acknowledgement can be set for 2, 8, or 20 seconds. Installation is simpler. A built-in system diagnostic flashes a warning in case of incorrect connection. The master module provides video outputs for both scan and hold monitors.

The V1504 is housed in the modular Phase Eight package, which allows each switching system to be tailored to the needs of the overall installation. In standard configuration, the V1504 can switch from 4 to 32 cameras. In fully expanded format, the maximum capacity is 64 cameras.

Circle 3 on Reader Response Card



Aphex Adds Typed C Improvements to its Exciter

Aphex Systems Ltd. has announced

The world's first simulated stone outdoor speaker system Completely water and weather proof Designed for Audio Sonic Accuracy

Frequency response 58 Hz-18.5 kHz.

Power handling 100 watts continuous

Whether your applications are:

- industrial
- architectural
- landscaping
- indoor gardens
- amusement parks
- shopping centers
- office buildings
- or for your own back yard



you won't believe the sound of the **ROCKUSTICS** loudspeaker systems.

Enhance the looks and sound of your next installation.

ROCKUSTICS INC.

41 East Main Street, Bayshore, NY 11706 (516) 665-6497

Circle 227 on Reader Response Card

A Sound Performance



With No Strings Attached

The Williams Wireless Microphone System offers performance second to none, with complete frequency synthesis. And, the longest warranty in the industry.

Check these important features:

Programmability. Simple on-site frequency programming eliminates the need for costly and time-consuming crystal changes. Choose any of 8 high-band frequencies instantly.

True Diversity. Our Diversity FM Receiver eliminates dropouts and phase interference. Plus you'll get noise-free switching.

Availability. Because of our unique programmability, the system is in stock—

awaiting your most demanding delivery schedule.

3 Year Warranty. Only Williams Sound offers a superior product with a three year warranty to back it up . . . with no strings attached.

For complete information, call 1-800-328-6190. (In MN: 612/931-0291. In Canada: Call Thorvin Electronics 416/276-7271.)



The Williams Tour Guide is an affordable, pre-packaged listening system designed especially for factory tours



The Personal PA hearing assistance system is recognized as the industry leader.



WILLIAMS SOUND CORP.

5929 Baker Road
Minnetonka, MN 55345-5997

Circle 237 on Reader Response Card

Wireless Solutions

Multi-channel headaches?

This is the solution. The PRO 4 channel system provides 4 simultaneous channels without intermodulation or crosstalk problems. The front-end and IF filtering in the R185 receiver offer the highest selectivity of any wireless receiver in the world. The DM4 distribution module provides single or dual diversity antennas/s, filters the signal with helical resonators, and maximizes the isolation between receivers.



Multiple PRO 4 channel systems may be stacked for as many channels as you need. Discrete or mixed balanced outputs are provided. Reliable performance with no headaches.

Need a different hand-held?



The H185 plug-on transmitter converts any standard microphone to wireless operation. This means you can use your best or favorite hand-held microphone . . . wireless. The typical frequency response is 50Hz to 18KHz \pm 1 dB, so that the wireless will not change the sound of your microphone or the EQ settings of your sound system. The H185 gives you the freedom of choice with a very compact and attractive plug-on transmitter.

No AC power available?

In spite of its tiny size, the CR185 miniature receiver offers broadcast quality audio with a balanced XLR audio output. It operates from an internal 9 volt battery, external 12 volt DC or 110 volt AC with the supplied adapter. A 6-pole helical resonator front-end, double balanced diode mixer and crystal IF filtering provide outstanding selectivity. This is the finest mini receiver in the world, and in fact outperforms our competitor's full sized units.



Call us toll free: (800) 821-1121



LECTROSONICS, INC.

P.O. Box 12617 • Albuquerque, New Mexico 87195 • Phone: 505-831-1010

Circle 224 on Reader Response Card

that its popular Type C Aural Exciter will soon be changed to incorporate the latest advancements in its proprietary Aural Exciter circuitry. Greatly reduced output and noise, less noise enhancement of noisy signals and continuous operation from -10 dBm to +4 dBm, are all features of the new circuitry. The model number has been changed to 103A.

According to Apex product manager Jon Sanserino, output noise of the new circuit is close to -100 dBm. The Aural Exciter sidechain is not automatically 'gated' to further reduce noise during quiet passages. The new circuit has a dynamic range of 115 dBm allowing it to operate at any input level between -10 dBm and +4 dBm with no adjustments. The suggested price remains \$299.95.

Circle 4 on Reader Response Card



Bogen's Centralized Sound System

Series 115A Centralized Sound System from Bogen Communications, Inc. offers a customized approach to the intercom, paging and program distribution needs of small or large schools and institutions. Series 115A is readily adapted to serve up to 250 rooms. The control centers are available in configurations ranging from desktop consolets to floor-standing consoles and vertical racks.

Series 115A control centers feature a built-in microphone, cassette player and FM/AM tuner, as well as facilities for external microphones. Selection is by push button.

Circle 5 on Reader Response Card

a closer look

by gary d. davis



Meyer Sound's P-1A Control Electronics Unit

Meyer Sound has announced the release of a new product—the P-1A Control Electronics Unit.

Designed to be used with Meyer's ultra-compact UPM-1 loudspeaker, the P-1A (which now supercedes the now discontinued model P-1) incorporates design enhancements that afford improved performance. Six stages of Meyer's exclusive complementary phase equalization give the UPM-1 flatter frequency response with outstanding phase characteristics. An additional octave has been added to the low frequency response, extending the UPM-1's range to 60 Hz. And a sliding filter circuit, which activates only at the onset of overload, affords greater dynamic range with improved driver protection. Owners of the discontinued model P-1 can obtain an upgraded

kit from any Meyer Sound dealer.

The P-1A increases the sonic performance and accuracy of the UPM-1 loudspeaker system. With the P-1A, the UPM-1's high midrange now sounds fuller, its low midrange is smoother, and its sound quality remains uncompromised at high sound pressure levels according to the company. The UPM-1/P-1A System is suited to a variety of professional applications, including near-field monitoring, foreground music installations, multi-channel audio visual playback systems, and low-level sound reinforcement.

Comments: Meyer Sound is widely known as a manufacturer of so-called "processor-based" loudspeaker systems—that is, loudspeakers which incorporate line-level signal processing as a part of their design. In such systems, a dedicated "processor" or

"controller" (Meyer's term is *Control Electronics Unit*) is connected in series with the power amplifier signal inputs. Its function is to optimize the loudspeaker's performance by preconditioning the source signal in various ways. In general, processor-based systems can be more complicated to install, but they offer potentially greater reliability with less necessity for on-site equalization (depending upon the strength of the design).

This month's *Closer Look* deals with the new P-1A, one of Meyer's proprietary Control Electronics Units (hereafter, we'll use the abbreviation CEU). Because the P-1A is not really a stand-alone product, however—it's designed to be used only with Meyer's UPM-1 loudspeaker—a little background information is necessary in order to appreciate the significance of the product announcement. For this, we have drawn on supplementary materials provided to us by the company.

The UPM-1 Loudspeaker: As the press release suggests, the UPM-1 is not, itself, a new product. First introduced in mid-1982, the unit was designed specifically for delay fill applications in sound reinforcement systems. Despite a somewhat higher-than-average price tag, it is reported to have found acceptance in both legitimate theatre and sound contracting.

Befitting its original intended application, the UPM-1 is quite compact: the cabinet is just over 7 inches deep, and 6¾ inches wide by about 18 inches high. Weighing in at 17 pounds, it is fitted with standard ¾-inch—16 threaded inserts on the top and bottom, so it easily mounts on an AKG-style microphone stand. Connections are via 3-pin XLRs, and the unit sports both a male and a female connector to allow for looping between cabinets.

Beneath a grey foam grill (backed by a metal screen for added protection) are mounted two 5-inch cone drivers and a 2-inch by 5-inch horn-loaded piezo-electric tweeter. Meyer has re-

(continued on page 67)

by Ted Uzzle

An Education on Batteries

Richard A. Perez, *The Complete Battery Book*, Blue Ridge Summit, PA, TAB Books, 1985, vi + 185 pp., \$16.95, paper.

Throughout most of this century the march of progress meant new devices that were bigger and more powerful. In more recent years, however, household appliances, test instruments, and the like have been designed to be much smaller and to require less power to operate. Over these

“What about...batteries...? All too often we take them for granted, and sometimes our uninformed choice of battery type is incorrect.”

same years, new battery types have been introduced that dramatically improve the performance and reduce the price of these indispensable power sources.

The result is that today we are surrounded by these little miracles. We have more and more portable, battery-operated machines around us, and more and more batteries in them.

What about the batteries themselves? All too often we take them for granted, and sometimes our uninformed choice of battery type is incorrect. Richard A. Perez's book, *The Complete Battery Book*, is meant for beginners in battery technology, and offers a broad introduction to the subject.

The opening chapter defines the basic terms used about batteries. Taken from electrical and chemical engineering, these definitions cover Ohm's Law, battery types, and specialized battery terms. A table compares lead-acid batteries and Nickel-

cadimium (NiCad) batteries in electrical, life, and cost terms, and gives an outline for thinking comparatively about batteries. Finally, there's a thorough description of series, parallel, and series-parallel connection of batteries for different combinations of voltages and currents.

There follows a group of chapters on various types of batteries: lead-acid (the kind used for starting automobiles), NiCad batteries, the very rare Edison cells, and primary cells. These last are the batteries we think of mostly, and include zinc-carbon, alkaline-manganese, mercury, silver oxide, and lithium.

Lead-acid batteries (so called because of the generation of electricity by chemical reactions of lead and sulphuric acid) may be classified according to the use cycle they will survive. The ordinary automotive starting battery doesn't care to be used deep-cycle; that is, completely discharged repeatedly. There's a long parade of devices meant for deeper cycle use. These have thicker plates, and often some amount of antimony added to them.

NiCad batteries offer an altogether different operating principle, and an altogether different set of economic rules. They cost between \$2,000 and \$9,000 per kilowatt-hour, 100 times more than the lead-acid types. The NiCad likes deep discharge: these batteries prefer to be discharged all the way, or almost all the way, before being recharged. They last longer this way, and take more of a charge each time.

Edison cells, using nickel and iron, were popular for electric automobiles at the turn of the century. These devices have fallen almost completely into disuse because of their astronomical cost and fast self-discharge: disconnect them from the charger and let them sit without load, and they will discharge themselves almost as fast as if they were powering a load.

Primary cells may be used once only, and then are discarded. In 1800 Alessandro Volta stacked up silver plates (there goes the dinner service!),

zinc plates, and leather washers, soaking the whole thing in seawater. Sixty years later Georges Leclanche developed the zinc-carbon cell, and soon it was available with a dry electrolyte. In 1900 the United States consumed two million dry zinc-carbon cells.

Today's carbon batteries actually use manganese dioxide as a cathode: carbon no longer generates electrochemical action (although a rod of it is used as a current collector).

Alkaline batteries are actually only zinc-manganese cells using purer materials (for example, a carefully prepared manganese material) and traces of other elements, such as mercury, or gold on the contacts for corrosion-proofing. The superior performance, and higher price, of alkaline batteries compared to carbon batteries represents the same chemical reaction tuned up and built more carefully.

In mercury cells, the zinc remains but powdered mercury is used for the cathode. This costs several times over the cost of carbon or alkaline batteries, but has one sterling quality: it can be dramatically smaller. Button-sized mercury batteries are used in watches, hearing aids, cameras, and such devices where small size and low weight justify the extra expense. Typically these applications also require that leakage be prevented at all costs, so a precision made and tightly sealed case is also usually a feature of the mercury cell.

Silver oxide cells are very similar in construction to mercury cells, but offer some advantages at higher costs. The anode is zinc, again, but the cathode is now one of several silver compounds. At slow discharge rates they provide more power than mercury cells, and they have a much longer shelf life.

With lithium batteries we finally see a premium material replace zinc as the anode. Lithium anodes are a bear to manufacture, however, because they spoil almost instantly in the presence of water vapor or oxygen. Lithium batteries will be candidates as early products when manufacturing starts in the near-vacuum of space.

The Complete Battery Book offers a descriptive chapter on battery charging methods. These fall into five categories: chargers powered from house current, solar powered chargers (after all, all solar powered electricity must be put through batteries for use after the sun goes down), motorized chargers, wind and water powered chargers, and batteries charging batteries. This last isn't as absurd as it may seem. It permits batteries with one set of characteristics (perhaps easy to recharge, but big and fragile) to recharge batteries with a different set of characteristics (for example, hard to recharge but portable). There is also a chapter on inverters, by which batteries make AC.

Two very useful chapters conclude the book. A chapter on effective battery use reviews such issues as battery noise, power transmission, and battery safety. A chapter on energy management takes up the complex relationship of battery and load.

This book would be more useful if it included reference data on commercially-available batteries: type cross-references, dimensional and mounting information, and more specific (and less generic) performance tables. With that material, it could be an everyday reference tool in the electronics laboratory, and not just a learning resource.

The Complete Battery Book is written at an elementary level, essentially for beginners (though it certainly did not insult the intelligence of your reviewer). It requires only the simplest rudiments of electronics, algebra, and chemistry: any high school graduate can master it. It is quite broad but without much depth, and is obviously meant to provide a framework for the bits and pieces of battery knowledge accumulated by the typical electronic practitioner. Many in the sound and communications industry will read it with profit, and companies that have formed libraries of introductory texts offered to entry-level employees ought to consider adding this one.

Ted Uzzle is a member of AES, the Acoustical Society, and SMPTE. He is director of marketing development at Altec Lansing and has written several book reviews for *Sound & Communications*.

Become a distributor for MacKenzie's new digital message-on-hold system

Here's your chance to break into the immense message-on-hold market with the most reliable, state-of-the-art system *and* the most complete marketing program available today.

THE PRODUCT

It's MacKenzie's Dynavox Digital Message-on-Hold System, the only equipment designed especially for demanding message-on-hold applications. The Dynavox is an all-solid-state record/play system designed to provide years of reliable service—unlike players that use tape cassettes never intended for continuous operation.

Dynavox has *no moving parts* and requires *no maintenance*. In fact, each Dynavox system is unconditionally *warranted for two years* of trouble-free operation. The sound is completely natural. It's perfect for promotional messages and all types of music. Best of all, Dynavox is manufactured by MacKenzie Laboratories, the leading name in message repeaters for over 25 years.

THE PROGRAM

To a limited number of committed distributors, MacKenzie is offering a complete marketing program filled with money-making potential. Here are just a few of the outstanding features:

Custom Productions—Experienced copywriters will work closely with your customers to develop scripts and record messages using professional voice talent and music. Your customer simply calls a toll-free number, and in a few days his programs are ready.

Advertising—With each program you buy, you'll earn co-operative advertising dollars with which to generate leads for your direct sales force. MacKenzie will provide prepared print ads and other promotional material ready for your use. We'll also be supporting your efforts with a wide-ranging national ad program.

Sales Training—We'll help you increase profits with sales manuals, publications and lots of ideas to keep your sales force motivated and up-to-date on selling Dynavox products.

Call Dan Squibb, National Sales Manager for the Dynavox program, to discuss qualification requirements for this exciting marketing opportunity. Here's the toll-free number: **800-423-4147**.



Dynavox runs continuously and repeats automatically with absolute reliability.

MACKENZIE MacKenzie Laboratories, Inc., 5507 Peck Road
Arcadia, California 91006 USA, 818-579-0440

Circle 238 on Reader Response Card



Jackfield Line Featured in New Catalog

ADC Telecommunications, Inc., a supplier of jackfields to the telecommunications industry, has published its new *Wired Assemblies* catalog.

The 50-page catalog covers ADC's entire line of jackfields, including Bantam Jackfields in connectorized and pre-wired models Bantam connectorized patch bays; and Longframe (310) Jackfields in connectorized and prewired versions. A fourth section of

the catalog lists all jackfield accessories available from ADC, including terminal blocks, patch cords and plugs.

Circle 6 on Reader Response Card

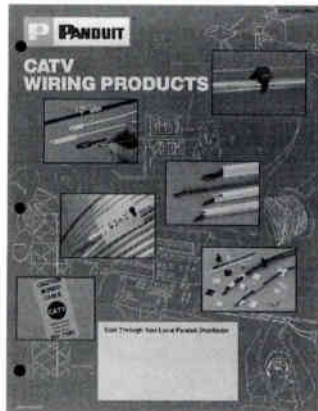

Panduit Catalog Describes CATV Wiring Products

A completely revised and updated 24 page catalog is available free from Panduit Corp., Electrical Group. Catalog E-CATV-2A describes the company's full line of wiring products

for signal communication installations (cable tv, security, etc.).

The illustrated brochure provides complete listings of Panduit cable ties for indoor and outdoor applications.

Circle 7 on Reader Response Card

NATA Releases Streamlined Sourcebook

The North American Telecommunications Association (NATA) released its just updated and streamlined 1988 Telecommunications Sourcebook.

The 250-page sourcebook contains: an alphabetical listing of over 300 voice and data system equipment manufacturers and suppliers; a geographical directory of over 1,500 interconnect contractors and the products they carry; and an overview of over 140 companies providing financing, leasing, consulting and publishing services to manufacturers, distributors and end users.

Prices for NATA's Members, \$25 per copy, nonmembers \$35.

Circle 8 on Reader Response Card

NSCA • WORKSHOPS
• EXHIBITS • MORE
EXPO '88
RENO NEVADA • BALLY'S GRAND
MAY 18th, 19th, 20th

MAY						
S	M	T	W	T	F	S
1	2	3	4	5	6	7
8	9	10	11	12	13	14
15	16	17	18	19	20	21
22	23	24	25	26	27	28
29	30	31				
MARK YOUR CALENDAR						

312/593-8360



**SUPPLIER
OF
INTERCOMS
AND
ELECTRONIC
WIRES**

Call toll free
1-800-247-9099



**TAPPAN WIRE
• CABLE, INC.**

256 OAK TREE ROAD,
TAPPAN, NY 10983

Circle 229 on Reader Response Card

SOUND & COMMUNICATIONS

QUICK
PRODUCT
INFORMATION
GUIDE

SOUND & COMMUNICATIONS

FEBRUARY 1988

QUICK PRODUCT INFORMATION CARD

NAME: _____ TITLE: _____
 COMPANY: _____
 STREET: _____
 CITY: _____
 STATE: _____ ZIP: _____
 TELEPHONE: () _____

- | | |
|---|---|
| <p>1 Are you a subscriber to Sound & Communications?
 <input type="checkbox"/> Yes <input type="checkbox"/> No</p> <p>2 Primary Job Function (only one):</p> <p><input type="checkbox"/> A Management/Owner
 <input type="checkbox"/> B Engineering/Technical Mgt
 <input type="checkbox"/> C Sales/Marketing
 <input type="checkbox"/> D In-House Maintenance/Service
 <input type="checkbox"/> E Field Installation/Maintenance
 <input type="checkbox"/> F Consultant
 <input type="checkbox"/> G Advertising/Promotion
 <input type="checkbox"/> H Other _____</p> <p>3 Primary business of company (only one):</p> <p><input type="checkbox"/> 1 Contractor—Engineered Sound/Acoustical
 <input type="checkbox"/> 2 Contractor—Interconnect/Intercom
 <input type="checkbox"/> 3 Contractor—Fire/Alarm/Safety
 <input type="checkbox"/> 4 Electrical Contractor
 <input type="checkbox"/> 5 Pro Audio/Studio/Reinforcement</p> | <p><input type="checkbox"/> 6 Architect/Designer
 <input type="checkbox"/> 7 Engineering/Acoustical Consulting
 <input type="checkbox"/> 8 Maintenance/Service
 <input type="checkbox"/> 9 Dealer/Distributor/Rep
 <input type="checkbox"/> M Manufacturer
 <input type="checkbox"/> O Other _____</p> <p>4 Your purchasing authority:</p> <p><input type="checkbox"/> A Final approval/Buyer
 <input type="checkbox"/> B Recommend/Specifier
 <input type="checkbox"/> C No Direct Authority/User</p> <p>5 Intensity of your product need:</p> <p><input type="checkbox"/> 1 Have salesman call
 <input type="checkbox"/> 2 Need within 3-6 months
 <input type="checkbox"/> 3 Future projects</p> <p>6 Number of employees at your company:</p> <p><input type="checkbox"/> A 1-3 <input type="checkbox"/> B 4-10 <input type="checkbox"/> C 11-25 <input type="checkbox"/> D 26-100
 <input type="checkbox"/> E over 100</p> |
|---|---|

EXPIRES 6/1/88

NEW PRODUCTS: 43 60 77
 (Please Circle) 44 61 78
 45 62 79

1	15	29	46	63	80
2	16	30	47	64	81
3	17	31	48	65	82
4	18	32	49	66	83
5	19	33	50	67	84
6	20	34	51	68	85
7	21	35	52	69	86
8	22	36	53	70	87
9	23	37	54	71	88
10	24	38	55	72	89
11	25	39	56	73	90
12	26	40	57	74	91
13	27	41	58	75	92
14	28	42	59	76	93

ADVERTISING PRODUCTS:
 (Please Circle) 243 260 277
 244 261 278
 245 262 279

201	215	229	246	263	280
202	216	230	247	264	281
203	217	231	248	265	282
204	218	232	249	266	283
205	219	233	250	267	284
206	220	234	251	268	285
207	221	235	252	269	286
208	222	236	253	270	287
209	223	237	254	271	288
210	224	238	255	272	289
211	225	239	256	273	290
212	226	240	257	274	291
213	227	241	258	275	292
214	228	242	259	276	293

SOUND & COMMUNICATIONS

FEBRUARY 1988

QUICK PRODUCT INFORMATION CARD

NAME: _____ TITLE: _____
 COMPANY: _____
 STREET: _____
 CITY: _____
 STATE: _____ ZIP: _____
 TELEPHONE: () _____

- | | |
|---|---|
| <p>1 Are you a subscriber to Sound & Communications?
 <input type="checkbox"/> Yes <input type="checkbox"/> No</p> <p>2 Primary Job Function (only one):</p> <p><input type="checkbox"/> A Management/Owner
 <input type="checkbox"/> B Engineering/Technical Mgt
 <input type="checkbox"/> C Sales/Marketing
 <input type="checkbox"/> D In-House Maintenance/Service
 <input type="checkbox"/> E Field Installation/Maintenance
 <input type="checkbox"/> F Consultant
 <input type="checkbox"/> G Advertising/Promotion
 <input type="checkbox"/> H Other _____</p> <p>3 Primary business of company (only one):</p> <p><input type="checkbox"/> 1 Contractor—Engineered Sound/Acoustical
 <input type="checkbox"/> 2 Contractor—Interconnect/Intercom
 <input type="checkbox"/> 3 Contractor—Fire/Alarm/Safety
 <input type="checkbox"/> 4 Electrical Contractor
 <input type="checkbox"/> 5 Pro Audio/Studio/Reinforcement</p> | <p><input type="checkbox"/> 6 Architect/Designer
 <input type="checkbox"/> 7 Engineering/Acoustical Consulting
 <input type="checkbox"/> 8 Maintenance/Service
 <input type="checkbox"/> 9 Dealer/Distributor/Rep
 <input type="checkbox"/> M Manufacturer
 <input type="checkbox"/> O Other _____</p> <p>4 Your purchasing authority:</p> <p><input type="checkbox"/> A Final approval/Buyer
 <input type="checkbox"/> B Recommend/Specifier
 <input type="checkbox"/> C No Direct Authority/User</p> <p>5 Intensity of your product need:</p> <p><input type="checkbox"/> 1 Have salesman call
 <input type="checkbox"/> 2 Need within 3-6 months
 <input type="checkbox"/> 3 Future projects</p> <p>6 Number of employees at your company:</p> <p><input type="checkbox"/> A 1-3 <input type="checkbox"/> B 4-10 <input type="checkbox"/> C 11-25 <input type="checkbox"/> D 26-100
 <input type="checkbox"/> E over 100</p> |
|---|---|

EXPIRES 6/1/88

NEW PRODUCTS: 43 60 77
 (Please Circle) 44 61 78
 45 62 79

1	15	29	46	63	80
2	16	30	47	64	81
3	17	31	48	65	82
4	18	32	49	66	83
5	19	33	50	67	84
6	20	34	51	68	85
7	21	35	52	69	86
8	22	36	53	70	87
9	23	37	54	71	88
10	24	38	55	72	89
11	25	39	56	73	90
12	26	40	57	74	91
13	27	41	58	75	92
14	28	42	59	76	93

ADVERTISING PRODUCTS:
 (Please Circle) 243 260 277
 244 261 278
 245 262 279

201	215	229	246	263	280
202	216	230	247	264	281
203	217	231	248	265	282
204	218	232	249	266	283
205	219	233	250	267	284
206	220	234	251	268	285
207	221	235	252	269	286
208	222	236	253	270	287
209	223	237	254	271	288
210	224	238	255	272	289
211	225	239	256	273	290
212	226	240	257	274	291
213	227	241	258	275	292
214	228	242	259	276	293

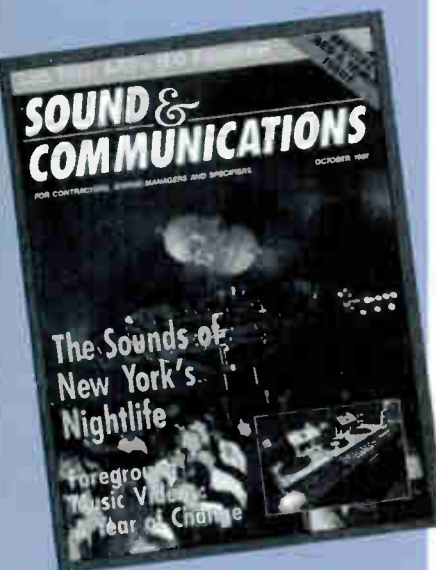
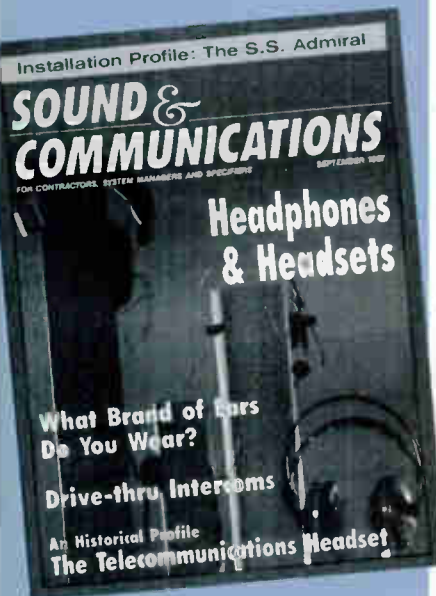

SOUND & COMMUNICATIONS

IT'S NOT JUST A MAGAZINE...
IT'S AN INDUSTRY

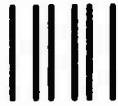

Place
Stamp
Here

TESTA COMMUNICATIONS
**SOUND &
COMMUNICATIONS**

25 Willowdale Avenue
Port Washington, NY 11050



Place
Stamp
Here

TESTA COMMUNICATIONS
**SOUND &
COMMUNICATIONS**

25 Willowdale Avenue
Port Washington, NY 11050



Anixter Introduces "Customer Friendly" Ordering System

Anixter Brothers, Inc. has introduced a catalog to accelerate ordering and delivery of its more than 60,000 wiring system products.

The new sectionalized catalog of more than 2,000 pages is the first reference book of its kind for wiring systems, and in comparison is twice the size of the Sears, Roebuck and Co. Fall/Winter catalog. The catalog consists of 37 individually bound, stand-alone sections, any number of which can be assembled for each of its customer's needs.

The new catalog has product descriptions, illustrations and diagrams. Also every Anixter product has its own part number, as well as supplier number.

Circle 18 on Reader Response Card

New North American Directory Published

Six US telecommunications companies have published a combined directory of their subscribers plus telex subscribers in Canada.

The fifth annual U.S. Directory for Telecommunications Subscribers contains more than 70,000 listings of current subscribers of FTC Communications, Graphnet, ITT World Communications, MCI International, RCA Global Communications and TRT Telecommunications. In addition to the U.S. subscriber listings, more than 40,000 Canadian subscribers of CNCP Telecommunications are included.

The new 1988 directory includes three sections—an alphabetical listing of the U.S. subscribers with their telex numbers and answerbacks, a separate alphabetical listing of the Canadian subscribers, and a classified directory that can be used for locating companies in selected industries throughout North America.

Copies of the directory are \$17.50 each.

Circle 19 on Reader Response Card

Tucker Electronics Reference Guide

A free, 350-page catalog is available from Tucker Electronics. It contains technical specifications and prices for more than 4,000 reconditioned test in-

struments, as well as factory new instruments, power supplies, coaxial components, waveguides and waveguide components and a line of technical books. Some items are current production models, others are hard-to-find, older models. All items are ready for immediate sale. Many are also available for short term rental or lease.

Equipment categories include amplifiers, generators, power supplies and microwave components.

Circle 20 on Reader Response Card

Lemo USA Introduces New Catalog

Lemo USA has introduced its newest, expanded and updated technical catalog, "A Pocket Reference for Connector Specifiers."

Originally introduced in 1986, this edition has grown in number of pages by 50 percent to include many new connector families, contact configurations and materials. Still measuring 3 1/2 inches by eight inches, this "pocket size" catalog permits connector specifiers to determine which Lemo connectors meet their needs.

The catalog's tables are organized around the main elements needed to specify connectors: numbers of contacts, working voltages and amps to accommodate cable OD, shell styles and insulating materials. Connector families include mixed and multicontact connectors, environmentally sealed connectors, coaxial, triaxial, high voltage and plastic.

Circle 21 on Reader Response Card

Mercer Electronic's Test Equipment Catalog

A new eight-page, catalog featuring low-cost test equipment was released by the Mercer Electronic Division of Simpson Electric Company.

The catalog features the company's full line of products, including its recently announced new multifunction frequency counters and 2 MHZ Sweep/Function Generator. Other products featured include 3 1/2 and 4 1/2 digit handheld DMM's; a volt ohm-ammeter; a high accuracy, full range 3 1/2 digit Capacitance Tester; and a variety of other digital instruments and probes.

Circle 22 on Reader Response Card

NADY 501 VHF WIRELESS. AFFORDABLE, AND EASY TO USE.

The Nady 501 VHF Wireless System is the perfect wireless for most stages, churches and studios. List price is under \$900.

And we designed the 501 with the speaker or entertainer in mind — you don't have to be a sound engineer to set it up and use it.

The 501 VHF is available with a good-looking handheld microphone, transmitter or a bullet-proof lavalier microphone transmitter. A lightweight, portable AC or DC-powered receiver completes the system.

Nady VHF wireless is the choice of today's major musical groups. Nine out of ten (based on Billboard Magazine's 1985 Talent Almanac) use our wireless microphone and instrument systems.

There are reasons for this. Nady Wireless is road-proven dependable. With audio quality that measures up to these artists' demanding standards. (Try a side-by-side comparison yourself — Nady Wireless always sounds best.)

Send for the specs on our affordable 501 VHF Wireless System, or ask your Nady rep for a demonstration. You'll like what you see — and hear.



Circle 228 on Reader Response Card

Nady Systems, Inc.
1145 65th St.,
Oakland CA 94608
415/652-2411



FACES AND PLACES



Amek Expands, Appoints New Engineer

Amek Systems and Controls, Ltd. of Salford, England, has announced that negotiations have been finalized on the purchase of a four acre industrial complex for expansion of its operations.

The new complex is adjacent to Amek's present facilities, where it has been operating since 1976, and provides the opportunity for new and larger metalworking, assembly, wiring, testing and shipping areas that have become necessary due to recent sales increases and production demands. Immediate plans are for complete refurbishment of over 15,000 square feet, including a new office and cafeteria section and rework of other space as required. Engineering and administration will remain in the previously occupied building.

This expansion has also resulted in a new address for Amek: New Islington Mill, Regent Trading Estate, Oldfield Rd., Salford M5 4SK England.

In other news from Amek, the company has announced the appointment of Ray Dilfield to the position of technical support engineer for the US operation.

Strand Joins Yamaha as District Manager

John Strand has become Yamaha's new district manager of pro-audio for the mid-atlantic states. Strand comes to Yamaha from Community Light & Sound where he was regional sales manager, national sales manager, and most recently, director of marketing. "It was time for a change," said Strand, "and I wanted to do something different than I had been doing for three and a half years. At Yamaha, I will be responsible for creating and maintaining distribution of the pro-audio products and servicing the ex-

isting accounts."

Strand will report to Bob Schomaker, national sales manager for pro-audio. "We're very excited to have John join us. His background is outstanding in the sound reinforcement business," said Schomaker.

Electro-Voice Announces Appointments

Electro-Voice has announced the appointment of Ivan C. Schwartz as broadcast/production marketing specialist, Doug MacCullum as general manager of EV Canada, Ltd. and Garry Templin as national sales manager.

Schwartz will be responsible for marketing all products related to TV, radio, film/video production, post production and broadcast. He was previously a sound engineer for Western Washington University and an independent audio system design consultant.

In the five years MacCullum has been with Electro-Voice, he has held

several sales/marketing titles including western regional sales manager, manager of the firm's Visalia, CA, operation, and most recently as national sales manager.

Templin, during his three years with Electro-Voice, has served as central regional sales manager and more recently as market development manager for the N/DYM microphones. Before that, he was an Electro-Voice field sales representative for several years.

Independent Consulting Firm Formed by Former CBSer

Mary C. Gruszka, formerly senior project engineer with CBS, is now an independent consultant and owner of MCG Audio Consulting. She specializes in TEF audio and acoustical measurements of control rooms, loudspeakers, etc.; audio, video and communications systems designs; and location sound recording and technical writing. She can be reached at 88 Myrtle Ave., Edgewater, NJ 07020.

REP NEWS

Lexicon announced the winners of its Outstanding Achievement Awards and Sales Rep Firm for 1986-1987 at the company's annual Pro Audio Rep Meeting held during the AES Convention. The Yore Company of White Bear Lake, MN, was voted Outstanding Sales Rep Firm of 1986-1987 by members of Lexicon's sales/marketing and finance departments.

Criteria for the selection included sales performances, customer service, and the efficiency and business-like manner with which the firm represents Lexicon. Outstanding Achievement Awards are presented to individual representatives who go far beyond the expected "call of duty" while representing Lexicon. The winners of Lexicon's Outstanding Achievement Awards 1986-1987 are: Wally Wilson of Wilson Audio Sales, Doug Kaysyon of McFadden Sales, Bruce Marlin of Marketing Concepts, Scott

Esterson formerly of Marshank Sales. Esterson joined Lexicon as western regional sales manager and now heads the company's new west coast office in Los Angeles.

Sorensen Company, a division of Switchcraft, Inc. has appointed a new representative company to handle its New England territory with the exception of Fairfield County, CT. ICS Associates, Inc. is the new rep company and is headquartered at 487 Groton Rd, Westford, MA 01886, phone, (617) 692-3545.

Javelin Electronics has announced the addition of a new sales representative. Roger Ponto Associates of Kirkland, WA, has been named as security sales representative for the Pacific Northwest, including Alaska. Ponto Associates can be contacted at 12816 N.E. 125 Way, Kirkland, WA 98034, (206) 821-2996.



THE HEAVYWEIGHT LIGHTWEIGHT.



The AKG Q 15 is the perfect headset for monitor work, cue pick-ups, and two-way intercom communications. Feather-light and adjustable, comfortable enough to wear all day but snug enough not to slip, you'll hardly know it's there — and yet it's so rugged you can tie it in a knot and it snaps right back.

More important, the Q 15 doesn't buy comfort at the cost of quality. Its pre-polarized condenser mic offers full-frequency response and its monaural earpiece — the one that rests gently on the ear instead of clamping down on it — is distortion free. There are even models designed to meet specialized needs, with additions like carbon equivalent pre-amps and squelch controls.

AKG . . . when you need a heavyweight lightweight.



77 Selleck Street
Stamford, CT 06902

© AKG 1987 # Akustische und Kino-Geräte GmbH, Austria
Product design subject to change.

S & C's Job Report

Format

STATE

city: Name of Job, \$ Total of Construction, Phase of Project. Contact: Name, Company, City, State; Telephone Number.

TOTAL CONSTRUCTION

- 1—up to \$1 million
- 2—\$1 million to \$9 million
- 3—\$9 million to \$17 million
- 4—\$17 million to \$25 million
- 5—\$25 million and up
- NA—Not Available

PHASE OF PROJECT

- A—Planning = Consultant is designing system
- B—Pre-Bid = Final plans near completion
- C—Bidding = Bid date set
- D—Starting = Electrical Contractor/
General Contractor/
Owner buying now

The following jobs are in various phases leading up to bid. If you are interested in any of the projects, please contact only the names printed below.

ALASKA

Aleutian Islands: Shemya AFB, NA, A. Contact: Craig E. Park, Paoletti/Lewitz Associates, San Francisco, CA; (415) 391-7610.

Fairbanks: Fairbanks Activity Center, NA, B. Contact: Craig E. Park, Paoletti/Lewitz/Associates, San Francisco, CA; (415) 391-7610.

ARIZONA

Tucson: Temple of Art and Music, 2, A. Contact: Robert Lorelli, Brannigan-Lorelli Associates, Inc., New York, NY; (212) 420-8787.

CALIFORNIA

Concord: Automatic Data Processing, 1, D. Contact: Craig E. Park, Paoletti/Lewitz/Associates, San Francisco, CA; (415) 391-7610.

Fresno: John Wright Theatre, California State University, Fresno, NA, A. Contact: Craig E. Park, Paoletti/Lewitz/Associates, San Francisco, CA (415) 391-7610.

Los Angeles: Ketchum Communications, 1, D. Contact: Craig E. Park, Paoletti/Lewitz/Associates, San Francisco, CA; (415) 391-7610.

Los Angeles: Simon Wisenthal Center, 3, B. Contact: Neil A. Shaw, Paul S. Veneklasen & Associates, Inc., Santa Monica, CA; (213) 450-1733.

Menlo Park: Raychem Corp, 1, A. Contact: Craig E. Park, Paoletti/Lewitz/Associates, San Francisco, CA; (415) 391-7610.

Milpitas: Sun Microsystems, 1, A. Contact: Craig E. Park, Paoletti/Lewitz/Associates, San Francisco, CA; (415) 391-7610.

Modesto: Trinity Presbyterian Church, 1, D. Contact: Craig E. Park, Paoletti/Lewitz/Associates, San Francisco, CA; (415) 391-7610.

Oakland: East Bay Municipal Utility District, 1, A. Contact: Craig E. Park, Paoletti/Lewitz/Associates, San Francisco, CA; (415) 391-7610.

Oceanside: Oceanside City Hall, 3, B. Contact: Neil A. Shaw, Paul S. Veneklasen & Associates, Inc., Santa Monica, CA; (213) 450-1733.

Palo Alto: Kleiner, Perkins, Caufield, Buyer, 1, C. Contact: Craig E. Park, Paoletti/Lewitz/Associates, San Francisco, CA; (415) 391-7610.

Palo Alto: City Council Chambers, NA, A. Contact: Craig E. Park, Paoletti/Lewitz/Associates, San Francisco, CA; (415) 391-7610.

Palo Alto: Syntex (USA) NA, A. Contact: Craig E. Park, Paoletti/Lewitz/Associates, San Francisco, CA; (415) 391-7610.

Pasadena: Lake Avenue Congregational Church, 4, A. Contact: Neil A. Shaw, Paul S. Veneklasen & Associates, Inc., Santa Monica, CA; (213) 450-1733.

Sacramento: Mercy Hospital, 2, D. Contact: Neil A. Shaw, Paul S. Veneklasen & Associates, Inc. Santa Monica, CA; (213) 450-1733.

Sacramento: Woodlake Resort/Convention Hotel, 1, B. Contact: Craig E. Park, Paoletti/Lewitz/Associates, San Francisco, CA; (415) 391-7610.

San Diego: UCSD Graduate School of International Relations, 1, A. Contact: Craig E. Park, Paoletti/Lewitz/Associates, San Francisco, CA; (415) 391-7610.

San Diego: UCSD Central Library, NA, A. Contact: Craig E. Park, Paoletti/Lewitz/Associates, San Francisco, CA; (415) 391-7610.

San Francisco: First Interstate Bank of California, 1, D. Contact: Craig E. Park, Paoletti/Lewitz/Associates, San Francisco, CA; (415) 391-7610.

San Francisco: Kleiner, Perkins, Caufield, Buyer, 1, A. Contact: Craig E. Park, Paoletti/Lewitz/Associates, San Francisco, CA; (415) 391-7610.

San Francisco: Portman Hotel, 1, D. Contact: Craig E. Park, Paoletti/Lewitz/Associates, San Francisco, CA; (415) 391-7610.

San Francisco: Calvary Presbyterian Church, 1, C. Contact: Craig E. Park, Paoletti/Lewitz/Associates, San Francisco, CA; (415) 391-7610.

San Francisco: The Moscone Convention

Center Expansion, 1, A. Contact: Craig E. Park, Paoletti/Lewitz/Associates, San Francisco, CA; (415) 391-7610.

San Francisco: City Hall Rotunda, 1, A. Contact: Craig E. Park, Paoletti/Lewitz/Associates, San Francisco, CA; (415) 391-7610.

San Jose: Ford Aerospace, 1, B. Contact: Craig E. Park, Paoletti/Lewitz/Associates, San Francisco, CA; (415) 391-7610.

San Jose: McDonnell-Douglas, 1, D. Contact: Craig E. Park, Paoletti/Lewitz/Associates, San Francisco, CA; (415) 391-7620.

San Jose: San Jose State University Recreation and Events Center, NA, D. Contact: Edward McCue, Paoletti/Lewitz/Associates, San Francisco, CA; (415) 391-7610.

San Jose: St. Joseph's Cathedral Center, 1, B. Contact: Craig E. Park, Paoletti/Lewitz/Associates, San Francisco, CA; (415) 391-7610.

Santa Monica: Santa Monica Bay Hotel, 5, B. Contact: Neil A. Shaw, Paul S. Veneklasen & Associates, Inc., Santa Monica, CA; (213) 450-1733.

Walnut Creek: Walnut Creek Presbyterian Church, NA, A. Contact: Craig E. Park, Paoletti/Lewitz/Associates, San Francisco, CA; (415) 391-7610.

CONNECTICUT

Hartford: Connecticut State Capitol Hall of the House of Representatives, NA, D. Contact: Chuck McGregor, Jaffe Acoustics Inc., Norwalk, CT; (203) 838-4167.

FLORIDA

Miami: Bayfront Park, 2, D. Contact: Chuck McGregor, Jaffe Acoustics, Inc., Norwalk, CT; (203) 838-4167.

Miami Beach: TOPA, 3, A. Contact: Chuck McGregor, Jaffe Acoustics Inc., Norwalk, CT; (203) 838-4167.

Naples: Marco Philharmonic Hall, 3, B. Contact: Rick Dyckman, Boran Craig Barber Construction, Naples, FL; (813) 643-3343.

Naples: Naples Performing Arts Center, 4, B. Contact: Robert A. Lorelli, Brannigan-Lorelli Associates, Inc., New York, NY; (212) 420-8787.

KENTUCKY

Alexandria: Campbell County H.S. Gymnasium, 1, B. Contact: Richard J. Lemker & Associates, Covington, KY; (606) 261-9529.

To have your jobs listed in S&C's Job Report, send your information to:
S&C's Job Report
25 Willowdale Avenue
Port Washington, NY 11050

TELECONFERENCING

(continued from page 23)

Engineering Society) should be carefully considered in the selection and layout of lighting systems; and all walls should be illuminated via zoned preset dimming controls.

Interior Architectural Design

There are many steps in the architectural design process that need to be understood in order to provide reasonable consulting information to an architect or to a client. Most importantly, the majority of conference center projects have no written program prior to their design, and thus it is very hard to discuss or defend quality based decisions. It is crucial that the consultant or audio dealer become part of the programming process if he is to have any reasonable input to the resultant facility. Normally, an architectural project moves through these phases in the process of designing this type of center (AIA terms): program development, schematic design, design development, construction documents phase, and contract supervision.

In the first of these phases, the most important decisions are made, and input is necessary at this time; otherwise the next two phases will reduce the cost and quality of the A-V system and room performance, due to having no accepted problem definition and solution in place. (It is interesting to note that the American Institute of Architects considers programming an optional service, and it is excluded on a large percentage of projects that we have been involved with.)

As with most articles of this sort, this is an overly simplistic treatment of a very complex set of subject areas. Since my firm is involved in all of the above disciplines and decisions, I hope that the resultant information provides a practitioner's introduction to the scope and character of the problem. It is easy for the client to express satisfaction and to judge a project's success; it is far harder to produce it. ■

Steven J. Orfield, a Minneapolis consultant, has been involved with architectural technology consulting for 15 years and practices in the fields of acoustics, audio, lighting, daylighting and thermal environment. He is a member of ASA, AES, ANSI, ASTM, IES and IFMA.

PME'S ROLE

(continued from page 24)

drafting and project management). Additionally, the PM/E writes out a list of technical comments explaining any limitations of customer desired equipment and advantages of recommended equipment in the proposal. Drawings are created along with specifications to accompany the proposal. The project management approach and quality control capability of the company is also included.

Once the contract has been awarded, the role of the PM/E is crucial. He assumes total responsibility for this project for the company and the customer. The PM/E will first meet with the salesman to review the approved contract and define the project for the implementation group. With the contract clearly defined a "systems meeting" is held. It is so called because the meeting includes representatives from the many departments that will be involved in the project. Purchasing, Administration, Credit, Sales, Installation and Engineering Departments are all represented. The systems meeting sets the stage for a smooth-running project.

At the meeting the contract is first reviewed item by item and any questions are answered or noted. If the size of the project warrants it, a project team will be selected to include a project manager, video engineer and audio engineer. Next the timeline is developed that includes crucial dates (installation start-finish, on-site availability, etc.). If the project has a fast-track deadline, then the timeline is based upon this.

An equipment delivery schedule is made based on the timeline along with dates for equipment status reports from purchasing. Meeting minutes are taken and distributed to all attendees. Included in the minutes are any questions that arise and when answers must be provided.

As the project gets rolling the PM/E's task is one of overseeing, coordinating and communicating. He must make sure the equipment is on schedule and will arrive on time. Communications with the end-user and the consultant (if applicable) is very important. This involves such aspects as advising the customer of any schedule changes or problems, attending on-site project meetings, getting drawing ap-

provals, appraising site readiness, and carrying out additional site surveys if required. The PM/E also coordinates drawing preparation with the project engineer and the "transfer of knowledge" to the technical departments to allow installation to start on-schedule.

From this point on, the PM/E tracks the project daily or weekly (depending on project size) so that it "gels." If any of the crucial milestones in the timeline change, the PM/E must adjust the rest of the schedule and advise all those concerned. As the project is being constructed in-house, the PM/E will meet with the QC manager and the installers to assess the project's progress. As in-house construction nears completion, the PM/E will coordinate with administration, the shipping department and the customer for on-site delivery.

During the on-site installation, it is important that the PM/E is available. He must be able to respond to on site problems and equipment failures. This keeps the installation going and keeps on-site costs down.

Test procedures and required documents are also prepared by the PM/E for the acceptance tests. These tests cover the entire project and reassure the customer that what he's paying for works. A final punchlist is developed from these acceptance tests. The PM/E, with this punchlist, coordinates with necessary people (administration, sales, technical and engineering) to finally complete the job.

Once the punchlist is complete, the PM/E will initiate any service or warranty contracts. He will also send as-built drawings and manuals to the customer. This finishes the PM/E's official involvement with the project. However, he will always be available to respond to questions or comments from the customer, as the PM/E will be the one most likely to be contacted.

A PM/E's responsibilities are far-reaching in today's marketplace. He brings all the people and pieces together to construct an installation that both his company and the end-user can be proud of. ■

**SUBSCRIBE TO
SOUND &
COMMUNICATIONS**

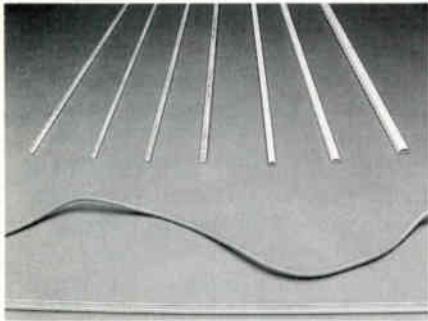

Kellems Introduces Wire Management Products

Kellems Division of Hubbell Inc. has introduced a new line of economical wire management products. Its new "MiniTrack" line features a series of wire positioning ducts designed to straighten, conceal and protect small wires and cords.

Constructed of P.V.C., MiniTrak provides a way of eliminating tangled and bent wires. Each five foot length (which can be cut to size) carries an adhesive strip that enables mounting on a variety of surfaces including plaster, wood, masonry, tile or metal.

Circle 10 on Reader Response Card

Samtec's Variety of Array Sockets and Adaptors

Samtec Pin Grid Array Sockets and Adaptors are available in over 200 pin grid array patterns from 8 by 8 to 20 by 20. Each is available with a choice of 13 standard lead socket and 11 standard terminal styles.

Custom patterns are also available in arrays from 2 by 2 to 20 by 20. These custom interconnects are easy to specify and are priced competitively with standard connectors.

Circle 11 on Reader Response Card

AMP's Plugs and Jacks Offer Space Savings

AMP Inc. has introduced shielded modular plugs and jacks that are available in six or eight position sizes. The connectors are plated phosphor bronze with 50 micro-inches of gold in the contact area over 50 micro-inches of nickel. They mate with standard unshielded products and verify mating with tactile and audible feedback.

Circle 12 on Reader Response Card



Murata Erie's Fresnel Lens

A new infrared sensor module featuring a Fresnel lens for increased sensitivity is now offered by Murata Erie North America, Inc. This new sensor-lens combination offers improved sensitivity over sensors previously available—five meter minimum human body detection range with 0.3 meter per second movement.

This new device also features a custom hybrid IC amplifier requiring 1.5mA for operation. Overall dimensions are 1.69 inches L by .91 inches W by .98 inches H.

Applications include lighting control systems, on/off controls for home appliances, heating system controls, automatic door openers and alarm systems.

Circle 13 on Reader Response Card



"THE SETTING IS A KNOCKOUT"

The New York Times, Friday, October 23, 1987

DINER'S JOURNAL

The forbidding Black Rock, as the CBS Building on Avenue of the Americas at 53rd Street is dubbed, has sprouted an exotic flower called China Grill, an offshoot of Chinoise on Main in Santa Monica, California.

The setting is a knockout—a soaring block-long space with pale jade-colored walls, huge eggshell-colored light shades suspended from the ceiling and a gleaming open kitchen.

This restaurant originally had forty twelve-inch coaxial speakers in its 30 ft. high ceiling. They have been replaced with six #168 black Soundsphere loudspeakers which are deftly hidden between the eggshell light shades. The manager and staff state that the background music is even and "delightful."

Steven M. Rosstad of United States Communications, New York City, is impressed by the sound quality and cost-saving installation. Steven looks forward to using Soundspheres as a "problem solver" in future challenging situations.

Write or call direct for further information.

SOUNDSPHERE A PRODUCT OF **SONIC SYSTEMS, INC.**

737 Canal Street • Bldg 23B • Stamford, CT 06902 • USA • Tel (203) 356-1136

Circle 233 on Reader Response Card

Sound & Communications

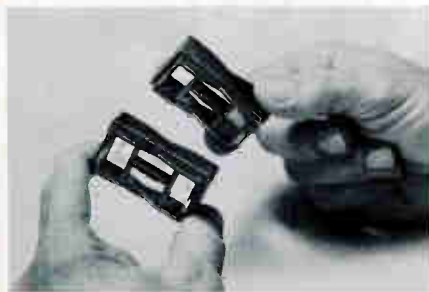

Panduit Announces Stackable Cable Spacers

A stackable cable spacer for use with TELCO, CATV and electrical cables has been announced by Panduit Corp, Electrical Group. The spacers have large openings to provide easy, four-way entry of cable ties for use perpen-

dicular or vertical to the cable.

The stackable cable spacers are made of black weather-resistant polypropylene for outdoor use. They have a snap-fit design which mates the spacers together.

Circle 14 on Reader Response Card



Field Installable TNC Connectors from Cambridge

A complete line of crimp-on and twist-on style field-installable connectors called "Fastfit" are available from Cambridge Products Corp. A bifurcated and preassembled center contact located between two insulators cap-

tures the (solid) center conductor of the cable in a secure connection.

In the twist-on version, no contact soldering, crimping, loose clamp nuts or contacts are handled. No tools and little manual dexterity is needed to achieve a firm, solid connection. The cable is trimmed and its center conductor inserted into the rear of the connector body. Twisting the cable engages the novel tapered and threaded back end, grabbing and holding the cable securely enough to withstand a 50 pound axial pull.

Circle 15 on Reader Response Card

Jensen Tools' Cable Tie Installation Kit

A Cable Tie Installation Kit is available from Jensen Tools. The kit contains a cable tie tool, 200 ties (100 four-inch and 100 7½-inch) and a 10¼ by 4½ by 1½ snap-close plastic case.

To operate the tool, feed the cable into the tool head, pull the trigger to secure tie, then twist the tool a single half-turn to sever.

Circle 16 on Reader Response Card

Look What we Have!

Take a look at the products offered by today's inter communications market. Now compare the quality, variety and affordability of Tektone's line. Isn't it time for you to make the right choice?

NC200N Nurse call system



VM102A Video intercom

EK804A Radio/intercom



DM228 Office/home intercom



SM210 Office intercom



IR104A Apt. intercom



SF202 Alarm unit

Tektone

Sound & Signal Mfg., Inc.
1331 S. Killian Dr., Lake Park Fl. 33403
(305) 844-2383 Toll-free order (outside Fl.) 1-800-327-8466 TLX 51-3438

Circle 245 on Reader Response Card

Dear Dr. Wokka

Dear Dr. Wokka,

I'm a famous acoustical consultant. I love my work but I'm bored. Can you relate? Any suggestions?

Ann Onomons

Dear Ann,

I can relate. This leads me to a favorite scientific subject—video games for audio engineers. Don't despair. There are so many fascinating computer-based video games and toys, you'll never be bored again. And you can use them to generate income.

First, some history. The first "pre-video" audio/video (A/V) game was, of course, the VU meter. Once studio engineers got tired of playing "peg the meter" and "What does "VU" mean?," things got old real fast. The first true A/V game was the oscilloscope, which still has a whole subculture of electronics engineers glued to the tube. Although it has great potential due to the number of front panel controls and the usual drug-like tube radiation, it is limited. Real-time stereo, lissajous patterns and dual-trace displays have a small attention.

A/V games are a boon to our industry and our profession. They allow us to play on the job and still get paid. Everyone knows that sound systems haven't changed since the 1940's and that it takes a few hours to design a good system for any venue or hall. The classic "Handbook of Sound Systems" by Masterson and Carr (J. Wiley, 1945), as everyone knows, will generate all necessary horns play patterns, equipment lists, etc. for any application known, and recent computerization of this work by my colleague, Dr. Fado do Console, makes this job a matter of minutes. So, as a dead end profession, the A/V game has brought new life to sound system design. Like the medical profession, outsiders view our work as magic and we need a continuously changing (thus improving) "front."

A/V games give us new words, new professional vocabulary, endless data—the customer wants to believe this work is mystical (I certainly hope you're getting more than \$250 per hour); a demonstrable on-site wonderment, which ensures sound with lots of winkie-blinks; and wonderful toy-

value equipment to while away the hours.

Currently, the A/V games available have grown past the RTA at an incredible rate, thanks to computers. Here are a few categories of them:

1) Sound System Cluster Design—This class of A/V game needs a big computer. These babies, given inputs of acoustical radiation, electrical behavior and mechanical specs, will draw radiation patterns, clusters, wiring diagram and SPL contours in 3D. Of course, no one ever uses them to design a system. They are merely to be given to the customer in a large binder in return for his check for the system (and the binder). The customer is happy and the designer gets to play with the computer all day. Several programs stand out in my mind. Moire Compusound (Oakland, CA) sells "Vivid Audiocomp" which displays, in full spectrum color, real time 3D SPL contours on any hall from any definable speaker cluster. This requires an IBM mainframe, but it's breathtaking on a projection TV, especially with the HI-RES option. You define the hall and the systems (requiring hours of fun data input) allocate any of 26 colors to various SPL levels and play your favorite CD in it. Real time resolution is 50 μ s, so the screen really jumps! I'm told that the visual input overload came close to killing a man who had experimented with LSD in his youth.

The other game worth mentioning is "All the GIG" by Tonaudio (Brare Green, Surrey England) which simulates a live rock and roll concert. Excessive SPL makes the crowd hold their ears. Excessive flying cluster weight makes the light and sound grid fall on the artists. A sub-routine here is called "bleeding ears" which matches the operator's reflexes with those of the audience's hands. This is also full color and was originally intended for touring and road crews so they wouldn't damage hotel furniture.

2) Acoustical Measurement—Various computer based acoustical measurement games have far surpassed the RTA for endless "hearing with your eyes" games. ("See, it sounds good"). Of course, anyone can pick up Masterson and Carr and do a system design



in an hour and listen to it to tell if it (a) sounds good and (b) is intelligible. However, now we can quantify all this with endless data. Two new games are noteworthy. First, the TLH machine (Time/Level/Hertz) made by Nortre Dame Instruments in South Bend, Indiana, will generate as many z-band 3D graphics of as many variables as you can imagine for a sound system. You can plot SPL v/s time, frequency, imaginary time, imaginary frequency, room dimension, imaginary room dimension. So, for a sales tool, you can charge your customer for as much time as you want to play with your THL machine. Of course, with the RTA, any of the displays can be construed to mean either good or bad sound, depending on your whim. These debates are great to present at your local AES chapter meeting for all-night shout-fests. If you have a PHD, you can hopefully disable the minds of lessers who might one day be your competition.

The other game worth mentioning is the RASTA intelligibility tester (BBK Instruments, Kingston, Jamaica) developed by a foundation of reggae music lovers bent on finding out why no words at all are discernable at reggae music concerts! This instrument is an A/V gamer's dream. It has three full-color, 5 inch video displays and 57 discrete front panel controls, all of which have an affect on each display. The machine puts out a signal (vaguely reminiscent of a muffled kickdrum and distorted guitar "chink") and picks it up with an internal microphone. None of the information on the displays mean anything at all, but the data output is phenomenal. One consultant I know used this machine to generate \$15,000 in income. He brought the machine to the "problem" location, generated two

(continued on page 68)

WIRELESS MICS

(continued from page 28)

seen, that antenna can be noiselessly switched on-line to replace the one experiencing interference. This system allows the operator to constantly monitor antenna status and provide the best signal available to the receiver at all times.

The other spectrum analyzer screen (See Figure 5) allows the other operator to view the amplitude and filter skirts as well as any spurious signals within 800 kHz of the transmitter center-frequency. This is particularly useful when scanning the upcoming transmitters during a commercial break. If some source of interference arises, a substitution can be made.

By adjusting the display bandwidth, it is easy to zero-in on sources of interference. On one production we noted an increase in the signal strength of the local television channel 10 sub-carriers. We were concerned that the weather prediction was for increased cloudiness. Because of the relative position of the transmitting tower, the cloud bank would reflect more signal down to our location which would necessitate replacing an adjacent frequency. We were fortunate that day. Eventually, the clouds dissipated and so did a lot of the mystery surrounding RF microphones.

Each year in metropolitan areas the interference potential is growing rapidly. The need for frequency coordination and accurate antenna placement becomes that much more important for all RF microphone installations. ■

Patrick Baltzell is a television P.A. mixer and senior technician for Burns Audio in Los Angeles, CA.

CLOSER LOOK

(continued from page 53)

ferred to the UPM-1 as a "passive quasi-three-way system," implying a rather complex crossover network. At low frequencies, both 5-inch drivers are active; frequencies above 250 Hz are handled by the upper cone driver alone, and highs (3.6 kHz and above) by the piezo tweeter. (According to the company, this scheme results in very even dispersion with a minimum of "combing.") The unit's impedance is 16 ohms.

The P-1A CEU: This is a single-channel rack space signal processor. According to the company's literature, its functions are: (1) loudspeaker frequency and phase response alignment; (2) SpeakerSense† driver protection; and (3) cut-only low frequency equalization. The UPM-1 cannot be used without it.

The P-1A is the epitome of the classic "black box." Besides a power switch, it features exactly two user-adjustable controls: a master level attenuator calibrated in dB, and a two position switch labeled "Lo Cut" and "Flat." Two front panel LEDs labeled "Sense" and "Limit" display the action of the SpeakerSense circuitry (see below).

Line level signal connections to and from the P-1A are via standard 3-pin XLRs. The input is actively balanced, and the output push-pull; maximum levels for both are +26 dBu balanced, or +20 dBu unbalanced, with hum and noise at -90 dBu (A-weighted). This would appear to offer more than adequate headroom and dynamic range.

†Registered trademark of Meyer Sound.

An additional connection (termed the "Sense" connection) from the power amplifier output back to the P-1A allows the unit's SpeakerSense circuitry to monitor the amp's output voltage. According to the instruction manual, the P-1A incorporates an RMS limiter and a peak limiter, both of which are activated whenever the amplifier output exceeds the safe operating limits of the drivers. We gather that this circuitry also controls the low frequency sliding filter mentioned in the press release. The function of all this is to protect the drivers from damage and provide a graceful overload characteristic.

Perhaps the most obvious function of the P-1A is frequency and phase response equalization. The redesigned unit incorporates the "complementary phase" equalization technology that Meyer developed for its SIM testing system (see June 1986 issue of *Sound and Communications*). This circuitry, which has generated considerable talk (and some controversy) within the industry, is claimed to offer precise corrective complements to natural acoustical resonances in both the frequency and phase domains. In this

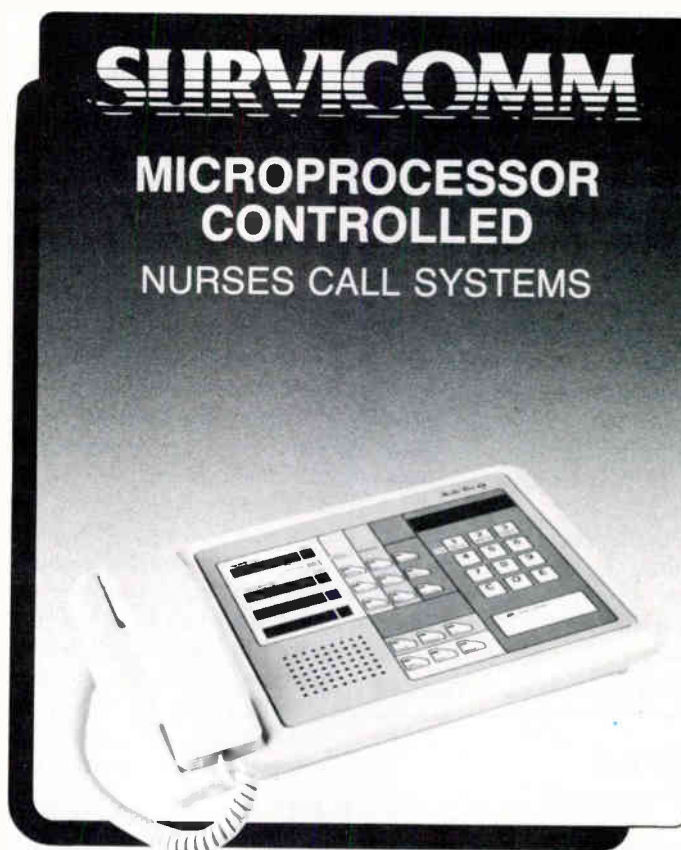

Multi-Vox

9967 BLVD ST-MICHEL,
MONTREAL, QUE.
CANADA H1H 5G7
TEL.: (514) 321-3131

respect, the P-1A certainly appears to offer a quite sophisticated level of technology. (The P-1A's equalization circuitry is factory-set and not user-adjustable.)

Conclusions: The UPM-1/P-1A system is emblematic of the Meyer Sound approach: the company makes no significant attempt to compete on price, preferring to aim for the high ground at the quality end of the market.

The system is more expensive than most of comparable size, and price may limit its applicability for many contractors. In performance, however, it is definitely a competitor for the top in its class. The UPM-1 is specified to be capable of generating an impressive 108 dB SPL continuous and 118 dB peak when driven with a 125 watt (16-ohm rating) amplifier. That's a lot of sound from so small a box. There are other amps which sense and correct for loudspeaker behavior, but Meyer's processor can be optimized for a specific loudspeaker, unlike the general purpose amps, so it has the potential for significantly better sound with very carefully monitored component protection. We had the opportunity to hear the system at the New York AES Convention last October, and can attest that its sound quality is excellent. (The company reports interest from several recording engineers in using the UPM-1/P-1A for near field monitoring: quite a compliment for a reinforcement product!)

Moreover, you need one P-1A per channel of sound—not per speaker—so the CEU cost goes down in cases where you may be using a lot of speakers but the system is monophonic. Since the box presents a 16-ohm load, you can parallel up to four on each amplifier output for further savings. The unit may therefore become quite cost-effective in larger installations.

For clients that require the highest sound quality and reliability, this loudspeaker system, we recommend that you give the UPM-1/P-1A system a closer look. ■

Circle 17 on Reader Response Card

DR. WOKKA

(continued from page 66)

boxes worth of full-color hardcopy on the spot, recommended a re-aiming of the cluster and went home in two

hours, leaving a satisfied customer with five weeks worth of entertaining reading.

In conclusion, design systems like you know they should be done; use Masterson and Carr and your own ears. Buy one of the hundreds of fascinating A/V games available and play your life away, dazzling and satisfying your paying customers with an ever expanding stream of full-color data like never before. Lastly, invent the most outrageous interpretation of this uninterpretable data you can for hilarious and rollicking debate with your colleagues, and find out if any of them really take these games seriously. (Mark these persons for future reference). In short, buy a video game for the audio engineer, fool your boss and play in your cathode-ray sandbox, secure and, above all, not bored. ■

Next Month: Scientifically correct usage of an equalizer.

WHITE HOUSE

(continued from page 47)

day and a half. Fine tuning and working out the several "surprises" took another two days. The job was completed in September, 1987, nine months after the contract was awarded. It is in daily use today.

Challenges

This project for the White House offered many challenges. Designing a system to be used by people at the highest level of government under "it can not fail" conditions is a big challenge. Designing a system which is both technically sophisticated while at the same time easy to use, and packaging all this in a single 19-inch by 77-inch equipment rack adds yet another degree of challenge.

Fifteen years from now someone reading this article may, himself, be designing a replacement system for this one. If you do, a couple of suggestions. First, pick the best equipment you can buy. Second, be prepared to commit whatever resources may be necessary to accomplish your goal—manpower, money and materials. Finally, be veerry careful when you estimate your labor. Good luck! ■

Bill Peterson founded Professional Sound Industries in 1971. PSI maintains a complete GSA schedule, consulting division, commercial and government sales division, and manufacturing facility.

Ad Index

RS#	Company	Page
—	AKG Acoustics (203) 348-2121	61
217	Altec Lansing (405) 324-5311	35
231	ART (716) 436-2720	3
219	Audio Technica (216) 686-2600	13
230	BGW Systems (213) 973-8090	30
215	Cetec Vega (818) 442-0782	11
210	Electro-Voice (616) 695-6831	C. II
232	Engineered Electronics (404) 949-3290	14
220	HME Electronics (619) 535-6060	25
211	IRP (312) 439-3600	C. III
213	JBL (818) 893-8411	5
224	Lectrosonics (505) 831-1010	52
238	MacKenzie (818) 579-0440	55
241	Multivox (514) 321-3131	67
228	Nady Systems (415) 652-2411	59
216	Quam-Nichols (312) 488-5800	7
221	Rane Corp. (206) 774-7309	21
240	Red Acoustics (517) 694-3618	17
227	Rockustics (516) 665-6497	50
223	Samson (516) 489-2203	29
236	Sennheiser (203) 434-9190	39
212	Shure (312) 866-2200	C. IV
229	Tappan Wire & Cable (914) 359-9300	56
226	Telex (612) 887-5550	14
222	TOA (415) 588-2538	41
218	University Sound (616) 695-6831	45
225	West Penn Wire (412) 222-7060	40
234	White Instruments (512) 892-0752	23
214	Yamaha (714) 522-9011	18

CLASSIFIEDS

INSTALLATION MANAGER needed for Phoenix area A/V contractor. Minimum 5 years experience in installation, engineering, estimating, scheduling, supervision, trouble-shooting and management. Progressive wage, benefits and incentives. Send resume to:

SLVA
P.O. Box 17197
Phoenix, Arizona 85011

SESCOM, INC.
"the audio source"
FOR ALL OF YOUR AUDIO NEEDS
2100 Ward Drive Henderson, NV 89015 U.S.A.
CALL TO RECEIVE A COPY OF
OUR POCKET-SIZED CATALOG
CATALOGS & ORDERS: (800)634-3457
OTHER BUSINESS: (702)565-3400
TWX(910)397-6996

SALES—Fast growing midwest Ohio Audio/Video contractor seeks qualified Sales Persons and Sales Engineers for its Dayton office. Applicants shall have a minimum of 5 years experience in audio and/or video systems. Both managerial and staff positions are available. All replies held in strictest confidence. Send resume and salary requirements to: Personal Director, P.O. Box 292974, Dayton, Ohio 45429.

PROJECT ENGINEER

Experienced in system design and system integration for government, institutional and commercial security systems including door control, fire alarm, card access and perimeter detection. National company with openings in Colorado, New Jersey and Georgia, send resume to: ECSI, 101 Halsted St., E. Orange, NJ 07018.

AUDIO SYSTEMS ENGINEER

New England's largest multi-discipline communications contractor seeks experienced professional to head established audio systems efforts starting April 1, 1988, preferably sooner. All major audio lines, administrative, engineering and secretarial support, fully equipped shop, IBEW-affiliated 45-member installation crew. Major and minor projects. Limited travel. Salary and expenses.

Contact Tom Bouliane, SESCO, INC., Boston, MA, (617) 825-6401 to receive details. All inquiries totally confidential.

CUSTOM PANELS

Anodized aluminum, photo plastic, silk screened or engraved for control panels and connector termination. Rack rails, hardware and custom circuit cards

PROTO-TEC - (815)744-7173
108 Fairlane Dr. Joliet, IL 60435

TIME SAVERS

- **PUSH-PULL RODS** Get Cable through tight places.
- **TEST-SET**, For the Audio Serviceman
- **EASY-KARY™** Wire Reel Holders — 3 sizes.
- **SPEAKER SUPPORT TRUSS** (T-Bar Bridge) Prevent ceiling sag. Speed Installation.
- **SPEAKER ENCLOSURE**, for use with the truss.
- **EXTENSION CORDS** 3 ft. and 10 ft. U.L. Listed

All 50 states call 1-800-527-1522
OR, Call Collect Local Phone 214-946-8460

MUSIC SUPPLY CO., INC.
809 N. MADISON
DALLAS, TEXAS 75208

PREMIERIAL
INSTALLATION & SERVICE AIDS

FREE 44pg Catalog & 80 Audio/Video Applic.

PHONO, MIC, TRANS, AC, TAPE, VIDEO, LINE, OSC

Video & Audio Dist. Amps.
RCA-Sync Dist. Amps

Routing Switches

OPAMP LABS INC (213) 934-3566
1033 N Sycamore Av LOS ANGELES CA, 90038

ENGINEER (SOUND SYSTEM DESIGN)

Established company looking for experienced sound, CCTV, intercom design engineer. Duties to include on-site surveys, print layout, equipment schedules, pricing and assistance with closings. Many fringe benefits. Send resume and salary requirements to: Independence Communications, Inc., 960 Rittenhouse Road, Norristown, PA 19403. Attn: W. Ahern.

RJ31X JACKS & CORDS
WIRE & CABLE
UL-PLENUM-FIRE
"B" CONNECTORS, TIE WRAPS
DRIVE RINGS & PINS
ARROW STAPLERS
FASTENERS
CALL TOLL FREE

cabletronix

800-431-WIRE (USA)
800-642-WIRE (NY)

CLASSIFIEDS

- Regular Classified — \$52 per column inch.
- Marketplace Display — 25 percent off rate card (up to 1/3 page).

Classified listings are accepted up to the 25th of the month preceding publication.

Name _____

Address _____

City/State/Zip _____

Telephone _____

Credit Card # _____

Check Heading You Want

- SERVICES
- MISCELLANEOUS
- FOR SALE
- SITUATIONS WANTED
- FOR RENT
- HELP WANTED

Please send copy & payment to:
Sound & Communications Classifieds
25 Willowdale Avenue, Port Washington, NY 11050
TELEPHONE: (516) 767-2500

Coming in March...

is another **Sound & Communications** pull-out section—this one's on **Powered Amplifiers**. This special, comprehensive guide will provide the sound contractor with a diverse selection of power amps to choose from to suit his particular needs.

Also look for articles on these topics in March:

Speech Synthesis/
Voice Recognition

Amplification

State of the Market
in Wire & Cable

The World Harvest
Church Sound System

Look for the
March 1988
issue of
Sound & Communications

Lines and Service

About the only thing that just about everybody reading this page has in common is sound. You might be a sound contractor that crosses over into the allied fields of video, security, CCTV, or specialties in teleconferencing, or noise masking. Or, you might be a specialty contractor, or music store that is involved in sound system installations. My favorite story about recent perspectives in sound contracting is looking back just a few years ago when there were no professional active electronic crossovers available (the early '70s). I impressed many clients with the ability to bi-amp with this little "wonder-box" from White—yes, those little passive crossovers and filters. In fact, most people thought that bi-amping was having a second amplifier ready in a stand-by mode.

We sure have come a long way since then. A quick look through this year's *Sound & Communications*' Blue Book shows over 30 manufacturers of crossovers. Speaking of amplifiers there are over 80 manufacturers of professional audio power amplifiers! Plain and simple, the marketplace demand for good sound has been increasing at such a rapid rate that these numbers are not stymieing—except perhaps to the reps. As a dealer, on the other hand, the competitive edge of line-exclusivity is rapidly diminishing and becoming a smaller factor. No single geographic marketplace can sustain a single dealer supporting that many exclusive franchised lines.

Technology has advanced to the point where it has become a challenge to design a bad sounding sound system with just about any components (within reason). The overused adage of science, art, and music really means more today than ever before. Any one facet cannot overrule the other. Sound really is about the only trade left that combines an empirical approach, combined with a good understanding of people and the emotions evoked within them. These days the average sound contractor does over one million in sales with the average system installation just over \$10k. With numbers like these the field is spread out with businesses specializing in different sized and types of sales.

While some contractors stay within the realm of houses of worship, others stay in bid work, and others specialize strictly in sophisticated design/install jobs. Most contractors are focusing in specifically different venues and areas of technical expertise. The questions do remain though of whose science, whose art, and whose music? Where do we garner these talents from? Where do we teach our designers how do develop these works of ingenuity? Where do we find competent installers and technicians to build and fix them?

Short of full electrical engineering courses—and the work some of these engineers have been turning out lately makes me wonder—we must all continue to share our mistakes and accomplishments as we always have in the past. Some time ago I attended an engineering seminar that got totally lost in calculus—to the point where the instructor failed to make the point. After some grueling hours of non-applicable theory, a brief presentation on one designer's point of view based on his 30 years of mistakes was a real mind-opener. Imagine, here I was busily writing as fast as I could, diagrams and all, saving myself from countless embarrassments, grief, and lost profits.

In essence that is what hopefully takes place in the forum provided by a specialized publication like *Sound & Communications* magazine. High-level engineering journals are primarily directed at advancing the state-of-the-art at the manufacturing level, while we are busy at trying to keep up with the state-of-the-business. Specialized libraries are hard to come by, but even with the best, applications are best illustrated using today's art, with today's music, and yesterday's science.

Jesse Klapholz
Technical Editor

VOICE-MATIC[®]

the only modular automatic mixer
that can be used with any microphone

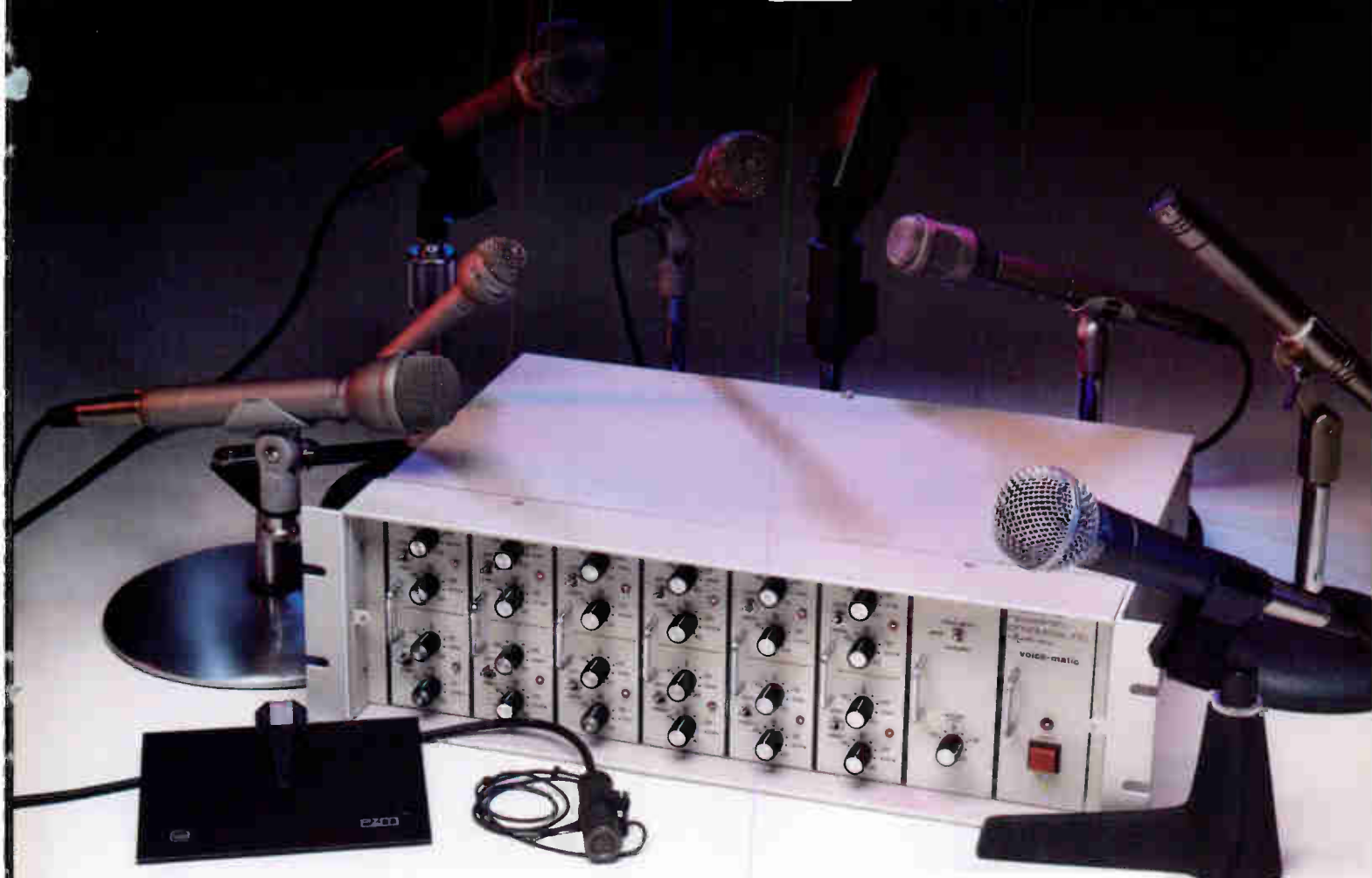

VOICE-MATIC[®] was the first modular automatic mixer and is still the mixer of choice in board-rooms, churches, courtrooms, meeting rooms and legislatures around the world. It can be used with virtually any microphone you choose—dynamic or powered.

Add the Level-Matic[®] module to eliminate system output changes and the TEQ[®] Transversal Equalizer module to eliminate ringing and transient signal coloration and you have the most complete, fully automatic and operatorless microphone mixing system there is.

VOICE-MATIC[®] Specified by sound contractors and consultants worldwide. Designed and manufactured by a company dedicated to solving problems in sound with state-of-the-art innovations and technology.

Circle 211 on Reader Response Card



Level-Matic[®] Module



TEQ[®] Transversal Equalizer Module

All IRP products are made in the U.S.A.

VOICE-MATIC[®]

automatic microphone mixer

INDUSTRIAL
RESEARCH
PRODUCTS,
INC.

A Knowles COMPANY

321 Bond Street • Elk Grove Village, IL 60007
In IL: 1-312-439-3600
TOLL FREE: 1-800-255-6993
TELEX: 701845 • FAX: 1-312-640-9607

MORE ENTERTAINERS INSIST ON THE SM58 THAN ANY OTHER MIC IN THE WORLD.

A recent independent survey of music dealers showed the Shure SM58 was the best selling microphone last month. The survey has shown the same result each month since it began. **M**ore rock, pop, gospel, country, and jazz vocalists and soundmen insist on the SM58 than

on any other microphone. That's because no other mic offers the SM58's distinctive sound and comfortable combination of weight and balance.

Not to mention its years of rugged, reliable performance. **T**he SM58 is the world standard professionals insist on. Don't entrust your career to anything less.



SHURE[®]

THE SOUND OF THE PROFESSIONALS... WORLDWIDE[®]

Shure Brothers Incorporated, 222 Hartrey Avenue, Evanston, IL 60202-3696. (312) 866-2553.

Survey data available upon request.

Circle 212 on Reader Response Card

World Radio History