

SOUND & COMMUNICATIONS

FOR CONTRACTORS, SYSTEM MANAGERS, AND SPECIFIERS

MARCH 1986

Contracting
close-up pg. 46

Distributed Loudspeaker System Technology

SGNDZMBAL5000 • BA0 01 0COMAY86+
MARK GANDER
JBL INCORPORATED
8500 BALBOA BLVD
NORTHRIDGE CA 91329

AUDIO TELECONFERENCING
MILITARY MARKET MANEUVERS
CALGARY CENTRE FOR THE PERFORMING ARTS

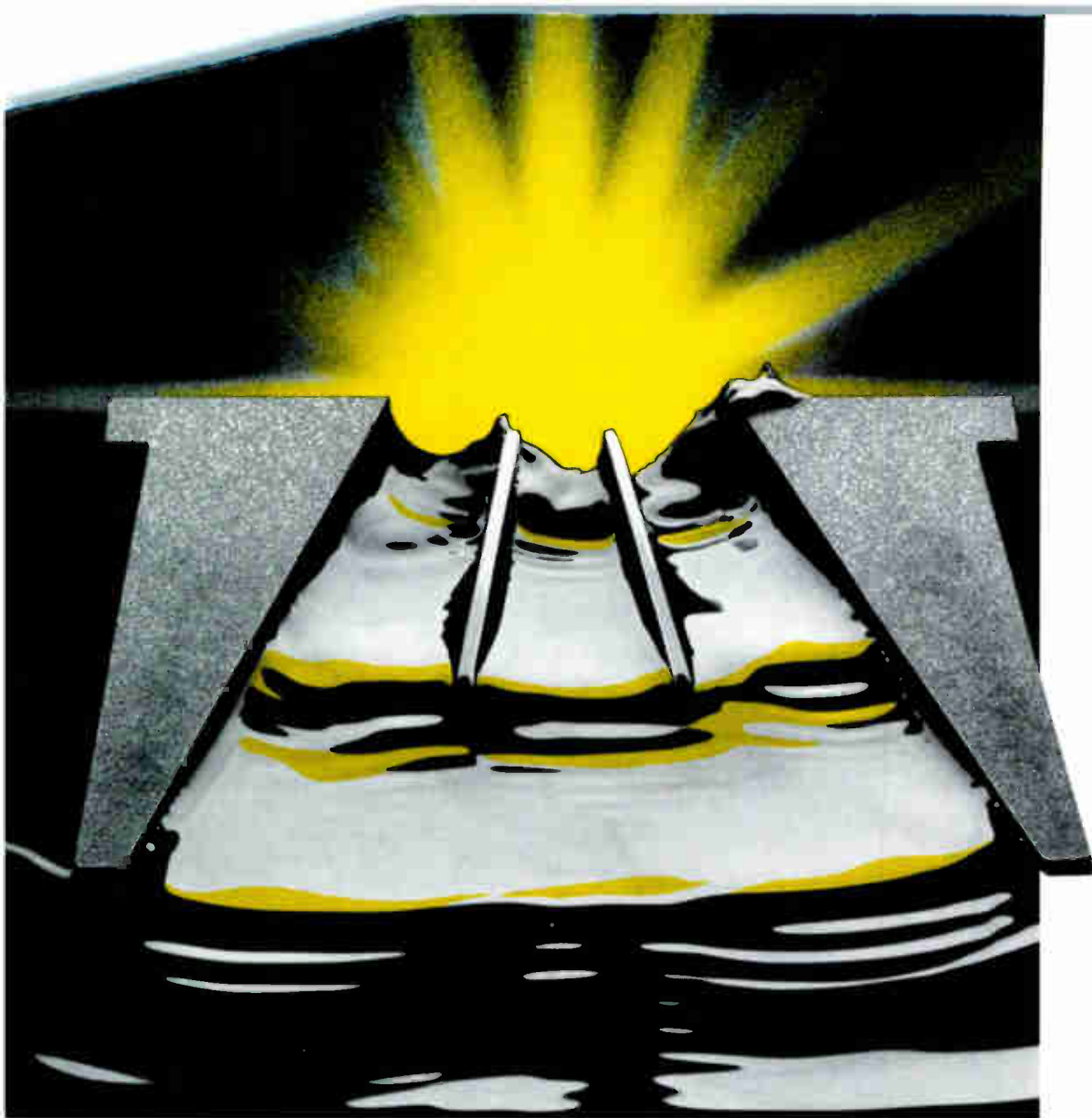

NEW WAVE DESIGN

Blocking the Incoherent Wave

Cast into the throat of every **TransPlanar™ HP horn**, unique beamwidth control vanes represent a revolutionary advance in constant-directivity design. Until now, two-inch-throat designs were compromised by on-axis dropout. Intrigued with this curious problem, EV engineers applied principles of geometric optics to isolate the incoherent waveform responsible for this phenomenon. Instead of coursing down the horn in an organized fashion, this offending wave reflects off the walls of a two-inch throat, shadowing direct output and causing a loss in level. Ray analysis was used to predict this occurrence and determine the exact configuration of slotted waveguides which block the cancelling wave and eliminate on-axis dropout.

Acting together with an optimum diffraction slot, the beamwidth control vanes also eliminate both horizontal and vertical beaming in the very highest octave. Other two-inch-throat designs exhibit narrowing of the coverage angle above 10,000 Hz. But the new HP horn maintains uniform dispersion to 20,000 Hz!

When Electro-Voice invented the constant-directivity horn in 1972, we really started something. Now we're making waves again . . . introducing second-generation CD design with the most uniform beamwidth control in the industry. To learn more about the new HP horn or the high-performance DH-1 and DH-2 two-inch-exit drivers designed especially for them, contact Pro Sound Marketing at Electro-Voice, 600 Cecil St., Buchanan, MI 49107. **We'll be glad to tell you why when the competition beams, we just smile.**



EV Electro-Voice®
SOUND IN ACTION™

The AT853 UniPoint™ Condenser Cardioid

It's been
hung,
planted,
buried,
strapped,
stood up,
clamped,
taped,
and swung...
all in the name
of better,
less visible
sound.

The AT853 condenser cardioid is a remarkable microphone. Smaller than your little finger, yet with flat response from 30 to 20,000 Hz, and an effective cardioid pattern, even at the lowest frequencies.

The AT853 is so light (1/2-ounce) it can hang on its own 25-foot cord above a choir or orchestra. The ingenious wire adapter permits pointing it exactly where it's needed without support cables or stays, making the AT853 even less visible.

It also includes a neat stand adapter to instantly convert the AT853 into a desk or floor stand model. Or simply hide it in the bushes, behind props, or wherever superb sound is

needed with minimum visibility.

The AT853 is operated by a single 1.5V "N"

battery or phantom power. The power module also has a low-frequency rolloff option to solve rumble and room noise problems.

The AT853 is one of a family



ACTUAL
SIZE



audio-technica®

Audio-Technica U.S., Inc., 1221 Commerce Dr., Stow, OH 44224
(216) 686-2600

SOUND & COMMUNICATIONS

MARCH 1986

Volume 32 #3

FEATURES

DISTRIBUTED LOUDSPEAKER SYSTEM TECHNOLOGY: PART ONE 14

Jesse Klapholz traces the development of distributed loudspeaker technology which has its roots in the earliest days of loudspeakers, amplification, and radio.

AUDIO TELECONFERENCING 20

Don Gayle of Shure Brothers Inc. discusses the market influences and demands which led to the development of his company's audio teleconferencing system. A clear case of being "market driven," Gayle highlights the market pressures which influenced the system's design and the system itself.

MILITARY MARKET MANEUVERS 28

Last year, Vj Electronics won the bid to gather the components for a high SPL paging/warning system for one of our nations's largest military bases. Due to the security measures of the base, almost every word written pertaining to the job was to be screened. Greg DeTogne talks with Vj Electronics about working for the government and about the logistical and operational details of the project.

CALGARY CENTRE FOR THE PERFORMING ARTS 32

Barry McKinnon reports on the sound systems installed in one of Canada's largest performing arts complexes. The Centre, which was completed late last year, includes three separate performing halls, each with very specific needs.

COLUMNS

IDEAS & OPINIONS 6

In reps we trust. Chris Foreman comments on the much misunderstood manufacturers' representative.

SALES & MARKETING 10

Joel Schwartz, president of the 40-year-old manufacturers' rep firm, LCA Sales, explains the role of the sales rep in relation to both the manufacturer and the contractor.

ON THE COVER

On our cover this month is a distributed loudspeaker system installation featuring Bose 102 Commercial Sound System. The development of these systems is the focus of the feature starting on page 14.

DEPARTMENTS

NEWSLETTER	8
LETTERS & OPINIONS	10
PRODUCTS IN REVIEW	36
A CLOSER LOOK BY GARY D. DAVIS	38
DATAFILE	40
BOOK REVIEW BY TED UZZLE	41
AD INDEX	42
SUPPLIES/SUPPORT/SERVICES	43
FACES AND PLACES	44
REP NEWS	45
CONTRACTING CLOSE-UP	46
DATEBOOK	49
CLASSIFIEDS	50

combining **SOUND MERCHANDISING & MODERN COMMUNICATIONS** FOUNDED 1955
© **SOUND & COMMUNICATIONS PUBLISHING, INC.**, 1986. Reprint of any part of contents without permission forbidden.
Titles Registered in the U.S. Patent Office. Sound & Communications (U.S. P.S. 943-140) is published monthly by Sound & Communications Publications, Inc., 220 Westbury Ave., Carle Place, N.Y. 11514. 516-334-7880. President, Vincent P. Testa.
Subscription rates: U.S.—3 years \$37.50, 1 year \$15.00. Canada and Mexico—3 years \$48.00, 1 year \$18.00. Foreign and South America—1 year \$25.00. Second Class postage paid at New York, NY and at additional mailing office. Postmaster: If undeliverable notify on Form 3579 address correction.

Toa/Files



Date

First Quarter 1986

Installation

Expanded the **Toa 900 Series Music & Paging System** in the downtown shopping center. Management office now has the six-channel mixer power amp, and the center's entire system now contains eight of the 900 Series' different modules.

Comments

This was a typical high-quality Toa installation, which means I don't expect to make any service calls. Customer is pleased with the sound quality and easy operation of the 900 Series, and I'm pleased with the 900 Series' flexibility, availability, and profitability.

Future Prospects

We discussed the expansion made possible by the 900 Series' modularity, which accommodates their future needs. Contact mall management next week & explain how simple it is to expand system to warehouse and employee lounges.

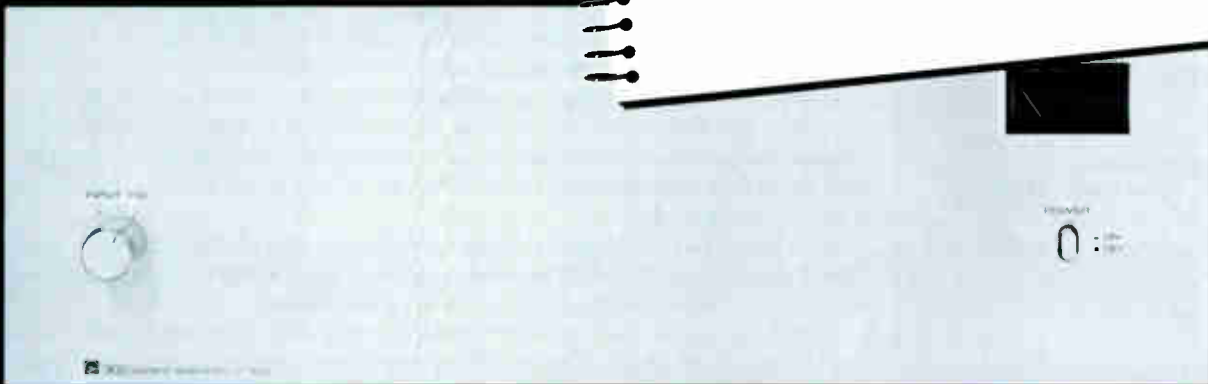

Install Confidence.



Toa Electronics, Inc.
Commercial/Engineered Sound Division

480 Carlton Court
South San Francisco
California 94080
(415) 588-2538

Toa Canada: (403) 489-5511 Edmonton, or (416) 624-2317 Toronto ■ Toa U.K.: (0277) 233882 Essex ■ Toa Europe: (040) 811127 Hamburg

Circle 234 on Reader Response Card

STAFF

Editorial Director

CHRIS FOREMAN

Managing Editor

NANCY PETERSON

Senior Editor

ELLIOT LUBER

Editorial Assistant

MARY PAT O'CALLAGHAN

Consulting Editor

JEROME J. BROOKMAN

Contributing Editor

GARY D. DAVIS

Contributors

GREG DeTOGNE

DON GAYLE

JESSE KLAPHOLZ

BARRY McKINNON

JOEL SCHWARTZ

TED UZZLE

Production Manager

SUSAN POWER

Art Director

KARLA TONNING

Production

BONNIE BRENNAN

BILL-LEE ITHIER

KAREN WENNISCH

Illustrator

STUART WEISS

Typesetting

GEORGE PROPER

DAVID SCHMIDT

Circulation Director

DENISE RIGOPOULOS

National Advertising Sales Manager

CLIFFORD CAPONE

West Coast Sales Manager

JAY S. MARTIN

Vice President

JUDITH MORRISON

President/Publisher

VINCENT P. TESTA

Editorial And Sales Offices

Sound & Communications

220 Westbury Avenue

Carle Place, New York 11514

(516) 334-7880

Advertising/West Coast

15532 Cohasset St.

Van Nuys, CA 91406

(818) 904-9669

Circulation audited by
Verified Audit Circulation Corp.

VERIFIED
AUDIT CIRCULATION

TESTA
COMMUNICATIONS
INC.

Sound & Communications • Music & Sound Output
The Music & Sound Buyer's Guide • Post
CES-TV News • NAMM-TV News • The Daily
The Music & Sound Electronics Retailer
Home Entertainment Magazine

IDEAS & VIEWPOINTS

IN REPS WE TRUST

by Chris Foreman

They are "manufacturers' representative." Sometimes they work directly for a single manufacturer, sometimes they are part of an independent organization that represents several manufacturers. In any case, they are a sort of "a go-between" whose job it is to temper the manufacturer/dealer relationship. For reasons which are probably partly deserved and partly undeserved, reps have acquired a bad image in the eyes of some contractors. That's too bad because, properly used, a rep is one of the most valuable allies a contractor can have.

I once knew a contractor who maintained that he truly hated reps. He honestly believed their primary goal was to do the least amount of work necessary to collect their commission checks from the manufacturers they represented. This contractor especially resented those commission checks. "I'm paying those commission checks! And I don't get a thing out of them!" he would exclaim. "Why don't the manufacturer's deal with me directly and give me a better price instead of giving him a commission?"

Being naive enough to believe that he wanted an answer, I once or twice attempted to explain the purpose of a manufacturer's rep and the tricks I had learned to make good use of reps, to "get your money's worth" out of those commission checks.

Needless to say, it didn't work. This contractor had had one or two bad experiences with manufacturers' reps and he had made the decision that all reps were bad.

What I wanted to tell that contractor is that I'm a realist when it comes to reps. I accept reps as a fact of life. I'm certain that some reps don't deserve their commission checks, at least not all the time. Most, however, are honest and hard-working and will really go to bat for the contractor—when asked to do so. (For an extensive understanding of the role of manufacturers' representatives, read *Using The Middleman* by Joel Schwartz on page 10.)

There's the secret, of course. To get the most out of a rep, the contractor has to ask the rep for his/her help, and do it often. If your only contact with the rep is when they come to your office on an every-so-often good-will visit, you will get little more out of your rep than a new catalog, a handshake, and maybe a lunch.

What should you ask for? Start by asking them to handle as many of the transactions between you and the manufacturer as possible.

Orders, for example. "They're simple enough that I could easily handle them myself," you say? What about those times when the manufacturer makes a mistake and you have to call and argue and complain and threaten? A good rep will do all that for you, but it's a lot easier for the rep if you let them handle the order in the first place.

"But that rep is never around when I need to place an order," you say? "And, I'm always in a hurry. When I need something, I need it now!" Well, a good rep will return his/her phone calls in 24 hours or less.

I know that some reps simply cannot take every order from every dealer/contractor in their territory. They're just not set up for that level of service. If that's the case, at least make them do those rush/special/complex orders. And let them handle returns, credit, and billing hassles.

Next, call the rep when you need a favor. (As did Tom Sawyer of Jv Electronics in Torrance, CA, when he needed a rush order for the military PA system he was doing. See story, page 28.) You really need a loaner? Call the rep, not the factory.

I could probably go on but you get the idea. The way to get your money's worth out of those commission checks the reps collect each month is to stop fighting your reps and put them to work. You may even find you've gained a new business ally.

“QSC Customers Are Buying More Than A Product; They’re Also Buying Our Support.”

Barry Andrews
President,
QSC Audio.

“What if it breaks?” That’s an ugly question, but an unavoidable one for anybody who buys a pro audio product. At QSC, we won’t leave you high and dry if you have a problem with one of our amplifiers. We pride ourselves on the reputation we’ve earned for quick and courteous service.

We offer a 3-year warranty on our Series Three amps

and a 2-year warranty on our Series One. For QSC, anticipating problems before they occur is a part of effective design. Through careful engineering, we’ve been able to make service easy for our customers, our dealers and ourselves. Protection from real-world hazards is built right into QSC amplifiers. Take the patented Output Averaging Circuit™ used in our top-of-the-line Series Three and more economical Series One. It provides complete protection from short circuits



without compromising the amplifier’s performance. Both the input and output stages of QSC amplifiers are fully isolated against overdrive, RF burnout or unstable loads. Even your speakers are protected against destruction caused by DC fault. The modular



design of our Series Three amplifiers makes service easy in the event that something does go wrong. Each channel is built into its own front-removal module, which can be easily taken out for service. Modules are connected to the mainframe by means of a locking gold-plated connector on a flexible cable—an interface that stands up to rough handling. For QSC, service means a lot more than just fixing things. It means listening. We listen to your problems as well as your praise. And we’ve incorporated that real-world experience into the design and service of every product we make. For more information contact: QSC Audio Products, 1926 Placentia Avenue, Costa Mesa, CA 92627, (714) 645-2540.

QSC Quality
Service
Commitment

Circle 233 on Reader Response Card



World Radio History

QSC
AUDIO

STEREO AMPLIFIER
MODEL 1400

GULTON INDUSTRIES SIGNS MERGER AGREEMENT WITH MARK IV INDUSTRIES

Gulton Industries Inc., parent company of both Electro-Voice Inc. and Altec Lansing, has reached a merger agreement with Mark IV Industries, allowing that company to purchase a majority of Gulton's outstanding shares. According to Gulton vice president of administration Diane Mickle, the definite merger agreement, approved by both boards of directors, sets a price of \$34 per share at which Mark IV has until March 17 to buy a majority of Gulton's outstanding common stock. Gulton has recommended that its shareholders accept the tender offer. At press time, both companies were awaiting Federal Trade Commission approval. However, Mickle said: "I don't think the acquisition will have any effect on our operating divisions whatsoever." Gulton vice president Robert Pabst of the audio sector said: "While I will have my first opportunity for meaningful discussion with Mark IV executives next week, all indications from Gulton CEO E. Maclin Roby are that if we succeed with our present plan, Mark IV will be delighted. There should be no visible changes as far as our customers are concerned, except that maybe we'll have to have our business cards reprinted."

AT&T'S SYSTEMS GROUP INSTALLS WORLD'S LARGEST DUPLEX SYSTEM FROM RING

AT&T's Information Systems Group has installed what is believed to be the world's largest duplex intercom system, the Ring-Master system by Ring Group of North America. The system is now in operation at Shearson Lehman Brothers' (an American Express company) headquarters in New York's financial district. The system is said to include over 1,900 stations, a nine-stage program distribution central exchanger (the microprocessor-controlled brain of the system) and special telephone "hoot and holler" communications circuits. The system will be used by Shearson Lehman brokers, traders, executives and administrative personnel to facilitate instantaneous communications; of particular concern to international finance organizations dealing with fluctuations in currency or stocks. In addition to hands-free, two-way communications, the Ring-Master is equipped with a number of features such as privacy and priority modes, soft speaking mode, station transfer, group/zone/all-call paging, and meet-me circuits, among others.

RENKUS-HEINZ INC. EXPANDS TO MEET GROWING DEMAND FOR SMART SYSTEMS

Renkus-Heinz, Inc. has been forced to move from its 6,000-square-foot facility to a new location with potential useable space of 30,000 square feet in order to keep up with rising demand for its Smart System product line, utilizing automated electronic crossovers. The new site is on the corner of Armstrong and Langley in Irvine, CA, within a few blocks of the old factory. Renkus-Heinz reports that it will also be more than doubling its staff during the next 12 months. Harro Heinz, president, and Jason Larson, director of marketing, are currently interviewing manufacturing and technical personnel to fill upcoming openings and are establishing a new franchised dealer network for Smart Systems

AES EUROPEAN CONVENTION HIGHLIGHTED BY 60 PAPERS AND PANEL DISCUSSIONS

The Audio Engineering Society (AES) 80th Convention, held March 4-7 in Montreaux, Switzerland, was highlighted by over 60 technical papers and several panel discussions, designed to continue dialogue on several controversial and timely topics. Subjects covered included digital audio techniques, digital standards, acoustics and computer science, studio technology, measurement and instrumentation, tape duplication, sound reinforcement, loudspeaker design, audio electronics, computer music and audio/video interface.

GOLLEHON INDUSTRIES EXPANDS, TARGETS CONTRACTOR MARKET

Gollehon Industries Inc. of Grand Rapids, MI, known for its sound reinforcement products for the music industry, has begun a market expansion that will include both sound installation products and professional audio. To serve this new market, Gollehon will introduce its first product designed specifically for the sound contractor. The first such product, new speaker systems, will be on display at the company's first NSCA Exhibit. At present, Gollehon is looking for additional sales representatives to serve the new markets. Until now, the company relied on musical instrument market reps for their distribution. According to president John Gollehon, the company will continue its commitment to design parameters such as power handling and efficiency, but will increase its concern for response and dispersion characteristics, which he said are more material to permanent installation.

TSI PRESIDENT MALTESE KEEPS HIS WORD DESPITE EMBARRASSMENT

Mario J. Maltese, president of TSI, reached "new heights" recently in response to the company's record sales figures. It seems that last year at a TSI sales meeting, Maltese was a bit skeptical whether the company could achieve as high a goal as his staff was predicting. "If we meet this goal, I'll dance the hula on top of this building," he said. On January 16, 1986, donning a grass skirt and Hawaiian leis, Maltese climbed to the roof of the company's building in sub-freezing temperatures to make good on his promise. With a crowd gathered below in the streets of Mineola, NY, Maltese, in skirt, leis, Hawaiian shirt, gym shorts, and black socks, proceeded to dance. Asked how he would follow this act if business continued as it has, the executive grinned and said, "Stay tuned!"

NON-PROFIT AV SALES TAKING SIGNIFICANT BITE OUT OF SMALL BUSINESSES

A campaign organized by the International Communications Industries Association (ICIA) to bring attention to the sale of equipment by non-profit institutions such as colleges, saw 15 states support protection of the small business it said were hurt by the practice in 1985. ICIA Legislative committee chairman John Moore of Moore's Audio-Visual Center in Portland, OR, said, "We are succeeding in our effort to move this issue to the agenda of problems that must be solved by small businesses." ICIA charges that universities and other tax-exempt organizations are selling products and services in the computer, video, and audio-visual businesses in direct competition with its membership.

LETTERS & OPINIONS

IN SEARCH OF . . .

Just read Ted Uzzle's interesting review of *Theatres and Auditoriums*, 2nd Edition. I have contacted my local B. Dalton bookstore and they don't show it as being available. Could you please provide me with information on where this book can be purchased?

Don Garrett
President
Don Garrett & Associates, Inc.
Englewood, CO

According to the publisher of Theatres & Auditoriums, Krieger Publishing in Melbourne, FL, the book is out of print. But, in a quick search through the phone

book I was able to find a bookstore, Theatrebooks Inc. (1576 Broadway, NY, NY (212) 757-2834), which has a couple of copies of the first edition. You may want to try there or a local specialty bookstore in your area.

THE BOYS FROM BRAZIL

Having worked as an audio-technician for the past four years, setting up PA systems for small to medium sized groups (50 to 2,500) and supervising the installation and operation of an audio system in a Baptist church (with a seating capacity of 700), from the 44 mike/line connection points to the monitoring studio and

600 watt capacity BES Planar speakers, I have become interested in furthering my education beyond what I have been able to acquire from reading Alton Everest (Tab Books) and subscribing to other Brazilian magazines.

I would greatly appreciate whatever information you could furnish on colleges or courses which specialize in audio: from acoustics to recording and equipment design for indoor, outdoor, and studio locations.

David Bryan Distler
Campinas, Est. de Sao Paulo
Brazil

There are several associations in the United States which hold educational seminars at their annual and bi-annual meetings. The three which would most meet your needs are the National Sound & Communications Association (501 W. Algonquin Road, Arlington Heights, IL 6005-4141; (312) 593-8360); the Acoustical Society of America (335 East 45 St., New York, NY 10017; (212) 661-9404); and the Audio Engineering Society (60 East 42 St., New York, NY 10165; (212) 661-8528.) The AES also publishes a Directory of Educational Programs which list audio seminars and short courses up to six months to college degree programs and post graduate work.

BYLINE BLOOPER

The byline on January's *Lab Test Report* is incorrect. The dbx 163x was tested by Farrel M. Becker, not Charles Bilello.

A FOOTNOTE . . .

Rosner Custom Sound was the installer of the original G.E. Boardroom system in Fairfield, CT, which the January issue's article on boardroom sound systems by Richard Feld who said it was "a highly successful installation."

HAVE A QUESTION OR A COMMENT?

Write To:
Letters Editor
Sound & Communications
220 Westbury Ave.
Carle Place, NY 11514



38 Revox Industrial and A/V Audio Recorders

Thirty-eight? Where are the other thirty-five?

No need to show them. They all look pretty much the same as the three basic transports shown: PR99 MKII, PR99 Playback Only, and B77 MKII. But, with all our special versions, modifications, and options, you can order a Revox to fill virtually any application. The "menu" includes:

- Auto-reverse 4-track playback for background music
- Auto repeat for loop play
- Alternate recorder control for logging
- Voice activated start
- Any two adjacent speeds from 15/16 to 15 ips

Other choices include balanced or unbalanced in/out, rack mount or cabinet, consoles, transport cases, monitor panels, vari-speed—the list goes on! PR99 MKII models also feature real time counter, autolocate, zero locate, and loop functions. And all three transports offer a die-cast chassis, full logic controls, servo capstan motor, and solid Swiss-German engineering.

If you need audio recording of any kind, give us a call. If we don't have what you need, we'll get cracking on #39.

STUDER REVOX
Studer Revox America
1425 Elm Hill Pike, Nashville, TN 37210 (615) 254-5651



AT THE STARTING LINE YOU CAN'T TELL SEATTLE SLEW FROM MR. ED.

Until the horses bolt from the gate, you can't tell a champion from an also-ran.

Likewise, equalizers "line up" evenly when covering the same "flat" terrain. It isn't until you demand "peak" performance that you can measure what an equalizer is truly made of.

JBL/UREI's 5547 Graphic Equalizer and 5549 Room Equalizer are made of the most advanced electronics ever packaged in an equalizing system. Their proprietary hybrid circuits deliver unprecedented low noise. Discrete active filter circuits provide the highest dynamic range ever achieved under real world operating conditions.

More headroom and less

noise is also a function of the 5547 and 5549's unique, headroom circuit. A special LED display and two gain structure controls allow you new precision in optimizing headroom and signal-to-noise ratio.

The 5547 Graphic Equalizer is the ultimate tool for creative equalization, offering both "Boost" and "Cut," while the 5549 is the ideal corrective

"Cut Only" Room Equalizer.

While both equalizers are at home in the studio, each is built extra-rugged for reliable roadability. And perhaps best of all, the 5547 and 5549's ultra-efficient hybrid technology gives you breakthrough performance at a breakthrough price.

Compare the JBL/UREI 5547 Graphic Equalizer and 5549 Room Equalizer to anything on any "track". Because when "peak" performance is paramount, the 5547 and 5549 simply leave other equalizers standing in the gate.



JBL Professional
8500 Balboa Boulevard
Northridge, CA 91329

JBL UREI
ELECTRONIC
PRODUCTS

Available in Canada through Goud Marketing

USING A MIDDLEMAN

by Joel Schwartz
President, LCA Sales

They've always been here... from the experimental infancy of the electronics industry through the rapid changes and lightning pace of its youth. Now, during the industry's evolving "middle years," manufacturers' representatives are more prominent than ever.

As key participants in the birth of the U.S. electronics industry more than 50 years ago, they were closely involved with and committed to the fledgling new field. Yet, the functions of repre-

"The primary reason a representative handles multiple lines is to offer his customers a solid product portfolio."

sentatives are still somewhat a mystery to some manufacturers and contractors. Though up to 80 percent of U.S. electronics manufacturers have used representatives, either exclusively as field sales teams or in combination with factory sales forces (according to a report issued by the Research Institute of America), questions still exist about the manufacturers' representative method of selling as well as the resulting impact on the marketplace. Because that impact has been and is

so significant, answers to the questions about representatives can not only remove the "mystery," but can yield greater benefits and advantages for all who are concerned with sales in any segment of the electronics industry.

Who, What, and Where?

A manufacturer's representative is an independent professional business owner who sells related, but non-competing, products for more than one manufacturer in a defined geographic territory. Income is generated via commissions on sales within the representative's territory. Neither legal title nor possession is taken of the merchandise sold which is generally shipped directly to the customer from the manufacturer.

The size of a representative company may range from fewer than five employees to more than 100. The firm maintains its own offices and automobiles; it hires, trains, and compensates its own sales, support, and clerical personnel; and it assumes responsibility for all operating expenses and overhead.

The annual sales volumes of representative companies vary from \$1 million or less for the smallest firms to \$50 million plus for many of the larger companies. Representatives' share of the total electronics industry gross national product in recent years has been estimated at \$40 billion.

Why's and How's

• Why do so many manufacturers use representa-

tives? According to several recent surveys, conducted by the Electronic Representatives Association (ERA) and the Manufacturers Representatives Educational Research Foundation, representatives provide more cost efficient and more cost effective sales via multiple line selling. Because a representative handles multiple, compatible lines, he deals with a greater number and variety of customers than factory salespeople do. Deeper market penetration and increased sales, result from a representative's detailed knowledge of his customer base and from the relationships and the trust he has built with customers built on his longevity and experience within his territory and industry.

The use of representatives gives manufacturers an established, trained sales force and immediate access and entry into new markets. When new products are being introduced, much of the inherent skepticism and sales resistance can be eliminated by representatives. Their customers know that representatives cannot and will not risk their reputations and customer relationships by recommending unsuitable products.

Other advantages for manufacturers include the continuity and quality of local service to customers that representatives provide plus the high level of motivation among a representative's salespeople. When income is derived

solely from commissions, service to customers as well as consistent sales activities are top priorities.

• How do representatives reduce manufacturers' costs? The most obvious way in which representatives lower manufacturers' sales costs is in freeing the manufacturers of the expenses of maintaining field sales offices and personnel. All the "extras" related to factory-paid sales forces are eliminated. Representatives totally absorb the expenses of: taxes, insurance, and retirement benefits; travel, entertainment, and auto usage; relocation of employees; trade show participation; secretarial and support staff; mail, telephone, and other overhead.

There are other, less obvious means by which representatives reduce sales costs. Because the commission costs of selling through representatives are stable and predictable, a manufacturer can calculate projected expenses easily and thus release available capital for research and development or other business activities.

Lower marketing costs also result through use of a representative network. At no additional expense above the set commission, representatives provide regional sales management and analysis, credit reporting and follow-up, creative marketing activities, market research and forecasting, product evaluation, application engineering, technical training and general consultation services. Complete

activity files on all customers, maintained by representatives, give manufacturers detailed customer reports and accompanying analyses. In many cases, representatives can also provide local warehousing and stocking services at costs lower than those of a factory facility.

• Why don't all manufacturers use representatives? The most prevailing reason given by manufacturers is a brief one...control. According to a 1984-85 study by the Manufacturers Representatives Educational Research Foundation, some sales managers are reluctant to surrender total control of their sales personnel and of the time allocated to sell their products. However, the rising costs of sales (now exceeding \$200 per call), plus rapidly changing market patterns and technological advances, are moving more and more manu-

facturers to investigate the benefits of using representatives.

The same Foundation study, which surveyed 34 manufacturers who had recently changed sales methods (from factory sales forces to representatives or vice versa), yielded these responses from manufacturers as to the advantages they felt representatives provided: (in order of priority) having sales coverage in place for new markets; the portfolio range of a representative and the compatibility of his product lines; variable cost of sales to shipments.

When survey participants are asked to list the disadvantages of using direct sales forces, they named: (in order of priority) cost of sales; expense and time of training; turnover of field sales personnel; short-term relationships.

• How do representatives

benefit their customers? Essentially, the manufacturers' representative active in the electronics industry today is a savvy professional whose business existence depends solely on his ability to supply customers with better products and service than they can obtain elsewhere. As a source of multiple product lines and as a vital link between customers and manufacturers, the representative serves customers in ways no factory salesperson can.

The primary reason a representative handles multiple lines is to offer his customers a solid product portfolio. As a result, the customer saves valuable time. He deals with one salesperson who knows his needs well and who can supply assistance in product selection and application. Because a representative is knowledgeable about many products, lines, sources, and

applications, he's able to help customers locate elusive items, uncover bits of information, or find a particular product that's needed for a specific project. A representative's broad-based expertise and experience also qualify him as a resource customers can tap to run internal sales and technical meetings.

As a catalyst or link between customers and manufacturers, a representative serves in many roles. As a "troubleshooter," he unspools red tape and solves problems as they arise. At the same time, he helps establish strong ties between manufacturers and customers that result from improved communication and consistently positive interaction.

Among the most common causes of friction between manufacturers and customers are unresolved credit

(continued on page 42)

No moving parts—no maintenance required

Solid-state, Natural Voice Digital Message Repeater

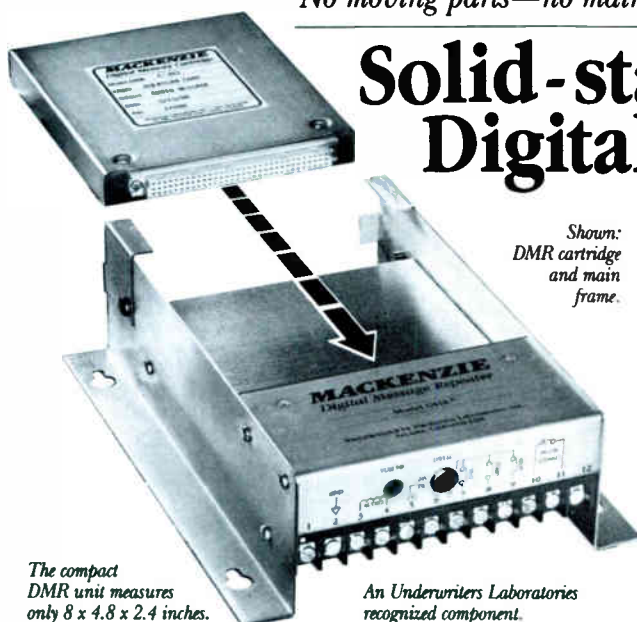

Shown:
DMR cartridge
and main
frame.

The compact
DMR unit measures
only 8 x 4.8 x 2.4 inches.

An Underwriters Laboratories
recognized component.

MacKenzie's Digital Message Repeater (DMR) is ideal for:

- Fire alarm messages
- Voice evacuation
- Fireman's return
- "Code Blue"
- Parking warnings
- "Watch your step" messages
- Rental car return instructions
- Sound effects
- Dark rides
- Exhibits and displays

MacKenzie's Digital Message Repeater is a revolutionary concept in repetitive sound. *No maintenance* is required because our all-solid-state DMR has *no moving parts*.

The DMR uses EPROM memory cartridges to store digitized recordings of human voices, music or sound effects. Upon demand, the digitized information is reconverted to analog and played to an audio output. The sound is *completely natural*—just like a conventional tape recording—and the audio quality is excellent. Messages are permanently stored and may be played repeatedly without loss of sound quality.

The DMR consists of the message cartridge and the controller main frame. The complete unit is very compact—only 8 x 4.8 x 2.4 inches. Standard message length is up to 60 seconds; longer message time is available. Models are available for multi-message random access. The DMR is an Underwriters Laboratories recognized component.

For more information about the DMR—including our new DMR record-play unit—call MacKenzie Laboratories toll-free at (800) 423-4147.

MACKENZIE MacKenzie Laboratories, Inc.

5507 Peck Road □ Arcadia, California 91006 USA □ (818) 579-0440

Circle 235 on Reader Response Card



Photos provided by Bose Corporation



Part One: The Development of . . .

DISTRIBUTED LOUDSPEAKER SYSTEMS

by Jesse Klapholz

It is universally accepted that sound reinforcement is necessary for amplifying speech or music outdoors or in very large halls; for example, when communication must take place over great source-to-listener distances. It is not so easy to say when a sound system is necessary in small spaces. This depends on a number of interrelated factors, including the loudness and directivity of the source, reflective surfaces that will either "reinforce" the sound or distort its transmission, the distance between the source and the listener, the reverberation characteristics, the room modes and their distribution, and the ambient background noise level.

Through the analysis procedure, as one determines whether or not a sound system is needed, many questions will be answered determining the appropriateness of a "central" versus a "distributed" loudspeaker system. Distributed systems are used under specific conditions for both sound reinforcement and music systems. In this article the reader will be presented with some background in the development of the technology with emphasis towards its application in distributed loudspeaker system design.

Research and development in telephony technology, beginning with the invention of the telephone by Bell and Watson in 1876, is really where modern communications started its practical development. The studies of speech intelligibility, acoustics, and

psychoacoustics was, in principle, the product of Bell Labs' and RCA's efforts in creating the telecommunications, recording, and talking motion-pictures industries during the first half of the 1900s. These "Golden Years" provided us with the development of the phonograph, vacuum tube, radio, condenser and dynamic microphones, loudspeaker, and amplifier substantial-

Distributed systems
are used under
specific conditions
for both sound
reinforcement and
music systems.

ly in the same way as we know and use them today.

Speech Intelligibility

During the early years of telephone, each telephone organization had its own laboratories conducting all of the research in speech intelligibility. The field of speech intelligibility and acoustics in general owes a far greater debt to Bell Labs than is generally mentioned. Not only was a great deal of pioneer research on speech and

hearing done there, but Bell Labs was very important in the organization and growth of the Acoustical Society of America and in the recognition of acoustics as a scientific discipline.

World War I created new problems. Early patents for noise-cancelling or pressure gradient microphones specifically cite airplane noise as the origin of the requirement. Pridham and Jensen applied for a patent in 1917, and the following excerpt describes the necessity: "The need for a telephone system which will clearly and distinctly transmit speech from an observer to a pilot, or vice versa, in an aeroplane is especially crying and since the beginning of the present war inventors and research workers everywhere have been striving to produce such an apparatus."

While research was going on in Europe, most of the important developments happened in the U.S. First Irving B. Crandall and then Harvey Fletcher led a group of outstanding scientists and engineers at Bell Labs that pioneered the science of speech acoustics, they included: Black, Cambell, Crandall, Dunn, Eyring, Green, Kellogg, Knudsen, Maxfield, Munson, Norris, Sivian, Steinberg, Stevens, Thuras, Wentz, and White. The concepts they developed created a new body of science; and work in the field is still based on their findings. The physical properties of the speech waveform: its energy, frequency distribution, duration, transition characteristics, phase effects, and statistical

distribution among speakers, were all quantities for which they developed measurement and analysis instrumentation. Articulation, treating vowels and consonants separately because of their differences in spectral distribution, intelligibility, and speech perception, are just some of the concepts developed at Bell Labs that we use in our everyday work.

Before joining Bell Labs in 1915, Harvey Fletcher was a professor at Brigham Young University. One of his students was Vern O. Knudsen. In 1918, Knudsen joined Fletcher at Bell, where he worked on the development of amplifiers and oscillators. In 1922, Knudsen accepted a professorship at UCLA's newly formed acoustics program. Knudsen went on to build a historically important acoustical research lab and contributed greatly to the writing of "the book" on acoustics. His interests ranged from hearing and speech to auditorium acoustics. During 1928-30, Knudsen designed the sound stages for MGM, Paramount Pictures, Fox, Universal, and Warner Brothers.

RCA

During the 1920s, Irving Wolff was head of the research labs at RCA's New York City location. Wolff had designed, out of necessity, apparatus for electroacoustical research of which most notably was the beat frequency oscillator. In 1928, Harry F. Olson joined RCA and Wolff's theoretical investigations of the radiation of sound from vibrating diaphragms. Their work was concerned with application of radio sets and then with motion picture sound equipment.

About the same time, Frank Massa was head of the research labs at the Victor Talking Machine Co., in Camden, NJ. In 1928, the recording and reproduction of sound was completely mechanical. Later that year, Massa was given the project of designing the first combination radio/phonograph. It was the great commercial success of Massa's design that peaked RCA's interest. RCA began talks with Victor which resulted in RCA's acquisition of Victor in 1929; the company then became RCA-Victor. Following the takeover, the radio engineering divisions of General Electric and Westinghouse moved to Camden. To meet the demand for movie sound equipment in the early 1930s, loudspeaker development ac-

tivities were intensified. The New York Lab moved to Princeton, NJ, and together they and Camden set the stage for the RCA legacy contributing greatly to loudspeaker, microphone, and amplifier technologies.

Good acoustic parameters are based upon subjective tastes, which must be translated into the "physical domain," and are then finally defined scientifically.

Harvard University

Two laboratories were established at Harvard University in 1940 which played an important role in the research and development of speech intelligibility. The Electro-Acoustic Laboratory directed by L.L. Beranek was primarily concerned with transducers and electronic equipment; the Psycho-Acoustic Laboratory direct by S.S. Stevens was primarily concerned with talker and listeners. Both were concerned with systems and worked together closely. Headed up by Harvey Fletcher, the Harvard Labs were responsible for producing a large volume of important works and for training many researchers. Fully half of the notable papers on speech intelligibility that were published between 1945 and 1955 have as a senior author a Harvard Lab alumnus.

Good Acoustics

Sabine, working at Harvard University in 1895, developed the first quantitative theories on reverberation. The assumption upon which Sabine's theory is based is that the growth, steady state, and decay of sound in a room may be treated as continuous processes, with equilibrium at all times between the energy density in the room, the power being added to the room, and the power being lost by transmission or absorption. Attempts

were subsequently made to provide a formula that gave more accurate results. The most successful was the formula developed simultaneously by R.F. Norris, and Carl Eyring, quite widely used today, which agrees with Sabine's formula when room absorption is low.

The techniques of statistical acoustics and reverberation time provides us with room characteristics which may be described as the long-term transient behavior of sounds in rooms; equally important are the short-term transient characteristics of rooms. The sequence of reflected sounds have a strong influence on the acoustical performance of a room.

A special objective of the early reflection studies was to investigate the relation between the timing of the various signals reaching the listener and the apparent location of the source. The effect, in how it relates to electronic reinforcement systems, was known at least as early as 1935, when two papers were independently presented by R.D. Fay and W.M. Hall at the 14th meeting of the Acoustical Society of America. In 1951, a more complete study was made by Helmut Haas, hence, the term "Hass-effect." We use these theories in time-delay systems (also known as precedence-effect).

Good acoustics is perhaps the most loosely used term in the business. Everyone from engineers to customers uses "good acoustics" freely in his vocabulary without stopping to think what it really means. Good acoustic parameters are based upon subjective tastes, which must be translated into the "physical domain," and are then finally defined scientifically.

It is our goal to provide a translation system so that the talker or musician may communicate his ideas to the listener. It is, therefore, the priority of the designer to accurately understand the requirements of the space, so that he can implement them into a physical design with good acoustics.

Loudspeakers

Most loudspeakers in use today have some sort of vibrating diaphragm, although the method by which the diaphragm is set in motion may vary radically. The diaphragm may be one of many shapes, including a cone, a flat surface or piston, a dome, etc. Where the diaphragm moves as a whole, without breakup, the diaphragm is anal-

ogous to a rigid piston. The characteristics of a circular, rigid piston are well defined, and are essentially derived from the fundamental work of Lord Rayleigh's *The Theory of Sound*, originally published in 1878.

Most of the earliest loudspeakers were based on the moving iron type system. Reproduction was marred by reed resonance, absence of bass, and distortion from the non-linearity in the single-sided operation of the reed. The balanced armature entered the scene in the early 1920s, and direct radiating cones began replacing the small horns. Still, there was resonance from the reed, and it was not possible to reduce the stiffness of the motor assembly to yield response below 120 Hz.

The first moving coil invention was the subject of Ernst Wermer's patent, filed by Siemens on December 14, 1877. And on April 27, 1898, Oliver Lodge filed for a patent on the invention of his moving coil loudspeaker. These inventions could not be practically implemented, as there was not sufficient power available in those days to operate moving coil drivers.

During the 1910s, radio was being developed by inventions which had

improved on earlier inventions. This was creating a tangle of conflicting patents. A court ruling in 1916 held that de Forest's Audion infringed on

The patent tangle was resolved by the formation of the Radio Corporation of America on October 17, 1919. And RCA became the marketing agent for radios built by General Electric and Westinghouse.

Fleming's valve, owned by Marconi, while the grid introduced by de Forest was protected by his own patents, which he had sold to AT&T. The two

companies were stymied. Neither could proceed without permission of the other. Nevertheless, vacuum tubes were needed. This brought the manufacturers of electric lamps, General Electric and Westinghouse, into radio.

The patent tangle was resolved by the formation of the Radio Corporation of America on October 17, 1919. RCA became the marketing agent for radios built by General Electric and Westinghouse, and by 1922 began marketing Westinghouse RA and GE Radiola I crystal sets. RCA Photophone Inc., was formed in 1928 to commercialize its sound on film system. By 1930, AT&T, GE, and RCA were all pushing to be the first and commercialize the best communications and entertainment systems and products. It was this great race that created a never to be repeated research and development of sound system products.

With the advent of the vacuum tube more power was available to those working with the new "wireless" technologies. The Commercial Wireless and Development Company introduced the "radio loudspeaker" (a moving coil dynamic driver for a phono-

Don't miss out on the action!



School system updating

From **schools** to **retirement complexes** the Telecor microprocessor controlled communications system bridges the generation gap!

Priced to compete in the modern age, Telecor offers standard advanced features, not add-ons at extra cost!

Programmable from each console, program selection and distribution, **zone paging** and emergency announcements are under fingertip control. Multiple class changes are initiated by multi-channel built-in clock programs to eight separate areas.

Call answer, hold and recall via telephone handset or built-in microphone. Architectural dialing with six levels of incoming priority!

Over **1000 station** capacity and up to 32 master consoles means that no job is too big!

Call us!
We mean business!

SEE US AT NSCA - BOOTH # 29

EDCON

USA-BCE/EDCOM Inc. 755 Center Street Lewiston NY 14092-0506 (716) 754-7130
Canada-Barrie Comm. Eq. Ltd. 1585A Britannia Rd. E. Mississauga Ont. L4W 2M4 (416) 678-0801

graph horn) in January 1913. The Magnavox Company was then formed to manufacture radio receivers using the "radio loudspeakers," and also provided the first public address systems starting in 1915. The Western Electric Company produced public address systems between 1918 and 1923 which used horn drivers of the Magnavox-type design.

Early in the 1920s, Chester W. Rice and Edward W. Kellogg, at the research laboratories of General Electric, set out to design an improved loudspeaker. The result of their work was patented in March of 1924 and was published in 1925. During the following year their loudspeaker hit the market as the Radiola Model 104, complete with built-in amplifier, at \$250. Thus, Rice and Kellogg (perhaps erroneously) are generally regarded as the inventors of the moving coil loudspeaker.

The early moving coil loudspeakers used high resistance voice coils, leather suspensions, and DC-powered electromagnets. Within a few years, the moving coil design had made most of its rivals obsolete. It is still the most widely used type of loudspeaker in professional audio applications today.

Amplifiers

The invention of the vacuum tube did not set the world on fire with dramatic changes in the amplification of sound; in fact, it took over two decades of radio broadcasting applications before amplified audio systems were recognized for their importance. The tube afforded, for the first time, a means by which sound could be amplified easily by non-mechanical means.

Amplifiers were quickly developed for applications ranging from measurement apparatus to loudspeaker amplifiers. A family of voltage amplifiers were developed for microphone, line, mixer, and speech inputs. These devices would be wired together to perform the necessary functions ahead of the power amplifiers. The power amplifiers had transformer-coupled outputs with taps typically at 4, 8, 16, 32, 125, 250, and 500 ohms. With multiple loudspeaker (distributed systems) hook-ups or long wire runs, impedance-matching transformers were used to balance the load back to the amplifier's output transformer 500-ohm tap. This meant accurate calculations on the part of the installer of distributed systems or constant-imped-

ance systems. The systems had to be designed so that individual loudspeakers drew the desired amount of power from the line, and the total impedance presented to the amplifier had to be close to its rated tap. Obviously, an alternative to make everybody's job easier was greatly needed.

The invention of the vacuum tube did not set the world on fire with dramatic changes in the amplification of sound.



The solution was the constant-voltage system, where the effective operating impedance varies as the power capacity of the system is changed, but the voltage across the load remains constant. The introduction of feedback techniques to audio amplifier design allowed the reduction of distortion, improved frequency and phase response, and better (signal to noise) S/N figures. Feedback amplifiers were originally developed by Bell Labs in the 1930s for telephone circuits where multi-channel carrier systems require distortion below .01 percent if cross-talk is to be avoided. Our greatest interest here, however, is the feedback circuit results in an amplifier which has the constant output voltage characteristics of a low-impedance generator. Hence, an amplifier that will maintain a constant output over greatly varying loads, an important role in constant-voltage distributed loudspeaker systems Solid-state

amplifiers accomplish the same end, but eliminate the necessity for special filament heating supplies, unreliable construction and performance.

The constant-voltage system allows the installer to use a lighter gauge wire than in the constant-impedance system—a direct economic advantage. It also enables the installer to hook up various impedance and power-level loudspeakers on the same line without impedance calculations.

Distributed Sound

Most of the early radio stations were not originally intended to be profit-making operations. Westinghouse, GE, RCA, and Zenith, who were all operating radio stations, believed that their stations would stimulate a demand for radios. Another important element, and of great interest here, in early broadcasting activities was the department store. Bamberger's started WOR. And three major Philadelphia stores obtained licenses in March 1922; Gimbel Brothers with WIP, Strawbridge and Clothier with WFI, and John Wanamaker with WOO. Gimbel's later started WGBC in New York. Other department stores throughout the country soon learned that a radio studio on the premises was a traffic builder which specifically moved receiving equipment and indirectly helped sell all the other lines of merchandise. Here are the roots of distributed sound.

This year is the 50th anniversary of Muzak. During those early days of the distributed sound business, companies providing the equipment included Bogen, Jensen, Shure, Stromberg-Carlson, and Western-Electric. Background music, however, is only one part of distributed sound; the other part is sound reinforcement.

Once the performance requirements are established, and the room's acoustic performance is evaluated, one can determine whether or not a distributed system is appropriate. Unfortunately, many times distributed systems are used when other designs should be used and likewise the opposite is also the case many times. Once a distributed system is indicated, the questions of devices type, size, performance, number, and location need to be answered. Drawing on the technology developed during the "Golden Years," we have the information necessary to design excellent distributed loudspeaker systems.

(continued on page 47)

New at NSCA in Las Vegas



**ON•THE•AIR...24 Hours a Day...Everyday...at the
National Sound & Communications Expo on April 29 - May 2**

**IN•THE•HOTEL ROOMS and
ON•THE•EXHIBIT FLOOR**

NSCA-TV NEWS WILL BROADCAST:

- ★ New Products
- ★ The Latest in Technology & Design
- ★ Interviews with Manufacturers
- ★ Workshop & Seminar Reports

Produced by the Publisher and Editors of *Sound & Communications* magazine.

**DON'T MISS IT! AN INDUSTRY FIRST!
BY THE INDUSTRY'S BEST!**

Be sure your news and product information reaches Nancy Peterson by April 23.

For Advertising information call Cliff Capone now. You can be on the air two times every hour, everyday, in every hotel room and on two large screen projection TVs on the exhibit floor of the NSCA in Las Vegas.

The Market's Influence on...

Audio Teleconferencing

by Don Gayle Shure Brothers, Inc.

In most cases in today's sound and communications market, products that are introduced come from the development of a new or improved technology. A manufacturer whose products evolve from this practice is called "technology driven." In other, less frequent cases, a manufacturer will develop a product based on what the market needs. A manufacturer whose product evolves under these conditions is called "market driven."

Although the latter practice is less common—it is happening more and more in today's sound and communications marketplace. In recent years, executives from larger and more sophisticated industries introduced the market driven philosophy to the sound and communications industry. Though many manufacturers have embraced it, few have fully implemented it. The following is an example of one company who has put the market driven philosophy to use. Shure Brothers Inc. developed its ST6000 audio teleconferencing system in response to the corporate world's changing needs.

With today's emphasis on corporate economies, more and more companies are taking a closer look at traditional operating expenses. A conspicuous target for potential cost-cutting is the company conference—the necessary gathering of personnel from

around the country or around the world to participate in a give-and-take discussion of various aspects of company business. Unfortunately, the increasing costs of transportation, lodging, and meals tend to limit this type of conference in both frequency and number

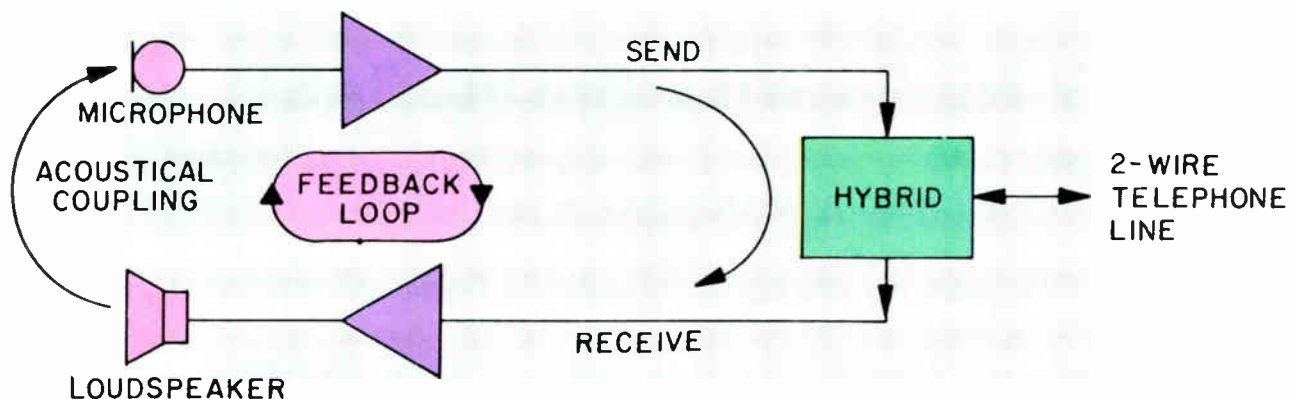

Figure 1: A single microphone-loudspeaker teleconference set.

What was once a complicated, expensive, unreliable luxury is now a viable, important, cost-effective part of the office equipment complement.

of participants. Audio teleconferencing—the ability to hold a conference virtually on the spur of the moment, and with relatively economical use of telephone lines and satellites—is a welcome answer. The business world, or any organization that requires frequent contact and interaction among widely dispersed personnel, can communicate better, more often, and easier than ever before.

When Shure Brothers, with

over 50 years of audio transducer and circuitry experience, contemplated entering the world of audio teleconferencing, the state of the art was carefully examined. With few exceptions, the implementation of good teleconferencing was stymied by equipment that was complicated and not always dependable. Limited sound quality—both transmitted and received—was further frustrated by the listener's inability to interrupt the talker;

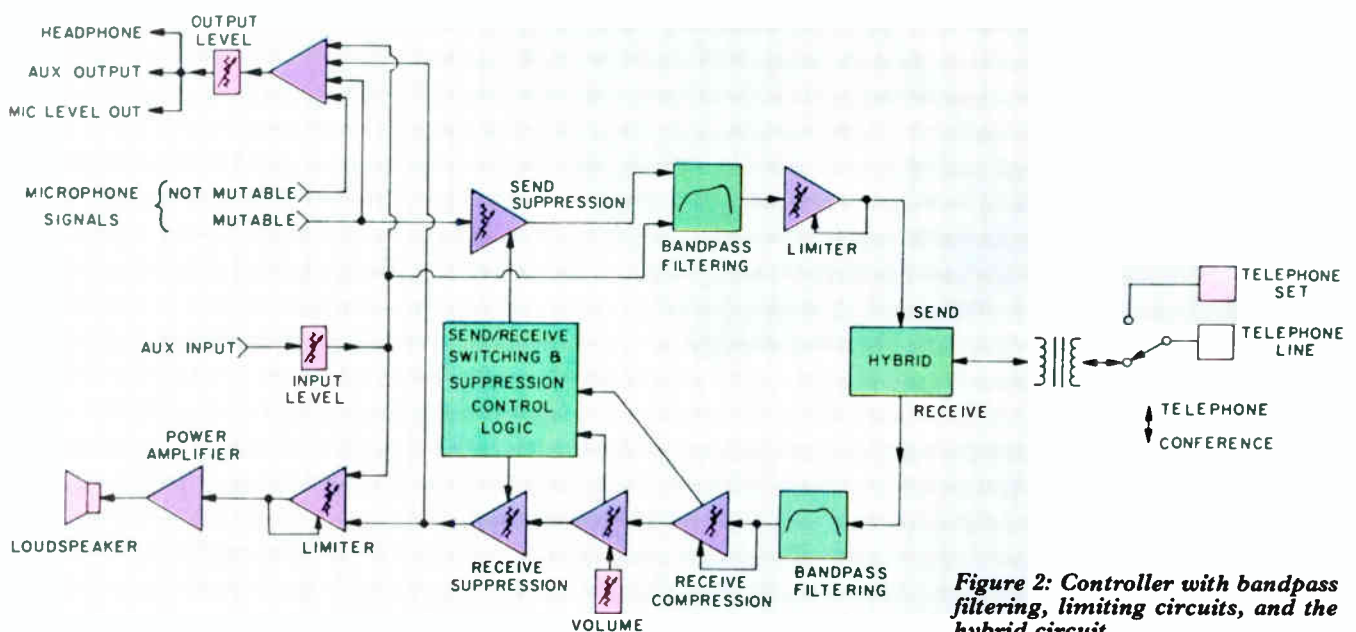

Figure 2: Controller with bandpass filtering, limiting circuits, and the hybrid circuit.

clarification of an unintelligible statement meant waiting for the talker to finish or pause. For larger conferences, the fact that conventional microphones and mixers cause an increase in room noise and reverberation pickup and sound levels must be reduced as more microphones are used, added to the

ST6000, a six-channel, expandable system which offers a unique and reliable method of turning microphones on only when voice-activated, avoiding unnecessary noise and reverberation pickup. At the same time, by adjusting gain automatically as more microphones are activated, it

needs soon were defined: while maintaining reliability and high-quality sound, the system must be lower in cost, portable, and able to be set up and operated by non-technically-trained personnel. The specific imperatives of maximum microphone sensitivity to speech and insensitivity to background noise and the appropriate microphone turning on for single or multiple talkers, must all be accomplished in the near totally reflective acoustic field that characterizes the smaller conference room. In addition, an optimal design would permit acoustically "dead" zones where sound sources could *not* turn the microphones on. These zones would be under the control of conference participants to prevent interruption by those who may, for the moment, desire only to listen.

In 1985, a system meeting these qualifications was introduced—the Shure ST3000. The ST3000 exceeds all the perceived criteria for an optimum small- to medium-size teleconferencing system:

Operating Environment — The system operates effectively in a wide variety of conference rooms and offices without expensive and complex room treatment. Drapes, curtains or acoustic tiles are not required (although sound quality may suffer in particularly reverberant rooms).

Sound Quality — Automatic activation of directional microphones minimizes "hollow" sound pickup and the system provides natural sound quality without "boominess." Optimized acoustical design of both microphones and loudspeaker for table surface use further enhances the natural tone quality.

Sound Level — The loudspeaker level is adjustable and can be heard easily by all conference participants. Automatic volume adjustment compensates for weak long-distance signals.

Interruptibility — The ST3000's "quasi-duplex" operation allows rapid and automatic switching between transmit and receive with full interrupt capability. Fully interactive conversation with mutual interruptibility is virtually identical to full duplex operation.

Reliability — Designed for long-term operation, the system can be left on between conferences without component stress. Long-life parts and minimal maintenance requirements provide years of trouble-free service.

Setup — Simple telephone, telephone

WITH TODAY'S EMPHASIS ON CORPORATE ECONOMIES, MORE AND MORE COMPANIES ARE TAKING A CLOSER LOOK AT TRADITIONAL OPERATING EXPENSES.

problems.

Those quality systems which were available—using satellite links and/or commercial telephone lines and equipment—required a considerable investment in equipment, training, and rental costs. As a response to these problems, Shure was able to adapt the direction-sensitive gating principles of its Automatic Microphone System (AMS) (U. S. Patent 4,489,442) to the specific requirements of audio teleconferencing, and in 1984 introduced the

controls acoustic coupling between microphones and loudspeakers to minimize potential howlback problems. Employing unique circuitry techniques (patents pending), it allows for fully interactive conversation with sensitive, natural interrupt capability.

The immediate response of installers, integrators, and customers to the ST6000 caused Shure to research the somewhat different requirements of the small- to medium-sized teleconferencing environment. These

EKTACOM L

The EKTACOM L is one of the best sounding, smoothest operating digital dialing, duplex intercoms available! It has decentralized logic which eliminates the expensive central 'switch'; every station has all-call which functions even if a conversation is in progress—(this lets you get through when the system is in 'busy') and costs dramatically less than multi-channel systems. Plug-in wiring, only three pair, circulating; UL Listed power supplies; incredibly rugged marine-industrial masters available nowhere else! Time tested circuits that work.

You should know more about the EKTACOM L! Write Today!



**FISHER
BERKELEY
CORPORATION**

5800 Christie Ave., Emeryville,
CA 94608 (415) 655-9696

Circle 250 on Reader Response Card

line, and Controller-to-Module connections make the ST3000 probably the easiest-to-install conference set available.

Operation — Two switches and a volume control are all that need be "learned." Muting switches at the Controller and Module provide added controls for the conference leader.

Portability — Only 12 pounds total weight enables the system to be easily carried to and from the conference room or office. The complete system can be stored and carried in an optional fitted carrying case or shipped in an optional shipping case.

Expandability — For larger conferences, additional Modules can be added for greater area coverage without additional amplification or additional noise and reverberation pickup. The system can be fed from other signal sources (tape player, tuner, etc.), and the conference output can be directly recorded, fed to a PA system, and monitored through headphones.

Room Intergration — The wood cabinets of both Controller and Module are available in either oak or walnut finish, making them compatible with most office decors. Equipment status indicators are visible without being obtrusive or distracting, and the volume control permits comfortable listening levels for different rooms. Only a standard modular jack telephone and a single AC power line are needed.

Functional Description

To understand the functioning of the ST3000, first consider a single microphone-loudspeaker teleconference set as shown in simplified form in Figure 1. The curved arrow at the left represents all direct and reflected sounds which couple from loudspeaker to microphone. Controlling the local feedback loop completed through the hybrid, which forms the connection of the set to a two-wire telephone line, is the dominant consideration in preventing howlback. The hybrid applies the send signal to the two-wire line while extracting the received signal. The nature of telephone lines dictates that the hybrid receive signal also contains a large part of the send signal. Howlback is avoided by making the acoustic coupling from loudspeaker to microphone low enough that the gain around the local loop is less than 0 dB at all frequencies, that is, any microphone input signal must return through the loudspeaker at a lower level.

Professional VHF Wireless for \$**900** Under



Rock and Roll or Rock of Ages—the pulpit or the Palladium... Whether you need a dynamic handheld for the stage or a miniature lapel mike for your church, Telex has an affordable single antenna wireless mike system that will fit your needs.

Telex FMR-50 systems have most of the high performance features of the more expensive top-of-the-line wireless microphones and provide a much clearer, stronger and better-sounding signal than competitive units.

All-important dynamic range is greatly enhanced because of the system's unique COMPANDER circuit. A special circuit at the transmitter takes the full dynamic range of the audio, compresses it to RF transmission limits, then restores it to its full strength at the receiver. The result is a full dynamic range with greatly improved signal-to-noise ratio.

Because it operates on high band VHF frequencies there is no danger of picking up interference from low band channels such as CB, cordless telephones, garage door openers and electric toys. And, Telex offers a FREE computerized service to assure the selection of an interference-free frequency based on known channel allocations in each operating area.

To read more about why this improved technology transmits a high quality signal over longer distances, write to: Telex Communications, Inc., 9600 Aldrich Ave. So., Minneapolis, MN 55420.

For quick information, call toll free
800-328-3771
or in Minnesota call (612) 887-5550.

TELEX®

TELEX COMMUNICATIONS, INC.

9600 Aldrich Ave. So. Minneapolis, MN 55420

Circle 246 on Reader Response Card

Accomplishing this is full-duplex operation (loudspeaker and microphone fully active at all times) is practically impossible if adequate outgoing microphone levels and loudspeaker volume are to be maintained, and if closeby reflective objects and extra gain for weak telephone connections

one another.

The ST3000 solves these problems by providing total system gain control under varying conditions, while maintaining full interactive conversational ability. With no local speech, microphones are automatically muted, totally breaking the acoustic coupling path.

THE NATURE OF TELEPHONE LINES DICTATES THAT THE HYBRID RECEIVE SIGNAL ALSO CONTAINS A LARGE PART OF THE SEND SIGNAL.

are considered. The most common solution to these problems is half-duplex operation: either the microphone or the loudspeaker is almost totally suppressed (attenuated), depending on the conversation direction. This does solve the feedback-related problems, but at the expense of natural, interactive conversation. Beginning syllables and even entire words may be lost, intentional interruption is often not possible, and both ends may be talking without hearing

(The Module Talk LEDs remain lit, indicating that the microphones will respond immediately to speech, leaving their muted condition quickly and reliably without chopping words or syllables.) The Controller provides a method of suppressing loudspeaker signals when local speech interrupts received speech. Note that the suppression only occurs to the extent necessary to reliably maintain feedback stability. When local speech is interrupted by received speech, the

outgoing microphone signal is suppressed and the loudspeaker is heard at a normal level. This send/receive direction switching, which Shure calls "quasi-duplex," occurs in an unobtrusive, conversationally oriented manner, with priority given to the interrupter when both ends talk simultaneously. A natural interaction is maintained, and either end can "get through" without yelling.

The Controller also contains band-pass filtering and limiting circuits, and the hybrid circuit for placing the microphone signals on the two-wire telephone line and recovering the received signal from the far end (Figure 2). The limiters on the send and loudspeaker outputs reduce gain levels to prevent overload. The aux input circuit, which bypasses the suppression circuitry for non-microphone sources such as tape players and tuners, feeds its signal to the local loudspeaker, the far end conference set, and the local Controller Headphone, Aux and Mic Outputs. These outputs contain *all* conference signals including aux input, received signals, and local speech. (The microphone signal does not totally mute in these

mobile d.j. system

MOBILE MUSIC MEANS MONEY

Here's the PPD pre-pak mobile system. Everything is included. Travel is easy since the carpet covered cases have pro 'roadie' hardware. Transport only four pieces. Set up in 15 minutes. Breakdown in less.

Use the MDJS19 as the nucleus of a premier club system. The pre-pak dramatically reduces custom booth carpentry costs. The speakers are ready to fly. Add two speakers, an amp, and DMS212C Subwoofers for maximum SPL.

**Suggested Retail MDJS19 —
\$4,339.00**

If economy is critical, use the PPD MDJS17 System. The same quality throughout with the less expensive DM1750RM Mixer, UD925 Microphone, and compact DMS310C 10" three-way speakers.

**Suggested Retail MDJS17 —
\$3,869.00**



FEATURES

- 15 space 19" Rack and Console
- DMS312C Speakers (12" three way design)
- DM1900 Mixer (5 Inputs, EQ)
- EQ250 Octave EQ and SA220 125W/Ch. Amp
- Two TT2400 Direct Drive DJ Turntables with Stanton 680 EL Cartridge
- Studio quality UD940 Mic with Gooseneck

For more information on PPD Mobile DJ Systems, please call or write Paul Friedman, National Sales Manager.

PPD

GO WITH THE PRO

Numark ELECTRONICS CORP.

General Offices: 503 Raritan Center, Edison, NJ 08837
Telephone: (201) 225-3222 Telex: 287-249 Fax: (201) 287-2155

West Coast Branch: 7850 Alabama Ave., Canoga Park, CA. 91304
Telephone: (818) 346-8222 Telex: 287-313

Circle 245 on Reader Response Card

outputs.)

Basic Installations

Standard Teleconferencing — Using one Module at each end, two groups can communicate clearly and easily without complicated setup and operation or costly room treatment. One person or half a dozen are provided with simple, reliable conference capability.



Shure's ST6000

Larger Conferences — One or two additional interconnected Modules permit a larger conference without loss of sound quality or any system functions such as conferee's control of Module muting. Also, the conference leader's ability to mute incoming or outgoing signals becomes even more important in a larger conference.

"One-on-One" Conference — The ST3000 can be used as a high-class telephone amplifier (speaker-phone), providing each person with quality, hands-free sound where paperwork can be spread over the length and width of the conference table.

"On Hold" Recorded Playback — Multi-location teleconferencing may take some time for all locations to dial in and engage the system. For a "meet me" or dial-in conference, rather than letting the first parties to engage hear only silence on hold (and wonder whether they are still engaged), pre-recorded music can be placed on the conference line. In addition to providing a pleasant background, the music serves to remind conferees that they are dialed into the system as long as they hear the music or the voices of other conferees.

Informative Recorded Playback — A message from the president, a report from absent personnel, the latest radio spot advertising—all are available to ST3000 conferees. Using the aux input jack and level control on the Controller, any pre-recorded message can

AUDIOCOM™

"The Intercom System"

INTRODUCING Phase 2

Now with two channel capability



Intercom technology takes a giant step forward as Telex advances to PHASE 2 of its popular Audiocom Intercom System. What's more, two channel capability and a full duplex audio system for both monaural and binaural systems is only a small part of the story! The new master station/power supply shown above features built-in IFB (interrupt feedback) and easy-to-use color coded line/channel buttons that can correspond with the same color of optional extension cables for convenient visual reference. The master station also features a brand new 20 kHz light signaling system, interlocking push-button channel switches, a listen/volume control, a mike on/off/signal control and a power on/off LED indicator.

Belt-pack headset station has special features

The new two-channel belt-pack intercom station allows the operator to selectively monitor one channel or both simultaneously. It has a mike on/off switch and separate listen/volume controls for each channel as well as a special carbon headset input and separate sidetone adjustments. There is also a rack mountable version of this unit available with all the same features. Additionally, Telex has developed an entirely new line of intercom headsets to accompany these exciting Phase 2 changes. And, they are lighter and more comfortable than ever before! The new offering consists of single/dual side units, monaural and binaural units, a super lightweight and a new headset.

ANNOUNCING complete compatibility!

Telex introduces the CCB-1 Clearcom/Telex interface unit. This new interface and others already in the line ends forever any problems in field compatibility between Telex and Clearcom, RTS or Telco.

For complete technical information and specifications write or call Telex today. Write Telex Communications, Inc., 9600 Aldrich Ave. So., Minneapolis, MN 55420. For quick information call toll free 800-328-3771. In Minnesota call 612-887-5550.

TELEX®

TELEX COMMUNICATIONS, INC.

Circle 244 on Reader Response Card

Aegis Technologies
Alphone Corp.
AKG Acoustics
Altec Lansing
ART
Atlas Sound Div.
Ashly Audio Inc.
Audio-Technica U.S. Inc.
Bogen Communications
Cetec Vega
Community Light & Sound
Conquest Sound
Cornell Electronic Products
Crown International
J.W. Davis
dbx
DIS•USA
DOD Electronics
Dukane Corp.
Electro-Voice Inc.
Environmental Sound
Fisher Berkeley Corp.
Four Jay Industries
F.S.R. Inc.
Galaxy Audio
Grommes Precision
JBL Professional
Jeron Electronic Systems
Klark Teknik Electronics
Knowles
LCA Sales
Lee Dan Communications
Mackenzie Labs
Nady Systems
NEI
Neutrik Products
Numark Electronic Corp.
Oaktron Industries
OWI Inc.
Panasonic/Video Systems
Paso Sound Products
Rane Corp.
Rowe Customusic
RTS Systems Inc.
Sennheiser Electronic
Shure Brothers Inc.
Sonic Systems Inc.
Soundolier
SPECO
Tape A Thon Corp.
TASCAM
TCE Electronics Group
Tektone Sound Signal
Telex Communications
TOA Electronics
White Instruments
Yamaha International Corp.
Yesco

SOUND & ***COMMUNICATIONS***

**regularly features advertising
and product information
from manufacturers of
this caliber, the companies
you deal with and the
products you need.**

**Use the enclosed rapid
response cards for fast
information on any
of the companies
featured in this issue.**

SOUND & ***COMMUNICATIONS***

**It's Not Just a Magazine,
It's An Industry.**

be an important contribution to the conference.

Conference Recording — Why record the conference? It may be necessary to save the proceedings for absent personnel to hear, or it may be company policy to transcribe conferences for company use. Then, too, the conference may be of immediate impor-

DUPLEX OPERATION SOLVES THE FEEDBACK-RELATED PROBLEMS, BUT AT THE EXPENSE OF NATURAL, INTERACTIVE CONVERSATION.

tance to non-confererees—connect the conference output to a remote PA system for all interested parties.

As the need for audio teleconferencing has increased, so have the applications. What was once a complicated, expensive, unreliable luxury is now a viable, important, cost-effective part of the office equipment complement.

The Editors of Sound & Communications...are always looking for qualified contributors who wish to write for the publication on a freelance basis.

If you are involved in the Sound & Communications industries, and would like to write for the magazine bearing their name, please write to the editor at the below address and outline your experience and particular interests.

Thousands may share your interests, and we're willing to share them with our readers.

The Editor
Sound & Communications
220 Westbury Ave.,
Carle Place, NY 11514
(516) 334-7880.

A perfect marriage of

NEW



lightweight comfort and heavy-duty protection.

Telex PH Series marries these two advantages to exceed even the toughest industrial requirements!

- Dynamic receivers resist mechanical shock, moisture and temperature extremes.
- Impact resistant earphone cups.
- Soft polyurethane cushion covers are resistant to temperature and ultra-violet extremes.
- Long-life superflex cable with strain relief.
- Vinyl covered, stainless steel split headband.
- Stainless steel adjustable yoke assemblies.
- Field replaceable dynamic mike and earphone elements save time and money.

Tough PH Series designed for user comfort

- Perfect clamping pressure for day-long use.
- Soft foam pads on headband and earcups.
- Washable nylon earphone socks.
- Headband has air vents to keep head cool.
- Clothing clip.
- Mike boom rotates for right or left side useage.

Ask about our wide variety of models

- Dual/single sided.
- Dynamic/carbon mikes.
- Binaural/monaural earphones.
- With/without in-line push-to-talk switch.



Single side models available

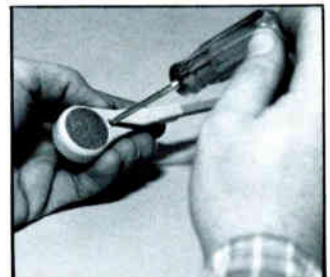

Dynamic models have economical, field replaceable mike elements

TELEX®

TELEX COMMUNICATIONS, INC.

9600 Aldrich Ave. So., Minneapolis, MN 55420 U.S.A. Telephone: 612-887-5550. 884-4051. telex: 29-7053

Call Toll Free in U.S. 800-328-3771 • In Minnesota Call (612) 887-5550

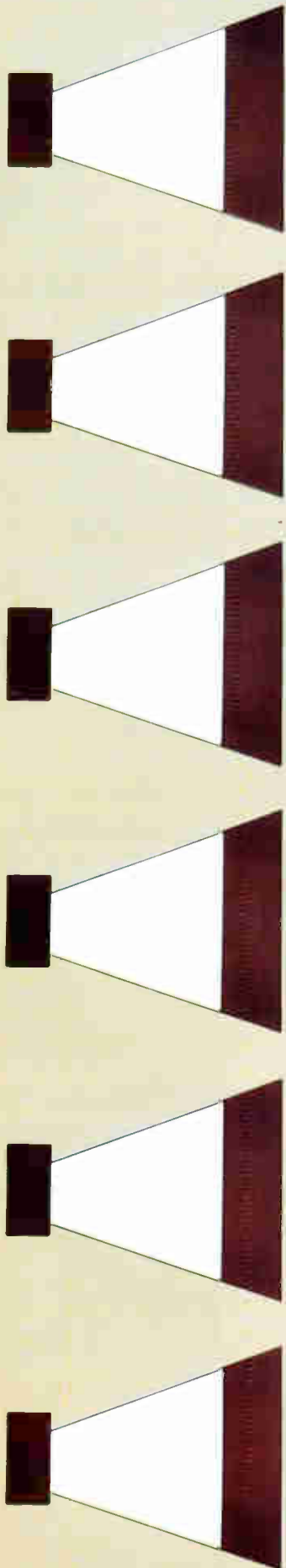

MILITARY MARKET MANEUVER

by Greg DeTogne

Once a contractor wins a bid on a government or military contract, the actual work that's done often becomes classified as top-secret, especially when it comes to matters that are perceived as affecting the national security. We are all used to seeing companies like General Dynamics and McDonnell-Douglas hiding details of their government projects under a dark cloud of secrecy, but would you seriously expect a sound contractor from Torrance, California to become involved in a government job so confidential that almost every word written about it must be screened?

Hardly, but nonetheless it is the truth. This hush-hush story is about Vj Electronics, who last year won a bid to gather the components for a high SPL paging/voice warning sys-

Y

ERS

tem for one of our nation's largest military bases. As alluded to above, the where, when, who and why of this project must remain anonymous, but the logistical and operational details can be told.

According to Tom Sawyer, one of Vj's audio engineers, although the job was different from most, it didn't take a tremendous amount of manpower to complete. "More importantly, it took good organizational skills, dependable sources, and an ability to work with the government, not against it," he said. "Government types—bureaucrats, the military, whoever—will always ask for the impossible to begin with. It's up to the contractor to negotiate with the purchaser and find a deal that's acceptable to both parties. Overall, this job allowed us to

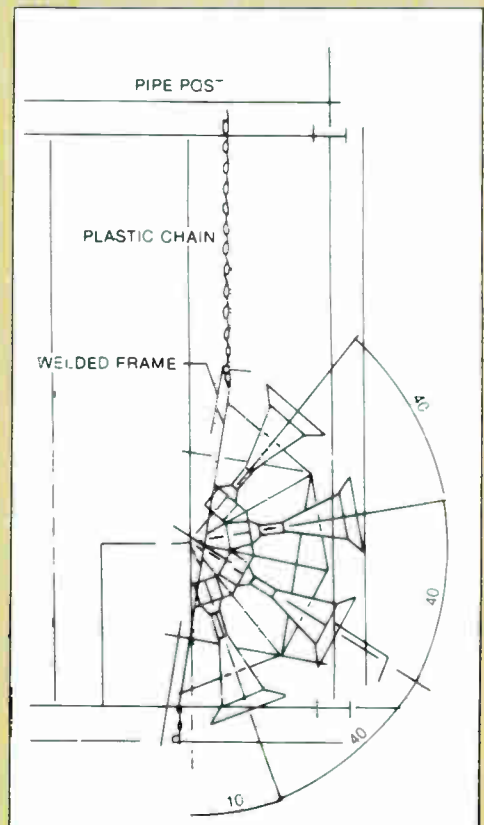

Measuring 44-inches high by 44-inches wide, eight of Community's horns with mouth extensions are in each of the system's two main clusters. Both arrays have a height of over seven feet, four inches.

express our creativity, and make some money to boot. The whole secret was paying attention to all of the forms and regulations, and bidding properly. Also, as is the case with most of these kinds of jobs, we had to not mind being paid a little slow."

Once Vj's bid was accepted, those in charge at the military base sat down with Sawyer and revealed their design plans. What they needed had to provide even coverage in an asymmetrical area measuring 1,200 feet. The drivers chosen would be mounted atop the coverage area's highest building, which stands 68-feet tall and measures 600-feet long. Articulation was crucial, as well as sheer power. The latter was necessary due to the fact that occasionally messages would be announced over the system that would be important for all personnel throughout the compound to hear.

After assembling all of the materials in a frantic search-and-locate effort that spanned the continent and produced an assortment of frayed nerves and exuberant air freight bills, Vj hauled the individual components of the rig to its new home. Due to the sensitive nature of the system's final resting spot, military engineers were responsible for the actual nuts-and-bolts installation.

"To obtain access to where the PA is, you definitely can't just wander in off of the streets," Sawyer said. "So many security clearances are needed that even I was lucky to get in and hear the system once it was up."

The military treated the completed project like a new toy. Besides playing "The Star-Spangled Banner" through it for the base's morning wake-up, the warnings and special messages that were broadcast could be clearly heard throughout the 1,200-foot coverage area. People at the far perimeters of the PA's range even remarked that what they were hearing sounded much closer to the source than it actually was—"it was like someone was talking over your shoulder although the

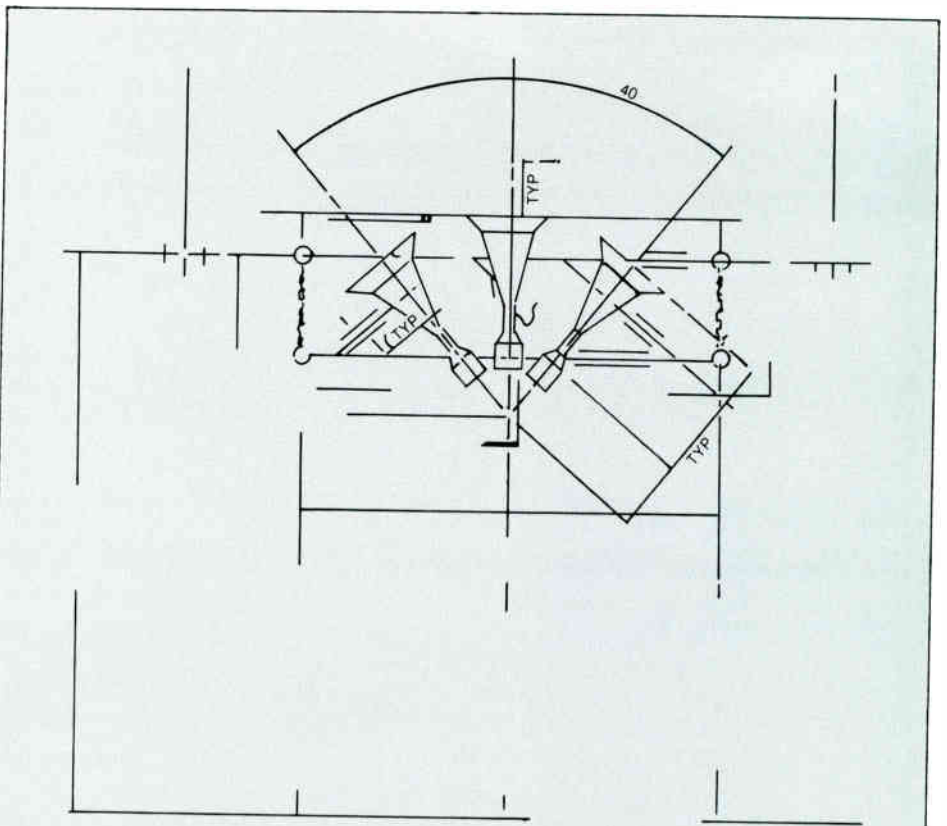

Community's PC 1564Ms were chosen for the system's smaller cluster which was mounted along with the two larger arrays atop the base's tallest building.

loudspeaker arrays were nowhere in sight."

Sawyer describes his brain child as an "engineer's dream come true." From a design standpoint, the entire system is straightforward and as simple as they could possibly get away with. Unlike fail-safe systems that are commonly found in some military installations, this one runs off of garden-variety AC. There are no back-up generators, wireless audio links, battery pack power reserves, or redundant elements in the wiring—everything is interfaced quite conventionally.

Three different clusters were hoisted by crane to the top of the building, and mounted atop three towers that provide access to the structure's elevators. Nineteen of Community Light &

Sound's M4 compression loudspeakers and PC Series of pattern control horns were utilized in the clusters, which were broken down into two groups of eight and one grouping of three (the former consisted of two groups of four stacked on top of one another). Each individual loudspeaker is powered by an AB Systems stereo amplifier which operates in a bridged mode to produce a total output of 1,000 watts. A Shure audio console was chosen to fill out the mixing chores, and attaches to a White equalizer with built-in frequency response contouring filters. Twin dbx compressor/limiters were added: one was set for high levels and provides maximum compression, while the other isn't compressed nearly as much,

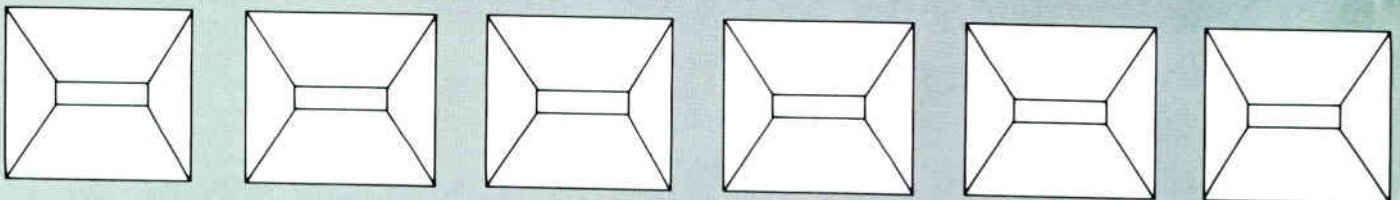

and lets the system run at a 10 dB lower level for normal operation. In turn, the compressors lead to the amplifiers, which are housed in each elevator tower as near as possible to the particular driver they power. Sixteen of the horns are Community's model PC1542Ms, and the remaining three are models PC1564M. With their mouth extenders in place, the PC1542Ms measure 44-inches high by 44-inches wide. In the two main clusters of eight that rely upon stacking these horns in pairs of two, the arrays have an overall height of 88 inches. All of the horns are set 40 degrees apart from one another in each array. Theoretically, given the frequencies that are found in the system under normal operation, the two main arrays have coverage patterns of about 15 degrees vertically, and 160 degrees horizontally.

Since the first audible signals thundered through its horns, the system hasn't presented any problems to its owners. The amplifiers are more than adequate for the drivers, providing plenty of head room and emitting a clean, highly-intelligible sound. The audio console, equalizer, compressors, and eight of the rig's amplifiers are all located in a single elevator tower. In keeping with the system's "simple is best" philosophy, the worst case of distance between an amp and a driver is 20 feet. During the initial stages of the system's use, the only unanticipated occurrence was a slight time delay in areas that were covered by two of the arrays, which was quickly remedied by the addition of an Eventide digital delay wired between the two offenders.

Sawyer claims the system wouldn't have been able to cover the distances involved with the clarity it has if the M4s wouldn't have been chosen. While the scramble was still going on to get all of the pieces together in the neophyte stages of the project, the M4s were one of the last things to be ordered. As the government's delivery
(continued on page 48)

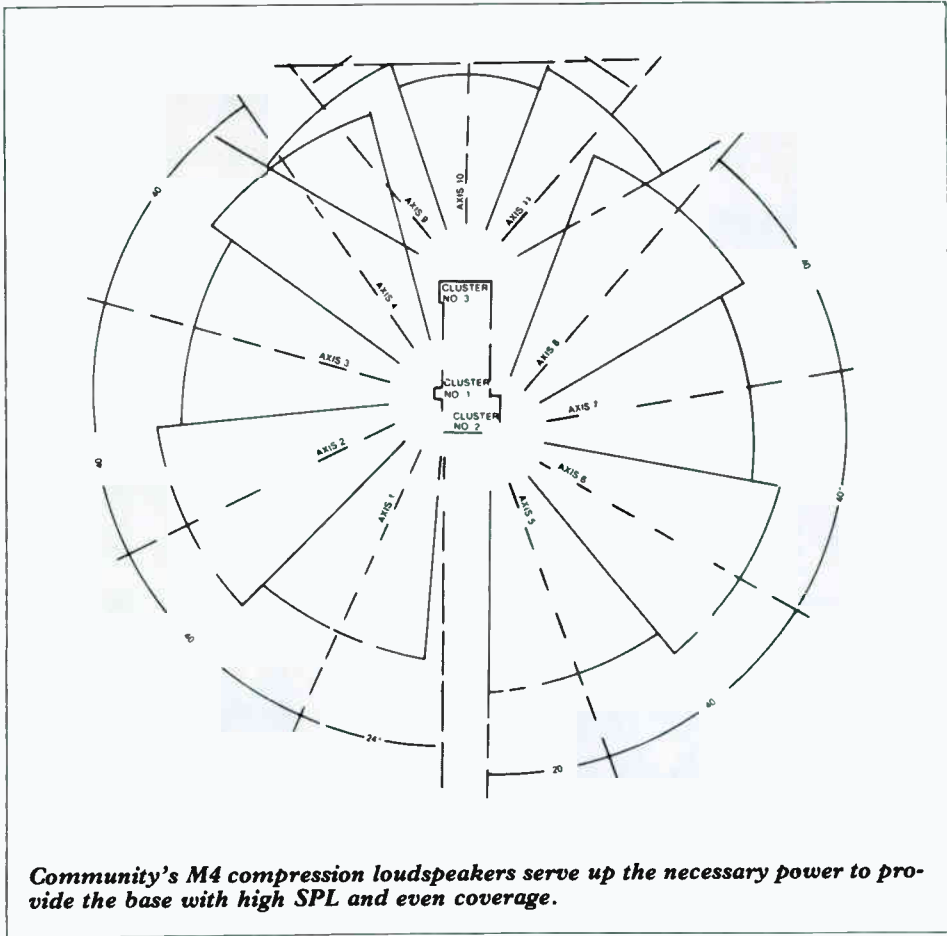

Community's M4 compression loudspeakers serve up the necessary power to provide the base with high SPL and even coverage.

APPLICATION FOR MEMBERSHIP



National Sound and Communication Association
501 West Algonquin Road
Arlington Heights, Illinois 60005-4411
(312) 593-8360

We are: _____ **Contractors** _____ **Representatives**
_____ **Manufacturers** _____ **Consultants**

We were sponsored by: _____

Company Name: _____ (Please type)

Street Address: _____

City: _____ State: _____ Zip: _____

Area Code: (____) _____ - _____

Your Name: _____ Title: _____

Dues For: Contractors	\$100.00
Representative Sponsor	\$125.00
Manufacturer Sponsor	\$250.00
Consultant Sponsor	\$125.00

My Check for \$ _____ is enclosed. Check No. _____ Dated: _____

_____ Please Invoice me for \$ _____

Signature: _____ Dated: _____

Please complete the application and mail it to NSCA.

Make checks payable to:

National Sound and Communications Association

Circle 249 on Reader Response Card

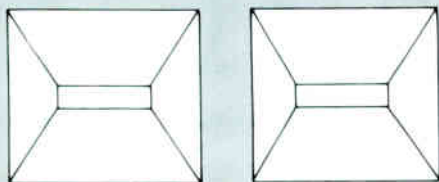

Installation Profile

The CALGARY CENTRE for the PERFORMING ARTS

by Barry McKinnon



The mixing console's location on the floor; (inset) the console's patch box. A second console is located in a control booth.

The Calgary Centre for the Performing Arts, Calgary's new self-contained theater district, had its gala opening on national television September 14, 1985. This is Canada's newest and most unique facility for the appreciation of the lively arts, the \$82 million facility covering an entire city block and housing three separate venues in its 400,00-square-foot complex, as well as a theater support company, restaurants, and retail space. With its varied architectural influences recalling some of the bygone days of Calgary's downtown district, the Centre promises to endear itself to residents and visitors alike as a viable first class facility.

The building has three performing spaces: the Jack Singer Concert Hall, an 1,800-seat room designed for music performances and the permanent home to the Calgary Philharmonic Orchestra; the Max Bell Theatre, a 750-seat theater for the presentation of dramatic performances and home to Theatre Calgary, a 17-year veteran of the theater scene in Calgary; and the Martha Cohen Theatre, an intimate 450-seat theater for dramatic arts and home to Alberta Theatre Projects. A fourth theater, a replica of the Em-

press Theatre which was built on the same sight in 1908, has had its shell constructed and awaits additional funding to complete it for its role as a community and amateur theater venue. J.V. Theatre Productions Ltd. is also a permanent resident of the Centre. A cooperative endeavor of both Theatre Calgary and Alberta Theatre Projects, this company builds the sets and props for both theater groups allowing extensive workshop space, facilities, and talent to be brought to bear on any production.

The building has been in the planning stages since its conception in 1976. It was brought from dream to drawings by Theatre Projects Consultants of London, England, with acoustical consulting by Artec Consultants Ltd. of New York, and architectural design by Raines Finlayson Barrett and Partners of Calgary.

Theatre Projects Consultants was responsible for all the design, including: the overall building, its eventual contents, staging, lighting and sound systems.

The "hard" design of the facility began in 1978, in cooperation with the architects and acoustical consultants,

and in 1981 sod was first turned on the site. David Collison, the director of TPC, was responsible for the complex and elaborate sound systems in use in the building.

According to Randy Cormack, TPC's field commissioning representative, "With a system of this complexity, it was very important to have a sound system engineering firm rather than a sound system installer."

Russel Johnson and Nicholas Edwards of Artec Consultants, already having an excellent record in concert hall design, were intrigued by the possibility of building a room that was to be used specifically for musical performances, rather than having the inevitable compromises present in a multipurpose room. After examining many of the world's classic concert halls, and determining what factors were of primary importance to the effectiveness of these rooms, a design based on the "shoebox" shape that many of the finest concert halls have was chosen. After the primary purpose of symphonic performance was accommodated, design of adjustable features to allow the space to effectively accommodate various kinds of music such as

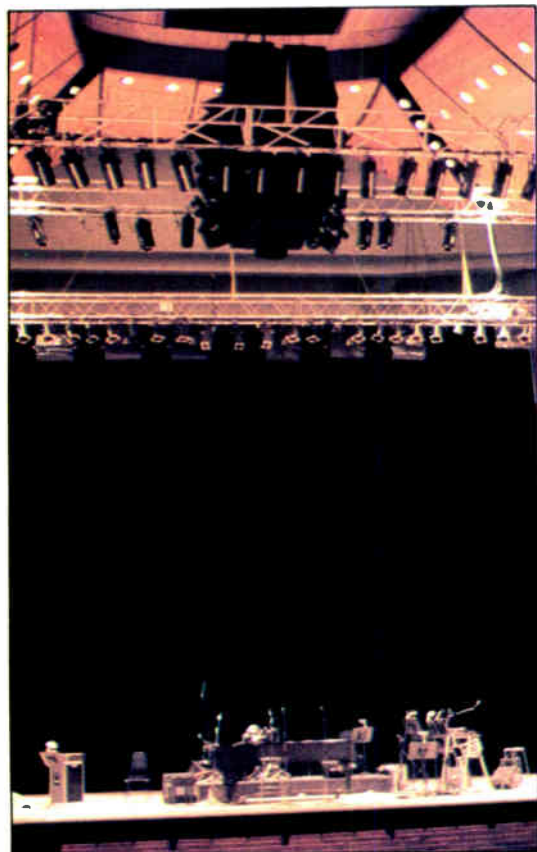

Full view of the stage with cluster above.

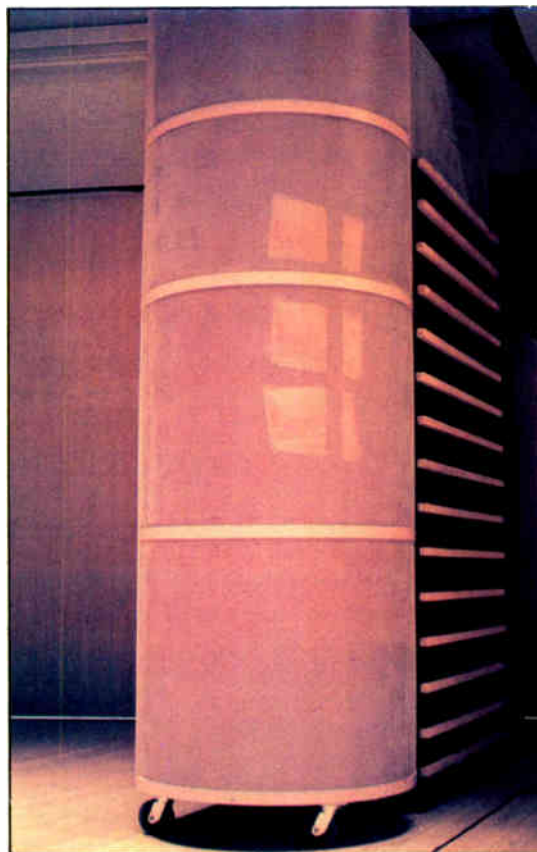

Side-stage speaker cluster.

pop, jazz, musical plays etc. was included. This adjustable character was achieved by using movable, retractable, sound absorbing curtains and a 60 ton hardwood canopy over the stage that is height adjustable to allow a more intimate space for a string quartet or jazz musicians, or an open stage to provide best working space for organ and choral works. Musician and audience acceptance of the Jack Singer Hall has been enthusiastic, which seems to bear out the design criteria.

The installation of the primary sound systems, nearly one million dollars of audio equipment, was awarded to International Aeradio Limited of Calgary, a veteran of large installations, having completed the system in the Olympic Saddledome just two years before. Les Schmidt, manager of IAL's Calgary office, said, "It was a good job technically, very diverse and very challenging, but squeezed into a horrendous time frame. Because of construction slow-downs, conduit was 14 to 16 months late and finished rooms were 10 months late, there was some concern about having it completed on time. Even on opening night there were conduit runs missing. The installation went very well considering the rush."

Mel Johnson, the project supervisor and Dave Howe, the site manager, were coordinating a crew of up to 25 people to build the extensive custom equipment, panels and patching as well as install equipment in 75 separate locations with all the associated tie lines and sound boxes.

ceiling to on stage level for servicing. There are trapdoors in the giant canopy to pass the cluster through to allow its use at the most effective height for the event being staged. The main cluster consists of four Altec Lansing 816A/515-8G and four Altec 817A/515-8G low frequency systems and a total of 20 Altec 291-16K high frequency drivers mounted on Electro-Voice HR40, HR60, and HR90 horns. Above these are 20 Altec MR902-16HF tweeters with JBL 3105 passive crossovers.

The upper side clusters are mounted on overhead rails that allow them to be pushed out of their niche in the wall for use. Each cluster consists of two Altec 816A/515-8G low frequency systems, three Altec 291-16K high frequency drivers mounted to Electro-Voice HR60 horns and crossing over into three Altec MR902-16HF tweeters through JBL 3105 crossovers.

The roll out side clusters may be positioned up or downstage. When downstage, they blend into the back wall and when moved upstage provide the on-stage directionality required for electric music enforcement. They each consist of two Altec 817A/515-8G low frequency systems with five Altec 291-16K high frequency drivers mounted on Electro-Voice HR60 and HR90 horns, with five Altec MR902-16HF tweeters and JBL 3105 crossovers.

As well as the main speaker systems there are 71 Soundolier eight-inch coax speakers located around the perimeter of the hall for an enhance-

DN330, limiters and Ashly SC-50 and SC-55 and delay lines are Industrial Research Product's DF-4015-4.

A system of this complexity would be expected to have elaborate control and patching capability, and this one meets those expectations. The sound-booth contains a multipair patchbay which brings a total of 133 mic lines up to a 67 input, three-way mic splitter complete with phantom power. This unit was custom built for this installation to allow active buffered splits for radio, TV, recording, monitoring, and sound reinforcement splits of any mic used. The Soundcraft 32x8 800B console has input modules that were custom built for this project and have since become part of Soundcraft's standard product line for theatrical applications. The console has an in-house position and a position in the control room. There are a large number of sound boxes that have tie lines that run to various locations to serve the broadcasting or remote recording trucks that use the facility. The Canadian Broadcasting Corporation has installed audio and video lines in the building to the mobile parking area to allow for fast and easy setup for coverage of cultural productions.

The on-stage monitors have 28 connector locations. An enormous custom-built patching system using Cannon EP-3 connectors is provided to allow various mixes to be sent to the necessary locations. All speakers in the building are connected with the EP-3's, with a total count of over 1,200 connectors in the facility.

The control room for this hall has a small broadcast booth for radio or TV announcers that affords the same view of the stage as the audio man. The audio control room is equipped with a variety of outboard gear for sourcing or recording of performances as well as adding some effects. Three two track Otari MX5050B recorders, a cassette recorder, and Technics SL-M2 turntable with a Harmon-Kardon preamp are on roll-around consoles. A Master Room reverb is available for enhancement as required. Booth monitoring is done with a pair of UREI 811A time align monitors. A wide selection of high quality microphones round out the equipment list.

The Max Bell Theatre

The Max Bell Theatre features a variable width proscenium through the use of hinged towers of box seats on either side of the stage allowing a stage width of 35 to 57 feet. Sound reinforcement in this theater is ac-

A system of this complexity would be expected to have elaborate control and patching capability, and this one meets those expectations.

The Jack Singer Hall

The Jack Singer Concert Hall is equipped with the most versatile and elaborate system due to its wide performance demands, ranging from un-amplified philharmonic concerts to electrified pop, jazz, and choral works to musical plays and opera.

The system is built around a central cluster with four movable side clusters for additional imaging and level enhancement. The central cluster is on a winch system which allows it to be located anywhere from a niche in the

ment effect system, and JBL 4691 and Electro-Voice 1202 and 1502 speaker systems for on-stage monitoring.

Amplification for all speaker systems is provided by Bryston 3B and 4B amplifiers, a total of 27 in all. Choice of amplifier was predicated on its ability to operate at rated output without fan cooling which would create another noise source in the building.

The amplifiers are fed from JBL 5234 crossovers with an 800 Hz crossover frequency. Equalizers used are UREI 539 and Klark-Teknik

complished with a combination of a central cluster and proscenium speakers, with a surround speaker system for special effects and sound effects speakers hung in the flytower.

The main cluster is fixed above the proscenium and contains four Altec 816A/515-8G low frequency systems and eight Altec 291-16K high frequency drivers on Electro-Voice HR60 and HR90 horns, with six MR902-16HF Altec tweeters, and six JBL 3105 passive crossovers. This system is augmented by eight Bose 802 speaker systems with equalizers mounted on each side of the stage on the movable seat sections.

The theatrical sound effects system consists of 20 JBL 4401 monitors flush mounted in the walls around the theater. A delay fed enhancement system utilizing 30 Soundolier eight-inch coax speakers is located around the room as well. Custom built sound effects speakers using JBL 2245 bass units, 2202 mid-bass units and 2421 drivers on 2370A biradial horns are located on adjustable hangers in the flytower behind the proscenium.

Power amplifiers are Bryston 3B and 4B models, a total of 14 in all. They are fed from a JBL 5234 electronic

crossover with an 800 Hz crossover point. Limiters are Ashly SC-50 and SC-55, equalizers are UREI 539, delay lines are Industrial Research Product's DF4015.

intimate performing space, seats are in a tiered three-quarter-circle around the stage, reminiscent of a Georgian-style courtyard theater. The farthest distance from stage to audience

The Martha Cohen Theatre is very intimate performing space, seats are in a tiered three-quarter-circle around the stage, reminiscent of a Georgian-style courtyard theater.

The control room is equipped with a Soundcraft 800B with the special input modules, in a 24x8 configuration. Two two-track and one four-track Otari MX5050B recorders are provided for sound effect and show tape production. A Technics SL-M2 turntable and a cassette deck provide signal sources. Monitoring is done with UREI 811A time align systems driven with Bryston power. Mic line and speaker patching are provided for versatility in assignment.

The Martha Cohen Theatre

The Martha Cohen Theatre is very

member on the theater floor is 39 feet. Because of its compact dimensions, primary reinforcement is done with a proscenium system, and with a surround sound system for effects. The proscenium system consists of six Bose 802 systems with equalizers, located on the seating tiers. The sound effects speaker system uses 15 of Galaxy Audio's Hot Spot monitors located around the theater walls. Portable speakers can be placed as required for additional directional sound effects, EV 1202 and 1503 systems are used,

(continued on page 48)

NEED
MIC/LINE
MIXERS



Call
EDCOR
800 854-0259
800 523-2824 CA
714 863-1529

EDCOR 16782 Hale Ave. Irvine, CA 92714

FANE
LOUDSPEAKER ENCLOSURE
DESIGN AND CONSTRUCTION HANDBOOK

\$6.95

EVERYTHING YOU NEED
TO BUILD YOUR OWN
LOUDSPEAKER
SYSTEM!!!



A complete handbook on speaker design with blueprints, speaker application, port tuning and chart recordings.

Send to:
FANE
P.O. Box 2344
Ft. Worth, TX 76113

I would like to order:
Qty _____ @ \$6.95 ea.
Design Handbooks Total Enclosed \$ _____

See us at AES Booth
#509 and #511

Name _____
Address _____
City _____ State _____ Zip Code _____

Circle 237 on Reader Response Card

Circle 238 on Reader Response Card

PRODUCTS IN REVIEW



MICROPROCESSOR-BASED SYSTEM FOR SILENT PAGING

QuietCall, a microprocessor-based visual paging system, has been introduced by Cornell Electronic Products, Inc.

The QuietCall system lets the user summon individuals without the noise associated with audible paging systems. It can be used wherever noise must be minimized, such as in health care facilities, as well as large retail stores, offices, and restaurants.

The system may also be useful in such inherently noisy environments as manufacturing plants, environments in which audible pages may go unheard.

According to Cornell, the QuietCall system consists of from one to 15 units for LED display of numerical codes, and compact master and remote consoles from which pages can be initiated.

An individual subject to paging is given a unique, three-digit code. To summon this person, the operator keys that code in on a master or remote console. In a tone-equipped system, a chime sounds and the code appears on all display units.

The QuietCall's microprocessor permits electronic storage of up to 25 such codes at once, from several locations. When more than one person is being paged, the display shows their codes in sequence for one second, beginning the series again as it completes each cycle.

Should an emergency page be required, an operator can interrupt the normal sequence and enter a priority code for continuous display.

□ Contact: Cornell Electronic Products, Inc., 4911 W. Good Hope Rd., P.O. Box 23411, Milwaukee, WI 53223; (800) 558-8957.

Circle 1 on Reader Response Card

DAVID CLARK AMP AIDS VOICE TRANSMISSION

Voice transmission in high noise environments may be improved with the use of a new, portable amplifier in conjunction with Voice Powered Communication Headsets, both manufactured by the David Clark Company, Inc.

The Model M5410 Amplifier weighs 7 ounces including battery and enables voice levels to be increased by up to 30 dB with an adjustable volume control. The weather resistant modular unit has a large positive action push-to-talk switch and may be held or clipped to belt or jacket.

Designed to work with the David Clark Company Voice Powered Communication Headsets and Systems, the amplifier is for extending the perform-



ance of voice powered communications used around piston and jet engine runup stands, at sporting events, by crane operators, and in other high noise level applications where clear reception of voice transmissions is critical.

□ Contact: Jack Kennedy, David Clark Company, Inc., 360 Franklin St. P.O. Box 155, Worcester, MA 01613-0155; (617) 756-6216.

Circle 2 on Reader Response Card

SINGLE CHANNEL DE-ESSER INTRODUCED BY dbx

dbx has introduced an easy-to-use single-channel de-esser, the dbx 263X. Priced at \$149, the new dbx 263X De-esser, which removes excess "ess" sounds, is designed to aid vocalists, but is equally useful to sound contrac-

tors, band leaders, DJs, announcers, and for small-studio application.

The dbx 263X provides a slider to control the amount of sibilance reduction, which is visibly indicated by a row of 12 red LEDs in segments ranging from -2 to -30.

Other front panel controls include a knob for adjusting the circuit's sensitivity to specific sibilance frequen-



cies and a pushbutton for selecting bandwidth. Operating status is provided by a green LED high-frequency indicator and yellow LED broadband indicator. The front panel also incorporates a high-impedance (Hi-Z) microphone jack with its own trim (screw adjust) on the rear panel.

□ Contact: Professional Products Division, dbx, P.O. Box 100C, Newton, MA 02195; (617) 964-3210.

Circle 3 on Reader Response Card

VIDEO SWITCHER AVAILABLE FROM RCA

RCA Distributor and Special Products Division, announced it has added an electronically-controlled video switcher to its line of video accessories. The Electronic Video Switcher, Model AV019, handles up to five video sources such as TV, VCR, video game, computer, or other auxiliary equipment. It enables selection of these sources once hooked up without disconnecting and reconnecting cables. LED lights indicate function in use.



The model AV019 features soft touch switches, high performance amplified circuitry with low signal loss, and a switchable RF amplifier for strong or weak signal areas.

The AV019 can be used with all major makes of video-related equipment. Optional list price is \$119.95.

□ Contact: RCA Distributor and Special Products Division, Deptford, NJ 08096; (609) 853-2243.

Circle 4 on Reader Response Card

SCHOOL INTERCOMS FROM ONE TO 40 STATIONS

Talk-A-Phone Company is offering the "Chief" Master Intercom System for use in schools, along with many other intercom systems, that will provide intelligible two-way conversation, selectively and privately between any two points. Masters can select a room to call. Rooms can call the principal or the maintenance department.

One built-in feature of the Talk-A-Phone Chief is an incoming call chime to indicate your Master is being called. Another popular feature is the External Relay Control which enables the Master to activate a siren, gong, or light in the high noise level areas. Each Master and Staff controls its incoming volume which is adjustable from a

whisper to full output of the powerful high-gain amplifier. Masters, Staff Horns, and other equipment may be added to the system as needed.

□ Contact: Talk-A-Phone Co., 5013 North Kedzie Ave., Chicago, IL 60625; (312) 539-1100.

Circle 5 on Reader Response Card

UHER PORTABLE STEREO CASSETTE RECORDER

Uher of America, Inc. has introduced the Uher 160-AV portable stereo cassette recorder.

The model 160-AV also features both Dolby® B and C noise reduction. Additional features include three built-in speakers for on-site monitoring, separate right and left level controls and switchable automatic level control with two time constants and twin peak-reading meters with dB scale. The 160-AV has a DIN accessory facility for synchronized film dubbing.

The 160-AV can be powered

six dry cells, nickel-cadmium rechargeable batteries, 12 volt car batteries and 110/220/240, 50-60 Hz current.

The suggested retail price for the Uher 160-AV is \$899.

□ Contact: Uher of America, 7067 Vineland Ave., N. Hollywood, CA 91605; (818) 764-1120.

Circle 6 on Reader Response Card

TOA'S MIXER/POWER AMPS FOR MUSIC & PAGING

TOA Electronics has introduced a new, economical line of Mixer/Power Amplifiers designed for paging and music reinforcement. The 500 Series is suited for smaller commercial and industrial facilities that require quality sound and maintenance-free operation.

The 500 Series (Models A-503, A-506, and A-512) is available in 30, 60, and 120 watt power configurations. These all-in-one "table-top" units provide four microphone inputs, a magnetic phono input, and three

(continued on page 39)

The clear choice...

ORATOR III

Wireless microphone system

Combines ease of operation with high performance at an affordable price. Its new audio processor provides very high signal-to-noise ratio and wide dynamic range. Operation is clean and clear up to 1000 feet, line of sight.

FEATURING:

TO-93 bodypack transmitter

Long battery life (up to 10 hours on a 9-V alkaline battery).

Power on/off switch

Recessed.

Mic level control

Screwdriver adjustment.

Mic on/off switch

Silent "no pop" operation.

Miniature XLR mic connector

Allows use of most lavalier mics.

Extra rugged case

High-impact Cyclolac.

106X mic
Other lavalier mics are available.

Terminal strip
Line-level output.

XLR connector
Switchable mic-level and line-level audio outputs (internal switch).

RO-95 receiver
Easy to set up.

Rugged steel case

REAR VIEW

Power switch

LED indicators

Transmitter on, audio overload, and power. For fast, simple setup.

Also available is the TO-92A hand-held transmitter. The ORATOR III operates on a clear VHF high-band frequency. It is rugged and dependable, and is manufactured in the United States by...



Cetec Vega

...the world's leader in wireless mics

9900 Baldwin Place
El Monte, California 91731
(818) 442-0782 TWX: 910-587-3539

Circle 239 on Reader Response Card

World Radio History

PRODUCTS IN REVIEW

a closer look

by gary d. davis

Electro-Voice's "Packaged" Theatre Sound Systems

Electro-Voice, Inc. has developed a line of loudspeaker systems aimed at the theater sound reinforcement market. The line includes the XEQ-504 (500 Hz) and XEQ-808 (800 Hz) passive crossover/equalizers, the HP940 and HP9040 90 x 40 degree constant-directivity high-frequency horns, the DH1 and DH2 high-performance high-frequency compression drivers, HMK-1 and HMK-2 horn mount kits, and direct-radiator low frequency enclosures in both single (TL606AX) and dual 15-inch woofer (TL606DW) configurations. These components are offered in four different "packaged" systems optimized for different size houses. (See below.)

In addition to these four main stage systems, EV offers a TL3512 high-output subwoofer, and a number of surround and monitor speakers, along with various mounting accessories. Contact: Electro-Voice, Inc., 600 Cecil

St., Buchanan, MI 49107; (616) 695-6831.

Comment: In the mid 1970s, Electro-Voice pioneered the constant-directivity horn, then under the technical leadership of Don Keele. That



technology originally required relatively large horns, but further refinements have made it possible to obtain uniform coverage over a broad frequency range with a shorter horn. As a result, EV has been able to create these "packaged" systems, some of which can actually be placed in the relatively

small space behind a motion picture screen, even in the new, relatively smaller "shopping center" sized theaters.

Because these systems are dedicated to theater applications, they are relatively more economical and easier to install, according to Janine Fromm, EV sales and distribution manager. For example, the XEQ-504 500 Hz crossover is less complex and less failure-prone than generic, multi-purpose crossovers. The HMK horn mount kits speed assembly, and add only about one-eighth-inch to the horn/driver depth. The TL606DW bass enclosure, which comes pre-loaded with DL15W woofers, is also pre-drilled to accept the HMK mounting sled. Another feature of the dual woofer enclosure is that the XEQ-504 crossover flush-mounts inside, in lieu of the speaker connection panel, thereby saving space and protecting the crossover. In very small theaters, the

(continued on page 48)

SYSTEM:

TS940D

TS940S

COMPONENTS:

HP940 CD Horn (11.2-inches deep)
DH1 Driver (5.15-inches deep)
HMK-1 Horn Mount Kit
TL606DW Dual Woofer
XEQ-504 Crossover/EQ

HP940 CD Horn
DH2 Driver (7.38-inches deep)
HMK-1 Horn Mount Kit
TL606AX Woofer
XEQ-808 Crossover/EQ

FEATURES:

High power in compact-sized enclosure for medium-sized houses where larger systems cannot be installed, or high SPL in small houses. Shorter horn advantageous, but tradeoff is lack of vertical CD below 1,500 Hz.

Smooth, accurate response from smaller, titanium-diaphragm driver with two-inch throat and single woofer in optimally vented enclosure; for smaller houses.

SYSTEM:

TS9040D

TSX

COMPONENTS:

HP9040 CD Horn (31.8-inches deep)
DH1 Driver
HMK-2 Horn Mount Kit
TL606DW Dual Woofer
XEQ-504 Crossover/EQ

HP9040 CD Horn
DH1 Driver
HMK-2 Horn Mount Kit
TL606W Dual Woofer

FEATURES:

High power with uniform coverage down to 500 Hz, and maximum SPL for medium to large houses; also good for reducing reflected energy in very narrow, reverberant houses.

A TS9040D w/o crossover: bi-amplification can deliver maximum power (800 W to woofers); multiple TSXs may be used economically for even greater coverage and acoustic output.

PRODUCT

(continued from page 37)

auxiliary inputs for cassette decks, radio tuners, CD players, chimes, and other high level signal sources. The system's outputs are isolated and transformer-balanced, for use with 25



volt, 70 volt, or 4 ohm speaker system.

Applications include restaurants, offices, recreation areas, department stores, and shopping centers.

The 500 Series features low distortion and full, smooth frequency response. Other features include self-protection circuitry, AC/DC operation, bass and treble tone controls, remote volume control, muting, and signal processing input/output.

□ Contact: TOA, 480 Carlton Court, S. San Francisco, CA 94080; (415) 588-2538.

Circle 7 on Reader Response Card

SHARP'S PORTABLE PA SYSTEM/RECORDER

A combination full-featured 20-watt RMS public address system and audio cassette recorder, the HK-25S, introduced by Sharp Electronics Corporation, incorporates several step-up features in a compact 20-pound package for complete portability as well as maximum operating convenience.

Among these step-up features, said Bob Garbutt, Professional Products Division general manager, is an industry standard slide/sync playback system to play one or two projector pre-recorded separate track A/V programs. "Previously recorded multi-image shows can also be played back through the HK-25S, when the unit's sync line-out jack is interfaced with an external dissolve unit," he said.

Audio programs can be played back through external sound systems, by utilizing the system's audio line-out jack.

Standard features include Auto Program Search System (APSSR), three-



channel mic/line mixing, and a front-mounted loudspeaker. The HK-25S, which will be available in August, has commercial UL approval.

□ Contact: Professional Products Division, Sharp Electronics Corporation, 10 Sharp Plaza, Paramus, NJ 07652; (201) 265-5548.

Circle 8 on Reader Response Card

(continued on page 47)

Dress up your presentation...

Vecta

Wireless Microphone System

...the perfect accessory.

FEATURING:

- Attractive price
- Easy to use
- Clean, crisp sound
- Wide dynamic range
- Extra-quiet—special noise-reduction circuitry
- Clean high-band VHF frequency
- Long battery life (up to 10 hours on one 9-V alkaline battery)
- Mic and battery on/off switches
- Solid, rugged construction
- Made in USA

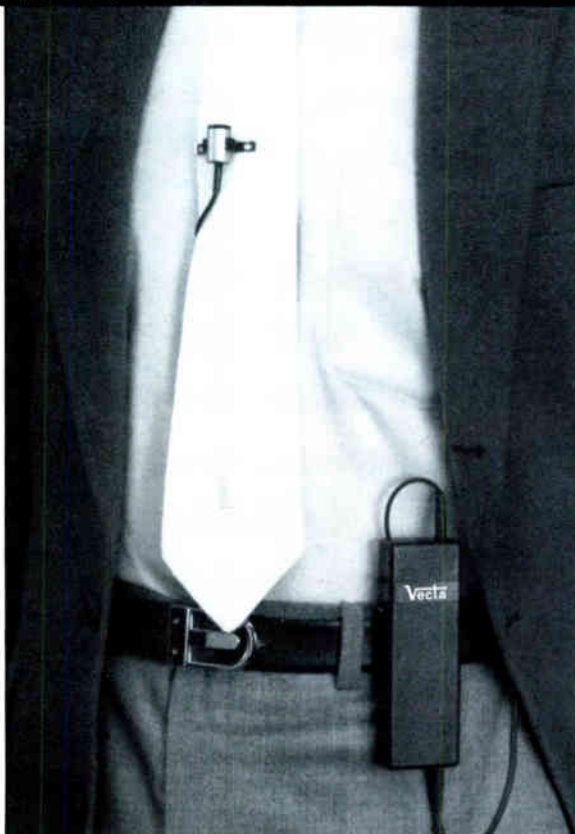

Vecta is a new name from the leading manufacturer of quality wireless systems since 1962.



For solid, dependable performance, choose a Vecta wireless microphone system, manufactured in the United States by...

Cetec Vega

Division of Cetec Corporation
9900 Baldwin Place
El Monte, California 91731
(818) 442-0782
TWX:910-587-3539



New Paso Commercial Sound Products Catalog

Paso Sound Products has announced availability of their new 1986 Commercial Sound Products catalog.

Illustrated within this 32-page full color catalog are Paso's 'TR Series' and '2000 Series' AC/DC booster and integrated audio amplifiers, multi source page/music systems, single and dual cassette decks, tuners, receivers, mixers, preamplifiers, equalizers, 1000 Series mobile DC amplifiers, sound columns, baffles, speakers, attenuators, paging talkback speakers, reflex trumpets, driver units, and base station microphones.

New additions for the '86 catalog include Paso's line of professional loud-speaker systems and stage monitors.

Contact: Paso, 14 First St., Pelham, NY 10803-1401; (914) 738-4800.

New ICIA Publications and Products Catalog Released

The new 1986 *Publications and Products Catalog* of the International Communications Industries Association has been published. Provided as a service to the industry, the latest edition of the popular resource catalog features more than 70 books, newsletters, pamphlets, filmstrips, slide/tape programs, multi-image programs and videotapes geared to the training and information needs of both commercial members of the industry and users of its products.

The free 30-page catalog includes photographs of many of the products and complete descriptions of all

publications. A supply of order forms is conveniently provided in the catalog.

Contact: ICIA's Member Services and Information Department, 3150 Spring St., Fairfax, VA, 22031-2399; (703) 273-7200.

Pirelli Cable Offers Catalog on Fiber Optic Installations

Pirelli Cable Corporation has issued a new four-page color brochure on its fiber optic turnkey installation service.

The brochure contains information illustrating Pirelli's turnkey capability, including project management, installation and field supervision, splicing, testing, training and emergency restoration. It also lists the diverse line of fiber optic products that Pirelli manufactures.

Contact: Pirelli Cable Corporation's Communications Division, 700 Industrial Dr., Lexington, SC 29072; (201) 687-0250.



1986 Product Catalog Offered by Western Telematic, Inc.

A new free 16-page catalog describing a broad line of low cost RS232 Interface Problem Solvers is now available from Western Telematic, Inc. (WTI). This array of peripheral devices can improve operating efficiency and add capability to existing data communication products.

This new catalog includes: Computer Port Expansion & Networking Units, Interface Switches, Printer

Sharing Units, Printer Buffers, Security Modems, Remote Data Collection Devices, Data Multiplexers and Data Distribution Devices. The catalog provides features, descriptions, application drawings, photos and prices on each product. Ordering information is also provided (including a toll free 800 number) along with terms and conditions.

Contact: Western Telematic, Inc. at (800) 854-7726.

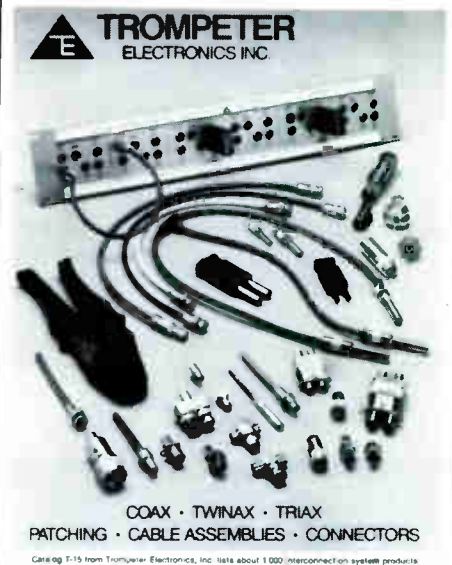

Catalog Lists Patching, Cable Assemblies and Connectors

A new 76-page catalog (T-15) from Trompeter Electronics Inc., describes about 1,000 of the company's interconnection system products. Also included in the catalog are eight pages devoted to the design of coax, twinax, triax, and quadrx cable systems and a two-page application note covering MIL-STD-1553B digital data systems.

Trompeter's coax, twinax, triax and quadrx connector families are described along with associated accessories, such as bend relief springs and cable holders.

Applications for Trompeter's interconnection systems include: computers, TV/video, industrial instrumentation, process controls, security equipment, smart building installations, automatic testing, microwave, digital data transmission, and local area networks.

Contact: Trompeter Electronics, P.O. Box 5069, Thousand Oaks, CA 91359-5069; (818) 707-2020.

by Ted Uzzle

Studio Acoustics: Fundamentally Speaking

Everest, F. Alton, *Acoustic Techniques for Home & Studio*, 2nd ed., Tab Books, 1984, viii + 344 pp., \$15.50

People whose interests are sharply focused on a specific application of technology are still obliged to master much that which is fundamental and of broad use. It might seem that such basic tools would be the most appealing ones to learn, yet human curiosity is much too perverse for that. If you want to teach fruit peddlers that $2 + 2 = 4$, you would do well to make it, "Two bananas plus two bananas equal four bananas." In a way, this may be a pity, but it is certainly the way to capture and hold the attention of readers who must be led over elementary and general material.

F. Alton Everest has assembled an exposition on architectural acoustics of remarkable breadth and depth in his

concepts of room resonances, eigen-tones, are developed at great length. Numerous design examples, profusely illustrated, are given. The mathematics are neat, unambiguous, and lend themselves to computer programs and impressive graphics (quite a few of which are reprinted here). Acousticians who like mathematics recognize they have hit the Mother Lode in wave acoustics. Yet, very few real designers pay much attention to this at all. Its application to the way we actually hear is problematic.

This is more a quibble than a criticism; the author has done well to include the material, and to let the reader sort out the more important bits, rather than omitting it altogether.

The next chapter deals with noise control in the studio, and is not much more than an anthology of construc-

reader can only praise the author of this book, and the authors (mostly consultants) of the sources he cites, for showing us these techniques.

Chapter 10 takes up the central problem in reverberation theory and, in spite of a couple of solecisms, handles it with proper discretion. Only two statements from over 30 pages are flatly wrong, in your reviewer's opinion, which makes this discussion one of the most accurate and sophisticated around. We are told the reverberation equations of Sabine, Eyring, and others assume random directional propagation of sound. In fact, Eyring's equation assumes sound rays always strike absorbers at exactly normal incidence, and this is precisely why it gives different numbers from Sabine's equation. Later we are told statistical acoustics are based on geometrical ray acoustics, and that these prove the mean free path to be $4V/S$. In mitigation, one must acknowledge that this fallacy is very, very widely believed in audio.

The next two chapters show the design of a studio and a control room, with all the techniques described so far in the book brought into play. Then, a chapter on adjustable acoustics takes up the rotatable panels, or panels with louvers in front, which used to be so popular in studios. Some modern practitioners have recognized that these not only change the absorption in the studio, but also the reflection pattern (because of the different angles of the panels at different degrees of rotation), and have begun to use sliding panels only, which change the facing material, but not the angle at which it's mounted to the wall.

Chapters 14 and 15 deal with instrumentation for testing the acoustics of the home listening room and the studio, with particular reference to electroacoustic response and reverberation time. The final chapter is a tour of studios around the world, with large, clear photographs focusing on details of construction affecting the acoustics. These studios tend to be outside the mainstream of commercial studios in the United States, and em-

Instead of assembling an anthology of techniques or tips, he attempts to explain the physics, or the psychoacoustics, behind the techniques.

book *Acoustic Techniques for Home & Studio*. Instead of assembling an anthology of techniques or tips, he attempts to explain the physics, or the psychoacoustics, behind the techniques. Everything in the book is aimed specifically at the recording studio or the home listening room.

The first four chapters form an introduction to sound. They cover the physical behavior of sound under such ideal conditions as the proverbial point source. The decibel notation system is described, with its origin in logarithms, and its applications in sound work. Speech, music, and noise, and some of their descriptors in audio work, comprise one chapter, as does the physiology and psychology of human hearing.

The next three chapters, as a group, deal with wave acoustics as applied to small rooms, particularly studios. The

tion details (cutaway views of wall, door, and window interiors). There are no references for further reading, which is rather a pity, since internal acoustics almost do not matter in a recording studio if intruding noises from outside cannot be eliminated.

The following chapter is truly outstanding, and worth the price of the book. It concerns itself with acoustical materials and structures. Its strengths are seldom found in practical essays on the subject. It pays proper attention to the mounting details of absorptive facings, and goes on to fascinating discussions of such specialized absorbers as polycylindrical, slat, and perforated panel absorbers, obviously written after much actual experience with them. Such esoterica are sometimes held as trade secrets by designers who know how to use them, and one seldom sees so full a discussion. The

phasize homespun solutions achieved on small budgets. This circumstance probably makes them more honestly functional, and thus more revealing, than photographs of cosmetically nicer installations would be.

This is the second edition of a book first published in 1973. It is larger about 50 percent, which means that the publishers have done an excellent job of controlling their prices (in constant dollars). Your reviewer's copy of the first edition is dog-eared and has the binding broken at many places, from frequent use and from many loanings to others who wanted to understand something of the why and wherefores of studio acoustics. There aren't many books with so fine a blend of practical shrewdness and theoretical conceptualizing for the beginner. Readers coming first to this new edition may find their copies dog-eared very quickly.

People who earn their livings from studio design call books like this dangerous. That's self-serving, of course. A grain of truth remains in the warning, however; you can read any number of books about swimming, and still drown the first time you go in the water. A little learning is a dangerous thing, as the poet said all knowledge can be dangerous, perhaps, but if you want to read a book about studio acoustics, you can't do much better than this.

SALES & MARKETING

(continued from page 13)

problems, poor deliveries, unreasonable ordering and inventory policies, misunderstood distribution patterns, improper use of sales aids, and difficulties in obtaining field assistance of repairs. The daily contacts of representatives with a variety of customers and manufacturers give the representatives the insight to foresee problems in the making and the ability to calm most troubles before they become insurmountable.

For example, representatives who know their customers intimately often intercede on their behalf in establishing realistic and acceptable credit limits with their principals. Unrealistic inventory requirements can also often be adjusted with a representative's intervention.

Because representatives know their market thoroughly and must continue to earn their livings in their territories, rather than moving on as factory salespeople often do; they understand the

importance of developing intelligent and practical long-term distribution patterns within the parameters set by their manufacturers. Because he knows his customers' interests, capabilities and areas of expertise, a representative can work closely with them to successfully match products and markets. Advertising leads are generally channelled by manufacturers through their representatives to customers who will pursue them effectively and aggressively. Supplying their customers with adequate literature, current price sheets plus new product information, samples and demonstrations are vital services provided by representatives.

At times, representatives can even do the "impossible" by expediting delivery of urgently needed materials. Part of a representative's routine is to check each customer's purchase order, confirmation and factory acknowledgment to ensure that the correct products are ordered and shipped. Cus-

tomers' credits and repairs are also monitored closely. Daily communication with factories alerts the representative to shipping delays, shortages, quality problems, engineering changes, upcoming price and policy changes. When such information is transmitted quickly to customers, many potential problems are avoided.

Special quotations, technical inquiries, layout requests and field assistance are also coordinated by the representative. He provides prompt access to factory personnel and technical assistance and can arrange special meetings when needed.

A representative's role clearly places him "in the middle," bridging the gaps that sometimes separate manufacturers and customers. But it is a choice made freely and with the positive attitude that the gaps need never be impossibly wide. As "bridge tenders," representatives can benefit all because they "work for" manufacturers first and customers always.

AD INDEX

<u>RS#</u>	<u>Company</u>	<u>Page</u>
241	Amek	III
231	Audio Technica	3
239, 240	Cetec Vega	37, 39
243	Edcom	17
237	Edcor	35
230	Electro-Voice	II
238	Fane	35
250	Fisher Berkeley	22
251	IED	45
236	JBL	11
235	MacKenzie	13
248	Nady	47
249	NSCA	31
245	Numark	24
233	QSC	7
242	Shure	IV
232	Studer Revox	10
246, 244, 247	Telex	23, 25, 27
234	TOA	5



Portable Battery Power Supply From Technical Projects

Technical Projects has introduced its PS713, a portable Power Supply Interface which serves as the system master in mobile situations. It interfaces to an external DC supply in the range 12 to 30 volts and contains a circuit breaker of 1 amp. The unit provides one communications circuit with three sockets. It will provide power for up to 24 belt packs or a mixture of headset and loudspeaker stations.

A self-contained magnetic circuit breaker protects the wiring. The robust extrusion gives this unique power supply advantages to the user. It can be run from a battery for difficult remote video and/or broadcast situations.

Contact: Glenn Mullis, Technical Projects, P.O. Box 1449, Barrington, IL 60010; (312) 382-5350 or (800) 562-5872.

Circle 9 on Reader Response Card

New Intercom Mounting Kit From Dukane Corporation

The Communications Systems Division of Dukane Corporation announced the availability of a new flush mounting kit for its 12-station intercom. According to Dukane, the kit provides an attractive installation that blends well with the intercom and surroundings.

Dukane's Intercom System consists of 12-station masters and one-and three-call remote stations.

Each compact master station, with self-contained amplifier, provides intercom capabilities for up to 12 other master stations and/or remote stations. The master stations are equipped with cords and plugs for installation.

Dukane's intercom master stations allow hands-free reply to other masters, and feature privacy switches preventing monitoring of conversations. Separate volume controls allow master station users to vary both in-

coming and outgoing call volumes—and convey messages clearly in any size room.

Intercom Remote Stations are available with one or three call-in switches, for communication with one or up to three masters. Both remote stations have automatic tone annunciation of calls placed and received, and privacy switches to prevent monitoring of conversations.

Contact: Dukane Corp., 2900 Dukane Dr., St. Charles, IL 60174; (312) 584-2300.

Circle 10 on Reader Response Card



Valcom Debuts Power Supply for Electronic Phones

Valcom has introduced a power supply to function in emergency situations. When the AC power fails, Valcom Battery Back-Up Supply will maintain uninterrupted operation on your electronic key telephone system for one hour or more (depending on usage). The Battery Back-Up Supply may be used with the following telephone systems: CMX, Northcom, and TIE.

Contact: Valcom, 1111 Industry Ave., S.E., Roanoke, VA 24013; (703) 982-3900.

Circle 11 on Reader Response Card

Speco Introduces F-65 Multitester and Battery Tester

Speco has announced the addition to its product line of the F-65 Multitester.

The F-65 is a compact 10,000 ohm per volt multitester with five functions and 14 ranges. The F-65 is also a battery tester. The unit is fuse and diode protected; comes complete with bat-



tery, probes and instruction manual. The F-65 is blister packaged. It is promotionally priced and designed for the hobbyist, do-it-yourselfer, and technician.

Contact: Speco, 1172 Route 109, Lindenhurst, NY 11757; (800) 645-5516, in NY call (516) 957-8700.

Circle 12 on Reader Response Card

CTS Corporation's New Modular Vertical Cabinet Line

CTS Corporation, Metal Products Group, has announced a new line of off-the-shelf knock-down vertical enclosures. This modular enclosure line not only rivals the strength and quality of a welded cabinet, but saves up to 66 percent in shipping costs and 80 percent in storage requirements, according to the company.

The CTS construction interlocks both the cabinet top and bottom to create the strength and rigidity associated with standard welded units. All CTS cabinets are of a heavy gauge cold rolled steel with textured EPA approved acrylic enamel finished to match or harmonize with standard computer industry products. The self-registration design enables easy assembly of any of the three enclosure styles. Additionally, the modular construction reduces parts replacement costs in that all CTS cabinet parts, including frame components, are removable and interchangeable should partial replacement be necessary.

Contact: CTS Corporation, San Jose Division, 660 Lenfest Road, San Jose, CA 95133; (800) 533-3393. In the central or eastern United States, CTS Corporation, Monon Division, Highway 16 West, Monon, IN; (800) 558-7297.

Circle 13 on Reader Response Card

FACES AND PLACES

Rauland-Borg Announces Several New Managerial Appointments

William Krucks, president, Rauland-Borg Corporation, has announced the following field sales management appointments:

Milton R. (Rick) Blunt assumes the post of sales manager, directly responsible for supervision of the company's nine U.S. territories and their district managers. Blunt joined Rauland 10 years ago, serving most recently as western regional manager.

William C. (Bill) Zophy becomes the eastern regional manager for Rauland, with special responsibility for the southeastern territory. Zophy's last post was vice president, field sales, a position in which he served for five years, building a highly successful sales organization.

V. Michael Meglio takes over as district manager for the New England-New York territory. Most recently, Meglio served as national accounts manager.

Vincent A. Ward is assigned to the post of district manager of the pacific northwest territory. Long associated with Rauland, Ward moves from his position as western district manager for Rauland-Borg (Canada) Inc.

Krucks also announced the appointment of Kenneth A. Rosin as vice president-controller of the company. Rosin has been associated with Rauland for eight years, having come from the financial staff of the Admiral Division of Rockwell International. Rick Stalkfleet has been appointed assistant controller.

dbx/ADC Promotes Frank and Moran

Richard Frank has been promoted to director of marketing for dbx and ADC, according to an announcement by Stan Peters, vice president for marketing and sales of both companies. Frank had been dbx consumer sales director.

Frank joined dbx in 1984. He had previously been eastern regional sales manager for *High Fidelity* magazine and has held sales management positions with Carver Corporation and Dahlquist, Inc., manufacturers of stereo components and loudspeakers,

respectively.

It was also announced that David Moran has been promoted to communications manager for dbx and ADC, according to Peters. Moran had previously served as editor for company communications and as technical writer for the dbx Engineering Department.

In his new position, Moran's responsibilities will include writing, editing, and production of literature for the dbx and ADC Marketing and Engineering Departments. He will also serve as liaison with the companies' advertising agency.



MICHAEL J. FENIELLO

RICHARD FRANK



Feniello Assumes New Duties at Sony Pro Audio Division

Michael J. Feniello has been promoted to manager of marketing administration, Sony Professional Audio Division, George Currie, divisional president, announced.

Feniello joined Sony Professional Audio Division earlier this year as a product manager. In his new position, he will develop and implement strategies for advertising, public relations, and trade shows. Additionally, Feniello will be responsible for coordinating contracts and legal matters and overseeing training and custom product sales.

Feniello came to Sony from Valley Audio, Nashville, TN, where he held positions in sales and marketing. His background also includes positions in audio engineering and tour management.

McAlister Named District Manager for Altec Lansing Corp.

Gayle Campbell, national sales

manager for Altec Lansing Corporation, has announced the appointment of Allen McAlister as district manager for southern California, southern Nevada, Arizona, New Mexico, Hawaii, and western Texas.

As district manager, McAlister will work with Altec's industrial and professional sound contractors and theater equipment dealers, providing factory assistance and business development. In addition, McAlister will represent Altec Lansing to the acoustical consultants, architects, engineers, and film studios in his area.

Bose Names Two To Pro Products Marketing Staff

The professional products division of Bose Corporation has announced two marketing department appointments: Barry R. Luz as product planner and Mark R. Mayfield as marketing development specialist.

Formerly the company's field sales representative for the midwest states, Luz will now be responsible for coordinating product development activities for new professional products from Bose. He joined the company in 1983 from Bridgewater Sound in Chicago, IL, where he was sales manager and sound engineer.

As marketing development specialist, Mayfield will be involved in preparing new marketing programs and analyzing the potential of new market segments. A graduate of St. Lawrence University, he recently received his M.B.A. in marketing from Boston College. Previously, Mayfield worked as a recording engineer with Professional Sound in Boston, MA.

Richardson and Sims Join Biamp Systems, Inc.

Don Waggoner, president, Biamp Systems, Inc., has announced that Anthony Richardson and Mike Sims have joined the firm as senior engineers.

Richardson previously served as design engineer with B-D Drake Willock; Sims was senior engineer at Sunn Electronics. Both will design and develop new products for Biamp.

REP NEWS

Peter Horsman, Cetec Gauss director of speaker marketing, has announced **Shirley Munger** of **The Hustlers** as **Gauss Rep of The Year** for 1985. "Shirley has taken a territory that at best was marginal and turned it into a very viable market for Gauss loudspeakers," Horsman said. "Because of this outstanding job, Shirley really deserved this award." The Hustlers cover the southeast and are headquartered in St. Petersburg, FL.

In other news, Horsman announced the following rep appointments: **Dimension IX Corporation** will cover the states of Texas, Oklahoma, Arkansas, and Louisiana. **Phil Canavespe** from Dimension will work out of the Houston office and **Terry Green** will work out of the Dallas branch. In the pacific northwest, **Gemini Electronics Marketing** of Edmonds, WA, will be Gauss' rep. Contact **Dean Norquist** at Gemini. And in Michigan, **Don Jones** of **Shalco** in Ferndale, MI, will be Gauss' sales rep.

L.P. Marketing of San Francisco, CA, was credited with the most dramatic Shure sales increase in 1985. **Larry Petersen**, from the Bay area rep company received the award from **Lottie Morgan**, regional sales manager for **Shure Brothers, Inc.**

Charles A. Sereno, executive vice president of **Buhl Industries, Inc.** of Fair Lawn, NJ, has announced the appointment of **MIDCOM** as their manufacturer representative for Ohio, Kentucky, and western Pennsylvania.

David Moore, sales manager of **Paso Sound Products**, has announced that the company's entire **U.S. sales representative force** recently convened at the Arrowood Conference Center in Westchester, NY, for a two day product conference. The conference which is the first of several slated for 1986, served to introduce Paso's new unidirectional dynamic microphone line, The Handlers.

"Our goal is to supply complete product knowledge to our representatives so they in turn can assist our customers with sales and application," Moore said.

Additional product conferences are planned to coincide with the introduction of other new product groups.

Audio Video Marketing of Fort

Worth, TX, has been appointed sales representative for **MPC Educational Systems, Inc.** They will be serving Texas, Oklahoma, Arkansas, and Louisiana.

A Los Angeles sales executive has been selected as the first member of a new million dollar sales club sponsored by the **Aiphone Corporation**.

William E. Bassett, president of **Bassett Sales Corp.**, Los Angeles, CA, received the designation for selling more than \$1 million of Aiphone products last year. Bassett Sales Corp. is Aiphone's manufacturer's representative in southern California, southern Nevada, and Arizona.

To be admitted to the club, representatives must have at least \$1 million in sales in one calendar year.

As a member of the club, Bassett will be awarded a trip for two to Japan, a permanent seat on Aiphone's manufacturer's representative council.

Galaxy Audio Visual, Inc., distributor of the Galaxy 2200 Video Centre, has announced their new factory representatives. The midwest representative is **Midwest Communications Company (MIDCOM)** of Northbrook, IL. The southwest representative is **Eugene Kout & Associates** of Plano, TX. And in the far west the representative is **PMP Marketing, Inc.** of Park City, UT.

To have your rep news listed, please send your information to: **Rep News, Sound & Communications, 220 Westbury Ave., Carle Place, NY 11514.**

SOUND & COMMUNICATIONS

CLASSIFIEDS GET RESULTS

For rates and information, please call
(516) 334-7880

IED'S SMART ELECTRONICS SOLVES COMPLEX AUDIO DISTRIBUTION PROBLEMS



Innovative Electronic Designs Inc.

is the leader in the industry using digital logic and a **MICROCOMPUTER** with **NON-VOLATILE MASS STORAGE** to control all phases of audio system operation.

Typical IED systems are installed at LAX International Air Terminal, the Hoosier Dome in Indianapolis, and Ocean Center in Florida.

IED also has designed and manufactures the **only AUTOMATIC MIXER** in the industry using "**SMART ELECTRONICS**", plus a full line of **BUILDING BLOCK** audio distribution cards.

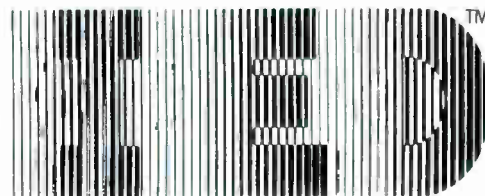

To become an **AUTHORIZED IED CONTRACTOR**

Contact Tom Roseberry
Innovative Electronic Designs Inc.
9701 Taylorsville Road
Louisville, KY 40299
(502) 267-7436

High-Tech Tiki



(Top) During the actual installation of the various components in the tiki.
(Bottom) The completed Menehune Tiki speaker system.

A Hawaiian sound contractor has come up with an innovative approach to satisfying the need for quality sound and visual integrity. Audissey, a 14-year-old, Honolulu-based firm, recently constructed a Menehune Tiki, a wooden Polynesian idol, with horns and drivers installed in its eyes, nose, and mouth. The tiki was designed by Rick Parlee and Boyd Collings of Audissey, with the help of a Samoan tiki specialist, for the Hale Aloha outdoor amphitheater in Laie, HI.

"The most difficult part of the whole thing was coming up with the concept of the tiki and then deciding where to put it," Collings said. The idea of the tiki speaker was based on a smaller prototype they had done for another project, he said. "The concept was to get optimum dispersion in the open-air facility. As it turned out, the best way to accomplish this was to place the tiki where the facility had planned to put a waterfall."

Audissey was able, however, to finally convince the people at the Hale Aloha to put the tiki in the waterfall's place. The tiki speaker features two Emilar EH-300 horns with Emilar EC-600 six-inch drivers in the eyes; two Design Direct Sound CFD2-61 horns with Emilar EC-320A two-inch drivers are installed in the nose. Inside the tiki's mouth are two Community Light & Sound BBH dual 15-inch horns with Professional Audio

(continued on page 47)

TekCom Installations

TekCom of Philadelphia, PA, recently completed two audio installations including an upgrade of the house sound system in the world renowned Academy of Music and a sound reinforcement system for the new cabaret in the Trump Castle in Atlantic City, NJ.

TekCom's Robert Forman oversaw the design for the upgrade of the house sound system for Philadelphia's Academy of Music, the home of the Philadelphia Orchestra. The installation of the system was directed by Tony Benson of Magnetic Productions. This system is intended for voice narration and music playback for traveling shows that are held at the Academy. The main objective of the upgrade was to improve the intelligibility of vocal reproduction and, as such, no changes were made to the existing bass enclosures.

The new components consist of four EAW MR101L mid bass reproducers crossed over at 1,500 Hz to four JBL 2425 drivers on 2370 horns. The crossover is a custom built EAW passive design incorporating both amplitude and phase compensation for very smooth (+-2 dB) frequency response in the 250 Hz to 12,000 Hz band. The resulting system maintains 90 degrees horizontal coverage over its entire operating range.

Richard Feld, the founder of TekCom, was responsible for the Trump Castle cabaret installation. The system consists of six EAW DS123 full range systems augmented by two EAW SB300L subwoofer systems. The installation is unique in that there are no compression drivers anywhere. Instead, the high frequencies are provided by RCF hard dome drivers in the DS123's.

According to Feld, "The Trump was looking for a PA system that sounded natural, not the typical PA sound. They evaluated a number of other systems before we brought in the DS123's. Initially, they thought the DS123's were too small to do the job, but after we hung them they were very impressed with the sound."

Book Now for NSCA

On April 29—May 2 the National Sound and Communications Association will be holding its fourth annual Sound Contractor Expo and Convention at the Sahara Hotel in Las Vegas, NV.

"We're expecting the biggest NSCA convention ever this year," said Bud Rebedeau, executive secretary of the NSCA. "Our exhibit space is already booked up and we have started a waiting list."

Rebedeau said he is expecting an attendance of over 3,000, which is about 1,000 more than last year. He also said that a very large number of Air Force reserves will be meeting in Las Vegas at the same time as the NSCA and advised attendees to get their reservations in as soon as possible.

For further information on the show, call the NSCA at (312) 593-8360. To make travel and hotel reservations contact the NSCA's Travel Counselor Service at 1-(800)-433-1790.

HI-TECH TIKI

(continued from page 46)

Systems HL-1580 15-inch drivers.

Audissey also used a Soundcraft 200-B, a 24-channel mixing console; Biamp 290 and 220 equalizers; and a Biamp SX-23, three-way stereo crossover. The Rane CD-48 was chosen for alignment, and the compressor/limiter is an Audio & Design Easy Rider. The Crest 4001, 3001, and 2001A were the power amps used for Lo, Mid, and Highs respectively. And monitor speakers are Professional Audio System's CX12-2M coax time offset corrected speaker systems.

PRODUCT

(continued from page 39)

SCS REFERENCE AMP OFFERS 900 WATTS OF POWER

The Model 2450A MOSFET Reference Amplifier, introduced by Sound Code Systems, is said to produce in excess of 900 watts total power. Three primary objectives focus upon achieving reliability (simplicity in design and quality parts) and performance (high slew rate + high current



output + high dynamic headroom = high fidelity) while maintaining a dollar-per-watt retail price. The new power MOSFET is used as a means to achieving these goals.

MOSFETs are a type of transistor with the advantage of having a self-protecting nature and near infinite cur-

DISTRIBUTED SPEAKERS

(continued from page 18)

A History of Broadcasting in the U.S., in three volumes, Erik Barnouw, Oxford University Press, 1966, 1968, 1970.

"A Brief History of Loudspeakers," Jesse Klapholz, *db Magazine*, September, 1984.

"Good Acoustics," Jesse Klapholz, *db Magazine*, January, 1986.

Personal communications with Hans Dietze & A.J. May (retired engineers from RCA).

rent gain, allowing for a less complex design using fewer parts. This increases reliability and performance
 Contact: Sound Code Systems, Inc. P.O. Box 2198, Garden Grove, CA 92640; (714) 554-0941.

Circle 14 on Reader Response Card

COM DEV VOICE SAVER FOR TELEPHONE OPERATORS

Voice Saver, which has been introduced by Com Dev, is a solid state voice greeting device that can benefit receptionists, telephone operators, service center employees, and anyone else whose job involves frequent answering of calls with the same phrase. Voice Saver assures that incoming callers receive a consistently clear, pleasant, and correct greeting.

Contact: Com Dev, 2006 Whitfield Industrial Way; Sarasota, FL 34243-9706; (813) 753-6411.

Circle 15 on Reader Response Card

NADY 501 VHF WIRELESS. AFFORDABLE, AND EASY TO USE.

The Nady 501 VHF Wireless System is the perfect wireless for most stages, churches and studios. List price is under \$900.



And we designed the 501 with the speaker or entertainer in mind — you don't have to be a sound engineer to set it up and use it.

The 501 VHF is available with a good-looking handheld microphone, transmitter or a bullet-proof lavalier microphone transmitter. A lightweight, portable AC or DC-powered receiver completes the system.

Nady VHF wireless is the choice of today's major musical groups. Nine out of ten (based on Billboard Magazine's 1985 Talent Almanac) use our wireless microphone and instrument systems.

There are reasons for this. Nady Wireless is road-proven dependable. With audio quality that measures up to these artists' demanding standards. (Try a side-by-side comparison yourself — Nady Wireless always sounds best.)

Send for the specs on our affordable 501 VHF Wireless System, or ask your Nady rep for a demonstration. You'll like what you see — and hear.

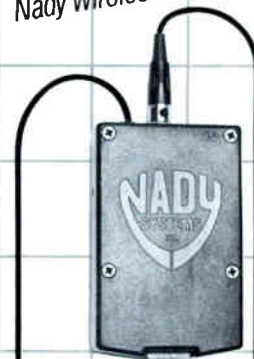

Nady Systems, Inc.
 1145 65th St.,
 Oakland CA 94608
 415/652-2411



MOVING?

Please attach your Sound & Communications mailing label or print your address exactly as it appears on the label.

NEW ADDRESS

NAME (Please Print)

COMPANY

ADDRESS APT. NO.

CITY STATE ZIP

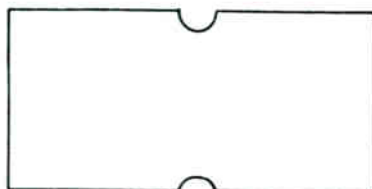

Return to:
 Circulation Dept.
 Sound & Communications
 220 Westbury Avenue
 Carle Place, NY 11514

A CLOSER LOOK

(continued from page 38)

TL606DW woofer can be replaced by the compact FR15-2, which will nearly always fit behind the screen.

EV claims these horns provide accurate, uniform dispersion of high frequencies all the way up to 20,000 Hz, eliminating the beaming (narrowing) that normally occurs above 10,000 Hz. Indeed, there have been many improvements in motion picture sound tracks over the last decade, especially in the magnetic or Dolby-encoded optical formats, which can take advantage of frequencies above the traditional 8 kHz "academy roll-off." However, the drivers tend to roll off above 16,000 Hz, and we wonder how much program energy most films deliver at the upper limits (we suspect it's mostly noise up there). It would seem that a sliding low-pass filter would be an important element in the overall theater sound system, enabling the operator (who is hopefully well trained and has a suitable monitor) to tailor the system bandwidth to the program on a week-to-week basis.

EV's Joe Katowich told us that the 11.2-inch deep HP940 horn does not maintain constant vertical directivity below 1,500 Hz, whereas the 31.8-inch HP9040 keeps it constant on both horizontal and vertical planes down to 500 Hz. Thus, one can get a more compact installation if willing to sacrifice some vertical control. Incidentally, the crossovers include some corrective EQ, basically 6 dB/octave below about, 3,500 Hz; this compensates for the intrinsic 6 dB/octave rolloff above 3,500 Hz exhibited by most CD horn/driver combinations, including the EV units, resulting in relatively flat frequency response.

While a lot of technical data on sensitivity, frequency response, and so forth was not in this release, EV has been a pioneer in publishing some of the most complete, appropriate, useful specs in the transducer industry, so we will withhold criticism; we assume full data is on their spec sheets.

We are encouraged that EV, along with other loudspeaker manufacturers, are promoting better theater sound. It will take something significant to pull people away from their VCRs and \$2/day rented videos and into the typical \$5/show theater seat. Top quality sound may keep the theater alive.

MILITARY MANUEVERS

(continued from page 31)

date drew alarmingly closer, the loudspeakers, horns, and mouth extenders were still on the east coast at Community's manufacturing facility. During the twelfth-hour effort to fulfill the order, M4 assemblies found themselves feverishly working through the Fourth of July weekend. Finally, with the help of Community's west coast sales rep, Eunice Davis, all of the shipping details were coordinated, and the M4s and their horns were sent via overnight air to Vj Electronics' doorstep.

"I decided upon going with the M4s for more than just one reason," Sawyer said. "Primarily, it was because their power-handling capability is high enough to handle the distances involved, and because their physical size is large enough to get the really low frequencies I was looking for. Also, given the geography we were working with other horns would have projected severely attenuated mid-range frequencies in the outer regions of the area of coverage. Because of the M4's strength in the midrange decade, however, we didn't encounter this problem. The end result is that it works and sounds great. When I heard it, it had a mellow sound for an outdoor paging system. The reason I think that it has the "close" feeling everyone talks about is because of its ability to project low frequencies in an articulate manner. This ability also seems to enable it to withstand variations in the temperature and humidity that may cause other horns to go slightly awry."

So there you have it—one of the world's top-secret sound systems discussed in a carefully-guarded manner. One thing puzzles me though. If the government is working so hard at keeping this system's existence concealed, how come it has the ability to split an eardrum at 1,200 feet? Whatever the reason, I'm sure Uncle Sam has done stranger things.

CALGARY CENTRE

(continued from page 35)

with additional speakers available from the common equipment pool in the building. Speaker patching allows enormous flexibility in the assignment of effects to various locations.

System control begins with a 16x8 version of the Soundcraft 800B used in the other rooms, with the capability to

be expanded to a full 24x8. The equipment compliment is otherwise virtually identical to the Max Bell Theatre with a total of seven Bryston power amplifiers being used.

All three rooms share some common features, a custom Clear-Com system is used in all three, featuring custom made producer's, director's, stage manager's desks that can be located in front of the house or backstage. Control room talkback systems are used in all three rooms, as well as a show relay system that allows the program from other audio control rooms to be picked up in *all* control rooms if desired. Tie lines run from dozens of locations in the building, both audio and video, to accommodate virtually any situation. All three theaters offer a hearing impaired system for their patrons, an FM wireless system in the Jack Singer Hall, and infrared wireless in the Max Bell and Martha Cohen Theatres. A common equipment pool is in place, providing items such as microphone stands mixers, speakers, and portable PA systems.

Another major aspect of such a large facility that can't be overlooked is the public address system. It was contracted independently of the entertainment reinforcement systems, with the equipment being supplied and installed by Hansen Sound Limited of Calgary. This system handles public address, emergency page, backstage paging, show relay, and evacuation over-ride for the entire building. Over 1,000 RSC eight-inch speakers are located in the ceilings connected with over 12 miles of speaker cable. Seventeen TOA P-912 and P-924 amplifiers are used with TOA E131 equalizers and UREI LA-4A limiters and Multivox zone and monitor select panels to control and feed the speakers through a custom fabricated relay switching assembly. Installation was accomplished in just over three months from June to the middle of September 1985 by George Maverley and crew.

Randy Cormack of TPC estimated the total man-hours invested in the audio installation at 8,000, a very impressive undertaking.

Reaction thus far by technical staff and patrons as well as artists and performers has been very positive. Design goals seem to have been well met and as the teething problems inherent in any project of this size and nature are ironed out, it would appear that Calgary has finally obtained the medium for its cultural growth.

DATE	EVENT/COMMENT	LOCATION	CONTACT
March 19-21	Planning For Success Management Conference for the A/V Communications Industry.	Saddlebrook Tampa, FL	ICIA (703) 273-7200
March 26-27	Sound Engineering Seminar Two day seminar in audio and acoustics by Synergetic Audio Concepts.	Red Lion/Jantzen Beach Portland, OR	Syn-Aud-Con (714) 728-0245
April 2-3	Sound Engineering Seminar Two day seminar in audio and acoustics by Synergetic Audio Concepts.	Holiday Inn Downtown Vancouver, B.C. Canada	Syn-Aud-Con (714) 728-0245
April 3-10	ERA's 27th Marketing & Management Conference.	Vienna, Austria	ERA (312) 649-1333
April 13-16	National Association of Broadcasters annual convention.	Dallas, TX	NAB (314) 721-7717
April 15-17	International Security Conference Sound, Signal, & Security.	Los Angeles, CA	ISC (213) 826-6070
April 22-23	SMATV/MATV/CATV/ TVRO Technical Seminar sponsored by Blonder-Tongue and Enjay Associates.	Tampa Airport Hilton Tampa, FL	Sharon Leight (201) 679-4000
April 28-29	Sound Engineering Seminar Two day seminar in audio and acoustics by Synergetic Audio Concepts.	Aladdin Hotel Las Vegas, NV	Syn-Aud-Con (714) 728-0245
April 28-May 1	Electronics Distribution Show and Conference A major showcase for electronic components, test equipment, and accessories.	Las Vegas Hilton Hotel Las Vegas, NV	Laurence Kauffman (312) 648-1140
April 28-May 1	Contractor's Expo and Conference for contractors, suppliers, engineers, and technicians sponsored by the National Sound and Communications Association.	Las Vegas, NV	Bob Barba (313) 254-5290 NSCA (312) 593-8360
May 12-16	L.A. Professional Video Show Exhibits & Seminars on video equipment & technology.	Long Beach Convention Center Long Beach, CA	Ann Bisgyer (800) 248-KIPI in NY (914) 328-9157
May 13-16	Teleconferencing '86 10th Annual conference on audio, graphic, video, & computer systems.	University of Wisconsin Madison, WI	ITCA (703) 556-6115

CLASSIFIEDS

RJ31X JACKS & CORDS
WIRE & CABLE
UL-PLENUM-FIRE
"B" CONNECTORS, TIE WRAPS
DRIVE RINGS & PINS
ARROW STAPLERS
FASTENERS
CALL TOLL FREE

cabletronix

800-431-WIRE (USA)
800-942-WIRE (NY)

Circle 201 on Reader Response Card

TIME SAVERS

- PUSH-PULL RODS Get Cable through tight places
- TEST SET, For the Audio Serviceman
- EASY KARY™ Wire Reel Holders 3 sizes
- SPEAKER SUPPORT TRUGS (T Bar Bridge)
Prevent ceiling sag Speed Installation
- SPEAKER GRILLES For 8 Speakers
- EXTENSION CORDS 3 ft. and 10 ft. U.L. Listed

CALL WRITE 30 DAY FREE TRIAL
Tex Call Collect (214)946-8450, All Other 1-800-527-1522

INSTALLATION & SERVICE AIDS

Circle 202 on Reader Response Card



SESCOM, INC.
1111 Las Vegas Blvd. North
Las Vegas, NV 89101 U.S.A.

"the audio source" FOR ALL OF YOUR AUDIO NEEDS
CALL OR SEND FOR A COPY OF OUR CATALOG
CATALOG REQUESTS & ORDERS: (800)634-3457
OTHER BUSINESS: (702)384-0993 FAX (910)397-0990

Circle 203 on Reader Response Card

CLOCK AND PROGRAM SYSTEMS by MONTGOMERY

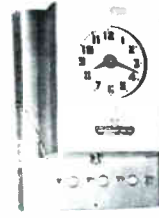

NEW! MULTI-CIRCUIT — Provides complete automatic operation of 1 to 5 separate schedules on 1 to 5 groups of signals. Signals adjust from 2 to 25 seconds. Calendar switch regulates automatic operation. Clock and program mechanism set by turning hands. Special signals, by push-buttons, do not disturb automatic operation. 12 or 24 hour models.
Write: MONTGOMERY MFG. CO., Owensville, Ind. 47665

Circle 204 on Reader Response Card

Position Available

TOA's Electronics Commercial Sound Division is accepting applications for a Regional Field Sales Manager, Eastern United States. A rapid expansion has created a need to establish this new position to work directly with TOA's team of sales representatives and customers. Regular regional travel required.

Send resume (in strictest confidence) to: Joe Green, TOA Electronics Commercial Div., 480 Carlton Ct., S. San Francisco, CA 94080

Circle 205 on Reader Response Card

Background Music for
SCA-CATV-Telephone
BGM INTERNATIONAL
A Division of
F. T. C. BREWER COMPANY
P.O. Box 8057
Pensacola, Florida 32505
904 433-7932

Circle 206 on Reader Response Card

Current Cable Company, Inc.

1801 W Diversey Parkway
Chicago, IL 60614
Suppliers of quality sound, intercom
and telephone cable.

For Prompt service call Toll Free

1-800-821-2432

In Illinois: 312-472-7790

Circle 207 on Reader Response Card



Lorum Street Tewksbury, Mass 01876

Tel: (617) 851-4541

Manufacturers of quality sound & communications cable.
Stock & price list mailed on request

Circle 208 on Reader Response Card

FREE 32pg Catalog & 50 Audio/Video Applic.

Stereo Mono Per Amplifier
PHONO SUPP EQ
TRANS ACN
TAPE VIDEO
LINE OSC

8-in 2-out 12-in 4-out 18-in 4-out
Video & Audio Dist Ampls
TV Audio & Recd Prod Consoles

OPAMP LABS INC (213) 934-3566
1033 N Sycamore Av LOS ANGELES CA, 90038

Circle 209 on Reader Response Card

REGIONAL SALES MANAGERS Commercial & Pro Audio

- Eastern U.S.
- Central U.S.
- Western U.S.

As the result of increasing demand for our innovative products, Panasonic Industrial Company is undergoing accelerated growth in major U.S. markets. This has created key opportunities for dynamic Regional Sales Managers in select areas.

OPENINGS EXIST IN THE EASTERN, CENTRAL AND WESTERN TERRITORIES FOR RESULTS-ORIENTED PROFESSIONALS

You will work with our manufacturers rep organizations, recording and broadcast dealers, sound reinforcement, sound contractors, and MI distributors, while assuming the responsibilities of sales administration. Oversee and conduct effective product demonstrations and instruct potential users, dealers and reps. Must be capable of integrating audio and video sales.

Qualified professionals will have a proven record of achievement in professional audio sales and sales administration, encompassing directing independent manufacturer representative organizations and selling to dealers.

These positions command excellent compensation packages along with the opportunity to make a significant impact within a major market territory. For immediate consideration, please forward resume, including salary history and territory of interest, in confidence, to: Panasonic Industrial Company, Personnel Dept., Attn: PAW, 6550 Katella, Cypress, CA 90630.

Panasonic®
Industrial Company

Circle 210 on Reader Response Card

CLASSIFIEDS

- Regular Classified—\$52 per column inch.
- Marketplace Display—
25 percent off rate card (up to 1/3 page).

Classified listings are accepted up to the
25th of the month preceding publication.

Name _____

Address _____

City/State/Zip _____

Telephone _____

Credit Card # _____

Check Heading You Want

- SERVICES MISCELLANEOUS
- FOR SALE SITUATIONS WANTED
- FOR RENT HELP WANTED
- BUSINESS OPPORTUNITIES

Please send copy & payment to:
Sound & Communications Classifieds
220 Westbury Avenue Carle Place, NY 11514
TELEPHONE (516) 334-7880

The art of engineering is serious business.



You made the decision to engineer audio because you care for the art of music and sound.

The realities are that you also need to operate as a business. The audio console that you choose for your creative fulfillment is the most expensive piece of capital equipment in your facility. Serious business.

We also consider the art of engineering a serious business. We have devoted 12 years to engineering and building truly the finest audio consoles. Year after year, we have reinvested our profit back into our design, manufacturing and distribution facilities.

The result is that TAC and AMEK together are among the world's largest professional audio

console companies. Serious business.

The SCORPION is one of the highlights of the TAC line. With 9 different modules, 2 mainframe configurations, 5 meter packages and 8 or 16 buses, the SCORPION can be configured to suit any professional application. Of course, each SCORPION comes standard with the EQ sound and chassis design that has made TAC/AMEK world renowned. Affordable value is serious business.

We ask only that you look deeper than just an ad, a brochure, or a sales presentation before you make your next major capital investment. At TAC, we treat the art of engineering as a serious business.

SCORPION 26 16/2
w/16 meter

TAC

AMEK CONSOLES INC., 10815 Burbank Blvd., North Hollywood, CA 91601 Tel. 818-508-9788 Telex: 662526 AMEK USA
TOTAL AUDIO CONCEPTS LTD., Islington Mill, James Street, Salford M3 5HW England Tel. 061-834-6747 Telex 668127 AMEK G

INTRODUCING THE SMART MIC* SYSTEM

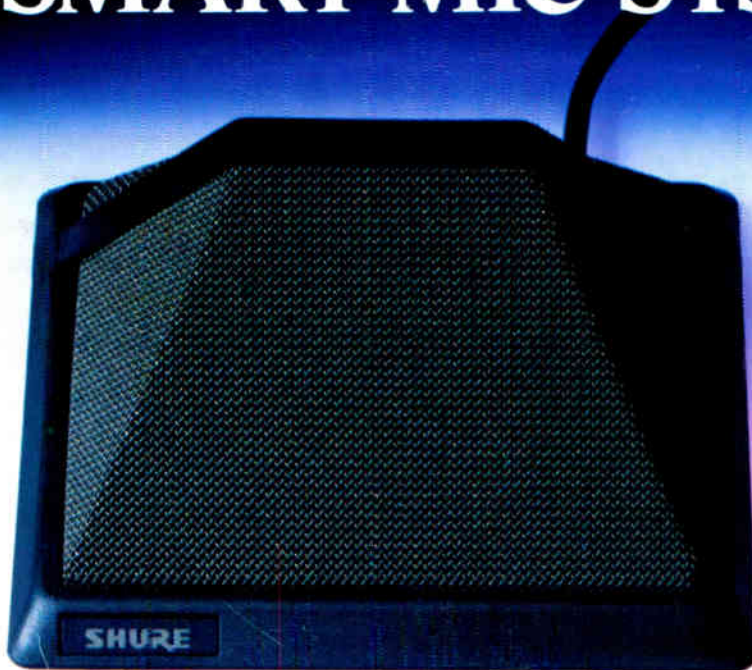

Actual Size

The most troublesome audio conditions can only be solved by today's most trouble free microphone system. The Shure Automatic Microphone System.

Total integration is the key.

For the first time ever, Shure has combined microphone, mixer and logic technology in a dedicated, totally integrated system—so advanced, its conception marks the beginning of a sound revolution in conference rooms, teleconferencing, churches, legislative chambers, courtrooms—anywhere speech related multi-microphone systems are employed.



At the heart of Shure's Automatic Microphone System (AMS) are revolutionary, angle-sensitive microphones that turn on automatically *only* when addressed within their own 120° "window of acceptance." In addition, each microphone continuously samples its own local acoustic environment, and compensates for changing room audio conditions—automatically.

The Shure AMS incorporates advanced signal processing circuitry—turning on to the sound source quickly, quietly, and automatically—and turning off with a smooth whisper. From

beginning to end—no clicks, pops, noise "pumping," or missed syllables.

Logic terminals on the rear panel of every AMS mixer offer unprecedented flexibility for advancing the system's capabilities. For example, when connected with Shure's Video Switcher Interface, the AMS will control commercially available video switchers. And for large gatherings, AMS mixers (both 4 and 8 channel models available) can easily be combined to effectively control over 200 individual microphones.

Since the AMS operates as an integrated system, many adjustments and controls have been eliminated. As a result, no other unit sets up as quickly. And operation is so easy and automatic, the only adjustments necessary are individual volume controls.

For more information on the revolutionary new Automatic Microphone System, call or write Shure Brothers Inc., 222 Hartrey Ave., Evanston, IL 60204, (312) 866-2553.

*Microphones and Intelligent Circuitry

SHURE®

THE SOUND OF THE PROFESSIONALS™... WORLDWIDE

Circle 242 on Reader Response Card
World Radio History



PATENTS
PENDING