

MIX

**Engineers' Tips
on Recording the
Acoustic Guitar**

**Field Test: Tascam's
DA-88 Digital Multitrack**

PROFESSIONAL RECORDING • SOUND AND MUSIC PRODUCTION

**A Look at Sony's New
MO Mastering System**

**Directory: Southeast
Recording Studios**



PRIMUS GO DIGITAL!

MARK GANDER
21000 W WINFIELD RD
TOPANGA CA 90290

*****5-DIGIT 90290
MX GANDEM003019303 1797 DIR



The ADAT Group™

digidesign

ALESIS

FOSTEX TIME LINE

AMPEX ALE

Technology is changing the music industry day by day. But, change without focus and compatibility delivers only chaos. Where should you turn?

The ADAT Group. Composed of a diverse group of manufacturers who have delivered extraordinarily focused products to the music industry, their products are successful because they shape technology into an extension of your creative personality.

Now, as members of the ADAT Developer's Program, they all agree on one thing: the technology of ADAT.

As a digital multitrack format. As a way of harnessing the incredible power of digital audio to make all the products of the ADAT Group work together as a compatible system.

In this day of leapfrog technology, the last place you want to be is on the bottom. Over 15,000 ADAT customers worldwide have chosen to stay on top. More than all other digital multitrack owners combined. To keep them there, The ADAT Group keeps pulling out all the stops. Making it safe for you to leap.

The ADAT Group - Focus on Compatibility™

For more information on The ADAT Group and the ADAT Developer's Program call 1-800-525-3747
Trademarks are property of their respective holders.

The ADAT Group™

USE READER SERVICE CARD FOR MORE INFO

M U L T I M E D I A ?



SL 8000 G Series MULTI-FORMAT PRODUCTION SYSTEM

- TV AUDIO with up to 4 stereo stripes
- TV/VIDEO SURROUND SOUND
- HDTV / DOLBY SR.D 5/6 channel audio
- FILM AUDIO - from 4 stripe LCRS to multiple DMEF dubs
- ADVANCED MUSIC FORMATS - '3-D' sound processing systems

World Radio History

Solid State Logic

International Headquarters:

Begbroke, Oxford, England OX5 1RU · Tel: (0865) 842300

Paris (1) 34 60 46 66 · Milan (2) 612 17 20 · Darmstadt (6151) 93 86 40

Tokyo (3) 54 74 11 44 · New York (212) 315 1111 · Los Angeles (213) 463 4444

US Toll Free Number 800-343 0101

This is no Fairy Tale



This is real life. The frog won't turn into a prince and his voice won't sound like Diana Ross — at Brüel & Kjaer capturing reality is what we're all about.

Today's studios are full of good sounding microphones but, fortunately, we are not one of them. With Brüel & Kjaer you are the artist. We supply you with a blank canvas and you get to add the colors, not us.

The B&K 4000 series offers 6 different condenser mics, featuring true omni or cardioid pickup which can be passively and accurately altered by our exclusive *acoustic pressure equalizer* (APE) adaptor. They're available in both 48 Volt Phantom or 130 Volt powered versions offering unmatched 168dB dynamic range for the most demanding snare drum crack to the subtlest details of nature's acoustical ensembles.

IF YOU'RE SERIOUS ABOUT YOUR
REFERENCE RECORDINGS:

4 0 0 0 S E R I E S

YOU CAN'T AFFORD NOT TO!!!



Brüel & Kjaer

Exclusive U.S. Distributor • Brüel & Kjaer/T.G.I.
North America Inc. • 300 Gage Avenue, Kitchener,
Ontario, Canada N2M 2C8 • Tel (519) 745-1158
Fax (519) 745-2364

USE READER SERVICE CARD FOR MORE INFO

WHEN YOU'RE MIXING FOR CD, EVERY LITTLE BIT COUNTS

INTRODUCING THE WORLD'S FINEST SOUNDING MIXDOWN, EDITING, AND MASTERING SYSTEM: THE DIGIDESIGN PROMASTER 20.

WHEN IT COMES TO MIXDOWN TECHNOLOGY, YOU'VE PROBABLY HEARD A lot of claims over the years about sonic breakthroughs. But the really significant breakthroughs — such as Dolby SR[®] and DAT technology — form a very short list indeed.

Now, we'd proudly like to add another to the list: the Digidesign ProMaster 20.

The First True 20-bit

Random-Access Recorder. In terms of simple, unadulterated sonic quality, the ProMaster 20 is far beyond any workstation, DAT recorder, or any other recording device you've ever used. Equipped with acclaimed converter and circuit-design technology by Ultra Analog Inc., the ProMaster 20 is designed for mixdown and editing sessions which require no compromise. Absolutely no compromise.

So How Good Is It? First, you'll hear a dramatically low noise floor. (We're talking 120dB internal dynamic range — and over 108dB post-converter signal-to-noise.)

Next, even after you leave 6 to 12dB of headroom, you'll still hear details throughout your work as you've never heard before.

And thanks to the ProMaster 20's high linearity across the least significant bits, you'll enjoy superb clarity in the most quiet and subtle passages of music.

(In fact, the ProMaster 20 — once you account for converter stages and necessary headroom — is the only random-access recorder to give you the full 96dB of dynamic range that CD and DAT offer. Listen to the

real-world dynamic range of 16-bit systems, after converters and headroom, and you'll hear what we mean.)

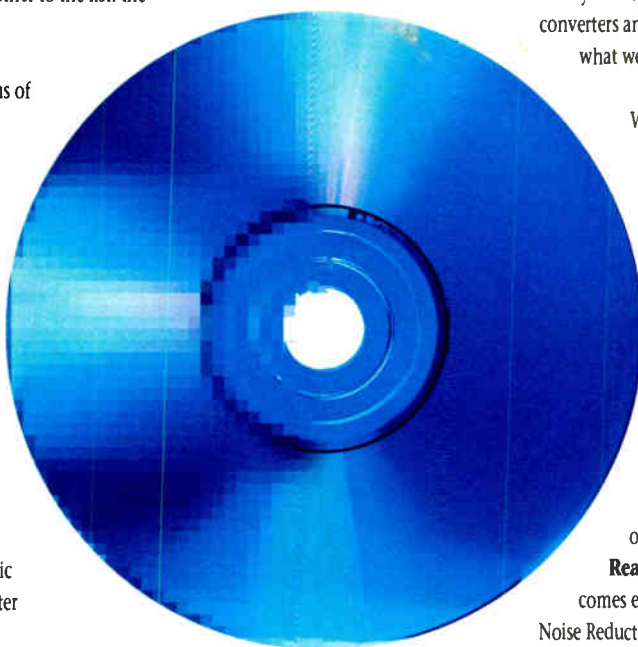

Better From Start To Finish.

Wondering what happens to all this great 20-bit audio once you convert it to CD- and DAT-compatible 16-bit audio? Our Digidesign Intelligent Dithering[™] algorithms assure that your 20-to-16-bit converted recordings actually sound better than if they had been recorded originally as 16-bit! (There's a reason we called it "intelligent.") Other details include a full 24-bit data storage and signal path; true, linear 20-bit A/D and D/A converters; ultra-high fidelity sync (via our SMPTE Slave Driver); and much more.

Ready For DINR. The ProMaster 20 also comes equipped to run Digidesign Intelligent

Noise Reduction[™] — already the world's most popular digital noise reduction system. And since the ProMaster 20 is a member of our popular Sound Tools II[™] family, and runs the same software, you'll enjoy the fastest and most powerful 2-channel graphic editing and assembly environment on the market.

So give us a call. We'd love to show you how some of the least significant bits you'll ever hear can make the most significant difference.



If you'd like to receive a FREE VIDEO describing the Digidesign ProMaster 20, DINR, and other professional developments — plus a technical paper which objectively shows the advantages of 20-bit audio — please call us at (800) 333-2137, ext. 108 (US & Canada), or internationally at +1-415-688-0600. We'll also be happy to arrange a no-obligations demonstration of the ProMaster 20, DINR, or any other Digidesign product.

The Digidesign ProMaster 20 is available as a stand-alone system, for use with any Mac II[™] or Quadra[™] computer, or as an Upgrade Kit for use with Pro Tools[™] or Sound Tools II systems.

digidesign

• 1360 WILLOW ROAD • MENLO PARK • CA • USA • 94025 • 415.688.0600

SAN FRANCISCO • LOS ANGELES • NEW YORK
CHICAGO • NASHVILLE • PARIS • LONDON

USE READER SERVICE CARD FOR MORE INFO
World Radio History

MIX

PROFESSIONAL RECORDING • SOUND AND MUSIC PRODUCTION

JUNE 1993, VOLUME 17, NUMBER 6

AUDIO

- 18 **Insider Audio:** In-Band Digital Radio
by Ken Pohlmann
- 28 **1993 Technical Excellence & Creativity Awards Nominees**
- 29 **The Fast Lane:** Half... *by Stephen St. Croix*
- 34 **Lunching with Bonzai:**
Hitman Phil Ramone, Part 2 *by Mr. Bonzai*
- 44 **Producer's Desk:** Nashville's James Stroud
by Dan Daley
- 64 **The Byte Beat:** Potpourri of Software Packages
by Paul Potyen
- 74 **DSP Explained** *by Ted Tanner*
- 77 **MIDI-Free Dynamic Reverb** *by Michael Cooper*
- 133 **The Operator:** Record Label Relations
by Chris Stone



PAGE 110



PAGE 96

MUSIC RECORDING

- 48 **Recording Acoustic Guitar:**
Tips From Top Engineers *by John La Grou*
- 110 **Recording Notes:** Paul Rodgers' Tribute to Muddy Waters; Karl Wallinger's World Party; Power of Seven; Jed Leiber's Hotel Hangout
by Blair Jackson, Bruce Pilato and Robin Tolleson
- 122 **Project Pork:** Primus Go Digital on Their Own Terms *by Jeff Forlenza*
- 125 **ADAT:** The Project Studio/Commercial Facility Connection *by Dan Daley*

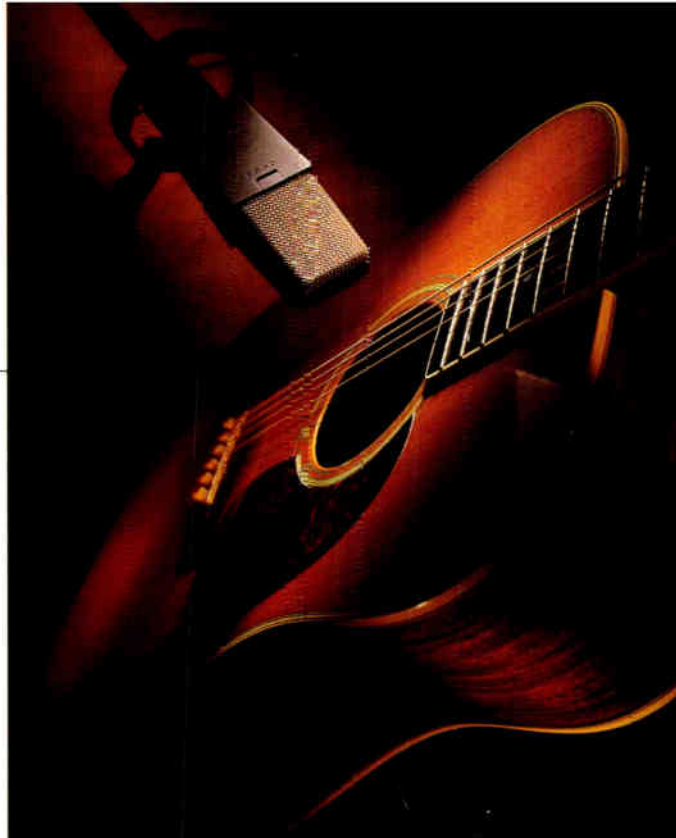

PRODUCTS

- 80 **Field Test:** Tascam DA-88 Digital Recorder
by George Petersen
- 87 **Auditions:** Bag End ELF Subwoofer System;
BBE Sonic Maximizer Model 862; Demeter
VTBP-201 Tube Bass Preamp
by George Petersen and Glenn Letsch
- 92 **Preview/Hot Off the Shelf**
- 131 **Audio Post-Production Products**

LIVE SOUND

- 96 **Club Sound:** A Tale of Three Cities
*by Jeff Forlenza, Karen Mitchell
and Maria Conforti*
- 103 **New Sound Reinforcement Products**
- 104 **Live Sounds:** Lindsey Buckingham at Bimbo's
by David (Rudy) Trubitt

TAPE & DISC

- 136 **Mastering and MO:** Sony's PCM-9000 Brings
Progress—At a Price *by Philip De Lancie*
- 142 **Duplicating DCC:** DCC Duplicators on
Post-Launch Production *by Philip De Lancie*
- 149 **Tape & Disc News/Splices** *by Philip De Lancie*

DEPARTMENTS

- 8 **From the Editor**
- 12 **Current**
- 16 **Industry Notes**
- 152 **Coast to Coast**
(Including Atlanta's
Burning, Nashville
Skyline, Tampa
Heats Up,
Miami Memo)
- 176 **Ad Index
& Reader Service Card**
- 177 **Classifieds**

Cover: Recording Arts is one of Nashville's most-respected studios and recipient of numerous gold and platinum record awards. The control room was designed by Art Noxon of Acoustic Sciences Corporation. Featured equipment includes a Soundcraft 3200 console with 64 channels of Optifile 3D automation, Bryston amplification, Yamaha monitors, and Mitsubishi and Otari multitracks. **Photo:** Rob Stack/Clark Thomas. Inset photo: Jay Blakesberg.

DIRECTORY

- 159 **Southeast
Recording Studios**



-12
-15
-18
-22
-27
-32
-38
-44
-51
-60

8 Tracks

RECORD INPUT

1	2	3	4	5	6	7	8
■	■	■	■	■	■	■	■
■	■	■	■	■	■	■	■



The Choice of Professionals
Winner of Two 1992 TEC Awards
Recording Product of The Year
Recording Devices/Storage Technology

Demos to masters. Creativity to tape. Dreams to reality. Magic phrases for those who want to make music that sounds as good as it feels.

The inspiration for these thoughts is the **Alesis ADAT Professional Digital Audio Recorder**, a technological revolution that tears down the walls to your creativity while delivering world class master recordings. Too good to be true?

Here's the concept. ADAT fuses a supersonic Alesis-designed very large scale integrated chip set with the proven reliability of an industrial grade S-VHS* tape transport and a logical, sensible user interface. The result is a digital tape recording system that exceeds the most demanding requirements of professional audio and that can be used by literally anybody. Hard to believe?

Here's some specs. Bandwidth 20Hz to 20kHz ± 0.5 dB. Total Harmonic Distortion plus Noise 0.009%. Wow and flutter unmeasurable. ADAT uses the professional standard 48kHz sample rate and delivers better than 92dB dynamic range.

Here's some features. ADAT uses the familiar tape recorder controls that you already know how to use so

recording is fast, intuitive, effortless. Connections are provided for balanced +4dBu levels on a single 56 pin ELCO** connector and unbalanced -10dBV signals on 1/4" jacks. And ADAT uses S-VHS tape because it's a proven, robust recording medium with wide 1/2" tape to solidly support ADAT's 8 recording tracks while delivering 40 minutes of recording time.

The best part. ADAT's Proprietary Synchronization Interface (Patent Pending) locks multiple ADATs, independent of the audio tracks, to single sample accuracy $\pm 5\%$ of 1/48,000th of a second! In other sciences this is referred to as 'air tight'. So multiple ADATs function in perfect mechanical and electronic unison: up to 16 ADATs without an external controller. That's 128 tracks!

More best part. ADAT's Proprietary MultiChannel Optical Digital Interface (Patent Pending) simultaneously sends all 8 tracks of recorded information out the Digital I/O for perfect safety tapes and perfect track bounces.

Even more best part. The optional BRC Master Remote Control opens a whole other door to the ADAT miracle. With it you can control up to 16 ADATs (128 simultaneous tracks) with full transport functions, track offsets, machine offsets,

8 Tracks to Megatracks, Megatrack and ADAT Worldwide Network are trademarks of Alesis Corporation
*VHS is a registered trademark of JVC **ELCO is a registered trademark of Elco Corporation-a Kyocera Group Company
Also available: The AI-1 ADAT to AES/EBU and S/PDIF Digital Interface with sample rate converter.
RMB 32 Channel Remote Meter Bridge.
Call 1-800-5-ALESIS for information about the ADAT Worldwide Network.



USE READER SERVICE CARD FOR MORE INFO

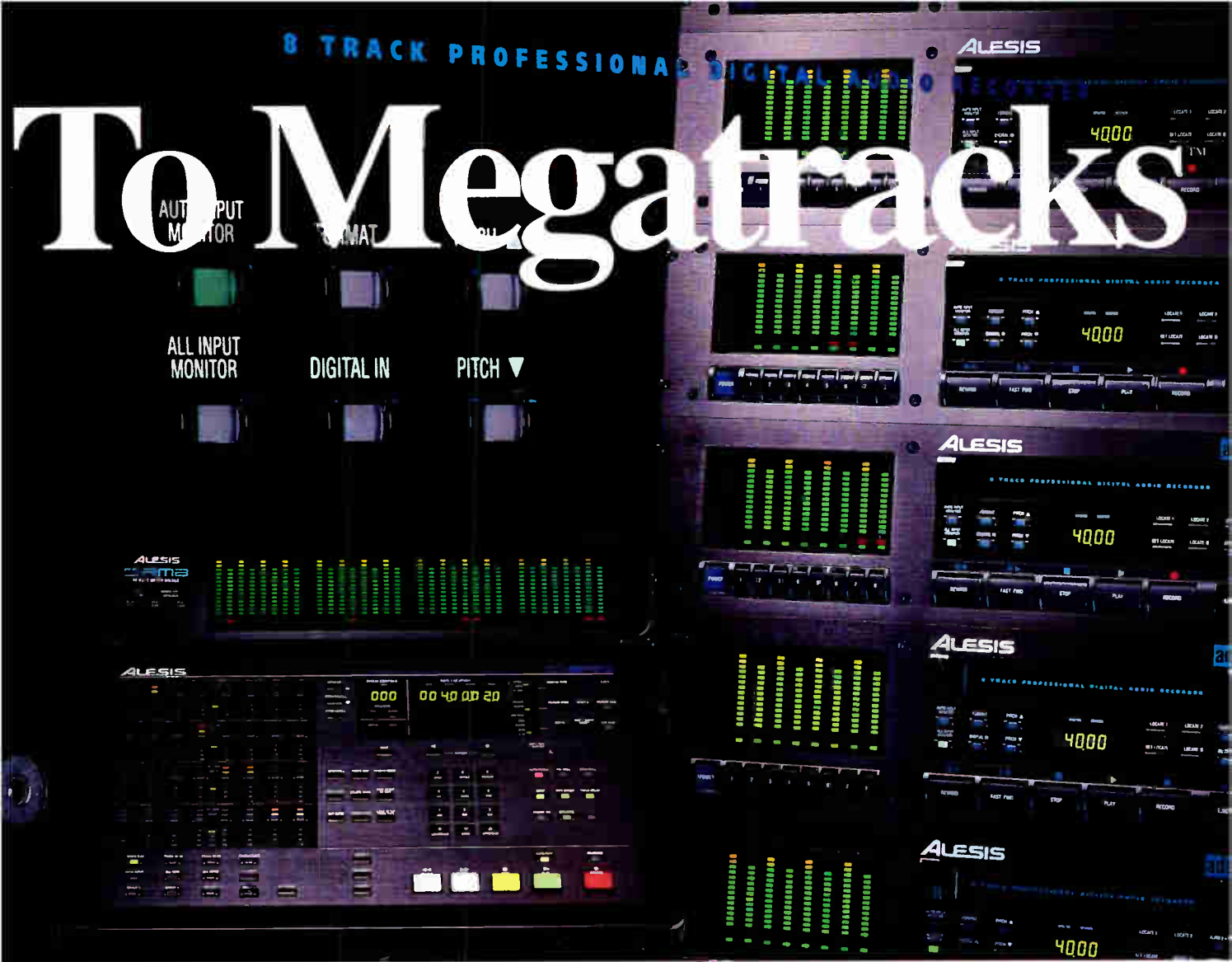

digital assembly editing via the Digital I/O, SMPTE and MIDI Time Code, Video Sync and more.

What does all this mean? Here's just a few benefits.

It's commonly known that many hours are wasted during expensive album projects while the artist, producer and engineer work in vain to reproduce the rhythmic feel and tonal nuance of demos. Demos that couldn't be used because they suffered from noise, limited bandwidth and overall sonic feebleness. Those days are over forever. ADAT's Sync and Digital I/O perpetually link your demos to your masters making them all part of the same creative process. Every track you record on ADAT is a master track that can be flown into any other ADAT recording, at any time. The best part is that ADAT can be there at any time to catch you at your best, flawlessly stored in the digital domain...forever.

Need more tracks? ADAT studios can be expanded at any time. The cost of a single ADAT is remarkably inexpensive and new ADATs can be added as budgets permit. Add the BRC at any time for more control and advanced editing. Producers please note: with ADAT, Megatrack™ recording is a reality.

Your favorite sax player lives in Idaho? No problem. Send "Supersax" a formatted tape with a guide track of your song. You'll get back 7 tracks of burning solos you can fly back into your production. All in perfect sync, all in the digital domain. All dripping with soul. Want more tracks? Just send more tapes.

ADAT is not only a new recording medium, it is the new recording standard. Imagine a network of ADAT users from bands, composers and project studios to professional studios, video editing suites and broadcast production studios. All recording master quality tracks with full compatibility and no barriers between their creative disciplines. In fact, we're launching the ADAT Worldwide Network™ multitrack recording group to facilitate communication between ADAT studios.

In time we'll all start taking these little miracles for granted. Before that inevitable event, unpack your first ADAT and track a minute of single notes and chords on your favorite instrument. Play loud, play soft. Play it back and listen really close. It's always a good feeling to have your mind completely blown.

See your Alesis ADAT Dealer today and start Megatracking on ADAT.



FROM THE EDITOR

Being a recording or live sound engineer requires somewhat of a split personality. While listening intently for sonic judgment calls, engineers typically seem to have another full-time consciousness on their control systems as they constantly imagine how to make their controls more convenient and their systems more powerful.

As a theme for this issue, we present articles such as John La Grou's "Recording the Acoustic Guitar" and assistant editor Jeff Forlenza's profile of the latest Primus recording sessions, as well as managing editor Blair Jackson's always interesting "Recording Notes," to illustrate the changing, challenging and, yes, exciting nature of music recording.

"Where is the excitement?" you ask. One such area these days relates to centralized control of audio systems using fiber-optic, object-oriented programming and networking technology. This young, yet crucially important field took an important psychological step forward at the recent National Sound Contractors Association gathering in Orlando. Though no standard protocol was agreed on at that event, all of the signs of a cooperative, continued development were in evidence. And the level of demonstrations of the existing systems was so impressive that it would be hard to imagine not using this technology, given the option.

Unlike the cockpit approach to control room design, where the most controls possible are at arm's reach, we are now on a rapid course toward control being at the push of a button, or at least at the click of a mouse. Building a virtual studio, or live sound system, on one's computer screen is now possible.

Imagine designing your own "dashboard" where every major facet of your control concerns—everything from signal processing device settings, to light levels in the room, to metering response of dynamic situations—is represented as icons on your computer screen. Click on an icon, and the full control panel of that device or effect pops open for your complete adjustment. Through the brilliant software engineering of folks such as Mark Lacas of Lone Wolf, and Crown's Clay Barclay, digital signal control is beginning to enter the mainstream of our industry. We support the AES SC-10 subcommittee's work toward compatibility of this common denominator technology.

We'll be monitoring developments in this area closely, as other manufacturers take advantage of this very modern approach to system design.

Keep reading,

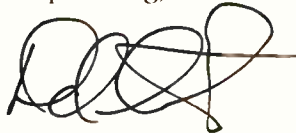

David Schwartz
Editor-in-Chief

 **BPA** Circulation independently audited and verified by Business Publications Audit of Circulation since 1985.

Mix magazine is published at 6400 Hollis St., #12, Emeryville, CA 94608 and is ©1993 by Act III Publishing. Mix (ISSN 0164-9957) is published monthly. Subscriptions are available for \$46.00 per year. Single copy price is \$4.95, back issues \$6.00. Missed issues within the U.S. must be claimed within 45 days of publication date and abroad, within 90 days. Send subscription applications, subscription inquiries and changes of address to Mix magazine, PO Box 41525, Nashville, TN 37204 or call (800) 888-5139. Outside U.S., call (815) 377-3322. POSTMASTER: Send address changes to Mix magazine, PO Box 41525, Nashville, TN 37204. Address all other correspondence to Mix magazine, 6400 Hollis St., #12, Emeryville, CA 94608; (510) 653-3307. Fax: (510) 653-5142. Second class postage paid at Oakland, CA, and additional mailing offices. Editor Responsible (Belgique), Christian Desmet, Vuurgatstraat 92, 3090 Overijse, Belgique. This publication may not be reproduced or quoted in whole or in part by printed or electronic means without written permission of the publishers. Printed in the USA.

STAFF

EDITOR-IN-CHIEF David M. Schwartz

PUBLISHER Hillel Resner

MANAGING EDITOR Blair Jackson
PRODUCT EDITOR George Petersen

ASSOCIATE EDITORS

Paul Polyen Tom Kenny

ASSISTANT EDITORS

Jeff Forlenza Adam Beyda

EDITORIAL ASSISTANT Barbara Schultz

SOUND REINFORCEMENT EDITOR

David (Rudy) Trubitt

TAPE & DISC EDITOR Philip De Lancie

SENIOR EDITOR Mel Lambert

TECHNICAL EDITOR Ken Pohlmann

CONSULTING EDITOR Stephen St. Croix

EDITOR-AT-LARGE Mr. Bonzai

TEC AWARDS EDITOR Karen Margroff Dunn

EAST COAST EDITOR Dan Daley

LOS ANGELES EDITOR Fred Jones

CONTRIBUTING EDITORS

Bob Hodas Chris Stone

Larry Oppenheimer Bruce Pilato

ART DIRECTOR Tim Gleason

ASSISTANT ART DIRECTOR Linda Gough

GRAPHIC ARTIST Ric Braden

ASSOCIATE PUBLISHER Jeffrey Turner

SOUTHERN CALIFORNIA/SOUTHWEST AD MGR.

Terry Lowe

EASTERN ADVERTISING MANAGER Michele Kanatous

NORTHWEST/MIDWEST AD MGR. John Pledger

SALES ADMINISTRATOR Joanne Zola

SALES ASSISTANTS

Christen Pocock Karen Lieberman

CLASSIFIEDS AD MANAGER Robin Boyce

CLASSIFIEDS ASSISTANT Mitzi Arnott

CLASSIFIEDS SALES ASSISTANT Shawn Langwell

DIRECTORIES ADVERTISING MANAGER Lauri Newman

DIRECTORIES ASSISTANT Melissa McMillion

DATABASE COORDINATOR Cyndi Lukk

DATABASE ASSISTANT Leor Beary

MARKETING MANAGER Elise Maimberg

ART DIRECTOR, SPECIAL PROJECTS

Michael Zipkin

ASSISTANT TO THE PUBLISHER/

EVENT COORDINATOR Jane Byer

MARKETING ASSISTANT Diana Sergi

DIRECTOR OF

OPERATIONS AND MANUFACTURING

Anne Letsch

PRODUCTION DIRECTOR Georgia George

COLLATERAL PRODUCTION MANAGER Ellen Richman

ADVERTISING TRAFFIC COORDINATOR Elizabeth Hildreth

PRODUCTION ASSISTANTS Beth Diggs Chris Ferrell

CIRCULATION MANAGER Steve Willard

CIRCULATION ASSOCIATE Karen Stackpole

CIRCULATION ASSISTANT Peggy Sue Amison

CONTROLLER David Rothenberg

SENIOR ACCOUNTANT Benjamin A. Pittman

ACCOUNTS RECEIVABLE MANAGER Lea Lewis

ACCOUNTING

Bettye Gardner Therese Wellington

WAREHOUSE MANAGER Anne Eickelberg

WAREHOUSE ASSISTANT Andy Jewett

RECEPTIONISTS Nicole Helley April Gladders

AN ACT III PUBLICATION

ALSO PUBLISHERS OF:

ELECTRONIC MUSICIAN

MIX BOOKSHELF

FOX MAGAZINE

GROUP PUBLISHER Hillel Resner

DIRECTOR OF CORPORATE DEVELOPMENT

David Schwartz

NATIONAL EDITORIAL, ADVERTISING and BUSINESS OFFICES, 6400 Hollis St., #12, Emeryville, CA 94608. (510) 653-3307. IMC 736. FAX: (510) 653-5142. **SOUTHERN CALIFORNIA ADVERTISING OFFICES**, 1999 Avenue of the Stars, Suite 500, Los Angeles, CA 90067. (310) 551-4035. FAX: (310) 556-3855. **EAST COAST ADVERTISING OFFICES**, 110 East 59th St., 6th Floor, New York, NY 10022. (212) 909-0430. **DIRECTORIES ADVERTISING**, (800) 344-LIST. **CLASSIFIEDS ADVERTISING**, (800) 544-5530. **MIX BOOKSHELF**, (800) 233-9604. **CIRCULATION INQUIRIES**, PO Box 41525, Nashville, TN 37204. (800) 888-5139. (615) 370-5643.

Founded in 1977 by
David Schwartz and Penny Riker Jacob



*More records go gold on Ampex than on
all other tapes combined.*

AMPEX

Ampex Recording Media Corporation 401 Broadway, M.S. 22-02, Redwood City, CA 94053-3199 ©1993 Ampex Recording Media Corporation

World Radio History

USE READER SERVICE CARD FOR MORE INFO

THE WORLD'S LEADING PROFESSIONAL AUDIO WORKSTATION NOW HAS MAJOR NEW FEATURES, DRAMATICALLY IMPROVED PERFORMANCE, AND LOWER SYSTEM PRICES.

SINCE 1991, THOUSANDS OF AUDIO PROFESSIONALS HAVE COME TO depend upon the power and flexibility of Digidesign's Pro Tools™ for audio post, music, and broadcast production. Indeed, you'll find hits made with Pro Tools on just about any top movie or music chart, just about any week of the year. In many circles, Pro Tools is even considered the *de facto* standard of multichannel professional audio workstations.

Rather than let this success go to our heads, we let it go to our brains. And ears. And hands.

You see, we've been thinking. And listening. And working hard. All to build something even better. Now, it's ready, and it's called Pro Tools 2.0.

Two Point Oh Wow. Pro Tools 2.0 is a new, software-based advanced user interface. Without any modifications or additional hardware, 2.0 runs with all past and present Pro Tools hardware. If you're already familiar with Pro Tools, the first advancement

More Than Speed and Efficiency. The benefits of Pro Tools 2.0 go far beyond the obvious. For instance, we improved Pro Tools' already acclaimed audio quality: Our new digital EQs are as effective and musical as they are clean. We've added a host of intuitive automation, autolocation and transport features. Pro Tools now has a no-wait waveform overview mode. There's complete time-stamping. Enhanced grouping. Better scrubbing. More session management options. Bigger, brighter, faster, and



Thanks to our new Apogee-clock-equipped SMPTE Slave Driver™, Pro Tools 2.0 delivers ultra-high-fidelity, ultra-low-jitter, ultra-easy digital synchronization in playback and record, complete with varispeed.

more accurate VU metering. Improved MIDI sequencing and control. Extensive undo commands. In fact, Pro Tools 2.0 has dozens of new features, and scores of enhancements, for audio post, music, and broadcast production applications.

YOU MIGHT CALL THAT IMPRESSIVE.

you'll notice is that 2.0 combines full-featured recording, mixing, signal processing, automation, along with advanced waveform and event editing — all in one, easy-to-use, integrated program.

There is simply no other interface as fast, as powerful, as flexible, and as complete.



Are you a Pro Tools owner who has been holding your breath as you read this ad? All registered owners will be offered a 2.0 Upgrade Kit, including software, new manuals, and an instructional video. All for just \$49. So breathe easily.*

There's Much More To Come. We became the industry leader by responding to the needs of the people who use digital audio. And by listening carefully to people like you, we have a clear vision of what a professional digital studio should offer.

First of all, it should offer power, flexibility, loads of features, and excellent sound quality. It should be highly cost-effective, without compromising performance or quality. It should be modular, to allow each user to have the power he or she needs, without having to pay for unnecessary features. It should also be

Lower system prices now apply to 8-channel, 12-channel, and 16-channel Pro Tools systems. Four-channel Expansion Kits now also cost less. See your Authorized Digidesign Pro Tools Dealer for details. While all Pro Tools systems include built-in "trigger sync" for playback, the optional Digidesign SMPTE Slave Driver delivers the highest-fidelity record and playback sync (call us for the details). DNR uses Digidesign's optional Sound Designer II™ software, which runs with any Pro Tools system. *The USA49 Upgrade Kit cost applies to residents of the US and Canada, and includes shipping. Internationally, the cost is just US\$49, including express shipping. Pro Tools owners must be registered directly with Digidesign to be eligible to receive the Upgrade kit. © 1993 Digidesign. All rights reserved.

backed up by the best customer support in the entire industry. It's no coincidence that all of this describes Pro Tools 2.0, perfectly.

A Vision To Share. We believe that a truly professional digital audio workstation should have a truly open architecture.

By "open," we mean that you should be allowed to add software-based power when you need it. (DINR, our amazing Digidesign Intelligent Noise Reduction™ system, is the first of many forthcoming Digidesign software "plug-ins.")

By open, we also mean that your workstation should have powerful and affordable upgrade paths. (We think Pro Tools 2.0 makes this case quite elegantly.)

And by open, we actually believe that your professional digital studio

For three years running, Digidesign has been moving up the prestigious Inc. 500 list. For every year since our founding in 1984, we've been profitable.

Over the past four years, we've sold more digital recording & editing systems than all of our competitors combined.

Why is this important for you to know? Because you can count

on us to be with you down the road, with on-going development and support for your investment.

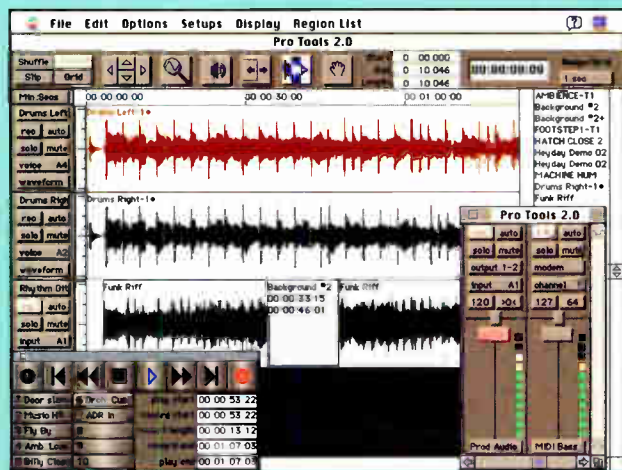

WE CALL IT PRO TOOLS 2.0

TDM Digital Audio Bus™ — a 256-channel, 24-bit system which will allow you to drop in DSP and other cards from Lexicon, Apogee, and other leading manufacturers. No muss, no fuss. You can even automate and route your existing analog and digital gear within this new, all-digital environment.

Of course, all past and present Pro Tools systems will be easily and affordably upgradable, to be totally compatible



With our TDM Digital Audio Bus, Pro Tools offers your studio an open door to the future.

should allow you to integrate hardware and software from a variety of manufacturers, and not just us. Which is why, in 1993, we'll be releasing the rather remarkable Digidesign

with the Digidesign TDM Digital Audio Bus.

Now that's what we mean by open.

Make Pro Tools 2.0 Your Reality. Thanks for taking a few minutes to read what we had to say. Hopefully, we've helped you understand better the depth of our commitment to the people who use Pro Tools today, and will be using it tomorrow.

So while we call it Pro Tools 2.0, you might call it exactly what you need. And if so, perhaps your next call should be to us.



For more information about Pro Tools, or about upgrading to Pro Tools 2.0, you can reach us at (800) 333-2137, ext. 100 (USA & Canada), or internationally at +1-415-688-0600. Call today, and we'll get you the information you need right away.

We can also provide you with information about DINR and other Digidesign products, as well as Pro School (the ultimate digital training ground). And if you like, we'll be happy to schedule you for a free, no-obligations Digidesign Professional Audio Seminar, or provide you with the name of your Digidesign Professional Products Dealer.

digidesign

• 1360 WILLOW ROAD • MENLO PARK • CA • USA • 94025 • 415.688.0600

• 48 RUE DES TOURNELLES • 75003 PARIS • FRANCE • +33.1.40 27 0967

SAN FRANCISCO • LOS ANGELES • NEW YORK CHICAGO • NASHVILLE • PARIS • LONDON

CURRENT

NAB CONVENTION HIGHLIGHTS DIGITAL TECHNOLOGY

Silicon Graphics and Avid Technology stole the lion's share of the attention at this year's National Association of Broadcasters convention, held in Las Vegas, April 19-22.

Avid announced a six-year joint research and development agreement with George Lucas' newly formed subsidiary, Lucas Digital, which includes Skywalker Sound and Industrial Light & Magic. Avid also demonstrated AudioVision, a full line of Media Composer options, and a fiber optic, OMF-compatible file exchange with Sonic Solutions from across the convention center. Meanwhile, Silicon Graphics introduced Sirius Video, Cosmo Compress (JPEG compression) and Galileo Video as part of its new "Silicon Studio" package. Then the two companies announced that Avid's Media Suite Pro would now be bundled on the Iris Indigo RISC PC platform.

While last year's discussions of video compression were largely of a disparaging nature, this year it seemed that the question was not whether digital compression was practical, but which compression schemes would prevail, and how the resulting products would be positioned. This was also the year of the integration of digital video and digital audio.

ImMix, Grass Valley, Calif., launched its VideoCube digital video post workstation, combining disk-based, real-time editing and processing of 60 field-per-second video with CD-quality audio. Capabilities of the \$38,500 system include digital video effects creation, high-res character generation, 4-channel digital audio mixing/editing (with onboard EQ and DSP) and 3-channel video switcher.

Not to be upstaged, NewTek (Topeka, Kansas) showed Video Toaster 4000, the latest incarnation of its revolutionary personal video system, offering video switcher, character generator, paint, effects and 3-D animation—all in an under-\$5,000 unit.

On the video recorder front, there was plenty of talk about Sony's debut of Digital Betacam, which extends the benefits of 10-bit component serial digital recording to the Betacam format. The new VTRs feature full-playback capability of analog Betacam and Betacam SP tapes, four 20-bit digital audio channels (plus cue track), up to 124 minutes of record time, and support of both 4:3 and 16:9 aspect ratios.

Solid State Logic unveiled OmniMix, the "big brother" to the company's successful Scenaria system. Configured for high-end post users, OmniMix provides dynamic pan automation of up to 32 sources (or submixes) in 4-, 5- or 6-channel surround, with an entirely new palette of panning and spatial effects.

Fostex staged the first U.S. showing of its RD-8 modular digital 8-track recorder, which uses the Alesis ADAT format to record 8 tracks of audio on an S-VHS cassette. Slated for release in September 1993, the RD-8 includes extensive onboard SMPTE synchronization capabilities (24/25/29.97/30 frame DF/NDF), along with MIDI machine control, RS-422 and chase-lock sync.

Also making its U.S. debut was Sony's DMX-S6000, an all-digital console (profiled in the May *Mix*).

Euphonix showed its latest digitally controlled analog console. The CS2000 features an open architecture mix controller design that

allows customers to expand the console size after installation, while new software supports up to 96 extra mix buses and aux sends. The board can be specified with 16 to 176 faders (in one- to four-operator versions) with SnapShot Recall, Total Automation and a computerized matrix switcher that instantaneously crosspatches line-level sources.

Another popular attraction was Otari's Concept I, a digitally controlled analog console with recall of console setups as well as dynamic automation of faders and mutes. Other features include dual-path architecture providing two inputs (with 4-band EQ) from each module, 24-track buses and ten aux sends. A 64-input board is priced from under \$55,000.

There were plenty of other hip products at NAB, and we'll cover those in future issues of *Mix*. More surprises should be in store when NAB returns to Las Vegas next year, from March 20-24, 1994. See you there, and as they say in Vegas, "Have a lucky day."

VAN GELDER, GABRIEL TO RECEIVE TEC HONORS

Master engineer Rudy Van Gelder will be honored with the Hall of Fame Award and musician/producer/world music and human rights champion Peter Gabriel will be given the Les Paul Award at the ninth annual TEC Awards, Friday, October 8, in New York City.

Rudy Van Gelder has recorded literally thousands of jazz sessions from his Englewood Cliffs, N.J., studio. From the genre's originators like Dizzy Gillespie, Miles Davis, John Coltrane and Art Blakey, to the new generation of young lions, Van Gelder has set the tech-

—CONTINUED ON PAGE 16

GUILTY.

AS THE BUILDERS OF D&R mixing consoles, others have accused us of being rather zealous. Maniacally dedicated. Over the top. Passionately committed to crafting the finest consoles at any price.

We plead guilty as charged. After all, our shameless vendetta against smeared sonics leads us to the highly unreasonable length of phase-correlating every audio stage. We're the

crazed console crafters who — in our unstoppable desire to eliminate RFI and other noise — starground every circuit on every console, with the aid of a custom-welded steel chassis.

And yes, we're the ones responsible for "high-def" EQs, floating subgroups, and other pioneering features which show so little regard for ordinary designs.

While overcoming the challenges of physics and the temptations of mediocrity, our unreasonable standards deliver what many consider to be the best consoles on the market. At the most reasonable prices.

You might think life could be lonely when you're guilty of a passionate pursuit for perfection. But along the way, we've met thousands of others who understand our intolerance for anything short of excellence. They are the thousands who have asked us to handcraft them a D&R.

So if you've been accused of ridiculously high standards for your work, let us reassure you



Exhibit A: To find evidence of our remorseless commitment to sonic integrity, look no further than the new D&R Triton. Its transparency, flexibility, and unparalleled support put it in the same league as our flagship, the D&R Avalon.

that you're not alone. We're here whenever you need us. And we understand completely how you feel.

D&R

D&R ELECTRONICA B.V.

Rijnhade 15B, 1382GS Weesp,

The Netherlands tel (-) 31 2940-18014

D&R WEST: (818) 291-5855

D&R NASHVILLE: (615) 661-4892

D&R SOUTHWEST: (409) 756-3737

D&R USA: (409) 588-3411

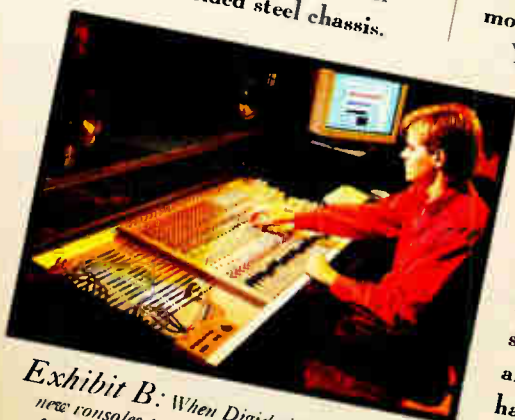

Exhibit B: When Digidesign was judging new consoles to use with their own 20- and 16-bit digital recording & editing systems, they knew the board would have to be good. Very good. And quiet. Very quiet. Their verdict? The D&R Orion.

D&R handcrafts consoles for recording, live sound, theatre, post-production and broadcast. Whether you own a world-class facility or a serious project studio, there's a D&R for your needs and budget.

The Serious

THE TASCAM DA-88 THE DIGITAL MULTITRACK DECK FOR SERIOUS PRODUCTION

It's true. The first machine designed specifically for low cost digital multitrack production is now available. And it comes to you from the world multitrack leader, TASCAM. It's simply the most advanced, well thought out and heavy duty digital 8-track deck you can buy. The best part is, it's incredibly affordable.

The DA-88 is built for production. The integrity of TASCAM's design is evident in every facet of the deck. From its look and feel — to its exceptional sound, unsurpassed features and expansion capability.

GOES FASTER, LASTS LONGER AND TAKES A BEATING

While we admit that it's an elegant looking machine, it's tough to see its finest asset. The tape transport. Designed and manufactured by TASCAM specifically for the DA-88, it's fast, accurate and solid. And that's what counts in production — in personal studios, project studios or in those demanding high-end facilities.

You'll notice it uses superior Hi 8mm tape, giving you a full 108 minutes of record time. What's more,

the transport is lightning fast and yet so quiet you'll barely hear it blaze through a tape.

We didn't stop there. Because production environments are notorious for constant, if not abusive, shuttling, punching, 24-hour operation — you get the idea — the transport was designed and built to take a beating.

Even more impressive is the transport's responsiveness. Take a look at the front panel. Notice the shuttle wheel? Turn it just a bit and the tape moves at one fourth the normal play speed. Turn it all the way and it flies at 8 times faster. Do it all night if you want. It's quick, smooth and it's precise. Need to get to a location quickly? Accurately? Shuttle a bit and you're there. The location is easily viewed on the DA-88's 8-digit absolute time display — in hours, minutes, seconds and frames. With the optional SY-88 sync card it displays timecode and offset, too.

YOU ALREADY KNOW HOW TO OPERATE IT

Unlike other digital multitrack decks, the DA-88 works logically and is simple to operate. Like your analog deck. All functions are familiar and easily operated from the front of the deck.



Adding the optional SY-88 synchronizer card is as easy as changing a Nintendo® cartridge. With it you're SMPTE and MIDI compatible. And no matter how many DA-88s you have locked up, you need only one sync card. Other optional accessories include AES/EBU and SDIF2 digital interfaces allowing the digital audio signal to be converted for direct-digital interfacing with digital consoles, signal processors and recording equipment.

s Machine



Take punching-in and out, for example. You have three easy ways to do it. You can punch-in and out of single tracks on the fly. Just hit the track button at the punch-in point. Hit it again to punch-out. You can use the optional foot switch, if you like.

Or, for multiple tracks, simply select the track numbers you want to punch, push play, and when you're ready, hit record to punch-in, play to punch-out.

Finally, for those frame accurate punch-ins, you've got auto punch-in and out. In this mode you can rehearse your part prior to committing it to tape.

No matter which way you choose, your punch-in and out is seamless and glitch free due to TASCAM's sophisticated variable digital crossfade technology.

That's not all, you also can set your pitch ($\pm 6\%$), sample rates (44.1 or 48K), as well as crossfade and track delay times. All from the front of the DA-88.

COMPLETE SYNCHRONICITY

There's more. Add the optional SY-38 synchronizer card to just one of your DA-88s and you've got full SMPTE/EBU chase synchronization. The best part is, you can record time-code without sacrificing one of your audio tracks. You also get video sync input, an RS-422 port to allow control of the DA-88 from a video editor, and MIDI ports for MIDI machine control.

A DIGITAL RECORDING SYSTEM THAT GROWS WITH YOU

The DA-88 is truly part of a digital recording system. Start with 8 tracks today — add more tomorrow.



Adding tracks is as simple as adding machines — up to 16 for a total of 128 tracks. They interconnect with one simple cable, and no matter how many DA-88s you have, they'll all lock up in less than 2 seconds.

Controlling multiple machines is made simple with the optional RC-848 remote. With it you can auto locate and catch 99 cue points on the fly. It comes complete with shuttle wheel, jog dial, RS-422 and parallel ports, and it controls other digital and analog machines, too.

LISTEN TO THE REST

Of course, the sound quality is stunning. With a flat frequency response from 20Hz to 20kHz and dynamic range greater than 92dB, it delivers the performance you expect in digital recording.

So get to your authorized TASCAM dealer now. Check it out. Touch it. And listen to it. Once you do you'll know why the TASCAM DA-88 is the serious machine for digital production. The TASCAM DA-88 is the choice of studios worldwide. And at only \$4,499, it should be your choice.



TASCAM

Take advantage of our experience.

7733 Telegraph Road, Montebello, California 90640
(213) 726-0303

INDUSTRY NOTES

EDnet (San Francisco) and Digital Patch, two major suppliers of high-quality, long-distance telecommunication services for recording studios, recently merged. EDnet's Tom Kobayashi will serve as president of the new venture, with Digital Patch's Stewart Sloke serving as VP of sales for audio and radio broadcast. .3M (St. Paul, MN) is building the first San Francisco Bay Area CD-ROM manufacturing facility. Located in Fremont, the facility will be in production by the second quarter of 1993. . . Alesis Corp. (Los Angeles) hired Gary Lynn as broadcast sales manager. In this newly created position Lynn will help assemble a network of A/V and broadcast dealers to market the ADAT for broadcast and post-production applications. . . Todd Rockwell joined Community Professional Sound Systems of Chester, PA, as its new engineering and marketing liaison. . . Thomas Kowalczyk was appointed district sales manager in California for Kurzweil (Cerritos, CA) professional products. In other Kurzweil news, keyboardist Jordan Rudess joined the company's team of professional product specialists. . . Symetrix Inc. (Seattle) hired Allen Goldstein to the newly created position of director of engineering. . . SSL (New York City) hired Steve Rainford as digital products training manager to work with the company's Scenaria and ScreenSound clients. . . Michael Charles was named U.S. sales coordinator for Allen & Heath (Salt Lake City). . . Beyerdynamic (Farmingdale, NY) appointed some new reps: In the New York City area, Sigmnet Marketing will handle pro and MI dealers, and Consumer Audio will focus on consumer audio and video dealers. MTA is the company's new rep for Southern California, Arizona and Southern Nevada. . . ddrum has moved. The company's new address is 300 Long Beach

Blvd., Stratford, CT 06497; phone (203) 380-0000 or (800) 882-0098. . . Euphonix (Palo Alto, CA) opened a new regional office in Nashville headed by Tom Semmes. The address is 1102 17th Ave. S., #202 Nashville, TN 37212; phone (615) 327-2933, fax (615) 327-3306. . . Studio Audio Digital Equipment Inc. (Cambridge, UK), recently acquired A.R.A.S. . . Digital F/X (Mountain View, CA) transferred the assets of its Broadcast Video Business to Andersen Group Inc. (Bloomfield, CT), which will operate the business through its subsidiary. . . Microtime Inc. . . Silicon Prairie (Omaha, NE) recently initiated a research and development division to provide engineering services to clients for developing microprocessor and analog control systems. . . London's HHB Communications Ltd. appointed Independent Audio of Portland, ME, as its North American business coordinator. Independent audio will provide a sales and warehousing center for HHB-distributed products. . . Pro-Bel Ltd., London-based designer/manufacturers of routing matrices, formed a new American subsidiary, Pro-Bel Inc., to serve North and South American markets. The new company is headquartered in Dunwoody, Georgia. President and CEO Dave Spindle appointed several executives to the new company: Annette Sardelich is chief financial officer; Stephen Sedoff is western regional manager and will operate out of Marin County, CA; John Miller serves as northeastern regional manager, with an office in Boston; and Alan Schoenberg, southeastern regional manager, will be based in Orlando, FL. . . Steve Greene recently formed the independent Mark of the Unicorn User's Group. For more information call (617) 446-6543. . . Sigmnet Corporation (Valley Forge, PA) appointed two new sales reps, John Cardone, and Kelly Ireton. ■

—FROM PAGE 12, CURRENT

nical standard of jazz recording for more than four decades.

Peter Gabriel, one of today's most popular recording artists, is widely acknowledged by music fans and technical luminaries alike as a true innovator.

The complete list of 1993 TEC Awards nominees are on page 28. For more information about the TEC Awards, call Karen Dunn at (510) 939-6149.

NSCA REPORT

Spotted on lapels all across the Orlando Convention Center were buttons proclaiming "I Support SC10," the AES subcommittee charged with the task of defining a standard for the computer control and networking of sound systems. Lone Wolf's MediaLink network continued to gather third-party support. The company showed a single network, which included prototype product from Rane, QSC, Carver, TOA and JBL/UREI.

Crown and Lone Wolf will work together to define how Lone Wolf's MediaLink network can carry Crown's IQ protocol. This does not mean Crown is abandoning IQ. Rather, the companies will work to enable IQ equipment to also operate on a MediaLink network.

A similar arrangement exists between Crest and Lone Wolf, as the two companies have agreed to interface and share technology toward Crest's NexSys and MediaLink compatibility. Again, this does not mean Crest is abandoning NexSys.

AES: BACK TO SF IN '94!

The 97th AES convention will be held November 10-13, 1994 (it's still in New York this year), at Moscone Center in San Francisco. This is a change from the previously announced dates of mid-October 1994 in Los Angeles. Meanwhile, next year's 96th convention will be held February 27-March 2 at the RAI Center in Amsterdam. For more information call AES at (212) 661-8528. ■

Studer unchains digital audio

Introducing Dyaxis II™ Studer's 2nd generation digital workstation delivers real-time DSP power, unlimited channel capacity and immediate interchange between projects, in a modular multitrack system. Stack up to six 8-track systems for 48 tracks of simultaneous playback. Work with individual processors off-line, then combine all 48 tracks for final assembly.

Onboard Dolby AC-2™ 4:1 data compression lets you *Plug & Play™* optical removable media. Unleash your creative potential with the power of Dyaxis II. Call your Studer representative now for complete details.

Optional
master bridge
module

Stack up to six
Dyaxis II units

Expandable
hard disk &
optical storage

Intuitive Macintosh™ interface

STUDER

STUDER EDITECH
1370 Willow Road, Suite 2C1
Menlo Park, CA 94025
415.326.7030/Fax 415.326.7039

STUDER REVOX AMERICA, INC.
1865 AirLane Drive, #12
Nashville, TN 3721C
615.391-3399/Fax 615.391-5974
New York 212.626.6734
Los Angeles 818.760.4234

STUDER REVOX CANADA
1947 Leslie Street, Toronto, Ont M3B 2M3
416.510.1347/Fax 416.510.1294

by Ken C. Pohlmann

IN-BAND DIGITAL

A

s the 20th century draws to a close, the member nations of the civilized world are avidly pursuing a digital audio radio broadcasting system to replace analog broadcast methods. However, whereas many countries are looking to the Eureka 147 system to open up new digital audio broadcast bands outside existing FM and AM bands (see last month's "Insider Audio"), the United States has tackled the difficult but provocative challenge of developing an in-band system that would transmit Digital Audio Radio signals in existing FM and AM bands, along with analog radio signals. Such an in-band system would be incompatible with out-of-band Eureka systems; thus, the desire to take such an approach has upset progress in other countries and delayed deployment of a Stateside DAR system. But the political and commercial advantages of an in-band system certainly make it attractive. On the other hand, no one can say for sure that the performance of a future in-band, narrowband system will equal that already demonstrated by the wideband Eureka system.

Out-of-band systems require a spectral space of their own, but space

The United States has tackled the difficult but provocative challenge of developing an in-band system that would transmit digital audio radio signals in existing FM and AM bands, along with analog radio signals.

is difficult to obtain because of existing allocations and the political fallout from AM and FM broadcasters, who fear obsolescence. In-band systems use the existing AM and FM bands, and would permit broadcasters to simultaneously transmit analog

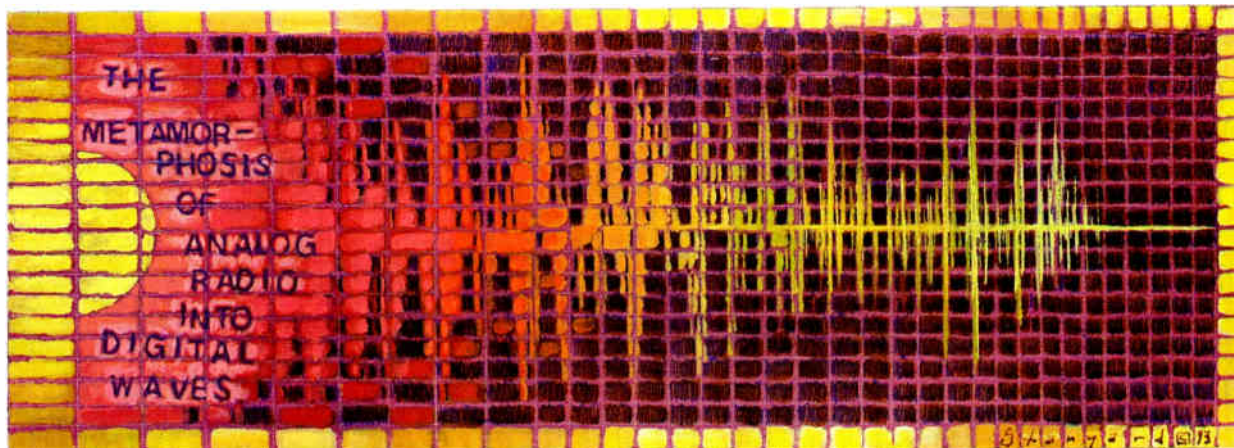

ILLUSTRATION: STEWART STANYARD



Bob Ludwig and Dan Crewe of Gateway Mastering Studios quietly discuss their move to Portland, Maine.

BL: *Well Dan, my dream studio is up and running in my dream city . . . I couldn't be happier with our move to Portland. Glad I thought of it.*

DC: *Bob, you followed me here.*

BL: *But I knew Portland was right because after all, it's the perfect escape from the madness of the city. You know, the rocky coast of Maine; real fresh air. No congestion. People who don't growl. Not to mention all the restaurants, galleries and clubs. Oh and how about the deal I got on our great new space?*

DC: *Bob, Downtown Portland Corporation helped us finance the space — does a low interest loan ring a bell? And how about all the red tape cutting they did for us?*

BL: *You know I wondered who all those people in suits were. But you've got to agree with me on one point.*

DC: *What's that?*

BL: *It's much easier to get a table at lunch here.*

Call Downtown Portland Corporation today and we'll talk to you about why a move to Portland is the smart move to make. We'll even send along a free video and brochure.

1-800-874-8144

PORTLAND, MAINE

The City That Plays Well For The Music Industry

Downtown Portland Corporation • 389 Congress Street • Portland, Maine 04101 • Tel: 1-800-874-8144 • Fax: 207-874-8649



gateway mastering studios, inc.

and digital programs. Such a system would be much simpler and cheaper than an out-of-band system. Moreover, it seems promising because digital signals are inherently highly immune to interference. So a digital receiver should be able to reject the analog signals. However, it is more difficult for an analog receiver to reject the digital signal's interference. The trick is to broadcast the digital signal at a much lower level; because of the broadcast efficiency of DAR, a low-power signal could still maintain existing coverage areas for digital re-

ceivers while maintaining the ability of analog receivers to reject the interfering signal.

In the U.S., FM radio stations are assigned a bandwidth of 200 kHz, and AM stations use 10kHz bandwidths. An in-band system would fit within the same bandwidth constraints and, furthermore, efficiently use the FCC-regulated RF mask in which the channel's spectrum widens as power decreases. Specifically, if a DAR signal is 26 dB below the FM signal, it would occupy a 480kHz bandwidth. In the case of AM, if the DAR signal is 26 dB below the AM signal, the band may

be 40 kHz wide. Because the digital signal's power can be lower, it can thus efficiently employ the entire frequency mask area.

An in-band system should provide improved frequency response and lower noise and distortion within existing coverage areas. It would be possible to design receivers so that if the digital signal failed, the radio would automatically switch to the analog signal. Clearly, because of the wider FM bandwidth, an in-band system would be much easier to implement in the FM band. The narrow AM channels would greatly limit DAR data rates; in addition, existing AM radios would not be as amenable to DAR signals as FM receivers. On the other hand, AM broadcast is not hampered by multipath problems, whereas multipath immunity is more difficult to achieve in a narrowband, in-band FM system, compared to a wideband DAR system. Of course, any DAR system would have to rely on perceptual coding to reduce the channel data rate to 128 kbps or so, to allow the high-fidelity signal (along with non-audio data) to be transmitted in the narrow bands available.

Given this framework, two DAR methods immediately come to mind, along with numerous variations. First, an In-Band Interstitial system would transmit DAR signals on frequencies adjacent to existing stations; this helps reduce the problems of differentiation between the types of signals. In a single-channel IBI system, the DAR signal is placed in one adjacent channel (upper or lower). Alternately, both adjacent channels could be used; of course, this would reduce the number of available stations. In a single-channel, multiplexed IBI system, various stations in a market would multiplex their DAR signals, and they would be broadcast in adjacent channels across the band, providing greater frequency diversity and protection against multipath interference.

A second DAR method would employ an in-band, on-channel (IBOC) system in which DAR signals are exactly superimposed on current FM and AM transmission frequencies. Importantly, no modifications are required; new DAR receivers would receive both analog and digital signals. This method is highly attractive because it obviously fits within

OPTIFILE 3D

POWERFUL AFFORDABLE CONSOLE AUTOMATION

Retrofits any console



Optifile 3D, with the new intelligent cue list and machine control, gives you total command over mix and machines. Call Sascom Marketing Group for a brochure and discover how easy it is to automate your console utilizing existing faders.

SPARS
WWW.SPARS.COM

**SASCOM
MARKETING
GROUP**

Tel: (416) 420-3946
Fax: (416) 420-0718

USE READER SERVICE CARD FOR MORE INFO

“DYNATEK PRODUCES”

TEDDY RILEY



Teddy Riley has produced hits with such artists as Michael Jackson, Bobby Brown, James Ingram and Stevie Wonder.

For digital recording and sampling, Teddy exclusively uses DynaTek TRACK Series rackmount data storage products.

Find out why.

See the complete line of TRACK Series products at a dealer near you.

 **DYNATEK**
STRUCTURED FOR STORAGE

*DynaTek Automation Systems Inc.
Digital Music Storage Division
15 Tangiers Road
Toronto, Ontario
M3J 2B1 Canada
Tel.: (416) 636-3000
Fax: (416) 636-3011*

World Radio History

USE READER SERVICE CARD FOR MORE INFO

CS2000

Digital Control Studio System



The CS2000 expands the family of Euphonix studio control systems. Featuring state-of-the-art digital control technology, the CS2000 suits applications from commercial music studios to large film dubbing theatres.

The CS2000 provides Total Control of the mix environment. SnapShot Recall™ system and Total Automation™ speed up the process of mixing, and allow for more creative freedom. SnapShot Recall resets everything in less than 1/30 second. Total Automation allows all controls and switches to be automated to code. The CS2000 reaches beyond the console with MIDI and a high speed interface capability to external effects devices, sequencers, multitracks and DAWs.



The CS2000 has been ergonomically designed to give the operator instant access to all functions, with central assignability for operations such as EQ adjustment.

The system is fully modular and highly cost effective. Systems can be configured on purchase to suit specifications and budgets. Dynamics, additional aux sends and film mix buses are just some of the options that may be added whenever they are needed.

The CS2000 is an audio mixing platform that will take a studio into the twenty-first century with a flexibility and power of control that has never before been available.



Euphonix

220 Portage Ave.
Palo Alto, CA 94306
(415) 855-0400

Worldwide Sales
Los Angeles, CA (818) 766-1636

USE READER SERVICE CARD FOR MORE INFO
World Radio History

THEY DO

MORE.

THEY DO IT

BETTER.

THEY DO IT

FOR LESS.

A simple message that is not often easy to back up. But Behringer's European reputation for excellence in signal processing gives these words new meaning.

Consider for a moment our latest interactive processors, conceived and engineered to deliver transparent performance for studio and live applications.

COMPOSER The Composer functions as a studio grade, automatic and manual controlled stereo Compressor, Expander, Gate and Peak Limiter. The automatic mode offers program-dependent attack/release times for inaudible processing.

Unique Interactive Knee Control circuitry combines the musicality of soft knee compression with comprehensive hard knee control. Special Interactive Gain Control Peak Limiter circuitry enables simultaneous Clipper and Program limiter functions while serving as a zero attack, distortion-free absolute gain threshold.

INTELLIGATE The Intelligate is an Expander/Gate/Ducker with Ultra Transient Response circuitry for instantaneous attack. Proprietary high performance Class A VCAs provide exceptional audio quality. Precise key filters permit frequency-sensitive keying.

Like the Composer, the Intelligate includes Interactive Ratio Control Expander circuitry to eliminate "chatter" on or around threshold. Both units feature servo-balanced Neutrik 1/4" and XLR inputs and outputs, precise metering and a 5 year warranty.

Behringer. When you listen, the message becomes clear.

THE PERFECT EAR.



Exclusively distributed in the U.S. by Samson Technologies Corp., P.O. Box 9068, Hicksville, NY 11802-9068 Tel (516) 932-3810 Fax (516) 932-3815
SAMSON 1992

USE READER SERVICE CARD FOR MORE INFO

World Radio History

much of the existing regulatory statutes and commercial interests. Moreover, because new digital signals would simply be simulcast over existing equipment, start-up broadcasting costs would be extremely low, as would the cost of DAR receivers. However, the differentiation of the analog and digital signals presents technological challenges. Specifically, the DAR signal must not interfere with the analog signal in existing receivers, and DAR receivers must employ encryption methods to extract the DAR signal while ignoring the much stronger analog signal.

FM receivers are good at rejecting amplitude noise; for example, their limiters would reject a DAR signal using ASK modulation. Existing FM receivers, therefore, would see the much weaker (30 dB or so) digital signal as noise and reject it. It is more difficult to extract the digital information from the analog signal. One developer, USA Digital, employs an adaptive transversal filter using Acoustic Charge Transport technology—fairly exotic stuff. It provides interference cancellation to eliminate the FM (or AM) signal so that on-channel digital information can be processed. Thanks to the industrial-military complex, signal extraction technology has been well developed by U.S. companies; for example, the problem of retrieving signals in the presence of jamming signals has been carefully studied. In the case of IBOC, the problem is further simplified because the nature of the jamming signal (the analog signal) is known at the broadcast site, and can be determined at the receiver.

The idea of developing an IBOC DAR system was first proposed by Kintel Technologies. IBOC relies on the FM capture effect to multiplex several signals on one channel; the modulation of the weaker signal is attenuated, and the stronger signal emerges. In the Kintel system, a lower-level digital carrier is mixed with the analog carrier. When in DAR mode digital radios receive the combined signal, then use cancellation in a phase-tracking circuit to attenuate the FM signal; the stronger DAR signal is captured by the receiver, and the remainder of the FM signal is eliminated. The DAR signal is 10 dB or lower, relative to the FM

The Only "ROCK & ROLL" You'll Hear on a MARK 10[®] CASSETTE ...is the *Music!*



Only the Shape[®] Mark 10[®] Cassette with its "Patented Independent Bridge" delivers the kind of performance that makes it absolutely the standard of excellence in the industry today. Hands down.

This independent bridge stabilizes the tape path and maintains the most accurate, stable and consistent azimuth alignment in the industry, eliminating the unwanted tape path instability (Rock & Roll) inherent in lesser designs.

SHAPE,

We're committed to excellence.

Available in custom colors, unloaded or loaded.

For information about the Mark 10 or any of the Shape products, please call 1-800-MARK-TEN (1-800-627-5836).



US Patent Numbers
RIE 32,447, D 280,815

SHAPE[®]

SHAPE Inc., Biddeford Industrial Park, Biddeford, Maine
FAX 207/283-9130

USE READER SERVICE CARD FOR MORE INFO

signal, and employs FSK modulation. Additional signals could be multiplexed, at different power levels.

USA Digital, a partnership of CBS, Group W and Gannett, has developed the Project Acorn system, under the engineering leadership of Bill Huntsinger. Project Acorn is considered the leading in-band IBOC system currently under development. One implementation uses QPSK modulation onto 21 carriers 9.5 kHz apart across the 200kHz FM band, at a level approximately 30 dB below the FM signal; like Eureka, Acorn

uses coded polyvector digital modulation. At a demonstration in Los Angeles, Project Acorn broadcast in-band digital signals from KTWV-FM and KNX-AM. The system provided audio bandwidth up to 20 kHz, and a dynamic range of 96 dB. The digital signal in the FM band was encoded as a 192kbps MUSICAM datastream, with error coding and overhead pushing the rate to 400 kbps. The digital signal was 30 dB below the main FM carrier, and effective radiated power was 54 watts. The digital signal in the AM band was coded at a 96kbps rate, rising to 126 kbps with error-correction and overhead.

A linear amplifier operating at 200 watts provided transmission power. Using a prototype receiver, listeners could tune in AM, FM or either-band digital channels.

While U.S. companies compete to develop, and U.S. regulators try to decide on an in-band system, the rest of the world waits. More specifically, at a meeting of the International Radio Consultative Committee virtually every country supported the adoption of Eureka 147 as a worldwide standard, except the U.S. That opposition, coupled with impressive demonstrations by Project Acorn and sudden enthusiasm by delegates from Japan and Sweden, stalled any decision on the part of CCIR Working Group 10B, at least until it meets again in October. The NAB Radio Board has formally endorsed an in-band, on-channel system for the U.S. Meanwhile, although broadcasters question their ability to perform testing, the Electronic Industries Association has scheduled tests of in-band systems for this summer. The following companies initially indicated a willingness to participate in the EIA tests: AT&T Bell Laboratories, AT&T and Amati Communications, Thomson Consumer Electronics and Eureka 147, Jerrold Division of General Instrument, NASA and Voice of America, and USA Digital.

However, complicating things immensely, USA Digital has withdrawn Project Acorn from the EIA testing because of the perceived lack of broadcaster participation. One compromise would have the National Radio Systems Committee perform the in-band testing. However, the EIA has expressed a desire to proceed with out-of-band tests, leading to the possibility of two proposed U.S. standards. Without question, it is confusing, and time is running out. Until the U.S. interests can find an in-band champion for their cause, Eureka 147 will remain the leading candidate for digital audio radio. And the world won't wait much longer.

[For more information on digital radio, see "Digital Radio Basics" by Skip Pizzi and "Understanding DAB," available from the National Association of Broadcasters.] ■

Ken Pohlmann's three books, Principles of Digital Audio, Advanced Digital Audio, and The Compact Disc Handbook are all conveniently available through the Mix Bookshelf.



723 7TH AVENUE (AT 48TH STREET), 3RD FLOOR, NEW YORK CITY
(212) 719-2640 FAX: (212) 302-4289

Your Tools for Audio Production

DIGITAL RECORDERS

The largest selection of hard disk systems including **DAR Sigma**, **Korg Soundlink**, **AKAI**, **digidesign ProTools**, **Roland DM-80**, and IBM based stereo or multitracks

AKAI ADAM and **Tascam DA-88** multitrack tape recorders

MONITORS & AMPLIFICATION

Precision monitors from **Genelec**, **KRK**, **JBL**, and **Tannoy**; **Crown** Macro Reference power

PARTS & ACCESSORIES

Patchbays, **cable**: assemblies and bulk, **racks** and cabinets, **tools** and chemicals, **connectors**

Replacement parts for **AMEK**, **Otari**, **Tascam**

COMPUTERS

Apple Macintosh, **Quadra**, **Centris**, **VX**, and peripherals, **PC compatibles**

PEOPLE

"THE SAM ASH PROFESSIONALS"

A knowledgeable and experienced sales staff who enjoy helping you find the best products and solutions



723 7TH AVENUE (AT 48TH STREET), 9TH FLOOR, NEW YORK CITY
(212) 302-5114 FAX: (212) 302-5744

USE READER SERVICE CARD FOR MORE INFO

You Can Take It With You.

Full of Features and Convenience.

The Shure VP88 MS Stereo Condenser Microphone marks a new age of convenience in the art of live and recorded stereo.

While reducing the setup complications normally associated with producing quality stereo, the VP88 offers a variety of stereo signals – from a single source – that never degrade if combined into mono.

The portable and rugged VP88 utilizes two condenser cartridges – a forward-facing cardioid (Mid) and a perpendicular bi-directional (Side) – with a switchable built-in matrix to convert Mid and Side signals into discrete left and right outputs. The VP88 lets you choose from three selectable degrees of stereo spread, or provides a classic MS signal for complete control of width and ambience.

VP88 shown actual size.

Excels In Every Environment.

Wherever your successes take you – from the studio to the stage to the great outdoors – you will never want to be without your VP88.

The VP88 faithfully reproduces the spaciousness and subtleties of orchestras and ensembles. It handles the most demanding percussion and the softest strings. It adds ambience to live house tapes and expands recording capability.

The VP88 makes it easier than ever to produce stereo DAT recordings so realistic you'll swear you are there.

With both phantom and battery power capability, there's no place your VP88 can't go.

And the VP88 is a remarkable value. No other stereo microphone gives you so much versatility and quality at such an affordable price.

Audition Shure's VP88 MS Stereo Condenser Microphone. Hear how much life can be brought to your productions through two ears rather than one. For the VP88 dealer nearest you call **1-800-25-SHURE**.

SHURE®

The Sound Of The Professionals®... Worldwide.

USE READER SERVICE CARD FOR MORE INFO

World Radio History



THE 1993 TEC AWARDS NOMINEES

OUTSTANDING INSTITUTIONAL ACHIEVEMENT

ACOUSTICS/FACILITY DESIGN COMPANY

Harris, Grant Associates, Iver, England
Perception Inc., Los Angeles, CA
Russ Berger Design Group, Dallas, TX
studio bauton, Los Angeles, CA
Walters-Stork Design Group, Highland, NY

SOUND REINFORCEMENT COMPANY

Audio Analysts, Colorado Springs, CO
Electrotec Productions Inc., Canoga Park, CA
Maryland Sound Industries Inc., Baltimore, MD
Showco Inc., Dallas, TX
Ultra Sound, San Rafael, CA

AUDIO POST-PRODUCTION FACILITY

John Alberts Sound Design, New York, NY
Post Logic, Hollywood, CA
Howard Schwartz Recording Inc., New York, NY
Skywalker Sound, San Rafael, CA
Sync Sound, New York, NY

MASTERING FACILITY

Bernie Grundman Mastering, Hollywood, CA
Masterdisk Corporation, New York, NY
Masterfonics, Nashville, TN
Precision Mastering, Los Angeles, CA
Sterling Sound, New York, NY

REMOTE RECORDING FACILITY

Design FX Remote Recording, Culver City, CA
Effanel Music, New York, NY
Le Mobile, North Hollywood, CA
Remote Recording Services, Labaska, PA
Westwood One Mobile Recording, Culver City, CA

RECORDING STUDIO

A&M Studios, Hollywood, CA
The Hit Factory, New York, NY
Ocean Way Recording, Los Angeles, CA
Record Plant, Hollywood, CA
Skyline Studios, New York, NY

OUTSTANDING CREATIVE ACHIEVEMENT

RECORDING ENGINEER

David Bottrill
Ed Cherney
Flood
Steve Lillywhite
Hugh Padgham

REMOTE/BROADCAST RECORDING ENGINEER

Guy Charbonneau
Randy Ezratty
Ed Greene
David Hewitt
Kooster McAllister

MASTERING ENGINEER

Bernie Grundman
Ted Jensen
Stephen Marcussen
George Marino
Doug Sax

SOUND REINFORCEMENT ENGINEER

Robert Colby
Clive Franks
Stanley Miller
Joe O'Herlihy
Robert Scovill

AUDIO POST-PRODUCTION ENGINEER

John Alberts
Bruce Botnick
Ken Hahn
Skip Lievsay
Shawn Murphy

RECORD PRODUCER

David Foster
Mitchell Froom
Daniel Lanois
Russ Titelman
Don Was

OUTSTANDING TECHNICAL ACHIEVEMENT

ANCILLARY EQUIPMENT

Brainstorm SR-15 Time Code Stripalyzer
Crown VZ-5000 amplifier
Lexicon 20/20 AD analog-to-digital converter
Neutrik Combo 1/4-XLR connectors
RPG Diffusorblox acoustic building material
TimeLine Lynx-2 synchronizer

COMPUTER SOFTWARE/PERIPHERALS

Digidesign Intelligent Noise Reduction software, DINR
Mark of the Unicorn MIDI Time Piece II
Opcode StudioVision 1.4
Passport Producer
Steinberg Cubase Audio 1.1 (Macintosh version)
Techron TEF-201i acoustic test system

MICROPHONE TECHNOLOGY

AKG Blue Line modular microphone system
Beyer MC833 stereo microphone
Brueel & Kjaer APE Acoustic Pressure Equalizers
Crown Differoid microphones
Mierotech Gefell CM92S tube microphone
Sony C-800/C-800G tube microphones

SOUND REINFORCEMENT LOUSPEAKER TECHNOLOGY

Clair P-4 Piston
EAW KF650i Virtual Array system
JBL Array Series Model 4894
Meyer Sound Labs MSL-2A
Ramsa T-Series
TAD TCM Series

STUDIO MONITOR TECHNOLOGY

Boxer Five (F) Film Monitoring System
Genelec 1038A
JBL 4400A Series
Peavey PRM-308si
Tannoy System 6 NFM
USCO Audio DFW-3

MUSICAL INSTRUMENT TECHNOLOGY

E-mu Systems Emulator HIXP sampler
E-mu Systems Vintage Keys
Korg Wavestation SR synth
Kurzweil K2000RS sampler
Roland JV-880 synth
Yamaha QY20 production center

SIGNAL PROCESSING TECHNOLOGY

Aphex C2 "Big Bottom" Aural Exciter
dbx 172 Supergate
Dolby Spectral Processor Model 740
Ensoniq DP/4 Parallel Effects Processor
Lexicon LARES
t.e. electronic M5000 Audio Mainframe

RECORDING DEVICES/STORAGE TECHNOLOGY

Avid Technology AudioVision workstation
Digidesign Session-8 XL workstation
Fostex PD-2 portable time code DAT
Nagra D 4-channel digital recorder with time code
Solid State Logic Scenaria workstation
Sony PCM-3324S 24-channel digital multitrack

SOUND REINFORCEMENT CONSOLE TECHNOLOGY

Allen & Heath GL-3
Amek/TAC SR6000
Crest Century GT
Midas XL3-16
Soundcraft Vienna
Yamaha PM4000

RECORDING CONSOLE TECHNOLOGY

Amek Big by Langley
API Legacy
George Massenburg Labs HRT 9100
Neve Capricorn
Soundcraft Spirit Folio
Trident Series 90

HALL OF FAME

Rudy Van Gelder

LES PAUL AWARD

Peter Gabriel

These are the nominees chosen by the Nominating Panel of the Ninth Annual Technical Excellence & Creativity Awards. The TEC Awards will be held Friday, October 8, 1993, at the Marriott Marquis in New York City. For more information, contact Karen Dunn (510) 939-6149.

**WATCH FOR YOUR VOTING BALLOT
IN THE AUGUST ISSUE OF MIX.**

by Stephen St.Croix

HALF...

NOW

I just returned this morning from a session in L.A. that surprised me as much as it will you. I will tell you about it, but first, as I have been known to do, I will give you a bit of background. (Hey, I gotta work to write it, so I think you can work a little to *read* it.) I'll even be fair and warn you right up front that this is a two-part column.

THEN

In my youth (yes, more about when I was a kid), I listened to everything that came out of my little GE portable AM radio once I set the station and removed the little wheel that let me change it. Okay, a bicycle accident removed the tuning wheel, but I stuck by the fate handed down to me that day. I became one of the first radio listeners to develop brand-name loyalty at that time—to KRIZ, Phoenix, Arizona.

I would feel a wave of pleasure whenever KRIZ would see fit to give me certain special songs. "The Wanderer," "Wake Up Little Susie," "Calendar Girl," "Runaway" and "Traveling Man" all made my bike a little faster and the desert air a little cooler.

NOW AGAIN

I have mentioned many of these songs before, and I may again. They are as much a part of modern American culture as is the Bike of Iron, or greasy fries, burger and a shake.

I don't eat that garbage any more (I have been out of warranty for a couple of decades now, and the time that I used to spend in the diner I now spend in the gym). But some things just won't go away.

Even today, hardly a Davidson goes by that doesn't immediately evoke vivid memories of desert highways, hot sun refracting through 20 coats of hand-rubbed transparent tangerine over another ten of candy black cherry, over metalflake gold. With the smell of its exhaust come the smells of all the Western diners I used to live in. With the unmuffled symphony of that outrageous uneven firing American twin come the sounds of all those songs.

All of this together is how I remember my youth, whether or not it was actually that way.

I have often lamented in these very pages on the lost art of making songs like those. Pure retro is not what I was asking for. What's the

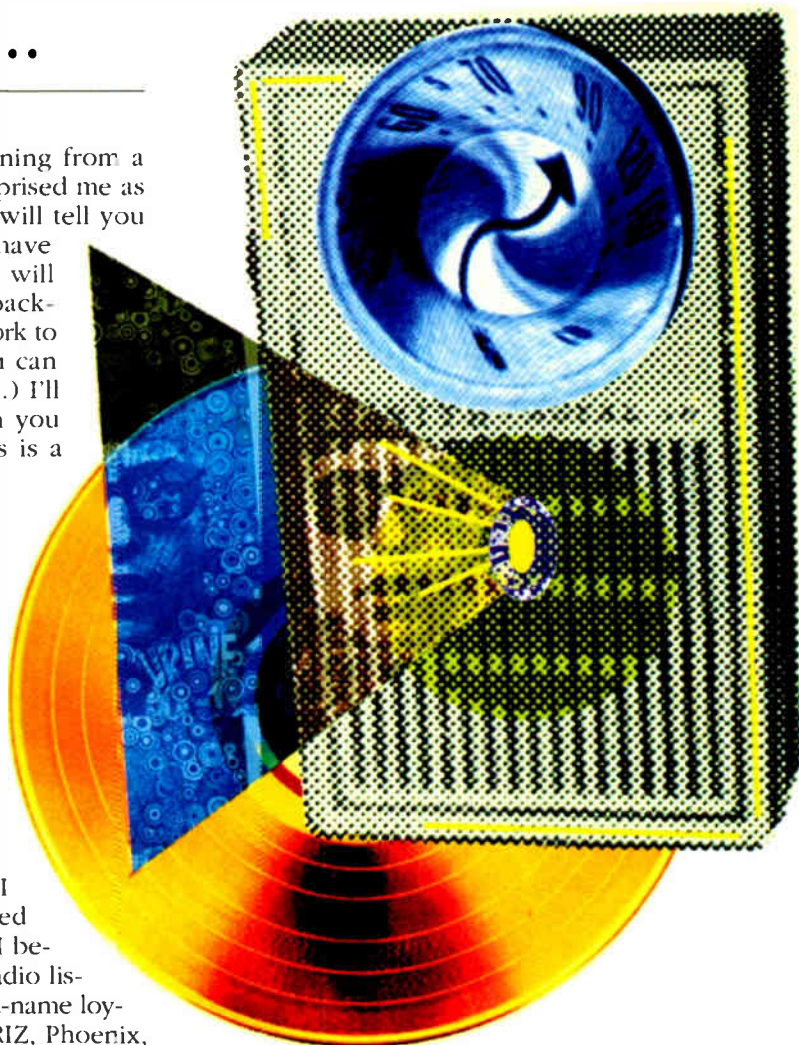

ILLUSTRATION: ANDREW FAULKNER

Ed Rak

DEMANDS
DOLBY SR

Ed Rak in Control Room B of Clinton Recording Studios

Vincent Mancini

Digital was my first choice for ten years. So why am I recording analog again?"

Occupation

Engineer, producer, and owner of Clinton Recording Studios, NYC

Recent credits

Juan Luis Guerra, Patti LaBelle, Roy Hargrove, Cleo Laine, Liza Minnelli, John Pizzarelli, Michel Camilo

Career credits

Artists: Karen Carpenter, Steely Dan, Dave Grusin, NY Philharmonic, Diana Ross, Frank Sinatra

Films: "Manhattan," "Reds," "Peggy Sue Got Married," "Tequila Sunrise," "A Stranger Among Us"

Career direction

"Recording great film scores in one of New York's few remaining large orchestral recording spaces is a fabulous job, and I look forward to doing lots more."

On his technique

"I capture the *sense* of each soloist and section, lock them together in perspective, and apply the glue when I mix."

On Dolby SR

"Dolby SR hears it my way—everything I record sounds like I want it to, from start to finish. Plus Dolby SR has insured my investment in analog equipment for years and years to come."

Studio A:
Clinton Recording

Dolby SR: now over 70,000 tracks worldwide.

point? We already *have* pure retro, the originals. Modern interpretation isn't it either, for though a couple have been perfect (Bonnie Raitt's "Runaway" and the other retro cover of "Runaway" used for the gangster TV show *Crime Story*), most miss for me. How could anybody hope to re-record a tune that was magic for *me* 30 years ago, and recapture the components that made it so?

The answer is simply to make new music that does the same thing. The mystery is, of course, *how*?

THREE FOR THREE

Well, boys and girls, I may have just seen how last week in L.A. Three different times, three different hows.

First, I caught a dirty little band known as Cheap Date at The Roxbury on the Strip. This is Jeff Baxter's latest effort to upset the locals. It worked. Skunk played pedal steel, and every one of his solos picked you up by the little hairs on the back of your neck and hung you out to cool in a breeze that blew in all the way from the '60s. This was good, since there were a lot of little emergency solos; rehearsal is not really a part of this band's history. Slim Jim Phantom (Stray Cats) did his amazing stand-up drum act (now *this* is the essence of good retro) and even ended the evening's single set by landing on his back in the audience. I *think* he was trying to kill the vocalist and missed, his murderous momentum carrying him well into the endless sea of black-lingerie-clad, 20-year-old girls. Oh, yes, the vocalist. Harry Dean Stanton, the actor from another galaxy (and *Repo Man*), played that role.

This was a bar band from the depths of faded memories, from the near future. A local band with members from all over time and place. Half the audience told me they understood Cheap Date, but half of *those* were wrong. The band did "Kansas City" (though Harry Dean Stanton was doing "Mustang Sally" at the time). Get the idea?

It was interesting to be there. A mixture of Blade Runners and Oh-Please-Look-At-Me 18-year-olds populated the club and the street it was on, along with some metalheads and a few plastic bad guys. It was cute. There was a V.I.P. area upstairs that was exactly like all the other areas,

POST TOASTY.

Full Sail's the place for the perfect Studio Tan.

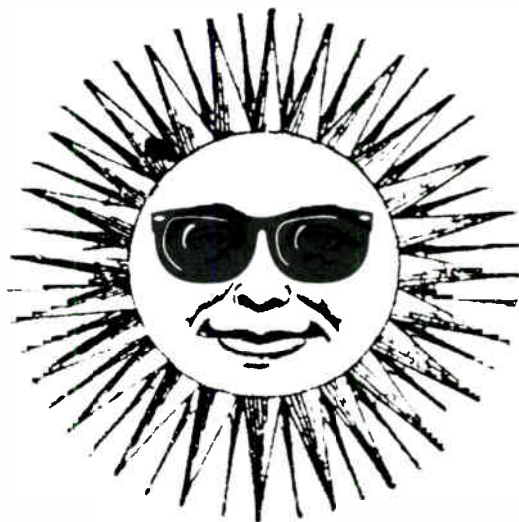

In case you haven't heard, Full Sail Center for the Recording Arts near Orlando, Florida is one of the nation's *hottest* educational facilities for learning all about post-production. Audio-for-video. Digital audio post. Automated mixing. The *hottest* gear: **Digital Audio Workstations. Montage Digital Picture Processor. Studer / Dyaxis II. Lexicon / Opus. Neve and SSL consoles.** Learn in the same 10-studio, 60,000 square-foot complex (and 48-track mobile unit) that has done pro sessions for **10,000 Maniaes, Amy Grant, Bon Jovi, The Allman Brothers, Joe Sample, The Cure, Al DiMeola, Fu-Schnickens, Nitro, Rick Wakeman** and commercial work for the **Walt Disney Company, Universal Studios, Hanna-Barbera and HBO.** And *maybe* catch some rays.

1-800-CAN-ROCK



WATCH FOR FULL SAIL'S
**DREAMS
ACROSS
AMERICA**
ON TOUR NOW IN THE
SOUTH & CENTRAL U.S.
CALL NOW FOR TICKET
INFORMATION

3300 University Boulevard, Winter Park (Orlando) Florida 32792

Discover The Secret Of The Pyramids.

We've discovered a new acoustical foam that outperforms any we've ever seen (or ever sold).

ALPHA Acoustical Foam.

The secret is in its unique pyramid design.

Performance. ALPHA Pyramids have a superior ability to absorb low-end ambient noise. No other product can compare.

Pattern. ALPHA Pyramids' uniform pattern means easy matching for an attractive installation. Other products require random matching.

Packaging. All ALPHA Pyramids are UPS shippable.

Alpha Acoustics has discovered the secret of the pyramids. And we're impressed. That's why we now offer ALPHA Acoustical Foams to our customers. Call us. We'll gladly send you a brochure and a free sample.

Call 1-800-782-5742.

Acoustical Solutions, Inc.

Richmond, Virginia

Licensee **Alpha Audio Acoustics**

USE READER SERVICE CARD FOR MORE INFO

There's more to Ear Monitors[®] than meets the ear.



The RADIO STATION UHF Stereo wireless system shown with Ear Monitors[®]

Transmitter / receiver performance is the critical link in any wireless signal chain. The Radio Station UHF wireless system is specifically designed for at-ear monitoring applications and provides the capture and broad dynamic range necessary for full fidelity at-ear monitor mixes.

Artists and engineers around the world have come to rely on the superior audio quality made possible by the reliable and compact Radio Station / Ear Monitors[®] combination.

Available in stereo UHF wireless or stereo hardwired configurations, Ear Monitors[®] systems provide a customized, studio-quality listening environment anywhere on the stage or set. To learn more about Ear Monitors[®] and at-ear monitoring systems just call or write.



Ear Monitors[®]
The winner of the 1992 TEC award:
Sound Reinforcement Product of the Year

**FUTURE
SONICS**
INCORPORATED

655 DANBURY COURT, NEWTOWN, PA 18940 TEL. (215) 579 4414 FAX (215) 579 0769
© Future Sonics Inc. 1993

except it was a V.I.P. area, so everybody spent all their time trying to convince the V.I.P. area *guards* that they were cool and connected enough to get in. Since this wasn't too hard, it soon became the most crowded, hottest and most uncomfortable area in the club. It was a Very Infernal Place, all right.

One lone, beautiful, young 110-pound girl in underwear did an amazing job of beating the hell out of three 285-pound club bouncers. I have witnesses. Twenty of us watched that fight from the upstairs picture windows as it spilled out into the middle of Sunset and stopped traffic for five minutes, until the police showed.

I need to do more live club performing. I forgot the subtle beauty of a music-inspired audience interacting with the local authorities, the complex bouquet of vodka, beer and gasoline in the superheated air around the little stage. I forgot what it was like to find a groove that hasn't changed in 30 years and have a good portion of the audience hook up for the ride.

TWO OUT OF THREE

Next, there is the mere *existence* of the Stray Cats. As I write, Baxter is wrapping their next album, and I keep calling to see if it's ready yet. This is retro Art. This minimalistic interpretation of '50s/'60s bop seasoned with simplified modern blues/rock is as refreshingly blatant as Nagel's cold, minimalistic treatment of the females in his paintings. Both produce a timeless phantom warmth where there really is none, an end result that far exceeds the summation of its components.

AND NOW...

Are you ready? I don't think so. I just spent a week with another band that is finishing an album. This band is in a very strange position, for several reasons. They have stuff they have to live down. They have stuff they have to live up to. They have a totally *successful* image and past that they have to *overcome!*

They are...Wait, I'm out of time. I guess I'll have to tell you about these guys next time. Stay tuned. ■

Stephen St. Croix's mail-order prose course showed up this week.

improving the way the world sounds.

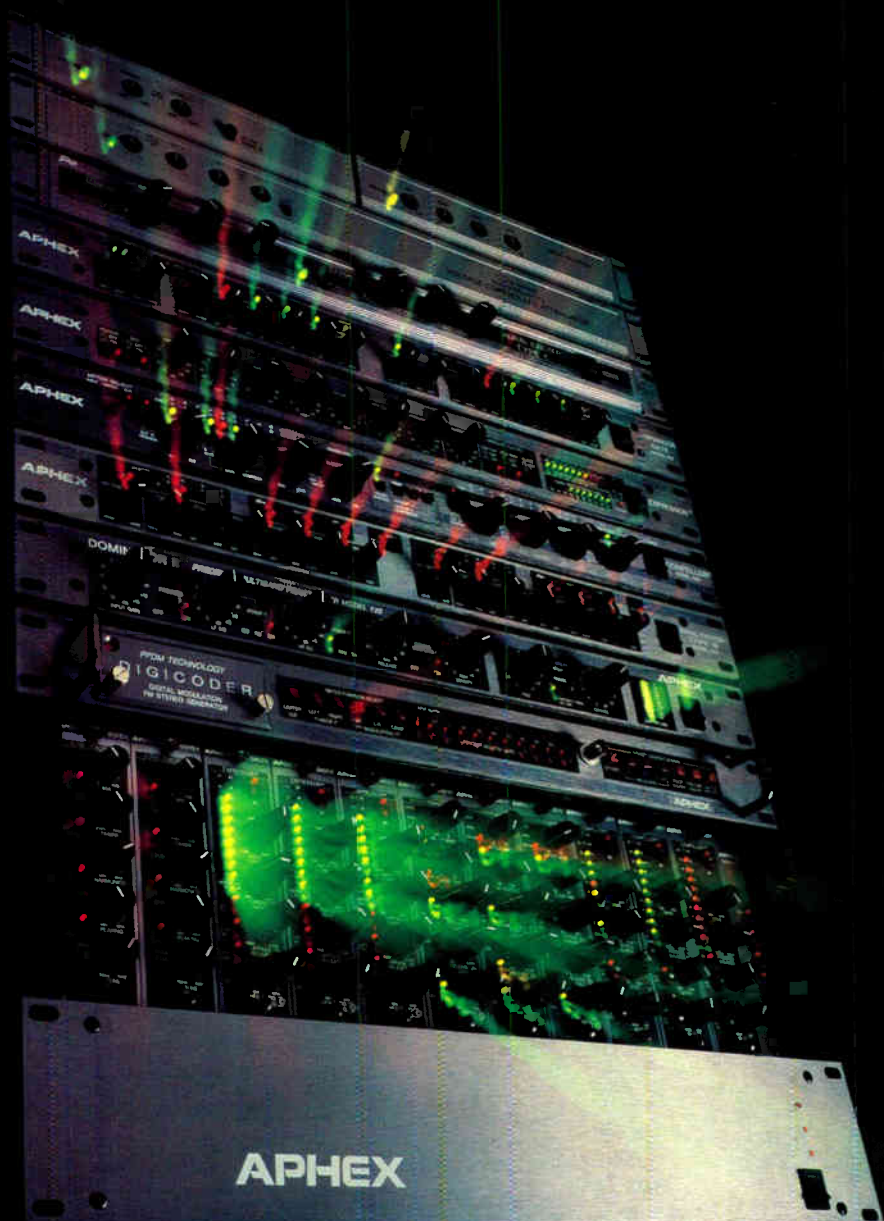

Apex
Professional
Audio Products
for recording,
broadcasting,
sound
installations and
live performance:

- ▶ Compellor® the "intelligent" Compressor/Leveler
- ▶ Dominator™ Multiband Precision Peak Processor
- ▶ Digidcoder™ FM Stereo Generator
- ▶ Expressor™ Compressor/Limiter
- ▶ Expander/Gate, simply the world's finest gate.
- ▶ Modular Signal Processing
- ▶ Distribution Amplifiers
- ▶ Audio Level Interface
- ▶ VCAs
- ▶ Aural Exciters®

ARGENTINA—AG Electronica; AUSTRALIA—East Coast Audio; AUSTRIA—AKG Acoustics; BELGIUM—Trans-European Music; CANADA—Erikson Pro Audio; CZECHOSLOVAKIA—Audiopolis Studio Systems; DENMARK—SC Sound; EGYPT—Alpha Audio; FINLAND—Nores; FRANCE—Cineco; GERMANY—AKG Acoustics; GREECE—Omikron.; HOLLAND—TM Audio; HONG KONG—Ace; HUNGARY—ATEC; INDIA—Pro Sound; INDONESIA—PT Multi Audio Perkasa; ISRAEL—Sontronics; ITALY—Audio Equipment; JAPAN—Otaritec; KOREA—Young Nak So Ri Sa; MEXICO—Audioacustica y Electronica; NEW ZEALAND—Maser Broadcast Systems; NORWAY—Audiotron; PERU—ABBA Trading; POLAND—Europe Sound System; RUSSIA—MS MAX; SAUDI ARABIA—Halwani Audio; SINGAPORE—Auvi Private; SOUTH AFRICA—Tru-Fi Electronics; SPAIN—Lexon; SWEDEN—LEAB; SWITZERLAND—Audio Tech; TAIWAN—Advancetek; U.K.—Stirling Audio

APHEX Audiophile Signal Processing
SYSTEMS

11068 Randall Street, Sun Valley, CA 91352 U.S.A ■ (818) 767-2929

All trademarks are property of Apex Systems Ltd.

Aural Exciter, Compellor, Digidcoder, Dominator and Expressor are covered by U.S. and foreign patents issued or pending.

by Mr. Bonzai

PHIL RAMONE

LOOKING BACK, LOOKING AHEAD, PART II



[Last month, Mr. Bonzai lunched with Phil Ramone, focusing on the esteemed producer's most recent projects. This month we go back in time, dancing through the '60s, '70s and '80s with one of the true legends of the recording industry.—Eds.]

Bonzai: Bill Dooley is an engineer who worked with you on a Paul Simon collection. He remarked that over a span of perhaps ten years you had achieved such a consistently incredible low end. How do you get that great bass?

Ramone: Well, that's a great compliment. In my early days of making records, the hardest thing to do was to capture the bass properly. Acoustic basses, electric basses—they didn't sound great for a long time. Not until the late '70s did people actually get things on the air that sounded like a bass. My aim was to make this *fat-back bottom* work on radio. The switches to FM were the best moves that we ever had, but we still had a struggle to make a record that played well anywhere.

The LP was really tough. One of the first things that really impressed me about record making was the way Paul McCartney sounded on records. I always thought that George Martin did something that I didn't know about.

Bonzai: That's true—Paul has always had such a great bass sound.

Ramone: It also helps that you have Paul playing. When I worked as an engineer on one of his albums, I learned a lot. I think one of the reasons I got the job was that I understood some of the bass content of records. I've always loved the fact that a good bass line with the melody line can work incredibly for an audience. They may not know why, but it really makes the difference and it carries the groove.

For me, it goes back to working

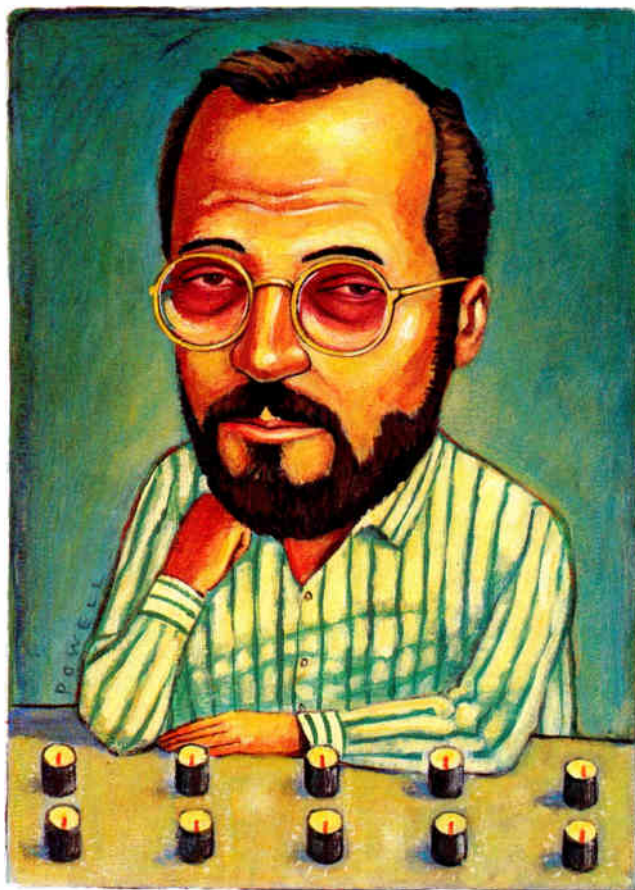

with Burt Bacharach and people whose bass lines were so great, along with the top end. It might be working with John Barry on a film score where he wrote for eight basses. You would get an incredible low end in the room and say, "Now I understand. And now I've got to get it on the record."

I explored the anharmonic structure of what a bass note sounds like: combinations of tones that resemble the same harmonic from the original note. For instance, the bottom of the bass is actually fundamental, and then there are harmonics of it. Many times you don't hear either one, but if you can accentuate one of the har-

ILLUSTRATION: CHARLIE POWELL

Some things are worth preserving...

Photo courtesy of Rainforest Foundation International
(212) 451-9098 Photo credit: Sue Cunningham

...including your recordings

Apogee Electronics Corporation, a pioneer in digital audio technology, has earned a reputation for excellence by manufacturing award winning products for the world's most important recording artists, producers, engineers, and studios.

When we announced we were developing a high definition DAT tape, it was only appropriate to address the concerns of these professionals...professionals, like you, who strive to create quality recordings.

You need a DAT with minimum-to-zero errors, extraordinarily long shelf life and the ability to start recording without the customary wind in.

Combining all of these features with consistency, durability, and reliability, we are pleased to introduce the **Apogee Mastering DAT**.

You can't afford to risk losing what you've worked so hard to create. Preserve your recordings on Apogee DAT.

Simply the best there is.



Apogee Electronics Corporation
3435 Ocean Park Boulevard #211
Santa Monica, CA 90405 USA
Tel: (310) 314-1700
Fax: (310) 452-4343

Available in lengths of
15, 30, 60, 90 and 120 minutes.

Also from Apogee for storing your DAT
material:

Master Pac
holds two tapes.

Project Pac
holds up to ten tapes.



We've Always Talked Performance. Now Let's Talk Price.



266 Dual Compressor/Gate

Uses the newly developed dbx AutoDynamic™ attack and release circuitry which delivers classic dbx compression for a wide range of applications—plus an advanced new gate circuit which overcomes the functional limitations of traditional “utility” gates. Both compression and gating provide superior versatility and sonic performance.

\$299



296 Dual Spectral Enhancer

Cleans up and details instruments, vocals and mixed program material on stage or in the studio. Dynamic self-adjusting circuitry lets you dial in just the right amount of sparkle and sizzle you want. HF Detail and Hiss Reduction work together so you can actually cut hiss while adding High Frequency Detail. LF Detail solidifies the bottom while removing mid-bass mud.

\$349



274 Quad Expander/Gate

Four independent channels of high-performance gating or downward expansion in any combination of stereo pairs or mono channels. Patented dbx VCA and RMS detection circuitry provides ultra-fast attack times to preserve the character of percussive sounds and an incredibly smooth release that won't chop off reverb tails or hanging guitar chords.

\$449

Now, with the dbx Project 1 series of signal processors, there's no need to settle for second-tier equipment to save money. Those ever-abundant budget brands have touted great pricing but have never matched dbx quality, reliability and experience.

dbx
PROJECT 1

dbx Project 1 is ideal for both studio and sound reinforcement applications. Each unit delivers real dbx sound and reliability, plus innovative new performance enhancements—at the same price of other models with fewer features.

By using the latest technologies, we've streamlined the manufacturing process to reduce production costs. At last, you don't have to forego the quality and features you want to stay within budget.

So now that we've talked price, isn't it time you talked to your nearest dbx dealer and asked for a demo?

dbx

1525 Alvarado Street, San Leandro, CA 94577
Phone: 510-351-3500 Fax: 510-351-0500

AutoDynamic is a trademark of AKG Acoustics, Inc. dbx is a registered trademark of Carillon Electronics Corporation. AKG is a registered trademark of Akustische u. Kino-Geräte Ges m b H., Austria © 1993 AKG Acoustics, Inc.

USE READER SERVICE CARD FOR MORE INFO

World Radio History

LUNCHING WITH BONZAI

monics into the range of radio and the compressor doesn't kill it, you can believe you are hearing the sound that is actually being played. Your ear plays tricks on you, because it doesn't know that some of that frequency isn't there. You have to imagine what it would be like.

There was this great belief that if you made a hot-sounding disc, it sounded better on the radio or anywhere else. It had to do with a mixture of compression and tonality. To me, it's part of the artistry of making a good-sounding record. That's why Bruce Swedien and these guys are so good at what they do: They understand the normal fundamental, which sounds good in a big studio with big monitors screaming at you. But how does that person who is sitting at home feel about what they are hearing? It's nice to personalize that record, and the low end is one of the toughest things to get. You can get it bristling on the top, but it's really a bitch to get it clean down on the low end.

Bonzai: Were you involved with the first CD?

Ramone: Yes, with Billy Joel, from analog into digital and carefully mastered. It became very successful, and I ran around the country promoting the idea that CDs were the future. I was laughed at a lot.

Bonzai: You pushed and bent the analog envelope, worked with the limitations and maybe created new sounds because of the medium. With digital, are there still things that you can bend and push?

Ramone: Oh yeah, I think moreso. We took off a big veil when we opened up the digital world. The problem people had was like when I first worked with high-definition cameras, and I realized how far and deep and wide the picture was compared to a standard NTSC picture.

You've never really been involved until you've switched over from tubes to transistors and from transistors to something better. Suddenly someone says, "By the way, if you open this door, here's what it really is." A lot of people don't want to deal with that. They have a built-in prejudice about what digital is about. New technology always scares the hell out of people. Digital just lets you work artistically twice as well, if you really concentrate on it. But your work is much harder.

MICRO SOUND

Digital Audio Workstations

38 Stereo-Tracks

When even 24 tracks are not enough...

Use hundreds of stereo segments to build hour+ Mixes with up to 38 playing at the same time! Create and move audio segments as easily as MIDI sequencing.

Sample precision graphic wave editing allows instant, seamless changes to be done/undone/redone at any time, while zone mixing further increases speed.

Record master files direct to disk using simultaneous record/play overdub and sync optionally to MTC, SMPTE or Video for sample precision synchronization.

Ready to run 486-33/50MHz Workstations starting at \$7,795 with 96 track-minutes @ 44.1KHz. Add to your computer - \$3,690.

Ask today for a free 24 page brochure to discover how Micro Sound will improve your quality and productivity.

Quality Digital Audio since 1977

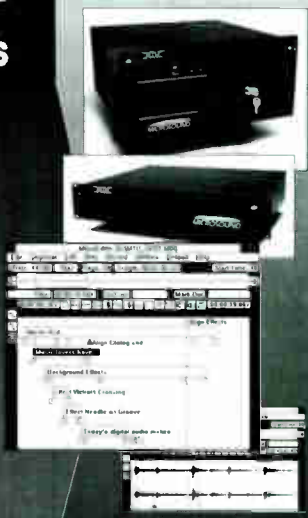

(919) 870-0344

Fax: (919) 870-7163



Micro Technology Unlimited

156 Wind Chime Court
Raleigh, NC, USA 27615

USE READER SERVICE CARD FOR MORE INFO

RELEASE YOUR OWN CD'S!

500 CDs plus 500 Cassettes **\$2,690**

with two-color inserts and chrome tape



Release your own major label quality CDs and cassettes affordably without sacrificing your artistic integrity or audio and graphic quality.

Our packages are complete and include insert design, film, and printing. No hidden costs! All you need to do is supply us with the master tape and photograph, and we'll do the rest.

- Major Label Quality
- Money Back Guarantee

"I want to thank you for your assistance on Jaime Valle's 'Round Midnight'. Everyone tells us how great everything looks and sounds. I would especially like to thank your graphic artists and design staff for making our projects look so professional."

— David B. Atkens,
PALMUSIC,
San Diego, CA

Call today for our FREE, full-color catalog and complete Guide to Master Tape Preparation
1-800-468-9353



DISC MAKERS

1328 North Fourth Street, Philadelphia, PA 19122
FAX: (215) 236-7763 • Outside USA call: (215) 232-4140

AV10493-6

I used to fight to get that fifth or sixth cut sounding good on an LP. It was a terrible situation. It was so bad. And now you have a CD, and it doesn't care if it was made on analog or digital.

People want to go back to the Neves and the old consoles now—the APIs and such—but we had some real nightmares with some of the old consoles. They tell me it gives them a warm sound. Then learn how to use the equipment and mix it, because your standard SSL or Neve of today, or your Euphonix, is going to become far more hip in the next two to three years. You better be ready for the change, because it's going to be incredible.

The whole format of how to make a record, and the sounds of it, and the styles, whether you like digital or not, comes down to this: Here come the boys with 8-track digital. And they are coming into your home. And if they sound better than the record being made in the studio, you better get your head together and your knowledge. Accept the fact that people nine and ten years old are going to make great-sounding records.

And when you were 20, you couldn't get the sound out of a bass...well, that's life. It moves on. A lot of people have learned to change, like Swedien and myself. Some songs, some things, have to be done partially analog, partially digital. Mix the two. I have a habit of mixing things from Dolby SR at 15 ips with some things done at 30 ips with a different bias on the tape machine, then dumping it onto a nice 48-track digital and finishing up the master that way.

Don't lose your marbles over the fact that you walk into a studio that only has a digital machine, and it only has one particular console and some mics that are new to you. You have to decide how you will use the tools. Should they be plugged in direct, should you go past the console? Half the people today are using outside preamps, which tells you a lot. The original Class A Neve console preamp is what people are working back to, because it had an incredibly warm sound. I can understand this. Let's face it, the vocalist wants to sound big, fat and great.

I work with people who have been busting their chops for the last ten years, starting as a second, work-

ing their way up, and they've been brought up on SSLs. So SSL comes out with one new equalizer, but they have to have that old equalizer because that's where their familiarity is.

The training ground bothers me, because the younger person hasn't had the advantage of going through all the crap of doing live acoustic dates. They never have to fight the problem of leakage and getting the EQ and getting around so many obstacles. When you have done that and realize how hard it is, and then you get into the digital world, it's like the greatest-sounding thing you've ever heard.

Bonzai: Well, you started recording in the real trenches. Didn't you shellack your bedroom to make an echo chamber?

Ramone: Yes, and I appreciate what I had to go through. I come from the school that knew it always could be better and bigger. The technology now is so superior to what we have

New technology always
scares the hell out of
people. Digital just lets
you work artistically
twice as well, if you really
concentrate on it.

had, yet I will sometimes take an echo chamber and delay it with real tape, because the delays are not quite there. Certain things will happen in a chamber.

I remember when the EMTs came in and were basically a failure in America during the early '60s. I found new sounds by delaying it and working tape machines into it and out of it. At the time, it was considered the coldest metallic sound ever heard in music, and a live chamber was the only way to go. In most studios, if you didn't have a live chamber they wouldn't record with you. So, not having any money and working in your typical studio, we hid an EMT in the basement and told everybody we had a big room down there. After two major hit records, the clients would ask, "Can we have that big

room down in the basement?" "Well, I'll have to call up and see if I can book it."

After a while, we ended up with three EMTs per room—left, center and right. And people didn't understand what that was about. I've had some very interesting conversations regarding the sounds of different digital delays and reverbs. In my opinion, there are a lot of scary things happening with phase. People are not being careful to listen to—God forbid—*mono*.

Many folks aren't driving with two speakers on at the same time at the same level where you are sitting while you were engineering. Some of those wonderful effects you spend hours and hours creating don't translate. Phase cancellation is a major crisis inside a reverb unit. People don't like to hear about it, but it's one of the things I worry about. Constantly switching back and forth between mono and stereo helps you beat the problems. You can create the space, and I love the new devices—that's what music recording is all about.

I see room mics put up, and I ask people if they have listened to the room much. Not many rooms sound good. I learned to beat the sound of a room with the proper reverb and chambers. The first room I worked in was in an apartment, certainly not acoustically well-designed. After that it was a studio that had cement floors and a low 12-foot ceiling.

Bonzai: Can you recall the first session where you flew solo as an engineer?

Ramone: Yes, and afterward there were stains on my pants. It was a Neil Sedaka record. I was about 17, and I had never balanced a whole rhythm section before. It was like the first time that your dad says, "Okay, son, now you take the wheel." It was incredibly exciting, and I still get that feeling.

Consistently, over the years I have worked with big bands. A few years ago Quincy Jones called and asked, "Will you do Sinatra with me with a big band?" And I was able to reproduce that experience recently while working with Sinéad O'Connor and a big band. You put your hands on the console, and suddenly you realize, "Oh, my God. It all depends on me, and if it falls apart it's my ass."

You learn from exasperating experiences what it takes to make a good record. Guys like Tom Dowd and Al Schmitt were major influ-

MACINTOSH® INTERFACE
Available!



LEXICON'S TWO FOR ONE DEAL—IT'S A SNAP

THE 300 DIGITAL EFFECTS SYSTEM: NOW WITH MORE EFFECTS AND MORE FUNCTIONS

Version 3.0 software for the industry acclaimed* 300 Digital Effects System gives you the *power of two machines* within a single mainframe. The 300 is the most versatile and inspiring effects processor in its price class. It's the only one to combine comprehensive time code effects automation, Dynamic MIDI®, indispensable digital interfacing (AES/EBU/SPDIF) and world respected Lexicon sound.

Our new 3.0 upgrade multiplies the powerful features of the 300—the latest product in a heralded range of processors that improve through software updates. New "Split" and "Cascade" configurations now permit versatile dual-processing modes. We've added five new algorithms to further extend the 300's incredible array of useful sound effects—all with the same brilliant sound quality you would expect. And — as if this wasn't enough — our 3.0 update also includes MIDI time code, the ability to *automate parameter glides* through time code...and more.

*1991 Mix Magazine TEC Award Winner

Audio engineers all over the world rely on the 300 for the finest reverb and ambience programs available. Many mastering engineers also depend on the 300's powerful Stereo Mastering algorithm for precise level, balance and equalization in the digital domain. And for rigorous post-production engineering tasks, the built-in SMPTE time code reader and 50 cue EDL are vital.

For over 20 years, audio professionals have relied on the superb quality and control of Lexicon Digital Effects Processors. So much so that today, 80% of the most successful productions are processed with a Lexicon.

If you're a 300 user, contact us on how to get 3.0 performance—and extend the return on your investment. If you're interested in more powerful processing, consider the advantages of offering the renowned Lexicon Sound in your facility — and the latest improvements on an already brilliant machine.

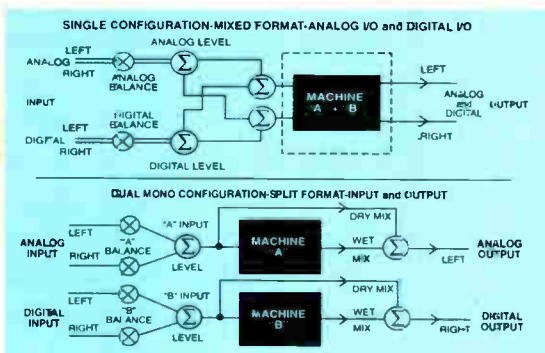

Macintosh is a registered trademark of Apple Computer, Inc.

Lexicon

HEARD IN ALL THE RIGHT PLACES

LEXICON INC., 100 BEAVER STREET, WALTHAM, MA., 02154-8425 TEL: (617) 736-0360 FAX: (617) 891-0340

USE READER SERVICE CARD FOR MORE INFO

ences, and Bill Schwartau was my mentor. Bill was a nut case, a wonderful guy. Bill worked with me at JAC Recording, a demo studio [where projects] ran about 15 minutes a song, including string overdubs and whatever was needed.

Bonzai: When you say overdubs, was this multitracking?

Ramone: No, we were 2-track, and sometimes it was mono to mono. We were just bouncing back and forth from machine to machine. I think we were the first recording studio at the time, in the early '60s, where you could listen to both stereo and mono.

Most of the other studios had a separate room to do stereo. They'd take a couple of mults and record on a 2-track recorder, but the record business didn't really want to know about stereo. We bought an Ampex 3-track machine and were ahead of all the 2-track studios. That was the start of making pure 3-track recordings, and the beginning of all the Brazilian music I did in New York with Creed Taylor, where the middle channel was hard middle. There was

a stereo blend, but it was with the two outside tracks.

Then Scully came along with a 4-track, followed by the move to 8-track. The 8-track recorder was the best discipline to make a record on. You made a lot of decisions in the room, saving certain channels so you could overdub. And now we are back to 8-track for home recording. You learn to live within those confines and go back to bouncing the tracks carefully and making the technology work in your favor. You make early commitments to the record, and it's healthy. Bruce Swedien and others work very hard to make their work tapes. If you learn to make that commitment, then you can really use the extra tape machine.

Bonzai: Let's talk about the time when you were music director for the Kennedy administration. What's the story behind Marilyn Monroe singing "Happy Birthday Mr. President"?

Ramone: Well, it was a birthday party for Jack Kennedy at Madison Square Garden. I was only 22 and had been adding speakers and trying to improve the overall sound of events.

Throughout the show, it became a running joke that Marilyn would be next, and, of course, she wouldn't appear, so another artist would perform. Finally, a huge birthday cake was carried out by 20 people and out popped Marilyn. Hank Jones was at the piano, and she went up to the mic and sang "Happy Birthday." It's just become a fun moment in history.

From a musical point of view, I was just very fortunate that people were calling on me to do these spectaculars. I must have had a screw loose when I worked at the Armory in Washington. I put up these huge NASA balloons filled with styrofoam to deaden the ceiling. But how do you straighten out a hall? You can't buy \$4 million worth of drapery.

But the sonic improvement was noticeable, and the producers had faith in my engineering ideas. I just used my instincts and my logic, and I was given the freedom to do what I wanted. It rarely happens, particularly if you are a youngster. We hung 250 speakers, did things that had never been done before with delays and stuff. I worked with the set designers so that we had ramps for the

**WITH DCC TECHNOLOGY, EVEN AUDIOPHILES
WILL BE MAKING TRACKS FOR YOUR PRODUCT.**

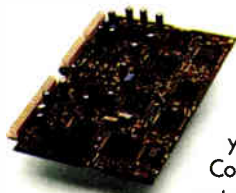

Even the most discerning ears will perk up when they hear your new Digital Compact Cassette systems. DCC delivers unequalled sound quality, track after track.

DCC technology allows you to offer more...

- digital recording • increased shock resistance
- ability to play current audio cassettes • sampling at 32, 44.1, and 48 KHz • digital error correction.

Specify DCC modules from Philips, the inventor of DCC. Philips gives you everything you need for your perfect DCC system: components such as mechanisms, PCB's, IC's and complete functional systems,

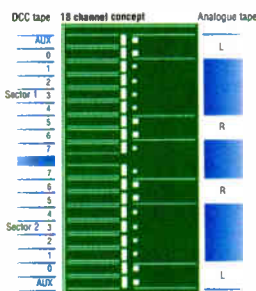

including hardware and software development tools. Philips DCC modules take your system to audio optimization!

- **LDU 1000...** Load/record/playback unit
- **DIG 1000 Signal Processor...** PCB with complete DCC electronic set
- **PASC IC's...** Complete Precision Adaptive Sub-band Coding IC set
- **Thin Film Heads...** 9 track record/playback to 18 track playback

Call today and let Philips help you make a quality sound decision!



PHILIPS

It's Time
U.S. 1-800-235-7373
Outside U.S. FAX 31-40-732277

P H I L I P S K E Y M O D U L E S G R O U P

USE READER SERVICE CARD FOR MORE INFO

Be Prepared

with "Neumann Sound"



It's difficult to describe *Neumann Sound*. Words such as warm, smooth, natural and open are often used. No matter how you describe it, *this sound* is the reason more top professionals use Neumann microphones.

The KM 100 Microphone System offers Neumann performance at a price that's much less than you might think. Interchangeable capsules, a wealth of accessories, and compact

design make the KM 100 System adaptable to the widest variety of applications.

Don't settle for imitations when you can afford to use Neumann... the choice of those who can hear the difference.

Call us for a demonstration and your free copy of our KM 100 brochure. We'll also give you details on how you can get your very own Neumann pocket knife.



The KM 100 Microphone System



Neumann|USA

6 Vista Drive, PO Box 987, Old Lyme, CT 06371
Telephone: 203.434.5220 • FAX: 203.434.3148
West Coast Tel: 818.845.8815 • FAX: 818.845.7140



IT FITS INTO ANY CONSOLE AND EVERY ENVIRONMENT
 "The System 2000 is easy to install and maintain. All of the processing is an integral part of your fader module, eliminating the need for external racks. Software-based, Uptown fits into any board and room and is easily customized."



If these rooms could speak, they'd tell you why they chose Uptown Moving Faders Automation.

IT WORKS INVISIBLY
 "Uptown automation works virtually unnoticed in the background. You never have to look up from or leave your console because it follows your method of working. The System 2000F includes unique features like *Kill*, *Touch* and *Latch* that make audio-for-film easier, more creative and less time-consuming."



ITS OPEN-ENDED DESIGN GOES AS FAR AS YOU WANT IT TO
 "Uptown's open-ended approach to system design facilitates updating and customizing. It allows automated control of EQs, Sends and the Fader itself, depending on your individual needs and budget."

For a personal tour of Uptown Moving Faders Automation, call Chris Fichera at 310-306-8823

Exclusively distributed by Group One, Ltd.
 80 Sea Lane, Farmingdale, NY 11735
 Tel: 516-249-1399 Fax: 516-753-1020



audience to sit on, and carpeted them. I had more than two monitors onstage so that everyone could hear themselves, which was a new off-the-wall idea. We hung drapes on the wall opposite the stage.

I was asked back for the 1964 inaugural. It was an honor to be involved in the preservation of music in the White House, which may have set a pace for the funny Nixon years: Recording the presidential comments became part of the tradition. Before this, it was mostly newsreel footage or radio transcriptions. It took people awhile to realize that while you are living the history, you must preserve it in some way.

There wasn't much of a budget in the White House, so I brought in friends, and companies contributed speakers and tape machines. I had access to the studios of the Marine Corps Band, or the Navy Orchestra, or the choir—amazing stuff at my disposal.

Bonzai: What was your first hit as a producer?

Ramone: I believe it was "Everybody's

Talkin'" with Harry Nilsson for *Midnight Cowboy*. You know, I worked with him again last year on Ringo's album, and he sang some background vocals.

Bonzai: I was just listening to that last night. Isn't it a shame when a good record disappears because it doesn't immediately streak up the charts?

Ramone: There is something unfair about the timing, when something happens or doesn't happen. It comes from that old world where music was disposable, and you and it weren't supposed to live very long in the eyes of the public. But now we are seeing Eric Clapton being appreciated after 30 years.

For an industry that makes so many records a week, a year, it's amazing that anything is heard more than a few times. And works of art, meaning exciting albums, have a tendency to find their life somewhere. But it's tough on folks like Ringo, because he certainly put the effort into making a fine record recently, and that's only a stepping stone to a better record. He's a terrific guy. I think that there are mature album artists

that should be handled in a different way. I saw him on the road, and it was a great night of music.

Bonzai: You worked on Ringo's album alongside some rather respectable cats. Are you inspired by hearing what other guys are doing?

Ramone: Well, Don Was is certainly a very respectable cat, as are Peter Asher and Jeff Lynne. I think Narada is an incredible guy. I like what Walter AfanasiEFF is doing with Mariah. LiPuma does an incredible job. Certainly Arif Mardin. I'm a big fan of Jimmy Jam and Terry Lewis. When I hear a record on the air, and I'm driving in my car, I've been known to pull over to the side because it's so good. And then I go out and buy it.

I've always been worried that somebody is going to do it better. There is a competitive side to making great music and finding ways for it to slot better, to sound better, to be heard in a different way than ever before. I'll be honest with you, when you start a new record, there is no cushion under your ass. ■

Watch for roving editor Mr. Bonzai's upcoming 20-bit jokebook.



A Whole
New Concept
With A
Fresh Set
Of Parameters...

Valley Audio

MODEL 730 DIGITAL DYNAMICS PROCESSOR

The next generation of dynamics control from Valley Audio! Bridging the gap between high fidelity analog and modern digital innovation comes a breakthrough professional audio tool -- the Model 730 Digital Dynamics Processor.

More than just a digital version of an analog stereo compressor, limiter, expander, sibilance controller or keyed gate, the Model 730 allows complex, easily programmable multi-threshold, multi-ratio dynamic transfer curves to be combined for total control of demanding audio signals. There's nothing like it, anywhere!

The Model 730 features zero-attack detection for distortionless broadband limiting, simultaneous multi-ratio compression and expansion, externally keyable gating and selectable high frequency limiting. An optional dual linear fader

remote control allows assignable "in-hand" parameter and volume control, great for remote zipper-free digital fade-ins and fade-outs on DAT to DAT transfers!

The Model 730 speaks every common signal and control protocol, from analog -10 to +4, digital 30 kHz to 50 kHz AES/EBU, S/PDIF, SDIF-2; TOSLINK optical, MIDI, RS-232, and RS-422.

Internal 24 bit architecture with 18 bit I/O conversion insures the utmost in high fidelity, and ROM resident software, flexible Aux connectors and daughter board modular expansion provide lots of room for future growth.

The options and functions could fill a brochure, which we'd be happy to send you. Or contact your favorite pro audio dealer for a test-listen of the Model 730.



Valley Audio Products Inc.

9020 West 51st Terrace, Merriam, Kansas 66203
Phone (800) 800-4345 FAX (913) 432-9412

USE READER SERVICE CARD FOR MORE INFO

by Dan Daley

JAMES STROUD

NASHVILLE'S NEW ARCHETYPE

James Stroud's credentials certainly merit this space. He started as a session drummer in Los Angeles three decades ago (also working as an engineer), backing artists such as Paul Simon, the Pointer Sisters, Gladys Knight and Bob Seger. Stroud is now at the apex of the Nashville producer pyramid, crowned with his multi-platinum productions of Clint Black, among scores of others, and a 1989 ACM Producer of the Year award. He is also vice president of A&R for Giant Records in Nashville. This is not bad work if you can get it.

But Stroud, like others of his stature, is best understood within the context of the Nashville music business. Only in Nashville can an act be signed to a major label by, be published by, and be produced and recorded in a studio owned by, the same person. The intensity and significance of this almost feudal arrangement, which concentrates tremendous power into a very few hands, is not lost on Stroud, who stresses a team approach to both production and business, and, one suspects, life itself, since the three are inseparable when you live in a town they call Music City.

A team approach is also expedient when you are producing or co-producing as many as a dozen records a year, which in Stroud's case included John Anderson's huge comeback *Seminole Wind*, Tim Mensy's debut record, country rockers Zaca Creek's first Giant release and Clint Black's *The Hard Way* last year. His engineering ensemble for this prodigious output includes Pat McMakin, Lynn Peterzell and Julian King.

On the subject of co-production, which is as much a way of life here as cowriting is for songwriters, Stroud says it's expedient but at the same time a way to give the artist as much attention as possible. "If I find an act needs more development than I can

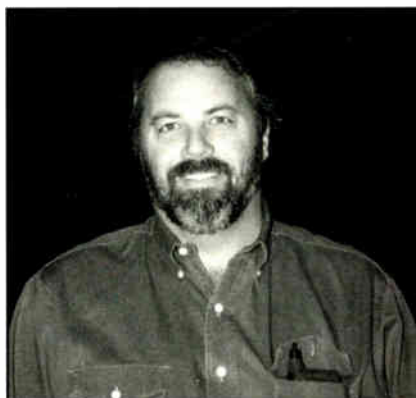

give at a certain time, I bring in a co-producer," he explains. "It's not a matter of hiring someone to work with the artist until it's time to make the record, then I get in there. It's more a matter of who has the time and what skills are available. Most of the people I co-produce with are successful producers, and they're often just as busy as I am. Co-production is a way to keep a focus on the artist and still get all the work done."

Not that co-production is as clinical as it may appear on paper, though "It's like any of the other teams that make this town work," he adds. "Barry Beckett and I did Hank Jr., and we had a great time at it and so did Hank. That's the best situation. We cover each other, and the artist is always covered, and there's three sets of ears working."

After cutting his production chops in L.A. and Muscle Shoals on R&B records, and after a successful career as a session drummer in those cities (with occasional forays to New York), Stroud made the move to Nashville in 1981. Sessions were plentiful for producers like Jimmy Bowen and Tom Collins, although he became mindful of Southern session protocols early on.

"Nashville was making the transition toward pop-type records at that time, with people like Ronnie Milsap and Eddie Rabbitt getting hits on the

pop charts," Stroud recalls. "I was coming from Los Angeles and had certain ideas about sounds and drums, and I guess attitudes. [The late] Larrie Londin and I were the first drummers in town to use cartage services, which was seen by some as an 'attitude thing.' I had to be very careful not to hurt feelings and egos. It was a very sensitive situation in many regards."

Stroud's drumming was familiar to

Production, business
and life itself are
inseparable when you
live in a town they
call Music City.

cutting-edge country producers of the early '80s like Tom Collins, who recognized the drummer's nascent production capabilities early on. Stroud the musician still plays on many of the records produced by Stroud the producer, saying it gives him a physical as well as emotional involvement with the music, bringing him that much closer to a project.

But sessions are easy compared to getting his foot into the production door in a town whose rigid power structure was firmly entrenched. The next generation of producers, though, was playing sessions together in those days—Stroud, Paul Worley, Keith Stegall and others. "Tony Brown [Wynonna Judd, Reba McEntire] and I were making gospel records together," he remembers. "But in the beginning, people like Paul and Tony and me had a hard time getting productions. There was a standard here. The town had gotten to a certain place and was happy selling 150,000 records. Nashville then was a branch town in the music industry. But after *Urban Cowboy* and the pop influence—after Eddie Rabbitt went platinum and other records were starting to sell 750,000—it sort of blew the lid off. We learned to make country records with a pop edge." Stroud, with his L.A./R&B background, was rather well-suited for the transition. As a drummer, he knows that timing is

everything.

Stroud's early productions, including Lacy J. Dalton, the Bellamy Brothers, Lee Greenwood and Eddie Rabbitt, and his production of Dorothy Moore's *Misty Blue*, which garnered five Grammy nominations and sold three million units, put him on a fast track in Nashville. But it was Clint Black who put Stroud on the map as a contender for Music Row royalty. Manager Bill Hamm (ZZ Top) played Black's demos for Stroud and got him to come down to Texas and listen to Black on his home turf, the Houston nightclub circuit.

"The first time I saw Clint was in a little club outside of Houston," Stroud says. "We got the idea to do the pre-production for the project in the club during the day and try the arrangements and songs out on the crowd at night. What didn't work we just threw out; if they got up and danced and clapped, it went on the record."

Some of Black's band played on that record, *Killin' Time* (co-produced with Mark Wright), which was a departure from another Nashville convention of using the local A-team on records and consigning the road band to the bus. "Every chance I get, I try

IT TAKES 22 YEARS FOR OUR SOUND TO REACH YOUR EARS



BUT IT'S WORTH THE WAIT

22 Years of experience has told us that it takes at least eight days to build an accurate monitor. Not just a monitor that reproduces quality sound, but one that ensures the absence of all sonic imbalances. Whether your business is recording,

digital editing or post production the equipment you choose will determine the level of satisfaction you are able to give your clients. At Westlake Audio we believe that before our sound reaches your ears it has to satisfy ours.

from acoustic design
to down beat ...

**Westlake
Audio**

Manufacturing Group
2696 Lavery Court, Unit 18
Newbury Park, California 91320
805 499-3666 • FAX 805 498-2571

USF READER SERVICE CARD FOR MORE INFO

to bring in something of the artist," Stroud explains. "If the guitar player or keyboard player plays well enough, I'll bring him in and make him part of the [studio] band. There's a couple of reasons for that. The player brings some of the artist in with him, some of the musical sensibilities that get the performance across; and it also makes the artist more comfortable to have someone that he works with in the studio."

Considering Stroud's A&R duties and the administration of his pub-

lishing companies, Stroudavarious and Stroudacaster, it's amazing he's found time to be in a studio at all. Like many other Nashville producers, Stroud commissioned his own studio, Loud Sound, which opened in the UA Tower on Music Row in February and is outfitted with equipment leased from longtime friend and fellow country and pop producer Richard Landis.

The single-control-room facility provides a comfortable place for Stroud to work at his convenience—as an adjunct to the tracking and mixing rooms that he uses regularly.

Masterfonics and Soundstage are two of his favorite haunts, with the SSL desks he likes to track with and the Neve boards he likes to mix on. Loud will have Landis' SSL board. Stroud, however, chooses his studios based on more than technology.

"There are a lot of studios in Nashville, but not a lot of the right studios," he says. "I carry most of my mixing gear with me in racks, so all I need is a console and a computer. But for tracking, the room is critical. So from the core of very good studios available here, after the technology, it's a function of personal relationships. I like to bring my work to the people who have helped me in the past."

Loud will be a traditional commercial studio, open for outside bookings when Stroud isn't using it. Considering how much he works, the studio's revenues will likely be relatively immune to the Nashville rate fluctuations. But Stroud acknowledges that he is more than aware of how personal recording will have an impact in a city where—according to local industry publication *Music Row*—approximately half the revenues for 24-track facilities come from songwriter and artist demo sessions, sessions which increasingly take place in people's home studios.

As for his future, Stroud is showing evidence that his pop origins are still there; as we spoke, he was doing some pilot sessions with Billy Falcon, a gravel-voiced troubadour whose single a couple of years ago, "Power Windows," positioned him on the narrowing meridian between country and lyrical pop. But Stroud is cautious about how far country production can venture into pop territory before there's a problem.

"Back in the early '80s, it blew up in our face," he says. "We were making plastic records. Things got a little too slick. It wasn't bad music, but we sort of lost our identity in country. So we went back to the real things, finding it in people like Randy Travis: traditional country but with the sonic updates of pop. And in terms of production, that's the line Nashville, and not just the producers, have to walk, because the records can get too slick, and we can overmarket ourselves right into trouble again." ■

East Coast editor Dan Daley has authentic Tony Lama cowboy boots to go with that swagger.

LOUDER BY DEFINITION.

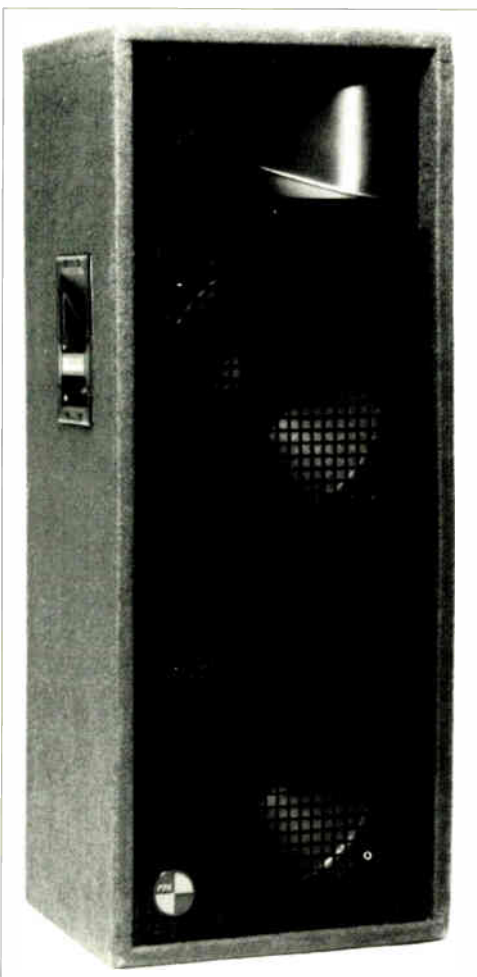

Looking for high level sound reinforcement that lets people hear everything? The best way to get superior vocal and instrumental reproduction with exceptional power handling capability is the Target T1550U two-way portable system.

The T1550U's high power handling is provided by two PAS cast frame 300 watt 15" woofers and a high power 1" compression driver on a constant coverage horn.

A perfect choice for PA companies, clubs and theaters, the T1550U features the finest quality components, construction and finishing to make it a dependable performer for the long haul.

Target T1550U. The new mark for audio quality and power handling in portable sound.



Professional Audio Systems 660 N. Twin Oaks Valley Rd., Suite #101, San Marcos, CA 92069
TEL: 619-591-0360 FAX: 619-591-3602

USE READER SERVICE CARD FOR MORE INFO

DOUBLE TAKE

As if they weren't already an unbeatable team, the DPMSM SP/DPMSM SX combination now has twice the punch with the introduction of the new DPMSM SX II Stereo Sampling Expander Module from Peavey.

There are many reasons why the Peavey DPM SP has become the most popular sample playback instrument in the industry; affordability, expandability, sonic quality, and ease-of-use, just to name a few. Now there is another reason -- the DPM SXII.

The SXII Sampling Expander is designed specifically to complement the SP. It offers stereo inputs which accommodate quarter inch or XLR connectors for true stereo sampling. New features include: real-time sample transfer over SCSI, so it samples directly into the SP's memory,

eliminating the need to expand memory in the SXII; a stereo audio output allows monitoring and auditioning samples as they are recorded; a MIDI input allows samples to be played directly out of the SXII from a MIDI keyboard or trigger device; and yes, the SXII comes with SCSI as a standard feature.

Now there is no doubt, the DPM SP teamed up with the DPM SXII is absolutely the most flexible and affordable 16-bit stereo sampling system available.

PEAVEY HAS JOINED FORCES WITH THE TOP NAMES IN THE INDUSTRY TO OFFER AN EXTENSIVE LIBRARY OF SOUNDS AND SOFTWARE FOR THE DPM SP AND DPM SXII. LOOK FOR THESE SUPPORT PRODUCTS AT YOUR LOCAL PEAVEY DEALER:



INTERVAL
SP Remote — Front Panel Editing Program for the DPM SP and MacintoshSM Computers. Created for Peavey by Interval Music Systems.



DENNY JAEGER
Denny Jaeger Master Violin Library — Available on a series of three CD-ROM disks for the DPM SP. Created for Peavey by Denny Jaeger.



PROSONUS
DPM SPSM Sample Disk Library — A complete library of sample disks for the DPM SP. Created for Peavey by Northstar, Stratus Sounds, Prosonus, and others.

RECEIVE A FREE "SAMPLE THIS" T-SHIRT WITH THE PURCHASE OF EITHER THE DPM SP OR DPM SXII. SEE YOUR PEAVEY DEALER FOR DETAILS!

For complete Peavey keyboard information and software upgrades, pick up the latest edition of **Key** issues at your local Peavey dealer.

The Monitor Magazine by Peavey is a publication filled with the latest information that musicians want to know. To receive 4 issues for only \$5 (price good in U.S.A. only) send check or money order to Monitor Magazine, Peavey Electronics, 711 A Street, Meriden, MS 39302-2898

PEAVEY

PEAVEY ELECTRONICS CORPORATION • 711 A STREET
MERIDEN, MS 39302 • (601) 488-5300 • FAX: (601) 484-4375

World Radio History



USE PEAVEY SERVICE CARD FOR MORE INFO



RECORDING
THE
**ACOUSTIC
GUITAR**

TIPS FROM TOP ENGINEERS

More than
any other instrument,
the guitar has defined popular music
in the late 20th century.

 And though the electric
guitar dominates in popularity, 
acoustic guitars are still a mainstay in
studios and stages worldwide. Faithfully
and artfully capturing the sound of
la guitarra is something

B Y · J O H N · L A · G R O U



PHOTO BY BILL SCHWOB

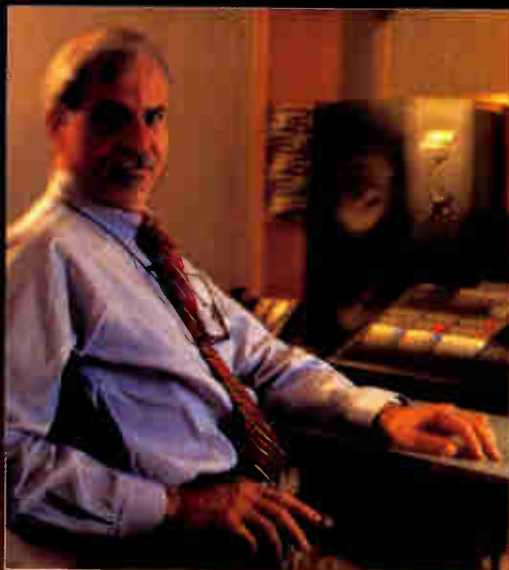

**Jack Renner
and the ATM35 on**

Bass, Brass, and all that jazz!

Jack Renner needs little introduction. As co-founder, Chairman, and Chief Engineer of Telarc International he has been nominated 11 times and won 5 Grammys just for classical engineering alone. Jack Renner and the Telarc team pioneered digital orchestral recording and the minimalist microphone technique that is now the standard for premium-quality classical CDs.

But when Jack recently decided to create a series of jazz CDs to complement the superb Telarc classical library, he knew – from his years of location recording – that he would need a new approach to solve the difficult acoustic and performance problems posed by live recording in jazz night clubs.

After an intensive search, he has found exactly the string bass sound he needs...with the Audio-Technica ATM35. This small cardioid condenser microphone can be clipped directly to the instrument. Its unique mount is readily positioned for best balance and consistent level all night long.

The cardioid capsule can also be easily replaced with an omni element when needed. Its low noise is impressive and the smooth extended response is both realistic and musical. Everyone loves the results: the musicians, the technicians, the record buyers, and Jack. But he also found the ATM35 has another role to play.

When Jack Renner clips the ATM35 to a trumpet or trombone he finds it equally musical, even with very intense playing. He gets very low distortion and noise, and consistent high quality no matter how much the musicians move around. Jack's goal of recording brass exactly as it is heard in live performance has been met simply and precisely.

He notes that while the microphone is actually quite close to the instrument it sounds farther away, with acoustic "air" that provides an amazingly natural perspective. And the ATM35 offers almost no restriction to the freedom of movement and expression that is so important to live jazz.

Location photos: Frank Miceliotta



You can hear the superb performance of the ATM35 for yourself. Just listen to this sampling of recent Telarc CDs that have gained critical acclaim:

To Diz With Love (Live at the Blue Note) *Dizzy Gillespie*, trumpet, *Peter Washington*, bass
Lionel Hampton (Live at the Blue Note) *Milt Hinton*, bass
Bobby Short (Late Night at the Cafe Carlye) *Beverly Peer*, bass
Manhattan Mambo sax, horns, vocals
The Count Basie Orchestra (Live at El Morocco) brass solos...and more releases in this live jazz series are due shortly.

Put the mighty little ATM35 to work today. Whether used for quality sound reinforcement or the most critical recording, this versatile microphone is outstanding. Just ask Jack Renner and Telarc! Write, phone, or fax for more details or see your Audio-Technica sound specialist today.



audio-technica®

INNOVATION □ PRECISION □ INTEGRITY

Available in the U.S. and Canada from Audio-Technica U.S., Inc.
1221 Commerce Drive, Stow, OH 44224
(216) 686-2600 • Fax (216) 686-0719

**Model ATM35
Cardioid Condenser
Microphone**

every instrumental recordist aspires to, and, with some understanding of basic principles, sonic success is easily within reach.

Dr. Thomas Rossing, a noted authority on musical instrument physics, has described the acoustic guitar as a "system of coupled oscillators." That is, every subpart of the acoustic guitar responds and radiates by its own unique set of rules. Fig. 1 (p. 53) diagrams this principle in action. Lower string frequencies are radiated over the entire surface of the guitar, whereas higher frequencies tend to radiate only from the top plate and bridge.

Recent finite modeling by Rossing and Watson also characterizes the guitar as a complex radiator. At low frequencies (100 to 200 Hz), the guitar exhibits an omnidirectional radiation pattern. As frequencies rise, the radiation pattern becomes bipolar, then quadrupole, and finally breaks into numerous complex multipoles above 800 Hz. This explains why even minuscule microphone movements can reveal markedly different guitar "personalities." Rossing aptly states that, "The subtle details of [acoustic] guitar physics could be the object of a lifetime of research."

Appropriately, when miking a guitar at very close range, it's crucial for the player to remain quite still during takes. Slight variances in close-range mic-guitar orientation can noticeably alter timbre balance, phasing and volume. Uniform, repeatable tracking is essential for post editing, yet we all know that some players simply will not endure a confined production arrangement. In such cases, a better instrument with more consistent tonal balance will prove easier to work with. If all else fails, simply ask the artist if "that Dobro sound" is acceptable. Cooperation may follow.

Acoustic guitar fundamental and partial energies also exhibit considerable variation throughout the attack, sustain and decay envelope. The complexity of overtones (i.e., intensity and distribution of partial sine waves) depends largely on the manner and force of attack on the strings. Other factors include the material, winding and diameter of strings; the player's fingerboard technique; pick variables; bridge and nut variables; body and neck materials; instrument construction, and so forth.

Who among us hasn't tried to mike

GOOD THINGS STILL COME IN SMALL PACKAGES.

JVC's XD-P1 PRO Portable DAT Recorder

JVC
PROFESSIONAL

At a mere 12.5 ounces, the XD-P1 PRO from JVC has the flexibility to go wherever you go. Compact, sturdy, lightweight and SCMS free, the "Baby DAT" is ideal for a wide array of field recording situations, from reporting, news conferences and interviewing, to sound effects sampling and studio sessions.

The unit's integrated package boasts a DAT recorder and M-S microphone with digital output, that offer outstanding sound quality. To find out more about the amazing XD-P1 PRO DAT Recorder call 1-800-JVC-5825.



USE READER SERVICE CARD FOR MORE INFO



LEARN THE ART OF RECORDING

THE RECORDING WORKSHOP IS THE WORLD'S LEADING SCHOOL FOR "HANDS-ON" TRAINING IN MUSIC RECORDING TECHNOLOGY. IN OUR INTENSIVE, 5-WEEK PROGRAM, YOU'LL LEARN THE CREATIVE OPERATION OF PROFESSIONAL RECORDING EQUIPMENT. WE'LL TEACH YOU THE JOB SKILLS NEEDED TO SUCCESSFULLY START YOUR CAREER AS A RECORDING ENGINEER, PRODUCER OR STUDIO MUSICIAN.

- ▶ 6 STUDIOS FILLED WITH THE LATEST EQUIPMENT: DIGITAL RECORDING TO HARD DISK, DAT MASTERING, AUTOMATED MIXING, MID, AND MUCH MORE
- ▶ INTENSIVE, 5-WEEK PROGRAM GIVES YOU MORE QUALITY, IN-STUDIO EXPERIENCE THAN MOST LONG-TERM SCHOOLS
- ▶ SMALL CLASSES, PERSONAL ATTENTION
- ▶ JOB/INTERNSHIP PLACEMENT ASSISTANCE
- ▶ NO PREVIOUS EXPERIENCE REQUIRED
- ▶ FINANCIAL AID AVAILABLE
- ▶ LOW-COST, ON CAMPUS HOUSING



FOR FREE BROCHURE, PLEASE CALL OR WRITE TODAY

THE RECORDING WORKSHOP

1-800-848-9900 1-614-663-2510

455-X MASSIEVILLE ROAD, CHILLICOTHE, OHIO 45601

OHIO STATE BOARD OF SCHOOL AND COLLEGE REGISTRATION #80-07-0696T

©1989 THE RECORDING WORKSHOP

“Using mics on live acoustic guitars is asking for trouble. Unless the music on stage is all acoustic, and the monitors are leveled low, mics often cause more problems than they solve. The main problem is leakage. With all the extraneous noise, the guitar mics can become trampled.” —Dave Hewitt

a great-sounding acoustic guitar only to be frustrated by a dull, unnatural-sounding recording? It's important to first characterize a guitar's polar pattern by moving your ear(s) around the guitar body while the instrument is being played. Of course, miking too close to the sound hole almost guarantees a rude introduction to low-frequency Helmholtz resonance. Unless you desire a boomy effect, be sure to stay far enough away, and at a pleasing angle, from the sound hole.

Many have noticed that an acoustic guitar can sound different from day to day. Some say it's an illusion, but many players are convinced it's true and attribute the phenomenon to humidity, temperature, pollution and other ambient variables. Having owned and played

acoustic guitars for more than 20 years, I'm convinced that guitars do change in tonal quality—often unpredictably.

Guitarists often leave their instrument to “breathe” in the recording environment well in advance of a session. They say it helps acclimate the guitar and strings. Engineers have long recognized the effects of climatic change on microphone and room timbre. It follows that guitars should receive the same kind of attention.

It's tempting to mike a guitarist from a distance of more than ten or 15 feet to gain a “performance hall” sound, especially in a good-sounding room. Unfortunately, acoustic guitars—certainly nylon string varieties—exhibit relatively low acoustic

output. The gain required at far-miked distances virtually assures audible self-noise from microphone/preamp and room ambience. When far-miking, listen especially for low-frequency airborne energy, such as trucks, jets and HVAC, because it can sneak in unnoticed on near-field studio monitors. (Original RCA stereo tapes of the Boston Symphony Orchestra monitored through a high-Q LFBP filter revealed a convoy of Boston's industrial traffic.) Better s/n ratios can be achieved using cardioid or hyper patterns. However, if true room acoustics are desired, an omnipattern A-B spread may be a better choice. As with any recording, always experiment and listen carefully.

My own experience recording acoustic guitars reduces generally to

PURE GENIUS

Now Acoustic Instruments Can At Last Share The Forefront With Electric Instruments Live On Stage, With Full Acoustic Timbre and Minimum Feedback.



Figure 1:
Every subpart of the acoustic guitar responds and radiates by its own unique set of rules.

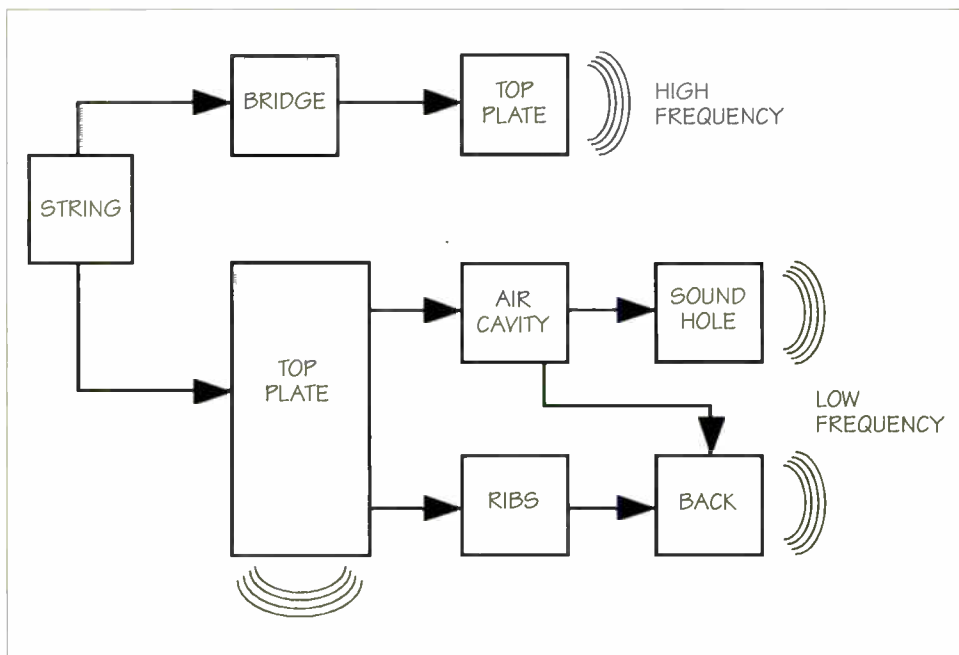

a few guidelines:

1. Record in the quietest, most acoustically balanced room available—especially when using sensitive omni mics at longer distances.

2. Experiment with mic placement. Finding the ideal blend of direct sound, reflections, overtone balance and solid imaging is never trivial. Take your time.

3. Unless you require artistic coloration, use the most accurate condenser microphones and mic preamps you can find.

4. If allowable, use the finest instrument available to you. No mic technique or outboard processor can substitute for a fine instrument and player.

5. With few exceptions, install new strings just before recording.

High partials sing most clearly with clean strings.

To explore further the topic of guitar miking, I spoke with seven leading audio engineers about their methods. While they all had their own approach, such conversations bring us closer to understanding the

art and science of acoustic guitar recording.

OLIVER DICICCO
Mobius Music, San Francisco
 From his Neve 8068-based studio in San Francisco, Oliver DiCicco is known for capturing a big, present

THE MAP33 MIDI/PROGRAMMABLE ACOUSTIC INSTRUMENT PROCESSOR

Introducing The First Programmable Technologically Advanced Preamplifier/Processor Dedicated to ACOUSTIC INSTRUMENTS.



Rane's renowned signal processing and digital expertise have combined to create a quantum breakthrough in acoustic instrument amplification. The MAP 33 effectively preserves complex acoustic timbre through a unique system that processes two different pick-ups *separately* with an impressive arsenal of programmable functions: from EQ to separate monitor mix. With 64 configuration memories and full MIDI control, the MAP 33 can satisfy the most demanding venues with a sound quality of *unprecedented* purity, strength and flexibility! Call us for a detailed brochure and your nearest MAP 33 dealer.

RANE CORPORATION 10802-47th Ave. W. Mukilteo, WA 98275 • (206) 355-6000

USE READER SERVICE CARD FOR MORE INFO
 World Radio History



THE SOUTH'S LARGEST MUSIC RETAILER

THOROUGHbred MUSIC RULES

FREE T-SHIRT MOST PURCHASES

Rule Number One: Satisfy the Customer.
Rule Number Two: Know your Products.
Rule Number Three: Provide Great Value through the Widest Selection.
Rule Number Four: When in doubt, see rule Number One

1 (800) 800-4654

Coming Soon, the Largest, most Elegant Music Store in the World

THOROUGHbred Music
 Electronics, Amplifiers, Percussion, Guitars, Keyboards, Pro-Audio, Service

MasterCard VISA

in Florida Dial: (813) 238-6485

2204 E. Hillsborough Av. Tampa, Florida 33610 FAX: (813) 238-5443

USE READER SERVICE CARD FOR MORE INFO

White DSP 5000

Your Complete Digital Signal Processing Tool Box!

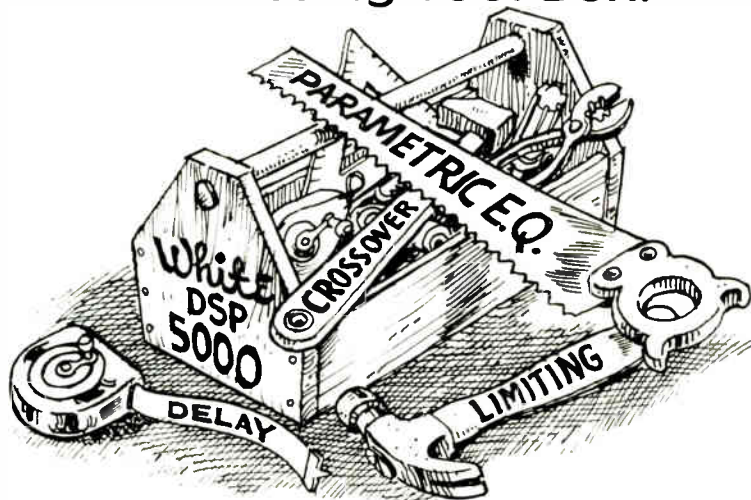

P.O. BOX 698
 Austin, TX 78767

White
 instruments
 Division of C VAN R Inc

Phone 512/389-3800
 FAX 512/389-1515

image of acoustic guitars. Having worked with Michael Hedges, Alex DeGrassi, Richard Thompson and others, DiCicco says, "It's important to allow the guitarist to work spontaneously. I've developed recording techniques that are repeatable, require little setup time and can be fine-tuned from the control room. In this way, the guitarist is not continually bothered with changing room positions and mic readjustments. I've found that too much technical intrusion can really affect the musical quality of a session."

Part of DiCicco's repeatable recording technique includes using a room with known characteristics. "A good room is essential. Our 18x30x14-foot main room has tunable panels to adjust the amount of ambient return. We've learned that an overly live room can inject offensive energy into the recording.

"Once the guitarist is positioned, I'll usually place four mics. Virtually everything I record these days uses stereo pairs. In general, two [Neumann] KM84s are positioned directly on the guitarist—one angled sharply around the 12th fret and the other down around the large, lower section of the guitar body. Neither mic points directly at the sound hole; sometimes I even point the mics far off axis of the sound hole. Both mics are generally six to 12 inches from the guitar. If they're too close, the proximity rise can be overpowering—too far and the instrument tends to lose presence and size.

"The second pair of mics is usually B&K omnis. We use these for room ambience and often for close miking. They are very transparent—sometimes too revealing, depending on the artistic objectives. For ambience, we space the B&Ks about 15 feet apart, eight feet high and far enough from the guitarist to get a convincing boom. Occasionally, we'll put up a mono U47 even farther away for adding a bit of color or fill."

DiCicco maintains that his mic technique is simply a starting point, because every musician and producer has different musical objectives. "It's important to be ever mindful of your client's artistic requirements. Is it a solo project or part of an ensemble mix? Who is the audience, and what are their ears expecting? These kinds of questions will ultimately determine the sonic qualities we shoot for.

"If you listen, you'll find that mic

The sound, priceless. The cost, considerably less.

The only argument about the **new** Panasonic **SV-3200** Pro DAT is whether its most remarkable feature is its advanced digital technology or its extraordinarily affordable price. Ideal for project studio, broadcast and recording studio work, the SV-3200 is designed after our award winning Panasonic SV-3700. With 44.1 kHz/48 kHz sample rates (analog input), 1-bit A/D and D/A converters, a shuttle wheel with dual speed range and a high-speed search (400 x normal), this machine sounds as good as the very best. Especially when you hear the price. **\$950** suggested retail price. To hear more, please call us at (714) 373-7277.

Panasonic
Broadcast & Television Systems Company



Hear The Warmth . . . Summit Tube Processing

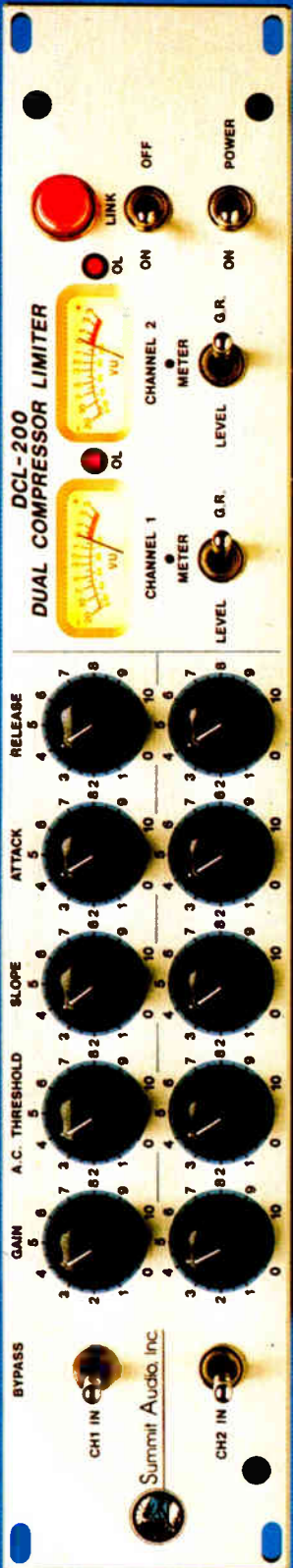

Summit Audio Inc.

P.O. Box 1678, Los Gatos
California 95031 U.S.A.
408-395-2448
Fax: 408-395-1403

cables have differing personalities," says DiCicco. "We run all Mogami cables directly into the Neve console. When reverb is necessary, a Lexicon 224 with the original algorithms is my first choice. The newer 224XL reverb programs seem to lack some of the warmth of the earlier firmware." To preserve a natural dynamic range, DiCicco tries to avoid compression but, if necessary, will reach first for a dbx 160 or UREI LA4. A Studer 827/24 with Dolby SR rounds out the control room at Mobius. He states, "We've tried digital recording of acoustic instruments, and we keep returning to the analog/SR format. It's clearly more flattering to the work we do."

With respect to guitar pickups, DiCicco has not yet found one he likes. "Acoustic guitar pickups are fine for live work, but I've yet to hear one on a steel string instrument that sounds comparable to well-placed microphones," though he admits that an occasional artist will require a blend of microphone and DI. In such cases, DiCicco says he normally uses passive DI boxes with custom transformers into a Lang EQ.

BOB NORBERG Capitol Records

In his 25 years with Capitol Records, Bob Norberg has engineered a sizable library of acoustic music. His solo guitar work includes most of Christopher Parkening's catalog, a number of recordings for Spanish guitarist Angel Romero and much more. Speaking from his mastering suite at Capitol, Norberg explained his techniques.

"Listening to the guitar in the room is very important. I wouldn't try recording anything without first understanding what the whole package was saying. From there, I usually choose a pair of cardioid mics and space anywhere from coincident up to seven inches. I've tried omni mics on guitars, and, although they have a wonderfully large sound about them, their imaging often suffers. The Capitol recordings all deliver a clearly placed instrument. There's nothing indefinite about the location, and it doesn't seem to drift. That's very hard to do with spaced omnis."

Says Norberg, "My favorite mics for acoustic music are the B&Ks and Neumann TLM170s, though each session is different and requires experimentation. In Chris' [Parkening's]

"Unless you're a classical recordist with gobs of experience, avoid multiple stereo pairs of mics. It's phasing hell. But don't be afraid to experiment with unconventional recording techniques."

—Steven Miller

case, we spent over a year in sessions testing various TLM170 microphones. He has exceptional hearing and can tell subtle differences from mic to mic. We finally found a pair we liked, and Chris bought them.

"Each guitarist has a different sense of how the record should sound, so the engineer's life is never dull. Parkening likes a spacious recording, whereas [Angel] Romero prefers the closer, more immediate approach. With Romero, the mics might be no more than two or three feet from the guitar, whereas Chris always pushes the limits on far-placed mics. The earlier Parkening recordings are very far-miked, and the noise really starts to build up. But those recordings sound great—

full and rich, very much like you would hear while sitting in the audience at one of Chris' recitals. I also find that keeping the mics up high off the floor tends to balance out the sound. Depending on the guitar and player, I'll also experiment with different materials on the floor underneath the guitarist to soften or harden the important first reflections.

"As for additional ambience, we take advantage of the eight huge reverb chambers under Capitol Records' parking lot. Each chamber has its own set of speakers and microphones, and all have a unique personality. Many of us think the chambers sound more natural and smooth than any digital reverb. Some of the chambers are just right for adding a bit of wash to the acoustic guitar."

STEVEN MILLER
Windham Hill, etc.

Arguably the most influential engineer in the creation of Windham Hill's bigger-than-life guitar sound is Steven Miller. Having produced and engineered albums for Alex DeGrassi, Michael Hedges, David Broza, Will Ackerman, John Gorka and many others, Miller has certainly earned his reputation.

Miller admits that "the guitar sounds of the early Windham Hill period were startling. Everybody fell in love with the lush tonalities and giant images. Lately, though, I've been moving toward a more natural-sounding environment. But not too natural! I worry sometimes that I might be departing too far from that original sound.

"For instance," says Miller, "on the last Michael Hedges record [*Tap Root*] I used a pair of B&K cardioids into a Sony PCM-F1 and Beta machine. The mics were set about one foot away from the guitar, and the x-axis spread would change on each song. On one song, we actually had one mic at each end of the guitar, a great old 00-18 prewar Martin. The only effects I used on the project were a TC-1210 Spatial Expander and some reverbs; the combination added a wonderful sense of depth."

When asked about pickups, Miller says his "favorite is the Pendulum Systems. James Taylor, John Gorka and many others are using it. Frankly, I avoid pickups if possible, but when necessary I'll concede. Often, I'll delay the leading edge of

The Zoom 9200
Advanced Reverberation Processor

It is about passion. It is about the joy of sound. It will make your music and audio tracks sound better. It will make you stay up late. Free of gimmicks, it is honestly the most refined spacial simulator ever built, at any price. Simply, the Zoom 9200 is pure sonic ecstasy.

ZOOM

Zoom Corporation Of America
385 Oyster Point Boulevard, Suite 7, South San Francisco, California 94080
Tel: (415) 873-5885 Fax: (415) 873-5887

USE READER SERVICE CARD FOR MORE INFO

Recordable Compact Discs From TDK,
The Media Expert. New: 74-Minute Length



audio or computer data are recorded by laser using special CD-R equipment (wobbled format—now available from a number of hardware manufacturers). Once the TOC (table of contents) is written, the disc is, for all intents and purposes, equivalent to a mass-produced CD or CD-ROM.

TDK CD-R media are available in two sizes and three recording lengths. The CD-W12EL and CD-W12 are 120mm (4.72") in diameter; the CD-W08 is 80mm (3.15"). Digital audio recording capacities are 74, 63, and 18 minutes, respectively.

The recordable compact disc (CD-R) is, technically, a highly specialized write-once optical disc. It is distinct from other write-once formats, however, in its playback compatibility with conventional audio CD and computer CD-ROM players. Digital

GET SERIOUS
TDK

VIDEOTAPE
PRODUCTS INC

320 North Madison Avenue
Los Angeles, California 90004

800•422-2444

Cheers subside.
Anticipated silence.
Fingers tense.
Lips to mike. All at stake.
But in control.
With the biggest name in rock'n roll.
45 years of tried and true.
Performance art.
For this one moment.
The moment of truth.
Fender Pro Audio.

©1993 FMIC.



USE READER SERVICE CARD FOR MORE INFO
World Radio History

ELECTRONICS

the pickup signal to match the wave front hitting the mics; the delay can be substantial, and this correction really helps tighten up the sound.

"Will Ackerman requires an entirely different approach than Michael Hedges," says Miller. "On his latest record, I found that some older Neumann KM56 tube mics worked really well. They have a natural boost in the 5kHz range, which sounds good with Will's playing. We placed fairly close to the instrument—I would say about five inches away. There was also a Sony 55P mic that Allen Sides loaned me. It sat about two feet out and six feet up. We fed the mics into Neve 1073 modules with little or no EQ and printed directly to a Sony PCM-3324 digital multitrack."

Concerning reverbs and ambience, Miller answered, "Right now, my favorite acoustic guitar reverb is the Klark-Teknik DM-780. It can maintain a huge wash without the funny transient combing that makes other reverbs, even the best ones, sound pingy. Guitars shoot out a blur of quick, complex energy, which close miking really accentuates. It's difficult finding a reverb that can handle the complexity.

"Unless you're a classical recordist with gobs of experience, avoid multiple stereo pairs of mics," Miller warns. "It's phasing hell. But don't be afraid to experiment with unconventional recording techniques. When Michael Hedges first heard *Aerial Boundaries* with all the ambient effects added, he ran out of the mobile truck horrified and didn't come back for hours. Later on, after the fourth bottle of wine, we realized something fresh and exciting had taken place. And, although we didn't know at the time, it would actually inspire an entire genre of imitations."

DAVE HEWITT

Remote Recording Services

Dave Hewitt is a prolific recordist of live and remote acoustic guitar work. With his well-endowed recording truck, Dave has recorded talent as diverse as k.d. lang, Mariah Carey, Neil Young, and rockers Tesla, whose 1990 live Platinum album *Five Man Acoustical Jam* helped spark the recent explosion of "unplugged" acoustic sets.

When recording *Jam*, Hewitt worked with Tesla's existing acoustic guitars and staging during their live

sets at the Trocadero in Philadelphia. "Most of the recording for Tesla was taken from their own AG pickups into Countryman Type 85 DI boxes and split into our truck via Jensen transformers," Hewitt explains. "We reinforced the DI with a few mics, but it was predominantly DI."

When asked about the specific equipment used on *Jam*, Tesla guitarist Frank Hannon says, "There were three guitars used for the live sets, each with its own unique pickup method. Our Guild thinline comes factory-stock with a pickup and tone/EQ control. Another two Guilds, large-body six- and 12-string types,

each had Dean Markley sound hole pickups, though our recent favorites are the new Gibson Dove and Gibson Starburst cutaway, both with factory stock pickups.

"Using mics on live acoustic guitars," says Hewitt, "is asking for trouble. Unless the music on stage is all acoustic, and the monitors are leveled low, mics often cause more problems than they solve. The main problem is leakage. With all the extraneous noise, the guitar mics can become trampled. What's worse, other instruments can resonate the guitar strings and body and really mess things up. When mics are usable, one of my fa-

SIMPLY THE BEST!



...and it just keeps getting better. **Simon Systems** has set the new standard of excellence in professional audio signal processing. The four channel **RDB-400 Integrated Direct Box** is simply the best direct box you can buy. This AC powered unit is based on a totally active (transformerless) audio path design with no insertion loss. And with features like variable line level output, variable attenuation trim, unbelievable headroom, speaker level input pad, active unbalanced/balanced outputs, front and rear inputs and output connectors, ground isolation switch, and toroidal power transformer, it's easy to see why so many professionals insist on it in the studio as well as on the road.



The portable single channel **DB-1A Active Direct Box** is based on the same design philosophy as its big brother. Its three-way independent power scheme* facilitates a unique design that simply blows every other DI away! In addition to features like line level output and no insertion loss, the DB-1A has rechargeable battery capability and automatic system power check.

*Simon Systems PS-1 Power Supply is recommended.

And for the ultimate in headphone distribution systems there is the **CB-4 Headphone Cue Box**. The CB-4 features four headphone outputs independently controlled by conductive plastic stereo power controls. The XLR input/output connectors allow numerous boxes and headphones to be connected to the same amplifier with headroom, clarity, and flexibility that cannot be achieved with active headphone cue amplifiers. A three-position switch selects left mono, right mono, or stereo mix, allowing for additional cue mixes. It's no wonder why the CB-4 has become a standard in the industry.



So the next time you think signal processing equipment, think like the pros:
Simon Systems - Simply The Best!®

Thanks for setting the trend:

Alabama • Fleetwood Mac • Whitney Houston • Tito Jackson • Jimmy Johnson • Kenny Loggins • John Mellencamp • John-Luc Ponty • Jeff Porcaro • Leland Sklar • REO Speedwagon • Universal Studios



SIMON SYSTEMS® ENGINEERING, INC.

707 Clear Haven Drive, Agoura Hills, California 91301 (818) 707-9980

USE READER SERVICE CARD FOR MORE INFO

PORTABLE DSP RTA

Lab Studio • Live Sound
Optional Printer & RS232 Ports



STUDIO

Test and Alignment:

- 1/4 dB accuracy
- Fast machine alignment using standard test tapes
- Selectable filter slopes

LIVE

Equalization:

- Voice rooms
- Eliminate feedback
- Large 85 dB window
- Scroll display

Retail \$1500

Contractor Prices Available

GOLD LINE
MANUFACTURED IN U.S.A. SINCE 1961

Box 500 • West Redding, CT 06986 • Ph (203) 938-2588 • Fax (203) 938-8740

USE READER SERVICE CARD FOR MORE INFO

**Microphones
Signal Processors
Digital Multitrack
Mixing Consoles
MIDI Gear
Monitors
Cable
Tape**

**grandma's
music & sound**

800 S-T Juan Tabo Blvd NE
Albuquerque, NM 87123

**TOLL FREE
1-800-444-5252**

FAX 505-293-6184

JACK VAD

**Chief Engineer, SF Symphony
Independent Engineer/Producer**

Having recorded many fine guitarists (Parkening, Barrueco, Yeppes, The Romeros, etc.), Jack Vad is well known for his work with Harmonia Mundi, Nonesuch, Koch, Musical Heritage Society, Saydisc and other labels. And as chief broadcast engineer to the San Francisco Symphony, Vad's orchestral recordings are heard each week on more than 550 radio stations worldwide.

"The room is often the most important consideration when doing acoustic work," says Vad. "I usually prefer a live environment for solo instruments. I'll ask the talent to warm up while I stroll around the room listening for nodes and such. Then we'll experiment with different playing locations within the room, listening for articulation, fret noises and general balance throughout the score. When we're satisfied with our location, I'll start setting mics."

Jack says he prefers omni microphones for guitar work, normally choosing between stereo pairs of B&K 4006s and Sennheiser MKH-20s. "The MKH-20 offers more color than the B&Ks. There's a subtle emphasis in the 100- to 300-cycle region that makes the Sennheisers attractive for certain guitarists and rooms. The 4006s with silver grids are my choice when I need a more natural and flat response.

"Though mic placement varies on each session, a nominal arrangement will locate the main pair at a slight angle to the guitarist's right. In a live room, the mics are positioned five to six feet high and three to five feet away from the guitar. Mics are spread anywhere from a few inches up to a couple feet, depending on image requirements. I'll often point the mic pair off-axis at 45-degree angles—especially with a bright guitar or aggressive player. The very highest frequencies are softened, and it can give the guitar a velvety character."

Vad often suggests that the guitarist try wearing headphones during the recording. He says, "It's a real discovery for a guitarist to hear from the microphone perspective in real time. With headphone recording monitors, guitarists can often refine and control delicate colors and attacks that may not be evident from their normal playing position." ■

John La Grou is an engineer, musician and inventor.

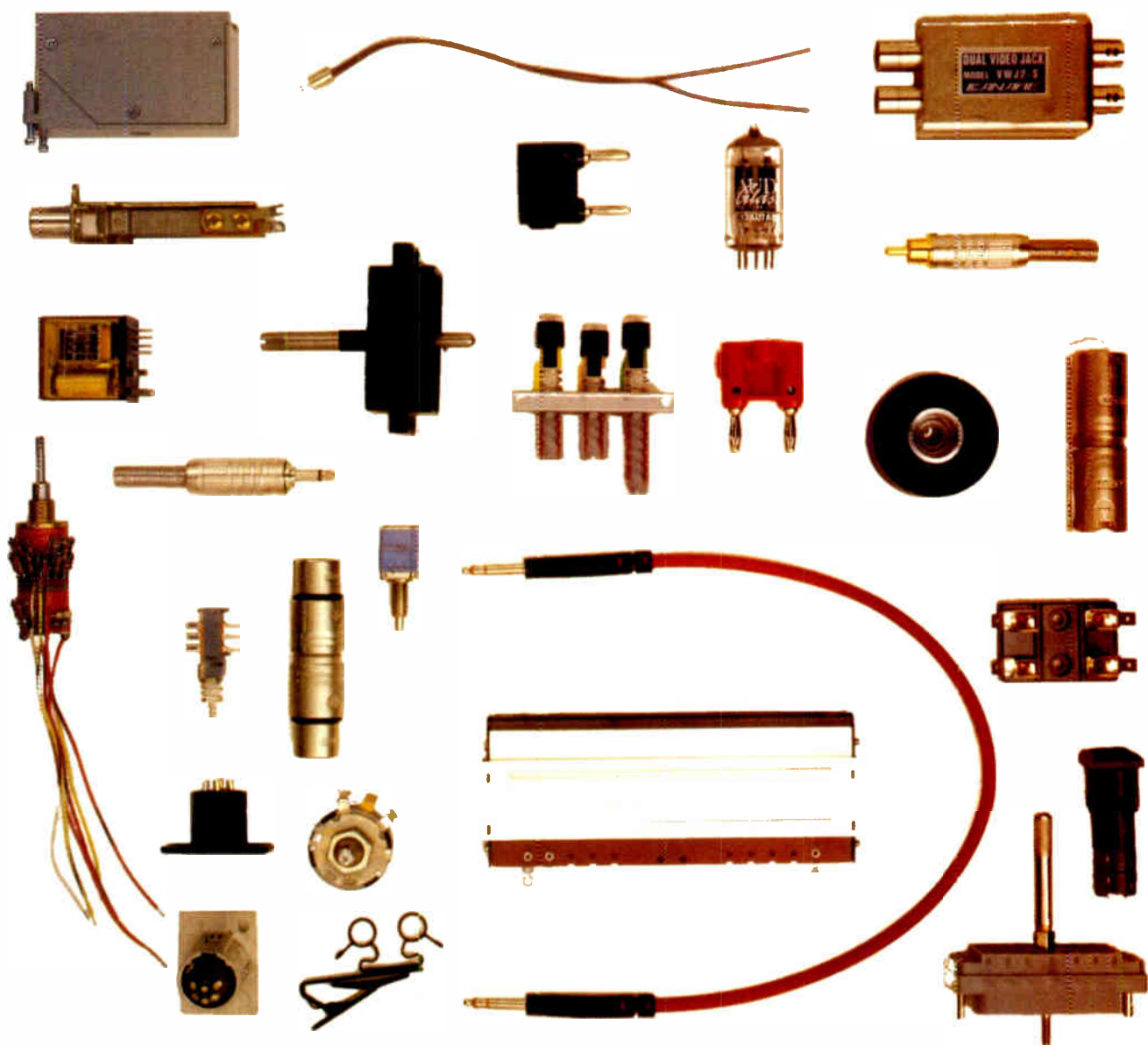

THERE ARE ANY NUMBER OF PARTS OUT THERE BUT ONLY ONE NUMBER WHERE YOU CAN FIND THEM.

You're in the middle of a late night session. Your gear goes down and you need a hard-to-find part to get up and running again. What to do?

Just fax or call AudioTechniques and your problems are over. Our expanded parts department has the largest inventory around -- including

all the major lines.

And each part is backed by AT's legendary service and support. Because we have the experience and know-how to answer any questions you have about parts.

Fast turnaround? Fax us directly from your midnight session at our 800 Fax Order Line and we'll

respond by 12:00 noon of the next working day! Or call us any weekday between 9:00 AM and 6:00 PM for fast service.

Whatever the number of parts you need, now there's only one number to fax and one number to call. AudioTechniques.

1-800-PRO-AUDIO

AudioTechniques

A Manny's Company
1600 Broadway, New York City, N.Y. 10019

Telephone Order Line: 1-800-PRO-AUDIO (776-2834)

Fax Order Line: 1-800-775-2834

In NY State, call 212-586-5989

USE READER SERVICE CARD FOR MORE INFO
World Radio History

by Paul Potyen

SOFTWARE POTPOURRI

This month we take a look at three interesting software packages for the Macintosh. Two of them—Passport Designs' Producer and Bliss Interactive Technologies' Resource Navigator—are useful media production tools. The third—Rock, Rap 'n' Roll, from MacWorld CD Ventures—is a CD-ROM that is interesting as an entertainment product in itself, as well as for the production values it demonstrates.

PASSPORT DESIGNS' PRODUCER

Passport Designs (Half Moon Bay, Calif.) has been in the music software business for 13 years—a long time by any standard, and in particular by software standards.

With Producer, Passport has established some strong credentials as a multimedia software publisher. The company describes Producer as a Macintosh software package that is designed to integrate and synchronize the various kinds of media avail-

Producer is as intuitive as any program I've seen on the Macintosh—an impressive feat given the number of features.

able on the Mac (text, images, animation, digital video in the form of QuickTime movies, and audio in the form of MIDI and digital audio). The result might be anything from a promotional piece that runs in a trade show booth to an informational kiosk in a shopping center, to a mock-up of a TV commercial on videotape.

Figure 1:
The timeline window for Passport Designs' Producer

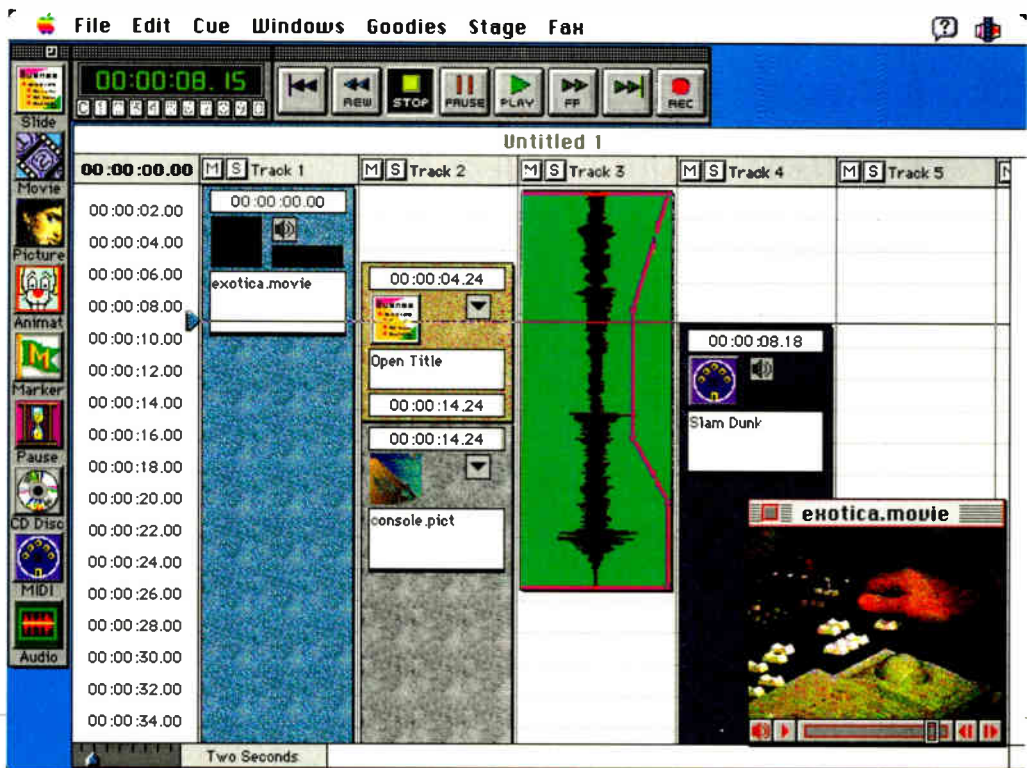

(The third example requires that your computer have the requisite hardware for printing to videotape.) For example, the recent San Francisco NARAS Awards ceremony included a production created with Producer and played back directly from a Quadra

Figure 2: One of ten working windows from the CD-ROM, Rock Rap 'n' Roll—an entertaining, easy-to-use, click-and-drag music maker

950 to a 50-foot rear-projection screen.

Unlike some authoring programs such as Macromedia's Director or Claris' HyperCard, Producer is *not* an interactive authoring system. Similar in concept to a videotape system, it is capable of creating and playing back linear presentations. There is, however, the added advantage that you can specify precise points in the presentation where you want to pause for a specific amount of time or pause until a specific MIDI or other triggering event.

And unlike programs like Adobe's Premiere, the current version of Producer does *not* create QuickTime movies.

So far I've talked about what Pro-

ducer is *not*. So what *will* it do? The answer is plenty. To some extent, the capabilities of Producer depend on what other software tools are at your disposal, because the beauty of this program is its ability to integrate media types. Producer can work with PICT images, PICS animations, QuickTime movies, digital audio files in AIFF and Sound Designer format, audio CDs that are in your CD-ROM drive, and MIDI Type 0 and Type 1 files. You can customize the program to allow editing of these media types (except, of course, audio CDs) by your application of choice. The key here is that Producer *integrates* the various media types that are created using other Macintosh programs into a seamless production. You assemble your production by clicking and dragging one of the icons on the cue palette (Fig. 1). At that point a dialog box appears, allowing you to import a file from

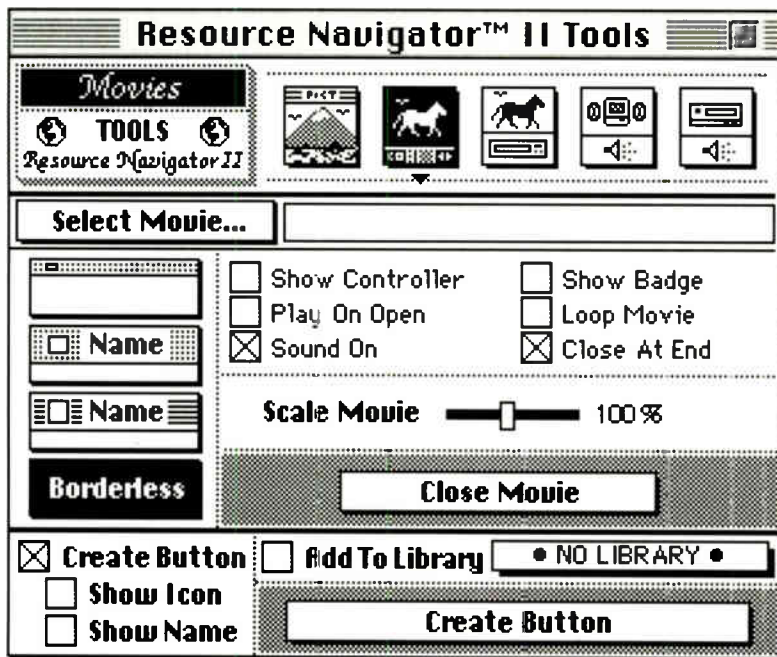
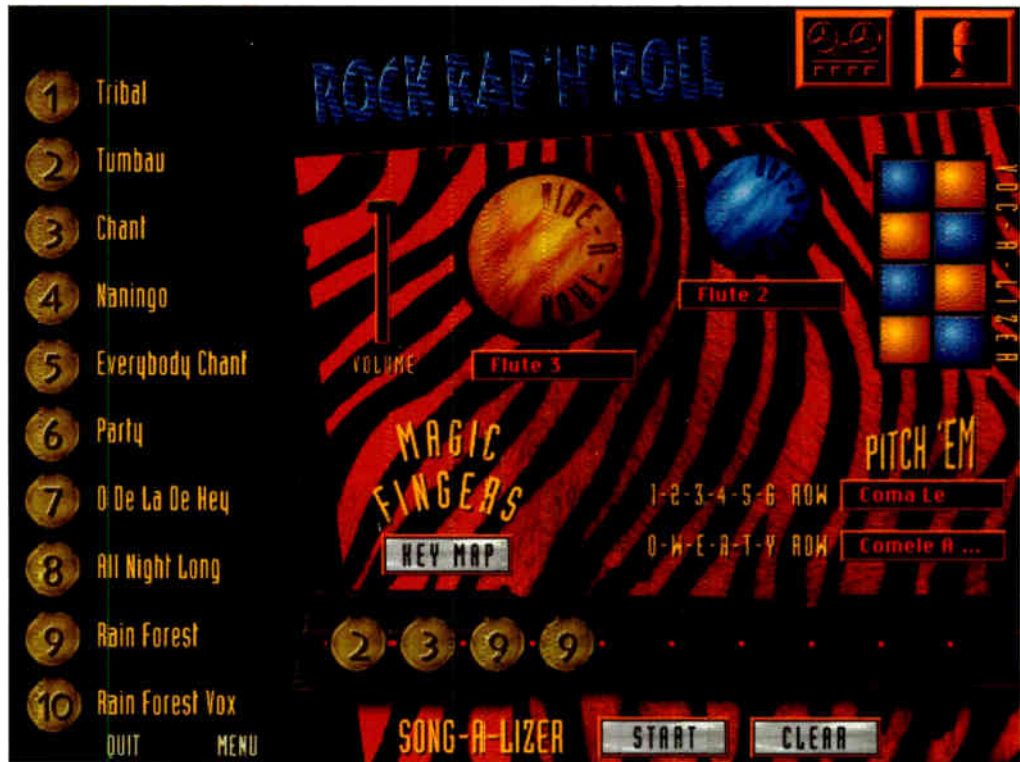

Figure 3: Screen view of Bliss Interactive Technologies' Resource Navigator

AT \$399*, THIS 12x2 MIXER SHOULD BE IN EVERY PRO AUDIO TOOL KIT.

MS 1202

8-TRACK MONITOR MIXER

Just "Y" out of the recorder inputs right into the MS1202.

INDEPENDENT MONITOR MIXER

"Y" mics and keyboards into the MS1202 for on-stage monitor mixing.

COMPACT DRUM OR KEYBOARD SUBMIXER

16 or more extra inputs in less than one square foot of space!

HIGH QUALITY MIC PREAMPLIFIER

A favorite MS1202 pro application. No wonder. See explanation below.

IMPEDANCE OR LEVEL CONVERTER

Convert virtually anything to anything: hi-Z inputs to bal. line level (& vice versa), potentially noisy +10dBV signals up to +4dBV "professional" levels (and vice versa), etc.

Before the MicroSeries 1202 mixers, the affordable were rightly considered Mids. With steel chassis, built-in power supply and the same preamps, headroom and sound quality as our CR-1604, the MS1202 has been taken seriously. By in-the-trenches pros as well as home hobbyists.

Warranty card responses tell us that 1202s are used daily in radio and TV studios, video production houses,

Fortune 500 corporation audio/video departments, permanent sound installations and large recording studios. We even know of several top L.A. engineers who carry their trusty 1202 with them to every

session — and in case they need extra inputs or submixes while using big studio consoles.

If you need a compact mixer for a small home studio, our MicroSeries 1202 is unbeatable. But even if your audio applications are far more complex, there's always room for a 1202 in your bag of tricks. Its uses are limited only by your imagination and ingenuity.



Now available at many local dealers. The Ace KEB22 Gig Bag, especially designed for the MicroSeries 1202.

HEADPHONE amp with volume control

Easy metering system: 12-LED display showing left and right channel outputs, 11 and 0dBm, and output level (PL)

Real mono AUX RETURNS for all 12 channels from guitar to the wall

Robust STEEL CHASSIS, 100% aluminum, 12" wide

Power switch instead of fuse, quiet, no hum, no pop and warble or hiss (unlike

has enough gain to drive any program

2-BAND EQ at mutually useful points: 20Hz LO (vs. conventional 100Hz) & 120Hz HI (instead of 300Hz)

Rotary CONTROLS

Exclusive Unity Gain STRUCTURE achieves high insulation and low noise at the same time. Plus you get 20dB 20154 gain above Unity, eliminating the need to constantly readjust trim controls while mixing.

TECHNICAL SPECIFICATIONS

12x2 CHAN. 100Hz (-3dB) HAS 18dB/100KHz (20dB/20KHz) 20154 GAIN

Designed and built in Woodville, VA, USA

3 Year Limited WARRANTY



12x2 MAIN OUTS

12x2 INPUTS & OUTPUTS

Line to 600Ω with 15dB of gain (gain above Unity so you can regulate channel volume & still keep effects "super wet")

One 3-pin XLR or 2 mono inputs. "Pan-Taste" INSERTS/DIRECT OUTS

One 1/8" Four pole low-pass filter

Judging from MicroSeries 1202 owners' comments, you rarely find preamps this good on mega-expensive consoles.

If you're not familiar with Mackie Designs, you may find it hard to believe that the mic preamplifiers in our "399" mixer have specs (and performance) that meet or beat 750,000 consoles. But strap a MicroSeries 1202 into the test bench and you'll see we're not exaggerating: 10Hz to 300kHz bandwidth, 0.001% Total Harmonic Distortion. And Equivalent Input Noise (E.I.N.) of -129.6 dBm at 150 ohms, 20 Zoltz.

This last, critically important spec bears some explaining. The absolute upper

theoretical, lowest possible limit of E.I.N. is -130.85 dBm (150 ohms). That's the "noise" output of a 150-ohm resistor at 70°. No mixer in existence can achieve it. Many ultra-expensive studio consoles such as Neve and SSL do spec out at -129.6 dBm. But the MicroSeries 1202 is the only mixer in its class that has a real and verifiable E.I.N. specification this low — within 1.25dB of the theoretical noise floor! The MS1202's

preamps also have extremely high headroom and a natural, uncolored musical sound. In fact, the 1202 is becoming the overwhelming choice of audiophiles for live-to-DAT recordings. Our secret? Instead of cheap, off-the-shelf integrated circuits, Mackie preamps use discrete circuitry with 4 corporate-patented, large-signal geometry transistors — the lowest noise, highest quality available. This means virtually undetectable E.I.N. even when you're running a channel at extremely low gain levels.

MACKIE

20205 144th NE • WOODVILLE, VA • 98072 • 800/258-8883 • FAX 306/487-4337
COMPUTERIZE: GO MACKIE • REPRESENTED IN CANADA BY SF MARKETING, 800/363-8883

Suggested Retail Price. Slightly higher in Canada.

anywhere on your Mac into the designated Producer track.

Producer incorporates SMPTE for easy, frame-accurate placement of cues. Theoretically, an unlimited number of tracks can be played simultaneously, but you will want to use a Quadra to play back larger multitrack cues with transitions in order to avoid timing delays. I found Version 1.1 of Producer to be capable of playing much more complex programs than the original version.

High-resolution PICT files created in Adobe Photoshop, however, might cause problems. Passport offers two tips to minimize those problems: First, compress your images with Apple's image-compression software; and second, place sequential PICT files on different tracks in Producer.

With Apple's MIDI Manager, you can use SMPTE to slave your production to an external source. MIDI Manager is also required to implement Producer's MIDI playback capabilities. However, this is not as discouraging as it might sound to those of you who scorn MIDI Manager. According to Passport's Dennis LeBrequé, Apple's new version of MIDI Manager will offer major improvements in speed, as well as eliminate the need for new software drivers for every new Mac that comes out. And it will also allow future QuickTime movies to incorporate MIDI.

As you might expect from an audio software manufacturer, the audio features are well-implemented and intuitive. Producer Version 1.1 supports Digidesign's AudioMedia II, Sound Accelerator II and Pro Tools cards, as well as Media Vision Pro's AudioSpectrum 16 and RasterOps' MediaTime boards. And, of course, any audio cue can be routed (in its 8-bit rendition) through the Mac speakers.

On the visual side, Producer is not as complete as some might hope. For example, you can choose from 18 visual transitions, but strangely absent is the ability to do a simple dissolve. Among my other wishes are the ability to scroll text and more control over letter spacing in the slide texts.

Producer is as intuitive as any program I've seen on the Macintosh—an impressive feat given the number of features. Audio-types who are used to wrestling with so-

phisticated MIDI programs will find Producer refreshingly easy to use. You can save your production in a "play-only" version—useful if you want to distribute your production. (Up to 100 copies of Player may be made at no charge; additional copies must be licensed.)

Passport recommends at least 5 MB of RAM and 2.5MB application memory for use with 8-bit color (8 MB of RAM and 5MB application size for 24-bit color).

In short, there's no other program quite like Producer, and I expect that it will occupy an important role in the studios of Macintosh-based media producers.

Passport Designs, 100 Stone Pine Rd., Half Moon Bay, CA 94019.

BLISS INTERACTIVE TECHNOLOGIES' RESOURCE NAVIGATOR

Have you ever been tempted to create a demonstration or presentation using HyperCard on your Macintosh, but were turned off by the prospect of learning the HyperTalk scripting language? Well, I have been both tempted and turned off, and I recently found a way to get the job done without taking a HyperCard course, and without even burying my face in a half-dozen books. The solution: Resource Navigator from Bliss Interactive Technologies of Austin, Texas.

Described as a media-integration authoring tool, Resource Navigator is object-oriented software for creating your own HyperCard stacks. It allows you to incorporate QuickTime movies and PICT images into your stack, and perhaps even more important to the audio community, it lets you play CD-Audio on your CD-ROM drive, as well as videodisc sequences from a Level III videodisc player, all directly from HyperCard. Object-oriented is a key word here. You can do all of this by clicking and dragging in response to an easy-to-use interface that lets you see and hear what you are doing. As you incorporate each media type into your stack, Resource Navigator is at work behind the scenes, so to speak, sticking all that scripting language into the right place.

Installation of Resource Navigator is as easy as using it in your stack. Once installed into the stack of your choice, it appears as an item under the Edit menu. Choose Go To Resource Navigator Tools, and you're

SPECIALISTS IN MIDI SYSTEMS
AND HOME RECORDING

Sweetwater Sound
NO HYPE
NO HASSLES

For 12 years, Sweetwater Sound has been dedicated to providing the latest technological breakthroughs at affordable prices. Isn't it about time you found out why musicians and engineers around the world have come to depend on Sweetwater Sound for all their equipment needs?

E-mu Systems

Proteus/1, 2 and 3 World
EMAX II, EIII and EIII-X samplers
PROcussion module
Proteus MPS keyboard

TASCAM

Analog & Digital Multi-Track
Recorders, DAT machines
Mixers, Mastering Decks

KORG

01/W, 01/WFD, 01/WPro
01/WProX, 0/3RW, M1
Wavesation EX and A/D

Roland

Synthesizers, Tone Modules
Drum Machines, Samplers
MIDI controllers and Mixers

KURZWEIL

Music Systems

FREE Sweetwater Newsletter

New Sales • Support • Mods • Service • Upgrades

Opcode • Mark of the Unicorn • AKAI • Digidesign • Sony
Ramsa • Passport • TOA • AKG • Panasonic • Digitech
InVision • Nakamichi • JBL Studio Monitors • BBE
Fostex Recording • Lexicon • Coda • Carver • J.L. Cooper
Mackie • Dynatek • Rane • Soundcraft • TAC/Artek
Crown • Aralek • Furman • Oberheim • Tannoy • Juice Goose
KAT • Stewart • Tech 21 • 3M, Ampex & Denon Tape
Macintosh, IBM and Mac MIDI software & interfaces

OTHER MAJOR BRANDS TOO! HUGE IN-STORE INVENTORY!

Our exclusive guarantee:

"If you don't like it, we'll take it back — with no hassles!"

Confused? What are you waiting for? Pick up the phone and call us for friendly, FREE advice and great prices!

Sweetwater
SOUND Inc.®

NO SALES TAX (except IN)
VISA • MasterCard • Discover
AMEX • COD • Trades

5335 BASS ROAD • FT. WAYNE, IN 46808
(219) 432-8176
FAX (219) 432-1758

USE READER SERVICE CARD FOR MORE INFO

off and running.

You may be asking yourself why I'm writing about HyperCard in a pro audio magazine. Well, I know a lot of you use Macs, and I think many of you are interested in expanding your professional horizons. This tool makes it easy to expand right into simple interactive CD-ROM authoring—an area that holds a lot of promise for people with musical and audio skills. I have been using HyperCard and Resource Navigator to create an interactive mixed-mode CD-ROM (CD-Audio and non-audio data on one disc) with great success. I was able to concentrate on the

content and design issues without getting bogged down in syntax. While the HyperCard environment is not as flexible and powerful as other authoring systems (Macromedia Director, for example), it is less difficult to master, and it *is* appropriate for many interactive applications.

Resource Navigator represents the first generation of truly easy-to-use authoring software—flexible, object-oriented tools that allow the rest of us to create and design multimedia applications and presentations. Resource Navigator never crashed (or even hiccuped!); the manual is well-done, and the technical support staff

was competent and helpful. My only complaints were minor: It is slow (although I believe that this is at least in part the fault of HyperCard); some of the icons were a little confusing at first; and there is a lot of graphic information packed onto the diminutive Resource Navigator window (Fig. 3), and I suspect that a larger window size would make it less cluttered.

Resource Navigator 1.0 offers an excellent means for anyone who wants to use HyperCard to play back CD-Audio, AIFF files and/or QuickTime movies, as well as display still images in PICT format. And at \$99, the price is right. A final note: As of this writing, Bliss Interactive Technologies is completing work on another tool that uses object-oriented techniques to allow you to add color—either PICT images or plain color—to HyperCard buttons, fields and cards.

Bliss Interactive Technologies, 6034 W. Courtyard Dr., Suite 305, Austin TX, 78730.

ROCK RAP 'N' ROLL DIGITAL MUSIC MACHINE

Ever since my interest in CD-ROM was piqued several years ago, I've availed myself of every opportunity to check out all kinds of CD-ROM titles—from arcane text databases to audio samples to products intended for the educational and entertainment markets. To date, the one that has been the most *fun* is a new release, published by MacWorld CD Ventures, called Rock, Rap 'n' Roll. It's also the most interesting disc of this kind that I've come across from a production standpoint, because it's an entertainment product that deals interactively with a data type that many CD-ROM producers have not capitalized on to date: that's right, audio!

Produced jointly by Interactive Audio (see "The Byte Beat," June 1992) and Medior Inc., Rock, Rap 'n' Roll is a very clever package that appeals not only to those who know nothing about music theory or production, but also to professional musicians. In fact, I showed it to a professional musician who is computer-illiterate, and she spent about two hours playing with it before reluctantly dragging herself away.

The disc contains ten musical styles, such as Latin, rap, street jazz and techno pop. Choose a music style by clicking on its name, and



The Ultimate Choice
Tape Duplicating Systems
For The 1990's ...

- High Speed / Chrome & Ferric
- Easy To Use / Simple To Maintain
- Highest Standards Of Performance
- American Quality / Proven Reliability
- Complete Turnkey Installations

Versadyne
*...when you care enough
to sound the very best.*

504-D Vandell Way, Campbell, CA 95008
(408) 379-0900 FAX: (408) 379-0902 TLX: 28-8826

USE READER SERVICE CARD FOR MORE INFO

you are presented with a screen like Fig. 2. (Incidentally, CD-ROMs are notoriously slow, but the design of this disc is such that the only wait comes after you've chosen a music style. I found that once the screen for a particular style was loaded, I was happy to splash around there for a while rather than immediately explore another music style.) The interface is intuitive. However, help (in the form of QuickTime movies) is available for those who want it. Ten rhythm grooves, from two to eight bars long, are shown along the left side of the screen. You can drag any combination of grooves into one of the Song-a-lizer slots at the bottom of the screen, and clicking the "start" button causes your sequence of grooves to cycle repeatedly until you stop it.

You can then jam along with your customized sequence of grooves by clicking on hot buttons on the screen, as well as pressing keys on the Mac keyboard. A key map is available for each music style, each with its own sounds, which consist of horn phrases, vocalizations and percussion sounds.

Production on this disc is remarkable in two respects: First, it's all *very* cleanly recorded 8-bit, 22kHz digital audio; and second, all the parts at least marginally work together from a musical standpoint, no matter how you arrange them. This second aspect is not a trivial accomplishment. Obviously, a lot of thought and planning went into the production of the CD.

And if that's not enough to convince you that this is indeed a well-conceived package, get this: You can record, save and play back your own performances to/from your hard disk. And if you have 8-bit audio digitizing hardware, you can also record your voice or any other performance along with your groove. Kind of like karaoke for computer nerds.

Rock, Rap 'n' Roll is obviously not intended to be a professional composing tool. It is a lot of fun, and for anyone interested in the audio possibilities of interactive CD-ROM, it's also an excellent example of how to do it right. It works on any QuickTime-capable Macintosh with a minimum of 4 MB of RAM, a CD-ROM

drive and System 6.0.7 or later. Suggested retail price is \$59.95.

MacWorld CD Ventures, PO Box 105443, Atlanta, GA 30348-5443. ■

Mix associate editor Paul Potyten is also a recovering musician.

CHIP SHOTS

DIGITAL F/X HITCHCOCK

Recently announced from Digital F/X (Mountain View, CA) is Hitchcock, a nonlinear digital video editing system for the Macintosh. The system supports 30fps video 640x480 screen size and 24-bit resolution, along with two channels of digital audio. Hitchcock can print to tape directly from your hard disk, as well as export to QuickTime movie format. EDLs created in Hitchcock can also be exported to CMX, GVG and Sony systems. The system (minus a Quadra) is scheduled to be available in April at \$7,995.

Circle #201 on Reader Service Card

Write or Call for FREE CATALOG

USA & Canada
1-800-331-3191

NYC Area: 516-678-4414
FAX: 516-678-8959

SHIPPED FROM STOCK

● PRICED RIGHT ●

IMMEDIATE DELIVERY

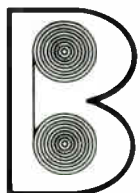

Burlington Audio / Video Tapes, Inc.

106 Mott Street • Oceanside, New York 11572



996 / 966 / AUD / 275 / PRO-DAT

Distributors of **3M** Professional Audio & Video Products

Including:

- | | |
|--|---|
| <input type="checkbox"/> ALL ANALOG & DIGITAL MASTERING TAPE | <input type="checkbox"/> ALL ACCESSORY ITEMS |
| <input type="checkbox"/> ALL FORMATS OF AV TAPE | <input type="checkbox"/> REELS, BOXES & FLANGES |
| <input type="checkbox"/> ALL HARD TO GET AV PRODUCTS | <input type="checkbox"/> LEADER & SPLICING TAPE, ETC. |
| <input type="checkbox"/> R-DATS & EVERY PACKAGED CASSETTE | <input type="checkbox"/> LOGGING TAPE & MAG FILM |

USE READER SERVICE CARD FOR MORE INFO

"AUDIOPHILE
QUALITY"...

EUROPADISK LTD.
U.S.' MOST
COMPLETE FACILITY!

• **Compact Discs**

New, Low-Cost Packages!

• **Cassettes**

Finest European Equipment

• **DMM® Vinyl**

Mastering & Pressing
Cleanest, Hottest 12" Vinyl!

• **Graphics**

Printing with
Free Custom Layout!

• **Mastering
Studios**

Neve Digital EQ, Sony Digital
Editing. Major Label Mastering.

SPECIALS - "With This Ad Only"

500 Cassettes - \$595

Complete with **FULL COLOR** Graphics!
Everything included - Test, Typesetting
& Layout, Full Color: J-Card, Norelco
Box & Shrink-Wrap

500 CD's - \$1,380

3-WEEK DELIVERY!
Everything included - 1630, Glass Master,
Typesetting & 2-Color CD Label,
Packaging in Slimline Jewel Case

CD Ref's - \$95

Your DAT master *digitally* transferred
to a Compact Disc:

Up to 25 minutes - \$95, each addit. \$75
Up to 63 Minutes - \$125, each addit. \$105
Up to 74 minutes - \$175, Each addit. \$150

500 12" Vinyl - \$995

Complete 12" Single Package
Direct Metal Mastering, Test, Label Layout
& Printing, Plastic Sleeve, Die-Cut Jacket
& Shrink Wrap

Call For Our Complete Catalog

EUROPADISK LTD.

75 Varick Street, New York, NY 10013
☎ (212) 226-4401 FAX (212) 966-0456

USE READER SERVICE CARD FOR MORE INFO

OSC DECK 2.0

Version 2.0 of the popular DECK multitrack digital audio workstation software for the Mac has been announced by OSC of San Francisco (the software was previously distributed by Digi-

from your Macintosh, a stereo system, a microphone, and another stereo source such as a CD-ROM player. An XLR mic input and pre-amp out allow you to use a pro-level, low-impedance balanced mic



Screen from DECK 2.0 multitrack digital audio workstation software for the Mac

design). DECK 2.0 offers 16-bit, 4-track, nondestructive hard disk recording (on Audiomedia or Sound Tools II), real-time moving fader automation, timeline-style multitrack waveform editing with track-slip, continuous SMPTE synchronization to all SMPTE formats, synchronous playback with supporting MIDI sequencers on a single Macintosh, unlimited track bounce, and synchronous QuickTime picture and audio playback from disk. A nondestructive editing window allows an unlimited number of tracks and instantaneous swapping between track versions or takes, as well as visual editing of automation data.

Circle #202 on Reader Service Card

GAINES AUDIO MACMIXER

The Gaines Audio (Rochester, NY) MacMixer allows you to mix audio

for recording audio into your Mac as well. Suggested uses are for desktop monitoring through a stereo system, audio mixing for multimedia, stereo sampling and recording, and mixing for live presentations. Suggested retail price is \$249.

Circle #203 on Reader Service Card

**VIDEOFUSION
POST-PRODUCTION SOFTWARE**

VideoFusion is a QuickTime software package allowing users to add special effects to movies, video productions, presentations, storyboards and CD-ROMs, using standardized cut/copy/paste commands. The effects library includes pan/zoom/rotate, warp, a variety of transitions, composite layering, direct-channel processing and key frame-based dy-

Gaines Audio's MacMixer



**CREST AUDIO
IS PROUD TO
WELCOME
THE DAWN
OF A NEW
CENTURY**

**CENTURY
SERIES
CONSOLES**



Century GT consoles are engineered to perform superbly on everything from hard rockin' Front Of House to worship services; from industrials to theater. Century GT's comprehensive feature package makes it possible: Powerful four-band sweep EQ, a unique four Scene Mute system for one-touch mute resetting, and an expandable Matrix system for broadcast mixes, delay speaker systems

and remote speaker feeds. All primary outputs (including all eight aux outs) are electronically balanced.

The GT is one of four new Century Series consoles, all created with a fresh vision of design, durability and value; all made in the USA by Crest Audio—makers of the renowned Gamble consoles, and the world's leading touring power amps. Call Crest at 201-909-8700 and see how much mixing power advanced engineering can build into your budget.

 **CREST
CONSOLES**

THE POWER OF INTELLIGENCE.

CREST AUDIO INC. • 100 Eisenhower Drive • Paramus, NJ 07652 USA • Tel: 201-909-8700 • Fax: 201-909-8666
CREST AUDIO EUROPE • 5a Wilbury Grove • Hove • East Sussex BN3 3JQ England • Tel: +44 (0) 273 325840 • +44 (0) 273 775462
CANADA: Contact Distribution Ltd. • 60 Venture Drive, Unit #6 • Scarborough, ON M1B 3S4 • Tel: 416-287-1144 • Fax: 416-287-1204

9 PIN SMPTE RS-422 FOR YOUR PC

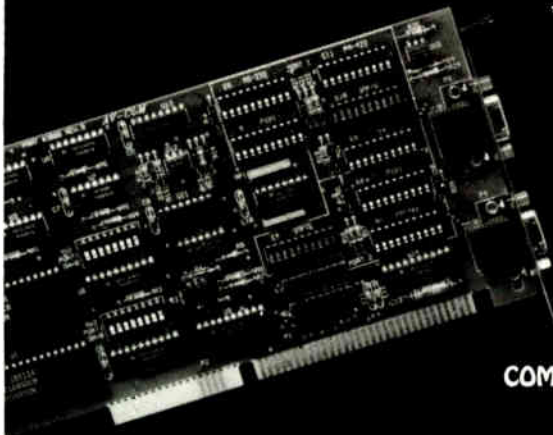

- * TWO SMPTE PORTS
- * PROVIDE SONY 9 PIN RS-422 CONNECTION
- * SELECTABLE SMPTE, MIDI, PA-422, OR RS-232
- * SELECTABLE COM: ADDRESS AND IRQ
- * MICROSOFT WINDOWS™ COMPATIBLE COM: PORTS

APPLICATIONS INCLUDE PC-BASED VIDEO AND AUDIO EDITING, STUDIO AUTOMATION AND WINDOWS BASED MULTIMEDIA SOLUTIONS. PLEASE CALL US TO SEE HOW WE CAN HELP WITH YOUR APPLICATION.



SEALEVEL SYSTEMS INC.
PO BOX 830
LIBERTY, SC 29657
803-843-4343

USE READER SERVICE CARD FOR MORE INFO

Sound to DI for



Tech 21 Presents the First Bass Direct Box with Warmth, Life and Personality.

Now you can have the convenience of a direct box without having to sacrifice the rich sound of a miked bass amp system. With its exclusive SansAmp tube amplifier emulation technology, SansAmp Bass DI delivers **pure, natural, consistent** quality sound studio to studio, venue to venue. Trimmable internal controls adjust clarity and definition, from crystal clear to grinding grunge. With SansAmp Bass DI, harmonics noticeably jump out. You maintain an upfront presence and won't get lost in the mix.

Sounds good on paper? Prepare to be convinced!

Designed and manufactured in the U.S.A. by

Tech 21

1600 Broadway, NY, NY 10019
(212) 315-1116 / Fax: (212) 315-0825

dynamic filters. Creative control and custom effects are available with dynamic morphing, true 3-D rotation, sub-pixel positioning and perspective. VideoFusion lists for \$649.

Circle #204 on Reader Service Card

SYQUEST SQ3105S

SyQuest (Fremont, CA) is shipping SQ3105S, its new 3.5-inch, 110MB, removable, hard-cartridge SCSI drive. The SQ3105S features removable Winchester technology and an average access time of less than 14.5 ms. SyQuest expects the new drive to benefit commercial multimedia users as well as those working with very large individual files.

Circle #205 on Reader Service Card

ROLAND MICRO MONITORS

Roland has added three new models to its line of powered speakers, offering high fidelity and flexibility for Macintosh and IBM PC desktop systems. The MA-20 (\$160) is a two-way coaxial speaker housed in a bass-reflex enclosure, with a rated power of 15 watts per channel. The MA-7 (\$230) is a slim, space-saving, two-speaker system that can be adjusted for optimal separation and is equipped with dual stereo inputs, a mic input and individual level controls. A horizontal two-speaker unit, the CS-30, is available for \$170.

Circle #206 on Reader Service Card

NORTHERN MEDIA VIDEO NAVIGATOR

Northern Media (Tucson, AZ) announced an integrated edit control package, for use with the Video Explorer card from Intelligent Resources, that gives video pros full production capabilities on the Macintosh. Edit-control features include precise A/B-roll edits with real-time transition effects from the Video Explorer, frame-accurate control of one record and up to four RS-422 serial source decks, log lists to quickly find and store clips from source tapes, and graphical edit lists for storing multiple edit sequences. Also included are sophisticated character generation and support of popular 3-D rendering programs, generation of anti-aliased text (scrollable and crawlable) on top of live video, potentially unlimited font variation, and real-time switching for the Video Explorer card. Shipping is scheduled to begin this fall.

Circle #207 on Reader Service Card

Hear Tomorrow

today



M5000 Digital Audio Mainframe

Reverb and much, much more! Leading edge technology (at a cost half what you might expect), engineered to deliver legendary TC Electronic quality, the M5000 is a software-based digital signal processor capable of interfacing with your world the way you want it to: AES/EBU, SPDIF, optical I/O; analog I/O; real time MIDI; SMPTE; serial remote; standard RAM card slot; optional 3.5" floppy drive, SCSI interface, and LAN port; slots for up to four totally independent true stereo DSP cards—all in a 2U 19" rack unit.

Algorithms include reverb as only TC Electronic could do it, pitch/harmony effects, and unmatched chorus/flange/delay effects. Other algorithms are already under development by TC Electronic and third party programmers. Since the M5000 is software based, updating or adding new algorithms is as simple as loading in a RAM card or floppy disk.

Thanks to its open architecture, software-based design, and over-the-top specification, the M5000 will never be obsolete. A dream machine today, the M5000 has many futures—this is just the beginning!

OF DENMARK

t.c. electronic

Technology for today and tomorrow.

International Head Office **DENMARK:** Phone:(+45) 86 26 28 00 Fax:(+45) 86 26 29 28

AUSTRALIA: (03) 428 9797 **AUSTRIA:** (222) 601 17 **BELGIUM:** (0)11 281458 **CANADA:** (514) 738 3000 **CHILE:** (2) 231 2356

ENGLAND: 0691 658 550 **FINLAND:** (9) 0-592 055 **FRANCE:** (1) 48 47 45 26 **GERMANY:** 052 313 2972

GREECE: 8837 629 **HOLLAND:** 30 414500 **HONG KONG:** 3 620202 **ISRAEL:** (0) 3 5441113 **ITALY:** (0) 2-5084 278

JAPAN: (0) 3 332 3211 **KOREA:** (02) 741-0831 **NORWAY:** (2) 710710 **PORTUGAL:** (1) 4754348 **SINGAPORE:** 748 9333

SPAIN: (93) 796 31 00 **SWEDEN:** (+45) 86 26 28 00 **SWITZERLAND:** 093/872656

TAIWAN: 2 7192388 **U.S.A.:** (805) 373-1828 Fax: (805) 379-2648

USE READER SERVICE CARD FOR MORE INFO

U N D E R S T A N D I N G

DSP

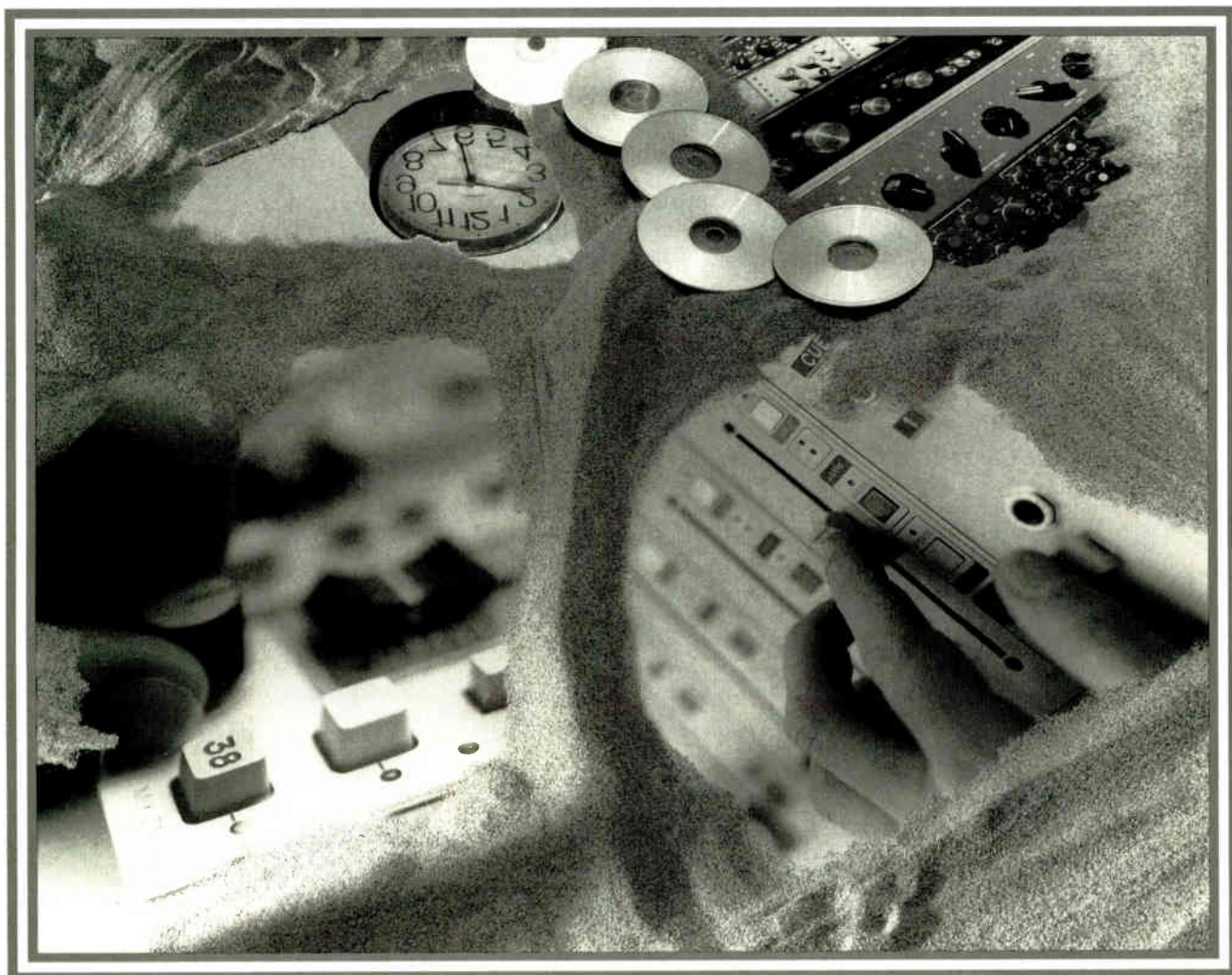

PHOTO: RICHARD CASH

ACCESS TO DSP TOOLS IN
STUDIOS AND LIVE PERFORMANCE IS
LITERALLY A FEW
KEYSTROKES
AWAY...



How easy is DSP

technology to understand or use as a flexible, powerful audio tool? Do you limit yourself to factory presets, because you don't comprehend a unit's features? Armed with some basic knowledge, we can bring the technology out of the confines of the pocket protector/lab coat set and into the hands of music makers.

Digital Signal Processing appears everywhere in today's recording and live performance scenarios. And while outboard processors for ambience, pitch shifting, delay and chorus/modulation effects flood the market, the power of DSP manipulation is being incorporated increasingly into digital consoles and computer-based workstations, to the point where access to a variety of DSP tools is literally a few key-strokes away.

But how easy is DSP technology to understand or use as a flexible, powerful audio tool? Do you limit yourself to factory presets, because you don't comprehend a unit's features? Armed with some basic knowledge, we can bring the technology out of the confines of the pocket-protector/lab coat set and into the hands of music makers. Creativity is enhanced when understanding replaces "blind knob twirling" to achieve a desired sound.

DIFFERENCES BETWEEN ANALOG AND DSP

Analog signal processing usually occurs in the form of a continuous time-based format. "Continuous time" is defined as one complete waveform. Due to the anomalies of the analog-to-digital conversion (processing analog audio into individual samples or "slices" of the original continuous waveform), digital signal processing takes place in the form of discrete time. This means that digital filters only operate on values taken at certain points in time, determined by the sampling

frequency of the system. It is this discrete digital time that digital filters use to process digital audio data.

SOME DEFINITIONS

There seems to be little standardization of the terms and features of the processors in today's studios. As mentioned before, the algorithm is the base program that the processor uses for the effect. Algorithms are put together and saved as patches for later recall. Pretty straightforward. Yet terms such as HF Damping, Spread or the multiple uses of the word Depth might not be so obvious. Here are explanations of some frequently encountered terms found in typical DSP devices.

Degitch—Deglitching is a method of optimizing a pitch-shifting algorithm to minimize unwanted artifacts.

Depth—Depending on the processor, depth can refer to several things: In a reverb, depth can be used to vary the illusion of being farther away from the source; in a flanger or phaser, depth controls the amount of modulation. Take your pick.

Diffusion—This determines how dense the late-field decay of a reverb sounds. If increased, it causes the

by Ted C. Tanner Jr.

echoes to build up more quickly over time, a reverb condition that is pleasing to most humans.

Early Reflections—Early reflections in a room or space give us an impression of how big the space is relative to the source. Usually denoted ER, this function typically is expressed as a percentage of relative delay value to the late-field decay. When this is turned up, it sounds like the source is more predominant in the mix.

Feedback—Found in most digital and some analog processors, feedback is a condition where the output of a circuit recycles through its input. For example, part of a signal routed through a digital delay can be fed back into the delay to create a more complex effect. This also is called “regeneration.” Negative values are usually safe. For positive values, make sure you are riding the fader. In most cases adjustments are relative from 0% to 100%, with 100%

being maximum feedback.

FIR Filter—Finite Impulse Response Filter. This filter does not occur in the analog world, mainly because you can have linear phase (see below). FIR filters are also easier to design.

HF Damping—In most processors, this simulates the effect of high-frequency absorption due to air. It usually makes the effect (i.e., delay or reverb) sound more “dark.” Decreasing the damping increases the decay of high frequencies in the effect. It

Digital Filters Explained

The subject of digital filters is usually followed by a lengthy discussion of mathematics. This will not be the case in this article. Instead, I will attempt to explain the digital filter in verbal context rather than a string of Greek letters.

The output of a digital filter is equal to the sum of the present and past outputs multiplied by a certain value, *minus* the past outputs multiplied by a certain value. The quality is equal to how long you want to sum the values.

Known as *coefficients*, these “certain values” give the filter the characteristic of lowpass, high-pass, bandpass or bandstop. The input and output are stored in memory. The way the digital filter software is written is referred to as the algorithm. A DSP chip is actually a specialized microprocessor. In the past, signal processing was performed offline by mainframe computers and then by desktop central processing units. Today, the architecture of the chips has changed so that the language they speak is optimized to process digital data. Higher-level languages (usually an object-oriented approach such as C++) can now communicate with the lower-level assembly language. For the user this is a transparent issue.

In the October 1992 *Mix*, Ken Pohlmann provided an in-depth analysis of a general-purpose DSP chip and an algorithm for a simple lowpass filter. The design of basic filters for signal processing has been greatly simplified due to sig-

nal processing packages on the market available for the Macintosh and PC clones (August 1992 *Mix*). Taking the simplified blocks and putting them together creates the complex algorithms that most of the available audio signal processing devices use.

Digital filters offer many advantages over analog filters. Analog filters require passive components (i.e., resistors, capacitors and inductors) and active components (i.e., transistors or op amps). These components have imprecise values or tolerances that are also subject to temperature drifts. These tolerance drifts can lead to imperfect output response. Digital filters implemented with digital components or specialized chips have no temperature drift but are subject to rounding problems in the values of the software. This rounding problem occurs because we are dealing with a discrete digital word instead of a continuous waveform.

The noise in a digital filter is different from the noise in an analog filter. Unlike analog filters, digital filters are sampled systems and are subject to aliasing, an undesirable noise component created when the sampling frequency of a digital system is *less* than twice the highest frequency of the input signal. When formed from digital electronics, digital filters do not have inherent noise in the word lengths to form the filtering. Word length refers to the number of bits used to represent the digital coefficient.

Analog systems have thermal, shot and 1/f noise to contend

with. Thermal noise is the result of the random motion of charged particles (usually electrons) in a conducting medium such as a resistor. Shot noise arises from the nature of the current flow of electrons in a tube or transistor. 1/f or “flicker” noise is often a limiting factor in the minimum signal an analog device can process, thereby decreasing dynamic range.

Analog filters can operate up to the gigahertz range. Currently, digital filters cannot operate at the higher GHz range of the analog filters; however, with advances in parallel processing, this frequency range is increasing. The biggest benefit of the digital filter is probably its flexibility. Once a program or algorithm is written, it can be changed easily to operate quite differently. Usually the same program can run different numbers or “coefficients” and obtain a completely different output.

Analog filters are hard to maintain and manufacture. Due to the initial software development, the cost of a digital filter is much higher than its analog counterpart but decreases rapidly once the program is written. The analog filter has the initial cost of research, which is usually lower; however, the hardware components usually level out at some cost-per-component value. Digital filters that are much less complex than their analog counterparts can have increased performance characteristics. Furthermore, many of the digital filters used in today’s audio technology cannot be implemented in the analog domain.

—TT

"MIDI-FREE" DYNAMIC REVERB

by Michael Cooper

For all of the power that "dynamic MIDI" offers (by way of controller-parameter patches), setup and execution of dynamic reverb effects via this method can be a real pain in the butt. By the time you've assigned a controller to the appropriate parameter, slaved your sequencer to tape, checked for identical MIDI channels, and programmed the controller's range of influence default parameter value and increment/decrement polarity, everyone in the control room is either asleep or totally pissed off! Yet, many engineers don't realize that real-time, dynamic reverb effects can be programmed in the wink of an eye, without so much as touching a MIDI controller. All that is required is an effects processor offering a gated reverb algorithm with programmable release time. An adjustable threshold para-

meter sweetens the pot even more.

The typical gated reverb effect cuts off abruptly at the expiration of the programmed gate time. That is, the gate's release time is very fast. Extending the release time a bit makes the reverb decay more naturally. Extend it *a lot*, and the reverb will decay so slowly that it doesn't even sound like gated reverb anymore. But you get something totally cool in exchange.

What you get is a reverb program with two decay rates. The original decay time stays in effect as long as the input signal exceeds the gate's threshold. In some units, such as the Lexicon PCM70, the threshold is preset at a level so low that the mere presence of the input signal opens the gate. The gate time doesn't start tickin' away until the input signal ceases. At the end of the gate time, the release time determines a new reverb decay rate. Renewal of input signal at any time during the envelope's progression will revert the reverb back to its original decay rate.

Imagine the possibilities. You can slap a tight reverb with short decay time on a vocal track and program it to bloom into a long decay time only in the gaps between vocal phrases (i.e., in the absence of input signal). Or go vice versa—long decay time and medium-short release—for an imploding room effect. But there's a trick to all this.

To accomplish these effects, you must set the gate time to be *significantly* shorter than the decay time. Otherwise, the reverb already will have decayed to nothing by the time the release phase kicks in. (We're assuming that the reverb's decay envelope has a decreasing slope. The flat-sloped variety obviously doesn't start decaying until the gate time has expired.) As the discrepancy between gate time and decay time increases (i.e., gate time gets relatively shorter), the effect of the "release time" reverb will kick in sooner and be *louder* to boot. The beauty is that the processor will not switch over to the new decay

—CONTINUED ON PAGE 78

NEW VIDEO PATCH PANELS

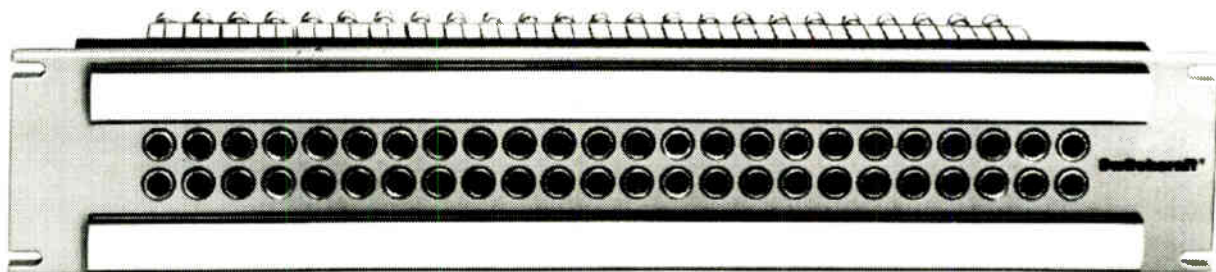

BY **Switchcraft**®

NOW AVAILABLE
FROM:



METAL HANDLES
OR
RUBBER BOOTS

CAL SWITCH
CALIFORNIA SWITCH AND SIGNAL, INC.

DISTRIBUTOR OF
THE DECADE

[800] 225-7924 [310] 538-9830 [213] 770-2330 [818] 761-5226 [714] 525-6606 [619] 231-6740
[415] 621-7386 [408] 279-8848 [510] 452-1009 [916] 448-6370 [209] 441-1725 FAX [310] 327-2741

USE READER SERVICE CARD FOR MORE INFO

MANUFACTURING
SERVICES FOR THE VERY
BEST QUALITY AVAILABLE.

Fast Turnaround
Competitive
Pricing
Dependable
Service

Compact Discs
Cassettes
Graphic Design
Printing and
Packaging



CALL JIM LOYD • (615) 327-4533
28 Music Sq. E. • Nashville, TN 37203

USE READER SERVICE CARD FOR MORE INFO

Music for:

Broadcast

Corporate

Multi Media

Films

Trailers

Sports

& More!

Production Music in
a Class By Itself

MANHATTAN

PRODUCTION • MUSIC

311 WEST 43rd ST., SUITE 702, NEW YORK, NY 10036

800•227•1954

212•333•5766

FAX 212•262•0814

will also have the pronounced result of high-frequency attenuation at the same roll-off (decrease) as the delay or reverb decay. The parameter has the adjustment relative to cycles per second (Hertz).

IIR Filter—Infinite Impulse Response Filter. This is the digital equivalent of the filters that you've used for years in your analog console. I've always wondered why,

when a digital graphic or parametric EQ came up on the screen, the user would say something about phase problems.

Linear Phase—Linear Phase is the result when the phase of the signal changes at a constant rate for the respective change in frequency. What this means is you will hear all of the low and high end at the same time. Or, if you move a fader on a FIR EQ,

—FROM PAGE 77. MIDI-FREE REVERB

rate, no matter how short the gate time is, if the input signal is continuously above threshold.

But wait. The party's not over yet. Units such as the PCM70 and Dynacord's DRP20 offer additional goodies. First, the PCM70.

The PCM70's RTL STOP and RTM STOP parameters accomplish the same thing as a release time control while effecting independent damping coefficients for low and midrange frequencies. In the absence of continued input signal to the PCM70, these parameters cause the unit to transition into new and separate decay times for low (bass) and midrange frequencies after the programmed gate time has expired. (The unit's RT LOW and RT MID parameters determine *initial* decay rates for low and midrange frequencies, and an adjustable cross-over helps define each bandwidth's range.) By programming different damping coefficients for the initial and release phases, you change more than room size. You change the furniture. The curtains. The hardness of the walls. Instantly and automatically. Boy howdy!

Until now, we've been stuck with placing reverb decay time transitions at the end of musical phrases. Wouldn't it be cool if we could do it mid-phrase? Enter the Dynacord DRP20 (wild applause).

The DRP20 (a personal fave) offers an adjustable gate threshold parameter for increased dynamic control of reverb decay. Here, the *level* of the input signal (and not just its mere absence or presence) determines the reverb decay time. For audio input above the threshold level, the unit's initial decay time setting is in effect. Input below the threshold affects a decay time equal to the gate's release time setting.

Thus, by setting the threshold level high, the decay time long and the release time short, you can make a track explode out into a huge space on peaks couched in the middle of (or anywhere within) a musical phrase! Set the gate time very short if you want the "explosion" strictly limited to peak input levels. This is very useful for, say, highlighting one impassioned word on a lead vocal performance. Conversely, by setting the gate time long, you can continue the effect for a longer duration even though the lyrics immediately following the peak may have slipped below the threshold level. Hence, with forethought, placement of the effect need not be dictated solely by level.

Of course, a track can also be brought forward in the mix on peaks by setting the threshold high, the decay time short and the release time long.

For all the legions of PCM70 owners out there, it's worth mentioning a couple of idiosyncracies specific to the unit. The PCM70 regards wimpy (but audible) input signal levels that fail to light the input meter's -24dB LED as *no input*. Not knowing this specific threshold can cause a confusing lack of response when adjusting the unit's RT LOW and RT MID (initial decay) parameters. Since you're below the gate's threshold, initial reverberation will exhibit release-phase (RTL STOP and RTM STOP) decay rates. Also, when you edit the PCM70's RTL STOP and RTM STOP parameters' current values, you must trigger the gate to open once before the new values will take effect.

In closing, don't get me wrong: I still think that MIDI automation of reverb parameters is totally fab. But it's not the *only* show in town. ■

only the amplitude spectrum would be changed at that point. This is something that does not truly happen (it can be close) with analog filters.

Recursiveness—A condition that occurs when some part of the filter output is fed back to the filter input. This is essentially a form of feedback. IIR filters have this characteristic.

Spread/Width—Spread controls the relative stereo spatial positioning of the image. Sometimes too much spread can cause muddiness in the mix. Decorrelating the two channels (giving two channels different delay values) can create a perception of enhanced imaging. Another trick is inverting the relative phase of one channel to the other. In most cases, the parameter adjustment is relative to a percentage value and has a delay value associated with it.

Spin—At first glance, one might think this had something to do with controlling a Leslie rotating speaker effect, but in some processors spin allows the user to determine the degree of randomization on the early reflection/presence, or how much the image "moves about" in the stereo field.

Sweep Rate—A means of controlling how fast or slow an effect modulates or moves. The sweep rate basically lengthens or shortens the delay of the effect.

Threshold—A user-defined level that determines the point at which an effect triggers relative to the strength of the input signal.

FUTURE DIRECTIONS

As the technology advances (i.e., speed and memory increase), we will see more functionality placed into smaller and smaller packages. Bulky outboard effects racks could become obsolete. Dialog windows or preprocessor macros could allow users to choose the effects for the session. The only limitation is the hardware. What this means for engineers and producers is that they will be able to have a complete studio without all of the patch bay cables running around like last night's bowl of angel hair pasta.

Imagine choosing some predefined keystroke and having a menu of favorite effects (some that are not analog-realizable) show up on the screen. Imagine being able to place these processes in any order without having to reach over to the patch bay and reconfigure the I/O. No

more crackling cables or having to turn around to change the patch. Need another compressor? No need to call the rental house or pro audio dealer to have one sent by courier. It is already there, just run it. And by the way, there is no reason this could not all be MIDI-controllable.

Amazing as it sounds, this vision is limited only by the available DSP horsepower. You could have ten, 20 or 30 different delay units. Try that in a small confined space. The controls will be the same. The LED indicators will be a higher-resolution. Try having an instantaneous readout of 640x480 pixels with regular effects and consoles. You will no longer have to worry about "pro" or "semipro" level matching. Who really thinks in *dBm* anyway? It will all be taken care of and still reside in the digital domain.

Although this technology has been around for a while, there are many effects and functions yet to be realized that will make the studio an even more creative instrument. Hmm, how about a wrong note filter? ■

Ted Tanner is a DSP engineer at Digidesign Inc.

FOR FURTHER READING

Here are some useful references for the reader seeking a more comprehensive explanation of DSP. These are available through technical bookstores or from the Mix Bookshelf. It probably would help if you dust off your old trigonometry text before reading some of these books.

F. Richard Moore, *Elements of Computer Music*, Prentice Hall, Englewood Cliffs, NJ (1990).

Ken Pohlmann, *Principles of Digital Audio*, Howard W. Sams Co., Indianapolis, IN (1989).

Ken Pohlmann, Editor *Advanced Digital Audio*, Howard W. Sams Co., Indianapolis, IN (1991).

John Strawn, Editor, *Digital Audio Signal Processing: An Anthology*, William Kaufman Inc., Los Altos, CA (1985).

RECORDING EQUIPMENT

—All Major Brands—



FOR STUDIOS/HOMES CHURCHES/CLUBS

- Reel to Reel Decks (2-4-8-16-24 Track)
- Cassette Decks • Mixing Boards
- Mikes • Studio Monitor Speakers
- Special Effects Units Accessories

TASCAM
TEAC Production Products

- VOLUME DEALER
- NEW & USED
- E-Z TERMS
- ALL MAJOR CREDIT CARDS
- PROFESSIONAL ADVICE



Call for pricing information.

RHYTHM CITY

1485 NE Expressway
Atlanta, Georgia, 30329
1-404-320-SALE • 1-404-320-7253
Special Pricing for Package Systems.

USE READER SERVICE CARD FOR MORE INFO

by George Petersen

TASCAM DA-88

DIGITAL MULTITRACK RECORDER

Once the exclusive domain of the rich and famous in the recording industry, affordable digital multitrack machines have arrived for all of us. Those who postponed the decision to go digital now have another choice.

For those who have been living in a cave during the past couple of years, the Tascam DA-88 is an 8-track deck that can record 108 minutes of digital audio on a standard Hi-8mm videotape. Unlike the process of syncing two or more analog recorders, DA-88s do not require the use of audio tracks or expensive external synchronizers for multimachine lockup; a single cable is all that's required for sample-accurate synchronization. This modular approach allows up to 16 of these \$4,499 machines to be interlocked, providing up to 128 tracks (in 8-track increments) of recording capability.

FEATURES AND FUNCTIONS

The Tascam format uses a four-head rotary, helical scan transport to store audio on Hi-8mm videotapes, running 10% faster than a camcorder

rate. A 120-minute tape provides an actual running time that is 10% less than that figure, or 108 minutes. The machine automatically ejects any tapes that are longer than 120 minutes or not Hi-8mm.

Before recording, the tapes must be formatted (this procedure can also be done while recording), with the 44.1 or 48kHz sampling frequency selected before the formatting process begins. The formatting procedure requires several push buttons, so there's little chance of accidental formatting, which would also erase all of the audio information on the tape. One interesting bit of trivia is that tapes previously recorded with video information cannot be formatted for DA-88 use, so forget about trying to track over your camcorder tapes of little Jimmy's birthday party.

The DA-88's four-rackspace front panel is uncluttered and logical. Operation is fairly straightforward, especially to anyone familiar with the locator operations on Tascam's other pro multitrack products. Besides the usual transport functions, the front



Tascam DA-88
with optional
RC-848 remote
controller

panel includes controls for tape shuttle, sample rate select, two locator points, Rehearse and Auto-punch modes, clock source select, time code generate/record switches (these function only with the optional SMPTE sync card), and arrow up/down keys. The latter increment/decrement softkeys are used in conjunction with a

The meters are 15-segment LED ladders, which are large and bright but slightly inset; they are difficult to read if the viewer is more than 50 degrees off-axis to the recorder. No resettable peak hold is provided (something I really depend on when doing digital sessions), but the action of these fast, peak-reading meters is

number of specialty cable companies.

You've heard of SPDIF and SDIF-2, so get ready for TDIF-1 (Tascam Digital InterFace), a bidirectional 25-pin D-sub port on the DA-88 that connects to a second deck for making clone copies of tapes and provides the link to optional AES/EBU and SDIF-2 interfaces that Tascam

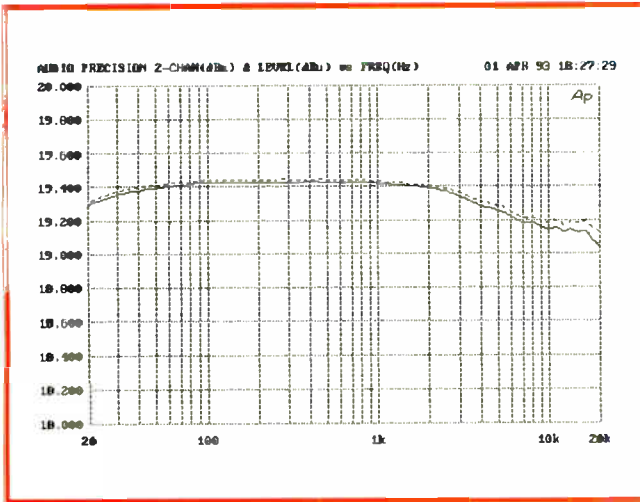

Figure 1: Frequency response test

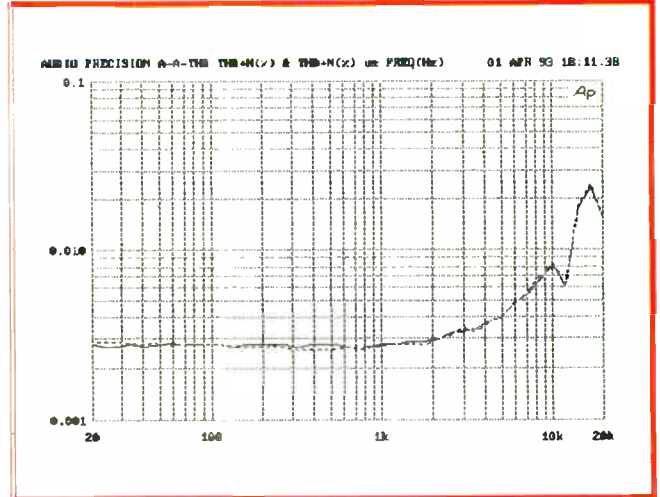

Figure 2: THD+N test

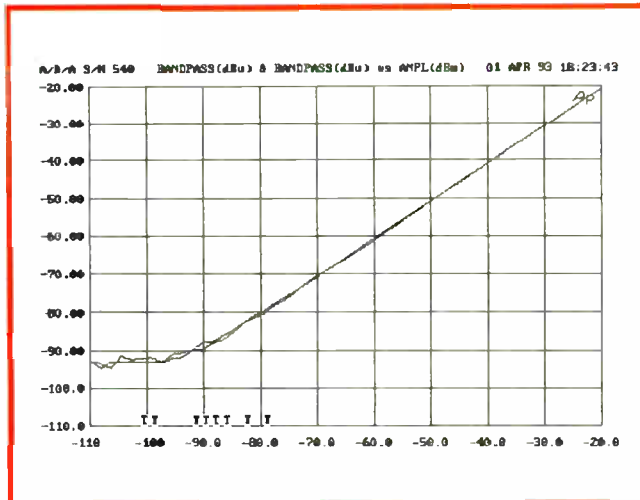

Figure 3: Linearity test

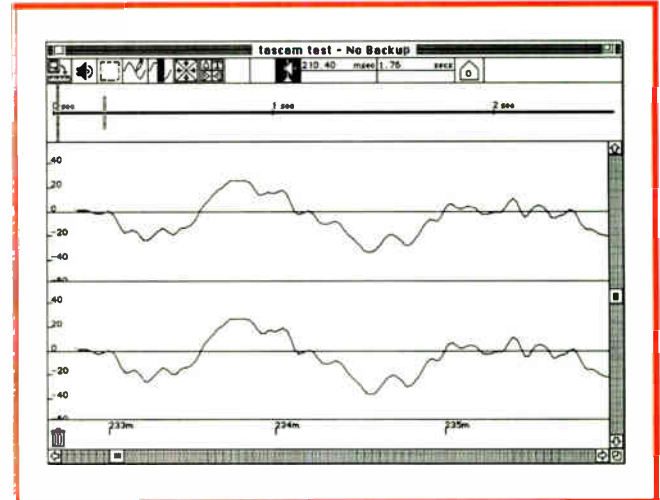

Figure 4: Sync accuracy test

display button, allowing the user to set preroll times, crossfade times, sync offset in a multimachine setup, $\pm 6\%$ pitch change and playback delays on any individual tracks. The numeric LED readout displays any of the softkey parameters and can be switched to show absolute time in hours/minutes/seconds/frames, as well as time code (if the sync card is installed) or the two memo/locator points.

very good. As an alternative to the onboard meters, an optional 24-track meter bridge will be offered.

The rear-panel analog inputs and outputs are unbalanced RCA pin jacks (-10 dBV) and +4dBm balanced line on a 25-pin D-sub connector, such as that used on Tascam's M-600 and 700 consoles. For those who hate to solder, optional Tascam PW8D/XM and PW8D/XF D-sub-to-XLR snakes are available, as are snakes from a

(and probably some enterprising third parties) will offer at some future date.

Two 15-pin D-sub sync in/out ports allow multimachine lockup and connect to the optional RC-848 full-function autolocator; an 8-pin DIN jack connects to the RC-808 basic transport control, also optional. Another 15-pin jack connects to the optional meter bridge. A 1/4-inch jack permits remote punch-in/out operations with

an optional footswitch.

BNC word sync in and out ports are included on the rear panel, but I couldn't think of any practical applications where these would be of any use, without having the optional AES/EBU or SDIF-2 interfaces. A Tascam employee explained that the DA-88's $\pm 6\%$ varispeed range can be expanded to $+18\%/ -12\%$ by feeding an external clock source to the word sync input, although this is not mentioned in the manual.

Not available at presstime, the optional SY-88 synchronization board (\$799) is a plug-in SMPTE card for chase-lock to video or other time code sources, and MIDI machine control. Time code is recorded into subcode data, so no audio track is required. A single SY-88 card provides SMPTE functions for the master recorder and up to 15 additional interlocked DA-88 units operating as slaves.

Other future options include the mini-RC-808 (\$175) single-machine remote and the RC-848, a large, multi-machine autolocator priced at \$1,499. The RC-848 has record select buttons for up to 48 tracks (six DA-88s), along with 9-pin RS-422 output for interfacing to video systems, two ports for controlling Tascam analog decks, 99-point autolocation, large shuttle wheel, LCD status screen and two large LED time displays.

On the front panel is a rotary forward/reverse shuttle control, which is similar in function to that found on several DAT machines on the market. The small size of the DA-88's shuttle knob takes a bit of getting used to and as with other shuttle systems audio is noticeably degraded in shuttle mode. Also, in multimachine chase mode, the slaves do not shuttle exactly in sync with the master. I was far more impressed with the $\pm 6\%$ varispeed control, which changes pitch in $\pm 0.1\text{dB}$ increments: Varismooth!

Punch-ins and outs were seamless, even on difficult material. The DA-88 defaults to a crossfade time of 10 milliseconds, and users can change this up to a maximum of 90 ms (in 10ms increments). Incidentally, battery-backed memory stores the crossfade time, pitch change, memo points, track delays, preroll and punch-in/out points, even when the DA-88 is powered down.

The transport is fast and generally smooth, although it emits some strange

whirring sounds when going into and out of "play" and "stop." In a quiet control room, machine operation was noticeable but not objectionable: about as loud as a hard disk whirring. Transport operations happen very quickly, in much the same manner as a DAT recorder, where minutes of tape zip by in a matter of seconds. A 100-minute tape rewinds or fast-forwards in 80 seconds, and during rewind, the transport slows down about three minutes before the end of the tape, presumably for better tape packing. The repeat (loop) and locator memories worked flawlessly, in either single or multimachine chase modes, and in the latter, the DA-88s locked up quickly and efficiently.

Transport operations happen quickly: minutes of tape zip by in a matter of seconds.

THE TEST

We disassembled a DA-88, and yes, Elmo, it worked fine after we put it back together. The DA-88 employs a modular construction, with all the major electronics mounted on cards that can be removed easily from the back panel. In addition to simplifying servicing, this allows future upgrades and opens the door for third-party companies to create specialized DA-88 cards, such as custom sync modules or high-end D/A or A/D circuits.

The boards remove easily with a standard Philips screwdriver. The digital-to-analog converters are Analog Devices DA-1865N, 18-bit, 16x oversampled; A/D converters are 16-bit Crystal 5339s—all quality stuff, but I was puzzled as to why the RCA jacks are lined up from channels 8 to 1, while the board is laid out in reverse order, requiring a crisscross of audio lines to get the signals in the right order. This didn't create a noticeable change in audio performance, as the channels spec'd out nearly identically, but perhaps that extra wiring will disappear in a later version. The out-

TOOLS FOR THE RECORDING STUDIO

whirlwind DIRECTOR Direct Box

whirlwind Hot Box Act

OUTPUT 30

MUTE MUTE

whirlwind

MK-4 LOW Z CABLES
MIDI CABLES
PHSAT HEADPHONE BOX
LINE BALANCER
HOT BOX • IMP 2 • DIRECTOR
CUSTOM PANELS • PATCHBAYS
MEDUSA MULTIWIRED SYSTEMS
COMBINER • SPLITTER • LITTLE IMP
PHASE REVERSE • LIFTER
P-45 AND P-12 POWER AMPS
MIX-5 MIXER

THE BEST PERFORMANCES ARE BETTER WITH

whirlwind

100 Boxart Street • Rochester, NY 14612
716-663-8820 • FAX: 716-865-8930

USE READER SERVICE CARD FOR MORE INFO

side of the entire card cage is enclosed in thick, heavy-gauge slabs of copper sheeting, which should provide excellent shielding from EMI, RFI and other such gremlins.

The power supply is a conventional linear design with a large transformer, massive heat sinks that extend two inches beyond the rear panel, and a muffin fan to keep heat under control. That large iron-core transformer is a major contributor to the unit's 33-pound heft—make sure your roadies are in shape if your location recording plans require mounting three DA-88s in an ATA case!

The transport is a solid, rugged-looking mechanism and is mounted at the top-left front, easily accessible for maintenance or head-cleaning duties. A Tascam employee I spoke to recommended using a dry 8mm head cleaner, which should suffice, but my guess is that after the warranty expires, most maintenance pros will clean the heads, rollers and guides manually, just like any other video transport. The entire transport assembly removes with four screws.

After a quick reassembly, it was time for a bench check. The Tascam XLR snakes (wired pin 3 hot) use high-quality AMP connectors for the D-sub ends, an appreciated touch. Unfortunately, the AMP connectors use USA 4-40 threads for the connector hold-down screws, and the DA-88 has metric threads on the D-sub, so the threads will strip out if you fasten them tightly. Undaunted, we connected the DA-88 to an Audio Precision System One to check out performance. As the optional AES/EBU and SDIF-2 digital adapters were unavailable, all tests were done in the analog domain.

Fig. 1 shows a frequency-response plot of two channels, with the vertical axis in 0.2dB divisions. Our measurements indicate 20 to 20k Hz performance that is flat to ± 0.2 dB—much better than the ± 0.5 dB spec that Tascam claims. The Total Harmonic Distortion + Noise results in Fig. 2 show a figure that's under 0.003% at 1 kHz (nearly three times better than the 0.007% on the DA-88 spec sheet); even in the worst case (at 18 kHz) in the plot, our THD+N measurement is approximately 0.025%—quite respectable. Fig. 3 shows linearity that is rock-solid down to the -90dB range.

According to the Tascam manual, up to 16 DA-88s can be interlocked

FIVE TOWNS COLLEGE KNOWS A GOOD THING WHEN THEY HEAR IT.

The Five Towns College faculty is proud to announce that it has selected
**TANNOY SYSTEM 215 DMT
MONITORS**
for its new 48-track recording studio.



For information about College programs call (516) 424-7000, ext. 110

USE READER SERVICE CARD FOR MORE INFO

Russo
PROFESSIONAL SYSTEMS

"the right choice"

Marantz CDR-600 COMPACT DISK RECORDER



The affordable option for:

- customized sound effects libraries
- pre-sequenced music bumpers
- creating reference disks
- archival work
- in-house production work

Competitive Pricing • Knowledgeable Staff • Huge Inventory

— CALL OR FAX FOR MORE INFORMATION —

1989 ARENA DRIVE • TRENTON, NJ 08610 • TEL 609-888-1808 • FAX 609-888-3492
OPEN WEEKDAYS 10 AM-9 PM & SAT. 10 AM-5 PM EST • MAJOR CREDIT CARDS ACCEPTED

ROCKET LAB

MASTERING STUDIO

COMPLETE

DIGITAL MASTERING

MUSIC EDITING

& CD REFERENCES

ATLANTIC RECORDS

WARNER BROTHERS RECORDS

SHRAPNEL RECORDS

DIGITAL UNDERGROUND

MICKY HART

BRAD GILLIS

RY COODER

ROY ROGERS

RYKODISC

RELATIVITY RECORDS

JOHN LEE HOOKER

TRAMAINÉ HAWKINS

MCA RECORDS

RCA RECORDS

JERRY GARCIA

TOMMY BOY RECORDS

THE RESIDENTS

2 PAC

POLYGRAM RECORDS/

MERCURY RECORDS

PRIORITY RECORDS

TNT PRODUCTIONS

REFERENCE RECORDINGS

DAVID GRISMAN

JEFF WATSON

HOLLYWOOD BASIC

NARADA RECORDS

51 FEDERAL STREET #100
SAN FRANCISCO, CA 94107

FAX: 415-495-2684

PHONE: 415-495-2297

USE READER SERVICE CARD FOR MORE INFO

for multimachine operation. Unfortunately, I didn't have 16 decks, but thanks to local Tascam rep Bill Stevens, I had two, so I could run sync accuracy and multimachine tests. While the DA-88 uses 15-pin D-sub connectors for sync, an off-the-shelf computer cable will *not* work in this application and may damage the equipment. You can get either the optional Tascam cable or make one by connecting all pins except 12 and 13. After rolling my own, it occurred to me that I simply could have bought a ready-made cable and cut or removed pins 12 and 13, an inexpensive, no-hassle alternative.

Machine lockup is easy. A tiny rotary switch on the rear of each machine selects a Machine ID number (sort of like a SCSI ID number): ID number 0 for master, number 1 for the first slave, number 2 for the second, etc. Once IDs are set, just load your tapes, push the Chase button on the slave deck, and the slave faithfully follows the master transport. The increment/decrement controls can be used to set offsets between the machines, up to plus or minus one hour in single-frame steps.

I recorded a short burst of mono audio on both machines simultaneously, rewound the tapes, powered down, and restarted the machines in Chase mode. The audio burst, recorded at the 80-minute mark, was played back and dumped into a Digidesign Sound Tools system for analysis. Note that the divisions on the horizontal axis are in milliseconds, where the elapsed time in the window is just over 0.003 seconds. The results, shown in Fig. 4, indicate that playback sync is sample-accurate.

AMAZE YOUR FRIENDS!

One of the DA-88's more interesting features is the ability to delay the playback of individual tracks, to a maximum of 7,200 samples. At 44.1 kHz, this equates to a delay of 163 milliseconds, or 150 ms at 48 kHz. As the delay is displayed in samples, you'll need to keep your slide rule or calculator nearby when using this feature. In addition to some fun signal processing tricks, the onboard track delay is invaluable for making phase adjustments.

For example, when recording two tracks of bass guitar—combining a direct box with a miked amplifier—a

couple milliseconds of delay on the direct track really tighten the bass for a punchy sound. Recording drum tracks, it is possible to delay the close mics on snare, hi-hat and toms to align with the overhead and/or room mics for a killer sound. Other applications include classical recording, and combining (and phase aligning) the mid- and far-field mics. Track delay opens a world of possibilities to the creative recordist. Another hip trick on the DA-88 involves the TDIF-1 digital port. Designed mainly for making clone tapes or attaching those soon-to-come outboard digital interfaces, I wanted to see how the DA-88 would handle digital assembly editing.

First, I needed a TDIF-1 cable with double-ended, 25-pin D-sub male connectors. A typical computer cable won't work, as this bidirectional port requires the following pinout: pin 1-to-pin 13, 2-to-12, 3-11, 4-10, 5-9, 6-8, 7-7, 8-6, 9-5, 10-4, 11-3, 12-2, 13-1, 14-25, 15-24, 16-23, 17-22, 18-21, 19-20, 20-19, 21-18, 22-17, 23-16, 24-15, 25-14. There's a definite pattern here, so I made a cable using two push-on D-25 plugs and 15 inches of ribbon cable. By attaching the plugs to the ribbon cable with one facing up and the other facing down (or putting a half-twist in the cable), you end up with the correct pinout. My cable (at an electronics junk shop) was \$1. Assembly time was under two minutes. Though I probably violated every FCC emissions regulation, the Petersen Interface worked perfectly.

One snag in the digital dubbing process is that each channel must be delayed by 43 samples (less than 1 millisecond) to adjust for a processing time delay. The manual says this should be done individually, track by track. However, by pressing the Up and Digital Input keys simultaneously, the 43-sample delay occurs automatically on all tracks. Of course, if you forget to enter the delay, the clone is still less than $\frac{1}{1,000}$ of a second out of sync—nothing to cry about.

Using a tape with the instrumental basic tracks of one verse and chorus, I set out to create an assembly-edited version of a full-length song. I began by cloning the basics from machine one to a preformatted tape on machine two. Then I repeated the process, this time assigning a 37-second/11-frame offset to the slave deck so that the "new" verse and chorus

would come in precisely after the first cloned tracks. A third pass, with a longer offset, yielded a finished track with three verses and choruses. I then placed the cloned, full-length song in the master deck, put a fresh tape in the slave and continued overdubs on the 16-track project. Total time: under ten minutes, most of which was spent searching for the perfect offset times.

Caveat: The digital cloning/assembly process requires setting the erase-protect tab on the *master* tape to the "nonprotected" position, and then pressing "record" on the master deck, which enables the record function on the slave deck. If any of the track-arming buttons on the *master* are selected during this process, those tracks on the master will be erased, an unpleasant scenario that could occur if a tired engineer attempts to make a safety copy of tracks after an all-night session.

While the DA-88s can lock up to sample accuracy, digital assembly is limited to frame accuracy, due to offset and punch-in/out resolution. This situation may change with the introduction of the optional SY-88 sync card, as its MIDI machine control capability would presumably offer punch-in/out accuracy determined by sequencer resolution, typically 20 times more accurate than SMPTE frames. And speaking of frames, the DA-88 operates at—or at least displays time in—the somewhat non-standard rate of 33 frames/second. I presume the SY-88 card will take care of that, too.

The recorder is capable of multi-machine digital editing, yet the DA-88 is currently unable to copy tracks on a single machine in the digital domain. For example, if you had only one DA-88 and wanted to combine several vocal takes into one seamless, perfect track (i.e., inserting the first verse from take two/track two into the take one/track one performance), this would have to be done in the analog domain. The solution may be in the bidirectional TDIF-1 interface, and either Tascam or a third party could build a matrix router or patch bay array that would allow the user to redirect the TDIF-1 digital inputs and outputs to any desired track—in the digital domain.

The DA-88's manual is fairly sparse for a unit of this complexity. No system diagrams, flow charts, schematics or even a description of the for-

I WANT MY TDK[®]

TDK SA is the best cassette tape at any price. At QCA we use TDK exclusively for all our music cassette duplication (at no additional cost). Your music deserves the best.

CALL QCA 800-859-8401



QCA, Inc. • 2832 Spring Grove Ave. • Cincinnati, OH 45225

USE READER SERVICE CARD FOR MORE INFO

You Know Bryston



for their exceptional monitoring products, including power amplifiers, stereo preamps, and crossovers.

But do you know about the **BMP-2**, Bryston's new dual channel microphone preamplifier? With the reliability and sonic fidelity you would expect from Bryston, the **BMP-2** features:

- All discrete audio circuitry
- Class "A" operation
- Dual Hi-Z instrument inputs
- 10 frequency low cut switch
- 20 LED peak or average meters
- Gold-plated switches and connectors

Call Studio Consultants for a demonstration.

AKG, API, Apogee Electronics, B&B, Bryston, Drawmer, Eventide, Gefen Systems, Genelec, Lexicon, SigTech, Sonic Solutions, Sound Ideas, Soundcraft, Westlake, White Instruments, and other exceptional audio products.

studio consultants, inc.

321 West 44th Street, New York, NY 10036 (212)586-7376
Equipment, support, and design services for professional audio facilities and broadcasters — since 1971.

UCLA
EXTENSION Entertainment Studies

Study with Top Music Professionals This Summer

Summer Quarter Begins June 26

- **Introduction to Audio Engineering** with *Michael Braunstein*, recording engineer/producer
- **Techniques of Multitrack Mixing for Music Mastering** with *Van Webster*, recording engineer, producer, and owner of Digital Sound Recording
- **Microphone Techniques for Professional Recording** with *Allen Sides*, studio owner, producer, and engineer
- **Console Automation Systems** with *Guy DeFazio*, recording engineer
- **A Musician's Guide to Recording** with *Peter Mclan*, producer/engineer whose credits include Mr. Mister and Men at Work
- **Audio Post-Production for Film and Television: An Evolving World** with *George Johnsen*, President, EFX Systems

For more information call
(310) 825-9064.

HL F26

Call now for your free catalog **(800) 554-UCLA.**

USE READER SERVICE CARD FOR MORE INFO

see the incredible new compact disc printer
in booths 607 & 609 at the replitech show in santa clara, ca.

apex
since 1903

- the inventor and manufacturer of the first production on-audio cassette printer.
- the inventor and manufacturer of the first production on-video cassette printer.
- the largest and finest manufacturer of on-audio and on-video cassette printers in the world.

why settle for less ? ?

apex machine company
3000 n.e. 12th terrace • ft. lauderdale, fl 33334 usa
ph: 305-565-apex • fax: 305-563-2844 • telex: 271601 apex ur

domestic representatives: west coast: master recording supply, inc.
4000 w. magnolia blvd. ste. j • burbank, ca 91505
ph: 818-841-7500 • fax: 818-841-8134

mid-west: encore marketing company
p.o. box 386 • kenilworth, il 60043
ph: 708-256-6223 • fax: 708-256-8362

mat's basic technology is included. There are no warnings about the danger of using standard computer cables for TDIF-1 or sync functions. The maintenance section is limited to the phrase, "Don't use any commercially available head-cleaning tape, which could cause premature head wear." There is, however, a section on how to properly ground an outdoor antenna and a warning about the danger of using the "appliance" near bathtubs and swimming pools. Serious pro users require—and deserve—better documentation than this effort.

Fortunately, the DA-88 sounds better than it reads. Its specs are impressive, and my subjective sonic evaluation is that the machine sounds about the same as any high-quality DAT recorder. If you've heard Tascam's DA-30 studio DAT machine, then you have already had a preview of the DA-88's sound. If you're an engineer who absolutely despises DAT mastering and will only mix to ½-inch analog 2-track at 30 ips, then you probably won't like the DA-88. As for me, the DA-88 sounded just fine. Of course, once Tascam's AES/EBU interfaces become available, users could pick and choose from any number of outboard D/A and A/D converters to create their own sound.

The Tascam DA-88 offers plenty for its \$4,499 price: high-quality audio; a fast, rugged transport and special sync/offset functions that combine to create a very attractive package for either the project room or commercial facility. Its 100-plus minutes of record time should certainly appeal to location and concert recordists, who will also appreciate the versatility of the track-delay feature. With the delivery of the DA-88, Tascam has taken a major step in advancing the state of modular recording. It will be interesting to see how the market—both users and third-party developers—reacts in embracing this new format.

Tascam Professional, 7733 Telegraph Road, Montebello, CA 90640; (213) 726-0303. ■

Mix product editor *George Petersen* would like to thank *Paul Alioshin, Gary Hall, JJ Jenkins* and *Jeff Mock* for their assistance with this evaluation.

by George Petersen

PRODUCT

CRITIQUES AND COMMENTS

BAG END ELF SUBWOOFER SYSTEM
 There's nothing new about ELF™ technology; in fact, it was unveiled by inventors Ed Long and Ron Wickersham in 1982. What is relatively new is the fact that Bag End has licensed the technology and is offering it in a variety of systems for studio monitoring and sound reinforcement (fixed and touring) applications.

The names Long and Wickersham should be familiar to anyone involved in pro audio. The pair also developed the Pressure Recording Process™ licensed by Crown for use in its successful PZM microphone line. Wickersham, the ELF electronics designer, is also the president of Aembic Inc. (manufacturers of high-quality electric guitars and basses). And Long's profound impact on the field of transducer design ranges from his development of the MDM Near-Field Monitor™ series, pioneering the concept of listening to studio speakers at close quarters, to his groundbreaking 1976 AES paper on Time-Align™ technology (that led to his collaboration in the development of the UREI 813 Time-Align studio monitor).

Compared to conventional subwoofer technology, the ELF (Extended Low Frequency) system takes a radically different approach. The speaker enclosures are sealed and compact, for a substantial savings in both weight and enclosure size. The woofer is controlled by an outboard circuit, called a dual integrator, that provides active equalization, frequency-dividing and loudspeaker protection. In the Bag End system, the ELF-1 System Integrator processor is a 2-channel device that can be used in stereo or as two independent mono channels. The ELF-1 is placed between the sound source (i.e., mixing console) and the amplifiers driving the loudspeakers.

In most LF loudspeaker/enclosure



designs, particularly when using ported or vented cabinets, the usual goal is to achieve a resonance frequency (determined by the interaction of the driver mass and the stiffness of the air in the box) that is as low as possible. However, in ELF technology, the driver and its sealed enclosure are tuned so the system resonance is just below the desired lowpass crossover frequency. The upper range of the LF response rolls off at 12 dB/octave, at a point below the system resonance. At the same time, the LF input signal is raised by 12 dB/octave at a point just below system resonance, for a resulting flat response. The ELF system accomplishes this using a patented dual integrator, thus avoiding the inherent delay problems and phase anomalies common to conventional LF filter networks.

A Bag End ELF system consists of an ELF-1 System Integrator combined with one or more ELF subwoofer cabinets, which range from single 8-inch woofers to dual 18-inch boxes. The enclosures are available in three versions: ¾-inch ply with black ozite carpeting and road handles, oak veneer over ¾-inch pressed fiberboard, and a fixed installation (no hardware) version with black paint over

Bag End ELF-1 dual-channel integrator with security cover removed

¾-inch plywood. All of the cabinets in the ELF line have two Neutrik Speakon jacks and a pair of banana plug inputs on the back panel. Additionally, Bag End markets a line of ELF raw woofer components for users who require custom cabinets or other specialized applications.

The system I tested included two S18E-C 18-inch subwoofers and the System Integrator. I also had the opportunity to test the system in live performance, combined with a pair of Bag End TA12-Cs, two-way loudspeakers with 12-inch woofer, and a constant directivity horn tweeter.

The back panel of the one-rack-space ELF-1 controller has two balanced inputs for connecting to your console outputs, and individual ELF and highpass outputs for connecting to the amplifiers driving the rest of your system. But the fun really starts when you remove the security cover from the integrator's front panel, revealing an intimidating array of 90 switches (45 for each channel), allowing the user to precisely tailor the ELF system response to any particu-

lar application.

Somewhat daunted at this point, I turned to Bag End's ELF user manual, which did not offer a great deal of help. I should add that I was using a *preliminary* version, as Bag End is currently working on a more com-

plete manual; however, this is of little consolation to the users who have suffered with such sketchy documentation for those systems currently out in the field. The manual has no schematics or signal flow diagrams; the section explaining the ELF technology is a scant two pages, and the operation of those 90 switches is covered in three pages! A chapter of applications notes—with tips, techniques and maybe a troubleshooting section—would be nice. A blank setup sheet that can be photocopied and filled in to save "presets" of switch settings *is* included, which is an appreciated touch.

System hookup is no more complicated than using a two-way active crossover. I began my testing by connecting the ELF-1 integrator and two of the 18-inch speakers with a pair of Meyer HD-1 monitors in the studio. The Meyers are powered with balanced inputs and are flat down to 40 Hz, so I felt it would be interesting to see how they would blend in with some ultralow bass from the ELF. One caveat: Though the S18E-C speakers have a fairly high sensitivity (92 dB at 80 Hz, 1w/1m), you still need *lots* of amplifier power to reproduce ultra-LF energy, so you'll need at least 400 watts/channel to adequately drive the

By combining the ELF system with your studio main or compact reference monitors, you can hear—and hopefully fix—LF problems before they go to disc or on the air.

plete manual; however, this is of little consolation to the users who have suffered with such sketchy docu-

Your assistant is here.



Met your new gain control assistant—the 421 AGC-Leveler. Patch the 421 anywhere in your console path, set the target output level, and rest easy. Signals below target are automatically boosted while signals above are smoothly held back. The 421 brings other skills to the studio: brick wall limiting and downward expansion with AutoThreshold for noise elimination, Speech Curve EQ, and a unique parallel input/output metering system for precision monitoring at a glance.

For dialog and effects leveling in post, film & music dubs, vocal & instrumental tracking, or any application where constant level and intelligibility are a *must*, hire an assistant—the Symetrix 421 AGC-Leveler.

USE READER SERVICE CARD FOR MORE INFO

NOW AVAILABLE
The New ASR-10 Rack-Mount



EXPLOSIVE FEATURES!

The ENSONIQ ASR-10 brings the features you've always wanted to a sampling workstation.

Announcing the latest *ENSONIQ boom*—the new ASR-10 Advanced Sampling Recorder. With features like stereo sampling, dynamic effects processing, time compression/expansion, an integrated sequencer and 31-note polyphony, ENSONIQ brings innovation to the world of sampling—*again*.

To start with, the ASR-10 supports up to 16 megabytes of sample mem-

ory—eight times the memory of our previous sampler, and uses industry-standard SIMMs for easy expansion.

For on-board effects, the 24-bit digital effects processor has 50 algorithms, many derived from the DP/4 Parallel Effects Processor. Input sampling is easily routed through the effects processor. You can re-sample in stereo through the effects, and even process external signals while you play live.

And for drum loops and other time-based samples, use the ASR-10's time compression/expansion facilities to change the length of a recording without changing the pitch.

The ASR-10's quad-density (HD) disk drive increases storage capacity and speeds load times. Add the optional SP-3 SCSI interface, and you can connect up to seven hard drives and CD-ROMs for easy access to an extensive library of sounds.

Together with a flexible, integrated 16-track sequencer, Poly-Key™ Pressure keyboard and Performance Presets that provide instant recall of sound combinations, you have one powerful workstation.

Harness the power of an ASR-10 for your music. Play one today at your Authorized ENSONIQ Dealer. For the one nearest you, call 1-800-553-5151.



The ASR-10 Rack-Mount has all the power of the keyboard version plus eight outputs and a SCSI interface.

ensoniq®
THE TECHNOLOGY THAT PERFORMS

Please send me more information on the ENSONIQ ASR-10 Also, please send me information on ENSONIQ Synthesizer Workstations DP/4 Parallel Effects Processor

Name _____ Address _____

City _____ State _____ Zip _____ Phone (_____) _____

Mail to: ENSONIQ Department X-34, 155 Great Valley Parkway, P.O. Box 3035, Malvern, PA 19355-0735



SQ-1 32 Voice Personal Music Studio



SQ-2 32 Voice Personal Music Studio



KS-32 Weighted Action MIDI Studio



DP/4 Parallel Effects Processor

SQ-R PLUS 32 Voice Synthesizer Module

subwoofers. This equates to a sound pressure level that is approximately 115 dB—more than enough for the typical studio situation.

In fact, in this case, the double-18 setup proved to be a lot in my 11x16-foot control room. A double-12 or a mono-15 system would have been fine in a room of this size. This was apparent from my first listening test: a helicopter effect on a CD I produced a couple years ago. Initially, I thought the ELF system was malfunctioning; I didn't hear any additional bass output, but, after a few seconds, the entire room started to vibrate, and objects started falling off shelves. This was my first clue to the reality that there *is* something to this ELF stuff after all. Fortunately, that previously mentioned bank of 90 switches includes Cut Off controls that allow you to tailor the degree of how low the system goes, from eight to 70 Hz in 2Hz increments. Curtailing the response at 20 Hz proved to be a realistic compromise, providing plenty of solid bass while keeping the windows from falling out.

I was also impressed by the transparency of the ELF-1 System Integrator's highpass output: The HD-1s sounded virtually identical, whether routed through the System Integrator or not. There was no change in the sound whatsoever, either in frequency response, phase or imaging. Clearly, Bag End did its homework in the electronics design.

After an hour, I was comfortable with ELF's imposing switch matrix, some of which is not self-explanatory. For example, the Contour controls add low-frequency boost to compensate for directivity when using multiple ELF boxes in a large sound reinforcement system. Much simpler to fathom are the Gain controls, which are banks of switches that provide ± 15.5 dB of boost or attenuation to the respective LF or HF sections of the system. The main mystery in the controls is that these banks of DIP switches combine their values to give the desired result. So if you want a 13.5dB boost, you set the "+" (boost) control along with the 8-, 4-, 1- and 0.5dB switches for a net gain of 13.5 dB. A similar procedure follows for the highpass (crossover) frequency, ELF dynamic filter threshold and HF limiter controls, while individual switches are provided for mute, -10dB

attenuation, polarity, stereo/mono and ELF sum/dual controls in each section of each channel.

The control switches are extremely small, but, once you find the combination that sounds best, it's time to put that security cover back on. By the way, the security cover doesn't look much like the typical security cover, so it's unlikely that curious fingers will find their way to the switches underneath. And with the cover in place, you still can see clearly the six large, bright LED status displays that indicate signal presence, high threshold (HF limiter) and low threshold (ELF concealment) on/off from a distance.

If you spend a two-month period using the ELF system in critical listening, tracking and mixing sessions, a few things become obvious. One soon realizes that the typical near-field studio speaker is wholly inadequate when it comes to revealing the actual character of low-bass informa-

tion. Speaking of the latter, it is important to note that a stereo ELF setup needs only one ELF-1 integrator to handle any number of subwoofers connected to the system. The ELF-1 integrator has a list price of \$2,460; therefore, ELF becomes more cost-effective as the size of the sound reinforcement system increases.

Priced from \$234 to \$1,598 the Bag End ELF enclosures are affordable. And although the System Integrator is hardly inexpensive, the savings on freight and trucking fees alone may help pay for the system in the long haul. Overall, Bag End's ELF system is a versatile tool in either studio or live applications, providing maximum output from minimum enclosures. If you need tight, BIG sound from little boxes, ELF may be your best bet.

Bag End Systems, Box 488, Barrington, IL 60011; (708) 392-4550.



tion on the tape. I was amazed at the amount of LF crap I heard on commercial CD releases, which ranged from air-conditioning rumble, boomy room noise and what sounded like distant freeway sounds on a couple of classical recordings. This was less problematic in release product with vinyl discs, because mastering engineers typically rolled off the bottom end in the disc-cutting process. But with CD releases, all these LF anomalies typically go right onto the disc. By combining the ELF system with your studio main or compact reference monitors, you can hear—and hopefully fix—LF problems before they go to disc or on the air. After using the ELF system for a while, it's hard to go back to using conventional monitoring.

Combining the 18-inch ELF sub-boxes with a couple TA12-C mid/high cabinets creates a compact P.A. system, which, despite its diminutive size, provides a high-SPL system with excellent clarity and superb intelligibility. The TA12-Cs can be mounted on poles above the ELF subs, stacked or flown (with optional hardware), offering a variety of choices to suit dif-

BBE SONIC MAXIMIZER MODEL 862

Over the years, sonic enhancement processors from BBE have improved steadily, offering better performance at prices that likewise have improved in favor of the audio consumer. Ten years ago, you would have paid \$1,495 for the company's first professional product, the model 202R, which was housed in a two-rack-space chassis. Today BBE offers the Sonic Maximizer, providing better performance and more features in a single-rack-space box costing about one-third the price of that original model.

The Sonic Maximizer 862 is a 2-channel unit that incorporates the "BBE Process" high-frequency enhancement the company is famous for, along with Low Contour controls that yield ± 10 dB of bass boost/cut at 50 Hz. In addition to the BBE Process and Low Contour controls, each channel has a 5-segment LED output level indicator. Although the unit can be used as a stereo or dual-mono processor, a single switch (with process in/out LED indicators) controls the Bypass mode for both channels.

Though the front panel looks simple enough, the markings on the control potentiometers can be somewhat deceiving. Looking at the pots, one might get the impression that the nonprocessed, "flat" setting would be with both controls set to the farthest counterclockwise position. However, this is only true for the BBE Process controls; the flat setting for the Low Contour knob is at the 12:00 position. This would be more obvious had BBE used center-indented pots or screened the panel with +/- markings. This is a minor point, but one that could cause confusion for some users.

The rear panel is simple, with electronically balanced XLR inputs and outputs (pin #2 hot), along with 1/4-inch TRS jacks. The 1/4-inch jacks are paralleled to the XLRs, with the sleeve connected to XLR pin #3, so there's no problem if standard, unbalanced 2-conductor, 1/4-inch connectors are used. Users with unbalanced systems should check out the BBE Model 462, which is similar to the Model 862 but substitutes unbalanced 1/4-inch and RCA connections. The attached AC cord is a 2- rather than 3-pin type.

According to the manufacturer, the BBE Process works by adjusting the phase relationships of the low, mid and high frequencies of the input signal. For example, by adding longer delay times to lower frequencies, the circuit claims to compensate for a speaker's natural tendency to delay higher frequencies. The process also adds high-frequency brilliance and boosts low frequencies through dynamic program-driven augmentation.

So much for theory. I was more interested in finding out how the 862 sounded, so—armed with a pile of favorite CDs—I began listening. And I liked what I heard. Listening on a variety of loudspeakers—JBL, KRK, Meyer, Tannoy, Yamaha and a few lesser-known names—I discovered that the BBE process provided a nice punch to older recordings without being brittle or shrill. The LF contour emphasized the bottom end, without adding undue boominess, as long as the control wasn't in the extreme position. A 10dB boost is pretty radical, but it's nice to have that extra margin when you need it.

In some cases, I wanted the LF effect to be sweepable, perhaps up in the 80Hz region, but, overall, the bass boost is a useful addition, par-

ticularly when the 862 is used as an in-line device to process program material. The 862 can be a real lifesaver when dealing with poor quality source material, whether it be in film/video or broadcast production, mastering or tape duplication chains.

In the recording studio, I generally used the 862 as a mixdown device to enhance individual tracks—such as acoustic instruments, drums or vocals—as well as sampled and synth sounds. My usual method is to use the 862 fed from a console send or direct patch feed and then bring the unit's outputs into board faders or effects returns, so I can sneak as much or as little BBE processing into the mix as required. In such cases the 862 can bring just enough HF sparkle to restore instrument clarity or increase vocal intelligibility—without appreciably adding level.

Five years ago when I reviewed the BBE 802, which retailed at \$499 (in 1987 dollars), I was sufficiently impressed with the unit that I bought it and have used it on easily more than 100 sessions since. Now BBE's Model 862 offers the same HF enhancement capability, along with bass contouring and improved metering. At \$599, this versatile audio device is worth checking out.

BBE Sound Inc., 5500 Bolsa Ave. #245, Huntington Beach, CA 92649; (714) 897-6766. ■

George Petersen lives with his wife and two musical dogs in a 110-year-old Victorian house on an island in San Francisco Bay.

DEMETER VTBP-201 TUBE BASS PREAMPLIFIER

by Glenn Letsch

Solid-state amps are popular with bass players. Their circuitry helps articulate the front of the note played, giving it a punchy, well-defined entrance. In a live-performance context, this helps prevent the bass from being lost against the other instruments, keeping it relatively percussive. However, once the note has arrived, solid-state amps often fail to provide a feeling of tonal warmth. A lack of aurally pleasing overtones becomes evident.

Enter the tube preamp, almost literally, in terms of a note's tonal development. Now you get the "blanket of sound," the "tonal floor" bassists have been searching for (which

—CONTINUED ON PAGE 158

FUTURE DISC SYSTEMS

10 YEARS

MASTERING STUDIOS
HOLLYWOOD, CA
213/876-8733
FAX 213/876-8143

HAMMER
TOM PETTY
LUTHER VANDROSS
GEORGE HARRISON
ICE-T
BOBBY BROWN
ALICE IN CHAINS
BEBE & CECE
WINANS
GEORGE MICHAEL
JANE'S ADDICTION
GEORGE HOWARD
BOYZ II MEN
QUEEN

NEW PRODUCTS

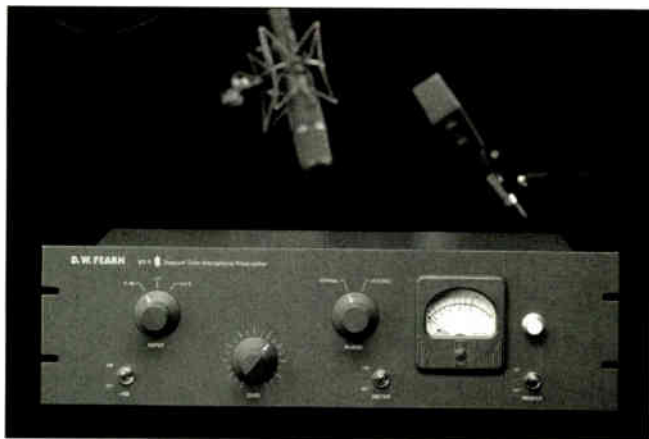

FEARN TUBE PREAMP

New from D.W. Fearn (Pocopson, PA) is the VT-1 Vacuum Tube Preamplifier, designed to re-create the warmth, clarity and presence of the classic tube preamps of the 1960s. The single-channel, three-rackspace unit retails at \$2,000 and includes switchable 48VDC phantom power, -20dB input pad, phase reverse switch and a large VU meter.

Circle #228 on Reader Service Card.

DENON PRO CASSETTE

Designed for professional use, the DN-720R is a dual-head machine featuring Denon's Amorphous Alloy Record/Play head for improved HF performance. Features include a real-time tape counter (accuracy is said to be ± 3 seconds per hour); $\pm 12\%$ pitch control; automatic selection for Types I, II and IV; and Dolby B, C and HX noise reduction.

Circle #230 on Reader Service Card.

ROLAND SRV-330 REVERB

The SRV-330 from Roland (Los Angeles) provides three-dimensional reverb at a list price of \$995. Emulating the effects of natural reverberation, the SRV-330 can generate up to 40 early reflections at up to 20 locations in a complete 3-D sound field; conventional reverb effects are available as well. Other features include 44.1kHz sampling rate, 30-bit internal processing, discrete stereo algorithms to facilitate independent stereo processing, +4dBm and -20dBm switchable I/O, 256 patch locations to store effects combinations, MIDI In/Out/Thru and three control jacks for real-time expression.

Circle #226 on Reader Service Card.

APOGEE AD DAT TAPE

Apogee Electronics (Santa Monica, CA) has contracted with NOV to produce the AD Series of DAT tape, which are designed for an error rate of less than 1 in 360,000 flux transitions. Embossed friction sheets maintain even tape wind, minimizing drag and edge damage for greater data integrity. In addition, new computer-designed hub clammers provide smooth packing, free of the errors caused by beginning- and end-of-tape dents created when tape rolls over conventional hubs. Shelf life is projected at 30 years.

Circle #227 on Reader Service Card.

SONY PERSONAL DATS

Sony introduces two new personal DAT products: the TCD-D7, a DAT recorder/player; and the WMD-DT1 DAT player. These new DAT Walkman units run on AC current, AA alkaline batteries (with up to four hours of battery life) or a 12V power supply. The TCD-D7 (\$629.95) features manual or automatic level control modes and can place a "time and date stamp" on individual recordings. The WMD-DT1 player (\$449.95) includes high-fidelity stereo earphones.

Circle #229 on Reader Service Card.

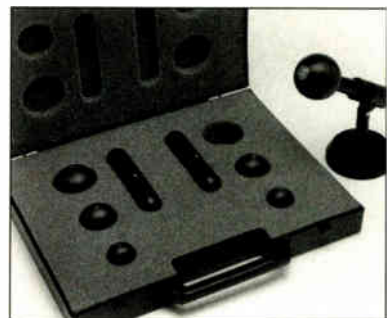

B&K APE ADAPTERS

For use with the 4003 and 4006 omnidirectional mics from Bruel & Kjaer (dist. in North America by TGI, Kitchener, Ontario), these new Acoustic Pressure Equalization adapters use diffraction technology to modify sound reception near the diaphragm, thus changing the microphone's frequency and polar response. The APE 30 and APE 40 increase directionality, starting at 2 kHz; the APE 30 delivers enhanced frequency response at 5.5-6 kHz, and the APE 40 at 4-5 kHz. The APE CYL has enhanced response at 500 Hz, 2 kHz and 4 kHz.

Circle #231 on Reader Service Card.





DIGITECH DHP-55 HARMONY PROCESSOR
 DigiTech's (Salt Lake City) DHP-55 is a five-part harmony processor. Its intelligent harmony is said to provide musically correct and natural-sounding chordal, scalar and chromatic harmony. A special algorithm allows chordal pitch shifting, and the unit recognizes chords from MIDI keyboards, allowing MIDI control of harmonies and effects. The dual DSP design allows each voice to be treated individually with effects; additional features include steel guitar harmony, 12-string/chordal shift, multiband chorus and flanging, 31-band digital EQ, distortion, detune, sampling, up to six seconds of delay, multitap delay, hold sample and repeat sample.

Circle #232 on Reader Service Card.

TEKTRONIX DIGITAL SCOPE

Tektronix (Beaverton, OR) announces the TDS 320, a 100MHz digital real-time oscilloscope for the service, education and design markets. Each channel digitizes input at a rate of 500 million times per second, eliminating the potential for aliasing of the input signal and boosting the single-shot bandwidth to the full analog bandwidth of the scope. At slower sweep speeds, a peak-detect acquisition mode enhances the ability to capture and display waveform activity. The TDS 320 also offers an intuitive interface, the choice of dot or vectored display, and an optional communications package for printing hard copy and downloading waveforms; list price is \$2,795.

Circle #233 on Reader Service Card.

dbx 760X MIC PREAMP

The 760X from dbx (dist. by AKG Acoustics, San Leandro, CA) offers two channels of preamp for studio and live recording applications. The circuitry is flat (+0/-0.15 dB) from 20-20k Hz, with a functional bandwidth of 2-200k Hz. Housed in a half-rack chassis, the 760X features gain trim, polarity reverse, 48V phantom power and overload indication at a list price of \$349, including rack-mount hardware.

Circle #234 on Reader Service Card.

SONY PRO MINIDISC

Designed as a replacement for the NAB audio cartridge are the new PMD-C1P MiniDisc Cart player and PMD-C1 player/recorder from Sony (Park Ridge, NJ). The units combine the large lighted-button, press-and-play functionality of standard carts with up to 74 minutes of near-CD-quality audio on low-cost 2.5-inch discs, programmable random access and an alphanumeric display of track names and numbers. The 6-inch-wide units are rack-mountable three across, and they offer balanced analog outputs (and inputs for the recorder) and parallel remote capabilities.

Circle #235 on Reader Service Card.

ALLEN & HEATH GS3V AUTOMATED CONSOLE

The new GS3V from Allen & Heath (Salt Lake City) is a VCA-automated version of the GS3 console. Automation controls all of the channel inputs (16, 24 or 32) and the master L/R signal path. Standard automation functions such as grouping and editing are included, as are programmable function keys and other special features. The console's internal computer provides true frame resolution on fader moves down to bit resolution on mute events, thus eliminating the limitations of MIDI resolution.

Circle #236 on Reader Service Card.

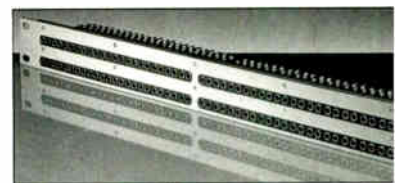

RE-AN CLASS 1 PATCH BAY

New from Re-an (Fairfield, NJ) is the Class 1 Patch Bay, offering 96-point patching in a TT (tiny telephone) format. The single-rackspace unit comprises Re-an's new Studio Jacks, with nylon spacers between adjacent connectors to prevent contact. Jacks are aligned in pairs on standard 8mm centers and are offset to provide a wider ID strip. The company also offers a line of TT patch cords in a variety of lengths.

Circle #237 on Reader Service Card.





MORENZ SA-200 AMP

Listing at \$795, the SA-200 from Morenz Development Corp. (Carlsbad, CA) uses pulse-width modulation to deliver 100 watts per channel into 4 or 8 ohms, with a frequency response of 20-30k Hz and THD of 0.1%. Inputs are XLR, 1/2-inch phone and phono, while output is via two binding posts. The dual-mono, half-rack unit weighs less than five pounds.

Circle #238 on Reader Service Card.

DRAWMER DL441

QMI (Natick, MA) announces the Drawmer DL441 Quad Auto Compressor/Limiter, providing four channels of the DL241 Auto Compressor and a variable peak level section in a single rackspace. The unit offers switchable hard/soft-knee compression with ratio control, auto attack and release, and peak level control adjustable between 0 dB and +16 dB. Inputs and outputs are balanced XLR, and operation is switchable for +4 dBu or -10 dBu.

Circle #239 on Reader Service Card.

AUDIO FACTOR MONITORS

The MX Series of studio reference monitors from Audio Factor (Fort Worth, TX) offer dynamic tweeter protection, frequency range of 40-22k Hz and high-power handling. The MX-860 features a 1-inch soft-dome tweeter and 6.5-inch low/mid driver;

the MX-460 includes the same components in a smaller, mirror-image cabinet. The MX-1080 has a 1-inch soft-dome tweeter and an 8-inch polygraphite woofer in a mirror-imaged cabinet. A dual 12-inch subwoofer completes the series. Priced from \$489/pair.

Circle #240 on Reader Service Card.



THE FIRST AUTOMATED MIXER THAT WAS COMPOSED, NOT IMPROVISED.

If you'd rather mix than mess around with a bunch of outboard boxes, we suggest a serious look at the new M-3700 Series from Tascam.

The M-3700 Series is a professional-quality mixing console with a perfect memory of its fader settings. A console whose automation isn't a pain in the pots. And whose under \$14,000 suggested retail price isn't either.

Ours is the only automated console that provides you with both *snapshot* automation (to recall any pre-set levels or switch positions stored as "scenes") and *dynamic* automation (to recall levels and switch positions locked to real-time locations).

The M-3700 also features an onboard disk drive; SMPTE timecode generator/reader; write/update mode; choice of 24- or 32-channel configuration; and the ability to automate the main, monitor and aux send mutes, and EQ ON/OFF for each channel. Without outboard computer screens, wires, mouses or the usual added-on hassles.

From us, you'll get a compact, familiar-looking system that'll help you create the mix you want. And precisely recall any previous mix, so you can tweak some channels without affecting others. All without wasting your valuable time or talent.

The musician-friendly M-3700 Series automated mixing console. Now waiting to wow you at your nearest Tascam dealer.

TASCAM®

© 1990 TEAC America, Inc., 7733 Telegraph Road, Montebello, CA 90640 213/726-0303.

USE READER SERVICE CARD FOR MORE INFO

World Radio History

ARRAKIS TRAK*STAR

For use with Arrakis' (Fort Collins, CO) digital audio workstations, the Trak*Star system is a family of single-function software applications designed for use with specific digital audio tasks; currently available are Trak*Star-2 and Trak*Star-8. Trak*Star-2 is an advanced 2-track digital cut-and-splice editor designed for long program edits (up to ten hours), while Trak*Star-8 is an 8-track digital mixer/editor designed for complex audio files such as radio spots, jingles and news programs. Future software packages will include a dedicated news workstation and a dedicated effects box for on-air use.

Circle #241 on Reader Service Card.

HOT OFF THE SHELF

The AI-2 is a companion synchronizer for the ADAT recording system. Designed by TimeLine, the AI-2 permits stand-alone operation of ADATs with Sony video editors, MIDI control devices and TimeLine's Lynx-2 and MicroLynx synchronizers, with SMPTE time code chase capability. Alesis: (310) 558-4530; TimeLine: (619) 727-3300...OTTO-1604 (\$799) offers real-time fader and muting MIDI automation for the Mackie CR-1604 16-channel mixer; OTTOmix, the companion software, allows mixer automation sequencing in conjunction with the user's sequencer. Call (800)

258-6883... "The Art of Home Recording and Music Production" is a new video illustrating basic techniques of multi-track and home audio recording. Written by Mark Healey, the tape features Spencer Davis and Joe Molland of Badfinger as moderators. Call (800) 728-0223, ext. 9928 to order... Solid State Logic's G3.2 software offers full mix compatibility with Ultimotion to G Series console users, as well as features like 15 software groups, inverse and offline cuts, insert mixing, Safe Replay status and non-integer tach rates. Contact SSL at (212) 315-1111... Machine Art Corporation's Compact Disc Identifica-

tion Kit permanently etches the user's name, state and driver's license number onto the center hub of CDs and jewel cases; (800) 231-6835... Studio Technologies StudioComm products add communications and monitoring functions to digital audio workstations. The group includes a rack-mounted central controller, a desktop control console and one or more portable talent amplifier units; call (708) 676-9177... Ampex 467 DATs are now available in 15-minute lengths for studio recording, available in shrink-wrap or the DATpak storage system. See your dealer or call (415) 367-3888. ■



A TALE OF Three Cities

Most of us began working with sound in the spawning ground of the clubs. Many bands and sound people early in their careers look toward moving out of the club circuit, while others opt to stay put, finding that the best aspects of club work are often lost in the transition to larger venues. And, in some ways, the club performance remains the ideal, as countless arena and stadium sound mixers say they attempt to “re-create that intimacy” in the most unclublike of venues.

This issue takes a slice of '93 club life as we check out three unique clubs across the country. So get up to your board! Doors are opening, and the band's coming on.



TIPITINA'S
Professor Longhair
Lives on at New Orleans'
Legendary Nightclub
by Jeff Forlenza

On a typical night, Tipitina's is packed and sultry; the sound pumping out of the P.A. permeates every living thing in the house, from those buying Tipitina's merchandise at the front entrance downstairs to the V.I.P.s in the roped-off section upstairs. This world-renowned, almost mystical club in New Orleans rocks.

You walk in the front door at Tip-



PHOTO: SYDNEY BYRD

Eek-A-Mouse onstage at Tipitina's

Tipitina's, and you're confronted with a life-sized bust of Professor Longhair, a.k.a. Henry Roeland Byrd, the venerated pianist and godfather of Crescent City funk. "Fess" was one of the primary owners of Tip's, which opened in 1977 to give him and the teeming local talent a regular venue to perform in. More than 15 years later, Fess is gone, but his spirit—and his music—lives on in the club named after one of his songs.

Sonny Scheidau, sound man for Fess as well as one of the original owners of Tipitina's, presently serves as talent buyer, production manager and FOH sound engineer, although

he's no longer an owner of the club. "Fess used to perform regularly at the club," Scheidau says of the early days. The club fell into hard times after Professor Longhair passed away in 1981. "We closed in mid-'84, because the original corporation that opened the club, which included Fess and myself, went bankrupt. The club sat dormant for a while, until the present owner, James Green, started it up again, renovated the building and reopened in January of '86."

Hired for the acoustic design of the renovated room was Sherman Bernard, CEO of New Orleans' Bernard Productions, a regional sound

reinforcement and gear rental company. "What we did was put a perforated type of metal on every available wall space," Bernard explains. "This tinlike, corrugated metal has hundreds and hundreds of little holes in it. Underneath the metal is soundboard and Fiberglas. It does two things: It allows all the lower midrange and bass frequencies to penetrate through, and all the upper midrange and high frequencies are diffused by the irregular shape. So we took advantage of the room size by diffusing the sound, and all the lower frequencies that are too large to be reflected actually go through

GOODMAN MUSIC

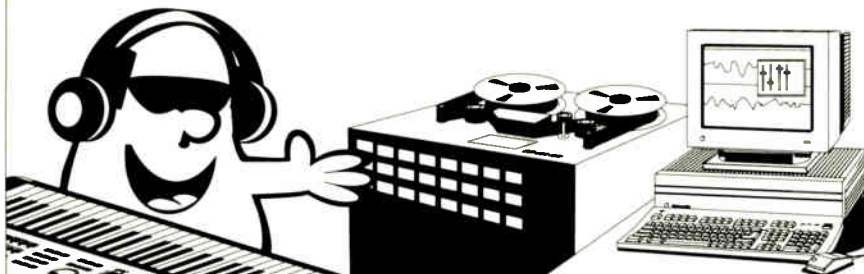

Keyboards • Computers • Pro Audio
Digital Recording, MIDI Software
Synthesizers, Workstations, Samplers
Pro DAT's, Recordable CD, Multitrack
CALL 1-800-842-4777

UNIVERSAL CITY
 3501 Cahuenga Blvd. W
 (Lankershim exit off
 Hwd. Fwy. turn left)
 (213)845-1145
 (818)760-4430

WEST SIDE
 4204 S. Sepulveda Blvd
 (Culver exit
 off 405 Fwy.)
 (310)558-5500

SHERMAN OAKS
 4631 Van Nuys Blvd
 (2 Blocks N. of
 Ventura Blvd)
 (818)784-6900

WEST COVINA
 544 Azusa Ave
 (1 Block North of
 the 10 Fwy.)
 (818)967-5767

ANAHEIM
 1676 W Lincoln Ave
 (Corner of Lincoln
 and Euclid)
 (714)520-4500

MC, VISA, AMEX, OPTIMA, DISCOVER, DINERS, CARTE BLANCHE, APPLE & ROLAND CREDIT

USE READER SERVICE CARD FOR MORE INFO

CLUB SOUND

the porous holes and are absorbed."

Bernard Productions was also contracted by Tipitina's to supply a sound system. "We have a sound system that we rent from Bernard," Scheidau says. "It's a Soundcraft 600 console out front with 32 channels. At the side of the stage, we have a Yamaha 2408 with eight available mixes as monitor console. The speaker configuration is eight Earthquake 18-inch cabinets, four JBL 15-inches with Perkins cabinets and four JBL 2-inch horns in Renkus-Heinz boxes. We have Biamp wedges with 15-inches and horns onstage."

Of note are the "Earthquake" speakers: Cerwin-Vega built these bass-heavy boxes for Universal Studios and their earthquake movies. Tipitina's uses them to seismically shake the house with solid bass response for reggae and R&B acts. The Earthquakes are stacked in groups of four on each side of the stage.

"We're using all Peavey components in the monitors," Bernard continues. "In the front of the house we're using the Earthquake speakers for lower frequencies. The midrange is JBL speakers, and the horns are Renkus-Heinz. And there's a 32-channel snake, a transformerized split [to feed house and monitor consoles from the stage].

"We rent them effects as well," he adds. "[They have] a REV7, an SPX 900, an SPX 90II, a Roland SDE-1000, a dbx 903 limiter, Gatex gates. They also have your basic mics: Shure SM57s and 58s, a couple of condensers and a kick drum mic. Nothing fancy"

Tipitina's sound system may not be anything fancy or state-of-the-art, but it is well-maintained and constantly updated by the Bernard staff. Besides, many an act will book the room on its mystique and history alone. "There might be 12 to 15 dates in a year where the acts will be carrying production and their own engineer, and we'll go ahead and use their stuff," explains Scheidau.

Recent club openings in New Orleans include the 1,500-person-capacity New Orleans Music Hall and other smaller venues. But Tipitina's —with a maximum capacity of 1,000 —is still *the* club to catch music in New Orleans.

"Yes, the competition has increased," Scheidau admits, "but it

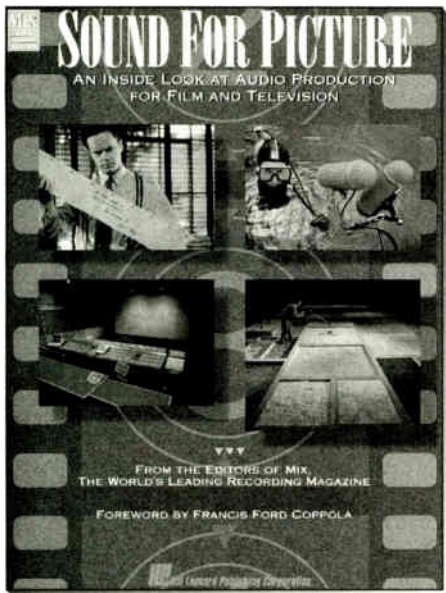

.....
New Book
On
"Hollywood"
Sound

I will take you behind the scenes as top sound professionals reveal how dialog, sound effects and musical scores are recorded, edited and assembled into seamless soundtracks. Exclusive case studies spotlight blackbusters like *Terminator 2*, *Malcolm X*, *Beauty and The Beast*, *Twin Peaks*, *The Simpsons*, *Northern Exposure* and many others. Includes coverage of the history, technology and psychology of contemporary soundtrack work.

SOUND FOR PICTURE: An Inside Look at Audio Production for Film and Television. From the editors of *Mix*. © 1993, 134 pp. (P) Includes glossary.

Only \$17.95 (plus shipping)

ORDER NOW! Call toll-free (800) 233-9604, (510) 653-3307, Fax (510) 653-3609 or write to Mix Bookshelf, 6400 Hollis St., #12-F, Emeryville, CA 94608. Include \$3 for shipping. Please allow 3-4 weeks for delivery. CA and NY residents please add state sales tax. Also, request a **FREE** copy of our new catalog that features over 500 instructional books and videos for music professionals.

hasn't really affected us. There's no other club that's our size. And because of our split-level design, we can accommodate a lot of different acts. We can do a show that has an audience of 300 or 400 and just open the downstairs, and it'll look like a decent house. And we have the ability to open the balcony and bring it out to 1,000."

Scheidau counts himself blessed to be a part of Tipitina's and the memory of Professor Longhair. Working with the varied acts who come from all over the planet to play the legendary club as well as presenting the best of local talent to international audiences that descend upon New Orleans during Mardi Gras and Jazz Festival, Scheidau has kept delightfully busy.

"I really enjoy my work," Scheidau says. "We do so many different kinds of music it's great. But for me, the ultimate Tipitina's experience is the Neville Brothers at Tip's."

THE GRIZZLY ROSE Denver's Premier Venue for Country-Western Music

by Karen Mitchell



PHOTO BREWMAN LINSLEY

Above: Chris LeDoux onstage at the Grizzly Rose

No one is more satisfied with the newly leased, distributed sound system at the Grizzly Rose Saloon and Dance Emporium than Kevin Beckham. Beckham has been the production manager/house engineer at the club for over two years. As the premier venue for Denver's country-western mu-

sic scene, The Grizzly is often frequented by touring country acts. Willie Nelson, Waylon Jennings and Chris LeDoux all played the club last winter.

The high-visibility dance hall, facing Interstate 25, is also a favorite stage for local and regional dance bands that draw two-stepping, line-dancing crowds from all over northern Colorado and beyond.

"We need to have a house system because of our irregular size," says Beckham. "We're one of the larger country clubs—approximately 30,000 square feet—although we're smaller

than Billy Bob's in Texas."

The Grizzly is asymmetrical: an L-shaped room in which the stage is not centered in the seating area. The bar is off to one side of the room, and along the rear periphery of the club there is a "street" of faux western shops where customers can order chicken-fried steak, get their boots shined or buy a designer cowboy shirt just like the one Garth Brooks wears on his album cover (leaving their street clothes in a bag behind the counter for the evening).

"When I first came here, we were using a stacked P.A. system," Beck-

C:MAX Wearable Monitor Systems



- Choose between wireless and hardwired versions
- Control your own listening volume and stereo environment
- Protect your hearing
- Universal ear pieces — no special custom molding required
- Lowers stage volumes and *eliminates feedback*
- No more heavy amp racks and speakers — reduces truck space
- Our wireless systems are FCC licensed

CMCI Systems are designed by RF experts, live mixing professionals, and leading audiologists, and use the patent pending C:MAX™ psychoacoustic stereo environment.

Leading the Way in Monitoring Technology



Circuits Maximus Company, Inc.

9017-B Mendenhall Court
Columbia, MD 21045
Phone: (410) 381-7970
Fax: (410) 381-5025

© CMCI 1992. C:MAX and CMCI are service marks of Circuits Maximus Company, Inc.

USE READER SERVICE CARD FOR MORE INFO

Kdisc mastering
 5550 Sunset Blvd., Hollywood, California 90028 • (213) 466-1323 • FAX (213) 466-7237

COMPLETE MASTERING SERVICES
DIGITAL AND ANALOG
CD, CASSETTE, VINYL

USE READER SERVICE CARD FOR MORE INFO

CELEBRATING
40
YEARS OF SERVICE
 1953-1993

Boynton Studio

Wants to know,
"Are you ready for digital recording?"



It's hot. It's affordable and it's in stock.
 The long awaited **TASCAM DA-88.**

your full service pro audio dealer

Melody Pines Farm • Morris, NY 13808

Phone (607) 263-5695

Fax (607) 263-2373

Hear Yesterday, Today and Tomorrow



CLUB SOUND

ham says. "We encountered constant complaining about volume from the people sitting close to the stacks. In order to create coverage and clarity, we had to push it really hard, especially at the mix position. People in closer took the brunt. Engineers coming through were not happy either. They had to drive too hard, or they were radically EQing to get the mix they wanted."

Beckham says the complaints have dwindled since the Grizzly leased a house system from Audio Analysts USA Inc. of Colorado Springs late last year. "The basic issue at the Grizzly Rose was its asymmetry," says Albert Leccese, Audio Analysts' vice president of engineering. "The stage right side is only 20 feet wide, [but the] stage left is 100 feet wide. The sound system was set up like it was for a small theater or small club with stacks of P.A. left and right. Patrons were sitting literally one to two feet away from a couple of big stacks. To get sound at the back end of the L-shape, the sound had to be really loud at the front of the bar, and the bar people couldn't hear the drink orders."

Audio Analysts' solution was to put in a high-power distributed system, augmented with subwoofers. "That way you can get real good mid-high information clearly throughout the club and let the subwoofers kick in to suit the low-frequency needs of whatever artist is playing there," Leccese explains.

The system was designed using six zones throughout the room, each with its own level adjustment and equalization, as well as delays for the zones farthest from the stage. All the cabinets used in the installation are of Audio Analysts' design. Six boxes cover the dance floor with ten more delayed enclosures spread over the audience seating area. All loudspeakers are suspended from the roof grid, except the two subwoofers at each side of the stage.

Before the system could be installed, the Grizzly Rose's stage area had to be acoustically treated, due to a number of midrange problems. "There was a low, metal roof," Leccese says. "Wedges on the stage would fire up into the ceiling and the lead vocal 'edge' would bounce back to the drummer. The stage wasn't stiff

enough, and there were resonance and reflection problems."

At Leccese's suggestion the club installed two-inch Owens Corning insulation on the ceiling walls above the stage as well as baffles beneath the stage to break up standing waves. "We also stiffened the stage floor," Leccese adds. "They laid a couple of sheets of plywood on top of the stage to get rid of some of the resonances."

"It's a strange concept not to have a stack of speakers left and right," he says. "In a normal linear seating area it would be fine, but at the Grizzly it didn't work. We're not talking about a heavy metal club. Everybody needs to hear well. Vocals are of importance. You have to sit down and listen to this system—it's unconventional, but it works really well."

Engineers seem to like working with the Grizzly's updated system. Joe Clark, Chris LeDoux's soundman for about nine years, has worked the club more than half a dozen times and was especially pleased by the new Yamaha PM3000 he found during his visit in January.

"This is a great console to have in a place like this. My objective is to get everything as clear as possible and as loud as 100-110 dB in the room," says Clark, who admits his Saddle Boogie Band is louder than most. "We're just a refined garage band that's good 'n' loud, [and this system] is very punchy and powerful."

Maybe Mark Sissel, LeDoux's road manager and Saddle Boogie guitar player, says it best: "This is like honky tonkin' with full-fledged equipment."

WEBSTER HALL **New York City's Multilevel** **"Four-in-one" Club** by Maria Conforti

Schmoozing, raving, boogieing and jamming all come together under one roof at Webster Hall. The multilevel downtown New York club, which opened late last year, marks the first time Canadian club owners Stephen, Lon, Peter and Douglas Ballinger have ventured into the Manhattan market. The brothers already own five clubs in the Toronto area, so they know what they like.

So does audio engineer and designer Peter Lima of Sound Dymax (Mississauga, Ontario, Canada), who

**Schmoozing,
raving, boogieing
and jamming all
come together
under one roof at
Webster Hall.**

worked on previous Ballinger club projects. This time, his emphasis was on maintaining the clubs' split personalities, thus rendering Webster Hall four clubs in one.

The club's basement V.I.P. lounge has a low ambient sound level, with very few speakers. The emphasis there is on bar schmoozing and intimate performances. Equipment includes two EV MTL-2 sub-bass enclosures and four 1503 full-range speakers. Two EV floor monitors are also available, as well as Rane GQ-30 and MQ-15 graphics, AC-22 two-way crossovers, DC-24 compressor/

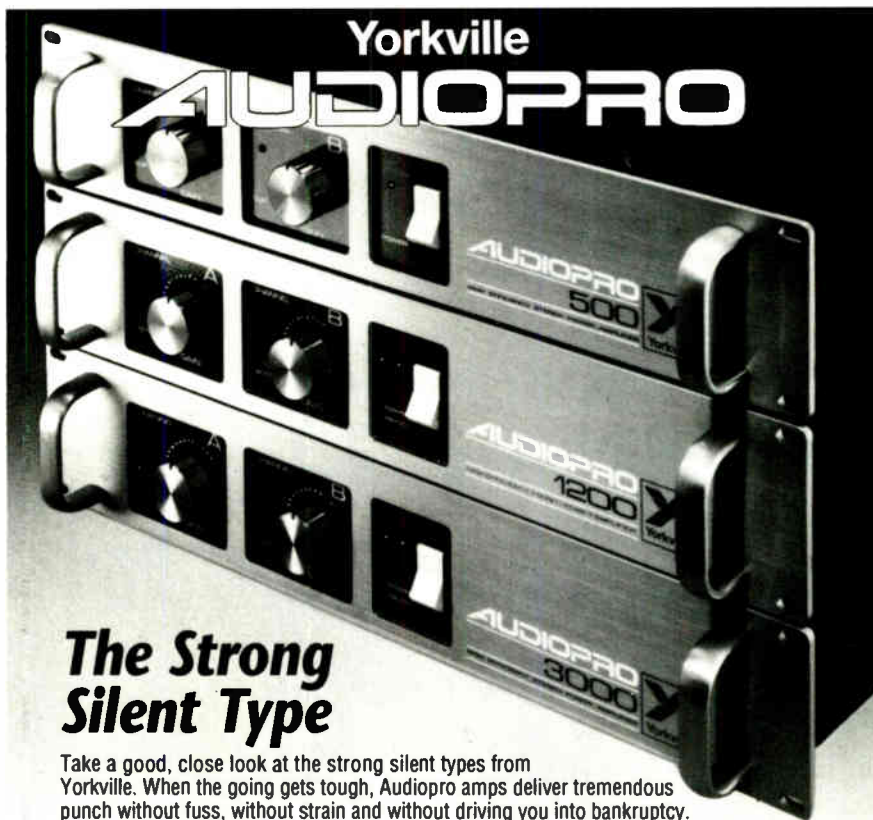

Yorkville
AUDIOPRO

The Strong Silent Type

Take a good, close look at the strong silent types from Yorkville. When the going gets tough, Audiopro amps deliver tremendous punch without fuss, without strain and without driving you into bankruptcy.

In the middleweight category the AP1200 has several innovative features such as a switchable sub-sonic filter and switchable internal limiters that manage the gain for maximum dynamic range. The limiters automatically prevent audible clipping while allowing the transient spikes through unaffected. If this looks interesting on paper, wait till you hear what it sounds like! You can even have the AP1200 configured to deliver its maximum power into either 2 ohms or 4 ohms. The AP1200 delivers 1300 watts* of solid, clean power for the full 12 rounds, night after night, with complete reliability and uncompromised fidelity.

With 500, 1300 or 2400 watt models, there's an Audiopro Amp to suit your needs and budget. See and hear them at your dealer soon and, oh yes, bring your checkbook. You're going to like what you hear.

*Continuous Average Power Bridged into 4 ohms

YORKVILLE SOUND LTD.
80 Midwest Road
Scarborough, Ontario
M1P 4R2



YORKVILLE SOUND INC.
4600 Wilmer Industrial Estate, Unit #1
Niagara Falls, New York
14305

AUDIOPRO PULSE Micromix STAGE elite BETA

USE READER SERVICE CARD FOR MORE INFO

CLUB SOUND

limiters and Crown amps.

The small ballroom on the middle floor re-creates the '70s-to-early-'80s dance era. "Its sound has a little hard edge to it," Lima states. "The sound system is stacked from the ground up and has the 'bulk' look of the touring '70s." This system is entirely component-based, starting with the mainstay of a bygone era, eight folded-horn bass bins with Gauss 18-inches and moving up through EV bass, mid-high and su-

per-tweeter drivers, all mounted in individual stacked enclosures. Rane processing and amplification are also used.

"Upstairs [the main ballroom] is the industrial nightclub," Lima continues. "It is supposed to [handle everything] from rave to industrial to house, and also support live [headline] entertainment." Here the equipment includes eight EV MTL4P bass cabinets and a collection of EV component drivers, including TL606DW lows, DH1A 2-inch mid-high compression drivers, as well as EV super tweeters, both mounted on constant directivity

horns. Rane equalizers, limiters, cross-overs and DJ mixer are used, driving a variety of Crown amps, including MA600s, 1200s, 2400s and 3600 VZs. A pair of EV S1503 full-range cabinets are used as stage fill for live acts.

The balcony lounge area, originally slated for very light background sound as an alternative to the main ballroom, now has live capacity as well. Two MTH-2 mid-high enclosures are flown in pairs as a balcony fill system. They are also used to supplement live systems brought in by various acts.

The structure—most recently home to the Ritz before that entity moved to Midtown—dates back to the 1800s, and it presented some problems for the install. "The isolation was kind of difficult," Lima says, "because the floor at any point can deflect about half an inch to three quarters of an inch when you have 2,000 people on it. The balcony had to be very secure [against] vibrations. The rigging points over the stage [leftovers from the Ritz] were fairly good.

"Because of all the wood in the club, the system is very soft-sounding," Lima says. The man said *soft*, mind you, not wimpy: Lima "dusted the place" when he first cranked up Webster Hall's new system. "There is still an old model mirror ball there that turns in five different directions," he says. "The first day we fired up the system, I think about 40 pieces of glass fell off the monolith from all the bass vibration, and it was snowing inside for days."

The Ballingers prefer elevated, windowed DJ booths in their clubs, because they want the party animals in the club to see the DJ performing. "The construction was an isolation construction, and even with that, the floor still deflected. So we further suspended the turntables," Lima says.

Since Webster Hall opened, the neighbors haven't been sleeping as well as they used to, resulting in some ongoing fine-tuning. "They're putting some sound-absorption material in the front, and closed off and insulated some doors," explains Lima. "They're addressing the roof and the rigging cavity on stage, because the rear neighbors are complaining. There are eight EV MT4Ls on the dance floor now, powered by eight Crown VZ 3600s. Quite an SPL level can be created on the dance floor, and the sympathetic vibrations are what the neighbors are complaining about." ■

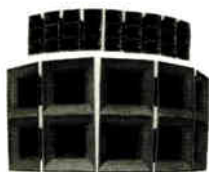

**Meet The Only Team
Powerful Enough To Play
Yankee Stadium, The Astrodome
The Georgia Dome, The Orange Bowl
& Sheffield Arena.**



Power That Will Blow You Away.



PROFESSIONAL SOUND SYSTEMS

1 - 8 0 0 - 2 9 2 - 1 1 6 5

(FAX 215 - 874 - 0190)

WRITE: COMMUNITY, 333 EAST FIFTH ST., CHESTER, PA, USA 19013

USE READER SERVICE CARD FOR MORE INFO

SOUND REINFORCEMENT NEW PRODUCTS

YORKVILLE PERFORMANCE SERIES

New from Yorkville (Niagara Falls, NY) are the IS-112F and IS-115F, two-way 12- and 15-inch enclosures with pan fittings that enable them to hang easily. The speakers are designed to blend with natural surroundings in places of worship, theaters and the like, with an oak veneer and cloth grilles. The IS-112F and IS-115F share many features and components with Yorkville's Pulse and YS Series, and list for \$399 and \$499, respectively.

Circle #212 on Reader Service Card

**JUICE GOOSE 'ZILLA 8LM**

Juice Goose (Houston, TX) is now shipping the 'Zilla 8LM, a ten-amp power distribution device retailing for \$189. The 8LM has eight switched AC power outlets and pull-out dimmable lights, plus a meter monitoring incoming voltage between 90 and 130 volts; 20 rectangular LEDs are color-coded to indicate safe (green), marginal (yellow) and dangerous (red) levels of incoming voltage.

Circle #213 on Reader Service Card

FENDER SPL TOUR SERIES

Fender's new series of professional live sound products kicks off with a group of loudspeakers including the SPL-2912 (12-inch woofer and 1-inch exit horn), SPL-2915 (15-inch woofer and 1-inch horn), SPL-118S (18-inch subwoofer) and SPL-215S (two 15-inch woofers). Short-term power-handling specs are 400 watts, 500 watts, 600 watts and 1,400 watts, respectively. All except the 215S are trapezoidal, facilitating use in arrays, and all are compatible with Fender's RigSafe system, ATM Flyware and JBL's S.A.F.E. system. Two Neutrik NL-4 connectors and two high-current ¼-inch phone jacks provide input for the enclosures.

Circle #214 on Reader Service Card

**CROWN CM-311**

The CM-311 is a head-worn microphone with a pickup pattern similar to that of the CM-310 Diferoid handheld mic and is said to offer superior noise cancelling and superb isolation of high-level stage instrument sound. A unique behind-the-ear design and headband provide a tight fit without obscuring the performer's face, while the belt pack provides XLR and ¼-inch phone jacks for output to mixers or wireless transmitters. The CM-311 has both the microphone and battery pack, while the CM-311/E includes only the microphone unit.

Circle #215 on Reader Service Card

YAMAHA GQ2015 GRAPHIC EQUALIZER

Yamaha's (Buena Park, CA) GQ2015 is a two-third-octave graphic EQ for installations or touring sound. The one-rack-space unit is said to have THD of less than 0.05% and noise level below -94 dB. Features include an 80Hz highpass filter; 15 bands of EQ; range switches to select ± 6 or ± 12 dB cut/boost, and balanced XLR and unbalanced ¼-inch inputs/outputs.

Circle #216 on Reader Service Card





Monitor mixer
John Oster
(left) and FOH
mixer Rob
Mailman

Lindsey Buckingham

OUT OF THE CRADLE AND INTO THE CLUBS



by David (Rudy) Trubitt

"I had been wanting to try something larger for a while," explains guitarist/singer/songwriter Lindsey Buckingham. "Something that went beyond what people normally would try to do. On records [including his latest, *Out of the Cradle*], there are a lot of levels of orchestration that most people would opt to pare down onstage."

But rather than trim parts, Buckingham chose to use ten musicians, including four additional guitarists (two male, two female). "The challenge is to keep it from sounding like mush," he cautions. "On a lot of songs you have people waiting to come in for something very specific and then dropping out again. A lot of people said that it wouldn't

PERFORMER

Lindsey Buckingham

VENUE

Bimbo's 365 Club

San Francisco

March 10, 1993

SOUND COMPANY

Sound Image

FOH MIXER

Rob Mailman

MONITOR MIXER

John Oster

SYSTEM TECH

Brent Britto

work, but this is great. All the parts can be realized by a band of this size, which never would have been done in a million years in Fleetwood Mac [his former band].

"The other reason for having this many people," Buckingham

Choose a fully functional, pre-configured GDM (Graphic Display Module) for any IQ System component.

IQ Turbo more than doubles the speed of previous releases. Plus, it's high-speed network compatible.

Multi-Link lets you sort and group amplifier channels according to your criteria.

Dynamic objects let you decide how to control any feature of any component.

Build detailed representations of any device with fully functional monitoring and control features.

Add Module

- Text
- Button
- Pot
- Bar Meter
- LED
- Graphic Display
- Container

Okay Cancel

HOW TO BOOST YOUR IQ.

(And have fun doing it!)

Introducing Turbo 1.0, the new high-speed control software for Crown's IQ System. It's fast—more than twice the speed of previous releases. And now, it's the easiest, most user-friendly software ever developed for controlling an audio system.

IQ Turbo is designed to give you exactly what you want in your system because you design the interface you want. Using simple tools, you can create anything from a simple on/off button in your choice of colors to a

full-color screen with fully functional representations of every system component.

Equally at home in a small church system or a touring rock extravaganza, Turbo lets you monitor and control every feature of every component in real time. And with outstanding new capabilities such as Multi-Link, you have even more options in managing your system. Plus, IQ Turbo is designed for compatibility with current and future

high-speed networking options.

Best of all, the power of Turbo software is so easily configured that it actually becomes fun!

For more information on IQ Turbo or other Crown IQ System software and components, call us toll-free: 1-800-535-6289.

 **CROWN**
Guaranteed Excellence

Join the growing list of top manufacturers with IQ-compatible equipment. Crown's IQ System is now open for licensing agreements.

Metallica - 1992 North American Tour - dB Sound, Des Plaines, Illinois

Since their debut five years ago, Electro-Voice **MT-4** and **MT-2 concert systems** have become the most popular "off-the-shelf" touring cabinets in the world. It's easy to see why.

EV's patented **Manifold Technology**[®] design provides a superb combination of high output and wide-bandwidth sound from a modular package that's easily stacked or flown.

Around the world, Electro-Voice MT systems are the choice of

FLY FIRST CLASS

Simply Red - 1992 European Tour - SSE Hire, Birmingham, England

performing professionals. Contact us at

800/234-6831 for information on how you can join the ranks of first-class sound companies worldwide.*



USE READER SERVICE CARD FOR MORE INFO

Electro-Voice 600 Cecil Street Buchanan, Michigan 49107 616/695-6831 In Canada: 613/382-2141

continues, "is that you can double up on three- or four-part [vocal] harmonies. When you've got seven people singing at once, you get a lot of strength. And it's a concept that nobody's really doing, and that in itself appeals to me."

Front-of-house duties fall to Rob Mailman of Sound Image of San Marcos, Calif. (Mailman has been with the company since 1985; his last major tour was with the Indigo Girls.) "It's been working pretty well," Mailman explains, "but it's quite a chore keeping up with five guitar players. With all that material in the same

**MIC HIGHLIGHTS FOR
BUCKINGHAM'S BIMBO'S GIG**

VOCALS

Beyer M88, 500

CONGA, BONGO

EV N/D 408

GUITAR AMPS, TIMBALES

Shure SM57

ROTO-TOMS

Shure Beta 57

PERCUSSION OVERHEADS

AKG 452

bandwidth, there are a lot of separation and placement problems, especially when two people are playing the same part.

"Originally," he continues, "everybody was going direct, with no amplification onstage. It was a great place to start, but it wasn't working well for them, particularly on the Fleetwood Mac material that was more rock 'n' roll-oriented. We're using fairly small amps, but they pack a lot of punch. Even though we went with amps, everybody still is DI'd. On people who are playing leads, I mix the DI and mic. Lindsey, in particular, I blend the whole night.

"The DIs are all Countryman," Mailman adds, "which are very standard and reliable, although not necessarily the best in the world. We use a stand-up bass [on two tunes], and, on one of those, Lindsey uses a ukulele and one of the women plays a man-

dolin. With that in mind, I needed a good, reliable active DI."

In addition to the wall of guitars, the band includes three percussionists. Originally, no trap set was planned, although a basic kick/snare/hat set evolved in rehearsals. The percussion community's close proximity to guitar amps created the potential for leakage problems. "We do baffle (with clear Plexiglas) right behind the guitar line," says Mailman. "because we have so many open percussion mics and open-

back guitar amplifiers up there."

The tour is carrying a 24-box Phase Loc rig, Sound Image's active five-way JBL and TAD-loaded loudspeaker system. A modified BSS unit is used as the system crossover. Sound Image uses QSC amps exclusively, although the company is presently engaged in development of new cabinet, crossover and processing configurations. As a result they are also evaluating amps from other manufacturers, using their existing QSC amps as the

Hard Disk Recording Tips

by Digital Audio Labs

"I use The EdDitor™ whenever I need to assemble life-like sound effects."

"On one project a client needed a street scene with a little boy selling newspapers on the corner. We used an existing street noise sample, looped it a few times, and then mixed in some siren samples, a couple more automobile samples, and a very low volume subway sample. We had one sample left to mix in and that was the paperboy. So we brought in a 10-year-old brother of one of the clients to do the voice. We recorded the voice slightly off to the left in the stereo mix for all of the vocal part, except for when the paperboy offered a paper to someone walking down the street. For the last vocal part of the paperboy we recorded his voice almost extreme left (about 8 o'clock on the pan pot) as if he turned his head to the right (our angle of view as straight on facing the paperboy and on the opposite side of the street). The hardest part was trying to find the proper volume for the voice. But with The EdDitor's non-destructive editing, it only took seconds to undo the last mix, and try again at a different level. Soon we found the right level, and the result was very life-like. It sounded great!"



Local groups love to use Electro-Sound for their CD projects. The CardD System helps Greg make great sounding recordings, and for studio fees so reasonable they'll surprise you.

The CardD System, by Digital Audio Labs.

The CardD.....	\$795
Stereo audio card for IBM AT compatibles.	
The EdDitor for Windows.....	\$250
Stereo waveform editor program.	
The I/O CardD.....	\$295
Optional companion card for digital (S/PDIF) in/out.	

Digital AUDIO LABS

14505 21st Ave. No., Suite 202
Plymouth, MN 55447
(612) 473-7626 FAX (612) 473-7915

"The best sound effects library is The Hollywood Edge — without a doubt!"

Oliver Stone, Director

(J.F.K., Born on the Fourth of July, Platoon)

"Excellent!"

Martin Scorsese, Director

(Cape Fear, GoodFella's, Raging Bull, Taxi Driver)

"Nothing else even comes close!"

Shadoe Stevens

(American Top Forty)

Hot off the press!!!

Ask us about CARTOON TRAX.

Listen for yourself-

If you buy sound effects for your company, call us for a

FREE DEMO DISC!

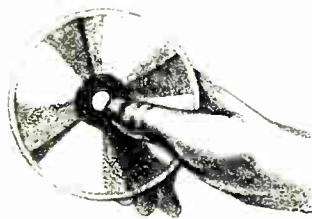

Call Toll Free

800-292-3755

In CA Call

213-466-6723

The
HOLLYWOOD
Edge

7060 Hollywood Blvd. • Hollywood, CA 90028

USE READER SERVICE CARD FOR MORE INFO

LIVE SOUND

benchmark.

"I haven't worked in most of these venues before," explains Mailman. "So, when I walk in, I generally take a look around, see what's available to me in the house PA. That plus seating and sightlines dictate how much [of my own] PA. I'm going to bring in. I try to make the best call possible without getting too overbearing, but without leaving myself short. We do play at quite an appreciable SPL. Lindsey's a little bit adamant—he really wants you to feel it."

At the Bimbo's gig, the club's system included six Meyer UPAs in left-center-right pairs, 650 subs and two small EAW cabinets installed as delay fills in the back of the room. Bimbo's house sound man, Kirk Schreio, took a vocal-only feed for this system. Mailman brought in one Phase Loc stack per side, each comprising two high-mid and two bass cabinets, although in larger venues the ratio of high to low boxes is somewhat higher.

When it comes to mixing, "We are re-creating [the records] pretty close," Mailman says. "As far as the processing and ambience, I have a pretty free hand. A lot of times, [room] environments dictate how much you can do there. But as far as the placement of things in the mix, it's real close to the record, because [Lindsey's] very specific about where he wants little pieces placed and how it's knitted together."

Buckingham regularly spends some soundcheck time at the FOH. "We have a couple of tunes that seem to be our focal points," explains Buckingham, "ones that are so conceptual that they tend to be the most problematic, as well as varying the most from room to room. 'Don't Look Down' is one of those. It fits together like a jigsaw, and its impact hinges on the level of things in relationship to each other, [such as] the vocals coming in loud enough. Certain things have to be really close to being right, at least in my mind, for it to come off."

"I work with cue cards all night long," Mailman adds, "because of all the different instrumentation. The set builds and falls twice. It starts out with Lindsey doing a couple of solo acoustic things. Then the band comes out, and it builds through some Fleetwood stuff. After it gets really hot and heavy, it drops off again for another couple of acoustic things [before coming up for the finale]. Through all that there are a lot of fader moves going on."

The tour is carrying a Midas XL-3, although Mailman admits to mixed feelings about the board. "On the last leg," he explains, "I started out with a PM-4000, which is a real nice, friendly board. As far as routing, user-friendliness and terminology, the XL-3 has shortcomings, although I've been able to work around [most of them]. I've had contact with Midas, and they're hopefully going to send me a modified master module [to address] the things that I wasn't able to get around." High on his request list was the ability to preview the main stereo mix in the phones with automatic solo override. Mailman also feels that "there's a lot of wasted real estate in the matrix," adding that he has found no use for it as currently implemented. "But sonically," he adds, "it's a pretty superior-sounding board, and I can live with most of the shortcomings, especially with a view [toward its continued evolution]."

"Processing wise," he continues, "I'm using typical stuff, REV5, SPX900, the new Sony R-7, which is a real nice-sounding unit. I don't do a lot of gating or compressing. I use compression on Lindsey's vocal, the bass and the keys, but none of the back-up vocals. I come from the school where the less processing, the better. It keeps things cleaner, and I don't really need it with this particular act."

At the controls of the Ramsa WRS-840 monitor desk is John Oster, another longtime Sound Image staffer. Oster runs ten mixes, one for each player. The

—CONTINUED ON PAGE 158

AN INVITATION TO KARL WALLINGER'S WORLD PARTY

Chances are you haven't heard much about World Party or the British group's driving force, Karl Wallinger. (In fact, one could convincingly argue that Wallinger *is* World Party.) Aside from the song "Ship of Fools" from WP's 1987 debut album, *Private Revolution*, not much of Wallinger's music has made it onto U.S. radio. That's a shame. Wallinger is making some of the best-sounding and most interesting rock records around.

World Party's second album, *Goodbye Jumbo*, was easily my favorite

album of 1990, and the just-released follow-up (there was an EP in between), called *Bang!*, is another sparkling breath of fresh air—a remarkable potpourri of styles, rhythms and textures that are so imaginatively put together it'll make your head spin. Underlying Wallinger's hodge-podge of apparent influences, ranging from the Beatles and Beach Boys to the Stones and Stevie Wonder, is a clear artistic vision that is utterly unique. Wallinger's songs are both socially conscious and more than a little ec-



PHOTO: LORENZO AGUI

Karl Wallinger

centric, yet they also work in classic pop formulaic ways—just like many of the pop oddities

—CONTINUED ON PAGE 113

PAUL RODGERS' TRIBUTE TO MUDDY WATERS

For Paul Rodgers, the husky-voiced singer and one-time leader of the riff-heavy blues-rock bands Free and Bad Company, making his new album, *Muddy Water Blues: A Tribute to Muddy*

Waters, marked a return to his roots. "Long before I was in Free, I had a Muddy Waters album that I played all the time," the native of Middlesbrough, England, says. "And the first bands I

played in were blues bands. A few of the songs on the new record are ones I played back in the '60s. There were a lot of

—CONTINUED ON PAGE 114

Right:
Muddy Waters;
Below:
Paul Rodgers



ILLUSTRATION: CHARLE POWELL

Artist's Studio:
**JED LEIBER'S
HOTEL HANGOUT**

by Bruce Pilato

A quick glance at the magazine rack in the lobby of the Sunset Marquis and it's not hard to realize this is not your typical swanky Los Angeles hotel. *Radio & Records*, *Billboard*, *Mix* and several other music biz titles overshadow a handful of standard consumer publications. The Marquis is, in short, a rock 'n' roll hotel.

Its roster of guests often includes record industry executives and musicians. Now, it has also become a regular hangout for musician Jed Leiber, a composer, studio musician and producer who has worked with the likes of Peter Frampton, Terri Nunn, Graham

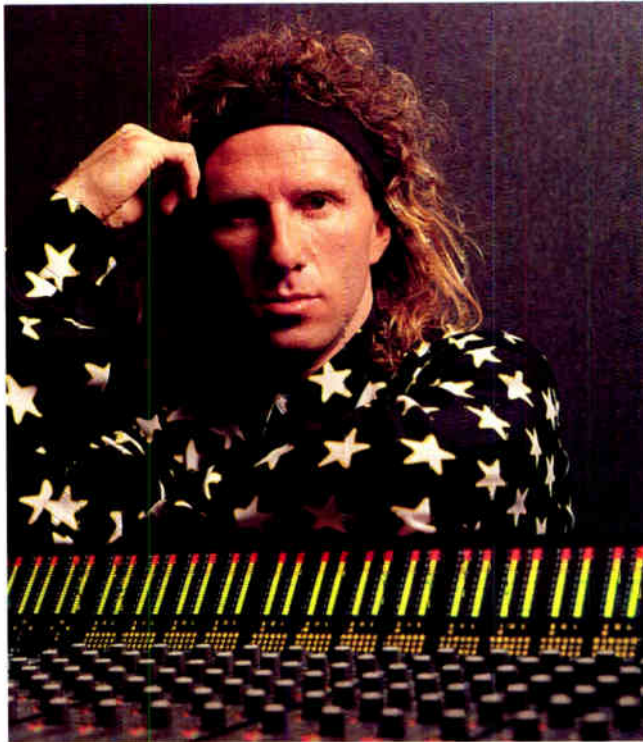

Parker, Thelma Houston, Mavis Staples and, most prominently of late, Jeff Beck, with whom he has formed a musical partner-

ship. Leiber and Beck have worked on two major film projects, *Honeymoon in Vegas* and the recent A&E television

miniseries *Frankie's House*, a drama about British photojournalists based in Vietnam during the war. (The disc of the latter soundtrack is a must for Beck fans.)

In what must be one of the most unusual arrangements of its kind, Leiber chose an isolated section of the Sunset Marquis' parking garage as the site of his new personal recording studio. "There had been a small MIDI studio in the same spot, installed as a demonstration room for Synclavier," Leiber explains. "When the space became available, I saw it as an ideal spot to do my work."

With a tracking room, control room and vocal booth, Leiber has designed the facility for his personal use, mainly for his soundtrack projects. "I like this place," he says.

—CONTINUED ON PAGE 116

**POWER OF SEVEN:
IT'S THE
SINGERS' SHOW**

by Robin Tolleson

If they gave a Grammy for Most Ambitious Session, this year's pop award would have to go to *Up-Front*, Sheffield Labs' live-to-2-track recording by the Power of Seven. The album gives seven of the world's top background singers—Mona Lisa Young, Clydene Jackson Edwards, Myrna Matthews, Maxi Anderson, Carmen Twillie, Alfie Silas and Yvonne Williams—the chance to step up, and they do. Fortunately,

the musicians, arrangers, producer and the all-important engineer also turned in excellent performances. "Remember, everything is mixed live," says producer Jeffrey Weber, who enjoys walking the tightrope. "If we don't have our act together, and they come up with an amazing performance, boy, we are in the hot seat."

"Everything was on [engineer] Jim Scheffler's shoulders," Weber says. "I'm sitting behind him in the control room listening for balances and throwing out my opinions. To the right is a vocal supervisor who's reading the score and cueing us on



The Power of Seven (L to R): Maxi Anderson, Mona Lisa Young, Alfie Silas, Yvonne Williams, Clydene Jackson Edwards, Myrna Matthews and Carmen Twillie

vocals so that he can make adjustments. And on the other side is the music supervisor, who's saying when the horns are coming in." Scheffler says that the cues kept him on

his toes but didn't add to his stress level. "I like to memorize an arrangement in one or two rehearsals, and then I've got all the moves," he says. "But

—CONTINUED ON PAGE 119

DAT-to-D2 44.056-to-44.1
CD-to-DAW DAW-to-DAT
32-to-48 CD-to-DAT
DAT-to-1630 44.1-to-48
DAW-to-Digital Console
48-to-44.056 Varispeed-to-44.1
DAW-to-Digital Multitrack
DAT-to-DAT DAW-to-D2

Finally! Solve your digital audio copy problems for just \$2595...

Your customers want "all digital." Now you can give it to them with Roland's new SRC-2 Dual Sample Rate Converter. It's getting rave reviews from customers. "It sounds great!" "Very innovative--a remarkable design." "I can crossfade and mix with the two digital inputs--fantastic!" "I intend to buy at least three of these units; every room will need one..."

Roland's ASIC chip set, two years in development, is what made this "leapfrog" sample rate converter design possible. So now the A/D, D/A signal degradation you've had to put up with is gone. And your "all digital studio" can really be...all digital!



ProAudioVideo

© 1993 Roland Corporation US

For the solution to all your digital copy problems, call Roland at (213) 685-5141 ext. 337 or FAX (213) 722-0911.

—FROM PAGE 110, KARL WALLINGER

turned out by the impressive previously mentioned chart-toppers.

"A lot of World Party songs are sort of like downtown Tokyo—they're pretty dense," comments Wallinger, who in addition to writing the songs, singing and playing most of the instruments on World Party's records, also produces and engineers. "But everyone's got to find someplace to live, so someone's on the top floor, someone's in the basement, and there are a lot of people in the middle. I think of sound pictures as being like that: I've always liked putting together interesting combinations of instruments and sounds. I'm just doing things that I think are like the things they did on records I liked listening to, whether it was *Sgt. Pepper's* or the double white [*The Beatles*] or [the Beach Boys'] *Pet Sounds* or whatever. I'm not trying to re-create them faithfully or re-create the '60s. But there's a spirit of adventure there I love. Emulation is always a part of creativity, or else you're working in a vacuum."

Wallinger calls his ironically named Seaview Studio in North London, "the world's most expensive demo studio." The 48-track room is stuffed with new and vintage gear, including "a big old Cadac desk from 1975, an Amek Angela from 1985, Otari tape machines, all kinds of guitars and keyboards, and other instruments, reverbs, delays, compressors and all that." Actually, though, labeling it a demo studio is a bit of a misnomer because, "I don't make demos," Wallinger says. "I just have the tape rolling, and the things that go on the tape are the things that go on the record." Well, sort of. For *Goodbye Jumbo*, 60 hours of tape was edited down to just under an hour of music.

But the point is well taken—Wallinger does not usually work in traditional ways. Sometimes he might start with a sequence that sends him in some songwriting direction. For *Bang!* he frequently got together and jammed with two of the members of his 1990 touring version of World Party, Chris Sharrock and Dave Catlin-Birch, occasionally pulling song ideas from those sessions. "Actually, the first thing we did on this album was recorded with this early music ensemble called the Dufai Collective, who are a nice bunch of eccentric musicians who

play things like hurdy-gurdys and eight-string cellos," Wallinger says. "Nothing ended up on the record, but it was nice to start with something acoustical and aurally taxing."

Wallinger says he rarely has pre-conceived ideas about what his records will sound like, but he does acknowledge, "There's usually some train of thought behind it, something I want to do, some combination of sounds I want to hear. There might be some tempo or flavor or atmosphere that I want, or I might not really know what it is until I start trying things out. It's almost like I write things around those sorts of notions and then try to connect those with some lyric idea at some point."

In short, the entire album-making process is an ongoing experiment, "a learning process where we see what the songs become," as Wallinger puts it. Sometimes that involves stacking tracks conventionally and trying and rejecting different musical ideas and sonic textures. Other times it involves more radical techniques:

"Radio Days' [on *Bang!*] was a whole reel of tape that was chopped up. 'Kingdom Come' was two completely different pieces of music just chopped in together. It's sort of an exploration of Brian Wilson's tape editing [technique], where you take one section in one tempo and key and bang it into a sequence which is in a related key but different tempo, and then you just enjoy the difference. On 'Kingdom Come,' the string breaks in the middle were done totally separately from the rest of the tracks, with no conception of whatever time signature there was going to be for the main body of the track. And the main body was done with no reference at all to that bit. It was a fluke. It's like 'Strawberry Fields' with the varispeed, or [the Beach Boys'] 'Heroes and Villains' or 'Good Vibrations'—get the razor blade out and chop that tape up."

The album is loaded with interesting aural touches, big and small. On "Radio Days" there's the backward hi-hat and guitar, and a distorted lead vocal achieved "through the mic inputs of the old Cadac desk. If you get the gain structure right you can really crunch it up, but it distorts it in a great sort of Little Richard way," Wallinger explains. The snippets of radio broadcast overdubs were recorded contemporaneously with the jam that constitutes the

Over 350 Product Lines!
AUDIO VIDEO LIGHTS
1-800-356-5844

FULL COMPASS

Consultation: 608/271-1100
5618 Odana Rd., Madison, WI 53719

USE READER SERVICE CARD FOR MORE INFO



ONLY THE BEST!

A GLOBAL NETWORK OF THE FINEST STUDIOS IN THE RECORDING INDUSTRY

AUSTRALIA

STUDIOS 301, Sydney

AUSTRIA

MG SOUND, Vienna

BELGIUM

KITSCH, Brussels

ENGLAND

NOMIS, London
RIDGE FARM, Surrey

FRANCE

GUILLAUME TELL, Paris

GERMANY

STUDIO SOUND *N*, Cologne
ARCO STUDIOS, Munich

IRELAND

WINDMILL LANE, Dublin

ITALY

CAPRI DIGITAL, Capri

JAPAN

HITOKUCHI-ZAKA, Tokyo

NETHERLANDS

WISSELOORD

RUSSIA

MOSFILM, Moscow

SOUTHERN AFRICA

BOP

SWEDEN

EUROPA AB, Stockholm

SWITZERLAND

SOUNDVILLE, Lucerne

UNITED STATES

A&M, Los Angeles
ANDORA, Los Angeles
ARDENT, Memphis
BAD ANIMALS, Seattle
CONWAY, Los Angeles
MASTERFONICS, Nashville
PAISLEY PARK, Minneapolis
RIGHT TRACK, New York City
SKYLINE, New York City
SKYWALKER SOUND N., San Francisco

WEST INDIES

CARIBBEAN SOUND BASIN, Trinidad

CALL CHRIS STONE FOR BOOKING INFORMATION 213-465-7697

USE READER SERVICE CARD FOR MORE INFO

backing track. On "Hollywood," Wallinger put in a pair of overdubs of himself playing a drum kit, recorded in mono with a single mic about 15 feet away, and then put those tracks on either side of a drum machine track. "It's got a nice vibey sound," he says simply. "Rescue Me" features a Fairlight voice that sounds like steam whooshing through the track, as well as a bizarre musical build near the end that suddenly disassembles as if a switch has been pulled to eliminate half the tracks. Different songs have ping-ponging backup vocals like something off the Beach Boys' *Smiley Smile*, and Wallinger seems to view every lead guitar part as a playground for a different signal processing approach.

Wallinger insists he doesn't labor over these ideas endlessly. "A lot of people will get hung up over whether that backward cymbal is in exactly the right place," he says, "but I couldn't tell you. I don't even think about it. If I like something I keep it. If something bothers me I get rid of it, and it's on to the next thing." Be-

cause of his unorthodox method of recording and building tracks, Wallinger says he's always in mix mode when he's tracking—he considers it part of the same process, really. Still, for five songs on *Bang!* he brought in Steve Lillywhite to mix, and Wallinger proclaims himself very pleased with the input that the much-heralded producer/mixer offered: "There's a guy who's really got a handle on ambient sound! We worked together really well."

Now that the album is completed and in the stores, Wallinger is faced with a new daunting task: learning how to play the songs live. "I'm afraid I never even think about their performability," he says with a chuckle. "They're all so different, it's a real nightmare. It's like what we're listening to is the demo, and then when we play it live it becomes *the song*, you know what I mean? I'm always sitting there going, 'I don't know how this goes, because I've only played it once!' But I like that, too. Recording or playing, it's like discovery all the time." ■

—FROM PAGE 110, PAUL RODGERS & MUDDY

bands in England that played blues, and we were all in competition with each other, but we all drew from the same influences: Muddy Waters, Howlin' Wolf, Sonny Boy Williamson, B.B. and Albert King. We assumed everyone in America was raving about the blues, too, so I was surprised to learn it was actually considered a pretty obscure thing over here."

That is until recently. Now that two or three generations of blues-influenced musicians—from Brits like Free, Led Zeppelin and Eric Clapton to Americans like Stevie Ray Vaughan and Robert Cray—have paved the way, the worldwide audience for blues is probably the largest it's ever been. Which makes the timing of Rodgers' new blues record all the more fortuitous. "Our approach, if there was one," he says, "was to get a good nucleus for a band and then lock us in a rehearsal room with Muddy Waters tapes and see what came out." The band, which tackled more than a dozen tunes associated with Muddy Waters, features Jason Bonham, son of the late Led Zep skinsman John Bonham, on drums, veteran Welsh session bassist Pino Palladino, a young guitarist named Ian Hatton, and then a slew of fa-

mous guest lead guitarists: Jeff Beck, David Gilmour, Queen's Brian May, Neal Schon, Trevor Rabin of Yes, Gary Moore, Brian Setzer, Steve Miller, Bon Jovi axeman Richie Sambora and the ubiquitous Slash. "We had a long list of guitarists we wanted to use," Rodgers says, "but only half a belief that it would come off." The result is a heavy, crunching blues disc that bears Rodgers' unmistakable stamp—this could almost be the great lost Free album.

All of the basics were cut at One On One Studios in North Hollywood, with Billy Sherwood (Motorhead, Yes) producing and Tom Fletcher engineering. "Except for the lead guitar tracks, it was all cut very live," Fletcher says. "There was such a good feeling in the band that everything went very quickly and smoothly. We probably even kept 95 percent of Paul's scratch vocals. The guy just sings so phenomenally, and he was really inspired."

Fletcher, an independent engineer/producer whose credits range from Toto to Ronnie Laws to Ozzy Osbourne, says that One On One was the perfect place for these sessions: "It's a *great* room for drums, and it has an SSL G Series with Ultimotion, which made things real easy.

IMAGINE A RACKMOUNT MIXER...



The

DAT

DIGITAL AUDIO TAPE

Store

MiniDisc

in stock now!

DIGITAL

DCC

COMPACT CASSETTE

featuring

SONY MINI DISC RECORDER

Quick Random Access
Total Durability
Shock & Vibration Resistant Portability
74 Minute Recordable Disc
Superb Compactness with Quality Sound

TECHNICS & PHILIPS DCC

Digital Record/Playback
with Outstanding Sound Quality
Playback Compatibility
Quick Track Access with Address Data
Text Information Display

MARANTZ CD RECORDERS

Directly Records Audio from Any Source
Final Recorded Discs are Compatible
with Conventional CD's

SONY MICRO DAT RECORDER

Ultra-small Stamp-size Cassette
Long Battery Life
with a Single "AA" Battery
Digital Stereo Recording

**DIGITAL AUDIO TAPE
RECORDERS**

Over 25 Makes & Models
Home, Studio, Portable, Professional,
Pro-Portable, and Time Code

**SALES ♦ RENTALS ♦ REPAIRS
DUPLICATIONS & TRANSFERS:**

Any Combo ♦ DAT ♦ CD ♦ DCC ♦ MiniDisc
4mm Data Cartridge & Blank DAT Tape
(2.0 Gig & 3 hour available)
Accessories & Blank Media for all Recorders

**WE DO MAIL ORDER!
WE'LL SHIP ANYWHERE!**

VISA ♦ MASTERCARD ♦ AMERICAN EXPRESS
DISCOVER ♦ C.O.D. ♦ SHIP U.P.S. OR FED-EX
Mondays - Fridays: 9:00AM - 6:00PM
Saturdays: 1:00 - 4:00 ♦ Closed Sundays

The DAT Store

2624 Wilshire Boulevard
Santa Monica, California 90403
Fax No. 310-828-8757
Phone No. 310-828-6487

You can take a split off the console, so each guy can mix his own mix for the headphones. It's nice when everyone really likes what they're hearing." Palladino's exceptional bass tracks were cut with a combo of direct signal and a miked amp. Fletcher's method of choice for guitars is putting an SM57 and a 451 on the amp, and then a 414 about three feet from the amp. For Rodgers' vocals, Fletcher used a 57 with a dbx 160 compressor. He's a fan of Pultec, Lang and Summit tube EQs, and of tube compressors. "They give me the bottom that rock 'n' roll needs," he says.

With the exception of Beck, Gilmour and May, the guitarists came into One On One to lay down their parts after the band had recorded the basics. "We didn't make it too tough," Fletcher says. "We brought them in, got the sounds up—which took a matter of minutes, usually—and we just told them to play. We didn't want to contrive parts for them to play—it's the blues! Ninety percent of the time we'd do a full take, then do another one, but it was always the first take we used."

For the players who couldn't come to Los Angeles, Fletcher sent slave tapes, which the guitarists worked on

and then returned with their parts included. Fletcher notes, "With Gilmour, he sent me a tape that had four tracks of solos, and he let me put it all together—select what I felt was best for it. So I sat there and comped together out of those performances what sounded the most like the Gilmour I grew up with. It wasn't hard. With Beck, it was verbatim. He sent us something with six tracks, and we used all six tracks because they were spectacular—he really orchestrates his solos." Fletcher says he also added some tube EQ to the solos "to spice them up a bit."

Fletcher and Sherwood cut a few keyboard and vocal overdubs at One On One and then took the tapes to Cornerstone Recorders in Chatsworth to mix on that studio's Neve VR60. "All in all, it was probably the most carefree recording I've been involved with," Rodgers says cheerfully. "It's the most pleasurable record I've ever worked on," agrees Fletcher. "There was an incredibly great vibe surrounding this project. Nobody got hung up on anything, and there were never any tense moments. Everybody was always smiling." And now, somewhere, Muddy Waters is probably smiling, too. ■

—FROM PAGE 111, JED LEIBER'S HANGOUT

"I feel very comfortable when I'm in this hotel, and by living in the neighborhood it is certainly convenient."

It's also totally mobile, he says. "The keyboards, the console, the amps, everything is connected with multipin umbilical chords and can fit into a group of flight cases. I can pack the whole place up in a matter of minutes." Leiber also has a residence in New York, so the portability is important.

At the heart of Leiber's studio is the new Euphonix CS-II console. With 112 inputs and 56 channels, the board allows Leiber to route all his sources to any combination on the board via the console's advanced CUBE matrix unit. Routing and mixes are saved with the CS-II's SnapShot Recall System.

For monitors, Leiber chose the Tannoy PBM-6.5 for reference speakers, and Genelec 1042s for mixing. For power, he employs Crown 150 power amps. The studio has both a 24-track Studer and four Tascam 8-track tape machines, all

linked together. He also uses Macintosh computers and Digidesign Pro Tools software for digital editing.

Of course, the studio is also equipped with plenty of processing gear, including TC 2290 digital delays, an Eventide H3000, Yamaha SPX1000, two Lexicon 300 reverb units, and assorted compressors and limiters.

As a keyboardist, Leiber is continually experimenting with the gear he uses in the studio and for composing. In his studio he uses primarily a Peavey DPM-C8, an 88-note keyboard controller, hooked up to a Mac. He has several banks of keyboard modules, including Yamaha TG77s, Korg Wavestations and Roland D-550s. He also uses a number of older analog synths. For samplers, he prefers an Akai S-1100, a Roland S-770 and an Emulator III.

Leiber is no stranger to writing and recording music. His father, Jerry Leiber, is half of the legendary Leiber/Stoller songwriting team, who penned such classics as "Hound Dog," "Jailhouse Rock," "On Broad-

WITH ALL THESE FEATURES AND THE SOUND OF A PROFESSIONAL STUDIO CONSOLE.

- 22 inputs. 10 XLR balanced inputs featuring a low noise, padless pre-amp design. Six true-stereo inputs.
- 4-Band EQ. High and low shelving filters: low band 80 Hz/high band 12 kHz. Two resonant mid-band filters: low mid 800 Hz/high mid 2.5 kHz.
- Quad discrete transistor mic preamps.
- Rotating jackfield for conventional mixing or rackmounting.
- 6 Aux sends: 1 pre; 5 post.
- 5 dB more overall gain than any mixer in its class.



- High quality, center-detent Panasonic® faders.
- Panasonic sealed potentiometers.
- 4 true-stereo returns.
- The only 4 buss design in its class (using 4 dedicated sub group faders) with discrete Group and Main summing outputs.
- 128 dB overall signal-to-noise ratio, A weighted.
- 10 Hz to 30 kHz frequency response.
- Ceramic hybrid channel design that further reduces noise and optimizes stability.

THE NEW MPL 2242

Our new rackmount mixer has more features than anything in its class. But the real key to mixing technology is *sound*.

In fact, it has already come through with flying colors working alongside studio consoles costing over 10 times as much!

We love defying people's expectations. That's why we can hardly wait for you to get your hands on the new MPL 2242.

Because it's easy to see all the features that set us apart, but a lot harder to show you how great it sounds.

SAMSON AUDIO

USE READER SERVICE CARD FOR MORE INFO

For more information about the MPL 2242, please contact Samson Audio, a division of Samson Technologies Corp., P.O. Box 9068, Hicksville, NY 11802-9068 (516) 932-3810 FAX (516) 932-3815

Panasonic is a registered trademark of Panasonic Corporation
© 1993 Samson

DIGITAL EVOLUTION

Technology evolves. The market develops. DIC Digital excels.



As one of the original suppliers of DAT tape to the professional, DIC Digital recognized industry demands. As a result, we were the first DAT supplier to offer a truly professional DAT cassette.



Once again DIC Digital is leading the way by introducing recordable CD's. Our discs are fully compatible and bear the "compact disc" logo. DIC Digital's CD-R's are readily available in 18, 63 and 74 minute lengths. Call today for the name of your nearest DIC Digital dealer.

THE ULTIMATE IN SOUND

DIC DIGITAL™

222 Bridge Plaza South, Fort Lee, NJ 07024
Phone: 201-224-9344 or 1-800-328-1342, Fax: 201-224-9363

way," "Stand By Me" and dozens of other classics. Jed is acutely aware of the media curse that often follows second-generation rockers: plenty of notoriety at the beginning because of who you are, but rarely a chance to be taken seriously.

"I'm very proud of my dad's legacy, and his influence is certainly recognizable in my work," says Leiber, "but it has always been most important for both myself and Oliver [Jed's brother, also a producer/musician] to make it on our own talent." In fact, the senior Leiber tried talking both of his sons out of working in music. "He was very ambivalent about our being in a business he thought was filled with crooks—which it was."

Leiber taught himself to play piano, but his father convinced him that if he wanted a stable existence in the music business he should also have formal training, so he studied music at Oberlin, Aspen Music School and Juilliard. After graduating, he worked as a session musician and arranger, and his career has taken off—without the benefit of his father's connections. ■

—FROM PAGE 111, POWER OF SEVEN

there was so much going on with this music that I was thankful for all the cues."

"This is probably one of the most dangerous records ever made," says Weber. "Some of the singers couldn't work after this project for a while. It's very hard to sing continuously for six hours a day with emotion, sharpness, a certain level of intensity and accuracy. It's really the toughest instrument to capture and tame on a continual basis in this unforgiving recording process." Yvonne Williams, one of the terrific singers among The Seven (and a guest on *In Living Color*), agrees: "When you multitrack, there's a rest period in between. You do a phrase, stop, listen, do a phrase. It's not hard singing for four minutes straight. This project took a toll. There's a certain schedule that needs to be kept. So sometimes even though the voice was to a point where it needed that recoup period, we had to just push on through it."

"We had to find the concept for each song, each texture," Williams adds. "Each background was different, just like we would do on anyone else's record. So we spaced our-



ATHAN CORPORATION

QUALITY MOTOR REFURBISHING

Assure a long life for your tape recorder:

- We do ALL motors for ANY Audio equipment
- Quality & Service are #1
- Lowest Prices—Guaranteed
- Fastest Turn-around
- New Motor Exchange Program reduces down time
- All replacement parts surpass original specifications

For burned-out motors, we provide:

- Rewiring of commutators or flux windings
- Replacing of rotors for pancake motors

Call 415-589-5206 to extend the life of your motor.

ATHAN CORPORATION—where quality and service are #1

50 South Linden Ave., #10 • South San Francisco, CA 94080 • Phone: 415-589-5206

USE READER SERVICE CARD FOR MORE INFO



THE DIGITAL COMPANY

Experience The Industry's
WIDEST SELECTION
of Digital Audio Workstations
and Multitracks.

Why waste time and money canvassing the country when one call to EAR will do it all? Whether you need complete digital audio workstation systems or computers and peripherals, you can count on EAR for:

- Most Extensive Selection in the U.S.
- Leasing Specialists
- Buy/Sell/Trade
- Complete Technical Support

EAR

Digital Audio Workstation/Multitrack Specialists.

PROFESSIONAL AUDIO/VIDEO 2641 E. McDowell Phoenix, AZ 85008 602.267.0600

Affordable Sample Rate Conversion for Digital Audio



- Real Time Conversion performed entirely within the Digital Domain
- Convert between any 2 frequencies from 30 to 50 kHz

- All features selectable from front panel
- AES/EBU input and output

Digital Integration, Inc.
3530 Forest Lane, #38
Dallas, Texas 75234
Fax:(214)350-6344

For pricing and more information, call us toll-free at 800-369-2230

selves properly around the mics to get balance. They experimented with various mics for the lead voice, because of the different styles and timbres in our voices, and found a good mic that worked for us."

Scheffler reports using a Telefunken 251 for most lead vocals, along with Sheffield's own line-level tube mic developed some years ago for their projects: "That's a vacuum tube mic built around an AKG large-diaphragm capsule. It's similar to the 251, though there are subtle differences between those mics or even from one mic to the next of a given model—differences in capsule age, et cetera. The Sheffield tube mic is lower-distortion than the 251, and there is character to it that would sound cleaner on a lot of singers. The 251 may have a little more lower midrange thickness, warmth to it.

"They have a couple of versions of their line-level tube mic," Scheffler adds, "and I had those on key pieces like the drums, the snare, tom-toms, the bass, piano and some of the vocals. There's a very discernible warmth that the tube mic preamps bring to the project. It's a little snappier sound, too. Reverb is a key on good vocals, and we had four or five different echo devices including a wonderful acoustic echo chamber. Bill Putnam studios, God bless him, have always had live acoustic chambers. I used that on vocals, and the EMT 250 digital reverb. I think I used a little bit of the AMS reverb, too. When you blend reverbs together, it takes on a transparency that's helpful—you don't necessarily hear any one particular thing.

"By the second run-through, we were rolling tape," Scheffler says. "The singers would always come in and listen right away to that first take, figuring out where their weak spots were or where their blend needed to be altered. It wasn't something that I could blend or balance for them. They had to adjust themselves to the mic accordingly for the blend they wanted to hear. They made mental adjustments about what they wanted to do differently the next time."

"The women got a blend time and time again that is all natural," Weber says. "We didn't have seven individual mics. It was marvelous, because you can't get total isolation and all your druthers when you have so many people involved. You

have to make certain sacrifices in the name of emotion. I'd love to have every singer be on pitch all the time, and the latest state-of-the-art technology. But that's not what it's all about. It's the performance."

It took a little doing to find a sound that everybody was happy with for the ensemble vocal parts. "We were struggling with getting a real presence on the girls," Scheffler says. "They wanted to feel more upfront, so we used two C-24s in a conventional X-Y, a pair of cardioid X-Y capsules on each. Though there were two physical microphones, I had four faders so I could make subtle balance differences—pan them left, left-center, right-center, right, and put them crisscrossed. They kind of overlapped. That seemed to make the best blend and focus for them."

Up-Front was Scheffler's first time engineering in Studio A at Ocean Way. It was also very early in the life of a new console in that studio, a 72-channel Focusrite (with Focusrite EQ on each channel) that replaced an API. "It was very helpful to have the grouping capabilities," Scheffler says. "With 72 channels, it spans almost the entire width of the control room, 14 or 15 feet. So I could group brass onto a fader, split the rhythm section up onto a couple faders and groupers all right in front of me in the center of the console. I'd have all the vocal mics on modules that were close to the center of the console, and the groupers would help me reach those modules way down at the end.

"Sheffield always brings their own 2-track tape machine and their own digital converters," he continues. "We recorded onto a couple of real hot-rodged ATR-102s, 1/2-inch running at 30 ips, no noise reduction. So sonically they are just primo. And they were trying a new 20-bit converter on the record."

Up-Front, the background singers' chance to shine, is an intriguing blend of technology and gut-level performance, a success on many levels. "Doing an album of this nature requires a certain focus and relaxation," says Williams. "Letting it flow like you would perform it live. That part of it was very opening, very releasing. Nevertheless, it was a challenging project from beginning to end, and I was just glad to be a part of it and to be partners with these other wonderfully talented women." ■

Every once in a while a product comes along that just blows you away.



Say hello to a hurricane... The EV/Dynacord DRP 15 High-Quality Reverb!

"... I am reluctant to part with the DRP 15, the sheer quality is addictive."

—SOUND ON SOUND, England*

"... immediately usable... The DRP 15's reverb and delay quality is brilliant... audibly superior to the standard of rival products!"

—SOUNDCHECK, Germany*

"... It was obvious immediately that the reverbs are dense, rich and full—great stuff."

—MIX, USA*

*Reprinted with the permission of the magazine.

Backed by Electro-Voice's famous service and three-year electronics warranty, the DRP 15's precision German engineering is winning fans worldwide!

The DRP 15 has 228 programs with a palette of time-tested, high-quality reverbs and other effects programs. The DRP 15 has the easiest user interface you'll find anywhere, with program changes done quickly, in real time, and with absolute silence. Program editing is also child's play, thanks to a "compare" button and graphic illustration of parameter ranges. The EV/Dynacord DRP 15 has it all—great sound, easy operation, and solid construction quality and reliability.

Check out the EV/Dynacord DRP 15 soon—and experience the winds of change.

EV DYNACORD®

EV/Dynacord a MARK IV company 600 Cecil Street Buchanan, Michigan 49107 Phone: 616/695-6831 Toll Free: 800/234-6831 In Canada: 613/382-2141

USE READER SERVICE CARD FOR MORE INFO
World Radio History

PROJECT
PORK

PRIMUS

GO DIGITAL ON THEIR
OWN TERMS



At the helm of their project/rehearsal space, (L to R) drummer Tim Alexander, bassist Les Claypool, engineer Derek Featherstone and guitarist Larry LaLonde set the controls for the heart of the swine.

A

technician solders a circuit board in one warehouse. Phones are ringing in another warehouse full of road cases and mic cables. Heaters are humming in a third warehouse scattered with memorabilia: a Boston Celtics poster signed by Bill Walton here, a photo of a Nelson Mandela tribute concert signed by Carlos Santana there. Grateful Dead posters everywhere.

Bassist Les Claypool and his Primus bandmates—guitarist Larry “Lei” LaLonde and drummer Tim “Herb” Alexander—joke with their engineers Derek Featherstone and Ron Rigler at their rehearsal space in the warehouses of Ultra Sound in Marin County, California. As many know, Ultra Sound provides sound reinforcement equipment and service to the Grateful Dead, special Bay Area functions and other touring artists.

Although it probably comes as no shock that a top “alternative” band like Primus would record an album in their rehearsal space, it is surprising that this group— de-

scribed as “anti-technology” and “staunch analog fans”— would record their self-produced release using digital recorders. But the four Alesis ADATs linked together with Elco multipin connectors were the very tools that allowed Primus to work at their own pace in their own space.

“I was very skeptical of these ADATs,” the admittedly low-tech Claypool says. “I’m producing a few albums right now in my basement recording on a Tascam 388, which I think sounds amazing. It’s got dbx in it. They’re amazingly quiet. Actually there are a few songs from *Pork Soda* that are recorded on that [“The Air is Getting Slippery” and “Hail Santa”]. And our first album [*Suck on This*, on Claypool’s Prawn Song label] was recorded on the 388.”

Primus’ latest release, provocatively titled *Pork Soda*, was recorded over a five-week stretch with a combination of Ultra Sound and Primus gear: four ADATs, a Gamble EX 56 sound reinforcement console, as well as a wide variety of quality mics and a rack of outboard gear both of

which Primus uses for live shows. After tenacious touring with the likes of Rush, U2 and Public Enemy and watching their major label debut, *Sailing the Seas of Cheese*, go Gold, this technically proficient power trio wanted to re-create some of the chest-thumping, stage-diving intensity of a live Primus gig for their sophomore release on Interscope Records.

Engineers Ron Rigler and Derek Featherstone handled tracking and mixing on *Pork Soda*. Featherstone is the band’s general live sound guru, while Rigler is the studio specialist who engineered all of the Primus releases except for their

first

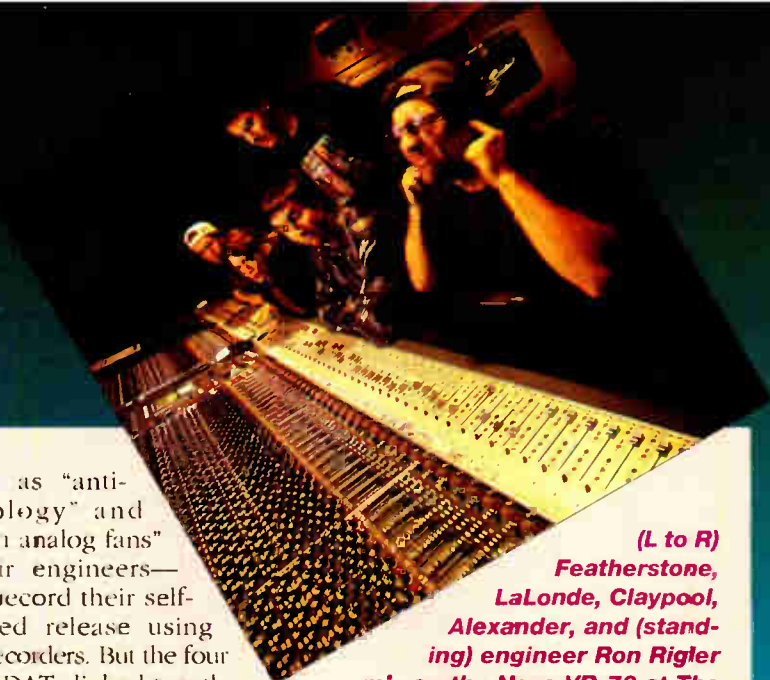

(L to R) Featherstone, LaLonde, Claypool, Alexander, and (standing) engineer Ron Rigler mix on the Neve VR-72 at The Plant, Sausalito, CA.

BY JEFF FORLENZA

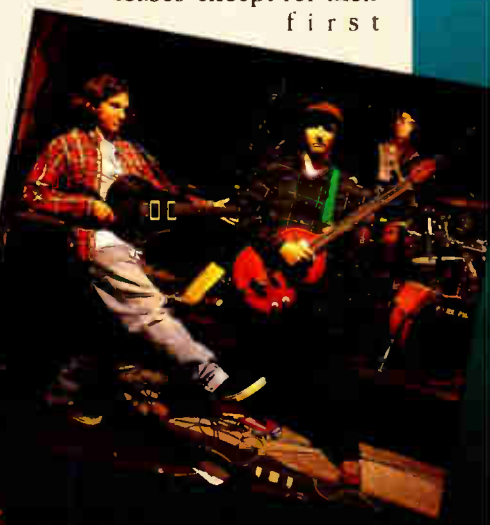
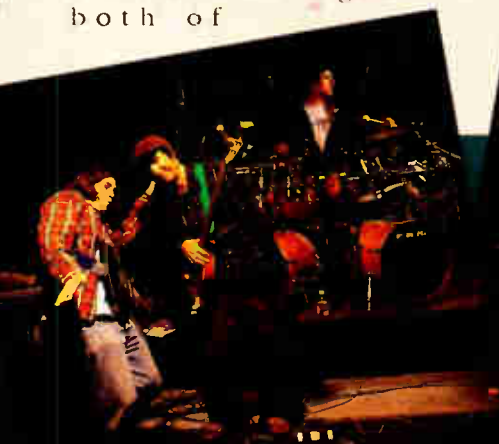

all photos by Jay Blakesberg except top right: Andrew MacNaughtan

DIGITAL AUDIO • DIGITAL VIDEO

Scenaria

Digital Audio/Video Production System

Audio Recording, Editing, Sweetening and Mixing

- 38-channel, automated digital mixing system
- Digital EQ and dynamics on every channel
- Integral 24-track random access recorder/player
- Multitrack digital audio editor

Random Access Video Storage

- Integral VisionTrack system

Control of External Devices

- Multiple ATR/VTR serial machine control
- Automated audio/control routing

System Compatibility

- Compatible with ScreenSound and SoundNet
- Multi-user networking capability

Solid State Logic

International Headquarters:-
Begbroke, Oxford, England, OX5 1RU
Tel: (0865) 42300

Paris (1) 34 00 46 66 • Milan (2) 262 24956
Darmstadt (6151) 93 86 40 • Tokyo (3) 54 74 11 44
New York (212) 315 1111 • Los Angeles (213) 463 4444

SSL DIGITAL

One of three Scenarias at
Post Perfect/Mixed Nuts, New York

Alesis ADAT: The Project Studio/Commercial Facility Connection

Nearly two-and-a-half years ago, the Alesis ADAT was announced at the January 1991 NAMM show. Now it's been more than a year since production-level deliveries began. A lot has happened during the interval of the company's lag time between announcement and delivery, but a survey of project studio users reveals it was worth the wait.

The 8-track, S-VHS modular format has proven robust according to the users we contacted, all of whom were well aware of the street talk about the VCR-type transport on the ADAT.

"If it breaks, I'll just buy another one," explains Mike Lawler, a Nashville session player and 16-track ADAT owner, who was recently named an A&R producer for the Mercury Nashville label. Not everyone can afford to be so cavalier about such an investment, but it's not hard to understand Lawler's insouciance given the \$4,000 price tag of a basic 8-track system.

Nashville engineer Will Pevear describes the transport as "clunky, like a VCR. It's impossible to get multiple location points precisely on it. But for \$4,000, that's simply not enough of a problem to be major. As long as your overdub level perfectly matches your recorded level, the cross-fades are great. Any complaints really have to be looked at in the context of its price and performance."

Price got people interested, and Alesis' primacy in the market pulled them in. "People got the impression that

—CONTINUED ON PAGE 128

album.

"It would have been hard for one engineer to do it all by himself in this environment—it's pretty difficult going from warehouse to warehouse," Featherstone says of the recording setup. "Ultra Sound is a working company that does its business during the day, and at nighttime we'd come in and do our thing. There are four warehouses up at Ultra Sound, and we took over three of them: Herb was in the main rehearsal room, which houses his drum kit. Then we took Ler's guitar and put it in the next warehouse over and isolated him with some speaker cabinets. Les and his bass were in warehouse number 4. We ran talkback mics and headphones to all three rooms. In addition, there was a video camera in each room and TV monitors in the control room. They couldn't see me [or each other], but I could see them."

"The only weird part was not seeing anyone, because we were far away from each other, which kind of made it a little scary," drummer Alexander explains. "It was kind of a guess when we were gonna go to a lower dynamic or change a part. The best thing about it was that it was a place I was familiar with, so I could play pretty well. There wasn't a lot of pressure."

Since the band only had part of the album written, much of the material on *Pork Soda* was created as they recorded. Some songs evolved out of bass and drum grooves that LaLonde later overdubbed guitar onto; others grew out of bass and guitar riffs that Alexander added drums to later. There were also times all three musicians—in their separate warehouses—waded through never-before-rehearsed, loosely sketched new material.

"When they came into the project there were only four or five songs completed," Featherstone explains. "For the rest of the songs the plan was to let the band jam, while Ron and I would continuously run tape. We burned through four cases of ADAT tape [80 tapes total]. It's still more cost-effective than it would have been if we used analog, even though it is a lot of tapes. Of those 80 tapes, we used 16 of them for the final mix. We ended up getting a lot of material on tape that's just jamming and rehearsing."

The band then listened back and



INTRODUCING OUR NEW PARTS & ACCESSORIES DEPARTMENT

FOR THE DISCRIMINATING
ENGINEER & STUDIO

CABLES, PATCHBAYS,
CONNECTORS, TOOLS,
TAPE, RACKS, ETC.

PICK-UP COUNTER
RUSH DELIVERIES • MAIL ORDER

BRANDS INCLUDE:
ADC; AMPEX; AMPHENOL; CANARE; 3M;
MIDDLE-ATLANTIC; GEPCO; NEUTRIK;
PANDUIT; SWITCHCRAFT; MANY MORE.

723 7th Avenue (at 48th Street)
9th Floor, New York City

(212) 302-5114
Fax: (212) 302-5744

Managers: Jim Gillespie & Myron Dubb,
formerly of Martin Audio

USE READER SERVICE CARD FOR MORE INFO



No matter how you stack it...

Nobody reconditions tape heads like JRF.

- Heads restored to new performance spec at a fraction of new cost
- Precision recontouring
- Digital/optical head assembly alignment, first developed by JRF
- Full line of replacement heads
- Expanded, fully equipped facility

Experience the difference experience makes. Ask around. Nobody treats you or your heads better than JRF.



(201) 579-5773
Fax (201) 579-6021
249 Kennedy Rd.
Greendell, NJ 07839

CASSETTE INSERTS

IN

7

DAYS

CS Printing

111 Oak Lawn Ave.
Dallas, Texas 75207
(214) 747-8705
FAX: (214) 748-9922

USE READER SERVICE CARD FOR MORE INFO

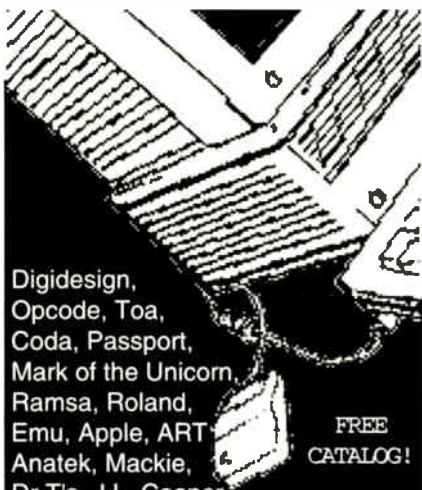

Digidesign,
Opcode, Toa,
Coda, Passport,
Mark of the Unicorn,
Ramsa, Roland,
Emu, Apple, ART,
Anatek, Mackie,
Dr. T's, J.L. Cooper,
Kawai, Microtech, Panasonic, Chinon
Pacific Coast, Tascam, Rapco,
Ultimate Support, Prosonus & much,
much more...

FREE
CATALOG!

1-800-MAC-BEAT
1-505-473-4929



1314 Rufina Cr., Ste. A4 Santa Fe, NM 87501

picked out sections they liked and added tracks as needed. Some songs, like "Hamburger Train," remained instrumentals, while others needed lyrics, like "DMV," which Claypool put his vocals on during the last night of *mixing*.

"Basically, the whole album is live-to-ADAT," engineer Rigler explains. "We did some overdubs, but even when we did the overdubs a lot of times it would be just a complete pass."

Operationally, the ADAT is much like a cassette deck: You put in a tape, format your tape, rewind and then record when you're ready. The main complaint from the Primus camp was that they didn't have the BRC—the Big Remote—which had not yet been released by Alesis. This made it somewhat difficult to locate cues, since they only had forward, rewind, play, stop and record functions.

"We didn't have too many problems," Featherstone says of the ADATs. "Any time there was a problem, it was usually a matter of stopping the tape and rolling it again or perhaps turning the power off."

In keeping with the idea of capturing Primus' live sound on a semi-studio album, the group used their live sound console configured as a studio board. "We basically used everything that we use at a live gig," Featherstone says. "We used a Gamble EX 56-channel live console configured with multipin connectors. As far as sending stuff to the ADATs, we were using subgroups, direct outs and Ultra Sound custom mic preamps. Basically, there wasn't a standard signal path, as you would normally see where the signal comes in one place and goes neatly out another. If you wanted to change something, you really had to think about it, because it was very convoluted.

"We were using 16-channel Mackie 1604s for mixing down effects," he adds. "When we ran out of the 56 channels on the Gamble, which we did pretty quickly, we extended onto the Mackie input effects returns just for monitoring purposes. We'd use the effects returns on the Mackie so we could make mixes for our own use."

Both Claypool and Alexander stress the importance of using a quality analog console to warm up

the digital tracks. "I think a lot depends on the board you use," Claypool says. "That Gamble board was really nice. And we mixed on a Neve, which I like the sound of, but I didn't like the automation. If you work with [ADATs], you just have to approach it a different way. It's gonna be brighter and a little more brittle, so you have to bring out warmth in other ways like using that Neve board, EQing and tweaking."

"I also think that the ADAT brings out a lot of attack and a lot of that clear kind of transparent sound," Alexander adds. "Drums can get transparent or thin-sounding on the ADAT. It's not that warm analog sound. You really have to work with the EQing and the mixing and the miking—it's not just gonna pop off there and sound amazing."

When it came time for final mix-down, it was over to Sausalito and the Neve VR-72 console and Ampex ATR-102 analog recorder in Studio B at The Plant. The Primus party brought their whole recording setup from Ultra Sound, and with the help of a J.L. Cooper sync box they were able to run the ADATs with the Neve's Flying Fader automation.

Mixing was an evolutionary process on *Pork Soda*, since bandmembers were taking tapes home after tracking and remixing and rearranging songs as they recorded. That creative (or re-creative) process continued into the final mixdown, where the band didn't print anything to analog tape until the last couple of nights of their three-week stay at The Plant. In fact, they practically printed the whole album in one night.

"You have to spend time in the mix," drummer Alexander says. "I've heard people say they've mixed in a day or two. If you can do that, great; but with this band, we sometimes spend a complete month mixing. We only spent a couple of weeks at The Plant, but we had been mixing as we were recording—we were making tapes at Ultra Sound and taking them home—so we kind of had an idea how it was gonna sound. But when we jumped on the Neve at The Plant we had to re-EQ everything and get it sounding good. And that took awhile."

"What we ended up doing at The Plant," Featherstone recalls, "was to take a pair of 40-foot mic cables and

New.
Powerful.
Uncomplicated.
Rugged.
Guaranteed.
American.

And Inexpensive.

AMPLIFIER MODEL	8 OHM @ 1K	4 OHM @ 1K
USA 370	125 Watts	185 Watts
USA 850	270 Watts	425 Watts
USA 1300	400 Watts	650 Watts

The New USA Series Amplifiers from



1675 MacArthur Blvd. Costa Mesa, CA 92626-1468
Phone (714)754-6175 Fax (714)754-6174

QSC is a registered trademark of QSC Audio Products, Inc. USA

USE READER SERVICE CARD FOR MORE INFO

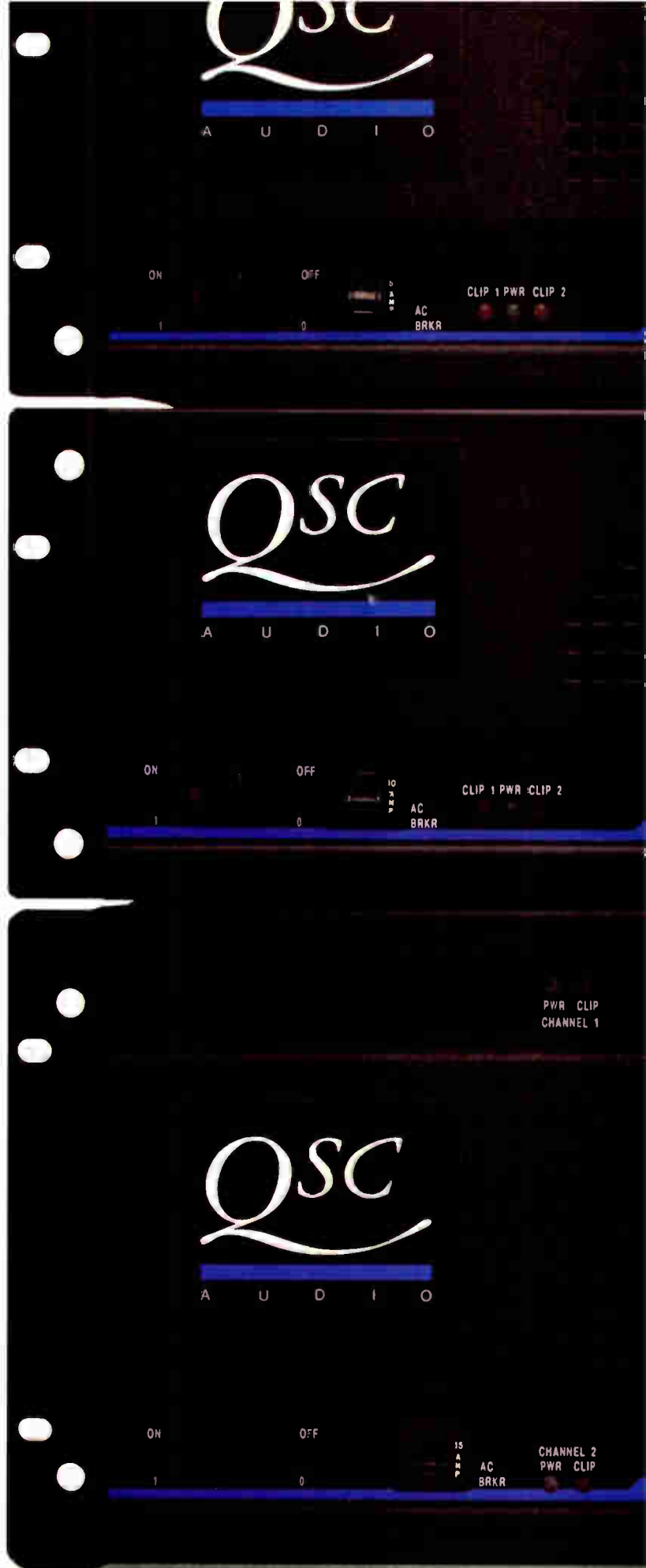

World Radio History

HEAD RELAPPING

The contour and performance of your heads are restored to factory specifications before a precise optical/digital assembly alignment is performed. Original replacement heads also in stock.



MOTOR REBUILDING

Your Capstan, Reel, and Tachometer motors are rebuilt to quiet, flutter free perfection.



— Become an AMP SERVICES customer and enjoy a level of quality workmanship and individual attention rare in today's business environment. Call:

Audio Magnetic Professionals

AMP SERVICES INC

224 Datura Street, Suite 614
West Palm Beach, FL 33401

1 (800) 826-0601 In Florida (407) 659-4805

Authorized OTARI, SONY, TEAC Parts Dealers

USE READER SERVICE CARD FOR MORE INFO

making digital easy



TASCAM DA-88

... just do it!

**multitracks, dat,
work-stations at
an affordable price**

**NATIONAL SOUND
1-(800) 541-9140**

—FROM PAGE 125, ALESIS ADAT

there were problems due to the long time between the announcement and actual availability," says David Peacock, owner of New York project studio Big Trouble Sound Labs and one of the original ADAT purchasers back in June 1992. "But I'm glad they did, because it gave them the chance to get it right."

Interchangeability proved to be a welcome by-product of Alesis' fast (relatively speaking) jump into the market. With a one-year head start on rival Tascam, they've already seen (and are now officially encouraging) networking among users. This interchange is having a profound effect upon the interaction between project/personal studios and commercial facilities. For instance, Peacock regularly interfaces with other ADAT users on record projects, often taking scoring data on DAT from a soundtrack producer working at Power Station, dumping it to his ADAT, composing and scoring the project at home, then bringing it back to the larger studio for the rest of the work.

"Everyone is able to stay in the digital domain all along, and that's what makes it so attractive to producers working at commercial facilities," Peacock explains. "They know that the off-line work will be done digitally."

run them direct out of the console into a line-in on the CD player in my car. We would go out to the car and listen in order to get a better perspective of the mix in an environment we were all familiar with. It was a lot easier than mixing to cassette and then taking the cassette mix to the car."

After they were satisfied with their mixes, they recorded to Ampex 456 1/2-inch analog tape at 30 ips with no SR. Finished tapes were sent down to John Golden at Hollywood's K-Disc for digital mastering.

It would be hard to deny the fact that the arrival of affordable digital recorders like the Alesis ADAT and the forthcoming Tascam DA-88 have affected the professional recording industry. And we'll see more artists—

Between ADAT and the rest of the world, however, full digital interactivity awaits the availability of the BRC remote controller, which will allow track-to-track digital bouncing and interfacing with other digital systems. According to Alesis, the BRC should be shipping by the time you read this. Its delay was one of the few sore points among users.

A dealer, speaking anonymously, said that although the ADAT was slow to get to market, and the wait for the BRC has been annoying, user satisfaction has been high. Retailers are looking to the coming marketplace confrontation between ADAT and Tascam's 8mm/8-track system with mixed emotions.

"One might be considered more 'pro' than the other, so to speak, and the VCR transports will probably give out at some point," the dealer said. "But we've had problems with the 8mm format before, too, including some error-correction problems."

Regardless of how the sales wars turn out, the bottom line is that the ADAT and other linear digital systems are an evolutionary step in just the right increment at just the right time. Affordable, tape-based digital recording may provide the broad institutional link between project studios and commercial facilities.

—Dan Daley

Gold and Platinum artists—go the way of Primus: recording when they want, where they want without the studio clock ticking away money. With the help of four ADATs, two talented engineers and a six-pack of *Pork Soda*, Primus did just that.

"Bottom line is that the way these guys work is however they want to," Derek Featherstone says. "They don't want to be in an uptight studio working with some engineer just telling them what to do or not listening to them. The whole idea of this project is that they do it the way they want, and if they don't know something then Ron and I can help them figure out how to do it." ■

Jeff Forlenza likes Pork Soda on vinyl, just for the taste of it.

Digital Recording for Computers in the Real World.

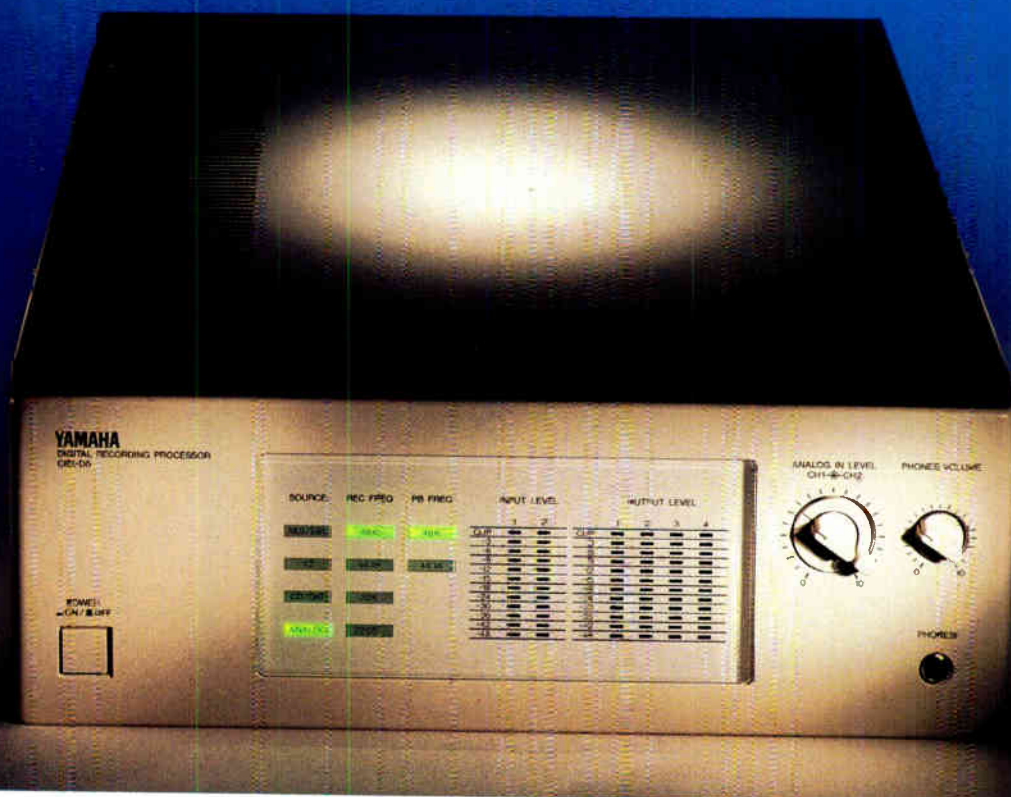

If you're thinking about hard disk recording, you've probably heard that you'll need to buy a bigger, faster computer, with more slots and accelerators, that will end up costing you a whole bunch of money.

Until today!

The new Yamaha CBX-D5 Digital Recording Processor, developed in cooperation with premier hardware and software designers throughout the world, can be immediately interfaced with the most popular and affordable computers being used today. This impressive list includes Atari (ST, TT, and the new Falcon), Apple Macintosh (SE30, all II models, Quadras, and PowerBooks), IBM PS2, and even clones running Microsoft Windows 3.1.

The CBX-D5 system was designed to let your computer compute and your storage devices store while the CBX-D5 handles the processor-intensive work. The CBX-D5 controls digital multi-track recording, analog-to-digital and digital-to-analog conversions, digital audio routing, digital signal processing and digital equalization, digital inputs and outputs in all standard formats, word clock synchronization, MIDI, and much more.



Cooperative design input from companies such as Mark of the Unicorn, DynaTek, and Steinberg made this all possible. The CBX-D5's modular format also provides a logical upgrade path with the ability to add more tracks, more storage, and more computing power without disrupting, scrapping, or obsoleting the rest of the system.

See the Yamaha CBX-D5 Digital Recording Processor in action at your local Yamaha Dealer or call 1-800-932-0001, extension 500 for more information.

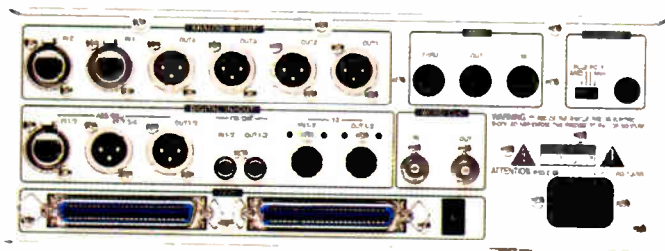

Detail of back panel

Yamaha Corporation of America, P.O. Box 6600 Buena Park, CA 90620 714-522-9011
 ©1993 Yamaha Corporation of America. All brand and product names are the trademarks of their respective holders.

YAMAHA

USE READER SERVICE CARD FOR MORE INFO



OTARI'S NEW CONCEPT I: A 48 INPUT, DIGITALLY CONTROLLED, AUTOMATED CONSOLE FOR UNDER \$55K!

- ✓ All digital routing with active block diagram
- ✓ Dual path signal flow -- each with 4-band E.Q. and 100 mm fader
- ✓ Integrated fader and mute automation
- ✓ Programmable master status switching
- ✓ SMPTE and MIDI-based snapshot switch automation
- ✓ 10 Aux send buses
- ✓ Soft keys on each module
- ✓ CompuCal™-digital calibration system
- ✓ 48-96 automated inputs in three mainframe sizes

All this for under \$55K!

What a Concept!

Call Otari 1-800-99CONCEPT
(1-800-992-6623).

OTARI

Otari Corporation
Foster City, CA
(415)341-5900
Fax: (415)341-7200

USE READER SERVICE CARD FOR MORE INFO

Otari Corporation
U.S.A.
(415) 341-5900
Fax: (415) 341-7200

Otari Inc.
Japan
(0424) 81-8626
Fax: (0424) 81-8633

Otari U.K. Ltd.
Technical Center United Kingdom
(U.K.) 44-0753-580777
Fax: (U.K.) 44-0753-542600

Otari Deutschland GmbH
Sales and Marketing Europe
(Germany) 49-2159-50861
Fax: (Germany) 49-2159-1778

Otari Singapore Pte., Ltd.
(65) 743-7711
Fax: (65) 743-6430

POST NOTES & PRODUCTS

Projects: Alan Ett Music, Burbank, CA, is in the midst of expanding to the west side, expecting to open two new rooms and a pre-production space. Recent projects for the composer/producer range from the theme for TV's *How Did They Do That?* to a new theme and music cues for *Tom and Jerry* cartoon remakes...John Alberts and Jay Vicari of John Alberts Sound Design (NYC) handled the audio post for a number of recent MTV *Unplugged* sessions, including Rod Stewart, Neil Young and Denis Leary. Alex Coletti produced...Master's Workshop, the Toronto-based audio post house, received its seventh straight Golden Reel nomination, this one for work on Atlantis Films' *African Skies*. The company also received an Academy Award nomination for mixing the soundtrack for *Fires of Kuwait*, an IMAX film...Some local talent was in Atlanta's Doppler Studios recording ADR for the pilot episode of *Shenandoah*, a Civil War-era historical drama. Jeff Harstedt produced for CBS, with engineering by Curt Bush, assisted by Dennis Johnston...Michael Aharon, a partner in Philadelphia's Maja Music (the music production arm of Sigma Media Center, owners of Sigma Sound), scored the Academy Award-nominated documentary film *Beyond Imagining's*, based on the life of literary revolutionary Margaret Anderson... At Russian Hill Recording

in San Francisco, engineer Jeff Kliment recently recorded ADR for Philip Kaufman's *Rising Sun*, a summer film based on the Michael Crichton best-seller. Kliment was also recording Robin Williams' voice for an upcoming 20th Century Fox feature film...Mike Moore of Smoke Eater Studios (Inkster, MI), recently cut vocals for a video project with the cast members of the play *Steps*. Craig Carnell was executive producer...A cooperative venture between software company General Magic, AT&T, Sprint, Sony, Motorola, Philips, Xerox, IBM and Apple, called The Alliance, will address the issues surrounding technology standards for the consumer...Patrick Fitzgerald of Music Annex recently handled a massive auto-conform, mix and layback for the group's 20-minute promotional tape, titled "February 8th and Beyond"...

People: Bob Orban was honored in March with a Scientific and Technical Award from the Academy of Motion Picture Arts & Sciences. The Oscar comes for Orban's development of Dolby Laboratories' Container, a stereo 5-band processor. The original research was for AKG's Optimod processor...Solid State Logic has appointed Steve Rainford as Digital Products Training Manager, based out of its New York office. The new position is in re-

sponse to the needs of a growing base of Scenaria and

ScreenSound users...

Sync Sound, NYC, recently hired Tony Pipitone as a sound editor...Charles P. Meister, recently at RKO Pictures, has been hired as director of marketing for Intermedia Partners. Intermedia is the parent company of Soundelux Hollywood, Soundelux Florida and The Mind's Eye in N. California...Steven A. L'Heureux has been named manager of North American sales for the Cineon digital film system developed by the Motion Picture and Television Imaging business unit of Eastman Kodak Company...

Facilities & Equipment: Studio Management and Investors Ltd., owners of Hollywood Recording Services, acquired DB Sound Studios of New York on the first of the year. The partner facilities will be connected by digital land lines, allowing for 8-channel digital audio to and from each location... Sony Notes: Hollywood-based Fox Tape installed three new Sony component digital edit bays, including DVS-8000C digital switchers, BVE-9100 editors and 12 BVW-D75 Betacam SP recorders with component digital ins and outs. Also, Power Station and Magnetic Image in NYC took delivery of D2 composite digital recorders, as did Encore Video of Los Angeles...Sound Techniques, a Boston

post facility, has added a fourth room to house its new SSL Scenaria. The Scenaria complements the facility's two ScreenSound systems and SSL 4056 G Series console...Meanwhile, Sound Services Inc., the Hollywood facility that puts out high-profile film trailers and broadcast commercials, purchased three ScreenSounds...Neve Flying Faders automation is being retrofitted to two SSL 5000 film consoles at Skywalker Sound, San Rafael, CA...Studio 5 Recording, Bellevue, WA, recently added a Wave-Frame 401 (now supported by Digital F/X), the first of its kind in the Puget Sound area...Four Crown Macro-Reference amplifiers now power the Daryl F. Zanuck screening theater at 20th Century Fox in Hollywood. Engineer Jay Palmer says he's never heard such a clean 20Hz sound before...

And finally: The International Television Association will hold its 25th annual conference June 2-5 at the Phoenix Civic Plaza in Phoenix, AZ. Call (214) 869-1112...Corbell Publishing has released the premiere edition of the *Pre-Recorded Video Suppliers Directory*, listing facilities and suppliers across the U.S. Call (310) 821-6675.

FAIRLIGHT TOWER

Unveiled at April's NAB convention in Las Vegas was the Tower from Fairlight ESP of Sydney, Australia. The Tower is a disk-based audio post-pro-

Professional Audio for the Northwest United States

AUDIO Images

- Audio for Film and Video
- Multi-Track Recording
- Digital Audio Workstations
- Sound Reinforcement
- Computer Music Systems
- Tape and Accessories

70 Oak Grove Street, San Francisco, California 94107
Tel: (415) 957-9131 • Fax: (415) 957-1531

550 Mercer Street, Suite 130 Seattle, Washington 98109
Tel: (206) 285-9680 • Fax: (206) 283-9744

Davis Business Center 4370 N.E. Halsey Street
Portland, Oregon 97213
Tel: (503) 295-5948 • Fax: (503) 386-4062

USE READER SERVICE CARD FOR MORE INFO

WhisperRoom^{INC} MUSICIAN'S ISOLATION ROOMS

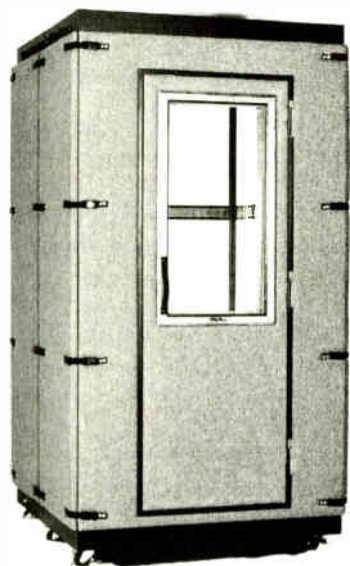

Various Sizes ★ Portable ★ On Wheels
Assemble/Disassemble in Minutes
Quiet Ventilation System
Endorsed By: RCA/BMG Studios, NY
Tel. (615) 585-5827 ★ Fax (615) 585-5831
116 S. Sugar Hollow Rd. ★ Morristown, TN 37813

duction editing system in a compact, floor-standing unit, expandable to 24 tracks. Offering all the standard features of Fairlight's MFX2 system (except sampling), a basic Tower system is priced at \$49,000 in an 8-channel/12-track configuration. Operation is via the same high-speed,

THE FILM GROUP

TCD-D3 SYNC UPGRADE

For \$650, the Sync Upgrade from The Film Group (Wethersfield, CT) turns the Sony TCD-D3 DAT recorder into a completely functional film sync

TCD-D3 DAT with sync upgrade



mouse-free console and graphic interface used in the MFX2. An optical disk option allows a 12-track project to reside on a single removable disk.

Circle #190 on Reader Service Card

BMKS MACSPOTTER

MacSpotter from BMKS (El Cerrito, CA), is a Macintosh software program for ADR information management. Designed to spare sound editors the drudgery of endless retyping, MacSpotter allows a user to print cue lists for dialog recording, as well as master lists that show the number of lines per character for each reel. Lists can be sorted by character or time, with the ability to move scenes between reels; time is displayed in feet/frames or SMPTE time code.

Circle #191 on Reader Service Card

FIBER OPTIONS SERIES 240B

Designed for the simultaneous routing of stereo audio and video signals over fiber-optic cable within production facilities is the Series 240B transmission system from Fiber Options (Bohemia, NY). A complete 240B system consists of compact transmitter and receiver units and is available in modular or rack-mount versions.

Circle #192 on Reader Service Card

recorder, enabling the D3 to transfer material from digital cassettes to other formats in total sync and providing it with a precise internal time base clock. A video interface cable provides connection to any video signal for synchronization, while an AC reference generator is included to genlock to the AC line current of a synchronous film recorder. The upgrade fits into a 1/2-inch case that attaches to the bottom of the D3; the retail price includes installation of the upgrade as well as the video cable and the AC reference generator.

Circle #193 on Reader Service Card

SUNRIZE SMPTE OUTPUT

Sunrize (Campbell, CA) introduces SMPTE Output software for generating longitudinal 24, 25, 29.97 and 30 fps time code using a Commodore Amiga computer. The program can lock to the sync pulse of each video frame when used with a genlock or Video Toaster to provide accurate TC generation. Features include Drop-Frame and Non-drop modes; multiple reset points; and Fast Forward, Rewind, Play and Pause buttons. SMPTE Output runs on models A500 and up, with at least 1 MB of RAM, and can be used alone or as an expansion module for the Studio16 audio editor. ■

Circle #194 on Reader Service Card

by Chris Stone

RECORD COMPANY RELATIONS

OPERATOR TIP OF THE MONTH:

Your greatest tools to get and keep the attention of record companies are the phone and the fax. It is a verbal business. It is a “give-me-an-update-every-day” business: Today is what matters.

When I opened the Record Plant studios in the late '60s, the vast majority of our work was for record companies, and those budgets were quite lucrative for many years. As times changed, and business became more challenging, record companies became less and less a meat-and-potatoes part of our studio's recording business. In fact, today many studios do just fine, thank you, without ever having contact with a record label.

But for those studios whose hearts and minds are motivated by the joys of music recording, it pays to be sensitive to the subtleties involved with building and maintaining relationships with record companies.

To be successful, you have to deal with them because they pay the bills, in many cases, for the artists and producers/engineers who make the choice to record in your facility. It requires a multitude of skills and diplomacy to forge and maintain a relationship with these decision-makers who have the veto power over whether or not *their* artist works with you.

If you ask a label A&R person or an A&R administration person to describe the process that makes them feel comfortable with your studio, inevitably you will hear the term “reputation.” By that they mean they trust you to charge a fair price for the service you perform, and that it will be done on-time and on-budget, and up to their technical standards. This

will put your studio on their “approved” list, along with your competition, for a particular budget level of artist. There are certain basic axioms that almost always apply:

1. You have the right equipment that works all of the time within spec, and you have the right people available to quickly fix it if, God forbid, it should stop working. Nothing sours a label faster than late starts, breakdowns or inadequate tech maintenance. Few things make them happier than to compare your studio's sound with a tape from another, much more expensive studio and decide that your studio sounds better.

2. You know how to help them juggle all of the egos involved in making a record within the arena of your studio. The artist, the manager, the producer/engineer and the A&R person (who is the project manager for the label) all must be kept happy, or you will definitely hear about it. The A&R administration person gives you a purchase order and processes the necessary approvals of your invoices so that you will/may get paid. You learn quickly to keep all of those people happy, or you don't get the next project.

3. You *never* spend their money without their permission. The artist will always want “stuff” to feel more comfortable, or a special piece of gear (which you don't own and have to rent) in the middle of the night

when there is no A&R administration person to give you authorization. If you fall into this trap, you will lose a great deal of money.

4. The atmosphere of your studio and the attitude of your people will go a long way to cover up small mistakes. The artist is there to make music, and if he or she does it better, faster and for less money than your competitor down the street, you win. This is still a word-of-mouth business, and a lower price than the competition is only one important factor that

will be considered. The big key, once you get the business in the door, is the comfort level of the creative people.

Why else do studios have games, jacuzzis, and free food and drink? A comfortable artist makes better music. An uptight artist makes no music at all. Your studio is judged by the myriad of occurrences that cause good or bad music to be made. How much "trouble" the client had in your studio is the measure of whether you won or lost. The key question in your mind should be whether the artist/producer/engineer/A&R people want to come back for their next

record? Will they tell other people who do what they do that they had a good experience at your studio?

Once you have established your reputation, then the social interaction of maintaining the relationship with the label begins. If they don't know who you are or the quality of the music that comes from your studio, there is very little you can do except give the time away. As Rose Mann, the rarely disputed queen of the "happy bookers" says, "If you don't hang out and keep calling them until you get them into your rooms, they ain't gonna make their record with you. It's like having a baby. You want people who care about you around all the time until it's born, then it is all yours! It is the balance between the creative and the business side of your studio; you have to have them both together all of the time, or the client will go to your competitor."

Forge and maintain: You have to do it your own way, but some of the starters are just common sense. Hang out—at clubs, concerts and music industry events—any place you can meet and greet the clients you seek. This does not have to cost a lot of money. That comes later, after the personalities you have coveted and won feel that you owe them something. Mail your literature and any PR you can get to them so that they become familiar with your studio's name.

Meet and greet: Follow your phone call or mailer with a short visit—or another phone call if you don't live near them—to introduce yourself and to ask the A&R guys and gals if you can improve the services your studio is providing them. They want to see and speak to a person and learn about any news or changes of what is going on in the recording studio world.

One of the most important reasons you are in the studio business is that you believe your facility can make better music than the others in your market. Getting your reputation together and maintaining the relationships you make with the record companies through reliable, caring service and your personal exposure to them will be the factors they will demand before they allow you to make *their* music. ■

Chris Stone, a former studio owner and consultant to the pro audio business, is president of the World Studio Group, a global studio-booking agency.

M-1 MICROPHONE PREAMPLIFIER

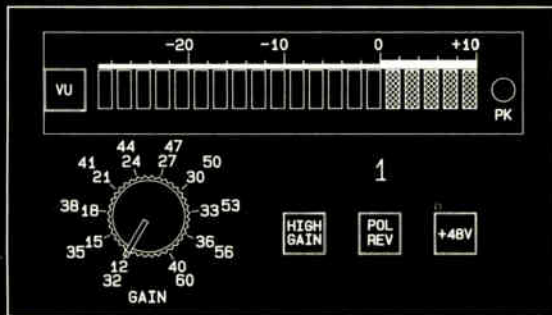

(ACTUAL SIZE)

"No comparison!" "Whoa!" "Even the producer could tell the difference!" A few typical comments! The M-1 is clearly superior. Here's why:

The JENSEN JT-16-B INPUT TRANSFORMER, IMPROVED!
The world's best mic-input transformer, now even better!

THE 990 DISCRETE OP-AMP. The 990A-24V is far superior to the monolithic op-amps found in other equipment.

DC SERVO and INPUT BIAS CURRENT COMPENSATION
eliminate all coupling capacitors and degradation they cause.

Standard equipment: illuminated push-buttons, shielded toroidal power transformer with 6-position voltage selector switch, silver plated XLRs, ground-lift switches, phantom power, polarity reverse and gain controls. Options include the Jensen JT-11-BM output transformer, VU-1 meter (shown), PK-1 meter, gold plated XLRs.



THE JOHN HARDY COMPANY

P.O. Box AA631
Phone: (708) 864-8060 Evanston, IL 60204 Fax: (708) 864-8076

CIRCLE #250 ON READER SERVICE CARD FOR MORE INFO

Compatibility Proven on National TV-PRO* → Circular Sound Placement, Seamless Movement, Spatial Expansion, Eliminates Spatial Masking* Recovers Lost Clarity* New Studio Compatible Production Tool* Affordable

Expandable to 24 Inputs * Mono. Real-Time, Multi-Track, 3-D Joystick Operation * Modular Design



SPATIALIZER

WHAT IS SPATIALIZER?

Spatializer is a real-time three-dimensional processor that allows placement, movement and scaling of individual tracks in space from two loudspeakers. The recording engineer has dimensional control of near/far, front/rear, and scale/size of the stereo image by intuitive joystick adjustments. **Blow Your Mind, Not Your Budget!**

Contact Audio Intervisual Design
213 845 1155

Spatializer is a registered trademark of Desper Products Inc.

Patents pending
© 1992

USE READER SERVICE CARD FOR MORE INFO



by Philip De Lancie

MASTERING AND MO

SONY'S PCM-9000 BRINGS PROGRESS—AT A PRICE

It's been about 15 years since Sony and others began promoting the use of video-style recording technology for digital audio. Overall, the approach has been fairly well-accepted, as evidenced by the adoption of the PCM-1610/1630 format as the standard for CD masters and the widespread use of PCM-F1 and then DAT machines in studio and location recording applications.

Despite their infiltration into the world of audio, however, these ro-

lifespans of the ½-inch U-Matic masters it produces. And although both insert and assembly editing are supported on the DMR-4000, the tape itself (as with any cassette-based format) may not be physically edited. So there is no way short of retransferring a program to resequence a recorded master or change the amount of time between selections.

The 1630 format gets the job done, and it is a universally accepted standard. That alone is a major asset in a world full of competing formats. But the format is used with more resignation than enthusiasm as engineers wait for something better to come along.

Both DAT (with time code) and CD-Recordable have been suggested at one time or another as possible replacements for the 1630 format in CD-premastering applications. CD-R, particularly the PreMaster CD variant developed by Sonic Solutions, even enjoyed the apparent support of Sony's own U.S. CD plant, Digital Audio Disc Corporation (see "Tape & Disc," February 1992). But Sony in Japan evidently had its own ideas. The company has unveiled its own vision of the future—not only of CD premastering but of 2-channel recording in general. The device is a magneto-optical disc recorder dubbed the PCM-9000.

Product manager Art Gonzales cites two main motivations for Sony's development of the new machine: replacement of the PCM-1630 for CD and MD premastering/mastering use, and development of a very high-quality 2-channel recorder. The device is appropriate, he says, for "any application where the very high quality of a 20- or 24-bit recorder is required. Obviously, a budget studio isn't going to run out and buy one of



The right side of the PCM-9000's front panel is removable, to double as a remote controller for the unit. Not shown are optional plug-in cards (20-bit A/D and D/A converter, serial remote/time code interface, SDIF-2 digital I/O, DAQ-1000 interface, SCSI interface and memory expansion board) that allow the user to configure the PCM-9000 to suit various specialized applications.

tary-head tape recorders are not without their frustrations for engineers who use them. The PCM-1630/DMR-4000 combination used in CD and MiniDisc premastering and cutting, for instance, is well-known for the relatively high reject rate and short

Go forth and multiply.

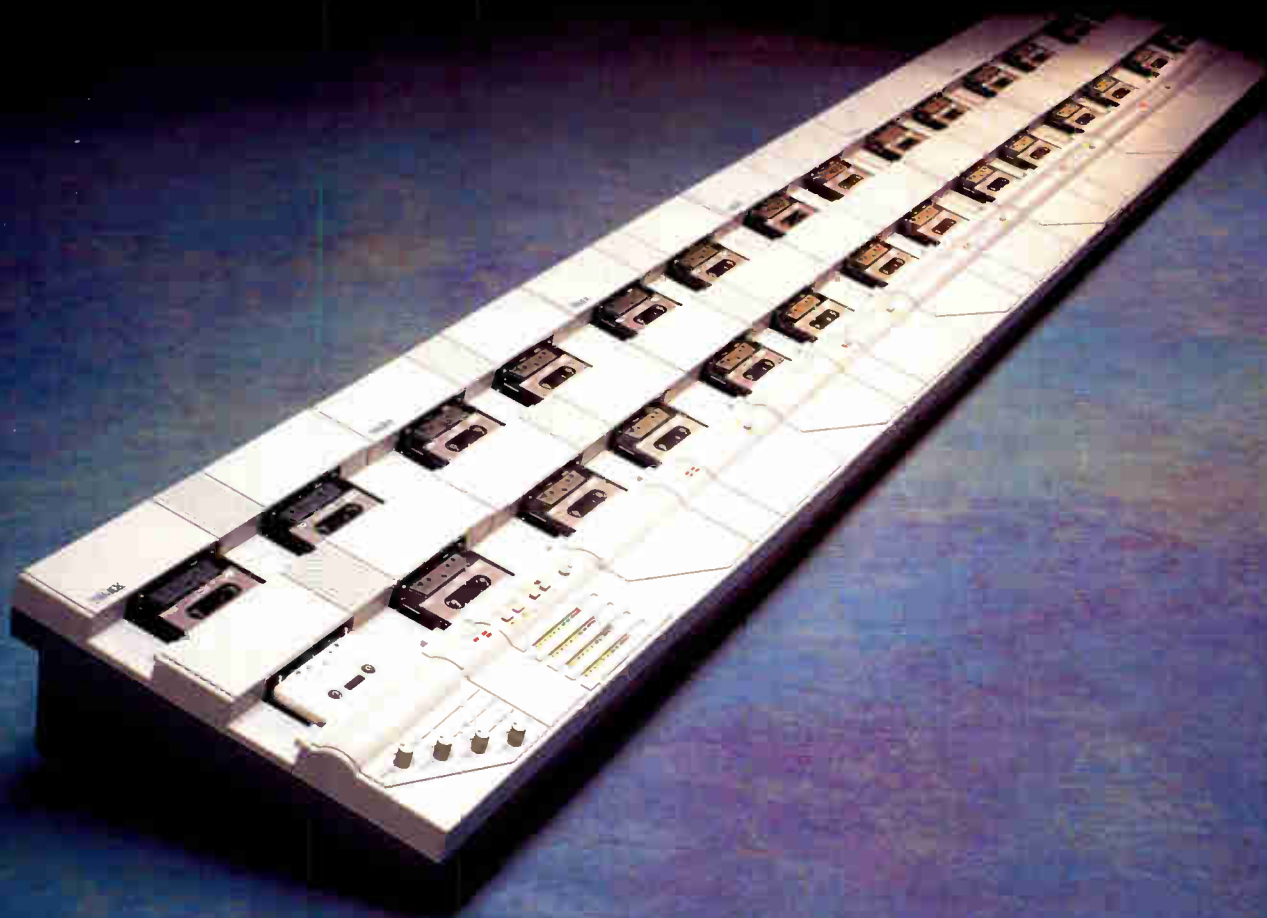

Introducing our new ACC Series: a high performance, easy-to-use line of cassette duplicators that offer better specs and expandability than any product in their class.

Available in 1/4 track (stereo) or 1/2 track (mono), these compact, lightweight units copy both sides of a cassette at 16 times regular speed. The control units can duplicate three cassettes at once, while the

copying units can handle four. And they're so easy to operate and clean even "non-techies" can do it.

Find out all the ways we keep ahead of our competition. Ask your dealer for more information about the ACC Series, or call Telex at 1-800-828-6107.

After all, we may be the leader in audio duplication, but we didn't get there by copying someone else.

The ACC Series Control Unit.



TELEX®

Dual Domain Audio Testing

Don't Take Chances



We have a System that works. System One from Audio Precision

In studios and labs, on benches and factory floors, in stations and networks, thousands of System One Audio test systems around the world attest to the fact that this is the System that works. Hardware and software refined to match the application produce both superior performance and superior reliability as demonstrated by our three year warranty on parts and labor.

THE RECOGNIZED STANDARD

System One is known the world over as the recognized standard in audio test and measurement. Component suppliers, manufacturers, equipment reviewers, and end-users all rely on Audio Precision for measurement quality they can trust.

COMPREHENSIVE & FAST

System One is a completely integrated digital and analog audio test system. By combining all the necessary instruments into one package System One provides higher performance at lower cost than conventional instruments. In addition, System One can grow with your needs. Your initial purchase of a basic System One allows you to add any option later.

Optional FASTTEST & FASTTRIG DSP capabilities test any audio channel, producing 160 measurements from a stimulus signal less than one second in duration. Options such as input and output switchers and the DSP-based FFT and digital domain modules make "one-stop" audio testing easy.

EASY TO USE

Straightforward features and stored sample audio tests make System One easy to use. Color graphic test results also may be copied to printers and plotters.

GO/NO-GO testing against limits and test sequencing with automated procedures save time and repetitive motions.

HIGH PERFORMANCE

New digital and analog technologies leave yesterdays "good enough" performance far behind. System One easily handles high performance challenges such as state of the art analog preamps or digital recording systems.

The integrated System One offers premium specifications and performance, but at no premium in price compared to lesser test sets or equivalent separate instruments.

Our worldwide force of Audio Precision representatives will be pleased to provide further information and an onsite demonstration.



Audio precision

P.O. Box 2209
Beaverton, OR 97075-3070
503/627-0832, 800/231-7350
FAX: 503/641-8906

USE READER SERVICE CARD FOR MORE INFO

INTERNATIONAL DISTRIBUTORS: Australia: IRT Electronics Pty. Ltd., Tel: (61) 2 439 3744 Austria: ELSINCO GmbH, Tel: (43) 222 815 04 00 Belgium: Trans European Music NV, Tel: (32) 2-466 5010 Bulgaria: ELSINCO, h.e. Strelbishte, Tel: (359) 92 581 698 Canada: GERRAUDIO Distribution, Tel: (416) 696-2779 China, Hong Kong: A C E (Int'l) Co. Ltd., Tel: (852) 424-0387 Czech Republic: ELSINCO Praha spol. s r.o., Tel: (42) (2) 4702 1. 451. 452 Denmark: nbn Elektronik aps, Tel: (45) 86 57 15 11 Finland: Genelec OY, Tel: (358) 77 13311 France: ETS Mesureur, Tel: (33) (1) 45 83 66 41 Germany: RTW GmbH, Tel:(49) 221 70 91 30 Hungary: ELSINCO KFT, Tel: (36) 112 4854 India: HINDITRON Services PVT, Tel: (91) 22 836-4560 Israel: Dan-El Technologies, Ltd., Tel: (972) 3-544-1466 Italy: Audio Link s.n.c., Tel: (39) 521-598723 Japan: TOYO Corporation, Tel: (81) 3 (5688) 8800 Korea: B&P International Co., Ltd., Tel: (82) 2 546-1457 Malaysia: Test Measurement & Engineering Sdn. Bhd., Tel: (60) 3 734 1017 Netherlands: TM Audio B.V. Tel: (31) 034 087 0717 New Zealand: Audio & Video Wholesalers, Tel: (64) 7 847-3414 Norway: Lydcorsult, Tel: (47) 9 19 03 81 Poland: ELSINCO Polska sp. z o.o., Tel: (48) (22) 39 69 79 Portugal: Acutron Electroacustica LDA, Tel: (351) 1 9414087 / 9420882 Singapore: TME Systems Pte Ltd., Tel: (65) 298-2608 Slovakia: ELSINCO Bratislava spol. s r.o., Tel: (42) (7) 784 165 South Africa: SOUND FUSION, Tel: (27) 11 477-1315 Spain: Telco Electronics, S. A., Tel: (34) 1 531-7101 Sweden: Tal & Ton Elektronik AB, Tel: (46) 31 80 36 20 Switzerland: Dr. W.A. Gunther AG, Tel: (41) 1 910 41 41 Taiwan: ACESONIC Intl Co., Ltd., Tel: (886) 2 719 2388 United Kingdom: SSE Marketing Ltd., Tel: (44) 71 387-1262

World Radio History

these. But high-end studios can use it to replace analog recorders, DAT or 2-channel DASH machines. The PCM-9000 is certainly a contender for that very high-end market."

Unlike the 1630/DMR combination, the PCM-9000 is housed in a single 19-inch rack-mount unit, three rack units high (see photo). About half of the front panel is made up of a removable remote, which features transport controls and other control functions.

MO RECORDING

At the heart of the PCM-9000 system is the magneto-optical drive. The PCM-9000 uses a process similar to that used in the MiniDisc. MO discs contain a layer of magnetic particles oriented perpendicular to the plane of the disc. The discs are "pregrooved," providing a spiral track for the record/playback optics to follow. As the disc turns during recording, particles are rotated under a spot at which the record laser beam is focused. The beam heats this spot to a temperature above the "Curie point" of the particles, which means the particles become thermally excited, and their pre-existing north/south orientation is erased.

At this point, the particles are susceptible to orientation by a mild magnetic field. On the PCM-9000, this field is provided by a magnetic head capable of nearly instantaneous magnetic flux reversal corresponding to 1s and 0s in the digital signal stream. As the particles rotate out of the record laser beam, they cool below their Curie point, and the magnetic orientation imparted by the magnetic head is "frozen" in place.

During playback, the disc is read using a phenomenon known as "Kerr rotation." When light from the laser (in Read mode) is reflected off the magnetic particles, the plane of the light's polarization changes depending on particle orientation. This is in contrast to the CD system, in which the pickup reads variations in the amplitude of light as it is reflected from molded pits and "land" area.

This difference in the way the two types of pickups work means that MO discs, even if they were to be made the same size as CDs, cannot be read by CD players. So in a mastering context, an MO system could not be used to provide clients with

reference CDs the way a CD-R can. But the advantage of MO is that, unlike CD-R, it is rewritable. The process of heating and orienting the magnetic layer can be repeated hundreds of thousands of times without wearing out the disc.

MO recording has been used for years in the computer industry. But the PCM-9000 differs from data-MO drives in several important respects, starting with the use of Constant Linear Velocity rather than Constant Angular Velocity. According to Gonzales, CLV allows more efficient storage of data.

Using CLV, Sony is able to fit 1.3 Gigabytes of data on a single-sided 133mm (5¼-inch) disc. (Data-MOs are double-sided.) That works out to a

audio recorder. "It has a Record button and a Play button," says Gonzales, "and it is just like a tape machine. You can do sync record, individual-channel recording or dual-channel recording." In this mode, the PCM-9000 can be considered for any 2-channel recording application, including studio mixdown.

Recorded material may be edited on the PCM-9000 in Program mode, which is similar to the nondestructive editing performed by digital audio workstations. In effect, the user creates a playlist that tells the machine in what order to play data off the disc. "Program mode allows you to change the order of the selections," Gonzales says, "and also to mark the beginning of the program for CD. You don't need

any external editor to do this. This is all done on the machine itself, using the remote.

"When you record," Gonzales explains, "the machine automatically generates an in point and an out point. Later you can go back and mark a new begin point and end point without actually altering the part of the program that you don't really want. All it does is change the Table of Contents information." Crossfades between segments are fixed at ten mil-

liseconds.

"The disc itself stores not only the audio data," Gonzales says, "but also the TOC and edit information." Up to nine edit information files may be stored on disc. This information is protected with a separate write-protect tab in addition to that used for the audio.

Because the playlist is an integral part of the content of the disc, Gonzales says that CD plants will be willing to cut glass masters from discs that are nondestructively edited. But there will also be the option, once the playlist has been finalized, of using the Optimize mode to erase unwanted material and defragment data remaining on the drive.

Facilities equipped with two PCM-9000s may wish to transfer portions of a program from one disc to another to create a final CD master. This is accomplished in Program Copy mode (Fig. 1). "You can either transfer just the audio data," Gonzales

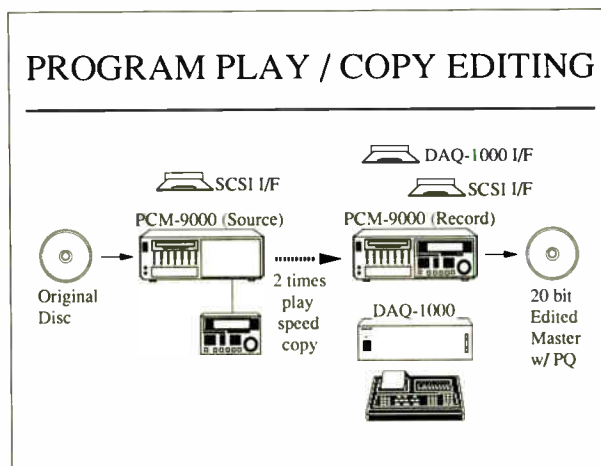

Figure 1

capacity of about 100 minutes of 16-bit PCM audio, 80 minutes of 20-bit or 65 minutes of 24-bit. Gonzales says that Sony, based on accelerated aging tests, gives "more than ten years" as the typical expected life of recorded media, though the company actually expects the figure to be closer to 30 years under "real-world conditions." The disc is housed in a cartridge, measuring 143.7x160.5x10.9 mm, which is keyed to prevent inadvertent insertion into a data-MO drive.

OPERATIONAL MODES

Because of the multiple uses envisioned for the product, Sony has designed the main unit as a base device only, with optional cards required to make the system work in a particular setting. The company probably will market various common configurations including all the options needed for specific applications.

In its simplest form, the device is used in Normal mode as a linear

by Philip De Lancie

DUPLICATING DCC

DCC PLANTS ON POST-LAUNCH PRODUCTION

A certain excitement generally fills the air as a major new entertainment format makes its way from the drawing board to the marketplace. In the case of DCC, there was considerable speculation about how good the format would sound, how well it would work, who would support it, how tapes would be duplicated, and how it would affect other configurations like analog cassettes and CDs.

In the midst of all this anticipation, complicated by the near simultaneous appearance of MiniDisc, the race to launch date seemed dramatic. Now that both formats are launched, however, there comes a period of waiting, which is more than a little anticlimactic. Most reasonably well-financed devices don't sink or swim overnight; it may take years for a product to find wide acceptance or slowly fade away. Progress (or lack thereof) is incremental, taking place in the showrooms of the consumer electronics retailers and record stores.

Because the post-launch era has barely begun, record labels are still in the process of getting titles duplicated and into the stores, relying on the handful of duplicators that committed early to DCC. The ability of those duplicators to make working DCCs consistently and efficiently under production conditions is one indicator of the format's long-term viability. Another is the extent to which their duplication capacity is currently in demand.

All three DCC duplication facilities in the U.S. get their tape stock from one (the only) supplier: BASF. According to BASF's Terry O'Kelly, "Tape usage is small as far as sales of pallets of pancake material. The record stores are not really sure if they want to stock DCC, or how much they

want to stock at this point. But we are not surprised, because we know it is very early in the career of this format. This is what we expected."

O'Kelly says he will know that the market has moved up to the next level "when we start selling multiple pallets to customers every month.

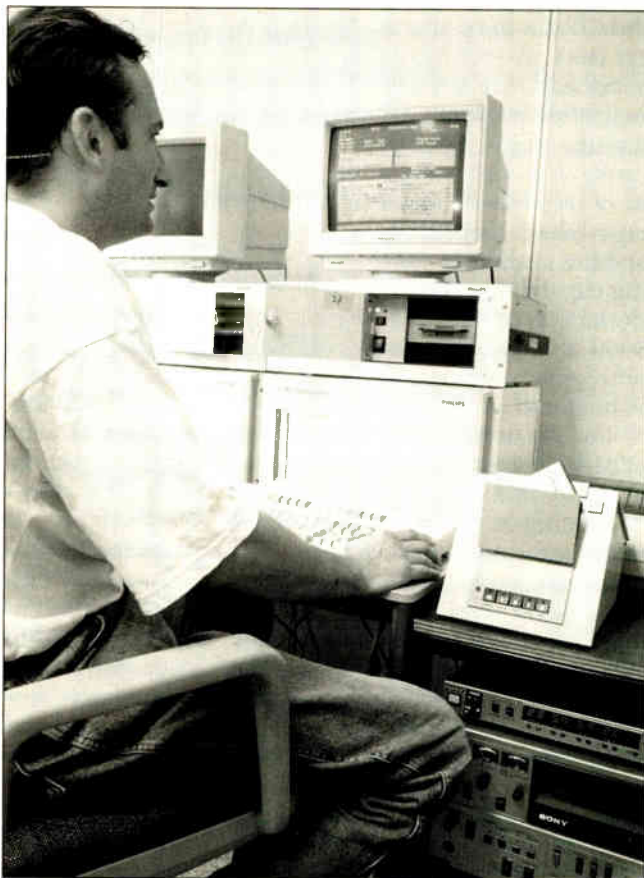

DCC mastering station

That would be significant. It's hard to say whether the demand is going up right now. It is still too early, and we don't yet have a track record to see whether or not there is a dramatic increase from one month to the next.

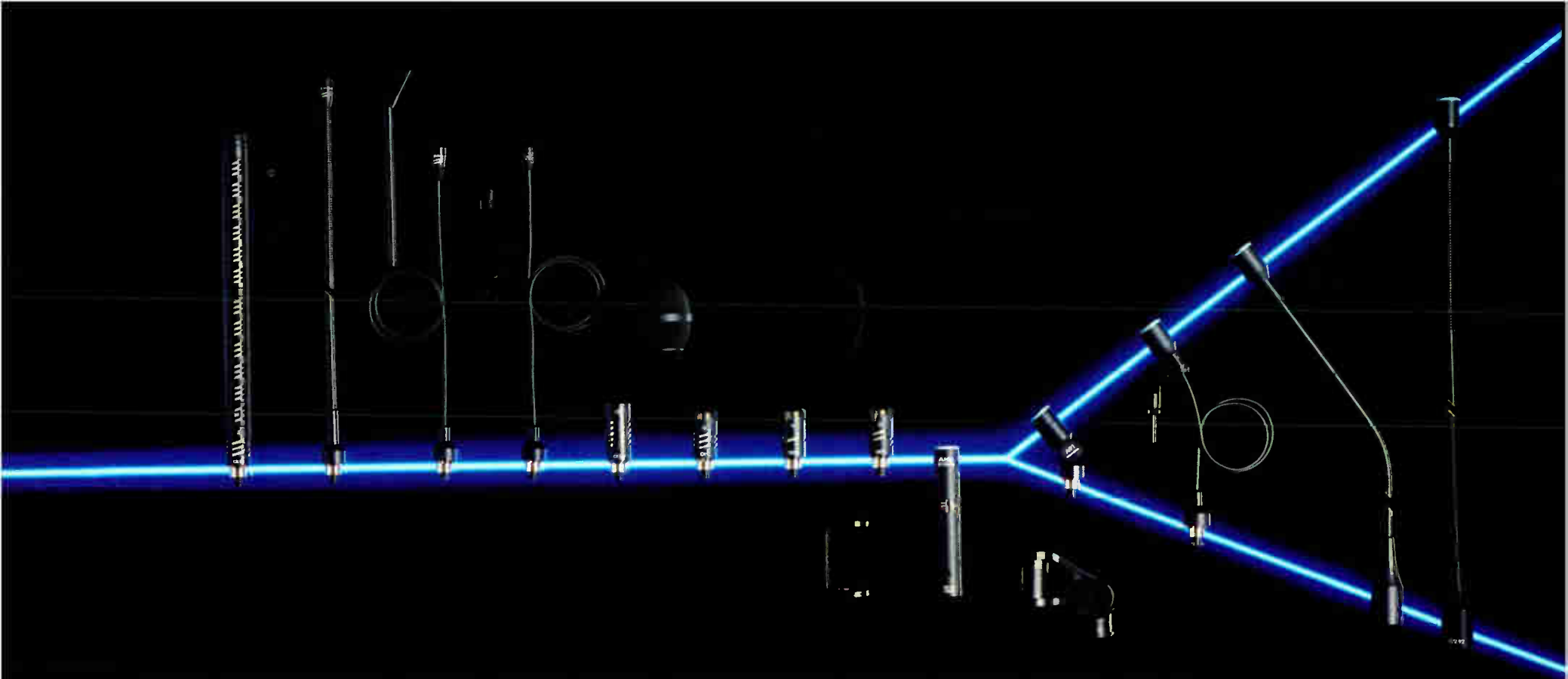

Blue Line.

The Newest Modular Microphone Family from the Leader in Condenser Microphone Design.

Every polar pattern, every configuration you'll ever need, interchangeable in seconds.

All with the rugged construction, precision craftsmanship and impeccable audio quality

that are unmistakably AKG.



AKG Acoustics, Inc. 1525 Alvarado Street, San Leandro, CA 95477 510/351-3500
© 1992 AKG Acoustics, Inc. AKG is a registered trademark of Akustische u. Kino-Geräte Ges.m.b.H., Austria.

USE READER SERVICE CARD FOR MORE INFO
World Radio History

It is just a slow process. At this point a pallet could hold somebody almost a month."

BASF sells its DCC stock in pancakes of 10,800 feet, with 936 pancakes per pallet. That works out to about 26 45-minute tapes per pancake, or 24,000 tapes per pallet (assuming 100% yield). A pallet or so per month for each of the three plants translates into an infinitesimal amount of production for a duplication industry that produced 1 million analog cassette albums per day in 1992.

To assess how duplicators feel about this nascent market and the experiences they have had so far in duplicating the format, *Mix* contacted Ron Anderson, manager of technical services at Cinram. The Canadian company announced plans last year to run a 2.5-million-unit annual capacity operation out of its U.S. plant in Richmond, Ind., where Anderson is based. We also spoke with Dean Wilson of BMG-owned Sonopress in Weaverville, N.C. With annual capacity set at 900,000 in pre-installation announcements, the Sonopress operation is less ambitious than Cinram's, but still represents a substantial investment. Wilson was involved in installation and continues to provide follow-up engineering.

Describe the DCC duplication system you are currently using for production.

Dean Wilson: We have one downloader unit, one four-deck slave to record four pancakes at once, one Tapematic loader, one QC test station, and one setup of the mastering equipment [see photo] and the PQ editor.

Ron Anderson: We have a couple of the four-deck Philips duplicators, a Philips downloader and Solid State Master, and Lyrec QC. Our loaders are a couple of Tapematic 2002s, which we modified in-house for DCC.

The loaders are outfitted with an air-bearing package, and the speeds are turned to the minimal point as a precaution against tape damage. You can't have any kind of edge damage due to tape contact with anything in the tape path, because your track width with DCC is only half that of the analog cassette.

Is your current system size sufficient for your current demand?

Wilson: Yes. We probably do 1,000

per shift, so about 2,000 per day running two shifts, five days per week. We could probably put out a maximum of 1,200 per shift. If we wanted to go higher than that, it would take another loader, or we could run the loader three shifts.

Those numbers are based on having only three of the four slave decks operating. We just expect to have one down for some reason or another. The way that PolyGram slave is built, if one deck goes down you either have to take the entire slave down to fix it, or just let it run with-

“DCC tape usage

is small, but

it is very early.

This is what

we expected.”

—*BASF's Terry O'Kelly*

out that deck. You can't repair the deck while it is running. So we wouldn't stop unless two decks were down.

Our bottleneck is our loader. Philips has had Tapematic slow the loader down considerably. It takes about a 17-second cycle time per DCC, compared to three to five seconds for an analog cassette. We have done experiments comparing the loader set at a real slow wind speed with it set as fast as it will allow us to wind. We did quite a bit of error monitoring both ways, and it doesn't seem to affect the tape.

Our other bottleneck is testing. We use the Lyrec QC machine to test pancakes before they are loaded and to calibrate the slave response levels and azimuth. They have a “quick-view” test where you put on the pancake, play it for 15 seconds and get a good idea of the quality of the pancake. So we catch a few bad pancakes that way.

After duplication, we use the Philips QC play units to do the error monitor reports. The tapes are already in the shell at this point. The QC deck

is a special machine that will read all 18 tracks at once. The deck hooks up to a computer. You can't hear the backward channel, but you can analyze it. We do a 100 percent check in real time of eight tapes per shift, maybe two from each deck of the slave. For some reason we get a better result error checking from those machines than we do checking the pancake after recording. So they still have a few bugs in the pancake test station.

Anderson: Capacity is very comfortable for the order size. We have been able to completely fulfill all of our clients' requirements. We have successfully duplicated and shipped all the orders on schedule.

What has your experience been as far as reject rates and yields?

Wilson: We get close to a 100 percent yield. Every now and then we have to scrap a pancake that we catch on quick-view before it gets loaded. I only know of a couple of times where we went back and scrapped a pancake after it was loaded. Most of our losses are just tape, after duplication but before loading. Once you get a good load into RAM in the Solid State Master, it goes pretty smooth.

Anderson: We've only been in production since December, and the rate is around four percent. That is high compared to analog. Analog rejection rate is under one percent.

One of the greatest concerns among duplicators before the launch was that the life of the thin-film slave heads would be very short compared to analog heads, perhaps as low as 200 hours. Has that been borne out by your experience?

Wilson: We are still on the first set of heads. Right now I think we have about 140 hours on our heads. We checked response today, and they are still all right.

Anderson: 200 to 300 hours was the information that Philips was giving last year. Initially, we were experiencing much shorter head life than that, less than 100 hours. Currently, the situation is getting better. We see head life currently at around 250 hours. It is not really because of anything that we are doing differently. All of our alignment procedures are the same, and we still maintain our head tension at the same place it was initially. It is just that Philips keeps improving the heads. They are perfecting the



MICHAEL JACKSON'S "BLACK OR WHITE"
MICHAEL JACKSON'S "REMEMBER THE TIME"
THE LAST OF THE MONICANS
CLIFFHANGER
AMERICAN TAIL, "FIEVEL'S PLAYLAND"
BORN ON THE FOURTH OF JULY
KONGFRONTATION, "THE RIDE"
JAWS, "THE RIDE"
E.T.'S ADVENTURE, "THE RIDE"
KEY WEST
GLORY
PURE COUNTRY
JFK
HOMER ALONE 2
BACKDRAFT, "THE ATTRACTION"
HOMeward BOUND: THE INCREDIBLE JOURNEY
ROGER RABBIT'S TRAIL MIX-UP

Music Suite A. Soundelux Florida

SOUNDELUX is a diversified audio production company, located in Orlando and Hollywood, dedicated to superior and innovative sound design and music for the motion picture, television, and theme park industries.

Soundelux depends on Peavey Audio Media Research equipment...from recording consoles and reference monitors to multi-effects processors and stereo studio amps.
Quality and innovation: Soundelux and Peavey!

PEAVEY®

Peavey Audio Media Research 711 A Street, Meridian, MS 39302-2898 Telephone: 601-483-5365 Made in the USA ©1993
USE READER SERVICE CARD FOR MORE INFO

STARR PARODI - COMPOSER, PRODUCER, ARSENIO HALL SHOW KEYBOARDIST

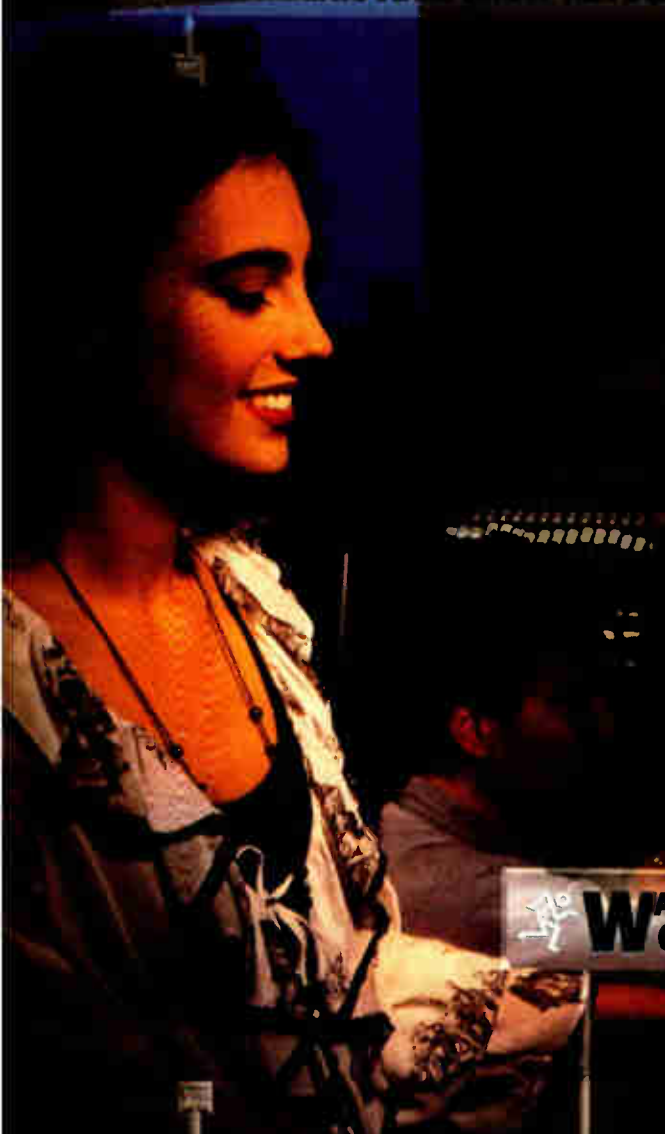

"On the Arsenio Hall Show, many groups want to reinforce live drums with sampled loops from master DAT or master CD. I like to

pump the volume of the samples high to get a big sound. When I do, the show's sound engineers come out of the booth and give me this 'you're doing it again' look...because the signal from the CR-1604 is so clean and hot that it regularly peaks their meters. Yet the T604 never distorts. High headroom and dynamic range are why Jeff and I use Mackies in our commercial production studio and on the road...most other compact mixers in this price range artificially color the sound. Incidentally, not only does the Arsenio Hall Show use a total of four Mackies, but it's also the mixer I see most often in the racks of groups that we have on the show."

WHY PROS PREFER MACKIE... PART ONE

Starr Parodi/Parodi Fair Productions: Film trailers and television: El Mariachi, Trespass, Extreme Justice, Prelude to a Kiss, Mississippi Masala, Straight out of Brooklyn, Graduation Summer, Livin' Large, The Edge, Fame; Commercials: Subaru, Arco, Chrysler, Coors Pure Water 2000, Paramount Theme Park, Better Homes and Gardens, Charter Hospital and many more. In addition, Starr has released a stunning debut album, "Change," with another coming soon.

Before you buy a 16-channel mixer, call us toll-free. You'll learn why successful professionals who can afford to own any compact mixer overwhelmingly choose the remarkably affordable Mackie.

WAYNE SHARPE - CINEMAX FILM AND COMMERCIAL SOUNDTRACKS COMPOSER



"My soundtrack for 'Welcome to the Max' was mixed direct to six discrete digital channels at Toyland Studios through three Mackie CR-1604 16-ch.

View from 10,000 ft above Manhattan as Max talks to earth from outer space. From Liberty Sciences signature film 'Welcome to the Max.' 1993 Rosalini Film Productions, Inc.

mic/line mixers combined via a MixerMixer. The producers wanted the cleanest possible sound and needless to say, the CR-1604s delivered as usual. I've used Mackies to produce my recent television commercials and movie soundtracks, and continue to be amazed at the sound quality that comes from such affordable mixers. I've also recommended CR-1604s to a lot of other musicians. All I can say is, 'Accept no substitutes.'"



Max is awaits his orders to be transported on his mission to discover the secrets of CINEMAX from the Liberty Science's signature film 'Welcome to the Max.' 1993 Rosalini Film Productions, Inc. Soundtrack by Wayne Sharpe.

Wayne Sharpe photo: Sheila Graue; Starr Parodi photos: Peter Eigen

ABOVE: Starr Parodi and husband/co-producer Jeff Fair in their home studio. Essential equipment includes Akai digital samplers, Panasonic DAT, eight Korg keyboards and of course, two Mackie CR-1604 16-channel mic/line mixers.

Wayne Sharpe: Film music for 70mm "Welcome to the Max," "Atlantis," "Geresene Demonic," Commercial scores for Revlon, Dristan, Cover Girl, NEC, Red Lobster and Hawaiian Punch national TV spots; MIDI consultant/programmer for Beach Boys, Tommy Shaw (Styx & Damn Yankees), Rick James, and others.

MACKIE.

WOODINVILLE WA USA 1-800-258-6883

OTHER DISTINGUISHED MACKIE USERS INCLUDE: CHESTER THOMPSON (GENESIS), SHEEN/ROSEN, LES LUTINS, SHIPP PETHRONI, FRANK PRISON, BAWIRI JOHNSON (WHITNEY HOUSTON), BRANFORD MARSHALLS, THE NIVILLE DUOS, JONATHAN MURPHY (BRAD PITT), BETTY TUGOLE (DAVID LEE ROTH BAND), MARK FEETWOOD, OMAR HAKIM ESTING, MADONNA, GREG WELLS (J.J. LAROC), KASHI, GARY DODMAN (HUGH JACKMAN), VERNIE CARLHART, BILLY MUGER, STEVE ROACH, BABE FACE (K-C MUSIC FACTORY), BLAS TRIAS (LAUGHTER), JOHN MATTHEW (CURRENTLY ON TOUR WITH ALABAMA) AND MANY OTHERS.

USE READER SERVICE CARD FOR MORE INFO

World Radio History

head more as time goes on.

We have done several head changes, so we have gotten a good feel for it. We have done a fair amount of production, enough volume to begin to get a feeling for the patterns of the production cycle. As in any production process, you can eventually begin to do anticipated maintenance. You can anticipate through experience that you are going to have to do something at so many hours. We aren't near that point yet with DCC, but we have run enough volume that it is not all guesswork.

How is the process of mastering the TTTS text being handled, and how is it working out so far?

Wilson: I would guess that we are doing about 80 percent of the text work in-house. It's kind of tough going back and forth with the client to get everything just the way they want it. The consumer decks available right now only have the single-line, 12-character display. In the future they are supposed to have the two-line display and video text output. But right now, unless they have the Philips mastering equipment with the text editor, there is no way for clients to get in and look at those other display modes. All they can see is the one-line display. So that is a confusing thing right now.

What we need—that we haven't been able to get from Philips—is a software package that will allow them to look at the text file on their computer screen without having to buy the editing software, which is pretty expensive. If we had that, it would help a lot.

Anderson: In most cases we do the text in-house for the clients. It is a detailed, involved process that takes additional time in mastering. But we haven't had any complicated problems or hurdles.

Now that you have been in production for a while, are you encountering anything different from what you expected, or has everything gone pretty much according to plan?

Wilson: It took a lot of work getting everything up and running. We didn't start producing until last December. We had intended to start about the middle of the summer. The only thing now is that I'd like to get a second source for the tape. Our biggest prob-

lem seems to be the tape.

Anderson: Surprisingly enough, we have had more success with the product as a whole than I had anticipated. Because it is a new, start-up format, I really expected more headaches and less success than what we have enjoyed. There have been problems along the way, but overall I am pleased with the success so far in being able to manufacture the format.

It all hinges on your procedures. You have to be very disciplined. To get consistent quality with analog cassettes, you have to be very disciplined, too. But to make DCC, you

“As far as the actual mechanics, DCC

duplication is a twin to

the analog process.

But it's slower, you have

a higher reject rate and

a higher need for a

clean environment.”

—Ron Anderson

have to have even more discipline. You have to have your procedures in place, and you have to follow those procedures to the letter. You really can't let anything slide. The big key here is clean. Dirt and dust are the enemy. Duplication takes place in a class 100 clean room.

Overall, once all the systems are in place, how does the DCC duplication experience differ from that of analog cassette?

Wilson: The process of cleaning heads, loading and threading the slave and loading the housings is all the same. Doing the whole QC process is a lot different.

Anderson: As far as the actual me-

chanics of it, it is a twin to the analog process. But you have a higher reject rate and a higher need for a clean environment. It is also a slower process, even though we duplicate at 64:1 and the loading is fast.

The quality-assurance check is so slow with Philips' real-time error-monitoring system that your output is very, very low compared to analog. The only way to speed the process is to buy several error-monitoring systems. The machine is a DCC deck integrated with a PC, but they cost approximately \$50,000 each. And then you have to staff it. One person can run quite a few decks, perhaps ten. We have four of them right now. At this point we feel that we have to keep tight inspection checks on the product, because we do have limited experience with it.

Do you have mostly the same DCC clients you had when you started, or are more labels getting into the market?

Anderson: We do have some new clients that came onboard for DCC, but primarily we have the same clients that we do analog for. Surprisingly, we have duplicated DCC for companies other than the major labels. But our smaller accounts are limited.

Are your existing clients broadening their initial range of titles, or mostly making more of the same titles?

Anderson: They are definitely broadening, trying to get DCC copies of their hottest numbers. I don't know exactly what their criteria is for putting stuff out on DCC, but there is a wide range of musical styles. We are doing what I would term as the higher-profile artists.

From your vantage point, how would you assess consumer reception to DCC to date, and what's your feeling about the format's long-range prospects?

Anderson: I like DCC, and I think it makes sense. There is a place for it. But I would like to see a much larger, more fierce marketing campaign. There are people out there buying different formats that are unaware of DCC. There is still widespread ignorance due to lack of exposure. As a consumer myself, I haven't seen the DCC software in the stores here in the Midwest, though the hardware is available. I don't want to see DCC get killed off before people even have a chance to be exposed to it. ■



There's no faster, easier or better way to record incredible stereo.

When you compare Crown's new Stereo Ambient Sampling System™ (SASS™) and a DAT recorder with traditional recording methods you'll discover there's no faster or better way to record natural, beautifully imaged stereo.

Lightweight, durable and extremely easy to set up, the SASS microphone is an exciting improvement in stereo recording. Combined with a DAT machine, it becomes a high-quality, no-compromise recording system that goes everywhere.

Crown's SASS eliminates traditional stereo recording compromises in sound quality, ease-of-use, and cost. No longer do you have to settle for weak low-end or off-axis coloration common to Midside, X-Y and near-coincident pair mics. Assembly and positioning time is also reduced

significantly compared with conventional stereo micing techniques.

The SASS is available in two versions: the SASS-P, with switchable battery or phantom power and Crown's finest studio-grade PZM®



capsules; or the SASS-B, which uses the famed Bruel & Kjaer 4003 and 4006 studio mics (not supplied).

Regardless of which you choose, you'll enjoy full ambience without coloration, excellent sum to mono,

and extraordinary broad frequency response. With SASS's superb imaging capabilities, every sound is audibly reproduced in its precise position resulting in a stereo experience of uncanny realism.

Readily adaptable to all common stands, the SASS includes a carrying case and accessories.

No matter what your stereo recording requirements are—from sampling to electronic news gathering to remote recording of live events—you'll find Crown's SASS family the simple choice. See your Crown representative or call toll-free for information: 1-800-535-6289.

 **CROWN**

Crown International, Inc. • P.O. Box 1000
Elkhart, Indiana 46515-1000 • 219/294-8000

USE READER SERVICE CARD FOR MORE INFO

World Radio History

© Crown International, Inc.

Tape & Disc News

RIAA REPORTS RECORD REBOUND

Final 1992 figures from the Recording Industry Association of America show the year was good for the six major labels who dominate the trade group and account for approximately 95% of U.S. prerecorded music sales. Net units shipped, after returns, rose 11.8% to 895.5 million (see chart). The dollar value, at list price, of the shipments rose more than 15% to \$9 billion. Every configuration experienced an increase in value, with the exception of LPs.

Leading the charge were CDs, at 407 million units. With unit sales up 22% over 1991, the CD growth rate in

47% of total albums. The results demonstrate a significant stabilization for cassettes after their steep drop in the prior year's figures. Cassette singles rebounded more strongly, with unit gains of 23%.

Among the most volatile of the configurations is music video, which the RIAA began tracking in 1989. Video shipments have yet to return to their 1990 peak, but they have survived the beating they took in 1991. Music video units rose 25% in 1992 to 7.6 million.

CONCEPT DESIGN WINS DIGITAL BIN TRIAL

A jury in Charlotte, N.C., found in favor of Concept Design in a patent infringement case that clouded the future of digital bin technology for more than two years. Rival bin maker Duplitrionics had alleged that the use of RAM in Concept Design's DAAD-R digital bins infringed on patents controlled by Duplitrionics. The com-

NEW HIGH-SPEED VHS DUPE SYSTEM

A new method for high-speed duplication of VHS videotapes was announced at the recent ITA Seminar in Phoenix. Hightree Media Corporation unveiled its Direct Contact Heat Transfer process, the first to offer in-shell video duplication at high speed. The technology duplicates at 7.5 meters per second, copying a two-hour movie in less than one minute.

The Hightree process involves a heat-transfer approach similar to that used in Otari's TMD. But instead of using a laser, Hightree uses a small heater applied directly to the magnetic coating on the copy tape as it contacts a "mirror master." The thermally excited particles of the copy tape take on the orientation of the master as they pass through the heat and then cool. The company claims the process yields excellent video quality.

According to Hightree, a single duplicator will replace 160 real-time duplication machines without the clean room requirements of competing high-speed systems. The company envisions machines the size of a tabletop printer using ordinary household current with no external air or cooling requirements. Hightree plans to market products using the technology later this year.

NIMBUS TOUTS VIDEO CD

An extension of the CD standard has been proposed by Nimbus Technology and Engineering that would allow the storage of up to two-and-one-quarter hours of video on a single CD. The Nimbus method uses a combination of digital video compression and increased CD track density.

According to a report in *Billboard*, the full-motion video discs are expected to appear early in 1994 in a normal-density version with up to 79 minutes of program. The double-density, feature-length versions would come later. Any standard CD-Audio player with a digital output would be able to play the discs with the addition of a hardware decoder, estimated to cost between \$200 and \$300. New players could be outfitted with a built-in playback chip for much less.

Nimbus claims its discs will deliver "better than VHS" quality. The system uses the MPEG 1 video compression scheme, even though the Moving Picture Experts Group is already at work on an improved

The Recording Industry Association of America's 1992 Year-end Statistics

		1989	1990	1991	1992	% CHANGE 1991-1992
Units Shipped (In Millions)	CDs	207.2	286.5	333.3	407.5	22.3%
Dollar Value	CDs	2587.7	3,451.6	4,337.7	5,326.5	22.8%
Units	CD Singles	-1	1.1	5.7	7.3	28.0%
Value	CD Singles	-7	6.0	35.1	45.1	28.5%
Units	Cassettes	446.2	442.2	360.1	366.4	1.7%
Value	Cassettes	3,345.8	3,472.4	3,019.6	3,116.3	3.2%
Units	Cassette Singles	76.2	87.4	69.0	84.6	22.6%
Value	Cassette Singles	194.6	257.9	230.4	298.8	29.7%
Units	LPs/EPs	34.6	11.7	4.8	2.3	-52.1%
Value	LPs/EPs	220.3	86.5	29.4	13.5	-54.1%
Units	Vinyl Singles	36.6	27.6	22.0	19.8	-10.0%
Value	Vinyl Singles	116.4	94.4	63.9	66.4	3.9%
Units	Music Videos	6.1	9.2	6.1	7.6	24.6%
Value	Music Videos	115.4	172.3	118.1	157.4	33.3%
	Total Units	806.7	865.7	801.0	895.5	11.8%
	Total Value	6,579.4	7,541.1	7,834.2	9,024.0	15.2%

1992 exceeded 1991's 16% increase over 1990. The market for CD singles, though still tiny, grew 28%. (Not coincidentally, the Electronics Industries Association recently reported that CD player sales were up 26% in 1992. Though sales of home CD players fell 16%, that drop-off was more than offset by the booming market for CD players in the portable, personal and automotive categories.)

Growth in the cassette market was much more modest, with album shipments rising just less than 2% to 366 million. That is down from the peak of 450 million cassette albums shipped in 1988, but it still represents

pany had attempted to collect royalties from Concept Design and duplicators using the DAAD-R systems. But the jury in the case apparently took Concept Design's view that the Duplitrionics patents were not infringed.

The trial verdict does not necessarily mean an end to all legal action in the case. Reacting to the verdict, Duplitrionics' Jeff Binder said, "We were surprised and disappointed. We believe the verdict was in error, and we intend to pursue other remedies available to us under the law." A separate trial on charges of unfair competition brought against Duplitrionics by Concept Design is still pending.



SONEX. CHEAP.

SONEX? Cheap? Unfortunately for us, everyone thinks **SONEX** is the most expensive acoustical control material. Fortunately for you, it's not. **SONEX** gives you more absorption per dollar than any other treatment. No lie. Call today for your free **SONEX** Information Packet.

illbruck

Minneapolis, Minnesota

1-800-662-0032

USE READER SERVICE CARD FOR MORE INFO

Recording Arts



The Mix Room

Digital and Analog

RECORDING
ARTS



P.O. Box 121702 • Nashville, TN 37212
(615) 321-5479 • (615) 321-0756 FAX

TAPE & DISC

MPEG 2 standard. *Billboard* says Nimbus is currently wooing Hollywood in an effort to attract crucial support for its idea.

REPLITECH CONFERENCE

Replitech International, a conference and exhibition on magnetic and optical media duplication and replication, will be held June 15-17 in Santa Clara, Calif. Cosponsored by the ITA, the conference portion of the event will look at both technical and market aspects of the field in more than 45 half-hour to one-hour sessions. General sessions will be held on the first day, and the second and third days will feature four conference "tracks," one each for audio cassettes, optical discs, video cassettes and floppy disks. The exhibit hall will include more than 225 booths offering manufacturing technology and services. Call Knowledge Industry Publications at (800) 800-5474 for information and registration.



GAUSS DCC SLAVE

Gauss is entering the market for DCC duplication gear with the introduction of the Model 2440 duplication slave, previewed at last October's AES convention in San Francisco. The machine, based on the Gauss 2400 high-speed transport, will be supplied complete with interfacing, write electronics and write heads. It features a dual-capstan drive, front and back tape wiping, switchable input feed from two master sources, and a filtered laminar clean-air flow system. The two 9-track write heads (for forward and backward play on the finished DCC) mount on an adjustable azimuth head plate with pre-

cision guides.

CEDAR GOES 24-BIT

CEDAR Audio has upgraded the input and output resolution of the DC-1 De-clicker from 16 to 24 bits. Owners of existing units may upgrade free of charge. CEDAR director Gordon Reid said, "Since the AES/EBU standard can, in principle, accommodate 24-bit words, we saw no reason to limit ourselves to just 20-bit resolution." The DC-1 is distributed through dealers in 19 countries in Europe and the Far East.

FUJI FINISHES FACTORY

Fuji Photo Film U.S.A. completed construction on a VHS videotape factory in Greenwood, S.C., that company officials describe as the largest-capacity facility of its type in North America. The \$100 million factory, encompassing about 290,000 square feet, is capable of producing the equivalent of 150 million two-hour videocassettes annually. The plant had been producing in limited quantities since late 1991. But with installation of a double-coated tape manufacturing line now complete, Fuji has begun full production at the site.

SPLICES

Verbatim Corporation of Charlotte, NC, has begun manufacturing CD-R discs and offering CD-ROM mastering and replication services...Filam National Plastics (Paramount, CA) appointed Mort Fujii as sales and marketing vice president. The company also introduced its Omega cassette shell, featuring a patented Independent Tape Path Component...Concept Design (Graham, NC) selected dBm of Surrey, England, as its international sales representative...Research Technology International (Lincolnwood, IL) announced the D-11 Dropout Analyser for media flaw detection on virtually any analog videotape format. The unit reads RF off tape and includes a built-in printer for reports...Pete Townshend was in Barry Diament Audio to master his forthcoming *Psychoderelict* album...Masterdisk (New York, NY) was busy with a variety of projects for Def Jam, Delicious Vinyl, Atlantic, Elektra and EMI...A 31-song Judas Priest collection was remastered at Sound Cellar in London for Columbia...Trutone (Hackensack, NJ) mastered new releases on the Caroline, Mic Mac, Matador and Get Hip labels. ■

Capture the Truth of the Moment

As a working professional, you can't afford to compromise. You need microphones capable of exceptional sound with a full range of accessories to make every assignment easier. Whether you're working in the studio, miking performers on stage, or capturing elusive sound in the field, you don't get a second take.

When you use Sennheiser, you'll think we've built our mics just for you. Actually, we have. Our mics are designed for the real world and provide unequalled performance.

Sennheiser offers microphones for every professional application including three ranges of shotgun mics; lavaliers with small profiles and big sound; studio tools with unsurpassed accuracy; and musicians' models that bring out the best in every singer and player.

When your job depends on the performance of your microphones, you know you can depend on Sennheiser.



 **SENNHEISER**

6 VISTA DRIVE, P.O. BOX 987, OLD LYME, CT 06371 · TEL: 203.434.9190 FAX: 203.434.1759
IN CANADA: 221 LABROSSE AVE., PTE-CLAIRE, PQ H9R 1A3 · TEL: 514.426.3013 FAX: 514.426.2979

USE READER SERVICE CARD FOR MORE INFO

C O A S T

TAMPA HEATS UP

by Chris Stone

Recently, one of my consulting clients asked me to do a market study of Tampa, Fla., as a possible location for future facilities. I was surprised and pleased to find that this emerging market has several fine music studios and a booming audio-for-video market. Tampa even has its own pro audio leasing company, with services furnished by Larry Stephen of Blockwell Funding, who moved to the area from New York City last June and is the market's greatest promoter. Being almost two hours by car from Orlando's Disney and Universal Studios resort market, Tampa is competitively isolated on Florida's central west coast.

Tampa and St. Petersburg's two modern concert venues attract major acts to the central

—CONTINUED ON PAGE 157

Tampa's West End Recording

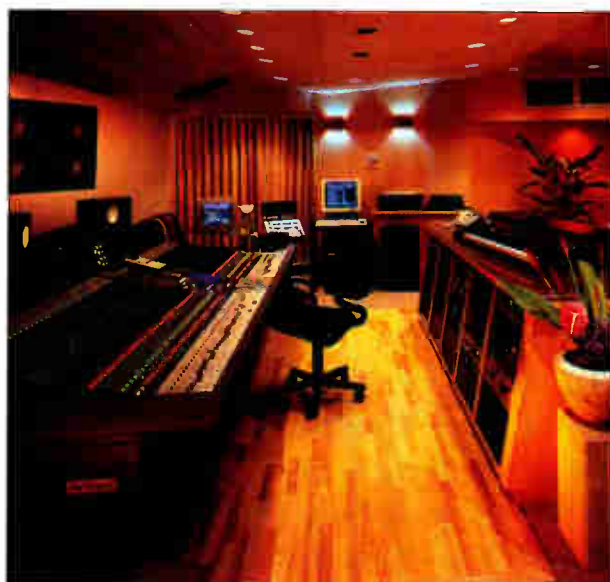

Gloria Estefan's
Crescent Moon
Studio in Miami

MIAMI MEMO

by Dan Daley

The freshly painted Art Deco fronts of the hotels lining recently revitalized Miami Beach harken back to

the strip's heyday in the 1950s and '60s. You can almost picture Jackie Gleason walking down Collins Avenue, collar open, waving a Havana cigar in one hand and talking to Sammy Spear about the next *Music for Lovers Only* album. Gleason would churn out.

Like Atlanta, Miami has reflected the changes in the country's social fabric. For starters, it's a bitch to get a real Havana cigar now, but the *comidas cubanas* are aplenty on Washington Avenue, as are kosher delis, in this pastiche of old money, new money and no money. "It's the way the American Dream is supposed to be," observes Nancy Mraz, studio manager at South Beach Recording, which resides in the Hotel Marlin. (The Marlin is one of the comeback hostleries of the row and is owned by Island Records presi-

—CONTINUED ON PAGE 156

C O A S T



Nashville's Woodland Digital

would even out the bookings through slower periods."

Quad Studios bought a 32-track Otari DTR-900 digital deck earlier this year. Studio manager Kelly Pribble says that digital recorder prices are beginning to approximate analog at the same time that client demand is increasing. "I can rent the 32-track out for \$250 a day, which is less than half of what I had to charge to rent one," he explains. The clients aren't just the hat acts: Quad recently picked up a pair of Gold records for work with Bobby Brown and Whitney Houston, both of whom tracked in the studio last year.

Ron Treat, manager at Sound Stage Studio, notes that the increase in digital capability at mid-level studios has a lot to do with the growth of contemporary Christian music and the genre's expanded budgets. "We're one of the major SSL and digital rooms in town, as we're seeing more inquiries from that sector," says Treat. "So it's apparent that their budgets are allowing them to move up, and studios that traditionally have catered to Christian music are accommodating that growth with new digital equipment."

Off the Beaten Path: Elysian Fields opened in mid-April in Boca Raton, Fla. The \$2 million facility was designed by Steven Durr & Associates and built by Backman Construction, both Nashville-based firms. The 26x30-foot control room sports a Neve V3 with Massenburg automation and Durr/TAD custom monitors with full surround capability. The 35x40-foot studio has mahogany wood floors and three iso booths. Owner John W. Henry is aiming for a combination of local business and artist development. ■

NASHVILLE SKYLINE

by Dan Daley

Woodland Digital goes retro: The studio renovated two of the live chambers from the original facility before it was revamped last year, and a third is due shortly. Co-owner Bob Solomon says, "When it comes to reverb and natural ambience, [digital devices] pale in comparison to the real thing." Woodland also has five EMT-140 modified stereo plates and an AKG BX 20E tube-amplified stereo spring reverb.

Nightingale Studio added Uptown automation to its vintage (1975) UK-manufactured Helios console, which has been the studio's board since it opened in 1987. Co-owner Steve Tvight attributes the choice to pricing and features, but says that the primary reason for adding automation was marketing. "Summer is traditionally the slow time in Nashville, when acts go out on the road," he says. "Since we're known mainly as a tracking room, we felt that adding automation would enable us to get more mixing work that

ATLANTA'S BURNING

by Dan Daley

Atlanta provides a good example of the changing of the guard in professional recording. Even before the Southern rock phenomenon of the '70s put "Hot Lanta" on the map, the town was an R&B mecca and a pop powerhouse on a par with Memphis. Gladys Knight & the Pips, Otis Redding and James Brown all cut here early in their careers through the '50s and '60s.

Pop moved to Los Angeles and R&B mutated into disco and dance, which was centered mainly in New York (and Philadelphia). Music recording in Atlanta quieted down while post-production became the focus. Starting in the late 1970s, Ted Turner's CNN and TBS provided a huge revenue base for multiroom post houses like Crawford and Doppler to build on. But as the social fabric changes, so do the studios. Within the last two years, major R&B artists and producers—Bobby Brown, LaFace, Keith Sweat, Dean Gant—brought work from L.A. and New York and stayed, some building studios, others becoming anchor clients, others buying existing facilities. Young urban producer Dallas Austin built his own studio from the ground up last November with two SSLs to handle acts like Tina Turner, ABC and Tracy Spencer.

Rock is also picking up, as fast-rising mixing star and Atlanta native Brendan O'Brien (Black Crowes, Pearl Jam, Aerosmith, Red Hot Chili Peppers) is moving back to set up a profes-

—CONTINUED ON PAGE 155

THE VIEW IS ALWAYS BETTER FROM THE TOP.

STUDER D820-48

To stay ahead of the competition, you need the *ultimate* in digital technology. Studer's D820-48 can put you right where you need to be — on top. With 48 tracks of superb sound and the built-in 40-second 4-channel sound memory, the D820-48 allows unlimited creativity and artistic freedom. And once you've experienced the legendary sound, and Studer's outstanding support, you'll agree that *there is no competition*. Experience excellence. Call the regional office nearest you for more details.

STUDER

Studer Stereo America, Inc. • 1463 Air Lane Drive • Ft. Lauderdale, FL 33304 • Tel. (305) 571-2200 • Fax. (305) 571-2204
New York 212-203-6700 • Los Angeles 310-760-8224
Studer Stereo Canada Ltd. • Toronto 416-210-1187

STUDER

D 820 DIGITAL MULTICHANNEL RECORDER

World Radio History

USE READER SERVICE CARD FOR MORE INFO

—FROM PAGE 153, ATLANTA

sional base, bringing his acts with him. And while the new Purple Dragon takes in some R&B, it is aiming squarely for the burgeoning rock market with its Russ Berger design, 48-input SSL G Series desk, and mix of analog and digital tape formats.

"People like Brendan and Bobby Brown being here on a full-time basis lends a new legitimacy to Atlanta among R&B and rock artists," explains Jon Marett, studio manager at Bosstown Studios, which Marett opened as Soundscape in 1984 before selling the facility to Brown in late 1990. "People back in Los Angeles and New York hear what they're doing, and it attracts more artists and producers here. There was always a strong music base in Atlanta. It had quieted down some in the last two decades, but the know-how was here."

According to freelance engineer Thom Kidd, "When I first came here from Knoxville in 1983, there were no independent engineers, only staffers, and there was hardly any music happening on a national level except maybe for Cameo. It's like night and day now."

All of this work has turned Southern Tracks from a private studio into a commercial facility, according to co-owner Mike Clark, a veteran of the area studio scene. Southern Tracks will be the home of Brendan O'Brien when he moves back to town, says Clark, and he'll account for much of the bookings in the studio's single, large, SSL-equipped, Augspurger-designed room. Southern Tracks will also continue to handle the spillover from LaFace, Keith Sweat and others, in addition to the studio's regular clients.

"This town is far from overcapacitized," says Clark. "It's a snowball effect: People hear what's coming out of here, and they want to come here. I don't think this is too good to be true; it's happening, and I think it will continue to happen because Atlanta is as good a town to live in as it is to work in."

In response to all this new business, area studios have changed their technology mix somewhat. Bosstown installed a 64-input SSL G Series console in its A room, complementing the SSL E Series in its other room. Southern Tracks upgraded to a 64-input G Series desk, the first in town with Ultimotion, despite the fact that Mike Clark feels you can mix anything with 40 inputs. "It's all the MIDI gear used on sessions

that doesn't go to tape until the final mix that drives that," he says. "I'll go for a larger console, because I hate to see people leave town to mix."

Purple Dragon Recording owner Stanley Gaines is representative of the newest breed of studio owner in Atlanta. The aggressiveness of his Earl Scheib-style marketing approach—"I'll give a free week to the first artist to put a gold record on my wall"—is perhaps a portent of things to come. New York session players T.M. Stevens, Tommy Price and Phil Grande are becoming a sort of house band at the studio. "It's all about creating a vibe," says Gaines. "I'm the first studio in town to put in a shower and have Apogee filters."

In terms of audio post-production, Atlanta never stopped growing, according to Pete Caldwell, owner of the quarter-century-old Doppler and past president of SPARS. But the growth of music recording has made the city's success more consistent than in the past. "It's not technology but people that make the difference, and Atlanta has them," he says, "along with a quality of life they can't find in some other cities."

Advertising, long the mainstay of Atlanta post, is bouncing back after two years of recession, Caldwell asserts, buttressed by new work in industrial video, cable and broadcast markets. Rather than adding new technologies, Doppler has sought new applications for its existing equipment (including its WaveFrame hard disk systems), such as film ADR and synchronizing Nagra audio from film dailies on video.

There is a fairly precise division of clients at studios in Atlanta. Post houses do post, although music is increasing at them, says Caldwell, who now derives 30% of revenues from music, adding that much of post-production's 70% is also involved with music at some level. On the other hand, Bosstown's Jon Marett says that 95% of that studio's work is music, with the occasional piece of broadcast post for Ted Turner.

Atlanta can say what few other large secondary markets in pro audio can say these days: There's more than enough work for everyone, which in turn has fostered a community spirit among studios that other large markets often lack. "What's changed is that Atlanta isn't importing its talent anymore," says Jon Marett. "It lives here now." ■

In Northern California, audio professionals know that Leo's is the one place for all their audio needs—whether a special connector or a top line digital audio workstation. Rentals, too. Pro Audio for Professionals.

we listen so you'll be heard...

Leo's

PROFESSIONAL AUDIO, INC.
5447 Telegraph Ave.
Oakland, Ca 94609
510.652.1553 or fax: 510.652.6575

USE READER SERVICE CARD FOR MORE INFO

RECORDING WORKSHOPS

At
The Peabody
Conservatory of Music

MIDI AND COMPUTER MUSIC
June 21-25 McGregor Boyle

ADVANCED MIDI APPLICATIONS
June 28-July 2 McGregor Boyle

**AN INTRODUCTION
TO RECORDING TECHNOLOGY**
July 12-16 Alan P. Kefauver

THE MICROPHONE WORKSHOP
July 19-23 John Eargle

**MULTI-TRACK MUSIC
RECORDING AND MIXING**
July 26-30 Alan P. Kefauver

All workshops are
M-F 9 a.m.-4 p.m.
Tuition is \$420 per workshop
and graduate credits are available.

For application and further information:
Peabody Conservatory of Music
1 East Mount Vernon Place
Baltimore, MD 21202-2397
(410) 659-8136

Sound Trax PC-CONNECTION

For Alesis ADAT



- Power of ADAT under PC Control
- CMX list auto-assembly of audio
- Archival Sound Effects & Music Libraries
- Sound Effect & Dialog Editing with SMPTE Chase and Lock
- 8255 based editing and control system interface ports
- Supports Fostex ATR interface cables
- Software and PC Board Supplied*

*Mid time-code board, and 386PC required

Version For Macintosh Available In Fall 1993



Developed by Award Winning
SOUND TRAX STUDIOS
especially for Feature Films &
Television Sound Post-Production

(800)959-9722

2815 W. Burbank Boulevard • Burbank California 91505

ADAT, Macintosh & IBM PC are trademarks of Alesis Corp. Fostex Corp. Apple & IBM respectively.

USE READER SERVICE CARD FOR MORE INFO

—FROM PAGE 152, MIAMI

dent Chris Blackwell.)

South Beach is a mix/overdub room, loaded with an SSL E/G and the first set of large Genelec monitors in the South. President Joe Galdo is a veteran Miami producer whose credits include Miami Sound Machine, the act that put the city on the contemporary pop map. "Joe understood the potential of this area for a long time," Mraz says, noting that along with the indigenous Hispanic influence, Miami has become a locus for international Latin artists, such as Julio Iglesias, as well as European and Japanese acts. And befitting the area's saturation with demi-monde types, Grace Jones has been the studio's longest-running production to date, working there more than half the year the studio has been open and keeping truly vampirish hours.

Mraz has been working in Miami music for more than ten years, including a stint at International Sound and for rock manager Doc McGhee. "Miami has the potential to become as diverse and busy as New York or Los Angeles but on a smaller scale," she says. "The key to marketing here is all word of mouth." Already, South Beach has defied the seasonal downturn that most Miami businesses suffer when summer comes. "We were booked all through our first summer, and now we're taking bookings for August," she says.

Emilio and Gloria Estefan's Crescent Moon Studios is also drawing its client base from around the world, according to studio traffic manager Susan Zekofsky. "Japan and the Hispanic market have been a big part of the client base," she says. The studio, which opened in April 1990, sports a large Neve console in its main control room, which shares a mid-sized iso booth with a smaller control room featuring a Sony MXP-3000 console used mainly for overdubs. Crescent Moon became a commercial facility shortly after its opening, and that second control room has gained the studio some clients, says staff engineer Charles Dye.

The facility, which is heavily digital in its storage media, including 48- and 32-track recorders, a 16-track PostPro and an Akai A-DAM deck, was designed to accommodate the tastes of Estefan and his co-producers of Miami Sound Machine, Clay Ostwald and Jorge Casas. But, says Zekofsky, with the addition of an analog 24-track

deck, that technology mix has been fine for the other clients who now use the rooms, which recently included Iron Maiden and Disney's Orlando theme park. That encounter has led to consideration of expanding Crescent's post capabilities, now limited by the lack of video formats at the studio. "We've done some posting on Gloria's live concerts, but we had to send unconformed mixes to local post houses," explains Dye. "A Beta or D-2 deck is the next major purchase. We already have CMX conforming capability through the PostPro."

Zekofsky says that the Miami studio community is relatively close-knit, mainly because there's plenty of work to go around. "We refer clients to each other regularly," she says. This cornucopia of clients has meant that marketing plans tend to be ad hoc and revolve mainly around tweaking the studio's technical capabilities to accommodate new clients. However, the south Florida market is still partially dependent upon climate and amenities, and Gloria Estefan has purchased a hotel in Miami's South Beach area, which will be part of a package offered to clients.

The afternoon sun has faded the colors from many of the labels on the scores of Gold and Platinum awards hanging in the glassed atrium of Criteria Recording. This tableau is both a testament to past glory and a declaration of longevity for the 40-year-old studio (Jackie Gleason actually did record there), which is still the center of rock for Miami, according to studio manager Trevor Fletcher. Fletcher, who literally grew up in Criteria—his mother is the facility's accountant—said the studio took its older Soundcraft Sapphire room offline in March, but the remaining four rooms are doing very well.

"Historically, we're known for rock, but our client base includes—and has always included—Latin and international artists," says Fletcher. Criteria did phenomenally well in the 1970s, with acts like the Bee Gees using it as a home base. The record industry recession of 1979, which tore through record revenues like a Caribbean hurricane, affected the studio, dropping rates from \$250 per hour to \$80 at one point, Fletcher says, a situation worsened later by the south Florida area's underground economy, which sprouted short-lived studios paid for with cash.

"Record companies weren't sending artists out with bags of money

DEMETER

INNOVATIVE AUDIO SYSTEMS



The Original
Tube Direct Box VTD8-2A
... Interface without
degradation or coloring
to the signal in any way.

"I took the Tube Direct down to Nashville to work on a project (for new artist Buddy Mondlock) and it blew away every DI in the place."

STEVE ADDABO *Engineer*
Suzanne Vega, Shawn Colvin, Eric Anderson

"It warms up synths...makes them not so hard-sounding"

LARRY CRAGG *(Guitar tech & repairman)*
for Neil Young, pedal steel with Nils Lofgren

DEMETER
2912 COLORADO AVE. #204 SANTA MONICA, CA 90404
SALES 818.986.7103 FAX 310.829.3755

anymore and letting them write the records in the studio," Fletcher says. But a diverse client base allowed the studio to continue and prosper in the late '80s through today, with rock acts centering on the refurbished Studio A, with its classic Neve 8078 and expanded control room.

Criteria resisted the trend to add extensive post-production equipment during that time, preferring to rely on the diverse regional music base and its historical place in the rock world, although its 16mm film and ADR capability have brought in some episodic television work.

"In a sense, we're insulated from the regional music scene—in terms of depending upon it for revenues—by our reputation," says Fletcher. "On the other hand, like any of the studios down here, we have to cater to the new clients who come to Miami for more than its studios. The whole Miami Beach scene has revitalized itself. Five years ago you couldn't pay anyone to stay there. Today, it's easy to be optimistic, because the blend of musical cultures and the social patterns here indicate a long period of growth ahead." ■

—FROM PAGE 152, TAMPA

Florida area, some of which, like U2, stay to record or make a video while in the area. There is also a new, growing SPARS chapter there that meets once a month to discuss common concerns. The market seems healthy, although low-priced, and is considered by many to be the center for "death metal" music. Morrisound owner/producer Tom Morris and engineer/producer Scott Burns have been featured in European music magazines, which has attracted death metal groups from Germany, France and Sweden to Tampa.

CPN Television Inc. is a 40,000-square-foot teleproduction facility located on seven acres in Clearwater, Fla. CPN houses a world-class digital audio post-production suite, three video editing suites with all-new Sony equipment, two shooting stages and a four-port C-band Scientific Atlanta Satellite uplink/downlink.

Cypress Video Productions is an excellent video post facility in the middle of Tampa that was purchased by CPN on March 1. In a unique marketing experiment, they have subleased space to West End Recording (two fine audio post rooms featuring Spectral

Synthesis workstations), Sample Music (a MIDI composition suite with Ernie Sample [that really *is* his name] furnishing composition and synth chops for film and video music requirements), and Garapoldi Design (a well-equipped computer graphics house). It is truly one-stop shopping, which is greatly appreciated by local and regional advertising agencies and film companies.

Tucked away in an almost residential area is Ron Rose Productions, of Detroit fame. This branch facility, now locally owned, provides radio jingle services as well as audio-for-video rooms and cassette and video duplication. Four employees and a clean sound keep the agency and corporate clients coming.

In the music recording arena, Morrisound tops the list with two rooms, one with an SSL and Mitsubishi digital 32-track for tracking and the other with a Sound Workshop console and Otari MTR-90. Situated in the suburbs, an almost rural atmosphere provides a most relaxed environment for tracking or mixing. Morrisound also regularly sponsors the South Eastern Music Conference, which is like a mini New Music Seminar, featuring a live showcase for 70 unsigned artists from around the country.

Another fine-sounding room is Hurricane Pass Recording with one of the few remaining A-range Trident consoles in the country. Clean sound, vintage mics and former Criteria/Miami engineer Roger Kenton Hughes keep the main room and MIDI suite hopping.

The trophy for being in the studio business in Tampa the longest goes to Progressive Music Studios (known to friends as PMS), which has been around for 15 years. Ken Veenstra has a master's degree in composition and offers arranging services as well as a full complement of instruments at no extra charge. Located in a legal house near the famous Bearn Steak House, PMS offers duplication services, audio-for-video and special talents to local bands. Much of this business comes from other recording studios who refer business that they don't have time to handle.

Prices in Tampa are somewhat lower than the major markets, but *service* is the key to the successful local growth. It is such a pleasure to go into an emerging small market and see busy studios with little to complain about and very reasonable prices. ■

DUPLICATION

- Digital Bin Cassette Duplication**
- Hi-Fi Stereo VHS Duplication**
- CD Replication Service**
- Sonic Solution Pre-Mastering**

SAS offers packages to fit your individual needs. We provide high-quality products and personalized service which few in the duplication industry match.



SAS INDUSTRIES INCORPORATED

Call for our Information Package
1-800-955-7271

USE READER SERVICE CARD FOR MORE INFO

Cutting Edge

In a competitive world, the only way to stay on top is to be on the cutting edge.

Equipment, attitude, and professionalism make YRS the perfect choice for your audio productions.

Our new weekend package includes 2 lockout days and 2 nights hotel accommodations for only \$1,500.



YRS
MULTIMEDIA

182 Oxford Rd
Orlando, FL 32730 (407) 331-4588

—FROM PAGE 108, LINDSEY BUCKINGHAM
frontline players get most of the instruments off the stage, relying on wedges primarily for their vocals. “Most of the stage sound is shaped around their own volume and where they are placed on stage,” Oster explains. “When they’re soundchecking, I’ll stand in Lindsey’s spot and listen. There’s an incredible separation up there, especially in this large of a band. It can be hell—having seven vocals and that many mixes up there—it’s a challenge, but it’s a fun gig.”

Most of the band uses Sound Image’s latest wedge, a dual-12 with a TAD 2-inch design. Buckingham started with that wedge in rehearsals but at the last moment switched to an older Sound Image single-15 wedge. “I can get the two 12s a lot louder,” says Oster, “and they sound better, but the single-15 sounds more like a rock wedge, and that’s what Lindsey wants to hear. So I’m running two cue

wedges—one of each.

“I give Lindsey vocal, a little percussion, keys and a sizable amount of guitar,” continues Oster, “because he likes to be surrounded up there. When he goes into a solo, I pump it up about a notch and a half. [On the other hand,] Lindsey also likes to hear the house, especially when he does his solo [acoustic] stuff. I pull his vocal way down in those numbers.” Whatever the requirements, communication seems to be very open on this tour. “You can talk frankly with him and work things out,” says Oster. “He’s probably the most reasonable artist I’ve ever done monitors for.”

Sound at the Bimbo’s gig was loud and clear, with an emphasis on *both*. Diverse musical arrangements were complemented by equally varied mixes, both in relative level placement and ambient treatment. Some of the sparser material, often mixed with extended depth of field, showed off the Sound Image

system exceptionally well, which is not to say that the system was any less punchy on the louder tunes, just that stage level became more of a factor on those numbers. Among the most tricky tunes was a faithful rendition of “Tusk” with the entire ten-piece band playing full out, lacking only the original’s full marching band.

Overall the show’s dynamics were quite effective, which allowed the loud points to be exciting while the quieter numbers gave one’s ears a chance to bounce back.

Most enjoyable was the energy traded between Buckingham, band and the audience. Buckingham summed it up nicely during the sold-out show when he told the audience that on this tour he was “probably having the best time I’ve ever had!” It showed. ■

After many years in club sound, David (Rudy) Trubitt is still getting the stale smell of cigarettes and liquor out of his hair.

AUDITIONS

—FROM PAGE 91, AUDITIONS

should not be confused with tube distortion). This explains the re-emergence of the tube preamp used with either a tube or solid-state power amplifier by many of today’s top bassists.

The VTBP-201 Vacuum Tube Bass Preamplifier from Demeter combines the best of both worlds (tube and solid-state sounds). The front of the note is sharp and immediate, and the subsequent body of the note is dense in tone. It gives the player the feeling of being inside an old Motown record, or an early Led Zepelin album, experiencing the sound of the bass the way James Jamerson or John Paul Jones heard it.

The controls on the two-rack-space front panel are simple to operate. They consist of high and low inputs, volume, treble (± 6 dB at 4 kHz), middle (± 6 dB at 500 Hz), bass (± 6 dB cut or boost selectable at 60 or 120 Hz), presence (± 6 dB selectable at 3 or 6 kHz), and bright (6dB boost at 2 kHz). Effects loop and studio output with Jensen transformer are standard on the VTBP-201DBL. The

direct out on the VTBP-201 is accessed either pre- or post-preamp. This allows you to go directly to tape with the sound you dial up on the front panel or record the bass direct before the sound is processed by the preamp. An internal bi-amp crossover is optional.

The tube circuitry also creates a “limiting” effect when slapping style is employed. Consequently, the normally expected increase in volume from pizzicato (finger style) to slap & pop is negligible. Because of this built-in limiting and the player’s ability to control playing dynamics with either style, there is no need to use an outboard limiter/compressor with the preamp.

I compared the Demeter preamp side by side to an SWR 400, using the same power amp, speaker cabinet and bass. My nine-year-old daughter, whose musical tastes range from Tower of Power to James Taylor (not including Guns N’ Roses), was asked to choose the version of James Brown’s “Cold Sweat” that sounded better. Blindfolded, she chose the Demeter both times.

According to Innovative Audio

Systems, manufacturer of the Demeter tube bass preamp, the device “has the warmth and dynamic range that only tubes can produce yet has lower noise than most solid-state devices.”

These are some pretty courageous claims, as are most manufacturer-written brochures. However, in this case it is all true. Regarding the above-stated description of a great amplified bass sound: warmth, dynamic range, punch and clarity, the Demeter is without peer. Simply stated, it accomplishes the tonal goals other solid-state or tube bass amps attempt to reach. At \$749, the Demeter VTBP-201 Tube Bass Preamplifier is equally well-suited to either the pro bass player or as an addition to the outboard rack of any studio that is serious about bass sounds.

Innovative Audio Systems/Demeter Amplification, 2912 Colorado Ave., Santa Monica, CA 90404; (310) 829-4383. ■

Glenn Letsch is a pro touring and session bassist who has worked with Robin Trower. He has recently been playing with artists such as Jonathan Cain and Johnny Colla.

Southeast RECORDING STUDIOS



Henninger Digital Audio, a three-studio facility located in the Washington D.C. metropolitan area, was created in response to the success of digital post-production at Henninger Video. Two Lexicon Opus integrated digital production systems handle editing and mixing, while Emulator E-II and E-III keyboards, a Gefen M&E network and the studio's Foley pits provide sound effects. Facility design by John Storyk features two mirror-image, RPG-treated environments. A third analog room is available for recording narration, music and sound effects. **Photo:** Mark Daniels.

Upcoming Directory Deadlines:

Southern California, Hawaii and Southwest Recording Studios: **June 8, 1993**

AES Issue/New Products: **July 8, 1993**

North Central and Canadian Recording Studios: **August 9, 1993**

CONTENTS

161 Alabama

162 Florida

165 Georgia

166 Kentucky

166 Louisiana

168 Mississippi

168 North Carolina

169 South Carolina

169 Tennessee

173 Virginia

175 West Virginia

175 Outside U.S.

Mix listings procedure: Every month, Mix mails questionnaires to recording studios and/or other vital facilities and services for the recording, sound and video production industries. There is a nominal charge to list a Boldface Listing (name, address, contact) and an Extended Listing (equipment, credits, specialization and photo or logo). If you would like to be listed in a Mix Directory, write or call the Mix Directories Department, 6400 Hollis Street #12, Emeryville, CA 94608; toll free 800-344-LIST.

Looking For Contacts In the Audio Industry?
Find Them in the

1993 Mix Master Directory

The 1993 Mix Master Directory has the audio contacts you've been looking for. Published by *Mix*, the audio industry's most respected professional magazine, the Master Directory is your primary source for audio information, with **comprehensive listings** of audio manufacturers, suppliers and services throughout the U.S. and Canada. You'll find cross-referenced listings for:

- **Recording & Video Production Facilities**
- **Remote Recording Facilities**
- **Sound Reinforcement Companies**
- **Independent Engineers & Producers**
- **Mastering, Pressing & Duplication Services**
- **Facility Designers & Suppliers**
- **Recording Schools, Programs & Seminars**
- **Equipment Manufacturers**

...and dozens of other audio businesses, from record companies to industry organizations.

If you need audio services, supplies or products, look no further than this essential reference guide! Use the attached form to order your copy of the Mix Master Directory, or call **toll-free** to place your order: (800) 233-9604.

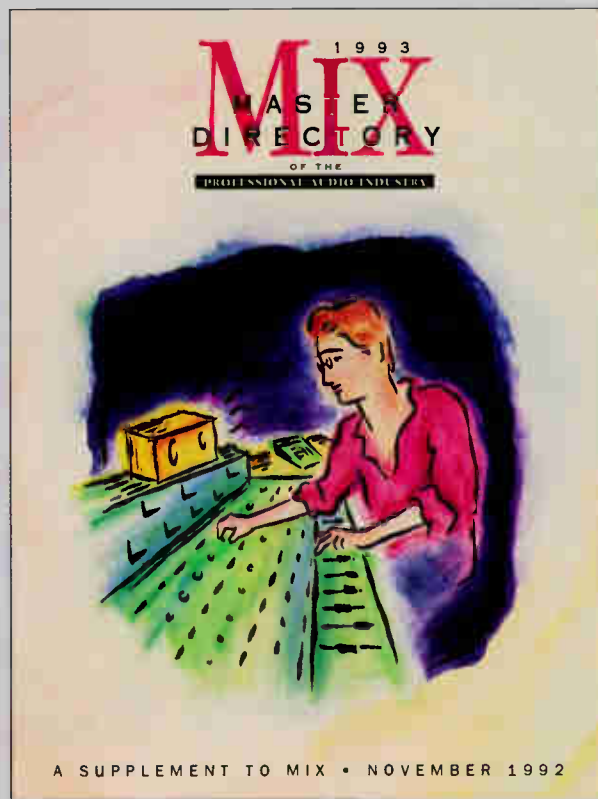

Please send me copies of the 1993 Mix Master Directory at \$24.95 each. (Add \$3.50 shipping and handling. CA, NY & IL residents add appropriate state sales tax.)

Please send me information on being listed in the *Mix* monthly directories.

Name

Company Name

Address

City/State/ZIP

Daytime phone () ext.

Check or Money order enclosed

Check #

Charge to Visa MasterCard Discover Card

American Express Expiration Date

Credit Card #

Cardholder Signature

Shipping times may vary; please allow two to three weeks for delivery. For immediate customer service and rush orders, call (800) 233-9604 or (510) 653-3307. 24-hour fax line (credit card orders only): (510) 653-5142.

Mail completed order form and prepayment to Mix Bookshelf, 6400 Hollis St., Suite 12-G, Emeryville, CA 94608

World Radio History

MIX

PROFESSIONAL RECORDING
SOUND & MUSIC PRODUCTION

SUBSCRIBE AND SAVE 50%

Subscribe to *Mix* and get the industry's most current and comprehensive production applications, new product reviews, industry news and technical information at half the newsstand price!

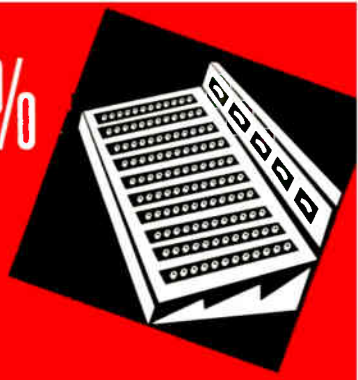

MIX

PROFESSIONAL RECORDING
SOUND & MUSIC PRODUCTION

SUBSCRIPTION SAVINGS CERTIFICATE SAVE 50%

YES! Send me 12 issues (1 year) of *Mix* for just \$29.95—a savings of 50% off the regular newsstand price.

INCREASE MY SAVINGS!
Send me 24 issues (2 years) of *Mix* for just \$52.95.

Payment Enclosed Bill me later (U.S. only)
Charge my: Mastercard VISA

Card # _____ Exp. date _____

Signature _____ Date _____

Name _____

Company _____

Address _____

City _____ State _____ Zip _____

Offer good in the U.S. only. Foreign subscriptions add \$40/year (U.S. funds only); Canada and Mexico subscriptions add \$20/year (U.S. funds only). Basic annual subscription is \$46. Please allow 6-8 weeks for first issue to arrive.

B30605

TO QUALIFY FOR THIS SPECIAL INDUSTRY OFFER, PLEASE COMPLETE ALL QUESTIONS BELOW:

1. Please indicate DNE category that BEST describes your JDB TITLE:

- A. Corporate Management**—President, owner, other manager, etc.
- B. Technical & Engineering**—Engineer, mixer, editor, design, etc.
- C. Production & Direction**—Producer, director, etc.
- D. Sales & Administrative**—Sales rep, account executive, etc.
- E. Other** (please specify): _____

2. Please enter the DNE three-digit code from the business activities listed in question 3 below that BEST describes your MAIN business activity:

3. Please check ALL business activities that currently apply to your professional audio industry work:

- RECORDING/PRODUCTION FACILITY**
- A01 2-4 Tracks
 - A02 8-16 Tracks
 - A03 24+ Tracks
 - A04 Digital Recording
 - A05 Remote Truck
 - A06 MIDI/Music Production

SOUND REINFORCEMENT

B08 Sound Reinforcement

VIDEO/FILM

- C10 Production Co.
- C11 Post-Production Co.
- C12 Remote Truck
- C13 Multi-Image Production
- C14 Videotape Duplication

EQUIPMENT MANUFACTURING

- D17 Audio Equipment
- D18 Music Equipment
- D19 Video Equipment

DUPLICATION/DISC MFG.

- E20 CD Manufacturing
- E21 Tape Duplication
- E22 Mastering Only
- E23 Other (please specify): _____

ACOUSTICS/DESIGN CONSULTANT

F26 Acoustics/Design Consultant

SOUND/VIDEO CONTRACTOR

F27 Sound/Video Contractor

BROADCAST PRODUCTION

- G30 Radio Station
- G31 TV Station
- G32 Other (please specify): _____

MEDIA

- H35 Ad Agency
- H36 Magazines/Newspapers/Books

RECORD COMPANY

J39 Record Company

INDEPENDENTS

- K42 Audio Producer
- K43 Audio Engineer/Technician
- K44 Video Producer/Director
- K45 Video Editor/Technician

EDUCATIONAL

L48 Music/Recording School or Program

INSTITUTIONAL

- L47 Corporate Facility
- L49 Trade Association
- L50 Government

RETAIL/RENTAL/MFG. REP

- M51 Audio/Music
- M52 Video/Film
- M53 Rep/Sales

INDUSTRY RELATED

- N45 Musician/Artist/Composer
- N46 Artist Management/Booking
- N47 Music Publisher
- N48 Student
- N49 Other (please specify): _____

MIX

PROFESSIONAL RECORDING
SOUND & MUSIC PRODUCTION

SUBSCRIPTION SAVINGS CERTIFICATE SAVE 50%

YES! Send me 12 issues (1 year) of *Mix* for just \$29.95—a savings of 50% off the regular newsstand price.

INCREASE MY SAVINGS!
Send me 24 issues (2 years) of *Mix* for just \$52.95.

Payment Enclosed Bill me later (U.S. only)
Charge my: Mastercard VISA

Card # _____ Exp. date _____

Signature _____ Date _____

Name _____

Company _____

Address _____

City _____ State _____ Zip _____

Offer good in the U.S. only. Foreign subscriptions add \$40/year (U.S. funds only); Canada and Mexico subscriptions add \$20/year (U.S. funds only). Basic annual subscription is \$46. Please allow 6-8 weeks for first issue to arrive.

B30605

TO QUALIFY FOR THIS SPECIAL INDUSTRY OFFER, PLEASE COMPLETE ALL QUESTIONS BELOW:

1. Please indicate DNE category that BEST describes your JDB TITLE:

- A. Corporate Management**—President, owner, other manager, etc.
- B. Technical & Engineering**—Engineer, mixer, editor, design, etc.
- C. Production & Direction**—Producer, director, etc.
- D. Sales & Administrative**—Sales rep, account executive, etc.
- E. Other** (please specify): _____

2. Please enter the DNE three-digit code from the business activities listed in question 3 below that BEST describes your MAIN business activity:

3. Please check ALL business activities that currently apply to your professional audio industry work:

- RECORDING/PRODUCTION FACILITY**
- AD1 2-4 Tracks
 - AD2 8-16 Tracks
 - AD3 24+ Tracks
 - AD4 Digital Recording
 - AD5 Remote Truck
 - AD6 MIDI/Music Production

SOUND REINFORCEMENT

B08 Sound Reinforcement

VIDEO/FILM

- C10 Production Co.
- C11 Post-Production Co.
- C12 Remote Truck
- C13 Multi-Image Production
- C14 Videotape Duplication

EQUIPMENT MANUFACTURING

- D17 Audio Equipment
- D18 Music Equipment
- D19 Video Equipment

DUPLICATION/DISC MFG.

- E20 CD Manufacturing
- E21 Tape Duplication
- E22 Mastering Only
- E23 Other (please specify): _____

ACOUSTICS/DESIGN CONSULTANT

F26 Acoustics/Design Consultant

SOUND/VIDEO CONTRACTOR

F27 Sound/Video Contractor

BROADCAST PRODUCTION

- G30 Radio Station
- G31 TV Station
- G32 Other (please specify): _____

MEDIA

- H35 Ad Agency
- H36 Magazines/Newspapers/Books

RECORD COMPANY

J39 Record Company

INDEPENDENTS

- K42 Audio Producer
- K43 Audio Engineer/Technician
- K44 Video Producer/Director
- K45 Video Editor/Technician

EDUCATIONAL

L48 Music/Recording School or Program

INSTITUTIONAL

- L47 Corporate Facility
- L49 Trade Association
- L50 Government

RETAIL/RENTAL/MFG. REP

- M51 Audio/Music
- M52 Video/Film
- M53 Rep/Sales

INDUSTRY RELATED

- N45 Musician/Artist/Composer
- N46 Artist Management/Booking
- N47 Music Publisher
- N48 Student
- N49 Other (please specify): _____

World Radio History



NO POSTAGE
NECESSARY
IF MAILED
IN THE
UNITED STATES

BUSINESS REPLY MAIL

FIRST CLASS MAIL PERMIT NO. 7231 NASHVILLE, TN

POSTAGE WILL BE PAID BY ADDRESSEE:

MIX

PROFESSIONAL RECORDING
SOUND & MUSIC PRODUCTION

P.O.Box 41525
Nashville, TN 37204-9830

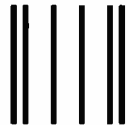
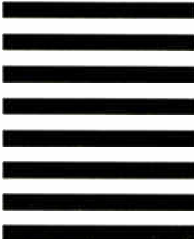

NO POSTAGE
NECESSARY
IF MAILED
IN THE
UNITED STATES

BUSINESS REPLY MAIL

FIRST CLASS MAIL PERMIT NO. 7231 NASHVILLE, TN

POSTAGE WILL BE PAID BY ADDRESSEE:

MIX

PROFESSIONAL RECORDING
SOUND & MUSIC PRODUCTION

P.O.Box 41525
Nashville, TN 37204-9830

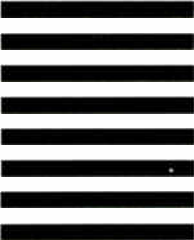

Southeast RECORDING STUDIOS

"Ever since the first tiny bloom had opened, it had called her to come and gaze on a mystery. From barren brown stems to glistening leaf-buds; from the leaf-buds to snowy virginity of bloom. It stirred her tremendously. How? Why? It was like a flute song forgotten in another existence and remembered again. What? How? Why? This singing she heard that had nothing to do with her ears." —Zora Neale Hurston

LEGEND

- Maximum digital tracks
- Maximum analog tracks
- Remote recording
- MIDI production
- Tape duplication
- Audio-for-video/film
- Digital editing/CD prep
- In-house music services

Information in the following directory section is based on questionnaires mailed earlier this year and was supplied by those facilities listed. *Mix* claims no responsibility for the accuracy of this information. Personnel, equipment, locations and rates may change, so please verify critical information with the companies directly.

ALABAMA

BABYBOY PRODUCTIONS/WLBJ MUSIC

387 Georgena Curve, Montgomery, AL 36105; (205) 284-8150; FAX: (205) 269-9142. Owner: Wilter Bush Jr./J.P. Smith.

BACKWOODS STUDIO

2361 County Rd. #294, Selma, AL 36703; (205) 418-0880. Owner: Richard L. Wilson. Manager: Richard L. Wilson.

BATES BROTHERS RECORDING

25 Joy Ave., Ste. #101, Birmingham, AL 35023; (205) 491-4066; FAX: (205) 491-7476. Owner: Eric Bates. Eugene Bates. Manager: Eugene Bates.

BIRDLAND RECORDING STUDIOS INC.

4891 County Rd. 585, Town Creek, AL 35672; (205) 685-3812. Owner: Owen Brown, James Murphree, Jeff Simpson. Manager: Owen Brown.

BOUTWELL RECORDING STUDIOS INC.

720 S. 23rd St., Birmingham, AL 35233; (205) 251-8889; FAX: (205) 251-9905. Owner: Corporate. Manager: Mark Harrison.

DOGWOOD RECORDING STUDIOS

2813 Springhill Ave., Mobile, AL 36607; (205) 476-0858; FAX: (205) 479-0364. Owner: Springer, Denson, Evans. Manager: Chris Springer.

FAME RECORDING STUDIOS

603 E. Avalon Ave., Muscle Shoals, AL 35662; (205) 381-0801; FAX: (205) 381-6337. Owner: Rick Hall. Manager: Don Srygley.

POLYMUSIC STUDIOS INC.

2717 19th St. S., Birmingham, AL 35209; (205) 871-8442. Owner: Daniel Whiteside. Manager: Daniel Whiteside.

RIDGE RECORDING STUDIOS

399 Cahaba Rd., PO Box 308, Greenville, AL 36037; (205) 382-7800; FAX: (205) 382-2714. Owner: Cleveland Poole. Manager: Cleveland Poole.

SOUND OF BIRMINGHAM PRODUCTIONS

3625 5th Ave. S., Birmingham, AL 35222; (205) 595-8497. Owner: Don Mosley. Manager: Betty Mosley.



STUDIO 6/PERSUASIVE MEDIA



6 South 55th Pl.; Birmingham, AL 35212; (205) 591-0804; FAX: (205) 591-0804. Owner: Frank Pigott. Manager: Frank Pigott.

FLORIDA

AUDIO PLAYGROUND



699 Clay St.; Winer Park, FL 32789; (407) 628-2119; FAX: (407) 647-2846. Owner: Michele Koplow, Joseph Rivers. Manager: Joseph Rivers.

AXIUM RECORDERS



2406 S. MacDill Ave.; Tampa, FL 33629; (813) 837-6384. Owner: Shaun Egger. Manager: Shaun Egger.

BAY SOUND PRODUCTIONS



301 Floral Dr.; Tampa, FL 33613; (813) 962-6175. Owner: D. Smith.

CPEQ INC.



210 Cook St.; Brandon, FL 33511; (813) 685-3740; FAX: (813) 685-3740. Owner: Thomas Downs, Greg Salyer. Manager: Thomas Downs.

CPN-TELEVISION STUDIOS



14375 Myer Lake Circle; Clearwater, FL 34620; (813) 530-5000; FAX: (813) 536-1864. Owner: Stuart Arnold. Manager: Dan Mockensturm.

CRITERIA RECORDING STUDIOS



1755 NE 149th St.; Miami, FL 33181; (305) 947-5611; FAX: (305) 956-5181. Owner: Joel M. Levy. Manager: Margie J. Curry.

ECHO BEACH STUDIOS



947 Alternate A-1-A; Jupiter, FL 33477; (407) 622-9902; FAX: (407) 622-9902. Manager: Chas Payson.

FOOTSTEP STUDIOS



3500 N. Courtenay Pkwy.; Merritt Island, FL 32953; (407) 459-2508; FAX: (407) 452-8472. Owner: Calvary Chapel of Merritt Island. Manager: Joel Wild.

HOLLYWOOD RECORDING STUDIO



3130 SW 19th St. #448; Pembroke Pk., FL 33009; (305) 962-1586. Owner: Wayne Ricker.

HUMMINGBIRD RECORDINGS



P.O. Box 061625; Palm Bay, FL 32906; (407) 676-9722; FAX: (407) 676-9002. Owner: John Foley. Manager: John Foley.

FRUSTRATED WITH OWNERS MANUALS?

Get a free copy of the Mix Bookshelf catalog, which features tips and techniques books for equipment by Roland, Alesis, Yamaha, Casio, Korg, Ensoniq, Kawai, Kurzweil, Oberheim and E-mu. Call toll-free (800) 233-9604.



HURRICANE PASS STUDIOS
Clearwater, FL

HURRICANE PASS STUDIOS



2382 Congress Ave.; Clearwater, FL 34623; (813) 784-5000; FAX: (813) 784-7411. Owner: James B. McCullough. Manager: Roger K. Hughes. Engineers: Roger K. Hughes, Steve Sonnen, Jeffrey Stottlar, David Cassell. Dimensions: Room 1: 20'x24', control room 16'x25', Room 2: 15'x20', control room 8'x10'. Mixing Consoles: Trident prototype A-Range 40x24x8x4x2, Tascam M2524 24x8x2. Audio Recorders: Studer A80 MkIV w/ALC 24-track, Tascam MRS16 16-track, Ampex 440 2-track, Panasonic SV-3700 DAT, Tascam DA 40 DAT, (2) Tascam 122 MkII cassette. Monitors: (2) B&W Studio Matrix, (2) Phase Tech PC60 MkII, (2) Annoy PBM 6.5, (2) Tannoy SRM-12B, (2) Yamaha NS-10. Other Major Equipment: Niche 24-/16-track automation, Lexicon 300, Lexicon 200, Lexicon LXP-15, Eventide H3000SE, Korg DRV-3000, Korg DRV-2000, (2) Yamaha SPX90, Yamaha D1500 delay, (2) Roland SDE-1000 delay, Klark-Teknik Quad comp/limiter, (2) dbx 160, dbx 160X, Yamaha dual compressor, Symetrix 501 compressor, (2) Valley People Quad Gate, ART IEQ programmable EQ, Space Station SST-282, Neumann U47, (3) Neumann U87, (2) Neumann KM84, AKG The Tube, (2) AKG 414, AKG D-112, (2) AKG 451, (4) Sennheiser 421, Sennheiser 441, (3) Yamaha MZ204, (8) Shure SM57 LC, (2) Audio-Technica 4031, (3) Shure E330 ribbon, Macintosh based MIDI production w/Visions, Roland S-770, Akai S-950. Specialization & Credits: "Class A" tracking facility with the original Trident studios (of London), Trident A-Range prototype console, (4) isolation rooms, large clients' lounge and lodging included with basic studio rate at studio's convenient ranch house. We offer the perfect working vacation, located close to all of Florida's major attractions. Rates are as follows: \$85/hour, \$800/(12-hour) day lock-out, \$4,000/(6-day) week and custom packages with further discounts for larger "blocks."

LETHAL AUDIO



1607 Venetian Dr.; Key West, FL 33040; (305) 296-7141; FAX: (305) 294-5678. Owner: James M. Lee. Manager: Scott Gordon. Engineers: Jimmy Lee, Scott Gordon. Dimensions: Studio: 20'x15', control room 14'x12'. Mixing Consoles: Tascam M3700/32 automated. Audio Recorders: Tascam MSR16S 16-track, Tascam DA30, Tascam 122 MkII, Phillips FC515. Monitors: JBL 4208. Other Major Equipment: Eventide H3500SE Ultra Harmonizer, Sony R-7 digital reverb, Lexicon LXP15, Roland RSP-550, Drawmer DL-241, ART MDC 2001, dbx de-esser, BBE 822 Sonic Maximizer, Aphex Aural Exciter Type C, Akai MPC60 drum/sequencer, Roland R-8, Kurzweil D-2000, E-mu ProCussion, Paul Reed Smith custom guitar, Mesa Boogie Mark IV combo amp, Yamaha FX500, Halfer Pro 2400 amp, AKG 414, Sennheiser 421, (3) Shure SM57.

LONE PINE RECORDING STUDIO



5024-A Simmons Rd.; Orlando, FL 32812; (407) 281-6881; FAX: (407) 275-1495. Owner: Michael A. Hurley. Manager: Patti Pool. Engineers: Michael Hurley. Dimensions: Room 1: Studio 30'x23', control room 21'x17'. Mixing Consoles: Trident Series 80-B w/ Visionary Audio modified mic preamps and Dptille 3D automation. Audio Recorders: Otari MX-80 24-track, Studer A-807 2-track w/ center track time code and Dolby SR, (2) Panasonic SV-3900 DAT w/ MK 390 controller, Tascam TSR-8 1/2" 8-track, Tascam 44 1/4" 4-track, Tascam 42 2-track, Meridian CD-R compact disc recorder, (2) Kenwood KX-800 cassette decks. Monitors: UREI 809 w/subwoofer, Yorkville YSM-1 nearfield, Yamaha NS-10M studio nearfield, Auratone. Other Major Equipment: Lexicon PCM70. Eventide H3000 SE Ultra-Harmonizer, (2) Summit Audio TLA-100 tube compressors, Aphex Compellor, BBE 802 processor, (2) Alesis Quadraverb, (2) Alesis MIDiverb II, (2) dbx De-essers, Technics 1300 series CD player, Adams-Smith Zeta III synchronizer w/remote, Sony 9850 3/4" video deck, Bryston 4B amplifier, Bryston 3B amplifier, (3) Dynaco amplifiers, Yamaha 9' concert grand piano, Yamaha drumset, Yamaha KX-88 keyboard controller, E-mu Proteus 1 synth module, E-mu Proteus 2, Korg M-1, Roland D-550, (2) Neumann U89, (2) AKG 414, (2) Audio-Technica 4051, (6) Neumann KM-86, AKG 460, (6) Shure SM57, AKG D-112, (7) Manhasset music stands, (250) #2 pencils, (18) cool mugs, four acres of nice land.

METANOIA INC.



7660 Harbour Blvd.; Miramar, FL 33023; (305) 983-9710. Owner: Charlie Stracuzzi. Manager: Charlie Stracuzzi.

MIDILAND RECORDING STUDIOS



4041 Laguna; Coral Gables, FL 33146; (305) 444-6222; FAX: (305) 446-5356. Owner: Andres Valdes Jr. Manager: J.C. Ulloa. Engineers: J.C. Ulloa, Will Tarak. Dimensions: Room 1: studio 21'x29', control room 21'x18'. Room 2: studio 7'x7', control room 18'x11'. Room 3: control room 10'x7'. Mixing Consoles: Trident Series 80B 50x24x24 w/Disk Mix III moving faders, Trident Series 65 32x8x16. Audio Recorders: Otari MTR-90 II 24-track, Otari MX-80 24-track, Otari MTR-12 2-track 1/4", Sony PCM-2500 DAT, Panasonic SV-3700 DAT, (2) Tascam 122 MkII cassette, (2) Kenwood KX3510 cassette, Sony PCM-100ES DAT, Otari MTR-12 2-track 1/2". Digital Audio Workstations: Digidesign Pro Tools. Monitors: Meyer 833 w/834 subwoofers, Westlake BBSM-6, (3) Yamaha NS-10M, (2) Auratone 5-C, JBL 4312. Fourier. Other Major Equipment: Lexicon 480L, AMS RMX 16, AMS DMX 15-805, (3) Lexicon PCM70, (2) Lexicon PCM42, Eventide H3000, (3) Yamaha SPX90, Roland SDE-3000 delay, Ibanez DM-2000 delay, Alesis MIDiverb II, (2) ADR compex stereo limiter, dbx 162 stereo comp, (2) L/Lab 660 comp, dbx 165 A limiter, (8) Aphex CX-1 comp/gate, (4) Valley People Kepex II gate, (7) Valley People Gain Brain II comp, (4) Drawmer 201 stereo gate, BSS DPR-404 quad de-esser, (2) API 550B EQ. Extended Equipment Description: AKG C-24 stereo tube mic, (2) AKG 451, AKG D-12, (2) Neumann U47 FET, (2) Neumann U87, (2) Schoeps CMC5, (4) AKG 414, (4) Sennheiser 421, Sennheiser 441, (2) Sony ECM-55, (2) Sony C-37, (6) Shure SM57, Shure SM7, (4) Beyer M88, (2) Beyer 101, (2) Fostex M88, Bryston 4B amp, (2) Halfer P-505, (2) Halfer P-225, Steinway D9 grand piano.

MIRROR IMAGE SOUND & RECORDING INC.



619 S. Main St.; Gainesville, FL 32601; (904) 376-8742. Owner: Robert McPeck. Manager: Ray Valla.

MORRISOUND RECORDING INC.



12111 N. 56th St.; Tampa, FL 33617; (813) 989-2108; FAX: (813) 980-6950. Owner: Morrisound Recording Inc. Manager: Tom Morris. Engineers: Jim Morris, Tom Morris, Judd Packer, Scott Burns, Rick Miller. Dimensions: Room 1: studio 40'x30', control room 24'x25'. Room 2: studio 14'x30', control room 24'x25'. Mixing Consoles: SSL 4064 G Series w/Total Recall, Soundworkshop Series 34 w/automation. Audio Recorders: (3) Otari MTR-90 24-track, Mitsubishi X850 32-track, Otari 5050 MkIII 8-track, (3) Otari 5050B 2-track, (2) Panasonic SV-3500 DAT, (2) Panasonic SV-3700 DAT, (6) Tascam 122 MkII. Digital Audio Workstations: Sound Tools, Spectral System. Monitors: (2) UREI 813B, (2) Yamaha NS-10M, (2) Auratone 5-C, JBL 4312-A, Eastern Acoustic Works MS 50. Other Major Equipment: Lexicon 480L, Lexicon 224XL, (2) Lexicon PCM70, Lexicon PCM60, (3) Lexicon PCM42, Lexicon Prime Time, (3) TC Electronic 2290, (2) Eventide H3000, (2) Eventide H910, Yamaha REV7, (2) BBE Sonic Maximizer, (4) dbx 1176, (2) dbx 165, dbx 166, (2) EXR Aural Exciter, BSS DPR-502, (4) UREI LA-4, Adams-Smith Zeta-3.



NEW RIVER STUDIOS INC.
Fort Lauderdale, FL

NEW RIVER STUDIOS INC.



408 S. Andrews Ave.; Fort Lauderdale, FL 33301; (305) 524-4000; FAX: (305) 524-3999. Owner: New River Productions Inc. Manager: Virginia Cayia. Engineers: Larry Janus, Dave Barton, Jim Thomas, Riley J. Connell. Dimensions: Room 1: studio 35'x30', control room 20'x25'. Room 2: studio 8'x8', control room 12'x14'. Mixing Consoles: Neve 8108 56x48 w/ Flying Faders, Trident Series 65 32x16. Audio Recorders: Mitsubishi X850 32-track w/ Apogee Filters, (2) Studer A800 Mark III 24-track, (2) Studer A80 1/2" & 1/4" 2-track, Studer A80 4-track 1/2" & 1/4" w/ center track SMPTE, (2) Studer Revox B77 1/4", JVC DSDT 900 Time Code DAT, Sony PCM-2500 R-DAT. Monitors: Westlake BBSM10 monitors w/Meyer 834 subwoofers, (4) Westlake BBSM6, (4) Yamaha NS-10M, (2) Auratone 55C, (2) JBL 4430 studio monitors. Other Major Equipment: AMS RMX16 digital reverb, Lexicon 480L, (2) Lexicon PCM70, (2) Yamaha SPX 90 II, EMT 1405 stereo tube plate, Lexicon 97 Super Prime Time, Eventide H3000 Harmonizer, (2) Eventide H949 Harmonizer, (2) Pultec EQP1, (4) API 550A, (2) API 550, A&R Vocal Stressor, (3) dbx 165 comp/limiter, dbx 162 comp/limiter, (2) UREI 1176, (2) Drawmer DS201 dual noise gate, A&R w/ Scamp processor rack w/(2) S01 comp/limiter, (2) S04 parametric EQ, S06

dynamic noise filter. **Extended Equipment Description:** S06 dynamic noise filter, S23 Auto Panner, S24 Time Shaper, S25 de-esser, (4) F300 expander/gate, Neumann TLM50, M49 (tube), U47, KM84, KM86, (2) Neumann U87 Z, U87 Z (Klaus Heyne modified), Neumann U89 Z, various other microphones. JVC BVU850 SP 3/4" Umatic video recorder, (3) Adams-Smith Zeta 3, Hammond B30 organ w/ Leslie, (2) Dolby SR, Dolby SP24. **Specialization & Credits:** We have been in operation for over ten years, and have the opportunity of working with some of the finest musical groups and artists. Our recent credits include Extreme, Skid Row and Bob Seger. We have two studios; Studio A for tracking and mixing, Studio B for MIDI production and overdubs. Commercial clients include Blockbuster Video's new radio and TV campaign jingles and the Florida lottery. We can assist in locating housing and rental cars. Please feel free to call for information and rates.

JOSH NOLAND MUSIC STUDIO

RR **DP** **CD** **MC** **TV** **MA** **SA**
760 W. Sample Rd.; Pompano Beach, FL 33064; (305) 943-9865; FAX: (305) 943-9865. Owner: Josh Noland. Manager: Josh Noland.

PALM BEACH SOUND & SYNTHESIS INC.

R24 **D4** **CD** **MC** **TV** **MA** **SA**
3885 Investment Ln., Ste. 1; Riviera Beach, FL 33404; (407) 842-7211. Owner: John and Deborah Simsic. Manager: Deborah Simsic.



PARC STUDIOS INC.
Altamonte Springs, FL

PARC STUDIOS INC.

R24 **DP** **CD** **MC** **TV** **MA** **SA**
658 Douglas Ave.; Altamonte Springs, FL 32714; (407) 292-0021; FAX: (407) 578-5235. Owner: Pat Armstrong. Manager: Andy de Ganahl. Engineers: Andy de Ganahl, Dana Cornock. Dimensions: Room 1: studio 30'x40', control room 26'x26'. Room 2: studio 31'x18', control room 25'x18'. **Mixing Consoles:** SSL 6056E, Soundworkshop 34C. **Audio Recorders:** Studer A800 24-track, Studer A80 III 24-track, (2) Studer A80 IV 2-track 1/2"-1/4", Studer A80IV 4-track 1/2", Studer A820 2-track 1/2"-1/4", Studer A810 2-track 1/4", Panasonic SV-3500 DAT, Panasonic SV-3900 DAT, Otari 5050 8-track, (3) Nakamichi MR-1B cassette. **Digital Audio Workstations:** Digidesign Sound Tools. **Monitors:** (2) Meyer HD-1, (4) Yamaha NS-10, (2) Fostex LS-3, (2) Auratone 5-C, (2) JBL 4430, (2) Tannoy PBM-6.5. **Other Major Equipment:** Adams-Smith Zeta-3 sync; (2) Lexicon 224XL, Lexicon 480, (2) Lexicon 200, Roland 880, AMS RMX-16, (2) Yamaha REV5, (3) Yamaha SPX90 II, Alesis MIDI-verb II reverbs; (2) AMS 15805, (3) TC Electronic 2290, (3) Lexicon PCM42 DDLs; Lexicon Prime Time 93, Klark-Teknik DN-780 reverb, (2) Drawmer 201 gate, Aphex Type B Aural Exciter, Aphex Compellor, Aphex Dominator II, dbx 900 rack w/(2) 903, (4) 905, 929; (2) Hafler DH-500 amp. **Extended Equipment Description:** (2) B&K 4003 line power, (2) B&K 4011, B&K 4006, B&K 4000, (3) Neumann U47 (tube, (2) FET), AKG C-12A, (4) Neumann U87, (6) Neumann KM86 microphones; Drawmer 1960 tube compressor; (7) Sennheiser 421, (2) Sennheiser 441 mics; Sony 5950 video 3/4", Sony Beta VCR, Quasar S-VHS VCR, Yamaha C-2 conservatory grand piano, (5) AKG 460, (4) AKG 414 mics; (2) Teletronix LA-2A comp., Pultec EQP-1A3 EQ, Lang PEO tube EQ. **Specialization & Credits:** Parc Studios is a full-service audio production facility suitable for album, commercial, jingle, film or demo productions. 48-track, mix-to-video, MIDI and Synclavier services are available upon request. Recent clients include: records—CBS, Capitol, RCA, Epic, Myrrh; TV and film—Walt Disney World, Sea World, The Disney Channel. Our second room provides complete music production service with an extensive MIDI system and a full complement of instruments and amplifiers. Two client lounges with apool table and video games are provided. Located in sunny Orlando, Parc offers our clients and their guests many other amenities, including luxury hotels and over 40 restaurants within minutes of the studios. The Disney theme parks, Sea World and Universal Studios are close by. (Even the beach is less than an hour's drive!) Real-time cassette duplication on-site. Location recording with a 48-track mobile also available. Call for rates.

TURN TO PAGE 161 FOR AN EXPLANATION OF RECORDING SERVICE SYMBOLS.

PINE GROVE STUDIO

RR **DP** **CD** **MC** **TV** **MA** **SA**
10985 SW 172 Terrace; Miami, FL 33157; (305) 255-1495; FAX: (305) 225-7209. Owner: Newton Simmons. Manager: Newton Simmons.

PLATINUM POST AT FULL SAIL

R48 **D48** **CD** **MC** **TV** **MA** **SA**
3300 University Blvd., Ste. 160; Winter Park, FL 32792; (407) 671-1111; FAX: (407) 671-1112. Owner: Full Sail Recorders. Manager: Buffy Thibodeaux. Engineers: Gary Platt, Ken Latchney. **Mixing Consoles:** Neve VR 60 w/Flying Faders Automation and Recall, Solid State Logic 6000 E (48x32) Fully Automated w/Total Recall, Sony MXP 3036 (36x24), Neotek Elan (36x24), Neotek Elan (28x28), Sphere Eclipse A (32x24), (6) Tascam M3500 32 input console. **Audio Recorders:** Studer A800 24-track, (2) Otari MTR 100 24-track, (2) Otari MX80 24-track, Studer A80 2-track, (2) Otari MTR 12 2 & 4 track, Otari MTR 10 2-track, (2) Otari MX55 2-track, (3) Otari 5050 2-track, Panasonic 3700 DAT, Technics SV DA10 DAT. **Digital Audio Workstations:** (3) New England Digital Synclavier System, (2) New England Digital Direct to Disk System, Studer Dyaxis II, Lexicon Opus. **Monitors:** Meyer HD 1, Meyer 833, Yamaha NS-10, Tannoy Gold. **Other Major Equipment:** Lexicon 480L, Montage Digital Picture Processor Editing System 3, (2) Lexicon PCM 70, (2) Lexicon PCM 41, (2) Lexicon PCM 42, Eventide H3000 B Ultra-Harmonizer, BBE 802 Sonic Enhancer, TC Electronic TC 2290, Dolby SR (2-track), Sphere graphic EQ rack, Teletronix LA-2, Roland SRV-2000, Roland DEP-5, (2) Yamaha SPX1000, dbx 900 series rack, (2) Aphex Dominator, (2) Aphex Compellor, (2) Aphex Aural Exciter, (2) Roland SDE-3000, EcoPlate plate reverb, (2) Lynx and Adams-Smith synchronizer, CMX 330-A w/GISMD Motion Controller (video computer editor).

PROGRESSIVE MUSIC STUDIOS

RR **DP** **CD** **MC** **TV** **MA** **SA**
2116 Southview Ave.; Tampa, FL 33606; (813) 251-8093; FAX: (813) 251-6050. Owner: Ken Veenstra. Manager: Ken Veenstra.

RADIO ACTIVE PRODUCTIONS RECORDING

RR **DP** **CD** **MC** **TV** **MA** **SA**
PO Box 2523; Marathon Shores, FL 33052-2523; (305) 743-4248. Owner: John Bartus. Manager: John Bartus. **Specialization & Credits:** The jingle specialists at Radio Active Productions Recording continue to create the finest broadcast music and production. In addition, we still cater to the local musicians and songwriters in the Keys with affordable demo and album packages. Our motto "master quality at demo prices", reflects the care and attention each project receives, whether it's a local songwriter demo or a national jingle package—as well as our clients' concerns about keeping the project within budget and on time. Our MIDI system features the most modern and up-to-date gear along with classic vintage pieces. Sync it to our multitrack for voices and guitars, and mix-down to DAT or analog 1/4". Add spice with our full SFX and production music libraries, or we'll create the custom musical identity of your dreams. The tropical creative experience awaits you here in the Keys. Call or write for package prices and rates.

RCS PRODUCTIONS

RR **DP** **CD** **MC** **TV** **MA** **SA**
6583 Samoa Or.; Sarasota, FL 34241; (813) 379-4002. Owner: Risha Ann Gravelin. Manager: Risha Ann Gravelin.

REEL TIME RECORDING INC.

R24 **DP** **CD** **MC** **TV** **MA** **SA**
939 Carswell Ave.; Holly Hill, FL 32117; (904) 238-7002; FAX: (904) 255-0030. Owner: Corporate. Manager: Mark D. Ignoffo. Engineers: Mark Ignoffo, Alan Kolby, Nick Santos, independents welcome. Dimensions: Room 1: studio 24'x23', control 24'x13'. Room 2: studio 16'x11'. Room 3: studio 11'x10. Room 4: studio 8'x5'. **Mixing Consoles:** TAC Matchless 36x24x8x2. **Audio Recorders:** Otari MX 70 16-track, Fostex E-16 16-track, Otari MX5050 MKIII 2-track, Panasonic 3700 DAT, Sony DTC M100 DAT, Technics SV DA 10 DAT. **Digital Audio Workstations:** Access to Studer Dyaxis, Monitors: UREI 809, Tannoy PBM-8, Auratone Cubes. **Other Major Equipment:** (2) Yamaha P2201 amplifiers, Fostex 4030/4035 synchronizer, Lexicon PCM60 reverb, Lexicon LXP-1, Lexicon LXP-5, Yamaha SPX90, DigiTech IPS 33B Harmonizer, (2) DigiTech DSP 256, Aphex Compellor, Aphex 612, dbx 166, (4) dbx 163X, dbx 463X, Audio Logic MT66, (2) Furman QN4A 4 channel noise gate, Valley People Dyna-Mite, BBE 822 Sonic Maximizer, Neumann U87, Beyer MC740, (3) Beyer M6S, Sennheiser 441, AKG 451, (3) AKG D12E, (2) Shure SM81, (6) Shure SM57, Electro-Voice RE20, Nakamichi MR-1 cassette, (3) Nakamichi MR-2 cassette, Aiwa F800 cassette, (8) JVC 707 dual record cassettes, Yamaha MSS1 SMPTE/MIDI converter, Roland S-50 sampler/sequencer, Yamaha DX-5 synthesizer, 100+ CD music production library. **Specialization & Credits:** Reel Time Recording is devoted to giving you the highest quality in recording and/or packaging your project. We offer personalized service, a friendly atmosphere, and the best prices on CD replication, CD booklets, J-cards, cassette duplication, mastering and packaging. Our fast turnaround means we'll make your deadline. This year, we've taken a bold new step in helping our clients promote their projects. March 1993 will see the release of *Latitude 29*, Vol. 1, a compilation CD, showcasing 13 new bands that have cut tracks here at Reel Time. We are a full-service studio, working to ensure that your project is not compromised. From demos to albums, CD and cassettes, artwork and packaging. Reel Time is your real choice.

Doggedly pursuing better sound.



"Sam"

NEW RIVER
STUDIOS

408 S. ANDREWS AVENUE
FORT LAUDERDALE, FL
(305) 524-4000

USE READER SERVICE CARD FOR MORE INFO

CD-LIKE
QUALITY
ON CASSETTES!!

KLARITY KASSETTE

REAL-TIME/HIGH-SPEED
CASSETTE DUPLICATION

5 Day Turnaround!!
500 CASSETTES

INCLUDES:
- Free Master Prep
- On-Shell Printing
- Bk & Wh J-Card Inserts
- Packaging & Shrinkwrap
- Up to 48 00

High Speed
MUSIC EXPRESS
\$615.00

See Next
Page for
CD SPECIAL

KLARITY KASSETTE, INC.
Waterville, ME 04901
1-800-458-6405
207-873-3911



RON ROSE PRODUCTIONS INC.



3409 W. Lemon St.; Tampa, FL 33609; (813) 873-7700; FAX: (813) 875-6633. Owner: Ron Rose Productions Inc. Manager: Buddy Pendergrass.

SATURN SOUND STUDIOS INC.



515 S. Olive Ave.; West Palm Beach, FL 33401; (407) 832-2148; FAX: (407) 832-1957. Owner: Clinton Smith, Allen Pearson. Manager: James Crockett. Engineers: James Crockett. Dimensions: Studio 20'x38', control room 16'x16'. Mixing Consoles: MCI JH-636 30x24x2 non-automated. Audio Recorders: MCI JH-24 24-track w/autolocator III, (2) MCI JH-110B 2-track w/remotes, Panasonic SV-3700 DAT, (6) Tascam 122B cassette. Monitors: JBL 4411 control, Yamaha NS-10M near-field, Bozak studio. Other Major Equipment: Kawai GS30 6' conservatory piano, Ludwig drum kit, Apple Macintosh SE w/MDTU Performer 4.01; sampler, synth, drum modules and sync available; Yamaha SPX1000, Yamaha SPX90 II, DeltaLab Effectron ADM 1024 delay, (3) dbx 165A, dbx 166, Symetrix 564E, Symetrix TI-101 telephone interface, Drban 6228, Neumann U87M, KM84; AKG 414, 451EB; Sennheiser 421, 441, Shure SM85, SM7, SM57; (2) Crown DC300A, D150, D75 stereo amps; Sony VD-5800 3/4" VTR, BTX/Cypher Digital 4700 VTR to ATR sync system, Sony 19" video monitor, Dolby 363 SR noise reduction 2-track, Technics SL-1100 CD player, complete network CD production music & SFX libraries.

SONIC RECORDING STUDIO



1059 NE 7th St; Cape Coral, FL 33909; (813) 772-0040. Owner: Bo Davis, pres. Engineers: Bo Davis, Scott Haines, Rob Robinson. Dimensions: Room 1: studio 30'x27', control 20'x20'; Room 2: studio 13'x10'; Room 3: studio 10'x8'. Mixing Consoles: Soundworkshop Series 34C. Audio Recorders: MCI JH-24 2", Panasonic 3500 DAT, Otari 5050 1/4". Monitors: UREI 813, Electro-Voice Sentry. Other Major Equipment: (2) Lexicon PCM42, (2) Eventide H-3000, (2) dbx 165A, Lexicon 200, Lexicon LXP-1, Lexicon LXP-5, Lexicon Prime Time, Yamaha SPX-1000, Roland RE-555 chorus/echo, Aphex 612 gate, BSS Quad Gate, Neumann U87, AKG 414, (2) AKG 460 B, (6) Shure SM57, (2) Sennheiser 421, (2) AKG D-12, Yamaha and Crown power amps, (3) complete Marshall stacks, Mac IIc, Hammond B-3 w/Leslie, other vintage instruments. Specialization & Credits: We're the latest state of the art 24 track studio in the Fort Meyer area. Recent recordings with Blackfoot and Liz Larin (Atlantic).

SONIC III INC.



7162 SW 47th St.; Miami, FL 33155; (305) 662-3919; FAX: (305) 662-4867. Owner: Hernan Polo, Ken Campbell.



SONSHINE SOUND INC.
Pensacola, FL

SONSHINE SOUND INC.



8804 University Parkway; Pensacola, FL 32514; (904) 479-4660; FAX: (904) 479-3638. Owner: David Gillette. Manager: Mark Pursler. Engineers: Mark Pursler. Dimensions: Room 1: studio 30'x30', control 23'x22'. Mixing Consoles: Euphonix CSII 8056. Audio

Recorders: Studer 827 24-track, Panasonic SV 3700 R-DAT, Panasonic SV 3500 R-DAT, Digital Audio Workstations: Digidesign Pro Tools. Monitors: Custom Hartman Research Mains, Custom Hartman Research NFM, Yamaha NS-10M. Other Major Equipment: Lexicon 480L, Lexicon 300, (2) Lexicon LXP-1, Roland R880, Eventide H3000B, Teltronix LA2A, Euphonix 8 channel Dynamics, CAD C6M-2 Champ stereo comp/limiter, JBL 7110 comp/limiter, (3) CAD polyframe single channel compressor, (3) CAD polyframe Dynamic expansion, (2) Audio Logic MT44 gate, Bedini BASF Audio Spatial Environment, (2) Neve 1066-1036, Neumann U47, U87, AKG C-12, Sample cell card, Roland S550 sampler, Roland S50 sampler, Roland D50, Kurzweil PX1000 Plus, Yamaha TX 816, Korg T3, Korg M1, E-mu Proteus II, Yamaha KX 88, Hammond C-3 organ, Yamaha C-6 piano, Roland R-8, Studio Vision software, Sound Designer II software, various other microphones, and instruments, BBE 822.

SOUNDTRACK INC.



1975 NE 149th St.; N. Miami, FL 33181; (305) 945-4449; FAX: (305) 940-6434. Owner: George Blackwell. Manager: Vince Oliveri.



SOUTH BEACH STUDIOS
Miami, FL

SOUTH BEACH STUDIOS



1200 Collins Ave.; Miami Beach, FL 33139; (305) 673-8203; FAX: (305) 531-9929. Owner: Chris Blackwell. Joe Galdo. Manager: Nancy Mraz. Engineers: Cesar Sogbe. Dimensions: Studio 15'x15', control room 27'x15'. Mixing Consoles: Solid State Logic 4072 E w/(B) G modules and G computer, (16) E EQs. Audio Recorders: Mitsubishi X-880 32-track w/Apogee filters, Studer A820 24-track w/Dolby SR, Studer A820 2-track 1/2" w/Dolby SR. Digital Audio Workstations: Sony 7030 DAT wall options, Sony 2700 DAT, (2) Tascam 122 MkII, (2) Pro Tools & Sound Tools, Apogee AD 500 A-to-D converters. Monitors: Genelec 1034 A (mains), (2) Yamaha NS-10, Westlake BBSM-4, Tannoy 6.5, EV Sentry 100A. Other Major Equipment: CD recorder, Lexicon 224, Lexicon 224XL, Lexicon 480L w/LARC, (2) Lexicon PCM70, AMS RMX16, EMT 250, EMT 240 stereo plate, Klark-Teknik DN-780, (2) Eventide H3000 SE, (2) Eventide 949, AMS DMX 1580S, (2) Yamaha REV5, (2) Yamaha SPX1000, (2) Yamaha SPX900, (2) Yamaha SPX90 II, Alesis MIDiverb, Roland 880 digital reverb, (4) Lexicon PCM42, TC Electronic 2290, Cyclosonic auto panner. Extended Equipment Description: Roland Dimension D, Aural Exciter Type III, Bel flanger, (2) Dynaflex noise reduction, Sony DRE-2000, Ursa Major Space Station SST-282, (2) dbx RM 160 D2, (2) 160X, (2) 163, 900 rack; Neve 33609, (2) UREI 1176, (2) Focusrite 130, (2) LA-2A, SSL G 384, Neve Prism rack, (4) Focusrite 15A 110 HD, GML 8200, Aemek Medici EQ, Pultec EQP-1, dbx 120X Boom Box, (6) API 550A.



STUDIO CENTER
Miami, FL

STUDIO CENTER



6157 NW 167th St., Ste. F-4; Miami, FL 33015; (305) 828-7231; FAX: (305) 826-8615. Owner: Studio Center. Manager: Craig Powell. Dimensions: Room 1: studio 22'x15', control room 16'x19'. Room 2: studio 12'x8', control room 14'x13'. Mixing Consoles: SSL 6056E G Series computer w/Total Recall, MCI 428B. Audio Recorders: Mitsubishi X-850 32-track digital, Sony PCM-3324 24-track digital, MCI JH-24 24-track, Sony PCM-3402 2-track digital,

Sony APR-5002 2-track, (2) Sony PCM-2500 R-DAT, Nakamichi MR-1, Tascam 122 MkII. Digital Audio Workstations: Digidesign Sound Tools recorder/editor. Monitors: Crown Macro Reference, Bryston 3B, (2) Meyer MS-1000, (2) BGW 250, Meyer 833/834, (3) Yamaha NS-10M, Auratone Super Sound Cube, EV Sentry 100A. Other Major Equipment: Lexicon 480L, Lexicon 224XL, Lexicon PCM70, (2) Lexicon PCM42, Eventide H3000 SE Ultra Harmonizer, Eventide H949 Harmonizer, (12) API 550A, Teltronix LA-2A limiter, (2) dbx 160 comp/limiter, (2) dbx 165 comp/limiter, Drawmer DS-201, Drawmer DL-231, Demeter VTMP-2a mic preamp, Summit Audio DCL-200 dual tube comp/limiter, (2) Macintosh II computer, Dpcode Vision 1.4 sequencing software, Dpcode Galaxy Plus editor/librarian, Dpcode Studio 5 SMPTE/MIDI interface, Dolby A/SR available on request. Specialization & Credits: At Studio Center, our warm, relaxed atmosphere and courteous, efficient staff combined with the latest technology, provides a comfortable, creative environment for your recording project. We offer a fully equipped MIDI production suite as well as post-production facilities for film and video. Give us a call to discuss your next project. You'll be glad you did!

TROPICAL RECORDING STUDIO



4842 SW 74 Ct.; Miami, FL 33155; (305) 661-3599. Owner: Daniel Diaz. Engineers: Daniel Diaz, Rick Reed. Dimensions: Room 1: studio 15'x25', control room 35'x25'. Room 2: studio 10'x6', control room 15'x25'. Mixing Consoles: Sony MXP-3036 w/automation, Trident Series 65 w/automation. Audio Recorders: Sony APR-24 24-track, Tascam MS-16 w/dbx noise reduction, Sony APR 2-track, Panasonic SV-3900, Nakamichi MR-1 cassette, Tascam 122 MkII cassette. Monitors: Genelec 1031A, Digital Design LS261, Yamaha NS-10, Tannoy FSM (mains), Auratone 5-C Super Cube. Other Major Equipment: AKG ADR-68K, AMS RMX-16, Yamaha REV1, Yamaha REV7, (2) Yamaha SPX90, (2) Lexicon LXP-1, Lexicon PCM70, Eventide H3000 Harmonizer, Alesis MIDiverb II, (2) Lexicon PCM42, (2) TC Electronic TC 2290, Roland SDE-3000 delays; TC Electronic TC 1210 Spatial Expander, TC Electronic TC 1140 parametric EQ, (2) UREI LA-4 comp/limiter, (2) dbx 165 compressor, (8) Aphex expander/gate.

UNITY GAIN RECORDING STUDIO



2976-F Cleveland Ave.; Fort Myers, FL 33901; (813) 332-4246; FAX: (813) 334-3450. Owner: Anthony Iannucci. Manager: Patricia Iannucci. Engineers: Anthony Iannucci, Michael Junkrowski. Dimensions: Room 1: studio 25'x17', control room 21'x16'. Mixing Consoles: Soundtracs PC MIDI Series 24x16x2 48 returns. Audio Recorders: Tascam MSR-16 16-track, Tascam 38 8-track, Tascam 32 2-track open reel, Tascam DA 30 DAT, (2) Tascam 122 MkII 2-track. Digital Audio Workstations: MDTU Performer. Monitors: UREI Time Align 809A, Yamaha NS-10. Other Major Equipment: SMPTE enhanced direct time-lock via MDTU MTP; Akai 5950 sampler, Proteus XR-1, Roland D-50, Eventide H910 Harmonizer, Korg DRV-3000, Lexicon PCM70, Lexicon PCM42, Lexicon LXP-1, Korg A-3, B&B Aphex CX-1 comp/gate, dbx 166.

THE WAREHOUSE STUDIO



2071 Emerson St. #20; Jacksonville, FL 32207; (904) 399-0424; FAX: (904) 398-9683. Owner: Tom Markham. Manager: James Ardolino.

WOLF'S HEAD PRODUCTIONS



658 Douglas Ave., Ste. 1112; Altamonte Springs, FL 32714; (407) 682-6669. Owner: Dana W. Cornock. Manager: Dana W. Cornock.



YRS MULTIMEDIA
Fern Park, FL

YRS MULTIMEDIA



182 Oxford Rd.; Fern Park, FL 32730; (407) 331-4588; FAX: (407) 331-8239. Owner: Charles Given. George York. Manager: Joseph Smith. Engineers: Joseph Smith, Don Rogozinski, George F. Meyer III, Neils Kaster. Dimensions: Room 1: studio 18'x16', control room 20'x16'. Room 2: (iso) studio 8'x10'. Room 3: (iso) studio 9'x5'. Room 4: (iso) studio 5'x7'. Mixing Consoles: Tascam M-700 w/Moving Fader Automation. Audio Recorders: (2) Akai A-DAM 12-track digital, Dtari MX 80 24-track, Dtari 50V50 2-track, Panasonic

3700 DAT, Carver PST 24 cassette. **Digital Audio Workstations:** Digital EFX 16-track 4 output direct to disk. **Monitors:** Tannoy DTM 15, Yamaha NS-10M. **Other Major Equipment:** Adams-Smith Zeta-3 w/Autolocator, Lexicon 200, Lexicon PCM60, Lexicon PCM42, Roland SDE 3000, Klark-Teknik DN 780, Yamaha SPX900, Yamaha REV7, Rocktron Intelliflex, Korg DRV 3000, Korg A-1, Peavey SDR 20/20, Korg T-1, Kurzweil Pro 1, Roland R-8M, Casio VZ-10M, Peavey SX/SP Sampler, Behringer Composer, Behringer Denoiser, Valley People 610, Valley People Dynamite, Valley Gatex, BBE Process, Rane dual channel graphic EQ, Behringer parametric EQ, (3) Audio Arts parametric EQ, Neumann U87, (2) AKG 414, (2) CAD Equitek, Audix SCX-1, (2) Crown PZM, (4) Sennheiser 421, Sennheiser 441, (2) Shure SM57, (2) Shure SM58, Shure SM81. **Specialization & Credits:** Here at YRS, client service is foremost. We pride ourselves in making your project, no matter what the size, the very best it can be. The friendly staff and comfortable atmosphere make YRS one of the top notch studios in the south. Recent additions include the Tascam M-700 console with moving Fader Automation, Digital FX/Digital Master 16 track, 4 channel direct to disk system, and 12 more tracks of Akai digital audio to make a total of 24 tracks digital and 24 tracks analog. YRS Multimedia's client list includes: True Spirit Ensemble (produced by Grammy-nominated songwriter Darius Brooks), Bass Patrol, DJ Kid Fury (one of the pioneers of Bass Music), the Jimmy Dorsey Orchestra, the Tommy Dorsey Orchestra, and Star Search grand prize winners Coyote, Limpopo, and Beth Hart.

GEORGIA

ALLGOOD PRODUCTIONS INC.



1827 Powers Ferry Rd.; Bldg. #15, Ste. 100; Marietta, GA 30067; (404) 956-7956; FAX: (404) 980-9249. **Owner:** Toni Allgood. **Manager:** William Allgood.

APC STUDIOS



3838 Oakcliff Industrial Ct., Atlanta, GA 30340; (404) 242-7678; FAX: (404) 242-0278. **Owner:** Salvatore Nappo. **Manager:** Sal Nappo.

CATSPAW RECORDING STUDIO



560 Dutch Valley Rd.; Atlanta, GA 30324; (404) 876-2287; FAX: (404) 881-8409. **Owner:** Catspaw Productions Inc. **Manager:** Brad Jones.



**CRAWFORD
AUDIO SERVICES**

CRAWFORD POST PRODUCTION INC.
Atlanta, GA

CRAWFORD POST PRODUCTION INC.



535 Plasamour Dr.; Atlanta, GA 30324; (404) 876-7149. **Manager:** Steve Davis.

LEGEND

- Maximum digital tracks
- Maximum analog tracks
- Remote recording
- MIDI production
- Tape duplication
- Audio-for-video/film
- Digital editing/CD prep
- In-house music services

CROSTOWN AUDIO INC.



2135 DeFoor Hills Rd, NW; Atlanta, GA 30318; (404) 352-4790; FAX: (404) 352-2143. **Owner:** Brandon Wade, pres. **Manager:** Jon Aaron.

DOPPLER STUDIOS



1922 Piedmont Cir.; Atlanta, GA 30324; (404) 873-6941; FAX: (404) 872-2160. **Owner:** Pete Caldwell. **Manager:** Bill Quinn. **Engineers:** Joe Neil (chief engineer), Curt Bush, Granger Beem, Steve Schwartzberg, Tommy Smeltzer, Peter Blayney, Jason Shablik, Blake Eiseman. **Dimensions:** Room 1: 35'x50', control room 26'x28'. Room 2: 50'x35', control room 26'x28'. Room 3: 25'x35', control room 15'x17'. Room 4: 20'x15', control room 15'x17'. Room 5: 10'x13', control room 12'x15'. Room 6: control room 12'x15'. **Mixing Consoles:** SSL SL 4048E 40-channel G computer, SSL SL 4040E 32-channel G computer, Sphere B 28-channel, Audiotronics 110A 28-channel, (3) WaveFrame DSP 16-channel. **Audio Recorders:** (4) Otari MTR-90 II 24-track, Otari MTR-10 4-track, (13) Otari MTR-10/12 2-track, (3) Ampex ATR-102 2-track, Tascam ATR-6018 8-track, Panasonic SV-3700 R-DAT, Panasonic SV-250 R-DAT, Tascam DA-30 R-DAT. **Digital Audio Workstations:** (3) WaveFrame 1000. **Monitors:** (4) George Augspurger custom, (2) UREI 813C, EAW MS-30, Yamaha NS-10, JBL 4425. **Other Major Equipment:** (5) Cipher Digital Softouch Systems, (2) Lexicon 224XL, (2) Lexicon PCM70, (2) EMT 140 plates, Focusrite mic pre/EQ, Eventide H3000 B, (2) Drawmer M-500, (17) Neumann, (10) AKG microphones; Sony DVR-10 D2, Sony BVW-70 Betacam SP, Sony BVH-1000 1", (2) Sony 9850 3/4" SP, (2) Sony 5850 3/4", Steinway B grand piano, Baldwin baby grand piano.

**ER
EASY
RECORDING**

a subsidiary of
EASY ENTERTAINMENT PRODUCTIONS, INC.

EASY RECORDING INC.
Lithia Springs, GA

EASY RECORDING INC.



1948 Brennan Way; Lithia Springs, GA 30057; (404) 739-8747; FAX: (404) 941-2559. **Owner:** Easy Entertainment Productions Inc. **Manager:** Theodore Noye. **Engineers:** Theodore Noye, Buz N Black, Norman Banton. **Dimensions:** Studio 13'x11'. **Mixing Consoles:** Soundcraft 2400 Series. **Audio Recorders:** Fostex G-165 16-track, Otari MX-5050B 2-track, Akai M8614 4-track, Panasonic SV-3500 DAT, Nakamichi MR-2 cassette, Tascam cassette, Denon DRT-2000 DAT, JVC TD-W707 double cassette. **Monitors:** Yamaha NS-10M, Electro-Voice Sentry, Auratone Sentry. **Other Major Equipment:** Lexicon PCM70, Lexicon PCM60, Lexicon PCM41, Yamaha SPX90 II, Yamaha REV7, (2) dbx 166 comp/limiter, (2) Alesis 3630, Korg DRV-3000, Valley Audio Gatex, Korg M-1R, Roland MT-32, Roland D-550, Yamaha TX812, (2) Akai S950, (2) Akai S900, Akai MPC60 II, E-mu SP-1200, E-mu Proteus, Roland A-50, Macintosh II w/color monitor, (2) Neumann U87, (2) AKG 414, Kawai K-4, Yamaha DX7, Hafler, Carver. **Specialization & Credits:** Easy Entertainment Production Inc. brings you Easy Recording, located just fifteen minutes from downtown Atlanta, our studios boast a creative and stress-free environment in a quiet, relaxing setting. Our in-house producers and engineers handle rap, R&B, contemporary, gospel, hip house, reggae and alternative music. Easy Recording is a full-service recording facility, offering a wide range of services designed for any budget. All aspects of recording, including artists pre-production services and consultation are available. We utilize top-of-the-line synthesizers and computer software and are equipped to handle your project from conception to completion. Accommodations include a basketball hoop, a spacious lounge, kitchen, showers, even a private retreat room with 27" color TV, stereo system and four-track MIDI studio (so as not to waste any sudden inspiration). You owe it to yourself to contact us for your next session. When you want professional results, it's Easy.

EXOCET STUDIOS



3264 Shallowford Rd.; Chamblee, GA 30341; (404) 455-7256; FAX: (404) 455-0637. **Owner:** Michael D. Adams. **Manager:** Scott Glazer.

EZ RECORDING AND PRODUCTIONS



119 Williamsburg Ln.; PO Box 1283; Woodstock, GA 30188; (404) 924-0433. **Owner:** Rick Payne. **Manager:** Rick Payne.

6054 Sunset Boulevard
Hollywood CA 90028

Phone: (213) 465 6264
Fax: (213) 465 8367

USE READER SERVICE CARD FOR MORE INFO

CD's From

KLARITY KASSETTE

COMPACT DISC REPLICATION

INTRODUCTORY SPECIAL
1,000 CD's Only **\$2.60** each.

INCLUDES

- Master Set-Up
- Conversion & Plates
- Typesetting
- Proofs
- 2 Color Label Print
- 2 Panel Booklet & Tray Card
- Packaging
- Shrinkwrap
- Full-Color Print!!

See Preceding Page for Other Services

KLARITY KASSETTE, INC.
Waterville, ME 04901
800-458-6405



JOHN KEANE STUDIOS



165 Hillcrest Ave., Athens, GA 30606; (706) 548-4137; FAX: (706) 548-0766. Owner: John Keane. Manager: John Keane.

THE MIDI TWIN RECORDING STUDIO



1600 Wilson Way, Ste. 2; Smyrna, GA 30082; (404) 432-3844. Owner: John and Steve Briglevich. Manager: Steve Briglevich.

OLIVERIO MUSIC INC. (OMI STUDIOS)



750 Ralph McGill Blvd. NE, Atlanta, GA 30312; (404) 525-4440; FAX: (404) 525-4545. Owner: James Oliverio. Manager: Bob Gillespie.

ORACLE RECORDING STUDIO



PO Box 464188; Lawrenceville, GA 30246; (404) 921-7941. Owner: Gene Smith. Manager: Gene Smith.

"THE PEACH" RECORDING STUDIO



PO Box 150; Covington, GA 30209; FAX: (706) 786-3366. Owner: Kerry Livgren.

RM AUDIO



3586 Pierce Dr.; Atlanta, GA 30341; (404) 458-6000. Manager: Bill Satterwaite.

SOUTHERN TRACKS RECORDING



3051 Clairmont Rd. NE; Atlanta, GA 30329; (404) 329-0147; FAX: (404) 329-0162. Owner: Bill Lowery, Mik Clark. Engineers: Karl Hielbron. Dimensions: Studio 25'x40', control room 24'x26'. Iso room 1: 15'x18'. Iso room 2: 16'x20'. Iso room 3: 8'x10'. Alcove: 12'x12'. Mixing Consoles: SSL 4064G w/Total Recall and Ultimatum. Audio Recorders: Mitsubishi X-800 32-track digital w/Apogee filters, (2) Sony JH-24 24-track, Studer A80 2-track 1/2", (2) Sony 2500 R-DAT, (2) Tascam D 30 R-DAT. Monitors: George Augspurger custom (mains), Wright near-field, Yamaha NS-10. Other Major Equipment: TC Electronic 2290. Tube-Tech compressor, Tube-Tech EQ, Neve 33609C compressor, (2) Neve 1066 EQ & mic pre, (2) Neve 1079 EQ 7 mic pre, (2) API 4-band EQ, GML 8200 EQ, UREI LA-2A compressor, (4) Lexicon PCM70: 224, 224XL, 300; Eventide H3000; microphones include tube mics by Neumann, AKG and the custom "47" by Gene Lawson. Specialization & Credits: The Black Crowes, Pearl Jam, Keith Sweat, Kansas, Dene Stone, Silk, 38 Special, Another Bad Creation, Atlanta Rhythm Section, WTBS/CNN, L.L. Cool J.

Mix Bookshelf Catalog

WE PICK THE BEST AND LEAVE THE REST.

Call for your free copy of the very best selection of instructional book, video and tape courses for the pro audio and music recording industry. (800) 233-9604.

SOUTHERN LIVING AT ITS FINEST



669 Antone St.; Atlanta, GA 30318; (404) 352-3204; FAX: (404) 350-8886. Owner: Ricky Keller. Manager: Tim Holbrook.

STUDIO SOUTH RECORDING



2510 Peach Orchard Rd.; Augusta, GA 30906; (706) 793-7800; FAX: (706) 793-9547. Owner: Howard and Lindy Lovett. Manager: Howard Lovett. Engineers: Howard Lovett, Dorian Taus. Dimensions: Studio 30'x30', control room 25'x30'. MIDI studio 10'x12'. Mixing Consoles: Sony/MCI MXP-3036 w/SMPTe-based fader automation. Audio Recorders: Studer A80 24-track, Ampex ATR-100, Studer A820 2-track master w/center track time code, Panasonic SV-3500 DAT, Panasonic SV 255 portable DAT, Sony DTC 700 DAT, Tascam 112 cassette. Monitors: JBL 4430, Meyer HD-1, Tannoy PBM-8, Yamaha NS-10. Other Major Equipment: George Massenburg 8200 parametric EQ, Valley People compressor, Galex, Aphex Studio Dominator, dbx 166 and 162 compressors, Symetrix 528 Vocal Processor, T1-101 phone patch, Aphex Aural Exciter, AKG ADR 68K digital reverb, Lexicon LXP-15 digital reverb, Yamaha SPX900 and SPX90 digital reverb, Lexicon PCM 41, Eventide 949 Harmonizer, Dolby SR 24-track/XP series, Dolby SR 2-track, Neumann U87, ASC studio condenser, AKG C-414EB, 452; Shure SM-5. Electro-Voice RE-20, Shure SM57, Sennheiser 421, Fostex M88RP ribbon, Sony BVH 1100 1", JVC KR-8500 3/4", Adams-Smith Zeta-3 synchronizer, Hitachi 26" video monitor, Yamaha 7" grand piano, Ludwig drums, Roland W-30 digital sampling keyboard workstation w/S-550 Disk Library, Roland NU-220 module, Korg M3R module, Yamaha DX7, Korg DVP-1 voice synth, Korg CX-800 analog synth, Alexis D-4, four music libraries and 10,000 sound effects.



TRICLOPS SOUND STUDIO
Atlanta, GA

TRICLOPS SOUND STUDIO



120 Interstate North Pkwy. E.; Ste. 164; Atlanta, GA 30339; (404) 955-3550; FAX: (404) 955-3803. Owner: Rick Meyer, Mark Richardson. Manager: Rick Meyer. Engineers: Mark Richardson—chief engineer and producer/co-owner, Jeff Tomei—second engineer and assistant. Dimensions: Room 1: studio 40'x50', control room 22'x20'. Iso. 1: 12'x12'. Iso. 2: 12'x14'. Mixing Consoles: Neve 8088 MkII 48-channel w/Flying Fader automation. Audio Recorders: Studer A8000 MkIII 24-track 2", Studer A80VU/ 24 MkIV 24-track 2", (2) Ampex ATR-102 2-track, Ampex AG440 2-track, DA-30 DAT, SV-2700 DAT, 122 MkII cassette. Monitors: UREI 813 original issue, Tannoy DMT-10, KRK 7000, Westlake BBSMA, ROR, Auratone. Other Major Equipment: Tascam ES-50/51 sync system; EMT 140 tube stereo plate reverb/echo; EMT 250, EMT 251 digital reverbs; Publison DHM 8982 delay/harmonizer; Pultec EQP-1 EQ, UREI 1176 LN, dbx 160 and 165; Neve 3226A compressors; Yamaha SPX90 and D1500; Aphex 612; Roland RE-501 and RE-555; Kepep gate; Gain Brain; Altec tube compressor; Altec filter; Macintosh 2300, Yamaha P2700, P2200 monitor amps; Neumann, Beyer, Sony, AKG, Sennheiser, Shure, EV classic microphones; 5-station headphone system by Mytek Tech many special musical instruments: Steinway 1959 9' concert D grand piano, Hammond B-3 and C-3, Mellotron, MiniMoog, Oberheim, Korg, Akai MPC-60; large stock of classic amps: Marshall, Vox, Fender, Ampeg; classic Ludwig drum set. Specialization & Credits: Since our opening in June 1990, Triclops continues to producing a signature sound of "warmth" and "power" for our clients. Our Neve 8088 console, purchased from New York's A&R Studio, was retrofitted with new Flying Fader automation in mid-1991, and upgraded to 8088 status in 1992 with the permanent installation of a 16-channel bucket of identical MkII modules; a total of 48 channels. Triclops is a 100% music production facility. Our growing list of clients and album credits include most recently: The Smashing Pumpkins/Virgin/Butch Vig, prod.; Warren Haynes/Megatorce/Chuck Leavell, Warren Haynes, prod.; Drivin' "N" Cryin' Smoke/Island/Geoff Workman, prod.; Kansas Live at Whiskey/Intersound/Jeff Glixman, prod.; others: Follow For Now/Chrysalis; Ben E. King/Ichiban; Bob Thompson/Ichiban; Tinsley Ellis/Alligator; and more. Co-owner/engineer, Mark Richardson, has over 20 years recording experience world-wide. Full promotional packages and prices are available upon request.

TWELVE OAKS STUDIOS 3 NEW STUDIOS



620 Powder Springs St.; Smyrna (Atlanta), GA 30082; (404) 435-2220. Owner: Randy Bugg, Sonny Lallerstedt. Manager: Randy Bugg.

KENTUCKY



ALLEN-MARTIN PRODUCTIONS INC.
Louisville, KY

ALLEN-MARTIN PRODUCTIONS INC.



9701 Taylorsville Rd.; Louisville, KY 40299; (502) 267-9658; FAX: (502) 267-9070. Owner: Ray Allen and Hardy Martin. Manager: Bill Porter, pres.

LMR PRODUCTIONS INC.



947 Winchester Ave.; Ashland, KY 41101; (606) 324-9911. Owner: LMR Productions Inc. Manager: Scott Czeskleba. Engineers: Scott Czeskleba, Billy J. Sells, Ray Whitlock. Dimensions: Room 1: studio 16'x30', control room 12'x17'. Room 2: studio 10'x12'. Room 3: studio 9'x11'. Mixing Consoles: Tascam M3524, Tascam 388. Audio Recorders: Tascam MSR24, Tascam 388, (2) Tascam DA 30, Tascam 112, Tascam 22-2, (3) TEAC W520R, TEAC W430C, TEAC V340. Monitors: (2) Tannoy PBM-8, (2) Tascam CM4, (2) Optimus Mach II, (4) Fostex T-20. Other Major Equipment: Ensoniq DP4, DigiTech DSP128, ART Proverb, (4) Aleis 3630, Aleis MEQ-230, Rocktron Hush HIX, Aphex 103A, dbx 150X, Rane HC6, Aleis RA-100, Audio-Technica AT4033, (2) AKG C-1000S, Sennheiser 441, (2) Sennheiser 421, (2) Electro-Voice ND757, (2) Electro-Voice ND357, (3) Electro-Voice ND408, Electro-Voice ND308, Yamaha SY77, Yamaha RY3G, Yamaha CVP8, Roland SCC-1, Roland PAD-8, Roland PD-10, Aleis D-4, E-mu Performance Plus, Pearl Drum-X, (4) Pearl DRX-1, Packard Bell 386/20-650XL, MIDI Quest MXQ32M, Technics SX-K700, Ovation Patriot, Kramer 200ST.

TREE OF LIFE STUDIOS



PO Box 25788; Lexington, KY 40524-5788; (606) 273-8037; FAX: (606) 273-8037. Owner: Bill Jones. Manager: Bill Jones. Engineers: Bill Jones. Dimensions: Studio 30'x12', control room 22'x12'. Mixing Consoles: Tascam M320B, Mackie MS1202. Audio Recorders: Aleis ADAT 8-track, Tascam DA 30, Technics RS-TR155, TEAC A-40105, Tascam 388 8-track. Monitors: (2) JBL 4208 w/12" subs, (2) Tannoy PBM-8, (2) Auratone 5-C. Other Major Equipment: Aleis Quaraverb Plus, Lexicon LXP-1 reverb, Lexicon LXP-5, Aleis 3630 compressor, MXR dual limiter, Audio Logic quad noise gate, (2) Yamaha 02031 EQ, MXR dual 15 EQ, Yamaha dual 10 EQ, (2) Audio-Technica ATM-4033, Shure SM57, Audio-Technica ATM-P microphones; Panasonic WJAVES video switcher, DTK 386-20 MIDI computer, Cakewalk Pro MIDI sequencer, JVC HR-56700U SVHS Hi-Fi VCR, (3) Sony 13" TV monitor, (3) Vidicraft video enhancer/switcher. Other equipment upon request.

TRUSTY TUNESHOP STUDIOS



8771 Rose Creek Rd.; Nebo, KY 42441; (502) 249-3194. Owner: Elsie Trusty Childers. Manager: Michael Cain. Engineers: Michael Cain. Dimensions: Room 1: studio 32'x30', control room 22'x20'. Room 2: studio 12'x10'. Mixing Consoles: Tascam M3700, Studiomastrer 16x8. Audio Recorders: (3) Tascam DA 88, Otari MX-5050-8, Panasonic DAT, Pioneer. Monitors: (2) JBL, (2) Yamaha NS-10, (2) custom built w/JBL parts. Other Major Equipment: Neumann U87 A, Sennheiser MD-421, (5) AKG D-1000E, AKG D-200E, (2) Audio-Technica, Shure SM58, baby grand piano, Lexicon PMC70 (V2 & 3) reverb.

LOUISIANA

AIRLIFT PRODUCTIONS



3927 Iberville St.; New Orleans, LA 70119-5115; (504) 482-9609; FAX: (504) 482-6650. Owner: Mike McCann. Manager: Carol Ziants.

ALIEN SOUND



PO Box 230; Slidell, LA 70459; (504) 646-2653; FAX: (504) 643-4859. Owner: Inter Muse Corp. Manager: S.M. Schneider.

BAYOU BREEZE PRODUCTIONS



PO Box 66124; Baton Rouge, LA 70896; (504) 928-5289. Owner: Robert Vaughn, Buster Fresina. Manager: Robert Vaughn. Engineers: Robert Vaughn, Chuck Bush. Dimensions: Studio: 20'x24', control room 10'x12'. **Mixing Consoles:** Soundcraft 6000 32x16x2. **Audio Recorders:** Tascam MSR-16 16-track 30ips, Tascam 38 8-track, Tascam 32 2-track, Tascam DA-30, Sony TCD-D3, Denon DRM-15. **Monitors:** Soundcraftman PCR800 and Kenwood M1 monitor amplifiers. (2) JBL 4311. (2) Yamaha NS-10M. (2) TDA near-field. **Other Major Equipment:** (2) Tascam OX-809 dbx. (2) Tascam DX40 dbx, Lexicon PCM70, Korg DRV-3000, Yamaha SPX90, Yamaha R1000, Aphex Compellor, Aphex Aural Exciter Type C, Rane RE-27, Rane GE-14, (2) Rocktron Hush 300, (3) Alesis Microgate, Neumann U87, AKG C-414, (2) AKG 451, Electro-Voice PL20, (3) Sennheiser 421, (2) Shure SM81, (8) Shure SM57, Korg M1, Yamaha DX7IID, Yamaha TX81Z, Ensoniq Mirage, Roland JX-8P, Roland TR-707, Roland TR-727, Ensoniq ESO, Yamaha TX802, Atari 1040ST, Steinberg Q-Base 2.0, Sony 3/4" U-matic.

THE BOILER ROOM



8359 Fig St.; New Orleans, LA 70125; (504) 866-2863; FAX: (504) 861-3450. Owner: Boiler Room Inc. Manager: Ken Devine. Engineers: Tony Guillory, Mark Bingham, William Johnson, Jack Berry, Mark Hood, Mike Montero, Jeff Treffinger, Charles (Chopper) Brady. Dimensions: Room 1: studio 35'x24'x19', control 32'x20'; Room 2: control 29'x18'. **Mixing Consoles:** Trident 70 (Acoustilog and Broadcast Technical mods) 24x24x2, Amek/TAC Bullet 28x8x2 (portable), Mackie 1604 (portable). **Audio Recorders:** Otari MTR 9011, Tascam MSR-245 (portable), MCI JH-110, Panasonic 3700 R-DAT, Sony TCD-10pro R-DAT, Luxman cassette decks. **Other Major Equipment:** Lexicon 300, EMT stereo tube plate, Ibanez SDR 1000+, Lexicon Prime Time II, Lexicon LX-1 (audio upgrades mods), Lexicon LX-5 (audio upgrade mods), SPL Vitalizer, Altec tube mic preamps, Langevin mic preamps, Neumann U-47 (Klaus Heyne mods), AKG 414, 460, Beyer 88, Neumann KM-84, Sennheiser 421, RCA 77 and 44, Shure SM-57, Neve stereo comp/limiter, (2) dbx 160, 165, Drawmer Spectra Sonics and Alesis compressors, Halfer, Carver, Yamaha and Crown amps, (2) White 4001 EQ, Digidesign Sample Cell, Studio Vision, Roland D-70, Russian Dragon, Hughes Sound Retriever.



DINOSAUR STUDIOS
New Orleans, LA

DINOSAUR STUDIOS



2115 Magazine St.; New Orleans, LA 70115; (504) 529-3033; FAX: (504) 529-1387. Owner: Dinosaur Productions Inc. Manager: Richard Paddison, Richard Bird.

DOCKSIDE STUDIO



PO Box 27; Milton, LA 70558; (318) 893-7880; FAX: (318) 893-5987. Owner: Steve Nails. Manager: Steve Nails. Engineers: Tony Daigle, Victor Palmer, Steve Nails. Dimensions: Room 1: studio 30'x33' control 35'x22', Room 2: studio 10'x12', Room 3: studio 10'x8', Room 4: studio 27'x15' control 27'x15', kitchen 9'x15'. **Mixing Consoles:** Neve 8058 32x24 vintage customized, Soundcraft 1600 32x24 w/JL Cooper automation, Audio Trac 16x8x2—Mobile. **Audio Recorders:** Studer A820 24-track, Panasonic SV-3700 DAT, Fostex 2-track w/center time code, Studer cassette deck, Tascam 112 cassette deck, Fostex 16-track, Fostex 8-track. **Digital Audio Workstations:** Mac II w/Sound Tools, E-mu E III, JL Cooper Automation, Alchemy, Sound Design, Master Trax Pro, Fully equipped MIDI production studio. **Monitors:** (2) Steve Durr custom monitors, (2) Yamaha NS-10M, (2) JBL 4412, (2) Fostex near-field, Carver 300, Carver 120. **Other Major Equipment:** Neumann U67 tube, (3) Sennheiser 421, Sennheiser 409, Beyer, Shure SM/81, (2) Neumann U87, Crown PZM, AKG C12, (4) Audio Logic gates, Lexicon PCM 70, (2) Lexicon LP-1, (2) Yamaha SPX90, BBE Exciter, (4) Rane 28-band EQ, (3) Summit Audio TLA-100 compressor, (2) Orban compressor, Audio Control spectrum analyzer, grand piano, Yamaha Recording

—SEE PHOTOLOGO TOP OF NEXT COLUMN



DOCKSIDE STUDIO
Milton, LA

Series drum kit & assorted rigs. **Specialization & Credits:** State-of-the-art estate, Dockside Studio is tucked away in a 19th century setting along the Vermilion River 90 minutes from New Orleans in the heart of Cajun/Zydeco country. The studio is the epitome of southern elegance and harbors one of the most technologically advanced recording facilities. Dockside offers vintage Neve sound mixed with MIDI high tech. The finest services are provided and each room has a warmth of sound echoing from the varieties of woods, which cover the sound room walls. Southern hospitality includes a complete and separate musicians lodging overlooking pool. There is a basketball and tennis court and two-acre "fish are jumping" pond with trails throughout the 11-acre estate. The tranquil, secluded setting is perfect. Recordings include commercials, soundtracks and label recordings, and each project's needs are satisfied. Video locations are endless within the estate for movies as well as music videos.



HART SOUND PRODUCTIONS
Belle Chasse, LA

HART SOUND PRODUCTIONS



604 Good News Ave.; Belle Chasse, LA 70037; (504) 394-8839. Owner: Rick Hart. Manager: Rick Hart. Engineers: Rick Hart. Dimensions: Room 1: 14'x12' control 10'x11', 2 iso booths. **Mixing Consoles:** AMR Production 800 24x8x16. **Audio Recorders:** (3) Alesis ADAT, Panasonic SV-3500 DAT, Sony DTC-700 DAT, Harmon/Kardon TD-4600 cassette. **Monitors:** (2) Tannoy NFM-8 (modified by Hot House), Tannoy PS-88 (sub). **Other Major Equipment:** Drawmer 1960 (mic pre), Aphex 720 Dom II, Aphex 250 Aural Exciter, Aphex 320 Compellor, Aphex 651 Expressor, Aphex 104 Exciter Type C w/Big Bottom, BBE 822A Sonic Maximizer, (2) Peavey autograph and automate digital 1/3 octave EQ, (3) AMR NGT-2 stereo gates, Alesis Microgate, (2) Alesis Microlimiter, (2) Ensoniq DP-4 effects, AMR PMA-250 monitor amp, Ensoniq ASR-10 stereo sampler, AKG C-12A, C-414, Electro-Voice PL20, (2) Sennheiser 421, AKG C-460, Electro-Voice N/D 408A various other mics, Alesis BRC remote synchronizer, Alesis AI-1 digital in/out, Ensoniq digital in/out for ASR-10, Alesis SR-16 drum machine, Peavey Classis 50 tube amp, Martin D-35 guitar, Peavey Foundation bass, Alesis D-4 drum module. **Specialization & Credits:** Located approximately 15 minutes from downtown New Orleans, Hart Sound provides a convenient and relaxed atmosphere to record in. Hart Sound has recorded clients such as Cowboy Mouth, Dash Rip Rock, Louisiana Purchase, Deadeye Dick, Chozen, Big Ike and Mari Serpas. Please call for rates!

JY RECORDING



201 Trenton St.; West Monroe, LA 71291; (318) 325-4413; FAX: (318) 323-5915. Owner: James Young. Manager: Chris Turner.

NEW ORLEANS RECORDING COMPANY



3229 8th St.; Metairie, LA 70002; (504) 833-0066. Owner: Steve Himelfarb. Manager: Steve Himelfarb. Engineers: Steve Himelfarb. Dimensions: Room 1: studio 35'x27', control 27'x15'. **Mixing Consoles:** Neve 8232. **Audio Recorders:** Sony 5002, Studer A80 Mark IV, Sony DAT PCM 2500, Sony DAT DTC-700, (2) Yamaha cassette decks. **Monitors:** Tannoy SGM-15B, Tannoy BM-8, Yamaha NS-10M, Fourier. **Other Major Equipment:** (2) UREI 1176 limiter, (2)

—LISTING CONTINUED ON NEXT PAGE

AUGUST 1993

Get in the

Control Room

▲ Project Studio and Multimedia Room Design

▲ TEC Awards Voter's Guide & Ballot

Directory

Facility Designers and Suppliers

Ad Close

June 7, 1993

Materials Due

June 15, 1993

List In The Mix Directories!



Upcoming Issues & Listing Application Deadlines

OCTOBER

AES/New Products

For 1994

Deadline: July 8

NOVEMBER

North Central U.S. &

Canadian Studios

Deadline: August 9

DECEMBER

Mastering, Pressing &

Tape Duplication Facilities

Deadline: September 8

Toll-Free Mix Directories number:

(800) 344-LIST (5478) or
(510) 653-3609 fax

TURN TO PAGE 165 FOR AN EXPLANATION OF RECORDING SERVICE SYMBOLS.



—LISTING CONTINUED FROM PREVIOUS PAGE

dbx 160X compressor, (2) Summit Audio 100A limiter, (3) Drawmer DS201 gates, Drawmer LX 20 compressor, Roland R-880 reverb, Lexicon PCM70, (3) EMT 140 reverb plates, Eventide Ultra-Harmonizer, Roland SDE 3000 delay, Lexicon LXP-1, Lexicon LXP-5, (2) Yamaha SPX90 2, Yamaha C3 grand piano, Fender Bassman amp, (2) Neumann U87, 84, Neumann TLM 170, Sennheiser 421U, (3) Electro-Voice 308, Electro-Voice 408, (2) AKG 451, D112, (4) Beyer 88, (4) Shure 57, custom 24-input direct box, (2) Countryman Direct Boxes, (4) Conquest Direct Boxes. **Specialization & Credits:** Credits include Aaron Neville, The Neville Brothers, Evangeline, Kevin Costner, Jimmy Buffett, The Iguanas, The Smithereens, Dr. John, Buckwheat Zydeco, Beausoleil, Thomas Dolby, Ellis Marsalis, k.d. lang, Robbie Robertson, The Subdudes, The New Orleans Recording Company is dedicated to excellence. We feature the best equipment and the care you deserve to make your project a success. As an engineer I have ten Gold records and three Grammy nominations. With your talent and my experience we could be a winning combination.

NIGHT WING RECORDING COMPLEX



4321 Fairy Ave.; Shreveport, LA 71108; (318) 636-7394. Owner: W.C. Wheat Jr., Marie Wheat. Manager: Wendell DePrang.

SEE PAGE 165 FOR AN EXPLANATION OF THE STUDIO SERVICE ICONS. FOR MORE INFO ABOUT MIX LISTINGS SEE PAGE 159.

WE ARE THE "KING" OF
REAL TIME
CASSETTE TAPE
DUPLICATION
Progressive Music
Features

- Digital Mastering
- Audiophile REAL Time Duplication on All New Equipment
- Gold Foil Direct Imprinting
- 1,000 4-Color J-Cards — from \$185 (complete)
- We Beat Anyone's Price!
- "Fastest Turn-Around in the Known Universe!"
- 10% Discount on Duplication to Studios
- Blank Chrome Cassette Sales
- No Order Too Large or Small

Progressive Music
2116 Southview Ave.
Tampa, FL 33606
(813) 251-8093
FAX: (813) 251-6050
Toll Free: (800) 421-TAPE

USE READER SERVICE CARD FOR MORE INFO



ULTRASONIC STUDIOS
New Orleans, LA

ULTRASONIC STUDIOS



7210 Washington Ave.; New Orleans, LA 70125; (504) 486-4873. Owner: Jay Gallagher. Engineers: David Farrell, Jay Gallagher, Steve Reynolds. **Dimensions:** Main studio: 50'x50', control room A: 25'x16', control room C: 15'x17'. **MIDI suite:** 12'x15'. **Mixing Consoles:** MCI 652 52x48 w/automation, Studiomaster 16x4x8. **Audio Recorders:** Studer A827 24-track, MCI JH-24 24-track, (2) Panasonic 3700 DAT, Sony 1000 DAT, Sony 5003 2-track w/center time code, Akai 1214 12-track, Sony PCM-F1 2-track digital, MCI JH-110 4-track, Ditar 5050 2-track. **Digital Audio Workstations:** Digidesign Pro Tools 24-ch Dolby SR, Digidesign Sound Tools recorder/editor, Yamaha KX88 controller, Macintosh w/Performer and Vision software. **Monitors:** Tannoy SGM-10B; JBL 4331A, 4401 & L-100; Yamaha NS-10; JBL Cabaret; Auratone; EPI 100. **BGW 250B & 100.** **Haffer Pro 5000** monitor amps. **Other Major Equipment:** Yamaha MSS-1 MIDI/SMPTE, TimeLine Micro Lynx, Lexicon 300, (3) Yamaha REV7, (2) Yamaha SPX90, Lexicon PCM70, Lexicon PCM41, Alesis MIDIDverb II, Roland DEP-5, EXR Exciter, Gemini Easy Rider, Roland SDE-2000, (2) dbx 160XT, (4) UREI 1176LN limiter, (4) Allison Research Kepex, (4) Allison Research Gain Brain limiter, UREI 565 filter, Drawmer stereo tube limiter, Neumann U87, KM84, SM69; AKG C-414EB, C-451, C-33, D-160, D-112; Shure SM57, SM81; Beyer 201, 101, Sennheiser 421, 441. **Extended Equipment Description:** Kawai grand piano, Ludwig drums w/Zildjian cymbals, Kurzweil 1000PX synth, Roland D-550 synth, (2) Akai S900 sampler, Korg sampling grand, Hammond B-3 w/Leslie, Roland MKS-80M MKS-20 synth, Yamaha TX802, Korg EX-8000 synth, Moog MIDImoog, Alesis HR-16 drum machine, Roland Octapad controller, LinnDrum, Latin percussion congas, WX7 wind controller, Sony 58003/4" U-matic. **Specialization & Credits:** Ultrasonic's recently renovated recording room features a spacious new room with five separate isolation areas. Our engineering staff has ten Grammy nominations as well as a Best Traditional Blues Album of the Year to their credit. We are the only studio in New Orleans to offer automated mixing and digital editing. And, of course, New Orleans offers the best food, musicians and nightlife in the world. Ultrasonic also has a complete audio/video MIDI suite and a resident composer specifically for film scoring and commercial music beds. **Credits:** Linda Ronstadt, Robbie Robertson, Bruce Hornsby, Dolly Parton's *Down in New Orleans* TV special (Emmy Award—sound mixing), Paul Shaffer, Todd Rundgren, Fats Domino, Aaron Neville, Dirty Dozen. **Advertising:** Miller Lite Beer, Fischer-Price Toys, Mazola, Busch Beer, Oldsmobile, Barq's Root Beer. **Clients:** HBO/Cinemax, Epic/Sony, CBS, Elektra, ABC, Saatchi & Saatchi, DDB Needham Worldwide, Rounder, Windham Hill, Black Top, Capitol. Creole and Cajun catering available.

MISSISSIPPI

FERNANDEZ CREATIVE SERVICES



200 Commerce, Ste. B; Jackson, MS 39201; (601) 353-0266. Owner: Sergio Fernandez. Manager: Jack Ofton.

SHARP RECORDING STUDIO



116 Gloucester Rd.; Natchez, MS 39120; (601) 446-6186. Owner: Richard B. Sharp Jr. Manager: Richard B. Sharp Jr.

NORTH CAROLINA

ACOUSTIC CREATIONS



4813 W. Wendover Ave.; Greensboro, NC 27410; (919) 632-1004; FAX: (919) 632-9765. Owner: Kip Williams. Manager: Kip Williams.

HIX STUDIOS



2901 Hwy. 70 West; Hickory, NC 28602; (704) 328-2487; FAX: (704) 328-2489. Owner: Charles and Virginia Hicks. Manager: Marcus Kearns.

JAY HOWARD PRODUCTION AUDIO



307 Atherton St.; Charlotte, NC 28203; (704) 525-7864; FAX: (704) 523-5473. Owner: Jay Howard. Manager: JoAnn Jeffries.

LLOYD STREET STUDIOS LTD.



116 C W. Main St.; Carrboro, NC 27510; (919) 967-5775. Owner: Corporation. Manager: David LLoyd.

NEW HORIZON RECORDING STUDIO



1490 Union Cross Rd.; Kernersville, NC 27284; (919) 996-2633. Owner: Mitch Hensdale. Manager: Mitch Hensdale.

NEW MOON PRODUCTIONS



7676 Anthony Rd.; Kernersville, NC 27284; (919) 643-4115; FAX: (919) 643-4299. Owner: Frank A. Bruno. Manager: Frank A. Bruno.

OVERDUB LANE RECORDING



300 E. Main St.; Carrboro, NC 27510; (919) 942-9434. Owner: Wes Lachot. Manager: Wes Lachot.

REFLECTION SOUND STUDIOS



1018 Central Ave.; Charlotte, NC 28204; (704) 377-4596; FAX: (704) 375-9723. Owner: Wayne Jernigan. Manager: Kelly Bright. Engineers: Mark Williams (chief eng.), Tracy Schroeder, Jamie Hoover, Dave Harris, Mike Lawler. **Dimensions:** Studio A: 44'x35' w/18' ceiling, control room 19'x24'. Studio B: 10'x12', control room 20'x12' (MIDI suite). Studio C: 18'x24', control room 18'x14'. **Mixing Consoles:** Sony MXP-3036 36-ch. hard disk automation, 4 types of EQ; Sony MXP-3036 32-ch., 4 types of EQ; Allen and Heath Saber Plus 36-ch. JL Cooper MAGI automation. **Audio Recorders:** (2) Sony PCM-3324A 24-track digital, Sony APR 24-track analog, Sony/MCI 24-track digital, Sony PCM-3402 2-track, Sony APR-5002H 2-track 1/2", Sony APR-5003 2-track 1/4" (SMPTE), Otari MX-5050 2-track, (2) Sony PCM-2500 R-DAT, Sony 7010 R-DAT w/SMPTE **Digital Audio Workstations:** Digidesign Sound Tools w/1.8 gigabyte hard drive. **Monitors:** Studios A and C—TAD double 15" systems, powered by Haffer and AB Systems amp w/White EQ; Tannoy Series 8 w/subwoofer. **Other Major Equipment:** Lexicon 224XL w/LARC controller, (2) Lexicon PCM-70, EMT 140 stereo reverb, Deltalab digital delay, Aphex and EXR Aural Exciters, Tube-Tech CL-1A comp, Tube-Tech PE-1B EQ, Drawmer noise gate, UREI comp, dbx comp, noise gates, TC 2290 DDL and effects proc., Fostex 4010 time code generator/reader, Dolby SR 24-channel (available to rent), Neumann U67, U47, U64 and wide range of condenser and dynamic microphones; (2) Sonor drums kits, Yamaha C7 grand piano, Kawai 74" grand piano, Hammond B-3 w/Leslie cabinet, Fender Rhodes, Wurliizer piano, various keyboards, guitars and amps, Akai S1000 HD 20 meg RAM, Korg M-1 Rex, Roland D-550, E-mu Proteus 1.2, Pro-Cussion, Yamaha KX-88, Macintosh IIcx running Performer, Galaxy, Sound Designer II, Macintosh SE, Yamaha TX81Z, TX7, Adams-Smith Zeta-3 sync, (2) Mark of the Unicorn MIDI time piece, (2) Sony Trinitron monitors, Sony VO-9800 3/4" VTR. **Specialization & Credits:** Studio and remote, 48-digital and analog. John P. Kee and New Life Community Choir, Joe Walsh, Joe Cocker, Stephanie Mills, R.E.M., Aerosmith, Mitch Easter, Don Dixon, Marti Jones, Donald Lawrence, Company, Copperhead, Dillon Fence, Guadalupe Diary, Let's Active, Kenny Loggins, Lonesome City Kings, Pylon, The Spongtones, Matthew Sweet, Jim Brock, Scott Cossu, Joe Boyd, Bill Szymczyk.

SONIC CAFE RECORDING STUDIO



3400 Common Wealth Ave.; Charlotte, NC 28205; (704) 568-7773. Owner: Scott Renfroe. Manager: Scott Renfroe.

SOUND LAB INC.



3716-A Alliance Drive; Greensboro, NC 27408; (919) 294-9095; FAX: (919) 288-0298. Owner: Thomas Rowan/Mary Schenck. Manager: Mary Schenck.

SOUTHWYNDE STUDIOS



PO Box 958; Wilmington, NC 28402; (919) 251-9963. Owner: Conceptual Music Productions. Manager: Randy Drew.

STUDIOEAST RECORDING STUDIO



5457 Monroe Rd.; Charlotte, NC 28212; (704) 536-0424; FAX: (704) 536-8098. Owner: Timothy A. Eaton. Manager: Timothy A. Eaton.

SYNERGEN ENTERPRISES



Rt. 2, Box 205; Pittsboro, NC 27312; (919) 542-5463. Owner: Charles E. Jones. Manager: Charles E. Jones.

WHITEWATER RECORDING



1152 Sweeten Creek Rd.; Asheville, NC 28803; (704) 274-0956; FAX: (704) 274-0956. Owner: Adam Greenberg. Manager: Adam Greenberg.

SOUTH CAROLINA

CHERRY GROVE STUDIO



404 7th Ave. N.; Myrtle Beach, SC 29577; (803) 626-3415; FAX: (803) 448-6730. Owner: Ron Thompson. Manager: Tim Bode. Engineers: Ron Thompson, Tim Bode, Steve Senn. Dimensions: Studio 12'x24', control room 12'x14'. **Mixing Consoles:** Studiomaster Series II 48x8x2, Roland M-160, Alesis X-2 24-channel MXR. **Audio Recorders:** Fostex G16 S 16-track, (3) Alesis ADAT 8-track (24-track sync), Technics 1500S 1/2-track, (12) TEAC 275C cassette, Panasonic 3700 DAT, Panasonic 3200 DAT. **Digital Audio Workstations:** Atari 030 Falcon 4-track computer, Roland DJ-70 sampling, Atari 1040 ST MIDI w/Master Tracks Pro, Alesis MMT-8 sequencer, Alesis DATA Disk, Steinberg-Jones Cubase software, (3) Alesis ADAT 8-/24-track. **Monitors:** Fostex 1000, Fostex 800, Auratone, (8) AKG M240 headphone, Alesis Micro-Cue, amp monitor amplifier. **Other Major Equipment:** (2) Oberheim Matrix-1000; Yamaha Clavinova w/310 module; Alesis SR-16, Alesis HR-16, Alesis D-4, Boss 660 drum machines; Steinbar K-5, Kawai K1-R; (6) UREI LA-4, (2) UREI 1176, (2) UREI LA-3, (3) UREI LA-2 limiters; Lexicon 200 reverb, Lexicon LXP15 reverb/delay, DigiTech ISP33 Harmonizer, DigiTech VHM-5 Harmonizer, Neumann U67 tube mic, (12) assorted mics, Hughes AK-100 sound retrieval system.

THE COOLER RECORDING STUDIO



PO Box 2703; Orangeburg, SC 29116; (803) 536-3638. Owner: Walter Durr. Manager: Walter Durr.

EVANS BROTHERS' STUDIO



1125 Moore Duncan Hwy.; PO Box 60; Moore, SC 29369; (803) 574-6104; FAX: (803) 574-2001. Owner: Duane Evans. Manager: Duane Evans.

SOUTHEASTERN SOUND STUDIO INC.



4880 Earle E. Morris Jr. Hwy.; Easley, SC 29642; (803) 269-2540; FAX: (803) 269-2540. Owner: Buddy Strong, Paul Waring. Manager: Buddy Strong, Paul Waring.

STRAWBERRY SKYS RECORDING STUDIOS



1706 Platt Springs Rd.; West Columbia, SC 29169; (803) 794-9300. Owner: Gary Bolton. Manager: Mike Smith.

TRACK ONE STUDIOS



PO Box 355; Williston, SC 29853; (803) 266-3410. Owner: Barry Keel. Manager: Barry Keel.

TENNESSEE



ARDENT STUDIOS INC.
Memphis, TN

ARDENT STUDIOS INC.



2000 Madison Ave.; Memphis, TN 38104; (901) 725-0855; FAX: (901) 725-7011. Owner: John E. Fry. Engineers: John Hampton,

TURN TO PAGE 165 FOR AN EXPLANATION OF RECORDING SERVICE SYMBOLS.

Jeff Powell, Erik Flettrich, Skidd Mills, Jeffrey Reed, Iddo Patt. **Dimensions:** Room 1: studio 37'x25' control room 20'x24'. Room 2: studio 25'x35', control room 20'x25'. Room 3: studio 25'x35', control room 18'x25'. **Mixing Consoles:** Neve VR w/Flying Faders automation 48x48. Solid State Logic 6000 E/G 56x32. Neve V Series w/Necam 96 automation 40x48. **Audio Recorders:** (2) Mitsubishi X-850 32-track digital, Mitsubishi X-800 32-track digital, (3) MCI JH-110 2-track, Studer 827 24-/16-track, MCI JH-24 24-track. **Digital Audio Workstations:** Studer Dyaxis. **Monitors:** Yamaha NS-10, JBL, KLH, Advent. **Other Major Equipment:** Fairchild 670 stereo limiter, (2) Fairchild 660 mono limiter, (2) Pultec EQP-1A EQ, AMS RMX 16 reverb, (2) Quantec, (2) UA 176 limiter, (6) Yamaha REV5, Lexicon 224XL, Publison Infernal 90, (2) Eventide 949 Harmonizer, Marshall Time Modulator, (3) EMT 140, H3000 w/HS 395 sampler board, (4) dbx 160, (6) dbx 165. **Microphones:** Neumann M249, U67, KM86, Sennheiser MD-421, MD-441, AKG C-414, C-451, D-12, Shure, Sony, RCA, EV, Crown, Sanken, B&K. **Specialization & Credits:** Ardent Recordings Inc., the largest recording facility in Tennessee, was founded in 1966 by John E. Fry, who still serves as president. The custom-built facility was designed to provide optimum efficiency as well as a unique and comfortable environment for clients. Ardent also offers support services in the form of accommodations and ground transportation packages. Clients include ZZ Top, R.E.M., Tom Cochrane, Robert Cray, Tora Tora, Stevie Ray & Jimmie Vaughan, Gin Blossoms, Spin Doctors, Lynyrd Skynyrd, Travis Tritt, Little Texas, the Eric Gales Band and numerous others. Ardent is also engaged in the representation of the following producers and engineers: John Hampton, Tom Harding, Jim Dickinson, Paul Mahern, Warren Bruleigh, Michael Rosen and Michael Wandich.

AURAL CANVAS



1407 Allen Ave.; Murfreesboro, TN 37129; (615) 890-1521. Owner: Forrest York. Manager: Forrest York.

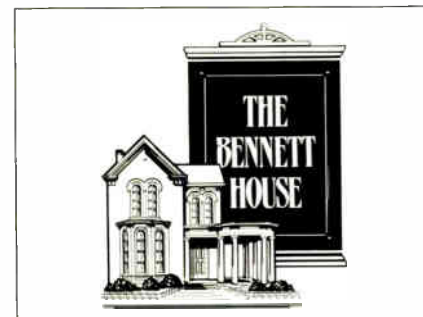

THE BENNETT HOUSE INC.
Franklin, TN

THE BENNETT HOUSE INC.



134 4th Ave. N.; Franklin, TN 37064; (615) 790-8696; FAX: (615) 790-9034. Owner: Keith Thomas. Manager: Daryl Bush. Engineers: Shawn McLean. **Dimensions:** Iso room has 21' ceiling. Room 1: studio 17'x11', control room 20'x26'. Front parlor: studio 22'x18'. Parlor: studio 16'x21'. Dining room: studio 16'x22'. *all 3 rooms have 12' ceilings. **Mixing Consoles:** Trident A Range 28x24. **Audio Recorders:** (2) Otari MTR-90 III 24-track, Ampex ATR-102 2-track 1/2", Panasonic SV-3700 DAT, (2) Tascam 103 cassette. **Monitors:** Tannoy System 10, Yamaha NS-10M, (2) EV 100A. **Other Major Equipment:** (3) TimeLine Lynx SMPTE time code module, Lexicon 300, (2) Sony MU-R201, (2) Yamaha SPX900, Yamaha REV7, (2) UREI/Teletrex LA-2A, (2) UREI LA-4, (2) UREI 1176LN, (8) Valley People TR804/810, Trident stereo limiter, (2) Neve 33115 mic pre-amp, (8) AKG C-414, (2) Neumann U87, Neumann M49, (5) Shure SM57, (5) Sennheiser MD-421U, Neumann KM84, Neumann U47, (2) AKG 451, (4) AKG D-224E, (2) Sanken CU-41, Sanken CU-32, Schoeps stereo 501U, Sony ECM-50PS, EV RE20, Macintosh MC2300, Yamaha PC4002M, Yamaha P2200, Yamaha CDC625, Sony SLV-585 HF VCR, assorted direct boxes, Mitsubishi 32" color monitor, Sony 5850 3/4" U-matic, Baldwin 7" grand. **Specialization & Credits:** The Bennett House harmonizes the stately architecture, character and feel of its 1875 Victorian and Greek revival two-story house, with progressive audio recording capabilities. Five main rooms of the house are used as the primary cutting rooms and others as ambient chambers, providing a multiplicity of creative recording possibilities. Both floors are tied to the newly renovated control/isolation room suite through 48 mic lines, 2 stereo cue feeds, and 6 video cameras, and 10 video monitors via 5 video feeds. Main rooms have turn-of-the-century hardwood floors, plaster/brick walls and 12' ceilings. Optional lodging is available in two second-story comfortably furnished bedrooms. Guests have use of the renovated kitchen, two lounge areas and secluded landscape courtyard with deck. Diverse guests: Jimmy Buffett, Collin Raye, Vanessa Williams, Barry Beckett, Allgood, Frank Filippetti, Amy Grant, Doug Stone, James Ingram, Justing Niebank, Beth Nielsen-Chapman, Brown Bannister, White Heart.

BIG MAMA RECORDING STUDIOS



400 Enslay Dr.; Knoxville, TN 37920; (615) 577-5597; FAX: (615) 573-1811. Owner: Norbert Stovall. Manager: Michael Davey.

SALE! PLUS FREE ADHESIVE!

MARKERFOAM™ ACOUSTIC FOAM GIANT 54" x 54"



Immediate Shipping

2" Reg. \$29.95 Now \$19.99 • 3" Reg. \$39.95 Now \$29.99! **KILL NOISE QUICK!**
High performance, full-size sheets of super high density Markerfoam. EZ mount. Blue or gray. Super-effective sound absorption for studios. Markerfoam offers best value, looks professional & is proven in studios worldwide. Request Foam-Buyers Guide/Catalog, specs & free samples today. VISA, MC, AMEX, COO, PO's, QUANTITY DISCOUNTS.



MARKERTEK JUMBO SOUND ABSORB BLANKETS

Heavy-duty 72"x80" padded blankets absorb sound wherever they're hung or draped. Fabulous for stage, studio & field use. Top professional quality at a super saver price! Weight: 6 lbs. Black, \$19.99.

MARKERTEK BLADE TILES™

HIGH PERFORMANCE LOW, LOW COST!

\$3.49 per tile, 16x16x2" America's best acoustic tile value, only from Markertek! Charcoal. Also available 16x 16x3" as shown, \$4.49 each.

MARKERSTIK™ foam adhesive. FREE with any Foam purchase in this ad! Limited offer. A \$5.95 per tube value.

SONEX All the colors and sizes plus great prices!

Get our FREE 149-page catalog of over 6,000 exclusive and hard-to-find supplies for audio & video.

800-522-2025 America's most unique catalog for audio & video!

FAX: 914-246-1757
MARKERTEK™ VIDEO SUPPLY
4 High St., Saugerties New York 12477 U.S.A.

USE READER SERVICE CARD FOR MORE INFO

ULTIMIX STUDIOS

- 48 Track Recording
- Soundtools Digital Editing
- Digital Performer®
- SampleCELL®
- Full line of MIDI Gear

WE SPECIALIZE IN:

RAP R&B
DANCE HOUSE
TECHNO Alternative

FOR THE ULTIMATE MIX CALL

Tel: (919) 230-2390
Fax: (919) 288-0060

ULTIMIX Studios
506 Guilford Avenue
Greensboro, NC
27401



BRANTLEY SOUND ASSOCIATES INC.



204 Third Ave. S.; Nashville, TN 37201; (615) 256-6260; FAX: (615) 255-9369. Owner: Lee Brantley. Manager: Bobby Brantley.

THE CASTLE RECORDING STUDIO



1393 Old Hillsboro Rd.; Franklin, TN 37064; (615) 791-0810; FAX: (615) 791-1324. Owner: Joseph Nuyens. Manager: Joseph Nuyens, Mike Janas.



COMMERCIAL MUSIC RECORDING COMPLEX
Memphis, TN

COMMERCIAL MUSIC RECORDING COMPLEX



CFA 232- Memphis State University; Memphis, TN 38152; (901) 678-2559; FAX: (901) 678-5118. Owner: Memphis State University. Manager: Larry Lipman. Engineers: E. Joe Walsh, Larry Lipman, advanced students in audio degree program. Dimensions: Studio A: 60'x60'x20, Studio B: 23'x16'x20', Electronic Music Lab: 16'x10'x12', Digital Workstation Lab: 11'x11'x10', Film-Scoring Lab: 11'x11'x10'. Mixing Consoles: MCI JH-636 (36x24). Audio Recorders: Otari MTR-90 II 24-track, Otari MTR-12 CT 1/4" 1/2-track, (2) Panasonic SV 3700 OAT, Otari 5050 Mark III-8 1" 8-track. Digital Audio Workstations: Synclavier 3200 w/16 voices, 16MB waveform RAM, 2Gb optical disk drive loaded with NED Timbre Library, 80MB & 160MB Winchester drives, 20MB Kennedy cartridge drive, 1.2MB disk drive, Macintosh II Graphics Workstation, extensive sample library. Monitors: UREI 813A, (2) UREI 811A, Tannoy GLM, Yamaha NS-10, JBL 4412. Other Major Equipment: dbx 208 24-channel, Lexicon 224XL, Lexicon M97 Super Prime Time, (2) Yamaha SPX90 II, Yamaha EMP100, Aphex Aural Exciter Type B, Eventide H949 Harmonizer, (2) dbx 160X, (4) Valley Audio Dyna-Mite, (2) SCAMP Effects Racks, GateX, (2) Apple MacIntosh, (2) Neumann U87, Neumann KM84, (4) AKG C-414EB/P48, (2) AKG C-452/CK15, AKG tube, AKG D-112, (6) Sennheiser MD421U, Sanken CU-41, (2) Shure SM81, (2) Shure SM57, Electro-Voice RE20, (2) Crown P2M30GP, (4) AB Systems monitor amplifiers, BGW monitor amplifiers, Steinway 7' Grand piano, Yamaha DX7, Roland JX-10, Roland PAO 8 Octapad, Roland MT-32, Akai S900, Akai ME-30P, full complement of studio, orchestral and percussion instrumentation available, CMX 3100, (2) Ampex VPR2/TBC2B, Grass Valley 100, Vital VIX 114, (3) Ikegami HL55/MA79, Chyron VP2, (2) Sony BVW15, (2) BV/P3A/BV/P1A. Specialization & Credits: The Commercial Music studios are operated primarily as instructional facilities for the University's Commercial Music degree programs and Highwater record company. Although normally unavailable for commercial use, studio rental is authorized under special circumstances. Memphis State offers a Bachelor of Music in Commercial Music with concentrations in Recording Technology and Music Business. Our programs stress a thorough understanding of fundamental concepts, yet place equal emphasis upon developing the student's ability to quickly adapt to new practices, technologies and creative directions. Instructors are actively involved in today's commercial music industry and possess a broad knowledge of music industry practices. CMUS majors have won the prestigious NARAS Student Music Award. The Memphis arts community offers diverse cultural opportunities and a rich assortment of internship possibilities. Scholarship funds are available for exceptional students, and many states offer financial assistance through the Academic Common Market program. A commitment to personal attention and quality instruction requires that enrollment be limited and based on selective procedures.

DIGITAL DOMAIN RECORDING STUDIOS



1708 Grand Ave.; Nashville, TN 37212; (615) 322-9560. Owner: Rick Horton. Manager: Rick Horton. Engineers: Rick Horton, Todd Kidd, Linell. Dimensions: Studio 1: 25'x35'. Control room 1: 18'x25'. Control room 2: 14'x14'. Mixing Consoles: Amek TAC Matchless 36x32, Yamaha DMP7D, Ramsa WR44412 12x4 remote. Audio Recorders: Mitsubishi X-880 32-track digital, Mitsubishi X-86 2-track digital, (2) Mitsubishi X-80 2-track digital, Sony PCM-2500 Pro DAT, Sony PCM-501ES digital audio processor, (2) Panasonic SV-3700 DAT, (2) Panasonic SV-3900 DAT, Studer A80 24-track analog, Otari MTR-12 2-track 1/4" and 1/2" analog. Digital Audio Workstations: Studer Editech Dyaxis Digital Production System 3.5 GB. Monitors: Tannoy NFM-10, Auratone T-6. Other Major Equipment: Dolby A 2-channel, Dolby SR 2-channel, Dolby C 2-channel, (2) Aphex stereo Compellor comp/limiter, Aphex Dominator II multiband processor, Aphex Expressor comp/limiter, Adams-Smith Zeta-3 w/remote, Eventide H3000 Ultra-Harmonizer, (4) Aphex 612 expander/gate, Lexicon PCM70 processor, (2) Yamaha REV7 processor, UREI 1178 dual peak limiter.

ELEVEN ELEVEN SOUND



1111 17th Ave. S.; Nashville, TN 37212; (615) 329-1111; FAX: (615) 329-1138. Owner: Frank Oileo. Manager: Rodney Good. Engineers: Rodney Good, Steve Ledet, independents. Dimensions: Studio 34'x36', control room 17'x11'. Mixing Consoles: Amek TAC Scorpion 28x24x12, Alesis 1622 16x4x2, Neve V Series III 48x48. Audio Recorders: Alesis A0AT 32-track digital, (2) Panasonic SV 3700 OAT, Mitsubishi X-850 32-track digital, Otari MTR-9011 24-track analog, Mitsubishi X-80A 2-track digital, Studer A80 2-track analog, Studer B67 2-track analog, Revox B710, Onkyo TA-2066, Sony TC-K870ES. Monitors: (2) Sierra Audio w/oak dispersion horns, (2) KEF C-55, (2) Yamaha NS-10M. Other Major Equipment: Adams-Smith Zeta-3, Lexicon 224XL w/LARC, Lexicon 224 w/LARC, Lexicon PCM70, Yamaha REV5, Yamaha REV7, Yamaha SPX90II, TC Electronic 2290, Lexicon Prime Time, EMT 162, Alesis Quadraverb, Tube-Tech CLIB comp/limiter, GML Moving Fader automation, UREI 1176 comp/limiter, Eventide Instant Phaser, Eventide Harmonizer, Trident comp/limiter, (2) Neumann M249 tube, (2) U87, Neumann 47 FET, KM84, Sanken CU41, (4) AKG 414, (2) AKG 460B, (6) Sennheiser 421, Sennheiser MKH-40, (2) Studer SKM5U, Beyer M101, (2) Sony ECM-50P, (5) Sony ECM-33P, ECM-22P, (2) Electro-Voice RE20, (3) Shure SM57, various others, Steinway 7' grand piano w/Forte Music MIOI, Yamaha OX7 Fender Rhodes piano, Wurflitzer piano, Hammond B-3 organ w/Leslie, harpsichord, vibes, clavinet, congas, McIntosh 2500, BGW 600, (2) BGW 2500, Hafler 500, Crown D-150, Crown 60, Crest P-3501, BGW 75 monitor amplifiers.



EMERALD SOUND STUDIOS
Nashville, TN

EMERALD SOUND STUDIOS



1033 16th Ave. S.; Nashville, TN 37212; (615) 321-0511; FAX: (615) 329-9417. Owner: Dale Moore. Manager: Anthony Little. Engineers: Kerry Kopp, chief technical engineer; Nick Sparks, staff assistant engineer. Dimensions: Room 1: studio 28'x36', control room 19'x21'. Room 2: studio 16'x18', control room 12'x14'. Mixing Consoles: SSL 4064EG Series computer w/Ultimation & 64 modules, Ramsa WR-8616 (radio production suite). Audio Recorders: Mitsubishi X-850 32-track w/Agogee, Studer A800 24-track 2", Studer A80 RC MkII 2-track 1/2", Studer A80 RC MkII 2-track 1/4", Panasonic SV-3700, Panasonic SV-3500, Sony PCM-2500 OAT, (2) Studer A710 cassette. Monitors: (2) Hideley/Kinoshita Model 2, (2) Yamaha NS-10, (2) Genelec S30 triamp, (2) JBL 4408, (2) JBL 4410, (2) JBL 4430, (2) Auratone 5-C, (2) Electro-Voice Sentry 100A. Other Major Equipment: (2) TimeLine Lynx SAL (L410-38), ADR F769X-R Vocal Stresser, AMS DMX 15-80 delay/dual sampler/pitch change, AMS RMX 16 digital reverb, API 5502 4-band parametric EQ, Aphex Aural Exciter II, (2) dbx 165A comp/limiter, dbx 902 de-esser, Demeeter VTP-2 dual mic pre, Oramur OS-201 dual gate, (2) EMT 140ST reverb plate, EMT 250 digital reverb, Eventide H949 Harmonizer, Eventide H3000SE Ultra-Harmonizer w/Steve Vai option, Lexicon Prime Time II, Lexicon Super Prime Time, (2) Lexicon PCM70, (2) Lexicon 224XL, Lexicon 480L w/SME sampling option, Publison IM90 Internal Machine w/21-sec. sampling, ADR E900 RS sweep EQ, Quantec Room Simulator, (2) Sontec MEP-250 parametric EQ, Sontec ORC-20A dynamic range controller, (2) Teletronix LA-2A, (2) UREI LA-4, (6) Valley Audio Kepex II noise gate, (2) Valley Audio Gain Brain II, (2) Yamaha SPX90, Yamaha SPX1000, Yamaha REV7.

Specialization & Credits: Bridging the gap between work and pleasure, Emerald Sound Studios takes pride in providing the comforts of home while continuing to command a position of sonic excellence and professionalism. This foundation, coupled with our dedication to service, has attracted such esteemed clients as: Steve Winwood, Reba McEntire, Whitney Houston, Alabama, Lynyrd Skynyrd, James Ingram, Restless Heart, Amy Grant, Travis Tritt, Clint Black and a host of others. Our Tom Hideley-designed control room features a Hideley/Kinoshita monitoring system providing a state-of-the-art listening environment. Emerald also boasts a large, high-ceiling tracking room with four isolation booths. Amenities include private offices, secretarial assistance, technical support, security, full-size kitchen, private and open lounges, movie/Video library, Nintendo Entertainment system, steam shower, ping-pong and billiard suite. Emerald is also home to a full-service broadcast facility, with an on-site I.O.B. KU band stereo satellite up/downlink and T-1 (1.544 MBPS) digital carrier.

ENGLISH VALLEY MUSIC



541 Forest Retreat Rd.; Hendersonville, TN 37075; (615) 822-6341; FAX: (615) 822-5570. Owner: JCI Pulstford.

GHL AUDIO



5216 Waddell Hollow Rd.; Franklin, TN 37064; (615) 794-0550; FAX: (615) 794-0017. Owner: Gary Hedden.

GREAT CIRCLE SOUND



365 Great Circle Rd.; Nashville, TN 37228; (615) 742-6803; FAX: (615) 742-6915. Owner: Benson Music Group. Manager: David Murphy. Engineers: David Murphy, Andreas Krause, Jeff Baggett. Dimensions: Room 1: studio 40'x60', control room 19'x22'. Mixing Consoles: MCI 528 highly modified. Audio Recorders: Studer A800 24-track, Studer A80 2-track 1/2", (2) Panasonic SV-3700, Studer A710 cassette, Nakamichi cassette, (2) MCI JH-110 2-track. Monitors: UREI 813 biamp, Yamaha NS-10M. Other Major Equipment: (4) UREI 1176, (2) UREI LA-3A, (2) dbx 160 limiters; (2) AOR Vocal Stressor, (4) Valley People Kepex II, Lexicon 224XL, Yamaha SPX900, Alesis Quadraverb, Alesis MID/Verb, Yamaha REV7, Roland SDE-3000, Korg SDD-3000, Roland Dimension D, (2) Neumann, (9) Sennheiser, (6) AKG, (3) Shure microphones; (3) Sennheiser headphones.

HILLTOP RECORDING STUDIO



902 Due West Ave.; Nashville, TN 37115; (615) 865-5272; FAX: (615) 865-5553. Owner: Linneman Partners. Manager: John Nicholson. Engineers: John Nicholson, Tim Fitzpatrick. Dimensions: Studio 35'x18', control room 20'x18'. Room 2: control 22'x18'. Mixing Consoles: Mitsubishi Westar 36x24, Sound Workshop Series 34 40x24 w/ARMS automation. Audio Recorders: Sony 3324 24-track digital, Sony APR-24 24-track analog, MCI JH-110B 2-track, Fostex E-2 2-track w/center-track time code, Panasonic SV-3700 DAT, TEAC DAP-20 DAT, (2) Nakamichi HR-1 cassette, Onkyo TA-2058 cassette. Monitors: (4) Klipsch K-horn (mains in both rooms), (2) Tannoy NFM-8, (2) Yamaha NS-10, (2) EV Sentry 100A, (4) Auratone 5C, (2) JBL 4301, (20) Fostex T-20 headphone, (4) Sony MDR-7506 headphone. Other Major Equipment: (26) dbx Type 1 noise reduction, (2) Dolby SR noise reduction, Lawson plate reverb, Yamaha SPX1000, Yamaha SPX90 II, (2) Ibanez SDR-1000, Yamaha REV7, (4) dbx 160, (2) UREI 1176LN, Eventide H910 Harmonizer, (2) Valley People Kepex II gate, (2) Valley People Maxi-Q EQ, (2) UREI 545 parametric EQ, Alesis O-4 drum module; (5) Audio-Technica 4033, (5) Neumann condenser, (5) AKG condenser, (20) Shure, EV, high-quality studio microphones; Steinway CO-9' grand piano, (7) Crown various amps.



KIVA RECORDING STUDIO
Memphis, TN

KIVA RECORDING STUDIO



904 Rayner St.; Memphis, TN 38114; (901) 278-1888; FAX: (901) 725-1983. Owner: Gary Belz. Manager: Gary Harwood. Engineers: Gary Harwood, Jack Holder, Greg Archilla, William Brown. Dimensions: Room 1: studio 30'x45', control room 27'x19'. Room 2: studio 11'x18', control room 18'x22'. Room 3: 23'x24'. Mixing Con-

soles: SSL 4056 G w/Total Recall & G Series, Westar w/Neve Flying Fader 52-channel, API w/550A EQ & SSL automation 16-channel, Neve 16-channel 4-band. **Audio Recorders:** Mitsubishi X-850 32-track, (2) Mitsubishi X-800 32-track, Studer 827 24-track, Studer A800 24-track, Mitsubishi X86 2-track, Studer A80 2-track 1/4", Otari 2-track 1/2", Panasonic & Sony DATs. **Monitors:** Hipley, Kinoshita—studio A; JBL w/TAD woofers—studio B. **Other Major Equipment:** (2) Lynx, Adams-Smith Zeta-3, (2) Lexicon 480L w/LARC, (8) Pultec EQ, (6) Neve 1073 EQ, (2) AMS 1580 S, Fairchild 670, (3) EMT 140, EMT 250, GML EQ & mic pre, (3) Lexicon PCM70, (3) Lexicon PCM42, (2) Drawmer DS-201, (10) UREI 1176, Bosendorfer grand piano w/MIDI, Hammond B-3 organ w/Leslie, (2) LA-2A, (4) Telefunken mic pre, (3) Neumann M48, Neumann M49, AKG C-12, (2) TC Electronic 2290, Drawmer DL241, Drawmer DS301, Neve Prism rack, (2) Neumann TLM170, RCA 44, (6) AKG 414, RCA 770X, Schoeps MK26. **Specialization & Credits:** Studio A, a Tom Hidley-designed, 20Hz control room, is the only total mix room in the region, featuring SSL G as well as discrete class A API console and additional equipment. Kiva has 23' high tracking space with ample iso booths. Kiva has common ownership with Peabody hotel and Holiday Inn-Overton Square, offering great packages and total services.

MAGNETIC MEMORIES



PO Box 3373; Kingsport, TN 37664; (615) 246-3010. Owner: Lawrence Morris.



MASTERFONICS INC.
Nashville, TN

MASTERFONICS INC.



28 Music Square E.; Nashville, TN 37129; (615) 327-4533; FAX: (615) 242-0101. Owner: Glenn Meadows, president. Manager: Traci Samczyk, scheduling. **Engineers:** Glenn Meadows, Milan Bogdan, Benny Quinn, Jim Loyd, Scott Gunter, David Boyer. **Dimensions:** Room 1: mix control room 26'x20'. Room 2: studio 45'x20', control room 17'x16'. Rooms 3&4: mastering room 20'x14'. CD prep room 20'x14'. **Mixing Consoles:** Room 1: SSL 4000E 64x32 44 mic/line, 16 dual line, 4 stereo modules installed. Room 2: SSL 4000E 48x32 40 mic/line, 8 stereo modules. (Both SSLs equipped w/Total Recall and G Series automation.) JVC DM-900 digital, Neumann SP75/272. **Audio Recorders:** (2) Otari DTR-900 II 32/64-track digital, Otari MTR-100 24-track analog 2", (5) Philips CD-R, (9) Tascam DA 30 R-DAT, JVC 900 2-track digital, Sony 1630 2-track digital, Sony 3402 2-track digital, Mitsubishi S-86C 2-track digital, Fostex D-20 R-DAT, Sony 601 2-track digital, JVC DS-DT900 R-DAT, analog 1/2" and 1/4", (20) Tascam 122 MKII real-time. **Monitors:** Hidley/Kinoshita, various near-fields; FM Acoustic, JDF monitor amp. **Other Major Equipment:** (4) EMT plate, EMT 250/252, AMS DMX 15-80s, AMS RMX 16, (3) Sony MU-R201, Quantec Room Simulator, (2) Lexicon 480L/224XL, (2) Lexicon PCM70, TC 2290, (3) Fairchild 670 tube, (3) Teletronix LA-2A tube, (2) Pultec EOP-1A3 tube EQ, Sontec EQ, Sontec DRC-202, GML 8900, (4) API 550A EQ, Wendel Jr., (2) Publison IM-90, Eventide H3000E, Drawmer DS-201, Sontec DRC-202, (2) dbx 160X, dbx 165A, Universal 175 limiting amp, Neumann 47 tube/M49 tube and others, Telefunken, AKG, Shure, EV, Audio-Technica, Sennheiser, Sony, more; Yamaha grand piano w/MIDI, Fender Rhodes electric piano, Leslie cabinet, SADIE hard disk editor, Roland DM-80 8-track, Turtle Beach 56K hard disk editor, Sony R-DAT editor, Cedar audio restoration system, D/A and A/D converters by



- Maximum digital tracks
- Maximum analog tracks
- Remote recording
- MIDI production
- Tape duplication
- Audio-for-video/film
- Digital editing/CD prep
- In-house music services

Apogee/Drake/Wadia/Pygmy/NVision, Sony DFX-2400 and NVision NV4448 sample frequency converters, JVC AE-90/AE-900 digital editors, (3) JVC DS-LC900 digital parametric controller, Yamaha PDS CD disc system, Wadia Digilink 20 fiber-optic system, BASE, Neumann VMS-70. **Specialization & Credits:** Special Services: Complete CD, cassette and vinyl manufacturing services. Custom packaging, artwork, printing. Highest quality, excellent pricing. Contact: Jim Loyd. Audio restoration with the CEDAR system.

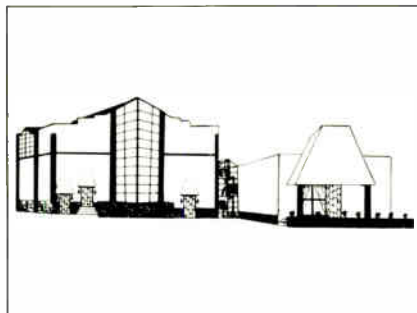

MASTERLINK STUDIOS I & II
Nashville, TN

MASTERLINK STUDIOS I & II



Divisions of Al Jolson Enterprises; 114-116 17th Ave. S.; Nashville, TN 37203; (615) 244-5656; FAX: (615) 242-2472. Owner: Albert Jolson. **Engineers:** Glenn Rieuf Jr. & Independents. **Dimensions:** Studio 1 40'x40', control room 15'x17'. Room 2: 25'x30'. **Mixing Consoles:** Control Room 1: Sphere Eclipse C 40x32 w/ automation, Control Room 2: Trident Series 75 28x24. **Audio Recorders:** Otari MTR-100A 2" 24-track w/CB-131 synchronizer & Dolby HX-Pro, Ampex MM-1200 2" 24-track w/16-trk headstack, Studer A-810 1/4" 2-track w/center-track time code, Studer A-80 1/4" 2-track or 1/2" 4-track, Studer B-67 1/4" 2-track, Scully 1/2" 3- or 4-track, (2) Ampex AG-440-C 1/4" 2-track, Sony 2500 R-DAT, Nakamichi MR-1. **Digital Audio Workstations:** NED Synclavier 64 voice, MIDI, SMPTE, VITC, Macintosh II 5-40 w/Performer. **Monitors:** Westlake TM-1, (2) Westlake BBS-M10, (4) Meyer HD-1, (2) B&W DM-100, (2) Yamaha NS-10M. **Other Major Equipment:** (2) McIntosh MC-250, (2) McIntosh MC-2100, (2) Studer A-68, (3) Yamaha P-2050 monitor amplifiers (2) Aphex type B Aural Exciter, API 5502 parametric EQ, (2) dbx 160, Eventide H-910, H-949, Eventide H3000 Ultra-Harmonizer, (2) Gatex noise gate, Sontec parametric EQ, Summit Audio leveling amplifier, (2) Teletronix LA-2A, (2) UREI 1176-LN, Valley People Rack w/(2) Kepex, (2) Commander, (2) Gain Brain, (2) DSP de-esser, AMS RMX-16, Lexicon 200, (2) Lexicon PCM70, Lexicon Super Prime Time, Roland DEP-5, Yamaha REV5, (2) Yamaha SPX90, a collection of over 50 vintage & current mics, spanning 3 decades including AKG, Altec, Audio-Technica, Beyer, Countryman, Electro-Voice, Neumann, Sennheiser, Shure, Sony & Western Electric, Sony VO-9800 3/4" Umatic w/address track time code, (2) Sony 27" monitors, Otari EC-201 time code reader, (2) Dolby SR, (2) Dolby A-361, (2) dbx, Baldwin 9'5" grand, Kawai 5'10" MIDI grand, Hammond B-3 w/Leslie, Akai 900 sampler, E-mu Emulator II+ w/hard disk. **Specialization & Credits:** Masterlink 1 is a spacious 40'x40' tracking room with a 28-foot ceiling. This room features a 4-channel active cue system for smaller tracking dates in addition to 50 new CLHR 4-channel passive cue boxes driven by (2) Crown MicroTech 1000s to accommodate the larger orchestra dates. Mogami audio cable as well as Belden & Canare coax is run through the entire facility linking all rooms. Masterlink 2 is a great MIDI production room featuring a 64 Voice FM/Poly NED Synclavier system. This room is also ideal for light overdubs as well as 24-track mixing. Regular clients include TNN *On Stage*, *American Music Shop*, BMG Music, etc. Adjoining Masterlink Studios is the Cassette Express housing the largest KABA cassette-duplication system in the Southeast. This facility is capable of producing 110 real-time slaves per pass.

MATRIX RECORDING



1010 17th Ave. S.; Nashville, TN 37212; (615) 321-4006; FAX: (615) 322-9500. Owner: Randall Harris. Manager: Jack Howell.

MILEDEGE STUDIO



5281 Lochinvar; Memphis, TN 38116; (901) 346-8818. Owner: Michael Elledge. Manager: Michael Elledge.

THE MONEY PIT



622 Hamilton Ave.; Nashville, TN 37203; (615) 256-0311; FAX: (615) 259-4541. Owner: Paul Worley, Ed Bayers Sr., Ed Bayers Jr. Manager: Jim Burnett.

MUSIC CITY AUDIO INC.



PO Box 4762; Nashville, TN 37216; (615) 227-3542. Owner: Music City Audio Inc. Manager: Joe Mills.

FOR BIG LEAGUE RECORDINGS, USE THE BIG LEAGUE BBE 822A!



"Increases intelligibility, restores harmonics, and improves clarity... most impressed with the effect on instrumental tracks of all sorts... recaptured the natural sparkle and punch... an indispensable tool for the audio professional."

Mix Magazine

- ▼ 10K ohms input; 600 ohms output
- ▼ +24dBu clip point
- ▼ XLR and 1/4" Tip-Ring-Sleeve Balanced/Unbalanced

BBE Sound Inc. Huntington Beach, CA
(714) 897-6766

ASK YOUR DEALER FOR A DEMO TODAY

USE READER SERVICE CARD FOR MORE INFO

New Orleans' Finest

- 24/48 track
- Large tracking room
- Four iso rooms
- Digital editing suite
- Remote recording
- Complete MIDI suite

ULTRASONIC
Studios

call (504) 486-4873 for
rate card & eqt list



MUSIC CITY MIOI



PO Box 2379; Hendersonville, TN 37077; (615) 264-1819. Owner: K. K. Proffitt. **Specialization & Credits:** Music productions, audio-for-video and demos.

MUSIC MILL



1710 Roy Acuff Pl.; Nashville, TN 37203; (615) 254-5925; FAX: (615) 244-5928. Owner: Harold Shedd. Manager: Kimberly Williams.

NEW MEMPHIS MUSIC



1503 Madison Ave.; Memphis, TN 38104; (901) 276-8520. Owner: Nikos Lyras. Manager: Sara Lyras.

OAK VALLEY SOUND



105 Oak Valley Dr.; Nashville, TN 37207; (615) 262-2600; FAX: (615) 226-4070. Owner: Nashville Teleproductions Inc. Manager: Kevin McManus.

OMNISOUND RECORDING STUDIO



1806 Division St.; Nashville, TN 37203; (615) 321-5526; FAX: (615) 321-5528. Owner: Esprit Sound Inc. Manager: Michael Koriba. Engineers: Patrick Kelly-chief engineer, Aaron Swihart-asst. engineer, Greg McNeer-Technician. Dimensions: Room 1: studio 20'x30', control room 28'x14'. Room 2: studio 12'x10', control room 20'x10'. **Mixing Consoles:** Trident A-Range 40x24x24 w/Otari DiskMix IV Moving Fader automation, Trident 80B w/Optifile 3-D automation. **Audio Recorders:** Otari MTR-90 III 24-track, Studer A800 24-track, Ampex ATR-102 2-track 1/2", Studer B67 2-track 1/4", (2) Panasonic 3700 DAT, (3) JVC KD-V6 cassette. **Monitors:** Tannoy FSM, Tannoy LGM 12", (2) Yamaha NS-10M, Altec Big Reds, Auratone 5-C. **Other Major Equipment:** (2) Lexicon PCM70, Lexicon PCM42, Yamaha SPX90 II, (2) Roland SRV-2000, (3) Teletronics LA-2A, Tube-Tech CL1B, (4) Kepex II gate, (3) dbx 160 limiter, dbx 161 limiter, (2) Drawmer DS-201 gate, ADR Vocal Stresser, tri stereo chorus, Lawson echo plate, (8) Formula Sound Q8 cue system, Yamaha C7 concert grand w/MIDI, (5) AKG 414, Neumann U67 tube, (2) Neumann U87, (7) Sennheiser 421 and much more.

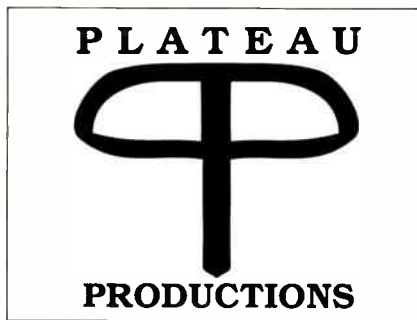

PLATEAU PRODUCTIONS
Monteagle, TN

PLATEAU PRODUCTIONS



313 Main St.; Monteagle, TN 37356; (615) 924-2070. Owner: Monteagle Arts. Manager: Peter Keeble. Engineers: Peter Keeble, various independents. Dimensions: Room 1: studio 20'x30', control room 15'x18', 130-seat performance room. **Mixing Consoles:** Tangent 3216. **Audio Recorders:** MCI JH-114 24/16-track, Studer B67 2-track, Ampex 4408 B 4/2-track, Scully 280 2-track, Revox A700 2-track, Tascam DA 30 DAT. **Monitors:** Tannoy System 10, JBL 4313, JBL 4311, Auratone Sound Cube, MDM-4 time-aligned. **Other Major Equipment:** dbx 24-channel, Dolby 361 2-channel, Yamaha REV7, AKG BX-10, DeltaLab DL-1, DeltaLab DL-4, Eventide H910 Harmonizer, Eventide DL91, LA-2A tube limiter, LA-3A limiter, (2) dbx 160, (2) dbx 161, dbx 165, (2) Orban parametric EQ, (2) ADR sweep EQ, (4) Allison Research gate, (3) Neumann U87, (5) AKG 414, (2) Neumann KM84, Neumann U47 FET, (3) Sony 33P, (3) Sony 22P, (2) Sennheiser 441, (4) Sennheiser 421, AKG D-12E, (5) Beyer M201, Beyer M101, (6) Shure SM57, (2) Shure SM58, Bryston 4B, BGW 150B, BGW 100B, Crown D-60, Hammond B-2W w/percussion organ, Wuritzer electric piano, Yamaha DX7 synthesizer, Steinway 1923 grand piano, Pearl drums, Slingerland drums, Yamaha RX11 drum machine, stage setup—monitors/mixer house. **Specialization & Credits:** Located on the Cumberland Plateau at the intersection of U.S. Highway 41 and Interstate 24 in Monteagle, Tennessee, Monteagle Arts occupies a landmark at the highest point on the Dixie Highway. Designed and constructed in 1951, the Monteagle Motel stood as a testament to the spirited architecture of the era. The buildings have found new life as the Monteagle Arts complex, which houses 313 Main—a 130-seat performance room, an informal production space, guest rooms for Plateau Productions, its technical areas and offices. The remaining spaces are occupied or available for other arts-related use. Plateau Productions is a full-service company emphasizing efficient live performance recording in conjunction with more fixed studio amenities. Area attractions include: South Cumberland Recreation Area, Wonder Cave, University of the South, Sewanee Natural Bridge, historic settlements, and bed & breakfast inns. Feel the difference.

PYRAMID RECORDING



1208 Lula Lake Rd.; Lookout Mountain; Chattanooga, TN 37350; (706) 820-2356; FAX: (706) 820-0539. Owner: R.H. MacLellan. Manager: Jim Stabile.

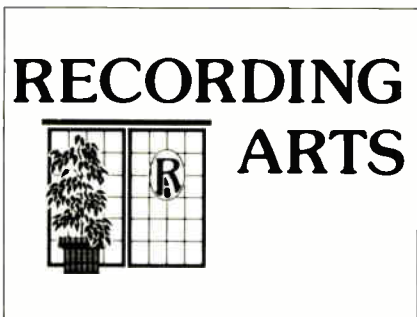

RECORDING ARTS
Nashville, TN

RECORDING ARTS



Box 121702; Nashville, TN 37212; (615) 321-5479; FAX: (615) 321-0756. Owner: Carl Tatz. Manager: Lou Johnson. Engineers: Lou Johnson, Carl Tatz, Larry Lee. Dimensions: Room 1: studio 14'x16', control room 12'x25'. Room 2: studio 14'x12'. Room 3: studio 8'x10'. **Mixing Consoles:** Soundcraft 3200W 64 channels of Optifile 3-D automation. **Audio Recorders:** Otari MTR-90 II 24-track analog, Mitsubishi X-850 32-track digital w/Apogee filters, Sony 7010 Pro DAT w/SMPTE & Memory Start, Aiwa AD-F1000 cassette, Aiwa F990 cassette, Revox A77 2-track analog, Sony 701ES digital processor/Beta. **Monitors:** (2) Yamaha NS-1000M, (2) Yamaha NS-10M studio, (2) Fostex RM-780, (2) Visonic David 9000, (4) Auratone 5-C. **Other Major Equipment:** Lexicon 480L, (2) Lexicon

PCM70, Lexicon PCM42, Lexicon Prime Time, Eventide H3000 SE V, Klark-Teknik DN780, Roland SRV-2000, Roland DEP-5, Roland Dimension D, Yamaha REV7, Yamaha SPX90 II, Teletronics LA-2A, (3) UREI 1176LN, (2) LA-4, (3) dbx 160X, Drawmer DL241, Valley People 440, (2) Focusrite ISA 110 mic pre/EQ, Adams-Smith Zeta-3, Alesis D4 drum sampler, J.L. Cooper PPS sync, Neumann U87 modified, (2) AKG 414EB, EV RE20, (4) Sennheiser 421, (2) Sennheiser 441, (3) Shure SM57, (2) Bryston 6B amp, (3) Bryston 4B amp, Recording Arts comp/lease vocal compiler, (8) Judenus headphone boxes, Sony CD player, (2) LofTech TS-1 RMX test set, Alphatron PC-100 Phase Checker. **Specialization & Credits:** Recording Arts is Nashville's affordable "A room" for automated mixdown as well as overdubbing tracking. It features one of the three largest automated consoles in Nashville. It is superbly designed and equipped in a very inviting and comfortable atmosphere. The console is sonically breathtaking with non-VCA gates on every channel. The monitoring is very accurate, and the outboard equipment selection is excellent. The studio has been awarded multiple Gold and Platinum records by the RIAA.

REDWOOD RECORDING



628 Elaine Dr.; Nashville, TN 37211; (615) 331-0533. Owner: Rich Henry.

ROCKINGCHAIR STUDIOS



165 S. Holmes; Memphis, TN 38111; (901) 458-8564; FAX: (901) 458-8564. Owner: Ruth Thompson, Mark Yoshida. Manager: Alan Mullins.

SANCTUARY RECORDING STUDIO



1216 16th Ave. S.; Nashville, TN 37212; (615) 329-2294. Owner: Barry Sanders. Manager: Barry Sanders.

SCENE THREE



1813 Eighth Ave. S.; Nashville, TN 37203; (615) 385-2820; FAX: (615) 383-1026. Owner: Kitty Moon, Marc Ball. Manager: Nick Paladino.

SCRUGGS SOUND STUDIO



2828 Azalea Pl.; Nashville, TN 37204; (615) 383-7994. Owner: Randy Scruggs.

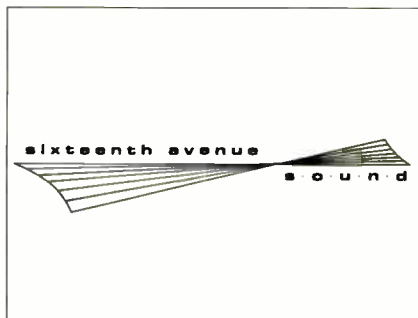

SIXTEENTH AVENUE SOUND
Nashville, TN

SIXTEENTH AVENUE SOUND



1217 16th Ave. S.; Nashville, TN 37212; (615) 327-8787; FAX: (615) 321-0928. Owner: Services Management Inc. Manager: Preston Sullivan. Engineers: Darren Smith Dimensions: Room 1: Studio A studio 40'x24', control room 28'x24', Room 2: Studio B studio 29'x15', control 15'x13'. **Mixing Consoles:** Studio A—Solid State Logic 405E E series w/G computer & 32 G mic pre's, Studio B—D&R Avalon 32x32 large/small fader in-line design. **Audio Recorders:** (Studio A)—Mitsubishi X-850 32-track digital w/Apogee filters, Studer A820 24-track analog w/auto alignment, Studer A820 2-track w/1/2" & 1/4" headstacs, (2) Panasonic SV-3700 DAT, (2) Tascam 122 cassette deck (Studio B)—Otari MX-80 24-track analog, Panasonic SV-3500 DAT, Tascam Model 42 2-track, Tascam 122 cassette. **Monitors:** Studio A—main: UREI 813C near-field, Meyer HD-1, Tannoy SRM12-B, Yamaha NS-10M, Studio B—main: Meyer 834 monitor/subwoofer/processor/amplifier system, Meyer HD-1, Tannoy SRM12-B, Yamaha NS-10M. **Other Major Equipment:** Studio A—Formula Sound 8-channel active headphone system, Studio B—standard: stereo cue, optional: Formula Sound Cue 8, Studio A—AMS RMX-16, AMS DMX-15-80 stereo harmonizer/sampler, Lexicon 480L, 224, LARC, (2) PCM70, (2) PCM42, (2) PCM41, Eventide H3000 SE, Yamaha SPX90, Tube Tech CL-1-B tube compressor, (2) dbx 165, (3) Valley PR-10 w/KepeX, (2) Commander, Gain Brain, Leveller, DSP De-esser, Studer A725 CD player, Adams-Smith Zeta-3 synchronizer w/cables for all popular machines, Arden Systems interface unit to control Sony 3324/3348 from SSL console, Kawai 75" grand piano, large selection of microphones, studio B—Lexicon PCM70, LXP-1, LXP-5, MRC, Yamaha REV7, SPX90, UREI LA-2A

Get Listed in Mix Directories

Upcoming deadlines:

Southern California &
Southwest Studios
June 8, 1993

AES Issue:
New Products for 1994
July 8, 1993

North Central U.S. &
Canadian Studios
August 9, 1993

Call (800) 344-LIST for
a listing application.

tube compressor, (2) dbx 161, (2) Valley 440, (2) Gatex, Meyer CP-10 parametric EQ, Loft 440 analog delay, DeltaLab 1024, ADA S1000, Mitsubishi DP-103 CD player, Yamaha upright grand piano, Arden Systems modified Fender Twin guitar amp. **Specialization & Credits:** Sixteenth Avenue Sound is a multi-purpose facility geared toward album projects, jingles and music for film or video. We have a full-time/full-service staff to accommodate your most demanding needs. Tracks recorded/mixed at Sixteenth Avenue Sound (Studios A & B) vary from hard rock to country, from pop to R&B to contemporary Christian. Recent artists include: Steve Winwood, Kenny Rogers, Amy Grant, Ziggy Marley, Michael W. Smith, Lorie Morgan, Wynonna Judd, BeBe & CeCe Winans, Dolly Parton, Vanessa Williams, George Strait, Peter Wolf, Brent Bourgeois, Charlie Peacock, Margaret Becker, Allan Jackson, and Whitney Houston just to name a few.

THE SOUND BARRIER RECORDING STUDIOS



4605 Gallatin Rd., Nashville, TN 37216; (615) 228-6565; FAX: (615) 227-4001. **Owner:** Trey Smith. **Manager:** Chad Evans.

SOUND EMPORIUM STUDIOS



3100 Belmont Blvd., Nashville, TN 37212; (615) 383-1982; FAX: (615) 383-1919. **Owner:** Garth Fundis. **Manager:** Susan Dey Siko. **Engineers:** Gary Laney, Dave Sinko. **Dimensions:** Room 1: studio 33'x40'—additional 20'x22', control room 20'x22'. Room 2: 14'x23', control room 10'x7'. **Mixing Consoles:** Neve 8128, Trident 80B. **Audio Recorders:** Mitsubishi 850, Otari 9011, Sony/MCI JH-24, Sony 2500, (2) Studer A80. **Monitors:** Westlake BBSM-10, BBSM-5, Yamaha NS-10, Tannoy LGM-12, KRK 900. **Other Major Equipment:** (2) PCM-70, AMS RMX 16, (2) EMT 140, Yamaha SPX90, AMS DMX 15, (2) Harmonizer 910, Harmonizer 969, Lexicon Prime Time II, Quantec room simulator, (2) live chambers, Lexicon 224LX, Lexicon PCM42.

SOUND STAGE STUDIO



10 Music Circle South; Nashville, TN 37203; (615) 256-2676; FAX: (615) 259-2942. **Owner:** Ron Kerr. **Manager:** Ron Treat. **Engineers:** Craig White, Derek Bason, John Thomas III, Warren Rhoates, Ron Treat, Randy Le Roy. **Dimensions:** Room 1: studio 30'x60', control room 14'x30'. Room 2: studio 26'x26', control room 20'x20'. Room 3: studio 15'x9', control room 15'x13'. Room 4: control room 15'x15'. **Mixing Consoles:** (2) Solid State Logic 4000 E, G computer, 48 modules; Otari/Sound Workshop 32 modules; Massenburg custom mastering. **Audio Recorders:** (2) Mitsubishi X-850 w/Apogee filters, Otari DTR-90, Studer A827, (2) Panasonic 3500 R-DAT, (2) Panasonic 3700 R-DAT, (3) Studer A710 cassette, Studer A80 2-track 1/2", (2) Studer A80 2-track 1/4", Sony PCM-7010 R-DAT SMPTE, Panasonic 3900 R-DAT. **Digital Audio Workstations:** Sonic Solutions enhanced mastering & CD prep. **Monitors:** (2) Hildley-Kinoshita, (3) Yamaha NS-10, KRK 900. **Other Major Equipment:** (2) AMS 15-80, dbx 165A, (2) dbx 160, (2) Publison Fullmost de-esser, (6) Valley People Kepex II, (4) Valley People Gain Brain II, (2) Lexicon PCM70, (2) Sony MCR-201, (2) Yamaha SPX90 II, (2) Eventide H3000SE, (2) Eventide DFX3500, (3) Teletronix LA-2A, (2) Lexicon 224XL, (2) Lexicon 480L, (2) Lexicon 300, (2) AMS RMX-16, (2) TC Electronic M5000, (2) Lydkraft Tube Tech CL-1B compressor, Lydkraft Tube Tech PE-1C EQ, Lydkraft Tube Tech MP-1A mic preamp. **Specialization & Credits:** Final Stage is a mastering facility offering both digital and analog processing featuring the Sonic Solutions CD premastering digital workstation. With a 4-track hard disk system, Final Stage can complete complex CD assembly with automated EQ and compression and perform varispeed and sample rate conversions. **Contact:** Randy LeRoy. **Equipment:** Sonic Solutions CD premastering digital workstation, Macintosh IIci computer, KRK 9000 reference monitor, Apogee D/A 1000 converters, Apogee A/D 500 converters, Sony PCM-1630 digital mastering 2-track, Sony PCM-7010 DAT recorder w/SMPTE, Panasonic SV-3900 DAT recorder, Sony CDP-2700 CD player, Sony 730ES cassette deck, GML Series II stereo compressor.

SOUNDS UNREEL STUDIOS



1902 Nelson Ave., Memphis, TN 38114; (901) 278-8346; FAX: (901) 278-8347. **Owner:** Don C. Smith. **Manager:** Monica Smith.

STUDIO 19



821 19th Ave. S., Nashville, TN 37203; (615) 327-4927. **Owner:** Larry Rogers, Pat Brewer. **Manager:** Larry Rogers.

SYNCR0 SOUND STUDIO



1030 16th Ave. S., Nashville, TN 37212; (615) 242-2455; FAX: (615) 242-2455. **Owner:** Randy Wachler. **Manager:** Terri Shirley.

TREASURE ISLE RECORDERS



2808 Azalea Pl., Nashville, TN 37204; (615) 297-0700; FAX: (615) 297-1413. **Owner:** Treasure Isle Recorders Inc. **Manager:** Fred Vail, gen. mgr. Fred Shipley, chief engineer.

THE WAREHOUSE STUDIO



453 Tennessee St., Memphis, TN 38103; (901) 521-9551; FAX: (901) 521-9662. **Owner:** PolyGram Records. **Manager:** Warren Tuttle. **Dimensions:** Room 1: studio 40'x30', control 30'x25'. **MIDI:** studio 30'x30'. **Mixing Consoles:** Amek Mozart 40x32, Fostex 450. **Audio Recorders:** Otari MTR 90 MkII, Panasonic SV 3700, Panasonic SV 3500, Technics 1520. **Digital Audio Workstations:** (3) Tascam 122 MkII, Akai MPC 60 II, Digidest Sound Tools and Studio Vision w/Mac IIci, Ensoniq. **Monitors:** Westlake BBSM-15, Tannoy, KRK, Yamaha. **Other Major Equipment:** Eventide H3000 SE, Eventide H3000, H949; Lexicon PCM70, (2) Lexicon LXP1, Yamaha REV7, SPX1000, (2) dbx 165A, (2) UREI 1176 LN, (2) Drawmer 241, Audio Logic MT44, (4) API 500-B4, BBE 822, Teletronix LA2A, BGW monitor amp, Haller monitor amp, Crown macro-reference, microphones: Shure, AKG, Neumann, Sennheiser, Electro-Voice, Beyers.

WESTPARK SOUND



3212 West End Ave., Ste. 201; Nashville, TN 37203; (615) 292-5838; FAX: same. **Owner:** Tom Reeves. **Manager:** Tom Reeves.

WOODLAND DIGITAL



1011 Woodland St., Nashville, TN 37206; (615) 262-2222; FAX: (615) 262-5800. **Owner:** Bob Solomon, Dave Cline. **Manager:** Jake Nicely. **Engineers:** Dave Cline, Daniel Johnston, Marc Frigo, Amy Hughes. **Dimensions:** Room 1: studio 42'x34'. Room 2: studio 24'x32'. **Mixing Consoles:** Neve 8068 44-input 32-bus, Neve VR-60 w/Flying Faders automation 60-input. **Audio Recorders:** Mitsubishi X-880 w/Apogee filters, Mitsubishi X-850 w/Apogee filters, Otari MTR-100 24-track analog w/sync, Studer A80 2-track 1/2", Studer A80 2-track 1/4". **Digital Audio Workstations:** Roland DM-80 w/S-770 sampler 8-track hard disk recorder, Roland S-770 sampler 16 meg RAM. **Monitors:** Westlake w/JBL horns, TAD LF & HF drivers; Westlake w/Westlake horns, TAD LF & HF drivers; Meyer 833, Yamaha NS-10M near-field, (3) Yamaha NS-10MS near-field, Digital Design DD161 near-field, Auratone. **Other Major Equipment:** Lexicon 480L w/SME board, Lexicon 300 digital effects system, Lexicon PCM70, Lexicon PCM60, Lexicon PCM41, (2) live chambers, (5) EMT tube 140 1-track stereo plate, AKG BX20E stereo spring reverb, Roland SRV-2000, Yamaha SPX900, Yamaha REV5, Yamaha SPX90 II, Yamaha SPX90, Pultec EQH-2, (3) dbx 160 & 160X comp/limiter, Drawmer DS-201 dual-channel gate, LT Systems CLX-2 dual-channel gate/comp, (4) UREI LA-4A/1176LN, (6) Valley People Kepex II gate, ADR F769XR vocal stressor Compex limiter w/gate & EQ.



ALIVE STUDIOS



1251 Virginia Ave., Harrisonburg, VA 22801; (703) 434-6703; FAX: (703) 434-5556. **Owner:** Mennonite Board of Missions. **Manager:** Abe Rittenhouse.

WALLY CLEAVER'S RECORDING



2200 Airport Ave., Fredericksburg, VA 22401-7220; (703) 373-6511. **Owner:** Peter L. Bonta. **Manager:** "Buffalo" Bob Colbroth. **Engineers:** Peter Bonta, Pete Fields, Chip Wills, Don Holcombe, Dave Hibbits. **Dimensions:** Room 1: studio 20'x40', control room 18'x22'. Room 2: studio 8'x8'. Room 3: studio 8'x9'. **Mixing Consoles:** Custom ESP w/44 inputs and JL Cooper, Magi II Automation on 32 channels and 8 subs. **Audio Recorders:** MCI JH-114 24-track w/AL III, Tascam 85-16B 16-track 1" w/dbx N/R, Otari SC50 2-track w/Dolby SR/A N/R, Scully 280B 2-track w/dbx N/R, Revox A77 2-track, Panasonic SV-3700 DAT, (2) Panasonic SV-3500 DAT, (2) Tascam C-3RX cassette. **Monitors:** UREI 809 Time Aligned, Tannoy PBM-6.5 near-field. **Other Major Equipment:** Sony DPS-R7, Lexicon Prime Time delay, Lexicon LXP-1, Yamaha REV7, Lexicon PCM-41 DDL, AKG BX-10 stereo reverb, (2) UREI LA-4 limiter, (2) UREI 1176 limiter, Valley People Dynamite stereo limiter/gate, (2) dbx 160 limiter, Symetrix 522 stereo limi A&D stereo limiter, Eventide 91C Harmonizer, Aphex Aural Exciter, AudioArts stereo 4-band parametric EQ, DOD Electronics 15-band stereo EQ, Neumann U-87, U-47 FET; (4) Neumann KM-84, (2) AKG C-414, (4) AKG C-451EB, (2) Electro-Voice RE-20, (2) Sennheiser MD-441, (2) Sennheiser MD-409, Sennheiser MD-421, RCA 44A, RCA 77DX; RCA 64, RCA BK-5B, Shure SM-56, 57, 54; Countryman Active DI, (2) PZM, Crown CD-300A, DC-150; (2) BGW 150, Yamaha 6' grand piano, Hammond M-3 organ w/Leslie cabinet, Korg SG-1 sampling grand, Korg M-1, Yamaha DX-7.

CONTOUR RECORDING



203 Yoakum Pkwy., Ste. 1626; Alexandria, VA 22304; (703) 751-3475. **Owner:** Brett Harnett. **Manager:** Eric Chambers.

ONE STEP AHEAD

Coming in Mix:

July 1993

Digital Audio

- **DIRECTORIES**
Independent Engineers and Producers
- **TECHNICAL FEATURES**
Long Distance Digital Audio Transmission
Networking Workstations
Exchange of Digital Sound Files
- **AUDIO FOR FILM**
Post-Production for *Jurassic Park*
- **LIVE SOUND**
Computer Control
Lucas Live
- **INSIDER AUDIO**
Digital Audio
Data Compression
- **BYTE BEAT**
Storage Technologies
- **PRODUCER'S DESK**
Brian Eno
- **PLUS!**
Bonzai Lunches with Lee Herschberg

ATTENTION ADVERTISERS:

Deadline for ad placement is the seventh of the month, two months prior to publication. Call (510) 653-3307 for a 1993 *Mix* Editorial Calendar, space reservations and complete advertising information.

MIX

TURN TO PAGE 171 FOR AN EXPLANATION OF RECORDING SERVICE SYMBOLS.



CUE RECORDING LTD.
Falls Church, VA

CUE RECORDING LTD.



109 Park Ave., Ste. E, Falls Church, VA 22046; (703) 532-9033; FAX: (703) 533-7956. Owner: Jeff Jeffrey. Manager: Tom Deakin. Engineers: Ken Schubert, Jim Ebert, Bill Appleberry, Tom Deakin, Michael Tinsley, Michael Newman. Dimensions: Room 1: studio 35'x24', control room 25'x21'. Room 2: studio 14'x11', control room 14'x13'. Room 3: studio 8'x6', control room 14'x11'. **Mixing Consoles:** Solid State Logic SL 4000 G series w/automation, MCI JH 636 w/automation, Tascam M-3700 w/automation. **Audio Recorders:** Studer A827 24-track, Sony APR-24 24-track, (2) Alesis ADAT digital recorder, Studer A807TC 2-track, Studer A810 2-track, (3) Panasonic SV-3700 DAT, Tascam DA-30 DAT, (12) Tascam 122, Otari 5050B MkIII 2-track, Nakamichi MR-1 cassette. **Digital Audio Workstations:** Digidesign Sound Tools. **Monitors:** (2) S.O.T.A. main monitors (A), (2) Tannoy SRM-15 main monitors (B), (8) Yamaha NS-10M, (4) Tannoy PBM-8.0, (4) Tannoy PBM-6.5, (2) JBL 4401, (2) Auratone cube, (20) Fostex T-20 headphones. **Other Major Equipment:** Lexicon 480L reverb effects processor, (2) Lexicon 200 reverb, (2) Lexicon PCM-70 reverb, (2) Yamaha REV-70 reverb, EMT ST 140 tube reverb, Eventide Ultra-Harmonizer, Yamaha SPX90 reverb, TC Electronic 2290 delay, (3) DeltaLab Effectrons, GML 8200 discrete EQ, (2) API 550B EQ, API 550A EQ, Pultec MEQ-5 tube EQ, Roland stereo chorus, BBE Exciters, (4) Aphex Exciter, Demeter stereo tube mic pre, (4) API discrete 412B mic pre, (4) Kepex II noise gate, (2) Drawmer noise gate. **Extended Equipment Description:** (2) dbx 363 noise gate, (2) UREI 1176N limiter, (3) UREI LA-4 compressor, Teletronix LA-2A compressor (tube), (4) dbx 166 comp/limiter, dbx 902 de-esser, (3) Drban de-esser, Neumann U-47 tube microphone, (3) Neumann U-87 microphone, (2) AKG 414E, (2) AKG 451, KM-86, Atari ST 1040E w/C-Lab software, Korg M1 module, Kurzweil K2000 keyboard, E-mu Proteus I module, Korg O1W/FD keyboard, Akai S-1000 sampler, Akai MPC-60 drum machine. **Specialization & Credits:** Cue Recording, Ltd. is a four-studio facility located just five minutes from the nation's capitol. From automated mixing in Studios A, B and C to our extensive computerized MIDI room, Cue provides world-class recordings at sensible rates. Advanced control room monitoring has been achieved using the Reflection Free Zone architecture and RPG diffusers in control room A. Neil Muncy Associates Ltd. in Toronto designed the room producing excellent results. Recent awards include the Double Platinum #1 Billboard hit *I I Ever Fall In Love* by the group Shai on Gasoline Alley/MCA Records, which Cue tracked and mixed. Cue was voted Best Studio in 1991 and 1992 by the Washington D.C. Area Music Association. Other clients include Toni Braxton/LaFace, Randy Gil/Gasoline Alley, Fox Television (*America's Most Wanted*), Life/PolyGram, Glen Jones/Atlantic, the Rollins Band/Imago, Dem Twinnz/Atlantic, Annie Haslam/CS-Epic, and Gene Griffin.

CYGNET STUDIOS INC.



5660 E. Virginia Beach Blvd., Ste. 103, Norfolk, VA 23502; (804) 455-8454; FAX: (804) 461-4669. Owner: Leonard A. Swann III. Manager: Heather Boswell.

OAN-SING RECORDING STUDIO



120 Ridgcrest Dr., Danville, VA 24540; (804) 836-4673. Owner: Roy Frazier. Manager: Scott Frazier.

FLAT FIVE PRESS & RECORDING CO.



18 E. Main St., Salem, VA 24153; (703) 389-9427. Owner: Thomas P. Ohmsen. Manager: Thomas P. Ohmsen.

GOLDREEL STUDIOS



3611 Centreville Rd., Chantilly, VA 22021; (703) 665-2715. Owner: Goldier O'Neill. Manager: Goldier O'Neill.

HENNINGER DIGITAL AUDIO



2611 Wilson Blvd., Arlington, VA 22201; (703) 522-3444; FAX: (703) 522-3933. Owner: Rich West. Manager: Ellen West.

IN YOUR EAR



1300 W. Main St., Richmond, VA 23220; (804) 359-3937; FAX: (804) 353-2256. Owner: Carlos Chafin. Manager: Gay Chapman. **Specialization & Credits:** In Your Ear Music and Recording Services features original music production and sound design for commercials and films. Our facilities include two recording studios equipped with NED 16-track and 8-track PostPro digital workstations as well as a fully equipped MIDI composition, post-scoring and digital recording suite. Credits include music and sound designs for 20th Century Fox, Wal-Mart, Sears, Wrangler Jeans, USAir, Mercedes, Bell Atlantic and Bell South. Our studios and composition services are available for record clients and other collaborative production efforts.

INNER EAR STUDIOS INC.



2701 S. Oakland St., Arlington, VA 22206; (703) 820-8923. Owner: Don Zientara. Manager: Don Zientara. Engineers: Don Zientara, Brooke Delarco, Jeff Turner, Charles Bennington, Eli Janney. **Dimensions:** Room 1: studio 14'x32' control 14'x22'. Room 2: studio 8'x14' control 14'x12'. Room 3: studio 16'x16'. **Mixing Consoles:** Amek Angela 36x24x36, Tascam M-520 20x16x16, custom console 24x24, Kawai MX-8R. **Audio Recorders:** Otari MTR-90 II, Tascam 52, (2) Tascam 32 w/dbx-NR, (2) Tascam D-20, Fostex B-16, Tascam 22, Tascam 122, (2) Aiwa cassette, JVC cassette. **Digital Audio Workstations:** Casio FZ-10, Casio FZ-10M, Korg SG-1D, Yamaha RX-5, (2) Macintosh sequencing. **Monitors:** Electro-Voice Sentry 500, Tannoy PBM-6.5, Tannoy PBM-8, JBL 4408, AR Model 18, Auratone. **Other Major Equipment:** Lexicon PCM70, LXP-15, LXP-1, LXP-5, PCM60, Klark-Teknik Supergate, Aphex Compellor, Alesis Quadverb, (2) Alesis D-2, (2) Korg SDD-2000, (2) Wendell Jr., Altec compressor, Alesis MIDverb, (2) Fostex limiter, (3) BBE 822, (8) Valley People GateX, Aphex C-109, (2) dbx 160X, (2) dbx 166, DigiTech IPS-33.

MAINSTREAM DIGITAL



105 Don Juan Dr., Yorktown, VA 23693; (804) 596-8362; FAX: (804) 596-8362. Manager: Donald Von Cannon.

MASTER SOUND RECORDING STUDIO



5249 Challedon Dr., Virginia Beach, VA 23462; (804) 499-0000; (804) 496-0553. Owner: Robert Ullsh. Manager: Robert Ullsh. Engineers: Robert Ullsh, Mike Trimble, Brent Havens. **Dimensions:** Room 1: studio 45'x35', control room 22'x20'. MIDI room 18'x12'. **Mixing Consoles:** Amek G2520 40x24x96 w/VCA bypass and MasterMix II automation. **Audio Recorders:** Studer A827 24-track, Sony/MCI JH-24 24-track w/autolocator III, Sony 3202 2-track digital, Otari MTR-12H 1/2-track 1/2" 30 ips, Sony 5003V 1/2-track 30 ips, (2) Panasonic SV-3500 R-DAT. **Monitors:** (2) JBL/JUREI 4435, (2) Tannoy SGM-15, (4) Tannoy PBM-8, (2) Tannoy PBM-6.5, (2) Yamaha NS-10, (2) Auratone, (2) Toa. **Other Major Equipment:** (2) TimeLine Lynx, Sony JH-45 SMPTE, (2) Lexicon 200 stereo digital reverb, (2) Yamaha SPX90II, (2) Alesis QuadraVerb, Ibanez SDR-1000, Eventide 969 Harmonizer, DigiTech IPS-33, Lexicon PCM42, PCM70, DigiTech DSP-128, ART Multiverb, Korg DRV-3000, Drawmer 1960 stereo tube limiter, Drawmer 201 stereo gate, Aphex 612 stereo expander/gate, (4) Valley Audio GateX 4-channel gate, LT Sound CLX-2 stereo comp/limiter/expander, BBE 802 2-channel exciter, Universal Audio 175 tube limiter, BS-402 stereo comp/limiter, (11) Valley Audio comp/limiter, Panasonic SL-4300 CD player, (2) Neumann U87, U47; Neumann TLM170, U89; (6) AKG 414ULS, AKG TL-414, The Tube, (8) AKG C-451/460B, AKG D-112, D-12E, (6) Sennheiser MD-421, Sennheiser MD-441, (17) additional assorted dynamics.

POSH RECORDING



1114 Shipman Lane, McLean, VA 22101; (703) 524-1617. Owner: Phillip S. Kerlin. Manager: Simone Kerlin.

SOFTWARE STUDIOS



10322 Ford Rd., Fairfax, VA 22030; (703) 691-2174. Owner: Tom Moravansky. Manager: Jim Moravansky. Engineers: Jim Moravansky, Tom Moravansky. **Mixing Consoles:** Allen and Heath System 8.

Audio Recorders: Fostex A-80. **Other Major Equipment:** PPG 2.3, PPG Waveform B, Oberheim Matrix-12, Sequential Circuits Prophet 5 w/MIDI, Moog MemoryMoog w/LAMM, Moog MiniMoog w/MIDI, (2) Roland MKS-80, (2) Roland MPG-80, Roland MKS-70, Roland MPG-80, Roland A-80, EML 101, EML 301, EML 500, Fender Chroma w/MIDI, (2) E-mu E-max SE, Waldorf Microwave, Oberheim Matrix-1000, Korg M-3R, Lexicon PCM70.

SOUNDPLUS



Rte. 4, Box 41, Leesburg, VA 22075; (703) 777-7176; FAX: (703) 777-7176. Owner: Philip W. Goshorn. Manager: Bob Gaskill.

SOUNDS! REASONABLE!



10203 Bent Tree Ln., Manassas, VA 22111; (703) 631-6376. Owner: Fred Wygal.

TURPENTINE MILL RECORDERS



320 Brook Road, Richmond, VA 23220; (804) 648-0306. Owner: Tim Holt. Manager: Tim Holt.

VIRGINIA ARTS RECORDING



512 Stewart St., Charlottesville, VA 22902; (804) 971-1411. Owner: R. Paul Brier. Manager: R. Paul Brier.

WALTON RECORDING INC.



5583-B Guinea Rd., Fairfax, VA 22032; (703) 425-9498; FAX: (703) 354-8912. Owner: James Walton, Bonnie O'Leary. Manager: Bonnie O'Leary.



WINDMARK RECORDING
Virginia Beach, VA

WINDMARK RECORDING



4924 Shell Rd., Virginia Beach, VA 23455; (804) 464-4924; FAX: (804) 464-1773. Owner: Michael Marquart. Manager: Colleen Marquart. Engineers: Michael Marquart, Skip DeRupa. **Dimensions:** Room 1: studio 30'x18', control room 25'x20'. Room 2: studio 20'x15', control room 20'x15'. **Mixing Consoles:** Neve 8058 MkII, SSL 4040E G series. **Audio Recorders:** Studer A827, Sony 3324, Studer A80, Mitsubishi X-86, Sony 3402, Sony PCM-7030, (2) Sony 2500, Sony portable DAT. **Workstations:** Sonic Solutions, yDaxis. **Monitors:** Custom-design w/TAD & JBL, (2) Yamaha NS-10M, Tannoy NFM-8 DMT, PBM-6.5, FSMU. **Other Major Equipment:** Yamaha YPDR601, Dolby SR, Lexicon Super PrimeTime, Lexicon 480L, Eventide H-3000, (2) Lexicon PCM42, Alesis MIDverb II & III, Yamaha REV7, (4) API 550B, (2) Focusrite 110, (2) Focusrite 130, Valley International 430, (3) dbx 160X, Drawmer DS201, (2) Summit EO F100, Vocal Stressor F769X-R, SSL G-384, (2) Neve 31102 EQ, (6) Neve 32264 comp/limiter, Kurzweil K1000 & K2000. **Specialization & Credits:** Windmark Recording Inc. is a world-class facility located in a unique resort atmosphere. Near many recre-

WINDMARK

- 048 Maximum digital tracks
- R48 Maximum analog tracks
- Remote recording
- MIDI production
- Tape duplication
- Audio-for-video/film
- Digital editing/CD prep
- In-house music services

ational activities and only minutes from the beaches of the Chesapeake Bay and Atlantic Ocean. Studio amenities include wide-screen cable TV, video games, basketball hoop, kitchenette and outdoor patio with barbeque. Windmark's combination of quality equipment, experienced staff and relaxed atmosphere allows clients to express and capture the very best of their talent and creativity.

WOODHOUSE RECORDING

R24 D2

2900 Brittany Wy., Chesapeake, VA 23321; (804) 483-6212. Owner: Larry Carr. Manager: Larry Carr. Engineers: Larry Carr. Dimensions: Studio 22'x18', control room 20'x13'. **Mixing Consoles:** Tascam M520 (soon to be replaced). **Audio Recorders:** Studer A800 MkIII 24-track w/A.L. & remote, Tascam MX-16 16-track w/A.L. & remote, Tascam 38 8-track, (2) Panasonic SV-3700 DAT, Tascam 32, Tascam 122 cassette, Technics RST 80R cassette, Technics RS-TR555 cassette. **Monitors:** AMR 312, AMR 308, Auratone 5-C. **Other Major Equipment:** dbx Type I on 16-, 8-, 2-track recorders, (2) Ibanez SDR1000 (turbo), Yamaha SPX90, Yamaha SPX900, Ibanez DMD-200, Valley People Dyna-Mite II, (2) UREI 537 EQ, Valley People GateX, (2) Yamaha GC2020B comp/limiter, (2) Yamaha Q2031 EQ, BBE 822 Sonic Maximizer, AKG, Beyer, Audio-Technica, Shure, Tascam microphones; Korg T-3 EX, Rogers 6-piece drum kit, Sansamp, Rockman X-100, Rockman Bass.

WEST VIRGINIA

CHANDLER AUDIO INC.

R24 D4

3030 Piedmont Rd., Huntington, WV 25704; (304) 429-6499; FAX: (304) 429-6499. Owner: Chandler Audio Inc. Manager: Denny Chandler. Engineers: Denny Chandler, Dick Hawkins, Steve Haynes, Michael Lyon. Dimensions: Room 1: studio 40'x36', control room 24'x25'. Room 2: studio 12'x10', control room 20'x16'. **Mixing Consoles:** Harrison 3624, Fostex 812. **Audio Recorders:** Studer A80 24-track, Fostex R-8 8-track, (2) Ampex ATR-800 2-track, Panasonic SV-3700, (2) Nakamichi BX-300, (2) Tascam 122. **Digital Audio Workstations:** Hybrid Arts Digital Master. **Monitors:** UREI 813B, (2) JBL 4311, (2) Yamaha NS-10, (2) Auratone, JBL Control 1. **Other Major Equipment:** (2) Yamaha REV5, (2) Yamaha SPX90, (2) Lexicon Prime Time, Klark-Teknik DN780, Lexicon PCM60, TC Electronic 2290, TC Electronic 1210, (2) Korg SDD-3000, Ursa Major Space

Station, Roland Dimension D, (4) Neumann U87, (2) AKG 414, AKG The Tube, (2) Shure SM81, (6) Shure SM57, (4) EV 408, (3) EV RE20, (3) dbx 160X, (2) UREI 1176, (4) Ashley comp/limiter, (3) White EQ.

MEDIA PRODUCTIONS

R32 D2

1001-1/2 Elizabeth St; Oak Hill, WV 25901; (304) 465-1298; FAX: (304) 465-1298. Owner: W. Doug Gent. Manager: W. Doug Gent.

OUTSIDE U.S.

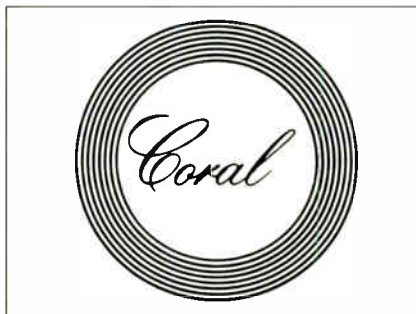

CORAL SOUNDS STUDIO
Port of Spain, Trinidad

CORAL SOUNDS STUDIO

R24

16 Milling Ave., Sea Lots, PO Box 783; Port of Spain, Trinidad, West Indies; (809) 623-7789; FAX: (809) 637-7086. Owner: Coral Recording Services Ltd. Manager: Mike Schuler. Engineers: Eric Michaud. Dimensions: Studio: 48'x30' w/20' ceiling, control room: 24'x12'. **Mixing Consoles:** Audiotronics 26x24 w/8 Focusrite ISA-110 module rack. **Audio Recorders:** Dtari MTR-90 24-track w/Dolby SR 24-channel connected, Dtari MTR-20 1/2" w/Dolby SR 2-channel

connected, Panasonic SV-3700 DAT, MCI 1/4", (2) Tascam 122 cassette. **Monitors:** (2) Altec Super Reds 604E, (2) Yamaha NS-10M, (2) Auratone 5-C, (2) viconic 9000, (2) Mastering Lab crossover. **Other Major Equipment:** Lexicon 200, Lexicon Prime Time II, Yamaha REV7, (2) Yamaha SPX90, Eventide H969 Harmonizer, (2) Aphex 103 Aural Exciter, Drban 516 Sibilance controller, (2) UREI 1176N limiting amp, (2) UREI LA-5 audio leveler, Drban 622 B parametric EQ, (2) AKG "The Tube," (2) Neumann U87, (2) Shure SM7, (2) AKG 414, BGW 75, BGW 250 E, BGW 75 A, (2) JBL/UREI 537 graphic room EQ, Studer A727 CD player, Sound Ideas CD effects library. **Extended Equipment Description:** Oberheim Matrix-12 synth, E-max sampler synth, Prophet 2002 sampler, Akai Linn MPX 60 drum machine/sequencer, Linn drum machine, Roland electronic drum kit, Kawai baby grand acoustic piano, extensive library of E-max, Akai, Linn & DX7 cartridges and diskettes; complete set of professional percussion instruments, AKG headphones, Countryman direct boxes. **Specialization & Credits:** Relax in a Caribbean Island studio with a purpose-built room (48'x30' with 20' ceiling), which has a great live acoustic sound, top-quality equipment and includes a studio engineer with 16 years recording experience and all equipment/instruments at the special introductory rate of U.S. \$45/hour (or even less for quantity block bookings). Dur largest international project to date was for Mr. Jean Michel Jarre from France who used a fifty-member local steelband orchestra for the main tracks on his album *Waiting for Cousteau*, which was used as the focus for a live show in Paris attended by two million people. We are "The Home of the Calypso Rhythm and Steelband Drums," in a modern 24-track studio with 24-channel Dolby SR, but welcome all types of music and projects and do our utmost to make all clients feel welcome and comfortable for their entire stay on the Island.

THE RECORDING STUDIO

R3 D2

PO Box 0V732; Devonshire OVBX, Bermuda; (809) 292-1103; FAX: (809) 295-4973. Owner: Ian Marshall. Manager: Ian Marshall.

Pro Audio dictionaries and technical reference guides are available through the Mix Bookshelf catalog. Call toll-free (800) 233-9604 for your free copy.

MIX Reader Service

For more information

about products and services advertised in this issue, fill out and return *Mix's* postage-paid reader service card! You'll receive information directly from the advertisers whose products interest you.

NEW FROM MIXBOOKS

MUSIC PRODUCERS

Top producers reveal exclusive details about their classic sessions and trademark sounds. From the editors of *Mix* magazine.

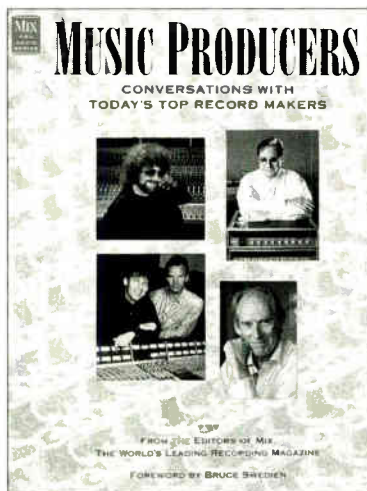

featuring:

Walter Afanasieff
Bruce Fairbairn
Daniel Lanois • Bill Laswell
Tom Lord-Alge • Jeff Lynne
George Martin • Hugh Padgham
Rick Rubin • Don Was
plus 14 others!

©1992, 120 pp. (P) \$17.95.
Add \$2.50 for shipping. CA and NY residents add state sales tax.

ORDER NOW!

Call toll-free, U.S. & Canada
(800) 233-9604 or (510) 653-3307;
fax (510) 653-5142.

We accept Visa, MasterCard, American

Express and Discover cards; or send personal check or money order payable to:

MixBooks, 6400 Hollis Street, Suite #12-S, Emeryville, CA 94608

AD INDEX & READER SERVICE PAGE

PAGE	READER SERVICE NUMBER	ADVERTISER
32	001	Acoustical Solutions
109	002	Akai
143	003	AKG Acoustics
IFC	004	Alesis (The adat Group)
6-7	005	Alesis (adat)
9	006	Ampex
128	007	AMP Services
86	008	Apex Machine Company
33	009	Aphex Systems
35	-	Apogee Electronics
61	010	APRS
26	011	Sam Ash Professional (audio production)
125	012	Sam Ash Professional (parts)
119	013	Athán
61	014	AudioForce
132	015	Audio Images
138	016	Audio Precision
50	-	Audio-Technica
63	017	AudioTechniques
171	018	BBE Sound
24	019	Behringer
100	020	Boynton Studio
2	021	Brüel & Kjaer
69	022	Burlington Audio/Video Tapes
77	023	Cal Switch
126	024	CCS Printing
60	025	Century Music Systems
99	026	CMCI/Circuits Maximus Company
102	027	Community
71	028	Crest Audio
105	029	Crown (IQ Turbo)
148	030	Crown (SASS)
13	031	D & R USA
116, 140	032	The DAT Store
36	033	dbx
156	034	Demeter Amplification
118	035	DIC Digital Supply
3	036	Digidesign (ProMaster 20)
10-11	037	Digidesign (Pro Tools 2.0)
107	038	Digital Audio Labs
120	039	Digital Integration
IBC	040	DigiTech
37	041	Disc Makers
30	042	Dolby
19	043	Downtown Portland Corp.
21	044	DynaTek Automation Systems
119	045	EAR Professional Audio/Video
106	046	Electro-Voice (EV)

PAGE	READER SERVICE NUMBER	ADVERTISER
89	047	Ensoniq
22-23	048	Euphonix
70	049	Europadisk
121	050	EV/Dynacord
58	051	Fender
83	052	Five Towns College
113	053	Full Compass
31	054	Full Sail Center for the Recording Arts
91	-	Future Disc Systems
32	055	Future Sonics
62	056	Gold Line
98	057	Goodman Music
62	058	Grandma's Music & Sound
165	059	Bernie Grundman Mastering
134	250	The John Hardy Company
108	060	The Hollywood Edge
150	061	illbruck
60	062	Institute of Audio Research
BC	-	JBL Professional
125	063	JRF Magnetic Sciences
51	064	JVC Professional
100	065	K disc Mastering
163	066	Klarity Cassette (Cassettes)
165	067	Klarity Cassette (CDs)
155	068	Leo's Professional Audio
39	069	Lexicon
126	070	MacBeat
66	071	Mackie Designs (MS 1202)
146	072	Mackie Designs (CR-1604)
78	073	Manhattan Production Music
169	074	Markertek Video Supply
78	075	Masterfonics
37	076	Micro Technology Unlimited (MTU)
98, 141	077	Mix Bookshelf
160	078	Mix Master Directory
128	079	National Sound and Video
41	080	Neumann/USA
163	081	New River Studios
20	082	Optifile/Sascom Marketing Group
130	083	Otari
55	-	Panasonic
155	084	The Peabody Conservatory of Music
47	085	Peavey Electronics
145	086	Peavey/Audio Media Research
40	087	Philips Key Modules Group
141	088	PolyQuick

PAGE	READER SERVICE NUMBER	ADVERTISER
46	089	Professional Audio Systems (PAS)
168	090	Progressive Music
85	091	QCA
127	092	QSC Audio
52-53	093	Rane
51	094	The Recording Workshop
150	095	Recording Arts
79	096	Rhythm City
84	097	Rocket Lab
112	098	Roland
83	099	Russo Music Center
115, 117	100	Samson Audio
157	101	SAS Industries
72	102	Sealevel Systems
151	103	Sennheiser
25	104	Shape
27	105	Shure
59	106	Simon Systems Engineering
1, 124	107	Solid State Logic (SSL)
156	108	Sound Trax
135	109	Spatializer
17	110	Studer Revox (Dyaxis II)
154	111	Studer Revox (D820-48)
85	112	Studio Consultants
56	113	Summit Audio
67	114	Sweetwater Sound
88	115	Symetrix
14-15	116	Tascam (DA-88)
94-95	117	Tascam (M-3700)
73	118	t.c. electronic
72	119	Tech 21
137	120	Telex
54	121	Thoroughbred Music
86	122	UCLA Extension
169	123	Ultimix Recording
171	124	Ultrasonic Studios
42	125	Uptown Automation
43	126	Valley Audio
68	127	Versadyne
57	128	Video Tape Products
45	129	Westlake Audio
82	130	Whirlwind
132	131	Whisper Room
54	132	White Instruments
114	133	World Studio Group
129	134	Yamaha
101	135	Yorkville
157	136	YRS Multimedia
57	137	Zoom

MIX READER SERVICE

For more information about products & services in MIX:

1. See the opposite page for a listing of Reader Service numbers for advertisers in this issue.

2. Circle the Reader Service numbers that correspond to each advertisement or editorial item in which you are interested. (Maximum of 20 numbers.)

3. Complete all information on the card below. Please check ONE answer for each question unless otherwise indicated.

4. Mail card postage-free!

Important Notice to Readers: Reader Service inquiries are mailed directly to the advertiser, who is solely responsible for sending product information. *Mix* does not guarantee advertiser response.

MIX Reader Service

P.O. Box 5069, Pittsfield, MA 01203-9856

Issue: *Mix*, June 1993 / Card Expires: October 1, 1993

Name _____ Title _____
 Company _____
 Address _____
 City _____
 State _____ Zip _____
 Phone (____) _____

1) Your company's primary business activity (check ONE):

- 01. Recording studio (including remote trucks)
- 02. Independent audio recording or production
- 03. Sound reinforcement
- 04. Video/film production
- 05. Video/film post-production
- 06. Broadcast/radio/television
- 07. Record company
- 08. Record/tape/CD mastering/manufacturing
- 09. Equipment manufacturing (incl. rep firm)
- 10. Equipment retail/rental
- 11. Contractor/installer
- 12. Facility design/acoustics
- 13. Educational
- 14. Institutional/other (please specify)

2) Your job title or position (check ONE):

- 15. Management—President, owner, other manager
- 16. Technical & Engineering—Engineer, editor, design engineer, etc.
- 17. Production & Direction—Producer, director, etc.
- 18. Sales & Administration—Sales rep, account executive, etc.
- 19. Artist/Performer—Recording artist, musician, composer, other creative
- 20. Other (please specify)

3) Your role in purchasing equipment, supplies and services (check ONE):

- 21. Recommend the purchasing of a product or service
- 22. Specify makes, models or services to be purchased

- 23. Make the final decision or give approval for purchase
- 24. Have no involvement in purchasing decisions

4) Your company's annual budget for equipment, supplies and services:

- 25. Less than \$50,000
- 26. \$50,000 to \$149,999
- 27. \$150,000 to \$249,999
- 28. \$250,000 to \$499,999
- 29. \$500,000 or more

5) Purpose of inquiry:

- 30. Immediate purchase
- 31. Files/future purchases

6) Where you got this copy of *Mix*:

- 32. Personal subscription
- 33. Recording studio/production facility
- 34. Audio/Video retailer
- 35. Newsstand
- 36. From a friend or associate

001	026	051	076	101
002	027	052	077	102
003	028	053	078	103
004	029	054	079	104
005	030	055	080	105
006	031	056	081	106
007	032	057	082	107
008	033	058	083	108
009	034	059	084	109
010	035	060	085	110
011	036	061	086	111
012	037	062	087	112
013	038	063	088	113
014	039	064	089	114
015	040	065	090	115
016	041	066	091	116
017	042	067	092	117
018	043	068	093	118
019	044	069	094	119
020	045	070	095	120
021	046	071	096	121
022	047	072	097	122
023	048	073	098	123
024	049	074	099	124
025	050	075	100	125

126	151	176	201	226
127	152	177	202	227
128	153	178	203	228
129	154	179	204	229
130	155	180	205	230
131	156	181	206	231
132	157	182	207	232
133	158	183	208	233
134	159	184	209	234
135	160	185	210	235
136	161	186	211	236
137	162	187	212	237
138	163	188	213	238
139	164	189	214	239
140	165	190	215	240
141	166	191	216	241
142	167	192	217	242
143	168	193	218	243
144	169	194	219	244
145	170	195	220	245
146	171	196	221	246
147	172	197	222	247
148	173	198	223	248
149	174	199	224	249
150	175	200	225	250

Circle number 250 and we will send you a subscription application & use subscription form in this issue of *Mix*.

Important Notice to Readers: Reader Service inquiries are mailed directly to the advertiser, who is solely responsible for sending product information. *Mix* does not guarantee advertiser response.

MIX Reader Service

P.O. Box 5069, Pittsfield, MA 01203-9856

Issue: *Mix*, June 1993 / Card Expires: October 1, 1993

Name _____ Title _____
 Company _____
 Address _____
 City _____
 State _____ Zip _____
 Phone (____) _____

1) Your company's primary business activity (check ONE):

- 01. Recording studio (including remote trucks)
- 02. Independent audio recording or production
- 03. Sound reinforcement
- 04. Video/film production
- 05. Video/film post-production
- 06. Broadcast/radio/television
- 07. Record company
- 08. Record/tape/CD mastering/manufacturing
- 09. Equipment manufacturing (incl. rep firm)
- 10. Equipment retail/rental
- 11. Contractor/installer
- 12. Facility design/acoustics
- 13. Educational
- 14. Institutional/other (please specify)

2) Your job title or position (check ONE):

- 15. Management—President, owner, other manager
- 16. Technical & Engineering—Engineer, editor, design engineer, etc.
- 17. Production & Direction—Producer, director, etc.
- 18. Sales & Administration—Sales rep, account executive, etc.
- 19. Artist/Performer—Recording artist, musician, composer, other creative
- 20. Other (please specify)

3) Your role in purchasing equipment, supplies and services (check ONE):

- 21. Recommend the purchasing of a product or service
- 22. Specify makes, models or services to be purchased

- 23. Make the final decision or give approval for purchase
- 24. Have no involvement in purchasing decisions

4) Your company's annual budget for equipment, supplies and services:

- 25. Less than \$50,000
- 26. \$50,000 to \$149,999
- 27. \$150,000 to \$249,999
- 28. \$250,000 to \$499,999
- 29. \$500,000 or more

5) Purpose of inquiry:

- 30. Immediate purchase
- 31. Files/future purchases

6) Where you got this copy of *Mix*:

- 32. Personal subscription
- 33. Recording studio/production facility
- 34. Audio/Video retailer
- 35. Newsstand
- 36. From a friend or associate

001	026	051	076	101
002	027	052	077	102
003	028	053	078	103
004	029	054	079	104
005	030	055	080	105
006	031	056	081	106
007	032	057	082	107
008	033	058	083	108
009	034	059	084	109
010	035	060	085	110
011	036	061	086	111
012	037	062	087	112
013	038	063	088	113
014	039	064	089	114
015	040	065	090	115
016	041	066	091	116
017	042	067	092	117
018	043	068	093	118
019	044	069	094	119
020	045	070	095	120
021	046	071	096	121
022	047	072	097	122
023	048	073	098	123
024	049	074	099	124
025	050	075	100	125

126	151	176	201	226
127	152	177	202	227
128	153	178	203	228
129	154	179	204	229
130	155	180	205	230
131	156	181	206	231
132	157	182	207	232
133	158	183	208	233
134	159	184	209	234
135	160	185	210	235
136	161	186	211	236
137	162	187	212	237
138	163	188	213	238
139	164	189	214	239
140	165	190	215	240
141	166	191	216	241
142	167	192	217	242
143	168	193	218	243
144	169	194	219	244
145	170	195	220	245
146	171	196	221	246
147	172	197	222	247
148	173	198	223	248
149	174	199	224	249
150	175	200	225	250

Circle number 250 and we will send you a subscription application & use subscription form in this issue of *Mix*.

Important Notice to Readers: Reader Service inquiries are mailed directly to the advertiser, who is solely responsible for sending product information. *Mix* does not guarantee advertiser response.



NO POSTAGE
NECESSARY
IF MAILED
IN THE
UNITED STATES

BUSINESS REPLY MAIL

FIRST CLASS MAIL PERMIT NO 705 PITTSFIELD MA

POSTAGE WILL BE PAID BY ADDRESSEE



MIX

PO Box 5069
Pittsfield, MA 01203-9856



NO POSTAGE
NECESSARY
IF MAILED
IN THE
UNITED STATES

BUSINESS REPLY MAIL

FIRST CLASS MAIL PERMIT NO 705 PITTSFIELD MA

POSTAGE WILL BE PAID BY ADDRESSEE



MIX

PO Box 5069
Pittsfield, MA 01203-9856



CLASSIFIEDS

MIX Classified Ads are the easiest and most economical means to reach a buyer for your product or service. The classified pages of Mix supply our readers with a valuable shopping marketplace. We suggest you buy wisely; mail-order consumers have rights, and sellers must comply with the Federal Trade Commission, as well as various state laws. Mix shall not be liable for the contents of advertisements. For complete information on prices and deadlines, call (800) 544-5530.

Acoustic Consulting

Building a Studio??

Studio & Acoustical Design
Complete Studio Plans
Wiring System Design
Studio Installs/ Pre-wiring
Otari & Tascam Service

Turn-Key Studio Deals Including
Equipment Packages !!
Have your new room or facility designed & built by audio professionals with over 20 years experience as mixers, producers, musicians & studio owners. Existing plans start from \$500!! New designs from \$2,000.

Tel: (617) 782-0648
Fax: (617) 782-4935

Business Opportunities

COMPOSER/PRODUCERS! MAKE BIG \$\$\$. Your unsold jingles may be worth tens of thousands. Our advertising/music-marketing network can place your jingles regionally all over the country, paying you for each regional sale. We are looking for well-recorded product with killer hooks. For info & submission guidelines, write to: **SCORE AMERICA**, 2141 East Jackson St., dept. G, Medford, OR 97504, or call (503) 770-3231 ext. 53 between 2-5 p.m. PST.

In search of SSL or NEVE. Very well established studio (2 rooms) with exceptional recording environment and major clientele seeks world-class console partner for expansion. NYC. (212) 255-6745.

INVESTMENT OPPORTUNITY
5,000-square-foot recording studio w/2 control rooms, offices, lounge. Good lease. Looking for investor or buyer. Call (212) 255-8911 and ask for Steve.

LET THE GOVERNMENT FINANCE your new or existing small business. Grants/loans to \$500,000. Free recorded message: (707) 448-0270. (NL3).

The deadline to place your ad in the Mix Classifieds is six weeks prior to the cover date. To place your ad in the next issue of Mix, call (800) 544-5530.

Equipment For Sale

The Studio POP Filter

A Great Improvement on a Good Ideal

Open up the sound of your vocals and voice overs without annoying "POPS" ruining your best take!

- Standard mic stand adaptor with threaded brass insert
- Improved, New Double Screen
- With optional Clamp and Gossneck 144PS

Only \$2400

ONE YEAR GUARANTEE plus shipping

AUDIO VISUAL ASSISTANCE
565 Sherwood Road,
Shoreview, MN 55126
Phone: 612-481-9715

SAVE \$300 ON T T

144 POINT PATCH BAYS
brokers of fine and coarse used equipment
audio village 619/320-0728

The Best Audio Test Meter Made!

Advantage Model 310
Precision Audio Signal
And Noise Level Meter



Professional Price! \$399

Call For The Nearest Dealer:
1-800-800-4345

- Low THD/Hi RI: Reject With Valley Audio's Trans-Amp™
- 1.0-Noise Wideband Circuitry
- Large Dual Scale Meter
- Super-Accurate Filters
- Average, RMS Or Peak Det
- 100 dB to +30 dB Range
- Scope and Preamp Monitoring Outputs

Valley People
Merriam, Kansas

Mix Classifieds (800) 544-5530

The **MAC & ATARI REMOTE CONTROL** from Friend-chip controls 21 transport & edit functions from anywhere in the room (14 on Atari)

The KAT gives your computer the familiar feel of a tape recorder. CALL NOW!
MAC KAT \$199, ATARI KAT \$149
Full range of Friend-chip products available.

Q-LOGIC MIDI METRO is your personal conductor. It reads and generates MIDI or works alone giving you a visual display of THE BEAT! Turn down the monitors and take off the headphones! Now you can SEE THE BEAT!
CALL (800) 726-6491 or write:
EURO - STUFF
4455 Torrance Blvd Suite 159
Torrance, CA 90509
CA residents add 8 1/2%. Dealers Welcome

LFCI Equipment Leasing

- Up to \$75,000 with credit application only
- Provides: Off-balance sheet financing, Tax benefits
- New & used equipment
- 100% financing
- Nationwide
- Dealers welcome
- Over 10 yrs in the A/V industry
- \$5,000 to \$1,000,000+

Apply by phone
(800) 626-LFCI

CAD Maxcon II console (see Nile Rodgers, Mix 5/92). 40-input (24 mic + 16 line). B-Frame, 6 quad, 2 octal, Type I output. Low miles, \$12k. Korg DUP-1, Roland VP-70. Best offers. Please call (408) 438-3096.

MCI JH-110 8-track 1" format with 8 modules of DBX 410, \$4,500; (2) MCI JH-110 2-track 1/4" format with remote controls, \$2k each. Prices negotiable, call Jim or Ray at CPI, Inc., (414) 291-9666.

(2) Ampex 440-C/7 5-15 ips 1/4" w/ Ampex roll around cabinets & remote control. Both machines have brand new erase, record & playback heads. Used very little & well cared for in a non-smoking home studio. Cosmetically speaking, they are both exceptionally clean machines. \$1,395 ea. Bill (313) 242-2319, 8-4 EST Looking for an Ampex ATR 102 15-30.

(2) Yamaha DMP7D w/MLA 7 (New), \$2,500 ea.; Tascam DA 50 DAT (New), \$965 ea.; (2) Tascam M1B (New) \$95 ea.; (2) Tascam ATR 60 2N (New), \$1,495 ea.; (3) Orban 412 Compressor (New), \$300 ea.; Pair TOC Monitors (Demo), \$800 pair; (2) Roland M160 Mixers (New), \$399 ea.; (2) Yamaha M-206 (New), \$575 ea.; Yamaha DTR 2 DAT (New), \$179 ea.; ART I/EQ (New), \$129 ea.; (3) Orban 414-A (New), \$500 ea.; Tascam ATR 60/8 (Demo on stand), \$2,600 ea.; (4) Otari MX-55-N (New), \$2k ea.; Otari CB-127 remote (New), \$50 ea.; Ramsa 820-B (New), \$4,395 ea. Fax Ian (MANNY'S MUSIC), (212) 391-9250.

Specialists in MIDI systems and home recording. A knowledgeable, helpful staff...major brands of MIDI-based music and recording equipment...E-mu Systems, Kurzweil, Akai, TOA, JBL, MOTU, Opcode, DigiTech, Rane, KAT, Tannoy, 3M, Tech 21, Lexicon, AKG, Carver, Ramsa, Panasonic, Fostex, Amek/TAC, J.L. Cooper, Digidesign, all Macintosh and IBM software and interfaces. Huge in-store inventory and in-store service department. Money-back guarantee if you are not completely satisfied. Call **Sweetwater Sound Inc.**, 5335 Bass Rd., Ft. Wayne, IN 46808; (219) 432-8176 or fax us at (219) 432-1758.

MIC-HEAVEN

- Tube Condenser & Vintage Mics
- Mic pre-amps
- EQ's
- Boards
- Tape Machines
- Quality Microphones

Bought • Sold • Listed
Call 201-656-3936 or Fax 201-963-4764

We Specialize in Audio/Video Equipment

EQUIPMENT FINANCING

FLEX LEASE Inc.
Commercial Equipment Financing

Fast, Easy Qualification
No Financial Statements Necessary
True Lease or Finance Lease

To Apply or Request Additional Information Call
Jeff Wetter Today

Loans By Phone: **(214) 771-9832**
Fax: (214) 771-6793

Have you outgrown your local music store as a supplier? Do you feel overwhelmed by all the new technologies? If you're not sure, you should call Pyramid. Pyramid is where sound and recording professionals go. Pyramid is where to go when you're ready to stop playing around and get serious about your sound or recording business. You'll learn more about sound and recording there.

- New and used equipment
- Custom installations
- Studio design
- 3D modeling CAD
- In-house technical staff
- Field service calls
- Loaner programs
- Creative financing



A Full Service Pro Audio Dealer
Serving Chicago & Midwest
708-339-8014

Specializing in professional audio and video
post equipment for Professionals!

Pyramid Audio Inc.



Audio Video Research is your source for over 100 lines of professional audio & video equipment.

Design * Sales * Service * Installs * Vintage * Used Gear *

AVR has offices in New England and Brasil.

Boston (617) 924-0660

Hartford (203) 289-9475

THE WIDEST SELECTION OF USED GEAR

CONSOLES: MCI JH-528 w/bay, automation, \$9k; Harrison 4032 10 yrs. old (ex. shape), \$17,800; NEVE 8108 48-ch. loaded, auto, bays, \$ Call; Soundcraft 6000 44 ins (mint), \$20.5k; Soundworkshop 34C 28x24 w/patch, automated, \$23.5k; Ramsa WRT 820 (clean) 20x8, \$2,600; Seck 18x8x2 in box, \$1,700; Fostex 454 8x4x8, \$700; Allen & Heath Saber 24x16x24 onstand (mint), \$10.5k; SSL 4000G 40 ins, 5 yrs. old, \$ Call; Roland M 240 line mix, \$475; TAC Scorpion 24x16x4, \$5,895; DDA DCM 232 40x32x40 w/bay, automated, \$75k. **DIGITAL:** Fairlight Series III 6.03 soft (Caps) 190 HD, 14 Meg RAM, \$25k; Mitsubishi X86 2 trk. digital, \$4,200; Digidesign Pro Tools 4-ch system w/650 meg drive, \$4,500; Digidesign Sound Tools w/DAT IO, Pro IO, \$2,600; Synclavier 16-trk. w/direct-to-disk, optical drives, 24 meg RAM, \$125k. **EFFECTS:** Yamaha REV & w/remote, \$500; Aphex Exciter III, \$550; Korg SDD 200 sampling delay, \$250; Lexicon PrimeTime 95, \$700; BBE 422 maximizer, \$150. **KEYBOARD/SAMPLERS:** Roland A-80 controller, \$1,200; Korg poly six, \$150; DX7 II fd, \$800; Akai S 1000 (in box), \$2,500; Akai 612 sampler, \$300; Roland R 8 M drum module, \$750; Yamaha TX 802, \$650. **MICS:** Crown PZM 30, \$200; Neumann U87, \$1,700; Neumann KM 86, \$450; Neumann U67 Tube, \$2,400; Sennheiser MKH 20 (Pair), \$1,600; Sennheiser MD 441, \$395. **PROCESSORS:** Fairchild 670 stereo tube compressor, \$CALL; ARTIEQ (in box), \$1,495; UREI LA 2A (in box), \$1,600; Klark Teknik DN 510 Dual Gate, \$575; Drawmer LX 20 Comp, \$250; Aphex Type C, \$125; Lexicon PCM 70, \$1,400; dbx 165, \$600. **AMPS:** Crown DC 300, \$400; QSC EX 4000, \$1,390; QSC MX 1500, \$550; UREI 6260, \$350; Crown Micro tech 1000, \$450; AB 1210, \$400. **RECORDERS:** Fostex G24S w/harness, stand, \$9,200; MCI JH 24 w/locator w/1624 Soundcraft console, \$11k; Otari MTR 90 5 yrs. old w/session controller, \$29.5k; Otari MX 80 w/remote, 4 yrs. old, \$19.5k; Studer A 80 MKIII, \$15k; Fostex G16S (mint), \$5k; Fostex E 16 w/stand & meter bridge, \$3,800; 3M M-79 2-inch w/locator, \$6.5k; Tascam MS 16 w/DBX, AQ 65, \$5,600; Akai 14D 12-track, \$2,400; Fostex R-8 8-track (no use), \$1k; Fostex A 8LR 8-trk, \$800; Tascam 38, \$1,200; Tascam 238 8-trk. cassette, \$800; Otari MX 5050 2-trk, \$750; NAK MR 2 cassette, \$450; Tascam 122 cassette, \$375.

ALL WARRANTIED AND CALIBRATED TO FACTORY SPECS OR YOUR \$ BACK.

WE BUY, TRADE AND LIST YOUR ITEMS FOR FREE.

MC

VISA

65 MAIN STREET WATERTOWN, MA 02172
TEL (617) 924-0660/FAX (617) 924-0497

OF DENMARK
t.c. electronic
INTEGRATED SYSTEMS (WEST)
Lease or Purchase the TC6032
Moving Fader Eq Remote System
Direct from the Manufacturer
(805) 373-1828

OF DENMARK
t.c. electronic
INTEGRATED SYSTEMS (EAST)
Lease or Purchase the TC6032
Moving Fader Eq Remote System
Direct from the Manufacturer
(800) 451-6032

Mix Classifieds (800) 544-5530 FAX (510) 653-5142

Millennia
Media

"Our hands down first
choice...the most accurate
mic preamp we tested."

Home & Studio Recording Magazine,
Blind preamp listening tests (3/93).

THE B&K SPECIALISTS
916-363-1096

SASCOM
MARKETING
GROUP

LAFONT CONSOLES

OPTIFILE AUTOMATION

PILCHNER ASSOCIATES

RAINDIRK CONSOLES

VITALIZER by S.P.L.

TEL: (416) 420-3946

FAX: (416) 420-0718

Sound
thinking

digidesign

SESSION 8
W/ 2 GIG H.D. \$5495
W/ 1.2 GIG \$4750
DINR \$700
(503) 386-2682

MCI JH-24-16 Two-Inch, 16-Track, the ultimate analog format. JRF Promix II head stack. 80-85% head life remaining, JRF head report. \$7,500 or best offer. (201) 635-0140.

Synclavier. 32 RAM, 64-voice, 16 outs, optical, 320 HD, Mac 3.2 Rel. \$75k. (212) 696-1154.

NECAM II 48-Fader Console Automation System. Fits standard size console faders. Spare cards & faders & Test Jig, \$10k. (24) Dolby 361 Modules w/CAT-22 'A' Cards, \$600 ea. Paul Camarata @ (213) 469-1186.

Music Valve Electronics. Vacuum Tube DI with regulated toroidal power supply. Sounds cleaner, punchier, more head room. New vintage European tube mics. U47 Tube nuvistor replacement kit, \$175. Tube gear tour-tested a million miles. (212) 924-3119.

VINTAGE USED CONSOLES:

SSL (1988) 6000 series/72 Frame-56 loaded/ E-Frame/G.E.O. 1-48. Brown E-02 E.Q. 49-56/G-modules/G-computer/Remote Patch Bay/No Desk \$250k. SSL (1982) 4000 E-series/48-frame/40 E-modules, 8-G modules/G-computer w/floppy/NO TR/new pots & switches \$125k; Neve 8106 (48in) w/GMLauto \$175k; Neotek MKII 56in w/auto \$85k; Trident A-Range(28in, 48 monitor) \$75k; Sony MXP-3036 (36frame 32in) call; Amek 2520 (40in) w/auto \$59k; Amex2500 (36in/in-line) 24 buss/4-band fully parametric/call; Soundtracs IL (48in) w/auto \$48k; Soundtracs Quartz (48in) w/trac mix \$35k; Harrison MR-4 (28in) \$26.5k; TAC Scorpion 24x16 \$6.9k; Neve 5432 'Drop Thro' 8x2 call; Neve modules-call.
24 TRACK RECORDERS: Studer MKIV wide body (5200hrs) \$25k; Studer MKIIw/IIupgrades/recent relap/punch mode/8700hrs \$17.5k; Studer MKII (14000 hrs) \$13k; Sony JH-24 \$17.5k; Otari MX-80 \$18.5k (low hours); 3M-M79 (1-polish left on heads) \$8.9k; Fostex G-16S \$4.5k.
8-TRACK: Otari 5050 MKIIIw/DBX \$3.5k (mint).
32 TRACK DIGITAL: Mitsubishi X-800 \$39k; Mitsubishi X-850 \$55k.
2-TRACK: Studer a-820 (1/4") \$11.5k; Studer a-80 R.C. (1/4" & 1/2) 8.5k; Otari 5050 B-2 \$1.3k; Tascam ATR-102 call.
DATS: NEW & USED CALL FOR PRICES!!!
Reverbs & Delays: AMS RMX-16 \$4.9k; AMS DMX-1580S \$4k; Quantec QRS call; Lexicon PCM-70 \$1.4k; Eventide H-300SE \$1995; Lexicon LXP-15 \$595; Lexicon LXP-1 \$325; Yamaha SPX-90 \$350.
COMPRESSORS: Drawmer 1960 tube-call; Drawmer DL241 \$499; DBX 166 \$350.
MICS: Neumann U-87 \$1.3k; AKG C-414ULS \$650; AKG C-451 \$250; AKG THE TUBE \$1.8k; AKG-460 \$325; (2) B&K 4003 \$1800pr; Senn 421 \$250; EV-RE-20 \$325.

NEW EQUIPMENT:

LEXICON / DRAWMER / SONY / AKG / FOSTEX / T.C.ELECTRONICS / EVENTIDE / DEMETER / MILLENNIA / SOUNDTRACS / NEOTEK / HAFLER / BGW / CREST / BEYER / DBX / DENON / MASELEC E.Q. 9001 / ELECTRO VOICE / SENN / PROCO

WE BUY USED:

SSL / LEXICON / API / NEUMANN / NEVE / AKG / UREI

LIST YOUR FOR SALE ITEMS FREE!!!



180a Central Street • Saugus, MA 01906
(617) 231-0095 • Fax (617) 231-0295

DATRAX

Originator in DAT Tape Storage Systems.

- DATRAX 60 Solid Oak in Natural or Black Finish
- Nylon DAT Tape Carrying Cases
- NEW! DAT Tape Storage Drawers 320

NEW PLASTIC LINE: ▲ DATRAX 40 ▲ Video 8mm Rax ▲ Cassette Rax ▲ All \$21.95

Tel: 310.305.0317 ▲ Fax: 310.305.9167
CALL TOLL FREE: 800.9.DATRAX

BRYCO PRODUCTS, 15½ Fleet Street,
Marina del Rey, CA 90292



RIP-TIE

Velcro® Cable Wraps

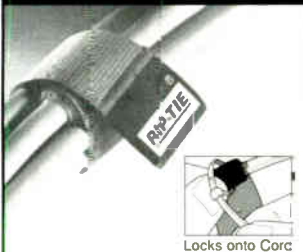

Locks onto Corc

The Rip-Tie Company
800-348-7600

P.O. Box 77394 San Francisco, CA 94107

American Pro Audio

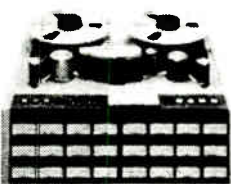

Digidesign • Opcode • Otari
Roland • Korg • Prodisk
Yamaha • Fostex • Dolby
Soundtracs • DDA • Ramsa
Trident • Neumann • Tannoy
Eventide • TC Elect • Summit

Great Prices!!!

Digital Workstations • Software
Keyboards • Recorders • Consoles • DAT
Leasing and financing.

1-800-333-2172

**AVALON DESIGN
SUMMIT AUDIO
T.C.ELECTRONIC
BRUEL & KJAER
FOCUSRITE
NEUMANN
DEMETER
MEDICI
SONY
GML
AKG
ADL**



ANY QUESTIONS?

Telephone: 508-543-0069
Fax: 508-543-9670

**FACTORY DIRECT
PRICES
ON**



**3M & AMPEX TAPE
Over 70**

**Professional Lines
STUDIOWORKS**

1018 Central Avenue / Charlotte, NC
(704) 375-1053 • 800-438-5921

MILAM AUDIO

"THE SOURCE"

SINCE 1967

SPECIALIZING IN
ALL TYPES OF RECORDING
EQUIPMENT, SUPPLIES,
DESIGN, INSTALLATION,
AND CONSULTATION

CONSOLES ■ D.A.T. ■ MICS
MULTI-TRACKS
MONITORS ■ AMPS

CALL US TODAY

MILAM AUDIO

1470 Valle Vista Blvd.
Pekin, IL 61554
(309) 346-3161
ORDER HOT LINE:
800-334-8187
FAX 309-346-6431

SUBSCRIPTION PROBLEMS? CALL (800) 888-5139.

EQUIPMENT FINANCING

- ◆ No Down Payment
- ◆ True Lease or \$1.00 Buyout
- ◆ Fixed Rates, Long Terms
- ◆ No Financial Statements Required
- ◆ New or Used Equipment
- for Transactions Under \$50,000



To apply or request information contact John McMindes

(713) 680-8822

STUDIO LIQUIDATION

All fair offers considered
Amek Angela, Studer 810,
& assorted mics, &
outboard gear.

(904) 574-0505.

Looking for new or used MIDI equipment? We've got tons of super clean pieces from Yamaha, Roland, Korg, Ensoniq, E-mu, Kurzweil, Akai, Alesis and hundreds more! **Worldwide delivery!** 63 years in business. Call, write or fax us today for price quotes & details. **Caruso Music**, 20 Bank St., New London, CT 06320, USA; (203) 442-9600. FAX (203) 442-0463.

SKB ATA Rack Mounts at an Affordable Price



Meets ATA class 300, Cat.1 Spec. available in 2U - 12U sizes and is half the weight of conventional wooden racks. Call your local dealer for a demo or fax for the name of your nearest distributor.

1121 East Ocean Blvd., Stuart, FL 34996 (407) 288-7200 • FAX (407) 288-7299



WHAT ARE YOU LOOKING FOR?

Join the thousands of audio professionals who rely on *Mix Classifieds* as their source for buying, selling, renting and repairing pro audio gear.

**Mix Classifieds
(800) 544-5530**

MICOR VIDEO EQUIPMENT

Production Consoles

AMEK BCII 32-input mono \$18K

AMEK 2002 28-input mono \$10K

Radio Station

PR&E BMX II 14-input stereo & 2 News mixers, EV mics, BE carts, Symetrix 104A, plus more. Call for more info.

Just In

Trident 80C console, Otari MTR-II 4 trk., Lexicon Digital Reverbs, AKG, Neuman, Sennheiser, and Shure mics.

Call for this and more...CHICAGO 312 334 4300



Turn DOWN your click track!

Visual Conductor™

Exclusive features... Pat. Pending

Full 12" x 19 1/2" display (not a skinny rack unit) • Light (bouncing OR conducting) simulates HUMAN GESTURES, anticipating the beat • EVERY time signature handled uniquely • Punch in anywhere - it will sync up • PROGRAMMABLE • Full 1 year warranty • Part of a growing family of studio timing products
NOW, FOR A LIMITED TIME!! - \$229+e/h - Call.
"Amazing and useful... like following a good conductor" - Home & Studio Recording

TimeStream Technologies, Inc.
318 Marlboro Road, Englewood NJ 07631 1-800-343-1149 Visa / MC Check / MO



Anthony DeMaria
LABS
RealTubeCompression
818-340-0228

NEW, USED, DEMO EQUIPMENT HUGE SELECTION OF DIGITAL/ANALOG RECORDERS, CONSOLES, DAWs, OUTBOARD GEAR.

Trident 80C w/MV Faders, Otari Concept One, Series 54, 24-Tk. Recorders, 8-Tk Digital Recorders, Pro Tools, Session 8, Mackie Consoles, Apple, IBM 386/486, Trident 24, Tascam MS16 16-Tk., Vitalizer, Soundcraft, Roland JD990, SP700, Samplecell II, CD Recorders, Drawmer 1960, Dbx, Summit Tube Processors, Microtech Tube Mics, Apogee Converters, TC Elec M5000, Lexicon Nuverb, Genelec, Tannoy, TAD, JBL Monitors. EQUIPMENT LEASING AND SYSTEMS SPECIALISTS — NEW AND USED COMPONENTS. CALL FOR CURRENT FAX LISTING OF EQUIPMENT.

EAR PROFESSIONAL AUDIO
(602) 267-0600

MERCENARY AUDIO WE HAVE LISTINGS ON SSLs, APIs, NEVEs, etc. ALSO OTARIs, STUDERs, AND MOST OTHER HIGH-QUALITY PIECES OF PROFESSIONAL USED EQUIPMENT. WE BUY, SELL AND TRADE VINTAGE EQUIPMENT.

in stock:
TRIDENT 48-INPUT 80 SERIES NEVE 1073s, 1084s, OTHERS MITSUBISHI WESTAR 36X24 MITSUBISHI X-850 32-TRACK FAIRCHILD 670, 660, 666 NEUMANN 49s, 48s, 47s, 67s CHURCH U47s (pair) TELEFUNKEN ELAM 251s, M221 AKG C-12, 224s RCA 77-DX, BK5A, BK5B SONY C-37A, 107A PULTECS LANG PEQ-2 TELETRONIX LA-2A (ORIG) STUDER A80VU 2- & 4-TRKS A.B.A.H.A.A.

"this is not a problem"
(508) 543-0069 TEL
(508) 543-9670 FAX

TUBE MICS

Neumann, AKG, Telefunken BOUGHT/SOLD/SERVICED Power supplies for all tube mics. Bill Bradley Microphones (216) 723-6494 Fax (216) 723-6595

Harrison MR-4 console, 24-bus, w/8 VCA subgroups, 28 input modules (\$66 for mixdown), 4 stereo modules, 6 Aux buses, left-side patch bay, producer's desk, excellent condition, automation-ready, non-smoking environment, \$26,500. Tom (816) 235-2964.

35mm MAGNETIC DUBBERS: Magna-Tech Reproducer/Recorders w/ Interlock: MD-235, MD-636, MR-436 for sale. Call Michael Temmer, (212) 206-1475. Fax: (212) 929-9082.

Neotek III-C console 28x24 with 6 echo returns. P&G faders, 3' producer's desk, 2 extra 56-in patch bays. One owner, \$20k or best offer. (216) 696-3277.

The deadline to place your ad in the Mix Classifieds is six weeks prior to the cover date. To place your ad in the next issue of Mix, call (800) 544-5530

WAVEFRAME 1000 for Sale. 2 in, 8 out. 16 voices, 32 meg RAM. DSP Card with 16x2 mixer & 24-bit reverb. 1.2-gig hard disk system filled with custom library including Prosonus Strings & Valentino Effects. PinLink 486 Computer interface & Sigma Designs LaserView monitor. \$28,000. Call (212) 206-8561.

MITSUBISHI X-86, VOCAL STRESSER, LUNCH BOX/API 550 Bs, JBL MONITORS (SEVERAL MODELS) (804) 464-4924.

Console—Amek M2500, 36 I/O. Full patch bay, stand. Mitsubishi X-80, 2-tk., digital, reduced. Dealers welcome. Pat (615) 256-7505.

ADATs in stock. Tascam demo ATR 60/2N, \$1,799 (still in box); Tascam M3700/24 console, floor model, \$8,895. Tascam M3500/24, \$5,500; M3500/32, \$6,195. Call Bill at Thoroughbred Music, (813) 238-6485, ext. 125. (800) 800-4654.

"We'll Still Be Here After The Deal Is Done !!!"

SSL 4040, \$100K; 6072 E/G, \$250K; Trident 80, 48 in, \$35K; Amek Mozart 56 in, \$85K; 2000, 28/16/24, \$18K. Neve, API, DDA call. 24+ Tr; Studer A800, \$30K; Otari MX80, \$18K; MTR90 call; MCI JH16, \$12K; Tascam 85-16, \$3.5K; Aphex Dominator, \$800.

db ENGINEERING
(617) 782-4838
Fax 782-4935
List your used gear for free !!!

MIC SPECIALS
Neumann U67 tube from \$2.5K; U87A w/susp \$1.8K. U47FET, \$1.8K; U87 from \$1.3K! Call for special pricing on real C-12 mics (not C-12A)!

Demeter, Aphex, Tannoy, Eventide. Now proudly offering **Quested** monitors !! tc Electronic M5000 reverb in stock !!!

SALES • INSTALLATION • DESIGN

Professional Audio Design, Inc.

Representing:
AKG, API, AKAI, AMS, B&K, DOA, DEMETER, DRAWMER, EVENTIDE, GML, LEXICON, MANLY, NEVE, NEUMANN, SONY, TANNOY, T C ELECTRONICS, TRIDENT, TUBE-TECH, WAVEFRAME

727 Atlantic Ave.
Boston, MA 02111

— NEW • USED • VINTAGE EQUIPMENT SALES

— SALES, INSTALLATION AND DESIGN OF PROFESSIONAL RECORDING SYSTEMS

— IMPORT-EXPORT SPECIALISTS Call for a complete list of products and services

PH 617-457-8100 FAX 617-457-8104

QUALITY EXPERTISE VALUE

Otari MX70 16-track recorder, \$8,500, o.b.o. Otari MTR-10 1/4" 2-track, \$3k, o.b.o. Call Mark: (809) 633-7030/31. Or fax: (809) 633-1991.

Multitrack recorder, 3M - 56, 2", 16-track, 15/30 ips with remote and autolocator, excellent condition. Includes several blank 226 2" tapes. \$5k or B.O. (707) 965-9528 eves.

API quad panpots. Neve 32264 compressors. Spectrasonics and Magna-Tech compressors. Parting out Studer A80 2-trk. Ampex ATR 102, 104. Loaded Scamp racks. A80 2-trk repro only. UREI 813, EMT stereo plate. (212) 924-3119.

96-point, TT-balanced patch bays. Switchcraft D1634B. Not the cheaper imitations. For a limited time, available at AVR for \$217 (Cash price only). Quantity pricing upon request. Call (617) 924-0660.

The following is for sale: LA-4 Black face; Telefunken MB 221 tube mic (Pair only). Not for the faint at heart: Elam 251 Klaus Heyne Modified in Mint condition; AKG C-24 in triple mint condition; Original U47/48 capsules in sealed box. Submit your offers or questions via fax to: (212) 545-1143. Cecco Music Inc.

SPECIALIZING IN NEW AND VINTAGE USED RECORDING EQUIPMENT. WE WILL BUY OR LIST YOUR QUALITY USED FOR-SALE ITEMS. SOME OF OUR AVAILABLE USED EQUIPMENT AND LISTINGS INCLUDE **Recorders:** 24-tracks: Studer A-80 MkIV; Otari MX-80; Tascam MSR-24; Sony JH-24; 3M M-79; Ampex MM1 100. 16-tracks: Otari MX-70; Tascam ATR-60; Tascam MS-16; Fostex G-16S; Tascam MSR-16. 8-tracks: Otari 5050 MkIII; Tascam 48. 2-tracks: Studer A-80; Ampex AG 500. DATS and ADATS also available. **Consoles:** Neve 8016; Neve 8108; SSL 48 inp; Sony MXP 3036; Trident 65; MCI 636; MCI 428; Wheatstone MTX-80; TAC Scorpion 24x16. **Reverbs:** Many Lexicons; AMS, Yamaha, Alesis available! **Mics:** Neumann U87, TLM 170; AKG 414ULS and EB, 460; B+K 4006; Schoeps 221 tube; **PLUS** modules, processors, compressors, monitors, etc. Please call for availability.

ODYSSEY

11 Eden Street
Salem, MA 01970
Tel. (508) 744-2001. Fax (508) 744-7224

Otari/Soundworkshop 34C Console w/ARMS 11 automation. 40x24x24 in-line, 4-band parametric EQs, 480 point patch bay, 60 TT cables, spare parts kit and manual. Mint cond. used 11 months. Asking \$34k. (2) White 4400 parametric EQs 28-band. \$1,400. Call Bill at (718) 224-9158.

Neve 8108 recording console, 48-input, custom-modified, 88 returns, 32 submasters, GML automation, 48 channels+ 6 groupers, 5 extra patch bays, currently in session. Available immediately! (213) 957-2996.

DYAXIS — Studer/IMS, 2-Channel, Digital Interface, 1-Hour Drive, System Synchronizer, Current Software: **Soundcraft 600** console, 16/8/2 w/patch bay. **MAKE OFFER.** Jim (703) 836-1333.

******* NEVE 8078 *******

40x24x32, in excellent condition, fully loaded, available for immed. sale. **ONLY 8078 PRESENTLY FOR SALE.** Price on request. Studer 827, MINT, w/remote, \$42k. Soundtracs MRX34PB, mint, \$12k. AMS RMX-16, AMS 1580 delay.
Call Perry
(516) 759-9110

NEVE NEVE NEVE

If you own any 80 Series console, EQ or compressor, I have the parts and ability to keep them working, as well as modules & frames to fill out or expand your console. 3-band EQ in stock, Model #3119.
Perry Margouleff.
(516) 759-9110

BERLER

Communications Company

HAVE: But really don't need:
•Akai digital 12-trk \$9k
•Nakamichi MR-1 cass \$600
•Neve 8058 \$60k
•Yamaha 9' grand Call
•Neumann M-49 Call
•Gefell UM70S \$1k
•Mitsubishi X400 16-trk \$18k
•Neumann KM-56 \$1,500
HAVEN'T GOT: But really want:
•STUDIO LIQUIDATIONS
•SMALL FRAME SSL
•RACK GEAR
(708) 263-6400/
Fax (708) 263-6455

SOUNDCRAFT SERIES 600 console "LIKE NEW"; 32 inputs, 6 aux, with 24-trk recording in a 336 point patch bay, with stand and cables, \$10,825. MCI JH100 2", 24-trk, autolocator II, like new, 16-trk heads included, \$8,200. Must sell. (619) 583-2717.

STUDER Dyaxis Digital Recorder. 1-hour stereo, 2-hour mono w/system sync. Tape backup AND DSP card (10-band parametric EQ, time compression and expansion). All the latest software, \$8k/O.B.O. Jess, (602) 948-5743.

Console-SOUND WORKSHOP 34C 32 Frame, 24 I/O modules, fully loaded patch bay, excellent condition, \$18k. Call Gary (212) 989-9292.

Equipment Rentals



PROFESSIONAL AUDIO RENTALS

310/838-6555
800/441-4415
24-hour Service

UNDERGROUND SOUND

PRO AUDIO RENTALS

Drum Machines • Monitor Speakers • Amplifiers • Microphones
Noise Reduction • Preamps • Samplers • Synchronizers • Sequencers
Digital Reverbs • Digital Delays • Digital Tape Mach • Analog Tape Mach
Compressors • Mixers • Noise Gates • De-Essers/Exciters
Tube Mics • Equalizers • Custom Racks...We've Got Em

WE CAN BEAT OUR COMPETITOR'S PRICES!!!

Seven Days A Week • 24 Hours A Day
(615) 321-4081 (615) 664-RENT FAX (615) 327-9285
-7383

Equipment Wanted

WANTED DEAD OR ALIVE NEUMANN CUTTING LATHES

VMS-80's, VMS-70's, VMS-66's, SX-74 Cutter Heads, SAL 74B Cutter Drive Logic, SP 272 Consoles, Cutting Limiters, Zuma Computers, Entire Systems

SPARE PARTS OF ANY KIND

Tel: (919) 230 2390
Fax: (919) 288 0060

EQUIPMENT WANTED BUY OR TRADE YOUR USED MULTITRACK RECORDERS AND CONSOLES EAR PROFESSIONAL AUDIO/VIDEO
(602) 267-0600

MERCENARY AUDIO WANTS TO BUY YOUR:

NEVE-SSL-TRIDENT-AMEK
UREI-TELETRONIX-FAIRCHILD
PULTEC-LANG-LEXICON
UNIVERSAL AUDIO-NEUMANN
AKG-TELEFUNKEN-AMS
ANYTHING THAT IS OF EXCEPTIONAL AUDIO QUALITY!

"this is not a problem"
(508) 543-0069 TEL
(508) 543-9670 FAX

We want your used keyboards, recording and audio equipment. We'll airmail you cash or take your stuff in trade toward over 350 brands of new and used musical equipment. **Come in or do it all through the mail! Worldwide delivery! 63 years in business.** Call, write or fax us today for price quotes and details. **Caruso Music.** 20 Bank St., New London, CT 06320, USA. (203) 442-9600, fax (203) 442-0463.

FAX your Mix Classified
(510) 653-5142

Instruction

EDUCATIONAL VIDEOS

12-hour sound mixing/recording course: \$239; 2-hour course: \$39; 2-hour MIDI course: \$39 plus shipping/handling. Visa/MC/check. For brochure: RECORDING ASSOCIATES, 5821 SE POWELL, PORTLAND, OR 97206. (503) 777-4621.

Frustrated with owner's manuals?

Get a free copy of our catalog, which features tips and techniques books for equipment by Roland, Alesis, Yamaha, Casio, Korg, Ensoniq, Kawai, Kurzweil and Oberheim.

All titles reviewed and guaranteed!

BOOKSHELF

6400 Hollis St. #12
Emeryville, CA 94608
(800) 233-9604 • (510) 653-3307

Maintenance Services & Repair

MAGNETIC RECORDING HEADS

RELAP/REPLACEMENT for Audio, Video, Time Code, Duplication. 30+ years of head design experience. **IEM,** 350 N. Eric Dr., Palatine, IL 60067; tel. (800) 227-4323.

Mix Classifieds are your best advertising buy in the industry. Phone (800) 544-5530.

ATR SERVICE COMPANY AMPEX Custom Parts and Support services for the ultimate in studio mastering and broadcast applications. Reasonably priced **Control** and **Chase Synchronizers** for instant mix-to-picture capability. Ultra low flutter capstans for the ATR100. New **Flux Magnetics** mastering and multitrack heads.

Call or fax **Michael Spitz** at (415) 574-1165 for details & pricing. Our customer list speaks for itself!

SYNTRONICS
MUSIC SERVICE
Repair of Vintage synthesizers,
Keyboards, Amps, Tape Decks,
Computers and Effects
CV/Gate Inputs for Roland TB-303 \$89.99
Notator LOGIC for MAC \$589.99
466 COMMONWEALTH AVE.
BOSTON, MA. (212)
617-266-5039

**Music Products/
Software**

Sound Bytes Drum Loops, Music Tracks
15, 29, 59
Beats and Sound Effects on
CD and DAT
for Producers/Musicians in
Film, TV, Radio and Multi-Media
CALL 407-260-0079
Customize your 2 track masters
with NEW drum tracks
Strange But True!
407-260-0079

StudioPal™
Macintosh music calculator.

- SMPTE time code formats
- feet and frames
- bars/beats/slicks & tempos
- delay settings, rhythms
- notes, chords, intervals
- frequencies, wavelengths
- sample rates, megabytes
- tape speed, capstan freq.
- MIDI reference chart

 **\$69.95**
+CA tax, MC/Visa
Harmonic Systems, Inc.
Box 488 • Fairfax, CA 94978
tel: (415) 485-5242 fax: 485-6018

**Records, Tapes
& CD Services
and Supplies**

**Orders...
Large or Small,
We Have It All!**
Everything in stock.
Wholesale distributors of:
AMPEX • BASF • 3M • MAXELL • SONY
• Audio video tape
• Assorted reels and boxes
• Splicing/leader tape
• Prepackaged cassettes
• We load bulk cassettes
in custom lengths
Call for Quote
(800) 854-1061
TEL (619) 277-2540 • Fax (619) 277-7610
Advance Recording Products
7190 Claremont Mesa Blvd., San Diego, CA 92111
Visa and Mastercard accepted
WHOLESALE DISTR

CALL 1-800-DAT-TAPE OR 1-800-245-6000
AMERICA'S LARGEST DAT TAPE SUPPLIER

SONY PRO	MAXELL	TKK	SONIX
DT-120 10 49	R-120 8 49	DAR 60 7 60	REGIOT 4 99
SONY	JVC	DAR 120 8 49	REGIOT 5 99
DT-90R 7 49	R-120XD 6 99		REGIOT 6 99
DT-120R 7 99			RYEOST 7 49
AMPEX			BASE
DAT-120 9 99			DAT-120 7 39
PAZ			DEC-MET
DAT-120 7 99			DAT-122 5 99

VISA MC NO. EXTRA CHARGE
WE'LL BEAT ANY PRICE
4.95 SHIPPING ANY SIZE ORDER
WE STOCK OVER 400 DIFFERENT AUDIO & VIDEO TAPES

Pro Digital Inc.
DAT Recorder Service
Fast, expert repairs
on all DAT recorder
brands & models.
Two day turnaround
on most Sony and
Panasonic machines.
Sony Authorized
Warranty Service
215.328.6992
FOSTEX • TEAC • SONY • PANASONIC • JVC • AIWA • TASCAM • PIONEER

**The DAT
Doctor
Is
IN**
Avoid those costly DAT
disasters with preventive
maintenance and sched-
uled overhauls from NXT
Generation. Your Sony or
Panasonic DAT machine
will be restored to guaran-
teed new factory spec. Our
technicians are factory
trained, and turnaround is
fast. Call today!

249 Kennedy Road
Greendell, NJ 07839
201-579-4849
fax 201-579-6021

RCA Microphones — Repair service
on all models. Complete sound and
cosmetic restoration. We also repair
other ribbon types. Call or write for
info: ENAK Microphone Repair, 420
Carew Avenue, Pitman, NJ 08071.
(609) 589-6186.

BOOKS, TAPES, VIDEOS
Get the world's most complete collection of
resources for the audio and music profession!
Write or call now for your free catalog.
BOOKSHELF
6400 Hollis St. #12, Emeryville, CA 94608
(800) 233-9604 • (510) 653-3307

MultiMedia
CDS! CASSETTES! ALBUMS!
POSTERS! VIDEOS! MORE!
Fast Turnaround! Great Service!
Great Price! FREE CATALOGUE!
Toll Free: 800-229-0355
Baltimore, MD # (410) 752-0355

COMPACT DISC PACKAGES
NO HIDDEN COST
500 1000
\$1671.00 \$2410.00
Sub & Glass Master, Typeset,
Color Seals & Proofs, Label Film,
Printing (color front), 2-page
booklet + tray, jewel box w/wrap
CHROME CASSETTE PACKAGE
1000 Full Color J-Cards
\$999.00 w/Camera Ready Art

a+r **PRICE BUSTER!**
902 N. Industrial Blvd.
Dallas, TX 75207
214-741-2027
TOLL FREE:
1-800-527-3472
MANY OTHER PACKAGES AVAILABLE

1000 PACKAGED CASSETTES
STARTING AT
\$988⁰⁰
Price includes Color Separations and Color Proof
800-348-6194
phyco audio/video Est. 1974

AAPEX
ULTIMATE FIDELITY
The world's largest Nakamichi
real-time cassette duplication
system. Full-service packaging.
50 to 50,000 qty. Outside CA,
call toll free (800) 323-AAPX
or (415) 492-1300
—Call AAPEX today!

**Custom Loaded
Cassette Blanks**
utilizing
MAXELL XLII HIGH BIAS TAPE
or your choice of
AMPEX, AGFA, BASF PREMIUM TAPE
Any length up to C-96 rushed to you in
minimum runs of 100 cassettes
TRUTONE INC.
310 Hudson St. Hackensack, NJ 07601
201-489-9180 Fax: 201-489-1771

**If You Don't Sound Good,
We Don't Look Good.**
State of the art mastering, replication, and duplication services
for the discriminating producer.
TRUTONE INC.
310 Hudson St. Hackensack, NJ 07601 • 201-489-9180 Fax: 201-489-1771

For Excellence in Sound Make the **BEST** Choice
BEST SERVICES UNLIMITED
RECORD PRESSING
CASSETTE DUPLICATION
CHROME BLANKS
COMPLETE ART DEPARTMENT
FULL COLOR PRINTING
COMPLETE PACKAGING
VIDEO DUPLICATION
7729 Oakport St
Oakland, CA 94621
1-800-ASHLEY-SINGLES
\$1,699.00
1-800-ASHLEY-FILES
\$3,199.00
Prices include pre-mastering, mastering, label printing, full color
0 card 0 card or four panel cd booklet printing, shrink wrap
price does not include comp. film or artwork
VISA MASTERCARD **1 (800) 627-7365**

WHEN YOUR READY FOR THE BEST!
**State Of The Art
Cassette Duplication**
HIGHEST QUALITY CASSETTE DUPLICATION •
CUSTOM LOADED BLANKS • LOWEST PRICES
1-800-242-2015
CLIP OF WATER PRODUCTIONS •
13780 12TH ROAD • PLYMOUTH, IN 46563

28 ROCKY DALE RD.
P.O. BOX 401
BRISTOL, VT 05443
(802) 453-3334
FAX: (802) 453-3343
Compact Disc and Audio Cassette Production

DISC MAKERS
**Cassette & CD
Manufacturing**
FREE Graphic Design •
Complete Packages •
Major Label Quality •
Money Back Guarantee •
500 CDs
with
B&W inserts
in two piece
jewel box
only \$1790
Call Today For Our
FREE Full Color Catalog:
1-800-468-9353
1328 N. 4th St., Phila., PA 19122
215-232-4140 FAX: 215-236-7763

**COMPACT DISCS
REAL-TIME CASSETTES**
duplicated on the largest KABA
System in the Southwest.
"Quick turnaround, low prices!"
MasterCard and Visa accepted
(214) 630-2957
Crystal Clear Sound
4902 Don Drive, Dallas, Texas 75247

REAL TIME DUPLICATION ON NAKAMICHI DECKS

COMPACT DISCS

Can you afford to promote your music on anything less?

CD PRE-MASTERING For a free brochure:
DIGITAL MASTERING & EDITING 1-800-456-GLAD (4523)
COMPLETE PRINTING & PACKAGING FAX 716-532-5061

ALL MATERIALS AND WORKMANSHIP GUARANTEED!
MASTERCARD, VISA & AMEX ACCEPTED.

GLAD PRODUCTIONS

13758 Rte. 62 • Collins, N.Y. 14034 • TEL 716-532-5098

Just Like the MASTER

500/500	1,000/1,000
CD-CASS PACKAGE	CD-CASS PACKAGE
1/C Insert - \$2.895	1/C Insert - \$3.395
4/C Insert - \$3.895	4/C Insert - \$4.195

PERSONAL SERVICE • QUALITY PRODUCT

(800)633-5006
(303)459-3509
In Colorado
24 HOUR SERVICE

CASSETTE PACKAGES

COMPLETE WITH THE BEST
FULL COLOR INSERTS

100 ONLY \$455
1000 ONLY \$1256

Cassette *mix*

- 100 Pcs. Minimum
- FREE Graphic Design
- Full Color or B/W
- Packages or Pieces
- Money Back Guarantee

Free Catalog
1-800-955-5273 24 Hours
Anderson Studios & Graphics

Disc Mastering & Record Prod.
CDs, LPs, 45s, Cassettes
**CD REFS AVAILABLE
THE CUTTING EDGE**
Box 217M
Ferndale, NY 12734
(914) 292-5965

Mix Classifieds are your best
advertising buy in the industry.
Phone **(800) 544-5530**.

CASSETTE ALBUMS FAST

no minimum
BASF & Maxell Tape
Bin Loop & Real Time Duplication
Color, B/W Inserts • On-Cassette Printing
Whol Blank Cassettes • Tape & Supplies
Call 904-399-0424 • Fax 904-398-9683

Audio **THE WAREHOUSE** since 1975
Sales **STUDIO SALES**
2071-20mx Emerson St. • Jacksonville, FL 32207

The *Presidential*
*Economy CD**
Package
* Clinton Discount

***** 500 CD's - \$1099 *****
Complete (From your 1630): Glassmaster - Free Layout & Design -
2 Color Label Printing - Protective (Safe Packing) Vinyl Sleeve
*** Convertible to our 1 Color CD Package anytime: (from your Camera-Ready Art):
1 Color - 2 Page Booklet and Traycard, Jewelbox and Shrink-wrap (including Composite Negs) add \$399.00.
1 Color Rear Cards for Residential Package including Typesetting add \$100.00

Rainbo 1738 Berkeley Street • Santa Monica, CA 90404
Records & Cassettes (810) 829-0355 • (310) 829-3476 • Fax (310) 828-8765

CASSETTE DUPLICATION SERVICES

"ANYTHING THEY CAN DUPE...
WE CAN DUPE BETTER!!!"

AND CHEAPER TOO!
Real Time duplication package: as low as \$1.05 ea.
• BASF, AGFA or AMPEX CRO₂
• clear SHAPE shell (made in U.S.A.)
• direct printing • NORELCO box • shrink wrap

CALL FOR FREE SAMPLE:
1-800-367-1921
CASSETTE DUPLICATION SERVICES **CDS**

Specialized Customer Service for 28 years!

- Custom Loaded Blank & Duplicated Cassettes
- Cassette Duplication
- Quality & Quick Turn-Around
- Complete Packages Personal Service

Jackson Sound Productions
3897 South Jason Street
Englewood CO 80110
(800) 621-6773

RJR DIGITAL

CD Mastering / Cassette Duplication
• mastering • manufacturing
• fabrication • printing
San Diego 619-267-0307
1-800-828-6537 Fax 619-267-1339

Mix Classifieds
FAX: (510) 653-5142

SMASH The \$2.20 Barrier

Compare!
Our Prices Beat All
Advertised Prices

- FAST SERVICE: It's our specialty.
- LOW PRICES: CDs low as \$2.10 per unit
- PERFECT: 100% guaranteed.

COMPLETE
500 CDs/500 cassettes \$2334.00
1000CDs/1000 cassettes \$3218.00

CDs include: 1630 transfer, glass mastering, jewelbox, shrink wrap 2C disc label, 2 panel 4C/BW booklet. Cassettes include: chrome tape, test cassette, standard 3 panel J-card 4C/BW

FREE NATIONAL ADVERTISING TO RETAILERS AND CONSUMERS FOR YOUR NEW RELEASE!

IMPS MUSIC IMPS CD Manufacturing
70 Route 202 North
Peterborough, NH 03458-1107

For details call Donna at 603-924-0058
or fax 603-924-8613

C.M.S.I.

"The Sound Investment"

All Our Products Are Major Label Quality

Full Color \$2495.00
1000 CD'S

Complete Packages NO HIDDEN COSTS
(716) 871-015K (3475)
FAX: (716) 871-9317

Full Color \$875.00
500 Cassettes

3407 Delaware Ave. Buffalo, NY 14217
200 N. Edison Ave. Tampa, FL 33606

ESP EASTERN STANDARD PRODUCTIONS
37 John Glenn Drive
Buffalo, New York 14228
716-691-7631
Fax 716-691-7732

TAPES & CDs

- CASSETTE DUPLICATION
- HIGH SPEED STEREO HX PRO
- AUDIOPHILE REAL TIME
- COMPACT DISCS
- CD ONE OFFS
- DIGITAL EDITING & MASTERING
- QUALITY PRINTING & PACKAGING
- CUSTOM BLANK CASSETTES

AUTHORIZED DEALER FOR 3M TAPE, MARANTZ PRO, & DENON

...EXPERIENCE THE DIFFERENCE!
CALL FOR A FREE BROCHURE
CALL TOLL FREE 1-800-527-9225

TDK

Pro SA Cobalt

CUSTOM LOADED CASSETTES NOW AVAILABLE TO DUPLICATORS

1-800-272-2591

call for free catalog

ARCAL
2732 Bay Road
Redwood City, CA 94063

EAST PRO AUDIO/VIDEO

MINI DISC & DCC AVAILABLE NOW

MAJOR LABEL QUALITY PRINTING AND PACKAGING FREE GRAPHIC DESIGN!

500 CHROME CASSETTES/ FULL COLOR INSERTS \$824

VIDEO DUPLICATION LOWEST PRICES!
1000 CD PACKAGE \$1999

STATE OF THE ART HI-SPEED DUPLICATION REAL TIME DUPLICATION ON NAKAMICHI DECKS

FREE CATALOG 1-800-365-TAPE(8273)

3M AGFA AMPEX SONY

Audio, video & digital tapes
Sony Professional Pro Audio,
Neumann, Sennheiser, B&K,
Shure & Crown Products.

R&M PRO AUDIO
691 10th Ave., S.F., CA 94118
Phone/Fax: (415) 386-8400.

Mix Classifieds (800) 544-5530

PROFESSIONAL RECORDING AND DUPLICATING SUPPLIES

AMPEX - STUDIO MASTERING TAPE

499 GRAND MASTER GOLD

2" x 2500' Reel	122.00 each
1" x 2500' Reel	57.80 each
1/2" x 2500' Reel	33.75 each
1/4" x 2500' Reel	18.50 each
1/4" x 2500' Bulk	10.15 each

456 GRAND MASTER

2" x 2500' Reel	114.08 each
1" x 2500' Reel	52.68 each
1/2" x 2500' Reel	30.43 each
1/4" x 2500' Reel	17.22 each
1/4" x 2500' Bulk	9.43 each

ORDER

500 - C10 Min. BASF CHROME + (High Bias) Blank Cassettes
25 Each \$12.500

OR
500 - C10 Min. BASF 649 (Normal Bias) Blank Cassettes
24 Each \$12.000

NEW! 1000 BULK CASSETTE LABELS FREE!

Offer Expires June 30th 1993

Custom Loaded Blank Audio And Video Cassettes
Laser Printed Cassette Labels & Caselmers
Direct On Cassette Printing
Norelco & Soft Poly Boxes
DAT's
Empty Reels & Boxes
Splicing & Leader Tape
CD Jewel Boxes & Trays
Endless Cassettes
U-Matics
Bulk Audio Cassette Pancakes
C-D's
Duplicating Equipment

764 5th Avenue
Brooklyn, New York 11232
In New York Tel: (718) 369-8273
24 Hour Fax Line: (718) 369-8275



National Recording Supplies Inc.

TOLL FREE 1-800-538-2336

THE BEST CD MASTERING...

Custom-designed hardware and software by Chief Engineer Bob Katz. 128x Oversampling 20-Bit A to D. Unique Digital Processors. Hard Disk Editing. Tube and Solid State Analog Recorders. CD Mastering is an art. Levels, fades, equalization, spacing—everything is important to you and to us.

CD REPLICATION...

1000 CD's at \$1.55 ea. w/Jewel & Shrink. 2500+ at \$1.50 ea. Glass Master Free with 2500+ CD's.

CD BOOKLET PRINTING...

1000 4-Panel Booklets at \$.23 ea. Full-Color Outside, B&W Inside. Full-Color Tray Card. Let our Graphic Artist give your presentation the same attention you give your music.



Audio for the Golden Ear...
New York, NY (212) 369-2932

...COSTS LESS!

From DAT to Disc. 1x1 copies of your master tape to Orange Book standard CD. 48-hour turnaround. Integrated Digital Systems (310) 478-4264; fax (310) 444-9224.

Video Equipment, Services & Supplies

Video for Audio Lockup. Rebuilt 3/4" VTRs for sale w/warranty (some w/ address-track time code). JVC: CP5500U, CP5550U, CR6650, CR8200U, CR8250U & CR850U. Some remote control units avail. Sony: VT-5000, VO-5600, VO-5800, VO-5850, BVU-800. (212) 580-9551/(212) 206-1475. Fax: (212) 929-9082. Michael Temmer.

What's New What's Hot in 1993!



PROFESSIONAL AUDIO/VIDEO TAPE, CABLE, ACCESSORIES, EQUIPMENT, SUPPLIES AND SERVICES

518-828-2000

New Products...Great Deals!

Call now for our CATALOG PREVIEW!

309 Power Avenue, Hudson, NY 12534
615/889-9292 Southern Office, Nashville, TN

MAXELL XLII BULK Custom Loaded Chrome Cassettes

Quantity	C10	C20	C30	C45	C60	C90
100	.59	.63	.69	.81	.94	1.33
500	.53	.57	.62	.73	.85	1.10

available ONLY from



575 Eighth Ave., New York, NY 10018
(212) 760-9300/Fax (212) 564-9488

FREE SAMPLE CASSETTE

Ask For Ed Stern

1-800-274-7666

TRAXX RECORDING PRODUCTS

325 Long Hill Road
Gillette, NJ 07933

Real-time cassette duplication
From cassette, DAT, reel to reel
Custom-loaded cassettes

For Free Catalog call:
(908) 580-9042.



COMPLETE CD & CASSETTE PACKAGE PRODUCTION

- digital mastering
- 16 channel digital editing
- CD replication any qty. (CD-audio, CD ROM & CD-i)
- graphic design studio
- printing & packaging
- multimedia specialists

call for best package price and service
213 / 655 - 4771 • fax 213 / 655 - 8893
8455 beverly boulevard • suite 500
west hollywood • ca • 90048-3416

1000 CD'S \$ 2,850.00

QUALITY WORK AT A LOW PRICE

INCLUDES:
- Pre-master
- Glass Master
- CD Fabrication
- Film Label
- Printing
- 4 Color Booklet
- 4 Color Tray Card

TRS

1-(800) 942-DISC (3472)

We'll put your DAT or 1/4" Master in any sequence at no charge

Single-Copy CDs made from your recordings. NEW LOW PRICES!

Backup and volume discounts.
CRAIG HOWARD PRODUCTIONS
PO Box 81, Masonville, CO 80541
Call/Fax (303) 223-7769
ALSO, Tape/Record Restoration.

Recording Services

WXXI Audio Production Facilities

Modernized Remote Unit
Studio Production With Dyaxis Editing
Award Winning Engineering Team
Contact: John Bell (716) 325-7500
PO Box 21 Rochester, NY 14601

•Competitive Pricing



CD MASTERING DIGITAL EDITING CD PRODUCTION DIGITAL TRANSFERS

250 West 57th. St, Suite 725
New York City, NY. 10019
212-397-4099 397-2207 (Fax)



BEST VALUES IN THE INDUSTRY!

- Cassettes With Full-Color J-Card: 500 - \$585
- CD's Complete In Jewel Case: 500 - \$1,380
- 12" DMM Vinyl Package: 500 - \$885
- CD-R's starting @ \$95 each

"U.S. Most Complete Facility": Neve Digital Mastering for CD, Direct Metal Mastering for Vinyl, Studer/Lyrec Dolby HX-Pro Cassette Duplication, In-house Art Department, Recordable CD Production

For a Complete Brochure, call or write:
EUROPADISK, LTD.
75 Varick Street, New York, NY 10013
(212) 226-4401 FAX (212) 966-0456



Miscellaneous

COMPLETE CD AND CASSETTE PRODUCTION



212-333-5950

MASTERING REPLICATION
PRINTING TOTAL PACKAGING
POSTERS GRAPHIC DESIGN STUDIO
PERSONALIZED EXPERT SERVICE

330 WEST 58TH ST. NEW YORK, N.Y. 10019

"FOR THOSE WHO HEAR THE DIFFERENCE"



An absolute necessity for every studio

\$59.95 includes screen, clamp, goose-neck and shipping

CALL NOW TO ORDER

Outside CA (800) 446-7677
Inside CA (818) 788-3635

POPPER STOPPERS
P.O. Box 6010-658, Sherman Oaks, CA 91413
DON'T SETTLE FOR LESS. GET THE BEST!
THE ORIGINAL POPPER STOPPER
NOW DOUBLE THICK FOR XTRA PROTECTION

How to Place a Mix Classified Ad

Please print or type in CAPITAL LETTERS and lowercase. There are 8 lines to the inch and approximately 24 CAPITAL letters or 32 lowercase letters per line. \$80 per inch—1" minimum. Each additional line is \$10. BOLD TYPE is \$10 per line; a border is \$10 extra; and a gray screen is \$15 extra. Logos or display advertising up to 4" will be charged at \$100/inch. Logos or display advertising must be camera-ready (width is 1-5/8" or 10 picas). Frequency discount rates are available. Call for information. Payment by check, money order or charge must accompany ad. DEADLINE is the 15th of the month, 6 weeks prior to publication. (Classified ads cannot be canceled or refunded after the deadline date.)

Categories Available (check one):

- Acoustic Consulting
- Business Opportunities
- Employment Offered
- Employment Wanted
- Equipment for Sale
- Equipment Rentals
- Equipment Wanted
- Instruction
- Maintenance Services
- Music Products/Software
- Miscellaneous
- Records, Tapes & CD Services & Supplies
- Recording Services
- Studios
- Video Equipment Services & Supplies

Co. Name _____
Name _____
Address _____
Phone _____

I am paying by (check one): VISA MASTERCARD AMERICAN EXPRESS

Card #: _____ Expiration Date: _____

Signature: _____

Check or Money Order #: _____ Amount Enclosed: \$ _____

MAIL TO: Mix Classifieds, Attn: Robin Boyce, 6400 Hollis St. #12, Emeryville, CA 94608.
Toll-Free Order Line: (800) 544-5530 (510) 653-3307 FAX: (510) 653-5142

THE POWER OF INTELLIGENT HARMONY

The ultimate in instrument harmonizers, the new DigiTech DHP-55 is the first five-part oversampled intelligent harmony processor designed especially for studio and instrument applications. Based on an innovative dual-micro/dual-DSP architecture, the DHP-55 can operate either as a true stereo or mono signal

processor. Proprietary technology allows the DHP-55 to provide a host of functions including intelligent five-part harmonies multi-octave pitch-shifting and, for the first time ever, true polyphonic (chordal) harmonizing.

Experience the power of intelligent harmony with DigiTech's revolutionary DHP-55 harmony processor and multi-effects system.

DHP-55

- ▲ Intelligent 5-part harmonies
- ▲ 7, 15 or 31-band digital EQ configurations
- ▲ Up to 6 full seconds of digital delay, sampling and multi-tap stereo delays
- ▲ Lush chorusing and flanging
- ▲ Dual DSP architecture
- ▲ Multi-octave pitch shifting
- ▲ True stereo or mono
- ▲ Digitally controlled analog compression and gating
- ▲ Modulation effects
- ▲ Ducking and dynamic filtering effects
- ▲ Powerful continuous control functions
- ▲ Full MIDI control

8760 S. Sandy Parkway
Sandy, Utah 84070
Tel. (801)-566-8800
Fax (801) 566-7005
International Inquiries:
Fax (603) 672-4246

DigiTech

A Harman International Company

USE READER SERVICE CARD FOR MORE INFO



Array Series. Designed To Impress Everyone Who Has Heard It All Before.



The competition to produce the "ultimate" sound reinforcement system is fierce. Each new system design brings claims of having *achieved perfection* or touts *this is the one*. Yet, in time, you can expect the very same manufacturers to introduce new models claiming to have further *perfected perfection* or that their *unorthodox* technology has rewritten the laws of physics. Sound familiar? So how do you impress everyone who has heard it all before? Simple.

JBL engineers have drawn upon proven advancements in loudspeaker design and state-of-the-art digital electronics to create Array Series: a comprehensive sound reinforcement system concept with performance second to none. Developed as dedicated array elements, Array Series systems can be easily configured to fill any venue with seamless coverage from a deceptively small package.

Such performance could only be achieved by designing the exact transducers required for the job. The Array Series is the first professional loudspeaker system to use neodymium magnets. The LF transducer's unique motor structure topology also includes proven Vented Gap Cooling (VGC™) and a deep copper-sleeved gap to significantly reduce distortion and power compression.

The 38 mm (1 1/2 in) exit HF compression driver also uses a neodymium magnet structure, a Coherent Wave™ phasing plug and damped titanium diaphragm. The result is effortless and reliable high frequency output with outstanding accuracy. A 45° Optimized Aperture Flat-Front Bi-Radial® horn assures proper matching and summing of multiple Array Series systems.

The 13 ply hardwood enclosure has 45° sidewalls to match the horn coverage in arrays, and is reinforced with integral steel attachment hardware, designed to interface with S.A.F.E.™ flying hardware for quick and secure cluster assembly.

Pictured above, Array Series installation at the Grand Palace, Branson, Missouri.

System functions, such as crossover filter points, transducer acoustic center alignment, system equalization and protective limiting are achieved totally in the digital domain by the ES52000 Digital Controller. The ES52000 employs Finite Impulse Response (FIR) filters for zero phase shift and requires no amplifier output sensing cables, so you can expand your system by adding Array Series loudspeakers without having to add additional controllers.

The sum of these parts is Array Series: a complete system providing extremely high power handling, very high sound pressure levels with full dynamic range, low distortion and unmatched fidelity. Truly a system capable of impressing *anyone who has heard it all before*.

Call or write for detailed specifications. Or, for more *immediate* response, you can get current product information on Array Series, the ES52000 Digital Controller and all JBL Professional products, *VIA FAX* by calling (818) 895-8190.



JBL Professional
8500 Balboa Boulevard, Northridge, CA 91329
(818) 893-8411
FAX Information: (818) 895-8190

■ A Harman International Company