

SEPTEMBER 1986  
U.S. \$4.00  
CANADA \$5.00

THE RECORDING INDUSTRY MAGAZINE

# Mix

David Byrne's True Stories

**Directory:  
Southern California  
Studios**

057632 MX 12-99  
JBL PROFESSIONAL  
MARK R GAIDER  
8500 BALROA BLVD BOX  
NORTHridge CA

**Film Sound '86**

**Michael McDonald  
High-end Consoles**

**Michael Boddicker**

**Production Music Libraries**

**Mr. Bonzai Goes to Japan**

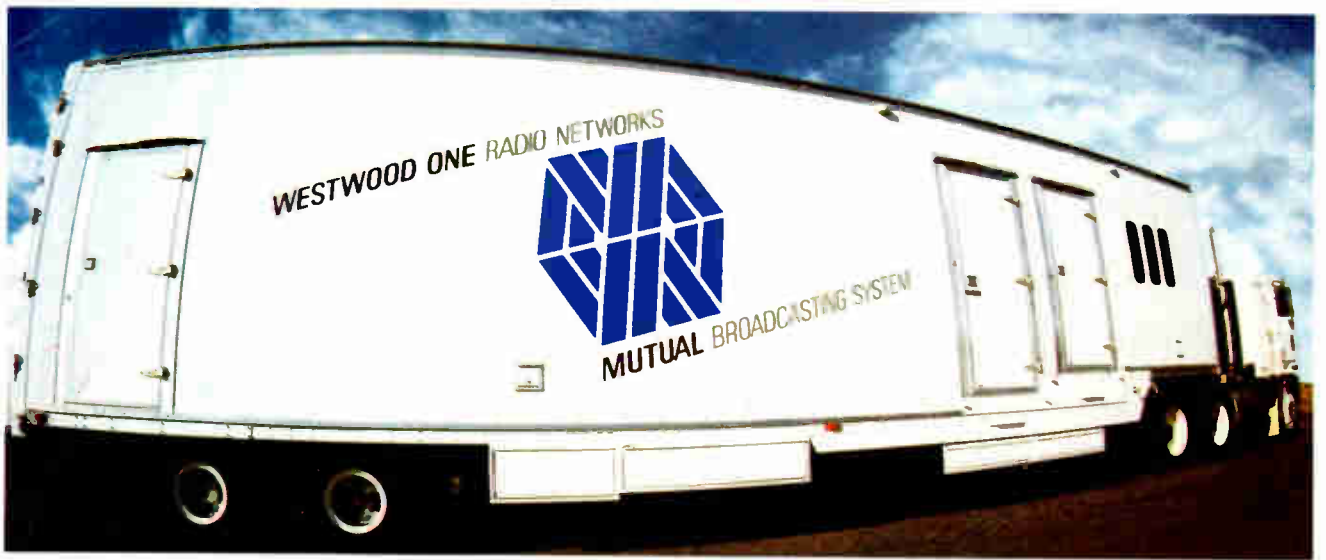

## ROLLIN'



Photography: Todd Andrews

## AND A REELIN'!

We're Westwood One Mobile Recording. On the cutting edge of the remote recording art. And we rule the road.

Our trucks are ready to roll. From L.A., Cleveland and Boston. Within 24 hrs. of everywhere. Equipped with the best in mobile technology and crewed by those who helped develop it. All at competitive rates.

We've earned our reputation. Our work speaks for itself. Like this year's Grammy Certificate for *Best Audio in Long Form Music Video* with Huey Lewis and The News' "The Heart of Rock and Roll." And live

recordings for broadcast that became live albums, including hit releases by Tina Turner, Brian Adams, Tom Petty and The Heartbreakers and The Thompson Twins. Or history making coverage of major events like the *Amnesty International* tour, *Farm Aid II* and *Radio USA for Africa*.

We capture it live. The sound *and* spirit. When and where it happens.

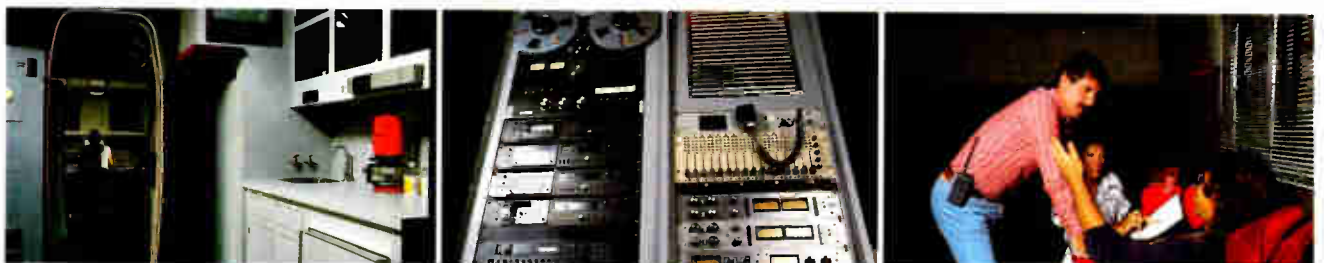

In Los Angeles. Contact:  
Richard Kimball, V.P. Mobile Recording  
(213) 204-5000

In Cleveland. Contact:  
Dale Peters  
(216) 289-1900

In Boston. Contact:  
Sam Kopper  
(617) 335-4208

Circle #001 on Reader Service Card



# DREAM MACHINE.

20.0

If mastering or post production is your business, our new MTR-20 is your dream machine. It's the only new 1/2" four-channel with 14" reels, to give you one hour recording at 15 ips. It also comes in 1/4" center-track time code, 1/4" two-channel, and 1/2" two-channel versions. And, the MTR-20 features Otari's exclusive Auto-Alignment for fully automatic calibration of record adjustments.

You can program the "20" to fit your personal style, with over 400 different set-ups. These range from controlled wind speed to a complete re-ordering of the transport control buttons—you can even make it left-handed if you want! You see, there are so many different applications for the MTR-20 that, rather than lock you into just *one* mode, we let you configure the machine to your specific needs.

Call your Otari dealer today, and wake up to the Dream Machine tomorrow. From Otari: The Technology You Can Trust, Otari Corporation, 2 Davis Dr., Belmont, CA 94002. (415) 592-8311 Telex 9103764890.

**OTARI**®



Circle #149 on Reader Service Card



# Mix

SEPTEMBER 1986

THE RECORDING INDUSTRY MAGAZINE

VOL. 10, NO. 9

PAGE 66



PAGE 36



PAGE 112

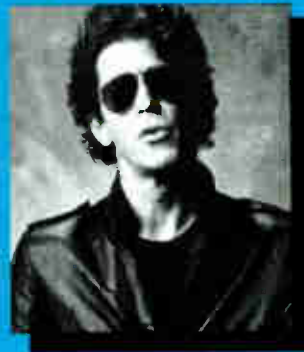

PAGE 82



## FEATURES—FILM SOUND '86

- 42 ELECTRONIC CINEMA: DAVID BYRNE'S TRUE STORIES**  
by David Gans *Behind the scenes at the making of a new film by Talking Heads' frontman.*
- 50 SOUND EFFECTS: THE NEXT GENERATION**  
by Peter Bergren *Synclavier and Fairlight experts talk about post-production.*
- 58 PRODUCTION, MUSIC & SOUND EFFECTS LIBRARIES** by George Petersen  
*A survey of some useful production tools.*
- 64 BURBANK STUDIOS: ON THE CUTTING EDGE OF FILM SOUND** by Robyn Flans  
*A look into one of the industry's most innovative facilities.*
- 66 MICHAEL BODDICKER: HIRED GUN**  
by Tony Thomas *The synth whiz discusses his equipment and recent projects.*
- 68 SOUNDTRACK MANIA!**  
by Blair Jackson *A light-hearted examination of the big money world of film music.*

## AUDIO

- 16 INSIDER AUDIO: Dolby SR**  
by Ken Pohlmann
- 22 BASICS: A Time Code Tutorial**  
by John Woram
- 30 INSTALLING THE BIG BOARD**  
by Greg Hanks
- 36 HIGH-END CONSOLE REPORT**  
by George Petersen
- 76 FIELD TEST: Bryston 4B Pro Power Amp**  
by Piers Brew
- 78 FIELD TEST: MDB Window Recorder**  
by Eddie Miller
- 92 SOUND ON STAGE: EAW's KF-550 Cabinet**  
by Mike Stande
- 106 IN SYNC: Mac-MIDI-Modem**  
by Bruce Nazanan
- 126 AFTERMIX** by Philip De Lancie
- 130 HALF-TIME AUDIO AT SUPER BOWL XX**  
by Bruce Erley
- 131 THE SUPERBOWL GOES TO CHINA**  
by Greg DeTogne
- 136 TELECOMMUNICATIONS ON ESI STREET**  
by Phil Tripp
- 144 SOUTHERN CALIFORNIA STUDIOS: New Sources of Business**  
by Linda Johnson

## VIDEO

- 140 VIDEO NEWS** by Elizabeth Rollins
- 142 MVP: The Intelligent Studio, Part 2**  
by Lou CasaBianca

## MUSIC

- 82 LUNCHING WITH BONZAI: A Taste of Japan**  
by Mr. Bonzai
- 100 MICHAEL McDONALD: No Lookin' Back**  
by Gene Kalbacher
- 110 MI UPDATE** by Craig Anderton
- 112 MUSIC NOTES: Lou Reed, John Prine, Narada Michael Walden & George Benson, Jimmy Maelen**

## DEPARTMENTS

- 6 CURRENT**
- 8 INDUSTRY NOTES**
- 10 SESSIONS**
- 12 STUDIO NEWS**
- 74 PREVIEW**
- 203 MIX WORDS**
- 204 FEEDBACK**
- 206 CLASSIFIEDS**
- 210 AD INDEX**



# FROM THE EDITOR

## DIRECTORY

SOUTHERN CALIFORNIA  
STUDIO DIRECTORY

- 163** STUDIO LOCATION INDEX
- 166** 4 & 8 TRACK STUDIOS
- 173** 12 & 16 TRACK STUDIOS
- 178** 24+ STUDIOS



This month's cover: Cherokee Studios' new custom designed recording console, incorporating the famous Trident A range equalizer circuit, is the centerpiece of Studio I. The Hollywood based facility is a TEC Award nominee for Outstanding Recording Studio. Photo by: Greg O'Laughlin  
Corner photo of David Byrne  
by: Bonnie Schuffman/Onyx ©1986



*Mix Magazine* is published at 2608 North St., Berkeley, CA 94702 and is ©1986 by Mix Publications, Inc. Third Volume No. Number Nine, September 1986, MSJ11111 (004-3057) is published monthly. Subscriptions are available for \$24.00 per year (single copy price is \$4.00; back issues \$5.00). Subscriptions outside U.S.A. are \$30.00. Please address all correspondence and change of address to *Mix Magazine*, 2608 North St., Berkeley, CA 94702. (415) 843-7901. Fax: (415) 843-2640. Second class postage paid at Berkeley, CA and additional mailing offices. *Mix Magazine* is distributed in printable stores, newsstands and other retail outlets. If you have a mailing or news-related business, and would like to distribute *Mix Magazine*, as a mail, bring advertising rates, rates and library data are available upon request. This publication may not be reproduced or quoted in whole or in part by newspapers or any other printed matter without written permission of the publishers.

**A** few days ago, something happened that made me think about how far we've come in the communications business. A writer called and said he had an article he wanted to send in to our sister publication, *Electronic Musician*. I was working at my computer when I took the call, and since he had a modem at his end, I suggested he send it to me then and there over the phone line. He did, and just seconds later his article was scrolling across my screen.

So far, so good. But I don't edit *Electronic Musician*; Craig Anderton does, from his high-tech cottage in Northern California. So from this point, I punched a few more keys to get into the electronic mail computer network and bounced the article into Craig's e-mail box. Later that day, Craig called the article up on his screen and applied his editorial handiwork.

What happens when Craig is finished editing? He can send it back to my e-mail box where it can flow through my computer directly into our typesetting department, where our masterful team of typesetters apply their magic touches to keep the words going in the right direction. And then, voila! Typeset copy, ready for pasteup.

When I worked in a studio some years back, we used to joke about phoning in our parts. It's no longer a joke. Digital signal transfer has opened new doors for all of us, as illustrated by both Bruce Nazarian and Phil Tripp in this issue. Bruce, in his "In Sync" column, tells us about the variety of special interest computer networks available to music people, while Phil e-mailed a piece from Australia taking a closer look at Esi, a network that has gained considerable favor with both studios and touring organizations.

If you'd like more on this area, catch the September issue of *Electronic Musician*, which devotes the bulk of the issue to the topic of telecommunications.

Keep reading,

David M. Schwartz  
Editor/Publisher

# CURRENT

## **Manufacturers Meet on DAT**

Manufacturers from 14 companies involved in home entertainment equipment, blank tape and software recently met in New York City to begin a dialog on the future of digital audio tape recording (DAT) in the home entertainment industry. The meeting, which was called by Chris Byrne, vice president of sales and marketing for Akai America, Ltd., also included A&M Records, Arista Records, Capitol Records, Denon America, GRP Records, Maxell, MCA Records, Onkyo U.S.A. Corp., Polygram, Sanyo Consumer Electronics, Sony Corp. of America, Telarc Records and Technics.

The meeting's main focus was to open channels of communication between hardware and software manufacturers relative to the technology that will soon allow consumers to make CD quality sound recordings of up to four hours on a cassette about two-thirds the size of the common analog cassette. The attendees agreed to continue the discussions in the future.

## **Studer/Philips Agreement Signed**

The joint venture agreement for research and development of CD-related professional studio systems (June, "Current") has been signed by Philips and Studer, with each partner holding a 50 percent share in the new Studer and Philips CD Systems AG, headquartered in Regensdorf, Switzerland. Chairman of the board will be Dr. Willi Studer, with Dr. Pieter Berkhout occupying the post of managing director. Products and distribution for the new company will draw on the resources of both parent companies.

## **Sam Ash Hosts Women in Music**

The Sam Ash Music Corp. is sponsoring an all-day festival September 27 in New York City's Union Square Park in recognition of the growing role of women in music. The three-stage festival is being presented by the Universal Jazz Coalition, Inc. which has

produced the New York Women's Jazz Festival for the past nine years. Organizers are soliciting donations for the event and can be reached at (718) 347-7757.

## **Gand Musictech '86 September 13 & 14**

Gand Music & Sound will hold their Musictech '86 at the Skokie, Illinois Holiday Inn, September 13 and 14. The session of seminars, demonstrations and workshops will include over 40 exhibiting manufacturers and many well known musicians and producers discussing topics such as digital sampling, sound reinforcement and the recording of film soundtracks. Exhibitors will include Akai, E-mu Systems, Fairlight, JBL, Lexicon, Otari and Tascam. Call (312) 446-4263 for further details.

## **SHAPE Moves CD Plant**

SHAPE Optimedia, Inc., of Kennebunk, Maine, is in the process of relocating their Compact Disc production operation to the former Computer Vision facility in the South Sanford Industrial Park, in Sanford, Maine. The four-year-old 100,000 square foot space will allow SHAPE to achieve production goals of 20 million discs by the end of 1987 and 40 million per year by 1988. The new facility will also allow SHAPE to offer mastering and packaging services.

## **Video Facility Study Released**

A research study titled "The U.S. Video Facility Industry: The Business and Hardware and Tape Marketplace" has been completed by Market Tech Associates and released to charter subscribers.

Among the findings from the 217 questionnaires returned and the 409 phone interviews with video facilities and services were that 1986 sales volume in this industry would reach \$1.25 billion and that the average spending per facility on equipment, alone, will be \$395,000 this year. The

250-page benchmark study is available in two parts: the statistical results with analysis, and a Leadership Study of the industry's key executives. For more information, contact Market Tech Associates, 295 Madison Ave., Suite 3300, New York, NY 10017.

## **NAMM Draws 24,175**

The Summer Expo for the National Association of Music Merchants in Chicago drew 24,175 attendees including 11,732 buyers, 8,154 exhibitors, 217 manufacturers' reps, 708 non-exhibiting suppliers, 213 press, 2,305 exhibitors' guests and 846 VIPS and visitors. The buyer attendance was up 28 percent from the 1985 Summer Expo in New Orleans. Total exhibiting companies was 575, occupying 283,615 square feet of display area.

## **SPARS Expands Test Program**

The Society of Professional Audio Recording Studios (SPARS) has announced that, beginning in December, educational institutions and recording studios will be allowed to administer their National Studio Exam for recording engineers, a program they created last year in conjunction with the Educational Testing Service. SPARS will be assisting the school or studio with publicity, registration, materials, scoring and other aspects of the procedure. For more information, contact the SPARS office at (818) 999-0566.

## **Nestor to Produce CD's**

Nestor International Corporation plans to enter the CD production business with support from General Electric "late in 1986 with initial annual capacity expected at ten million discs," according to president Tom Nestor. Nestor's 40,000 square foot facility currently under construction will house mastering, molding and research equipment for CD's, CD-ROM and CD-I products. For more information, contact Nestor at 44-17 30th Ave., Long Island City, NY 11103.



**You rehearsed long hours. Spent more hours laying down tracks. And a few more adding overdubs. Now it's time to mix down to your stereo master. This is no place for compromise. Insist on a two-track recorder from Studer Revox, a company dedicated to music mastering perfection.**

Tour the premier recording studios of the world – from Abbey Road in London to Power Station in New York to Lion Share in Los Angeles – and you'll find they have one thing in common: mastering recorders from Studer of Switzerland.

Granted, their Studer decks cost in the neighborhood of \$10,000. But, for about one-fifth that amount, you can own a two-track mastering recorder with the same bloodlines – a machine which draws on the same advanced audio technology and the same world-renowned expertise in precision manufacturing. The PR99 MKII.

Like its "big brothers" in top studios, the PR99 MKII is built for long-term performance. The transport chassis and head-block are solid diecast aluminum, milled and drilled with exacting precision. So the parts fit together right. And stay together for a long time.

The PR99 MKII is also loaded with professional features: Balanced and floating +4 inputs and outputs. 10½" reel capacity. Tape dump. Self-sync. Input switching for tape echo effects. Output mode switching. Edit mode switch. And built-in

front panel vari-speed. Options include steel roll-around console, monitor panel, and remote control.

The new microprocessor-controlled counter / locator saves time (and cools tempers!) in tricky mixes. Touch a button and go to zero. Exactly to zero. Touch another button and go to a locate point, which can be entered from the keyboard or "on the fly" from the counter. Because PR99 MKII finds your cues, you can concentrate on your mixing.

In overall sound quality, we believe the PR99 MKII once again steps out in front of the competition. So when you finish mixing, you hear a playback which captures all the excitement of your tracks.

But that's for your ears to decide. Contact your Revox Professional Products Dealer and arrange an audition. Why settle for less than mastering perfection?

## STUDER REVOX

Studer Revox America, Inc., 1425 Elm Hill Pike, Nashville, TN 37110 / (615) 254-5651

Circle #002 on Reader Service Card



# INDUSTRY NOTES

Korg USA has opened a 15,000 square foot complex including offices, a sound room and a warehouse to provide more services and support for their west coast dealers. The facility is located at 7886 Deering Ave., Canoga Park, CA 91304, (818) 888-2022. . . Valley Audio opened an Atlanta branch office, headed up by Ridge Nye, formerly of Interface Audio. The new office can be contacted at P.O. Box 467278, Atlanta, GA 30346, (404) 252-7968. . . J.W. Davis & Co., commercial sound manufacturer in Dallas, has named Jack Tucker vice president of sales. . . ADA Signal Processors, Inc. has appointed Bill Houston as chief engineer. . . Robert W. Sandell has been chosen as vice president of marketing and sales at Kurzweil Music Systems. . . Cubicomp Corporation has expanded and relocated its headquarters to 21325 Cabot Blvd., Hayward, CA 94545. . . Design Direct Sound, Inc., of Seattle, WA, has entered into an agreement to market mixing consoles manufactured by Walker Audio Visual Engineering under the DDS name. . . Simon Systems has moved to a new facility at 707 Clear Haven Drive, Agoura Hills, CA 91301, (818) 707-9980. . . One Pass, the San Francisco-based teleproduction center, has announced the completion of its acquisition by the George Banta Company, one of the nation's largest graphic arts and printing companies. . . Advanced Music Systems has relocated its facilities to a 28,000 square foot building at Billington Road, Burnley, Lancashire, U.K. BB11 5ES. . . Musication has opened a Music Technology Center, at 1600 Broadway in New York City, featuring a wide variety of services and resources for electronic musicians. They can be reached at (718) 680-5500. . . Samson Products Corporation has expanded to larger quarters, including a 6,000 square foot warehouse, at 124 Fulton Ave., Hempstead, NY 11550. . . Robert A. Slutske has been named senior product manager of video editing systems for the audio-video systems division of Ampex Corporation. . . James D. Sullivan has been promoted to director of DeltaLab, the pro audio division of Analog & Digital Systems. . . Audio Precision, Inc. has announced the appointment of Adolfo Rodriguez as marketing product manager for the company's System One audio test equipment. . . SPARS is making available cassette tapes of their recent studio business conference on the seminars "Obedience Training for Bankers," "Insurance Costs" and "Investment Analysis and Cash Flow." For more informa-

tion, write to the SPARS National Office, P.O. Box 11333 Beverly Hills, CA 90213. . . Suzanne Foster has been appointed marketing coordinator for Audio Kinetics Ltd. . . Syn Aud Con will be holding an "Intelligibility Workshop" in Chicago, September 23 through 26, with Rollins Brook of BBN, David Klepper of Klepper Marshall King, and VMA Peutz of Peutz & Assoc. Call (714) 728-0245 for details. . . Mitsubishi's pro audio group has announced the appointments of Allen Rumbaugh as their new regional manager for the mid-America district, Saul Walker as new manager for broadcast marketing for the New York regional office, Ralph Moss as eastern regional sales manager and former SPARS president Jerry Barnes as an "informal advisor" to the firm. . . Anchor Audio has announced the purchase of the ROH product line of intercom systems, audio distribution networks and audio line monitors. . . Panasonic Industrial Company has named James Murray western regional sales manager, Chris Forman marketing manager and Greg Braithwaite central regional sales manager for its RAMSA operations. . . Harold George, of Indiana Electronics has been elected president of the National Sound and Communications Association. . . Aphex Systems Limited has announced the appointments of Upstate Marketing as representative for Upstate New York, and Jack Nead & Assoc. as rep for Kansas, Missouri, Nebraska and Iowa. . . The James Lloyd Group has formed as a national executive recruitment company specializing in entertainment industry technology, at P.O. Box 3, Ashland, Oregon 97520. . . ADM Video Productions Inc. has opened a new production facility at 40 Seaview Blvd., Port Washington, NY 11050. . . Bill Rickard has been appointed vice president for marketing for Spectrum Magnetics, Inc. . . Sherwin H. Becker, vice president of engineering at Allied Film & Video, Detroit, MI, has been appointed manager of engineering for the Society of Motion Picture and Television Engineers. . . Capron Inc., of Needham, MA, has acquired Timbre Audio, of Georgetown, MA. . . Orion Research, of Cleveland, OH, has appointed Tom Harmon to the position of production manager. . . the audio systems division of Pierce-Phelps, Inc., Philadelphia, PA, has added Thomas Knauss, sales engineer; James Ritz, senior audio engineer; and Jerry Williamson, sales representative.

## MIX MAGAZINE STAFF

PUBLISHER/  
EDITOR  
David M. Schwartz

PUBLISHER/  
GENERAL MANAGER  
Penny Riker Jacob

ASSOCIATE PUBLISHER/ADVERTISING DIRECTOR  
Hillel Resner

MANAGING EDITOR  
Blair Jackson

ASSISTANT EDITOR  
George Petersen

ASSOCIATE EDITOR  
Ken Pohlmann

SENIOR EDITOR  
John Woram

MUSIC EDITOR  
David Gans

EDITOR-AT-LARGE  
Mr. Bonzai

EDITORIAL ASSISTANTS  
Linda Johnson  
Karen Dunn

CONTRIBUTING EDITORS  
Iain Blair Lou CasaBianca  
Dan Daley Bruce Nazarian  
Larry Oppenheimer Bruce Pilato  
Elizabeth Rollins Tony Thomas

ART DIRECTOR  
Tim Gleason

ASSISTANT ART DIRECTOR  
Dave Marrs

DESIGN AND PRODUCTION  
Patsy Messerer  
Anita Wong-Dun

TYPOGRAPHY  
Linda Dierking  
Connie Wiggins  
Melinda Breitmeyer

PRODUCTION MANAGER  
Anne Letsch

PRODUCTION ASSISTANT  
Kathy Badertscher

ASSISTANT ADVERTISING DIRECTOR  
EASTERN AD MANAGER  
Jeffrey Turner

SOUTHERN CALIFORNIA/SOUTHWEST AD MGR.  
Ken Rose

NORTHWEST/NORTH CENTRAL AD MGR.  
Horton Firmin

ADMINISTRATIVE ASSISTANTS  
Jane Byer  
Randy Alberts

DIRECTORIES/CLASSIFIEDS MANAGER  
Lauri Newman

DIRECTORIES ASSISTANT  
Athena Craig

TRAFFIC MANAGER  
Neil McKamey

CIRCULATION MANAGER  
Nick Clements

CIRCULATION SERVICES  
Judith F. Acton

CONTROLLER/BUSINESS MANAGER  
Mark Gunther

ASSISTANT CONTROLLER  
Linda Simpson

ACCOUNTS PAYABLE  
Cathy Boyum

CREDIT MANAGER  
Ann Cuadra

BOOK DIVISION GENERAL MANAGER  
Craig Wingate

ASSISTANT MANAGER  
Camille Coyne

FULFILLMENT SERVICES  
George Keres

OFFICE MANAGER  
Rachel McBeth

NATIONAL EDITORIAL, ADVERTISING  
and BUSINESS OFFICES  
2608 Ninth St., Berkeley, CA 94710  
(415) 843-7901

SOUTHERN CALIFORNIA ADVERTISING OFFICES  
19725 Sherman Way, Suite 160, Canoga Park, CA 91306  
(818) 709-4662





# Westar

*“It outperforms that well-known console, for much less money.”*

Compare features, specifications, sonic performance and dynamic automation options, and you'll agree. Key features: Fully parametric EQ on *all* 4 bands. *Eight* echo/cue sends. *Dual* stereo mix buses. 60 segment LED meters with *spectrum analyzer*. 24 track monitor, from 20 to 60 inputs. *Field expandable* frame. *Three* levels of automation options.

Typical performance: Transformerless +28 dB outputs. EIN at -129 dB. Output noise at -86 dB. IM distortion at 0.02% with VCAs. Crosstalk at -80 dB. Wide band frequency response. Excellent RF immunity.

With prices starting at less than \$50,000, it all adds up to a professional studio console system offering an unequalled performance/price ratio. Call or write for our comprehensive brochure.

Designed and built in U.S.A.

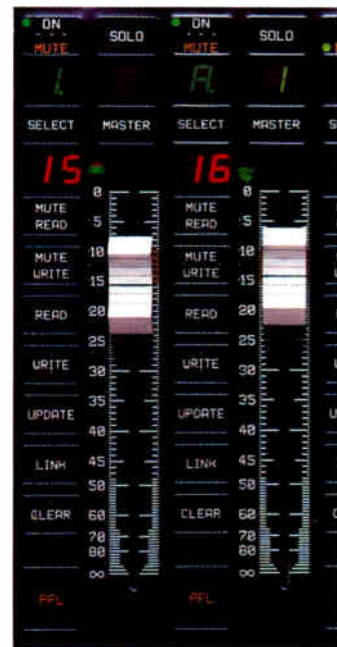

Optional IDF Faders



## MITSUBISHI PRO AUDIO GROUP

DIGITAL ENTERTAINMENT CORPORATION

Headquarters: 225 Parkside Drive, San Fernando, CA 91340 • Phone (818) 898-2341 • Telex 311786  
 New York: Suite 1530, 555 W. 57th Street, New York, NY 10019 • Phone (212) 713-1600 • Telex 703547  
 Nashville: Suite 306, 104 Eastpark Drive, Brentwood, TN 37027 • Phone (615) 371-6602 • Telex 5106017477  
 Canada: 2602 Esplanade, Toronto, Ontario M5A 1J2 • Phone (416) 365-3363 • Telex 06219839  
 United Kingdom: 1 Fairway Drive, Greenford, MIDDX UB6 8PW • Phone (01) 578-0957 • Telex 923003

## NORTH CENTRAL

Recording activity at *Studio A*, Dearborn Heights, MI, included TSR Jazz Records artist, **Dennis Coffey**, digitally mixing his first jazz album with **Eric Morgeson** at the console, **Bill Brooks** and **Eric "Lance" Livengood** assisting... Jazz pianist **Dave Bloom** was in Chicago's *Tone Zone Recording* with bassist **Larry Grey** and drummer **Joel Spencer** to record a number of tunes, including, "There'll Never Be Another You" and "Blue and Green." ... At *Comfort Sound* in Toronto, **The Nylons** taped three radio jingles for Levis, and **Jack De Keyzer** finished work on his new EP... At *Solid Sound Inc.*, Ann Arbor, MI, professor **Michael Udow** produced an album for the University of Michigan's percussion ensemble, with **Rob Martens** engineering... **Pete Special** of Big Twist & the Mellow Fellows was in at *Paragon Recording* (Chicago, IL) laying tracks on two new cuts, titled "Fat Back" and "Street Music." The project was produced by **Gene Barge**; **Bob Kearney** engineered... *Chicago Trax's* studio activity included **Darryl Thompson** producing a three-song demo for Epic recording artist, **Smoke City**, for their new album. **Al Ursini**, **Joe Tortorici** and **Bob Kearney** engineered the project...

## SOUTHEAST

Country singer **John Conlee** worked on a new album at *Muscle Shoals Sound Studio* with producer **Bud Logan**... At *Bias Recording* in Springfield, VA, engineer **Bill McElroy** has been engineering a project by **Sweet Honey in the Rock's Bernice Johnson Reagon** which will be released on the Flying Fish label entitled *River of Life: Harmony 1*... At *Cotton Row Recording* in Memphis, musician **Jeff Hale**, who's worked on albums by Waylon Jennings, David Allen Coe, and toured with Tanya Tucker and Marie Osmond, produced four sides for new artist **Jamie Kyle**. **Nikos Lyras** co-produced... Recent projects at *The Terminal Recording Studios* in Jackson, MS, included an album collaboration by **Tim Lee** (Windbreakers) and **Matt Piucci** (Rain Parade), and **Karnival Season** completed their project for MCA Records with **Randy Everett** and Tim Lee producing... Recent projects at *Morrisound Recording's* brand new facility in Tampa, FL, include **Agent Steel's** latest album on Combat Records and an album for the **Bell Shoals** 130-voice choir... **Randy Scruggs** completed production on **Sawyer Brown's** third LP for Capitol/Curb. **Ron Reynolds** engineered the project at *Scruggs Sound Studio* in Nashville...



Shown rehearsing at Dallas' Omega Audio for the HBO special, **Fats and Friends**, are left to right, **Paul Shaffer**, music director of the **David Letterman** show, **Ray Charles**, **The New Orleans Raylettes**, and guitar great, **Roy Gaines**.

## SOUTHWEST

Independent record producer **Gordon Perry** produced the latest release by **Stevie Nicks** for the upcoming motion picture soundtrack, **American Anthem** at his own *Goodnight Dallas*. Joining Perry and Nicks was guitarist **Michael Cambell** of Tom Petty & The Heartbreakers... Recording activity at *L.A.W. Recording Studios* in Las Vegas included MCA artist **Randy Hall**, mixed digitally for his new album; engineering was **Reggie Dozier**... Producer **Darrell Bledsoe** was in at *Rivendell Recorders* in Pasadena, TX, working on more material for **Silver Burdett, Co**, with **Steve Dady** engineering... *Goodnight Dallas* hosted **For Reasons Unknown**, MTV's recent Basement Tapes champs, who cut demos for their upcoming album on Epic Records. **Gordon Perry** produced with engineer **Tom "Gordo" Gondolf**...

## NORTHWEST

Recent activity from Alameda, CA, independent label **Jenpet Records** included a remote digital session with **The Brassworks Band**, recorded live at Oakland's Mills College, with **J.J. Jenkins** at the board in the truck and **George Petersen** producing... At the **Music Annex** in Menlo Park, CA, **Roger Wiersema** recorded demos with **Ronnie Montrose**. Wiersema also mixed the title track for the Tri-Star Pictures release **Creeps**... At the **Banquet Sound Studios** in Santa Rosa, CA, **Death Angel** completed their premiere album produced by **Death Angel** and **Davey Vain**, engineered by **Warren Dennis** and **Denis Hulett**... At *Prairie Sun Recording*

in Cotati, CA, **Mico Weaver** (Prince & The Revolution) worked on two songs: "I Get Hot," and "You're Just a Tease," with **Steve Fontano** at the board and **Daniel Crozier** programming the E-mu II and Mac... **Dan Fogelberg** and **Russ Kunkel** were in at *Lahaina Sound Recording Studio* (Maui, HI) doing overdubs for Fogelberg's new album **Niko Bolas** engineered with **Steve Tose** and **Dave Russell** assisting... At *Montage Recording Studio* in Newark, CA, recent sessions included an album by **Stan Robley** with **James McCallum** producing and **Jamie Bridges** engineering. And **Randy Spendlove** was in producing his band **La 'Vant's** latest LP... At *Triad Studios* in Redmond, WA, **Steve Miller** mixed his new album for Capitol Records. **Rick Fisher** engineered with **Mike Tortorello** assisting... Producer **Andy Kulberg** was in at *Russian Hill Recording* in San Francisco working with symphony violinist **Daniel Kobialka** on three new LP releases engineered by **Gary Clayton**... At *Spectrum Studios* in Portland, OR, artists **Nu Shooz** were in with producer/manager **Rick Waritz** cutting tracks for their recently released album **Poolside**, with **Mike Moore** and **Jim Rogers** engineering... SF rockers the **Yanks** worked on their third album at *Starlight Studio* in Richmond, CA, this time with producer **Norman Kerner**... **Holly Kline** was in at **Steve Lawson Productions** in Seattle, WA, working on a six-song demo with sound engineer **Bruce Calder**... At *Bear Creek* (Woodinville, WA) **Lionel Richie** and **Eric Clapton** recorded tracks for their soon-to-be-released album... At *CD Studios* in San Francisco, **True West** completed its third LP titled **Hand of Fate**. The album was produced and engineered by **Gary Hobish** with assistance from **Trey Sabatelli**...



**MIDI**  
Interface Now Available



# STAR QUALITY.

## Everybody wants it. The Eventide SP2016's Got It.

Why is Eventide's SP2016 Effects Processor/Reverb a part of so many hit records? Because, when you're going for a hit, you give it everything you've got. And the SP2016 simply has more to give. That's star quality.

The SP2016 offers more creative choices. From the start, it has provided many more different kinds of effects than other high end units. Everything from Loop Edit sampling to our incredibly versatile Multitap program. Plus a wide variety of very different reverbs (not just a few basic programs with lots of minor variations). And the SP's lead over the competition keeps widening, with new available programs such as Channel Vocoder and Automatic Panner, and new enhancements such as MIDI implementation. Because the SP2016's basic design is so powerful, we can continue to enhance it almost infinitely.

Star quality means stellar audio performance, too. And that's another big reason why so many studios, engineers, producers and artists specify the Eventide SP2016. Some digital effects units have one or two "hot" sound everybody likes, plus a number of "not-so-hot" programs nobody likes. But with the SP2016, you get great performance on every reverb and effect program. Our Stereo Room and Hi Density Plate programs, for example, are

smoother and denser than anything the competition offers. But when you need "nasty", gritty reverb sounds, the SP2016 has them too.

So the SP2016 is as suitable for the sound of Twisted Sister as it is for the sound of Mr. Mister. For George Duke and Mick Jagger, Arcadia, Hooters and Bronski Beat, Linda Ronstadt, Cyndi Lauper, Whitney Houston and Pat Benatar, B.B. King and Johnny Mathis, Ratt and the Roches. For all the other "star quality" performances and hit records we've been privileged to be part of. And all the hits to come.

Including perhaps, your next session. For more information, to request an SP2016 demo cassette or to set-up a "hands-on demo", call Eventide toll-free at (800) 446-7878.

And anytime you want an "instant" demo of the SP2016's star quality, just reach over and turn on the radio.

**Eventide**  
the next step

ONE ALSAN WAY • LITTLE FERRY, NJ 07643 USA • (800) 446-7878

NJ and outside USA: (201) 641-1200

## SOUTHERN CAL

At the *Village Recorder* in Los Angeles, **Thomas Dolby** worked on the MCA soundtrack for Universal Pictures' *Howard the Duck*, and the *Talking Heads* worked on projects in the newly reopened Studio A... *Survivor* was in *One on One Recording* in North Hollywood tracking for their upcoming record with **Ron Nevison** producing and engineering. **Toby Wright** assisted the session... Working at *Lion Share* in L.A. has been **Michael Omartian**, producing several cuts for *Donna Summer's* album on Geffen Records. Engineering the project is **Terry Christian**, with assistance by **Laura Livingston**. Omartian is also producing his own album for the Reunion/A&M label, with Christian engineering the dates... At *Wildcat Studios* (Los Angeles), rockers *Call of the Wild* began work on their first LP, with in-house engineer **Mark Coffin** engineering and producing... IRS artists *The Three O'Clock* worked on their next LP, *Ever After* at *Mad Hatter Studios* in L.A. **Ian "Kingfish" Broudie** produced (Echo & the Bunnymen and Wall of Voodoo) and **Ian Taylor** engineered... **Brian Setzer** and *The Stray Cats* were in *Capitol Recording Studios* (Hollywood) recording a new LP. The Stray Cats produced with **Peter Doell** engineering and **Sam Ramos** assisting... At *Soundcastle Studios* in L.A., **Denise Lambert** produced and **Jeremy Smith** engineered, tracked and mixed the new album by the *Commodores* with **Paul Erickson** assisting... The *Angels* worked on their LP at *Sound Image* (N. Hollywood) with guest artists **Paul Butterfield**, **Jerry Peterson**, and **Denny Seiwell** adding the finishing touches, with **John Henning** producing and engineering... Recent activity at *Sound Affair Recording* in Santa Ana, CA, included **Adam Ant** recording for EMI Records, with **Ron Leeper** and **Barry Keenan** engineering... At *Producers 1 & 2* in Hollywood, **Bob Ezrin** finished production on *Berlin's* latest LP... **Bonnie Raitt** did the final mixes on her new album at *The Complex* in West L.A. **George Massenburg** and **Bill Payne** produced the album; Massenburg also engineered, and **Sharon Rice** assisted. **Linda Ronstadt** and *The Nelson Riddle Orchestra* were also in putting the finishing touches on their latest album... At *Conway Recording Studio* in Hollywood, **Johnny Mathis** tracked his LP with **Henry Mancini**, called *Mathis & Mancini*; **Denny Diante** produced. **Daren Klein** and **Mick Guzauski** engineered with help from **Richard McKernan** and **Jesse Peck**... At *Mama Jo's*, North Hollywood, **Word** recording artist **Carmen** mixed his new LP with producer **John Andrew Schreiner** and **Steven Bradley Ford** at the controls... At *The Village Recorder* (West L.A.), Australian band *Mondo Rock* was in mixing their LP, engineered and produced by **Bill Drescher** with **Charlie Brocco** assisting... At the *Yamaha Research & Development Studio* in Glendale, **Bob Seger** was in cutting tracks with producer **Victor Flores** and engineer

Keith Cohen...

## NORTHEAST

**Bill Cosby's** new comedy LP was mixed at *Broccoli Rabe Entertainment Complex* (Fairfield, NJ) by **Brian Drago** and **Tom Zepp**. The album is entitled *Those of You With or Without Children, You'll Understand*, and was produced by **Camille O. Cosby**... In at *Rawlston Recording* (NYC) were **Kurtis Blow & Kuwa Music** with **Fonda Ray, Bic** and *Grand Master J* and the *Twin MC's*, co-produced by **Wayne Garfield** with **Tommy Weber** and **Frank Grant** engineering, and **T. Smalios** and **G. Mayers** assisting... *Tricky T's* new album for Sleeping Bag Records was completed at *I.N.S. Recording* in NYC. **Sam Sever** produced with **Robert Kasper** engineering and **Chep Nunez** editing... At *Sigma Sound Studios* in Philadelphia **Sheena Easton** recorded five songs for her new album. The sessions were produced by **Nick Martinelli**, and engineered by **Michael Tarsia**, **Gene Leone**, and **Scott Mac Minn**... Recent activity at Manhattan's *Platinum Island Studios* included **Noel Pointer** recording with writer/producer **Richard Eisenstein** and engineer **Jerry Gottus**... The Tangerine Dream LP, *Underwater Sunlight* and the Mahavishnu Orchestra's *Adventures in Radio Land* are two of the latest projects that were mastered digitally at *Trutone Records* in Haworth, NJ. They were mastered by **Carl Rowatti** and **Phil Austin** respectively... Activity at New York's *MediaSound Studios* included **Narada Michael Walden** producing the **George Benson** tune "Shiver." **Lincoln Clapp** was at the controls with **Victor Deyglio** assisting... The PBS Station WHYY called on Philadelphia's *Modern Audio Productions* to assist in the production of their new pilot, *Night Music*. Jack Dyke, technical engineer for MAP, coordinated the entire television audio portion... Actress/singer **Lee Merideth** was in at *Reel Platinum Recording* (Lodi, NJ) with producer **Jimmy "The Whiz" Wisner** putting finishing touches on her single "Pick Me Up"... In Woodbridge, CT, *Sound Concepts Inc.* was host to *100 Faces*, a New Haven-based band working on their debut EP; **David Greaves** engineered and mixed the project... At *Power Play Studios* in Long Island, **Bruce Forest** was in doing various projects, one of which was the re-mix of the *Dhar Braxton* record *Jump Back* for Sleeping Bag Records... At *39th Street Music* in NYC, **Ashford & Simpson** completed mixing their upcoming album, with **Mike Hutchinson** engineering and **Tim Cox** assisting. Also, **Rick Derringer** produced **Norman Nardini** for CBS Records with **Tom Edmunds** engineering, assisted by **Barnaby Bristol**... *Startec Studios* in Washington, D.C. completed a project with some of D.C.'s best go-go bands. *Redd's & the Boys*, *CI's Uptown Crew*, *Ovation Band*, *Pep Boys*, *Little Benny & the Masters* and *Petworth Band* were all involved, produced by **Verdine White** (Earth,

Wind & Fire) and *Tom Tom 99* (Tom Washington). The engineer was **Jack Rouben**, assisted by **Chris Murphy** and **Stuart Casson**... At *Giant Sound* (NYC), **Peter, Paul & Mary** recorded their all-digital LP for Gold Castle Records. It was engineered and produced by **John McClure**, and mixed by **Malcolm Pollock**. **Jeff Cox** assisted...

## STUDIO NEWS

*Marin Sound* in San Rafael, CA has upgraded its facility with the addition of a Studer A-80 24-track recorder. Also added were a number of new effects including a Sony PCM digital mix processor... *Crosstown Soundstage* is the new name for *Crosstown Recording* (Kalamazoo, MI) now that operations have been moved to Atlanta, GA. Mix-to-picture capability and an 1800 sq. ft. plant are part of the expansion plans for the new facility. For information contact: Brandon Wade, P.O. Box 52054, Atlanta, GA 30355-0054; (404) 237-5959... Howard Schwartz, president of Howard Schwartz Recording, has reopened *Studio West*, the seventh studio in the Howard Schwartz complex. It is large enough to fit 25 musicians and set up for commercial music recording, pre- and post-scoring for film and video, and record production work... *Horodko Soundtrax/T.L.A. Productions* in San Francisco has come online with satellite recording capability. They are now linked with other recording studios in major cities offering broadcast quality recording via satellite... *SoundStage I Recording* of Battle Creek, MI has recently added some new equipment to its racks including a Yamaha DX7, Ensoniq Mirage, Yamaha REV7, plus completed re-wiring of its effects/console harness... **Steve Bramberg** has exited his post as studio manager of Bears-ville Studios near Woodstock, NY to pursue the formation of a record production company... *Live Oak Studios* in Berkeley, CA, has acquired the first and only Publison Infernal Machine 90 Stereo Audio Computer in the San Francisco Bay area. This effects processor has 42 seconds of 16-bit sampling with option of up to five minutes. Music industry professionals recently enjoyed an exclusive demonstration of this incredible machine at an Open House Demonstration given by Live Oak and Sound Genesis with U.S. Publison expert, Camille Rizko, demonstrating. Also on hand was Lee Pomerantz of Digital Creations Corp. demonstrating the Disk-mix Automated Editing System... *Appletree Sound*, of Dallas, is a new synthesizer studio complex with the latest in computer-based recording as well as conventional 24-track tape technologies. The studios offer one of the largest collections of synthesizers in the Dallas area including Emulator II and Mirage samplers... *Sunset Sound* (Hollywood) took delivery of three Studer A800 Mk III 24-track tape machines. The initial placement is for Studio 2 which recently underwent a cosmetic change.



Series 65 / 24 x 16 x 16  
 1000 1944 97 776 1000  
 Dollars  
 John W. Hobbs  
 President



# AXON Audio

BOULDER, COLORADO 303-443-7301/442-2178

11 July 1986

Dear Trident:

In years of reading trade publications, I have become very aware of the Trident product. Most recently, Cherokee's new console incorporating Trident "A" Range technology caught my attention. I understand the only consoles they use are Trident.

We are continuing to update our multi-track studio. In investigating the various alternatives I have found the Trident Series 65 provides superior features at pricing substantially below other British consoles. As indicated by our Trident dealer, the sonic qualities (Trident's hallmark) carry through the 65 Series. My decision was clear.

We are a small facility in comparison with Cherokee, however the quality of our recording is of equal importance. We look forward to receiving our Trident.

Sincerely,

*John W. Hobbs*

John Hobbs  
 President

JH/sr



## Upgrade Vintage Tech

Cherokee Studios custom elements from the past v

By De



(213) 933-7555

WAYNE D. FREEMAN  
 PRESIDENT

308 NORTH STANLEY AVENUE, LOS ANGELES, CA 90036  
 TELEX: 5106000019 TRIDENT USA

Advertisement Courtesy:

acoustical  
 bridge.  
 When qu  
 ed to un  
 building  
 and

# Note



## Introducing a touch-sensitive system that's not out of reach.

You haven't gotten this far in your career by making compromises. That's the whole idea behind Casio's new line of professional products—uncompromising performance. It's also why we created a whole new division to help you get the most out of it.

And there's a lot to get. Our **CZ-1 (\$1,399)** is a full-size, 61-key synthesizer with programmable touch sensitivity. Initial touch, or velocity, can be programmed to control pitch, timbre and volume; while after touch can be adjusted to control modulation depth and volume.

It has 64 RAM memories which are loaded at the factory with a powerful assortment of PD sounds, or can hold the same number of sounds of your own creation. (You can still recall any of the factory presets at the touch of a button—even if you have written over them.) Our optional RA-6 cartridge (\$89.95) can immediately access another 64 sounds, for a total of 192 sounds in all!

In addition, the CZ-1 has a new Operation Memory, which holds 64 key-splits, tone mixes and other combinations for instant recall in the heat of performing. The key-splits

and tone mixes themselves now have added features to give you more flexibility, such as separate stereo outputs, independent detuning and octave shifts.

Of course the CZ-1's MIDI is advanced to the max—an 8-note polyphonic, multi-timbral system, which allows you to assign the 8 voices in any combination over the 16 channels of MIDI for all your sequencing needs.

And so you can easily keep track of all your sounds, the CZ-1 lets you name them yourself and shows you which ones you're using on its bright, back-lit alpha-numeric display.

Strapping on our **AZ-1 (\$549)** 41-key, full-size MIDI keyboard con-



# worthy.

AZ-1



troller is an easy way of adding mobility to your abilities. It's battery powered, touch-sensitive and will support all 128 program changes, even over two MIDI channels. The AZ-1 can be used to control any function of any MIDI instrument on the market by the use of ten controllers, five of which are user-definable. This allows you to customize its performance to match your set-up, no matter how your gear changes.

Adding drums to your system is as easy as plugging in our **RZ-1 (\$649)** sampling drum machine. It comes with 12 PCM presets, each with its own line output and volume slider, for ease of mixing.

When you want to add your own sounds, you can record up to four different samples at a 20 kHz sampling rate, with a .8 sec total sampling time. And to make your search for just the right sample easier, it comes with an audio tape of 91 drum and percussion sounds.

The RZ-1 has a 100 pattern/20 song memory and is one of the only drum machines on the market whose memory can accept dynamics from a MIDI keyboard or drum pad. Other features include real or step-time recording, auto-correction up to 1/96 of a beat, and tape or MIDI storage of your pattern or sample data.

Whatever system you're using, our **TB-1 (\$89.95)** MIDI switching thru box, will keep it neatly wired with two inputs and 8 switchable thru ports.

Even if price were no object, our new professional line would be a tough act to improve on. As it happens, though, it's the first touch-sensitive system that's not out of reach.

If performing is your life, you owe it to yourself and your audience to check out our performance. It's definitely noteworthy.

**CASIO**  
Where miracles never cease

Casio, Inc. Professional Musical Products Division: 15 Gardner Road, Fairfield, N.J. 07006 New Jersey (201) 882-1493, Los Angeles (213) 803-3411.

World Radio History

Circle #005 on Reader Service Card

# INSIDER · AUDIO

by Ken Pohlmann

Is there life after digital? That is the question being asked by analog-oriented audio manufacturers. Take Dolby, for example. That empire is built precisely on the shortcomings of analog tape. With digital steadily encroach-

## DOLBY SR

ing on all fronts—professional multi-track and 2-track, and consumer cassette—is that an enviable position to be in? On the other hand, should we expect the installed 90,000 tracks of Dolby A-type to quietly disappear, to become a footnote in history?

Enter Dolby Spectral Recording, or Dolby SR, a new type of noise reduction system for analog tape recorders. These single-channel plug-in modules are designed to replace the Cat. 22 card in existing and new Dolby mainframes; the new card, Cat. 280, plugs into Model 360 and 361 frames, as well as M-16, with the exception of channels 2 and 10. Other SR modules are under development, including the Cat. 431 module for SP and XP Series units. To identify a SR tape, and calibrate levels, bursts of pink noise are generated. At a cost of \$750 per channel, 24 or 32 tracks would amount to a down-payment on a digital multi-track. Is SR thus a viable, cost-effective alternative to digital recording? Or does it merely join other noise reduction systems as another in a family of incompatible products, with their fingers in a crumbling analog dike? The answer must begin with an analysis of SR's design...

Spectral Recording is a complimentary, dynamic noise reduction system; while other systems primarily use analysis of level changes, SR, as its name implies, uses analysis of changes in signal spectrum as well. Specifi-

cally, instead of responding to variations in overall signal waveform, SR reacts to changing amplitudes in different regions of the audio frequency spectrum. During recording, it provides additional gain to spectral regions containing low and medium level signals. During playback, the complimentary response is imposed.

To understand the task, let's consider a simple example of how the technique of level-dependent gain increase, and complimentary decrease works. Figure 1 shows an audio signal as a function of instantaneous amplitude versus time; in this case, a single frequency shows a gradual attack, and decay. Figure 2 shows the signal's changing level, exemplified by its envelope. Figure 3 introduces a noise floor, contributed from analog tape or other transmission channels; in practice, tape modulation noise and other level-dependent nonlinearities would be present. Figure 4 demonstrates the trick of increased gain during low level recording, and complimentary reduction upon playback. The result is lower noise during soft passages, while the signal masks the noise during high level passages. This technique is shared by Dolby A and SR.

However, considerations of the signal as a group of time-varying components in the frequency domain leads to the opportunity for further masking. Signal processing can be carried out in spectral regions not occupied by the signal, and hence not subject to masking. Figure 5 shows tape noise and tape saturation in the frequency domain. Tape noise is no longer a simple scalar; its time-averaged level varies with respect to frequency. Similarly, tape saturation (a function of equalization, tape characteristics, and spectra of typical program) varies with respect to frequency. Fortunately for both cases, human hearing is most sensitive in the middle range, where performance is good. A noise reduc-

tion system could decrease recording gain for high level signals at low and high frequencies, and increase gain during playback, and reversing the process applied at lower levels to achieve noise reduction. A key element would be the sensing of spectral regions not occupied by the audio signal. Figure 6 shows the SR system's use of a "gain surface" to process a 200 Hz tone. The curve shows the increased gain applied to a low-level signal by SR processing in the presence of the higher-level tone. The increased gain equals the noise reduction achieved by the system. Figure 7 shows a tone with frequency of 800 Hz; the SR circuit alters its spectral characteristics as shown. In Figure 8 the tone's frequency is 3,000 Hz; the noise reductions significant improvement shifts to a lower frequency.

Figure 9 shows the performance improvement claimed by the SR system. The figure is a plot of a recorder at 15 ips, with and without SR; in the central spectral region, dynamic range exceeds 105 dB measured between three percent distortion and the noise in each third-octave band.

Of course, such results are achieved at the expense of a considerable amount of analog circuitry; and the more tricks you play, the more extra tricks you need to cover your tricks, etc. In theory, SR utilizes the least possible processing to achieve its results. Let's take a closer look...

Figure 10 shows a complete SR block diagram. The main signal path primarily handles high level signals; the side chains are additively combined with the main signal during encoding, and subtractively combined during decoding.

The SR processor shows kinship to C-Type NR; however it uses three thresholds at -30dB, -48dB, and -62dB below reference level (20dB below SR peak signal level). Separate gain control is introduced as the signal

Figure 1

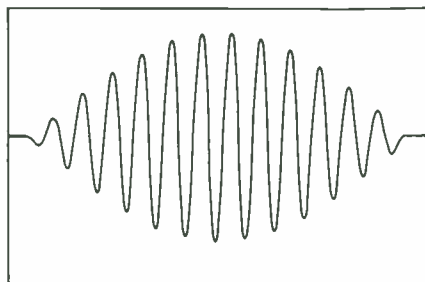

Figure 2

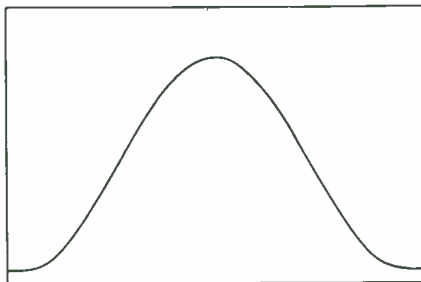
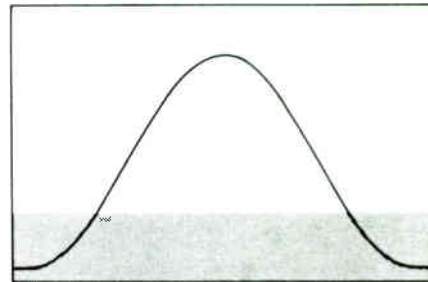

Figure 3





# 500 Golden Reel Awards



## 500 Golden Opportunities

Ampex proudly presents its 500th Golden Reel Award to Kool and the Gang for their album *Emergency*.

Thanks to their award-winning performance, we had our 500th golden opportunity to help.

Through seven years and 500 Ampex Golden Reel Awards, \$500,000 in charitable contributions have been used to combat disease, support medical research, promote the arts, help the elderly, preserve the environment, educate the underprivileged and more.

The Ampex Golden Reel Award is a symbol of

outstanding achievement honoring many of the world's top studio performers. An important part of the award is a thousand-dollar donation to the charity of the performers' choice.

The award is presented to albums and singles that have earned Gold Record status and are totally recorded and mixed on Ampex professional studio mastering tape.

We're pleased that 500 gold records and albums have been recorded on Ampex mastering tape. We look forward to 500 more.

**AMPEX**

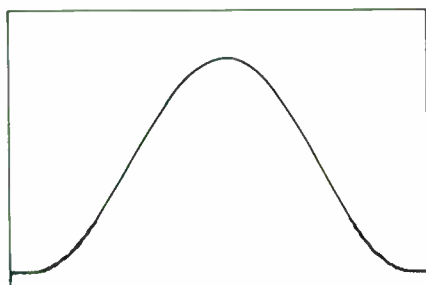

Figure 4

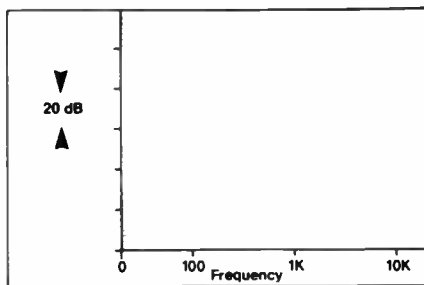

Figure 5

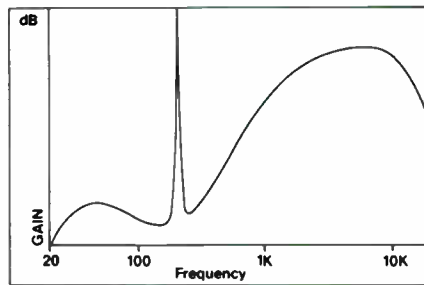

Figure 6

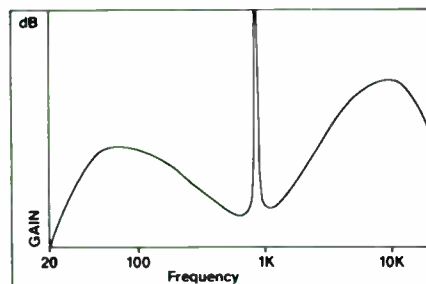

Figure 7

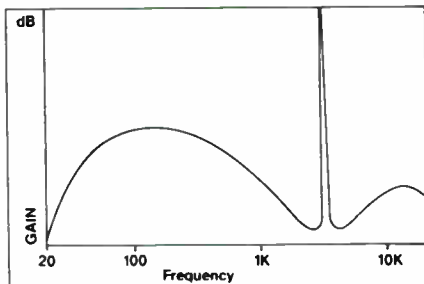

Figure 8

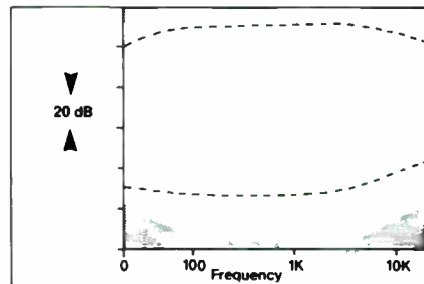

Figure 9

drops below each threshold. The higher two stages operate in separate high and low-frequency sections, with crossover at 800 Hz, while the lower level stage operates for high frequencies only, with an 800 Hz high pass characteristic. Overlap regions extend between the high and low frequency stages; the high frequency region extends down to 200 Hz, and the low frequency region extends up to 3 kHz. Each stage has a low-level gain of 8dB, thus an additive total of 16dB is obtained at low frequencies, and 24dB at high frequencies.

A spectral skewing circuit is provided; it serves to de-sensitize the system to frequency response and level anomalies in the tape and recorder. At very low and very high frequencies, less noise reduction is needed, thus strong spectral skewing action can be used. The high frequency network is a low pass filter with an attenuation characteristic similar to that of a 12 kHz two-pole Butterworth filter. The low frequency network is a 40Hz high pass filter also with a characteristic similar to a two-pole Butterworth filter. The spectral skewing circuits reduce the effects of signal components at the extreme ends of the audio frequency band; for example, irregular tape recorder frequency response might contribute supersonic interference. The skewing action is compensated for in the decoder.

To minimize audibility of processing, the encoder's design goal called for a predetermined, fixed gain for sub-threshold signals. Gain would be reduced only at large signal frequencies, according to a predetermined compression law. Thus the compressor attempts to fully boost all low level signals at all times, cutting back only at high level frequencies. Because the

high level signal masks its own gain change, the audible effect of this type of compression is that the signal appears dense and brighter, but without dynamic compression effects. Accordingly, this minimizes audibility of dynamic changes in the decoded signal, or errors in the event of gain or frequency response error in the recording.

Two methods are used to approach the design goal: an action substitution using fixed and sliding bands, and modulation control. Each of the five frequency bands incorporates a fixed and sliding-band filter, which interact to achieve an optimal configuration. In any stage, a fixed band is used, and a sliding band is substituted only when it provides better performance. This substitution is available on a continuous and frequency by frequency basis; for example, the output from a given high frequency stage will typically be from the fixed band for frequencies up to the dominant signal, and from the sliding band above that frequency. Conversely, the output from the low frequency stage will be from the fixed band for frequencies down to a low frequency dominant and from the sliding band below that. This action best utilizes the advantages of both the fixed and sliding bands; the encoder more closely approximates the goal of a fully boosted condition.

Modulation control also helps minimize signal-related modulation effects. In departure from A, B and C-Types, with a low threshold, highly limited side chain signal under high level conditions, whenever the side chain signal departs from an in-phase condition with respect to the main signal path, the threshold is raised. Also, after limiting has occurred, it is unnecessary to continue limiting as the

signal level rises. Thus side chain level stabilizes at a fraction of the main path level.

In the fixed band circuits, this does not affect the pass band (in-phase) frequency region. However, in the stop band region, the modulation control causes the limiting threshold to rise, and the degree of limiting to be reduced. Hence, large stop band signals do not cause modulation in the pass band, or impair noise reduction. In the sliding band circuits, as the input level rises, and once an overall gain of unity is obtained, further sliding of the variable filter is unnecessary. The modulation control circuit counteracts the variable filter; this too prevents unnecessary modulation and noise reduction impairment.

An overshoot suppression circuit operates on the control signals for the various stages. Overshoot suppression thresholds are 10dB higher than the steady state thresholds. Overshoot suppression is phased in gradually as a function of increasing impulse level, minimizing modulation distortion. Under relatively steady state signal conditions, overshoot suppression is phased out with increasing signal conditions; likewise minimizing modulation distortion. The thresholds are controlled by the same modulation control circuits used to control the steady state characteristics, thus there is no tracking action between the transient and steady state behavior.

The dynamic action may be summarized; first, for steady-state dominant signals. With low frequencies, dynamic action occurs in the range -48dB to -5dB relative to the reference level. There is no action in the lower 35-40dB of the total range, but there is linear dynamic action in the top 25dB of the total dynamic range, or for full boost-



# ECHO TIMES

In the last Echo Times you may have seen discussed the applications that a handful of early customers of AMS AudioFile were putting their systems to. Comments from those owners and subsequent users have helped in defining new and additional features which have now been incorporated on the control surface of AudioFile. As well as upgrading the control surface, production software has now been included in AudioFile which also reflects over 12 months of input with a view to making recording, editing and playback of material in sync with tape both easier and faster.

Since the benefits of using AudioFile in music recording became obvious, efforts were concentrated on the more specialist application of AudioFile for dubbing audio to video/track laying audio to video.

Of all the people invited to examine the production AudioFile – none were disappointed. The following 5 companies saw an immediate application and are a selection of customers who have ordered AudioFile systems for commissioning during May 1986: –

## AUDIOFILE



## The Best Thing Since Spliced Tape...

### MAGMASTERS

Magmasters has been in business for 5 years. Specialise in film and sound tracks which are either on 35mm or 16mm film or videotape and supply mixing facilities for those. Work can be for commercials, feature films or documentaries and television shows. Specialising in large budget commercials.

Having been aware of hard disk recorders for past 12 months and having considered Synclavier and Fairlight. AudioFile seems to offer more of an every day workhorse operation – and of course seems to do that whilst costing considerably less money. The advantages of working with AudioFile over a conventional tape is obviously the ability to shift tracks around which you can't do easily on a 24 track machine. AudioFile will make life

significantly easier when we are track laying sound effects to a video picture. Size was also a very important consideration and taking everything into account, AudioFile looks like the perfect device for our new studio which is specifically for post-syncing both sound effects and music to videotape ●

Steve Cook,  
Managing Director.

### SILK SOUND

Silk Sound is in its 8th. year of business and now has 4 studios, 2 of which are 24 track, 2 audio transfer rooms and a video transfer suite equipped with a 1" C format machine linked to the multitracks for video layoffs and laybacks. The studios specialise in commercials for television and radio and also corporate and broadcast programmes as well as audio visual training shows.

Silk Sound already owns several AMS audio processors and is therefore aware of the quality and reliability of AMS products. Having taken the time to visit AMS whilst considering AudioFile, we were very impressed by the obvious commitment of everyone involved.

Unlike many of AudioFile's competitors, it could be integrated into a mixing console as a total substitute for carts or CD effect players and even a digital multitrack. Using it as a digital multitrack locked to a tape transport saves a considerable amount of time as well as providing the ability for 'tracks' to be repositioned instantly.

Silk Sound sees AudioFile as an important addition to our commercial operation – not just a dream for the future ●

Robbie Weston,  
Managing Director.

---

## RUSHES

---

Rushes have been in business now for 9 years and in April announced expansion plans to provide Europe with its first fully integrated digital edit suite. To the already existing Quantel Paint Box is a new 'Encore' machine and the revolutionary new Quantel graphics system 'Harry'. Audio from AudioFile represents the final step in providing both digital vision and sound. It is expected that as well as using AudioFile with this graphics system, AudioFile will also feature at the heart of a digital sound facility proposed for Rushes sometime in the near future. Rushes were aware of other hard disk systems – some of which were just far too expensive and some of which required you to hire a piano player! AudioFile has been the right decision for Rushes. ●

Godfrey Pye,  
Chairman.

---

## SAUNDERS AND GORDON

---

Saunders and Gordon have been in business for just two years and specialise in sound for video. The majority of their work covers television commercials, industrial films, promotional films as well as pop promotional videos. The company became aware of the exciting possibilities of using hard disk based audio systems a little over 12 months ago when Lucasfilm introduced the SoundDroid. Although exciting, the

cost of SoundDroid was prohibitive and it did seem that other systems that appeared subsequently such as Synclavier were musical instruments rather than dedicated tools for recording, editing and sound manipulation.

As far as Saunders and Gordon are concerned, digital sound is definitely an advantage but the biggest plus for AudioFile is the ability to instantly recall sound with the capacity for having sound effects on-line. Whereas in the past film dubbers have had the advantage of being able to slip sprocket holes in film, we now have that same possibility – in fact AudioFile, being far more versatile, gives far more flexibility. ●

Robin Saunders,  
Director.

---

## ECO SOUND STUDIOS

---

ECO specialises in audio post production for film and video – mainly in the broadcast field and undertaking work with independent producers for Channel 4, S4C, HTV and the BBC. John Cross and Ken Rock, both directors of ECO, have spent time considering digital sound recording equipment and recently visited the NAB exhibition in Dallas where they had demonstrations of the currently available systems. Following due consideration of all the options, ECO accepted an offer from AMS in late April to be given a demonstration of the new and updated



John Cross and Ken Rock of ECO.

form of AudioFile that had not been seen outside the AMS factory previously.

The modifications that had been made to AudioFile meant the system would be perfect for ECO Studio 3. AudioFile will be used initially for revoicing French language programmes into Welsh giving the advantages of digital sound, no loss of quality due to regeneration and of course the unquestionable advantage of 'fine sync' on revoiced material. AudioFile will allow more efficient use of both studio and artists – It should soon pay for itself. ●

John Cross,  
Director.

---

# PEOPLE IN THE KNOW

---

"Some recordings can be relatively simple. Alison Moyet's voice was simply recorded straight with a little ghost behind it; AMS on quavers and crotchets.

Vocal lines are improved generally with a discreet repeat behind. I usually use AMS. I think it's the best because I have never wanted to do anything that it hasn't been able to cope with. The sampling is great and now you can use it as an alternative to spinning in choruses from tape because of the increased sampling time."

*Pete Wingfield talking to Janet Angus, Home and Studio Recording.*

"It's also very difficult for guitarists to play half a riff, wait, and then play the other half of the riff, and get it to sound monotonous in the best sense of the word, as the drum tracks were all sampled. The guitarist just played it through and we selected the parts we wanted and created a four part cycle just dropping the bits in by triggering them off an AMS.

We also did two further stages of work on a shaker. We sampled the opening beat of the shaker and put it into an AMS and recorded it again on another track to give a false dynamic. Then Sade sung a shaker sound into an

AMS. We took that and triggered it off in the same way, but on choruses only, just increasing dynamics."

*Robin Millar of Power Plant talking in Sound Engineer and Producer Magazine about the making of the track "The Sweetest Taboo" on Sade Adu's "Promise" album.*

**R-e/p:** Do you use digital sampling to capture elements and move them around in the song?

**Louil Silas:** Oh, man, all the time! In fact my nickname at one point was Louil "AMS" Silas! When I first came here to Larrabee (Studios, Hollywood), and Taavi showed me the things that different pieces of outboard equipment could do, I was amazed. I love the AMS (DMX 15-80S digital delay/sampler) and the (E-mu Systems) Emulator.

Usually, I use sampling for vocal phrases that I may want in a different part of the song. Or, for example, the song we're working on tonight – "Crush On You", by the Jets – has a tom fill at the end that I want to put in the first verse. So, we'll be using the AMS to move it.

*Louil Silas, Jr. talking to Recording Engineer Producer Magazine.*

Our philosophy is different to other producers; we would rather have plain decor and 7 AMS units. We have two REV1s, three REV7s and 9 AMS's. But when we make a record every piece of outboard gear is used and sometimes even more is hired from our own hire company.

There are no real instruments and even when we do use a guitar we use it through a Rockman with lots of effects into the desk. Any drummer will play Simmons pads triggering real drum sounds off an AMS. We don't need a studio because with this equipment we can build the Aibert Hall.

*Pete Waterman talking about his London recording studios to H & SR magazine.*

We use the AMS for certain things and I think you'll find most studios use them on the ambient setting because it's the best thing the AMS does. We got to a situation where Andrew would say 'Lets sample the cymbal into the AMS and just trigger it off?'

*Graham Gouldman formerly of 10cc talking about the making of an album with Andrew Gold to Paul White in Home and Studio Recording.*



# THIRD QUEEN'S AWARD

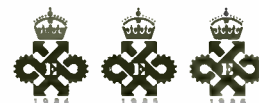

On the 21st of April 1986 AMS was pleased to be advised that for the third consecutive year that the company had been awarded the Queen's Award for Export Achievement. Pictured are Mark Crabtree and Stuart Nevison along with members of the workforce in the production area of the new factory.

Of particular note on this occasion is that the local press received the following statement from the Queen's Award office - "Exceptional to say the least - we are aware of only one other company winning the award three years on the run". The other company turned out to be Jaguar Cars.

The directors, members of staff and the entire workforce would like to take this opportunity of thanking each and every one of the company's foreign distributors whose efforts have resulted in this highly prestigious award being bestowed, remarkably, for the third successive time on A.M.S. ●



Pictured above is the new 28,000 square feet purpose-designed facility where all AMS's research and development, design and manufacturing have now been relocated. The new building provides additional space for all departments as well as incorporating

much needed areas for technical and sales seminars, demonstration rooms and of course additional space for expansion.

The building, on its own 7 acre site, has been the result of collaboration between senior management and a local

designer with a brief to provide "a light, bright, airy atmosphere - an environment that anyone would be happy to work in". The result has been beyond anyone's expectations and with its energy conserving reflective glass and air conditioning, seems more than adequately to have fulfilled the original specification.

One sad note (which we are sure will be understood by all those who have visited us in our Worsthorne factories) has been the move from the village which was finally completed in May. Our new buildings more than make up for many of the shortcomings of the Worsthorne facility, but we are still very sorry to leave behind the many friends we have made who have been so kind and helpful to us over the past 8 years in the village. ●

## PETER GABRIEL INTERVIEW

Peter Gabriel has been using AMS audio processors for some considerable time and his input, along with that of others, has been responsible for shaping products in the AMS range. His dedication to sound quality and sound experimentation has led to his release of some of the most exciting and stimulating albums of the 80s. Indeed, Peter's "Shock The Monkey" tour of North America resulted in more calls for information on the live applications of AMS products than that generated by live performances of any other artist.

As this Echo Times goes to press, Peter Gabriel's latest offering,

"Sledgehammer", is moving up the U.K. singles charts and his new album is about to be released. AMS would like to take this opportunity of thanking Peter Gabriel for crediting them on this, and his previous album, and wish him the success he deserves for what is a first class piece of work.

*A.M.S.: Did you come from a musical family and can you remember how you first got involved?*

**Peter Gabriel:** Talking history I must admit I'm bad with dates but on both sides of my family there were lots of musical people. There was always a lot of music at family gatherings. There was even an opera singer on my father's side.

*A.M.S.: So how did that translate towards rock music?*

**P.G.:** As a teenager I grew to love pop music, at 7 or 8 I remember Johnny Kidd and the Pirates - Red River Rock I think it was - the first thing I was ever excited about. When I was about 11 I

remember Love Me Do - there were certain critical records where I can remember the exact place that I was when I first heard that record. The Beatles' "Love me do" did that to me, the first time I heard Jimi Hendrix did that. It's a bit like everyone remembering where they were when Kennedy was shot. I must admit I am still that way...

*A.M.S.: Did any type of music appeal more than any other?*

**P.G.:** As I got into my teens, black music had the biggest impact on me. Soul, Otis Reading was my spiritual godfather, Nina Simone who just seemed to be able to get me to respond to rhythm and emotion. I was still very aware of beat groups and by the time I was 17 - psychedelic rock. I was really enamoured with all the hippy stuff, I used to escape from school and hang around clubs before catching the last train home in an evening. For me it gave me a glimpse of a world that seemed much more exciting.

*Peter Gabriel interview continued over page.*

**A.M.S.:** *Do you feel the 60's were a critical period for you?*

**P.G.:** Yes they were. They were very exciting as it was the first time that music was opening up on a large scale. Although Frank Sinatra or Bill Haley had gone before, there really had been no explosion of musical energy like there was in the 60's. Maybe people who were teenagers in the punk era feel exactly the same about that period, and it may have been as critical for them as the 60's were for me.

**A.M.S.:** *So when did you personally begin writing and how did you manage to get this issued on vinyl?*

**P.G.:** My first attempt at writing was in one of the partnerships that became Genesis – it was very primitive and literally produced by one finger at a time on a piano. I ended up being the turkey going round with cassettes that we'd done and spending the day looking at some A&R's secretary's feet. Success only came after being introduced to someone who showed me the technique of finding out whoever you wanted to see's Christian name – then burst into the office in a pretty unhappy state and scream "is Bob back yet?" or whoever. As you're on first name terms with her boss and obviously upset she'd better look after you and put you in his office! After using this technique once I realised that attitude is all important – talent is important but more important is the need of the psyche to achieve.

**A.M.S.:** *In those early days, what do you think it was that Genesis had that helped them succeed?*

**P.G.:** The approach with Genesis was to try and open up the writing to include different styles and rhythms. In the early 70's there were all sorts of slots and we didn't really fit in any. We tried to confuse the audience – we'd start acoustically like a folk group and end up loud and manic.

**A.M.S.:** *What about effects, audio processing or maybe your own distinctive vocal style?*

**P.G.:** During the time of "Lamb Lies Down on Broadway" I first invited Brian Eno to experiment with his EMS synth. All the band were very conscious of other people's sounds that they achieved on record – and of course we were always experimenting. My own voice sounds a little strange to

start off with – it's not really a regular singer's voice but I enjoy using my voice as an instrument.

**A.M.S.:** *Besides liking your style and approach very much, the first time A.M.S. contacted you was immediately after hearing the Nonlinear effect on Phil Collins' drum section on your track "Intruder". That sound is now a classic – did you realise how important that sound would become, and how did it come about originally?*

**P.G.:** As far as the "Intruder" drum sound goes I think I really had the sense when I first heard it to know that it would be a rock and roll standard because it really was so exciting. Hugh Padgham had set up the gated reverb which he had done once before with XTC although I don't think it had been given a lot of space on the track. When Phil Collins came in for the third album, I really wanted that to be a bit revolutionary in a way. One of the things I didn't like was cymbals on a lot of records, particularly with respect to the effect on separation. Phil was a little uncomfortable with having his cymbals taken away but he accepted it eventually, particularly after we put some additional drums in the places where we had taken the cymbals away. He was therefore playing the toms in instinctive cymbal positions. When Hugh brought in the gated reverb effect I immediately knew it was one of the best things I'd ever heard in my life. At that point the track that had almost been a rejected song was then built around the drum sound. Steve Lillywhite was there also.

Now AMS have developed the "Nonlin" and taken it further everybody including myself has it instantly on tap and can use it on a thousand and one different things. I really don't know what disco music would be without that sound now!

**A.M.S.:** *Had you heard of AMS before that contact?*

**P.G.:** Yes I had I first came across an AMS digital delay line at the Townhouse, and Larry Fast (my keyboards player) was the first to really make me aware how important sound processing is in being part of a sound.

**A.M.S.:** *How do you know if you have enough audio processing?*

**P.G.:** Now, if anyone asks me how they should set themselves up with equipment I tell them that whatever

they have to spend, half of it should be spent on sound processors. For me instruments are impotent unless you have the right things to put them through.

The way you decide how to spend your money is very critical as there are so many options. For me I've spent much more of my income on my studio than on myself and it has worked really well. There is a very different relationship with equipment when you own it – and for me that is essential. What I like very much about AMS is how easy it is to control perspective. I prefer on many occasions to use the effects returns rather than mix them in with the original. The RMX 16 and the DMX 15-80S are vital parts of my equipment and having been introduced to them and worked with them I can't picture not having them. A synthesiser sounds naked to me without processing – even if it is only pitch changing the outputs of the DMX 15-80S slightly up and down on either channel.

I will make time to explore the setting up of chains of various effects returns, continually trying to find different layers of performance. There is an AMS layer – after having started with a bare backbone that final layer adds the richness.

One of the things that I find very interesting is to use the returns from the RMX and the DMX during the recording where space will allow. This is different to putting it on in the mix to flatter the vocals or the instrument. Artists react differently when they overdub to the returns from an effect unit. For me audio processors can be applied afterwards but if a musician is responding to something he is hearing in his cans then you are dumb if you don't get that on tape – because that is part of the chemistry of that performance. A good example is trying to speak when you have your own slightly delayed voice in cans. I have a lot of AMS units and in most mixes it's difficult to find one not being used. I nearly bought a Harrison live console and had it customised, only because it had 16 effects sends so maybe that shows how important effects units are to me.

AMS outboard units are as important on the road as is the studio and although racks of outboard are a bit extra work and extra budget I believe it's worth every penny ●

**ams**

● **ADVANCED MUSIC SYSTEMS** ●

AMS Industries plc, AMS Industries Park,  
Billington Road, Burnley, Lancs. BB11 5ES,  
England.

Tel: (0282) 57011 Telex 63108 AMS-G



EXCLUSIVE DISTRIBUTOR

**HARRIS SOUND, INC.**

(213) 469-3500

DMX 15-80S DIGITAL PITCH CHANGE & SAMPLER  
RMX 16 DIGITAL REVERB  
DMX 15T TIMEFLEX DIGITAL TIME COMPRESSOR

**ams**  
AUDIOFILE

**DIGITAL SOUND EDITOR**

(NOW AVAILABLE) CALL FOR MORE INFORMATION



# Anything less than a Neve is just a lot of...

Bells and whistles may be all you need for New Year's Eve...or a birthday celebration. But is a desk full of bells and whistles enough for the demanding art and science of music and video production? Today, you need more. You need the Neve difference.

At Neve, the first name in audio mixing control and distribution systems, we offer you all the bells and whistles your creativity demands plus the sonic quality and reliability that sets Neve apart from the rest.

What's more, Neve's "V" Series Console, plus the incomparable NECAM 96 computer-assisted moving fader automation system give you the important extra of total command...with virtually unlimited flexibility and ease of operation. To enhance your creativity to a level you never dreamed possible with:

- 48 groups
- Intelligent solo facilities
- Split-or in-line operation
- Balanced mix buses
- Full channel dynamics
- Channel and rev status on all inputs
- Mix to analog; mix to digital; mix to picture capabilities

Hear the Neve quality difference for yourself. Find out firsthand how Neve advanced engineering gives you "a touch of the future."

Circle the bingo card for a literature pack. Or call (203) 744-6230 for a demonstration of Neve sound at your location.



Nothing sounds as good as a Neve...  
because nothing else is.

#### Rupert Neve Incorporated

Berkshire Industrial Park  
Bethel, Connecticut 06801  
Telex 969638  
Facsimile (203) 792-7863  
(203) 744-6230

#### Neve Electronics Int'l Ltd.

Cambridge House, Melbourn, Royston  
Hertfordshire SG8 6AU, England  
ph (0763) 60776 fax (0763) 61886  
telex 81381

7533 Sunset Blvd.  
Hollywood, California 90046  
(213) 874-8124  
Facsimile (213) 874-1406

P.O. Box 4008  
Nashville, Tennessee 37204  
Telex 786569  
(615) 385-2727

 Neve

A Siemens Company

Circle #007 on Reader Service Card

# NOISE

ing. With high frequencies, dynamic action occurs in the range -62dB to -5dB. There is no action in the lower 20 to 25dB of the dynamic range, but linear dynamic action in the top 25dB or for full boosting. In the dynamic action ranges the effects of the multi-level stages form a compression ratio of about 2:1.

Steady-state non-dominant signal components are boosted or attenuated over and above that of the dominant signal towards the spectrum extremes by sliding band actions. If there are two dominant signals, a fixed band compression or expansion effects the non-dominant signal between the frequencies of the dominant signal com-

ponents. Performance characteristics for analog media are improved. The choice of product name is particularly improved. If Dolby had announced a "D-Type" to replace A-Type, users would probably have been skeptical, or hostile. The intriguing name of "Spectral Recording" implies a wholly new form of recording, beyond both analog and digital recording, instead of an improvement on existing Dolby-Types of NR. Which raises the question of SR's market impact...

In this author's opinion, SR will not significantly affect digital's growth curve. Rather, it will provide an agreeable alternative for the many owners of existing analog recorders who are

BBQ pits, says a rumor that one burst into flames during a recent demo. My advice: don't put the steaks on until after the chips have burned to red-hot embers, and of course, finish up with marshmallows. **Masters of the Universe Department:** Rumors abound that both JVC and Neumann will introduce CD cutting lathes in the near future. In light of the Philips stranglehold, something has to give. **Self-Serve Department:** Pohlmann's sequel to *The Principles of Digital Audio*, his *Compact Disc Handbook*, coming soon to a galaxy near you. **The Price is Wrong Department:** Have you purchased parts for your MCI equipment lately? Sony is steadily raising

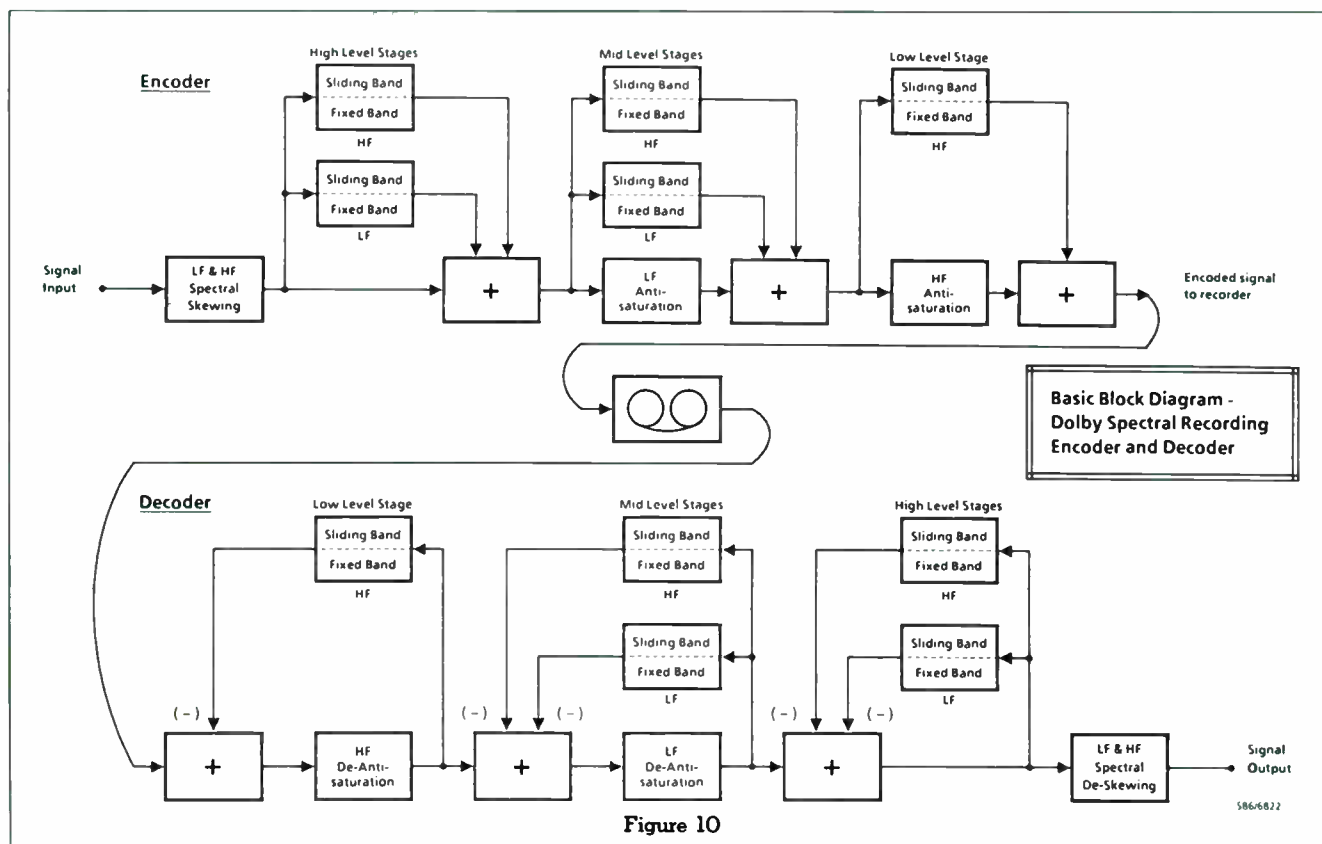

Figure 10

ponents. Boosting or attenuation is maintained towards the spectrum ends; this spectrally tracks the dominant signal. The use of cascaded stages helps provide a steep boosting or attenuation away from the frequency of the dominant signal; low frequencies have two stages, high frequencies have three stages. Overall, only those components above the threshold are subject to a reduction of boosting.

In summary, SR is clearly a product in the Dolby tradition. Many of the same techniques such as band splitting have been re-worked to further extend their philosophy of masking analog tape and channel noise. Specifically, SR shows kinship with C-Type noise reduction in philosophy and

priced out of the digital market. Ironically, SR's biggest challenge will probably not come from digital recorders, but from the prior success of analog recorders using A-Type. Those owners must evaluate SR (as well as Telcom, etc.) and decide whether yet another entirely new and incompatible (and improved) standard is really something to be purchased. On the other hand, professional digital equipment isn't exactly a happy family of compatibility either...

### Audio Rumor Central

**Weenie Department:** Not only are digital recorders quiet, with unmeasurably small wow and flutter, but certain PCM multi-tracks make great

prices on vintage MCI parts. Check this out: A 1N34 diode for \$7.77? A JH-110 dash pot for \$65? A rubber pinch roller for \$125? A flutter filter for \$243.61? Do those prices sound a little high to you? Well, they're a lot higher than they used to be. A glaring example: a hi/lo EQ switch for the JH-500 series was \$45 last year, and \$197.50 this year. I can hardly wait for next year.

Do you have information or rumors for AudioRumorCentral? Each month's hottest tip wins a *Mix* prize. Contact Ken Pohlmann, University of Miami, P.O. Box 248165, Coral Gables, FL 33124, Telex 519308 or *Mix* at (415) 843-7901. Come on! Don't get mad, get even. Send it in!



63 Sound effects. From the obviously necessary to the quite bizarre. Pre-packaged and MIDI selectable. Single and multi-tapped delays... with filtering and reverb ambient outputs. Perfect for vocals and instruments. Stereo effects that get attention. Reverb effects that don't exist on the plane of current reverb understanding. Interested? We call it MIDIFEX. And to get the effect of

# MIDIFEX

MIDIFEX without one, you'd need a very capable digital reverb, a few dozen digital delays, a couple of parametric equalizers and quite a few extra channels on your mixing board. By presetting the variables, we programmed the MIDIFEX to produce these effects at instant recall... at the front panel or through MIDI patch change. The polished sound you could work hours to get is here now.

And like MIDIVERB. The best part is the price.



... suggested list price

**\$399<sup>00</sup>**



# B A S I C S

**FIGURE ONE**

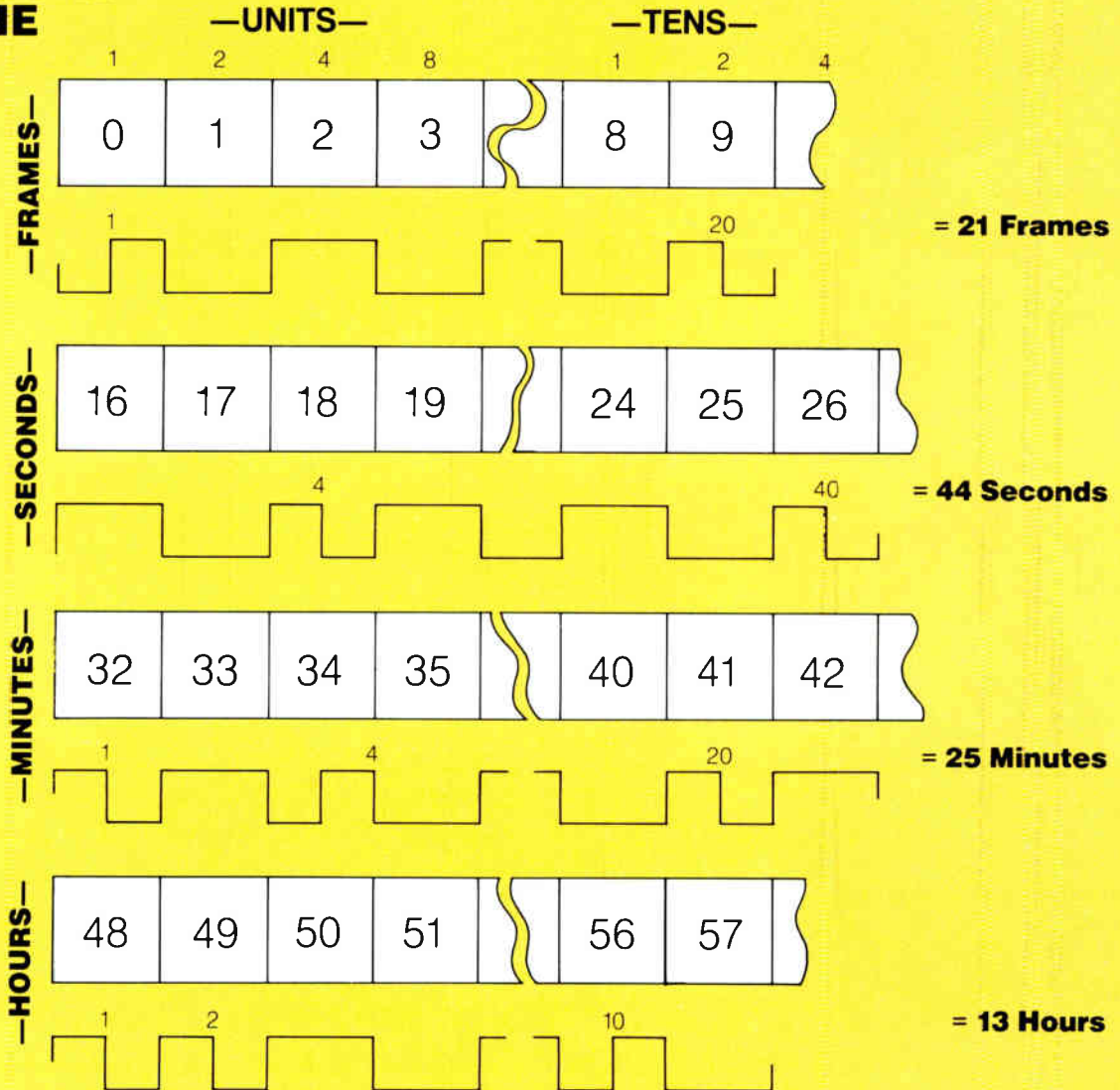

by John M. Woram

## A TIME CODE TUTORIAL

**T**his month's special feature is a Film Sound Update, and next month's *Mix* is the SMPTE Show special issue. I can pass on this information because as I write this, I'm staring at the *Mix*'s 1986 Editorial Schedule. It seems the editor actually knows what's going to appear in every issue, even if at least one monthly columnist hasn't got a clue. Actually, I have got a clue, because

that same editor sent along a little note with the schedule, suggesting that this column might touch on some of the basics of film sound, to tie into the general theme of these issues.

Well what could be more basic than the SMPTE (Society of Motion Picture and Television Engineers) time code? But first, some...

### Ancient History

Some pretty serious old-time movies are now relegated to the "quaint" category, because they are conspicuously out-of-sync with modern technology. As for film sound, even some





## **"TOMORROW'S STANDARD\*"**

\*STAND-ARD (stan' dērd), *n.* 1. Something established as a rule or basis of comparison in measuring or judging quality, value, capacity, extent, etc. 2. Something used by general agreement as a type, model, or pattern.

Peavey's all new PVM™ 38 and PVM™ 45.  
"Tomorrow's Standard."

*HandCrafted in the USA*





# Scotch<sup>®</sup>

## 250

### **One Tape Sounds True.**

Because capturing all the music is all that matters, we've created the world's finest music mastering tape. 3M 250 Recording Tape. Designed to deliver the greatest dynamic range and best signal-to-noise ratio of any tape in the world. To give you the truest sound.



# TO THOSE WHO PUT A RANGE OF MUSIC ON A ROLL OF TAPE, ONE TAPE IS TRUE.

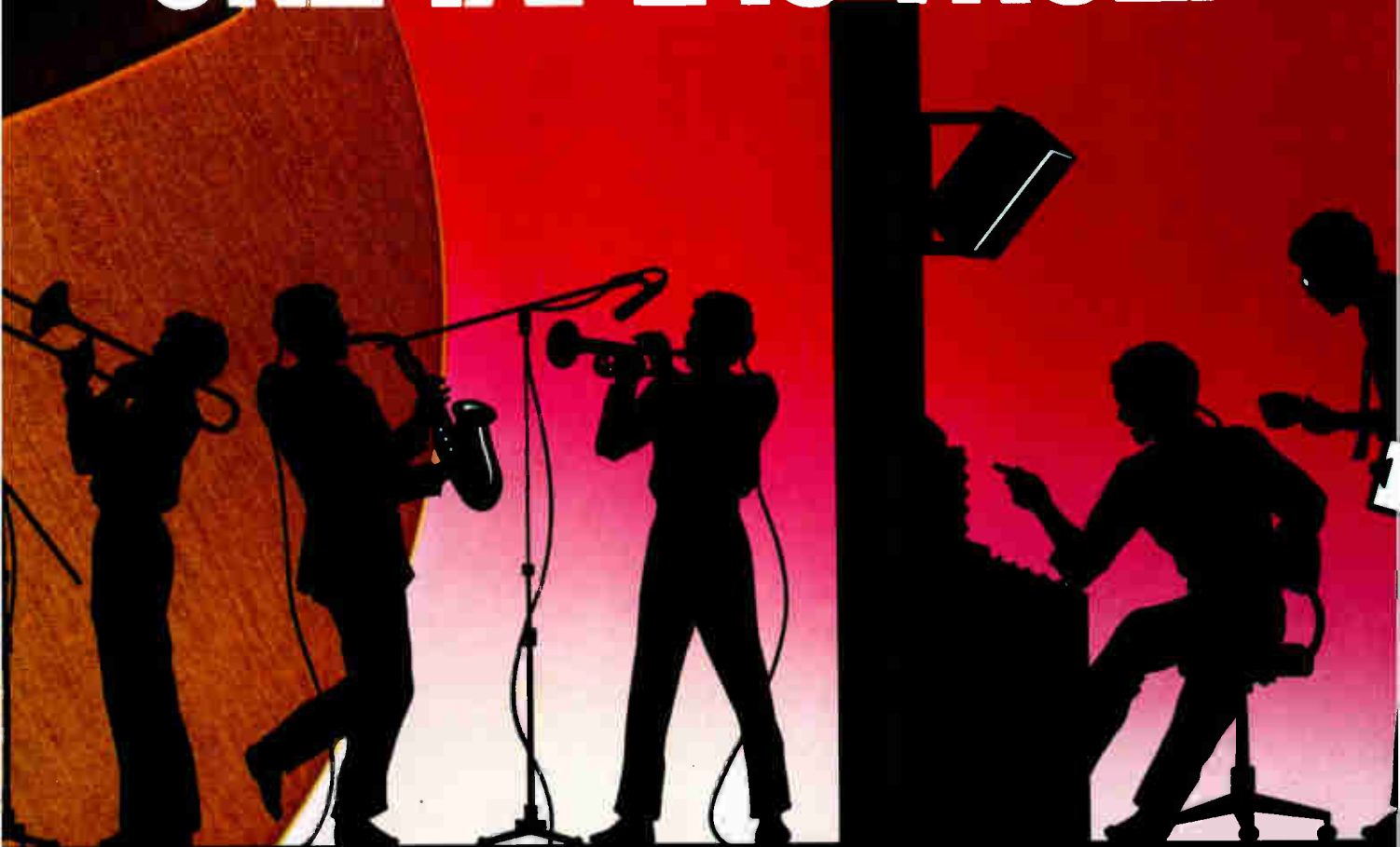

## One Tape Stands True.

Helping you capture all the music...that's what we've been doing since we introduced recording tape back in the 40's.

That's why we stand by you—with the largest support force in the field.  
And we stand behind you—with some of the most advanced research in the industry. All to keep our standing—as number one in the world of the pro.

**Scotch**<sup>™</sup>  
MAGNETIC MEDIA

**NUMBER ONE IN THE WORLD OF THE PRO**

**3M**

not-so-old movies are a little out-of-sync; you can tell the hero is about to speak, because his lips start moving. Then after a moment or two (actually just a fraction of a second, but it seems like forever) his voice is heard.

It's distracting today because by now we're long-accustomed to near perfect agreement between what we see and what we hear. Getting the two sensations to compliment each other is a two-part process involving art and technology.

On the artistic side, some techniques are more obvious than others. For example, a 747 flyby won't do much to enhance the mood of a civil war flick, even if the sound perfectly

matches the shadow of the plane as it passes over Scarlett's face. To help cope with such things, most dialog is recorded under controlled studio conditions, and combined with various sound effects to create the desired sound field.

For early editing sessions, when both sound and picture were on sprocketed film, the sprockets themselves could be used as a visual aid in synchronizing two or more films, and more sophisticated timing systems were not absolutely essential. But if you've ever gone looking for the sprockets on either audio tape or video tape, you'll know that something else is now required.

And that's where time code tech-

nology comes in. All those separate effects originate at various places, and even if the visual image is recorded on sprocketed photographic film, the audio sources are not. If you've ever tried to make an A/B comparison between an audio tape and an LP record by getting them to play in sync, you'll appreciate the problem. Once you become proficient at it, try the same thing with a film (optical or video tape—your choice), an assortment of sound effects records, a dialog tape, a music background tape, a stop watch and a bottle of Excedrin. Good luck.

Fortunately, there's an easier way. For purposes of illustration, let's consider a simple project involving a videotaped picture, with a complete soundtrack recorded separately on audio tape. Since this is a very basic column, we'll assume that the audio and video tapes would be in perfect sync, if only we could get them to instantly start at the same cue point.

There's nothing to it—almost. Just record a coded signal onto a separate track on both tapes. The code should represent an ascending numeric scale starting at zero and ending at whatever it takes to get through the entire production. The same device that records the code should display a read-out of the code as it is recorded, and later on as the tape is played back.

On playing back the audio tape later on, note that the gun shot is heard when the code reader displays say, 900. When the video tape is played back, it's seen that the gun shot should be heard when the video tape reader displays 893. Close, but not close enough.

Fixing this mix is easy. Assuming the two codes were in perfect agreement, the video tape deck could be designated as the master. With both machines running, the two codes are read and compared. If they don't agree, the audio deck shuttles forward or back until they do.

But in the case described above, there's a discrepancy between the two recordings. No problem: a seven-count offset can be dialed into the system so that 893 on the video deck lines up with 900 on the audio deck. With the right kind of software support, the master machine can be started, stopped, and shuttled back and forth, with the slave machine accurately following along. In fact, several slave machines can be locked to the same master deck.

Of course, codes like 893 and 900 aren't any more informative than the typical revolution counter on an inexpensive tape recorder. A more useful code would produce a readout in units of time; say, hours, minutes and sec-

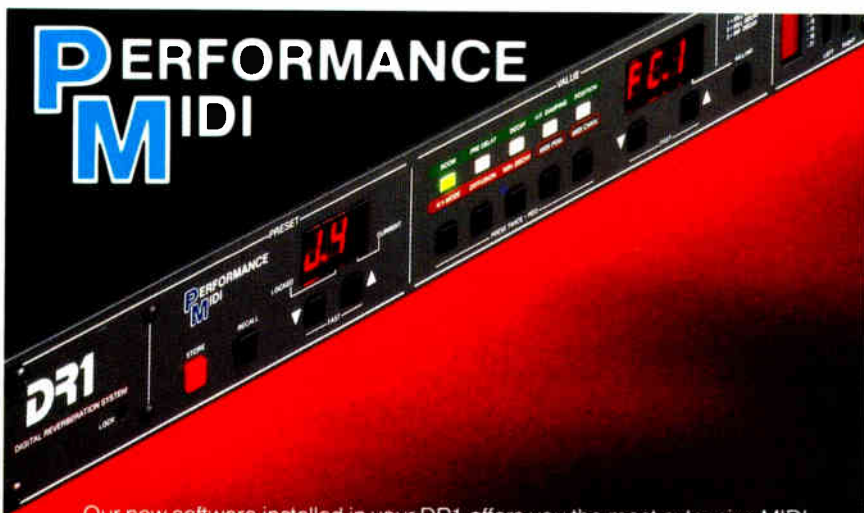

Our new software installed in your DR1 offers you the most extensive MIDI implementation of any reverb made and includes Performance MIDI!

You now have real time control, in addition to full computer control, preset dump and reload, and master / slave operations allowing you to link two DR1s. Other features standard in ART's new Version 1.2 software include a Flanger/Chorus Room, a Preset Sequences feature and 10 additional new Factory Presets.

For those who demand performance, check out these specifications for our DR1 with Performance MIDI:

PRESETS:	40 FACTORY 100 USER PROGRAMMABLE!
D/A BANDWIDTH:	16 BIT LINEAR - 14KHZ RESPONSE!
UPDATEABLE:	YES! AND, WE DELIVER VERSION 1.2 NOW AVAILABLE!
REMOTE CONTROL:	YES! FULL CONTROL OF ALL REVERB AND PERFORMANCE MIDI FUNCTIONS!
MIDI:	YES! THE MOST MIDI CONTROLLED REVERB AVAILABLE!
SPECIAL EFFECTS:	YES! UPDATEABLE AND EXPANDABLE!
DECAY TIME:	0.1 TO 25 SECONDS AND DYNAMIC DECAY TIME CAPABILITIES!
PREDELAY:	0.0 TO 200ms. IN 1.0ms. INCREMENTS!
OTHER CONTROLS:	H.F. DAMPING, POSITION AND DIFFUSION!

Simply, if you want the best sounding reverb with the fullest MIDI implementation available including the best sounding PLATES, ROOMS AND HALLS, contact us. We'll continue to impress you with unique products that deliver superior performance!

Call or write today, for more information!

- Digital Reverberation Systems
- Digital Delay Systems
- Full Line of Equalizers
- Pitch Transposer Packages
- Software Update Packages

**ART**

Applied Research & Technology Inc.  
215 Tremont Street  
Rochester, New York 14608  
(716) 436-2720

**PRO-AUDIO NEVER  
SOUNDED SO GOOD!**

Circle #010 on Reader Service Card



# The producer's choice . . .



AMEK ANGELA  
M42 OBJ 28/24

Maybe it is AMEK's reputation for reliability. Or maybe it's the ANGELA's wide variety of frame configurations and the ease of access to all of the console's controls. Or it could be the fact that an ANGELA gives you all of the features of a computerized console without the excessive cost. The real reason AMEK has supplied so many ANGELAs to today's leading producers is its outstanding sonic quality.

A truly talented producer realizes that the bells and whistles on a console do not make a hit. It is the sonic quality, ease of operation and the really usable features which allow you to reach your creative goals. All ANGELAs feature dual signal paths through each module, so with just a 28 input ANGELA, you can have as many as 68 possible line inputs. ANGELAs are available with up to 62 inputs with 48 track routing and full metering!

ANGELA's versatility and

ergonomic layout have also made them very popular with On-air broadcasters and post-production facilities. The availability of stereo modules and such standard features as the stereo analog sub-groups with three modes, in-place solo in the monitor and channel, and mute grouping give the ANGELA automation-like operation at no additional cost. And, any ANGELA can be readily automated, now or when the need arises, with any of the popular automation systems.

Audiophile performance, AMEK reliability and value, and configurations to fit any requirement have made the AMEK ANGELA the choice of the producers with the "golden ears." Drop us a line, or give us a call . . . we'll drop a few names of satisfied ANGELA owners. It really is the producer's choice.



Distributed by:

**AMEK CONSOLES INC.**, 10815 Burbank Blvd., North Hollywood, CA 91601 Tel: 818-508-9788 Telex: 662526 AMEK USA  
**AMEK SYSTEMS AND CONTROLS LTD**, Islington Mill, James St., Salford M3 5HW U.K. Tel: 061-834-6747 Telex: 668127 AMEK G

# AMEK

onds. But even that's not good enough for most film work, where the smallest edit interval is the frame.

The SMPTE time code provides a readout that displays hours, minutes, seconds and frames. The number of frames per second varies somewhat, according to the specific medium. Thus we have:

Frames per second	Medium
24	Motion Picture film
25	EBU Standard (European television)
29.97	NTSC color
30	NTSC monochrome
EBU =	European Broadcasting Union
NTSC =	National Television Systems Committee

For the moment, let's keep things simple and use the NTSC monochrome standard to study the structure of the code, which might be thought of as a hybrid analog/digital signal. It starts out as a 1,200 Hz square wave. Think of this as 1,200 equally-spaced cycles per second, divided between the film's 30 frames per second. This gives us

40 cycles per frame, each of which has a positive and a negative half cycle. In other words, there are 80 transitions per frame, and we can think of this as a stream of 80 "bit cells" per frame. A big cell is just a bit (sorry!) of jargon to describe an increment that can be used to pass on some useful information.

With no further action being taken, each bit cell represents a binary zero. But if a positive-to-negative (or vice versa) transition takes place in the middle of the bit cell, then that cell represents a binary one. And if every cell contains a transition, then we have a 2,400 Hz square wave, which represents a continuous bit stream of binary ones.

Neither alternative is very informative. But with 80 cells, each capable of representing either a zero or a one, we have an 80-bit word associated with each frame. That's 2<sup>80</sup> which, according to my calculator, works out to 1.2089258 multiplied by a one followed by 24 zeroes. (Since this magazine's typesetter doesn't own 24 zeroes, you'll have to work this out for yourself.)

In any case, an 80-bit word can store lots of information pertaining to its corresponding frame. We can begin by storing the frame number itself, followed by the time at which that frame was recorded. This could be

the actual time of day, but more likely it's the elapsed time since the start of the reel.

### Counting Frames

Continuing to keep things simple, let's have a look at the six bit cells which are used to store the frame count. These are cells 0, 1, 2, 3 and 8, 9. For the moment, we'll ignore cells 4 through 7. The first four frame-count cells (0-3) represent the decimal values of 1, 2, 4, and 8 units. The last two cells (8-9) represent 1 and 2 tens—that is 10 and 20.

Some of these cells will contain a transition, and some won't. Assuming the even-numbered cells (0, 2 and 8) each contain a transition, the ten-bit stream looks like this: 1010xxxx10. (xxxx represents the four bits that are being ignored.) This translates to decimal 1 + 4 + 10 = 15 and means that this is frame 15. If all six of these bits are 1, the frame number is 1 + 2 + 4 + 8 + 10 + 20 = 45, which means it's time to call the maintenance department, since the frame count should never be more than 29. (Frames are numbered 9 to 29, not 1 to 30.)

### Hours, Minutes, Seconds

In a similar manner, seven cells (16-19 and 24-26) are used to tally the seconds and seven others (32-35 and 40-42) do the same for the minutes. In each case, the decimal values for these bits are 1, 2, 4, and 8 units, followed by 1, 2 and 4 tens. This means the total value could be as high as 95, but only values from 0 to 59 are legal. The hour count is stored in six bits (48-51 and 56, 57). A seventh cell is not needed, since the hour count only goes from 0 to 23.

The chart seen in Figure 1 shows how these bit cells look when the time code represents 13 hours, 25 minutes, 44 seconds, 21 frames. Note that this particular time increment is tallied as 3 + 10 hours, 5 + 25 minutes, 4 + 40 seconds and 1 + 20 frames.

Obviously, other combinations might produce the same results—for example, 1 + 4 + 8 hours, 1 + 2 + 4 + 8 + 10 minutes, and so on. But to make sure that only one unique combination is used for each increment, the first four bit cells in each set are only used to represent values less than 10. Therefore, a 10 is always represented by a transition in the fifth bit cell and never by transitions in the second and fourth cells. Likewise, a 20 is always stored as a transition in just the sixth cell, and 30 is 10 + 20, not 2 + 8 + 20.

### The Sync Word

Assume the time code has been properly recorded and the tape is now

—CONTINUED ON PAGE 177

## THE NEW ALTERNATIVE!

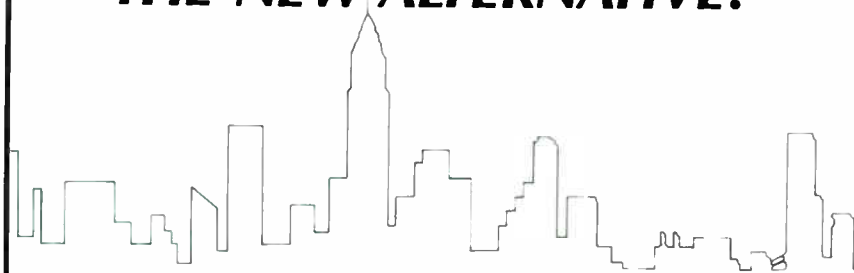

FOR A FREE DEMO TAPE

call

(212) 333-5766

or write

Manhattan Production Music

P.O. Box 1268

Radio City Station

New York, N.Y. 10101

• 24-track state-of-the-art digital and analogue recordings • direct-metal masters • audiophile virgin-vinyl pressings • easy-to-edit cuts • high-energy and exciting themes • accomplished, reknown composers and arrangers • reasonable needle-drop fees • ask about our low-cost annual blankets • assorted 60s, 30s and 10s • hundreds of satisfied clients •

**MANHATTAN**  
P R O D U C T I O N • M U S I C





# WE'VE JUST GOT MORE OF THEM THAN ANYONE ELSE.

Audio Logic incorporates more innovation and flexibility into signal processing equipment than any other manufacturer.

Make no mistake. We'll never tack on a bunch of unnecessary audio gimmickry.

We design sophisticated technology into each piece of pro audio equipment that improves your sound because it expands your capabilities.

Consider our MT-44 Quad Noise Gate. We've put four independent gates into a one-rack size. Not just two. There's a keying function in each channel. And the MT-44 lets you set the amount of gated signal



*MT44 4-channel Noise Gate*

attenuation from 0 to 100 dB, and release times from a short 50 milli-

seconds up to 4.7 seconds.

We've even included a logic output to trigger other pieces of equipment, for extra creative power.

Take a closer look at the MT-44. You'll discover its versatility and production power begin at the point where simple noise gates leave off.

For more information, contact your professional audio dealer or sound contractor. Or, give us a jingle.

(801) 268-8400.  
5639 So. Riley Lane  
Salt Lake City, Utah  
84107

**AL**  
**AUDIO LOGIC**

© 1986 DOD Electronics Corporation

# INSTALLING THE BIG BOARD

by Greg Hanks

Welcome back to the world of control room installation! This is the second part of a series devoted to the implementation of today's technology in the modern recording studio. The number of inputs necessary for many of today's tasks has grown to proportions unfathomable ten years ago. Sixty-four inputs with three groups of stereo main mix outs in conjunction with 32 mixing buses are currently in a number of studios. In order to cope with the sea of faders, knobs and switches, automation has intruded itself upon our sensibilities. Eating up a couple of tracks on a multi-track is anathema to the concept of individual instrument control, and besides, we have all of those inputs that we can use. . . . So, we add a second multi-track, and possibly a 3/4-inch VTR for the video for the single, give up the automation tracks, and now acquire SMPTE-based automation. We are now in the world of the "larger" console.

The installation and utilization of the features made possible by this type of console is what this article is about. It must be stated that this is *not* intended to be a compendium of large console manufacturers and the features of their consoles. By the time this goes to press, it is possible that some statements I have made will no longer be accurate. Please understand that this information is intended to provide *generic* information, and the mention of specific manufacturers is done so as to illustrate the functions and options discussed. If you are in the process of designing, building or selling a console that I don't mention, sorry about that!

One of the design criteria that set the larger console aside from the rest is the implementation and imbedded nature of disk-based automation. Neve was the first entry in the field of disk-based automation in the early '70s with the popular Necam system. Since that time, many manufacturers have joined them in this hardware and software philosophy. Disk-based automation is a system whereby the

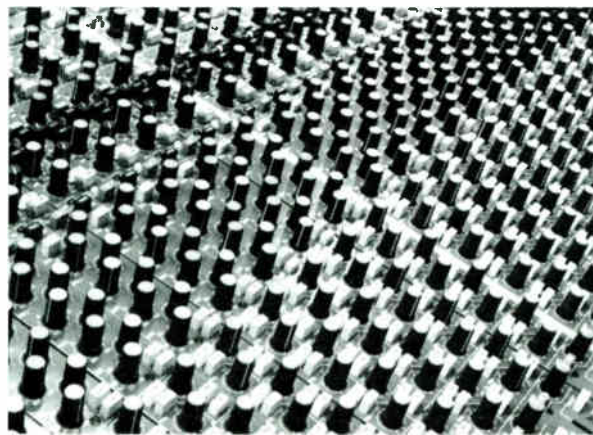

*Detail of Neve 51 Series*

data storage medium is synchronized to the master transport. This is accomplished through the use of SMPTE time code. The requirements imposed by most synchronizers are evident with some of these systems. Some of the necessary control lines include: transport function tallies, true direction lines, fast wind tach pulses, and the like.

The SSL and Calrec systems also provide for audio control of the multi-track(s). In these installations, the control wiring becomes much more extensive, and an interface must be derived to go between the audio control portions of the tape machine(s) and the console. This usually assumes the form of a cable, but depending upon the machine, may be more complex. As an example, the Otari MTR-90 MKII requires some modifications to the audio remote in order for the console to control the record ready and sync switching. (Contact either SSL, Otari, or New York Technical Support for details.) With this arrangement, the console becomes much more than the audio control center, it assumes the position of audio remote as well. Rather than go into the specifics of machine control, let's examine some of the physical plant requirements that these systems present to the installer.

Everything becomes more critical when the system size grows. Did you ever notice that when you were "8-track," the machine rarely went out of alignment, and the most pressing problems were related to production

and sales rather than technical difficulty? I use the rule of thumb that when you double the equipment expense, you square the number of problem areas. Therefore, with this in mind, we will attempt to anticipate and thwart Mr. Murphy with some attention to underlying support system design.

When there is this much money on the line, you want to make sure that the job is done properly, the first time. Therefore, all of the system design detail work outlined previously on these pages should be attended to.

## Power

A bigger board means more inputs, and more inputs mean more power consumption. When firing up a large desk, the peak surge demands can strain the electrical service. A set of 30 amp services is suggested, one for the audio supplies, and one for the computer. This figure is a general one at best, and the specific manufacturer should of course be consulted regarding the requirements of their particular product. One of the suppliers we contacted requires a full 100 amps for a 64 in x 64 out mixer. If the finances are available, then a power conditioner for the control room electrical lines should be used. Some of the current manufacturers are requiring conditioning for the automation supplies as a condition of the warranty.

Most of the commonly available surge suppressors and power line filters work by forming a very high "Q" 60 Hz filter on the output winding. This means that the source shunt impedance of the power line is very high at any frequency range other than 60 Hz. Many pieces of equipment rely on the low source impedance of the power line as a shunt element for RF rejection, at least within the power supply. In situations that have a very high RF field, or are plagued by EMI, the power conditioning may introduce more problems than they solve. This is not a common occurrence, as the most frequent source of pops, clicks, hum and RF are the power line and not radiation, but should nevertheless be



# the ELITE

**NEOTEK CORPORATION**

1158 West Belmont Avenue, Chicago, Illinois 60657

312-929-6699

© 1985 NEOTEK CORP.

Circle #013 on Reader Service Card  
World Radio History

# The SSL Stereo Video System

## The Practical Standard For MTS Production

**Before and beyond the transmitter, Multichannel Television Sound is an art.** In the studio and post-production suite, the creative use of stereo can do as much or more than lighting, lensing, colour and video effects to give depth, impact and immediacy to the television picture. It quite literally adds an entirely new dimension to the viewing experience.

In stereo, television is a whole new ball game — or newscast, or series, or advert, or sitcom, or special. Because stereo is both natural and compelling, the programming possibilities are as broad as the imagination and skills of today's sound designers. Technical limitations and the constraints of time are the only obstacles. And that's where SSL can help.

Our SL 6000 E Series Stereo Video System handles complex MTS production with unrivalled ease and efficiency. Designed to simultaneously speed and enhance all aspects of television audio production,



the SL 6000 E Series makes innovative stereo programming practical on a daily basis.

Only SSL has triple stereo mix buses for stereo music, dialogue and effects, plus rapid mix-minus matrixing for Second Audio Program creation. Only SSL provides compressor/limiters, parametric equalizers, expanders and noise gates on every channel — plus balance and image width controls for all stereo sources. And only SSL provides such time-saving operational features as patch-free audio subgrouping and pushbutton signal processor routing. For post-production efficiency, even the multitrack electronics remotes are built right in. And that's just the standard equipment!



Options include Total Recall™ — an SSL exclusive, completely independent of the audio path, which allows any operator to recreate the most intricate console setups for any programme with rapid accuracy, week after week. Programmable dynamic stereo equalisation and panning may also be added, along with

kept in mind in intense RF fields (such as the 17th floor in a Manhattan office building!)

Power conditioning presents a complete set of considerations regarding the location of the device, as determined by the noise (both acoustic and radiated EMI), hum fields and heat that it generates. Remember that if the system is single phase, then any noise currents on the neutral will not be eliminated. Unless the neutral is derived from the secondary of the conditioner in a Delta configuration, the neutral is not truly isolated. This can present problems in terms of the cost and physical size of the power conditioning device.

There is another aspect to electrical power that we should address before moving on, and that is the location of the console in relation to the major power feeds of the building. As the number of inputs grow, the gain of all the summing buses increases. Most consoles utilize the inverting input of an op-amp in a current summing topology. Newer implementations of this design are using differential summing techniques. Either way, the traces that are employed constitute a possible hum pickup. If there are any magnetic fields in the area of the bus, then the lines of flux cutting across this line will generate a current. When the gain of

this summing system is great, as it is with 48 or more sources, then this current can become substantial. This mandates that the proposed location be investigated for the possibility of a power feed line living in a location that could cause considerable grief when trying to make the system meet a low noise spec.

### Air Conditioning

When the number of inputs increases, so do the power requirements. Wait a second. I just said that. Well, the point is the same, because as the power requirements increase, so do the refrigerating needs, because all of that extra power is being dissipated into the air as heat. Again, the specifics must be requested from the applicable manufacturer, but set aside one to two tons of control room air conditioning capability just to cope with the console. As we know, heat is the enemy of the semiconductor, and most automation systems produce lots of it. The power supplies and the automation computer deserve their own closed space outside of the control room. This is done to reduce noise contribution as well as to conserve floor space, but it also provides the added benefit of providing a smaller space to air condition. So, when laying out the HVAC, install a drop into

the computer closet. Make sure that there is sufficient baffling in the plenums to isolate the noise generated by the rack from the control room environment.

### Grounding

The discussion of grounding a large recording system deserves far more space than is available at this time. (See the upcoming November issue of *Mix* for an in-depth view of this provocative field.) However, suffice it to say that it is a critical concern. Some areas where faults creep in, corrupting the system ground integrity will be discussed. As mentioned earlier, the automation system usually requires many different transport communication lines for proper operation. When integrating these signals into the wiring scheme, take special care that logic ground and audio common are not joined. Serial control signals sound awful! Most manufacturers include an isolation scheme in the design of their interface systems, be it relays or optoisolators. Use them, and vigilantly apply your particular screening philosophy.

The "two mix" outputs are particularly vulnerable to incorrect earthing. Many times it has occurred that the incessant buzz that ruined that fine



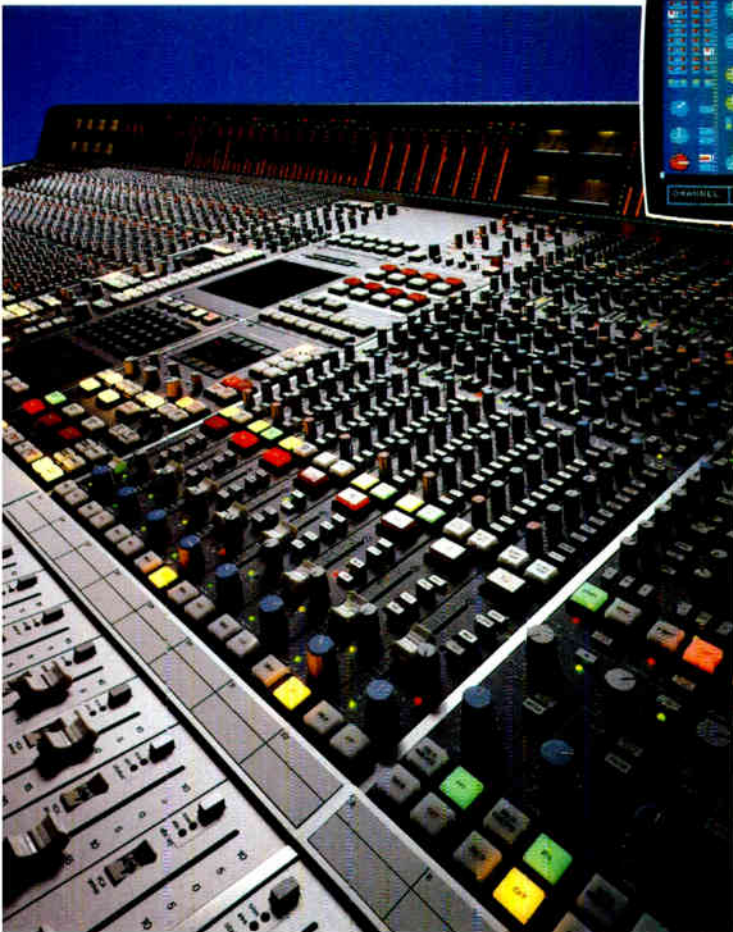

multi-repeatable Events Control, Automatic Dialogue Replacement, and centralised command of up to five synchronised audio and video machines. All of this is thoroughly integrated with the SSL Studio Computer — the world's number one choice for mixing automation.

Best of all, the SSL Stereo Video System is not a hasty revamp of an old mono design. Nor is it an experimental project in search of a guinea pig. It is a practical, reliable international standard for advanced television audio production — proven in well over half a million hours of network and independent studio and mobile operation — in Great Britain, Japan, Germany, Scandinavia, Australia, Canada and all across the United States.

Take advantage of our experience. Call or write today for a free 40 page colour brochure describing the operation and applications of the SL 6000 E Series Stereo Video System. If your station or facility is contemplating an upgrade to full MTS production capabilities, we'll be happy to arrange a complete demonstration. And be sure to ask about our training programmes.

## Solid State Logic

Begbroke, Oxford, England OX5 1RU • (08675) 4353  
 200 West 57th Street • New York, New York 10019 • (212) 315-1111  
 6255 Sunset Boulevard • Los Angeles, California 90028 • (213) 463-4444

mix" was caused by a cassette machine whose shield was carried through. The monitor rack deserves close attention as well, in that many systems are now sourcing all monitor outputs in a single-ended manner. There are no difficulties in this until there are a number of power amplifiers loaded into a rack, all of them individually brought to system audio common, and a few of them are single ended, thus resulting in a rather large ground loop, resulting in hum in the monitors!

Grounding of a large console interface is an interesting subject that we could pontificate on for hours, but as we said, space and time are lacking.

### Multi-Track Interconnections/(control)

There are currently two different philosophies in vogue concerning multi-track interconnection. Both hold merit and will be addressed.

One view holds that the console is not a machine controller, that this function should be handled by a device dedicated to that purpose. With a system designed with this philosophy in mind, the only interconnection necessary between the multi-track machine and the automation system is the cable carrying the time code. The Harrison MX-10 series and

the Quad Eight! Superstar are two examples of this type of design. The GML (George Massenburg Labs) embodiment of this design will function more properly when transport function tallies, true direction and tape timer tach pulses accompany said SMPTE code. This was done to accommodate fast winding to a given point in the tape, and hand positioning the tape to a SMPTE point for "fine tuning" the timing of a mute, level change or other automation supported function. While Massenburg Labs don't make a full console system for commercial sales, they do make a very nifty disk-based, moving fader automation system that is designed for OEM and retrofit purposes into existing consoles. The concepts involved and the parameters addressed in this article are fully applicable to this device. With all of the above mentioned designs, it is not necessary for the automation system to *control* the transport, as it is a slave to the incoming code. Therefore, if a machine controller is desired with any of the above systems, or designs of this type, it would be installed between the multi-track and the console, and the controller tallies would talk to the automation. Synchronization of other machines would be done as if the automation system were not present.

Another view is that the console is the heart of the recording process and system, and is therefore the nerve center of the studio. Holding with this concept, the console provides for both the receipt of information from the master transport for feedback purposes, and the transmission of commands that the master transport is to follow. In this type of design, autolocator functions, remote mode commands, master sync/repro switching, record drop in/out and parking functions are delegated to the console automation. Interface techniques used with these systems are a bit more involved than the aforementioned designs. An example of some of this difficulty can be brought to bear by just thinking about how some of the different multi-track machines bring out direction information. Say the console wants to see a voltage potential between two connections when the machine is going forward, and the machine brings out a logic "0." Damn, you say? Well, some machines bring out direction information in the form of bi-phase clock, and in either situation you have to build the interface. It's not hard, but you should plan for it.

### Set Up Memory

Another type of automation system

currently gaining popularity was first introduced by SSL under the name Total Recall. This system is not dynamic, in that it does not follow the moves of a mixer in time. Rather, the intent of the system is to take a "snap shot" of all the switches and pots on the console. The purpose is to facilitate the exact re-setting of the controls that affect a mix. The main implications of this system upon the console installation are: the inclusion of an RGB monitor (which should be positioned in the front wall of the control room), and questions regarding how this system talks to the fader automation system. Many other manufacturers are following suit with set-up memory of their own. Included in this

list are Trident (not officially released yet), Amek (also not officially released yet), Harrison's newly released MX-10, SSL, and Calrec's "assignable mixing system."

### Latest Generation Automation

As of this writing, there is another type of console appearing on the horizon. What is happening in console design philosophy is the emergence of digital control of analog circuitry as the predominant guiding force. The new Calrec and Amek consoles embody this philosophy. These systems make "set-up memory" obsolete, in that instead of merely remembering where a control was positioned, they now reset the control

to its previous setting. Harrison embodies as well in the MX-10 design. The implications of this concept are the removal of the audio analog hardware from the console surface, leaving only the human interface to occupy the real estate of the console work surface. This means that in the near future, we may see the console becoming a less imposing acoustic impediment.

### Real Time Events Control

Real time events control is best described as a large number of form "C" contacts that can be opened and closed by the console automation system. These switches can be controlled by SMPTE time code. Neve is offering real time control as standard fare with the Necam 96 package, and SSL and Calrec provide it as an option. Most synchronizer manufacturers have some form of option package that enables the use of this facility. When getting into the application of real time control, the pragmatic layout of the control wiring of the room becomes very important. It's really a pain to have to pull out and re-wire the remote connector on your 2-track every time you want to "fly in" an effect at a given time code point. It is this cabling requirement that leads us to assigning an area for all control wiring to pass through. In this proposed area, we also bring in the "real time" contacts. If in this area, all control cables are routed through some form of "punch block" or terminal strip, then it becomes an easy matter to "patch" the real time control to the desired device.

### Multi-Machine Control

With any system that requires considerable communication between the controller and the machine, there exists a time when you want to use a different master transport. For this purpose, a few manufacturers are offering Master Transport Selection as an option to their systems. SSL offers this as part of the Z8 rack; other offerings are from synchronizer manufacturers. Meant to alleviate the headaches of swapping multi-pin connectors, resetting gain/personality parameters and moving cables at the synchronizer, these items make multi-master facilities functionally possible. This is another type of tool that should be located within the "Control Line Closet."

### Options

Now that you have taken noise and heat into account, your computer and power supplies are safely tucked away behind the control room in a

—CONTINUED ON PAGE 205

## IT'S TIME THE WORLD FOUND OUT ABOUT

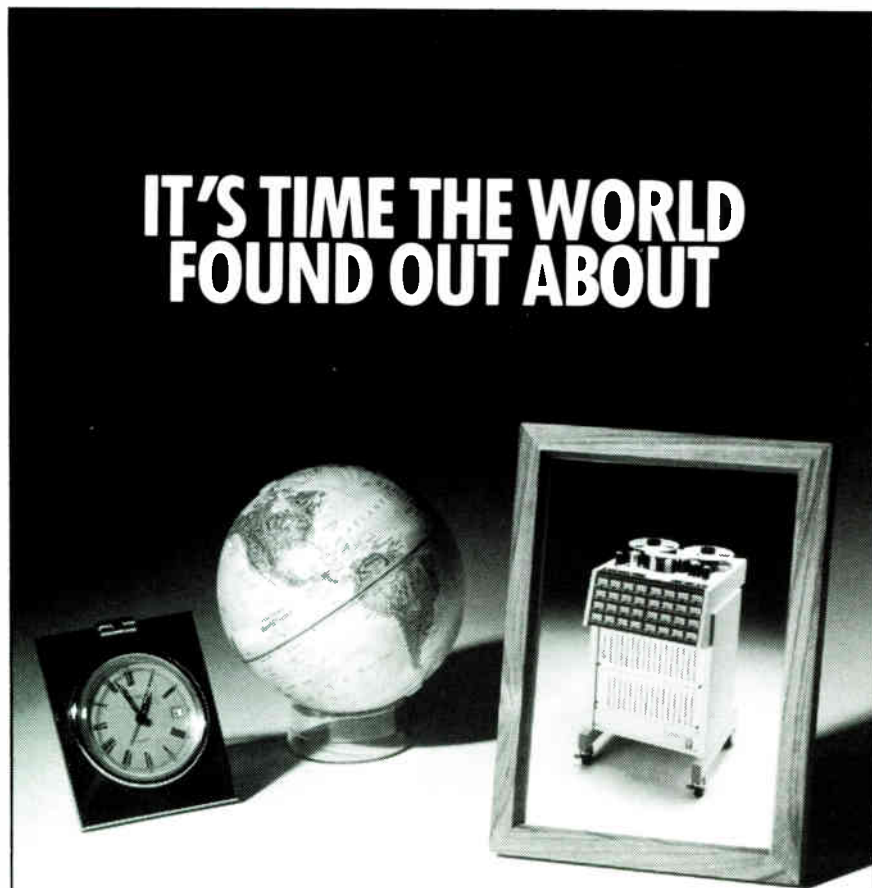

## THE 32 TRACK EDGE.

Recently one of our customers was considering a 24 track digital tape recorder until he found out about the new OTARI MX-80 2" 32 track analog machine. His comment was:

*"No matter what I do it's still 24 tracks. But with the OTARI MX-80 and the new DOLBY SR noise reduction, I can compete with digital for 1/3 the cost and have an extra 8 tracks. That gives me the edge."*

Lake agrees. We are a full line authorized dealer for OTARI and over 200 other product lines. We sell, service and support systems all over the world. For further information call us at 617-244-6881.

# LAKE

THE AUDIO COMPANY

55 Chapel Street  
Newton, MA 02160, U.S.A.  
(617) 244-6881



# How to keep your mixing board from holding you back.

Today's technological revolution is a battle fought on two fronts: quality and cost. Recent advances in recording equipment let you do more than you ever could before — And for less money. But what about your mixing console? Can it keep pace with recent giant steps such as the significant advances in the quality of analog and digital recording equipment? Without sacrificing your budget?



Program Mix Control

If you're mixing on a RAMSA WR-T800 series console, the answer is yes. RAMSA's 8-buss consoles are a smart choice for 8 or 16-track recording. They offer the *quality* you need to bring your recording chain up to today's demanding specs.

RAMSA's T-Series consoles save you time, too. Each input channel simultaneously accepts Mic, Line and Tape signals. A time-saving feature, the Program Mix

control and stereo Solo switches let you choose the signal source you want without re-patching. So you get from basic tracks to final mix in record time.

Because with the RAMSA T-Series, you get a mixing board that does much more for less without holding anything back.



Pushbutton Input Selection

## RAMSA

Panasonic  
Industrial Company



RAMSA WR-T820

# HIGH-END CONSOLES

**A \$200,000+ board isn't for everyone, but it's sure nice to go first class...**

by George Petersen

It's September, a time when automobile manufacturers anxiously unveil their latest models, all craftily designed to capture the hearts and minds of car buyers everywhere. As a child, I fondly remember looking through the fall issues of car magazines—checking out the Ferraris and Corvettes, as well as the Jaguars and Rolls Royces—and always wondered why Dad always seemed to pick a Ford station wagon.

The same thoughts could be applied to mixing consoles: why would anyone settle for an "ordinary" board, when marvels such as SMPTE-driven, automated 64-input models are available? Well, the answer is economics, pure and simple. Purchasing such a board puts one squarely in the \$200,000+ range—they're certainly *not* for everyone, although these megaboards can make life a lot simpler when dealing with a complicated mixing session.

The following is a showcase of world-class examples of the consolemaker's art. If you're in the market (or just "looking") for a high-end console, hop in as we cruise over to the dealerships and kick a few tires.

Officially introduced at the 1986 AES Convention in Montreux, Switzerland, and now beginning delivery (with the first board going to London's Strongroom Studio this month), the Assignable Production Console APC1000 embodies Amek's Large Architecture Console (LAC)<sup>®</sup> philosophy, a new design approach offering a wide range of control flexibility. Rather than being locked into a fixed "in-line" or "split" monitor design, the APC1000's channels can be dedicated to serve whatever functions desired by the operator; further, a large number (up to 128) of inputs can be accommodated.

Some of the APC1000's features include: a central keyboard control for

assigning module functions (stored in internal RAM), so various routing and switching setups can be recalled either as snapshots or dynamic, real time routing adjustments synchronized to time code; a reduction in module width—

48 channels fit into a space of approximately six feet; Audio Follows Video (AFV) ports for the remote control of levels and mutes from video peripherals; standard VCA faders that may be interfaced with the Audio Kinetics MasterMix computer; and eight mono and four stereo output buses (optionally up to 64) from each input.

The Amek APC is priced from \$175,000 to about \$450,000 depending on the desired configuration and options. Optional add-ons range from George Massenburg Labs moving fader automation to dynamics control modules and a recall system for memorizing the settings of rotary controls.

—CONTINUED ON PAGE 38



*Amek APC1000 console prototype*

*Calrec UA8000 at Puk Studios, Denmark*







Truly great amplifiers are measured by two standards. Sonic quality and reliability. Our new RAMSA 9055, 9110 and 9220 power amplifiers achieve excellence on both counts. And their superb, well-balanced design, combined with Matsushita's manufacturing processes and rigid quality control, gives us the confidence to back them with a 5-year limited warranty.\* This RAMSA warranty and UL listing assures you that we stand behind the 9000 series with everything we've got. And that's saying something. We challenge you to compare these new amps for yourself. But you better be prepared to re-evaluate your standards.

**RAMSA**

Panasonic  
Industrial Company

\*See terms of warranty for details © 1986 Panasonic



*Harrison Series X*

With the recent announcement that Calrec has been acquired by Advanced Music Systems (AMS), we may soon begin seeing the British-made Calrec UA8000 Ultimate Alternative consoles coming to studios on this side of the Atlantic. (The first board delivered went to ABBA's Polar Studio in Stockholm.) The UA8000s are available in either 64 or 48 channel versions, beginning at approximately \$200,000 (48 channel with automation) although shortloaded models can also be ordered. The automation system is VCA based, with an integral MasterMix memory.

Some of the UA8000s other features include: a complete dynamics section (compression/limiting/expansion/gating) on each module; four-band parametric equalization; switchable PPM/VU bar graph metering and a comprehensive internal routing architecture allowing full side chain control of equalization, dynamics and effects sends. Each module has over 75 LEDs (and two bar graph displays) which indicates the status of signal routing

every step of the way, thus requiring an auto-diagnostic "LED Test" button, which simultaneously lights every LED on the console when pressed.

Harrison Systems made quite an impact at last year's AES Show in New York with the introduction of the Series X (ten), the first totally automated audio console system. The board can be reconfigured to any required signal flow architecture in less than one video frame, and all levels, pans, equalization, dynamics processing and routing changes are dynamically automated with subframe accuracy. The automation system is referenced to SMPTE time code in any standard format—24, 25 and 30 frame—and mix data can be stored on 20 megabyte hard disk or 8-inch floppy disks. All Series X signal processing parameters are digitally controlled analog functions using DCAs (digitally controlled attenuators) rather than voltage controlled amplifiers, and Penny & Giles motor driven moving faders are standard equipment.

Each of the Series X modules contains two complete, totally automated signal paths, with two each of the following programmable controls: level, program mute, program pans (one stereo and one stereo/quad/left-center-right-surround cinema), four-band parametric EQ, high and low pass filters, compressors, gates, and assignment sections; eight automated aux sends are also provided on each module.

Prices for the Series X consoles range from \$384,620 for a 32/32 model up to \$639,780 for the 64/64 mo-



*Quad Eight's SuperStar console debuts at 1985 AES show.*

del with 64 modules, although one must keep in mind that each module has two complete signal paths.

The Neve V ("vee") Series is a 48 bus multi-tracking console available in 36, 48 or 60 channel mainframe sizes. Standard features include individual channel dynamics (limiter/compressor/gate) with external keying, eight mono/four stereo aux sends for more effects paths during mixdown, and Neve four-band Format Spectrum equalization. Also available are a choice of metering options, an independently assignable patching section, facilities for in-line or separate monitoring, and a structural design enabling console breakdown for simplified installation and relocation.

The Series V can be fitted with Necam 96, an intuitive touch-sensitive, moving fader automation system. Necam 96 offers free grouping, automated and group muting, update-from-any point capability, snapshot memories, real time control and displays, 1/3 frame accuracy on events and muting, and a range of other features.

Shown for the first time at the 1985 AES Convention, the SuperStar console by Quad Eight (a division of the Mitsubishi Pro-Audio Group) is a 72 input board designed specifically for digital recording. SuperStar uses "central assignment" output routing switching: 64 output buses are assigned from each input module by a central touch-control plasma display with an up to 96x64 completely software-driven switching matrix.

The SuperStar includes IDF intelligent digital faders—microprocessor-based 10-bit digital encoders supplying 0.25 dB resolution with 119 dB of dynamic range, and up to 256 IDFs can run independently without the need for external automation. SuperStar's internal automation is the Compumix IV SMPTE time code driven dynamic system, which stores every frame of information, allowing the performance of editing functions on-line. An 80 megabyte hard disk storage system is standard; options include a graphics display system.

—CONTINUED ON PAGE 40

*Neve V Series at Minnesota Public Radio's Studio M*





*Just when you thought the future  
couldn't shock you any more.*

Introducing the Lexicon PCM 70, our extraordinary new digital effects processor with dynamic MIDI. Designed, creatively speaking, to thrust you into the future.

To begin with, the PCM 70 gives you access to the same astonishing Lexicon digital effects used by the world's top artists and studios. With complete, variable parameter control, and registers that let you create and store your own programs.

Now, about dynamic MIDI. With this pioneering Lexicon development, you can vary any PCM 70 parameter through a MIDI keyboard while you're actually playing. Just imagine being able to vary the wet-dry mix, for example, through finger pressure on the keys. Or by your choice of other controls, like the modulation wheel. Or even by a computer.

There's more. The Lexicon PCM 70 digital effects processor is also a full-fledged digital reverb, with a complete selection of Lexicon reverb programs. And the price? Shockingly reasonable.



### **NOMINATED FOR 1986 TEC AWARD**

You'll want our detailed PCM 70 brochure. At your Lexicon dealer, or contact us. Lexicon Inc., 60 Turner Street, Waltham, MA 02154, USA. (617) 891-6790. Telex: 923468. Lexicon International, P.O. Box 122, 8105 Regensdorf, Switzerland. Telex: 59222.

Come to the future.

**lexicon**





*Solid State Logic SL 4000 E*

While Solid State Logic's SL 4000 E Series Master Studio System and SL 6000 E Series Stereo Video System consoles were introduced several years ago, SSL has made continual refinements to the systems to keep them at the cutting edge. Both Series are available in mainframe sizes ranging from 24 to 64 channels, although SSL recently delivered an 80 channel 4000 Series board—made from standard components—to Royal Recorders in Lake Geneva, Wisconsin. Prices vary from under \$100,000 to \$400,000, depending on configuration and options.

The SSL Studio Computer interfaces with all Solid State Logic consoles, offering: tape location using EBU/SMPTE time code, foot/frames or key words to specify cue and edit points; complete session data storage and list management with video displays and/or hardcopy printout; and the dual

floppy disk-based system provides dynamic mixing automation of all channel and group faders and mutes, with frame accurate mix editing and revision.

Optional subsystems include Total Recall™ (which stores the details of all I/O module settings on floppy disk for later recall to a quarter of a dB accuracy), the SSL Events Controller (for up to 32 multi-repeatable contact closures—with individual pre-roll memory—for external device/event control), the SSL Real Time System (allowing complex sequences of preset faders and mutes to be executed in real time from a single set of controls), the SSL Integral Synchronizer and Master Transport Selector (a five-machine synchronizer that combines with the console computer, automatically calculating offsets and letting any transport—audio, video, or film—to be des-

igned as the master), and a fully programmable, 3-band stereo parametric equalization package.

SSL has just announced a number of improvements for their Total Recall computer, including more detailed control graphics and memory extension that now incorporates control group assignments. The most dramatic aspect of SSL's Advanced Total Recall is a new feature called AutoScan, allowing the computer to automatically detect channels and controls which differ from their previously stored configuration, and Selective AutoScan lets the user define selected functions only for the scan, such as routing, dynamics, equalization or sends. The Total Recall Copy feature has also been updated to assist users working with setups that originated on larger consoles than they are being played back on. These developments are field-retrofitable to all SSL E Series consoles.

Unveiled at the Association of Professional Recording Studios Show this June in England, Trident's Di-An console represents a major step forward for the company. While the board is basically a digitally-controlled analog console (hence the name "Di-An"), it is "digital-ready," anticipating that its analog audio cards could be replaced with all-digital electronics at some future date, if desired.

The Di-An console does not contain any input or output "modules" in the accepted sense, but instead allows the user to access any number of central control panels via an illuminated "access" button above each fader. These access buttons, along with mute, AFL, PFL, stereo solo and channel status LEDs, are the only controls duplicated for every input. Signal processing is manipulated via centralized control panels, offering equalization, aux sends, routing, panning, phase reverse, dynamics (one gate/limiter per channel is optional), and so on—all assignable to each input. A four-character alphanumeric display enables the memorization or load-from-disk for information pertaining to that input.

Apart from the fader automation, the console provides static memory of all levels, routing, EQ, aux sends, panning, mutes and solos, with all software held in RAM, so floppy disks are only used for retrieval and storage of console settings. Since the static memory system is linked to SMPTE time code, console settings can be changed every frame, with sub-frame accuracy.

Options for the Di-An include the aforementioned dynamics controls, as well as internal tape synchronizing and additional software for providing track sheet information and the like, to be displayed on an external monitor.

*Trident Di-An Console*

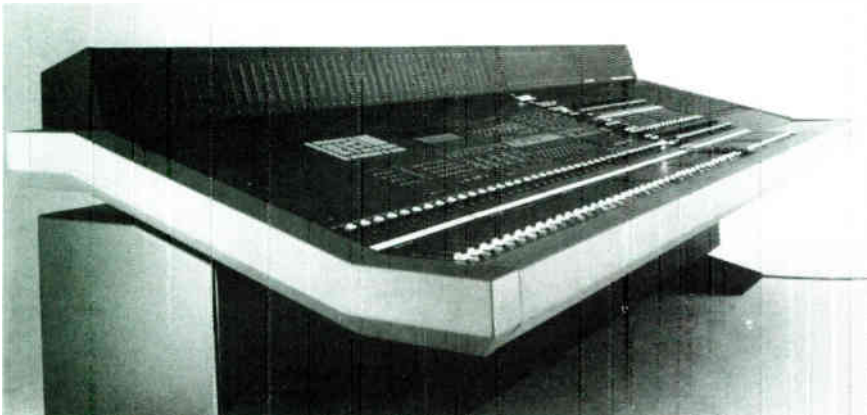





## Between a shadow and a whisper

That's where you'll find the ultimate in transport control. The Shadow II™ with its powerful microprocessor is capable of synchronizing virtually any audio, video or film transport on the market.

Softouch™ represents a technological breakthrough in audio editing. Sixteen Softkeys™ permit repetitive or intricate pre and post production editing routines at the

quiet touch of a single key. These units are affordably priced for today's professional.

The Shadow II and Softouch combined make a powerful editing system increasing productivity and enhancing user flexibility. Both units carry a 3 year warranty.

For more details contact Cipher Digital today. Call (800) 331-9066.



cipher digital, inc.

P.O. BOX 170/FREDERICK, MD 21701  
(301) 695-0200 TELEX 272065

*Timely today, consistent with tomorrow.*



PHOTO BONNIE SCHIFFMAN/ONYX © 1986

# David Byrne's True Stories

**T**he processes used to produce records and movie sound have developed independently over the years, each with its own set of solutions to unique problems. Only in the past few years have the two disciplines begun to borrow ideas from each other—and now, at San Francisco's Russian Hill Recording, multi-track techniques are being applied to film soundtrack work on a major scale.

The post-production techniques developed by sound designer Leslie

## AT RUSSIAN HILL RECORDING

by David Gans

Schatz for *True Stories* (written and directed by—and starring—David Byrne of Talking Heads) are a marriage of methods allowing musician Byrne to work in the style that's familiar to him and to use music nearly wall-to-wall throughout the film, often integrating it with ambient sounds—and, in places, to use sound effects as music.

"I usually hold onto my wallet when somebody says something's 'new' because that generally means it's going to cost some money," quips Schatz.



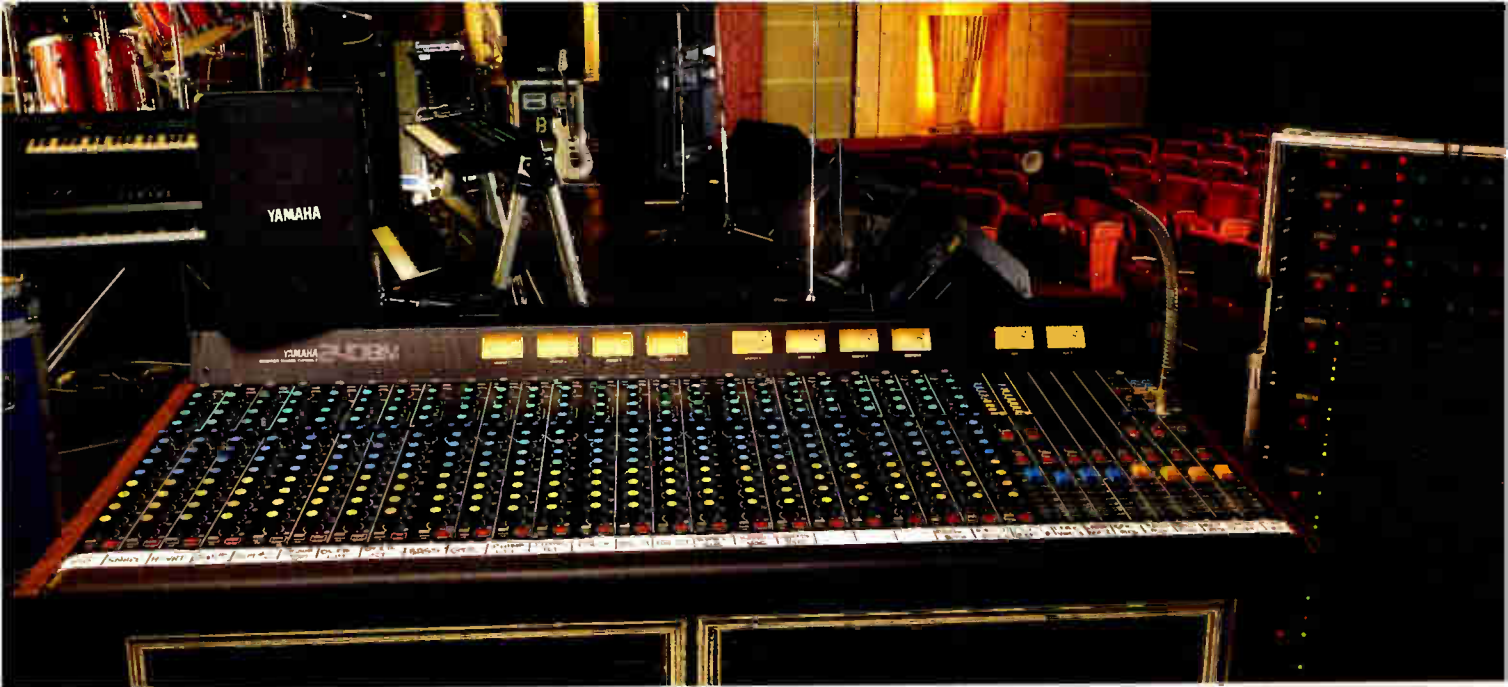

# Why should anyone else listen if you can't hear yourself?

A good monitor mix lets each member of the band hear exactly what he or she needs to hear. And that can be critical in helping any band play its best.

It's with this in mind that Yamaha designed the new MC monitor mixing consoles, the 16-channel MC1608M and the 24-channel MC2408M.

Both offer eight independent monitor mixes via eight outputs. And two auxiliary sends which can be used to patch in signal processors or tape recorders, as well as provide two additional mixes.

Each channel has a phase reverse switch, 20 dB pad, gain control, peak LED, three-band equalization with sweepable mid-frequency, two auxiliary send controls, eight rotary level controls, channel on/off switch, and channel cue switch.

The Input Channel Cue Priority System makes the monitor mix engineer's job a little easier. By pressing the cue switch on one or more input channels or auxiliary inputs, the master outputs being monitored are muted. So he can monitor only the selected input signal through headphones or speakers.

The MASTER section cue function permits the engineer to monitor an individual performer's monitor mix through his own headphones or near-field speakers without affecting

the overall monitor mix.

The MCM consoles' communication facilities include talkback assign switches, XLR talkback mic input, and COMM IN jack and level control. So the monitor mix engineer can communicate with the house mix engineer as well as with the individual performers.

All primary inputs and outputs are electronically balanced with XLR connectors. And there are insert patch points on all input channels as well as the master outputs.

Yet with all this flexibility and these features, both the MCM consoles are lightweight and compact. And at \$2,895\* for the MC1608M and \$3,995\* for the MC2408M, surprisingly affordable.

So now that you've heard us, it's time to go to your Yamaha Professional Audio dealer to check out an MCM mixing console. And hear yourself.

For a complete brochure, write: Yamaha International Corporation, Professional Audio Division, P.O. Box 6600, Buena Park, CA 90622. In Canada, Yamaha Canada Music Ltd., 135 Milner Ave., Scarborough, Ont. M1S 3R1.

\*U.S.A. suggested retail price. Prices will vary in Canada





**Leslie Schatz working at Russian Hill on "True Stories." (Pop Staples appears on the monitor.)**

"No single aspect of this is new, but I believe that the process itself is new."

For *True Stories*, says Schatz, "we approached the making of the sound-track like the making of a record. We added each new track to the monitor mix, so we could hear the sound effects, the ambience tracks and the dialogue coming together as we worked."

This way, the entire process remains maximally interactive almost up to the final mixdown—meaning that the dialogue, sound effects and music are much less likely to collide when they're brought together. It's a far cry from the "old-fashioned" way of creating movie sound, which involves many specialized people working in many different places, recording on sprocketed magnetic film with up to six tracks of sound each.

The moviola, the machine on which both picture and sound have traditionally been edited, "is basically a sewing machine that can run film," Schatz explains. "It's on that level of technology, of the industrial revolution."

"You can work with as many tracks as you like," explains Byrne, "because you can run as many machines as you like. If you need to you can have 50 tracks, which in the past put film mixing ahead of sound mixing."

"With a moviola," adds Schatz, "I know I can get a track perfectly in sync. With the Q.Lock [the device used to synchronize various machines by means of SMPTE time code], you have the same capabilities—you can change the sync by changing the offset—but somehow it's mentally more difficult. You constantly have to be on guard for the tendency to let things slide."

"It's funny, because the Q.Lock goes through all these changes to lock two machines together, reading time code and deciphering offsets and all that, and two miles from here people are doing the same thing by sliding a brass fitting onto a hexagonal shaft so one

motor will drive another shaft. It's the most basic thing you could possibly do.

"What I'm saying is, you can't delve into the new just because it's new. You have to have some selectivity. What goes on the screen and comes out the speakers is still the boss. You're still trying to entertain people, and that's it."

The potential power of film sound is just beginning to be realized, according to Schatz. "The visual lexicon of film has been developed to a really great extent. It's in its fifth or sixth generation. In less than a century we've gone from the invention of the closeup—and the invention of editing, period—to now, where on television it's not uncommon to see elisions in time that take place in editing, jumping from one thing to another so quickly, that an audience 20 years ago probably wouldn't have understood."

"The alphabet of sound is very elementary at this point," he continues, "but a new language is being developed. *Musique concrete*, sound montage—generally, sounds that depart from slavishly following the image in one way or another—is the direction I believe and hope sound will evolve in film. It's gradual, and it requires re-educating the audience each time you develop a new technique."

Enter David Byrne, habitue' of the leading edge. It's not surprising to learn that Schatz is a big fan of *My Life in the Bush of Ghosts*, an experiment in sound textures recorded by Byrne and Brian Eno several years before digital sampling became generally available. "The fusion of music and sound in that album has been an inspiration to me," says Schatz. "I always play it on my cassette machine when I'm on the job."

"That record would really appeal to a sound designer," Byrne notes. "That kind of record is very close to what he does." The two men found their ideas and aims sufficiently compatible to proceed with an experimental sound design scheme, and Schatz knew Russian Hill was the place to do it.

"Because of the kind of outboard equipment available and the way of monitoring and mixing," says Byrne, "I thought it would be more appropriate to do everything on 24-track—or two 24 tracks combined to one."

One major tradeoff in this method was that the film had to arrive at Russian Hill in its final, edited form before the dialogue was transferred to 2-inch tape and the multi-track recording process began. "The disadvantage is that once everything's on 24-track tape, you can't shift anything relative to the other sounds," Byrne explains. "Everything is pretty much locked into position. When all the stuff is on separate, sprocketed magnetic film—say the dialog's in one group and the music is in another—if a piece of dialogue seemed a split second off, you could shift it over. On 24-track tape, you have to make all those decisions ahead of time."

"It runs counter to all the accepted techniques of filmmaking," notes Russian Hill co-owner and chief engineer Jack Leahy, who mixed the music for *True Stories*. "It has always been the filmmaker's prerogative to make changes in the picture no matter what's going on, no matter how close you are to completion; sound is considered kind of a poor relation by most people who make films. They're thinking story and image, and sound is somewhere down the list."

David Byrne found out about the traditional Hollywood way of doing sound while he was working on *Talking Heads'* 1982 concert tour directed



by Jonathan Demme. "We did the sound mix on a conventional dubbing stage," he explains. "You have 15 union guys hanging around smoking cigars—a dialogue guy, an effects mixer, a music mixer, and so on, each sitting at a different section of this mixing board that's twice as long as any board in a recording studio. The thing is a mile long.

"When they had to do what they were hired to do, they were generally pretty good at it," Byrne continues. "It's just that they all had specialized jobs. For instance, if you needed an effect—the sound of a car, or something like that—there was one guy, who *only* did that stuff."

At one point in the final assembly of the *Stop Making Sense* soundtrack, Byrne recalls, a missing guitar note had to be replaced. "I said, 'Oh, I can fix that—I'll bring my guitar in and plug it into the board.'

"They said, 'No, you can't do that. Recording is done in a separate place down the hall, and you have to book it a couple of days in advance.' It was really difficult to do something simple... the technology was kind of outdated.

"I liked the movie mix of *Stop Making Sense*, but it was a real pain in the ass working with people who weren't used to thinking in recording studio

terms. I thought that all seemed kind of silly. It seems nice to have one person who can understand and coordinate all the different elements and to have one place where it could all be done, and Russian Hill happened to be the only place that offered all that."

Producer Karen Murphy (*This Is Spinal Tap*) brought sound designer Schatz into the picture. Schatz, who has worked in film sound since 1971, moved to the San Francisco Bay Area in 1978 to work on *Apocalypse Now* as dialogue supervisor for director Francis Coppola and sound designer Walter Murch. "Things seemed really good up here, so I stayed. After that I worked as sound editor on *The Empire Strikes Back* and *The Dragonslayer* and as a supervising sound editor on *One from the Heart* and *The Black Stallion Returns*, and dialogue supervisor on *Rumble Fish*."

Nearly 80 percent of the dialogue in *Apocalypse Now* was rerecorded in the studio, and Schatz found himself virtually in the role of director. Coppola "generally doesn't like to be around for those sessions, because they're really tedious. However, there are a lot of things that can go wrong, so I was lucky to have him put his trust in me. Basically, I was in charge of directing those actors, getting their performances in the studio. In the bat-

tle scenes," he recalls, "Robert Duvall was talking at maximum volume. It was hard to get that in the studio. People don't want to yell too loud, and you can't make the sound in their headphones very loud or it'll leak into the microphone. You just have to keep pushing and pushing, over and over again."

After working on *Dune* and *Once Upon a Time in America*, Schatz served as sound designer on *Mishima*, which was mixed at Lucasfilm, north of San Francisco. Then he worked on *The Journey of Natty Gann* at the Disney Studios in Los Angeles. "That was really interesting, because I was trying to utilize some of the techniques that I'm utilizing now, but in a stricter, Hollywood kind of context. We had to do a lot of sneaking around in the interest of quality," he laughs, "because the situation down there is really tight. I don't know whose rules I was breaking—if anybody's—but I didn't want to stay around and find out."

The post-production methods used on *True Stories* "are going to kind of radicalize the labor situation," says Schatz. "There's no longer a distinction among musician, mixer and editor. What we're doing here is replacing the functions of all three, and I don't know how the unions are going to deal with that.

# A SOUND INVESTMENT

Affordable 1/3 Octave Real Time Spectrum Analyzer

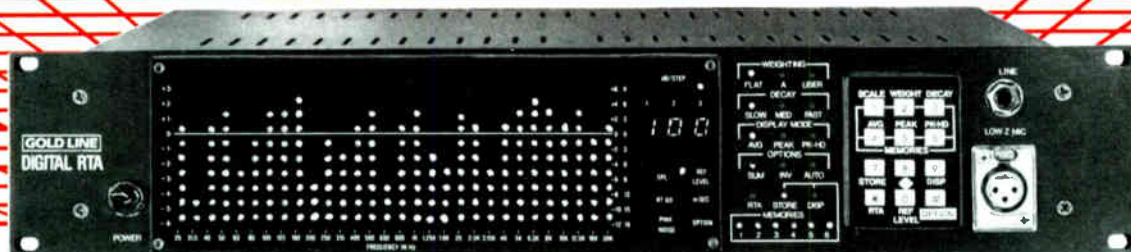

**DESIGNED FOR PROFESSIONAL USE IN THE STUDIO, ON TOUR, OR SETTING UP SOUND SYSTEMS.**

**Features include • 30 Bands • Six memories • Quartz controlled "switched capacitive filtering" • Rugged construction for road use • Microprocessor control • Pink noise • Weighted curves • Summing and averaging • Peak hold • Printout option**

**Model 30**  
Affordable at  
**\$2150**

**FREE LITERATURE**

Call:  
(203) 938-2588

Write:  
P.O. BOX 115  
WEST REDDING, CT 06896

# GOLD LINE

Circle #020 on Reader Service Card

**FILM SOUND '86**



*Russian Hill Recording co-owner and chief engineer Jack Leahy and sound designer Leslie Schatz at Russian Hill.*

"It's an important question, because we're in San Francisco working in sort of an ivory tower. We work on very few films every year, and generally they're all really choice films with post-production budgets larger than what people get in Los Angeles. And I think the view of what happens here can tend to be distorted in—I hesitate to say the 'real' film industry—where people are more concerned about schedules and budgets than they are up here. The guys up here have the luxury of spending more time on their films."

Traditional film techniques are labor-intensive. "This is all speculation on my part, but I gather that because the studios had to turn a certain amount of product every week, they had to have a large labor force engaged all the time. Now they're turning out less product and they don't really need the large labor force, but their methods are still designed to utilize a lot of people."

The way *True Stories* was done is more equipment-intensive. "On a normal film job there may be 14, 15 people," says Schatz. "On this job, there's me, the film assistant, the engineer and the second engineer."

"I don't really want to be in the position of putting people out of work, and I don't know that it necessarily will, but I do feel that there is going to have to be an evolution from the labor-intensive techniques to the techniques that utilize the new hardware and the new systems."

Still, Schatz believes, "You can't reinvent a whole new technique from thin air. The successful steps forward are going to be some kind of synthesis of what happened in the past—and

that's what we're doing here. We're taking film techniques from the past, digital techniques from—the future, or whatever—and recording studio techniques from what is currently happening."

Schatz's studio set-up centers on an Emulator II digital sampler and a Yamaha DX7 which, he says, "I don't use for musical purposes at all. I'm not a musician. I've created sound effects on the DX7 that are in a key and a pitch and a rhythm, associated with musical things that are happening in the film. With the DX7 and the Emulator, once you get a basic sound you can transpose it and have it in tune, play it in harmonies if you want; you can play it rhythmically."

"I believe that the DX7 and the Emulator are the most powerful tools for creating soundtrack in film. A lot of the old ways of doing things are going to fall by the wayside."

"Leslie understands that a lot of the sound effects and things can be treated almost like music," says Byrne. "There's a lot of music in the film, and even when there isn't music, sometimes the sound effects are treated musically. Sampling sounds on an Emulator makes it easier to think of them as music even though it's a footstep or something."

The most important lesson Schatz has learned along the way, he says, is that "no matter how artful you get with sound effects, you have to remember that the dialogue is the boss. If people can't understand the dialogue in the film, the rest of it might as well be thrown away."

"I'm sure you've had the experience of going to a movie and, when you don't hear what's going on, you turn to somebody and say, 'What did they say?' And from that moment on, you're out of the movie."

Film music generally arrives at the final mix on four tracks: left, right, center, and surround. "If you don't like the combination of the instruments, too bad," says Schatz. "Or if you have a way of making the music sound better—by featuring one of the instruments, say—you're out of luck."

Applying recording studio techniques to film work isn't a simple matter, however. "It's a whole different style of mixing," says Schatz. "When you do a mixdown for a record, you're setting basic parameters that generally don't change. You may be moving some faders in and out and muting things, but it's nowhere near the kind of radical convolutions of level changes and panning that you get in film sound."

"Music is fairly continuous, and if your tracks are recorded properly you're not making huge swings in

level, whereas in film, from one scene to the next you have to move a fader from zero to full on, with subtle shadings in between. So there is a big difference."

"Also, 24 tracks is not enough to do a film job. We had to be very disciplined in the way we organized the tracks and the levels that we laid things down at, because we were taking maybe a hundred tracks' worth of stuff and condensing them to 24 tracks by successive passes, bouncing things and submixing. There are a lot of complexities in a film job that aren't in a record job. It's no wonder nobody's really tried this before."

"There has to be a reason to do it. First of all, David wanted to approach it from a musical point of view, and second, I believe that's what this film really needed."

"Often, the music I get is deficient," says Schatz, "so I have to do things to it that aren't elegant such as apply lots of equalization, and generally in a brutal way."

A case in point: "There's a scene in the film where a woman is narrating a fashion show," Leahy explains. "She breaks into a song, and the song takes over the sound. There's a funky little band, and then all of a sudden this '30s orchestra stuff comes out of nowhere and she floats out into the ozone."

"So you have this girl talking, which is dialogue. Then she's singing, which is music. Those are different departments [in Hollywood], and it's usually not until you get on the stage that a mixer is going to realize that he's got this dialogue track that sounds completely different from the vocal track that was cut in a recording studio, even though it's the same person."

Because Leahy was mixing the music at the same time and in the same building where Schatz was working on the dialogue, "we had a lot of options," says Leahy. "We brought the actress for an ADR [automated dialogue replacement] session. I flew the first 16 bars of the song onto the ADR reel so Leslie could match the dialogue to it."

There are hundreds of similar situations in every movie soundtrack. Any time either mixer wanted to see what the other had going in a particular segment, all he had to do was step across the hall and ask for it. "I'd finish the cue I was on, slave up another machine, and fly this stuff over with the right SMPTE numbers on it. He'd put it up on his machine, transfer it to his work reel, and he'd have music."

Leahy hastens to point out that Russian Hill is by no means a state-of-the-art audio recording facility: "We don't have 70 tracks of fabulous automa-

—CONTINUED ON PAGE 125, BYRNE



# 1003 reasons the BASF Chrome Loop Master is the best bin tape you can buy.



## Horse sense.

From now on, using a ferric tape for high speed duplicating is going to be like entering any old horse in the Kentucky Derby. It will get you around all right, but you'll always be riding with a handicap. The fact is, ferric masters are designed for recording at 30 or 15 ips, not the 3¾ ips required for efficient high-speed duplication. BASF Chrome Loop Master 920 is the only mastering tape developed specifically for high-speed duplication. Which is one very good reason to use it.

## The ultimate repeater.

To begin with, the BASF Chrome Loop Master gives you at least 1000 more passes than a ferric tape. Although the total number of passes depends on your bin, you can expect up to 50% more running time, for the lowest cost per pass of all bin tapes.

More running time means less downtime for reloading—and fewer masters. All of which adds up to 1002 very good reasons to buy it.

## Chrome on the range.

The last reason is audio quality—cost efficiency wouldn't mean much with-

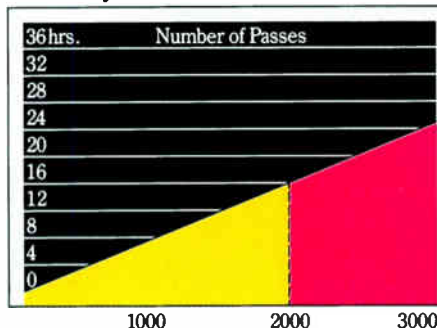

A bin that runs 2000 passes on a 600-ft. ferric master at 240 ips can run as many as 3000 passes on BASF Chrome Loop Master 920—that's 8 hours and 20 minutes more running time per master.

out it. And this is where BASF really excels. Even before you've started your first pass, Chrome Loop Master is better—with better high-frequency output and lower noise—for exceptionally wide dynamic range. And because of chrome's immunity to magnetorestrictive forces, that quality stays, pass after pass, long after contact pressures have begun to erase high frequencies on an ordinary ferric master. BASF Chrome Loop Master starts with better high-end response—and keeps it much longer.

## Chrome to chrome.

What it all adds up to is the perfect complement. Chrome Loop Master, with its greater high-frequency head-room, is the perfect match for BASF chrome cassette tape. Chrome-to-chrome duplication. High-fidelity, high-speed duplication—that's just plain unbeatable.

## Drop your iron.

So remember, no matter how much effort and talent you put into your work, you're only going to sound as good as the tape you use. Don't short change yourself with ferric. Reach for a bullet. Reach for BASF Chrome. And ride with the best.

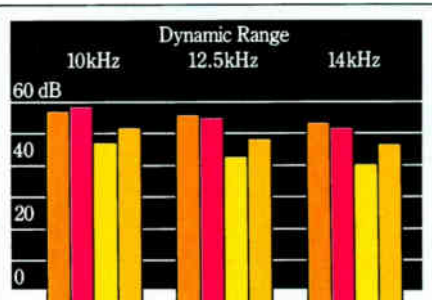

- Ferric Master 7½ ips
- BASF Chrome Loop Master 3¾ ips
- Ferric Master 3¾ ips
- BASF Chrome Cassette Tape (120 µs)

The dynamic range of a master tape must exceed that of the cassette stock to avoid compromising the cassette copy. At 3¾ ips recording speed, Chrome Loop Master 920 has more dynamic range than a BASF chrome cassette tape, but a ferric master has less.



For additional information call:  
1-800-225-4350 (East and South) or  
1-800-225-3326 (Midwest or West).



# BASF

# NEWS

# PUBLISON

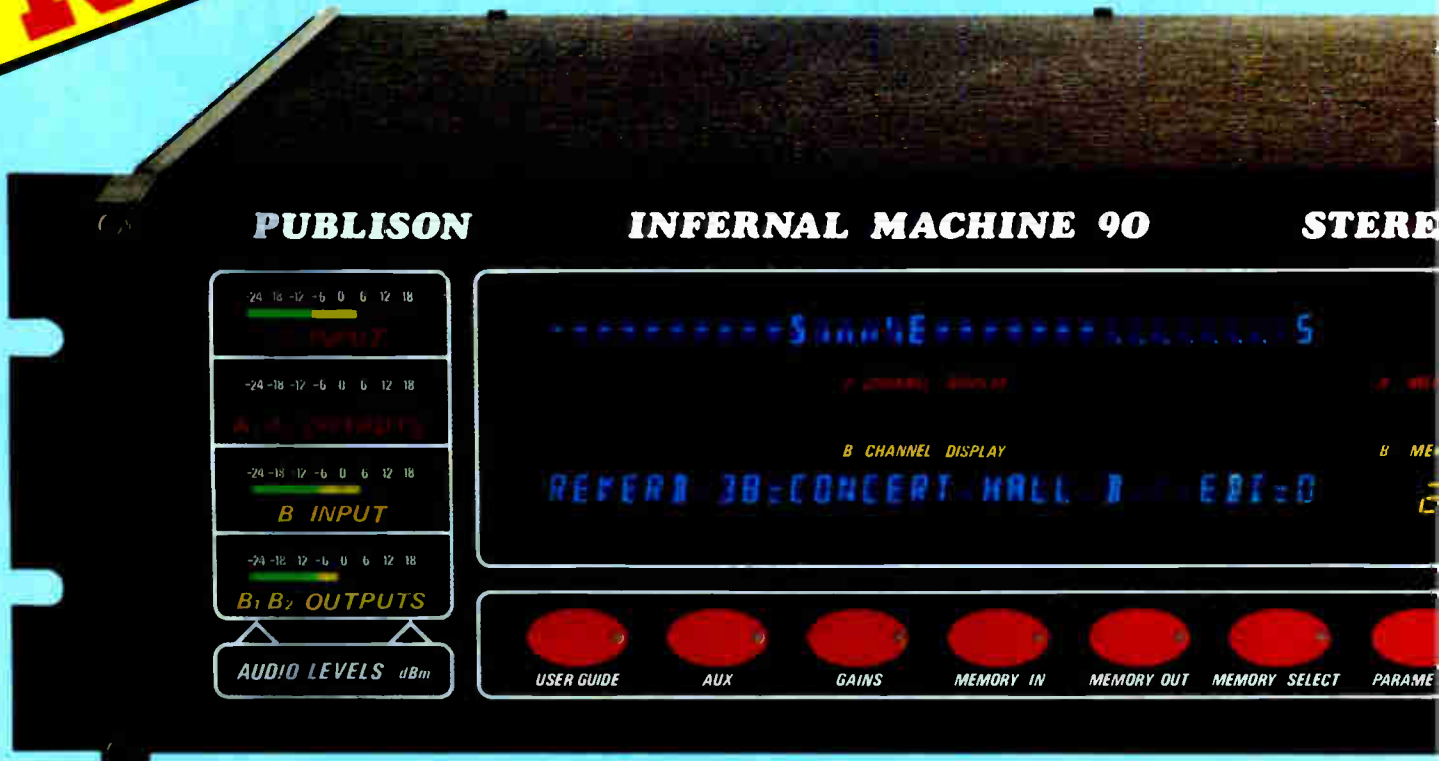

**PUBLISON**

**INFERNAL MACHINE 90**

**STEREO**

-24 -18 -12 -6 0 6 12 18  
**A INPUT**

-24 -18 -12 -6 0 6 12 18  
**A INPUT**

-24 -18 -12 -6 0 6 12 18  
**B INPUT**

-24 -18 -12 -6 0 6 12 18  
**B<sub>1</sub> B<sub>2</sub> OUTPUTS**

**AUDIO LEVELS** dBm

-----SOUND-----

**B CHANNEL DISPLAY**

REFER 38:CONCERT HALL B:EDIT=0

**USER GUIDE**   **AUX**   **GAINS**   **MEMORY IN**   **MEMORY OUT**   **MEMORY SELECT**   **PARAMETER**

### TWO SAMPLING MEMORIES

Two independent 20 kHz sampling memories  
 Number and length of samples at will  
 MIDI interface  
 MIDI key sample select of samples mode  
 MIDI chromatic stack mode  
 Loop  
 Sound triggering  
 Editing  
 Backwards mode  
 Pitch-ratio control  
 Evolving vibrato  
 Speed-control independent of pitch-ratio, which gives the time compression/expansion mode  
 Polyphony up to 8 notes with 4 machines  
 Storage of samples on external hard disk  
 Memory capacity at 20 kHz frequency response

Standard	: 2x5.2 sec
Option 1	: 2x20.9 sec
Option 2	: 2x87.6 sec

### TWO PITCH-CHANGERS

From -2 to +1 octaves  
 With 4 different deglitched algorithms  
 With MIDI interface  
 With evolving vibrato  
 With automatic arpeggio  
 With added delay settling

### TWO STEREO REVERBERATIONS

**ENTIRELY INDEPENDENT**  
 You have two stereo reverberations with independent settings on two separate channels  
 With 52 preset programs  
 With editing mode  
 With parametric mode  
 Size adjustable between 1 m<sup>3</sup> and 1,000,000 m<sup>3</sup>  
 Decay time from 0.1 sec to 200 sec  
 Predelay from 1 to 999 ms  
 Reverberation attenuation from 0 to 99 dB  
 Bass coefficient from 0.25 to 4.00  
 3 primary reflections separately adjustable from 1 to 999 ms and from 0 to -99 dB  
 Pre-reflections diffusion network  
 400 memory steps to save user's programs

### AND, OF COURSE,

Delay  
 Echo with digital feedback  
 Selection of the language of the Guide-Operator  
 400 non-volatile memories to save user's programs  
 New functions are coming regularly and the updating of existing machines is easy.



# INFERNAL MACHINE 90

★ ★ ★ HELLO! ★ ★ ★  
**THE INFERNAL SMPTE IS COMING**

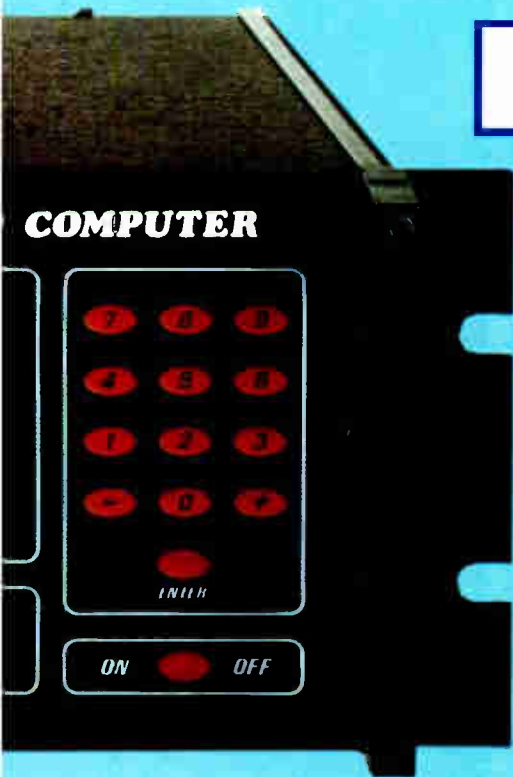

**NEW : SMPTE PITCH TRACKING**

With the SMPTE pitch-tracking you can automatically compensate the pitch-changes of vari-speed tape machine.

**NEW : SMPTE SYNCHRONIZATION**

The Machine can store up to 4000 time code steps to which you can affect any function of the machine with any parameter. The Machine will automatically be controlled by the received time code.

**NEW : SMPTE GENERATOR**

The Machine can generate a SMPTE time code by which it can synchronize other units or other Machines. The Machine can also be internally auto-sequenced.

**NEW : REMOTE CONTROL**

THE INFERNAL MACHINE remote control has all the display and control functions of the Machine.

In addition a digital potentiometer gives a fast and easy settling of the parameters, and the A & B key gives simultaneous control of both channels.

**NEW : HARD DISK INTERFACE**

With optional hard disk you can save up to 3 minutes of digital sound.



## PUBLISON AMERICA, INC.

6464 Sunset Boulevard, Suite 980  
Hollywood, CA 90028  
(213) 460-6355

TELEX: 3717528 UB PAI

# SOUND EFFECTS

## POST-PRODUCTION · NEW TOOLS & TECHNIQUES

by Peter Bergren

The *Star Wars* trilogy, the *Indiana Jones* films, *Brazil* and other highly visual films have set new standards for images. But *listening* to such films, it's obvious that sound effects standards have risen to meet advances in visual technology. Audiences expect alien creatures to speak a credible language, and that explosions will shake the walls of the theater. Even more mundane films, centered in reality rather than fancy, must pay heed to the aural details of that reality, and effects are often *designed* by people like Frank Serafine or Ben Burt, rather than simply being pulled from a library. These trends have made effects post-production, always a time-consuming and complex art, all the more demanding.

In last month's article, I discussed the pros and cons of using mag film versus SMPTE methods for effects post, comparing these approaches to new methods that utilize computer storage, access, and synchronization of sound elements. That article featured an interview with Dr. Andy Moorer, lead sound designer of The Droid Work's SoundDroid™ system, an extremely flexible computer-based audio post-production tool, which eliminates much of the tedious hand work involved in preparing effects. In this issue, I'll deal with using New England Digital's Synclavier system, and Fairlight Instrument's Fairlight III synthesizer for effects post-production. This is a role not commonly associated with these instruments, but it's something they're eminently suitable for, as you will see. However, allow me to review traditional working methods, to give the new technologies a context.

Both mag film and SMPTE-locked tape approaches lend themselves to effects work, yet both have corresponding disadvantages. Effects recorded on magnetic film can be synchronized on "dummies"—sprocket drive transports that can be separately resynched to picture or other soundtracks. This discreetness of sound elements allows sound changes to accommodate the inevitable changes in picture edits, and the large number of reproducers available on many re-recording stages permit very complex premixes of effects elements. But this flexibility



Rick Carson, president of Glen Glenn and Jim Wolvington (left to right).

comes with a price—the facilities are very expensive, and the labor required to produce numerous rolls of sound requires a lot of time be spent by some very expensive people. So to circumvent these problems, some producers use SMPTE time code synchronization of tape transports. This method allows a degree of automation in the placement of effects, and the number of personnel (and cost of facilities) is reduced. But the number of sound sources available to mix in real time is limited, unless individual effects are re-recorded on a multi-track recorder. And being on one piece of tape, "sync slipping" one sound against others or the picture becomes cumbersome.

Both mag film and SMPTE-locked tape require a great deal of winding and rewinding of film or tape stock, when auditioning, synchronizing, or mixing effects. There are also a lot of manual operations: splicing, changing reels, finding cue points. It's all very frustrating at times, and these distractions can rob one of the focus needed to fit together the effects

"puzzle." A technology that would aid rather than hinder this process would be very welcome, and as we found last month, is available. One of its key features is disk-based storage technology, which allows almost instantaneous access to material, and simultaneous playback of several sources, including time slipping of individual elements.

The Synclavier, and the Fairlight III (as well as some other systems emerging on the market) offer such features, among others. These systems are essentially computers, tailored to the demands of audio post-production and music synthesis. Audio is stored in digital form on a disk and/or RAM, and access is controlled by a keyboard or by trigger commands from a "multi-track" sequencer. This allows effects samples to be played from the keyboard, against picture just as if musical voices were being played. Or they can be triggered by a sequencer track, which could correspond to SMPTE code addresses. Both the Synclavier and Fairlight III are multi-voice sys-





# OPRYLAND

M E Y E R ■ S O U N D

"Opryland Talent produces theatrical and industrial shows year 'round, all over the country. We've come to rely on Meyer Sound technology— for better, more consistent sound than we've had from any other speakers. And, believe me, we've tried them all!"

*Mark Johnson, Coordinator  
Opryland Talent Agency<sup>SM</sup>*



Opryland's choice: *the Meyer Sound UPA-1A*

Circle #023 on Reader Service Card

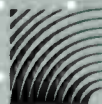

Meyer Sound Laboratories, Inc.  
2832 San Pablo Avenue  
Berkeley, California  
94702

tems, allowing multiple channels of effects to be montaged in real time, and both allow time slipping of separate effects elements. And since they are synthesizers, effects can be manipulated or resynthesized. In fact, an era is beginning where the traditional boundaries between what is an "ef-

---

**"In Back to the Future, there was a lot of Synclavier used for sound design—like the car taking off—where there's no real sound base."**

---

fect," and what is "music" are becoming blurred. The possibilities are wide open.

### **The Synclavier**

Steve Zaretsky, New England Digital's West Coast sales manager, arranged a Synclavier demonstration for me recently. The instrument's main controls were several banks of lighted push buttons, a digital readout window, and a single knob, all arrayed above a keyboard. Most of what Zaretsky showed me was controlled through these means, or through an alphanumeric CRT terminal near the keyboard. The machine was also equipped with other options, including a SMPTE code interface, a Sample to Disk™ facility (allowing polyphonic sampling of audio recorded on a Winchester hard disk drive), and a prototype four-channel hard disk digital recorder capable of extended recording times in conjunction with the Memory Recorder. The latter is a 32-track sequencer, which records timings and control parameters that can then be played back, repeating what was heard during recording.

Using these systems, Zaretsky was able to perform both simple and complex production operations while constructing various effects sequences. These operations were performed with great speed and flexibility, and without once touching a piece of tape or mag film. He was able to slip sync, make razor fine edits, shift pitch and tempo, rapidly audition effects from his library, and mix effect components in stereo. The work was fun and creative, not tedious. And the utility of the

Synclavier in fostering efficient experimentation was obvious. This is possible because the system is based around a data management approach, teamed with controls that align closely with a musician's or producer's way of thinking.

Before Zaretsky's demonstration, I interviewed him about the Synclavier in general, and its utility in sound effects production.

**Mix:** What does the Synclavier do?

**SZ:** The Synclavier is a digital music or digital audio system that will generate any sound that exists. It will store it in a digital medium, allow the sound to be manipulated and altered, and then take that sound and via the keyboard record that sound in a multi-track format with total storage and recall of all parameters that you have assigned to that sound. This Memory Recorder is a true multi-track type of format utilizing a digital, disk-based storage system.

**Mix:** Is the Memory Recorder actually recording the sound waveform, or its control parameters?

**SZ:** It's recording the control parameters, but *not* recording the waveforms.

**Mix:** If one were to record a sound effect—a gunshot for example—then what would happen on playback? Would the Memory Recorder access that portion of the Winchester or RAM storing the sound and "fire" it according to a time code reference, or according to when an expression device was played?

**SZ:** That's right. If a parameter change was recorded with the sound, let's say you've put a chorus effect on the gunshot, that chorus *setting* would be recalled.

**Mix:** Does this capability apply to pans and loops as well?

**SZ:** Yes. The Synclavier has a panning function that has access to 24 different parameters for panning. There's also keyboard control of panning, so that alternate keys can be touched and the sound will originate from the opposite speaker. And certain parameters can be added after the fact, just like automated mixing. We can write that information, such as volume or panning, over the original information, and the next time we load that sequence in, that information will be there.

**Mix:** Are people using the Synclavier for sound effects that are almost "musical" elements?

**SZ:** We are definitely seeing more of that. The advent of polyphonic sampling has opened up a lot of new terri-

tory for use of the instrument. We released polyphonic sampling in the spring of '85, so to some degree some of the new applications are just starting to blossom. We also now have the SMPTE interface that came out at the same time. So we're seeing a lot more utilization of that.

Certainly the Synclavier has been capable of creating very unusual sounds, and you could even call them sound effects within a musical context, where through our resynthesis program voices could be manipulated to become very unusual sound effects; any sound can be resynthesized. The sound could be a symphony orchestra, a door slam, a car screech, an acoustic guitar, or a voice. It has a tremendous amount of definition and manipulation, which is what allows the user to chisel away and contour the sound to really fit what they're looking for. And the SMPTE option—the ability to play to picture improvisationally, where you're literally just watching the picture and have the ability to play to the picture, and then have the option of being able to go back in time and move the sounds that were played—allows you a total freedom in scoring either music or sound effects. We have a screen that's called the "recorder display" that shows you each individual note or sound effect that is played. There's a little asterisk that moves along as each note is played, and that event is displayed in beats, seconds, or time code. So in trying to "hit" a given effect in a picture, say something very typical like a door slam, all you have to do is locate that SMPTE number on the picture, and type in that time code on the screen, and then the event is locked to the picture.

**Mix:** Who in L.A. is now using the Synclavier primarily as a sound effects device?

**SZ:** I know in L.A. Glen Glenn Sound has a Synclavier and they're using it as a sound effects device. Motown Recording/Hitsville have one, and they're starting to use it for sound effects. And then we have a lot of other owners who are using it with commercials, where the sound effects are being incorporated into the musical content. Also, a lot of "sound design" is being done. In *Back to the Future*, there was a lot of Synclavier used for sound design of sound effects that are breaking new territory, like the car taking off where there's no real sound base.

**Mix:** Are we talking about a machine that can digitally store dialog and music, as well as effects?

**SZ:** Yes we are. When you think about 320 seconds of RAM memory, you're talking about five minutes, 20 seconds



of sample memory. And we have in this office right now a multi-track disk recording system that is a prototype of our new function for the Synclavier—the ability to record directly to hard disk, in real time, a live digital recording that can be used in conjunction with the Memory Recorder. The Live-to-Disk function allows you to record directly to the hard disk and play those sounds back in sync with the Memory Recorder so that you don't have to trigger sounds from the keyboard and you are not limited to the RAM memory of the system for the duration of a sound. In the prototype, we've got about five minutes per track, with four tracks right now. But when the system comes up for sale in June of '86, we will ultimately be up to 16 tracks, and accommodate up to 20 minutes of recording per track. The direction of the Synclavier, as our ads state, is a tapeless recording studio. And we see a time in the very near future where there will be an entire film done on the Synclavier: dialog, effects, and music.

**Denny Jaeger**

I'm particularly intrigued by the possibility of breaking the boundaries between sound effects and musical elements. To explore this further, I interviewed Denny Jaeger, a noted com-

poser of both commercials and film scores, who helped the original Synclavier library of sounds. I found him in his home in the Piedmont area of Oakland, California, surrounded by sawdust and carpenters, overseeing construction of what promises to be the most comprehensive digital synthesis studio in the world (at least for a while).

**Mix:** What's the chief focus of your work?

**DJ:** One thing I do in my music is what I call "musical sound effects." They're sound effects, but almost part of the score. It's like you've got a car blowing up, and then there's an aura around that explosion that's another sound. It's not really a musical score, it's not a melody, and it's not a pure sound effect; it's a *musical sound effect*. I think if somebody is approaching film with the idea that there's a car smashing over *here*, and the musical score over *there*, that's 1950s film scoring. With musical sound effects, something happens, like an explosion, BOOMMM!!!, and you hear this low rumble, and as the rumble of the explosion disappears there's a note there, and in between that note and the rumble is some sort of musical sound effect, that took the rumble and expanded it into the note. Then maybe

the note becomes a low drone, and you begin to hear the oboe come in real light, and a little harp pluck, and you're into your score.

**Mix:** Can you give me another example?

**DJ:** I just finished some of the new Dr. Pepper TV spots. They were like little feature films. They had these weird footsteps. (The footsteps formed the click track for the music.) And I went in and I lifted these footsteps off and I looped them at a very precise moment that gave me a meter, like 7/4 or 6/9, something very bizarre. I was always manipulating sound effects on this spot. There were very few sound effects in the end result that weren't either processed by me or became part of my music track. Even voices became processed and became things that would go with the music. And in that way you can build such neat tracks.

I did a commercial for Levis where a pile drive was the click track, the rhythm of the spot. You hear this "KAA-COOMMMBB!" "KAA-COOMMMBB!" So you take this sound effect and you remove the first hit, and then you've got just the second one, "COOMMMBB!" which is just simple editing. So you've got this pile driver and instead of going "COOMMMBB!" on the Synclavier you

# dbx PERFORMER SERIES

... Great Sound Made Easy

**\$149** each  
Suggested retail price



Model 163X Compressor/Limiter/Preamp  
Smooth-sounding OverEasy® compression

Model 263X De-Esser  
Eliminates excessive sibilance

Model 463X Noise Gate Expander  
Gets rid of noise between notes

- DBX STUDIO QUALITY
- DBX TECHNOLOGY
- SIMPLE TO USE — SINGLE-SLIDER ACTION
- FRONT PANEL PLUG-IN
- RUGGED CONSTRUCTION

**dbx**

Professional Products Division  
71 Chapel Street  
Newton, Mass. 02195 USA  
617-964-3210



# Jensen Sound PRODUCTIONS

Original Music  
"Affordable Excellence"

- Soundtracks
- Backgrounds
- Jingles

Contact:  
Suzanne Jensen  
415/469-0192

Demos Available

Circle #024 on Reader Service Card

## DO YOUR PRODUCTIONS SOUND AS GOOD AS THEY LOOK?

They will,  
with music from APM.

More than 20,000 selections,  
specifically created to meet today's  
professional AV, film and video needs.

Give us a call for our latest  
free sampler cassette.

Exclusive representatives of the KPM, Bruton,  
Conroy and Themes Production Music Libraries.



**Associated Production Music**  
888 Seventh Avenue, New York, NY 10106  
(212) 977-5680  
6255 Sunset Blvd, Hollywood, CA 90028  
(213) 461-3211

Circle #025 on Reader Service Card

don't have to do a hard edit, you can assign a ramp speed, so it goes "oooo-MMMBBB!" Now you can go in with just one command, "REV," and the envelope of that pile driver's reversed; it's backwards, but it's still the same pile driver, and you've got the backwards pile driver for the second hit, and the forwards pile driver for the first hit.

Or I'll give you another example from *The Hunger*. At the end of *The Hunger*, Catherine Deneuve falls down about a thousand stories! It was the world's longest fall down a stairwell. She lands, and the spell is broken, and she's been alive for about three thousand years, and she starts to die. They wanted her scream to deteriorate, as she was deteriorating into dust, and then she literally just blew away and wasn't there anymore. Well, I took one scream from Catherine, a live scream, and processed it through the computer by doing some filtering, some phase shifts, and by varying the sample rate to make it lower and lower. And then I modulated the pitch bend, so when her head was flailing back and forth at all kinds of different speeds, I would just hit a key on the keyboard and turn this knob, and lower the speed of this thing and filter it appropriately. And I turned one scream to the point where there was nothing but *breath*: "HHHAAHHHHHHhhhhhh!" Then you got closer and closer to her and she was decaying away, and finally just became dust. Now *that* kind of technology has never existed before. That would have taken hours and hours of re-recording, maybe 15 to 20 generations of sound, to try and create something like that. Whereas all I had to do was just make up a program, and keep modifying it using my ears, always working in real time against picture. That's what the Synclavier's been giving me for years.

### The Fairlight III

The Synclavier's major competitor is the Fairlight III, from Fairlight Instruments in Australia. The recommended configuration consists of a CPU with 16 voices, eight megabytes of RAM (expandable to 14 Mb), a MIDI/SMPTE interface, a 114 Mb formatted hard disk, and one floppy disk drive. Standard control interfaces include SCSI (small computer serial interface), an alphanumeric CRT terminal, a touch-sensitive graphics tablet, a MIDI music keyboard, and an extensive software package for music synthesis and sound manipulation. The latter includes composition and sound sequencing programs (Page R and CAPPs). A package including these features costs roughly \$60,000, which is less than either a comparable Synclavier pack-

age, or the SoundDroid station.

I was able to arrange a demonstration of the Fairlight III and an interview with Dan Desouza, product specialist at Fairlight's L.A. office. As with Steve Zaretsky, my first question was, "What does the Fairlight III do?"

DD: The basic system is a 16-bit, 16-

---

"The Fairlight's editing capacity is full function. You could merge and mix sounds into others so that a car screech becomes a waterfall."

---

voice digital sampling machine. In essence, what it can do is sample real sounds to allow you to play them on the keyboard. You can sequence those sounds using various compositional languages on the machine, and you can take those sounds and reprocess them, resynthesize them and change the harmonic structure. It's intended to be a state-of-the-art production facility for sound, and whether it's configured to work in the musical realm or in the post-production realm is up to the user. It's got full-blown software architecture support, with numerous programs so that the user can custom-tailor functions.

**Mix:** If I wanted to create a typical effects sequence—say a car chase—how would you do that, and which features of the Fairlight would prove useful in sweetening such a sequence?

DD: The first thing to do would be to sample the sounds into the machine. Once in it, I can view the waveform and make any changes I need to. If there are any funny noises, transient clicks, those can be edited by just bringing up on the screen that portion of the waveform I need to work with. The sounds themselves are in RAM memory or on hard disk, and in terms of RAM memory, you've got an enormous amount—up to 14 Mb—of user available RAM, so you could have a couple of minutes of sound totally available for manipulation.

**Mix:** How is this manipulation accomplished?

DD: You bring in a voice, which constitutes one sound or instrument. But that voice can consist of up to 128



"subvoices," or elements beneath that. So if you're using the keyboard to have all the sound effects for a particular scene—of a car starting and driving away for example—you could have all the elements of the car—the footsteps to the car, the key in the ignition, and so forth—all laid out on the keyboard and marked on the screen if you wanted them.

Dan then went into detail about the 80-"track" sequencer, available via the Fairlight's compositional software. As with the Synclavier, sounds are triggered via recorded timing and control parameters, which access memory locations. And SMPTE time code can be used as the time base for the trigger points.

**DD:** When doing an effects sequence, if you had SMPTE lock running at the same time you could record a Foley artist's work to picture, and then edit the placement in the sequence memory.

**Mix:** You'd have to start with separate events and then put them up on the sequencer tracks?

**DD:** You'd have them recorded in memory and up on the keyboard, and then a particular pad or key is a particular sound effect. Then you'd watch the picture, and at the right time, BOOM! you'd hit it!

**Mix:** Do you have the option to slip any effects you wanted to in time?

**DD:** Yes, you could move it back and forth.

**Mix:** So the operation of the 80-track sequencer is a matter of it triggering particular sound samples at particular points in time, against a SMPTE code?

**DD:** Yes, it's a very efficient use of memory, because it's not that often that you're going to need virtual memory. After all, why do you have multiple tapes when doing sound effects? You take the *composite elements*, and put them together. And that's exactly what the Fairlight is; it's that multiple tape rack. Each of those sequencer tracks is a little tape loop or sample of sound that you have total, complete flexibility of where to place in time. And you have something you don't have with a tape system in that you can modify those sounds as they exist in the memory of the machine.

**Mix:** You can loop with the Fairlight?

**DD:** Oh yes. The editing capacity is full function. You could merge and mix sounds into others so that a car screech becomes a waterfall. You can have sounds played backwards. You could combine sounds so that the attack of a baseball bat becomes a chim-



**FUTURE DISC  
SYSTEMS**

**COMPLETE ANALOGUE & DIGITAL MASTERING SERVICES**

**FOR COMPACT DISC, RECORD & CASSETTE MANUFACTURING**

3475 CAHUENGA BLVD WEST, HOLLYWOOD, CALIFORNIA 90068  
(213) 876-8733

## *Keeping Pace with your innovations*



### **Sound Affair 16/24 Track Recording Studios**

*Years of experience and dedication to achieve a comfortable low key, yet professional atmosphere. Our engineers take an individual approach with each of our clients and their artistic requirements, utilizing state of the art equipment, and the finest acoustic environments. Please call or write for brochure with detailed equipment list or for a Studio visit.*

**2727 Croddy Way, Suite G / Santa Ana, CA 92704 (714) 540-0063**

Circle #027 on Reader Service Card

panzee screech. You could do this simply with commands: "Look at the waveform, make a marker, *this* is where I want the sound to end, *this* is where I want the sound to begin, *crossfade* all those sounds." Or you could make a crossfade within a loop to make a continuous environmental sound.

**Mix:** When would be the appropriate point to commit the output of the machine to reel-to-reel tape?

**DD:** At the point where you're satisfied with effects against picture you could then literally fly the Fairlight into the medium that the picture is on. I don't see any reason to have another generation if you have a lock with SMPTE. In terms of the "tapeless recording approach," there are emerging on the market a number of hard disk-based digital recorders that are similar to the multi-track recorder Synclavier is releasing on the market. AMS is coming out with a 4-track machine, Compu-sonics has a modular add-on system. They all can be used in conjunction with the Fairlight very easily.

**Mix:** Do you contemplate using CD disc for storage?

**DD:** It's very much in the forefront, a read/write CD.

**Mix:** And the potential information density of that technology—

**DD:** Is staggering. When I read of the speculative specifications of something like that, I can see it's going to be absolutely numbing.

**Mix:** That would then make all of your technology take a leap forward, as far as it becoming a tapeless recording system.

**DD:** That's what you need because right now it's pretty absurd. If you do some serious Winchester recording, you've got to have a *stack* of equipment.

**Mix:** Disk information density seems to impose serious limits. A tape recorder *can* record for a long time, after all.

**DD:** Yes. At this point, until the technology is ready, people have done quite well with Mitsubishi's and 24-track DASH recorders. I think we can "suffer along" with those recorders a little longer.

**Mix:** But in the area of post-production sound—

**DD:** The requirements are different. And that's where the Fairlight fills the void very nicely, between present and future recording technologies.

### Jim Wolvinton

I arranged a final interview with Jim Wolvinton who's a sound editor at

Glen Glenn Sound in Hollywood. He uses a Synclavier daily sweetening television and film projects, and I spoke with him in a room filled with his impressive array of post-production gear. This included a Sony 3324 for digital multi-tracking against picture, Sony 3/4-inch VCRs, a video monitor, a BTX Softouch™ synchronizer, cart players, and of course, the Synclavier. It's equipped with a SMPTE interface, separate outputs to the 3324, and a hard disk polyphonic sampling option. What most impressed me about

---

"Since the hardware architecture of the SoundDroid, Synclavier, and Fairlight III are extensively developed, further advances in software can be easily accommodated."

---

this setup (and the way Wolvinton uses it) is that the Synclavier seems to maximize the effectiveness of other parts of the system. For example, loops are derived from tape cartridges, which saves Wolvinton's four Megabytes of RAM space to use for spot effects. The Synclavier delivers these from keyboard commands or the sequencer, much like a tremendously flexible tape cart rack. The 3324 serves mainly to compile completed sequences, with each sample delegated to an appropriate track. And while SMPTE code serves as the entire room's time base, the Synclavier appears to consider it a natural ally; it seems to speak the same language, and had no problem relating samples to code addresses.

The facility is fast, efficient, and lends itself to experimentation. Wolvinton played a sequence in progress and the video monitor lit up with the image of a South American explorer paddling down a small, turgid jungle river. Wolvinton had sweetened all 900 feet of paddle strokes in the sequence, adding three sounds each time the paddle would dip into the river—a splash when it struck the water, a "SLLUURSHH!" as it was pulled through, and another splash and drip when it exited; some 600 separate effects in all. Doing this via traditional techniques would mean separately transferring, editing, and

synching at least three reels, one for each effect element, and then laboriously premixing the result; *days* of work. But with the Synclavier, Wolvinton simply assigned each element to a key or keys, and played them against picture with SMPTE code addresses automatically assigned to the Memory Recorder's program for playback. And each element was outputted separately to the digital multi-track for later mixing. Since Wolvinton's machine is polyphonic, he can play more than one key at a time to double a particular element, with dynamic emphasis controlled by the Synclavier's touch sensitive keyboard. All in all, a very *musical* approach.

### The Future

The beauty of the systems I've reviewed is that they *are* computers—computers configured for audio production. Sound is therefore data, and can thus be managed like any kind of data. And a good computer program excels at facilitating data storage, retrieval, and manipulation. Since the hardware architecture of the SoundDroid, Synclavier, and Fairlight III is extensively developed, further advances in software can be fairly easily accommodated, and this is something designers of all three systems are heavily involved in. In fact, the software-driven nature of this kind of technology lends itself to further advances in efficiency and creative advantage. At present, however, there *is* one "fly in the ointment"—the cost of really dense storage media.

At present, it's very expensive to store large quantities of sound on disk drives and in RAM. All three systems discussed require additional drives and RAM cards to extend storage capacity to times that rival tape or mag film. But each of the three systems have made great strides in solving this problem, each in a different way. The SoundDroid uses a "station" approach, with each Droid sharing memory space with other stations, which are assigned memory according to the needs of the task they're asked to perform. New England Digital has developed a Live-to-Disk option, which offers substantial recording time for making live, digital recordings of continuous performances, and in a multi-track format. And Fairlight will be offering interface of their technology with commercially-available disk recorders. But what would cause a real explosion in the tapeless systems field is the development of a cheap, practical read/write CD, in conjunction with even denser RAM storage. When this happens (and it may be soon) we're sure to see entirely new possibilities open to us. ■



# NOW YOU TOO CAN HAVE THAT FABULOUS, MODERN TURBOSOUND "LOOK"!

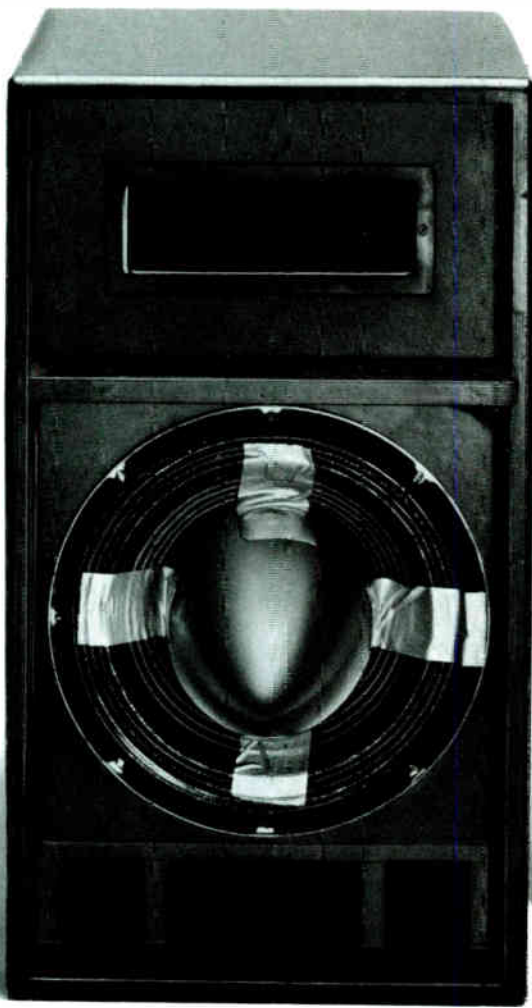

We weren't searching for a new look when we developed the design principles embodied in Turbosound reinforcement modules. We were simply looking for a better method of reproducing the dynamic range, frequency spectrum and transient attack of live music.

The Turbo (not just a phasing plug) in our TurboMid™ device is the most identifiable result of our efforts, which is one reason why we're seeing so many imitations these days. But the design developments that produce the patently superior sound performance of every Turbosound full range enclosure are the elements you can't see.

Tacking a simple phasing plug onto an obsolete design, for example, does

not magically endow a speaker system with the ability to reproduce a seamless midrange from 250 to 3700 Hz, or to project sound further and more accurately. That kind of performance results only when our proprietary 10" driver, exponential horn and Turbo, all designed on Turbosound principles,\* function as an integral system — the TurboMid™ device.

Nor will adding a phasing plug to a box enable it to generate the astonishing amount of clear, musical bass our TurboBass™ device does. And it certainly won't deliver the energy of live performance with the definition and dimension of a Turbosound reinforcement system. It's not the way an enclosure looks, but the reason it looks that way that's important.



Only Turbosound is Turbosound.™  
**Turbosound**  
A member of the Turbosound Group of Companies • London • New York

\*TurboMid™ and TurboBass™ devices are covered worldwide by Principle Patents, not simple design patents. The concepts embodied in these designs are, therefore, entirely unique. See Turbosound literature for full information.  
**Turbosound, Inc.** 611 Broadway #841, New York, New York 10012 (212) 460-9940 Telex 230199 IMC ABELSON — US **Turbosound Sales Ltd.** 202-208 New North Road, London N1 7BL (01) 226-0099 Telex 265612 IMC SALES — UK

**Worldwide distributors:** *Australia:* Creative Audio Pty Ltd. Melbourne Tel: (03) 354-3987 *Austria:* Audiosales Moedling Tel: (2236) 888145 *Canada:* Belisle Acoustique Inc. Quebec Tel: (514) 691-2584  
*China:* Wo Kee Engineering Ltd. Hong Kong Tel: (51 2) 19073-5 *Denmark:* Per Meisrup Productions Karlslunde Tel: (02) 151300 *France:* Regiscene Paris Tel: (01) 374-5836 *Greece:* Alpha Sound Athens Tel: (01) 363-8317  
*Holland:* Ampeco Holland b.v. Utrecht Tel: (30) 433134 *Hong Kong:* Tim Lee Music Co. Ltd. Hong Kong Tel: (3) 722-1098 *Indonesia:* PT Auvindo Merien Prima Jakarta Tel: (01) 323029/320704 *Israel:* Barkai Ltd. Ramat-Gan Tel: (03) 735178/732044  
*Italy:* Audio Link Parma (0521) 598723/4 *Milan:* (02) 285-0334 *Japan:* Matsuda Trading Co. Tokyo Tel: (03) 295-4731 *Korea:* Bando Pro Audio Inc. Seoul Tel: (02) 546-5491  
*Malaysia:* Atlas Hi Fi Sdn Bhd Kuala Lumpur (M3) 432104 432077 *Norway:* Nordiek Equipment a/s Oslo Tel: (02) 231590 *Singapore:* Atlas Sound (Pte) Ltd. Singapore Tel: 220-4484 *Spain:* Lexon s.a. Barcelona Tel: (03) 203-4804  
*Sweden:* Inter Music a.b. Skovde Tel: (500) 85263 *Switzerland:* Studio M + M Schonenwerd Tel: +64 415 22 *Thailand:* Bangkok Cine/Graphic Center Bangkok Tel: (2) 314-3570 *UK:* Turbosound Sales Ltd. London Tel: (01) 226-0099  
*USA:* Turbosound Inc. New York Tel: (212) 460-9940 *W. Germany:* Adam Hall GmbH Usingen Tel: (6081) 16031

# PRODUCTION MUSIC

# SOUND & EFFECTS

## LIBRARIES

by George Petersen

It happens every day, in production facilities everywhere. You've just finished mixing your: (pick one) a) radio ad jingle, b) promotional video clip, or c) multimedia presentation, and at the last minute, you discover that the client absolutely hates anything with a sax solo in it, which naturally happened to be the instrument you selected for the main theme. Luckily, you've got an entire TWO HOURS (!) before the client and agency people arrive. It's times like this that having a production music library really comes in handy.

Fortunately, the above scenario is an extreme case that seldom happens, but it illustrates the point that music libraries are useful tools that have a lot to offer the creative producer, especially in terms of saving time and money. And the quality of music available today is excellent, both from a technical and aesthetic standpoint—a far cry from the cliched "stock" music so common a decade ago. An enormous diversity of styles, ranging from historical to avant-garde electronic, can be provided from any of the dozens of libraries serving the industry today.

Basically, music libraries fall into two groups: those operating on a "buy-out" basis, and those offering music usage on a per-use, or unlimited use "blanket" licensing arrangement. A buyout allows the unlimited use of music or effects for a one-time charge. Licensing contracts and rates can take many forms, including: "needle drop," a partial or entire music selection used in a single segment of a production (therefore if the same theme was used in two different parts of a film, then two needle drop charges would occur; a "per-production" rate allows the un-

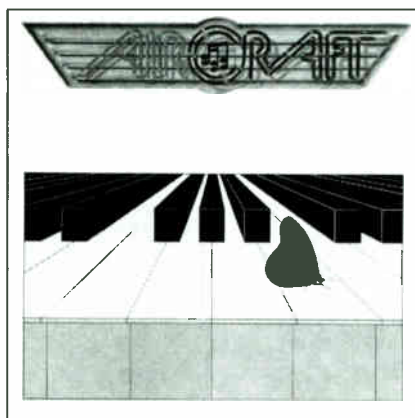

*Aircraft Volume 9*

limited use of a particular library or selection in a single production for a set fee, which depends on the audience market size/type, the medium used for distribution, and the total length of the project; a "theme rate" is used when a particular theme will be used in several projects, especially in jingles, ads and radio spots; and an "annual blanket" offers unlimited library use for a yearly payment.

Another factor to consider when selecting a music library is the available release formats of the music itself. Most libraries are available on record albums and/or tapes, although a growing number of companies are turning to the Compact Disc medium. CDs provide easier access to tracks, greater durability, and superior sound reproduction to the analog media, although due to the current backlog at CD pressing plants, the availability of software will be rather limited for the foreseeable future.

Like production music, sound effects libraries have likewise greatly improved over the past ten years, and a

large selection of choices are possible, not only in price (from under \$100 to thousands of dollars) but also in release formats—LP, tape or CD. Sound effects collections are usually sold under a buyout arrangement, where the user gets usage rights into perpetuity—with the exception of reselling or repackaging the sounds for sale as sound effects sets.

One overlooked use of sound effects is as a resource for sampled sounds to be used in a sampling keyboard or drum machine. A growling lion would make for a great kick drum, with an anvil snare, hissing snake cymbals, and thundering tom-toms; or how about loading some jackhammers into your Mirage or Emulator II? The possibilities are endless, and the costs can be quite low when compared to the total price for a sampling system.

The following is a survey of a few of the production music/effects libraries available today. Since subjective evaluation of the quality of the music offered becomes a difficult matter—after all, no one knows your own needs better than you—all of the companies will provide demos of their wares upon request, so you can judge for yourself. The firms are listed alphabetically, and their addresses are listed at the end of this report.

The current offerings in the **AirCRAFT Music Library** (of Boston and New York City) consist of 21 albums ranging from classical to contemporary, with full and alternate mixes as well as 30/60 second edited versions of most cuts. New LP releases are regularly sent to licensees, who subscribe on either an annual (\$1,500) or quarterly basis. Tape dubs of releases are also available for an additional fee. All AirCRAFT music is recorded and mixed at the company's in-house facilities using either Neve or SSL consoles,



and all records in the library are mastered via Direct Metal Mastering at Europadisk in New York, and pressed on Europadisk's "Audiophile" grade Teldec vinyl.

Designed specifically for the needs of radio spot producers, the New Production Library from **Airforce Broadcast Services** of Toronto offers a 20 disk collection with 300 30/60 second spot cuts and 60 random length production tracks. Usage costs for a three-year lease (with monthly LP updates) are based on station Arbitron ratings and are offered on a market-exclusive basis. Library cuts are cross referenced in a catalog listing various retail and promotional applications.

**American Image Productions** of Nashville has been producing libraries for 14 years, and their most current releases are *Airwaves*, *Tech Effects*, and *Champion*. *Airwaves* is a music production library that is available on a 36-month lease, market-exclusive arrangement. *Tech Effects* is a collection of synthesizer sounds and effects, offered non-exclusively for a \$500 buyout. *Champion* is designed for A/V, corporate and broadcast use, with longer music cuts; it can be had on either a needle-drop or annual blanket license agreement.

**Associated Production Music** of New York City is the exclusive U.S./



*American Image's Tech Effects*

Canada representative for the KPM, Bruton, Conroy, Themes Int'l, and Shepherd's Bush music libraries (all produced in England) with a combined total of over 800 albums in all. The KPM and Bruton libraries are quite large, 350 albums and 275 albums respectively, and cover a plethora of musical styles, including historical, electronic, classical, ethnic, rock, jazz, jingles, solo instruments, dramatic and documentary suites, and much more. The record albums are priced at \$10 each and usage rights range from a \$50 non-broadcast needle drop to

annual or per-production blanket rates. KPM has just released "Tradewinds," their first all-digitally recorded production music Compact Disc of relaxed pastoral themes, priced at \$20, plus usage rights.

Offering 50 albums with over 3,000 sounds, the **BBC Sound Effects Library** is a most comprehensive resource, providing everything from aardvarks and airplanes to zebras and Zulu drums. The library includes a 120 page index/guidebook, and in addition to the aforementioned traditional sounds, a wealth of less common cuts are offered, such as "Donkey Kong Game," "English 1928 and New York Trolley Cars," and of course Dr. Who's "Tardis Take Off and Landing." The BBC Sound Effects Library costs \$349 on a buyout basis and is distributed by Films for the Humanities (Princeton, NJ) and is also available through the *Mix Bookshelf* service (see page 175).

Written expressly for the needs of radio production, **Brown Bag Productions** of Englewood, CO, have released their third music/effects library series. Entitled "Escape," the new volume is slightly more adult-oriented than its two predecessors, "Starfire" and "Rock Trax." The latter contains 271 cuts for creating logos, station IDs, client beds, and sound effects, includ-

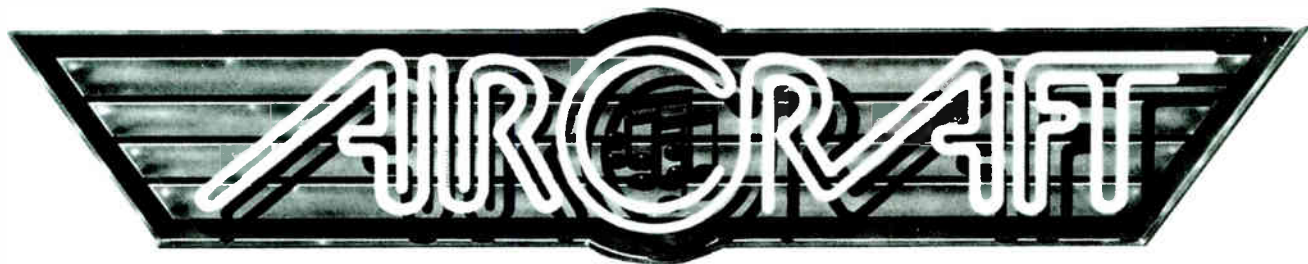

## Music Library

**The Best Composers... The Best Producers...  
The Highest Quality Mastering and Pressing...  
The Best Sounding Music Library Available ...**

**The Aircraft Music Library**

**You'll Hear The Difference, In Our Music; In Your Productions.**

**Call Us For A Demo.**

**(800) 343-2514**

77 North Washington St., Boston, MA 02114 (617) 367-0510 / 25 East 21st Street, New York, NY 10010 (212) 420-6010

Circle #029 on Reader Service Card

**FILM SOUND '86**

# The DeWolfe Music Library Presents a Second Set of Compacts Discs!



DeWolfe Music Library, Inc  
Call Collect  
(212) 382-0220  
25 West 45th Street  
New York, NY 10036

Circle #030 on Reader Service Card

## Top Quality Music...

### Hollywood Production Library

101 60's 101 30's 101 Others!  
11 Disc Library

**\$189.00**  
TOTAL BUYOUT

### LASER TRAX

177 Electronic cuts (54 60's!)  
4 Disc Library

**\$99.00**  
TOTAL BUYOUT

## ... Rock Bottom Prices!

Write for more info!

**L.A. AIR FORCE**

Box 3482, Rubidoux, CA 92519

Circle #031 on Reader Service Card



Sound Ideas' sound effects library is available on Compact Disc.

ing holiday material. "Starfire" features over 300 cuts—stings, contest elements, sound images/effects, and 30 beds for 30/60 second spots. All are available on a two to five year market-exclusive lease, and come on either 7.5 or 15 ips Ampex 456 tape.

The CBS Sound Library from CBS Special Products, New York City, goes somewhat beyond the usual approach to sound effects libraries, by also offering sounds recorded during actual historical events. Street riots, a moon-shot launch, and avalanches are all included in the 16-record first volume, with a total of 407 cuts—over eight hours of sound. Volume II is a ten-disk set with another six hours from the CBS sound archives: geographical locations, vehicles, and everything from applause to water buffalo. The albums are pressed at the CBS plant in Terre Haute, IN, and costs (buyout) are \$175 for Volume I, \$110 for Volume II, or \$260 for both volumes. A complete, cross-referenced index is included.

Dallas-based Century 21 Programming offers the Compact Disc Production Library®, a 15-disc set of production music on CD. The library contains 1,485 tracks, including 900 commercial-length instrumentals (with both 30 and 60 second versions), 325 random length accents or themes, and 260 stereo sound effects. A Technics SL-PJ91 CD player, featuring a ten-key track selector, is furnished with the music package and Century 21 plans to send new CD releases to subscribers every four months. The library can be purchased outright for \$3,750 and a monthly lease plan is also available.

Comprehensive Video Supply, of Northvale, NJ, distributes two music

libraries and several sound effects collections, all offered on a buyout basis. Music Library 8A has 150 selections—contemporary, jazz, classical, electronic, IDs/logos—on eight LPs for \$450. Library 8B complements the latter, offering additional useful themes for the same price. Three sound effects libraries are available: a 30-disk set with over 1,000 effects for \$411; a 15-disk set for \$206; and a basic, seven-disk set for \$95.

The De Wolfe Music Library of New York City has released the first 12 discs in their CD production music library, and another six CDs are now being manufactured and should be available by press time. Each set of six discs includes both contemporary and orchestral themes, as well as commercial-length cuts. The sets are priced at \$109 for six CDs, not including usage rights which can be arranged on a per use/needledrop or on an annual basis, personally tailored to the user's market and needs. De Wolfe also sells a 24 LP sound effects library, priced at \$399 (buyout) for the set, or \$20 per album.

Firstcom, a division of Jim Long Companies, Inc., of Dallas, markets the Digital Production Library, a 15-CD set with 1,032 tracks recorded exclusively for the Compact Disc medium. Besides a wide variety of production music themes, numerous incidental cuts are included, ranging from a tympani roll to minute-length selections. The library is available for a \$3,000 licensing fee, including all materials and first year usage rights. Costs for radio and TV broadcasters vary depending on market size.

Southern California-based compa-



# OUR STUDIOS TOWER OVER EVERYBODY!

ny L.A. Air Force is probably the only production music firm to include some admittedly "bad" themes in their library. Their "Cheap Radio Thrills"—a five-LP set of radio-oriented effects, audience reactions, commercial beds, promo/contest sounds, and production music—also contains tracks by "members of Tijuana's worst pit bands," botching their way through "Happy Birthday," "The Lone Ranger" and "Old MacDonald," among other standards. The set is buyout priced at \$149. L.A. Air Force also offers "Laser Trax," a four-LP set of commercial music (177 cuts) for \$99; and the "Hollywood Production Library," an 11-LP set of commercial and production music for \$189 buyout.

The **Made-to-Order Music Library**, of Los Angeles, has recorded 12 albums of various music cues, ranging from news and sports themes, to dramatic music, rock and techno-pop. Versions vary from five second tags to two minute tracks, with a selection of 30/60 second commercials included. The library is available through annual license, buyout, needle drop or ID theme arrangements, depending on client needs.

Although **Manhattan Production Music** is under two years old, they have attracted a wide assortment of discriminating users, among them NFL Films, IBM, AT&T, and Major League Baseball. MPM is a ten-record, 137 cut library released on Direct Metal Mastering albums, with a diversity of sounds: one LP, entitled *Power and Glory*, featuring fanfares and symphonic overtures, was digitally recorded at Abbey Road Studios in London. Three additional releases are currently in production, two of which contain all 30/60 second cuts. MPM is available for an annual license of \$650, and needle drop usage can also be arranged.

**Fresh Music** is a three-album set of production music from the Music Masters Library of St. Louis, MO, with 49 new, all-different medium, slow, and fast tempo cuts, including one side of 59 and 29 second pieces. Fresh Music is sold on a one-time, buyout charge of \$500.

**Network Production Music, Inc.**, of San Diego, has a 50-volume set of music available on 7.5/15 ips tapes or on WhisperDisc® vinyl records. A variety of moods and themes are presented, and each cut has long as well as 29/59 second versions. Many themes also come with a rhythm section mix for simple editing into the long version, or for overdubbing solo instruments for a custom music sound. The library includes a reference catalog/index with additional space for

- NEVE 8068 and 8108 NECAM
- 2 STUDER A-800 24 TRK
- STUDER A-80 VU MK-III 24 TRK
- Q-LOCK SYNCHRONIZER
- AMPEX ATR 102-104½"
- DIGITAL 2 TRK SONY AND JVC
- DIGITAL 2 TRK MASTERING
- 8 LIVE CHAMBERS
- EMT PLATE • EMT 250



- AMS REVERB & DDL • SUPER PRIME TIME
- LARGE ASSORTMENT OF NEW & CLASSIC OUTBOARD EQUIPMENT AND MICROPHONES
- DIRECT TO DISC MASTERING
- CUSTOM LACQUER AND XDR CASSETTE MASTERING
- STUDIO A (60 x 45)



Member of EMI World Music Group which includes such well-known studios as Abbey Road (England), 301 (Australia) and Toshiba EMI (Japan).



Capitol Studios, 1750 N. Vine Street, Hollywood, California 90028 (213) 462-6252, Ext. 442

Circle #032 on Reader Service Card

user notes. The releases are priced at \$12 for LPs, with 2-track tapes slightly higher; usage rights vary from a \$50 needle drop for a one-minute piece to a \$2,800 annual license, and several other plans (single theme, longer production rates, etc.) are offered.

The **Network Sound Effects Library** is a comprehensive collection of 3,000 effects, pressed on 87 Whisper-Disc® albums. A 482-page index, supplied with the set, includes 12,000 cross-referenced entries for quickly finding the right effect. The library is priced at \$850, on a buyout basis.

Omnimusic, of Port Washington, NY, has 43 releases in their music library, available on LPs or tapes. Just out is a Compact Disc version of the

library with six CDs (145 cuts) ranging from fully orchestrated and classical pieces for industrials and sports to electronic high-tech rock. The six CD set is \$75, LPs are \$9/each, and tapes are \$14 or \$20 (7.5 or 15 ips); usage rights can be had on a needle drop or unlimited use annual blanket license, as well as a per-production basis.

The **Soper Sound Music Library** is the largest buyout library in the industry, with over 30 albums arranged in 11 series sets ranging from one to five LPs in each. Most of the offerings from this Palo Alto, California-based firm are production music releases, but specialty disks, such as timed music commercial spot beds, stingers

and bridges, and a two-LP set of sci-fi sound effects are also available. Prices range from \$95 to \$325 per series, buyout, although a unique needle drop fee applied towards buyout purchase plan is also offered. Tapes can be ordered for an additional fee, and two music library data base indices are available.

**Sound Ideas**, of Toronto offers a complete library containing over 3,000 stereo sound effects on Compact Disc or 7.5/15 ips tapes. The CD version has 28 discs, priced at \$1,250 (buyout), including a 224 page catalog/index. The 125-volume tape sets are priced at \$1,500 (7.5 ips) or \$2,000 (15 ips). The Sound Ideas sound effects library was recently nominated for a *Mix* TEC (Technical Excellence & Creativity) award in the area of Film and Broadcast Sound Technology by the readers of *Mix* magazine.

**Synthonic Sound**, the Atlanta-based production music firm, have announced the release of their new Folio Series, a collection of the best material from their contemporary music library. Folios one and two are presently available with additional releases quarterly. Each folio contains ten cuts, and is licensed on a one-time buyout rate of \$199.

Representing over 50,000 selections from numerous libraries, **TRF Music** of New York City has been a leading source of television, radio and film music for over 50 years. The most well-known TRF libraries include Bosworth, Chappell, Demeter, Folkways, Montparnasse (MP 2000), Music Scene and TRF Alpha. The Folkways catalog is noted for its excellent collection of ethnic, seasonal, and traditional cuts. The TRF Alpha, Music Scene, Bosworth and Chappell libraries feature contemporary music for AV and television production. The MP 2000 offers ethnic, period, children's and electronic music. The Chappell library has recently expanded its symphonic offerings and has two new series—Chap and Chap AV—with industrial, period, electronic and jingle albums. TRF music is available on tape or LP, with albums priced at \$9 each (special prices are available on complete libraries—for example, the 41 disk Demeter library is \$150), and usage rights can be had on a per use or blanket license arrangement.

Also distributed by TRF is the **Folkways** sound effects library, available on a buyout basis of \$12.50 per LP, or the entire 50 album catalog for \$500.

**Valentino, Inc.**, of New York City, is the only company currently offering both production music and sound effects libraries on the Compact Disc format. Their LP/tape offerings are

—CONTINUED ON PAGE 209

## SIX ADVANTAGES OF A STUDIO CONDENSER WITHOUT A SOUND OF ITS OWN

**1** The MC 740 Studio Condenser is ideal for critical analog and digital recording situations because it is virtually inaudible — no self-noise, coloration or sonic footprint of any kind.

**2** All five of the MC 740's pickup patterns have equally uniform and identically transparent frequency response curves — a unique achievement for a large diaphragm condenser design.

**3** Like our ribbon mics, the MC 740 eliminates the icy, strident quality typical of condensers to reproduce voices and instruments with uncharacteristic warmth and intimacy.

**4** Unlike other condensers, the MC 740 is free of exaggerated sibilance, graininess or distortion.

**5** The MC 740 is exceptionally sensitive, yet also withstands extreme SPLs (up to 144 dB with the 10 dB attenuator in circuit).

**6** Typifying Beyer's world-renowned accuracy, the MC 740 reveals the subtle differences between instruments and ambient environments.

*If the advantages implicit in the unconventional design of the MC 740 are important to you, arrange for a hands-on audition of this remarkable instrument by contacting your Beyer dealer or writing us direct at:*

Beyer Dynamic Inc.  
5-05 Burns Avenue  
Hicksville, NY 11801

ACCURACY IN AUDIO

beyerdynamic





KLIPSCH HIP-2 PICTURED ABOVE

# Packs A Punch, Packs In Your Trunk, The New KLIPSCH HIP-2®

Throw away your book on loudspeaker logic. No longer does big sound require a big speaker. Not since the KLIPSCH HIP-2.

Here is an extremely rugged, high output speaker system that delivers 100 dB one watt one meter sensitivity and a phenomenal 122 dB total output at 150 watts.

Here is an extremely rugged, easy-to-carry speaker system that drops neatly into your trunk or back seat and positions quickly on stage.

These qualities make the HIP-2 an excellent choice for the *real* world of the performing musician — the hurry-up, move-it-in, move-it-out,

one-night-stands in small to medium sized clubs and halls.

The HIP-2 is horn loaded in the tweeter and midrange sections for sparkling clarity, low distortion, and wide dynamic range. The woofer is a 12" (30.5 cm) direct radiator mounted to a 77 ounce (2.2 kg) magnet, operating in a vented cabinet for tight, clean bass.

The input panel is fused for maximum driver protection. The cabinet is coated with black textured lacquer, trimmed on all corners for improved durability and appearance, and comes with a recessed handle for ease of carrying.

All in all, a very well-conceived

speaker system that sounds very good. To hear the new KLIPSCH HIP-2 for yourself, visit your nearest KLIPSCH Professional Products dealer. Look in the Yellow Pages or call toll free 1-800-223-3527.

The new KLIPSCH HIP-2. A little over two cubic feet in size. 122 dB maximum output. 65 Hz: -20 kHz: ± 4dB.



**klipsch®**  
A LEGEND IN SOUND™

P.O. BOX 688 • HOPE, ARKANSAS USA 71801  
Circle #034 on Reader Service Card

# BURBANK STUDIOS:

## On the Cutting Edge of Film Sound

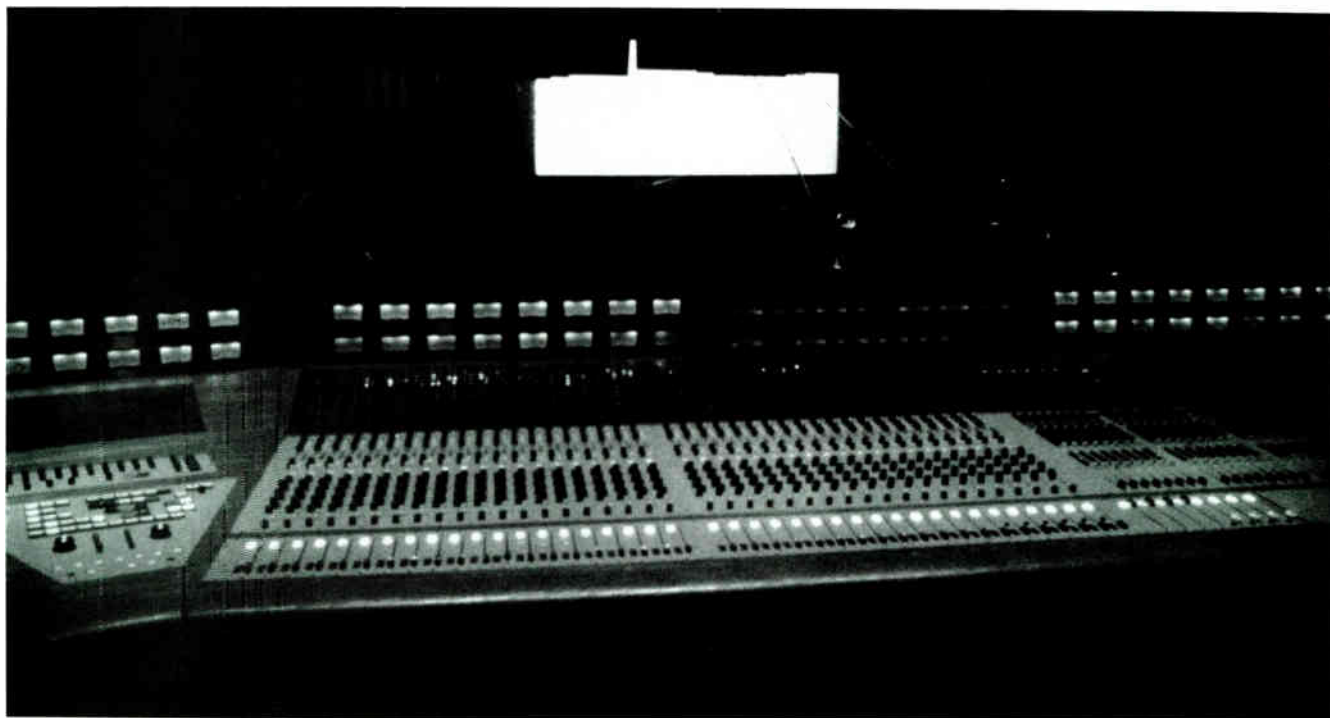

What is most impressive is not the amount of equipment, but the continuing ambition to grow, design new equipment and set industry standards.

by Robyn Flans

The fact that Burbank Studios is the largest facility of its kind in the world is quite impressive. Post-production sound consists of five high-speed film dubbing rooms with state-of-the-art equipment, including 35mm Dolby Stereo capability as well as multi-track recorders. Two scoring stages can record 6-track, 32-track digital, 24-track analog or all simultaneously. There are two ADR/Foley stages, 11 magnetic transfer rooms (that handle reformatting to, or from 6-track to single track, 16mm mag, half-inch, 1/4-inch or cassette), and two optical transfer suites. In addition to 22 screening rooms, 200 editing rooms and some 240 Moviolas, post-production sound is supported by its own machine shop as well as its own maintenance facility.

What is most impressive, however, is not so much the amount of equipment, but the continuing ambition to grow, design new equipment and set industry standards. Tom McCormack, head of post-production sound, cred-

its Burbank Studios president Gary Paster and vice president Ron Stein for the necessary support it takes to do so.

"We still have to explain what we do with the money, what we need it for and justify why we're doing it," McCormack laughs, "but they have been very supportive of what we're doing."

When McCormack started with Warner Bros. in their maintenance department in 1966, they "had equipment older than I am," he says. As WB became TBS in 1972, changes began to take place. Dubbing room 5 was built in 1972 and is the perfect example of TBS' growth. It has an 18-foot ceiling, from the back of the console to the screen is approximately 65 feet, and the width of the stage is 50 feet. The Quad-Eight console, which is 24 feet long with 108 inputs, is unique in that there are three sections—dialog, music and effects—each section acting as an independent console.

"The overall console can then look at a fourth recorder which will be considered the master, or it can be used



for sound effects. Any one of the mixers can punch in and out of each other's recorders so they're not locked in to just that one recorder. We can switch from one end of the console to the other, meaning if I'm dialog and handling too many tracks, and the effects guy doesn't have too many, I can switch the entire information over to that section via VCA and he can pick it up. Along with that switching, we've also added capabilities on buses 7 and 8, since there are eight mixing buses. Anything going down allows them flexibility. There are 54 equalized inputs on the console and the additional inputs are in the form of miniature consoles. They are 6-track mixing units, two in each section, which means they can feed the tracks into each one of those six channels, they can set levels and then set a master overall."

One of their recent innovations concerns working with director John Badham on *Short Circuit* in dubbing room 5.

"We started out doing digital in 1973 and used the Soundstream System at that time. We went on further to use the 3M digital machines with which we did *The Black Hole* for Disney and various other shows. Approximately in 1978, we got involved with Mitsubishi with regards to the 32-track. Primarily all of our scoring at this point is recorded digitally. Two years ago, we did a show called *American Flyer* for John Badham. John had booked dubbing 5 and we ran out of time to finish it in there because the next customer was booked. We were confronted with moving it to another stage but we had a tremendous amount of pre-dubs and wondered how we were going to put all these pre-dubs into a room with 27 sprockets. We talked about it and said, 'Why don't we transfer to digital multi-track?' So we set that up and to our astonishment, and also John Badham's, when we took the 35mm and transferred it over to digital, it took on a new characteristic. The quality and overall sound was different and it was cleaner.

"Some time passed, and John came back to dub *Short Circuit* here. He said, 'Now Tom, we want to go digital,' so all of a sudden we were thrown into the digital era in dubbing. We had attempted it several times before, *Body Double* being one of them, and that was when we embarked on building the interface to lock this machine up to the console, to fool the console into thinking it was still looking at the 35mm machine, yet letting the mixers have the flexibility of not worrying about what key is what and which machine am I on. They went along like they were doing a 35mm job,

except it was multi-track. We did all the pre-dubs, John was astonished at the quality that came back, and we proceeded to the dubbing job. All of a sudden we had a digital machine and everything was supposed to be quiet, but we had a lot of pops. A pop on the digital is like somebody setting off a firecracker.

"We found a way to erase the pops, but at the same time, we needed to clear it up. Let's say this happened on a Monday. By Wednesday morning we had built an interface to correct that difficulty. Basically what was happening was the 35mm equipment was controlling the whole situation and when you would push stop on the 35mm equipment, it instigated a slowing of the machinery coming down in speed to stop mode. As we punched that button to say stop, the digital 32-track was responding to that stop motion control. As it was sloping down, it was having problems with the sloping and we were getting errors that created pops. We needed to tell the multi-track that when we punched stop on the 35mm machine, it didn't really mean stop until it got down to stop. So we built a delay into it and, lo and behold, when we punched stop, it didn't say stop to the multi-track machine. It told it to keep going, the other came down in speed and away went the pops."

For *Miami Vice*, TBS took the first step in stereo television, again coming up with a new piece of time and money saving equipment.

"When *Miami Vice* came along, there was no set format, so it was, 'How should we record this? What should a master be? Should it be a 2-track, left and right, which doesn't lend you too much flexibility?' In conjunction with Universal, we came up with the idea of dubbing it on 6-track, dialog on one and two, music on three and four, effects on five and six. We would go ahead and dub to the 6-track, laying it down in that format, monitoring it while making it in a 2-track format, meaning we would listen to one, three and five on the left, and two, four and six on the right. Normally at other facilities, they would manufacture the 6-track, then create a 2-track from that and would have to spend additional time in the dubbing room. We built a piece of equipment to go in that transfer department which will allow us to put up a 6-track, punch all six tracks into a little black box we built that punches out a 2-track already balanced and everything else, saving them a lot of money in the dubbing room. We can make the 2-track for them, a 3-track mono or a composite mono, all from the 6-track, but all in

—CONTINUED ON PAGE 205



- ★RENTALS
- ★REHEARSALS
- ★SOUND STAGES
- ★STORAGE
- ★CARTAGE

SOUND  
REINFORCEMENT  
TOURS  
LIGHTING  
AUDIO  
PIANOS  
STEREOS

STUDIO INSTRUMENT RENTALS  
HOLLYWOOD      SAN FRANCISCO  
6048 SUNSET BLVD.      826 FOLSOM ST.  
(213) 466-1314      (415) 495-3200

Circle #035 on Reader Service Card

*The sound  
of the future  
is here today.  
Omnimusic  
on compact  
disc.*

OMNIMUSIC  
PRODUCTION MUSIC LIBRARY

52 MAIN STREET  
PORT WASHINGTON, NY 11050

CALL TOLL FREE:  
1-800-828-OMNI  
516-883-0121 (N.Y.S.)

See us at NAB Booth 2775

Circle #036 on Reader Service Card



# Michael Boddicker

by Tony Thomas

You may have never heard of Michael Boddicker. But unless you've been stranded on some exotic desert island for the past few years, it is almost inevitable that you have heard his sounds. He has contributed to projects as diverse as Michael Jackson's ubiquitous *Thriller* album, his score for the Imax/Omnimax classic *Magic Egg*, Barbra Streisand's *Broadway Album*, the mini-series *Space*, the soundtrack to *Karate Kid II*, as well as innumerable radio and television commercials and jingles. To put it simply, Boddicker is a "hired gun"—a "hit man" in the most commercial sense of the word. One of a new breed of studio cat—a sensitive synthesist and programmer whose seamless sounds can make or break a pop record, soundtrack or commercial.

More recently, Michael has been locked up in studios all over Los Angeles with the likes of the other Michael ("the gloved one"), Lionel Richie, and Chicago (with David Foster once again at the helm). We interviewed

## HIRED GUN

Michael at his recently purchased Sherman Oaks home, which will also house his planned recording studio. Amidst the sandblaster's dust (he was renovating and had not yet moved in at the time we spoke), we were able to discuss his latest projects.

**Mix:** How did you climb to the top of the heap of studio synthesists?

**Boddicker:** Well, there are a lot of people that specialize in studio synthesis that come in and blow it out. It's not a matter of just performing it once and being a show off. I like to sit and listen and make sure that my parts will endure. It's like the way Lionel Richie writes his songs. He makes sure that they will endure through a thousand listenings. I like to make sure my

parts are constructed in that fashion.

**Mix:** Your soundtrack to the *Magic Egg* is certainly indicative of that philosophy. **Boddicker:** Thank you. I'm very happy with that. I had done a lot of different kinds of composing. I like to diversify like that. If I had to just do record dates or film dates, or TV dates that would be boring. I can't wait to do another project like that where I can just take a month solid and just work on it seven days a week. Maybe when I get my studio built back here I can do something like that again.

**Mix:** What kinds of jingles have you done?

**Boddicker:** I work on jingles for a lot of different people. I've done national car spots like Chevrolet and Honda, consumer items like Clorox and I've written for Honda and Mattel. It's fun and I really like the 30 second medium, where you have to compress a symphony into 30 seconds.

**Mix:** What is your approach to scoring films?



**Boddicker:** Panic. Just, panic. They give me the project, I agree to do it and then it strikes me—I've agreed to do the project and I just start. I try to approach it not so much as a synthesist, but I try to hear it in my head. When I'm doing it myself, all I generally have to do is draw out the timings and come up with all the main transition points and then I know what happens in between. I usually don't have to write all the notes out, and sometimes I like it better when I don't.

That is particularly true with synthesizer sounds, unless you're dealing with stock colors, which I try to stay away from; then you don't know if the part is going to work and you have to be flexible. If I had every single note written out, then I would be more reluctant to change it. But if I'm able to improvise as I go, then I can make it fit better. Like in the most orchestrated section of the *Magic Egg* where you pass through the rings of Saturn was almost totally improvised, and even the fact that the time changed from 3/4 to 4/4 in the middle was a reflection of what I felt at the time when I looked at the picture.

**Mix:** What film scores have you worked on lately?

**Boddicker:** I have just finished a whole bunch of projects. I've done a couple of things with Bill Conti—*Karate Kid II* and *New Year's Eve*. On *The Karate Kid* there was an interesting use of electronics and acoustic instruments. I sampled some pan pipes up on the Emulator which Judd Miller played with the breath control, and it sounded beautiful. Then there was a Synclavier player, four synthesizer players and an 85-piece orchestra. The director on that film was really picky, so we were glad to see him walk away smiling. Bill just did a terrific job.

I also did a few films for Maurice Jarre including the *Enemy Mind* film which has been out for awhile. Maurice is incredibly knowledgeable about electronics, but one of the best things he does is turn the music over to the musicians. He writes the notes and pays attention, but he chooses the musicians and he trusts them. Maurice is not like other guys who say: "I don't know what I need here." He just says: "Get me what I need here" and doesn't encumber you with a lot of direction. I love working with Maurice.

When he did *Witness*, a lot of people thought it was his son [Jean-Michel Jarre], but it wasn't. It was Ian Underwood, myself and about three or four other guys [with synthesizers]. A lot of it was also Humberto Gatica. That's one thing about working with Humberto—you get your best sound up

and he'll take it about 40 percent farther with his effects. He has incredible taste and he also has that honesty factor. A lot of guys can be cajoled into accepting the sound, but Humberto is constantly saying: "No. We can do better." I love that; there is nothing I like better than working hard to make it sound phenomenal.

I also had the joy of working with James Horner on several projects. One was called *Lazaro*. He had a [Yamaha] KX88 and he had Ian Underwood and I get the sounds up and he'd watch the screen and improvise the whole thing. Now we're working together on *Captain Eo*, which is being produced

---

**"I like to sit and listen and make sure that my parts will endure. It's like the way Lionel Richie writes his songs—he makes sure that they will endure through a thousand listenings."**

---

by George Lucas for Disney and it stars Michael Jackson. Michael does a few songs, James did the score and I played on it with Ian and James along with the orchestra. It's a 3-D film for which I'm also superimposing sound effects for visual effects. It's a challenge to make it work and not get in the way of James and to please Michael.

**Mix:** What are you planning for your studio?

**Boddicker:** The studio that will be transplanted is the studio I have now. It's a 24-track studio with a 28-input board with plenty of outboard gear like Roland SRV2000s, Yamaha SPX 90s, a Yamaha REV7, a Lexicon PCM-70, a Quantec modified by Steve Marshall and lots of DDLs like Prime Time, Effectrons, and three Roland SDE-3000s. Then there are tape echoes, phasers, pitch doublers and one of the best echo plates I've ever heard. In my new studio, I'm also going to set up a kind of a permanent "rogue's gallery" of old classic synthesizers like Prophets, Minimoogs and PPGs that I can have available anytime.

**Mix:** What does your current synth setup consist of?

**Boddicker:** My regular setup on a date is two Yamaha DX7s, with eight-bank mods with a Apple Macintosh to catalog the libraries, a Roland Jupiter 6 with eight-memories, and Jupiter 8. I also use my Korg DW-8000 and EX-8000 all the time. They're all over the new Lionel Richie album and I think they are probably the cleanest studio synths I have. Then I have a Roland Super JX, two modified Emulator IIs, an Oberheim Matrix 12, a PPG with Waveterm, a Sequential Prophet VS and a Korg DVP-1 voice processor. Finally, I bought a bunch of Hill mixers which I've modified to run everything through.

**Mix:** Have you been using any sequencers lately or are you still anti-sequencers?

**Boddicker:** No, on *The Magic Egg* I completely changed my mind about sequencers. I really learned how to use the MSQ and came up with a bunch of techniques so that it didn't sound quite as sterile to me, and I'm no longer afraid of losing my technique because I try to practice the piano every day. I've also been using the Linn 9000 a lot lately for record dates that I've been arranging and playing on. I've also been using the Macintosh with Mark of the Unicorn performer software, and I love it.

**Mix:** Do you still have your apprehension about MIDI and the notorious MIDI delays?

**Boddicker:** Yeah, I do. It still bugs me to have to sit down and figure out delay settings to compensate. Now, I will use multiple MIDI channels on film dates where punch isn't that important. On record dates, I still build up sound on 24-track using a lot of synthesizers so I don't generally have the need to use more than MIDI channel one. Who knows? I'm changing all the time. But if there is any way I can just use channel one, I'll do it. It seems to pay off. Things seem to be tight and crisp.

**Mix:** How do you manage to combine such disparate elements as a sample of Janis Siegel's [of Manhattan Transfer] voice with Marcato strings with the sound of a guitar going through a Hot Tubes amp in your scoring such as in *The Magic Egg*?

**Boddicker:** It's not a matter of Janis Siegel or a guitar. It's a matter of deciding what makes a track not have the oomph it needs and feeling that a fuzz guitar down at the bottom would give it credibility. It's like Quincy Jones once told me—if it doesn't feel right in your gut, it's not right. ■

is substantially unchanged since the so-called "Golden Age" of the '40s, when prolific composers like Victor Young, Miklos Rozsa, Bernard Hermann and Dimitri Tiomkin were hitting their stride. Of course, every decade has also seen the influence of the popular music of the day on film music, too, whether it was big bands or jazz or romantic pop. Frequently, pop songs that appeared in films became national bestsellers in the '40s and early '50s, but those were eras geared to the sale of individual 78s, not albums, so orchestral film music received scant exposure off the screen. Not surprisingly, it was song-oriented films—specifically screen versions of Broadway shows—that netted the largest sales for soundtracks, and that phenomenon didn't really hit until the mid- to late-'50s with *Carousel*, *Oklahoma*, *Gigi* and *The King & I*. The occasional symphonic score struck the public's fancy, too: *Around the World in 80 Days*, *Ben Hur*, *Exodus* and *Lawrence of Arabia*, to name just a few.

Though countless films featuring rock and roll bands in them were made during the late '50s and early '60s (sort of the logical extension of the "Broadway Melody" series of the '30s) the widespread usage of rock and roll songs as soundtrack music (without the artists actually appearing in the film) didn't occur until the late '60s, when hip young filmmakers decided that rock was more relevant to the ideas they were dealing with than a traditional orchestral score. *Easy Rider* was one of the first so-called "youth" films to successfully exploit a diverse rock soundtrack—the songs were integrated beautifully and the resulting soundtrack LP was an artistic (and then commercial) triumph as well.

The smell of money in Hollywood has been aptly compared to the smell of blood to a shark, so it is no surprise that the success of *Easy Rider* (and *The Graduate*, which used Simon & Garfunkel songs) opened the floodgates for rock songs to be used as important soundtrack music. The two *American Graffiti* films expertly utilized tunes from the late '50s and '60s, spurring catalog sales for a number of artists who hadn't exactly been hot stuff in the early '70s. But all hell broke loose in 1977 when *Saturday Night Fever*—utilizing tracks by the Bee Gees and a slew of R&B artists—became the most successful soundtrack album in history. So that means that it may or may not be John Travolta's fault that it's virtually impossible to go to a movie now without being pummeled by a succession of throbbing rock and R&B songs—now rendered in deafening Dolby stereo more often than not, thank you.



The new part of the equation is television. Rock videos have been a boon to both record companies and film studios because of the rise of videos of songs from movies. Nine times out of ten, of course, the songs that appear in films—sometimes just in small snatches that are barely audible to the movie audience—have no particular connection to what is happening in the film. Yet because the song is in the film, a video is made artfully intercutting scenes of the band or singer with highlights from the movie. What this amounts to is a three-plus minute commercial for both the movie and the song. The fact that the videos are completely incomprehensible, even if you've seen the movie, doesn't seem to bother anyone—certainly not the business types who have shrewdly learned that since constant radio airplay gets teenagers to buy records, then constant videoplay might entice them into seeing the movies in which the songs appear. And that means money for everyone.

This has created an interesting climate in the record business. Labels correctly now see film as a primary outlet for breaking new artists, extending the life of already released albums, and even for giving exposure to artists between albums and tours. Rare indeed is the filmmaker who really has specific ideas about which rock songs he/she wants for a soundtrack. The key is to just get something that fits and which might have some hit potential with one or more demographic groups. And so there are song pluggers at record labels who keep tabs on film projects and suggest bands or singers on their label, hoping to land on a hot soundtrack. Of course a hit film is never a guarantee, so what looks like a possible smash album can die an ignominious death if the film stiffs. Likewise, sometimes songs in only moderately popular films can propel their soundtracks to levels the film never attains. Case in point—*Streets of Fire*, Walter Hill's muddled, over-dramatic paen to teen hormones was basically

a flop but generated a couple of hits from its soundtrack. Since the movie was all flash, it gave great video, so to speak, so *Streets of Fire* songs were all over MTV and other video outlets. Luckily, some of the songs were also good enough to stand up without visuals.

The money and exposure involved in placing a song on a soundtrack can be substantial. Fees for song usage in major motion pictures range from about \$3,000 up to more than \$200,000 (before royalties), depending on the act and how prominently a song is used. Not that acts always know how their songs will be employed in a film.

"Unfortunately we don't always get advance information on how our songs are going to be used," says Mark Leviton, a vice-president for Warners Special Products, who handle (among other things) the licensing of tunes by artists on the WEA family of labels (including Warner Bros., Elektra, Atlantic, etc.). "On the soundtrack for *Pretty in Pink*, for example, we had a lot of tracks cleared at different prices. It turns out the most expensive track is barely audible in the film, and the cheapest is very prominent. 'Cherish' [the old Association hit] is used very significantly, but I didn't know it at the time we were negotiating."

Generally, directors edit film to the kind of music they want to eventually use—which is fine except when they have fantasies about using music that is either unobtainable or unaffordable. "Sometimes they know they can't get the music they want," Leviton says, "so they'll cut the film to one kind of music and then go for music with a similar feeling in the end. But some of the problems come from directors insisting that they have a certain piece of music. The producers OK it and end up having to spend a lot of money for it, and then that sets a precedent for other higher deals when the word gets around.

"At one time," he continues, "Beatles songs were the most expensive—they were really almost prohibitive, but that's been eclipsed now. When *The World According to Garp* came out, it used 'When I'm 64' under the title credits and that was the most expensive use of a tune up to that point, but that's been tripled by now."

And that explains in part why you don't hear Bruce Springsteen songs in every movie. The licensing would be astronomical, even for a track or two. But most films use enough tunes to fill up an album (and sometimes considerably more), plus they commission a regular composer to write more traditional film music. It's that person who gets the big "Music By . . ." credit in the beginning of the film, even while you're hearing a tune by Mick Jagger



(in the case of *Ruthless People*) or Talking Heads (whose "Once in a Lifetime" is the splendid accompaniment for the opening of *Down & Out in Beverly Hills*). This says something about the power of legitimate film composers—that they still get top billing even when their music is sometimes reduced to being "filler" between rock tracks—but it probably says more about the power of unions in Hollywood. And many composers are also smart enough to negotiate their way onto soundtrack albums regardless of how many pop songs appear in the film. As a record buyer, sitting through the bombastic music labeled "Chase Scene" at home (effective as it might be in the film) is the price you pay for hearing the pop songs you actually bought the record for.

Coordinating a film's soundtrack is a complicated task, to say the least, because so often these days it involves finding appropriate already existing songs, new tunes that have hit potential, and standard "movie music." Look at *Ruthless People*, for example, which was a big enough deal at CBS Records that label boss Walter Yetnikoff himself is said to have been quite involved with the soundtrack LP. It features a dynamite new song by Mick Jagger which even bears the title of the movie—as opposed to a movie

like *Top Gun*, which doesn't have a title track per se, and therefore doesn't have the added bonus of pounding people with the title of the movie when they simply hear the song on radio. It has a new hit by CBS stalwart Billy Joel (which was a huge smash). It contains "Stand On It," an obscure recent Bruce Springsteen B-side that's never been on an album before. And it has "Foxy Lady," the Hendrix classic, in a prominent scene. So that's something old, something new, something borrowed... and a hit soundtrack is the result.

And more often than not, something motley, too. When soundtracks are assembled from so many different sources, sound consistency is always a problem. Ten songs by different bands recorded by different producers in different studios and sometimes even different decades often leads to a record that sounds as disorienting as a late-night TV hits package. But every once in a while you get a soundtrack like the one for the Gregory Hines/Billy Crystal film *Running Scared*. There, writer/producer Rod Temperton was able to write most of the songs (and the incidental music as well) and bring in different acts to perform it, so the MCA soundtrack album boasts songs by top names like Michael McDonald (the hit "Sweet Freedom"), Patti LaBelle,

Klymaxx, Ready for the World and New Edition, but sounds amazingly consistent. It works as a record.

Record labels frequently wield considerable power in assembling soundtracks (since filmmakers can't be expected to have their pulse on what's happenin' in music), and often they take advantage of that power by loading up soundtracks with cuts by their own up-and-coming artists. For instance, checking a stack of recent soundtracks put out by MCA, one sees the same names cropping up again and again: Nik Kershaw, Kim Wilde, Hubert Kah. Hubert Kah? Who or what is that? Well, that's the point, because if one of the soundtracks he's on becomes a big hit, he could go from a nobody to a big name overnight. As it was, the two films in question, *Secret Admirer* and *Once Bitten*, were box office duds, but Kim Wilde managed to get on *Running Scared*, so a lot of people who hadn't heard of her, and who probably ignored her own album, will hear her on the soundtrack. Hopefully that will then whet their appetite for more Kim Wilde music.

Filmmakers also sometimes rely on the expertise of the labels to pick older material where it's required, too. "I basically got to pick the records for *The Falcon & the Snowman*," comments Mark Leviton. "They told me,

## IF ONLY YOUR EARS COULD SEE

If you could see what your ears can hear, the precision which makes Tannoy monitors different would stare you in the face.

On most monitors you would see the phase incoherence and the time difference in high and low frequencies.

Put a Tannoy with SyncSource™ under the magnifying glass. Look at the phase perfection and the way in which the correct time relationships of fundamentals and harmonics are maintained.

Then look at the practical advantages. More complete audio information, and greater freedom of movement behind the recording console without being restricted to an on or off axis listening position.

**TANNOY**  
The Name for Loudspeakers

For more information on Dual Concentric Point Source monitor systems with SyncSource™ contact:

**TANNOY NORTH AMERICA INC.**  
(519) 745-1158 • 300 Gage Ave., Unit #1, Kitchener, Ont., Canada N2M 2C8

Circle #038 on Reader Service Card

'Look, it takes place in 1974, so what should we use?' So we dug up 'Midnight at the Oasis,' by Maria Muldaur, 'Pick Up the Pieces' by the Average White Band and a couple of Doobie Brothers tracks. 'You're So Vain' by Carly Simon is prominent in a party scene, as it probably would have been in 1974."

Leviton says that because there are so many filmmakers now who grew up listening to music in the late '60s and early '70s, more and more movies are licensing tunes from artists of that era. "They want to get the music that was important to them," Leviton says, "so we handle a lot of Aretha Franklin, Rascals, Wilson Pickett—things that people have good associations with

from their youth. 'For What It's Worth' by Buffalo Springfield is popular, too. It conjures up a lot of memories about political things."

Placing a vintage song in a film is money in the bank for Steve Stills or Aretha or Rascals leader Felix Cavaliere, but there are some artists who are nervous about having their older material in movies because they are intent in keeping their careers focused on the present and they don't want to live off past glories. And other contemporary artists worry about other things—like what kind of film their music is going to be used in, how it is going to be used, whether it will compete with their own albums, and things of that nature.

"I have an artist whose son died under certain circumstances and he doesn't want his music in films with a lot of violence," says Leviton. "Reuben Blades is very concerned about the stereotyping of Latinos in films, and before he'll authorize anything he wants to see the script to see how Latinos are being portrayed. Peter Gabriel is also down on gratuitous violence and wants to know what's going in a film before he lets his music be in it.

"Someone like Phil Collins has different concerns," he continues. "People who have had a lot of success with songs in films don't like to have too much of their music in different films because they want to pick prestigious films to have. So they might say, 'Well, I like the script but I don't think it's going to be a big film,' so they'll save the song for something else."

In the case of a Phil Collins-calibre performer, a hit off a soundtrack is often a warm-up for an album to come (where the really big bucks are made by the artist's label), but increasingly, soundtracks are used as sort of a testing ground by labels, to see if they can break a single by an act without having to promote a whole album, or simply to keep a band's name in front of the public eye. An act that isn't turning out albums regularly can crank out a song for a soundtrack every few months and look like it's busy. Then, the band can use the tracks from films to fill out its albums, and the record company has already made some money off those tracks.

This is good news for recording studios. If labels aren't springing for megabuck recording budgets like they once did, they are more willing than ever to drop a few thousand bucks to let an act cut something for a film. There is more soundtrack work being done by more studios than any time in the past, and unless the negotiators start to price themselves out of it by asking exorbitant fees, that is likely to continue. A trend that is not in the studios' favor is the increasing number of soundtracks being made in home studios with a wall of synthesizers and samplers. But that's another story.

In the final analysis, despite the advances in sound technology, the tremendous sums of money involved in soundtrack budgets and the styles of music being employed by producers and directors, the function of movie music is essentially the same as it was when your grandma and grandpa sat in the local bijou listening to the hottest organist in town accompany those amazing flickering images up on the screen. Music adds to the visuals and moves you in some way. All the rest is just dollars and cents. ■

# DIRECTIONS FOR A HIT

▶ TAKE THE 5 SOUTH TO ALAMEDA ▶ OR THE 101 EAST TO BUENA VISTA ▶ OR GO OVER BARHAM, CIRCLE BURBANK STUDIOS AND NBC AND YOU GET ENCORE STUDIOS.

**E**ncore

**YOU DESERVE IT WHEN YOU'RE GOOD**

721 S. Glenwood Pl. Burbank, CA 91506 USA Phone (818) 842-8300 Telex: 697-2449 ENCO UW

Circle #039 on Reader Service Card



INTRODUCING...



**Sound Impressions, Inc.**, formerly Music City Tape Duplicators, Inc. is proud to announce a *new* name, a *new* facility, and a revolutionary approach to record and tape manufacturing.

Our new Nashville facility is specially designed to provide you with the utmost in sonic quality and service. We are bringing everything in under one roof: record pressing, tape duplicating, 4-color printing, cassette mastering, jacket manufacturing, etc., etc., etc.!!!! Our environmentally controlled facility and continuous quality control measures assure the highest audio and aesthetic quality available.



*For Information, call or write:*

**Sound Impressions, Inc.**

325 Hill Avenue

Nashville, Tennessee 37210

(615) 244-3535 or 1 (800) 458-7756



WELCOME

# P R E V I E W



## 3rd Generation G16.8.2 Mixer

Tek Trak, of Voluntown, CT, is now distributing 3rd Generation, the British made line of professional audio gear. The first product introduced to the U.S. market is the G16.8.2 multi-track recording mixer. This 16x8x2 console features 16 balanced inputs with insert send and return, 4-band EQ, 3 aux sends, mute and solo switches, phase reverse switching, and 100mm faders throughout. The grouping/master sections include 8 input/output groups with 2 aux sends and 2-band EQ, solo, and fader reverse; -10 and +4 dB outputs; slate; oscillator and talkback controls; individual group and master VU meters. The G16.8.2 is priced at \$3,815.

Circle #040 on Reader Service Card

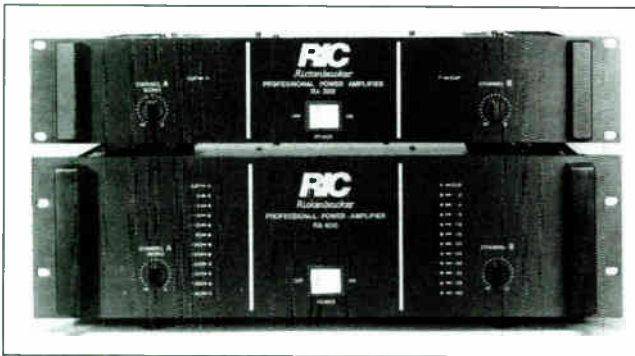

## Rickenbacker Power Amps

Newly available and now in stock are the Model RA300 and RA600 rack-mount power amplifiers from Rickenbacker International Corp., of Santa Ana, CA. Sporting the new RIC logo, these amps represent cooperation between Rickenbacker and one of Japan's most prestigious electronics companies, the first in a new range of professional sound reinforcement equipment.

Both models feature shielded toroidal transformer, a super rigid chassis design, oversize 5-way binding posts, and genuine XLR inputs/outputs. The Model RA300 delivers 150 watts per channel while the RA600 packs over 300 watts/ch into 4 ohms. Bridge mode delivers more than 300 and 600 watts respectively into 8 ohms, with THD less than .05% at full rated power. The RA300 lists for \$899 while the RA600 sells for \$1249.

Circle #041 on Reader Service Card

## TAC Scorpion Expander Unit

Amek Consoles Inc., of North Hollywood, CA has unveiled a 26 input extender unit that can be factory fitted to any long frame or short frame TAC Scorpion console. A normal 24-16 Scorpion is now capable of up to 50 mic-line inputs, a 16-8-2 up to 42 mic-line inputs or a 32-8-2 up to 58 total mic-line inputs. The extender unit may be fitted in a separate chassis for custom positioning in the field or bolted together with the existing mainframe. The 26 input extender is available at a retail price of \$9,400. A factory modification to the existing mainframe is required at a cost of \$500. Other new options available on the Scorpion include VU meters for the stereo bus and 8 auxiliary sends instead of the standard 4.

Circle #042 on Reader Service Card



## Publison IM90 Remote Control

Publison America of Hollywood, CA has announced the availability of a full function remote control for the Infernal Machine 90 software driven multi-effects processor. Besides giving fingertip control to all parameters, the remote unit also includes a large rotational knob for greater speed when editing or adjusting effects, as well as an "A&B" key for changing parameters simultaneously on both channels.

Circle #043 on Reader Service Card

## Meyer 500 Series

The 500 Series loudspeaker system from Meyer Sound, Berkeley, CA consists of a matched pair of full-frequency 500 series loudspeakers in combination with the 500 stereo integrated amplifier. The loudspeakers utilize a 15-inch low frequency driver in conjunction with a high-frequency driver mounted on a modified radial horn. The integrated amplifier consists of a professional-quality 600 watt/channel amplifier, control electronics, and sophisticated driver-protection circuitry, all located within a single 19-inch wide rack-mountable package that is only 5 1/4 inches high.

In addition to driving the 500 Series speakers, the 500 amplifier is capable of powering a complementary pair of 501 subwoofers for an overall increase in the system's frequency range and power handling capability. The amplifier accepts balanced or unbalanced inputs and interfaces easily with either pro or semi-pro systems. Rear panel variable high and low frequency controls are provided to accurately tailor the response of the system to various room conditions.

Circle #044 on Reader Service Card



## Pearl TL-4 Stereo Mic

Karlberg Enterprises, of Rockford IL, is now importing the Swedish AB Pearl TL-4 microphone to the U.S. market. The TL-4 is a high quality, phantom-powered dual cardioid 180° stereo mic which can be adapted for a variety of applications, such as omnidirectional or bidirectional mono, or used in a M-S stereo arrangement. The microphone comes with a 5-pin XLR output connector, and two cables are available—one terminates with a XLR-M 5-pin, while the other provides two standard 3-pin XLR-M connectors. An optional accessory box (PDV-B) provides an interconnect for an external 48 Volt source, along with external control of microphone patterns, and a choice of balanced XLR or unbalanced phono outputs. The Pearl TL-4 is priced at \$795, less cable.

Circle #045 on Reader Service Card

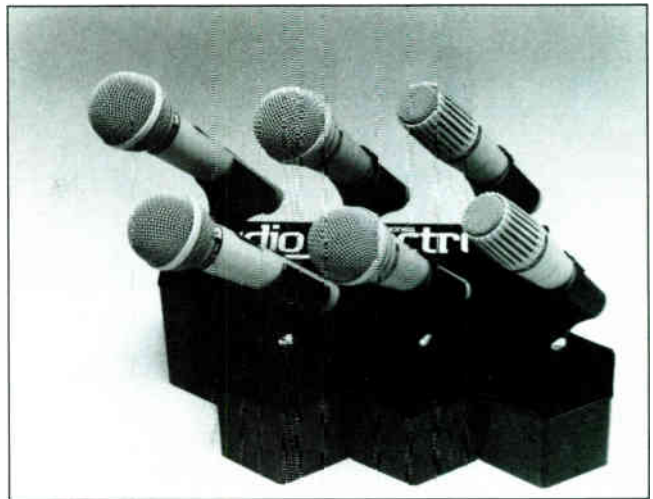

## Audio Spectrum Microphones

The Music People, Inc., of West Hartford, CT, have announced the exclusive distribution of the Audio Spectrum microphone line. The AS-350L (\$140 list) is a low impedance vocal mic with wide 50-18k Hz frequency response and presence peak for extra clarity. Other low impedance dynamic mics in the line are the AS-345L (\$129.95), designed for high SPL instrument applications, and the AS-246L (\$89.95), tailored for both vocal applications and most instrumental situations.

The Audio Spectrum Line also includes several condenser microphones—the top-of-the-line, full frequency response AS-354L at \$169.95, and the AS-335L (\$110) with the response and heavy construction needed for life on the road.

Circle #047 on Reader Service Card



## Kurzweil 150 MIDI Expander

The 150, from Kurzweil Music Systems of Waltham, MA, is a rack-mounted expander for use with any MIDI keyboard or control device. Retailing for \$2,995, the new instrument is a multi-timbral sound source equipped with 22 instrument voices, ranging from acoustic and electric pianos to guitar, bass, synthesizer, and mallet sounds. Sixty preset programs allow access to a variety of sound options that can be recalled at the touch of a button. The 150's instrument voicings are stored on internal ROM chips, and space is provided for 5 extra ROMs for future expansion.

In addition, the unit permits musicians to create their own programs for storage in the 150's battery-backed, non-volatile memory. For example, the keyboard can be split into 2 or 3 regions, each of which can be individually tuned, transposed and balanced. Further, the overtones of each sound can be varied via Kurzweil's "timbre shift" option. Other available effects include programmable chorusing, vibrato control and an 8-band graphic equalizer.

Circle #046 on Reader Service Card



## Audioscope Model 3211

The Audioscope Model 3211 Multichannel Audio Level Display from Apogee Electronics of Santa Monica, CA, provides accurate monitoring of up to 32 channels simultaneously on a separate RGB color monitor. Columns, graticules and secondary graticule colors may be programmed internally to suit individual requirements. Meter characteristics are switchable VU or PPM. If using the meter with a multi-track machine, a color square may be displayed at the top of each column to indicate the record mode of that channel, and switching may be effected automatically.

Circle #048 on Reader Service Card



## BRYSTON "4B-PRO" POWER AMPLIFIER

by Piers Brew

Professional equipment has traditionally been separated from audiophile equipment by the different needs of its users. Pro gear has to be durable, easy to maintain, and able to operate under a wide range of conditions, with the versatility to meet the requirements of various applications. These conditions can be met, but often at the cost of accuracy and quality of reproduction. Audiophile equipment does not have to operate under such adverse conditions and does not need to be as rugged. As a result, audiophile equipment can be designed and built for optimum sound reproduction.

Recently, companies have produced equipment that combines the durability of the professional world with the sound quality of the audiophile world. This is the goal that Bryston set for itself in the design of its "Pro-Series" amplifiers.

The Bryston 4B PRO, the professional version of their acclaimed 4B, occupies three rack spaces and weighs 50 lbs (its dimensions are 19- x 5.25- x 13.5-inches). On the front panel is a power switch with dual color LED power/clipping indicators for each channel. The indicators glow green to indicate "power on" and red to indicate clipping. Also on the front panel are volume trims for each channel; a flat head screwdriver is needed to ad-

just these.

Rear panel connectors include locking 1/4-inch input jacks (with balanced XLRs as an option), and gold plated posts for the speaker outputs. Bridging is accomplished easily with a switch that is located on the back. In the bridged mode, the input is taken through the left side, and the output is provided through the two binding posts for the + output of each channel. Also provided is a ground lifting switch for separating the signal ground from the chassis ground.

One immediate advantage the 4B has over most amplifiers of its size and power rating is its lack of cooling fans, thus eliminating operating noise, a useful feature for control room applications, yet fairly rare among professional units. Cooling is accomplished by 9600cm<sup>2</sup> of heat sinking. It is designed to run warm at idle, but this does not cause any problems with its performance. The amplifier provides ample power to be used in PA applications and can drive a load of any phase angle at 4 ohms or higher while still maintaining quality specifications.

Each channel is fully independent and separated from the other channel all the way back to the line cord—there is a separate power supply for each channel. This provides excellent channel separation between the left and right channels.

The power output is guaranteed to be at least 250 watts into 8 ohms (400

watts into 4 ohms), and 800 watts in bridged mode into a minimum load of 8 ohms. The 4B-PRO is capable of delivering up to 48 amperes instantaneous peak output current. This rating indicates the high current handling ability of the output transistors, but does not represent the amplifier's power output capabilities. This amount of current can only be delivered to a 1 ohm load.

As mentioned earlier, all Bryston amplifiers are designed to be very durable, while still maintaining audiophile specs. This is accomplished by providing extremely high safety margins for all components. Typical margins are about 250 percent, which increases the life expectancy ten to 20 fold. On top of this, each amplifier is run through a burn-in test to uncover any defective components. The burn-in (torture) procedure involves running the amplifier at full volume with a high frequency square wave which is applied for three hours and turned off for one hour every four hours for a total of 100 hours with the output connected to a capacitive load.

Bryston recommends that under normal conditions the amplifier should be left on continuously. This should not be any problem because the amplifier's idle current draw is equivalent to that of a 100 watt light bulb. This is also a good idea because of the size of the power supplies—if the power switch is on when the amplifier is being plugged in it may cause damage to the plug and the outlet.

The manual states that most speakers can handle the normal undistorted output of the amplifiers, but once clipping occurs, damage may be sustained by the high frequency drivers. This is due to the generation of harmonics caused by clipping. In normal operation, the clipping indicators can be allowed to switch on occasionally without causing damage to correctly rated speakers. Woofers may be damaged because the amplifier can reproduce low frequency transients at high levels. Bryston recommends that fuses be used to protect the speakers, and offers gold plated speaker connectors as an option.

When the amplifier first arrived, we hooked it up as the alternate monitor amplifier in our control room, here at the University of Miami's multi-track recording studio. This allowed us to try it out with a range of different



speakers, and the first opportunity to use it was during a tracking session that evening. The instrumentation of the tune was drum machine, guitar, bass doubled by synthesizer, several background synthesizer tracks, and lead guitar. The Bryston provided plenty of output level for the musicians in the control room to monitor while playing, and was able to reproduce the drum tracks very accurately, and with surprisingly low distortion for such high level reproduction.

The 4B-PRO has some more, less obvious, advantages over other amplifiers. Its protection circuitry doesn't kick in with any minor transient blemish that gets into the signal, and the nature of the protection circuitry is such that it will not fully disable the amplifier in order to protect itself. In the basic studio environment, we could not provide any signal that would distress the Bryston. It handled high level percussive sounds, high level low frequency sounds (bass "popping"), high frequency high level signals (lead guitar "harmonics"), and at the same time reproduced the most subtle synthesizer voices without the slightest hint of distortion, even into 2 ohm monitors.

The next test application was in a PA system for a rock ensemble performance. We used the 4B-PRO as the main speaker amplifier. The Bryston was operated very near clipping through the whole concert, only being allowed to rest during the small breaks between tunes, and often being pushed over the point where the clipping lights would come on. Every time the drummer hit his very loud "China" cymbal, the amplifier's clipping lights would go from green to red but no disagreeable increase in distortion occurred. The dual color LED power/clipping lights were very responsive, and easier to see than indicators that only switch on when clipping occurs. Since the lights are always on, it is very noticeable when they change colors to indicate clipping.

The amplifier got quite warm after it had been on for a while, but once it reached its operating temperature, it did not get any hotter. At first we were concerned about it running so warm, but we realized that its performance was not being affected, and it was nice not having fans switching on and off to cause any distraction from the work at hand.

Finally, we used the Bryston with a pair of electrostatic loudspeakers, and a Compact Disc sound source. The capacitive, frequency dependent load was no problem for the 4B-PRO to handle. No audible coloration was added by the amplifier, and, even at higher levels, there was no problem with it handling the varied phase angles of the load. It did not run nearly as warm as it had done in the other applications.

Every Bryston amplifier is tested before being shipped. An individual specifications sheet, showing the results of these tests is provided along with the amplifier. The basic ratings that all 4B-PRO amplifiers must meet are listed in Table I. The specifications of the amplifier that we reviewed were confirmed on our test equipment, and are listed in Table II.

The operating instructions provided with the amplifier are somewhat limited in scope. No schematics are provided, and the four page manual includes the operating instructions for the company's full line of amplifiers, nevertheless the instructions provided are more than adequate for the purchaser to understand fully how to use the amplifier.

Considering how well the amplifier endured such a wide variety of applications, while still producing a clear undistorted signal, the Bryston 4B-PRO met the manufacturer's goals with regard to durability, sound integrity and accuracy. Together with the reasonable price of \$1500 for such a powerful, high quality amplifier, I would strongly recommend the 4B-PRO to any professional user. ■

**TABLE I**

**Factory specifications**

**POWER:**

250 watts/channel into 8 ohms.

400 watts/channel into 4 ohms.

800 watts bridged into 8 ohms.

**NOISE:**

100 dB below full output.

**DISTORTION:**

< 0.01% from 20 to 20kHz at 200 watts

**IM.**

< 0.01 from 10 milliwatts to 200 watts

**SLEW RATE:**

> 60v/microsecond.

**TABLE II**

**Confirmed specifications of the amplifier we tested**

**POWER:**

277 watts/channel into 8 ohms.

**NOISE:**

104 dB below full output L-channel;

103 dB below full output R-channel

**Distortion: L-channel R-channel**

20Hz 0.0035% 0.0027%

200Hz 0.0036% 0.0026%

2,000Hz 0.0031% 0.0027%

20,000Hz 0.0067% 0.0062%

IM. 0.0017% 0.0013%

# MIC \$ALE

- AKG
- AUDIO-TECHNICA
- BEYER
- CALREC
- COUNTRYMAN
- CROWN PZM
- ELECTROVOICE
- RAMSA
- SENNHEISER
- SESCOM
- SHURE
- SONY
- STEWART
- TEAC
- TELEX
- TOA
- TRAM
- TRISTECH
- UREI



## GOING ON NOW!

BOOKS - DISCOUNTED

170 PRODUCT LINES FOR THE PRO

AMPLIFIERS • CASSETTES • HEADPHONES • INTERCOMS • SPEAKERS  
 • TAPE • TAPE RECORDERS • TEST EQUIPMENT • TURNTABLES  
 • LIGHTING • MICS • MIXERS • PARTS SIGNAL PROCESSING

TOLL FREE IN ALL 50 STATES

**1 (800) 356-5844**

IN WISCONSIN - 1 (800) 362-5445

**CONSULTATION**

LOCAL (608) 271-1100



6729 SEYBOLD RD., MADISON, WI 53719-1393

# FIELD TEST

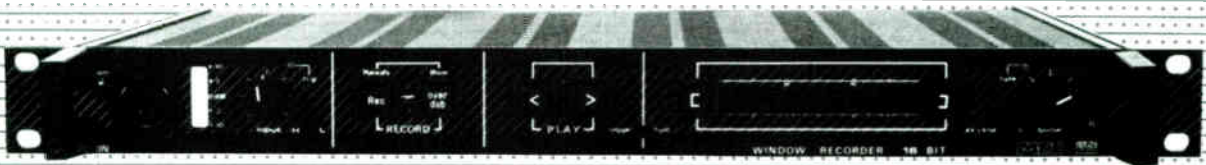

## MDB Window Recorder

by Eddie Miller

It seems that every decade or so the audio industry comes up with a special sound processing device or recording technique that everyone's just got to use. In the '50s, it was the reverb unit. What would the '60s have been without wah wah pedals? The '70s gave way to the rise (and fall) of quadrophonic recording and sound systems. Now in the '80s, the new technology is digital recording, and out of this has sprung a plethora of digital sampling devices. With the aid of these machines, any sound you can imagine (or sample, anyway) is at your fingertips to use as music, or sound effects.

The latest of these units to hit the market is the MDB Window Recorder made in Switzerland by Giant Electronics, Ltd., and distributed in the United States by Europa Technology, Inc. Giant Electronics boasts that their Window Recorder is currently "the highest quality sampling digital recording unit on the market" with "Compact Disc quality." Let's investigate...

Basically, the Window Recorder is a digital sampling unit that can be triggered to playback and transpose what has been sampled via

either a front panel control, or an external signal. The unit samples at a rate of 44.1 kHz using a 16-bit linear PCM system to digitize the audio signal. Twelve seconds of full bandwidth sampling can be stored and retrieved.

Located on the left end of the front panel (one rack unit in size) is the XLR input jack. The input level is selectable between mic or line level and can further be adjusted by using the input level control knob and LED meter. A green LED above this knob indicates whether the input level amplitude is sufficient to trigger the record function, if selected.

To the right of the input knob are the record and overdub select buttons. Next are the forward and reverse play buttons, followed by a trigger or hold two-position switch that will select single play or looping of the sample. The middle-right section of the front panel holds the visual "window display" of the unit. This display incorporates 32 "winking and blinking" LEDs that form a visual display of memory space.

On the right-hand side of the front panel is the tuning knob and a red LED that lights up when this control is in use. A two-position switch below this determines whether the sample will be played back at the initial sampling rate, or if the sample will

be transposed via the tuning knob. The reset button, which will reset the window length to its initial 12 second position, is the last item on the right side of the front panel.

The back panel holds the on/off switch, protection fuse, heat sink, fan, computer bus, XLR audio trigger input, MIDI input, two 1/4-inch gate inputs, two 1/4-inch trigger outputs, 1/4-inch 1V/octave CV input, and the XLR audio output plug.

Sampling an audio signal is a simple task: set the mic/line input switch to the appropriate position, adjust the input level control knob for the desired level, then hit the record button. The manual recommends use of line level audio sources for optimal quality. Unfortunately, the manual doesn't note that pin three of the XLR input and output connections is hot. After I figured that out, I was home free.

The tuning knob does not affect the recording as the sampling rate is not user-selectable. Overdubbing on top of a recorded sample is accomplished by depressing the overdub and record buttons. This can be done an infinite number of times, however the overdub function cannot be made to loop. When the power is turned off, the sample is lost.

After a sample is recorded in memory, it can be played forward or backwards by triggering the playback di-



# INSTITUTE OF AUDIO RESEARCH

## *Because your future depends on it...*

Get started in an exciting audio career. In just 9 months you'll have the skill and confidence to succeed in this rapidly expanding industry.

With a faculty of 20 internationally renowned, working engineers, headed by the nation's leading expert in technical training, Philip Stein, and the Immediate Past President of the Audio Engineering Society, Albert B. Grundy, you'll acquire state-of-the-art skills from the best and the brightest in the business.

### **Get Ready...**

You'll learn recording, mixing, overdubbing, microphone selection and placement, post-production editing, circuit construction, studio maintenance, special effects and much more. Engineer a professional recording project in the INSTITUTE's hot new room featuring a 24-track, automated console and wide range of the latest outboard gear.

You'll be placed in a professional studio internship and you'll benefit from the INSTITUTE's lifetime placement network that helps you with everything from that first job on up.

### **Get Set...**

High School graduates (or GED) can start any of four times a year – Summer, Fall, Winter, Spring. Or consider the special 2-Summer Program designed for college students. By the time you have your Degree you can also have your INSTITUTE Diploma and entree into the exciting worlds of music recording, broadcast, audio for film and video, concert and theater sound and much, much more.

### **GO!**

Call today (or return the coupon below) to arrange a personal appointment. Find out if you have what it takes to make it in the fast-paced recording industry.

**Call... (212) 777-8550**

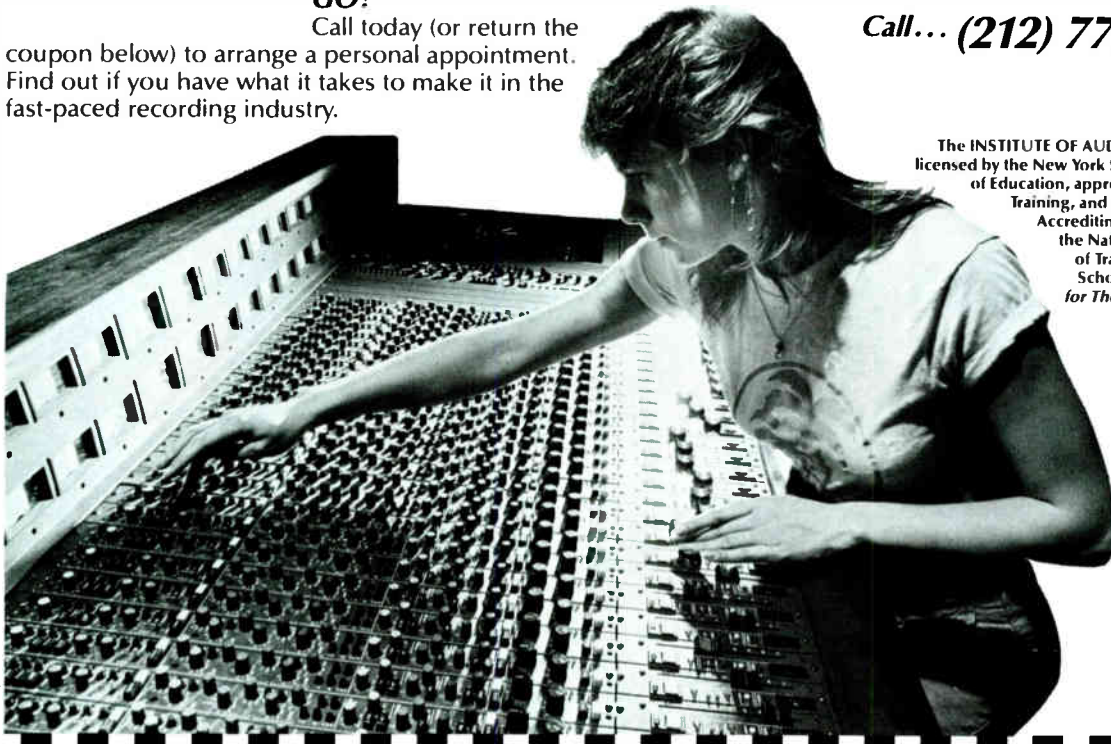

The INSTITUTE OF AUDIO RESEARCH is licensed by the New York State Department of Education, approved for Veterans Training, and accredited by the Accrediting Commission of the National Association of Trade and Technical Schools. *Financial Aid for Those Who Qualify.*

JOHAN LEBERS



Established 1969

YES, please send me more information.

Name \_\_\_\_\_

Address \_\_\_\_\_ Phone (\_\_\_\_\_) \_\_\_\_\_

City \_\_\_\_\_ State \_\_\_\_\_ Zip \_\_\_\_\_

## **Institute of Audio Research**

64 University Place, Greenwich Village, New York, NY 10003 • Telephone: (212) 777-8550

m

# SONEX sweeps carpet: costs less money, kills more noise.

You might think that because SONEX is a professional acoustic foam, specifically designed to control sound, it would cost more than carpet. Logical but wrong.

At just \$18/yard, SONEX is one-third the cost of good quality carpeting. Yet it's twice as deadly to noise. And even if you order special SONEX in low quantities, it's still only half the cost of carpet. So you can't lose. It's less expensive, yet more effective. Call

or write for the SONEX brochure, complete with acoustic charts and all the facts.

SONEX is manufactured by Illbruck and distributed exclusively to the pro sound industry by Alpha Audio.

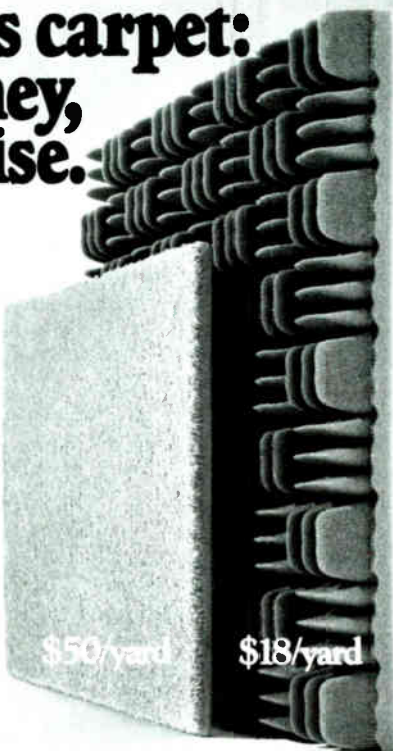
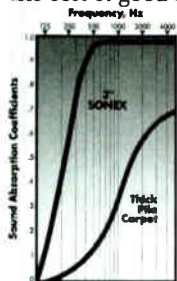

**Alpha Audio**

2049 West Broad Street  
Richmond, Virginia 23220 USA (804) 358-3852  
Telex 469037 (ALPHAUD C)

Acoustic Products for the Audio Industry

Circle #051 on Reader Service Card

## THE VERY HEART OF YOUR TAPE MACHINE

Can you trust it to just anyone?

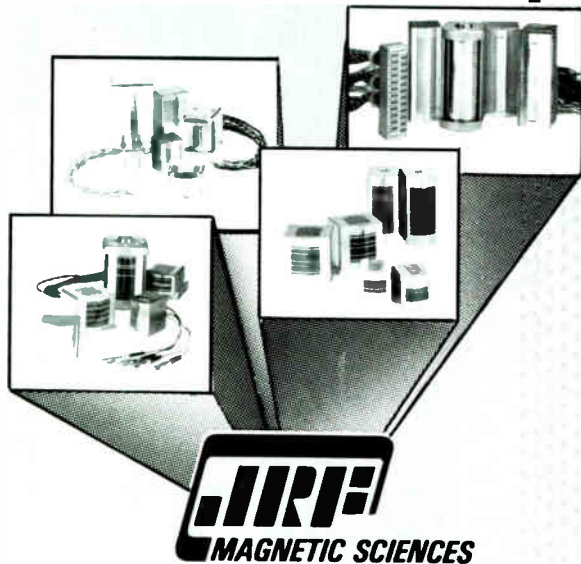

The audio magnetic professionals with the track record to prove it.

Complete lab facilities • Over 20-years of in-depth experience

Specializing in restoring worn, unserviceable magnetic heads for a fraction of the replacement cost.



101 Landing Road • Landing, NJ 07850 • 201/398-7426 • Telex: 325-449

Circle #052 on Reader Service Card

rection manually on the front panel, or by externally triggering the machine by way of a mic or line level trigger pulse. Rapid triggering of forward and backwards playback creates a "scratching" effect that rivals the abilities of even the world's greatest hip-hop DJs. When the hold switch on the front panel is kicked-in, the sample will infinitely loop in the specified direction. Upon playback, two output trigger signals are generated by the Window Recorder. The first is the "start out" trigger signal which occurs upon initiation of playback, and the second is the "end out" trigger signal which occurs upon completion of playback. These signals could be used to trigger an external source such as a drum machine or keyboard.

According to the manual, the playback frequency is variable by  $\pm 1$  octave, but I found it to be variable by almost  $\pm 3$  octaves. Another surprise I found is that the input to the machine always appears at the output, even when a sample in the machine is played back. The only way around this problem is to disconnect the input plug, or make sure that an audio signal is not entering the input of the machine.

The MIDI out signal from another instrument or sequencer can be used to trigger and transpose a sample in the Window Recorder. Looping of the sample will not occur when the Window Recorder is triggered via MIDI. Playback direction of the sample upon triggering is selected by pressing either the forward or reverse playback button. I found it difficult to try to match the sample pitch from the Window Recorder with the pitch of the controlling synthesizer. In attempting this, the tuning knob on the Window Recorder was very limited in range ( $\pm 1/2$  step instead of the previous  $\pm 3$  octaves) and it was necessary to tune my keyboard to the sampling unit. Because of this, the unit is most functional when it is controlled by a MIDI source.

One of the most useful features of this unit is the ability to edit the sample once it's in memory. The components used for this are the window display, the left and right window selectors, the two play buttons, and the reset button. Editing may be done visually by monitoring the 32 LED window, or visually and aurally by monitoring both the window and the vari-speed cueing system. The left and right window selections are depicted as brackets ([, ]), so the idea is to put the desired piece of the sample in those brackets.

To enter the "window select" (edit) mode, either of the two window select buttons can be pressed. The play but-



tons are used to cue up the sample to the editing points. Six different cueing speeds (forward or backwards) can be obtained by pressing six times on one of the two play buttons. I found that the tuning knob was handy for use in fine tuning any one of the six cueing speeds. Upon reaching the desired edit point, one of the window select buttons should be pressed. Pressing the window selector labeled "[ " will mark the edit point as the beginning of the sample; pressing the window selector labeled "]" will mark the edit point as end of the sample. The reset button will reset the left and right window selectors to their full 12-second position while keeping the full 12-second sample in memory. Ergonomically, it is located dangerously close to the tuning knob.

I have found that a smaller than full length window can be set up before or even while a sample is in memory, and only that section of memory will be used when the record button is pressed. Having established this, it would have been an efficient design idea to have allowed the user to store any number of variable length samples (not to exceed total memory space) in any number of registers for easy recall.

Upon testing the unit, I found its frequency response to be 20-20,000

Hz,  $\pm 1.25$  dB. Over a wide range of listening conditions, I confirmed that the Window Recorder accurately sampled and reproduced any given audio signal that was input to the machine.

### **MDB Window Recorder Manufacturer Specifications**

**Manufacturer:** Giant Electronics, Ltd., Switzerland  
**Sampling resolution:** 16 bit  
**Sampling rate:** 44.1 kHz  
**Dynamic range:** 98 dB  
**Bandwidth:** 20-20k Hz ( $\pm 1$ dB)  
**Pitch change:**  $\pm 1$  octave  
**Trigger accuracy:** 22 microseconds  
**Sample time:** 3, 6, or 12 seconds, depending on model.  
**U.S. Distributor:** Europa Technology, Venice, CA

For the future, Giant Electronics plans to use the MDB Window Recorder as the central unit in a component system designed for sampling, digital-

ly storing, and polyphonic playback of audio information. Plans are in the making for an external disk drive that would be used for storing samples on disk. Also in development is software for interfacing the Window Recorder with the IBM PC or Apple Macintosh computers. By interfacing the unit with a computer, storage, on-screen editing, display, and digital mixing would be possible.

Once the sample is stored as digital information, it could be loaded into a separate unit to be played back. Although this unit is also not yet available, an engineer could have a separate playback unit for each different sample to be played back in real time. With all these components, it could add up to be quite an elaborate system!

For applications requiring several seconds of quality sampling, the MDB Window Recorder is an easy to operate, high fidelity sampling machine. The model I tested, with 12 seconds of sampling time, lists for \$4,995 and carries a six-month warranty from Europa Technology, Inc. This unit is also available with either three seconds of sampling time (\$3,495), or six seconds of sampling time (\$3,995).

For more information, contact Europa Technology, Inc. at 1638 West Washington Boulevard, Venice, California 90291, (213) 392-4985. ■

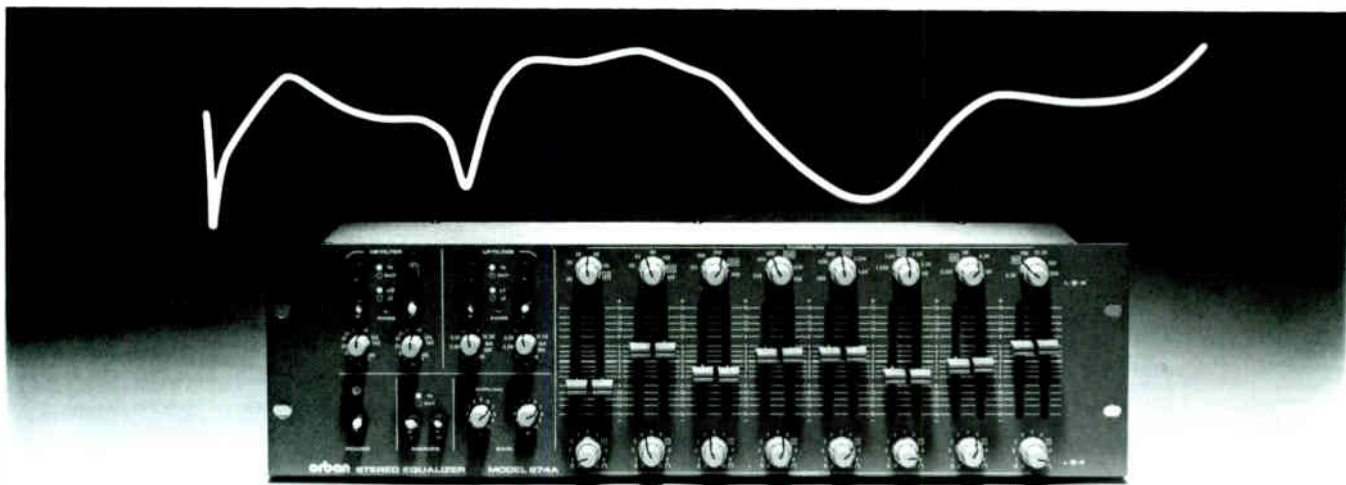

## **The Orban "Paracrossalizer."**

A one-of-a-kind word for a one-of-a-kind problem solver.

The Orban 672A (Mono)/ 674A (Stereo) Graphic Parametric Equalizer combines a full electronic crossover (high- and low-pass filters with 12 dB/octave slopes) with 8 bands of fully parametric EQ and easy-to-use, graphic-type controls. In many reinforcement systems, the 672A/674A is all you need: it replaces a separate crossover and old-fashioned third octave EQ with a system that has better phase and time-response characteristics. It not only *measures* better on today's sophisticated acoustic instrumentation, but—most importantly—it *sounds* better too!

The 672A/674A is at home in the studio as well. It's a single cost-effective package of sheer EQ power that can solve virtually any frequency-contouring problem in recording, music synthesis, broadcast production... you name it.

Contact your local dealer today for more information on the "paracrossalizer"—Orban's unique curve-bender for corrective and creative EQ.

**orban** Orban Associates Inc.  
 645 Bryant St., San Francisco, CA 94107  
 (415) 957-1067 Telex: 17-1480

# JAPAN

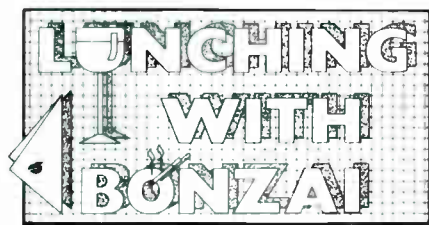

by Mr. Bonzai

In this lunching we will sample a Japanese/American buffet aboard a bullet train speeding East and West. We'll chat with Minoru Asai, a musical liaison working in both Tokyo and Los Angeles. We'll meet Kioshi Shikita, producer of avant-garde audio visual bonanzas, and his latest extravaganza, the band Cioccolata. Our guests will include Mark Mothersbaugh of Devo, who has released solo musical ventures under Shikita's TRA music/graphics banner, and also Hajime Tachibana, known internationally as a founder of The Plastics, one of the few Japanese bands to make a scene in both Europe and America. And we'll also chew the fat with that studio virtuoso Jeff Baxter, former guitarist for Steely Dan and The Doobie Brothers, and currently a techno/musical consultant for the Akai and Roland corporations.

Japan is a land of startling contrasts: bullet trains and ancient temples; sushi and Big Macs; peaceful natural wonders and ant farm cities. Japan has half the population of America on an island the size of California, and only 20 percent of the land is inhabited. The Japanese people live with a multi-layered code of honor and interpersonal expectations. They have created a crowded society that operates as smoothly and predictably as a quartz timepiece. The streets are clean, the cars are clean, the people are clean.



*Hajime Tachibana (left) Mark Mothersbaugh of Devo (right).*

*Jeff Baxter, studio virtuoso, techno/musical consultant, and former lead guitar with The Doobie Brothers and Steely Dan.*



PHOTO: MR. BONZAI

PHOTO: MR. BONZAI



**MONDAY**  
**DECEMBER**  
**1995**

**25**

*The HP Audio Analyzer  
might take its first day off.*

With 20,000 hours MTBF, it could be ten years before the HP Audio Analyzer takes a break. So you won't lose patience with down time or money on repairs. And at \$5800\* (or \$3900\* without a source), you can easily afford the most reliable audio distortion analyzer on the market.

For details about the HP8903B/E, call your local HP office listed in the white pages, or use our toll free number. 1-800-556-1234, ext.515. In California, 1-800-441-2345, ext.515.



**HEWLETT  
PACKARD**

\*U.S. list price

# Behind Every Synclavier



## Profile: **Murray Allen**

Accomplished musician, composer, engineer and businessman, Murray Allen owns one of the largest audio facilities in the world. Universal Recording offers every service in the field of audio from 24-track recording studios, film mixing theaters, and video sweetening rooms to remote sound crews and even a cassette duplication factory. Murray knows that every piece of equipment he purchases must not only provide the highest sound quality and operational flexibility available, but also be able to prove itself financially with a solid return on investment. He comments on Universal's recent completion of a dedicated Synclavier studio:

"We at Universal feel a studio cannot honestly call itself world-class nor can it claim to be state-of-the-art if it does not own and utilize a hard disk-based digital audio manipulation system. Now having said that, we have researched every such system on the market and some on the drawing board and have found only one system sophisticated enough, fast enough, with the kind of sheer computer power we need to serve our clients. That system is the Synclavier."





# There's a Success Story



## Profile: Nile Rodgers

Arranger, songwriter and guitarist Nile Rodgers is one of the most sought-after producers in the music industry today. In demand by such top artists as David Bowie, Madonna, Duran Duran, Sheena Easton, Jeff Beck, Diana Ross and Mick Jagger, his influence is redefining the sound of the 80's. Part of that sound is utilizing only the finest technology available to give him the speed of operation, reliability, fidelity and creative control that are the Nile Rodgers trademark. He remarks on why his Synclavier is at the heart of this production technique.

"As a producer, the Synclavier is a must for me in the studio. It isn't just a piece of equipment I sometimes use. It's mandatory; just as important as the speakers, microphones and console. And since the Synclavier is the most advanced system in the world, it gives me a creative edge that lets me concentrate on the artistic side of making records."

*Nile Rodgers*



New England Digital White River Jct., Vermont, 802/295-5800 NY: 212/977-4510 LA: 213/651-4016

Authorized Distributors — Atlanta: 404/351-5955 Dallas: 214/387-1298 Nashville: 615/327-4343 London: 202-4366 Tokyo: 341-4660 Toronto: 416/868-0528

In Japan, there is an all pervasive awareness of others, and a mutual respect stemming from natural survival.

After a long term fascination with abstract Japan, I first encountered its reality in 1977. I was managing a studio in California where a Japanese album was recorded, with a number of American session players called in to create a cross-cultural blend. For nearly a decade, I have sampled the food, dabbled in the language, and studied Kurosawa films. Last year, I married Keiko Kasai, an artist who carves granite and emigrated to America for its artistic freedom. I am a diligent student, but it could take a lifetime to understand Japan—maybe more.

I just returned from my first trip to Japan, where I met my new family for the first time. After our reception party, Keiko's aunts sang folk songs a capella and performed traditional dramatic dances. Song and dance are a part of daily life, and it is not uncommon to see a group of businessmen breaking into a spirited number after a hard day's work and a few cups of sake. But there are modern trends developing simultaneously. Pop music is heavily laced with Western styles, and the charts are bulging with American and European superstars. Additionally, there are fringe movements, incorporating wild concepts of music, art, video. To explain the Japanese music scene would be at least as laborious as explaining the full story of music in America today. I would like to introduce you to a few people who operate in both worlds. Keiko will help in translating the more delicate concepts.

Minoru Asai is the managing director of COM International, a trans-Pacific company that assists Japanese and American artists. This fall, Mr. Asai will bring Chikuzan Takahashi for his first concert tour of America. Chikuzan is 77 years old, blind, and a master of the shamisen, a three-stringed, banjo-like instrument. Over steaming platters of yakitori at a bustling Tokyo eatery, Mr. Asai suggested that foreigners venture beyond the city limits and investigate the very different daily life in the small towns and villages.

"Tokyo is not a typical example of the Japanese lifestyle," he told me. During the trip, I found this to be true, yet even in the ancient capital of Nara, I saw Rambo posters in the shop windows. Japan is plugged into the world. As I thought of *Mix* readers, I asked Asai-san if it would be easy for American musicians to play in Japan and tour the many cities. His opinion was that it would be easier for a clas-

sical musician to find work out of the major centers. "For a modern musician who is not famous, it would maybe be difficult in the smaller cities," he suggested politely.

In the hip Roppongi district of Tokyo, Keiko and I visited the offices of Kioshi Shikita. Mark Mothersbaugh, who has released his solo *Musik for Insomniacs* in Japan through the *TRA* cassette/magazine (that's ART spelled backwards), provided the introductions. Mr. Shikita, surrounded by computers and various pieces of audio/video gadgetry, is bucking the pop scene in Japan. He has chosen to develop alternate styles, releasing limited editions of music on cassettes in bold, unconventional packages. His latest project is the group Cioccolata, with equal emphasis on video and music.

The video I watched was a curious combo of surreal Dali-esque images in a Wizard of Oz setting. The lovely Cano Caoli sings operatically in English, Italian and Japanese amidst synth-pop backdrops and computerized bleeps and bloops. There is no focus on traditional Japanese values, yet Mr. Shikita admits, "You can smell something Japanese." When I asked about her musical influences, Caoli explained that she appreciated renaissance music, opera, and enjoyed natural sounds, like the wind or breaking glass. You won't find Cioccolata on the charts in Japan, but they have a devoted cult following and their records and videos are easily available.

On our return to Los Angeles, I realized I had just begun to understand the mysteries of Japan. To flesh out the story, I contacted Jeff Baxter, a musician who has achieved great success in both America and Japan. He invited us to his home/studio and we delved deeper.

• • •

**Bonzai:** When did you first visit Japan?

**Baxter:** In 1975, when I was touring with The Doobie Brothers. I was a complete barbarian—I did everything wrong, drank too much, and wore my bedroom kimono in the bar. I was a wild man, but luckily, I learn pretty quick and realized that was not the way to act. About the same time, I had been introduced to the Roland guitar synthesizer and was very impressed, although I knew it would take a few years to come to fruition. I have acted as a consultant to the company, making yearly trips to assist in research and development. I've also visited as a musician regularly—when I was with Billy & the Beaters we took a second prize at the Tokyo Music Festival. I continue visiting as a producer and have also been working with Akai in

developing sound and recording gear.

**Bonzai:** Is Japan a land of opportunity?

**Baxter:** This is a personal view . . . Because of the way Japan was structured socio-economically after WWII, there was an inherent tension in the society. As long as the economy could grow, there was room for personal advancement. But now they are faced with the same problems we have: rising labor costs and competition from other countries, like Korea. This means fewer corporate jobs, and with a big younger generation there are fewer opportunities and the competition gets fiercer. There is a generation now that can't be promised as much of a better life—the American dream that became the Japanese dream. What do you do with all these kids? When you put an insurmountable barrier in front of a young person, you get rock and roll. What's developing now is an undercurrent, a subclass of people who are disgruntled and unfulfilled and looking for ways to express it. Rock and roll must come from the gut, and the Japanese are beginning to use it to reflect their own society.

**Bonzai:** Let's touch on your personal career—is the guitar still your main form of expression?

**Baxter:** If your main instrument is the one where you have the widest vocabulary, then sure, it's the guitar for me. But when you sit down with a computer and a sequencer and a bank of synthesizers and samplers, it's hard to say what instrument you're playing. I started out studying piano as a kid, and learned harmony, theory, counterpoint. This has been invaluable in my use of the guitar synthesizer. When you study guitar, you study technique, and quite often a guitar player will be unprepared for the synthesizer. You have to have the head space of the instrument you're trying to interpret. If you want to sound like a Hammond organ, your intervals have to be keyboard intervals. But what instrument are you playing? You're playing guitar and you're interpreting the organ.

Take it a step further. You're sitting at a bank of computers and you want to put together a basic track of drums, bass, and piano. You load in your notes, put them where you want them to be, and play it back through the piano module, the electronic drums and the sampled bass. Then what instrument are you playing? My best technical ability is on the guitar, but when I sit down with a sophisticated music computer, it's hard to say what instrument I'm playing.

**Bonzai:** And you've grown up with



# CMC 24\* MK II FEEL THE POWER!

\$7200 PUTS YOU\*\* IN COMMAND



The **COMPUTER AIDED**  
**\*G.A.R.S. ROUTING SYSTEM**

with 32 banks of internal memory, gives instant recall of 16 track bus assignment and muting information (24 input channels and 16 monitor/input channels) through the onboard microprocessor.

Comprehensive monitoring and talkback systems keep you in command. A separate cue system, in addition to the 6 auxiliary Mix buses, allows simplified control of musicians headphone mixes. Improved electronic and mechanical construction offer new levels of performance over previous designs.

In addition, with optional Computer Interface/Sequencers, the CMC-24 may be controlled by an external source such as Keyboard, Drum Computer or Tape Track. Anyway enough talk, we believe the Excitement is in the Driving. . . We know you're ready!

For More detailed information on how the new CMC Series can bring your Mixing Capabilities into the Computer Age, contact your local authorized AHB dealer today.

\*Includes: MPS Power Supply.  
 Prices & Specifications subject to change without notice.



**Allen & Heath Brenell (USA) Ltd.**  
 Five Connair Road  
 Orange, Ct. 06477 / (203)795-3594

Mixing **ART** With **SCIENCE**

Circle #036 on Reader Service Card

**Allen & Heath Brenell Ltd.**  
 69 Ship Street, Brighton, BN1 1AE England  
 Telephone: (0273) 24928/ Telex 878235

# SOUND ON STAGE



*Speeda Sound's EAW KF-550 system (24 box) set up at California State University, Fresno.*

## Eastern Acoustic Works' KF-550 Cabinet:

**A Cost-Effective, Modular Loudspeaker System**

**S**everal major tours on the road in 1986 will make use of speaker complements that contains, in part, pre-packaged systems that have been subcontracted from regional sound companies.

by Mike Stande

Today more than ever, users of pro sound loudspeaker systems are searching for the "ideal system": quality sound, portability, status and cost are all important considerations, and an increasing number of manufacturers now offer pre-packaged loudspeaker systems for touring and installation use. Each system approaches a design problem in a different way: how to best package a full-bandwidth, high-level sound system that can tour easily, and is part of a modular array when combined in multiple numbers.

One manufacturer charges over \$4,000 for each box. Other firms have products that cost half as much, and some of them sound like it. A growing number of touring companies and sound system rental houses are still searching for the "best" speaker system. Within the past few years, many such firms have begun to take a closer look at horn-loaded loudspeaker systems, which can offer greater acoustical output for a lower investment in loudspeakers and amplifiers. Eastern Acoustic Works' KF-550 "one-box" full range horn-loaded system is becoming increasingly popular for a variety of applications.

### **KF-550 Design Parameters**

The EAW Forsythe Series KF-550 is a high definition, three-way sound re-

inforcement loudspeaker system. Designed by EAW's head of engineering, Kenton Forsythe, the KF-550 is intended for use as a modular building block in today's large touring sound systems.

The three horns integral to the KF-550 conform precisely to the original mathematical models developed by Forsythe through the use of a proprietary, polyurethane foam, reinforced hardwood construction technique. The nearly exact actualization of theoretical design concepts results in a speaker system that is said to have exceptionally smooth air-loaded impedance characteristics for smoother frequency response. In other words, wooden horns that are correctly built couple the loudspeakers to the air in a very efficient manner.

Each KF-550 contains two 15-inch loudspeakers in a folded-horn cavity, a single 12-inch speaker in a mid bass horn with an integral displacement plug, and a 2-inch exit compression driver mated with a Constant Horizontal Coverage horn. RCF LAB L15/554 and RCF LAB L12/P11 W loudspeakers are suggested for use by Eastern Acoustic Works. EAW custom-tailors the KF-550s for use with several different transducers upon customer request.

The KF-550 enclosure weighs approximately 325 pounds including the compression driver. Six heavy-duty recessed handles, optional casters and a flying strip enabling eight different hanging angles are available.

As the list of KF-550 users grows, the boxes are becoming a common sight on concert stages in the U.S. and abroad. One of the first large systems was assembled in 1984, when Killer Audio of Florida fielded a 48-cabinet system. Spectra Lighting & Sound of Orlando, Gainey Sound of Birmingham, Alabama, Scorpio Sound in Massachusetts, Uni-Stage of Buffalo, New York, Audiophon of Kingston, Jamaica, and Unicus of Japan were all early supporters of the new "one-box" system.

Recently, Speeda Sound of Fresno, CA and Roadwork Productions of Nashville, TN have fielded new KF-



*Affordable  
Quality*

**FMX SERIES MIXERS**

# SOUNDTRACS

A British company dedicated to the design and manufacture of one of the broadest ranges of mixing consoles in the World. We offer ten individual models in over fifty versions to suit your specific requirements.

The choice is yours.

Soundtracs plc, 91 Ewell Road, Surbiton, Surrey,  
KT6 6AH, England Telephone: 01-399 3392  
Telex 8951073/STRACS/G Fax: 01-399 6821  
U.S.A.: MCI Intertek Inc. (817) 640 6447



**Applications: Sound Reinforcement;  
Video Post Production;  
4&8 Track Recording;  
Broadcast "On Air"; Stage Monitoring.**

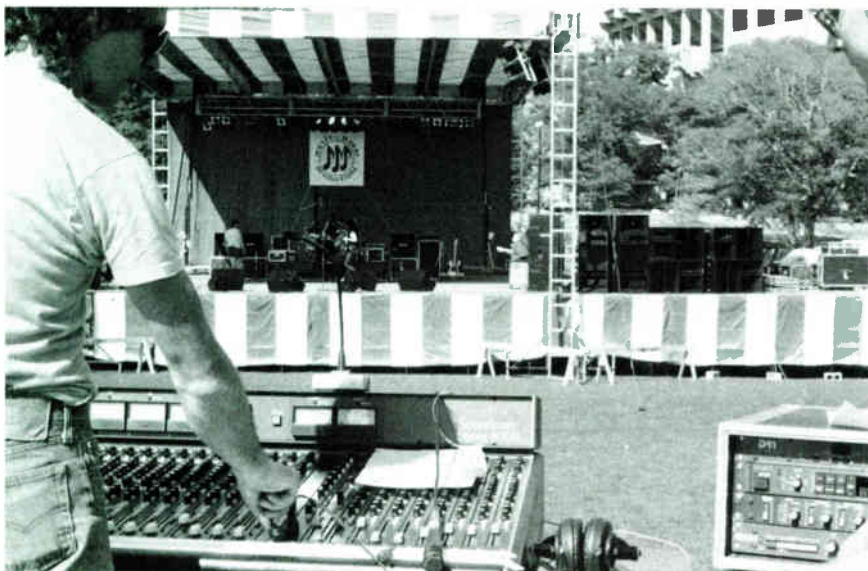

*Steve Lamberson sets up Jason & the Scorchers house mix at MSU's Rockfest. Roadwork Productions provided the Soundcraft/EAW system.*

550 systems. Let's examine these more closely.

### **Roadwork Productions**

Founded in 1980 by the Morrison Brothers as a spin-off of a successful music store chain, Roadwork Productions moved into the Pro Audio retail business and the concert sound system rental trade.

"Our first system was purchased and assembled for a tour that never materialized," laughs owner Mike Morrison of Nashville. "That's par for the course in the touring business, though. Eventually, we went on to do over 150 shows for Hank Williams Jr. with that four-way stacking system. When we started getting ready to work with Conway Twitty, we looked for a one-box system from a reputable manufacturer with a good track record. We purchased KF-800s, which made an ideal flying system for that tour. Our most recent purchase has been a KF-550 system. When we do large dates, we often combine the two types of cabinets, which work very well together." Roadwork supplied KF-550 and KF-800 cabinets for a recent tour of the southeastern U.S. The company sent out a full house and stage monitor system for Jason & the Scorchers, a Nashville-based act. "Through our facilities in Nashville and Jackson, Mississippi, we are able to offer band gear rental and full lighting systems as well," explains Mike Morrison of Roadwork. "Many acts like to have one-stop concert production services."

Roadwork relies on Soundcraft consoles and Crown Micro-Tech amplifiers. Stage monitor systems feature Yamaha Q-1027 graphic equalizers and EAW floor slant monitors with RCF

components. The firm is typical of a growing number of regional sound companies starting to break into national touring with selected clients. Such companies place a heavy reliance on the manufacturers of pre-packaged loudspeaker systems for both research and development, and custom engineering support.

### **Speeda Sound**

Located in Fresno, CA, Speeda Sound was started by owner Mike King a decade ago. King, a former rock musician, became interested in looking for better ways to present the sound of his own local group, and has been working with sound systems ever since.

"When it was time to put together a new system last year, we were originally planning to build our own custom enclosures," explains King. "That is much more involved than it was several years ago, due to the advances in live sound system design. Plus, it seems as if every act that we work with is starting to request a "one-box" type of enclosure, because it makes the sound of the show more consistent, and it is better visually, as well. We decided to go with a one-box pre-packaged horn-loaded system, and it came down to looking for a supplier that was ready to work with us right now. I didn't have time to sit around and wait for design and delivery."

King approached Eastern Acoustic Works' president Ken Berger, who agreed to build the KF-550 enclosures in the manner that Speeda Sound wanted. Twelve-gauge multi-pair cables with EP-8 connectors for speaker connections were supplied with the boxes, along with custom vinyl dip-coated steel grills. Speeda Sound bought the KF-550 boxes in mirror-image pairs, with Aeroquip straps to mate with the boxes' load-bearing points. The resulting system is visually pleasing, powerful and ready to fly.

Each KF-550, loaded with JBL E-120 12-inch speakers, E-140 15-inch speakers, and 2445 drivers on fiberglass horns weighs approximately 330 lbs. Speeda Sound makes use of a unique aluminum truss-bar hanging system. Each ten-foot truss bar will hang four KF-550 cabinets with a one-ton chain motor hoist. "We use 110-V motors from CM Lodestar," says Speeda Sound technician Carnot Pease. "With some smaller shows, many buildings don't have three-phase 220-V

*EAW floor slants for Jason & the Scorchers. The boxes can be fitted with either single or dual 12- or 15-inch woofers.*

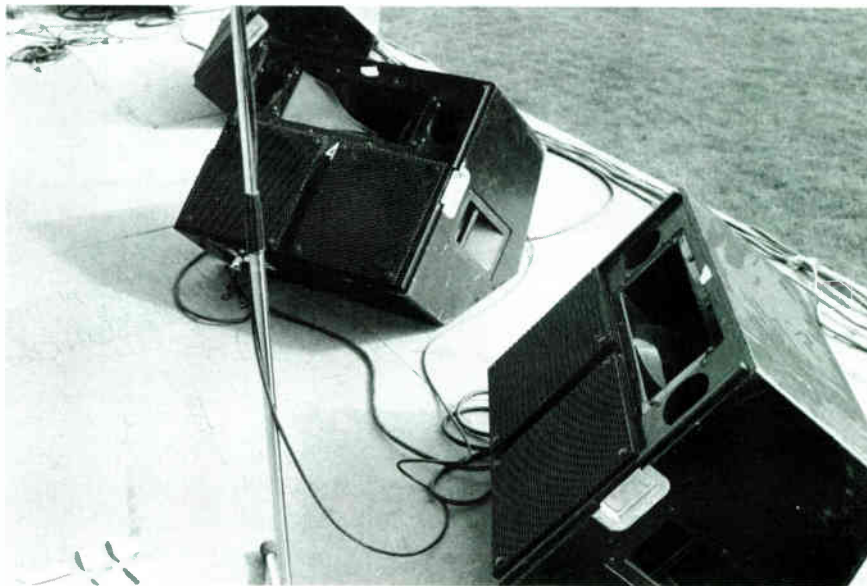



power, and then you're stuck not being able to use your motors. We like the show to always be able to go on."

Pease, who has been involved with live sound system operation since age 15, has found it interesting to observe the evolutionary development of touring sound systems over the years. "We used to have JBL 4550 enclosures, and 2350 radial horns, as did many other sound companies," he recalls. "Trying to get a warm sound that projects well into a modular package is a tough design proposition that many different manufacturers have been working on. We feel the KF-550 is the best approach yet to the problem."

Speeda Sound uses mixing consoles from Wheatstone Corporation (formerly Audioarts Engineering). A 40-input MTX-80 with programmable muting, stereo subgroups and output mix matrix was recently delivered to the company. Speeda Sound is one of the first touring firms to use Wheatstone's new M16 stage monitor mixing consoles, which offers 16 discrete outputs.

House electronics gear in use by Speeda Sound for such concert clients as Joan Jett, George Strait, Mickey Gilley, Tom Jones, Blue Oyster Cult and Los Lobos includes power amplifiers from A.B. Systems, Brooke-Siren Systems FDS-340 electronic crossovers, and effects devices from Lexicon, Ya-

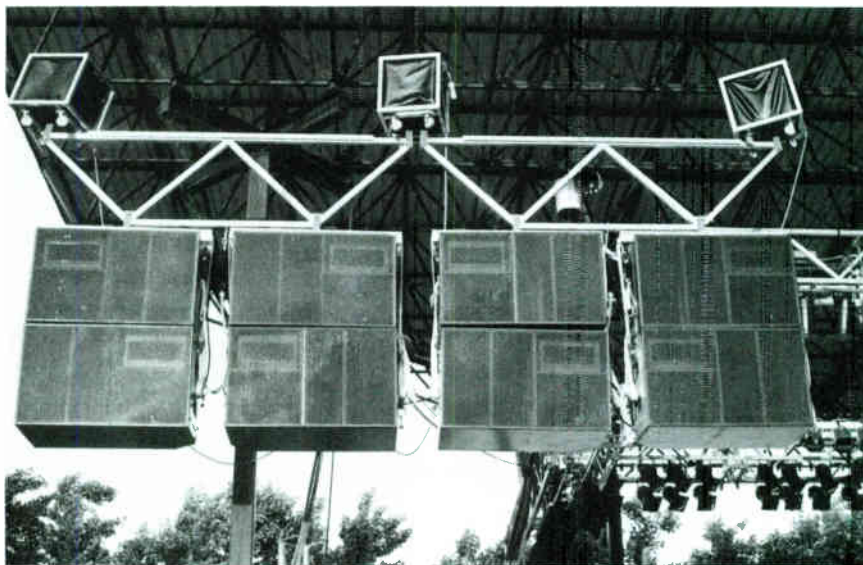

*Speeda Sound's aluminum truss system allows quick flying of their KF-550 mains system. Small boxes at top conceal hoist motors.*

maha and Roland.

"In assembling this entire system, we decided that we only wanted to go with gear that we felt would have a good resale value and would be acceptable for use by practically any rental client," says Speeda Sound owner Mike King. "In terms of the hanging system, we decided that we definitely did not want a junkyard in

the sky. It had to look as good as it sounded. Eastern Acoustic Works seemed to have a good, national reputation as a company that could work closely with touring sound companies like us to provide what we need."

Speeda Sound's decision to build a flying system was based on the increasing demands by regional concert promoters to offer a concert sys-

# dynafex<sup>®</sup>

Because it's a noisy world.

Fortunately, Dynafex, with its newly-patented and unique single-ended noise reduction process, solves your background noise problems with:

- Up to 30dB noise reduction (better than many compressor/expander systems)
- Works after the fact - no encoding or decoding required
- Simple, trouble-free operation
- Effective on any audio program material.

Dynafex. The *final* step in post-production.

Call 1(800) 535-7648 or write CRL today for the name of your nearest Dynafex dealer.

2522 West Geneva Drive, Tempe, Arizona 85282  
(602) 438-0888  
TELEX: 350464  
CRL TMPE. UD.

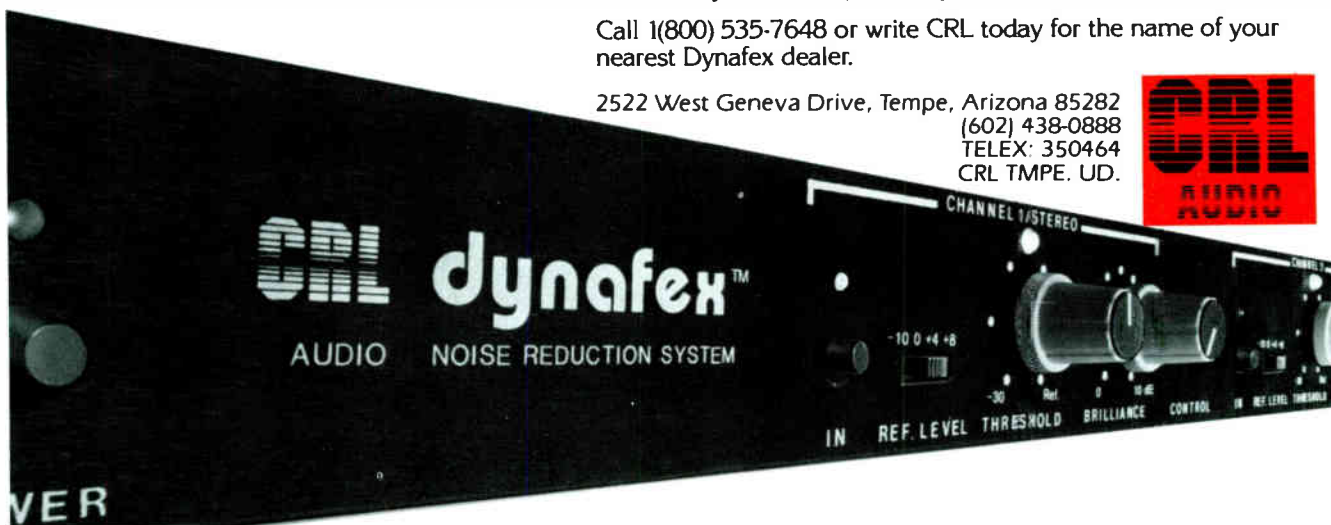

Circle #060 on Reader Service Card



*"Being an 8 piece ensemble we put a monitor system through rigorous demands and the Carvin system performs excellently. I'm impressed by the flexibility and overall layout of the Carvin MX mixers. We use the Carvin system for both rehearsal and live performances."*

*— Danny Elfman, Oingo Boingo*

## Carvin Tri-Amp Systems



**Tri-Amp System C12-3000E DIRECT \$3999 List \$7995**

The Carvin C12-3000E Tri-amp Concert system produces a wall-of-sound that's earth shaking! Components include; 12 ch MX1222 pro stereo console, 2 single 18" 3000E folded horn Electro-Voice sub-woofers, 2 1200E E.V. midrange enclosures, 2 R540H Carvin/Renkus-Heinz radial horns, 1 DCA800, 1 DCA300 power amp (1100 watts), and 1 XC1000 crossover.

# CARVIN... Made in USA

## Carvin System S12-980

**System S12-980 DIRECT \$1979 List \$3895**

Our best compact stereo 12 ch sound system features high powered speaker components designed for peak over-loads normally found in professional sound reinforcement. The quality of the S12-980 demonstrates its clarity of undistorted audio regardless of price! Components include: the MX1222P stereo powered mixer with 400 watts rms, 2 980M speaker enclosures, and cables.

The **980M** speaker enclosure features the Carvin high energy HE15 woofer and Electro-Voice DH1202 radial horn compression driver. **DIRECT \$369 List \$695.**

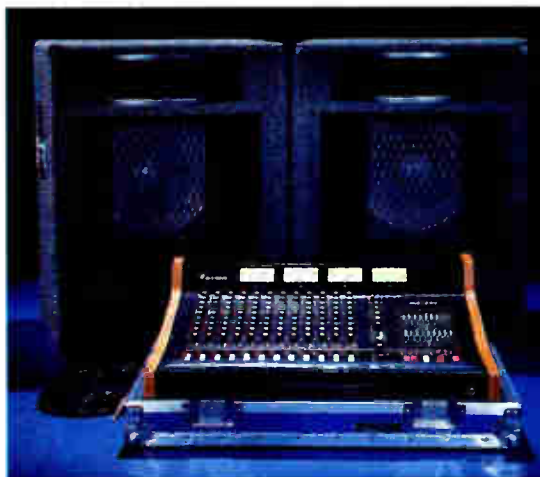

## Pro Monitors



Carvin's Pro monitors are incredibly powerful, projecting a clear full-range sound to your ears when everything around you seems deafening. The 12" 750M model sells **DIRECT \$179 List \$295.** The 15" 790M model sells **DIRECT \$219 List \$395.**

## Carvin System S8-960

**System S8-960 DIRECT \$1449 List \$2695**

One of our best performance values is the 8 ch S8-960 system featuring the 960M enclosures. The 960's offer Carvin's high energy HE15 woofer in a tuned port enclosure for smooth, deep bass output. Carvin's HE490 compression horn delivers superb highs for clarity. Components include: the MX822P stereo powered mixer with 400 watts rms, 2 960M enclosures, and cables.

The **960M** speaker enclosure has a high power capacity of 150 watts, 300 watts peak. An exceptional value at **\$269 ea. DIRECT List \$495.**



## DCA800 Power Amp



The stereo DCA800 amp clearly demonstrates uncompromising performance. Its 800 watts rms (bridged) output drives speakers from sub-audible sounds to explosive levels without distortion. Pro features include balanced inputs and fail-safe protection. **DIRECT \$549 List \$1095.**



Join the Pro's who use Carvin mixers or P.A. systems

- Tony Brock (Rod Stewart)
- Brad Gillis (Night Ranger)
- Danny Gottlieb (John McLaughlin)
- Peter McLan (prod. Men at Work)
- T. Lavitz (The Dregs)
- Musician's Institute
- Missing Persons
- Oingo Boingo
- Starship
- Steve Vai
- Frank Zappa

## MX1688 Recording Mixer

16 x 8 x 2

### Recording Features

- Eight Track Studio Control Center
- Input/Output Channel Organization
- Independent 8 Into 2 Monitor Mixer
- Four Auxiliary Busses w/ Pre/Post
- Three Band Parametric EQ w/ Defeat Switch
- Mute and Solo on all Input and Output Channels
- Two Effects Returns w/ Pan and Solo
- Talkback w/ Built-in Mic and Monitor Dimming
- Peak Warning Indicators w/ Peak Stretching
- Patch Points on all Channels
- Microphone Phantom Power
- Cue and Effects Sends from Output Channels
- Alternate Metering of Cue and Two-Track
- Quick Tape Playback Through Monitors
- Independent Mic and Line Preamps
- Studio Feed w/ Source Selection
- Totally Modular Internal Construction
- Input Noise of -128 dBV, THD less than .05%
- Frequency Response: 20 Hz to 20 KHz
- 20 dB headroom at All Stages

**\$2995**

List \$6950

### P.A. Features

- Eight Sub-Groups w/ Solo and Mute
- Channels Assignable to L & R Stereo Output
- Four Independent Monitor Mixes Available
- Headphone Monitoring of Main or Monitor
- 11 Step Gain Controls for Easy Set-up
- Talkback to Monitors



50 page Operation Manual preview of MX mixers. Specify MX22, 44, or 88 series \$10.

# Performance Guaranteed!



**MX1644** 16x4x2x1  
**\$695** List \$4595  
9 band EQ \$200  
Reverb \$100



**MX1222P** w 400w  
**\$1299** List \$2595

**MX1622** 16x2x1  
**\$1299** List \$2595

**MX2422** 24x2x1  
**\$1799** List \$3695



**MX822P** w 400w  
**\$949** List \$1795

**MX622P** w 300w  
**\$799** List \$1495

Don't let Carvin's low prices fool you. We are the company that has been making and selling pro audio gear DIRECT since 1946! Enjoy big savings because we eliminate "Retail Store Profits", not quality.

All "MX" consoles offer the professional features and performance you've grown to expect from Carvin! Computer grade components, heavy-duty regulated power supplies, modular circuits and low noise signal path designs optimize the "MX" boards for professional recording and sound reinforcement. Before you buy another PA board, discover the transparent, low noise performance of the Carvin "MX" consoles. We guarantee it or your money back after trying for 10 days! Carvin products are proudly made in the U.S.A. and warrantied for 1 year. Send for your FREE 84 page color catalog. To rush 1st class mail, enclose \$1, \$5 for foreign. Master Card and Visa accepted. For more information, call TOLL-FREE 800-854-2235 (Calif. 800-542-607#).

CARVIN'S New Hollywood store is conveniently located at 5900 Santa Monica Blvd., Hollywood, CA. (ph 213-461-2700) offering the same low Direct prices.



**CM90E** \$139  
**CM67** \$99  
**CM68** \$99

**M90** Condenser Recording mic \$139 List \$269  
**M67** Studio Instrument mic \$99 List \$199  
**M68** Professional Vocal mic \$99 List \$199

# CARVIN

Dept. MX69, 1155 Industrial Ave.  
Escondido, CA 92025

Circle #061 on Reader Service Card

## Free Catalog

FREE CARVIN CATALOG  
Free Catalog \$1 for Rush 1st: Class Mail

Name \_\_\_\_\_  
Address \_\_\_\_\_  
City \_\_\_\_\_  
State \_\_\_\_\_ Zip \_\_\_\_\_ MX69

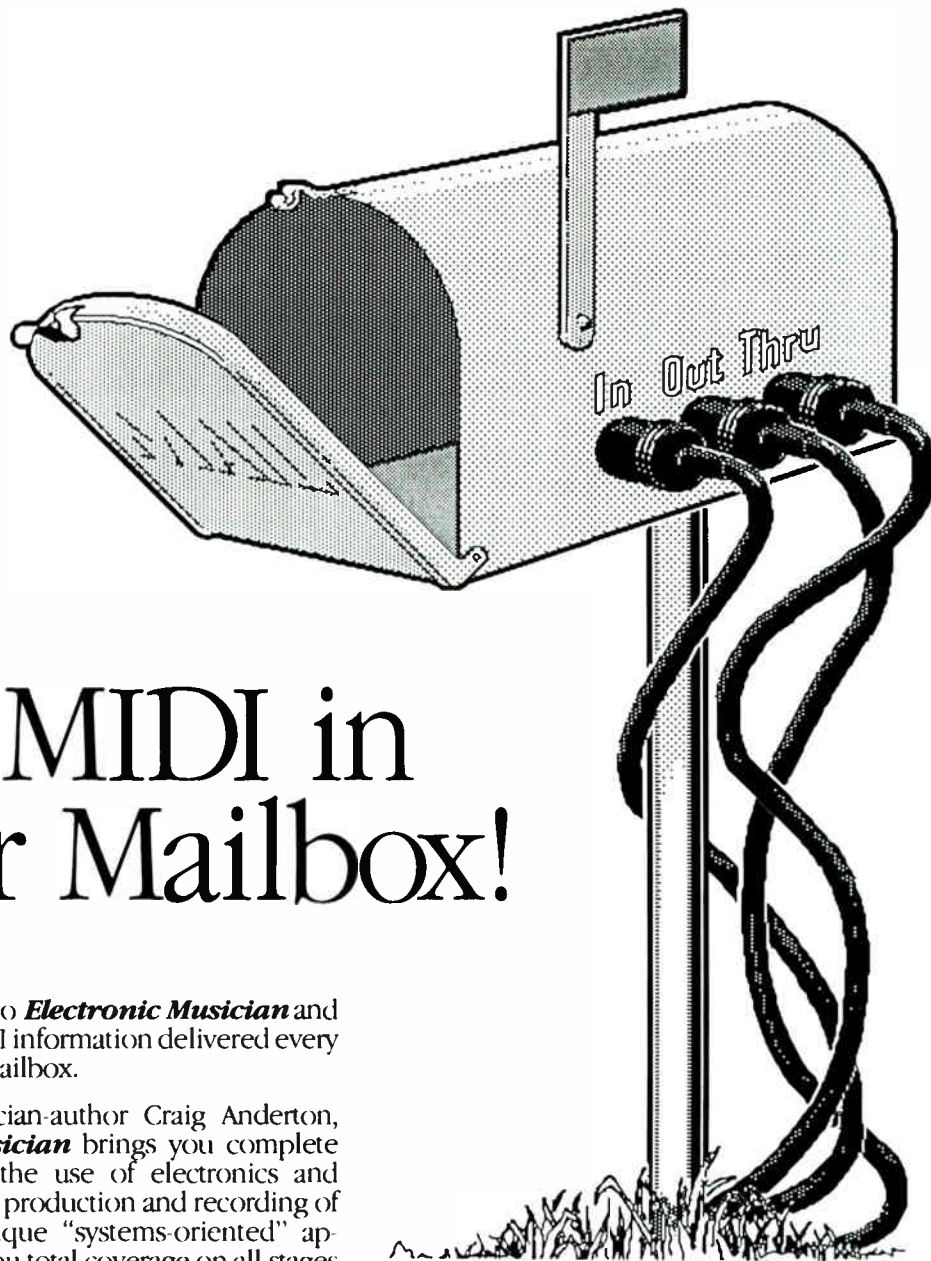

# Put MIDI in your Mailbox!

Subscribe *today* to **Electronic Musician** and get the latest MIDI information delivered every month to your mailbox.

Edited by musician-author Craig Anderton, **Electronic Musician** brings you complete information on the use of electronics and computers in the production and recording of music. **EM's** unique "systems-oriented" approach assures you total coverage on all stages of music creation, from the first musical thought to the final production of a demo tape.

Each month, **Electronic Musician** brings you timely articles on:

- ▶ MIDI
- ▶ Electronic instruments, including synthesizers, guitars, and percussion
- ▶ Computers and their music applications
- ▶ Music software
- ▶ Signal processors, effects, and recording techniques
- ▶ How leading artists, engineers, and others use the new technology
- ▶ New product reviews
- ▶ Most important, how to incorporate it all into *your* work

## GUARANTEED!

Subscribe today at the special rate of only \$14.95 for a full year (12 issues). That's a savings of **50% off** the newsstand price! We're sure you'll enjoy your first issue of **Electronic Musician**, but if for any reason you don't, simply return our invoice marked "cancel" and that will be the end of the matter. The first issue will be yours to keep!

Use the attached card to subscribe or write to: **Electronic Musician**, 2608 Ninth Street, Berkeley, CA 94710

Don't miss a single issue! Subscribe **TODAY** and save!



# Subscribe Today!



**SAVE OVER \$7<sup>00</sup>**  
off the ~~\$22~~ basic rate

- YES!** Send me 12 issues of **Electronic Musician** for just \$14.95.
- Save me more!** Send me two years (24 issues) for only \$27.95.
- Bill me     Payment enclosed  
(Outside U.S. add \$10/year)

Name \_\_\_\_\_

Address \_\_\_\_\_

City \_\_\_\_\_

State \_\_\_\_\_ Zip \_\_\_\_\_

1886



**SAVE OVER \$7<sup>00</sup>**  
off the ~~\$22~~ basic rate

- YES!** Send me 12 issues of **Electronic Musician** for just \$14.95.
- Save me more!** Send me two years (24 issues) for only \$27.95.
- Bill me     Payment enclosed  
(Outside U.S. add \$10/year)

Name \_\_\_\_\_

Address \_\_\_\_\_

City \_\_\_\_\_

State \_\_\_\_\_ Zip \_\_\_\_\_

1886



**SAVE OVER \$7<sup>00</sup>**  
off the ~~\$22~~ basic rate

- YES!** Send me 12 issues of **Electronic Musician** for just \$14.95.
- Save me more!** Send me two years (24 issues) for only \$27.95.
- Bill me     Payment enclosed  
(Outside U.S. add \$10/year)

Name \_\_\_\_\_

Address \_\_\_\_\_

City \_\_\_\_\_

State \_\_\_\_\_ Zip \_\_\_\_\_

1886



NO POSTAGE  
NECESSARY  
IF MAILED  
IN THE  
UNITED STATES

**BUSINESS REPLY MAIL**  
FIRST CLASS PERMIT NO. 2994 BERKELEY, CA

Postage will be paid by addressee

*Electronic*  
MUSICIAN

5615 W. Cermak Rd.  
Cicero, IL 60650

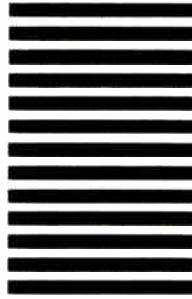

NO POSTAGE  
NECESSARY  
IF MAILED  
IN THE  
UNITED STATES

**BUSINESS REPLY MAIL**  
FIRST CLASS PERMIT NO. 2994 BERKELEY, CA

Postage will be paid by addressee

*Electronic*  
MUSICIAN

5615 W. Cermak Rd.  
Cicero, IL 60650



NO POSTAGE  
NECESSARY  
IF MAILED  
IN THE  
UNITED STATES

**BUSINESS REPLY MAIL**  
FIRST CLASS PERMIT NO. 2994 BERKELEY, CA

Postage will be paid by addressee

*Electronic*  
MUSICIAN

5615 W. Cermak Rd.  
Cicero, IL 60650

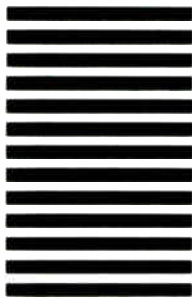



tem that sounded better in large venues and that saved sightlines. "Now that we've put this rig together, we are getting many calls from nationally-known groups coming through this part of the country. It has been good for business," King adds.

Speeda Sound is prepared for national touring as well, with a full band gear rental stock including amplifiers, piano and organ, and drums. The company's trucking fleet includes air-ride 45-foot trailers, and diesel 24-foot box trucks.

### EAW's Perspective

Some pro sound equipment manufacturers have come to realize that today's regional sound system rental firms may be tomorrow's national touring companies. Establishing solid relationships now with such companies is an important part of a national marketing strategy for any product that addresses the pro sound marketplace, be it consoles, amplifiers or loudspeaker systems.

"We are able to address the needs of touring concert sound companies now because nearly everyone involved with our company has a background in live sound," explains EAW president Ken Berger. "We were all into audio long before we were into manufacturing or marketing. Knowing what people need to hear and get out of loudspeaker systems is something that you can't only get from books; it takes getting out there and doing it yourself. The KF-550 cabinet is a direct result of that kind of experience."

### An Industry Trend?

Hardly five years ago, seeing factory-built loudspeaker systems on the road in modular touring packages was a rare occurrence. Within the past few years, such packaged systems have been gaining popularity, and these systems have put quality speaker packages within the reach of many regional sound firms.

Some of these same firms are now looking at the national touring scene with an eager eye. While the largest, traditional concert sound firms have tended to go with proprietary, custom-built speaker systems in the past, even that is changing in some instances. Several major tours on the road in 1986 will make use of speaker complements that contain, in part, pre-packaged systems that have been subcontracted from regional sound companies.

Buying and owning a large, new factory-built modular loudspeaker system does not guarantee success in the national touring industry by any means. It does, however, help to guarantee a more consistent, better-sound-

Some pro sound equipment manufacturers have come to realize that today's regional sound system rental firms may be tomorrow's national touring companies.

ing tour for the many entertainment groups not able to carry their own production systems. These acts rely on regionally-supplied systems at each venue; often a different system for every concert.

As pre-packaged sound systems become more popular, the average overall quality of sound heard by audiences around the country is bound to improve. Companies such as Eastern Acoustic Works sense the market need for such systems and they are becoming more visible on the concert stage. Modular "one-box" loudspeaker systems such as the KF-550 would seem to be providing a new standard of quality for those firms seeking cost-effective, good-sounding packaged systems.

ALL PHOTOS: MIKE STANDE

Because that's where you'll find the exclusive southern California dealer for NEOTEK's remarkable ELITE consoles.

**YOU DON'T HAVE TO GO TO GREAT LENGTHS TO GET HIGH PERFORMANCE,**

If you'd like to hear for yourself the truly unprecedented sound quality that has the recording business humming a different tune, just drop by AEA. You'll be more than impressed with NEOTEK's unexcelled equalization, their tremendous flexibility, high quality components and their rugged

modular construction.

The NEOTEK ELITE features dual-signal paths through each input, non-VCA grouping, multiple line inputs, and MIDI compatibility. Minimal stage signal flow design yields simple, logical control of complex operations with NEOTEK's legendary sonics.

We've gone to great lengths to bring you the broadest line of high performance audio products found under one roof. All you have to do is find Pasadena. It's easy. Just follow the parade.

**JUST TO PASADENA.**

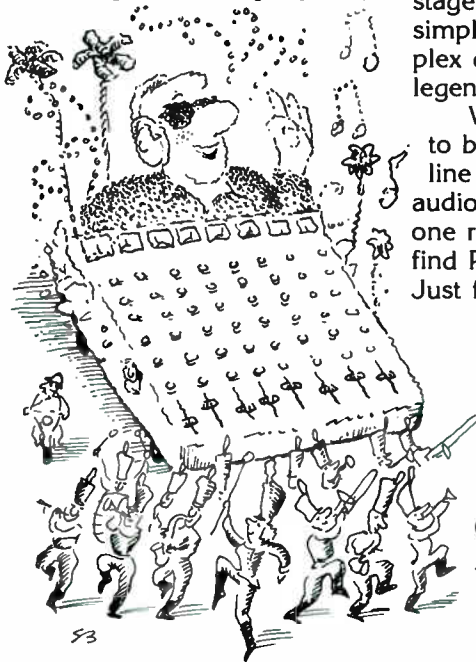

audio  
engineering  
associates



1029 North Allen Avenue  
Pasadena, CA 91104  
(213) 684-4461, (818) 798-9127

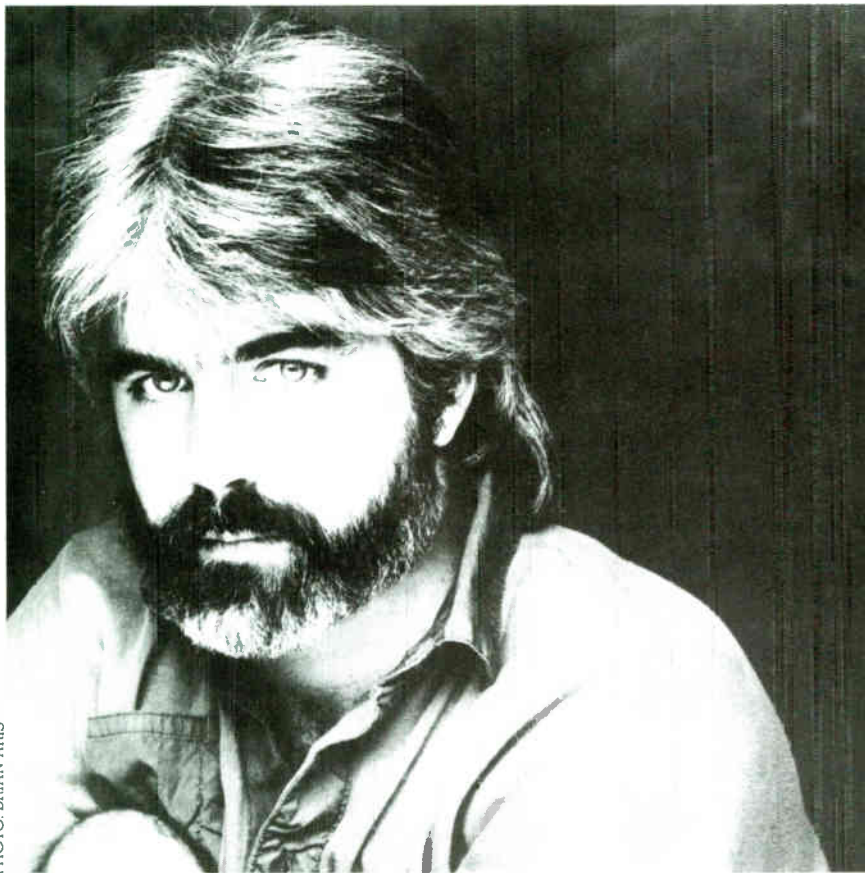

# MICHAEL McDONALD

by Gene Kalbacher

**C**omplete confidence and independence are seldom a matching set, just as composing and singing skills seldom work hand-in-glove. But Michael McDonald, solo artist and former lead voice of the Doobie Brothers, has found independence through introspection and studio experimentation.

"I was trying to look more inside myself and depend a little more on myself," says McDonald, the singer-songwriter behind such hits as "What

a Fool Believes," "Minute by Minute" and "Takin' It to the Streets." The gig with his own band just a few hours away, McDonald is getting a bit hoarse as he talks from his hotel room in Seattle, but the conversation about the making of his second solo album, *No Lookin' Back* (Warner Bros.), engrosses him so he continues gamely. His reedy tenor flows almost in counterpoint against the gentle hum of the heating system, like a grand piano on a synthesizer track. "With each album," he continues, "I was spending more and more money to be in the most expensive studio in town . . . with the highest-paid players . . . and I saw that this was a treadmill that really wasn't pulling its own end and, to some extent, was pulling me away from something that might be valuable to this record."

McDonald, 33, one of the most distinctive exponents of pop-R&B, was a group member and a team player for most of his professional life, and he

admits he's still adjusting to the demands of the solo career he began after the breakup of the Doobie Brothers four years ago. *No Lookin' Back*, his first effort in three years, his first almost fully self-realized album, is an apt title for his emergence as his own man in the studio. He recorded the bulk of the album at his 24-track home studio in North Hollywood, Dilling Street Studio USA. McDonald reunited with childhood chum, Chuck Sabatino, and co-wrote three songs. McDonald's odyssey from St. Louis to North Hollywood, from garage-band musician to arena rocker, has been marked both by fortuity and careful attention to craft. A chance meeting in 1973 with drummer Jeff Porcaro (later of Toto) led to McDonald's joining Steely Dan (as a backup vocalist) and, ultimately, the Doobie Brothers. Besides penning 1980's Grammy Song of the Year, "What a Fool Believes," McDonald has collaborated with Paul Anka, Burt Bacharach, Christopher Cross, Carly Simon ("You Belong to Me") and Kenny Loggins ("This Is It").

Since this interview was completed a few months ago, McDonald has kept a typically high profile on the charts, both as a solo artist and working with others. His duet with Patti Labelle, "On My Own" (written by Burt Bacharach and Carole Bayer-Sager) hit number one, and his contribution to the soundtrack of *Running Scared*, "Sweet Freedom," (written by Rod Temperton) was a smash as well. So even when he's singing others' material, McDonald's golden touch remains.

**Mix:** Your first solo album, *Michael McDonald* [1981], was produced by Ted Templeman and Lenny Waronker. You co-produced the new one, *No Lookin' Back*, with Ted. What did your co-production entail?

**McDonald:** The first album was probably a complete antithesis of this record. With the first album, not only did I leave a lot of the technical aspects—everything, actually, down to the hiring of the players—up to Teddy and Lenny, but in a way we did the album backwards this time around. With the first one, we sometimes went in with a six- or seven-man rhythm section, and most of what you heard on the first album were live dates. The overdubs were more of an afterthought, and just a few details like vocals and background vocals, but very few keyboard overdubs, if any, that weren't in the original arrangement. With this album, we did a turnaround. Basically all the tracks started off as demos, just to see how the tunes would work, and they were basically me with one keyboard, playing a basic keyboard part with a



# ATTENTION ALL MIDI USERS

**KEYBOARD, COMPUTER, GUITAR-TO-MIDI, SYNTHESIZER,  
DRUM MACHINES AND SAMPLERS!**



The ME25S Programmable Midi Note Separator is a device that has numerous uses and applications far beyond those that are readily apparent. Its 64 internal memory banks will memorize the MIDI channel, splitpoint, program change, octave shift, and modulation wheel settings. The main function of the ME25S is to convert a non-split keyboard into a multi-split keyboard, but you can use splits for other uses as well. For example, you can use one section of the keyboard to play on, and another section of the keyboard to select programmable effect changes. The ME25S can be used as a sequential program changer, an octave transposer, key overlapper, and numerous other functions limited only by your imagination. Make your instrument the master controller with AKAI's unbelievably versatile rack mount ME-25 Programmable Midi Note Separator.

List: **\$199.95**

## AKAI ME-25S SYSTEM APPLICATION

### Using as a MIDI Channel Converter/MIDI Channelizer

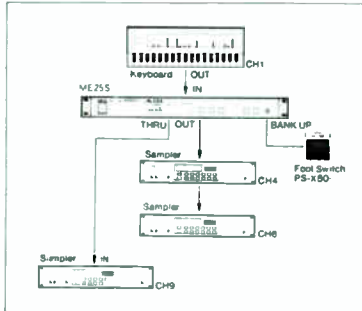

When the ME25S is used, transmission is possible on any channel by using the foot switch, even with a keyboard whose MIDI transmission channel is fixed at CH1.

### Using as a Keyboard Splitter

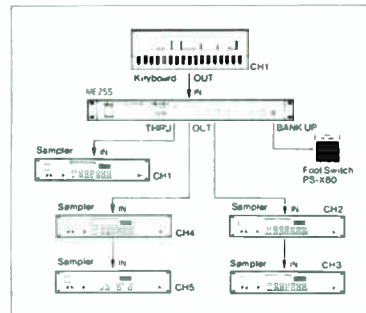

A keyboard not equipped with the split function can be split four ways.

### Using as a Keyboard Splitter with one Sound Source over Entire Keyboard.

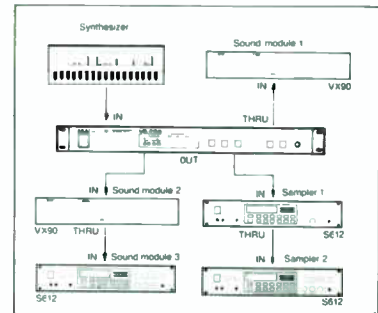

In this example, several external sources (sound modules, samplers) can be played on the keyboard with split voices.

### Using as a Program Change Number Presetter

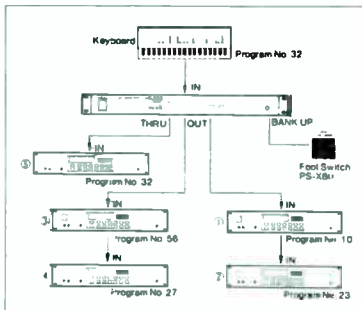

The ME25S can be used to preset the program change numbers, convenient when the keyboard's program change numbers are different from the MIDI delay, reverberator and external sound source's program change numbers.

### Using the Split Function to its Fullest

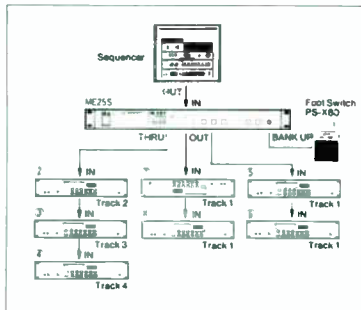

The split function on the ME25S can be used to run different parts on many external sound sources over a single sequencer track. The following example fully utilizes the octave shift function.

# AKAI

professional

P.O. Box 2344  
Fort Worth, TX 76113  
(817) 336-5114

Circle #063 on Reader Service Card

drum machine. I used the Yamaha DX7, which is the new staple for me, and the LinnDrum machine. We went back and forth between the Yamaha RX11 and the Linn 2. In most cases, I didn't even make a chain with the Linn; I would do a two-bar pattern on the Linn and just play the song down to whatever two-bar pattern worked, in hopes of either doing a chain later to the sync tone or coming up with a drum part for a real drummer.

**Mix:** So, unlike the first album, where the overdubs were minimal, the overdubs were quite substantial on the new album.

**McDonald:** They were everything. What we had in the beginning was just me and my engineer in the studio, Ross Pallone. He was leading me through the whole process of what we had to do. The real luxury was that if the song was too slow or it wasn't the right key, it was just a matter of putting a new sync tone down and not re-recording with seven guys at \$200 an hour in the studio. To some extent, on the West Coast, that seems to be the face of recording for most people nowadays—to do it as cheaply as possible in the beginning stages so that you can spend the money where you need it. So it was a reverse process.

**Mix:** Was this change in recording method necessitated by finances, or did it come about because of increased confidence in your own playing ability?

**McDonald:** I think, more than any reason, I was trying to look more inside myself and depend a little more on myself. When you get into a situation like I did on the first album—and I think the first album was a lot of fun, for one thing, and a good record—you start to depend more and more on everyone else and less and less on yourself. With each album, I was spending more and more money to be in the most expensive studio in town, with top-notch producers, with the highest-paid players and the most expensive engineer around. And I saw that this was a treadmill that really wasn't pulling its own end and, to some extent, was pulling me away from something that might be valuable to this record, which was looking inside myself musically and trying to depend more on myself and pull myself out of that rat race that a lot of successful artists get into. Like myself being with the Doobie Brothers, it was, "God forbid you should go into a cheap studio—the record won't be any good." I just felt it was time for me to get a little bit of a grip on myself artistically... It was more of a self-confidence thing than anything else.

---

“What I like to do is go hide away with just one instrument and a drum machine. A drum machine helps you facilitate your ideas writing-wise.”

---

**Mix:** So the basic tracks on *No Look-in' Back* were deliberately the smallest parts, while the overdubs were everything. Was there anything in your previous experience with the Doobie Brothers, and perhaps before that with Steely Dan, that prefigured or in any way anticipated your change in recording methods?

**McDonald:** In a way, maybe yes. A lot of times there's that old thing of "chasing the demo." [Guitarist] Jeff Baxter and I would record tunes at home to play for Teddy. Tiran [Porter, the bassist] and I sometimes recorded original stuff at home. You always felt as though that little demo, however terrible it sounded, had a certain magic about it that you could never get again once you got in the room with everybody in the band... I remember thinking to myself, "God, if it could only feel like the demo." So with this second album, it was a way to get closer to that instant where the song goes on tape and it's very intimate, and maybe a little raw or rough around the edges, but there's a kind of inexplicable magic and nobody really knows why it feels good. My experience prior to that, when I went in with musicians, was I'd always tell my-

self, "Don't try to beat the demo or capture the demo, because it never could happen." You would frustrate yourself, spend a lot of money, and never get what you wanted. You really had to forget about the demo. This second album was a way of maybe capturing the demo in the first place and not having to go through the secondary process with musicians.

**Mix:** When did you build your home recording studio, and how much has its capacity and usefulness been enhanced since then?

**McDonald:** It started out as an 8-track with a TEAC 80-8 and a 16-track Tangent console. That was kind of the reason I bought the house; it had a little studio out back, purely a demo studio. With the first album, we did a lot of the demos back there. But more than anything, it's that inevitable process where you get to the point where you go, "I'm either going to drop a lot of money here or I've got to stay where I'm at." With studios, it's a contagious thing. You wind up with a 24-track studio when you've promised yourself—or your accountant—that it's the last thing you'd do. We just got a little closer to it all the time. I bought a bunch of equipment through Lee Herschberg; it was equipment that had been sitting in the back room of Warner Studios when they redesigned one of their rooms. I bought this stuff, and it was in pretty bad shape, but Lee and a lot of guys—Jim Pace, an engineer who worked for me at the time—went in and worked on it, cleaned up all the modules. What I had bought originally was this old API console and an MCI 24-track tape machine. The MCI was in pretty bad shape, so we wound up selling that and getting a 3M 79. After we had a tape machine that worked, the next year we worked on getting the room to sound good, getting the gain structure in the room to be right. And it took a while. When you put equipment in, you've got a good six-month period to get 24-track stuff to link up, gainwise. After that, we were just about in time to do this record. It was really a lot of luck. A lot of what helped me get the studio in shape was a couple of projects I did prior to my own: one was with my sister Maureen for MCA Records; she's in the group Delta. We did a lot of their tracks more cheaply at home because we literally had no budget to work with. Through all that process, working with Ross Pallone, we really got the room to sound fairly decent. By the time I was ready to go in with [producer] Quincy Jones on this album, I realized that he was very busy and probably wouldn't be able to get to it, and that I really couldn't afford to wait much



# How to make a living as a recording engineer.

**I**t's no wonder that being a successful recording engineer is so appealing. In the magic environment of the studio, today's top engineers make a very good living by knowing how to bring music to life.

If you're serious about becoming an engineer whose services are constantly in demand by the music industry, there's something you should know. More than ever before, the hottest engineers will be those with the skills of both a technician *and* a musician. And now there's one place where you can develop your technical and musical awareness hand-in-hand—at the acclaimed Grove School of Music in Los Angeles.

Grove's new Recording Engineering Program is an intensive one-year course of study that gives you an exceptionally well-rounded approach to making music sound better. Grove instructors are working professionals based here in the entertainment capital of the world, where opportunities are at your doorstep in more studios and concert halls than you'll find anywhere else. Students from more than 30 countries have found the Grove School to be the most *practical* place to launch their music careers.

**1. Meet the versatility challenge.** Every recording, mixing and sound reinforcement situation is different. That's why the Grove program gives you such a broad range of experience, getting you comfortable engineering everything from 5-piece rock bands to 18-piece big bands to 40-piece orchestras.

You'll work with a full spectrum of acoustic to electronic music, from Top 40 to film and television scores. And you'll learn sound reinforcement techniques for a wide variety of live music applications.

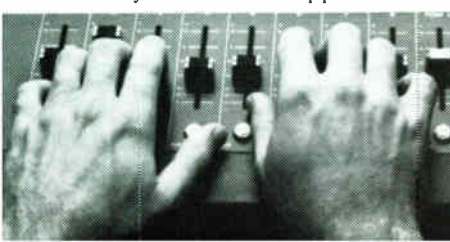

## 2. Get consistent hands-on experience.

There's no substitute for learning by doing. So you'll regularly have projects in Grove's two in-house studios, as well as taking advantage of the program's ongoing access to state-of-the-art 24-track facilities in the Los Angeles area.

To get the most from your time in the studio, you'll cover your technical bases with courses in acoustics, electronics, studio installation and equipment maintenance. You'll also learn studio management procedures to help prepare you for the business end.

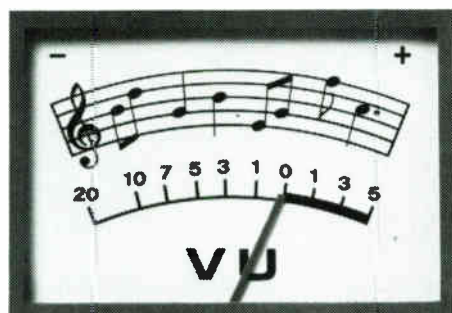

## 3. Hear music through a musician's ears.

The most talented engineers are usually musicians as well. The Grove program is designed to insure that you'll *understand the music* you're recording, and that you'll be able to *effectively communicate* with musicians on their own terms. Grove's outstanding courses in eartraining,

harmony, sightreading and rhythm section arranging will result in some great advantages for you when you're behind the board.

## 4. Prepare for related opportunities.

Successful engineers often expand their careers into related fields like record production and music video. Grove offers professional workshops in both these areas, as well as many others ranging from Songwriting to Synthesizers to Drum Machine Programming. You can build these into a customized course of study, and we'll help you tailor a complete package to fit your personal career goals.

## 5. Get a competitive edge.

The Grove Engineering Program begins each January and July. You may qualify for financial aid. And if you're concerned about getting a college degree, our accredited courses can be part of your B.A. in Commercial Music through our affiliation with Laverne University.

So if you want to make a living as an engineer, we'll send you more information. Just send us the coupon below to see how you can get a competitive edge, or call us at (818) 985-0905.



## Grove School of Music.

Mail coupon to: **Grove School of Music**  
12754 Ventura Boulevard  
Studio City, California 91604

Please Print:

Name \_\_\_\_\_

Street \_\_\_\_\_

City \_\_\_\_\_

State \_\_\_\_\_ Zip \_\_\_\_\_

Phone ( ) \_\_\_\_\_

MIX 9/86

I'd like to know more about the Recording Engineering Program.

I'd also like more information on the other programs checked below:

- Songwriting Program
- Synthesizer Program
- General Musicianship Program
- Vocal Program
- Keyboard Program
- Guitar Program
- Bass Program
- Percussion Program
- Composing and Arranging Program
- Film Video Composition Program

Circle #064 on Reader Service Card

longer to release a record or no one would remember who I was. I had Ross, and all the confidence in the world that he could make it sound good, so we just took the demos and said, "Hey, let's get rid of the stuff that doesn't sound good on the demo and replace it with guitars that sound good. So what started off as fairly good-sounding demos—a lot of which I'd cut before I started working with Ross—were purely salvageable. It was kind of a dream of a lifetime because I had toyed with the idea of actually doing an album in my studio... but I thought that was a couple of years down the line, if anything. As it turned out, we did the whole album there and at Jeff Porcaro's home studio [Villa Recording in North Hollywood].

**Mix:** Please describe the MIDI setup you employed for the keyboards on *No Lookin' Back*.

**McDonald:** It was pretty simple, at best. We didn't really work with sequencers on this album so much, except with one of the tunes, "(I Hang) on Your Every Word," for which we used the QX-1. We were kind of afraid to delve into the sequenced-feeling things too much, but this tune called for it. On the other things, it was basically me playing along with the drum machine live; we put a sync tone down and then the drum machine. As for the MIDI situation, at the time I was using a Jupiter 8 and two DX7s together.

**Mix:** You play a lot more keyboards on *No Lookin' Back* than you did on your first solo LP. Does this reflect greater confidence in your abilities as a keyboardist?

**McDonald:** I'm not sure, to tell you the truth. I've never felt that confident as keyboard player. I'm one of those classic guys who just plays by ear to write, and to a certain extent I emulate other keyboard players a little bit. But I just don't have the overall ability where keyboards are concerned to play as good as some of the people I emulate, in a key I feel comfortable in. What I've found in most cases, though, is that even with really good keyboard players like Greg Phillinganes on the live dates on the first album, it always wound up that I had to play along with them, basically for *feel* reasons; somehow things just didn't feel the same unless I was dictating the feel from a keyboard sense, conducting the band in a way. With this album, it gave me a chance to play the keyboards and get the overall track to feel the way I wanted it, without being under pressure [laughs] with a lot of musicians.

---

## No Lookin' Back, McDonald's first effort in three years, is an apt title for his emergence as his own man in the studio.

---

**Mix:** As a boon to songwriting, who are some of the keyboard players you have emulated?

**McDonald:** Probably Ray Charles, a lot. Gospel styles were always something my ears were drawn to. Also R&B styles, people like Greg Phillinganes. But in the early stages of my life, more than anyone else it was Ray Charles. He seemed to communicate so well through the piano in ways that were so different from what most people could do with the instrument. For him, it was the same extension of his ability as his voice was; he played piano like he sang.

**Mix:** You also make use on the new album of the Emulator and B-3 organ. How did that come about?

**McDonald:** The Linn 2 is one of the best sounding—as far as fundamental sound—drum machines. I remember when I first used the LinnDrum, I said, "God, if only we could get a snare drum to sound like this every time we went in and miked one, it would be wonderful." In making rough mixes, we would use the Quantec on the Linn, which is a room simulator, echo unit. Man, there was this *huge*, massive drum sound. The minute we put a real cymbal on one of the tracks, it was amazing how beautiful and how profound the sound of the acoustic instrument was up against all the synthesizer stuff. And the same with the B-3. With the DX7 and a lot of the synthesizers, they've got such great organ sounds. You just go, "Gee, this is better than I could ever get my organ or my Fender Rhodes to sound." Yet once you get a track full of synthesizers and you put a real B-3 on there and a real Rhodes, there's a certain incredible *presence* that the old instrument has amidst all the synthesizers that only have a certain amount of

frequency range. Synthesizers can only emulate the sound to a certain extent, because it's like thousands of harmonics; you just don't have enough oscillators on the synthesizer. They have a way of dwarfing what you thought was a huge sonic spectrum. All of a sudden you put a real cymbal on that track, and it stands out like a beautiful, incredible thing because up against the sonic spectrum you've created with all the synths, you suddenly realize that that cymbal reaches far beyond anything any of the electric drums can do. When we put real drums on it was amazing how incredible they sounded to us after having sat and listened to the electric drums for months. So it taught me a lesson with synthesizers: you can do only so much with synths at this point, and it gets better all the time, but when you really compare them to the acoustical value of an acoustic instrument like a grand piano or a B-3 through a Leslie, you really see what you're missing. So with this album, I wanted to be careful not to get too synthesized.

**Mix:** Do you have facilities to record, or at least to compose, at both of your residences?

**McDonald:** No, I don't. In Santa Barbara, I usually carry the DX7 and the drum machine when I go there to work. Pretty much only what I do up there is the conceptual stages of writing the songs and trying to get ideas that I think will hold up as songs. A lot of times you have a tendency to write with machines and sequencers and what have you. You spend so much time working on things that fool you to a certain extent because they sound good, the synths sound huge. You're being lured a little bit by sonics...

**Mix:** In other words, you can be deluded into hearing more than is really there.

**McDonald:** It happens a lot. A lot of times you realize, "God, I've got this great track" and all this, but not much of a song to speak of in the end. So, for me, what I like to do is go hide away with just one instrument and a drum machine. A drum machine does help you facilitate your ideas writing-wise. But it also doesn't take it so far before you have a chance to see what you've got to where you could fool yourself. Basically, I just go right into a little cassette machine; I put the machine on the counter and play and mumble or whatever I'm going to do just to get my musical ideas in place, or to work on musical ideas around some lyrical idea I might have. I want to see if it's a decent enough idea to spend the time on.



**Mix:** One of the things I've always liked about your tunes is the way you subdivide the beat, the tension-and-release inherent in many of your songs. In terms of cutting your own vocals, what kind of rhythm do you like working with best?

**McDonald:** There are a lot of pitfalls with doing vocals. When you have a lot of chorusing on the keyboards, you can have a problem with pitch. But as far as basic feel and what brings a good vocal out of you, I always like to have the drums up and the fundamental beat most predominant. If we're lucky enough to have a lot of the percussion overdubs already done—which in most cases we don't—I like to hear as much of it as I can. A lot of times, too, with what isn't there already—like when you're doing vocals in the early stages—what you have on tape is implying the subdivided rhythms anyway and you just fill it in with congas or percussion. When I initially write a tune, it's always in a divided-time feel. The straight-ahead, 2/4 backbeat thing is good sometimes, but for the very reason you mentioned, I really don't feel I have enough room to be subtle when I've divided up the beat into 16ths and I have kind of a half-time groove. The divided-time feel makes room for more dynamics in the song... which isn't something that rock is known for; there's kind of a one-dynamic sense about a lot of rock music.

**Mix:** In terms of the finished product, how close are your tunes recorded to the way you hear them in your mind's ear?

**McDonald:** Probably, this time around, more than at any other time, they're the closest to what I originally conceived. Basically, I was able to facilitate what was in my mind better than I was ever able to before, simply because of the number of people involved.

**Mix:** How much has the tremendous burgeoning of technology, especially in terms of synthesizers and the sounds and tonal colors they afford one, enabled or enhanced the musician's ability to get closer in the finished product to his original conception? And, conversely, what are the dangers?

**McDonald:** It definitely has enhanced it, but at the same time it's all perspective, what perspective you choose to put in. For me, it makes some things easier; on the other hand, it does lead you astray in some areas... Some people make brilliant records that are totally synthesized, but that's for their purposes. You really have to apply it to yourself.

# THE MYTH... "It costs a lot to make a hit record!"

FOR WEEK ENDING JULY 12, 1986

Billboard®

## HOT 100 SINGLES™

THIS WEEK	LAST WEEK	2 WKS AGO	WKS ON CHART	TITLE PRODUCER (SONGWRITER)	ARTIST LABEL & NUMBER DISTRIBUTING LABEL
(71)	82	92	3	ROCK'N'ROLL TO THE RESCUE T.MEILCHER B.B.HOUSE (M.LOVE T.MEILCHER)	◆ THE BEACH BOYS CAPTAN 5595

FOR WEEK ENDING JULY 12, 1986

Billboard®

## HOT BLACK SINGLES™

THIS WEEK	LAST WEEK	2 WKS AGO	WKS ON CHART	TITLE PRODUCER (SONGWRITER)	ARTIST LABEL & NUMBER DISTRIBUTING LABEL
(56)	82	—	2	HEY GOOD LOOKIN' G.CLINTON'S WASHINGTON (S.WASHINGTON G.CLINTON G.SHIPER)	GEORGE CLINTON CAPTAN 5602

FOR WEEK ENDING JULY 5, 1986

Billboard®

## TOP BLACK ALBUMS™

THIS WEEK	LAST WEEK	2 WKS AGO	WKS ON CHART	ARTIST LABEL & NUMBER DISTRIBUTING LABEL (CIRC. LIST PRICE)*	TITLE
(12)	13	15	5	MIDNIGHT STAR SOLAR 60454 (L.P.THA) (B.98)	HEADLINES
(17)	18	21	7	GEORGE CLINTON CAPTAN 51124 (L.P.) (B.98)	R&B SKELETONS IN THE CLOSET

# THE SOLUTION... Affordable Full Service 24 Track Recording SOUND SOLUTIONS

1211 Fourth Street, Santa Monica, CA 90401  
(213) 393-5332

Circle #065 on Reader Service Card

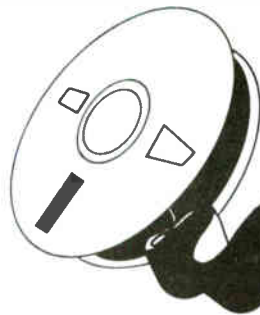

## When the tape runs out, call United Tape Company

Manufacturers of BASF Custom-Length Chrome Cassettes—  
Customized Video Cassette Loading

Authorized Distributor of

**AMPEX** Blank Recording Tape  
**SCOTCH/3M** Blank Recording Tape  
**TDK** Blank Recording Tape  
**BASF** Calibration Cassettes  
**CAPITOL** Audiopak Carts  
**TEAC/TASCAM** Accessories  
**DISCWASHER** Accessories

**AMPEX**  
Amper Corporation • One of the Signal Companies

**BASF 3M**

The **UNITED GROUP**

- United Office Supplies, Inc.
- United Tape Company
- United Audio-Video Supply
- United Tape Corporation

10746 Magnolia Blvd.  
North Hollywood, CA 91601 □ (818) 980-6700

Call for our free 40-page catalog

Circle #067 on Reader Service Card

by Bruce Nazarian

I spent an hour the other night engaged in a conference with ten other music professionals, including Roger Linn, discussing future musical products, the recent demise of Linn Electronics, and other fascinating topics. The interesting thing was, none of us in the discussion group actually heard the other's voices—we were calling in from ten different cities, watching everyone's comments appear on each of our computer screens simultaneously. We were having a Conference on PAN—the Professional Artist Network—an Online Computer System!

### Music Meets Computers!

One of the marvels of the age in which we live is the personal computer. So many things can be done by these miraculous machines that it is hard to determine where to begin to tell the story! As development and availability of personal computer hardware (computer, disk drives, etc.) has increased, so has the sophistication of the software (the programs) that drive them. With the recent introduction of MIDI interface units for the Apple Macintosh computer, high-quality music programs have begun to take advantage of the Mac's user-friendly approach—the famous "point-and-click" style. Recent software developments for the MIDI-ized Mac include: **MIDI sequencing software**—programs that turn the Mac into a multi-track MIDI event recorder. This is usually accompanied by incredibly detailed editing capabilities, MIDI event filtering, and sometimes even music score printouts. Typical of the breed are Southworth's "Total Music," Opcode's "MIDIMac," Mark of the Unicorn's "Performer," and Musicworks' "MegaTrack." **Patch librarians**—programs that store synthesizer sounds

("patches") in MIDI system exclusive format (SysEx), **Patch editors**—programs that provide sophisticated editing facilities for synth sounds, and... **Visual editing systems**—programs that couple the powerful graphics presentation of a Macintosh with "cut-and-paste" editing techniques for sound samples thereby creating a powerful, easy-to-use, package for manipulating those samples. This category includes programs like Digidesign's *Sound Designer* for the Emulator II, Prophet 2000/2002 and Mirage, and

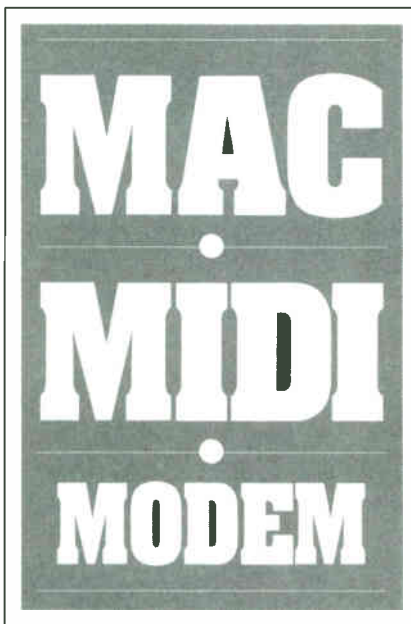

the recently field-tested *Sound Lab* for Mirage from Blank Software. (see June '86 *Mix* "Field Test"). Programs like this are the closest you can get to a Fairlight or Synclavier without actually owning one!

### Online Systems

Simultaneous with the development of these highly advanced "application" programs, there has been a tremendous increase in the number and power of dial-up Online Computer Systems dedicated to musical and/or entertainment business users. This month in In Sync, we will take a look at how much music you can make with your Mac (or any personal computer) and a telephone line when Online Systems and Musical Software collide head-on! As always, let's make

sure we get some terminology down before we get too deeply involved in the subject: **Online System**—(we'll refer to it as "the System") is any computer (from an Apple to a huge Prime mainframe) that can be accessed through the public telephone network, using your Mac and a... **Modem**—(Moé-dem) a device that converts computer data into a series of alternating audio tones which can be transmitted over a standard telephone circuit. (Modem is short for MOdulator/DEModulator.) The System receives these tones and converts them into the characters you sent. When responding, the System sends back tones that your modem receives and then converts into characters that it sends to your computer. To make sense out of this high-speed stream of characters, you usually need... **Terminal Software**—Since personal computers are capable of a great many different tasks, each task requires the appropriate set of instructions (software) to specify what the computer will do. Some of the most-used programs for Mac are MacTerminal and Red Ryder. Terminal software, then, will instruct your computer as to how to act as a telecommunications terminal; how to transfer characters to and from the modem, and how to accomplish a... **File Transfer**—Most of the computer information you will generate or receive (E-mail, program data, sound patches) is stored in some form of File structure. This makes it easy for the computer to keep track of where the data is and how much of it there is. File Transfer is the act of moving some of your data to the System, or some of the System's data to your computer. This usually takes place in one of two ways: **Downloading**—when the System sends YOU a file, or... **Uploading**—when YOU send the System a file. There are a wide variety of ways in which file data can be transferred, but each particular method has its own set of rules that both the sending and receiving computer must follow. This is called a PROTOCOL. (If you've been "online" already, you probably know some of these names—XMODEM, YMODEM, KERMIT, etc.) Most of the generally used Terminal programs have these protocols already included, and you just select which one you wish to use to make your file transfer. "Online"—When you are ac-



tually connected to the System via your modem, you are said to be "on-line." This is generally the time that you must pay for.

### The Connection

Once you have got the necessary hardware (your local computer store can help you with a choice of modems and the appropriate cables), then a typical online session might go like this: 1—Your Mac uses your modem to dial the access number (a phone number which connects you to the System's modem...) 2—When the System answers, it sends back a carrier tone, which your modem recognizes and responds to. If the System doesn't answer with a carrier, telecommunications is not possible. 3—Once you "connect," you use your logon procedure and your password to ask the System to allow you access to the desired service. If your procedure and password are correct, the System will log you ON and you are ready to go! (When you subscribe to any of the systems profiled this month, you will receive details on their logon procedures and your own password. For more information, contact any of the systems' representatives directly.) 4—Talk back and forth for as long as you wish, then 5—when finished, tell the System "BYE" or "OFF" and it disconnects you. 6—Hang up your modem.

### Which System?

Telecommunications has been around for quite a while, but it is just recently that we are starting to see specialized music-related systems coming online. While systems like CompuServe, GEnie, MCI Mail and The Source are widely-subscribed, general-purpose databases, systems like Esi Street (Entertainment Systems International) and PAN (Professional Artist Network) offer features that are more relevant to the music business. In addition to offering access to Electronic mail (e-mail), and other telecom services (Domestic and International Telex, TWX, and cablegrams), several exciting musical services are offered on each of these systems. Here's a brief summary:

### A Walk on Esi Street...

Esi Street Offers e-mail service between users located in many countries via its mainframe computers located in the U.S., U.K., and Australia. Users can have a "mailbox" on any or all of the three main systems, and can send and receive messages at will. Access is also provided to extra-charge services like Domestic and International Telex, Mailgram, Cablegram and others. Esi Street also provides pathways to premium-charge services like on-

line charts and music news (*R&R*, *Billboard*, *Street Pulse*, *Pollstar*, etc.) as well as electronic news clipping services, stock quotations, and even a tie-in to the electronic edition of the Official Airlines Guide (OAG)! Using OAG, you can scan airline and hotel schedules and rates, and even book a complete itinerary from the comfort of your own computer, 24 hours a day. If you need some studio equipment for your session, you can even dial in a reservation to a major equipment rental house, and book your gear from your computer. In addition, Esi Street provides members with their own Bulletin Board Service (BBS), wherein they can exchange comments, notices, for sale and/or want ads, and even the latest industry jokes. Esi Street is also the home of Special Interest Group (SIG) BBS's for SPARS members, SSL Users, and Fairlight enthusiasts. (Also, for what it's worth, the text of every In Sync column is transmitted via Esi Street from my home in Detroit to *Mix*'s editorial offices in Berkeley! The transmission is virtually instantaneous, and from there it is fed directly into the typesetting machine for composition into the words you read here!) You can get additional info for Esi Street from their offices in New York (212) 757-0320, L.A. (213) 937-0347 or London at (01) 221-2749. Phil Tripp has

written a more in-depth look at Esi Street elsewhere in this issue.

### SynthNet

Of special interest to musicians, Esi Street is also the home of SynthNet, the music-and-MIDI specialized BBS for contemporary musicians of all kinds. SynthNet provides a Forum for the discussion of current MIDI-related problems and solutions, as well as an extensive database of information and articles relating to MIDI, synthesizers, and contemporary music making. One of the most exciting features of SynthNet is its online sound file library, where patches for contemporary synthesizers (like DX7, Emulator II and others) are available. Most of these sounds may be downloaded for free; you pay only for the time that you are actually on the phone ("connect time"). Mac owners will note that their computer is well represented, as the online files are available in both Opcode and Total Music formats (for bulk DX7 patches), and in Sound Designer format (for Emulator samples). You can also download to your IBM PC or compatible, as files in Mimetics DX-Connect format are available also. If you're into MIDI or synth-related music making (and who isn't these days?) you'll want to check out SynthNet on Esi Street. The SynthNet contact number

**Bernie Grundman  
MASTERING**

6054 Sunset Blvd. Hollywood, California

**Complete Disc Cutting Services  
Analog and Digital Sub Masters for:  
Compact Discs  
Cassette Duplication**

Mastering Engineers:  
Bernie Grundman · Brian Gardner · Chris Bellman

**6054 Sunset Blvd., Hollywood, CA 90028 (213) 465-6264**

Circle #068 on Reader Service Card

**AKIA Electronics INTRODUCING!**  
**X-Z 100**  
**COMPUTER**

ON THE TOP OF DIGITAL  
 TECHNOLOGY

**MIDI EXPANSION FOR MIXER**

Your mixer becomes

**AUTOMATED MIXER**

installs in 30 minutes  
 syncs to tape at any point with  
 "TIME POINTERS"

128 noise gates  
 128 compressors limiters  
 128 channels

**Special Software for  
 LIVE PERFORMANCE**

Syncs Perfectly To Any Random Tempo  
 Changes Of The Performers



**JUMP INTO THE NEW GENERATION**

**GET YOUR STUDIO  
 AUTOMATED**

THE XZ-100 OFFERS:  
 THE MOST ADVANCED DIGITAL  
 COMPUTERIZED TECHNOLOGY IN  
 AUDIO MIXING.

all for basic cost of

**\$ 1499.00**

for free data write to **AKIA electronics**  
 16740 S.W. 301 St. Homestead, Fla. 33030  
 or call (305) 245-2727 or toll free  
 1-800-225-3675

in New York is (212) 564-1776. Their answering machine will take your call if they happen to be out at that time.

**PAN**

You'll also want to check out PAN. Accessible via modem in a similar manner as Esi Street, PAN offers a more musician-specific system with heavier leaning on the practical synth end of things. Many intense messages on the PAN forum actively discuss problems and solutions for various pieces of hardware or software providing, in effect, a real time evaluation of new products. PAN also provides gateways to Telex and ECOM (computer-generated first class U.S. mail), as well as travel-related services, an extensive technical literature database, and one of the largest Synth forums I have seen online! PAN also hosts online conferences with industry notables and manufacturer's reps who sign on and answer any and all questions from the membership. A conference on PAN is a pretty exciting thing to participate in! You can find out more by calling the PAN hotline, at (215) 489-4640. SYSOPs Perry and Susan Leopold are very friendly, and will be glad to share their electronic world with you!

**Synth-Bank**

One of the newest areas of interest on PAN is Synth-Bank. Operated by Bryan Bell (a West Coast kind of guy who, as engineer/producer/programmer has worked with such heavies as Santana, Herbie Hancock, and Al Di Meola), Synth-Bank is an online sound file database. While similar to SynthNet's online database, Synth-Bank also intends to include samples for more high-end equipment like the Fairlight III and Synclavier. It also has an extensive library of custom sounds (many the work of noted sound designers), which are available to be downloaded for a graduated fee. Bell's aim here is to have Synth-Bank provide access to as many quality sounds and samples as possible, for as reasonable a cost as practicable. While Synth-Bank is just coming online as this column is being written (early July), it promises to be an exciting addition to the already overwhelming array of services available on PAN.

**Synth-MIDI SIG**

The Synth-MIDI SIG area on PAN is an extremely active one (over 3,750 active messages already!), often seeing as many as 40 or 50 new messages posted in an evening's activity. In addition, there are gateways for Japanese synth users as well as European users, who can log in via their respective telephone networks. Any evening on Synth-MIDI can find users

from across the U.S. and around the world checking in to yack about the latest developments in their fields. (Yes, even Herbie Hancock shows up online occasionally!)

**MusicNet**

Only one-and-a-half years old, MusicNet is another of the up and coming online systems. Operated by SYSOP Jules Delgado, MusicNet appeals to the contemporary musician with its availability of new product reviews, news and a database of MIDI specs that is pretty thorough. MusicNet's file area, for example, has a complete MIDI implementation chart for most instruments of major manufacturers. In addition, there is a FreeSoft area where public domain programs are available to be downloaded for only connect charges. Some programs are also available for modest additional cost. MusicNet's Synth Patch area allows up- and downloading of synth patches for most popular synthesizers including Casio, Yamaha (DX-series), Oberheim, Ensoniq samples, as well as Prophet 2000 sounds and Emulator II banks in Digidesign's Sound Designer format. Of course, what would an online system be without user mail and mailboxes, and MusicNet offers that service, too?

**Dial-and-Buy**

A unique new service that seems to be catching on with some of the online systems is an "electronic shopping area." (PAN has one, too.) Current computer hardware and software is listed and available for purchase while you are online. While not designed to offer the most rock-bottom prices, online shopping areas are designed to provide convenient access to equipment that might otherwise be unavailable to some users. While we chatted, Delgado mentioned that MusicNet will also be offering keyboards and software through their shopping area. MusicNet is available, 24 hours a day, seven days a week, as are all of the systems profiled this month. Access is via either long-distance call direct to the 914 area, or via a toll-free WATS line (800) that is for use by subscribers only, at a modest charge. Delgado is trying to provide a "community feeling" among the MusicNet subscribers and, to that end, is attempting to have all manufacturers of MIDI gear represented online for fast feedback. You can call for info on MusicNet at (914) 724-3668 (voice) or browse online at (914) 442-4006 (modem).

**The MIDI Connection**

Our last stop on the Telecom Tour this month is New York City, where we visit SYSOP Gary Rottger at The



MIDI Connection, his online MIDI user group. TMC is definitely the place for MIDI-related subjects, and boasts a rather large file area (40 megabytes online) with not only MIDI and Synth related files available, but Mac-oriented files as well. Of course, user mail is a standard feature of this system, but uploading and downloading of files is encouraged. Presented in a very clear style, TMC is fast and easy to get in and out of to send your mail or to download some files. It's a recommended browse if you can handle the long distance charges. The MIDI Connection's data line is (212) 594-2646. (Say hello to THXMAN when you get there!)

### ... Logoff ...

Well, that's the end of our tour through music and MIDI fun on the phone. Hopefully, some of you out there will get the bug to join us online and share the fun. If you can't wait to get started, at least remember to call any of the systems I have mentioned this month for more information before you try to dial in. Most have restricted access until you have been on at least once and validated your user ID. In the case of paid services (Esi, PAN, MusicNet), you will have to formally apply for your user ID and make billing arrangements before you can get

total online privileges. After that, the sky's the limit. Have some fun! (... And if this month's In Sync has really caught your interest, you might want to check out our sister publication, *Electronic Musician*. Rumor has it that this month's issue is jammed full of even more interesting information about computers and online fun.)

### Some Comments

Lest I leave you with a pile of new information and not raise some curiosity, how 'bout contemplating this possible future scenario:

A producer is in the recording studio with his musician/programmers, both of whom have their computer keyboard hookups set up and ready to go. "Only another minute..." says programmer number one. "The arranger in New York is modeming some last minute revisions to the sequence." In the meantime, the producer indicates that he isn't happy with the sound sample being used for a particular effect in one part of the track. "No problem" pipes up the second programmer—"I know just the sound we need." Quickly dialing into one of the major online systems, he checks the file menu to find a sample called "REAL.LOUD. UGLY.NOISE," a sound effect that a programmer friend of his happened to play for him the week before. "Just a

sec... I'm downloading it now." Stepping back into the control room from a quick coffee break, the producer hears "REAL.LOUD.UGLY.NOISE" blasting out from our hero's sampling keyboard. "GREAT!—Put it on the tape, QUICK!" he cries, and our programmers emerge from the session victorious once again. Sound far-fetched? Well, it isn't... this scene can actually be played out today with currently available computers, files and Online Systems. With the growing numbers of personal computers in use, MIDI computer interfaces and standardized data file structures, all of this and more is not only possible, but inevitable as well. (What a wonderful time to be a musician!)

### More Gnome Online

Well, practicing what I preach, I am happy to announce that the 'ole GNOME has yet another electronic mailbox—if you are a member of PAN, and you have any comments to offer, or topics you'd like to see covered, feel free to PAN mail them to BEEZER (that's me). As always, Esi (IMC) members can address their Mail to GNOME-US. **MAIL CALL...** (You have 5 new messages) Whoops! My e-mail's piling up... gotta go for now. I will look for you all online, so get your modem workin'.

# Why do Jensen Transformers have Clearer Midrange and Top End?

The high frequency rolloff of a *Jensen Transformer* is optimized, by computer analysis, to fit the *Bessel Low Pass Filter* response. This means *minimum overshoot and ringing* and *flat group delay* for best *time alignment* of all spectral components of the musical waveform.

In other words, the harmonics arrive at the same time as the fundamental frequency.

The result is a clear midrange and top end without the harsh, edgy sound which has been one of the most objectionable sonic complaints about transformers.

There's no "midrange smear."

Only *Jensen* has this benefit of hi-tech computer optimization.

Visitors by appointment only. Closed Fridays.

10735 BURBANK BOULEVARD • NORTH HOLLYWOOD, CA 91601 • (213) 876-0059

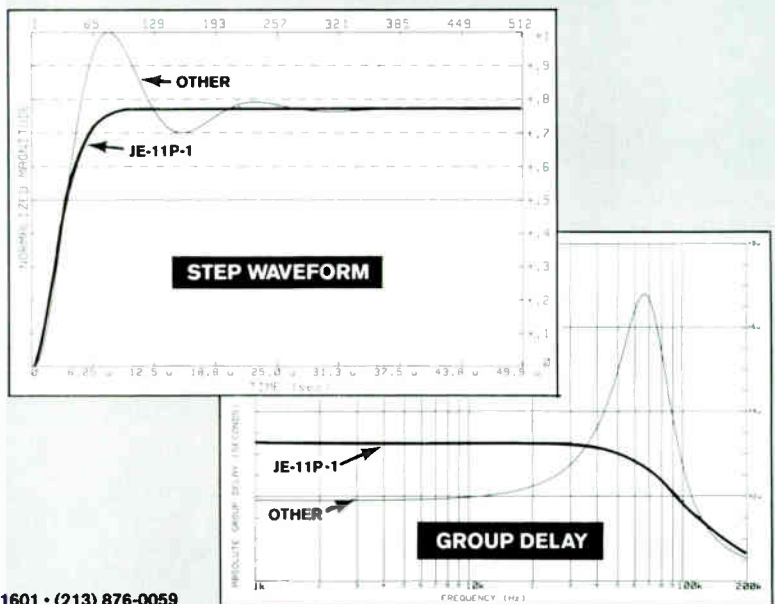

**jensen transformers**  
INCORPORATED

Circle #071 on Reader Service Card



*Airdrums from Palmtree Instruments (La Jolla, CA) is a new MIDI percussion controller consisting of a patch/note assignment editor-processor and two clave-sized, hand-held triggers with internal rotational accelerometers.*

## ON THE NAMM BEAT PART TWO

by Craig Anderton

Last month, we covered percussion controllers (one oversight: the "Airdrums" from Palmtree Instruments, about as close as you're going to get to a pair of MIDI maracas), synthesizers, automated mixdown, samplers, and guitar controllers. This time around, we'll look at signal processors, software, and even a collapsible guitar. Please note that many of these products are just past (or still in) the prototype stage, so prices and specs are subject to change without notice.

**Signal/Data Processors.** One of

the big hits of the show was the Alesis MIDIFEX (\$399). This small plastic box includes 63 different delay-oriented preset effects, including reverb, echo, stereo synthesis, and double/triple tap delays. Incidentally, some of these effects were formerly possible only with multiple delay lines. This seems like just the ticket for small studios who want to stretch their signal processing budget as far as possible.

ART showed the MIDI Performance package for the DR1 16-bit reverb that places your choice of any two parameters at a time under MIDI control. They also announced two promising, upcoming products—a programmable MIDI Parametric EQ, and MIDI Pitch Transposer.

Interestingly, though, these days we have not only signal processors but data processors. One of the most intriguing is the Mapper from Axxess Unlimited. This MIDI accessory essentially lets you manipulate the MIDI data stream so that one parameter can be "mapped" to another. For example, notes can be mapped to play different notes on expander modules, a controller's data can be assigned to several parameters at once (e.g. change filter timbre, pitch, and master volume from a single pitch bend or mod wheel), perform master patch selections to create different keyboard "setups," and the like. While not inexpensive, the Mapper is a highly versatile tool that is well-suited to any advanced MIDI setup.

**Software.** Bacchus Software Systems showed their Voice Manager program for the IBM-PC, which provides extensive editing facilities for the DX/TX user. Dr. T's Music Software, best-known for their Keyboard Controlled Sequencer, demonstrated a Commodore-128 compatible version and announced an upcoming version for the Atari ST. Speaking of the ST, their CZ Patch librarian is now available for that computer; and speaking of the CZ, Hybrid Arts said that a version of their popular DX Droid software program would soon be available for CZ series instruments.

Key Clique has expanded their family of ROM cartridges to include support for Roland's Super Jupiter, and has also started offering samples for E-mu's SP-12 drum machine. In the world of Apple II software, Key Clique introduced the Roland Super Jupiter Secretary library program, Film Mu-

sic Tool Kit for correlating music "hits" to time code, and the latest revision of their SysEx system exclusive data program.

Amiga owners have been waiting since the end of 1985 for some good music software, but it looks like the drought may soon be over. SoundScape, from Mimetics, provides sequencing, internal sampling, MIDI mixing, synchronization, and also makes extensive use of the Amiga's multi-tasking capabilities (for example, their demo had a Jean-Michel Jarre video genlocked to the Amiga while it was running SoundScape—pretty impressive). Mimetics also offers a digital sampling package for under \$100 and a MIDI interface for under \$50. Meanwhile, Roger Powell's Texture has been ported over to the Amiga, thus making Texture one of the few (perhaps only) sequencer programs available for the Apple II, IBM-PC, and Amiga.

Meanwhile, there was a lot happening over in Macintosh land. Composer Laurie Spiegel's "Music Mouse," which now includes MIDI, creates harmonic and melodic accompaniment based on how you move the Mac's mouse. What this means is instant music, but as you become more proficient, you can do just that much more with the program. At under \$60, this is a fun program for the Mac that also has a serious side.

Opcode, whose products are often considered a "best buy" in Mac software, showed Version 2 of their MIDI-Mac sequencer (among other improvements, it now has step editing) and a CZ Patch Editor/Librarian for the Mac. Mark of the Unicorn was demonstrating Performer, a very complete sequencer which, when coupled with Professional Composer, does excellent transcription and notation work. We even have a new Mac interface; Southworth Music Systems showed their JamBox interface, which can record up to four MIDI instruments simultaneously. Four independent MIDI outputs are available to create a star-network approach to MIDI data transmission, and to top it all off, the JamBox reads and writes SMPTE. More and more, SMPTE is being integrated into high-end music products.

With all the talk about Atari, Amiga, and Mac, let's not forget the Commodore-64 and 128. Sonus showed SuperSequencer 64 and SuperSequenc-



er 128, written by the same team that came up with Syntech's Studio I. Both new programs have added a MIDI system-exclusive librarian so that patches and such can be stored on the same disk as sequences; both SuperSequencers also offer several synchronization options and extensive editing facilities.

Roland has been very active with software. They recently upgraded Muse for the Apple II and were putting a big effort into their educational software, marketed under the Musicom banner. Of course, Roland is always good for lots of interesting stuff—I liked their new low-cost drum machines, guitar-to-MIDI converter, MKS-20 piano module, and DEP-5 multi-effects processor.

Before I stray from software entirely, Passport was showing a sophisticated sequencer for the IBM-PC, but of perhaps even greater interest is Passport's licensing of an advanced music printing technology developed by Dr. Leland Smith of Stanford University. I'm looking forward to the day when printing out music will be no more difficult or time-consuming than printing out a letter.

And finally... We're running out of space again, but here are a few last highlights. PPG showed a synthesizer called the Realizer; this one-stop audio Cuisinart produces, processes, records, and sequences sounds. It was demonstrated "realizing" the sounds of FM synthesis and a Minimoog, and the results were very accurate. Brick Audio brought plate reverb technology into the '80s with Proverb. The character is much warmer than the average digital reverb, and thanks to piezo transducers, the sound is clean and bright. Digidesign's "Burner" lets Sound Designer aficionados transfer sound data over to EPROMs for use in drum machines and other EPROM-based digital playback devices. And there were lighting products, and MIDI-controlled this, and MIDI-controlled that...

The techno-overload at a NAMM show is enough to make you want to pack up to the country and take a vacation. But if you do, you might want to take along one of the Genesis-Nova fold-up guitars. It sounds like a joke, but isn't; you too can slip a guitar in a backpack or sling it under your arm. And if you still have a regular-sized axe, no problem—the Tote-A-Note people will be glad to sell you a bicycle accessory that lets you take your guitar along on bike rides.

Hey, not bad for a NAMM report... I only left out 479 interesting products! Oh well, there's always next show. And there's always next month's M.I. Update column; see you then.

# Sound Off Two Ways



## For Studio Demos And For Retail Sales

You and your clients can sell your sound WITH your sound two ways, with a little help from Eva-Tone.

❑ **EVA-TONE SOUNDSHEETS:** They're a high-quality low-cost way to promote studios, new album releases and production libraries. They're a great way to introduce and promote syndicated radio programming. Use them as "audio pages" in magazines, in direct mail, as hand-outs, or as retail products.

❑ **EVA-TONE CASSETTES:** You'll love the sound from our latest generation of duplicating equipment. We can duplicate, label, package and mail your order to your specs. Complete printing and mailing services, too, for one-stop convenience. Your free copy of "Cassette Talk" explains it all.

Write or call today for further information on Eva-Tone Soundsheets, cassettes, printing or mailing. You're going to like what you see. And hear. So are the people who receive your Eva-Tone Soundsheets or cassettes.

**EVA-TONE** EVA-TONE INCORPORATED  
P.O. Box 7020, Clearwater, Florida 33518  
1-800-EVA-TONE (in Florida 813-577-7000)

Circle #072 on Reader Service Card

# THOROUGHbred MUSIC HAS FREE DELIVERY.

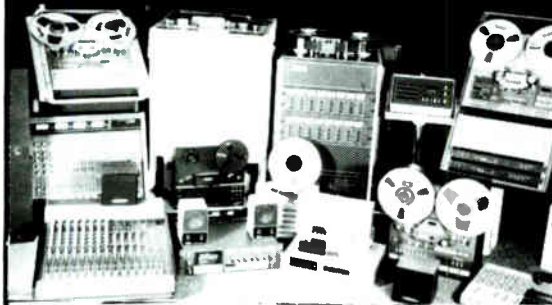

20,000 Square Feet Of  
State-Of-The-Art Pro Audio  
Shipped Daily

**THOROUGHbred  
MUSIC**

2204 E. Hillsborough Ave.  
Tampa, FL 33610  
(813) 237-5597

\* Mail orders only  
shipped in continental U.S.  
via U.P.S.



RECORDERS

MONITORS

AMPS

MICROPHONES

SIGNAL  
PROCESSING

TASCAM

FOSTEX

KURZWEIL

E-MU

ENSONIQ

AKAI

UREI

Circle #073 on Reader Service Card

## Lou Reed Aquits Himself Well With *Mistrial*

by Dan Daley

It's probably a coincidence that the day I sat down to talk with Lou Reed was the same day the obituary of Jean Genet appeared. The late French novelist/playwright's artistic vision was that of a world populated with social misfits and outcasts, for whom brutality was a way of life and redemption a vague and distant hope. Probably just a coincidence.

But that's just the sort of world that the abrasive and unconventional Reed has portrayed lyrically during the course of a career that verges on its third decade. Beginning with his association with the Andy Warhol-influenced New York art band, The Velvet Underground, and through a solo career covering 18 albums, Lou Reed has touched upon themes far beyond the traditional boundaries of pop music, from sexual perversity to drug addiction, and dealt with them in a gritty, realistic and straight-ahead manner, using music more as an assault weapon than a backdrop. His music has been regarded as minimalistic, at times cacophonous, at times just plain noise (viz. his *Metal Machine Music* LP). He is not easily confused with Paul McCartney.

Remaining aloof behind a trademark pair of aviator shades, Reed became the avatar of artistic nihilism for a generation of new wave rockers in the late '70s, who came to regard him as the Godfather of Punk.

His new record, *Mistrial*, is characteristically Lou Reed, with its stripped-down arrangements, and slice-of-life lyrics. But Reed seemed less eager to discuss lyrics than he was to talk about what he feels are the musical accomplishments on his record, which he co-produced with his long-time bassist Fernando Saunders. Reed also did all the guitars on this LP, continuing an approach begun with *New Sensations* and a key to a greater degree of the long-sought element of control in the recording process.

"This record's perfect," he says. "What I mean by perfect is that if someone showed up and gave me a couple

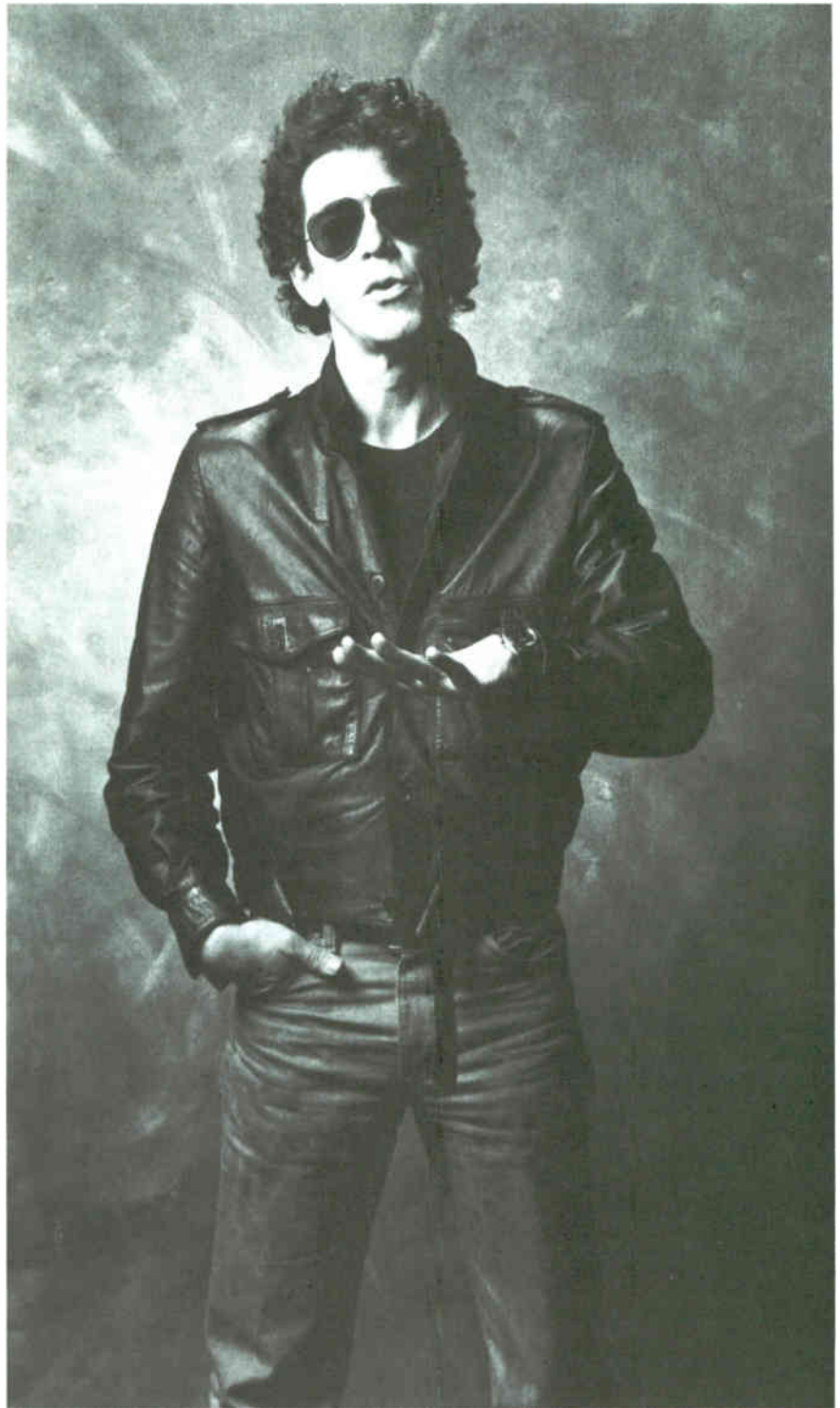

PHOTO: WARING ABBOTT

of dollars and said 'you can go back into the studio to do more work on it,' I'd say that this record is just the way it's supposed to be. It really, really is."

Reed set aside time to begin experi-

menting with guitar sounds in his country home in New Jersey. "I knew what I wanted sound-wise," he says. "A wood guitar through a tube amp, distorted—clean, controlled distortion."



He began writing tunes for *Mistrial* as he worked on the guitar sounds, using a Fostex X-15 as an electronic notepad for ideas and using a drum machine in the composition process, both new techniques for Reed. While he points out that the drum machine didn't affect the songwriting itself, he adds, "It made the process of arranging simpler. It was like having a drummer there with you who doesn't talk, doesn't drink, doesn't need a lot of space and you can turn him off. I also like the accuracy of tempos that drum machines gave me."

**"The heart of a rock and roll record is guitar and voice," says Reed. "If the engineer can't get the voice, the record's doomed."**

Reed's rural residence has a wooden cathedral-type ceiling, enabling him to test out various mic placements, which he was able to successfully translate later to the studio. "We went into [New York's] Power Station Studios and set the guitar and amp up exactly the same as in the house," he recalls. "I was ready to go through the agony of the engineer telling me that the sound was too dark or it was this or that. But lo and behold, it sounded exactly as it did at the house. Then I turned to the engineer and said, 'OK, now it's your turn. You have to get that sound on tape.'"

The heart of a rock and roll record is guitar and voice, not bass and drums, says Reed. His perception that his guitar and voice have been relegated to overdub status in the past partly fuels his dissatisfaction with the sounds of his previous albums. "If the engineer can't get the voice," he states plainly, "the record's doomed."

Wanting to keep the guitar the centerpiece of the record led to Reed's heeding some advice from the Cars' Ric Ocasek, who suggested that Reed use a drum machine in recording. "I told him I have a problem in the studio in that I like to do live basic tracks because I like the spontaneity of how it occurs in the studio for the first time,"

Reed says. "I don't like to work everything out beforehand. I wanted to have the fun of coming up with parts in the studio. But I always find that I lose control of my guitar sound because I'm not near enough to (the amp). The band is playing to that guitar. I'm very unhappy with all of my other records in that aspect, because I didn't get what I wanted out of the guitar." As a result, all but one of the tracks on *Mistrial* features electronic drums, programmed by Saunders with some help from Sammy Merendino, who also added percussion on some tracks. "That way, I could hear the guitar, and if it wasn't working I could stop and adjust the sound," he says, pointing out that his approach enabled him and Saunders to re-record bass and drum parts later, making them better fit the guitar parts Reed had laid down.

Reed credits Saunders' familiarity with his music and temperament as being an important part of the end result: "I'm comfortable with Fernando in the studio. I knew with him that the rhythm aspect of the record would be impeccable. He's aware of the concept of space in an arrangement, and he listens to and understands the lyrics."

Saunders functioned as Reed's technological interlocutor on *Mistrial*, which was fine with Reed, since, as he puts it, "I'm not an engineer. I'm not interested in being an engineer. I'm interested in having fun playing and arranging. Fernando could speak to the engineer to make sure I was getting that sound I wanted. Sometimes he can speak to them better than I can."

"But with [engineer] Bruce Lampcov, who mixed the record, there was no need. He understood from the word go. It was like being in heaven. He understood."

"So often in the studio you're talking

—CONTINUED ON PAGE 121



## Oh Boy! It's John Prine

by Holly Gleason

"I always want to be able to enjoy putting my head against the wood of the guitar and listening to the sound it makes. If the music business takes that away from me, then I'll take myself away from the music business. It's that simple."

John Prine runs a hand through his hair as he considers the statistics of the last 15 years of his life: eight major label and two independent albums, countless performances and thousands of miles. It's a staggering proposition, one the songwriter might be tempted to shrug off—if only it wasn't all so close to his heart.

"At one point I considered getting out of this business so I could remain a musician," Prine confesses softly. "It got to the point where I didn't enjoy picking up my guitar to play, so I figured I'd rather just do something else during the day and then be able to come home and play at night."

These are disheartening words coming from a man who has delivered wrenching portraits of the human condition without moralizing or flinching, from the eternal emptiness of the elderly in "Hello In There" and the inescapable futility of junkie veterans as seen through the eyes of a child in "Sam Stone," to the gapingly unfulfilled middle age of the woman in "Angel from Montgomery."

—CONTINUED ON PAGE 116

### THE FAR SIDE

By GARY LARSON



# Smiling in the Studio with Narada Michael Walden and George Benson

by David Schwartz

"The art of a producer is to take what we have to work with and make it accessible as well as artistic; to connect that artist with the audience without losing integrity," says Narada Michael Walden. "We don't have to be a Michaelangelo every time out, but it is important to let people know that you're not trying to put one over on them."

Walden's career as a record producer has spiraled to the top of the charts since his tenure drumming with John McLaughlin a few years back. These days he spends his time writing songs and producing hits in his San Rafael, California-based Tarpon Studios (formerly Tres Virgos Studios) for artists including Aretha Franklin, Clarence Clemons, Whitney Houston, Sheena Easton and Lionel Richie. He's also been collaborating with George Benson on his new album, a multi-producer affair.

"We're using three producers," says Benson. "We started with four, includ-

ing me, but I got crowded out by the songs that were presented to me by the other three producers. Narada is doing most of the tunes. He came in with five great songs. I ran past him in an airport not too long ago just long enough to say, 'Hey, man, let's talk on the horn!' and, lo and behold, a few weeks later we were producing an album."

Benson is also working with Kashif at his home studio in Connecticut. The third producer on the project is Tommy

Lipuma, Benson's associate through three platinum and four gold George Benson albums, including the multi-Grammied *Breezin'*.

"Narada is like a lightning bolt," says Benson. "He's really good at what he does. He understands the modern record buyer and the modern listener very well. I'm relying on him a lot in certain areas, but I'm trying also to stick to some of the things that have been working for me."

Walden sees his role on Benson's album as very simple: "To help serve George's mission and get his best on the table, and hopefully have something that in 20, 30, 40 years, we can look back on and be proud. I feel really blessed, because George is someone who I've loved for many years and I've always wanted to work with him... but I didn't know it would come so soon. All of a sudden there was a chance for me to work on this album, and I was very honored. I had sent him a piece of music called 'Teaser.' He liked it and responded by coming out here with a song he was working on, and we had a great time embellishing on it.

"I don't like to think of myself as a producer so much because I don't really relate to what I do in that way," Walden continues. "I relate more as a coach, like the guy who stands on the sidelines and roots for the cat. So I just give a push, to find the best vehicles and to leave plenty of room to let happen what has to happen.

"People like that cool sensibility George has. So whether we want to do a smokin' dance track, or a stock R&B thing or a totally pop ballad that

—CONTINUED ON PAGE 124



*Narada Michael Walden occupied the driver's seat for the Percussion Finale to the San Francisco Music Fair this summer, which included Steve Smith (ex-Journey), Santana's Michael Carabello, Huey Lewis' Bill Gibson, the Tubes' Prairie Prince and Buddy Miles in this all-star drum jam.*



PHOTO: MR. BONZAI



**THE REFERENCE GUIDE YOU'VE BEEN WAITING FOR!**

THE

**1987**

# MIX ANNUAL DIRECTORY OF RECORDING INDUSTRY FACILITIES AND SERVICES

Since 1977, each issue of *Mix* has included a directory of recording studios or other essential industry services. Now, for the very first time, these up-to-date and comprehensive listings are being collected into one convenient volume.

The first *Mix* Annual Directory is a compilation of our listings published during 1986, with changes and updates supplied by the companies listed. Also included will be special editorial features covering the year in audio. **Publication date is February, 1987.**

Now you can have this valuable information at your fingertips in one easy-to-use directory:

- **Recording Studios of the U.S. and Canada**—Over 2,000 studio listings, broken down by geographical region, including equipment, size of studios and control rooms, personnel, areas of specialization, rates and other useful information.
- **Mastering, Pressing, Duplication Facilities**—Over 450 listings of mastering houses, pressing plants, and tape duplicators. Includes rates, production capacity, equipment used.
- **Video Production and Post-production Facilities**—Nearly 1,000 video production companies, including post-production/editing, on-location production, and audio post-production for video. Listings give personnel, rates, and equipment.
- **Studio Designers and Equipment Suppliers**—More than 500 studio designers, acoustical consultants, audio/video equipment dealers and installers. The most comprehensive directory of its kind.

The *Mix* Annual Directory will retail beginning in December for \$24.95. By placing your order by November 30, you'll receive this indispensable reference guide for only \$14.95 per copy. Whatever your occupation in recording, sound or music, the *Mix* Annual Directory is a resource you can't afford to be without. Order yours today!

Please send me \_\_\_\_\_ copies of the 1987 *Mix* Annual Directory of Recording Studios and services at the pre-publication price of \$14.95 each. (Please add \$2.00 per copy postage and handling. California residents add 6% sales tax.)

**Order Now and Save 40%  
Off the Retail Price!**

I enclosed \$ \_\_\_\_\_  Check  Money Order

Please charge to my  Mastercard  Visa

# \_\_\_\_\_ Exp. Date \_\_\_\_\_ Signature \_\_\_\_\_

Name \_\_\_\_\_ Title \_\_\_\_\_

Company \_\_\_\_\_

Address \_\_\_\_\_

City \_\_\_\_\_ State \_\_\_\_\_ Zip \_\_\_\_\_

Mail to: MIX ANNUAL, P.O. Box 2526, Berkeley, CA 94702. (Offer expires November 30, 1986. Annual will be shipped by February 15, 1987.)

World Radio History

—FROM PAGE 113, JOHN PRINE

But John Prine is not a bitter man. The flip side of his *weltanschauung*—in “Dear Abby,” “Please Don’t Bury Me,” “Sabu Visits the Twin Cities Alone,” and a host of others—provides evidence of that, and his insistence that he has no axe to grind with the music industry removes any lingering doubts you might have. The Chicago native is determined to enjoy life, not waste it brooding over such mundane matters as the record business’ failure to do right by John Prine.

“What can I say? I just didn’t fit into what they do,” Prine allows of his relationship with big-time record companies. “I never had any battles with the people at Atlantic [his label from 1971’s *John Prine* through 1975’s *Common Sense*—they were as helpful as they could be. It’s just that they didn’t know what to do with me. They’d be looking at me, going, ‘What am I supposed to do with this?’ and then they’d shelve [the record] until they got something they could put on the radio.

“I’ve got no quarrel with those people. It’s just that I don’t need ‘em.”

Proof positive: Prine’s own Oh Boy label, which he launched with a single (“I Saw Mommy Kissing Santa Claus”) in 1982 and followed with 1984’s *Aimless Love* and the brand new *German Afternoons*. “This way,” says Prine,

“I’m making better records and making exactly the kind of music I want, instead of worrying about making records for radio.”

Though there was a five-year silence following his third (and last) Elektra/Asylum release, *Storm Windows*, in 1980, Prine and his audience managed to find each other when *Aimless Love* appeared to loud applause from fans and critics. For John Prine, doing it himself has proven to be the recording and marketing methods most in sync with his own way of thinking.

“The record business is based on turning out records as fast as you can,” Prine shrugs. “When I was on the labels, I couldn’t wait to get finished [recording] and get on the road. Then I didn’t care if I didn’t make another record for three, four years. Now, everything seems to fit in and make sense. I make my records; I take the checks down to the bank and pay all the bills for the record. Then I take what’s left and I go buy myself a boat.

“Now *that* makes sense!

“See, I’d never planned on doing this for a living. I mean, the entertainment business seems so goofy. There are so many flakes and egos. . . I figure most of ‘em sit up at night and try to figure out who to be.

“Anyway, I know it sounds like I keep coming back to the same thing,

but doing things this way makes sense to me.”

It also means the retiring Nashvillean has to take a more active role in his career than ever before, but that’s a role he doesn’t mind: “I’ve got my own record company, so I’m either in the studio or on the road or off somewhere writing,” he explains with a laugh. “It’s the hardest I’ve ever worked.

“When you start your own label, you’re going to sell fewer records, because you don’t have the distribution. It takes time to build that up. But I own all of these records I’m making, so if I decide to sell ‘em to a major label they’ll have to pay me for them.”

Don’t think because Prine has gone indie that there’s no interest in his work from the outside. Several labels have approached him, but he’s not selling. On his own, he says, “I can make a record for \$20,000 and actually see a profit.”

More important than the obvious cash-and-carry advantages, there is also the satisfaction of recording his songs the way he wants to record them. In the studio, Prine is slave to no man nor format, and that’s the way he likes it. It’s given him the freedom to create a wholly acoustic offering such as *German Afternoons* with nods to pure bluegrass (A.P. Carter’s “Lulu Walls”



## FIRST THE ULTIMATE PIANO.

This is the 9'6" Imperial Bösendorfer Grand. The ultimate in rich, sustaining tone. Since 1828, Bösendorfer innovations have made it the premier piano for recording artists everywhere. Every handcrafted feature, from its unique case construction to its 97-note scale . . . from its unique bass bridge design to its leather key bushings makes Bösendorfer the world's finest piano.

Now it becomes part of a revolutionary recording aid. With it, your studio can have a major competitive advantage.

**Bösendorfer**  
PIANOS  
*of Vienna*

A Division of Kimball International, Inc.  
P.O. Box 460-R Jasper, IN 47546 (812) 482-1600



and the new arrangement of Prine's own "Paradise") without apologizing or being sent back to trendy it up.

When Prine makes a record, he says, "I follow the songs. I don't plan them out in advance as a record. I usually end up with a strange collection... but at least I know I've done what's best for the songs."

Though Prine's songwriting has progressed from the straight-ahead storytelling of the earlier albums, one constant has always been his ability to hit that emotional bull's-eye inside the listener. "The first time I ever played my songs for anybody, it was just a couple of people in a room. They didn't go, 'Gee, that's nice—you put a song together'—they said 'That's something I've been trying to say for a long time.'"

"Suddenly, you don't feel so alone with all those feelings you have that would be so hard to tell somebody about in everyday conversation.

"It's a great feeling when you put something in a song and other people say that's exactly how they feel. That's been the most gratifying thing about songwriting for me. Being able to put those feelings down has always been a real outlet for me."

Somehow, Prine manages to turn isolation into a universal rallying point. His fans are ardent, judging from the consistently healthy turnout at his con-

certs and by the artists who choose to cover his songs—including, over the years, Don Williams (who went to Number One with "Love Is on a Roll" a couple of years back); Gail Davies, Tammy Wynette and Johnny Cash,

---

"Words come easy to me, so it's just a matter of making sense of 'em."

---

who've all cut "Unwed Fathers"; Bonnie Raitt, for whom "Angel from Montgomery" has been a signature tune for more than a decade; and even Bette Midler, who recorded "Hello in There" 15 years ago.

They're intricate songs, but Prine believes that "you've got to leave a

certain amount to the people listening. I hope I don't write songs where I've got to poke people in the ribs and say, 'You get it?'

"I don't pick and choose subjects. I just sit down and a bunch of words'll come to me. Then I just try to sort 'em out. Words come easy to me, so it's just a matter of making sense out of 'em."

Which probably accounts for some of Prine's more whimsical moments. In "The Bottomless Lake" (on *Aimless Love*), a family goes out for a Sunday drive and never returns; in the new LP's "Linda Goes to Mars," a wife's "inner space gets tortured by some outer space unknown." Granted, some of his songs' titles really are inspired by the photo captions in the *National Enquirer*. It's quite plausible to think his biggest goals in life include "spending more money than I make" and "finding a '54 Bonneville convertible in good shape."

Otherwise, Prine is quite content to keep writing songs and making records, sketching life as he sees it for those who care to listen. The former postal worker is not interested in winning converts with a hard sell: let us not forget that Prine once refused to let Atlantic Records release "Dear Abby" as a single because "I figured those fans'd be more trouble than they're worth if they thought all they



## NOW THE ULTIMATE RE-CREATION.

This is the Bösendorfer 290-SE. The first computer based piano performance reproduction system. It is not a player piano. Rather, a way you can store, edit and play back any performance on the Bösendorfer Imperial Grand. And re-create every note, every nuance of the original performance.

With this system, you can save vital studio time. Review various mike placements and accomplish other technical functions without the player's presence. By using edit functions, the player can perfect his solo part before the session begins. Bösendorfer 290-SE. Learn more by writing us today.



Bösendorfer 290-SE.

**Bösendorfer**  
of Vienna  
**PIANOS**

P.O. Box 460-R Jasper, IN 47546 (812) 482-1600

Circle #074 on Reader Service Card

# Take Your First Step Toward A Career In The Music Business



- Highly selective, two year training program
- Five campuses throughout North America
- Current theory mixed with practical hands-on training
- Modern state-of-the-art 24-track recording studios
- All classes taught by qualified, working professionals
- Job placement assistance

For a free brochure

**CALL 213-467-6800**



**TREBAS INSTITUTE OF RECORDING ARTS**

6602 Sunset Boulevard Hollywood, California 90028

Circle #075 on Reader Service Card

were gonna hear was songs like 'Dear Abby.'"

Conscience and pragmatism are still John Prine's guide. He's learned to trust them more and more over the years. If it ever comes to the point where he has to get out of the music business altogether, he figures he can open a worm farm behind his house. "I'll put up a sign out front that says 'Live Bait' and just talk to the people who come by. People might think I'm kidding, but I'm not..."

*(All of John Prine's Atlantic and Elektra/Asylum releases are still in print and are fairly easy to find. Aimless Love and German Afternoons are available at Prine's live shows or by mail for \$10 each postpaid, from Oh Boy Records, P.O. Box 36099, Los Angeles, 90036. As for the meaning of the new LP's title, Prine offered a vague and unsatisfying explanation in a recent issue of Musician but hints that a song of the same name might appear in the future.—D.G.)* ■

## Jimmy Maelen:

### The Man Behind The Beat

by Chris Doering

Dire Straits' *Brothers In Arms*, Bryan Ferry's *Boys and Girls*, James Taylor's *That's What I'm Here For*, the "Dancing in the Streets" remake Bowie and Jagger donated to Live Aid, Madonna's single "Over and Over," the 12-inch mix of Pat Benatar's "Sex is a Weapon," the new Grace Jones album, Roxy Music's *Avalon*... Jimmy Maelen is definitely one hot percussionist.

It's a long way from the black and Hispanic Brooklyn neighborhood where he started singing in doo-wop groups (and interrupting rehearsals to bang on the bongos or congas that were always around) to the exclusive circle of "first call" New York session players. Maelen's winding career path took him through ten years of hardcore Salsa gigs at the Corso and other Latin clubs around town.

Then he and Larry Harlow put together a "Chicago-type band" called Ambergris. It never really took off, but it did bring Maelen to the attention of Electric Lady co-owner Eddie Kramer, who gave him his first session work. When Wicked Lester, a band sharing Electric Lady and Maelen's percussion chops with Ambergris, became Kiss, his metamorphosis from doo-wop lead singer to rock and roll percussionist was complete.

"Word just spread around, and now I'm doing all these records," Maelen

Experience the cutting edge of musical technology...

**Gand  
Musitech  
"86"**

**Chicagoland's  
Consumer  
Music Show  
Sept. 13 & 14**

Holiday Inn Convention Center,  
5300 W. Touhy, Skokie, IL.

Over 40 Hi-Tech Manufacturers showing all the latest products  
KEYBOARDS • COMPUTER SOFTWARE • RECORDING • PRO SOUND  
GUITARS • AMPS • ELECTRONIC DRUMS • ACCESSORIES

CLINICS by many top-name artists and producers including:  
SAMPLING SEMINAR by Keyboard Magazine's TERRY FRYER  
Guitarist ALLAN HOLDSWORTH, performing on the SynthAxe,  
Synthmaster HERBIE HANCOCK on the Fairlight Series III.

Special DISCOUNTED PRICES on display equipment  
FREE DRAWINGS FOR EQUIPMENT DAILY

For tickets and information, contact:

**Gand Music & Sound**

780 Frontage Rd. Northfield, IL 60093 312-446-G-A-N-D

Circle #076 on Reader Service Card



# THE COMPLETE DRUM INTERFACE.

There are a lot of drum interfaces on the market that can do one or two things extremely well. However, no other drum interface comes close to matching the complete range of features found on the new MTM from Simmons.

MTM is an eight channel fully programmable interface unit that converts drum pad, tape or acoustic drum signals to trigger both MIDI and non-MIDI electronic sound sources under full dynamic control. Its signal processing capabilities are a result of extensive research and development by Simmons Electronics culminating in unique applications of existing interface technologies combined with totally new innovations.

Designed primarily for use with Simmons electronic percussion synthesizers, the MTM enhances the dynamic range and performance of the SDS5 and SDS7 by placing a computer between the drum pads and drum brain. MTM will also act as a fully assignable MIDI interface that can produce unlimited melodic, harmonic, tonal and rhythmic effects via drum pad triggering when used in conjunction with MIDI sound generators.

MTM has many other applications as well. For example, it can be used as an interface between acoustic and electronic drums, acoustic drums and MIDI

equipped synthesizers or in the recording studio for converting audio signals on tape to MIDI code.

As the complete drum interface, MTM allows creative flexibility for programming several signal processing parameters, each of which is independently adjustable.

## SIGNAL PROCESSING CAPABILITIES.

### ● TRIGGER PROCESSING

Threshold, the dynamic level an incoming signal must reach before it is recognized as a trigger, is programmable for Absolute, Initial, Fractional and Cross Channel characteristics.

Hold-off is used as a programmable gate system which "cleans up" incoming acoustic and electronic trigger

signals while allowing a controllable time period for each channel during which MTM will not recognize an incoming signal as a trigger or generate an output.

With MTM's on-board micro-computer, dynamic enhancement of

trigger signals is possible through velocity tracking, compression and expansion.

### ● MIDI PROCESSING

MTM's MIDI capability is designed for full programmable implementation including note assignment, channel assignment as well as

patch and program changes.

### ● EFFECTS PROCESSING

Repeat Echo, Sequencing and Note Layering are just a few of the MTM's programmable on-board effects. Repeat Echo is a single note retriggering effect that is adjustable for echo decay and echo speed. The Sequencing function allows programming of sequences up to sixteen notes on each drum per program. Pitched and non-pitched chords under full dynamic control are made possible by MTM's Note Layering effect.

### ● CHANNEL ROUTE PROCESSING

MTM's innovative design permits independent control of input to output channel routing.

### ● OUTPUT PROCESSING

Programmable dynamic control of pulse height and width allows triggering of non-MIDI drum machines requiring a voltage pulse.

## CHALLENGE YOUR CREATIVITY.

Just as Simmons' original SDS5 completely changed the way drums were played, the flexibility and features of the MTM will challenge the creativity of even the most sophisticated electronic musician.

So when it comes to completing your drum interface, choose the Simmons MTM. Anything else could be a complete disappointment.

# SIMMONS

The first name in electronic drums.

Group Centre Inc., 23917 Craftsman Rd. Calabasas, CA 91302 (818) 884-2653

Circle #077 on Reader Service Card

### SPECIFICATIONS

32 character LCD display; 1/4" and XLR inputs with individual sensitivity control; 1/4" output with master output control; MIDI in, MIDI thru and 2 MIDI out connections, selector pad interface port for access to 16 pre-selected programs, 100 program memory capacity

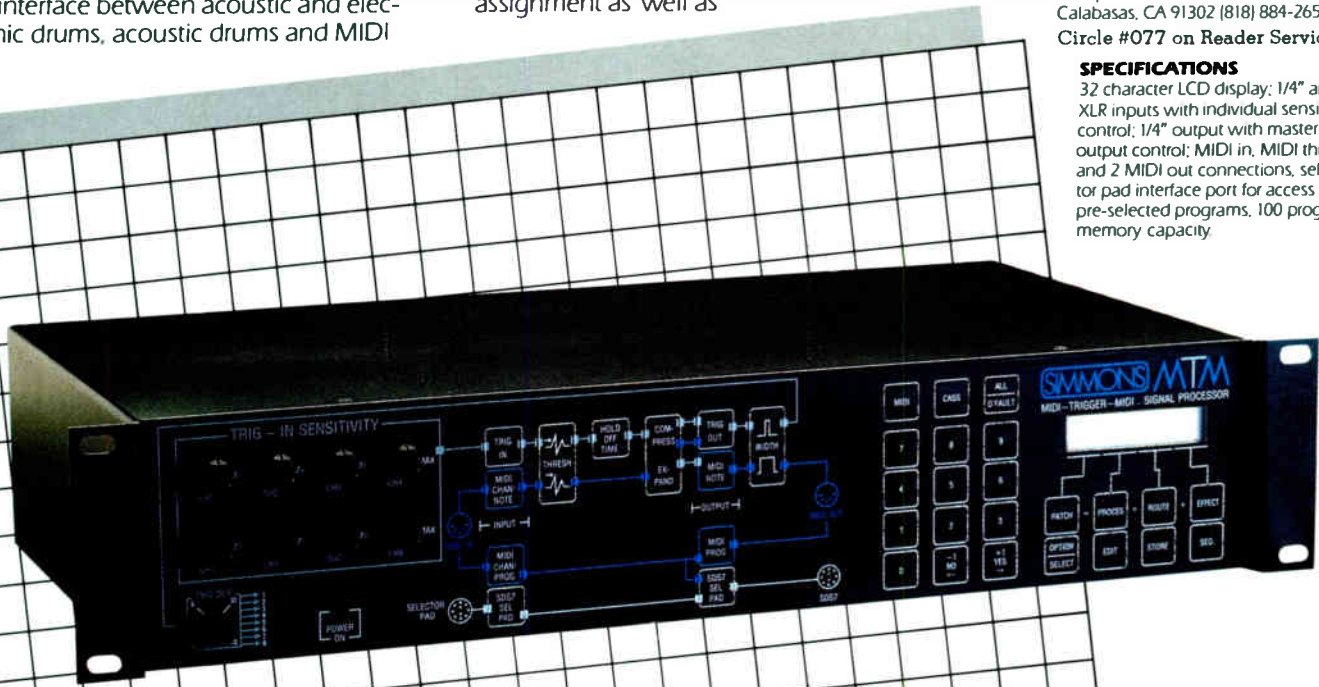
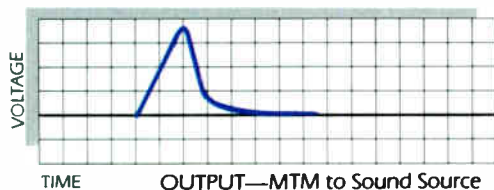
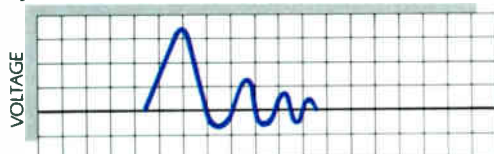

## Attention: Northwest Studios!

The January, 1986 issue of *Mix* will include our annual listings of studios in your region. Featured will be the studios of Northern California, Northern Nevada, Oregon, Washington, Idaho, Montana, Wyoming, Utah, Alaska and Hawaii.

Don't miss this **once-a-year** opportunity to inform the industry about the equipment and services your studio has to offer. If you have not received a questionnaire, call Lauri Newman at (415) 843-7901 today!

**Deadline for Returning  
Questionnaires:  
October 1st**



**Burlington**  
AUDIO TAPES INC.

TOLL FREE 1-800-331-3191  
IN N.Y. (516) 678-4414

# 3M

**Audio Recording  
Scotch® Tape**



Full Line of 3M  
Audio & Video Tapes.

In Stock and Priced Right.  
Reels, Boxes, Custom Cassettes,  
Leaders and Splicing Tapes.

**HARD TO GET ACCESSORY  
ITEMS**

106 Mott Street, Oceanside, New York 11572

Circle #079 on Reader Service Card

muses. "A lot of people got into the Bryan Ferry and Roxy Music albums, too, and that's helped me with a lot of artists."

The man's too modest. A self-taught player ("there was no one to study with in those days"), he's the one to call when your rhythm track lacks that certain spice, or when you need to humanize your drum machine. Lately he's been getting the latter type of call a lot. "Shakers, tambourines and some of the other sounds are very mechanical," he explains. "As sound effects, they're great, but those little notes in between are just too perfect for straight-time sequences. I still play it in time, but it's a feel the machine can't get yet."

The System is one of Maelen's major clients for this type of work. "I did both their albums and all of the stuff they produce. It's totally electronic, but I come in doing live stuff. They prefer it that way. The only thing they don't do is percussion."

Although he's grounded in Afro-Cuban patterns, Maelen doesn't limit himself to traditional percussion. "Rock is pretty much tambourines, big cowbell sounds," he says. "Congas you don't use too much. Now they're starting to use timbales a lot for fills. They're a little more exciting than toms." Despite the infrequent use he makes of them, Jimmy brings his own congas to most sessions. "Then I have a huge case filled with bongos, sound effects, shakers, bell trees, chimes, a couple of Brazilian instruments and various cowbells that I lug around. Most of the time I'll ask, 'Is there anything in particular you want?' Everyone's trying to get something they've never heard before on their record, but they end up staying with the basic stuff, which always works best anyway. I'm a big fan of playing simple and helping the track along. It's better just to support the rhythm, which is what percussion should be doing."

When that one-of-a-kind sound is needed, Jimmy will go into his bag in search of it. "If there's time, I kind of reach in and see what's there. I go more, believe it or not, to the toy store. Little kid chimes, which are just great in bell trees. Baby rattles—wife bought our eight-month-old daughter a rattle a couple of days ago, and I copped it, because it sounded great. Little rubber hoses that look like vacuum hoses. Take those and put them through a DDL—great effects. Those are all over the *Boys and Girls* album."

The Ferry solo project introduced Jimmy to another form of musician-machine interaction. "Bryan has an interesting technique. He records a drum machine first, and he'll put some more stuff on with the drum machine.

Then the drummer comes in, records on top of the drum machine and Bryan removes the machine, which I think is a great idea. When we did *Avalon*, there was a track with synthesizers, bass, and Bryan's reference vocal. Andy [Newmark] and I played to the drum machine live, then we removed the machine and I went back and did three or four overdubs."

Albums are the more visible part of his job. But like most New York players, Maelen spends most of his time in the studio working on jingles. "Sixty-second jingles, it's like one hour—you're in, you're out. The music's always different. This morning I did a Crystal Light commercial, a Caribbean kind of thing. Jingles are easy because everything's written out and the arranger's there. They pretty much know what they want, and they'll call you if they want a particular instrument.

"For a jingle, you have to really pay attention to the click. But from doing it so long, once it's there at the right volume in the phones, I don't listen to it anymore. Everybody automatically goes right into it. On certain records it works great, but on others it's back to that mechanical feel. You can find yourself listening to it and being controlled by the click, instead of everyone listening to each other play."

Jimmy doesn't get out to play live much anymore. One of the exceptions was the Winter NAMM show, which he attended as part of a manufacturer's band. "It was very exciting, incredibly noisy but really nice," he recalls. "The band was a lot of fun. It was nice to do four or five sets a day. It was like working a Latin gig, where you play for 45 minutes, take a half-hour break and come back."

On breaks, "all I did was walk around and look at instruments. I ran into so many friends there that I hadn't seen in ages. Percussion is getting very electronic-oriented, so I was looking around to see what new things are coming out. I think it's close to getting there, but most of the sampling percussion sounds I hear don't seem right yet. Congas don't seem to be working out too well. There's just too many little intricate notes in between when you're playing, little things that you're doing with your fingers that you can't pick up when you're sampling. You could, but you're going to take up too many channels doing it. You'd have to sample seven/eight sounds to get a conga sound."

As an alternative to an all-electronic approach, Jimmy is investigating the possibility of integrating electronic percussion into his existing setup. "I want to try playing congas and triggering different things with my foot, using a bass drum pedal. I need a



little more than a drummer because there are so many sounds that I have to deal with. That's what I'm trying to get together now, so I'm very interested in some of the new sampling synthesizers."

The electronic evolution is opening new directions, and the Maelen approach to the overall rhythmic flow of a piece of music is ready for them. "I like to get the eighth notes or sixteenth notes happening," he asserts, "and I like to hear that spread all the way across. Something in the upper register, not too obvious, just blending in with the drums. Shaker and hi hat or two hi hats split left and right. Then a tambourine or something to help the snare with the backbeats, and then try the sounds." Hearing him speak so casually about the rhythmic magic that very often separates the hits from the stiffs, it's easy to see why so many people rely on Jimmy Maelen's bag of tricks. ■

—FROM PAGE 113, LOU REED

about stuff that can't be explained; things that are intangible. Fernando knows a lot about what I like, so he would get a lot of that taken care of up front. But other intangibles, the engineer can either understand what you're after or he can't—and if he can't, you're

in trouble. You're beyond technical things; now you're talking feel, you're talking taste. And you can't give someone taste."

If *Mistrial* has a musical coherency, it is perhaps because Reed did his best to keep his creative environment concentrated and focused. "I run really small sessions," he says. "I don't believe in phone calls; I don't believe in friends coming up; I don't believe in record company people coming up. I don't like to have a lot of people and I don't like surprises. There were basically only four people in the studio: two engineers, me and Fernando. I'm only as good as the people I'm around. My main requirement for the studio was that the environment be calm—no tension, no egos. That's how I could get the record I wanted.

"I also don't like to switch people in the middle of a record. I really like to stay with the same ones. I'll bend over as far as possible to do that because I don't like introducing new personalities in the middle."

Mixing and mastering took on new aspects for Reed this time, too: "I learned that mixing is an art," he says, attributing much of his satisfaction this time to Lampcov's chops. "I've been so unhappy with all my mixes prior. I always dreamed what it would be like to have a great mix, not to have to sit

there and fight with the engineer and be told that you don't know this, you don't know that. It's my record. Why shouldn't it sound the way I want it to? This time I had enough money so that if I didn't get what I wanted, I'd shut it down and wait till I did."

*Mistrial* was digitally mastered at the suggestion of Lampcov, although here too there were overtones of Lou Reed versus technology. The mastering on the Sony 1630 was characterized by Reed as "an adventure, especially if you don't have the technical knowledge and you're just operating on ears." Reed maintains that in transferring between two Sony 1630 digital 2-track decks there is a compatibility problem which results in a degree of loss in bass response. "If you want to retain that big stereo spread, you have to go from a 1630 to a 1610," declares Reed. According to the artist, Sony's technicians said the problem didn't exist until he sat them down and showed them. "Fernando and I demonstrated to them that for all the knowledge they had, they were wrong, and that something that they said couldn't happen did happen. Now they all know that there's this thing that exists and they'll be talking to Sony about it."

[Masterdisk's Scott Hull, who did the digital editing, said he was initially

# GLM™



Advancing technologies can move at such a rate a new product may blur by without offering the true explanation of why it was developed in the first place.

Quite simply the new GLM is a superior studio quality microphone that incorporates all the benefits of its larger more conventional predecessors.

Crown technology has always ignored the conventions of new product development and recognized no limits in achieving the ultimate in professional quality.

See your nearest Crown dealer. Find out how this incredibly small microphone achieves such a high level of performance.

Crown International, Inc., (219) 294-8000  
1718 W. Mishawaka Rd., Elkhart, IN 46517

 **CROWN**

Circle #080 on Reader Service Card



## The New Musician Begins Here

The Center's new Music for Media program features 6 months of equipment-intensive training in electronic music synthesis, MIDI SMPTE technology, sound sampling, and computer sequencing. On individual workstations, students learn composing, arranging, and underscoring electronic music for film and video, jingle work, label recording, and live performance.

Call (212) 929-6999 for admissions information.  
Get your hands on the future of music.

CENTER FOR THE  
**MEDIA ARTS**

226 West 26 Street, NYC 10001

Circle #081 on Reader Service Card

skeptical of Reed's claim, but after scrutinizing the sound, admits, "although it's quite minor, it's there. Lou was right."]

The album was cut using direct metal mastering, and Reed credits Masterdisk's Bob Ludwig in that department: "Without his help, this record would not have been possible. He went out of his way to help. The test pressings were incredible. I never heard a record sound like that. That was Bob's doing and I'm in debt to him for that."

As pleased as Reed apparently is to discuss the technical side of things, he is less loquacious on the subject of lyrics, generally regarded as his strongest suit. If there is a lyrical theme to *Mistrial*, Reed says he doesn't see it. "That's for you to tell me," he responds. "I don't sit around with a theme inside me when I write." As for the significance of the title track, he says simply that "Mistrial" is the title cut and the first song on the album, though he later adds, "Mistrial means that even though you've been tried but not convicted, they can still go after you. I played the song for my mother and she said, 'What is that song?' I said it's called 'Mistrial.' She said, 'No, I mean the one that says, 'Don't point your finger at me.' That's the line in the song that my mother keyed into and I think that's the key to the song, that attitude, and that's what 'Mistrial' is about."

Is there something autobiographical about that feeling? "No. People seem to take (my songs) that way," he says, "which is kind of interesting. But in this case, I just like the attitude of the (character) who is singing 'Mistrial.' One interviewer asked me, 'What are you feeling guilty about Lou?'"—Reed shakes his head in disbelief—"You have to keep in mind how literal people can get sometimes."

"There aren't enough things that happen to me to write about. But I take things that happen to other people and put them together with what happens to me and write it as though it were all happening to me. It's more fun and interesting that way. It can't always be, 'What would I do?' Sometimes it's, 'What would be fun to do?' I'm the one who's writing; I can make anything happen I want. There's no one to stop me. I can make a character cross the street, I can have him find a hundred dollar bill in the street, I can have him get run over in the street. I can do anything I want to him."

If it's mentioned that getting run over by life's circumstances is a regular occurrence in Reed's lyrical world, he replies, "Not a lot of great things always happen in the world. . . I don't like to glitz things up and make them

**Music Annex**

THE TRADITION CONTINUES...

TWO NEW FULLY-EQUIPPED MEDIA PRODUCTION STUDIOS  
CONVENIENTLY LOCATED IN DOWNTOWN SAN FRANCISCO

69 GREEN ST., 2ND-FLOOR  
SAN FRANCISCO, CA 94111  
(415) 421-6622

970 O'BRIEN DRIVE  
MENLO PARK, CA 94025  
(415) 328-8838

EXCELLENCE...  
from start to finish

Circle #082 on Reader Service Card



# They searched for the best sequencer...and found PERFORMER

mid-rate rock ♪ = 110  
guitar  
Echo device

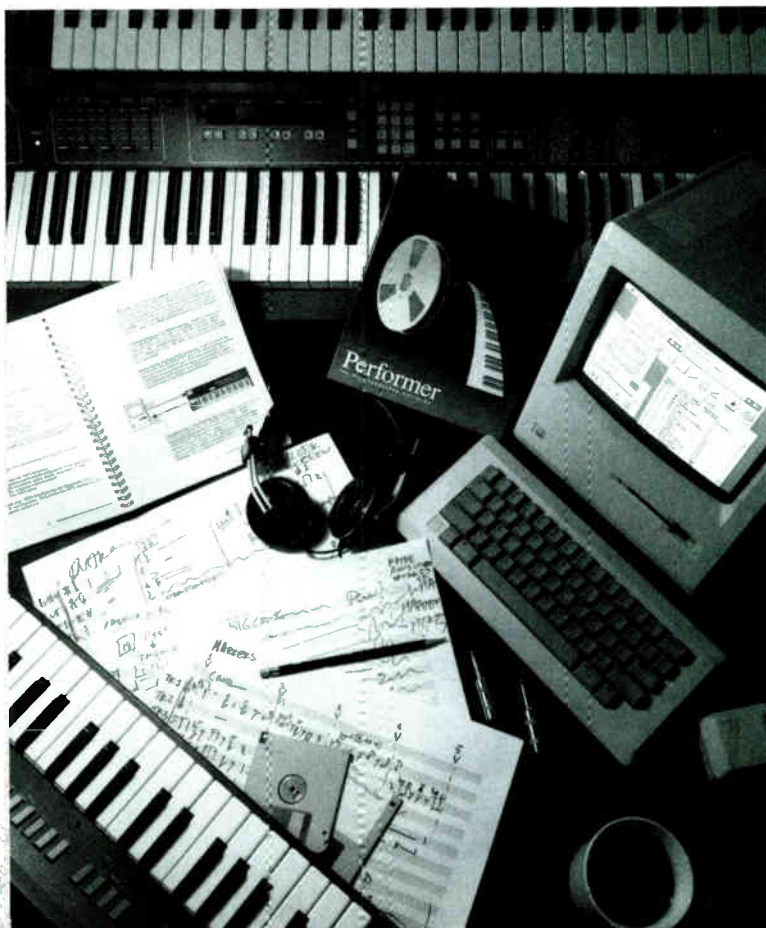

**Performer** for the Apple Macintosh has the specs to set it apart from other sequencers: 50,000 note capacity, 200+ tracks, 480 parts-per-quarter note beat resolution, real-time and step recording of *all* MIDI events as well as MIDI sync and song pointer. **With Performer**, you can edit single events, entire regions—even *non-linear data*—including durations, velocity, controller information and more. Create crescendos and fades in seconds. Program filter sweeps. And change from legato to staccato and back. **Performer** is also compatible with the Professional Composer manuscript printing program.



Circle #083 on Reader Service Card

**And best of all**, **Performer's** on-screen "tape deck" controls are easy to use. If you're familiar with multi-track recording, you'll be cutting tracks within minutes. **Keyboard Magazine** says, "...the attention to musical detail evident throughout **Performer** is remarkable." Find out why **Performer** is the sequencer of choice for music professionals everywhere. Write for a free brochure or call us at (617) 576-2760 for the **Performer** dealer nearest you. Our address is Mark of the Unicorn, Inc., 222 Third Street, Cambridge, MA 02142.



LARGEST INVENTORY OF  
RECORDING EQUIPMENT  
AND SUPPLIES - IN STOCK!!!

SHIP SAME DAY!!!

TASCAM	CARVER	OTARI	RAMSA
AKG	FOSTEX	LEXICON	TAC/AMEK
AKAI	CROWN	NEUMAN	TOA
ALESIS	DBX	ORBAN	U.S. AUDIO
AMPEX	DENON	RANE	VALLEY
APHX	EVENTIDE	SHURE	WHITE
ASHLEY	JBL-UREI	SONY	XEDIT

ALLEN & HEATH, AURATONE, AUDIO  
TECHNICA, ELECTRO-VOICE, HILL AUDIO,  
KLARK-TEKNIK, ROCKTRON, SENNHEISER,  
SOUNDCRAFT, AND MANY OTHERS ...

Call or Write

**ACE MUSIC CENTER**

13630 West Dixie Hwy.  
North Miami, FL 33161  
305-891-6201  
Ask for Jon or Cruz

Circle #084 on Reader Service Card

**Big Mo**  
Goes Everywhere



- \* Dual 24-Track Studio
  - \* New with Dolby A
  - \* Live Recordings
  - \* Remote Broadcasts
  - \* Audio for Video
  - \* Most Competitive Prices
- 12255 Viers Mill Road  
Wheaton, MD 20906



(301) 946-7364

Circle #085 on Reader Service Card

glamorous. It's just a rock and roll record."

Reed allows a small peek into his personal songwriting process: "Sometimes lyrics come first, sometimes the song comes, sometimes they come together. Generally speaking, what I need is a title. If I have a title, the song just flows. And some of the songs can change radically from what they were originally about."

From *Mistrial*, Reed uses "Video Violence"—his graphic and pulsatingly hypnotic commentary on the desensitizing effect of telegenic mayhem—as an example: the song began as "Coriolanus," a Shakespeare tragedy. "I was writing about the king in the play, and then I threw it away and 'Video Violence' came out instead. I don't know where it came from. It's my favorite on the record," he added, "and my favorite from the last couple of years. I think it's one of the best things I've ever done. Ever. I knew it the day I wrote it."

Although Reed disputes the sense

of anger that might be inferred from several of the songs on the record, he agrees that "Spit It Out" is a healthy re-direction of that emotion, "but a little Machiavellian," he smiles. "Healthy Machiavellian."

There was a point just after the record was completed when Reed took off to Florida for a break. He took along cassette copies of the mixes to listen to, but found he was becoming obsessive about hearing small, virtually imperceptible mistakes here and there on the album. "I knew I couldn't stop listening and going over and over it," he recalls, "so I just ripped up the cassette."

But in the end, the accomplishment of the emotional whole overcame the existence of tiny flaws of execution that only Reed himself could notice. He realized that the performances were faithful to the gut instincts that produced the songs in the first place. "See," he says, looking right at me, "I can't go wrong if I go back to the basics." ■

—FROM PAGE 114, WALDEN/BENSON

even Tony Bennett might do, we leave plenty of room for George to add whatever he spontaneously feels inspired to bring to it. That's the key for us. Lay out the skeleton, but leave plenty of room for this man to bring his magic to it."

Walden recognizes that to stay geared up for his level of output requires a clear head and a positive attitude. "The golden rule is to stay inspired. Before I come to the studio, I like to go out and run, play tennis, sweat a little bit, come in here and feel fresh. Don't bring yesterday's problems in here; come in with a brand new attitude. It makes a world of difference. And I like to go fast, because the first things that come to me are usually the strongest. The first inspiration is like—pow!—like when you first fall in love. I want to keep that feeling."

Having his own top flight studio enables Walden to maintain an intimacy with his artists while his staff caters to their recording needs. Says Benson, "I depend on Narada's expertise. He has a great spirit in his productions. People around him are really up, because of what he generates. And his production crew are really good dedicated people."

"This is the first time I've come into a studio and seen all of the other musicians plugged into the console. I mean, the whole rest of the band was in the control room—double keyboards, electronic drums, rhythm guitar, bass—they were all in there playing directly through the console. I was out in the studio all by myself! I was so inspired

and knocked out by that, it created a nice lift for my day."

Benson notes that the fine art of music production includes not only what is put in, but what is left out. "They key to a great artist is making whatever it is he's selling believable," he says. "I learned something from a producer many years ago who said, 'You can sell anything if you take away all of the objections to it.' I didn't know what he was talking about at first, but I'm doing this with Narada right now. Everytime I hear an objectionable thing on my record I say, 'Let's take that out.'"

"I spend a lot of what I get from the record company as front money to finance a Class A project," says Benson, "because years from now I want to look back and say that what I did meant something. I don't want to be ashamed of even one song. I feel that if you give people what they want, they will reward you. I've seen that since I was seven years old. I worked in night clubs in '51 and '52 and whenever I gave them something they loved, they threw money on the bandstand."

In the final analysis, for Walden as well as Benson, the key is to enjoy the work. "Everyone should just remember to be happy," says Walden. "Happiness is of the essence. George and I are both God lovers, and God inspires us to be happy."

"Try and bring out your inner self, your heart, your soul and be happy. That happiness will be pure energy. Like gas in your car, it'll put magic in your life. Even if you have to force it, force yourself to smile and it'll make a better record. It's as simple as that." ■



—FROM PAGE 46, BYRNE

tion or anything... [but] we're essentially taking a recording studio complex and dedicating completely to one project for a period of time. We have the ability to condense the sound work for the film into a relatively small perimeter and keep the creative work under the control of fewer people.

"This is the first major feature film with full-blown soundtrack that we've done soup-to-nuts here," Leahy continues. "I think we've built up credibility and we get really cool projects because we're kind of a small, guerrilla unit that is really excited by the possibilities and potential of this equipment. Everybody in this building participates, and each person here is personally dedicated to improving himself in his craft. That's one thing about Russian Hill that may not be unique but is certainly unusual. We're committed to doing things and we turn out good stuff. I don't know of another facility around, frankly, that's in our niche: *electronic cinema*."

Part of Russian Hill's appeal to Byrne, Leahy speculates, was "that it looks like a recording studio. It's a medium he understands. I think he felt—and rightfully so—that by coming to a place like this he could be closely in touch in a supervisory or artistic way with every element of the

film, and simultaneously at that."

Ordinarily, says Schatz, "even if the director *wanted* to be involved in the sound design he couldn't, because the work is dispersed over large amounts of time and in the hands of many people. There is always the day of reckoning, when you go to the mix and the director and the other people involved hear what you've done and pass judgment on it," Schatz explains. "They love it, or they hate it, or they like certain parts of it and want it changed—and all of a sudden you've got five days to change the stuff you spent several months creating."

Instead, Leahy mixed the music in one of Russian Hill's recording rooms while Schatz worked on the dialogue and sound effects across the hall, literally a few steps away. "It was so delightful to have Jack mixing the music down in the studio next door," says Schatz. "Not only was the willingness there, but we were working under the same roof; he was forming the music as I was forming the sound effects and dialogue. We literally worked on the same scenes side by side at the same time.

"If I had an intelligibility problem and I wanted to make sure my dialogue would come out the center speaker without anything infringing on it, I could ask Jack to tailor the

music mix around that."

"I don't know if the technical quality is that much different from what you get in a conventional situation," Byrne concludes. "I think if the system does catch on, whoever does it in a high-tech way—with Necam automation or whatever—will really clean up."

Leahy found Byrne to be an amiable and inspiring director. "He has ideas about what he wants to do, he's very clear about his directions, and he's good at delegating the work. It's obvious that he likes being in the studio a lot. He's one of those intuitive people that, while he doesn't play a lot of instruments well, has a very clear concept of music. He gets an idea of what he wants and he works really hard at finding a way to get it realized.

"That's really what studio work is about," Leahy adds, "and that's the payoff of the gig: being around people who are in a position to go for what they want. Obviously, with his success in the field, David's in a position to do what he wants to do, and he's no prima donna. He works really hard, which automatically garners the respect of his colleagues. You *want* to work hard for a guy who's working hard himself and who is a considerate person. He's delightful to work with. Couldn't ask for a better gig." ■

## GO WITH THE LEADER!



**SOUND PRODUCTIONS, INC.**  
**PRO-AUDIO & VIDEO**

### PRESENTING THE SONY® PCM-3102 Digital 2-Channel Audio Recorder

The PCM-3102 is a "Dream Come-True" for audio production engineers, and what else could we expect from a leader like SONY®!

- Five I/O-channel configuration: two digital, two analog cue, one analog time code
- Switchable 44.1 kHz and 48 kHz sampling rates for compatibility with CD mastering standards
- "Cross Interleave Code" error correction format for true data recovery from dropout conditions
- User adjustable digital cross-fade rate for smoothest possible program transition at edit points
- Internal SMPTE/EBU generator, reader, and chase-lock synchronizer

SOUND PRODUCTIONS INC. is proud to bring you the PCM-3102 and remember... **Leasing is available on this and many other fine products from SOUND PRODUCTIONS INC.**

CONTACT DICK McCALLEY  
**612-866-1868**

SOUND PRODUCTIONS, INC. 6021 LYNDALE AVE. SO. MINNEAPOLIS, MN 55419

Circle #086 on Reader Service Card

World Radio History

**FIGURE 1**

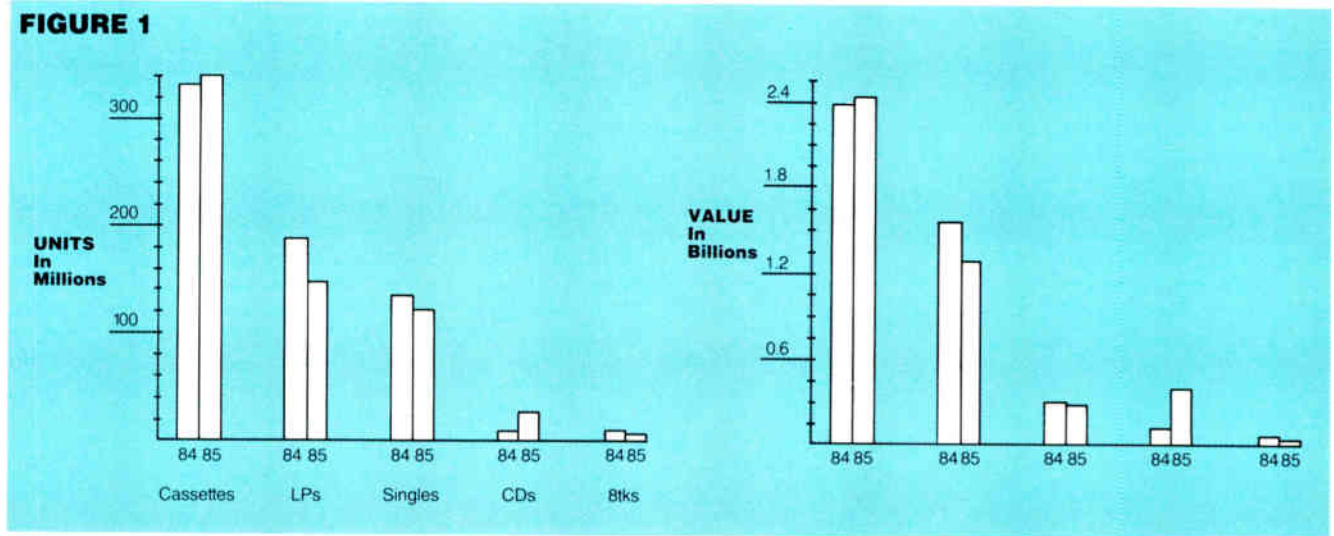

## SONY JUGGLES CD, R-DAT AND SPRINTER

by Philip De Lancie

The story of the Compact Disc's lighting drive towards dominance in its field seems about as believable as the plot from *Rocky*. But sales figures for 1985 from the Recording Industry Association of America (RIAA) confirm the trends [Fig. 1]. While the total dollar value (at suggested list) of net shipments of recording product from all U.S. manufacturers rose a scant 0.4 percent over 1984, the value of CD shipments rose 277 percent. By the same measure, LPs fell 17 percent, and cassettes, after years of annual growth over 30 percent, managed only a modest 1.2 percent rise.

The CD sales figures are all the more impressive in light of the ongoing shortage of CD manufacturing capacity. Product availability should im-

prove greatly as some of the numerous facilities in the works come on line between now and 1988. As record companies are able to increase their fill on orders and expand their CD catalogs, sales should continue to climb.

With all this good news for CD boosters, it's easy to forget that the CD is still far from the top of the prerecorded heap. The CD market share for 1985 was less than 9 percent in terms of dollar value, and 3.5 percent in terms of units sold [Fig. 2]. Thus, while it shows incredible potential, the CD has yet to establish itself as an integral part of the average music consumer's audio system. (LPs outshipped CDs by more than seven to one; cassettes outshipped by 15 to one.) For that reason, the dramatic ascent of the CD might conceivably be slowed considerably by the introduction of a competing digital audio medium into the consumer marketplace. R-DAT is the new system, and its combination of CD and cassette features may soon be pushing the CD out of the spotlight.

At last count, 81 companies worldwide had endorsed technical standards for R-DAT. (See Ken Pohlmann's "Insider Audio" in the May 1986 *Mix* for details on the specifications.) Sony seems to be taking the lead in pushing the system, having publicly demonstrated both home and auto models at the Summer Consumer Electronics Show in June. Other Japanese manufacturers will probably follow suit at this fall's Tokyo Audio Fair. Units are reportedly expected to be available

for sale in this country some time in 1987.

Many in the industry are less than thrilled by the prospect of another format on the scene, and important issues remain to be resolved before the system can attract the type of support it will need to succeed. Clearly, the effect of the new system on CDs is one of the concerns. Another is the availability of efficient (as in high-speed) techniques for the manufacture of prerecorded product, which the format will no doubt need in order to prosper.

Sony is in a unique position regarding the development of R-DAT. As a major player in the CD saga, the company is likely to have little incentive for undermining its growth. At the same time, as noted above, Sony seems so far to have been the most vigorous of the hardware makers in pushing R-DAT. Further, Sony's "Sprinter" system is, for the moment, practically the only game in town as far as high-speed video duping is concerned. Since R-DAT is essentially a video style system, video duplication technology provides a starting point for envisioning R-DAT duping.

As described by Sony, Sprinter is a contact printing system that allows duplication at up to 150 times normal playback speed, with no loss of signal quality. The basic operation of the system is as follows: the one-inch video master to be duplicated is played on a master VTR, with the output signal supplied to the input of Sony's MMV 5000B, the Mirror Mother VTR. The MMV 5000B records the signal onto



## Task:

Copy a few  
cassettes today,  
a thousand  
tomorrow and  
ten thousand  
next week. *BK*



### Problem:

Find a one-stop source for tape duplicating equipment that accomplishes the small tasks and the big ones—profitably.

### Solution:

Telex—unquestionably the company with the widest, most versatile line of tape duplicating products in the industry.

## Telex has a duplicator that fits your needs—today, tomorrow and next week.

Whether it's a new suit for yourself or electronics for your business, it makes sense to shop where you have the widest selection. And, if your purchase is as crucial to the profit line as a high speed tape duplicator, you shouldn't settle for a model that almost fits your needs.

Telex has models that copy as few as one cassette at a time or as many as twenty-three. Telex models are available in mono or stereo and also offer a wide variety of copying configurations such as cassette to cassette, reel to cassette, cassette to reel or reel to reel. For small to medium run cassette duplication, choose one of the new Telex CD Series, but if you need open reel capability plus larger cassette production, one of the Model 6120 configurations is probably best for you. At Telex, you can find the right duplicator at the right price, and you'll find it faster. For more information and detailed specifications, write to Telex Communications, Inc., 9600 Aldrich Ave. So., Minneapolis, Minnesota 55420, Telephone: 612-887-5531.

Call Toll Free in U.S. 800-828-6107

For small to  
medium production  
runs...

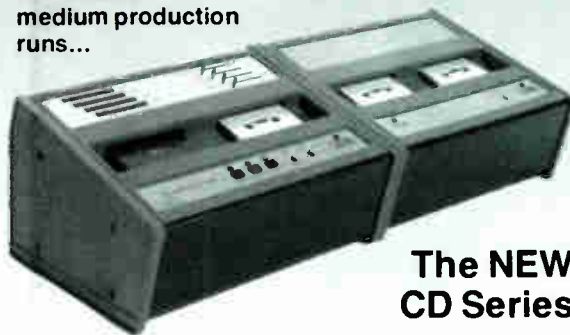

The NEW  
CD Series

# TELEX®



The Model  
6120—for  
medium to  
large produc-  
tion runs.

Ask a participating dealer about special payment terms available only with the Telex 6120!

Circle #087 on Reader Service Card

World Radio History

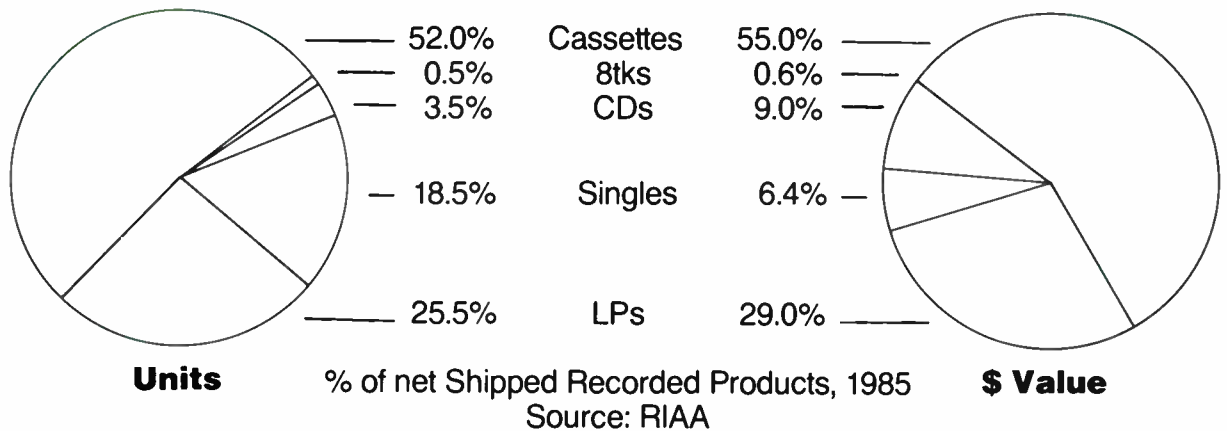
**FIGURE 2**

a specially developed half-inch high coercivity "mirror mother" metal tape. The track pattern recorded is a mirror image of the normal pattern for a tape of the format being duped (Beta or VHS, regular or Hi-Fi).

After preparation of the mirror mother, it is loaded along with the copy tape and a "drive tape" on the high speed printer, HSP 5000. In the printing mode, forced air pressure of 4kg/cm<sup>2</sup> against the back of the drive tape maintains close contact between the oxide coated surfaces of the mother and copy tapes as they round the transfer drum at high speed [Fig. 3]. Opposite the transfer drum is the "transfer magnetic field head." The head emanates a high frequency alternating magnetic field (Sony calls it "transfer bias") at a strength in the range of 900 Oersteds. As the tapes exit the field, the low coercivity (650 Oersteds) material of the copy tape is susceptible to the magnetic influence of the mirror mother, and assumes its particle orientation. As a mirror image of a mirror image, the copy has a normal track pattern. The high coercivity (2000 Oersteds) of the metal tape used for the mother allows it to pass through the field unaffected.

Sony's approach to high speed duping of video signals is not the only method. (Next month we'll look into the thermal magnetic duplication process advocated by Du Pont). But the existence of working Sprinter units in the field would indicate that Sony is in a good position to move into the related area of R-DAT duplication. Despite the video based design of R-DAT, however, adaptation of the technology is not without its obstacles.

The Sprinter technique is based on the assumption that the coercivity of the mirror mother is far greater than the coercivity of the copy tape. Otherwise, a magnetic field sufficient to act as a bias for the copy tape would be strong enough to affect the mother. In

R-DAT, playback operating parameters were developed with high output metal tape in mind. The coercivity of this tape formulation is too close to that of metal mirror mother tapes to allow its use in Sprinter style printing.

Recognizing the absurdity of a system without the possibility of high-speed duped product, the developers

increased production efficiency offered by high speed.

Assuming that Sony can come up with a workable high-speed R-DAT system, the company stands to benefit greatly from the inclusion of the Wide mode in the R-DAT standards. However, when I sought Sony's view on the current state of R-DAT and R-DAT

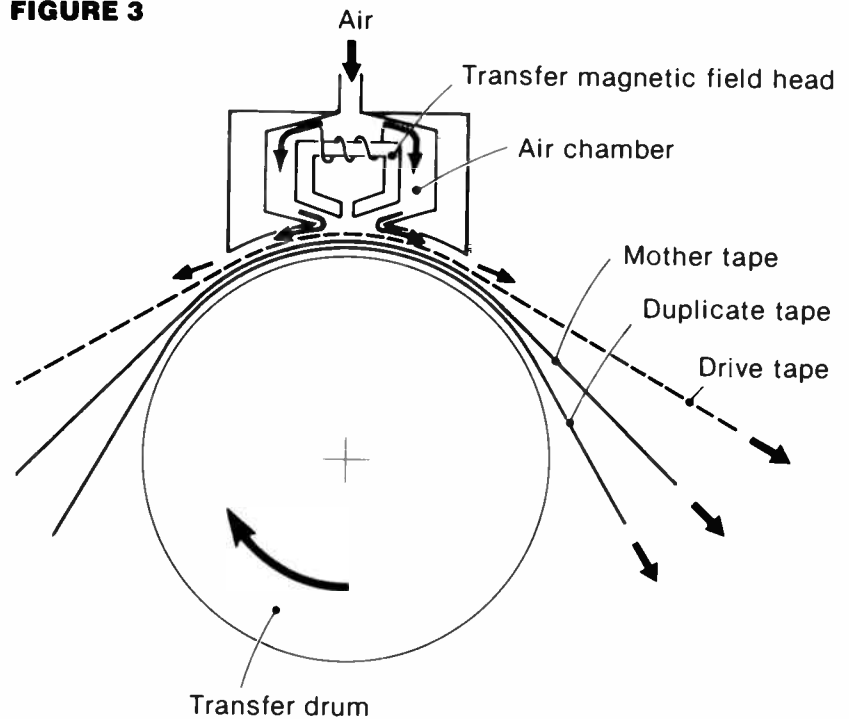
**FIGURE 3**

*Contact printing transfer mechanism for high-speed video duplication as utilized in the Sony Sprinter system.*

of R-DAT specifications added an additional playback capability. In Wide mode, the linear tape speed is 1.5 times greater, which increases the track width to make up for the lower output of low coercivity non-metal tapes. The resultant loss of playing time (80 instead of 120 minutes) will likely be an acceptable trade off for the

duping, I sensed that caution rather than excitement was the prevailing mood. Two employees directly involved with Sprinter were reluctant to comment at all. At the receiving end of their buck was Tom Sugiyama, manager of corporate communications, who was more generous with his time and information. The following is from



our conversation:

**Mix:** Can Sprinter, or a system based on the same principles, be used for R-DAT duplication?

**Sugiyama:** We are working on developing some system similar to Sprinter, but at this point we really cannot say how far we have come, and what the result may be. We have the basic technology already developed in video high-speed duplication, and we would certainly like to take advantage of that. But we are not going to develop something that the market may not be ready for.

**Mix:** But the basic principles around which Sprinter is designed can be adapted to R-DAT?

**Sugiyama:** That's what I understand. However, because of the characteristics that are different between video tape and DAT tape, there need to be different approaches magnetically. I think those are the things that they still have to work out because of the metal tape and the coercivity involved.

**Mix:** So it is too early to say how things are going to develop.

**Sugiyama:** Yes. In fact, the DAT itself is still up in the air in terms of marketability. I don't believe that it is at the point where we can talk about anything more concrete than that the development is being worked on.

**Mix:** Hasn't Sony announced plans to introduce the system to the U.S. market in 1987?

**Sugiyama:** Obviously, when we go into the market with something we have taken the leadership in developing, we would like also to be the leader in marketing. We are just indicating that the market will be ready sometime in '87. But, then again, you really don't know, and I think the whole atmosphere for now is very delicate because of the relation to Compact Disc. Sony, for one, certainly has a strong interest in marketing Compact Discs, in software and hardware, so we would like to see how this new format may affect the sales of CDs. We certainly don't want to go ahead before the market is ready and the industry is ready.

It will probably take a little while before we can make a final decision as to when we introduce it. There is no doubt about marketing DAT, but the timing is certainly important. It is still up in the air.

**Mix:** Do you feel that the success of the format will depend on the availability of software that can be duped at high-speed?

**Sugiyama:** Yes, definitely. When there is hardware available, I'm sure the

market will be looking for software that is readily and economically available with many titles.

**Mix:** If Sony develops a Sprinter tape duping system, what might be the unit cost to the consumer for prerecorded tapes?

**Sugiyama:** I don't think anybody can tell at this point. To come to a cost expectation, they have to know how big the market is. This whole market is still very, very premature. I don't know if anybody can make even a wild guess as to how many units of hardware may sell in the first year, which determines how tapes may sell.

**Mix:** When the duping system takes its final form, is it possible that Sony might open its own facility, as it did with its Digital Audio Disc Corporation for CDs, to lead the way in providing software to get the format off the ground?

**Sugiyama:** It depends on how fast the market grows. We could follow the Sprinter route and just sell the equipment to duplicators. Compact Disc production involves much higher technology. In that situation, it was worthwhile for Sony to make its own investment. In a case similar to Sprinter, you could simply install the equipment and supply the raw materials.

It may be more of a marketing decision. I don't think the decision has been made yet as to how aggressively we will be encouraging DAT, from a hardware or a software point of view.

**Mix:** And the CD market will be a very important factor in that decision?

**Sugiyama:** One of the factors, along with some of the technology issues. When it comes to duplication, I think the technology still has to be developed to make the tapes available at low cost. But certainly as far as marketing decisions go, the CD market and the way it goes will determine a lot about DAT's introduction.

•••

Shape Video, a division of Shape Inc. of Biddeford, Maine, began construction in June of an 83,000 square foot addition to its existing 70,000 square foot video cassette manufacturing facility. The \$3.5 million expansion will allow Shape, which claims to already be the largest independent U.S. manufacturer of VHS cassettes, to double its production capacity in Maine to 70 million units annually. The new facility will be ready for occupancy by the end of November, with production slated to begin by December 15. Approximately 125 employees will be added in manufacturing and technical positions at this plant.

—CONTINUED ON PAGE 203

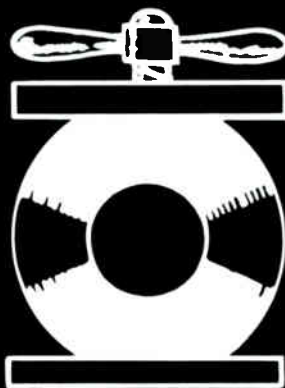

## THE DALLAS RECORD PRESSING PLANT SINCE 1967!

# Record Pressing

### IN HOUSE

- Custom Albums
- 45 RPM Singles
- Stereo Mastering With Neumann VMS70 Lathe & SX74 Cutter
- Plating With Europa Film Equipment

1000 7" 45 RPM Record Package \$419.	1000 - 1 Color 12" Album Package Records & Printed Covers \$1372.
---	--

Type Set & Proofs Included  
(FOB Dallas)

(To receive this special price, this ad  
must accompany order)

# Tape Duplication

- Any quantity, large or small
- Custom packaging
- Demo tapes (real time copies)
- Blank tapes - ANY length needed

A + R RECORD & TAPE MFG. CO.  
902 North Industrial Blvd.  
Dallas, Texas 75207  
214-741-2027  
Toll Free 1-800-527-3472



# a+r

Circle #088 on Reader Service Card

# UP WITH PEOPLE!

## SUPER BOWL AUDIO REVISITED



Overview of *Up With People's* half-time show at Super Bowl XX.

by Bruce Erley

*Ready or not, here comes the new football season, and with it the inevitable debates about which teams will wind up battling in the Super Bowl a few months down the road. You'll get no prognostications out of us; we'll stick to audio. And so, join us now as we look back at two interesting audio angles of last year's Super Bowl. No doubt it will be even more complicated next year.*

On January 26, 1986, *Up With People*, the international educational and cultural singing organization became the only group to produce and perform in an unprecedented four NFL Super Bowl Half-time shows.

*Up With People*, widely known for their contemporary, high-energy entertainment, wanted to produce a half-time show as spectacular as the Super Bowl itself. The NFL gave them the go ahead to attempt several innovative concepts utilizing all five of their casts, totalling more than 600 students from 22 countries.

Adding to the already complex task of creating an entertainment event for a live audience of 70,000 and a tele-

vision audience of 127 million, was the opportunity to be the first Super Bowl half-time broadcast in stereo.

*Up With People* determined that three independent mixes would have to be created—for the NBC Sports Telecast, for the Louisiana Superdome's house system, and for playback to the performers field set monitor system.

To insure the audio met the expectations of both NBC and the NFL, *Up With People* again tapped independent sound consultant Jim Bastin to head up the Super Bowl XX audio team. Bastin has been a longstanding producer/consultant to *Up With People*, and coordinated their audio for Super

Bowls XIV and XVI.

Bastin worked with *Up With People's* technical operations manager, Dave Turner and his crew, along with Fred Porter of Westwood Studios (Tucson), Clem Michel of Celectronics (San Luis Obispo) and Dave Callahan of Maryland Sound Industries Inc.

What Bastin and his team produced was, in the words of NBC half-time director John Gonzalez, "A wonderfully mixed presentation that not only thrilled the stadium audience, but translated marvelously to the small screen."

This is Bastin's story of how it all came together:

I knew from past experience the problem of creating a single mix in the studio for playback. You can never get it to work right for both the stadium and television.

Both of the previous Super Bowls I did for *Up With People* were in multi-track of some form with backups. SB XIV used stereo Nagras with instruments on track 1, vocals and announcer on track 2. SB XVI had two 4-track machines: track 1—rhythm, track 2—keys/brass/guitars, track 3—chorus vocals, track 4—lead vocals and announcer.

Initially, we felt a one-inch 8-track

—CONTINUED ON PAGE 134

*A pair of Celectronics consoles were at the heart of the half-time audio.*

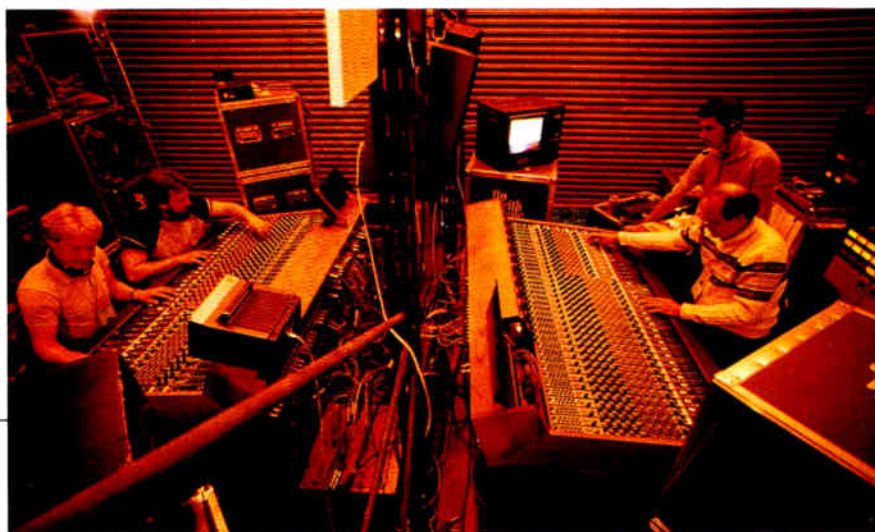



## T.L.I./STREETERVILLE STUDIOS BRING "OLIVE BALL" TO CHINA

by Gregory A. DeTogne

The scene was in a living room in The People's Republic of China, but from the reaction, it could have been in Anytown, U.S.A. Every eye in the room was riveted to the television set, watching intently as the Ai Guo Zhe (Patriot) team made a last-ditch attempt to defend their goal line from the marauding Ju Kiong (Giant Bear) team. On the screen, Superdome fans were all on their feet, shouting out cheers for their favorites, some more rambunctious than others from the effects of too much beer. Over the deafening roar, Bear's quarterback Jim McMahon called the signals for the next play, and handed off to number 72, the rookie folk hero Dian Bingxiang (The Electric Icebox). On cue, the missing-toothed giant lowered his massive shoulders and bashed through the defensive line for a touchdown, which sent the crowd into mass hysteria. The extra point was good, and while the teams prepared for the ensuing kickoff, an announcer broke in, gave a synopsis in Chinese of the action, and proclaimed that "this is turning out to be one of the highest scoring 'Super Cup Rugby Finals' in gan lan qiu (olive ball) history."

Historically, China has always held a basic mistrust of foreigners, their customs, and ideals. This belief isn't just a case of casual xenophobia, either. It is rooted in sound fact. Every time outsiders have entered China's borders from the days of the Mongols until the invasions of the 19th and early 20th Centuries, all any of these unwanted guests ever had in mind was plundering, pillaging, and rape. With visitors like that, it's no wonder The Great Wall was built.

Today, however, things are beginning to lighten up in the world's most populous country. The Chinese are anxiously welcoming foreigners, who in turn, are eager to swap technology and bits of culture for a shot at making a buck in the largest consumer marketplace around. As a result, elements of capitalism are starting to emerge in this formerly closed society, and consumer goods such as televisions, radios, and colorful western-styled clothes are hot with the citizenry,

which not long ago had to be content with baggy unisex Mao outfits and The Little Red Book.

T.L.I., a Chicago-based international marketing and communications firm, has been one of the front-runners in making inroads into Chinese society. If you want, they can help you define markets and promote anything from electric shavers to encyclopedias within the country's borders. Their greatest feat to date, though, has been the marketing of one of the greatest American icons of sport to the Chinese: the Super Bowl.

The idea of bringing the Super Bowl to China was originally conceived by a man named David Hughes, who works with the U.S. Department of Commerce. Hughes had heard that T.L.I. had connections with local TV stations in China's Liaoning and Guangdong provinces, so he approached them with his scheme. As T.L.I. president Lyric Hughes (no relation to the former) tells it, T.L.I. jumped on the project by buying the broadcast rights for the game from the NFL, and getting in touch with Winston Lord, the U.S. ambassador to China, who would provide the necessary clout to locally televise the game. As things developed, however, Lord went directly to the government-owned national network, the CCTV, and sold them the idea, which meant that the showing would have a potential audience of 300 million viewers.

Once the go-ahead was given, T.L.I. began working non-stop to bring the project to a conclusion by February 20, which would allow them enough time to deliver the tape for its scheduled March 9 showing. Sponsors were rounded up to help underwrite the costs: the State of Illinois, Nike, Gould, McDonnell-Douglas, and Hewlett Packard were among them. Next, T.L.I. made a trek to nearby Streeterville Studios, where the actual translation and production would take place.

"When T.L.I. first came here, they didn't have any idea what they were in for," Streeterville president Jim Dolan Jr. recalls. "At first, Lyric just wanted a straight translation of the game, but things just started getting bigger and bigger, and soon it had burgeoned into an in-depth affair. To make things as easy as possible, we took on a role where we would be more than a place with fancy equipment where tapes moved around. A large part of our efforts

Since 1911

**PRINTING**



### **Complete Printing Line for the Record Industry**

Record Labels, Cassette Insert Cards, Twelve Inch Sleeves, Album Slicks, Direct Board Jackets, Seven Inch Sleeves, Pressure Sensitive Labels, Brochures

## **QUALITY**

## **SERVICE**

## **PRICE**

### **KEYSTONE PRINTED SPECIALTIES CO., INC.**

321 Pear St., Scranton, Pennsylvania 18505  
(717) 346-1761 TWX (910) 350-6462

Circle #089 on Reader Service Card



—CONTINUED FROM PAGE 130, SUPERBOWL format would be enough for SBXX. But after making several trips to the Superdome in early '85 and meeting with NBC, we decided a 2-inch, 24-track format was our best bet. Several things made this necessary: stereo broadcast, a 52-acre dome with some "unusual acoustics," SMPTE track, a count track for director John Gonzalez and his cameramen, control tracks for the pyrotechniques, videotape ambience track and four echo/sfx work tracks.

Creating our 2-inch master was quite a process. We wanted to use various edited sections of *Up With People's Beat of the Future* album, as well as additional music in the 12 minute show. Dave MacKay, who produced *Beat of the Future* went to his studio, The Factory, located in Woldingham, England, and assembled many of the musicians and singers who had originally performed on the album to record the additional material needed for the show.

After editing 24-track masters from the album, he spliced in virgin 2-inch for the additional material and began the tedious process of punching in and out of each section, from basic tracks to final overdubs, until we had a multi-track master.

The next step was to mix the 24-track master that would be used for playback at the Super Bowl. To do this we locked up two 24-track machines, and mixed from machine A to machine B combining stereo pairs of tracks. Dave has a 48 by 24 Harrison console, so we set one side as our unity gain monitor system and mixed with the other 24 channels. Using one track on machine A for automation, we'd work with one tune until we had the mix we wanted, then with both machines locked up we'd record that mix on machine B, letting them run into the next tune for a couple of bars.

Making the final master tape was even more difficult. The music had to

be continuous for the entire 12 minute show. After the first tune was committed to machine B, the board was cleared and reset for the next mix. When we got that tune up the way we wanted it, we'd then roll back into the previous tune and punch in the new mix at a pre-determined point. If we blew the punch, especially by being early, it meant going back and remixing the previous tune.

It took us three days to mix the show and I'm happy to say we never did have to do a re-mix on anything.

When I returned to Tucson, everyone was pleased with our mix, but a concept change in a transition on stage for one of the segues made it necessary to go into Westwood Studios and erase and overdub some tracks on the 24-track master playback tape. Up With People music director Herb Allen, his assistant Scott Dickey, Fred Porter of Westwood and I were punching in and out 12 different tracks of a four bar segue, all recorded with the proper mix perspective.

Now that we finally had our master tape, the next piece of business was the final system design and set up. A contract was negotiated with Bob Goldstein, Will Parry and Ronnie Smith of Maryland Sound Industries to supply all the tape machines, monitors, communications and cable runs required. They also sent Dave Callahan along as tech and he turned out to be invaluable to the whole project. We used Celetronics consoles, custom designed for *Up With People's* five touring casts.

At the Superdome, our audio area was the turf storage room located off the South Tunnel, and right in the middle of the NBC compound, which came to be known as "Eastwood." We covered the walls and floor with the heavy rubber mats used to store the turf and got the room sounding pretty good.

Three simultaneous mixes were going to be used; stereo to NBC, mono to

the house PA and a different mono to the 500 cast members on the field and field set. We set the two consoles back to back in the center of the room. A pair of studio monitors were facing me so I could mix for TV, and a field monitor was facing Fred so he could mix House and Field. The Celetronics consoles were designed with TV and other multi-track purposes in mind and worked extremely well in this system because of their flexibility. Video and program audio feeds were supplied by NBC, and GTE ran all the communications to the various command points throughout the Dome.

Our back-up system consisted of a one-inch 8-track (composite mix from the 24-track) and a 2-track stereo mix. All the autolocators were at my mixing console with the 24-track in repro status while the other machines were on input status. A simple flip of a switch would engage either of the back-up machines in case of a problem with the 2-inch master.

Because of the long cable runs to NBC, to us, to the Superdome PA booth and to the field monitor systems, the potential for ground problems was great. Sure enough, after everything was interfaced, we had hum.

The ground bus available proved to be inadequate. We solved the problem by grounding our system back through the program feed to NBC, lifting the third wires on our equipment racks and disconnecting the shields at our end of the stadium PA and monitor feeds. No hum.

In order to keep the 500 cast members in sync, I knew it was critical for them to hear as much direct sound as possible. We put 24 JBL slants on the field set which was 90 feet in diameter, 11 feet high and weighed 18 tons. (By the way, the whole stage, set up of band and interconnect of the monitors was accomplished in under three minutes. It pays to have a lot of manpower and rehearsal time.)

For the people doing the field forma-

—FROM PAGE 133, STREETERVILLE

day"). The mere size of "Refrigerator" Perry amazed the Chinese, who on an average, are only half his weight and height. If the Chinese had a favorite team, it seemed to be the "Giant Bears of Chicago." Quarterback McMahon was viewed as calculating and intelligent, and Walter Payton was held in esteem for his dedication and abilities as a running back. On the sidelines, the Honey Bears cheerleaders created quite a stir with their leggy appearance, which Hughes was surprised

to see, since she had anticipated earlier that Chinese authorities would edit them out.

Given the violence of the game, you might also think that it wouldn't be fitting with the Chinese philosophy of social harmony and cooperation. "I was surprised, but I don't think the violence bothered the Chinese at all," Hughes observed. "In some cases, it may have been what they liked best."

Financially, T.L.I. broke even on the project, but in Hughes' estimation, it was worth it merely for the

exposure. Already, plans are in the works for the exchange of other sporting events and programming. The Chinese seem to have a passion for becoming American sports fans via the tube, but in the future, if Chinese men start spending too many of their Sundays watching football, drinking beer, and munching pretzels, they're going to have to come up with a translation for the term "football widow." Incidentally, I wonder if China could ever have its own version of Howard Cosell... ■



tions, which covered the entire playing area, we had two JBL bass units and horns at the four 15 yard line locations facing the field. UREI 1600 amps totalling 10,750 watts were used to make certain the cast could hear and perform in sync, which they did to perfection. Dave Callahan used multi-cable runs to each sideline location for the main feeds and their back-ups. Separate runs were made to the house interface location at the mouth of the South Tunnel.

Every aspect of the system had a back-up, including all cable runs. In addition, Clem Michel and Tim D'urso, from Circle A Industries in Tucson (who built the field set) were inside the set prior to the show connecting everything, and remained there for the entire half-time in case we had any problems with the monitors.

The Friday before game day, we recorded Dick Enberg's opening to the half-time and four other inserts and rolled them into the 24-track master to complete all pre-recorded parts of the playback tape.

For audience response and ambience, we flew three PZM's around the dome and transmitted to our multi-cable locations at the 50 yard line.

With Enberg's narration on tape and

---

*Adding to the already complex task of creating an entertainment event for a live audience of 70,000 and a television audience of 127 million, was the opportunity to be the first Super Bowl half-time broadcast in stereo.*

---

our ambient mics in place, we now had everything set to provide all the audio to NBC for the half-time.

Bill Parinello, who was engineering the audio for NBC, agreed that he should turn off his ambient mics for the half-time and let us give him a complete audio feed including ambience, then cross-fade from our ambience to his at the end of the show.

Friday was also our dress rehearsal day with NBC where we fine-tuned the three mixes. For the house PA we had to back-off on mid-range instruments that were fighting the vocals, added lots of drums and bass for the cast monitors. We began fine tuning audio to video for TV. For example,

during one song we had all the cast singing, but the camera shots focused on the solo vocal. It gave me the opportunity to feature the soloist and match the picture.

On Saturday, everything was checked and rechecked and we arrived on Sunday morning to finally do THE SHOW. Once again, all the system and feeds were re-checked, Fred and I practiced our mixes a couple of more times, and then we took off to enjoy the pre-game.

After working on this project for nearly 12 months, the actual 12 minutes for the show seemed to go by like a blink of the eye, with everything going almost exactly as planned. ■

## Constant Directivity Horns and Drivers



**For information on the complete family of RENKUS-HEINZ products call or write:**

RENKUS-HEINZ, INC.  
MANUFACTURERS OF PROFESSIONAL SOUND PRODUCTS

17191 ARMSTRONG AVENUE • IRVINE • CALIFORNIA 92714  
TELEPHONE: 714/250-0166 • INT'L. TELEX: 705568

**rh RENKUS-HEINZ**  
THE SMART SOLUTION

Circle #092 on Reader Service Card

---

The 3,500 international subscribers to Esi Street have turned the system that links computers globally into an efficient and technologically superb tool for communications and information services.

# TELECOMMUNICATIONS

by Phil Tripp

Some things never change. Writers always seem to court danger in making the deadline. Even using the advanced technology of computers in instant international communications—assembling a story by gathering comments by electronic mail and sending it from Australia to *Mix's* editor over the phone—human error comes into play and time can be lost. And in the music industry, time is the only constant. Everything else is a variable.

In the fight to make the most of time and stay in touch with a variety of global contacts in the entertainment industry, a valuable new tool has emerged. Established four years ago as a computer consultancy for touring bands and record companies, International Management Communications (now known as Entertainment Systems International, or Esi Street) evolved into one of the most significant advances in music since the electric guitar or synthesizer. Well, maybe that's a little strong, but the 3,500 international subscribers to Esi Street have turned the system that links computers globally into an efficient and technologically superb tool for communications and information services.

Esi Street users come from all levels of the industry: bands, their management, record companies, promoters, booking agents, concert production companies, touring personnel, merchandisers, travel agents, lawyers, accountants, studios, equipment manufacturers. . . the list is as varied as the

The logo for Esi Street features the word "ESI" in a large, bold, sans-serif font. A small rectangular box containing the word "ON" is positioned over the letter "I". Below "ESI" is a horizontal line, and underneath that line is the word "STREET" in a smaller, bold, sans-serif font.

music business itself. And now, the film, video, music video and advertising industries are coming online with Esi Street along with radio and television programmers primarily because Esi Street solves the problems they share with their music biz counterparts. Probably the worst problem is that of "telephone tag"—trying to track down and communicate with contacts who are highly mobile and hard to contact through time zone differences and availability.

The alternatives of telex or mail communications are significant but pale in comparison with the ease of communication offered through Esi Street. Using virtually any computer (most subscribers prefer portables like the Tandy 100 or NEC's 8201) connected through a modem or acoustic coupler, the subscriber can access their electronic mail system from most civilized countries through the phone systems' links with computer networks. Whether it's a pay phone at the airport, the hotel room handset or even a phone on a moving train, subscribers can send and receive messages to other users as well as utilize a telex and mailgram facility to contact non-subscribers. In addition, there are a number of information providers who supply the latest industry news, chart information from all over the world, and market research information. Plus, an extensive bulletin board system allows users to sell gear, studio time, services as well as exchange jokes, conduct forums on aspects of the industry and trade computer tricks.



One of the most interesting advancements of Esi Street is the emergence of specialized user groups such as Sslusers, which is open only to subscribers who use Solid State Logic equipment and Synthnet, which is geared toward electronic musicians. The SSL group is run by Ed Evans of the Power Station studio, not SSL itself. It's become an international discussion group of problems and opportunities recording studios have using SSL equipment.

Synthnet is perhaps the most adventurous of the user groups having a wealth of information including DX7 patches, Emulator II samples, online shopping and problem solving for MIDI users. Founded by New York producer and player Gary Rottger, Synthnet links keyboard players internationally and helps them exchange ideas, equipment settings and mutual interests. It even comes to the rescue, as was the case with the Canadian band Honeymoon Suite.

When their equipment truck was stolen, their Yamaha TX816 rack with DX7 sounds was desperately needed for the rest of the tour. Getting replacement gear was easy enough, but the problem of getting the sounds was more difficult. Fortunately, another copy of the sounds was located in Canada and was sent through the net-

## Ouagadougou Calling!

Esi Street has one aspect that has more to do with fun than serious computing. It's an international competition to see who can log onto the system from the most exotic location or in the most high tech fashion. So far, users have accessed the system from all over the world—Andorra to Zimbabwe—and perhaps the most interesting log on was done by Stevie Wonder's lighting designer who managed to place a call from a hovercraft between Calais and Dover, linking his laptop through an acoustic coupler. But the most esoteric application

work to keyboardist Ray Coburn before the next gig.

Just as musicians have embraced Esi Street for their use, so has the audio industry tapped into the immense capabilities of the system. Studios looking to fill blocks of time can post their message in the bulletin board or directly contact bands who will be coming near them. Equipment manufacturers can stay in touch with their customers on the road and supply upgrades, replacement gear or make known new

centered around a "chat" between two users: Jeremy Jones was traveling around London in a limo with a cellular phone and found his mate Paul Cummins of Dire Straits management online. Initiating a chat, he found Paul was mobile as well at that moment—plugged into a phone on a train between Munich and Cologne. One of the more touching Esi stories centers around Peter Morse, lighting designer for Lionel Richie. He recently had open heart surgery and whiled away the hours on his back by playing games online, sending messages to his friends and receiving get well messages as soon as the anesthetic wore off.

—Phil Tripp

applications.

Fairlight Instruments in Australia have established their own user group which includes news, a bulletin board for CMI and CVI users, a hotline and listings of sales or service outlets for their equipment as well as supplying applications hints and information on improvements and new products. Sound engineers on the road can keep in touch with their offices as easily as globetrotting producers can maintain contact with clients and studios. And

# Psssst.

## Q. WANT TO KNOW WHY YOU SHOULD BUY A DSP?

Simple. Our DSP units handily remove offensive sibilance problems without adversely affecting the upper-mid and high frequency content of the program material. You can use a DSP on vocals or mixed musical programs with complete freedom from coloration and loss of dynamics.

## Q. WANT TO KNOW WHY OUR DSP IS SO EFFECTIVE?

Easy. It constantly measures the sonic energy present in the band of frequencies in which sibilance problems occur and compares that energy with the energy contained in the broadband audio. If a signal is present which might be sibilance, the DSP then analyzes it for complexity. Should the analysis reveal that the signal is sibilance, the unit's control circuitry inverts the sibilant, and sums it with the original signal, thus neatly eliminating the sibilance.

## Q. NEED TO KNOW MORE TO BE TOTALLY CONVINCED?

Sure. Just send us \$5.00 (refundable upon purchase of our DSP) for a DEMO TAPE and you will hear why the VALLEY DSP is the answer to your sibilance problems. OR...if you prefer, we can arrange an immediate demonstration for you. We have the answer...just call.

## A. 1-800-FOR-A-TRY.



VALLEY PEOPLE, INC. • P.O. Box 40306 • 2817 Erica Place • Nashville, TN 37204  
(615) 383-4737 • TELEX 3785899 • NASH AUDIO  
VALLEY PEOPLE INTERNATIONAL • c/o Gotham AG, Regensdorf Switzerland  
TELEX 59222 gothm ch, Tele 0041-1-840-0144

Circle #093 on Reader Service Card

the studios themselves use the system not only for attracting clients but also for publicity and promotion. Studio 301 in Australia may be off the beaten track, but they send fortnightly press releases to a wide variety of publications who access the system on who's recording in their complex, equipment upgrades and personnel changes for the trades and audio publications.

In another out of the way locale, Aki Tanaka, manager of international relations with Epic Sony in Tokyo, uses the system to keep up with industry news around the world as well as to stay in touch with overseas artists on the label. Also in the Sony family is Gus Skinas of Sony Digital Audio in New Jersey. His response to a query on a usage

elicited this response: "I'm using the system to answer questions that come up while using the digital recording and mastering system—usually two to three serious questions a day. The studios who are on Esi Street have responded well and we hope to be setting up a digital users group shortly and becoming a bit more creative. We'll be sending out our technical updates and operating tips to everyone on the system with hard copies to those who aren't. At the least, our goal is to get everyone who has the digital multi-track onto Esi Street."

Bob Ludwig of Masterdisk Corporation in New York shares his experiences: "Esi Street has been quite beneficial in terms of greater comun-

ications with people one generally doesn't get to talk to. I have several ongoing conversations with people where it works to write when I can, and they answer back at their convenience—especially producers when I am mastering records," he explains in his E-mail. "While doing the Dire Straits *Brothers in Arms* CD mastering, the engineer came in on Friday, a courier took the CD master and reference disks to Europe and I had an approval waiting on my computer on Sunday afternoon, sent by Dire Straits from Yugoslavia!"

"On the new Genesis album, I was in communication with producer/engineer Hugh Padgham via E-mail, setting up all the particulars from both work and home. A telex would do the same, but the beauty is that I can use my computer at home where I wouldn't have or want a telex machine. When I'm finished with a day's work, I want to get out of the studio as fast as I can! At home, with my thoughts collected, really is a nice way to communicate with clients and friends."

Marie Brayman of E-mu Systems in Santa Cruz uses the system in a wide variety of ways. As she describes it, "E-mu has actively been online since February of 1986, though we had subscribed before that. But it wasn't until my boss Kevin showed me how to log on that we were on everyday. I was hooked immediately!"

"The first thing I do in the morning is check for mail, save it all and run upstairs to print it out. Then I distribute copies to individuals in the company and to technicians for service questions. If the mail concerns new sounds or general information, I'll answer and supplement with literature, instructions or schematics in the 'real' mail. Then in the afternoon, I'll collect the responses from individuals and send them off via the computer. Forum information from the network is passed on to the sales guys so they can keep up with the latest 'buzz,' and we post bulletins concerning software updates and new product teasers."

It's the kind of information flow as well as near instant global communications that makes the Esi Street system more than just a high-tech message center. Journalists and publications use the system to get copy in for immediate deadlines and to conduct interviews. Bob Hughes, a Sydney-based writer and radio announcer, has used the system to get the latest information from musicians on the road, scooping his competition in the process and arranging phone interviews to expand on the written responses. As a music trade writer, my own use of Esi Street has expanded my writing—like this article for *Mix*—with

## masters of midi...

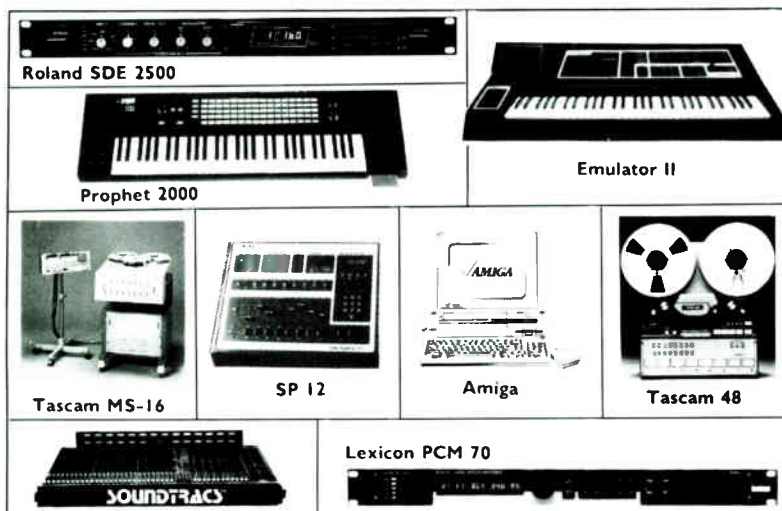

- Over 300 product lines *in stock*
- Courteous, knowledgeable sales staff
- Competitive prices
- Full rental & repair service
- We arrange financing

We specialize in helping studios and musicians design the most powerful MIDI systems available today. We've got the keyboards, computers, software, electronic drums, signal processors, MIDI guitar systems, MIDI bass systems and all the accessories to put it together.

# E.U. WURLITZER

## MUSIC ★ SOUND

360 Newbury St., Boston, MA 02115

# (617) 437-1815

Circle #094 on Reader Service Card



publications such as *Billboard*, *Music Week*, *On Location*, *Performance*, *Pollstar* and *Album Network* overseas as well as several publications in Australia. And there are others online like *Recording Engineer/Producer* which puts up newsy bits, the *Music Industry News Service* in the U.K. and Australia which offers subscribers charts and the latest happenings. But it's the charts that have recently been enhanced online that show how incredibly complex information can be sourced.

A user who asks for charts has the choice of *Radio and Records*, *Album Network* or *Street Pulse Group* information. The query can ask for radio formats or retail action. The radio charts can be categorized by artists, label or title in airplay, adds or movement activity in formats that include contemporary hit radio, album-oriented rock, jazz, black urban or Top 40 reports with others to be added. But beyond the hardcore communications facilities and information, there's a more human side to the system. The capability to "chat" online in real time with other users on the system makes for some interesting anecdotes. Veterans of the road who are sending off nightly reports back to the home office may do a quick check to see who else is online when they've finished mail-outs and can then drop a message on their intended "chatee" and conduct an interactive conversation via keyboards across town or around the world. There's even a conferencing function where several users can link together and conduct an electronic meeting with each in turn talking via computer and all parties seeing the conversation.

For the road weary, the games sector can provide an amusing, challenging or relaxing end to the day, though they are dangerous since a lot of money can be spent in intricate play over many hours. But the day never seems to end on Esi Street. While road crews and promoters on one side of the world are just getting to sleep, record execs and managers in another country are just logging on at home or the office, picking up their electronic mail, replying, reading the latest news or exchanging contracts and rider details. Esi Street is just like having your friends and business acquaintances around the corner from you. It's a short digital "walk" to meet them or post a note on their electronic door.

The system has enhanced the way business is done in the industry and has helped "shrink" the world to keep people in contact with each other. It's one of the more advanced uses of computers and certainly one of the most fascinating. ■

# BRYSTON

## BROADCAST PHONO PREAMPLIFIER

### REQUIREMENTS

- Musicality
- Serviceability
- Low Distortion
- Balanced XLR Outputs
- 27dBm RMS 600 ohms balanced
- Cartridge load adjustment
- High Overload Threshold
- Linear Frequency Response
- Reliability
- Low Noise
- 1 Space Rack Mountable
- Accurate RIAA ( $\pm .05$ dB)
- 21dBm RMS 600 ohms unbalanced
- Non-reactive Phono Stage
- Fully Discrete Gain Blocks
- Drive Loads as low as 300 ohms

### SOLUTION



#### BRYSTON BP-1

(BP-5 also available with 3 switchable high level inputs)

In the United States:

**BRYSTON VERMONT**  
RFD #4, Berlin, Montpelier, Vermont 05602  
(802) 223-6159

In Canada:

**BRYSTON MARKETING LTD.**  
57 Westmore Dr., Rexdale, Ontario, Canada M9V 3Y6  
(416) 746-0300

Circle #095 on Reader Service Card

## studio consultants, inc.

321 West 44th Street, New York, NY 10036 (212) 586-7376

### The source for:

- **Bryston:** Superb, reliable power amplifiers from 50W/channel stereo to 800W bridged mono, with balanced inputs, modular channel electronics, and dual independent power supplies. Professional preamps also.
- **API:** Classic audio module designs, including the 560A graphic and the all-discrete 550A three-knob program equalizers. Powered racks, moving fader automation, and new modules on the way.

Also: **White** equalizers and crossovers, **Westlake** and **Fostex** monitor speakers, **Valley People** signal processing, **Audio Digital** delays and effects, **Ursa Major** digital reverb and signal processing, **Audio Kinetics** Q-LOCK synchronizer systems—and other fine products.

Short-term needs? We rent the best: **Bryston** power amps and racks of **API** equalizers.

**Equipment, support, and design services for professional audio facilities and broadcasters.**

Circle #096 on Reader Service Card

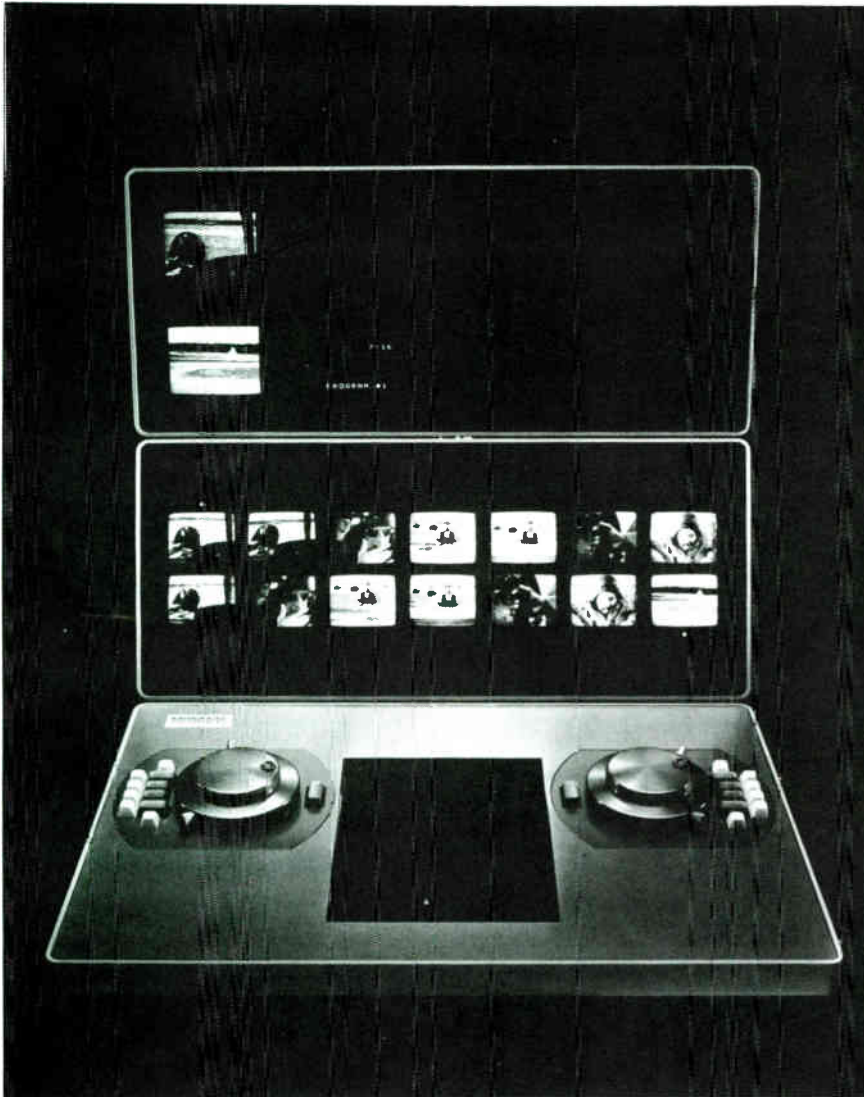

*The Montage Picture Processor: Non-linear, film style editing for video.*

by Elizabeth Rollins

## **Rebo Associates Bows High Definition TV Studio**

Barry Rebo's New York commercial production company is the first in the United States to have purchased the Sony High Definition TV (HDTV) sys-

tem. The 1125 line/60 Hz standard, which was developed by Japan's NHK television network, is being proposed as an international standard for high definition. Although Japan, the U.S. and Canada favor this standard, other countries, mainly in Europe, have reserved their support because they feel they can come up with a format that will more easily integrate with their 625 line/50 Hz television standard. So far, however, no alternative proposal has been presented to the international CCIR Plenary body.

Regardless of whether the rest of the world agrees on the NHK format, Barry Rebo took the plunge because he wants to offer a self-contained elec-

tronic cinematography laboratory that American producers with an eye on HDTV can experiment with. Rebo also has ideas of his own about HDTV programming for TV and the big screen.

Meanwhile, Canada and Italy have the jump on this market already. The CBC is currently producing a 13-part HDTV mini-series entitled *Chasing Rainbows*, and in June, the Italian network, RAI started shooting a HDTV feature for cinematic release entitled, *Giula and Giula*, which is being produced in English.

Sony Corporation manufactures the 1125/60 Hz HDTV system, which they demonstrated at NAB last April. "NAB really helped people understand what the HDTV system is all about," says Sony's Cory Carbonara. "A lot of companies expressed interest in buying after that, and we're working on confirming several deals."

## **Meanwhile, Montage Moves Ahead with Aggressive New Push**

Now that the smoke has cleared after Montage Corporation filed for bankruptcy last March, a new investment team has regrouped and opted for expansion. The Boston-based manufacturer of the Montage electronic, non-linear video editing system was bought out by a venture capital group spearheaded by company salesperson Harvey Ray and Simon Haberman.

According to Ray, the following production companies have recently acquired new systems: Polymedia, Salt Lake City (who'll be using their second Montage system to cut two feature films); editor Andy Monschein's NYC company, Sound One (Monschein cut Sidney Lumet's *Power on Montage*, and is now using it for Susan Seidleman's newest film, *The Making of Mr. Right*); Pace Communications, Portland, Oregon (this commercial production company already has three other systems); Crawford Communications, Atlanta (their second system); Pacific Video, Los Angeles (which actually leases four other systems); and Fox, Los Angeles (which now owns two and rents two more). Unitel, Los Angeles, has rented a second system, and Editel, NYC, recently upgraded the system they've owned for two years.

Now that the film and television industries have begun to respond to this new technology (see "Video News" in



Mix May, 1986), Montage is pushing for major design improvements that will be unveiled at the '87 NAB. "The next generation of Montage will offer substantially new improvements," according to Ray. "It will evolve more toward an on-line capability," he hints of the new beast.

There was some confusion with the phone system during the company's shakedown, but Ray says the new Los Angeles area number works now: (714) 525-5772. A New York office has been opened and can be reached at (212) 580-7500.

### Cinemax Comedy Experiment: *Shadoevision*

This month, Cinemax's *Comedy Experiment* once again plunges through the programming membrane of mainstream movies and low-cost television reruns-from-yesteryear that we have become accustomed to on cable TV. The half-hour program, entitled *Shadoevision*, is perhaps more what optimists at the dawn of the decade imagined cable TV would champion—unique, low-cost, but well-crafted stuff that you just don't see anywhere else.

But come to think of it, *nobody* really could have imagined *Shadoevision* except its creator, Shadoe Stevens and the wildly creative team that comprises his Los Angeles commercial production company, also called Shadoevision. (Southern Californians know Shadoe Stevens as the Fred Rated character on the ubiquitous Federated consumer electronics store commercials.)

*Shadoevision* isn't built on situation, gag, or one-liner humor—it's not yuk-yuk "funny." It's media-self-conscious, strangely modern, out-of-phase comedy that borrows heavily from a Fire-sign Theater tradition of the absurd.

This is going to be hard to describe . . . suffice it to say that the plot hinges on a smarmy Mr. Big variety show host (Johnny Dakota, played by Stevens) whose TV mind control rap is jammed by a pernicious CPA named Norman who's in the right place at the wrong time. Characters such as Neuter Blank, Snappy Patter and Quirrkly Twitcher are suspended in a psychopoly-dimensional landscape: "Beyond a state-of-mind, somewhere in the void between the accepted and the unexpected. . . *Shadoevision*," as Stevens intones with a voice that evokes a mix of *The Outer Limits* and Elmer Gantry. You with me?

On a budget of a mere \$150,000, producer Michael J. Hill, director Chuck Cirino, director of photography H.J. Brown and art director Rick Walker manage to characterize that texture visually. They use a smattering of de-

vices such as quick cuts, beautifully lighted film, cheesy video, glitchy video, claymation, matting, archival black and white film footage, and fast motion. (Yeah! No mo slo mo for a change.)

It's the imaginative soundtrack that really pulls you into *Shadoevision*. These guys are *into* audio. Stevens, who started a six-year career in radio at the age of 11 back in North Dakota, has retained an appreciation for the dramatic power of aural engagement. Director Chuck Cirino is also a working musician with two film scores to his credit. Staff music director Ron Artis has built a nicely equipped synthesizer-oriented 16-track studio in which the original score and many of the sound effects were created, processed and mixed.

"Shadoe is a bizarre character—he's a perfectionist," says Artis. "I hunted all over town for all those sound effects." At times, the SFX cacophony seems to come pouring out of a cartoon collective consciousness. They make you laugh. "I wrote 50 separate music bits for this show," he says, emphatically slapping his knee. "Out of those, Shadoe picked 26 pieces that are in it."

Cirino says a lot of the effects were created "where the five of us would just get together in the studio and make them ourselves collectively,"

using a number of synthesizers (including: Yamaha DX7, Prophet 2000, Linn 9000, Ensoniq Mirage and the Roland JX-8P. Some other older analog keyboards lounge forgotten in an adjacent room.) Engineer Chris Culverhouse presides over the complicated recording and mixing chores.

This self-contained creative team has been knocking out hundreds of comical Federated 30-second spots for four years, and now that the machine is well-oiled, programming is the next frontier. When asked if he thinks the off-beat *Shadoevision* will play in the heartland, Stevens says point blank, "I don't care. If this doesn't work, we've got too many other ideas to let that bother us." Among those other irons in the fire is comedy programming for Andy Friendly's new show, *The Rock and Roll Evening News*, which premieres in syndication this month.

The imposing Stevens squares his shoulders and manages to convey stolid credibility, though he's wearing a ridiculous, slightly shiny pink suit with blue suspenders. It's a costume for Fred Rated, the fast-talking L.A. smoothie character he portrays for the Federated commercials. "*Shadoevision* is exactly what I wanted it to be—a psychic roller coaster," he says. "It's a great ride." ■

## Print label copy right on your cassette with the apex printer



Forget about paper labels. Print over 7,000 units per hour. Save time, money, trouble, space. Eliminate inventory problems, costly label overruns. Save 4¢ or more per cassette.

Five models to choose from: One manual single color unit. Two semi-automatic one color table top models. Two high production multi-color consoles that print up to three colors in one pass.

Manufactured and distributed in U.S.A. by

**apex**

apex machine company  
3000 n.e. 12th terrace  
fort lauderdale, fl 33334 u.s.a.  
telephone: (305) 566-1572

Distributed internationally

**audio**

audiomatic corporation  
400 madison avenue  
new york, new york 10017 u.s.a.  
telephone: (212) 308-6888  
telex: 12-6419

Circle #097 on Reader Service Card

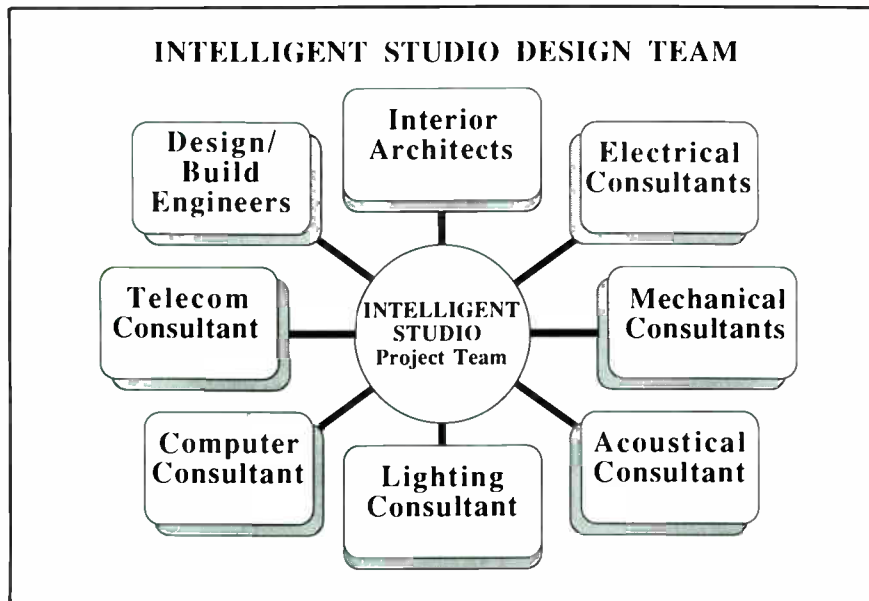

## THE INTELLIGENT STUDIO

by Lou CasaBianca

*"Any sufficiently advanced technology is indistinguishable from magic."* —Arthur C. Clarke

The advanced technology in the modern studio has put a host of "magical" tools in the hands of musicians, engineers, producers and directors. Digital recording, MIDI, SMPTE, IGES (International Computer Graphic Exchange Standard), the personal computer, and productivity software are technologies that have almost completely changed our creative and technical approach in the studio. Audio, video and computer graphic studio environments now demand a higher level of electronics integration than ever before.

In last month's MVP, we set up the concept of the intelligent or smart studio as an approach to handling the expanding complexity associated with the introduction and continuing refinement technology in the studio. There is an on-going need for new technology integration that can be managed cost effectively, the specialists who operate in the studio, and the studio managers have each had to adapt to the new approaches provided by the alchemy computers bring to the production process. Our goal is to interpret the implications of this technology for both recording studio and

video production/post-production suite. In this month's MVP, we present the second half of the "Intelligent Studio Technology Glossary," providing definitions for the design options currently available for integration of smart building services into the intelligent studio.

### Control Rooms and Soundstages

We will skip ahead to the control rooms and edit bays. These rooms have become smart spaces in otherwise low-tech buildings. They are equipped with production and/or post-production capabilities in the form of terminals, boards, instruments, audio, video and/or computer graphic processing and recording systems, outboard gear and furniture ergonomically configured to the applications and shape of the room. In a sense, it is now possible for the balance of a facility to attain a level of intelligence once limited to the production spaces.

Audio and video off-line rooms have become more important in the production process. In many cases, synthesizers and other instruments are being recorded "direct" in the control room. Mixing bays have to be able to accommodate racks of synthesizers and associated processing gear. This need has created the "synth room," a room dedicated to MIDI-synthesizer, sequencer, and drum box recording. Presented here are additional applications that can be brought into a stu-

dio facility to provide ancillary services for client convenience and operate as "free-standing" profit centers.

**Audio conferencing**—voice conferencing may be accommodated by the PBX "bridging" circuitry and speakerphones at the basic level. Customized audio conference rooms are acoustically conditioned and equipped with sophisticated balanced bridging and amplification systems. Additional equipment may be installed to accommodate larger audio teleconferencing requirements as another service.

**Audiovisual presentations**—a conference center can be designed to complement visual and audio presentations. This involves the cross application of the interior, ergonomic, acoustical, electrical, and electronic engineering disciplines.

**Video conferencing**—the addition of video conferencing to audiovisual presentations can provide another important in-house client service. Motion-full color and freeze frame video teleconferencing systems are available, each with cost/performance advantages. If properly implemented, video teleconferencing can offer significant travel savings.

### Telecommunications

The telecommunications field is experiencing the same kind of rapid advancement as audio and video. The ability to transmit six channels of voice, data and video information over standard twisted pair phone wire will soon be available as a standard product from Pacific Bell. This means that two people or machines will be able to exchange two-MIDI or computer data streams, two-voice channels and two two-way video picture channels simultaneously, over standard telephone lines.

**PBX service**—modern digital PBXs in addition to a vast list of voice features, offer simultaneous voice and data switching and transmission, data-link protocol conversion, voice mail, and shared use of common trunk groups by multiple users.

**Voice mail**—voice mail is a programmable and dynamically controlled voice recording, messaging, answering, routing, and intelligent call handling system that may or may not be integral to PBX equipment.

**Call detail reporting**—call detail recording and reporting (CDR) is a hardware and software system that records all outbound calls, arranges them in records with time, day, date, duration of call, kind of facility used, calling



code or station number originating, the call and the call's destination or point of global termination.

**Mobile and paging**—functionally, mobile and paging are two radio applications (generally FM) that may or may not be integrated in one system. Often, these features are interfaced to remote PBX systems through line or trunk ports, and are accessed through telephone terminals capable of generating touch dialing (DTMF) tones.

**Modem pooling**—the transmission of MIDI, SMPTE, computer graphics exchange programs like IGES (the International Graphic Exchange Standard) and access to networks and databases such as the IMC Network and Dow Jones requires modem data processing.

**Protocol conversion**—the modem pool can logically connect to protocol and code format conversion systems via PBX or data switching equipment. This service promotes universal connectivity, transmission compatibility, and adaptability.

**Basic timesharing**—the nature and efficiency of timeshared teleprocessing access to computer graphics, CAD, MIDI and digital audio systems may prove to be instrumental in promoting the communication arts and music recording industries' acceptance of an electronic "shared systems" studio concept.

**Remote database access**—entire libraries on virtually any subject of interest, including constantly changing or specific information resources generated by multiple disciplines, have been converted to magnetic media and are available via subscription service arrangements. Access to databases should be intrinsic to an intelligent studio's research and design development.

**Electronic mail**—the IMC (International Management Communications) network is among several "electronic publishers," providing database information, and electronic mail services distributed via modem.

### **Technical Operating Center**

An Intelligent Studio's TOCs, the machines and automation control systems should be located near the control room(s)/edit bay(s) to facilitate the integration of these systems through the universal distribution cable "plant" to provide economies of scale in environmental conditioning, and to optimize support.

### **Network Connectivity**

**Local exchange**—the telephone company's local exchange will provide a variety of local and long distance public and private services through the

use of common trunking.

**Metro area network**—a network of private facilities may be designed to provide optimum operating and cost efficiency, within specific metropolitan areas or between studio and client locations.

**Domestic long distance**—long distance communications within the domestic boundaries of the country are facilitated by a designed "mix" of line facilities. This mix must accommodate a higher grade of service while maintaining optimum cost efficiencies.

**International voice**—international voice communications which take advantage of automatic least-cost routing features in bypass PBX technology are now available on a shared tenant basis for the small and medium capacity users.

**Data networks**—the studio's systems should be designed to accommodate connectivity to a wide range of internal and external data networks. In effect, a private data network is designed among multiple studio room, soundstage and office locations.

**TWX/Telex**—the international text message connection and service offering is still widely relied upon as a primary national and worldwide communication service for hotel, travel, promotion, tour, and equipment arrangements.

**Satellite services**—satellite links are increasingly being used for a multitude of worldwide communications requirements, including high bandwidth applications such as video teleconferencing. Depending upon location and expected client requirements, the intelligent studio design, can include connection to satellite services via a local telephone company or through a teleport facility connected to the studio's cable plant. It is now economically feasible for studios and conference centers to have direct or remote access to satellite teleport or rooftop antenna facilities.

**Fiber optic services**—fiber optic services are also used to allow full spectrum capability for control rooms, edit bays and soundstage internal and external communications. This transmission device offers superior performance without the propagation delay inherent in traditional wiring facilities. Audio, video and computer manufacturers are now providing equipment that makes use of optical fiber in selected applications.

### **Integrated Infrastructure Security**

**Card access**—a number of card key access systems are now available, including products that require physical contact with the reader as well as

those that operate by proximity and require no physical contact.

**Window/door sensors**—perimeter security may be achieved by installing concealed magnetic reed switches on all doors and windows.

**Master antenna television (MATV)**—an MATV system permits ghost-free television reception within steel frame buildings. Distribution in the building is accomplished in much the same way CATV signals are distributed.

**Digital termination service (DTS)**—digital termination service is a low-powered point-to-point or point-to-multipoint terrestrial microwave system used to provide high bandwidth digital connectivity between metropolitan locations without using telephone company facilities.

### **Service Entrance**

**Main terminal room**—the main terminal room is the room into which the local telephone operating company brings the central office entrance cable.

**Fiber optic FDF**—a fiber optic distribution frame can be located in the main terminal room if optical fiber is to be used either to serve the building from the local telephone company exchange or internally within the studio. **CATV**—community antenna television services (cable TV) are usually distributed using coaxial cable as a transmission medium.

### **Summary**

Most studios facilities are expanding to meet the challenge of the "new" media. Studio technology requirements will not necessarily be as critical to other tenants in a multi-tenant building. Intelligent studio development also includes the concept of smart systems within smart space. The design enhancements provided by smart technology have created what amounts to almost an advanced electronic research laboratory environment in the studio. While not every studio manager will need to apply all of these techniques, it is clear that most studio managers will benefit by some application of this approach to their studios.

Intelligent Building Communications Group of San Francisco is a team of interdisciplinary experts consulting in the design and development of intelligent building technology. The Group has pioneered the concepts and the methodology used to review and evaluate intelligent buildings, and applied here to the studio. Special thanks to David and Karen Coggeshall and the consultants of the IBC Group for their valuable assistance in the preparation of this article. ■

# THE BEAT OF THE BUSINESS

## NEW SOURCES OF INCOME IN SOUTHERN CALIFORNIA

by Linda Johnson

Remember in your tenth grade economics class when your teacher went on and on about supply and demand? Back then, it probably all meant nothing more than a headache to you. But if you're directly involved in the studio business today, you've seen that this economic postulate is much more than scribble on the chalkboard. With demand represented by the needs of clients, and supply represented by the equipment and services offered to satisfy those needs, your tenth grade learnings have come to life.

Perhaps this article could be thought of as a summer extension class, as we take you to Southern California to learn about new sources of business in the area. What are clients demanding these days, and what is being done to cater to those needs? Plain and simple: where's the business?

### RECORD PLANT Chris Stone

After 18 years, the Record Plant moved to a new facility this year. "The basic difference between this place and the old one," says owner Chris Stone, "is that the old one was built for records and also did visual, and this facility is built for visual and also does records." Recent projects at the studio included albums for Bruce Springsteen, Judas Priest and Andy Taylor, music scoring for *Back to School*, *Running Scared*, and *Howard the Duck*,



and audio-for-video on TV shows *Dallas*, *Fame* and *Cheers*.

*What would you say is your newest source of business, and what have you done to accommodate it?*

Well, we could take remote as an example. In 1980, 90 percent of our remotes were records, and ten percent were visual. In 1985, those two

percentages reversed themselves. So the movement from straight record business to visual business is what has really happened in this town in the last few years. It's been that transition that has allowed us to stay on the leading edge of recording.

*How do you create business?*

—CONTINUED ON PAGE 146



### NICK SMERIGAN: Voice of The Village

On May 21 of this year, Nick Smerigan became executive director at the Village Recorder in West Los Angeles. His previous six years were spent as vice president at the Record Plant under the supervision of owner Chris Stone, from whom Smerigan says he learned much of his studio smarts.

"Chris Stone is what I consider the godfather of the studio business," he says. "I was fortunate to be able to learn the actual day-to-day running and psychology of the whole business through him. He turned over all the building projects to me and my responsibility was to get things set up and running. It was like a six-year learning period."

Today, Smerigan has his own ear to the ground, trying to stay on top of the latest industry trends. "On a day-to-day basis, I have to try and figure out ways to stay up with

—CONTINUED ON PAGE 146, SMERIGAN



# "I like the way BBE™ brings out the 'live' dimension in sound."

Bernie Grundman

When it comes to cutting discs, Bernie Grundman is the master. Ever since the late 60's, the music industry's top artists have been entrusting Grundman with the delicate task of preparing their record masters. The list of satisfied clients includes Stevie Wonder, Prince, Michael Jackson, Olivia Newton-John and Lionel Ritchie, to

Angeles. Even the finest components, you see, can be undermined by that all-important interface between amplifier and speaker. That's where phase and "overhang" distortion develop, due to voice coil characteristics, reflected impedance from the environment, crossover impedance anomalies and the

mechanical properties of dynamic speakers. The relationships among the fundamental frequencies, their leading harmonics and between the leading harmonics themselves become distorted in both amplitude and time. The result? Muddiness, poor imaging and pinched, colorized sound that lacks the presence and punch of the real thing.

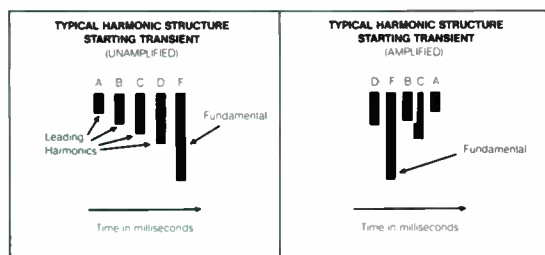

name just a few. So when a critical listener like Bernie Grundman lists himself as one of BBE's satisfied customers, it's quite a compliment.

"Unlike an equalizer, BBE is a dynamic process. It gives me the high end I want without the sibilance and without creating energy levels too intense for my cutting lathe to handle. I can foresee BBE becoming a very valuable tool in the mastering process."

The BBE 202R is a vital link in the chain of precision components used at Bernie Grundman Mastering in Los

angeles. Even the finest components, you see, can be undermined by that all-important interface between amplifier and speaker. That's where phase and "overhang" distortion develop, due to voice coil characteristics, reflected impedance from the environment, crossover impedance anomalies and the mechanical properties of dynamic speakers. The relationships among the fundamental frequencies, their leading harmonics and between the leading harmonics themselves become distorted in both amplitude and time. The result? Muddiness, poor imaging and pinched, colorized sound that lacks the presence and punch of the real thing.

The BBE 202R puts the clarity and sparkle back into amplified and recorded sound. We like to think of it as the "unprocessor." Rather than artificially altering the original source, BBE restores the natural harmonic balances that were present in the live performance. How? First it divides the audio spectrum into three bandwidths. Then it applies phase correction across the full spectrum and dynamic high frequency amplitude compensation

as required. BBE's continual sampling of the mid/high frequency relationship allows this correction to take place automatically. Convenient front-panel controls let you boost low frequencies and regulate the amount of high-frequency amplitude correction to suit your needs. There's no encoding or decoding involved, so BBE can be used anywhere in the recording chain—from individual tracks on a multitrack tape to a mastering lab monitoring system.

For disc mastering perfectionists like Bernie Grundman, BBE makes an audible difference. Shouldn't BBE be a part of your next mastering piece?

To find out what the BBE 202R can do for your sound, call us toll-free at 1-800-233-8346. (In California, call 1-800-558-3963.) Or write to us at Barcus-Berry Electronics, 5500 Bolsa Avenue, Suite 245, Huntington Beach, CA 92649.

Circle #098 on Reader Service Card

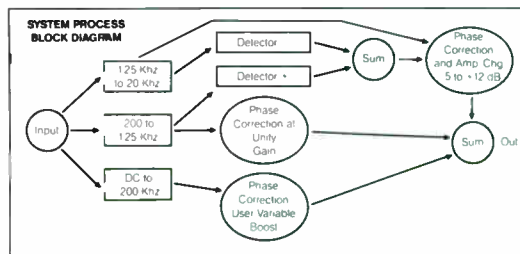

**BBE** All the sound you've never heard.  
**Barcus-Berry Electronics, Inc.**

© 1986 Barcus-Berry Electronics, Inc.

—FROM PAGE 144, *SMERIGAN*

where business is going," he says. "From there, it's just a matter of covering my eyes, taking a deep breath, and jumping."

With three Sony PCM-3324s, a Mitsubishi X-800, and other new equipment, The Village has indeed taken a serious plunge into becoming state-of-the-art, but Smerigan says that "selling studio time is a dangerous profession. You may have the latest and greatest in equipment, and six months later some guy in Indiana may come out with some gizmo that makes your machinery obsolete."

Therefore, Smerigan has come to believe that the "vibe" of a studio is perhaps the most important factor in creating business for a studio today. "The whole Record Plant theory was based on giving the atmosphere of someone's living room.

"Music is such a subjective form of art, and *making* it is even more

subjective," he continues. "What clients want to hear in your room—their working environment—is a tough thing to figure out. You can't please everyone with everything you do."

According to Smerigan, The Village is a place where clients (some of whom recently included Robbie Robertson, Berlin, and Ratt) can feel at home and know that the equipment and service they need will be there for them.

"Chris Stone instilled it into my head that we're not in this business to rip people off—we're here to service them," he explains. "Our clients keep coming back because they know that if they need something, someone will snap to it and will go get it for them. This is a service-oriented business, and when people feel that the studio will take care of them, their minds are free just to create music."

—L.J.

—FROM PAGE 144, *BUSINESS*

Basically, you try and service an industry, but there's generally a very dominant segment in that industry that provides the majority of your dollar volume. The studios that can afford to pay for the leading edge can then

afford to plow back all of those dollars into better equipment, and the whole thing perpetuates itself.

We've been fortunate enough to have a great amount of publicity through who we are and what we're doing. As we do major clients, we at-

### Larrabee Sound; Los Angeles, CA



tract more major clients. The next level, below the superstar, realizes that they need that kind of quality as well. And it becomes a matter of not how can he, afford it, but a matter of necessity because he *requires* that level of quality in order to compete with the superstar.

*What makes a good studio today?*

The latest equipment and acoustics, and that again attracts the best people. The majority of audio engineers are independent, so it's not that engineers *have* to work here; they work here because they want to. They pick this studio over the others because they can get the sound here that they can't get some place else.

*What direction do you think business will go in for the Plant in the next few years?*

It'll probably be 60 percent visual and 40 percent records. We designed our new building so it's flexible enough to let the music industry take us wherever it wants to go.

### OCEAN WAY Jay Kaufmann

Mr. Mister, Lionel Richie and Neil Diamond were all in recently at Ocean Way in Hollywood, where general manager Jay Kaufmann reports that the 13-year-old facility has also done its fair share of film scoring, including *Crossroads*, *Southern Comfort*, and *Paris, Texas*.

*What are some new sources of business for your studio?*

Overall, we're still providing the same high quality services we always have. I wouldn't say that there's any one major new source of business.

*How do you create business for your studio?*

It's all word of mouth. I think any other approach is futile. We have very unique rooms to the entire city around here. They're very large and live, which is unusual in itself. They were originally built by Bill Putnam in the '50s. We don't make any attempt at all to follow what anyone else is doing. We equip our studios with what sounds the best. We have one of the largest tube mic collections around; most of the equipment we have is hand selected. The staff here is very competent; we have very little down time. You put all those things together and the word gets out about our good reputation. There's not a lot we have to do to create business other than maintaining what we have to offer people.

*What makes a good studio today?*

It's two things: the people involved, and not necessarily going with what is considered state-of-the-art. I think it's more of going towards what makes your studio somewhat unique. Jump-





WORK DIRECTLY WITH THE WEST'S LARGEST  
INDEPENDENT RECORD AND CASSETTE DUPLICATING  
FACILITY FOR MAJOR LABEL QUALITY AND SERVICE.

# RAINBO RECORDS & CASSETTES

1738 Berkeley Street, Santa Monica, CA 90404

## — LIMITED OFFER —

### \* RECORD PRICES

#### \* 1000 12" FULL-COLOR PACKAGE **\$1666.00**

Lacquer mastering — 3-step metal plating — 8 test pressings — 2-color labels (including type) — full-color jackets — white sleeve — shrink wrap — test within 5 working days — completion 10–15 working days after test approval.

#### \* 1000 12" ONE-COLOR PACKAGE **\$1444.00**

Same as above package except One-Color Jacket. 10 to 15 working days.

#### \* 1000 7" 45's **\$555.00**

Lacquer mastering — 3-step metal plating — 8 test pressings — 2-color labels (including type) — white sleeve — completion 10 working days.

#### \* 1000 7" 33½ **\$575.00**

As above

### CASSETTE PRICES

#### \* 1000 FULL-COLOR CASSETTES **\$888.00**

Cassette mastering test cassette — Apex printing direct on cassette — label plate — full-color inserts\* — 1000 additional inserts for reorder — Norelco box — cellophane wrapped

\* Does not include composite negatives.

**Lacquer Mastering by: EMI America, Capitol Records, Inc.**

**Pressed with: KEYSOR 588 Translucent Select Quality Vinyl**

**Tape: BASF-LHD Audiophile Music Quality—State-of-the-Art Bin Loop—HX PRO**

**Pressing Credits:** Capitol Records for the Beatle Releases in the early 1960's, Enigma, Rhino, CBS, RSO, Casablanca, Twin Tone, Tommy Boy, SST, United Artists, Greenworld, Frontier, Pausa, Palo Alto, Celluloid, Metal Blade, Shrapnel, Warner Bros., Elektra, and many, many more including the recently completed MCA's *Miami Vice*.

**Special Projects:** Include Shaped Records, Picture Records, and other premium record products that must remain anonymous.

(Please mention "LIMITED OFFER" when ordering)

**(213) 829-3476      (213) 829-0355**

SMALLER QUANTITIES AVAILABLE

### REORDER

**\$1222.00**  
FULL-COLOR  
PACKAGE AS ORIGINAL  
10–12 working days

**\$999.00**  
ONE-COLOR  
PACKAGE AS ORIGINAL  
10 working days

**\$333.00**  
As Original  
7–10 working days  
7" 45

**\$333.00**  
As Original  
7–10 working days  
7" 33½

**\$777.00**  
As Original  
7–10 working days  
\*1000 full-color inserts

## Encore Studios

Encore Studios occupies part of the Burbank facility previously known as Kendun. "We purchased the building primarily to serve as a base of operation for Encore Records," explains Billy James, studio manager and vice president of A&R for Encore Productions, "and secondarily to be of service to outside clients.

"The first major move we made was to buy a second Studer 24-track," says James, adding that "the only other modification we did was to have motorized louvers installed.

"And we bought some toys, of course."

Escrow closed April 9, 1985, and Encore opened its doors very shortly thereafter. "Ed Palmer is the executive vice president," James notes.

"Financial backing is from Robert M. Andreoli, a prominent Rhode Island businessman/entrepreneur who writes songs every once in a while."

According to James, Encore's own artists have kept the joint jumping. These include Todd Smallwood, who had two tunes in *St. Elmo's Fire*; "Under Fire," led by Cary Sharaf—who wrote "No More Heartaches," covered on the Kantner-Balin-Casady band's forthcoming debut LP; Jackie Padgett, being produced by Nathan East and Marcel East; T-Men; Jamie and the Smashers, on temporary hold while guitarist Jamie Glaser tours with Chick Corea ("Jamie is a Berklee graduate, very highly respected," James notes. "He used to tour with Jean-Luc Ponty."); and Terry Young, an R&B singer and songwriter, who toured with Dylan doing backing vocals a few years back. "We're re-

leasing the 12-inch dance mix of one of Terry's tunes through independent distribution, starting in the Northeast," says James.

One of Encore's steadiest customers is MCA Records. "We hit the streets running with MCA," says James. "They were our first clients, and they're in *constantly*." Other recent outside clients include Stewart Copeland and Adam Ant, doing the title track for the movie *Out of Bounds*; Andre Cymone, for CBS; Animation; Berlin; the LA Dream Team; Maurice Jarre, recording the score for the film *Fascination* with Lee Ritenour, a shakuhachi player and a cellist.

"We have been blessed and extremely gratified by the response of the recording community in Los Angeles," says James. "We haven't been at 100 percent capacity, but we have been holding our own."

—David Gans

ing on the latest technological trend, you limit yourself to a certain clientele.

*What direction do you think your studio will go in in the next few years?*

I don't see that we'll be making any major change in our direction. The only thing that may happen is we may

push a little more into digital projects, now that the Mitsubishi X-80 is out there.

### AMIGO STUDIOS Armando Henriques

After 15 years as Warner Bros. re-

corded studio, Amigo Studios in N. Hollywood has been independent now for two years. The studio was recently expanded and upgraded, and studio manager Armando Henriques reports that they're still working exclusively on Warner Bros.' visual projects and records, including recent visits by David Lee Roth, Rod Stewart and Berlin.

*What are some new sources of business for your studio?*

We're kind of turning into a heavy metal studio! We have an engineer named Michael Wagner who's done seven albums out of here, and right now he's got four of them on the charts. So we've really expanded in that area. It's funny because we never really used to do heavy metal.

We're also doing a lot of digital work with Roger Nichols. We just expanded a lot, digital-wise, in both recording and mixing. We are going into film work more too, because we're in the midst of purchasing an SSL 6000. But I'd say more than anything we're just gearing up more for the digital stuff, and direct to metal mastering.

*In your eyes, what makes a good studio today?*

More than anything, because of the competition, I think the general attitude and atmosphere is most important. I mean, let's face it, there are over 200 24-track studios in L.A., and artists have a choice of where they want to work. Most of the people coming here wind up staying here on a long-term basis. We're real easy-going. We have great equipment, but so do a lot of other studios. Bob Ezrin and Roger

# Great New Music for TV, Film & AV

No Needle Drop Fees

COMPACT  
disc production library®

1,485 Total Tracks on 15 Compact Discs

6 Initial Discs plus 3 Updates per Year

450 Original Instrumentals

325 Accents - 260 Sound Effects

Only \$4,000 Buyout with CD Player

Or Finance at \$100 per month (9.24% APR)

century21  
PROGRAMMING, INC.

4340 Beltwood Parkway, Dallas, TX 75244-3225

(214) 934-2121 or toll-free (800) 582-2100



Circle #100 on Reader Service Card



**"STIMULATING REPRODUCTION"**



Stimulating reproduction through sonic purity and accuracy, rugged reliability through precision construction.

Solid feel. Metal, not plastic. Years of lasting quality.

Recorders, mixers, microphones, monitor speakers, power amps, and accessories ... precision engineered in America for the discriminating professional.

**AMR**<sup>TM</sup>  
"the American Sound"

World Radio History  
Circle #153 on Reader Service Card

AUDIO MEDIA RESEARCH/ROUTE 2, HWY 503/DECATUR, MS 38927/601-321-1111

# MPC-3000 MIC PREAMP

A direct plug-in for the  
SONY MXP-3000 consoles.



- 990 discrete op-amp.
- Jensen JE-16-B mic input transformer.
- DC Servo circuitry.

The best op-amp, best input transformer, and superior circuit design give you true STATE-OF-THE-ART performance.

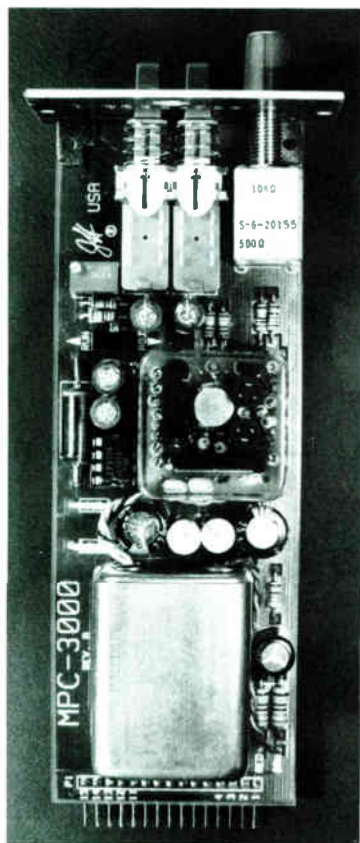

## THE HARDY CO.

P.O. Box AA631  
Evanston, IL 60204  
(312) 864-8060  
TELEX: 910-380-4670  
(JOHN HARDY CO)

Circle #101 on Reader Service Card

Nichols have been working here a lot lately. There are tons of other studios they could work at with comparable equipment, but it's the other factors that begin to matter, like having a relaxed and comfortable atmosphere to work in.

*Where do you see your studio headed in the near future?*

I'd say mostly record work still, although with the advent of this new SSL 6000, I have a feeling that we'll start doing more film and video projects. We'll be prepared for the visual work, but records will still definitely be our primary concern.

### ALLIED ARTISTS Coy Owen

Allied Artists in Sante Fe Springs is a subdivision of Consolidated Allied Artists, and works almost exclusively with groups on its self-titled label. Studio manager Coy Owen says that business is growing fast in its sixth year, as evidenced by the recent purchase

of three soundstages and the addition of a fully automated room. Some artists on the label include Luis Cardenas, Cynthia Manly and Lewis Price.

*Have you seen any new sources of business lately?*

Well, since the studio belongs to the label, we're not really in search of business. We are open to outside clients, but we're tied up with our label projects.

*What is the direction of the studio?*

One-hundred percent record production, but we have one-inch and 3/4-inch video machines so we do some video sweetening and master laybacks.

*How do you create business? What is it that attracts people to your studio?*

As it stands right now, the studio itself has only been up as a fully-automated SSL room for five months. Previously it was a different console. So now what's attracting everyone is the equipment. We're the only digital room with a brand new SSL console [in L.A.]. And we're soon to be 64 tracks of



PHOTO: LINDA JOHNSON

*Westwood One's Richard Kimball in the airlock of their Concertmaster I recording truck during the Amnesty concert.*

### Westwood One's Commitment to Amnesty

Keeping up with the ebb and flow of supply and demand in the recording studio or remote recording market can be a difficult task for any business. However, the arduousness of such a job is multiplied manyfold for Westwood One, the Culver City, California-based radio syndicator, who not only utilize the services of other remote recording companies, but also offer their trucks to outside clients whenever they are available. In fact, they purchased a third mobile unit, Boston's Starfleet Blair recording bus, and added its operator Sam Kopper

to the Westwood One team, just to keep up with their hectic schedule of producing dozens of top notch concert broadcasts every year.

We caught up with Westwood One vice-president of artist relations and mobile recording, Richard Kimball, who took a few moments to talk during the Amnesty International benefit tour this summer. Providing audio for concert simulcasts (such as the Amnesty event) is a constant source of activity for Westwood One. "We've done a lot of work, not only for MTV, but also for Showtime and HBO," Kimball explains, "and I would venture to say that we supply the audio for probably 90 percent of all the radio/television simulcasts you see today."

Certainly Westwood One has both financial as well as creative interests in the concerts they syndicate, however they took their concern with the Amnesty concerts one step further by offering to handle the audio gratis. "All of the money from this event goes to Amnesty—not only the money we've paid up front, but also all of the advertising revenues," Kimball adds. "Ideally, we want to re-broadcast some of these shows—audio only—over an 18 month period, with all the money going to Amnesty. We don't want this to end and then have everybody forget about Amnesty. The most important thing is to get the message out. There's no monetary gain for us, but fortunately, we are in a position to afford this."

—George Petersen



# SSL Congratulates Larrabee Sound

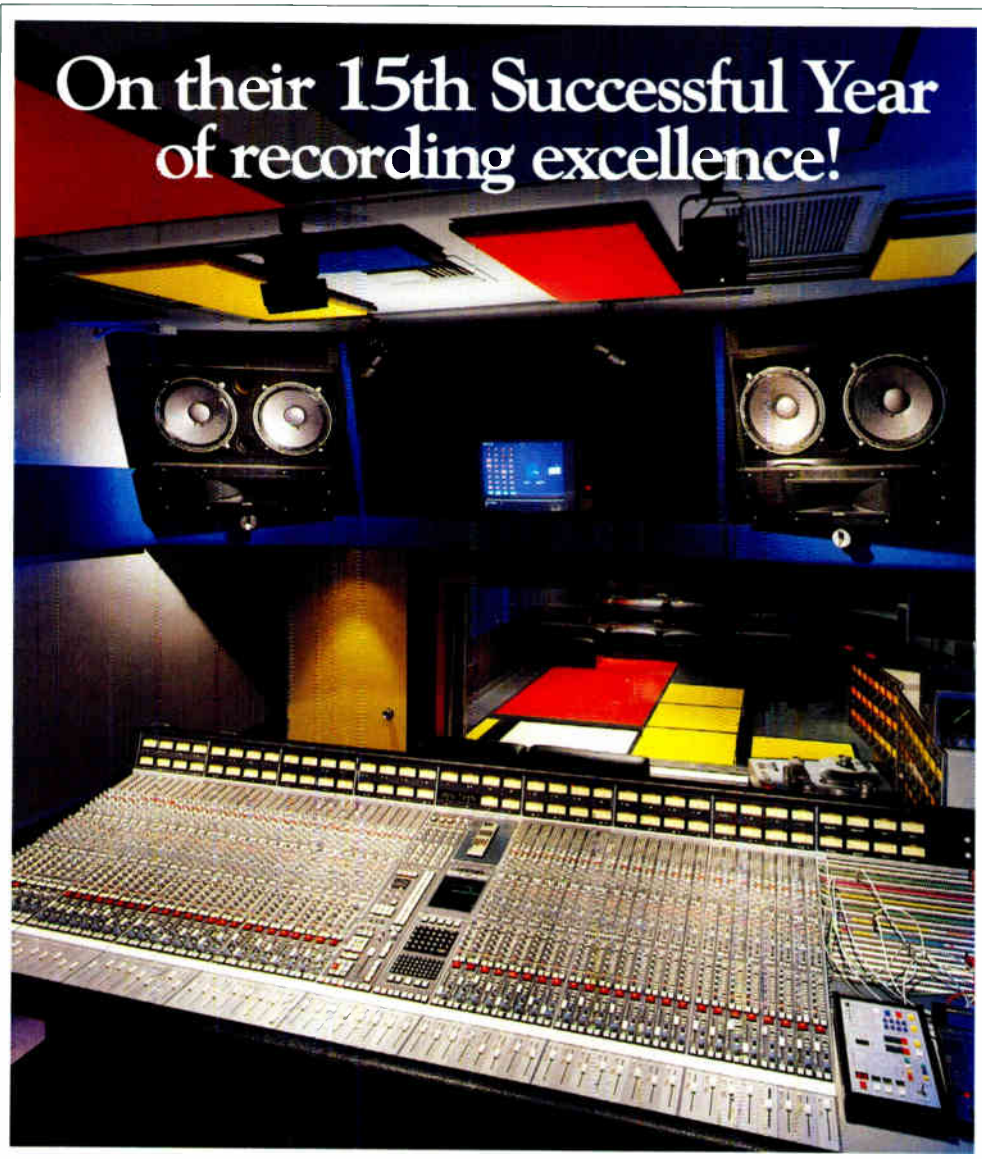

Larrabee Sound, Hollywood CA

And congratulations on the purchase of your  
third SL 4000 E Series Master Studio System,  
from all of your friends at

## Solid State Logic

Oxford • New York • Los Angeles

Begbroke, Oxford, England OX5 1RU • (08675) 4353  
200 West 57th Street • New York, New York 10019 • (212) 315-1111  
6255 Sunset Boulevard • Los Angeles, California 90028 • (213) 463-4444



PHOTO: ED FREEMAN

*Mixing sound for the syndicated series Fame in Studio 1 at the new L.A. Record Plant. Pictured at the Yamaha DX7 synthesizer is composer Gary Scott. Mixer Mike Stone is at the SSL-4000E console (with multi-track "sidecar" custom film console on the right) with second engineer Phil Jantaas.*

Mitsubishi digital. We also attract people from the East Coast because they can just bring their soft disks and

they're ready to go.

We really haven't done any advertising about our equipment, so it's all

been word of mouth. We're considerably different than a normal studio because we have a pressing plant in Wales and we have our fingers in a lot of different areas (three specialized divisions: remote, video and records), so it's just trying to keep up with our own product that keeps us busy.

*What makes a good studio today?*

I'd say in today's realm, as well as in the past, some of the most important things would be the sound of the room itself, the ability to get a good sound, and the attitude of the studio personnel—their interest in what the client is actually doing, and how well they accommodate the artist. Mostly though, I think it's the sound that the room is capable of, and that it is something you can rely on.

## **RUMBO RECORDERS**

### **John Carsello**

Owned by The Captain & Tennille, Rumbo Recorders in Canoga Park was recently visited by Tom Petty, Fleetwood Mac, REO Speedwagon and Survivor. Though studio manager John Carsello says that record work is the primary business, the studio also does some film work; Bob Dylan recorded the title track for the film *Band of the Hand* there.

*How do you create business for your studio?*

It's mainly through word-of-mouth from different producers, engineers, bands, and record companies that come in to record. We're always staying on top of being state-of-the-art.

*What makes a good studio today?*

The equipment of course, and your staff. You're only as good as your engineers and your equipment.

*Where is the business in today's market?*

Video is definitely making a great big dent as far as being part of the business in conjunction with records. I think they go hand in hand now. And we're finding the need to cater to that. We're in the process of researching video equipment, and may be getting into it soon.

But for now, we're keeping records as our primary business. Down the road, possibly some video. We're not geared for it yet, even though I agree that it is coming in big. But I don't think video is going to take over everything. We plan on just staying on top of the pile as far as records go.

## **CAPITOL RECORDING STUDIOS**

### **Charles Comelli**

"We're a one-stop facility," says studio manager Charles Comelli of Capitol Recording Studios in Hollywood, referring to the totality of services there. With record work as their pri-

# **THANK YOU RECORDING INDUSTRY FOR NOMINATING STEVE HALL AND FUTURE DISC SYSTEMS FOR THE TECHNICAL EXCELLENCE AND CREATIVITY AWARD IN MASTERING**



**COMPLETE ANALOGUE  
& DIGITAL MASTERING  
SERVICES FOR  
COMPACT DISC,  
RECORD & CASSETTE  
MANUFACTURING**

## **FUTURE DISC SYSTEMS**

3475 Cahuenga Boulevard West  
Hollywood California 90068  
(213) 876-8733



# EARLY REFLECTIONS

Engineers talk about their new discovery: the Ibanez SDR1000 Stereo Digital Reverb



"The combination of performance and value is great! Rather than exhausting your entire reverb budget on one high-end unit, you can have a rack full of these. This puts many different environments at your disposal".

Jan Hammer: Jan literally has done it all. He came to public attention trading leads with John McLaughlin and the Mahavishnu Orchestra. Jan then released a series of LP's as a soloist and with his group "Hammer". Afterwards, Jan toured with the Jeff Beck Group, cut an LP with Neil Schon, and started composing for TV and movie soundtracks. Jan's most recent work for the "Miami Vice" TV series has won him even wider critical acclaim. Jan's soundtrack LP from the series won a Grammy in 1985.



"The SDR1000 is a great unit! To call it a digital reverb is too one-dimensional because of its across-the-board capabilities. It's the most cost-effective processor we have in the studio."

Lance Quinn/O.B. O'Brien: Lance and O.B. have been extremely busy since opening the Warehouse Studios. Some of their most recent credits include Bon Jovi's "7800 Degrees" gold LP, Lita Ford's "Gotta Let Go", Nils Lofgren's "Flip Ya Foot" and the first album by Cinderella".



"For today's mixes, where I use as many as 10 separate reverb units, the SDR1000 is an extremely effective, flexible tool for a wide array of effects. The reverb algorithms give smooth, fat sounds that work great, whether they're used for large chamber or small room sounds."

Ed Thacker: Ed is one of the most sought-after free-lance engineers on the west coast. Ed has worked on Glen Burtnick's "Talking In Code" LP and Glass Tiger's "Thin Red Line" album. Ed also engineered the soundtrack for the movie "Goonies", including Cindy Lauper's track "Good Enough".

The SDR1000 Stereo Digital Reverb is a true dual-processor that delivers strikingly warm, full reverb sounds. 30 factory presets, created by top-chart engineers, and 70 user presets put a virtual sonic universe at your fingertips. Fully programmable (there's even a programmable on-board EQ!), the SDR1000 has easy-edit sound

creation software and MIDI-controlled patch recall to make it the "friendliest" reverb processor with this much flexibility. So whether you need a true stereo processor or two distinct reverb sounds simultaneously, the SDR1000 deserves your serious reflection—at your Ibanez dealer now!

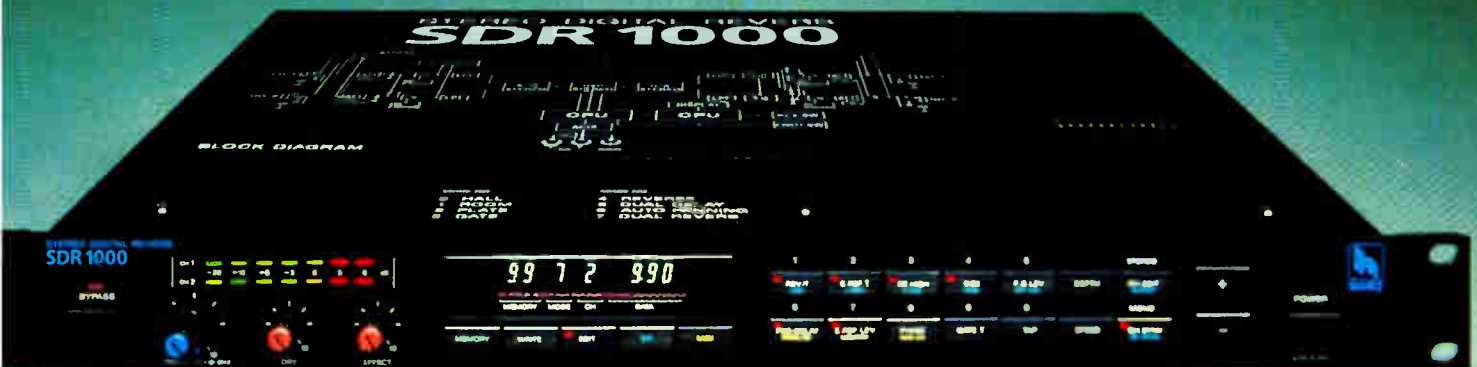

For a full color catalog send \$2.00 to: Ibanez, dept. MX 6 • P.O. Box 886, Bensalem, PA 19020 • 3221 Producer Way, Pomona, CA 91748-3916 • P.O. Box 2009, Mahwah, NJ 07430 • In Canada: 6969 Trans Canada Highway, Suite 105, St. Laurent, Quebec, Canada H4T1V3

many source of business, some recent visitors included Oingo Boingo, The Stray Cats, and from Japan, Onyanko.

*Where's the business today for your studio?*

It's basically been the same kind of clientele coming in—lots of record projects. Our next turning point will be in '87 when we will look into film and video scoring. I never want to own a video camera, but I do want to have a situation where the client can indeed walk out of here with time coded, 3/4-inch or one-inch videotape, and then sync in the visual onto that tape to provide the best possible sound. So we plan to cautiously approach the video and film scoring world.

*How do you create business?*

By word of mouth because we treat our clients quite well. We advertise very sparingly. We're well-priced, and we have a very good technical staff. Also, we have two cutting facilities here and mastering facilities. We do a lot of production work for internal purposes, which puts us in the CD/digital editing field. So overall, we're not just a studio, we're pretty self-supporting.

*What makes a good studio today?*

I think a studio should be economically and technically sound. Also, the attitude of your staff and your engineers is very, very important. That's really what keeps bringing clients back. People are attracted to the totality of service that we have here.

## **A&R RECORDING SERVICES**

### **Scott Seely**

David Sanborn, Ozzy Osbourne, and John Kodi were all in at A&R Recording Services in Rancho Mirage recently, where owner Scott Seely says his 8-year-old facility is doing very well, with mostly albums and some advertising work keeping them busy.

*Have there been any new sources of business for you recently?*

Not really. We do a little bit of everything.

*What makes a good studio today?*

Personnel. You can have mediocre equipment if you have good personnel. Being able to communicate with the musicians is very important. And we've got a very intimate studio atmosphere here, which I believe is important.

*What direction do you see the studio going in in the near future?*

Right now, we'll continue on the way we always have. If we tried to be more like other studios in L.A., we'd have to triple our prices, and in that case, our clients would just as soon go to Burbank to record. We're not a rat race studio; that's why I came down to Rancho Mirage from L.A.!

## **LARRABEE SOUND**

### **Kevin Mills**

One of the 1986 TEC Awards nominees, Larrabee Sound in L.A. underwent major reconstruction last year. According to studio manager Kevin Mills, over a million dollars was invested in new gear, including two new SSL 4000E Series 56-track boards and lots of AMS equipment. New Edition, Patti Labelle, Missing Persons and Don Johnson were all in recently using the newly designed rooms.

*Where's the business today for your studio?*

Lately, the biggest change is that we do remixes on 12-inch singles. We're doing mainly mixing, whereas before we did mostly recording. The last time we saw a drum set in here was about eight months ago. It's been a gradual change. But lately it's been magnified.

People are spending more money on mixing, and more time and effort. Before, we used to mix a song in two hours. Now, Don Johnson has been in for nine days mixing one song. People are going to cheaper studios to do tracking, and then going to the places with more sophisticated equipment and better rooms for mixing.

*How did you create this new source of business?*

By reinvesting in the business. People are becoming more specialized. They want more equipment, they want

**K disc mastering**

---

6550 Sunset Boulevard  
Hollywood, California 90028  
(213) 466-1323

---

**COMPLETE  
SONY DIGITAL  
MASTERING  
SYSTEM  
INCLUDING  
MUSIC EDITOR**

---

**TANDEM  
VMS 80  
NEUMANN  
LATHES**

Circle #105 on Reader Service Card





# IT'S ABOUT TIME

Finally, someone tied everything together — MIDI, SMPTE and the tape recorder — in one smart package. The company is Fostex and the product is the Model 4050. Much more than an autolocator, it provides a level of automation never before available.

Now musicians and songwriters have direct access to SMPTE time code, the universal time standard. Sync all your MIDI clocks and the tape recorder to SMPTE for rock stable timing.

Program and edit with a new level of confidence and accuracy. Features include:

- Up to 100 cue point memory for autolocate on Fostex Models 80 and 20, B-16 Series and all E-Series.
- Automatic programmable punch-in/out.
- Complete control of MIDI start time, tempo, meter and length of song.

The 4050 is the first autolocator to think musically.

the professional standard, worldwide.

Plus, the door to video is now wide open. Especially with the amazingly affordable Fostex synchronizer, Model 4030.



- Recognizes MIDI Song Pointer.
- Selectable Pre-roll up to :99 sec.
- Built-in SMPTE Time Code Generator/Reader — all four formats.

When your timing reference is SMPTE, you're in sync with

So hurry on down to your Fostex Personal Multitrack Dealer and put a 4050 into action. Because now's the perfect time.

## Fostex®

15431 Blackburn Ave.  
Norwalk, CA 90650  
(213) 921-1112

# GOLD, PLATINUM, AND GRAMMYS

## SDR STUDIOS

14511 DELANO ST.  
VAN NUYS, CA 91411  
(818) 994-9973

Circle #107 on Reader Service Card

## AMPEX 3M & AGFA

Professional  
Audio and Video  
Tapes

Open Reel Audio

Bulk Cassette Tapes

Video Cassettes & 1"

Reels, Boxes & Accessories

AVAILABLE FROM THE NUMBER ONE IN  
PROFESSIONAL RECORDING PRODUCTS:

### ADVANCE RECORDING PRODUCTS

7190 CLAIREMONT MESA BOULEVARD  
SAN DIEGO, CALIFORNIA 92111  
(619) 277-2540

CALL TOLL FREE: (800) 854-1061 IN CALIFORNIA: (800) 858-1061

Please call or write  
for our FREE catalog.



Circle #108 on Reader Service Card

better rooms, and SSL is the hottest console right now. So we completely remodeled the rooms from the dirt up. We've always been sort of moving in this direction. We decided we were tired of sitting on the fence, so we invested over a million dollars to try and have absolutely the best mixing rooms since that was the direction money was already moving in.

We also made the look of our studio nicer aesthetically so it would have a nice feel for mixing. There are very few other studios that can offer what we do. This has been by far our most profitable year ever.

*What makes a good studio today?*

One that can keep up with the monetary expense of continually investing in new equipment, and one that knows which direction to move the studio in, where the trends are. Being able to anticipate what kinds of rooms to open and what clients are going to need is very important.

*You say you've followed trends in the industry. What about video?*

We opted a long time ago not to get involved in video. We wanted to do one thing well rather than chasing all the various trends. We'll probably never do video or film.

*What are your plans for the near future?*

We are going to continually narrow our focus and anticipate where the trends are going. The movement into more complicated outboard equipment and more sophisticated monitoring and all this type of stuff is inevitable. It's just a matter of knowing where it's going.

## SOUND CITY Paula Salvatore

Record projects for the likes of Tom Petty, Bob Dylan, Brian Setzer and Donovan have kept Sound City in Van Nuys busy over the past year, and studio manager Paula Salvatore says they plan to continue accommodating various musicians.

*Have you seen any new sources of business lately?*

No. We'd have to make major equipment changes to move in a new direction, so we're sticking with the record projects. We have an old Neve console in here that everyone loves. It's real punchy.

*What attracts clients to your studio?*

It's real comfortable and low key. Studio A just has a great rock and roll sound, and we have a fantastic drum room too.

We have a good rapport with our clients: they always come back. We can't really advertise because we've got standard old equipment. Tom Petty did all of his first albums here. We've

got a real good rock and roll reputation.

*What makes a good studio today?*

Accommodating the client. Support them entirely through the project. We don't have all the digital equipment and all that, but we're still in the high competition. We're getting the good clients.

*What direction do you see the studio going in the future?*

We'll stick to recording rock and roll.

## SALTY DOG RECORDING David Coe

Over the past six months, Salty Dog Recording in Van Nuys underwent some major changes. A new Amek console was installed and a new extensive keyboard room was added, based around a Macintosh computer and an Emulator II. Owner David Coe says that SDR is working mostly on album projects, and notes that he plans to do more video and film work, already having the *Breakin'* soundtrack album under his belt.

*What are some new sources of business for your studio?*

We've upgraded our equipment extensively, so our new source of business has been producers who want to work in an upgraded facility.

*Did you add this new room in response to your clients' demands, or did you install it to create the demand?*

I've always found that it's supply before demand. I've never had someone come up to me and say "if you buy this equipment, I'll work here." I've always bought the gear and people came to work on it.

*What prompted you to invest in this new gear?*

Every project we've worked on recently has been extensively synthesizer-based. And I found that the programmers were typically being asked to do a lot of the pre-production programming at home and they didn't have the equipment they needed to do a whole album. So this involved a lot of rentals; people weren't coming in as prepared because the programmers came in and then started experimenting here instead of having all the gear they needed.

We now have in-house just about everything somebody would want. And if we don't have it, because of our SMPTE lock-up with the Macintosh, we can call something in for an hour and lock-up instantly. So it was just recognizing a trend that was there and putting in the equipment to service it.

*What makes a good studio today?*

You've got to have the equipment and you've got to have great service because anyone can buy the equipment.



# YOU'VE NEVER HEARD A TAD SPEAKER AND YOU NEVER WILL.

With TAD speakers, technicians get the purest, most powerful reproduction of sound in the industry. And nothing more. Because the TAD division at Pioneer Electronics prides itself on being colorless.

Our Professional Sound Lab insures the outstanding quality of our products through a series of tests, including Doppler lasers, holography lasers and anechoic chambers. Products are also tested by computer for phase uniformity, transient response and frequency response. Then, using only the finest



materials available, every component is assembled by hand, allowing for tolerances down to a millionth of an inch.

At Pioneer, we put so much more into our TAD speakers, they don't sound like speakers at all.

For more information regarding TAD speaker components, please contact Mike Fidler at Pioneer Electronics (USA) Inc.

**TAD** Technical  
Audio Devices

Professional Products Division of Pioneer Electronics (USA) Inc.,  
5000 Airport Plaza Dr., Long Beach, CA 90815. (213) 420-5700.

Circle #109 on Reader Service Card

## CHEROKEE STUDIOS Dee Robb

With a new custom console put on line in January, owner Dee Robb of Cherokee Studios in Hollywood says business is great, with recent visits by Air Supply, Rod Stewart, The Hooters and Patti Smythe. Other projects included scoring music for Mel Brooks' *Solar Babies* and audio-for-video on the TV series *Wacko and Rainhart*.

*What are some new sources of business for your studio?*

We're doing pretty much what we've always done. The bulk of our business is album work, and we're going to have our most profitable year ever

this year. However, we are more diverse than when we first started out. We always did a certain amount of film work. We did *Sergeant Pepper's Lonely Hearts Club Band*, *Saturday Night Fever*, *The Jazz Singer* and *The Idolmaker*, but those weren't scoring or post-production. The pictures were shot to the music.

We're starting to get into some traditional scoring now, and a lot more video and jingles. Those are things we never did before, and they've become lucrative. One of the reasons we didn't do them in the past was that the clientele wasn't compatible with the record clientele. In other words,

jingle and video people wanted to come in on a moment's notice, whereas bands tend to book three months in advance.

Our specialty is music, but we're doing more TV now because of the advent of stereo television. TV is becoming audio conscious. Where I see the difference in our business is not the changing of recording music, but what we're recording music for. I think we're going to be doing tons more film work, video, and multi-media things. *Everybody* is getting really audio conscious which I think is very healthy for our industry. I don't see any big change coming as far as what studios do; it's just *where* the product is going.

*How do you create business for your studio?*

Mainly it's just word of mouth. We credit our good reputation to strenuously trying to maintain an approach and a level of technical expertise here. We try not to be influenced by what's going on in the industry around us. We maintain a level that satisfies ourselves. At times, we have had the reputation of being audiophile.

Our philosophy is this: my brothers and I are mixers and we have pretty high standards. If we can keep the rooms in a condition that satisfies us, then that's the best we can do. We have a very large technical staff per room, and we've always had around-the-clock technical service. We have two full-time engineers who are constantly designing and building equipment specifically for us, and modifying what we already have. We completely redesigned our console over the past two years. We built it from scratch using certain elements of the Trident technology. We came up with something that's technologically, physically and economically different. It's a completely custom console using a Trident equalizer.

We were absolutely stunned by our clients' response. As a matter of fact, I have yet to have a client who's tried to console who didn't have very positive things to say. It has attracted a lot of business. We've never had a piece of equipment in the history of our business that had that kind of effect.

*What would you say makes a good studio today?*

I don't think it's the equipment, per se. As audio equipment becomes more and more influenced by production costs and techniques, more equipment starts to sound alike. We've always been very open about what we do here and what equipment we have because we feel that the studio business is a combination of hundreds and hundreds of components—physical, technical and philosophical. ■

## SIMPLY THE BEST!

Simon Systems is setting a new standard of excellence in professional audio signal processing equipment. It began with the **DB-1A Active Direct Box**. Boldly designed and independently powered\*, the DB-1A delivers performance that blows every other DI away. The unique design of the DB-1A is based on totally active (transformerless) circuit with no insertion loss. And with features like line level output, rechargeable battery capability, and automatic power system check circuitry, it's easy to understand why so many professionals refer to it as simply the best direct box money can buy!



Then came the **CB-4 Headphone Cue Box**. With four outputs independently controlled by conductive plastic stereo power controls, the CB-4 allows up to

four headphones to be driven from the same amplifier. A three position switch selects left mono, right mono, or stereo mix, and XLR input/output connectors are provided for paralleling additional cue boxes. It's no wonder why the CB-4 has become a standard in the industry.



And the tradition of excellence continues with the **RDB-400 Integrated Direct Box**. Based on the same design technique which made the DB-1A the premier direct box of the industry, the AC powered RDB-400 is four direct boxes in one. It can be rack or floor mounted and has countless uses. It features line level output mode with infinitely variable trim, attenuation mode with stepped variable trim, input overload LED, speaker level input pad, balanced and unbalanced buffered outputs with front and rear XLR connectors, ground isolation switch, and a toroidal power transformer.



So the next time you think signal processing equipment, think like a pro: Simon Systems — Simply the Best!

*Thanks for setting the trend:*

PAUL ANKA SHOW • GLENN CAMPBELL • FLEETWOOD MAC • KENNY LOGGINS • JEAN-LUC PONTY  
JEFF PORCARO • RED SPEEDWAGON • UNIVERSAL STUDIOS • TITO JACKSON • JOHN COUGAR



**SIMON SYSTEMS**

707 Clear Haven Drive, Agoura Hills, CA 91301. (818) 707-9980

Circle #110 on Reader Service Card

World Radio History



# Everyone Says They're Better — We Prove It!



- Time Delay
- Reverberation
- Crossovers
- Tape Noise Reduction
- Compressor / Limiters
- Expanders
- Spectrum Analyzers
- Parametric EQ

With all the strong claims by advertisers, it's not easy to distinguish between the hot air and the hot products. That's exactly why we prepared this demonstration album. In it we show you what our products do and how they compare with the best of our competition under identical circumstances.

You will hear our phenomenal MICROPLATE® Reverb with over 18 KHZ bandwidth in side by side reverb only comparisons with the EMT® Plate on percussion and vocals. No other spring reverb would dare attempt such a comparison! The cost is incredible too, under \$600 mono, \$1,200 in stereo!

We also show our CLX-2 Compressor/Limiter/Expander in side by side comparisons with the dbx® 165 and illustrate the CLX's audibly superior freedom from distortion as well as its other abilities of De-Essing, Expansion, Keyed Expansion, Push button Stereo Tracking, and Ducking.

Other demos feature our exceptionally versatile parametric equalizers, time delays and tape noise reduction. Examples are drawn from the master tapes of top 40 Hits and show some of the most sophisticated recording techniques ever devised. Let your ears decide who sounds best before you buy. Only direct sales allow us to offer a superior product at prices lower than the competition.

Write or call for a free 24 page brochure and demo album.

**LT Sound, Dept. MX-1, P.O. Box 338,  
Stone Mountain, GA 30086 Phone (404) 493-1258**

## LT Sound

We Make A Better Product

World Radio History

"We are working 24 hours a day, 365 days a year, and our clients will accept nothing less than the best ... that's why we use Hill Audio amplifiers. The transparency and definition of the sound, and the reliability, is unmatched – the bonus is that we now experience fewer speaker failures than ever before."

*Dee Robb*



**CHEROKEE:**  
Recording Studios



'000' Series  
power amplifiers  
DX1000, DX1000A,  
DX2000, DX3000

## Total Audio Transparency

Manufactured in the UK by:

Hill Audio Ltd., Hollingbourne House, Hollingbourne, Kent ME17 1QJ. (062 780) 555. Tlx 966641 HILL

Distributed in the USA by:

Hill Audio Inc., 5002B N. Royal Atlanta Dr., Tucker, GA 30084. (404) 934-1851 Tlx 293827 HLAD





# SOUTHERN CALIFORNIA

## STUDIO DIRECTORY

All of the information in the following directory is based on questionnaires mailed earlier this year. *Mix* does not take responsibility for the accuracy of the information supplied to us by the companies listed. We encourage other Southern California studios to contact us, to be listed in our next directory.



Located in Santa Fe Springs, CA, Allied Artists Studio is growing fast in its sixth year of business, as evidenced by the recent purchase of three soundstages and the addition of a fully automated room, designed by Christopher Huston. The new studio is equipped with one of two SSL consoles, a Mitsubishi X850 digital 32-track recorder and 2-track mastering machine. Huston designed the studio to give a unique "big room" sound using tuned strips of wood. Recent clients at Allied Artists included Luis Cardenas, Cynthia Manly and Lewis Price. Photo by: Janet Van Ham.

### CONTENTS

163	STUDIO LOCATION INDEX
166	2, 4 & 8 TRACK STUDIOS
173	12 & 16 TRACK STUDIOS
178	24+ TRACK STUDIOS

*Mix* listings procedure: Every month, *Mix* mails questionnaires to recording studios and/or other vital facilities and services for the recording, sound and video production industries. Basic listings (name, address, contact) are provided free of charge. Extended listings (equipment, credits, specialization), and photographs or company logos may be included at a nominal charge. If you would like to be listed in a *Mix* Directory, write or call the *Mix* Directories Department, 2608 Ninth Street, Berkeley, CA 94710, (415) 843-7901.

#### Upcoming Directory Deadlines:

Mastering, Pressing and Tape Duplication: **September 12, 1986**  
Northwest/Hawaiian Studios: **October 1, 1986**  
Independent Engineers/Producers: **November 5, 1986**

# **AKAI... The One Multi-Track Recorder That Will Make You Forget All Others!!**



MG1212  
12 TRACK MIXER RECORDER

### **ASK SOME OF OUR USERS:**

- Trevor Rabin of Yes*
- Lou Gramm of Foreigner*
- Stephen Stills of Crosby, Stills and Nash*
- Jeff Baxter of the Doobie Brothers*
- Ronnie James Dio of Dio*
- Randy Bachman of Bachman Turner Overdrive*
- Elliott Randall of Steely Dan*
- Bob Patin of Crystal Gayle Band*
- Nile Rogers, Producer of Mick Jagger*

When you want to discover Solid Gold... turn to AKAI! Contact us to arrange for a private demonstration at your nearest franchised AKAI dealer.

# **AKAI**

**Professional Products**

P.O. Box 2344 Fort Worth, TX 76113 817-336-5114

Another Product of **IMC**



# SO. CALIFORNIA STUDIO LOCATION INDEX

All studio information listed has been supplied to Mix by studios responding to questionnaires mailed in April 1986. People, equipment and locations change, so please verify critical information with the studios directly. Mix does not take responsibility for the accuracy of the information supplied to use by the studios.

<b>Agoura Hills</b>			
24 Blue Moon Studio.....	178		
<b>Alhambra</b>			
24 Martinsound.....	188		
<b>Alta Loma</b>			
8 Jephtha Studios.....	168		
<b>Arroyo Grande</b>			
8 Central Coast Rec.....	166		
<b>Atascadero</b>			
16 Sutton Sound Studio.....	176		
<b>Bakersfield</b>			
4 Chase Music Prod.....	166		
8 Creative Prod.....	167		
8 Custom Audio.....	167		
<b>Baldwin Park</b>			
24 Morning Star Sound Rec.....	190		
<b>Bellflower</b>			
4 R.I.M. Prod.....	170		
<b>Beverly Hills</b>			
24 Hanging Rock Studio.....	184		
<b>Bonita</b>			
8 Soundsations Studio.....	171		
<b>Buena Park</b>			
16 Hot Mix Rec.....	174		
<b>Burbank</b>			
24 Alpha Studios Audio/Video.....	178		
8 Audio Cybernetics Synclavier.....	166		
24 EFX Systems.....	180		
24 Encore Studios.....	180		
24 The Enterprise.....	181		
24 Evergreen Rec. Studios.....	181		
8 Facilitate Rock Solid.....	167		
16 Fatrux Studio.....	173		
24 Juniper APV.....	186		
24 Lucas Teleproductions.....	186		
24 Master Control.....	188		
4 PIC Studios.....	170		
24 RSC/Rec. Services Co.....	192		
16 Telstar Sound Recorders.....	176		
<b>Calabasas</b>			
4 Glide Studios.....	167		
<b>Camarillo</b>			
8 R.E. Copsy Rec.....	167		
8 Jazmine Prod.....	168		
8 Summit View.....	172		
<b>Canoga Park</b>			
8 Charlie's Studios.....	166		
4 JMK Rec. Service.....	168		
8 Onestop Studios.....	169		
24 Rumbo Recorders.....	192		
<b>Carlsbad</b>			
8 Pacific West Prod.....	170		
<b>Carpinteria</b>			
24 Gateway Studios.....	183		
<b>Chatsworth</b>			
2 Abbey Tape Duplicators.....	166		
24 GRS Studios.....	184		
24 Pacific Sound.....	190		
24 Smoketree.....	195		
<b>City of Industry</b>			
16 Livingston Musical Serv.....	174		
<b>Claremont</b>			
8 A.D.S.R.....	166		
8 The Attic.....	166		
24 Indian Hill Rec.....	185		
<b>Compton</b>			
16 Sound Off Studio.....	174		
<b>Corona</b>			
4 Dream Weaver Studio.....	167		
<b>Costa Mesa</b>			
24 Golden Goose Rec.....	183		
8 The Mad-Den Studio.....	168		
8 Moffett Manor Recorders.....	169		
24 3-D Studios.....	199		
<b>Cucamonga</b>			
24 Winetree Rec.....	202		
<b>Cula Vista</b>			
8 GMA Sound Engineering.....	167		
<b>Culver City</b>			
16 Bare Trax.....	173		
24 Studio II.....	197		
16 Sunburst Rec. & Prod.....	176		
<b>Downey</b>			
8 Jay Staggs Cassette Dup.....	171		
<b>El Cajon</b>			
24 Fanfare Rec. Studio.....	182		
16 Stonecutter Rec. Studio.....	176		
<b>El Centro</b>			
16 Rose Studios.....	174		
<b>Encinitas</b>			
8 HED Productions.....	168		
<b>Encino</b>			
4 Creative Services Group.....	167		
24 Le Mobile.....	186		
8 Solitaire Rec.....	171		
8 Wild Talent Studios.....	172		
<b>Fontana</b>			
8 Standing Room Only.....	171		
<b>Fresno</b>			
8 Bob's Band-aids.....	166		
16 Kenjo Audio.....	174		
24 Maximus Rec. Studios.....	189		
<b>Fullerton</b>			
16 Casbah Rec.....	173		
8 JR West Sound Recorders.....	168		
<b>Garden Grove</b>			
16 Audio Paragon.....	173		
4 Creative Media.....	167		
8 Hong Studio.....	168		
<b>Glendale</b>			
8 Berkens Sound Rec. Labs.....	166		
16 Ritchie Carbajal Music.....	173		
16 Good E.A.R. Studio.....	173		
24 MCA Whitney Rec. Studio.....	189		
12 The Rubber Dubbers.....	174		
12 The Shooting Star Studios.....	174		
24 The Truck Mobile Rec.....	200		
24 Yamaha Research & Dev.....	202		
<b>Granada Hills</b>			
8 CAB Prod.....	166		
24 Sounder.....	197		
<b>Grover City</b>			
4 Boomerang.....	166		
<b>Hawthorne</b>			
8 Heartstrings Musical Serv.....	168		
16 Mattel Inc. Rec. Studio.....	174		
<b>Hemet</b>			
4 Remote Video & Audio Rec.....	170		
<b>Hermosa Beach</b>			
8 Open Door Sound.....	169		
4 Rag Rec.....	170		
8 Westernmost Studio.....	172		
<b>Hollywood</b>			
24 Artisan Sound Recorders.....	178		
24 Bell Sound Studio.....	178		
24 Britannia Studios.....	178		
24 California Rec.....	178		
24 Capitol Records Studios.....	179		
24 Cherokee Rec. Studios.....	179		
24 Clover Recorders.....	179		
24 Conway Rec. Studios.....	179		
8 Crossover Sound.....	167		
24 Crystal Sound Rec. Studio.....	180		
24 Eldorado Rec. Studio.....	180		
24 Fiddler's Rec. Studio.....	182		
2 Fortress Studios.....	167		
24 Galaxy Sound Studios.....	183		
24 Group IV Rec.....	184		
16 Hark's Sound Studio.....	174		
24 Image Rec.....	185		
24 Interlok Studios.....	186		
24 Fred Jones Rec. Serv.....	186		
8 Kingcat Prod. (Club Vital).....	168		
24 Media Recorders.....	189		
8 The Media Staff.....	169		
24 Music Box Rec. Studio.....	190		
24 Music Lab.....	190		
24 Oddeo Engineering.....	190		
24 Paramount Rec. & Video.....	190		
24 Pasha Music House.....	190		
24 Post Logic.....	190		
24 Post Sound Corp.....	190		
24 Record Plant.....	192		
24 Record Plant Scoring.....	192		
24 Rusk Sound Studios.....	192		
24 Sage & Sound Rec.....	192		
24 Starworks Audio Rec.....	197		
16 Studio 9 (Budget Studios).....	177		
24 Sunset Sound.....	198		
24 Sunset Sound Factory.....	198		
24 Sunwest Studios.....	198		
24 Total Experience.....	200		
8 Vital T.V. Records.....	172		
8 Voice Over L.A.....	172		
24 Widetracks Rec. Studio.....	202		
8 XAN Soundtrack Prod.....	172		
<b>Huntington Beach</b>			
24 Adamo's Rec.....	178		
4 Hindu Arts.....	168		
<b>Inglewood</b>			
4 Target Recorders.....	172		
<b>Irvine</b>			
4 The Creative Word.....	167		
24 Noatz Prod.....	190		
4 PSI Inc.....	170		
8 Rainbow Rec.....	170		
16 Talent Center.....	176		
<b>La Crescenta</b>			
4 Consolidated Comm.....	167		
<b>La Habra</b>			
24 Formula 1 Music.....	183		
<b>La Mesa</b>			
4 BLT Prod.....	166		
<b>La Mirada</b>			
4 Critical Mass Prod.....	167		
12 Telewest.....	176		
24 Time Capsule Rec.....	199		
<b>Laguna Niguel</b>			
4 Incidental Sound.....	168		
<b>Lakewood</b>			
8 H.M.E.A.'s Studio.....	168		
<b>Lamont</b>			
2 Revival Tabernacle.....	170		
<b>La Verne</b>			
8 Dragonville Studios.....	167		
<b>Leucadia</b>			
4 Pacific Prod. Works.....	170		
<b>Long Beach</b>			
8 Bergmark Prod.....	166		
8 Cantrax Rec.....	166		
8 DB Prod.....	167		
16 Don Harper Prod.....	174		
16 Max Sound.....	174		
8 Garrison Putney Studio.....	170		
16 Soundgraphics Studio.....	174		
24 Trianon Rec. Studio.....	200		
8 24 Kt. Sound.....	172		
8 Greg Youngman Music.....	172		
<b>Los Angeles</b>			
16 ABC Watermark Studios.....	173		
16 Acrasound Rec. Studios.....	173		
8 Ascot Rec. Studio.....	166		
8 Beachwood Rec.....	166		
24 Blue Dolphin.....	178		
24 Bluefield Music.....	178		
16 Buzzy's Rec. Services.....	173		
8 Chalet Studios.....	166		
8 C.M. Sound/Creat. Media.....	167		
24 The Control Center.....	179		
24 Delirium Studios.....	180		
24 Detroit Sound Studios.....	180		
24 Digital Sound Rec.....	180		
2 Downunder Digital.....	167		
24 Fiesta Sound & Video.....	182		
8 The Five Spot.....	167		
8 Fullersound A.V. Rec.....	167		
24 Gold Rush Rec.....	183		
8 Rudy Guess Rec.....	167		
24 Hit City West.....	184		
24 Indigo Ranch Rec. Studio.....	185		
8 Intersound Inc.....	168		
16 J.E. Sound Prod. & Enter.....	174		
4 Jesus Is Lord Studios.....	168		
24 Jingle Bells Prod.....	186		
4 Joe's Place Studio.....	168		

T H E • 1 9 8 6



---

**JOIN US IN HONORING EXCELLENCE!**

**WHAT:** The 1986 Technical Excellence and Creativity Awards

**WHEN:** Thursday, November 13, 1986  
7:00 - 11:00 P.M.

**WHERE:** Hyatt Regency Ballroom  
Downtown Los Angeles, California

If you're a member of the professional audio and music community, and you plan to be in Los Angeles during the 81st AES Convention, the Publishers of *Mix* invite you to attend the 1986 TEC Awards Celebration. These awards, as nominated and voted by you, the subscribers of *Mix* Magazine, honor outstanding achievements by individuals and companies in all facets of audio and music during the past year.

Don't miss one of the industry's premier annual events. Use the coupon below to order your tickets today, or call (415) 843-7901 for complete information. (All proceeds of ticket sales to the TEC Awards are divided among: the House Ear Institute, for research and training of specialists in the treatment of hearing disorders; the AES Educational Foundation; and the winner of the TEC Award for Recording School of the Year.) Ticket price is fully tax deductible.

---

Please reserve \_\_\_\_\_  
ticket(s) at \$35 per ticket.

Please reserve \_\_\_\_\_  
table(s) for 10 people at  
\$350 per table.

I have enclosed my check  
for \_\_\_\_\_.

Please charge the above to my  Visa  MasterCard

CARD # \_\_\_\_\_ EXP. DATE \_\_\_\_\_

SIGNATURE \_\_\_\_\_

Make check payable to: House Ear Institute/TEC Awards  
(tax deductible)

NAME \_\_\_\_\_

TITLE \_\_\_\_\_

COMPANY \_\_\_\_\_

ADDRESS \_\_\_\_\_

CITY \_\_\_\_\_ STATE \_\_\_\_\_ ZIP \_\_\_\_\_

Mail to: TEC Awards Tickets, c/o Mix Publications, P.O. Box 2526, Berkeley, CA 94702.

Acknowledgement of receipt of ticket order will be sent immediately. Tickets will be sent in October 1986.



2	Lane Audio & Records	168
24	Lion Share Rec. Studio	186
24	Los Angeles City College	186
24	Mad Hatter Studios	188
8	Masterflow Rec. Studio	169
24	Music Grinder Rec. Studio	190
16	Muzic Trak Studio	174
4	O.K. Studios	169
16	Omni Rec. Studios	174
8	Outlaw Sound	169
24	Quad Tack Studios	191
8	Say "Vaughns" Rec.	170
24	Skip Saylor Rec.	194
24	Silvery Moon Studios	195
24	Sound Arts	196
8	Sound Imagery	171
24	Soundcastle Rec. Studios	197
8	Spectrum Sight & Sound	171
24	Studio Masters	197
4	Studio 99	171
8	Supersound Studio	172
24	TAJ Soundworks	198
16	Theta Sound Studio	176
24	Track Record	200
16	Trax Sound Rec.	177
12	West Side Sound	177
12	Westlake Audio, Rec. Serv.	201
24	Wildcat Studios	202
24	Wonderland Studios	202
<b>Los Osos</b>		
16	Dog Bark Rec.	173
<b>Lynwood</b>		
24	NSP Studios	190
<b>Marina Del Rey</b>		
24	American Video Factory	178
24	Warthog Studios	201
<b>Montecito</b>		
8	Sundial Rec. Studio	172
<b>Montrose</b>		
24	Fingerprint Recorders	182
<b>Newport Beach</b>		
16	JEL Rec. Studios	174
4	Phusion	170
<b>North Hollywood</b>		
24	Amigo Studios	178
8	Artist Sound	166
4	Customcraft Rec.	167
24	Devonshire Sound Studios	180
16	D-Town Platinum Sound Studios	173
24	Enactron Truck/Magnolia Sound	180
24	Gold Star Rec. Studios	183
24	Craig Harris Music	184
8	Khaliq-O-Vision	168
24	Magnolia Sound	188
24	Mama Jo's Rec. Studio	188
24	One On One Studios	190
24	Pacifique Rec. Studios	190
24	Premore	191
24	Present Time Recorders	191
24	Riverton Prod.	192
24	Score One Rec.	194
24	Sheika Prod. Studio	195
24	Sound Image	196
24	Sound Master Audio/Video Rec.	196
24	Superscore Studios	198
24	That Studio Rec. Serv.	198
24	John Thomas Studios	199
24	George Tobin	199
24	Valentine Rec. Studios	200
24	Weddington Studio	201
4	White Trash Studios	172
<b>Northridge</b>		
8	Creative Prod. Studios	167
8	Harpaz Rec. Studio	168
24	HQ1/Harlequin	185
24	Your Rec. Studio	202
<b>Oceanside</b>		
8	Exxel Rec.	167
<b>Ontario</b>		
8	The Reel Thing	170
16	Trilogy Rec.	177
<b>Orange</b>		
24	Advanced Media Systems	178
<b>Oxnard</b>		
8	SCA Studios	170
<b>Palm Springs</b>		
16	Mercantile Rec.	174
<b>Pasadena</b>		
2	AM Prod.	166
24	Audio Engineering Assoc.	178
16	Neil Recorders	174
24	Penguin Rec.	190
2	John Ritterath Mot. Pic.	170
24	Sound Chamber Recorders	196
8	Frank Sullivan Rec. Studio	172
<b>Pico Rivera</b>		
24	Produce Sound	191
<b>Placentia</b>		
4	C.S. Audio Prod.	167
<b>Port Hueneme</b>		
4	TKO Prod. & Media Serv.	172
<b>Poway</b>		
16	Blindfold Studios	173
16	Southland-Multitrack	174
<b>Rancho Mirage</b>		
24	A&R Rec. Services	178
<b>Rancho Palos Verdes</b>		
8	Sunset Records	172
<b>Redondo Beach</b>		
16	Antler Rec.	173
24	Beach Rec. & Filmworks	178
4	Rag Rec. & Rehearsal	170
24	Total Access Rec.	199
<b>Reseda</b>		
8	Superior Sonics	172
<b>Rialto</b>		
12	Flanders Unlimited	173
<b>Rolling Hills Estate</b>		
8	ATM Audio	166
<b>Rowland Heights</b>		
8	J&J Music & Sound	168
<b>San Bernardino</b>		
8	Trihedra Prod.	172
<b>San Diego</b>		
8	Audio Recorders	166
8	Audiovision	166
24	Broken Records	178
24	Circle Sound Studios	179
8	Tim Coffman Music Prod.	167
24	C.R.C./Demo Trak Studios	179
12	Equinox Prod.	173
4	Hearsay	168
16	Hit Single Rec. Services	174
8	K-Prod. & Rec.	168
2	Leavenworth/Sound	168
8	MaxTrax Rec. Studios	169
24	MixMasters	189
4	The Music Shop	169
8	Night Vision Prod.	169
8	Private Rec. Service	170
16	Roxy West	174
24	Seacoast Rec.	195
4	Sidestream Sound	170
8	Studio V	172
24	Sunsound Studio	198
<b>San Fernando</b>		
24	Dawn Breaker Studios	180
<b>San Gabriel</b>		
4	Trends In Professional Sound	172
<b>San Luis Obispo</b>		
8	Music Dept. Rec. Arts Prog.	169
<b>Santa Ana</b>		
8	Moser Sound Prod.	169
24	Sound Affair Rec.	195
8	South Coast Rec.	171
24	White Field Studios	201
24	Evan Williams Audio/Video	202
<b>Santa Barbara</b>		
16	Central Sound Recorders	173
8	Full Circle Prod.	167
4	Higher Octave Rec.	168
4	ICM Upper Room Rec.	168
16	J.E.R. Studio/Rec.	174
8	Master Tracks Rec. & Multimedia	169
8	Planet	170
24	Santa Barbara Sound Rec.	194
16	Spectrum Studio	174
<b>Santa Monica</b>		
4	Shaun Collard Prod.	167
24	Ground Control	183
24	Lyceum Sound Recorders	186
24	Santa Monica Sound Rec.	194
24	Sound Solution Rec.	197
8	Dana White Prod.	172
<b>Santa Monica Canyon</b>		
24	Mitchel Delivie's Secret Studio	180
<b>Santee</b>		
4	C. Allan Taylor Assoc.	172
24	Western Audio	201
<b>Saugus</b>		
4	Okay Bouquet Studios	169
<b>Sepulveda</b>		
4	Lu-Don Studio	168
4	Sigma Recorders	170
<b>Sherman Oaks</b>		
24	Brookhill	178
24	Footprint Sound Studios	182
8	Formost Prod. Studios	167
24	Record One	191
16	Kris Stevens Ent.	176
8	VCA	172
16	Woodcliff Studio	177
<b>Sierra Madre</b>		
16	Southwest Sound	174
<b>Silverlake</b>		
24	Silverlake Sound Studio	195
<b>Simi Valley</b>		
2	Audio and Video Arts	166
<b>Solano Beach</b>		
8	Crescendo Prod.	167
8	Third Ear Rec. Studio	172
<b>Somis</b>		
8	King Rec. Studio	168
<b>Studio City</b>		
24	Audio Video Alliance	178
24	Fidelity Studios	182
16	Hallsmark Rec.	173
8	Saban Prod.	192
8	Slidersound Studios	171
24	Studio City Recorders	197
24	Talon Rec. (Prod.)	198
<b>Sun Valley</b>		
24	Perspective Sound	190
<b>Sylmar</b>		
8	Southwind Rec.	171
<b>Tarzana</b>		
24	Can-Am Recorders	179
<b>Temple City</b>		
8	Syntrax Prod.	172
<b>Thousand Oaks</b>		
16	Future Sound	173
<b>Topanga Park</b>		
24	Skyline Rec. Co.	195
<b>Torrance</b>		
24	Audio Achievements Rec. Studio	178
24	Dynasty Studio	180
8	Opus One Rec.	169
24	Piper Rec.	190
24	Quantum	191
8	RK Cole Studios	170
<b>Tustin</b>		
8	Millennium Studio	169
<b>Universal City</b>		
8	Mazzetti Audio Remote	169
<b>Valencia</b>		
4	Koala Studio	168
<b>Van Nuys</b>		
16	D.M.O. Prod.	173
24	Kingsound Studios	186
24	Sound City	196
24	S.D.R. Studio	194
24	Westworld Recorders	201
<b>Venice</b>		
24	Mad Dog Studio	186
<b>Ventura</b>		
8	Catalina Rec.	166
24	Goldmine Rec. Studio	183
<b>Vista Delmonte</b>		
24	Ritesonair Rec. Studio	192
<b>Walnut</b>		
4	JKL Entertainment	168
<b>West Covina</b>		
8	The Garage Audio & Video	167
<b>West Hollywood</b>		
24	Larrabee Sound	186
24	Motown/Hitsville	190
24	Summa Music Group Studios	198
<b>West Los Angeles</b>		
24	The Complex	179
24	Studio Ultimo	198
24	The Village Recorder	200
<b>Westlake Village</b>		
24	West Oak Recorders	201
24	Westlake Recorders	201
<b>Westminster</b>		
24	Headway Studios	184
8	Selah Rec. Studio	170
<b>Whittier</b>		
16	Duchess Studios	173
<b>Woodland Hills</b>		
4	Chicoslavakia Soundstage One	166
4	Noh Sound	169
24	Preferred Sound	190
24	R.O.S.	192
24	The Studio	197
8	Studio 23	171
16	SyntheMedia Music Co.	176
<b>Yucaipa</b>		
8	Magnetic Ink	168

# SOUTHERN CALIFORNIA

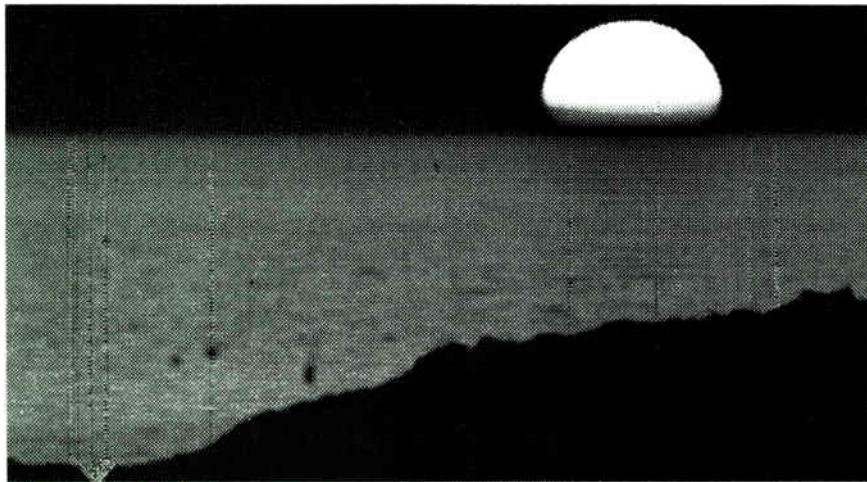

## 4 & 8 TRACK

[2] **ABBEY TAPE DUPLICATORS, INC.**  
9525 Vassar Ave., Chatsworth, CA 91311  
(818) 882-5210  
Owner: Norman C. Cooke

[8] **A.D.S.R.**  
**ANALOG & DIGITAL SYSTEMS RESEARCH**  
428 W. Harrison, Claremont, CA 91711  
(714) 625-2431  
Owner: Gary Mraz, Michael Monteleone  
Studio Manager: Gary Mraz, Michael Monteleone  
Direction: We are a full-blown MIDI studio directed at commercials, movie soundtracks, voiceovers, consultation and sales. We offer extensive librarian service. Thousands of sounds for every conceivable keyboard. Our clients range from Universal Studios, MCA, MTV, independently owned studios for session work to individuals seeking sounds.

[2] **AM PRODUCTIONS**  
*also REMOTE RECORDING*  
46 South DeLacey Ave., Pasadena, CA 91105  
(818) 449-0683  
Owner: Arthur C. Michaud  
Studio Manager: Arthur C. Michaud

[8] **ARTIST SOUND**  
10530 Burbank Blvd., North Hollywood, CA 91601  
(818) 506-6762  
Owner: Bob Jamison  
Studio Manager: Bob Jamison

[8] **ASCOT RECORDING STUDIO**  
1654 N. Harvard Blvd., Los Angeles, CA 90027  
(213) 663-6269  
Owner: James Rayton  
Studio Manager: James Rayton

[8] **ATM AUDIO**  
*also REMOTE RECORDING*  
#6 Masongate Dr., Rolling Hills Estates, CA 90274  
(213) 375-7673  
Owner: Andrew T. Martin  
Studio Manager: Andrew T. Martin

[8] **THE ATTIC**  
678 California Dr., Claremont, CA 91711  
(714) 621-7768  
Owner: A. John Mallinckrodt  
Studio Manager: A. John Mallinckrodt

[2] **AUDIO AND VIDEO ARTS**  
*only REMOTE RECORDING*  
P.O. BOX 398, Simi Valley, CA 93062  
(805) 583-0540  
Owner: Paul Gardocki  
Studio Manager: Paul Gardocki

[8] **AUDIO CYBERNETICS SYNCLAVIER STUDIO**  
4300 Sarah St. Ste. #20, Burbank, CA 91505  
(818) 840-0395  
Owner: Christopher Currell  
Studio Manager: Tammy Thomas

[8] **AUDIO RECORDERS**  
*also REMOTE RECORDING*  
3843 Richmond, San Diego, CA 92103  
(619) 296-6355  
Owner: J.A. Mullen  
Studio Manager: J.A. Mullen

[8] **AUDIOVISION**  
3191 Adams Ave., San Diego, CA 92116  
(619) 280-7941  
Owner: Jon A. Cline  
Studio Manager: Jon A. Cline

[8] **BEACHWOOD RECORDING**  
*also REMOTE RECORDING*  
2266 N. Beachwood Dr., Los Angeles, CA 90068  
(213) 461-1008  
Owner: James Lee Stanley  
Studio Manager: Stephen Chandler

[8] **BERGMARK PRODUCTIONS**  
550 Orange Ave., Long Beach, CA 90802  
(213) 491-5336  
Owner: Hakan Bergmark  
Studio Manager: Claudia Bergmark

[8] **BERKENS SOUND RECORDING LABS**  
*also REMOTE RECORDING*  
1616 W. Victory Blvd. Ste. 104, Glendale, CA 91201  
(818) 246-6583

Owner: William Berkuta, Richard P. Stevens II  
Studio Manager: William Berkuta  
Engineers: William Berkuta, Rick Stevens.  
Dimensions of Studios: 12 x 24.  
Dimensions of Control Rooms: 12 x 13.  
Tape Recorders: Tascam 60-8, 8-tracks; Tascam 38, 8-tracks; TEAC A-2340SX, 4-tracks; Otari MX-5050, 2-tracks; Fisher CR-4020, stereo cassette; Technics M222, stereo cassette.  
Mixing Consoles: (2) TEAC Model 3, 8 x 2; Opamp Labs BSRL, 14 x 4 x 2.  
Monitor Amplifiers: Crown Power Line One.  
Monitor Speakers: JBL 431D.

Echo, Reverb & Delay Systems: Lexicon PCM60 digital reverb, DeltaLab, etc.

Other Outboard Equipment: TEAC DX-8 dbx; dbx II 122, 124; dbx 166 noise gate and compressor; Realistic stereo 12-band EQ; MXR stereo 10-band EQ.

Microphones: (2) Neumann KM85I; (3) Sennheiser MD421 US; (2) Realistic P2M; (2) AKG D190E; (2) AKG D-1000; Shure 300 bi-directional; Sennheiser KZU shotgun. Instruments Available: Simmons SDS-8 electric drums, Yamaha CS01 synthesizer; Casio 202 synthesizer; Esly upright piano; Rickenbacker 12-string electric guitar; Ibanez Les Paul 6-string electric guitar; 6- and 12-string acoustic guitars, Yamaha clarinet, sax, violin.

Rates: \$8.50/hr., 4- or 8-track.

Extras: Music demo recording; theatrical sound design and consultation; commercial voice tape production, radio drama production, audio cassette mastering, NAB cartridge mastering, equipment rental.

Direction: Flexibility, effectiveness and cooperation are the key elements at Berkens, where resident producers are available to help you realize your project.

[4] **BLT PRODUCTIONS**  
Box 519, La Mesa, CA 92041  
(619) 562-6077  
Owner: Tom Kelly  
Studio Manager: Bill Moffitt

[8] **BOB'S BANDAIDS**  
*also REMOTE RECORDING*  
3782 E. Austin Way, Fresno, CA 93726  
(209) 228-0652  
Owner: Bob Martin  
Studio Manager: Bob Martin

[4] **BOOMERANG**  
P.O. Box 1310, Grover City, CA 93433  
(805) 481-0760  
Owner: C. Stepp  
Studio Manager: LT. Driftmeier

[8] **CAB PRODUCTIONS**  
12329 Lithuania, Granada Hills, CA 91344  
(818) 360-5732  
Owner: Christopher Bortolon  
Studio Manager: Christopher Bortolon

[8] **CANTRAX RECORDERS**  
*also REMOTE RECORDING*  
2119 Fidler Ave., Long Beach, CA 90815  
(213) 498-6492  
Owner: Richard J. Cannata  
Studio Manager: Nancy Cannata

[8] **CATALINA RECORDING**  
6003 Fiesta St., Ventura, CA 93003  
(805) 982-5098  
Owner: Michael Z. Dosa  
Studio Manager: Lyndon Turner

[8] **CENTRAL COAST RECORDING**  
684 Stagecoach Rd., Arroyo Grande, CA 93420  
(805) 489-7861  
Owner: Robert Montano, Ruth Accelo, Carol Wright, Robert Barr  
Studio Manager: Robert Barr

[8] **CHALET STUDIOS**  
3247 Shasta Circle North, Los Angeles, CA 90065  
(213) 256-5350  
Owner: Greg Tiner  
Studio Manager: Greg Tiner

[8] **CHARLIE'S STUDIO**  
8342 Penfield #21, Canoga Park, CA 91306  
(818) 998-8110  
Owner: Charlie Mustafa, Wendy Shannon  
Studio Manager: Charlie Mustafa

[4] **CHASE MUSIC PRODUCTIONS**  
*also REMOTE RECORDING*  
6501 Bronson Ln., Bakersfield, CA 93309  
(805) 832-0910  
Owner: Don and Nancy Chase  
Studio Manager: Don Chase

[4] **CHICOSLAVAKIA SOUNDSTAGE ONE**  
*also REMOTE RECORDING*  
4640 Danza St., Woodland Hills, CA 91364  
(818) 703-8940



Owner: David Chico Ryan  
Studio Manager: Chico Ryan

[8] C.M. SOUND/CREATIVE MEDIA CONSULTANTS  
also REMOTE RECORDING  
P.O. Box 491279, Los Angeles, CA 90049  
(213) 471-1166, 396-7105  
Owner: Creative Media Consultants  
Studio Manager: Michael Binstock

[8] TIM COFFMAN MUSIC PRODUCTIONS  
San Diego, CA  
(619) 571-5031  
Owner: Tim Coffman  
Studio Manager: Tim Coffman, Don Fredricks

[4] SHAUN COLLARD PRODUCTIONS  
also REMOTE RECORDING  
1107 Bay St. #D, Santa Monica, CA 90405  
(213) 450-6570  
Owner: Shaun Collard  
Studio Manager: Shaun Collard

[8] R.E. COPSEY RECORDING  
also REMOTE RECORDING  
P.O. Box 367, Camarillo, CA 93010  
(805) 484-2415  
Owner: Reese E. Copsey  
Studio Manager: Reese E. Copsey

[4] CONSOLIDATED COMMUNICATIONS  
also REMOTE RECORDING  
5125 Briggs Ave., La Crescenta, CA 91214  
(818) 957-0957  
Owner: Sherri Mudd  
Studio Manager: Mark Blinoff

[4] CREATIVE MEDIA  
7271 Garden Grove Blvd. #E  
Garden Grove, CA 92641  
(714) 892-9469  
Owner: Tim Keenan

# CREATIVE PRODUCTION STUDIOS

CREATIVE PRODUCTION STUDIOS  
Northridge, CA

[8] CREATIVE PRODUCTION STUDIOS  
18132 Schoenborn St., Northridge, CA 91324  
(818) 993-4643  
Owner: Kevin McGettigan  
Studio Manager: Kevin McGettigan  
Dimensions of Studios: 20 x 20 w/8 x 6 drum/isolation booth.  
Tape Recorders: Tascam Model 38, 8-tracks w/dbx and VSO; Tascam 40-4, 4-track; (4) JVC/KD-X1 cassette recorders for real time duplicating.  
Mixing Consoles: Tascam Model 10, 12 x 4.  
Monitor Amplifiers: Biamp TC/12D.  
Monitor Speakers: VA Series 300.  
Echo, Reverb & Delay Systems: ART 01A digital reverb, Lexicon Prime Time digital delay.  
Other Outboard Equipment: TVE-1 Vocal Eliminator.  
Microphones: Neumann U-87, Sennheiser, Shure, Sony, Crown P2M.  
Instruments Available: 7½-foot Kawai grand piano, Roland Jupiter 6 synth, Drumulator digital drum machine.  
Rates: \$10/hr., \$9.50/block, engineer and all equipment and instruments included.  
Extras: We are a small studio designed for singers and songwriters with or without a band, to economically get

their material on tape. We will help in any phase of your production including programming for drum or synth parts, as well as performing keyboard/synth parts as requested. Arrangements and lead sheets are also available.

[8] CREATIVE PRODUCTIONS  
also REMOTE RECORDING  
3128 Linden Ave., Bakersfield, CA 93305  
(805) 325-3676  
Owner: Roger Thiesen  
Studio Manager: Roger Thiesen

[4] CREATIVE SERVICES GROUP  
17456 Emelita St., Encino, CA 91316  
(818) 343-7005  
Owner: Rick Fleishman  
Studio Manager: Rick Fleishman

[4] THE CREATIVE WORD  
17885 B-2 Sky Park, Irvine, CA 92714  
(714) 261-8273  
Owner: Bryan Hill

[8] CRESCENDO PRODUCTIONS  
505 Mar Vista, Solana Beach, CA 92075  
(619) 481-0192  
Owner: David A. Kuspa

[4] CRITICAL MASS PRODUCTIONS  
14733 Costa Mesa Dr., La Mirada, CA 90638  
(714) 994-4507  
Owner: Danny R. Reynolds  
Studio Manager: Danny R. Reynolds

[8] CROSSOVER SOUND  
7403 Sunset Blvd., Hollywood, CA 90046  
(213) 876-5705  
Owner: Daniel W. Regan  
Studio Manager: Ken Weiner

[4] C.S. AUDIO PRODUCTIONS  
319 Eagle Dr., Placentia, CA 92670  
(714) 528-3273  
Owner: Curt Schatz  
Studio Manager: Curt Schatz

[8] CUSTOM AUDIO  
929 California Ave., Bakersfield, CA 93304  
(805) 324-0736  
Owner: Trenton T. Houston  
Studio Manager: Ken Houston

[4] CUSTOMCRAFT RECORDINGS  
also REMOTE RECORDING  
5440 Ben Ave., North Hollywood, CA 91607  
(818) 509-9649  
Owner: Dean Talley  
Studio Manager: Thomas D. Talley

[8] DB PRODUCTIONS  
also REMOTE RECORDING  
P.O. Box 21273, Long Beach, CA 90802  
(213) 433-7727  
Owner: Dan Brown, Bruce Crook  
Studio Manager: Bruce Crook

[2] DOWNUNDER DIGITAL  
also REMOTE RECORDING  
3008 Passmore Dr., Los Angeles, CA 90068  
(213) 851-1445  
Owner: Dennis Walters  
Studio Manager: Dennis Walters

[8] DRAGONVILLE STUDIOS  
1768 N. White Ave., LaVerne, CA 91750  
(714) 596-8205, 596-4371  
Owner: Barbara King  
Studio Manager: Diane Schmidt

[4] DREAM WEAVER STUDIO  
also REMOTE RECORDING  
834 Live Oak Pl., Corona, CA 91720  
(714) 371-5402  
Owner: John A. Fox  
Studio Manager: John A. Fox

[8] EXXEL RECORDING  
also REMOTE RECORDING  
102 N. Dittmar St., Oceanside, CA 92054  
(619) 722-8284  
Owner: J. Richard Lee  
Studio Manager: Bill Berry  
Engineers: Bill Berry, Michael Newman, Bill Kottcamp  
Dimensions of Studios: A: 24 x 15; B: 8 x 16.  
Dimensions of Control Rooms: A: 12 x 24; B: 12 x 16.  
Tape Recorders: Otari 5050 MK-III-8, 8-tracks; (2) Otari 5050-BII, 2-tracks; (2) Ampex AG440, 2-tracks; Revox A700, 2-tracks; Ampex ATR700, 2-tracks.  
Mixing Consoles: Biamp BIMIX 2016, 20 x 16; Yamaha MC1204, 12 x 4 x 2.  
Monitor Amplifiers: Hafler, Yamaha, Crown, QSC, SAE.  
Monitor Speakers: JBL, Yamaha, Auratone.  
Echo, Reverb & Delay Systems: Yamaha REV7, Yamaha SPX90, Orban 111B Spring, (2) Yamaha R1000, Deltalab Super Time Line 2024 DDL.  
Other Outboard Equipment: dbx noise reduction on all channels, dbx 166, Dyna-Mite 430, EXR SPII Exciter, Orban de-esser, Quad noise gates, graphic EQs, UREI 565T notch filter, Sony and Tascam 3-head cassette decks.  
Microphones: AKG 414s; EV-RE-20; Sennheiser MD 421; Shure SM-58, 57, 56; AKG 12 tube, Audio-Technica, others.  
Instruments Available: Yamaha U-3 piano, Yamaha DX7, SIEL DK600, SIEL EXP700, Roland MSQ700, Sequential circuits drumtracks w/extra chips.  
Rates: Call for a pleasant surprise.

[8] FACILITÉ ROCK SOLID®  
801 S. Main St., Burbank, CA 91506  
(818) 841-8220  
Owner: Rock Solid Productions  
Studio Manager: John Reuh

[8] THE FIVE SPOT  
3214 De Witt Dr., Los Angeles, CA 90068  
(213) 874-9090  
Owner: Robert Kraft  
Studio Manager: David Benson

[8] FORMOST PRODUCTIONS STUDIOS  
15149 Camarillo St., Sherman Oaks, CA 91403  
(818) 784-0337  
Owner: Michael Rummans  
Studio Manager: Mark Zuckerman

[2] FORTRESS STUDIOS  
1549 N. McCadden Pl., Hollywood, CA 90028  
(213) 467-0456  
Owner: Michael Rummans  
Studio Manager: Mark Zuckerman

[8] FULL CIRCLE PRODUCTIONS  
P.O. Box 5313, Santa Barbara, CA 93150  
(805) 969-2705  
Owner: Jeffrey Lovelace  
Studio Manager: Doug Scott, Chas Thompson

[8] FULLERSOUND A.V. RECORDING  
P.O. Box 65051, Los Angeles, CA 90065  
Owner: Mike Fuller  
Studio Manager: Michael J. Fulton Jr.

[8] THE GARAGE AUDIO & VIDEO  
also REMOTE RECORDING  
W. Covina, CA 91790  
(818) 337-7943  
Owner: Patrick Woertink  
Studio Manager: Alan Clark

[4] GLIDE STUDIOS  
also REMOTE RECORDING  
P.O. Box 8243, Calabasas, CA 91302  
(818) 902-0435  
Owner: Cho Paquet  
Studio Manager: Cho Paquet

[8] GMA SOUND ENGINEERING  
also REMOTE RECORDING  
P.O. Box 26681, Chula Vista, CA 92012  
(619) 575-5750  
Owner: Glenn R. McAllister  
Studio Manager: C. Alan Taylor

[8] RUDY GUESS RECORDING  
3662 Dunn Dr., Los Angeles, CA 90034  
(213) 202-8081  
Owner: Rudy Guess  
Studio Manager: Rudy Guess

[8] HARPZ RECORDING STUDIO  
18164 Guildford Ln., Northridge, CA 91326  
(818) 994-5788  
Owner: Yair Harpaz  
Studio Manager: Yair Harpaz

[4] HEARSAY  
7824 Tampico Ct., San Diego, CA 92126  
(619) 693-0132  
Owner: Glenn Osga  
Studio Manager: Glenn Osga

[8] HEARSTRINGS MUSICAL SERVICES  
5114 W. 135th St., Hawthorne, CA 90250  
(213) 676-5091  
Owner: Greg Conway  
Studio Manager: Greg Conway

[8] HED PRODUCTIONS  
754 Saxony Rd., Encinitas, CA 92024  
(619) 436-8110  
Owner: Lynn Poul Hedegard  
Studio Manager: Lynn Poul Hedegard

[4] HIGHER OCTAVE RECORDING  
(formerly Centersound)  
1187 Coast Village Rd. #1-192  
Santa Barbara, CA 93108  
(805) 565-1353  
Owner: Higher Octave Music  
Studio Manager: Nancy Hagens

[4] HINDU ARTS  
7042 Betty Dr., Huntington Beach, CA 92647  
(714) 841-2654  
Owner: Ron Eglit  
Studio Manager: Joey Eglit

[8] H.M.E.A.'s "STATE-OF-THE-HEART" STUDIO  
also REMOTE RECORDING  
P.O. Box 453, Lakewood, CA 90714  
(213) 423-0273  
Owner: Harpazol Ministries Evangelical Assoc.  
Studio Manager: Duane Everts  
Engineers: Duane Everts, independents.  
Dimensions of Studios: 15 x 21, iso 6 x 8.  
Dimensions of Control Rooms: 9 x 11.  
Tape Recorders: Tascam 38, 8-track; Tascam 32-2B, 2-track; Dokorder 1140, 4-track; (12) logic-controlled Pioneer CT-F550 cassettes; TEAC 234, 4-track cassette.  
Mixing Consoles: (2) TEAC Model 5, 16 x 8, (2) TEAC Model 1, 16 x 4  
Monitor Amplifiers: Sanyo P-55 100 w/ch., Marantz, TOA.  
Monitor Speakers: JBL 4311, KLH.  
Echo, Reverb & Delay Systems: Imagineering Audio's "Echo Digital Recorder"; 16 sec. delay w/forward and reverse play, Fostex reverb, MXR flanger/doubler, MXR autollanger, Ibanez DM-500 digital delay.  
Other Outboard Equipment: MXR dual 15-band EQ; (2) Fostex stereo compressor/limiters; 8-channel noise reduction (dbx); spectrum analyzer; Rock Trek II guitar preamp; Aphex Aural Exciter.  
Microphones: Shure SM57s, SM58s, 545; Audio-Technica AT-801s (x2).  
Instruments Available: Blackhurst custom electric bass; Blackhurst custom electric 6-string.  
Video Equipment & Services: Video production van, ISI 902 camera switcher, character generator w/downstream key edge; Sony and Conrac monitors; JVC U-matic recorder; CVS time base corrector; TEAC Model 3 audio console; Sony cassette decks; Tektronix WFM and vectorscope; Faroudja image enhancer; 3/4-inch editing and VHS duplication available.  
Rates: Under certain conditions "FREE;" call or write for details.

[8] HONG STUDIO  
12162 Movius Dr., Garden Grove, CA 92640  
(714) 636-4004  
Owner: Hong Thai Luong  
Studio Manager: Hong Thai Luong

[4] ICM UPPER ROOM RECORDING  
also REMOTE RECORDING  
928 Carpinteria St. Ste. 5, Santa Barbara, CA 93103  
(805) 962-8241  
Owner: Diane Lee Cooper, Jean MiFine  
Studio Manager: Diane Lee Cooper

[4] INCIDENTAL SOUND  
P.O. Box 7103, Laguna Niguel, CA 92677

## SOUTHERN CALIFORNIA



(714) 495-2159  
Owner: Fredenc B. Hodshon  
Studio Manager: Frederic B. Hodshon

[8] INTERSOUND INC.  
8746 Sunset Blvd., Los Angeles, CA 90069  
(213) 652-3741  
Owner: Frank Agrama  
Studio Manager: Kent Harrison Hayes

[8] J & J MUSIC & SOUND  
P.O. Box 8474, Rowland Hts., CA 91748  
(818) 965-9386  
Owner: J. Kubal  
Studio Manager: R.J. Kubal

[8] JAZMINE PRODUCTIONS  
398 Otono Ct., Camarillo, CA 93010  
(805) 987-9932  
Owner: Markus McDowell, Michele Wiggins  
Studio Manager: Markus McDowell

[8] JEPHTHA STUDIOS  
also REMOTE RECORDING  
8323 Orchard St., Alta Loma, CA 91701  
(714) 987-5605  
Owner: Jeff Dykhouse  
Studio Manager: Jeff Dykhouse

[4] JESUS IS LORD STUDIOS  
5000 O'Sullivan Dr., Los Angeles, CA 90017  
(213) 222-2304  
Owner: Zamar Unlimited, Inc.  
Studio Manager: Richard Zeier

[4] JKL ENTERTAINMENT  
P.O. Box 548, Walnut, CA 91789  
(818) 810-8979  
Owner: Kevin Reinhardt  
Studio Manager: Kevin Reinhardt

[4] JMK RECORDING SERVICE  
only REMOTE RECORDING  
20742 Lull St., Canoga Park, CA 91306  
(818) 340-7967  
Owner: Jeffrey M. Knecht

[4] JOE'S PLACE STUDIO  
8033 Sunset Blvd. Ste. 1010, Los Angeles, CA 90069  
(213) 659-3940  
Studio Manager: Joe Klein

[8] JR WEST SOUND RECORDERS  
also REMOTE RECORDING  
1025 N. Ferndale, Fullerton, CA 92631  
(714) 645-8492  
Owner: Jack Roberts  
Studio Manager: Jack Roberts

[8] K-PRODUCTIONS & RECORDING  
6436 Malcolm Dr., San Diego, CA 92115  
(619) 583-2717  
Owner: Dennis H. Keith  
Studio Manager: Dennis Keith

[8] KHALIQ-O-VISION  
5419 Hermitage Ave. #10, No. Hollywood, CA 91607  
(818) 761-1670

Owner: Khalq Glover  
Studio Manager: Khalq Glover

[8] KING RECORDING STUDIO  
P.O. Box 883, Somis, CA 93066  
(805) 987-2424  
Owner: Don King  
Studio Manager: Geoff King

[8] KINGCAT PRODUCTIONS (CLUB VITAL)  
1817 N. Fuller Ave., Hollywood, CA 90046  
(213) 850-7605  
Owner: Brad Thomas Bailey  
Studio Manager: Brad Thomas Bailey

[4] KOALA STUDIO  
also REMOTE RECORDING  
22931 Sycamore Creek Dr., Valencia, CA 91355  
(805) 259-8562  
Owner: Jack Adams  
Studio Manager: Shirley

[2] LANE AUDIO & RECORDS  
Box 29171, Los Angeles, CA 90029  
(213) 469-8007  
Owner: Michael R. Lane  
Studio Manager: Michael R. Lane

[2] LEAVENWORTH/SOUND  
only REMOTE RECORDING  
5004 Pendleton St., San Diego, CA 92109  
(619) 274-3566  
Owner: Bill Leavenworth

[4] LU-DON STUDIO  
16034 Bryant St., Sepulveda, CA 91343  
(818) 894-5693  
Owner: Don Tracy  
Studio Manager: Susanne Malloy

[8] THE MAD-DEN STUDIO  
1999 Anaheim Ave. Unit B, Costa Mesa, CA 92627  
(714) 631-4098  
Owner: Mark Madden  
Studio Manager: Mark Madden  
Engineers: Mark Madden, David Glenn, David Wheeler.  
Dimensions of Studios: 17.5 x 20  
Dimensions of Control Rooms: 8 x 20  
Tape Recorders: 3M 15+30 ips M 79, one inch 8-track; 3M 15+30 ips M-23, 1/4-inch 2-track.  
Mixing Consoles: Carvin MX1688, 16 x 8.  
Monitor Amplifiers: Carvin DCA 800, QSC 1400, RIC RA 600  
Monitor Speakers: JBL 4311B, KLH 4, Auratones.  
Echo, Reverb & Delay Systems: Lexicon Prime Time 93 digital delay, Eventide HM910 harmonizer, Marshall time modulator 5002A, Tapco 4400 stereo reverb, Yamaha E1010 analog delay.  
Other Outboard Equipment: (2) UREI LA-4s, UREI 1176 LN, (2) dbx 160X, Eventide FL 201 instant flanger, MXR EQs, Rane RE + 6E 27 EQs.  
Microphones: AKG C-12, Neumann TLM 170, U-67 and U-64, Sony C-37A, RCA DX77, EV PL20s, Sennheiser 421s Shure SM7 and SM57s, SM81s.  
Instruments Available: Roland IX-3P w/PG200, complete Ludwig acoustic drum kit, Tama Techstar drum kit, (2) Simmons SDSV pads and modules, Oberheim DMX w/extra voice cards and chips; (DMX can be triggered via Tama pads for a more human feel), many cymbals, guitar foot effects, etc. We'll help you find the sound you want to hear, to make you sound great. Professional, high quality demos.  
Rates: Negotiable. Please call for details.

[8] MAGNETIC INK  
also REMOTE RECORDING  
31625 Tennessee St., Yucaipa, CA 92399  
(714) 794-3582  
Owner: Doug Cross, Roger Cross  
Studio Manager: Steve Ertzner  
Engineers: Doug Cross, Roger Cross.  
Dimensions of Studios: 18 x 18 x 6 x 10 x 10.5—11 ceiling, isolation booth 5 x 8.  
Dimensions of Control Rooms: 12 x 8 x 8 x 8.  
Tape Recorders: TEAC 80-8, 8-tracks; Sansui digital PC-X1, 2-tracks; (10) Technics cassette RS-916 real time duplicating.  
Mixing Consoles: Tascam M-35, 8 x 4 x 2, Tascam M-35EX, 8 x 4.  
Monitor Amplifiers: Soundcraftsmen PCR 800, Sansui AV-317, Rane HC-6 headphone amp.  
Monitor Speakers: JBL 4411.  
Echo, Reverb & Delay Systems: DeltaLab ADM 1024 digital delay, Ibanez HD1000 HD1000 harmonics delay.



Orban dual reverb 111B, Yamaha REV7 digital reverb.  
**Other Outboard Equipment:** Valley People 610 compressor expander, Apex Systems Aural Exciter Type C, Garfield Electronics Mini Doc, ADC real time spectrum analyzer/EQ.

**Microphones:** Neumann U87; (2) Neumann KM84; Sennheiser MD421; (2) Shure SM57, (2) SM58, (2) PE585; (2) E-V PL 77B; (2) Audio Technica AIM63; (2) Active direct box MC220.

**Instruments Available:** Mesa Boogie Mark II, Mesa Boogie Mark III, Gibson Les Paul, Gibson ES335 Dot, Fender Telecaster, Fender Precision Special Bass, Ovation, Englehart stand-up bass, Roland Juno 60 w/MSQ 700 sequencer, Cabinet grand piano, Oberheim DX, Tama five-piece drum kit.

**Video Equipment & Services:** Cannon VR-40 (VHS), Sony Beta Hi-Fi SL5200, Quimac PX-1 video monitor.

**Rates:** Competitive rates, hourly and block rates, call for quote.

**[8] MASTER TRACKS RECORDING & MULTI-MEDIA**  
402 Loma Alta Dr., Santa Barbara, CA 93109  
(805) 966-6374

Owner: T. David Sommers  
Studio Manager: T. David Sommers

**[8] MASTERFLOW RECORDING STUDIO**  
1433 Silverlake Blvd., Los Angeles, CA 90026  
(213) 661-9589

Owner: Naomi J. Guillory  
Studio Manager: Debra Colter

**[8] MAXTRAX RECORDING STUDIOS**  
17471 Plaza Otonal, San Diego, CA 92128  
(619) 487-8787

Owner: Jefferson D. Stein  
Studio Manager: Franc Uberti

**[8] MAZZETTI AUDIO REMOTE**  
*only REMOTE RECORDING*  
P.O. Box 8874, Universal City, CA 91608  
(818) 761-1631

Owner: Mike Mazzetti

**[8] THE MEDIA STAFF**  
*also REMOTE RECORDING*  
6926 Melrose Ave., Hollywood, CA 90038  
(213) 933-9406

Owner: Jerry Maybrook, Lane Wipff, Sherwin Ruben  
Studio Manager: Mark Friedman

**[8] MILLENNIUM STUDIO**  
13052 Red Hill, Tustin, CA 92680  
(714) 838-7063

Owner: Bruce Burton  
Studio Manager: Bruce Burton

**[4] MOFFETT MANOR RECORDERS**  
2154 Canyon Dr., Costa Mesa, CA 92627  
(714) 646-3838

Owner: Robert Moffett  
Studio Manager: Robert Moffett

**[8] MOSER SOUND PRODUCTIONS**  
1923 W. 17th St., Santa Ana, CA 92706  
(714) 541-6801

Owner: Richard Moser

**[8] MUSIC DEPARTMENT-RECORDING ARTS PROGRAM, CALIF. POLYTECHNIC STATE UNIVERSITY**  
*only REMOTE RECORDING*  
San Luis Obispo, CA 93407  
(805) 546-2664, 2406

Studio Manager: Greg Barata

**[4] THE MUSIC SHOP**  
*also REMOTE RECORDING*  
11187 Camino Ruiz #77, San Diego, CA 92126  
(619) 693-3839

Owner: Vladimir Vooss

**[8] NIGHT VISION PRODUCTIONS, INC.**  
8695 Hebrides Dr., San Diego, CA 92126  
(619) 566-8989

Owner: Donald V. Phillips  
Studio Manager: Marianne B. Phillips  
Engineers: Donald V. Phillips, Andrew Paul Phillips.  
Dimensions of Studios: 20 x 15.

**Taperecorders:** Tascam 588, 8-track; TEAC 80-8, 8-track; TEAC 3440, 4-track; Tascam 225, 2-track.



**NIGHT VISION PRODUCTIONS, INC.**  
San Diego, CA

**Mixing Consoles:** Tascam M-35, 8 x 4 x 2; Yamaha PM-180, 6 x 2.

**Monitor Amplifiers:** Yamaha P-2200.

**Monitor Speakers:** JBL 4430.

**Echo, Reverb & Delay Systems:** REV7, PCM42, MXR double flanger.

**Other Outboard Equipment:** Macintosh Plus; Imagewriter II; Southworth Total Music Performer and MIDIMAC sequencer software; DigiDesign sound designer, Hybrid Arts MIDItrak III system; Compaq Plus; Atari 130XE; patch bays; TEAC MB-20; Peterson strobe tuner; Technics SL-P2 Compact Disc player.

**Microphones:** AKG "The Tube," (4) SM58, ECM 150.

**Instruments Available:** Emulator II; JX-8P; Juno-106; Fender stage piano; Pro-One; TR-707, TR-727, RX-11 drum machines; LP congas; tenor, alto, and soprano saxophones; flute; shakuhachi; Carvin DC200 guitar w/Kahler Pro Tremolo option; misc. percussion instruments.

**Video Equipment & Services:** JVC 6650 3/4-inch U-Matic Deck; SMPTE time code generator/reader; color monitors; audio-to-video post-production; sound effects library.

**Rates:** \$15-\$25/hr.

**[4] NOH SOUND**  
23281 Leonora Dr., Woodland Hills, CA 91367  
(818) 704-1886

Owner: Kyle Johnson  
Studio Manager: Kyle Johnson

**[4] O.K. STUDIOS**  
5829 Bowcroft St. #4, Los Angeles, CA 90016  
(213) 839-6377

Owner: Arlo Chan  
Studio Manager: Arlo Chan

**[4] OKAY BOUQUET STUDIOS**  
37039 Bouquet Cyn. Rd., Saugus, CA 91350  
(805) 270-0822

Owner: Jack Worth  
Studio Manager: Jack Worth

**[8] ONESTOP STUDIOS**  
*also REMOTE RECORDING*  
P.O. Box 2281, Canoga Park, CA 91306  
(818) 345-8765

Owner: Bob Blank  
Studio Manager: Pete Roy

**[8] OPEN DOOR SOUND**  
145 Pier Ave., Hermosa Beach, CA 90254  
(213) 374-9765

Owner: Mark "Fitch" Fitchett  
Studio Manager: Mark "Fitcn" Fitchett

**[8] OPUS ONE RECORDING**  
1971 Torrance Blvd., Torrance, CA 90501  
(213) 533-9897

Owner: Bill Krodol  
Studio Manager: Bill

**[8] OUTLAW SOUND**  
1140 N. La Brea Ave., Los Angeles, CA 90038  
(213) 462-1873

Owner: Allen Roth Productions Inc.  
Studio Manager: Allen Roth

# TRUE COMPRESSIONS!

Alright. We confess. Rocktron makes the smoothest compressors available. We're talking **True Compression**; put over easy back in the kitchen where it belongs.

The pros are demanding the performance that only Rocktron can provide. Only the Model 300 has famous **HUSH II** noise reduction. Only the Model 310 offers such easy use at a great price. Or try our new Model 320 stereo compressor.

You will find what you've been missing when you use Rocktron. And that's the truth.

See Your Rocktron Dealer.

**ROCKTRON CORPORATION**

1633 Star Batt Drive  
Rochester, Michigan 48063  
(313) 853-3055

All products patent pending.

Circle #113 on Reader Service Card

# Diskmakers

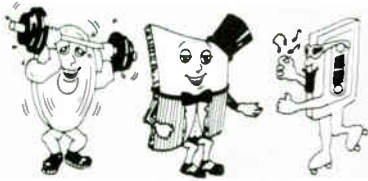

- RECORD PRESSING
- CASSETTE DUPLICATION
- RECORD JACKETS

A complete state of the art service from your master tape & art work to your finished pressing & jacket together.

Call Toll Free for complete package prices and our sample kit

**800-468-9353**

153 W. 46th St., N.Y., N.Y. 10036  
212-302-4140

Circle #114 on Reader Service Card



## FINALLY... C-Zeros You Can Trust!

Our shells are engineered to give you:

- ★ Perfect azimuth control
- ★ Smooth and uniform loading at ultra high speeds
- ★ Easy, direct on-cassette printing or labelling
- ★ The most competitive pricing

Also available are pancake and bulk loaded premium cassettes

**Call Us For Free Samples!**

**Jordax California Inc.**  
1513 Sixth St., Suite 204  
Santa Monica, CA 90401  
Phone: (213) 393-1572

Circle #115 on Reader Service Card

## SOUTHERN CALIFORNIA



### 4 & 8 TRACK

[4] PACIFIC PRODUCTION WORKS  
962 Hymettus Ave. Ste. B, Leucadia, CA 92024  
(619) 436-2112  
Owner: Erik Thompson  
Studio Manager: Bill Kalagian

[8] PACIFIC WEST PRODUCTIONS  
also REMOTE RECORDING  
P.O. Box 2222, Carlsbad, CA 92008  
(619) 729-1000

Owner: Stephen M. Cilizro  
Studio Manager: Steve Hill

[4] PHUSION  
only REMOTE RECORDING  
P.O. Box 7981, Newport Beach, CA 92660  
(714) 751-6670  
Owner: Mark O. Paul  
Studio Manager: Sylvia L. Waack

[4] PIC STUDIOS  
also REMOTE RECORDING  
2220 W. Magnolia Blvd., Burbank, CA 91506  
(213) 849-7345  
Owner: Sid Lane  
Studio Manager: Scott Wedding

[8] PLANET  
also REMOTE RECORDING  
535 E. Montecito St. B202, Santa Barbara, CA 93103  
(805) 966-0715  
Owner: William Steurer  
Studio Manager: Shela Wu

[8] PRIVATE RECORDING SERVICE  
5134 Saratoga Ave. #7, San Diego, CA 92107  
(619) 222-1039  
Owner: Tim Campbell  
Studio Manager: Billy Thompson

[4] PSI INC.  
also REMOTE RECORDING  
18019-A Skypark Circle, Irvine, CA 92714  
Owner: Robert Hagerty  
Studio Manager: Timothy Loftus

[8] GARRISON PUTNEY STUDIO  
4635 E. Anaheim St., Long Beach, CA 90804  
(213) 494-4552  
Owner: Clovis L. Putney (Cree H. Putney)

[4] RAG RECORDING  
1230 20th Pl., Hermosa Beach, CA 90254  
(213) 374-9966  
Owner: R. Grea  
Studio Manager: Ken Rogers

[4] RAG RECORDING & REHEARSAL  
200 Guadalupe Ste. 1, Redondo Beach, CA 90277  
(213) 822-7543  
Owner: Richard Grea  
Studio Manager: Enck King, Bill Scooter

[8] RAINBOW RECORDING  
only REMOTE RECORDING  
34 Jackson, Irvine, CA 92720  
(714) 551-5367  
Owner: Dale McCart  
Studio Manager: Dale McCart

[8] THE REEL THING  
11197 Tudor, Ontario, CA 91762  
(714) 628-3024  
Owner: Robert M. Hill  
Studio Manager: Robert M. Hill  
Engineers: Robert M. Hill  
Dimensions of Studios: 12 x 19 x 8  
Dimensions of Control Rooms: 8 x 6 x 8  
Tape Recorders: Tascam 80-8/dbx, 8-track, Tascam 35-2/dbx, 2-track; TEAC A-6010, 2-track; TEAC A601R (cassette), 2-track.  
Mixing Consoles: Tascam 35, 8 x 4  
Monitor Amplifiers: Spectro Acoustics 200R  
Monitor Speakers: JBL 4311B, Auratone cubes  
Echo, Reverb & Delay Systems: Fostex digital delay; Master-room stereo reverb XL-305 (MICMIX)  
Other Outboard Equipment: Tascam Model 1; MXR noise gate; MXR Phase 90; MXR Distortion Plus; Spectro acoustics graphic EQ 210R; dbx 161 limiter, Tubecube direct box; Aphex 602B Aural Exciter.  
Microphones: Beyer 500; Shure SM57, SM58, SM546; E-V RE20; Sony ECM 56F; Sennheiser 421.  
Instruments Available: Fender Twin Reverb amplifier; Fender Jazz Bass, Precision Bass, Coronado bass II, 12-string, electric 12-string, Stratocaster, Jazzmaster guitars; Gibson Les Paul guitar; Epiphone guitar; piano; Roland Juno 60 synthesizer; Roland Rhythm Composer TR-909.  
Rates: Please call for rates.

[4] REMOTE VIDEO & AUDIO RECORDING AND CASSETTE DUPLICATION BY STEVE McCAY  
also REMOTE RECORDING  
614 E. Date St., Hemet, CA 92343  
(714) 652-5110  
Owner: Steve McCay  
Studio Manager: Steve McCay

[2] REVIVAL TABERNACLE  
8510 Main St. (Mailing: 7505 Burger Way)  
Lamont, CA 93241  
(805) 845-0203  
Owner: Revival Tabernacle

[2] JOHN RITTEARTH  
MOT. PIC. PROD./TV SERVICE  
also REMOTE RECORDING  
1340 Ontario Ave., Pasadena, CA 91103  
(213) 681-4110  
Owner: John Rittearth

[4] R.J.M. PRODUCTIONS  
also REMOTE RECORDING  
9317 Cedar St. C, Bellflower, CA 90706  
(213) 925-0141  
Owner: Robert Moore  
Studio Manager: Jeffre S. Moore

[8] RK COLE STUDIOS  
1410 Amapola Ave., Torrance, CA 90501  
(213) 328-2446  
Owner: Randy Coleman  
Studio Manager: Randy Coleman

[8] SAY "VAUGHNS" RECORDING  
3460 1/2 Centinela Ave., Los Angeles, CA 90066  
(213) 397-2227  
Owner: Vaughn von Merwald  
Studio Manager: Vaughn von Merwald

[8] SCA STUDIOS  
3766 Santa Clara Ave., Oxnard, CA 93030  
Owner: C.S. Lamb  
Studio Manager: Brooke Lamb

[8] SELAH RECORDING STUDIO  
9190 Poppy Circle, Westminster, CA 92683  
(714) 898-5220  
Owner: Phil Gehlhar  
Studio Manager: Dave Gehlhar

[4] SIDESTREAM SOUND  
also REMOTE RECORDING  
5013 1/2 Narragansett Ave., San Diego, CA 92107  
(619) 222-0238  
Owner: Ken Totten  
Studio Manager: Ken Totten

[4] SIGMA RECORDERS  
Sepulveda, CA  
(818) 892-2153  
Owner: Allen Marshall  
Studio Manager: Allen Marshall



[8] SLIDERSOUND STUDIOS  
11684 Ventura Blvd. #270, Studio City, CA 91604  
(818) 906-2368  
Owner: Dan Slider  
Studio Manager: Charles "Slick" Johnson

[8] SOLITAIRE RECORDING  
5000 White Oak Ave., Encino, CA 91316  
(818) 501-5207  
Owner: Patrick Shipstad  
Studio Manager: Patrick Shipstad

[8] SOUND IMAGERY  
835 Parkman Ave., Los Angeles, CA 90026  
(213) 665-1841  
Owner: Gary Macheel  
Studio Manager: Gary Macheel

[8] SOUNDSATIONS STUDIO  
3212 Mesa Verde Rd., Bonita, CA 92002  
(619) 479-6208  
Owner: Alex Gonzalez  
Studio Manager: Alex Gonzalez

[8] SOUTH COAST RECORDING  
1818½ N. Main St., Santa Ana, CA 92706  
(714) 541-2397  
Owner: Jim Dotson  
Studio Manager: Jim Dotson  
Engineers: Jim Dotson.  
Dimensions of Studios: 10 x 27 (main); 10 x 11 (drum room); 4 x 5 (vocal booth).  
Dimensions of Control Rooms: 9 x 16.  
Tape Recorders: Tascam 38, 8-track; Tascam 25-2, 2-track; Nakamichi 480 cassette.  
Mixing Consoles: Ramsa WR-8112, 12 x 4 x 2.  
Monitor Amplifiers: QSC, Rene.  
Monitor Speakers: Electro-Voice Sentry 100A, AKG and Sennheiser headphones.  
Echo, Reverb & Delay Systems: Yamaha SPX 90 digital reverb, DeltaLab ADM 1024 digital delay, acoustic chamber, Furman RV1 reverb.  
Other Outboard Equipment: dbx 165A compressor/limiter.  
Microphones: Electro-Voice RE-20; (2) AKG D224E; (2) Shure SM81, (2) SM57, SM58; (2) Sennheiser MD-421; (2) Countryman associate direct boxes  
Instruments Available: Acoustic piano, various keyboards and drum machines available upon request. Call for information.  
Rates: \$15/hr.

[8] SOUTHWIND RECORDINGS  
14751 Ararat St., Sylmar, CA 91342  
(818) 362-3843  
Owner: Rick Thomas  
Studio Manager: Rick Thomas

[8] SPECTRUM SIGHT & SOUND  
1800 N. Argyle Ave. Ste. 100, Los Angeles, CA 90028  
(213) 462-0812  
Owner: Spectrum Sight & Sound  
Studio Manager: William Froggatt

[8] JAY STAGGS CASSETTE DUPLICATION  
only REMOTE RECORDING  
7419 Florence Ave., Downey, CA 90240  
(213) 928-7516  
Owner: Jay Staggs  
Studio Manager: Jay Staggs

[8] STANDING ROOM ONLY  
8228 Beech Ave., Fontana, CA 92335  
(714) 829-1314  
Owner: Stephen Robertson  
Studio Manager: Stephen Robertson

[4] STUDIO 99  
also REMOTE RECORDING  
1984 N. Main, Los Angeles, CA 90031  
(213) 227-9328  
Owner: L. Russo, E. Dingman  
Studio Manager: Kevin Slater

[8] STUDIO 23  
22725 Califa St., Woodland Hills, CA 91367  
(818) 704-8634  
Owner: Bryan Cumming  
Studio Manager: Bryan Cumming

## One Stop Service Quality Products Timely Deliveries



Let the quality of your graphics reflect the excellence they can expect to find in your music.

Stoughton Printing can provide all your record and video related printing and packaging. Direct board record jackets, 7 and 12 inch sleeves, labels. The finest in UV Coatings. All done in house. CD booklets and inlay cards, posters, box wraps and any other graphic material you may need to promote your products.

If it's worth doing, it's worth doing right. Come to the source . . . . We're there when you need us.

## stoughton printing co.

130 N. Sunset Avenue, City of Industry, CA 91744  
From Los Angeles: (213) 686-2753  
(818) 961-3678

Quality Printing For The Record Industry Since 1965

© 1986 Stoughton Printing Co.

Circle #116 on Reader Service Card

# EQUIPMENT FOR SALE?

If you have equipment to sell—whether it's a single microphone or an entire studio—**Mix Classifieds** are the place to advertise. **Mix Magazine's** classified section is the biggest in the industry, and more than 75,000 audio and music pros read **Mix** every month!

When professionals need equipment, **Mix** is the first place they look. So if you've got gear you absolutely must sell, advertise in the magazine you can count on to get results. To place your ad, call Lauri Newman at **(415) 843-7901**, or use the order form in the back of this issue.

# Mix

THE RECORDING INDUSTRY MAGAZINE

2608 NINTH STREET, BERKELEY, CALIFORNIA 94710 (415) 843-7901

## RACKRATE

A Unique New Product Designed to Safeguard your Rack Mountable Equipment

### RACKRATE FEATURES:

- Holds up to Six 'Spaces' of Equip. 11.5" deep
- Lower Weight, Greater Strength, Better Ventilation
- Surprisingly Low Price

Ask Your Dealer For A Demonstration

### FOUR DESIGNS CO.

6531 Gross Ave. Canoga Park, CA 91307 (818) 716-8540



## SOUTHERN CALIFORNIA



### 4 & 8 TRACK

#### [8] STUDIO V

also REMOTE RECORDING  
4774 Longbranch Ave., San Diego, CA 92107  
(619) 222-4592  
Owner: Vardan Burke  
Studio Manager: Vardan Burke

#### [8] FRANK SULLIVAN RECORDING STUDIO

also REMOTE RECORDING  
658 S. Hudson Ave., Pasadena, CA 91106  
(818) 793-1535  
Owner: Frank Sullivan, Lisa Campbell  
Studio Manager: James Cruce

#### [8] SUMMIT VIEW

9122 Worth Way, Camarillo, CA 93010  
(805) 987-2306  
Owner: John A. Cliff  
Studio Manager: John A. Cliff

#### [8] SUNDIAL RECORDING STUDIO

P.O. Box 5426, Montecito, CA 93150  
(805) 969-6926  
Owner: Don Messick  
Studio Manager: Don Messick

#### [8] SUNSET RECORDS

also REMOTE RECORDING  
6716 Eddinghill Dr., Rancho Palo Verdes, CA 90274  
(213) 377-7186  
Owner: J. David Lahey  
Studio Manager: J. David Lahey

#### [8] SUPERIOR SONICS

also REMOTE RECORDING  
19516 Hemmingway, Reseda, CA 91335  
(818) 701-5253  
Owner: Richard Peden, Kevin Vincent

#### [8] SUPERSOUND STUDIO

also REMOTE RECORDING  
8946 Ellis Ave., Los Angeles, CA 90034  
(213) 836-4028  
Owner: Morris David Golodner  
Studio Manager: Morris Golodner

#### [8] SYNTRAX PRODUCTIONS

Temple City, CA  
(818) 285-3698  
Owner: Bill Pearson  
Studio Manager: Bill Pearson

#### [4] TARGET RECORDERS

also REMOTE RECORDING  
1123 Rosewood Ave., Inglewood, CA 90301  
(213) 419-4017  
Owner: A.R. Thomas  
Studio Manager: Bonita C. Thomas

#### [4] C. ALAN TAYLOR ASSOCIATES

also REMOTE RECORDING  
9699 Follett Dr., Santee, CA 92071  
(619) 562-6478  
Owner: C. Alan Taylor  
Studio Manager: Joel Persinger

#### [8] THIRD EAR RECORDING STUDIO

also REMOTE RECORDING  
Jelly-Up Tavern, 143 S. Cedros  
Solana Beach, CA 92075  
(619) 481-3030  
Owner: Malcolm Falk  
Studio Manager: Malcolm Falk

#### [4] TKO PRODUCTIONS & MEDIA SERVICES

also REMOTE RECORDING  
P.O. Box 862, Port Hueneme, CA 93041  
(805) 488-0523  
Owner: T.R. Scharf, K.L. Scharf  
Studio Manager: T.R. Scharf

#### [4] TRENDS IN PROFESSIONAL SOUND & VIDEO DIMENSIONS

also REMOTE RECORDING  
7220 N. Rosemead Blvd. Ste. 108  
San Gabriel, CA 91775  
(818) 287-0921  
Owner: Tony Bohlin  
Studio Manager: Todd Barry

#### [8] TRIHEDRA PRODUCTIONS

1920 E. Foothill Dr., San Bernardino, CA 92404  
(714) 886-2569  
Owner: David Haggard  
Studio Manager: David Haggard

#### [8] 24 KT SOUND

4415 Lime Ave., Long Beach, CA 90807  
(213) 595-7131  
Owner: Todd Carter  
Studio Manager: Todd Carter

#### [8] VCA

also REMOTE RECORDING  
Sherman Oaks, CA  
(818) 786-2140

#### [8] VITAL T.V. RECORDS aka WALLY'S WEST

5307 Harold Way #4, Hollywood, CA 90028  
(213) 462-2388  
Owner: Gerry Rothschild  
Studio Manager: Denny Moore

#### [8] VOICE OVER L.A. INC.

1717 N. Highland Ave., Hollywood, CA 90028  
(213) 463-VOLA  
Owner: Voice Over L.A. Inc.  
Studio Manager: Robert J. Nicosia

#### [8] WESTERNMOST STUDIO

2330 The Strand, Hermosa Beach, CA 90254  
(213) 372-5806, 372-3782  
Owner: Jim West  
Studio Manager: Jan Elliott

#### [8] DANA WHITE PRODUCTIONS

also REMOTE RECORDING  
2623 29th St., Santa Monica, CA 90405  
(213) 450-9101  
Owner: Dana C. White  
Studio Manager: Mike Zipper

#### [4] WHITE TRASH STUDIOS

also REMOTE RECORDING  
11030 Aqua Vista Dr. Ste. 37, N. Hollywood, CA 91602  
(818) 506-1141  
Owner: White Trash Corporation  
Studio Manager: Robert Falkenhagen

#### [8] WILD TALENT STUDIOS

5720 Andasol Ave., Encino, CA 91316  
(818) 705-6985  
Owner: Wynnette and Stan Keiser  
Studio Manager: Stan Keiser

#### [8] XAN SOUNDTRACK PRODUCTIONS

North San Vicente, Hollywood, CA 90069  
(213) 855-1978  
Owner: Xan  
Studio Manager: Greg Easter

#### [8] GREG YOUNGMAN MUSIC

P.O. Box 8102, Long Beach, CA 90808  
(213) 425-9597

Economical 19" rackmount 'Furniture' for the Professional or Home Studio.

### FX RACK FEATURES:

- Holds up to Eighteen 'Spaces' of Equipment
- Complements any room decor (Basic Black)
- Surprisingly Low Price

Ask Your Dealer For A Demonstration

### FOUR DESIGNS CO.

6531 Gross Ave. Canoga Park, CA 91307 (818) 716-8540



Circle #118 on Reader Service Card



Custom pressing, tape duplication and packaging.

## 1,000

### 7"-45<sup>S</sup>

including mastering, metal parts and processing, white sleeves, labels, pressing.

## \$439.00

### 12" Albums with jackets

including mastering, metal parts and processing, poly dust sleeves, labels, pressing and printing of full colour ultra high gloss board jackets from customer supplied process film.

## \$1,390.00

(F.O.B. DETROIT)

- 2 - 3 WEEK SERVICE
- VIRGIN VINYL
- HIGH GLOSS BOARD JACKETS
- CrO<sub>2</sub> CASSETTES
- CUSTOM 7" SLEEVES
- INHOUSE ART & TYPESETTING

Call Toll Free Continental U.S.A.

## 1-800-263-7798

Canada's Largest Custom Producers



## WORLD RECORDS

BASELINE ROAD WEST, BOWMANVILLE, ONTARIO L1C 3Z3

Circle #119 on Reader Service Card



# SOUTHERN CALIFORNIA

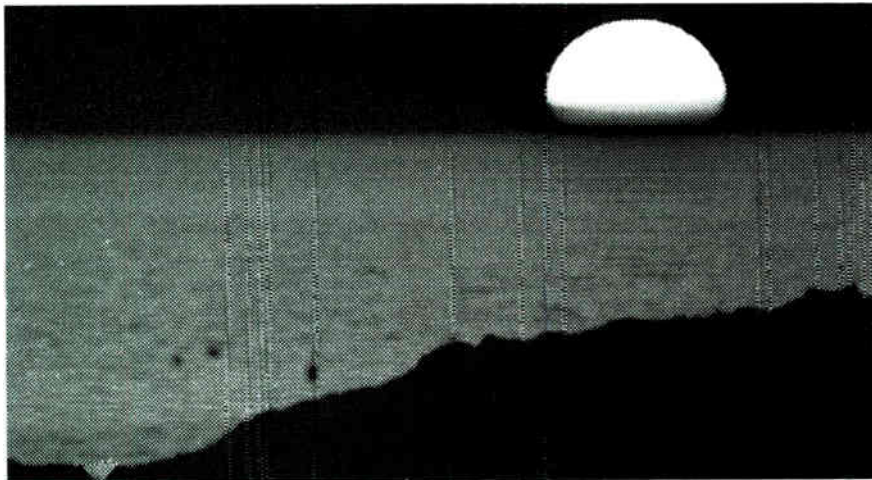

## 12 & 16 TRACK

[16] ABC WATERMARK STUDIOS  
3575 Cahuenga Blvd. West Ste. 555  
Los Angeles, CA 90068  
(818) 980-9490  
Owner: ABC/Cap Cities  
Studio Manager: Johnny Biggs

[16] ACRASOUND RECORDING STUDIOS  
5946 Guthrie Ave., Los Angeles, CA 90034  
(213) 936-8742  
Owner: Matt Warnick, Bruce Conover  
Studio Manager: Dia Wann

[16] ANTLER RECORDING  
P.O. Box 2212, Redondo Beach, CA 90278  
(213) 973-5465  
Owner: Mike Brebes  
Studio Manager: Mike Brebes

[16] AUDIO PARAGON  
11612 Knott St., Garden Grove, CA 92641  
(714) 898-8373  
Owner: Emmitt Sinaid  
Studio Manager: Rycharad Cox

[16] BARE TRAX  
P.O. Box 4988, Culver City, CA 90231  
(213) 390-5081  
Owner: Jon Bare  
Studio Manager: Jon Bare

[16] BLINDFOLD STUDIOS  
P.O. Box 253, Poway, CA 92064  
(619) 566-3850  
Owner: Gregg Brandalise  
Studio Manager: Gregg Brandalise

[16] BUZZY'S RECORDING SERVICES  
also REMOTE RECORDING  
6900 Melrose Ave., Los Angeles, CA 90038  
(213) 931-1867  
Owner: Walter Resnik  
Studio Manager: Larry Lantz

[16] RITCHIE CARBAJAL MUSIC  
637 Kimlin Dr., Glendale, CA 91206  
(818) 956-0723  
Owner: Ritchie Carbajal  
Studio Manager: Ritchie Carbajal

[16] CASBAH RECORDING  
1895 Commonwealth Ave. Ste. N.  
Fullerton, CA 92633  
(714) 738-9240  
Owner: Chaz Ramirez, Kim Larson  
Studio Manager: Rollo Ramirez

[16] CENTRAL SOUND RECORDERS  
1805 La Coronilla Dr., Santa Barbara, CA 93109  
(805) 962-5601  
Owner: Kevin Kelly  
Studio Manager: Kevin Kelly

[16] D-TOWN/PLATINUM SOUND STUDIOS  
also REMOTE RECORDING  
11657 Erwin St., North Hollywood, CA 91606  
(818) 761-1988  
Owner: D-Town Records, Inc.  
Studio Manager: Norm B. Hively

[16] D.M.O. PRODUCTIONS  
13768 1/2 Erwin St., Van Nuys, CA 91401  
(818) 994-4279  
Owner: Gary McLaughlin  
Studio Manager: Ophir Shur

[16] DOG BARK RECORDING  
1269 8th, Los Osos, CA 93402  
(805) 528-6939  
Owner: Jon Iverson  
Studio Manager: Photon

[16] DUCHESS STUDIOS  
also REMOTE RECORDING  
7923 Duchess Dr., Whittier, CA 90606  
(213) 695-7715  
Owner: Chuck Minear Sr.  
Studio Manager: Chuck Minear  
Engineers: Chuck Minear Sr., Chuck Minear Jr., Terry Eustler  
Dimensions of Studios: Studio A: 18 x 23; vocal booth: 12 x 10; production studio C: 8 x 10.  
Dimensions of Control Rooms: Studio A: 17 x 13; C: 8 x 10.  
Tape Recorders: Ampex 1100, 16-track; (3) Ampex ATR 500, 2-track; (2) Revox B77, 1- and 2-track; (2) Revox A-700, 2-track; Revox B-700, cassette; TEAC 80-B, 8-track  
Mixing Consoles: Amax 2500, 20 x 20; Carvin 16-44, 16 x 4 x 2 x 1.  
Monitor Amplifiers: McIntosh 2100, Ocamp Labs  
Monitor Speakers: UREI 811s, Philips #544, Yamaha NS-10M, Auratone SC.  
Echo, Reverb & Delay Systems: Lexicon Model 200 digital reverb, PCM42 delay; AKG BX-10 reverb; Klark-Teknik DN-36; DeltaLab 1024, 1030 DDLs.  
Other Onboard Equipment: Teletronix LA-2A; dbx 160; Mighty Mate; UREI 1176; EXR-3 Exciter; LT Sound VE-2



DUCHESS STUDIOS  
Whittier, CA

Vocal Eliminator; Symetrix gates; Orban 526A de-essers.  
Microphones: AKG, Beyer, Neumann, Sennheiser, Shure, PZM, RCA, etc.  
Instruments Available: Kawai 7'4" grand piano, Rhodes, Conn two-manual theater organ, guitar (acc), available; Mirage synth; DX7; REV7; LinnDrums.  
Rates: 16-track \$55/hr., block rates available.

[12] EQUINOX PRODUCTIONS  
3707 Ben St., San Diego, CA 92111  
(619) 279-8299  
Owner: Dave Kesner  
Studio Manager: Dave Kesner

[16] FATTRAX STUDIO  
623 Rosemary Lane, Burbank, CA 91505  
(818) 841-1288  
Owner: Chris Brosius  
Studio Manager: Chris Brosius

[12] FLANDERS UNLIMITED INC.  
190 N. Arrowhead Ste. C, Rialto, CA 92376  
(714) 875-4488  
Owner: Bruce Flanders  
Studio Manager: Vickie

[16] FUTURE SOUND  
also REMOTE RECORDING  
1842 Burlen Ave., Thousand Oaks, CA 91360  
(805) 496-2585  
Owner: Randy Dew  
Studio Manager: Randy Dew

[16] GOOD E.A.R. STUDIO  
1110 A W Glenoaks Blvd., Glendale, CA 91202  
(818) 241-9090  
Owner: Eric Sclar  
Studio Manager: Eric Sclar  
Engineers: Eric Sclar, Geoff Bond, Larry Kornfeld.  
Dimensions of Studios: 600 sq. ft. (irregular shape), 10-foot ceiling.  
Dimensions of Control Rooms: 12 x 20.  
Tape Recorders: Otari MX-70, 16-track; Otari MTR-12, 2-track; Otari MX5050, 2-track; Tascam 122B, 2-track; Revox A77, 2-track.  
Mixing Consoles: Sound Workshop 1600, 20 x 16 x 2.  
Monitor Amplifiers: Haller 220  
Monitor Speakers: JBL 4411.  
Echo, Reverb & Delay Systems: (2) Lexicon 200s, Lexicon Super Prime Time with MEO.  
Other Onboard Equipment: dbx 165A comp/limiter; Valley People: (2) Gain Brains, (4) Kepexs, (2) Maxi Q, (4) QLZ preamps.  
Microphones: (2) AKG 414s, Sennheiser 421, Neumann KM84, Shure SM57s, SM58s.  
Instruments Available: Linn 9000, Prophet 2000, DX7, Emulator II + HD, Macintosh plus computer, Martin D35, Ibanez Roadstar bass, Mansfield upright grand piano.  
Rates: \$30/hr. including engineer and use of all equipment and instruments.

[16] HALLSMARK RECORDING  
also REMOTE RECORDING  
11684 Ventura Blvd. 5074, Studio City, CA 91604  
Owner: Rich Hall  
Studio Manager: Sketter Topkins, Rich Hall



**DON HARPER PRODUCTIONS, INC.**  
Long Beach, CA

[16] **DON HARPER PRODUCTIONS, INC.**  
730 East Third St., Long Beach, CA 90802  
(213) 436-5053

Owner: Don Harper  
Engineers: Mark Jackson, Don Harper, Mike Pedersen.  
Dimensions of Studios: 30 x 12 x 13, 20 x 21 x 9.  
Dimensions of Control Rooms: 23 x 21 x 9.  
Tape Recorders: Otari MX-70, 16-track; Otari MX 5050, 2-track; Technics 1506, 2-track.  
Mixing Consoles: Trident 65 Senes, 20 x 8 x 16.  
Monitor Amplifiers: (3) Haller, (2) Crown D-75.  
Monitor Speakers: UREI 811B, Yamaha NS-10, Auratone.  
Echo, Reverb & Delay Systems: Lexicon PCM60 reverb, Lexicon PCM41 delay, Lexicon PCM70, Roland SDE-1000.  
Other Outboard Equipment: Yamaha SPX-90, Dynaflex DX-2 noise reduction, UREI LA-4 compressor/limiters.  
Microphones: Neumann, AKG, Sennheiser, E-V, Shure.  
Instruments Available: Yamaha C-7 grand piano, Yamaha DX7, Prophet-5, Oberheim Xpander, Roland Super Jupiter, Minimoog, Yamaha RX11 drum machine, Apple IIe sequencer software.  
Rates: Available upon request.

[16] **HARK'S SOUND STUDIO**  
also *REMOTE RECORDING*  
1041 N. Orange Dr., Hollywood, CA 90038  
(213) 463-3288  
Owner: Dick Bogert

[16] **HIT SINGLE RECORDING SERVICES**  
College Grove Center—Lower Ct. #4  
San Diego, CA 92115  
(619) 265-0524  
Owner: Scottman Ltd.  
Studio Manager: Randy Fuelle

[16] **HOT MIX RECORDING**  
5892 Los Molinos Dr. Buena Park, CA 90620  
(714) 761-2621  
Owner: Bob Chance  
Studio Manager: Robert Wahlestein

[16] **J.E. SOUND PRODUCTION & ENTERTAINMENT**  
11323 Santa Monica Blvd., Los Angeles, CA 90025  
(213) 479-7653  
Owner: John Goodenough  
Studio Manager: John Goodenough

[16] **JEL RECORDING STUDIOS**  
6100 W. Pacific Coast Hwy., Newport Beach, CA 92663  
(714) 631-4880  
Owner: Edo Guidotti  
Studio Manager: Sandra Gentosi

[16] **J.E.R. STUDIOS/RECORDING & REHEARSAL COMPLEX**  
214 Anacapa St., Santa Barbara, CA 93101  
(805) 966-4222  
Owner: John and Debra Esparza  
Studio Manager: John Esparza

[16] **KENJO AUDIO, INC.**  
607 E. Belmont Ave., Fresno, CA 93701  
(209) 266-9681  
Owner: Jim Clymer, Jr.  
Studio Manager: Jim Clymer, Jr.

## SOUTHERN CALIFORNIA



### 12 & 16 TRACK

[16] **LIVINGSTON MUSICAL SERVICES**  
332 N. Azusa, City of Industry, CA 91744  
(818) 964-9578  
Owner: John Livingston  
Studio Manager: John Livingston

[16] **MATTEL INC. RECORDING STUDIO**  
5150 Rosecrans Ave., Hawthorne, CA 90250  
(213) 978-7014  
Owner: Mattel Toys Inc.  
Studio Manager: Jacques L. DuLong

[16] **MAX SOUND**  
867 E. Walton St., Long Beach, CA 90806  
(213) 424-3121  
Owner: Max Solomon  
Studio Manager: Jamie Mitchell

[16] **MERCANTILE RECORDING**  
also *REMOTE RECORDING*  
P.O. Box 2271, Palm Springs, CA 92263  
(619) 320-4848  
Owner: Kent Fox  
Studio Manager: Kent Fox

[16] **MUZIC TRAK STUDIO**  
2227 Alsace Ave., Los Angeles, CA 90016  
(213) 931-7508  
Owner: Courtney Branch, Terrell Branch, Randy Branch  
Studio Manager: Courtney Branch, Terrell Branch

[16] **NEIL RECORDERS**  
678 St. John Ave., Pasadena, CA 91105  
(818) 798-2956  
Owner: Jim Neil  
Studio Manager: Jim Neil

[16] **OMNI RECORDING STUDIOS**  
5951 Venice Blvd., Los Angeles, CA 90034  
(213) 933-OMNI  
Owner: Warcon Production Group  
Studio Manager: Bruce Conover

[16] **ROSE STUDIOS**  
also *REMOTE RECORDING*  
1098 Rose Ave., El Centro, CA 92243  
(619) 352-5774  
Owner: Danny Berg  
Studio Manager: Kelly Berg

[16] **ROXY WEST**  
c/o 1400 Heritage Rd., San Diego, CA 92119  
(619) 697-2452  
Owner: Willie Roberson  
Studio Manager: Willie Roberson  
Engineers: Many available.  
Dimensions of Studios: 20 x 10.  
Dimensions of Control Rooms: 20 x 20  
Tape Recorders: Ampex 1100, 16-track; Tascam 38, 8-track; Revox PR99, 2-track, Ampex 1/2-inch, 2-track; Revox A77, 2-track; Tascam 322B, 2-track; Nakamichi cassettes.  
Mixing Consoles: Hill J3P, 16 x 16; Yamaha 4300, 8 x 4.  
Monitor Amplifiers: BGW, Yamaha, QSC.  
Monitor Speakers: UREI, JBL, Altec, Auratones.  
Echo, Reverb & Delay Systems: Orban 111B, Yamaha digital, (2) Super Time Lines, Effectron, others.  
Other Outboard Equipment: UREI parametric, Aphex, dbx comp., Orban stereo synth 245F, Yamaha 1/3 octave EQ, Haller, Orban 424A stereo compressor, dbx noise reduction.  
Microphones: AKG 414, 441, 421, Shure, many others.  
Instruments Available: Yamaha grand, Oberheim OB-Xa, Oberheim DX drum machine, MXR drum machine, complete drum kits, many vintage Martins, Fenders, Gib-

son guitars and basses, Fender amps.  
Video Equipment & Services: 3/4-inch Panasonic, Sony Beta Hi-Fi, VHS etc.  
Rates: Open.

[12] **THE RUBBER DUBBERS, INC.**  
626 Justin Ave., Glendale, CA 91201  
(818) 241-5600  
Owner: Peter Smolian  
Studio Manager: Eric Gotthelf

[12] **THE SHOOTING STAR STUDIOS**  
also *REMOTE RECORDING*  
416 Pioneer Dr. Ste. 11, Glendale, CA 91203  
(818) 243-3550  
Owner: William T. Jacobs  
Studio Manager: Jake Thomas

[16] **SOUND OFF STUDIO**  
200 N. Long Beach Blvd. (P.O. Box 127)  
Compton, CA 90221  
(213) 639-9565  
Owner: Jack E. Lauderdale  
Studio Manager: Mark D. Lauderdale

[16] **SOUNDGRAPHICS STUDIO**  
P.O. Box 91133, Long Beach, CA 90809  
(213) 498-9135  
Owner: David and Nicole Eastly  
Studio Manager: David Eastly  
Engineers: David Eastly, Nicole Eastly, Marc Smaniotto.  
Dimensions of Studios: 17 x 12.  
Dimensions of Control Rooms: 17 x 8.  
Tape Recorders: Otari MX-70, 16-track; Otari MX-5050 MKIII-2, 2-track; Crown SX722, 2-track.  
Mixing Consoles: Ramsa WR-T820, 20 x 8 x 2; Kelsey Series 3, 12 x 2.  
Monitor Amplifiers: QSC, Haller.  
Monitor Speakers: JBL 4311B, Yamaha NS-10M.  
Echo, Reverb & Delay Systems: Digital delays by Ibanez and Roland, digital reverbs by Lexicon and ART.  
Other Outboard Equipment: Symetrix stereo compressor/limiter/expander gate/ducker, Korg SQD MIDI sequencer, Amiga computer, DOD 15-band EQ.  
Microphones: AKG, Neumann, Sennheiser, Electro-Voice, Shure, PZM, and Audio-Technica.  
Instruments Available: DX7, GR700 guitar synth, Linn-Drum w/velocity and MIDI retrofit, Roland TR 707, Rockman X-100, Fender and Polytone amps, choice guitars and basses.  
Rates: \$25/hr., block rates available.

[16] **SOUTHLAND-MULTITRACK**  
P.O. Box 632, Poway, CA 92064  
(619) 748-2050  
Owner: The Memphis-Lee Organization  
Studio Manager: N.K. Elder

[16] **SOUTHWEST SOUND**  
also *REMOTE RECORDING*  
14 N. Baldwin Ave., Sierra Madre, CA 91024  
(818) 355-1367  
Owner: Devin Thomas  
Studio Manager: Devin Thomas

[16] **SPECTRUM STUDIO (by appointment only)**  
also *REMOTE RECORDING*  
664 Camino Campana, Santa Barbara, CA 93111  
(805) 967-9494, 967-1526, 963-7065  
Owner: Don Ollis  
Studio Manager: Don Ollis  
Engineers: Don Ollis  
Dimensions of Studios: 27 x 23 x 8; 14 x 12 x 8; 12 x 10 x 8.  
Dimensions of Control Rooms: 20 x 17 x 13.  
Tape Recorders: Ampex MM1000 w/VSO 2-inch 16-track; one-inch 8-track 15/30 ips; Ampex 440B, 2-track; Revox A77 7.5/15 ips w/VSO, 2-track.  
Mixing Consoles: Custom, 18 x 16.  
Monitor Amplifiers: Phase Linear 700As.  
Monitor Speakers: JBL 4311, 4301; Auratones.  
Echo, Reverb & Delay Systems: Ecoplate II reverb, Eventide H949 digital delays, also 15 and 30 ips tape delay.  
Other Outboard Equipment: Limiters: Teletronix LA 2A, RCA BA6A, Eventide H949 Harmonizer, EQs: Pullec EQPIA, MEQ5, Lang PEQ1s. Cassette decks: Sony TCK81, Hitachi D850, Technics M260. (8-channel) Drawmer noise gates, Korg Vocoder.  
Microphones: Telefunken 250, 251s; Neumann M49, U67s, KM56, U87s; AKG C12, C12A, C28, C28A, (4) 414s, 224, 452, 451s; Sennheiser 441, 421s; E-V CO-90; Sony C500, ECM377, 22P, 33P, ECM50s; Altec M11s, 633As; RCA 44BX, 44As, 77DXs; 74B; Shure 545s, SM56, SM57s PE50SP.  
Instruments Available: Kurzweil 250, DX7s, Juno 106, Minimoog, Korg PolySix, Korg Mono/Poly, Korg Signal Processor, vintage 7-foot Steinway B grand piano, Fender Precision bass, '57 Strat, Pre-CBS deluxe, Princeton, Guild





## NEW MUSIC LIBRARY

**TELE MUSIC—**  
over **100 Albums**  
of new music added to over  
**50,000 selections** of  
music already in the TRF  
Production Music Libraries.  
Be among the first to use  
the latest in production  
music.

Exclusively available through:  
**TRF PRODUCTION MUSIC LIBRARIES**



The largest source for  
production music

Call or write for free catalogs and music sampler:  
(212) 753-3234, TRF Production Music Libraries,  
Dept. MX 986, 40 E. 49th St., New York, NY 10017

Circle #120 on Reader Service Card

## CLEAN PATCH BAYS NO DOWN TIME

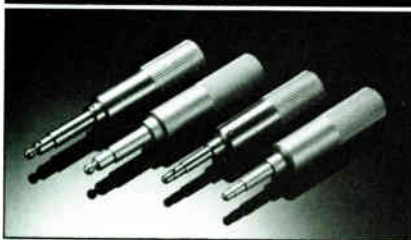

### VERTIGO BURNISHERS AND INJECTORS RESTORE ORIGINAL PERFORMANCE TO YOUR PATCH BAYS

**VERTIGO 1/4" TRS AND TT BURNISHERS:**  
Each used to eliminate noise caused by contamination  
of main contacts in normal patching situations.

**VERTIGO 1/4" TRS AND TT INJECTORS:**  
Each allows injection of cleaning solvent in breaking  
contacts (normals), to eliminate intermittency that  
occurs when patch cord has been removed

**STILL ONLY \$29.95 Ea.** (Cont. USA)  
Please write for additional information and order form  
Used by Professionals Worldwide Patent Pending

**VERTIGO RECORDING SERVICES**  
12115 Magnolia Blvd. #116  
North Hollywood, CA 91607  
Telephone: 818/769-5232  
Telex: 5106006748 VERTIGO RECRD

Circle #121 on Reader Service Card

## SOUTHERN CALIFORNIA



### 12 & 16 TRACK

D40, Simmons drums, Macintosh computer w/over 2000  
DX7 voices and 32-track sequence capability.  
**Video Equipment & Services:** IVC pro video monitor (19-  
inch), Sony SL5800 half-inch Beta recorder/player.  
Rates: 16-track: \$45/hr.; 8-hour block \$35/hr.; one-inch  
8-track: \$35/hr.; 2-, 4-track: \$30/hr.

[16] **KRIS STEVENS ENTERPRISES**  
14241 Ventura Blvd. #204, Sherman Oaks, CA 91423  
(818) 981-8255  
Owner: Kris Enk Stevens  
Studio Manager: Terri Harris

[16] **STONECUTTER RECORDING STUDIO**  
1136 Broadway Ste. #8, El Cajon, CA 92021  
(619) 579-6682  
Owner: Louis Lakser  
Studio Manager: Louis Lakser

[16] **STUDIO 9 (BUDGET STUDIOS)**  
5504 Hollywood Blvd., Hollywood, CA 90028  
(213) 871-2060, (818) 353-7087  
Owner: John Gillies  
Studio Manager: Steve Blazina

[16] **SUNBURST RECORDING & PRODUCTIONS**  
10313 W. Jefferson Blvd., Culver City, CA 90230  
(213) 204-2222  
Owner: Bob Wayne  
Studio Manager: David Starns, Bob Wayne  
Engineers: Bob Wayne, David Starns, Wayne Hoggatt, in-  
dependents.

Dimensions of Studios: 22 x 18, ceiling 12-14-foot.  
Dimensions of Control Rooms: 18 x 15, ceiling 10-12-foot.  
Tape Recorders: Otari 90-16/dbx, 16-track; Tascam 80-  
8/dbx, 8-track; Otari 5050 MKIII-30 ips, 2-track; Tascam  
25-2/dbx, 2-track; TEAC A3340S, 4-track; (2) TEAC C-3,  
2-track; Marantz C-205, 1-track.  
Mixing Consoles: Sound Workshop 1280-8 EQ w/expand-  
er, 24 x 24 direct x 8 bus out, 16 channels of Super EQ  
modules.

**Monitor Amplifiers:** BGW, Dynaco, Sony, Marantz.  
**Monitor Speakers:** E-V Sentry Vs, Yamaha NS-10Ms, Au-  
ratone cubes.

**Echo, Reverb & Delay Systems:** Lexicon 200 digital re-  
verb w/1-3 software update, Orban 111B spring reverb,  
Eventide H-910 Harmonizer, DeltaLab 1026 DDL, MXR DDL,  
Roland SDE-1000 DDL.

**Other Outboard Equipment:** dbx: noise reduction (ten  
channels), 165 compressors, 161 compressor; MXR: Stereo  
Chorus, 31 band graphic EQs, noise gates, flanger, Phase  
90, Distortion +; Mutron III; 5 direct boxes, Dual turntable,  
electronic metronome; Tom Scholz Rockman, (2) Fostex 8 x  
2 line mixers.

**Microphones:** Neumann U87, KM84s; AKG 414, 451s,  
100s; Electro-Voice RE-20s, RE-15s, 676; Crown PZM 30 GP;  
Sony ECM 33P, ECM 21; Sennheiser 421; Shure SM81, 565;  
Beyer M-500 ribbon.

**Instruments Available:** Keyboards: Kawai 7'4" grand pi-  
ano Model KG 6C, Hammond 1958 B-3 organ w/Leslie.  
**Video Equipment & Services:** Sony 1/4-inch w/operator  
and stereo mix—available at extra cost.

Rates: 16-track: \$40/hr.; 2-, 8-track: \$30/hr. Rates include  
engineer and all equipment except video. Prepaid block  
rates negotiable.

[16] **SUTTON SOUND STUDIO**  
also **REMOTE RECORDING**  
8390 Curbaril, Atascadero, CA 93422  
(805) 466-1833  
Owner: Rick Sutton

[16] **SYNTHEMEDIA MUSIC COMPANY**  
22432 Burbank Blvd., Woodland Hills, CA 91367  
(818) 883-6524

Owner: Ronald John Polito  
Studio Manager: Hollis Payseur

[16] **TALENT CENTER**  
also **REMOTE RECORDING**  
#10 McLaren Ste. A, Irvine, CA 92718  
(714) 837-3521  
Owner: David Thor  
Studio Manager: Leine Hansen

[12] **TELEWEST**  
14742 Beach Blvd. Ste. 121, La Mirada, CA 90638  
(800) 831-9763, (213) 947-8922  
Owner: Peter L. Vaque  
Studio Manager: Peter L. Vaque

[16] **TELSTAR SOUND RECORDERS**  
P.O. Box 2073, Burbank, CA 91507  
(818) 842-0936  
Owner: Phil Singher  
Studio Manager: Phil Singher  
Engineers: Phil Singher, Curt Wilson  
Dimensions of Studios: 18 x 23 x 12, 8 x 8 x 12, iso booth.  
Dimensions of Control Rooms: 14 x 16 x 12.  
Tape Recorders: 3M M79, 16-track; Otari MX5050 III-8,  
8-track; Otari MX 5050 B-2H, 2-track; TEAC and Technics  
cassettes.  
Mixing Consoles: Amek-TAC Scorpion, 24 x 16 x 2.  
Monitor Amplifiers: Haller.  
Monitor Speakers: Tannoy SRM-12B, Auratones.  
Echo, Reverb & Delay Systems: Lexicon PCM60 reverb,  
Lexicon PCM41 DDL, DeltaLab ADM-1024 DDL, DeltaLab  
ADM-256 DDL.  
**Other Outboard Equipment:** UREI 1176 limiter, (2) Sy-  
metrix CL-100 compressors, (4) USAudio gates.  
Microphones: AKG 414, E-V RE-20, (2) Shure SM81, (2)  
SM57, (3) Sennheiser 421, (2) Audio-Technica ATM-31, (2)  
ATM-41, (2) ATM-91, ATM-21, Crown PZM, (2) Countryman  
boxes, (3) DOD boxes.  
Instruments Available: Hardman 6'10" grand piano; Linn-  
Drum and synths available for additional fee.  
Rates: 16-track \$35/hr.; 8-track \$25/hr.; blocks available.



THETA SOUND STUDIO  
Los Angeles, CA

[16] **THETA SOUND STUDIO**  
Los Angeles, CA 90027  
(213) 669-2772  
Owner: Randy Tobin  
Studio Manager: Cyndie Tobin  
Engineers: Randy Tobin, Garry LaLone, Morgan Winters.  
Dimensions of Studios: 13 x 14 plus drum booth.  
Dimensions of Control Rooms: 10 x 12.  
Tape Recorders: Tascam MS-16, one-inch 16-track; Tascam  
38, 1/2-inch 8-track; Tascam 34, 1/4-inch 4-track; Technics  
RS1520, 2-track; (28 channels of dbx noise reduction); Sony  
501ES digital PCM processor; Aiwa F990, Aiwa F660 (4)  
and Onkyo 630D (3) cassette decks.  
**Mixing Consoles:** Ramsa WR-TB20 20 x 16 x 2 (38 x 2 in  
mixdown mode).  
**Monitor Amplifiers:** Kenwood Pro Series high speed DC  
amplifier, Rane HC-6 headphone amplifier system.  
**Monitor Speakers:** JBL 4301B, Yamaha NS-10M, Auratone  
5C.

**Echo, Reverb & Delay Systems:** Lexicon PCM70, Ya-  
maha SPX-90, Roland SRV-2000 digital reverb, Yamaha  
REV7 digital reverb, LT Sound TAD-4 stereo echo/delay,  
Yamaha R1000 digital reverb systems (2), Korg SDD-2000  
sampler/delay, MXR digital delay w/full memory, Ibanez  
harmonizer, 20ms fixed delay doubler.  
**Other Outboard Equipment:** dbx 166, dbx 163, Dyna-  
Mite, Symetrix, and MXR compressor/limiters; (4) Sound-  
craftsmen graphic EQs; Inter City exciters, Dual 1229  
turntable w/Shure V-15 Type V cartridge, Dr. Flick digital  
metronome/clock synchronizer



Microphones: AKG "Tube" and 414; Electro-Voice PL-20, (2) Countryman EC-101 and (3) Isomax II; (5) Shure SM57; (2) Beyer M-160, (6) M-500, (4) Radio Shack ultraminiature condenser.

**Instruments Available:** Yamaha C5 6'6" Conservatory grand piano w/updated (2 MIDI channels) Forte MIDI Mod (for controlling all of our MIDI synths from the piano!); (2) Yamaha DX7 synths, Ensoniq Mirage, Roland Jupiter 8 synth w/MIDI, Roland MSQ 700 MIDI sequencer, SCI Drumtraks drum computer, Simmons SDS8, Slingerland drum kit w/Tama hardware and cymbal assortment, Gibson Ripper Bass, Fender and Sunn amplifiers, assorted percussion.

**Video Equipment & Services:** Sony SL-2710 Beta Hi-fi VCR, Toshiba monitor.

**Rates:** 16-track: \$42/hr.; 8-track/editing: \$36/hr.; 4-, 2-track and voice elimination: \$30/hr.; tape duplication: \$20 to \$36/hr. (4 to 8 cassettes at once).

**Extras:** Computer generated cassette labels, lyric sheets, and promo materials; record production, packaging, art and graphics, photography, radio spots, jingles, voice elimination (for budget demos), recording classes and DX7 programming classes. Computer equipment (other than above); Panasonic Sr. Partner system with one Meq RAM, 20 Meq hard disk, custom software, and LQ and dot matrix printers.

**Direction:** 1986 marks yet another milestone in our nine years of expansion. In addition to the new equipment we've added two engineers to our facility and instilled in them the same philosophy that has kept this studio growing to meet the needs of our clientele. Our unique environment and experienced engineer/musicians make Theta Sound one of the best multi-track facilities in Southern California. Some of our clients include: Durell Coleman, Robin Williamson, Dale Gonyea, Misha Segal, Harriet Schock, August, Michael Scott and Doug Norwine-EWI, Nia Peeples, Pam Matteson and John Strauss. A safe, creative space... providing the tools necessary for producing recorded products... that communicate your intention.

**[16] TRAX SOUND RECORDING**  
1916 Manning Ave., Los Angeles, CA 90025  
(213) 470-8180

Owner: Michael McDonald  
Studio Manager: Robyn Whitney  
Engineers: Michael McDonald, Russ Iadevaia.  
Dimensions of Studios: 24 x 12, (2) isolation rooms: 6 x 9 and 7 x 9.

Dimensions of Control Rooms: A: 13 x 15; B: 18 x 9.  
Tape Recorders: Tascam 85-16B, 16-track; Tascam 90-16.

**—FROM PAGE 28, TIME CODE**

parked somewhere in the middle of the reel. When the play button is next hit, how does the time code reader know where the next frame count begins in the bit stream?

For a time code reader, there's nothing to it. In each 80-bit word, the final 16 bit cells (64-79) are always used to store a Sync Word, comprised of 2 zeroes, 12 ones, 1 zero and 1 one (0011 1111 1111 1101). This unique bit sequence will never be found elsewhere and so it is immediately recognized as an end-of-frame marker.

The Sync word is recognized whether the tape is moving forward or backward, thus giving the time code reader the necessary reference point at which to begin reading the rest of the code.

So far, we've used up 26 bit cells for time code, and 16 bits for the Sync word, leaving 38 cells for other purposes. I'll try to figure out what other purposes by next month.

**Legend**

Figure 1. The 26 bit cells seen here are used to store the time code for each frame. The first four cells in each column represent units; the last two (or three) represent tens. The values of all bit cells containing a transition are summed to give the time in hours, minutes, seconds and frames. ■

16-track; Otari MX-5050B, 2-track-15 ips; Otari/R-Tek MX-5050B-30 ips, 2-track; Pioneer RT-1050, 2-track; Aiwa and Technics cassettes.

**Mixing Consoles:** Soundcraft 2400, 24 x 16 x 2 (48 inputs mixdown); Audioarts R-16, 27 x 16 x 2.

**Monitor Amplifiers:** AB Systems, SCS, G.A.S., Crown, Nakamichi.

**Monitor Speakers:** UREI 811s, Yamaha NS-10s, Auratones.

**Echo, Reverb & Delay Systems:** Yamaha SPX-90 digital processor, (2) Ecoplate III plate reverb, Roland SRV-2000 digital reverb, MXR O1A digital reverb, Roland SDS-1000, DeltaLab Effectron 1024 delays.

**Other Outboard Equipment:** dbx 165, 160 limiters; Audioarts limiters; Symetrix 522 compressor/gates; Eventide H910 harmonizer; EXR exciter; Orban de-esser; (8) Omnicraft GT-4 gates; Rocktron Hush-2B noise reduction (2); UREI 527-27 band EQ, Innovative Audio tube mic, pre-amps and direct boxes. Roland and Ibanez chorus units.

**Microphones:** Neumann U87, AKG 414s, AKG 452s; AKG D12-E; E-V RE-20, RE-15s; Sennheiser 421s; Crown PZMs; Shure SM57s; Foxtex M88-RP ribbon Sony ECM-56.

**Instruments Available:** Yamaha C-7 7-foot grand piano, guitars, amps, Rockman, effects.

**Rates:** Studio A: \$32/hr. engineer included. Studio B:

\$25/hr. engineer included. Block rates available.

**Extras:** We have access to most of the popular drum machines and synthesizers at rental rates far below most commercial rental rates.

**Direction:** Our clients include: Columbia Pictures Music, TV and Walt Disney Productions, The Disney Channel, Chrysalis Records, Malaco Records, Warner Bros. Records, Chapel Music, CBS Songs, Glen Larson Productions, Paramount Pictures, Island Records, Motown (Jobete Music), Screen Gems Music, MCA Music (Unicity) ABC and NBC television, and many others.

**[16] TRILOGY RECORDING**  
718 La Paloma, Ontario, CA 91764  
(714) 391-1930

Owner: Frederick Bettge, Robert Hord  
Studio Manager: Frederick Bettge

**[12] WEST SIDE SOUND**  
Manning Ave., Los Angeles, CA 90064  
(213) 470-3437

Owner: David Schwartz  
Studio Manager: David Schwartz

**[16] WOODCLIFF STUDIO**  
4156 Woodcliff Rd., Sherman Oaks, CA 91403  
(818) 784-7259

Owner: Frank Rosato  
Studio Manager: Russ Bishop  
Engineers: Russ Bishop, Frank Rosato.  
Dimensions of Studios: 18 x 15 x 12.  
Dimensions of Control Rooms: 12 x 8.

**Tape Recorders:** Otari MX-70, 16-track; Otari MX5050B, 2-track; TEAC 124 cassette; Yamaha K-520 cassette.

**Mixing Consoles:** Ramsa WR-T820, 20 x 16.  
**Monitor Amplifiers:** Crown Micro-Tech 1000, Yamaha B-2, QSC 5.1.

**Monitor Speakers:** Foxtex RM-780s, Auratones.  
**Echo, Reverb & Delay Systems:** Yamaha REV7, Lexicon PCM60, Roland SDE-1000, Yamaha D1500, DeltaLab ADM 64.

**Other Outboard Equipment:** dbx 160X compressor/limiter, UREI LA-4, Yamaha GC2020, USAudio (Quad) noise gate/expander.

**Microphones:** Neumann U87; (2) AKG 414, 460, MD421, 409; (2) Beyer 160, 500; (2) E-V RE20; (4) SM57, 58.

**Instruments Available:** Yamaha CP-70, DX7, Prophet 5 (MIDI), Oberheim DX, Tama (seven-piece) drum kit, assorted percussion.

**Rates:** Please call for rates.



**TRAX SOUND RECORDING**  
Los Angeles, CA

# Need a reliable employee?

**Mix Classifieds** are the place to advertise for management, sales and technical personnel. They all read **Mix**, the audio industry's largest, most widely-distributed magazine!

To place a **Mix Classified** ad, call Lauri Newman at **(415) 843-7901**. Deadline: 10th of month, two months prior to publication.

THE RECORDING INDUSTRY MAGAZINE

**Mix**

# SOUTHERN CALIFORNIA

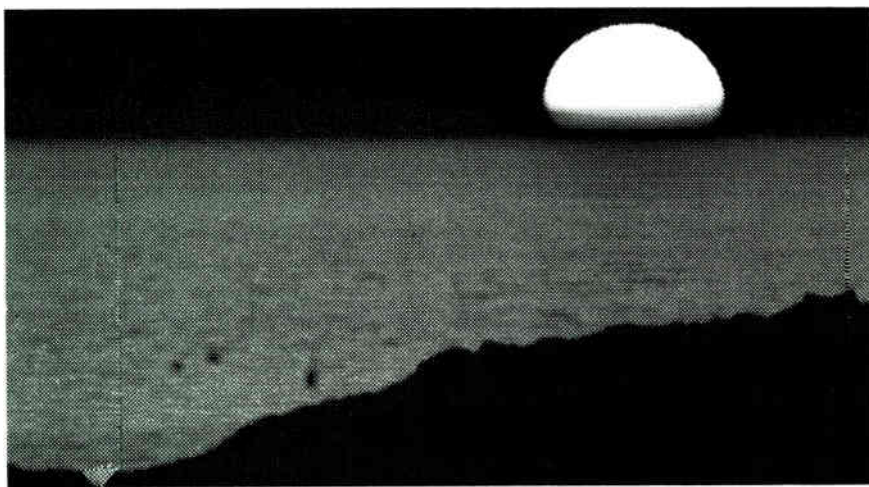

## 24+ TRACK

**[24+] A&R RECORDING SERVICES**  
also **REMOTE RECORDING**  
71906 Highway 111, Rancho Mirage, CA 92270  
(619) 346-0075

Owner: Scott B. Seely  
Studio Manager: Nick Mandala, Scott Seely  
Engineers: Nick Mandala, Scott Seely  
Dimensions of Studios: 30 x 18  
Dimensions of Control Rooms: 12 x 12  
Tape Recorders: Soundcraft 382, 24-track; Ampex ATR-102, 2-track; Revox A77, 2-track.  
Mixing Consoles: NEOTEK Series 2, 24 x 24.  
Monitor Amplifiers: BGW 700, Crown 60, Crown D-150s.  
Monitor Speakers: JBL 4311s, Altec 604s, Auratone 5Cs.  
Echo, Reverb & Delay Systems: Master-Room XL-210, Acoustic Computer MXL-305, Lexicon PCM60, Lexicon PCM70.  
Other Outboard Equipment: dbx 160, Orban 424A, Del-taLab DL2, Kepex, Denon and Akai GX-M50 cassette decks, Ashly SC-66As, Clap Trap, Eventide H949 Harmonizer, Eventide Harmonizer.  
Microphones: Neumann U47 tube, AKG P48s and 414, E-V RE-20s, SM58s, Audio-Technica.  
Instruments Available: Steinway A grand piano, ARP String Ensemble, Prophet 5-1000, Minimoog, MiniKorg, Rhodes Pro piano modified, Yamaha CE25 synth, Casio Model 3000.  
Video Equipment & Services: Available in-house or remote location; two cameras available.  
Rates: On request.

**[24+] ADAMO'S RECORDING**  
16571 Higgins Circle, Huntington Beach, CA 92647  
(714) 842-2668  
Owner: Jerry Adamowicz

**[24+] ADVANCED MEDIA SYSTEMS**  
833 W. Collins Ave., Orange, CA 92667  
(714) 771-1410  
Owner: Daniel R. Van Patten, David Hayes, Bob Brown  
Studio Manager: David Hayes

**[24+] ALPHA STUDIOS AUDIO/VIDEO INC.**  
4720 W. Magnolia, Burbank, CA 91505  
(818) 506-7443, (213) 877-3072  
Owner: Del Lewis, Gary Brandt, Denny Shaw  
Studio Manager: Gary Brandt  
Engineers: Gary Brandt, Dennis Shaw, Dana Collins, Jeff Meade.  
Dimensions of Studios: Audio: 44 x 22 x 12+ sound lock and attached 50 x 50 stage w/35 x 40 cyc.  
Dimensions of Control Rooms: 20 x 24.  
Tape Recorders: Ampex 1200 and 1100, 24 x 16; ATR 2-and 4-tracks; Ampex VPR II video recorders w/TBC; JVC 3/4-inch; Scully carts, 24-track Dolby unit available.  
Mixing Consoles: Alpha Studios/API custom 40 x 24+ (up to 72 with monitor foldback).  
Monitor Amplifiers: BGW 750, Phase 700A.  
Monitor Speakers: TAD TSM-1.

Echo, Reverb & Delay Systems: EMT 140 stereo, FMX 16, Lexicon DDLs, Roland DDLs, Eventide Harmonizer.  
Other Outboard Equipment: dbx gates and de-essers; Kepex gates and limiters; Pultec EQs; UREI limiters.  
Microphones: All current Neumann, AKG, Shure, etc., and a collection of tube mics.  
Instruments Available: Steinway B grand piano.  
Video Equipment & Services: Complete BTX lock-up system w/Cypher time code gen, RS170 A sync sources, video DAs, etc. Back screen RCA 50-inch in main studio for sweetening. We do all forms of audio post- for the entertainment industry plus video edit production for commercials and music video. Film production and Ultimate uses on our stage. We specialize in high quality audio and simultaneous video production. Music recording/audio post. Complete on-line and off-line bays. On-line: CMX 340 XP, (4) one-inch C-format Ampex VPRs, + 3/4-inch BVUs and 4-track ATR. Grass 100 switcher, Zeus TCs, Ikegami monitors etc. Off-line: CMX Edge editor BVU-200s 2-machine system at present. CMX 8-inch disk at completion. Services: On-line/off-line: List clean and separate A/V, duplication, titles Chyron etc.  
Rates: One-inch (3) machine less DVE \$210/hr.; (4) machine less DVE \$245/hr., w/DVE add \$100/hr.; off-line \$65/hr. (2) machine.

**[24+] AMERICAN VIDEO FACTORY**  
4150 Glencoe Ave., Marina Del Rey, CA 90292  
(213) 823-8622  
Owner: Andrew Maisner  
Studio Manager: Robert Knudson

**[24+] AMIGO STUDIOS**  
1114 Cumpston St., No. Hollywood, CA 90028  
(818) 980-5605  
Owner: Che  
Studio Manager: Armando Henriques

**[24+] ARTISAN SOUND RECORDERS**  
1600 N. Wilcox Ave., Hollywood, CA 90028  
(213) 461-2070  
Owner: Alvaro Latorre  
Studio Manager: William Rogers

**[24+] AUDIO ACHIEVEMENTS RECORDING STUDIO, INC.**  
also **REMOTE RECORDING**  
1327 Cabrillo Ave., Torrance, CA 90501  
(213) 533-9531  
Owner: Audio Achievements, A Cal. Corp.  
Studio Manager: Donovan

**[24+] AUDIO ENGINEERING ASSOCIATES**  
1029 N. Allen Ave., Pasadena, CA 91104  
(818) 798-9127  
Owner: Wes Dooley  
Studio Manager: Michael Mroz

**[24+] AUDIO VIDEO ALLIANCE**  
12426 1/2 Ventura Blvd., Studio City, CA 91604  
(818) 506-0824  
Owner: Steve Katz, Steve Mitchell  
Studio Manager: Ellis Sorkin

**[24+] BEACH RECORDING AND FILMWORKS**  
2810 McBain, Redondo Beach, CA 90268  
(213) 371-5793  
Owner: David Harms, Geoff Emery, Mike Colton  
Studio Manager: Geoff Emery, David Harms

**[24+] BELL SOUND STUDIO**  
also **REMOTE RECORDING**  
916 N. Citrus Ave., Hollywood, CA 90038  
(213) 461-3036  
Owner: Sandra Marshall, Don Piestrup, Jon Francis  
Studio Manager: Christopher Smith

**[24+] BLUE DOLPHIN**  
650 N. Bronson Ave., Los Angeles, CA 90004  
(213) 467-7660  
Owner: Bruce Langhorne, Morgan Cavett, Stan Young  
Studio Manager: Morgan Cavett

**[24+] BLUE MOON STUDIO**  
28205 Agoura Rd., Agoura Hills, CA 91301  
(818) 889-8920  
Owner: Joe Vannelli, Gino Vannelli  
Studio Manager: Diane Ricca  
Engineers: Available upon request.  
Dimensions of Studios: 18 x 20.  
Dimensions of Control Rooms: 18 x 25, tape equipment room 8 x 16.  
Tape Recorders: Otari MTR-90 II, 24-track; Otari MTR-12, 2-track; Otari 5050B, 2-track; TEAC cassette recorder 2-5000, 2-track; dbx (digital audio processor) 700, 2-track.  
Mixing Consoles: Amek Angela 36 x 24.  
Monitor Amplifiers: Acoustat, Yamaha, Crown.  
Monitor Speakers: JBL 4435s, Yamaha NS-10Ms.  
Echo, Reverb & Delay Systems: Lexicon 224XL, Yamaha REV7, Yamaha SPX-90, Lexicon PCM70, Effectron DDLs, Eventide 910 Harmonizer.  
Other Outboard Equipment: (9) Kepex II noise gates, (8) dbx 904 noise gates, Audio & Design Vocal Stresser, (2) UREI 1176 limiters, (2) dbx 165A compressors, (2) dbx 166 comp./gates, (3) dbx 902s, Yamaha 1/3 octave stereo EQ, SAE octave stereo EQ, other equipment available upon request.  
Microphones: U47 tube, (2) PMLDC-63, (2) Shure SM81, (6) Shure SM57, AKG 460B.  
Instruments Available: Yamaha DX7, TX-816 rack, QX-1 sequencer, RX-11, C-7B grand piano, Roland digital piano, Fender Rhodes, Memorymoog, LinnDrum, Ludwig acoustic drums, other instruments available upon request.  
Video Equipment & Services: JVC 3/4-inch deck.  
Rates: Available upon request.

**[24+] BLUEFIELD MUSIC**  
P.O. Box 726, Los Angeles, CA 90028  
(213) 463-SONG (7664)  
Owner: David Bluefield  
Studio Manager: Marc Mann  
Extras: Kurzweil 250 w/sampling; (2) Macintosh Plus computers w/professional composer/performer; Opcode sequencing programs; (3) Fostex 4050 autolocator, SMPTE to MIDI converter; (4) Sony PCM (analog-to-digital converter).  
Direction: "Shoot to the music then score to the picture."

**[24+] BRITANNIA STUDIOS INC.**  
3249 Cahuenga Blvd. W., Hollywood, CA 90068  
(213) 851-1244  
Owner: Gordon Mills Ent.  
Studio Manager: Greg Venable

**[24+] BROKEN RECORDS**  
17471 Plaza Otonal Ste. 16, San Diego, CA 92128  
(619) 487-8787  
Owner: T.I.P. Inc.  
Studio Manager: A. Bell

**[24+] BROOKHILL**  
P.O. Box 55752, Sherman Oaks, CA 91413  
(818) 883-6696  
Owner: Brookhill Records, Inc.  
Studio Manager: Steve McDonald

**[24+] CALIFORNIA RECORDING**  
5203 Sunset Blvd., Hollywood, CA 90027  
(213) 666-1244  
Owner: American Music Ind. Inc.  
Studio Manager: Tim Garnry



**[24+] CAN-AM RECORDERS INC.**  
18730 Orndart St., Tarzana, CA 91356  
(818) 342-2626

Owner: Can-Am Corp.  
Studio Manager: Larry A. Cummins  
Engineers: Brian Malouf, Stan Katayama, Jim Dineen.  
Dimensions of Studios: 25 x 40 x 14, plus (3) iso booths.  
Dimensions of Control Rooms: 20 x 25.  
Tape Recorders: Studer A800 MKIII, 24-track; Ampex ATR 124, 24-track; Studer A820, half-inch 2-track; Ampex ATR-102, half-inch, 1/4-inch 2-track; MCI JH110A, 2-, 4-track.  
Mixing Consoles: SSL 4000E 52 input.  
Monitor Amplifiers: Crown, Yamaha, Technics.  
Monitor Speakers: JBL, Yamaha, Auratones.  
Echo, Reverb & Delay Systems: EMT tube 140, EMT 240, AMS RMX 16, AMS DMX 1580s, Lexicon 224XL, Lexicon PCM70, Yamaha REV7, Yamaha SPX 90, live chamber, Prime Times, Harmonizers, Roland SDE 3000.  
Other Outboard Equipment: Massenburg EQ, mic pre-amps; dbx de-essers, flangers; Pultec EQ; Drawmer, Kepex II gates; Cyclosonic Auto Panner, Autochorus; UREI LA4, 1176 limiters; dbx 160X, 165 limiters; EXR 3, 4; Dynaflange; Orban parametrics; Dolby noise reduction.  
Microphones: Neumann, AKG, Sennheiser, Beyer, Shure, PZM, Sony, Superscope, E-V, A-T, Fostex.  
Instruments Available: Yamaha C7 piano.  
Rates: Please call.



**CAPITOL RECORDS STUDIOS**  
Hollywood, CA

**[24+] CAPITOL RECORDS STUDIOS**  
1750 N. Vine St., Hollywood, CA 90028  
(213) 462-6252

Studio Manager: Charles Comelli, Barbara Hein  
Engineers: Judy Clapp, Hugh Davies, Kevin Dixon, Nick Dofflemeyer, Steve Himelfarb, Gary Hollis, Bob Norberg, Sam Ramos, Jay Ranellucci, Larry Walsh, Eddy Schreyer, Wally Traugott.

Dimensions of Studios: A: 60 x 45; B: 33 x 31; C: 10 x 12.  
Dimensions of Control Rooms: A: 15 x 20; B: 20 x 22; C: 18 x 22.

Tape Recorders: (3) Studer A800, 24-track; Studer A80, 24-track; (8) Ampex ATR-100, 2-, 4- 1/4-inch, half-inch; (2) Studer A80, 2-track; (4) Sony BVU 800 (3) PCM 1610, 2-track; (2) JVC 8200/BP90 (proc.), 2-track w/editor; (4) Sony DMR-4000 decks, 2-track; (2) Sony PCM 1630; Sony editor DAE-1100.

Mixing Consoles: Neve 8068, 32 x 16; Neve 8108, 48 x 32; Quad 8 custom, 32 x 16.

Monitor Amplifiers: Modified Hafler P-500s.  
Monitor Speakers: (C) UREI system; (B) Augspurger system; (A) JBL 4320 custom. All two-way systems.

Echo, Reverb & Delay Systems: (8) live chambers, AMS digital delay, AMS reverb, EMT-250, EMT-140 (stereo), Cooper Time Cube, Prime Time, (2) Super Prime Time, (2) Roland 3000, Klark-Teknik analog delay, (2) Yamaha REV7, (2) Eventide 949, Eventide 910.

Other Outboard Equipment: dbx limiters 160, Trident parametric EQs, Kepex II (10 channels), Q.Lock synchronizer system, ITT parametric EQ, UREI 1176, (2) Fairchild stereo limiters, (10) Neve 8078 EQs.

Microphones: Over 200 microphones. All popular makes and models.

Instruments Available: Steinway grand piano, 9-foot Yamaha concert grand, Fender Rhodes 73 and 88, Wuritzer electric, Celeste, Vibes, Hammond B-3.

Rates: Studio A (days) \$125/hr., (nights) \$135/hr.; Studio B and C (days) \$135/hr., (nights) \$150/hr.

Extras: XDR cassette mastering featuring digital mastering for Capitols' highly acclaimed, high quality XDR cassettes, library of sound effects, private artists lounge, half-inch 2-track recording and mastering. Two mastering rooms, mixdown suite 48-track. Digital 2-track recording and mastering. Zuma cutting system, Q.Lock, facility tie-lines for interconnecting studios. Digital editing and Compact Disc mastering.

Direction: Complete in-house facility from tracking to mastering w/(4) Neve consoles, (2) Neumann SAL74 mastering systems, both w/Studer 2-track playback. We have been chosen by Great American Gramophone Co. and others for the major direct-to-disc session on the West Coast. Superior studio acoustics and the wide variety of equipment available to draw clients from all major record labels as well as Capitol. Let us help make your next hit record.

**[24+] CHEROKEE RECORDING STUDIOS**  
751 N. Fairfax Ave., Hollywood, CA 90046  
(213) 653-3412

Owner: The Robbs  
Studio Manager: Shari Dub

**[24+] CIRCLE SOUND STUDIOS**  
3465 El Cajon Blvd., San Diego, CA 92104  
(619) 280-7310

Owner: R&B Music Corp.  
Studio Manager: Richard Bowen

**[24+] CLOVER RECORDERS**  
6232 Santa Monica Blvd., Hollywood, CA 90038  
(213) 463-2371

Owner: Chuck Plotkin  
Studio Manager: Scott Weinstein  
Engineers: Squeak Stone, James Champagne, independents.

Dimensions of Studios: 26 x 23 x 10.5; (iso booth): 15 x 16 x 10.5; (vocal booth): 5 x 6 x 10.5.

Dimensions of Control Rooms: 15 x 15.

Tape Recorders: MCI JH-16, 24-track; Ampex 1/4-inch, 1/2-inch ATR-100, 2-track; Studer 1/4-inch, 1/2-inch: A-80, 2-track; Otari MX5050, 2-track; Sony digital PCM-F1, 2-track.  
Mixing Consoles: API Jensen custom 2844, 32 x 24 x 2.  
Monitor Amplifiers: Hafler, Crown.

Monitor Speakers: UREI Time, E-V Sentry 100, Yamaha NS-10M, JBL-4311, Auratones, Advents.

Echo, Reverb & Delay Systems: EMT-250, (2) EMT-140s plates, Ecoplate, Lexicon Prime Time, Publison DDL, Eventide DDL.

Other Outboard Equipment: Teletronix LA-2A, (2) UREI LA-3A, (3) 1176 LN, (2) EMT PDM-156, Eventide Omnipressor, (4) Kepex 1 gates, (2) Roger-Meyers gates, (2) Allison Gain Brains, (2) Marshall Time Modulators, Orban parametric EQ, (2) SAE 1/2-octave EQ, Orban de-esser, Eventide instant flanger, Bel flanger, Eventide Harmonizer, Pultec filters, Yamaha REV7.

Microphones: Neumann tube U47, U48, (3) tube U67, U87, (2) KM46, (2) KM48, (2) AKG C-12A, 414, (2) 451 EB and 451E, (2) E-V RE-20, RE-15, (4) Sony C-37, ECM 22, Beyer 160, Sennheiser 421 and 441s, vintage RCA ribbons, plus assorted Shure mics.

Instruments Available: Steinway 13-foot grand piano; Prophet 2000; extensive library featuring Kurzweil, E-mu II, and Synclavier samples; Yamaha DX7 and TX7 (most extensive library on West Coast); Apple Macintosh computer system; Apple II+ computer system; full Simmons set; Oberheim matrix; DW8000 Korg; Memorymoog; Linn-Drum machine; and full MIDI SMPTE synchronization.  
Rates: Call for rates.

**[24+] THE COMPLEX**  
2323 Corinth Ave., West Los Angeles, CA 90064  
(213) 477-1938

Owner: The Complex  
Studio Manager: Rich Salvato



**THE CONTROL CENTER**  
Los Angeles, CA

**[24+] THE CONTROL CENTER**  
128 N. Western St., Los Angeles, CA 90004  
(213) 462-4300, 413-2522, 650-2334

Owner: Aseley Otten, Frank Sposato, Rick Novak  
Studio Manager: Rick Novak, Frank Sposato, Aseley Otten

Engineers: Aseley Otten, Rick Novak, Frank Sposato, Steve Catania.

Dimensions of Studios: 18 x 24 main room; 7 x 12 live room.

Dimensions of Control Rooms: 12 x 16.

Tape Recorders: Ampex MM-1200, 24-track; Ampex ATR 102, 2-track; Otari 5050, 8-track; Technics cassette.

Mixing Consoles: Custom API console w/550A EQs 32 x 16 x 24.

Monitor Amplifiers: BGW, Crown.  
Monitor Speakers: Tannoy 15X, JBL 4312, Yamaha NS-10M, Auratone 5C.

Echo, Reverb & Delay Systems: Yamaha REV7, digital reverb, Ursa Major Space Station, Eventide 910 Harmonizer and delay, MXR digital delay.

Other Outboard Equipment: dbx 161 compressors, UREI LN1176 limiters, Valley People Dyna-Mites, DOD flanger, pinball game.

Microphones: AKG 414-EB, 451, Neumann U87, Sennheiser 421, 441; Shure SMS7, SM77.

Instruments Available: Howard baby grand piano, Linn-Drum and synthesizers upon request.

Rates: Call for rates, but they are very competitive.

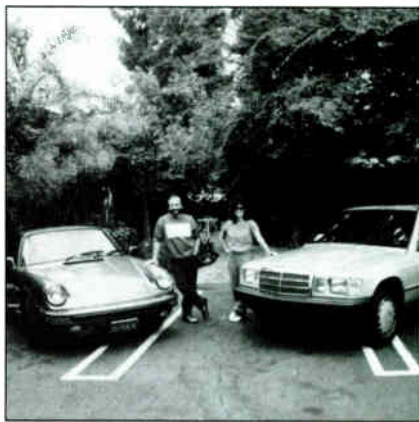

**CONWAY RECORDING STUDIOS**  
Hollywood, CA

**[24+] CONWAY RECORDING STUDIOS**  
655 N. St. Andrews Pl., Hollywood, CA 90004  
(213) 463-2175

Owner: Buddy and Susan Brundo  
Studio Manager: Nadine White

Engineers: Mick Guzauski, Csaba Petocz, Joe Chiccarelli, F. Byron Clark, Steve Toby, Daren Klein, Richard McKernan.

Dimensions of Studios: 30 x 60 x 16.

Dimensions of Control Rooms: 26 x 25 x 16.

Tape Recorders: (2) Studer A-800, 48-track; Mitsubishi digital, 2-track; Ampex ATR-102, 2-track; Ampex ATR-104, 4-track; Studer TLS 4000 synchronizer; Dolby model "SP" noise reduction 48-channels.

Mixing Consoles: Neve 8108, 48 x 32 w/Massenburg moving fader automation system.

Monitor Amplifiers: Perreux.  
Monitor Speakers: TAD components in Augspurger design enclosures; variety of small speakers.

Echo, Reverb & Delay Systems: EMT-250, AMS-RMX 16 and 15-80s, (2) EMT 140 plates, and lots more.

Other Outboard Equipment: Everything else.  
Microphones: Plenty of everything including 251s, 47s, 49s, 67s, TLM-170s, C-24, etc.

Instruments Available: Nine-foot Yamaha concert grand piano.

Rates: \$2,400/day lock out.

Extras: Park-like atmosphere in the middle of Hollywood. Ample off-street parking for your fine European motor car.

Direction: Studio 2 in the works.

**[24+] C.R./DEMO TRAK STUDIOS**  
629 5th Ave., San Diego, CA 92101  
(619) 234-7724

Owner: J.D. Beneventi  
Studio Manager: J.D. Beneventi

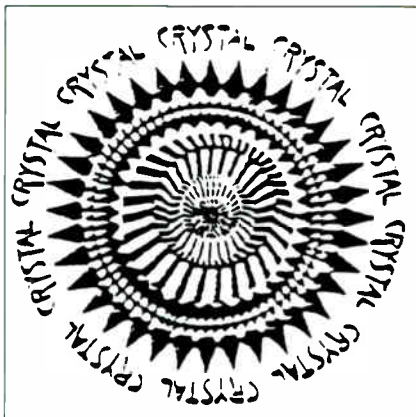

**CRYSTAL SOUND RECORDING STUDIOS**  
Hollywood, CA

[24+] **CRYSTAL SOUND RECORDING STUDIOS**  
1014 N. Vine St., Hollywood, CA 90038  
(213) 466-6452  
Owner: Andrew Berliner  
Studio Manager: Robert Margouloff  
Dimensions of Studios: 40 x 50 x 15; fully adjustable acoustics on wall and ceiling. Drum platform and vocal booth.  
Dimensions of Control Rooms: Studio A: 27 x 30 x 16.  
Tape Recorders: Studer tape machine.  
Mixing Consoles: 48 x 24 x 32 Crystalab system console; Crystalab model 2424, 40 x 24; Mastering room: Neumann Leihe 5X74 head and Crystalab electronics.  
Microphones: Extensive microphone selection—many tube mics.  
Instruments Available: Yamaha 9-foot concert grand piano, Hammond B3 Orban w/ Leslie, Fender Rhodes electric piano; ARP string synthesizer.  
Rates: Available on request.

[24+] **DAWN BREAKER STUDIOS**  
also **REMOTE RECORDING**  
216 Chatsworth Dr., San Fernando, CA 91340  
(818) 365-5633, 361-5766  
Owner: Marsha Day  
Studio Manager: Garnie Toppino

[24+] **MITCHEL DELEVIE'S SECRET STUDIO**  
also **REMOTE RECORDING**  
401 Sycamore Rd., Santa Monica Canyon, CA 90402  
(213) 459-7290  
Owner: Mitchel Delevie  
Studio Manager: N.D. Mix

[24+] **DELIRIUM STUDIOS**  
2770 La Cuesta Dr., Los Angeles, CA 90046  
(213) 850-5000  
Owner: Nathan Sassover  
Studio Manager: Nancy A. Benson

[24+] **DETROIT SOUND STUDIOS**  
also **REMOTE RECORDING**  
P.O. Box 43609, Los Angeles, CA 90043  
(213) 299-5002  
Owner: Frank H. Jackson  
Studio Manager: Dr. Broham

[24+] **DEVONSHIRE SOUND STUDIOS**  
10729 Magnolia Blvd., No. Hollywood, CA 91601  
(818) 985-1945  
Owner: David Mancini  
Studio Manager: Dee

[24+] **DIGITAL SOUND RECORDING**  
also **REMOTE RECORDING**  
607 N. Ave. 64, Los Angeles, CA 90042  
(213) 258-6741, 258-0048  
Owner: Van Webster  
Studio Manager: Mariellen Webster  
Engineers: Van Webster, George Sanger, Mariellen Webster.  
Dimensions of Studios: Studio A: 40 x 32 x 11, plus 7 x 11 vocal booth.  
Dimensions of Control Rooms: 16 x 16 x 10.  
Tape Recorders: Analog: 3M Mincom 79, 24-track; Studer 67, 2-track; Ampex 440, 2-track; TEAC 3300, 2-track. Digital: Sony PCM 1600/1610, 2-track.  
Mixing Consoles: MCI 428B, 28 x 24.  
Monitor Amplifiers: SAE 2400L, SAE 2600 biamped

**SOUTHERN CALIFORNIA**



**DIGITAL SOUND RECORDING**  
Los Angeles, CA

w/SAE crossovers, McIntosh 275, Dyna, JBL  
Monitor Speakers: JBL, Auratone, RSL  
Echo, Reverb & Delay Systems: Digital reverb, live chamber, Eventide phaser and Harmonizer, Marshall time modulator, Sound Workshop time delay, Master-Room Stereo Super C, tape delay, Scamp, Ellectron.  
Other Outboard Equipment: Adams-Smith 2600 synchronizer system. Scamp rack, Burwen DNF/1000 noise filter, Limiters: Scamp, UREI Teletronix LA-2A, Inovonics, dbx. Expanders: 3BX, Kepex, Scamp; Pultec filters, Orban stereo synthesizer and sibilance controller, VXO, parametric EQ, 3M Selectake II.  
Microphones: Neumann SM2 (tube), UM64 (tube), Neumann U47 FET, and U47 tube, U87, KM84; AKG 451 452, 224E, C-60 (tube type); Electro-Voice RE-20, RE-15 666; Sennheiser 421, 403; RCA 77DX; Shure 545-SD, SM58, PE-54D; Sony F-121; direct boxes, 8 channel direct box.  
Instruments Available: Steinway Model B grand piano, Oberheim OB-X.  
Video Equipment & Services: Full video production services for broadcast and industrial productions. Complete audio sweetening services and interlock to 3/4-inch video masters. Sony recorders, Hitachi camera, Crosspoint Latch special effects, Fortel TBC, 3M character generator, Ikegami monitors. Digital audio services for Beta and VHS Hi-h masters.  
Rates: Call for rates.  
Direction: Digits' Sound Recording is your first choice for Compact Disc mastering, digital audio for film and video and music mastering recording. We have the longest record of continuous Sony digital audio recording service in Southern California. In addition, we are widely experienced in all phases of video and audio sweetening.

[24+] **DYNASTY STUDIO**  
1614 Cabrillo Ave., Torrance, CA 90501  
(213) 328-6836  
Owner: Phil Kachaturian  
Studio Manager: Phil Kachaturian

[24+] **EFX SYSTEMS**  
919 N. Victory Blvd., Burbank, CA 91502  
(818) 843-4762, (213) 460-4474  
Owner: Partnership  
Studio Manager: Byl Caruthers  
Engineers: Leslie Baerwitz, Sherry Klein, Jerry Lentz, Jeff Vaughn, Scott Wolf, Ricard Cottrell  
Dimensions of Studios: M: 35 x 47 x 20 S: 14 x 14 x 10  
Dimensions of Control Rooms: M: 22 x 26; S: 14 x 14  
Tape Recorders: (2) Sony 3324 digital, 24-track; Studer



**EFX SYSTEMS**  
Burbank, CA

A800, 24-track; Sony JH24, 24-, 16-track; MCI JH114, 24-, 16-track; Sony JH110C, 8-track; Sony JH1103 "C" layback; Sony 5002 1/4-inch and 1/2-inch, 2-track; Sony JH 110C 1/4-inch and 1/2-inch, 2-track.  
Mixing Consoles: Amek 2500/2000A, 36 x 24; Sony MXP3000 48 x 32 w/hard disk automation.  
Monitor Amplifiers: Sundholm, Crown, Yamaha, Hafler.  
Monitor Speakers: Altec Time Aligned, JBL, Yamaha, Auratone, Tannoy, Electro-Voice.  
Echo, Reverb & Delay Systems: Lexicon, EMT, Klark-Teknik, Ursa Major, Eventide, Audio Digital, Stocktronics.  
Other Outboard Equipment: Our incredible "Wall O'Equipment in each of our rooms includes all of your favorites. Limiters by UREI, Orban, Teletronix, Symetrix, and dbx. Gates by Allison, Valley People, Rebis, and Symetrix. EQs by Lang, Altec, Trident, UREI. Noise reduction by Dolby, dbx, Dynaflex, Phase Linear, and Burwen, BTX Softouch and CMX Cass-I synchronization systems. Hair by Marcees of Hollywood.  
Microphones: A veritable smorgasbord including vintage tube models (U47, KM56, C12, etc.), modern esoterics (AKG P48, PML DC63, Schoeps, Neumann U89), and everything in between. 168 mics available.  
Instruments Available: Steinway grand piano, Rhodes 88, Hammond B3, Clavinet and an entire room full of synths including DX7, the Emulators I and II, and all the latest toys, Fairlight Series II, Memory Moog.  
Video Equipment & Services: Full synchronizing services with multiple transport lockup. We have a full digital sound fx library and full sweetening, ADR and Foley capabilities.  
Rates: Call for rates. Rates are suited to your project's requirements.  
Extras: Full audio post-production planning for music videos, film and television. Our experienced staff speaks many languages, including "SMPTÉ" and "sprockets." We can guide you through the stages of production and post-production budgeting and scheduling. Let us help you meet the highest quality standards without breaking your budget.  
Direction: This facility was designed from the ground up to serve the modern recording artist and independent production company. Our high ceiling room and top of the line equipment reflect our commitment to high fidelity. Our rate card reflects our commitment to being cost effective. Our excellent staff reflects our commitment to the fact that people make the difference between a good facility and a great one. From 60-piece orchestras to full scale digital audio post-production for TV and film, we are committed to being the "Total Audio Complex." If you are tired of working in a conventional studio, give EFX a call.

[24+] **ELDORADO RECORDING STUDIO**  
1717 N. Vine #20, Hollywood, CA 91604  
(213) 467-6151  
Studio Manager: Gary Gunton

[24+] **ENACRON TRUCK/MAGNOLIA SOUND**  
5102 Vineland Ave., No. Hollywood, CA 91601  
(818) 761-0511  
Owner: Brian Ahern  
Studio Manager: Franny Parrish

[24+] **ENCORE STUDIOS**  
721 S. Glenwood Pl., Burbank, CA 91306  
(818) 842-8300  
Owner: Robert M. Andreoli  
Studio Manager: Billy James  
Engineers: Les Cooper, Adnan Trujillo  
Dimensions of Studios: 25 x 40  
Dimensions of Control Rooms: 26 x 26  
Tape Recorders: (2) Studer A-800, 24-track; Studer A-80



half-inch, 2-track; Studer A-80 ¼-inch, 2-track; (3) Aiwa ADF 660 cassette.  
**Mixing Consoles:** SSL 4000B, 40 x 32 modified to 56 x 32.  
**Monitor Amplifiers:** Studer A68.  
**Monitor Speakers:** Sierra/Hidley TM8 biamped monitor system; Sierra quad monitors, JBL 4311s, Yamaha NS-10s, Auratones.  
**Echo, Reverb & Delay Systems:** (2) EMT 140 tube echo plates, Lexicon 224XL, AMS digital echo.  
**Other Outboard Equipment:** Studer TLS tape lock system; AMS digital reverb; AMS digital delay; Lexicon Prime Time; Lexicon Super Prime Time; Eventide Harmonizer H-949; Eventide digital delay; ADR Vocal Stresser; Inno-sonics, UREI and dbx compressor/limiters; Drawmer, Kepex and Roger Mayer gates; (3) dbx 902 de-essers; rack of 24 Dolbys.  
**Microphones:** Neumann, Sennheiser, AKG, Electro-Voice, Beyer, Sony, Shure, RCA, PML, tube and vintage.  
**Instruments Available:** Yamaha 9-foot grand piano, Yamaha DX7, Oberheim DX drum machine, Tama electric drums.  
**Video Equipment & Services:** On request.  
**Rates:** Upon request.

**[24+] THE ENTERPRISE**

4628 W. Magnolia Blvd., Burbank, CA 91505  
 (818) 505-6000  
**Owner:** The Enterprise Recording, Inc.  
**Studio Manager:** Derra Shelley  
**Engineers:** Craig Huxley, Andy Schatz, Lee Miller.  
**Dimensions of Studios:** 22 x 27, 10 x 16.  
**Dimensions of Control Rooms:** 25 x 30, 25- x 27, 20 x 21, 12 x 8.  
**Tape Recorders:** Mitsubishi X-800 digital, 32-track; Mitsubishi X-80 digital, 2-track; Otari MTR-90-II, 24-track; Otari MTR-124, 4-, 2-track; Synclavier 128 voice 64-track.  
**Mixing Consoles:** Amek/3500, 56 x 32; Amek/Master-Mix 2500, 48 x 24.  
**Monitor Amplifiers:** Threshold, Yamaha.  
**Monitor Speakers:** Custom.  
**Echo, Reverb & Delay Systems:** EMT, AMS, Yamaha, Lexicon, Eventide, Publison Internal 90, Quantec.  
**Other Outboard Equipment:** Massenburg EQ and compressors, dbx, Dolby SP, Drawmers, LA-2As, SRC, Simmons SDS7, Yamaha DX1 w/computer and MIDI racks.  
**Microphones:** AKG C24, C12; Neumann SM69, M49, M50, U47; Tele 251, PML DC63.  
**Instruments Available:** Steinway; Synclavier Poly Towers w/guitar, sampling, printing; Yamaha TX816, Linn 9000.  
**Video Equipment & Services:** Six-foot x 12-foot screens, Cinema Beam, ¾-inch 8250, Q.Lock, one-inch Ampex.  
**Rates:** Vary; video, mixing, dubbing, recording, IA, digital programming.

**[24+] EVERGREEN RECORDING STUDIOS**

4403 W. Magnolia Blvd., Burbank, CA 91505  
 4024 Radford Ave., Studio City 91604  
 (818) 841-6800  
**Owner:** Charles Fox, Gayle Levant, Artie Butler  
**Studio Manager:** Sandra Smart  
**Engineers:** Marc Gebauer, John Richards, Mike Hatcher, Gary Luchs, David Marquette.  
**Dimensions of Studios:** A: 46 x 70; overdub room: 12 x 17; rhythm stage: 16 x 8; B: 35 x 35 and drum booth; iso room: 14 x 27; Radford: 130 x 70 x 30.  
**Dimensions of Control Rooms:** A and B: 20 x 26; Radford: 22 x 27.  
**Tape Recorders:** (3) Ampex MM1200, 24-track; (5) Ampex ATR-104, 4-track; (5) Ampex ATR-102 (w/½-inch headstack capability), 2-track; (2) Magna-Tech w/6-, 4-, or 3-track overdub capability; (3) Magna-Tech 3- or 1-track dummies; (2) Magna-Tech 3- or 1-track recorders; (2) Magna-Tech PR635 hi-speed projectors w/Xenon lamps; Radford: Studer A80, 24-track.  
**Mixing Consoles:** Studio A: Harrison (custom) 4832, 48 x 32; Studio B: Harrison (custom) 4032, 40 x 32; Radford: Harrison (custom), 54 x 32.  
**Monitor Amplifiers:** Crown PSA-2 in control rooms and for playback in studios.  
**Monitor Speakers:** UREI Time Aligned, JBL 4311s, Yamaha NS-10s, Hitechis, Auratones; Radford: custom Evergreen components (LCR monitoring).  
**Echo, Reverb & Delay Systems:** (2) live chambers, (2) EMT stereo 140s, Lexicon 224 and 220; Radford: (3) EMTs, (2) digital, (2) lives.  
**Other Outboard Equipment:** Eventide Harmonizers, Lexicon Prime Times, Kepex IIs, Dolbys, UREI, Inno-sonics. Plus: EECO sync (B), Adams-Smith sync (A), Shadow sync (Radford). Complete transfer facilities: MAG, reel-to-reel, cassettes. Projection in all rooms.  
**Microphones:** All standard makes and models.  
**Instruments Available:** Yamaha grands.  
**Video Equipment & Services:** (3) ¾-inch VCRs w/monitors for control rooms and studios.  
**Rates:** Film scoring and record rates: call for information.

*New from Marantz*  
**THE SOLID GOLD SOUND  
 PMD 430 PORTABLE CASSETTE DECK**



Professional quality stereo recording and playback, three head mechanism, Double Dolby® System and dbx™ noise reduction are some of the features that make this sturdy Marantz portable a truly professional recorder.  
 Other features include pitch control ±6%, 3-position tape selector, limiter, 4-way power supply and built-in speaker. And, all Marantz audio equipment is backed by the Marantz Solid Gold Warranty.  
 Call us for other duplicating products.

**B&L SALES**  
 10640 Magnolia Boulevard  
 North Hollywood, CA 91601  
**(818) 985-1792**

Circle #122 on Reader Service Card

**HOLDS UP  
 ON THE ROAD**

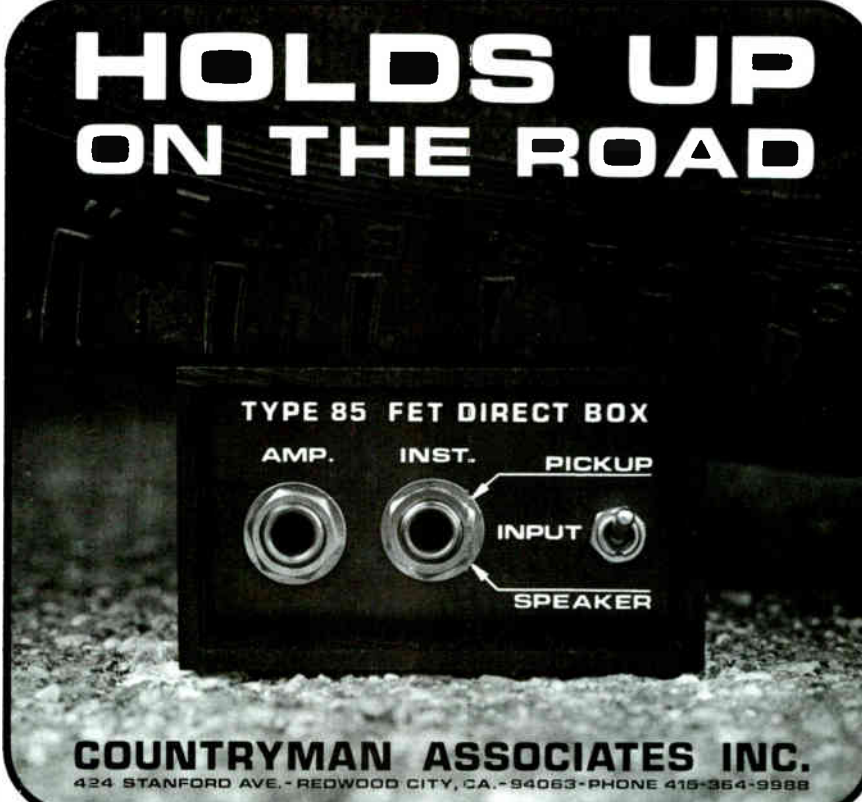

**TYPE 85 FET DIRECT BOX**  
 AMP. INST. PICKUP  
 INPUT SPEAKER

**COUNTRYMAN ASSOCIATES INC.**  
 424 STANFORD AVE. - REDWOOD CITY, CA. - 94063 - PHONE 415-964-9988

Circle #123 on Reader Service Card

**IF YOU'RE NOT USING IT... SELL IT!**

**THE BERTECH ORGANIZATION**

**YOUR NATIONAL CLEARINGHOUSE FOR FINE USED AUDIO AND VIDEO**

Our mailers reach thousands of professionals every month. We'll list your used equipment free of charge — or help you find that rare item you've been looking for.

**THE BERTECH ORGANIZATION**

Distributors, brokers and custom fabricators of quality audio and video equipment

14447 CALIFA STREET  
VAN NUYS, CA 91401  
(818) 909-0262

Toll Free Outside CA  
(800) 992-2272

**THINK BERTECH FIRST!**

Circle #124 on Reader Service Card

**digital brothers**

**HIGH QUALITY**

**Real Time Cassette Duplication**

From A Digital Running Master  
To 3 Head Dual Capstan Slaves  
with HX Pro\* Headroom Extension

**Feel Free To Give Us A Call**

**Benjamin Shaw Bryan Shaw**

**(714) 645-9702**  
**(714) 646-4244**

1731 Bonaire Way  
Newport Beach, California 92660

\* HX Professional Originated By Bang and Olufsen

Circle #125 on Reader Service Card

## SOUTHERN CALIFORNIA



### [24+] FANFARE RECORDING STUDIOS

120 E. Main St., El Cajon, CA 92020  
(619) 447-2555  
Owner: Ronald L. Compton  
Studio Manager: Carol A. Compton  
Dimensions of Studios: 23 x 30; isolation room #1: 10 x 12; isolation room #2: 7 x 7.  
Dimensions of Control Rooms: 17 x 20  
Tape Recorders: MCI JH-24, 24-track; MCI JH-16, 16-track; MCI JH-100, 2-track; Ampex 440B, 1-track; Ampex 440B 4- and 2-track; (2) Revox A 77 2- and 1/4-track; Nakamichi 700 B cassette.

Mixing Consoles: MCI 636 (full mixing automation, trans amp inputs), 36 x 36.  
Monitor Amplifiers: BGW and Crown.  
Monitor Speakers: JBL, Auratones, Altec, Sennheiser, AKG headphones, Yamaha NS-10M.

Echo, Reverb & Delay Systems: EMT Stereo Plate, Lexicon 224 w/all programs and non-volatile memory, Eventide Harmonizer; DeltaLab digital delay, Yamaha REV7, SPX-90, Alesis.

Other Outboard Equipment: (4) Orban parametric EQs, (4) UREI LA-4A compressors, 1176 LN limiters, (2) Gain Brains, (4) Kepexes, Orban sibilance controller, UREI digital metronome, Pultec EQ, Orban stereo synthesizer, EXR Exciter, (2) dbx 124 compressors, Dolby noise reduction, Syntech Studio I sequencer, Mini-Mag synchronizer for 24- and 16-track machines.

Microphones: Neumann U87, KM86, KM84, U47; AKG 414, 202E, 119; Shure SM56; Electro-Voice RE-15, RE-10; Sony 337 (4); Altec 19B; RCA 44BX; over 50 mics to choose from.

Instruments Available: Seven-foot Yamaha conservatory grand piano, Hammond B-3 organ w/tube type Leslie speaker, Fender Rhodes electric piano, Ludwig drums w/concert toms, Syn-drums, ARP Omni, ARP Odyssey, congas, orchestra bells, chimes, percussion devices, Drumulator, and Mirage digital sampling keyboard w/extensive software library, Roland Octa-pad, Casio C-Z w/ computer interface librarian.

### [24+] FIDDLER'S RECORDING STUDIO

7430 Melrose Ave., Hollywood, CA 90046  
(213) 655-6087

Owner: Michael Claussen  
Studio Manager: John X

### [24+] FIDELITY STUDIOS, INC.

4412 Whiteett Ave., Studio City, CA 91604  
(818) 763-6323

Owner: Artie and Phyllis Ripp  
Studio Manager: Violet Ripp  
Engineers: Larry Elliott, Cliff Zellman, Steve Lang, Bernard Frings, Bob Bridges, Sean Boyd, Larry Jasper.

Dimensions of Studios: A: 23.5 x 16 x 12 and (2) booths; B: 23 x 16.5 x 8 and (2) booths.  
Dimensions of Control Rooms: A: 18 x 13 x 9 and transport room; B: 16 x 12 x 9

Tape Recorders: (2) Ampex (Heider/Butt modification) MM1200, 16-, 24-track; Stephens 821B-40, 16-, 24-, 32-track; (2) Ampex ATR-104, 2-, 4-track; (2) Ampex ATR-102, 2-track (1/2- and 1/4-inch); (4) Otari MX5050, 2-track.  
Mixing Consoles: A: MCI automated JX500, 42 x 32; B: Aengus/B&B custom, 24 x 8.

Monitor Amplifiers: Haller, BGW, Phase Linear.  
Monitor Speakers: A: UREI 838 Time Align, Yamaha NS-10M, Auratones; B: JBL 4311, Tannoy Super Reds, Yamaha NS-10M, Auratones.

Echo, Reverb & Delay Systems: Publison Internal Machine 90, AMS DMX-80s stereo delay/pitch changers, EMT 250, Lexicon 224, Roland SRV-2000 digital reverbs, (2) EMT 140s plates, AKG BX-20, Lexicon Prime Time, (2) Eventide 910 Harmonizers, Marshall Time Modulator.

Other Outboard Equipment: Limiters: (2) LA-2A, (4) LA-3A, (4) 1176LN, (2) dbx 160, RM-58 stereo, Orban sibilance controller, ADR Vocal Stresser, (2) NEVE 2254A, Aphex II Aural Exciter. Gates: (8) Kepex II, (7) Roger Mayer, Kepex.

EQ: (8) B&B EQF-1, (2) Pultec EQP-1R. Noise reduction: Dolby 24-track M-series, (4) Dolby 361. Sync: BTX Softtouch, (2) Shadows, Cypher.

Microphones: AKG: 414-P48, 451EB and pads, C-24, C-12, C-60. Neumann: U87, U67, M-49, KM56, Sennheiser: MD-421, MD-441. Sony: ECM-22P, ECM-250, C-500, C-37A, C-38. E-V: RE-20, RE-666. Shure: SM56, SM57, SM545. PZM.

Instruments Available: A: Yamaha grand piano. B: Mason and Hamlin grand piano. Both: Hammond B-3 w/Leslie, Roland JX-3P.

Video Equipment & Services: Monitors: RCA Colortrak-2000 25-inch color, Panasonic 10-inch color, (2) Hitachi 7-inch b & w. (2) BVU-800 VCRs, Bell & Howell broadcast synchronizing generator, BTX Softtouch, (2) Shadows, Cypher, VCR hookups.

Rates: Please call.

Extras: We feature an extensive library of finished masters and songs available for film, video, television and commercial productions. Long and successful relationships with major distribution companies afford Fidelity the ability to provide liaison and the exposure necessary to secure recording, motion picture, television and home video arrangements for your production. Additionally, Fidelity can provide complete music clearance services from the #1 record on down, including copyright, publisher/writer clearances, and licensing. Having its own in-house publishing and production companies, Fidelity is fully staffed with composers, musicians, music arrangers and producers for all of your music needs.

Direction: Fidelity Studios is the only complete creative sound and music service facility in Los Angeles. We are proud of our warm, creative atmosphere and technical expertise that serve a complete scope of clientele from all area of the entertainment and communications industries.

### [24+] FIESTA SOUND & VIDEO

also REMOTE RECORDING  
1655 S. Compton Ave., Los Angeles, CA 90021  
(213) 748-2057

Owner: R.G. Robeson  
Studio Manager: Rick Robeson  
Engineers: Octavio Villa, Quico Cadena, Jose Grajeda.  
Dimensions of Studios: 30 x 60 plus isolation rooms.  
Dimensions of Control Rooms: 25 x 15.

Tape Recorders: MCI 24-track; MCI 2-track; Otari 2-track.  
Mixing Consoles: MCI 428, 24 x 24.  
Monitor Amplifiers: Crown DC 300.

Monitor Speakers: JBL 4333  
Echo, Reverb & Delay Systems: Lexicon 200 digital reverb, Eventide H969 Harmonizer, Lexicon DDL, Master-Room III echo, Yamaha REV7, Yamaha SPX90.

Other Outboard Equipment: UREI graphic EQs, 31-band EQ, Dolbys, 1176 and dbx 160 compressor/limiters, Orban 424 comp./limiter.

Microphones: Neumann U87s, KM84s, AKG C-452s, C-414s, Sennheiser MD-421s, Shure SM57s, SM7s, Sony ECM33Fs, E-V RE-20s.

Instruments Available: Steinway 6-foot grand piano, Fender Rhodes electric piano, D-6 clavinet, ARP Omni, ARP Odyssey synth, Fender Twin Reverb amp., Steinway grand.

Rates: Call for rates. We encourage block booking.

### [24+] FINGERPRINT RECORDERS

also REMOTE RECORDING  
P.O. Box 834, Montrose, CA 91020  
Owner: Mark Heard  
Studio Manager: Mark Heard

### [24+] FOOTPRINT SOUND STUDIOS

13216 Bloomfield St., Sherman Oaks, CA 91423  
(213) 872-1854

Owner: Jerry Fuller  
Studio Manager: Annette Fuller  
Engineers: Brian Friedman, Neil Hopper.  
Dimensions of Studios: 27.5 x 16.5 w/20-foot high strng room plus isolation booth, drum booth and projection room/loft.

Dimensions of Control Rooms: 10 x 12  
Tape Recorders: Ampex MM1200 24-, 16-track; ATR-100, Ampex 350, 2-track; Sony 2 various 1/4-track; Technics cassette (2).

Mixing Consoles: Trident "Series 80" w/mixing capabilities up to 56 tracks.  
Monitor Amplifiers: SAE, Crown, Yamaha P2100, Haller 225s (2).

Monitor Speakers: MDM-4s Time Aligned, Auratones, Yamaha NS-10M, JBL 4411s.

Echo, Reverb & Delay Systems: AKG BX-10, Orban dual reverb, Eventide DDL, Lexicon Pnme Time, Ecolate; (2) Harmonizers: DeltaLab Effectron; Yamaha REV7.

Other Outboard Equipment: UREI 1176, LA-3A, dbx 160 comp./limiters, GT-4 noise gates, UREI 527-A and Spec Acoustics graphics EQ, Orban parametrics EQ, UREI digital metronome, Orban de-esser, Sync Pulse.

Microphones: Neumann, AKG, Electro-Voice, Shure, Sony, Sennheiser, Crown PZM.



**Instruments Available:** Complete 7-piece drum set, Yamaha 6-foot grand piano, Yamaha DX7 w/ROM carts, Sequential Circuits Prophet 5, Iso-Box, Fender bass/guitar amps, Rockman amps, percussion; Yamaha RX11 drum machine; all keyboards MIDI'd.  
**Rates:** 24-track from \$55/hr. to \$95/hr. plus special rates (all equipment included).  
**Extras:** Production assistance available. Musicians' lounge, coffee, tea, refreshments, swimming pool, basketball, nearby restaurants, liquor store/market, guest room available.  
**Direction:** Quality, affordable product in relaxed environment. Clientele: Glen Campbell, Tanya Tucker, Jerry Fuller, Johnny Mathis, Kimberley Springs, Irene Cara, James Ingram, Cliffe Stone.

[24+] **FORMULA 1 MUSIC**  
 641 S. Palm St. Ste. #D, La Habra, CA 90631  
 (213) 691-2710  
 Owner: Jon St. James

[24+] **GALAXY SOUND STUDIOS**  
 1635 N. Cahuenga Blvd.-3rd, Hollywood, CA 90028  
 (213) 461-1971  
 Studio Manager: Vanessa Jollivette

[24+] **GATEWAY STUDIOS**  
 6381A Rose Lane, Carpinteria, CA 93013  
 (805) 684-8336  
 Owner: Jim Messina  
 Studio Manager: Amy Foster  
 Engineers: John Pace, independents.  
**Dimensions of Studios:** Main studio: 23 x 27; piano isolation: 11 x 16; vocal isolation: 11 x 13.  
**Dimensions of Control Rooms:** 18 x 23.  
**Tape Recorders:** Studer A80, 24-track; Studer A80 1/2-inch, 2-track; Scully 1/2-inch, 4-track; Scully 1/4-inch, 2-track; Otari 1/4-inch, 2-track.  
**Mixing Consoles:** Soundcraft Series 2400, 28 x 24.  
**Monitor Amplifiers:** Phase Linear 700B.  
**Monitor Speakers:** Altec 604E w/Mastering Lab cross-overs and 15-inch sub-woofers (Super Reds).  
**Echo, Reverb & Delay Systems:** AMS DMX1580S stereo digital delay, 224X digital reverb w/LARC, AKG BX20 E1 spring reverb.  
**Other Outboard Equipment:** Valley People trans-amps, Drawmer dual gates, Pulleys EQP-1, EQP-1A3, + EQ-MEG-5, UA limiters 175, 175A, 1176, Teletronix and leveling amps, UREI EQs, Langevin EQ-252-A, Altec 9073A graphic EQ.  
**Microphones:** AKG, Beyer, Neumann, Crown, RCA, Electro-Voice, Schoeps, Sennheiser, Shure, Sony.  
**Instruments Available:** Roland keyboards, JX8P w/programmer and Juno 106, Yamaha DX7, Oberheim controller keyboard, Minimoog, Apple IIe w/DX pro software and MIDI soundfiler, Linn 9000 w/digital sampling, drums, Seymour Duncan amps. Guitar rentals: Fender, Gibson, Dobro, Martin, etc.  
**Video Equipment & Services:** Video monitoring w/BNG connector for hookups.  
**Rates:** Call for rates.

[24+] **GOLD RUSH RECORDING**  
 8800 John Ave., Los Angeles, CA 90002  
 (213) 589-0248  
 Owner: Wayne Vaughn

[24+] **GOLD STAR RECORDING STUDIOS, INC.**  
 P.O. Box 4532, No. Hollywood, CA 91607  
 (818) 990-2382  
 Studio Manager: Stan Ross, David Gold

[24+] **GOLDEN GOOSE RECORDING**  
 2074 Pomona Ave., Costa Mesa, CA 92627  
 (714) 548-3694  
 Owner: Dennis O. Rose  
 Studio Manager: Dennis Rose

[24+] **GOLDMINE RECORDING STUDIO**  
 1393 Callens Rd., Ventura, CA 93003  
 (805) 644-8341  
 Owner: Goldmine Productions  
 Studio Manager: Tim Nelson  
 Engineers: Jeff Cowan, Tim Nelson, Ken Felton.  
**Dimensions of Studios:** 40 x 26 x 12; (2) iso: 26 x 16 x 12, 9 x 10 x 12.  
**Dimensions of Control Rooms:** 18 x 16.  
**Tape Recorders:** Otari MTR-90, 24-track; TEAC 80-8, 8-track; Otari 5050B, 2-track; Technics 1506, 2-track.  
**Mixing Consoles:** NEOTEK w/Jensen 990s Series II, 28 x 24.  
**Monitor Amplifiers:** Hafler DH500, Fostex 600, Phase Linear 700B.  
**Monitor Speakers:** UREI 813, Yamaha NS-10s, "All Tones."  
**Echo, Reverb & Delay Systems:** Prime Time DDL, MXR

DDL, Effectron by DeltaLab, H910 Harmonizer, Yamaha REV7 and Roland SRV 2000 digital reverb, Echo Plate II.  
**Other Outboard Equipment:** LA-2A limiters, UA175 limiters, dbx 161s, Valley People noise gates, Omni Craft gates.  
**Microphones:** Neumann, Sennheiser, Sony, AKG, Shure, PZMs, E.V.  
**Instruments Available:** Yamaha C-7 grand piano, Yamaha DX7, Yamaha CP-80 Yamaha PF-15 piano, LinnDrum, "Cooper" drum chest, Marshall guitar amp.  
**Rates:** \$45/hr. (24-track); \$30/hr. (8-track); \$25/hr. (2-track).

[24+] **GROUND CONTROL**  
 1602 Montana Ave., Santa Monica, CA 90403  
 (213) 453-1255  
 Owner: Paul Ratajczak  
 Studio Manager: Lisa Roy  
 Engineers: Paul Ratajczak, Darwin Foye.  
**Dimensions of Studios:** 40 x 30 w/16-foot ceilings, w/isolation rooms: 10 x 7 and 12 x 10, 60 x 30.  
**Dimensions of Control Rooms:** 15 x 22, 18 x 25.  
**Tape Recorders:** Studer A-800 MKIII, 24-track; Lyrec (Denmark), 24-track; Ampex ATR 102, 2-track; 440B, 2-track; Studer A-80 VU MKII, 2-track; Sony cassette TCK 777; TEAC cassette C-1.

**Mixing Consoles:** Amek (England) M3000, 36 x 24 x 4, 8 returns; SSL 4000E series 56 channel.  
**Monitor Amplifiers:** PMF 2150B Perreaux, Carver PM-1, 5, Hafler DH 220.  
**Monitor Speakers:** TAD TSM-1, Sony APM 700, Yamaha NS-10s, Auratone, along w/Stax electrostatic headphones and Dahlquist DQ-10s for additional reference, Fostex RM780, Visonik David 9000, Tannoy NFMB.  
**Echo, Reverb & Delay Systems:** EMT 140 plate (tube), 7-foot Ecoplate, AKG BX-20E, a live room chamber and for electronic digital reverberation the AMS RMX16. Delay systems include Eventide 949, MXR Delay IIs, MXR Delay I, phaser and flangers, Marshall Time Modulator, AMS dmx 15-80S, Lexicon 224XL, Eventide SP2016, Yamaha REV7, Yamaha SPX 90, Lexicon PCM7s.  
**Other Outboard Equipment:** Compressor/limiter selections include UREI LA-2A, LA-3A, dbx 165, Spectra Sonics 610, Allison Gain Brains, and for noise gates and key effects, Allison Kepex II system, MDB window recorder.  
**Microphones:** Neumann U67 and U87, KM84, U47F; Cinc Church; AKG C12, D12E, 451s, PML DC63, 414s, C60s; Telefunken 251; RCA 77; E-V 666; Sennheiser 421; Altec 195; Shure SM57s.  
**Instruments Available:** Yamaha 7'4" grand piano, ARP 2800, selection of acoustic and electric guitars.  
**Video Equipment & Services:** Available upon request.  
**Rates:** Please call.

# NOISE REDUCTION FOR UNDER \$10.

MIXING CONSOLES

SWITCHES

MICROPHONE CONNECTORS

SNAKE CABLES

BATTERY CONTACTS

ALL PLUGS & JACKS (XLR, PHONE, PHONO, DIN, MIDI, ETC.)

PATCHBAYS

FADERS, POTS

TERMINAL STRIPS

SPEAKER TERMINALS

## CRAMOLIN®

Even the finest equipment in the world can't guarantee a noise-free recording. One "dirty" connection anywhere in the electrical path can cause unwanted noise or signal loss.

### "MORE THAN A CONTACT CLEANER"

**CRAMOLIN®** is a fast-acting, anti-oxidizing lubricant that cleans and preserves all metal surfaces, including gold. When applied to metal contacts and connectors, **CRAMOLIN®** removes resistive oxides as it forms a protective molecular layer that adheres to the metal surfaces and maintains maximum electrical conductivity.

**CRAMOLIN® - USED BY THOSE WHO DEMAND THE BEST:**

Bell & Howell	Hewlett Packard	MCI(Sony)	Nakamichi
Capitol Records	John Fluke Mfg.	Motorola	RCA
Dolby Laboratories	McIntosh Labs	NASA	Switchcraft

SINCE 1956

## CAIG LABORATORIES INC.

1175-O Industrial Ave., (P.O. Box JJ) - Escondido, CA 92025-0051 U.S.A. • (619) 743-7143

[24+] **GROUP IV RECORDING**  
 1541 No. Wilcox, Hollywood, CA 90028  
 (213) 466-6444  
 Owner: Angel Balestier, Dennis Sands  
 Studio Manager: Angel Balestier

[24+] **GRS STUDIOS**  
 20531 Plummer, Chatsworth, CA 91311  
 (818) 998-0443  
 Owner: A.E. Sullivan  
 Studio Manager: A.E. Sullivan

[24+] **HANGING ROCK STUDIO**  
 9994 Reevesbury Dr., Beverly Hills, CA 90210  
 (213) 275-2086  
 Owner: Frank Unruh, Titch Pleasance  
 Studio Manager: Frank Unruh

[24+] **CRAIG HARRIS MUSIC**  
 P.O. Box 110, No. Hollywood, CA 91603  
 (818) 508-8000  
 Owner: Craig Harris  
 Studio Manager: Miles Joseph

[24+] **HEADWAY STUDIOS**  
 (previously Gopher Baroque)  
 7560 Garden Grove Blvd., Westminster, CA 92683  
 (714) 891-8548  
 Owner: Steve McClintock  
 Studio Manager: Catherine Enny  
 Engineers: Steve Kempster, Michael Mikulka, Michael Edwards, J.B. Lawrence, Martin Beal, Stephen Anderson, independents welcome.  
 Dimensions of Studios: A: 45 x 22 x 18 ceiling; live and dead areas + 2 iso rooms. B: 16 x 12 x 12 ceiling + iso booth.  
 Dimensions of Control Rooms: A: 20 x 15, B: 16 x 12.  
 Tape Recorders: Otari MTR-90II, 24-track; Tascam 85-16B, 16-track; Tascam, B-, 4-, and 2-track; Ampex ATR, 2-track; Technics cassettes, TEAC cassettes.  
 Mixing Consoles: Trident Series 75, 28 x 24 x 24; Tascam M-16, 24 x 16 x 16.  
 Monitor Amplifiers: BGW, Hafler, Crown, QSC.  
 Monitor Speakers: JBL 4435; JBL 4311; Yamaha NS-10M; Auratone T-6; Auratone 5-C.

## SOUTHERN CALIFORNIA



**24+ TRACK**



**HEADWAY STUDIOS**  
 Westminster, CA

Echo, Reverb & Delay Systems: Lexicon, Roland, Yamaha reverbs, Roland, De:laLab, Yamaha, MXR delays.

**Other Outboard Equipment:** dbx compressors, limiters and gates; Valley People compressors limiters and gates; Aphex and BBE exciters; parametric EQs.  
**Microphones:** Neumann, Telefunken, AKG, Sennheiser, Shure, E-V, P2M, PML.  
**Instruments Available:** Pearl drum set; 7-foot grand piano, B-3 w/Leslie, Yamaha DX and TX, PPG, Prophet sampler, Moog and Casio synths, Linn, E-mu, Roland drum machines, Macintosh and Commodore computers for programming and sequencing, staff keyboard programmers upon request.  
**Video Equipment & Services:** Upon request.  
**Rates:** Please call for info.  
**Extras:** Two lounge areas, kitchen area, showers, lots of creative space for the artist. Also, real time tape duplication room, full time maintenance staff, independent production co., jingles-to-records, commercial photography studio, stylists, vocal instruction studio, full-service music publishing co., talent agency, management co., full-facility rehearsal studios three minutes away!  
**Direction:** "The Headway Group" is a very unique and very innovative entertainment complex that was created for the inspiring and aspiring artist. Our complex is maintained by a professional and conscientious staff, doing what we can to make our clients feel comfortable, welcomed and happy.



**HIT CITY WEST**  
 Los Angeles, CA

[24+] **HIT CITY WEST**  
 6146 W. Pico Blvd., Los Angeles, CA 90035  
 (213) 852-0186  
 Owner: Jason Bell  
 Studio Manager: Jason Bell  
 Engineers: Jason Bell, Ron McCoy, Kevin O'Connor, Wesley Craft  
 Dimensions of Studios: Studio A: 18 x 30, Studio B: 13 x 5.  
 Dimensions of Control Rooms: A: 16 x 15, B: 13 x 15.  
 Tape Recorders: MCI (transformerless) JH114 w/Auto Locator, 24-, 16-track; Tascam w/dbx noise reduction 85-16B, 16-track; Otari, 4-, 2-track; Ampex (transformerless) ATR-102, 2-track; MCI JH-110, 2-track; AKAI GX-624, ¼-track; NAD and Aiwa cassette decks.  
 Mixing Consoles: "A" Soundcraft Series 2400, 28 mic., 52 line, 24 out; "B" Soundcraft Series 600, 24 inputs, 6 sends.  
 Monitor Amplifiers: HH, Crown, SAE, Technics.  
 Monitor Speakers: Custom JBL monitors w/wood horns, TAD and JBL drivers, Yamaha NS-10M and Auratones.  
**Echo, Reverb & Delay Systems:** Lexicon 224X digital reverb, EMT Gold Foil, (2) Yamaha REV7 digital reverbs, Lexicon PCM70, Master-Room Super C, Master-Room XL-305 stereo reverb, Ursa Major Space Station, Countryman flanger/phaser, DeltaLab DL-2 Acousticcomputer, Eventide 910 Harmonizer, Eventide 949 Harmonizer, Eventide instant flanger, Lexicon Prime Time and Prime Time II, Roland SDE-300 digital delay.  
**Other Outboard Equipment:** UREI Model 545 Parametric EQ, UREI Model 537 1/3 Octave Graphic EQ, Technics model 9010 parametric EQ, dbx 160, dbx 165, dbx 160X, UREI 1176, Allison Gain Brains, Allison Kepex gates, Drawmer dual gate, Orban de-esser (5 channels), ADR Vocal Stresser, EXR SPIII psychoacoustic projector, UREI digital metronome.  
**Microphones:** AKG, RCA, Beyer, Countryman, Crown, Neumann, Sennheiser, Sony, Telefunken.  
**Instruments Available:** Knabe grand piano, Casio 101, DMX drum machine, Prophet 2000 synthesizer, Emulator SP-12 drum machine w/sampling.  
**Video Equipment & Services:** Time Lynx synchronization system, ¾-inch JVC CR 6650U video recorder/player, Sony monitors.

**Our Graduates Work**

A practical education in audio and video recording arts and sciences. For anyone who takes recording seriously.

**Institute of Audio-Video Engineering**

NATIONAL 1-800-551-8877  
 STATE 1-800-972-1414  
 LOCAL 213-666-2380

1831 Hyperion Ave., Hollywood, CA 90027  
 Dept. E

Circle #127 on Reader Service Card



Rates: Call for rate information.

Extras: Producer's lounge w/piano, full real time tape duplication sound effects and music library.

Direction: Bobby Womack, Wall of Voodoo, Motley Crue, Babylon Warriors, The Dillards, Freddy Hubbard, LL Cool J, Dwight Yoakam, Mojo Nixon, Honeymoon Suite, The Alarm, Syayer, Red Hot Chili Peppers and major advertising agencies are among the clients who have found that our experienced, knowledgeable staff, the professionally designed state-of-the-art studios, and comfortable working environment make Hit City West an ideal place to bring their projects.

[24+] **HQ1/HARLEQUIN**  
19347 Londelius St., Northridge, CA 91324  
(818) 993-4778

Owner: Paul and Jeff Stillman

Engineers: Jeff Stillman, Paul Stillman, Steve Brenner, Gary Dulac, Jeff Meyers.

Dimensions of Studios: Audio playing room: 20 x 30 x 16; iso booth: 12 x 12 x 15; insert stage: 42 x 35 x 16.

Dimensions of Control Rooms: (audio) 14 x 22 x 12; (video) 20 x 12 x 8.

Tape Recorders: Stephens 821 B-24 w/locator, 24-track; Tascam 38, 8-track; (2) 3M M64 30 ips/15 ips, 2-track; Otari 5050B, 2-track; Technics RS1500, 2-track; TEAC 3440, 4-track; Fostex 250, 4-track; Technics RSB 100 cassette.

Mixing Consoles: Modified and expanded Tangent 3216, 32 x 24 x 16.

Monitor Amplifiers: (3) Hafler P-500s, 200, 220.

Monitor Speakers: JBL 4435 (bi-amped), Yamaha NS-10s. Echo, Reverb & Delay Systems: Lexicon 200 digital, Yamaha SPX90, Jim Williams reverb, Lexicon PCM42 delay, DeltaLab acoustic computer, AAD, MXR.

Other Outboard Equipment: UREI 1176, dbx 161, 160x, Delta Graph, Biamp and Sphere graphics, Williams parametrics and noise gates, EXR Exciter, Yamaha SPX-90.

Microphones: Neumann, AKG, Sennheiser, Calrec, Shure, Sony, Schoeps, etc.

Instruments Available: DX7, Emulator, Sequential Circuits, Fairlight and Chamberlain drum machine, Jupiter 8, 7-foot grand piano, drums, amplifiers, vibes.

Video Equipment & Services: One-inch, 3/4-inch, 1/2-inch formats, 3/4-inch editing, insert stage w/lighting, 50K power, dimmer board, grid, coving, dressing rooms. JVC KM2000 switcher, EECO Ives II edit controller, Sony M-3. Rates: Supply and demand, call for rates.

[24+] **IMAGE RECORDING, INC.**  
1020 N. Sycamore Ave., Hollywood, CA 90038  
(213) 850-1030

Owner: Harry Maslin, John Van Nest

Studio Manager: John Van Nest

Engineers: John Van Nest, Steve Krause, Ron DaSilva.

Dimensions of Studios: Studio A: 20 x 40 x 20, Studio B: 18 x 12 x 8.

Dimensions of Control Rooms: Studio A: 14 x 20 x 10, Studio B: 13 x 15 x 10.

Tape Recorders: A: (2) MCI JH-24, 24-track; (2) Ampex ATR-102 1/2-inch, 1/4-inch heads, 2-track; Sony PCM-F1, 2-track. B: MCI JH-16, 24-track; Ampex ATR-102 1/2-inch, 1/4-inch, 2-track.

Mixing Consoles: Solid State Logic 4056, 60 x 32; Trident Series 80B, 32 x 24.

Monitor Amplifiers: A: McIntosh 2300, Nakamichi 100W; B: McIntosh 2300, Hafler 500.

Monitor Speakers: UREI Time Align monitors, Yamaha NS-10M, Auratones A & B.

Echo, Reverb & Delay Systems: A: EMT 140 plate, AMS RMX-16 digital reverb, Lexicon 200, Lexicon PCM70, (2) Yamaha REV7, AMS DMX-1580s digital delay/Harmonizer, Lexicon Delta T, Marshall tape eliminator; B: EMT 140 plate, Lexicon 200, Yamaha REV7.

Other Outboard Equipment: A: Eventide Harmonizer, AMS flangers, ADR panscan, Dytronic cyclosync panner, Drawmer noise gates, dbx noise gates, dbx de-essers, (12) limiters including UREI 1176LN, LA-2A, LA-4, LA-4, dbx 160, dbx 160X, Inovonics 201, 48 channels Dolby noise reduction, Neve input modules 1064; B: Eventide 949 Harmonizer, API 550 EQ, Scamp Rack, Prime Time, Roland delays, LA-2A, dbx 165, Inovonics 201.

Microphones: Over 80 available, including 35 Neumann, AKG, Sony, Beyer, Sennheiser, Shure.

Instruments Available: Yamaha C7 7-foot grand piano, Kawai grand piano w/MIDI Forte, Hammond organ, Simmons drums, Roland vocoder, various keyboards on request, Vox amp.

Video Equipment & Services: JVC 3/4-inch VCR, Lynx synchronizer Proton 602M 25-inch monitor, Sharp 15-inch monitor.

Rates: On request.

[24+] **INDIAN HILL RECORDING**  
also **REMOTE RECORDING**  
224 N. Indian Hill Blvd., Claremont, CA 92346  
(714) 864-3333

Owner: Charles Whittington

Studio Manager: Terry Dwyer

Engineers: Jeff Kopang, Marc Dietrich, Debbie Robertson

Dimensions of Studios: 32 x 27.

Dimensions of Control Rooms: 18 x 22.

Tape Recorders: Ampex MM1200, 24-track; Ampex ATR 102, 2-track; Ampex AG 350, 2-track; (2) Revox A77, 2-track.

Mixing Consoles: Neve/custom 24 x 28 w/DC grouping.

Monitor Amplifiers: McIntosh 2500, Crown D150s, (5) AB Systems.

Monitor Speakers: UREI 813s, JBL 4311s, Auratones, Altec 604s.

Echo, Reverb & Delay Systems: Lexicon 224, Ecoplate II, Yamaha REV7, live chamber.

Other Outboard Equipment: Eventide Harmonizer, Pandora DDL, Compu-Effector, UREI 1176, dbx 160s, UREI LA-4, Valley People Dyna-Mites, Orban 622 parametrics, etc.

Microphones: Neumann U87, KM84, AKG 451, 414; Sennheiser 441, 421; Shure SM7; E-V RE-20; etc.

Instruments Available: Yamaha C5 grand piano, Fender Rhodes, LinnDrum, synthesizers. Rentals available. Proph- et 2000.

Video Equipment & Services: JVC CR-8250, 5550 decks, VE92 editor, Panasonic W14600 C SEG, Hitachi VE-102, Hitachi FP-1010U, 1020U, FP3030, GP7 SMPTE generator/reader (drop frame and non-drop frame).

Rates: We're competitive!

Direction: Indian Hill Recording is the Inland Empire's only complete 24-track audio/video production facility. Our studio is located in the heart of beautiful Claremont Village, moments away from a variety of fine restaurants and hotels. You will enjoy recording in our large studio and control room, and our experienced engineers help to create a relaxed, hassle-free atmosphere, while assuring uncompromising attention to every detail of your production. Indian Hill Recording also offers 3/4-inch location video, specializing in high-end industrial and commercial production.

[24+] **INDIGO RANCH RECORDING STUDIO**  
-MALIBU  
P.O. Box 24-A-14, Los Angeles, CA 90024  
(213) 456-9277

Owner: Richard Kaplan, Michael Hofmann

Studio Manager: Michael Hofmann

Engineers: Chris Brunt, Richard Kaplan

Dimensions of Studios: 22 x 30 plus iso rooms.

Dimensions of Control Rooms: 20 x 20 (keyboard player's dream).

Tape Recorders: 3M M-79, 24-track; 3M M-79 1/4-inch, 2-track; 3M M-79 1/4-inch or 1/2-inch, 2-track; Stephens 821 1/2-inch, 4-track; (3) Sony 777 cassette decks; (2) Technics

M-65 cassette decks; Technics M-85 cassette deck.

Mixing Consoles: "Deane Jensen"/Aengus custom 32 x 24 fully automated plus eight echo returns and 14 sends.

Monitor Amplifiers: H&H custom bi-amp 1600 watts per side, Crown DC 300As, EA-31s.

Monitor Speakers: Custom 4-way JBL, Yamaha NS-10, Visonik Little Davids, Auratones, Brauns.

Echo, Reverb & Delay Systems: EMT 25, (3) EMT plates, (Publison Internal 90 and AMS available on request), MXR 01, Ursa Major, Telefunken reverb, MICMIX Master-Room reverb, Loft flanger, Roland 3000, MXR DDLs, (2) Eventide DDLs, (3) Eventide Harmonizers, Marshall Time Modulator, Cooper Time Cube, Eventide instant phaser.

Other Outboard Equipment: Teletronix LA-1, LA-2, LA-2As; ADR stereo comp./limiters; ADR stereo selective processor, Pulleys, Lang, Fairchild, UA-175 and 176s, Collins 26, RCA BA6A, UREI 1176s, dbx 160s, Gain Brain limiters; Orban parametric, API, B&B, Aengus EQs, Kepex and RM noise gates; UREI Little Dippers.

Microphones: AKG C12, C12A, C28, C60, C61, C451, C456; Neumann U47, M49, KM53, KM54, KM56, U67, U64, KM64, KM84, KM86, U87; Sony C37A, C37P, C57, C107, ECM22, ECM54, ECM56, C500; Schoeps, E-Vs, Aliecs, Sennheisers. Over 250 mics to choose from; most in sets of four or more; over 100 vacuum tube mics!

Instruments Available: Steinway grand piano, (2) Clap-Traps, guitar accessories, etc. Most things available on request.

Video Equipment & Services: The Indigo Ranch Studios support facilities and grounds (orchards, mountains, canyon and ocean view) are very picturesque, private and conducive for film and video production.

Rates: Please call for rates.

Extras: Secluded 60-acre ranch, with satellite TV, minutes from beach; living and cooking facilities. Great for artist from out-of-town and a wonderful retreat for those living in the Southern California area.

Direction: Indigo Ranch provides a unique environment conducive to musical creativity in a home-like but professional setting. Located in the Malibu Hills overlooking the Pacific Ocean, Indigo services top recording artists from all over the world. The 60-acre ranch offers sleeping accommodations, kitchen facilities, and a gourmet cook (on request). The ranch and its fully-equipped, state-of-the-art studio are beautifully maintained by an experienced and conscientious staff, doing its utmost to make clients feel welcome and comfortable. We are pleased to announce that Indigo Ranch Studios is entering its second decade of continuous service to the musicians, producers, and engineers of Los Angeles and the world.

# WISE MUSIC

"VISIT THE MIDWESTS' LARGEST MULTI-KEYBOARD SPECIALIST"

## KEYBOARDS

**KORG, SEQUENTIAL, OBERHEIM, AKAI  
EMULATOR II, KAWAI, CASIO, PPG  
KURZWEIL 250**

## DRUM COMPUTERS/SEQUENCERS

**LINN DRUM, LINN 9000, LINN 6000  
DX, DMX, SEQUENTIAL TOM, Em U SP-12  
KORG DIGITAL DRUMS, SQD-1SEQUENCER**

## PA/RECORDING

**TOA, LEXICON, FOSTEX, AKAI MG 1212  
AUDIO-TECHNICA, APHEX, ART**

**ALL SOFTWARE & INTERFACING SUPPORTED**

**MIDI CABLES, STANDS, CASES, BAGS**

**SEND FOR FREE "GUIDE TO EXPLORING MIDI"**

**1-800-241-1881 ext. 267**

**11740 WEST FLORISSANT AVE., ST. LOUIS, MO 63033**

Circle #128 on Reader Service Card

**[24+] INTERLOK STUDIOS**  
6000 Sunset Blvd., Hollywood, CA 90028  
(213) 469-3986  
Owner: Jim Mandell, Mike Perricone  
Studio Manager: Jim Mandell, Mike Perricone

**[24+] JINGLE BELLS PRODUCTIONS**  
1260 N. Havenhurst #104, Los Angeles, CA 90046  
(213) 656-3990  
Owner: Michael Hurwitz  
Studio Manager: Michael Hurwitz

**[24+] FRED JONES RECORDING SERVICES**  
6565 Sunset Blvd. Ste. 211, Hollywood, CA 90291  
(213) 467-4122  
Owner: Fred Jones  
Studio Manager: Fred Jones

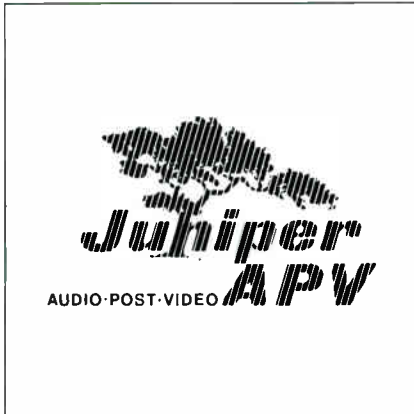

**JUNIPER APV**  
Burbank, CA

**[24+] JUNIPER APV**  
719 Main St., Burbank, CA 91506  
(818) 841-1244  
Owner: Geoff Levin, Stephen Sharp  
Studio Manager: Barbara Wiseman  
Engineers: Stephen Sharp, Jim Emrich, Brian Vessa, Duff Talian, Bruce Chianese.  
Dimensions of Studios: Main room: 24 x 12 x 16; drum booth: 7 x 9; iso room 18 x 11; piano iso 13 x 5 x 8.  
Dimensions of Control Rooms: 19 x 19.  
Tape Recorders: MCI JH-114 w/autolocator, 24-, 16-track; TEAC A3340S, 4-track; MCI JH-110C ¼-inch, 2-track; (2) Hitachi cassette decks; Otari Mark 3 ½-inch, 4-track.  
Mixing Consoles: Amek-TAC Matchless MCDS, 32 x 32; Valley People "Trans-Amp" (transformerless preamps); 9 x 9.  
Monitor Amplifiers: Accuphase 180; Nikko; Dyna Kit; BGW.  
Monitor Speakers: JBL 4430s, Auratone, Yamaha NS-10s; Tannoy "Golds."  
Echo, Reverb & Delay Systems: Lexicon 224X digital reverb w/LARC; (3) Korg programmable digital delays; (2) Roland 2000 reverbs.  
Other Outboard Equipment: Aphex Aural Exciter, MXR pitch transposer, Aphex Compeller limiter, dbx 160X, UREI LA-3A limiters, Burwen noise filter, UREI digital metronome, Dyna-Mite limiter/gates; Eventide Harmonizer.  
Microphones: Neumann U87; AKG 414, 451, 414EB, D25; Sennheiser 421, 441; Electro-Voice 666; Sony C37P, 56P, ECM50P, ECM 33P, 22P, 9P; Crown PZM; Shure SM81, SM56, SM57. Rental: tube mics.  
Instruments Available: Minimoog synth; Crumar orchestrator, Steinway "A" grand piano, Pearl drum kit, DX7 Yamaha synth. Programmer and many other synths available for rent.  
Video Equipment & Services: Adams-Smith controller (1986 version); (3) synchronizers; Sony 5850 w/address track head (full edit insert); Sony 19-inch monitor; Adams-Smith time code generator w/Jam Sync.  
Rates: 16-, 24-track starting at \$32-\$42/hr. Audio sweetening for video starting at \$85/hr.

**[24+] KINGSOUND STUDIOS**  
7538 ½ Woodley Ave., Van Nuys, CA 91406  
(818) 997-1353  
Owner: Eddie and Mari King

**[24+] LARRABEE SOUND**  
8811 Santa Monica Blvd., W. Hollywood, CA 90069  
(213) 657-6750  
Owner: Jackie Mills, Dolores Kaniger  
Studio Manager: Mandy Kofkin

## SOUTHERN CALIFORNIA



Tape Recorders: (4) Studer A-800-III, 24-track; (2) Studer A-820, 2-track; (5) Ampex ATR, 2-, 4-track; Mitsubishi digital X-80; Lynx or Q.Lock synchronization.  
Mixing Consoles: (2) Solid State Logic 4000 Series, 56 w/Total Recall.  
Monitor Amplifiers: Bryston, BGW.  
Monitor Speakers: Custom.  
Echo, Reverb & Delay Systems: EMT 252s and 240s, Yamaha REV-1, AMS RMX-16, Lexicon 224, Lexicon 224XL.  
Other Outboard Equipment: Lexicon 200, PCM70, PCM42, Super Prime Time, AMSDMX 4.8, AMS DMX 6-4, Publison DHM 89B plus a large selection of noise gates, compressors, limiters and outboard equipment.  
Microphones: Large selection including tube mics.  
Instruments Available: Kawai grand piano.

**[24+] LE MOBILE, INC.**  
only REMOTE RECORDING  
Ste. 790, P.O. Box 1842, Encino, CA 91426  
(818) 506-8481, (800) 662-4538  
Owner: Guy Charbonneau

**[24+] LION SHARE RECORDING STUDIO, INC.**  
8255 Beverly Blvd., Los Angeles, CA 90048  
(213) 658-5990  
Studio Manager: Terry Williams  
Engineers: Jay Antista, Paul Bassett, Laura Livingston, James Golorth, Ralph Sutton, Ray Pyle.  
Dimensions of Studios: Studio A: 20 x 36; Studio B: 17 x 18; Studio C: 18 x 20.  
Dimensions of Control Rooms: Studio A: 18 x 13; Studio B: 13 x 15; Studio C: 17 x 20.  
Tape Recorders: Analog: Studer A800, 24-track; Studer A80 RC ½ and ¼, 2-track; Studer A80 VU ½ and ¼, 2-track; 3M 79, 24- and 2-track; Digital: Mitsubishi X800, 32-track; Mitsubishi X80A, 2-track, Mitsubishi X80, 2-track.  
Mixing Consoles: Neve 8108 56 x 48, Neve 8128, 48 x 32, API De Medio 36 x 24.  
Monitor Amplifiers: Bryston 4B, 2B; H&H V800, V500, Studer A68.  
Monitor Speakers: JBL (custom), JBL TAD (custom), Yamaha 1000, Auratones T66, T6.  
Echo, Reverb & Delay Systems: (3) live stereo echo chambers, (6) EMT 140s, (3) Lexicon 224X LARC, (3) AMS RMX-16 reverb, (3) AMS DMX 15-80s DDL, EMT 250 reverb, Quantec room simulator.  
Other Outboard Equipment: Publison DHM 89-B2, harmonizers, ADR Vocal Stresser, (3) Lexicon Prime Time, Super Prime Time, Aphex II Aural Exciter, Eventide DDL lines and omnipressors, harmonizers, phasers and flangers, Scamp Rack, 48 tracks of Dolby; Limiters: Neve, (3) Massenburg dual limiters, Teletronix LA-2As, Inovonics; dbx 160, 160X, 165, 162 stereo, UREI LA-3As, (3) Massenburg dual parametric EQs.  
Microphones: Neumann M-49 tube, U48 tube, U47 tube, U67 tube, U87, U47, KM84, KM86, KM88; Shure SM81, SM7, 546, SM57, SM56; Sennheiser 416, 435, Binaural 2002, 421; AKG 412, 414, 452, C24 tube; E-V RE-20, RE-15; Telefunken 250 tube.  
Instruments Available: Sequential Circuits Prophet-10 synthesizer, LMI drum machine, Bosendorfer grand piano, (2) Steinway grand piano, Eddy Reynolds Rhodes 88, Hammond B-3.  
Video Equipment & Services: Ampex VPR 2B, Sony BVU 800, BVU 200; Beta and VHS ½-inch recorders. BTX synchronizer, Studer TLs-2000. Post-production sweetening and mixing using Necam automation w/48-track analog and/or 32-track digital-to-picture. Sound EFX included.  
Rates: Open. Upon request.

**[24+] LOS ANGELES CITY COLLEGE**  
855 No. Vermont Ave., Los Angeles, CA 90029  
(213) 669-5545  
Owner: Los Angeles Community College District  
Studio Manager: Chuck Britz

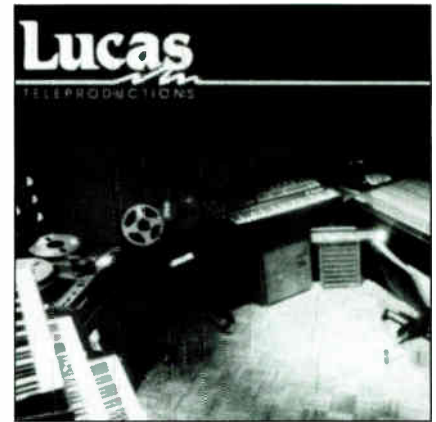

**LUCAS TELEPRODUCTIONS**  
Burbank, CA

**[24+] LUCAS TELEPRODUCTIONS**  
4106 W. Burbank Blvd., Burbank, CA 91505  
(818) 845-1700

Owner: Jan Lucas  
Studio Manager: Fred Miller  
Engineers: Jan Lucas, Ran Ballard  
Dimensions of Studios: 13 x 16; 13 x 10.  
Dimensions of Control Rooms: 13 x 19.  
Tape Recorders: 3M Model 79, 24-track; Otari 5050, 2-track; Revox A-77, 2-track; Aiwa F660, 4-track.  
Mixing Consoles: Amek/TAC Matchless 26 x 24.  
Monitor Amplifiers: Crown, Roland.  
Monitor Speakers: JBL, Yamaha.  
Echo, Reverb & Delay Systems: Yamaha REV7, Lexicon PCM60, ART 01A 2.4, (2) ART 1500, Roland SDE 1000, Ibanez HD-1000, Effaction 3, tape, live chamber.  
Other Outboard Equipment: (12) Gate noise gates, Hush 2c, Aphex Aural Exciter, (2) Audioarts 3100 parametric EQ.  
Microphones: AKG, Neumann, Shure, EV.  
Instruments Available: E-mu II; (2) DX7s; Prophet-5; OB-8; Casio 1000, 5000, 101; Yamaha CP-70; Roland Octapads; Korg Ex80Q; Oberheim DMX and DX; 360 digital keyboard; Chroma; and more.  
Video Equipment & Services: Three-quarter-inch editing bay w/3 Sony machines, time code, window dubs, and 3M character generator, plus ½-inch duping. Video interlock available.  
Rates: Audio w/engineer: from \$50/hr., video w/editor: from \$75/hr.  
Extras: MTV in the lounge, and a clean, attractive Burbank location. Musicians, programmers, sequencers in house.  
Direction: Dance oriented records, jingle production, as well as soundtrack work and motion picture production. Polynesian cooking and dairy farming figure heavily into our five year plan also.

**[24+] LYCEUM SOUND RECORDERS**  
2601 B Ocean Park Blvd. #156  
Santa Monica, CA 90405  
(213) 390-5800  
Owner: Vitus Matate  
Studio Manager: Vic Abascal

**[24+] MAD DOG STUDIO**  
1715 Lincoln Blvd., Venice, CA 90291  
(213) 306-0950  
Owner: Mark Avnst, Dusty Wakeman, Yvette Colón  
Studio Manager: Jimmy Kul.  
Engineers: Dusty Wakeman, Mark Avnet, Erick Westfall, Don Tittle, Jerry Pachter, Michael Williams.  
Dimensions of Studios: 25 x 18, 10 x 5 iso., 25 x 25 cassette duplication + pre-production room.  
Dimensions of Control Rooms: 20 x 15.  
Tape Recorders: Otari MTR-90, 24-track; Ampex ATR-102, 2-track; Technics 1500, 2-track; Sony TC-K777 cassette, (22) Denon M44 HX cassette recorders.  
Mixing Consoles: Amek Alpha 28 x 24 w/parametric EQ, 6 echo sends, 4 stereo subgroups.  
Monitor Amplifiers: Crown BGW, HH, Phase Linear.  
Monitor Speakers: Westlake BBSM-12, Auratone 5C, JBL 4311, Yamaha NS-10.  
Echo, Reverb & Delay Systems: Lexicon 224 digital reverb w/level 4.3 programs, Yamaha REV7, ART DR-1, MICMIX Master-Room XL-305, DeltaLab DL-2 Acoustic-computer, Eventide Harmonizers, MXR digital delay w/all cards, Sequential Circuits Pro-FX programmable digital delay, Lexicon PCM60 digital reverb, Korg digital delay.  
Other Outboard Equipment: Limiters: dbx 165, dbx 161, UREI LA-4A, UA 175 tube. Misc. EXR 4 Exciter, EXR SP Exciter, Kepex II, Symetrix keyable gates, Roland stereo flange/chorus, White EQ, Biamp EQ, Orban stereo syn-





"Our studio clients require the highest quality cassette copies possible and with the KABA System we can run multiple copies right off of their freshly-mixed master. Our duplication customers love it, too!"

**Bill Berry**  
 (Shown with Engineer  
 Michael Newman at left)  
 Exxel Recording,  
 Oceanside, CA

# AUDIOPHILE QUALITY DUPLICATION EQUIP.

24 Commercial Blvd., Novato, CA 94947  
 in CA call (415) 883-5041



**KENNETH A. BACON ASSOCIATES**  
 Toll Free (800) 231-TAPE

"We're fanatical about quality. That's one reason why our business has doubled in the last two years. And that's why we've had to install a second KABA Realtime System. Why KABA? Because they feel the way we do about quality."

Shirley Cohen, Sales Manager

**t&t** Recording/Duplicating  
 Hollywood, California



Circle #129 on Reader Service Card

World Radio History

# FROM CONCEPT TO VINYL

## SDR STUDIOS

14511 DELANO ST.  
VAN NUYS, CA 91411  
(818) 994-9973

Circle #130 on Reader Service Card

**"THE FRESH APPROACH"**  
to the business side of your business is

### PRISTINE'S RECORDING STUDIO MANAGEMENT SYSTEM

We've created the **first** and most **comprehensive** studio software package on the market today, by approaching the problem fresh...**not** by taking already existing software and trying to modify it to "sort of" fit the needs of the industry. With this system, you'll be able to truly **control and manage** your studio from the initial phone call for a booking, through billing all the way to financial statements.

- Studio Bookings
- General Ledger
- Billing - A/R
- Tape Library
- Accounts Payable
- Inventory Control

To see how our "fresh approach" can be the right approach for you, **call us now!**



**PRISTINE SYSTEMS, INC.**  
6515 Sunset Bl. #201B  
Hollywood, California  
(213) 461-2819

Eastern USA: Westec Audio/Video (212) 586-1662  
Australia: Editron/Sontron Inst. (03) 568-4022

Circle #131 on Reader Service Card

## SOUTHERN CALIFORNIA



24+ TRACK

thesizer, triggerable Simmons-like drum synthesizer, more. Microphones: Neumann U87, U67 tube; PLM; AKG 414, 452; Shure 57, 58, 81, 33, SM7; Electro-Voice; Beyer; Sennheiser; more.

**Instruments Available:** MIDI LinnDrum, Alembic basses (fretted and fretless), Guild and Martin acoustic guitars (6-and 12-string), Gibson and Fender electric guitars (6-and 12-string), synthesizers and programmers, Yamaha grand piano.

**Video Equipment & Services:** On request.  
**Rates:** On request.

[24+] **MAD HATTER STUDIOS**  
2635 Griffith Park Blvd., Los Angeles, CA 90039  
(213) 664-5766  
Owner: Chick Corea  
Studio Manager: Ron Moss, Evelyn Brechtlein

[24+] **MAGNOLIA SOUND**  
5102 Vineland Ave., No. Hollywood, CA 91601  
(818) 761-0511  
Owner: Brian Ahern  
Studio Manager: Franny Parrish



**MAMA JO'S RECORDING STUDIO**  
North Hollywood, CA

[24+] **MAMA JO'S RECORDING STUDIO**  
8321 Lankershim Blvd., No. Hollywood, CA 91605  
(818) 982-0305  
Studio Manager: Terry Piro  
Engineers: Steven Bradley Ford, Nyya Lark  
**Dimensions of Studios:** Main Room: 23 x 22 w/15 x 10 alcove; 1st iso booth: 16 x 12; 2nd iso booth: 12 x 10.  
**Dimensions of Control Rooms:** 23 x 20.  
**Tape Recorders:** (2) MCI JH16-24 w/auto locators, 24-track; (2) MCI JH-110A w/¼-inch and ½-inch assemblies, 2-track.  
**Mixing Consoles:** Trident Console Series 80, 40 x 24 w/64 input mixing, GML Moving Fader Automation System.  
**Monitor Amplifiers:** "NOYB" amp.  
**Monitor Speakers:** Custom 604-E w/Mastering Lab cross-overs.  
**Echo, Reverb & Delay Systems:** (2) EMT 140 stereo plates, Lexicon 224.  
**Other Outboard Equipment:** EQs: API 550A EQ, B&B, UREI 545, Klein & Hummel, UE 400, Langevin 251. Limit-

ers: UREI LA-2A, UREI LA-3A, UREI 1176LN, Inovonics 201. Gates: Allison Kepex II, Drawmer noise gates, Aphex CX-1; tube mic pre-amps; Roland 3000 DDLs; DeltaLab DL2; Lexicon Prime Time; Eventide 949 Harmonizers; Eventide DDL w/pitch card, AMS RMX16 digital reverb, Lexicon PCM70 digital effects processor, Massenburg EQs. Microphones: Telefunken 250s, Telefunken 251s, Neumann U47s, M49s, U67s, U87s, KM56s, KM54s, KM84s, KM88s, AKG C-412s, C-414s, C-414s, C-451s, C-452s, C-12A, C-24s and many more.

**Instruments Available:** Yamaha C7 grand piano, Hammond B-3 w/Leslie.

**Rates:** Please call for studio rates. Special rates on block bookings.

**Extras:** EMT 250, EMT 251, Dolby MH 24 noise reduction units, AMS DMX-15-80 DDL, Pultec, Fairchild 660 mono limiters, Fairchild 670 stereo limiter, UREI LA-2 limiter, Prophet 5, DMX drum machine, BTX Shadow Unit, SMPTE transfers.

**Direction:** We have made a "commitment to excellence" so we are constantly pursuing the best in equipment whether it's new or old vintage type. The studio gives an at-home feeling w/a full kitchen area and comfortable lounge. We have recently done work on LP projects for George Duke, Jennifer Warnes, Four Tops, Howard Hewett Jr., Chris Sutton, Twila Paris, Terry Talbot, Nick Gilder, Danny Wilde, Smokey Robinson, Colonel Abrams, Chris Eaton, Pat Benatar, Koinonia, Yellowjackets, Deniece Williams, Carmen, The Cure, Greg Voiz, Robert Brooks, misc. soundtracks.

[24+] **MARTINSOUND, INC.**  
1151 W. Valley Blvd., Alhambra, CA 91803  
(818) 281-3555  
Owner: Joe Martinson  
Studio Manager: Annette

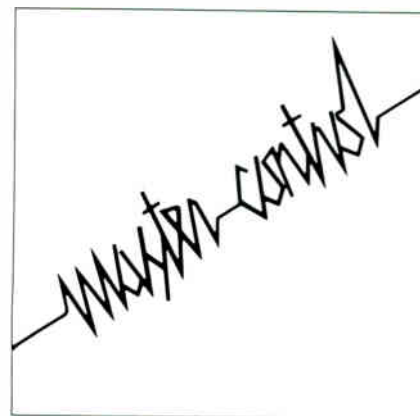

**MASTER CONTROL**  
Burbank, CA

[24+] **MASTER CONTROL**  
3401 W. Burbank Blvd., Burbank, CA 91505  
(818) 842-0800  
Owner: Aseley Otten, Steve Catania  
Studio Manager: Aseley Otten, Steve Catania  
Engineers: Steve Catania, Aseley Otten, Michael Frondelli, Dan Nebenzal, independents.  
**Dimensions of Studios:** Main room: 58 x 24; iso room: 14 x 18; vocal booth: 7 x 8.  
**Dimensions of Control Rooms:** 20 x 24.  
**Tape Recorders:** Studer A80 VU-K1 III, 24-track; Studer A80 RC-MK II (¼- and ½-inch), 2-track; Revox PR-99, Studer A710 cassette deck.  
**Mixing Consoles:** Solid State Logic 4048E, 52 x 32 w/primary computer and total recall.  
**Monitor Amplifiers:** Crown PSA-2, Eagle 2A, Studer A-68, Crown 150, Crown 75.  
**Monitor Speakers:** JBL 4435, JBL 4311, Tannoy SRM 12B, Yamaha NS-10M, Auratones 5C, Realistic Minimus 7.  
**Echo, Reverb & Delay Systems:** AMS RMX 16 digital reverb, Lexicon 200 digital reverb, Great British Spring reverb, DeltaLab 1024 Electron II.  
**Other Outboard Equipment:** UREI LA-2A, 1176 limiters, Eventide 949 Harmonizer w/de-glitch, dbx 160X limiter/compressors, Valley People 430, Dyna-Mite limiter/gate, CBS Audimax II RZ limiters, Pultec EQP-1, EQP-1A, EQP 1-S, API 560 graphics.  
**Microphones:** AKG 414 EB-P48, "The Tube," Beyer M160, Neumann U87, U47 FET, KM84, KM85, Sennheiser MD-421, 441; Shure SM57, SM77; Crown PZM; RCA 77DX; American DR 332; E-V 665, 666.  
**Instruments Available:** Steinway C grand piano, Hammond B-3 w/Leslie, LinnDrum and others upon request.  
**Rates:** Very competitive, call for specifics.





MAXIMUS RECORDING STUDIOS  
Fresno, CA

[24+] MAXIMUS RECORDING STUDIOS  
also REMOTE RECORDING  
2727 N. Grove Industrial Dr. Ste. 111  
Fresno, CA 93727  
(209) 255-1688

Owner: Triad Communications, Inc.  
Studio Manager: Leigh Ratliff, Robert Langstaff  
Engineers: Jeff Hall, Eric Seaberg, Nye F. Morton, Loyd Clift, independents.

Dimensions of Studios: Studio A: 28 x 34, iso room: 16 x 21; Studio B: 21 x 29, iso room: 12 x 15; Studio C: 9 x 10.  
Dimensions of Control Rooms: Studio A: 24 x 19 w/machine room; Studio B: 24 x 18; Studio C: 16 x 10.

Tape Recorders: Studer A-800 MKIII, 16-, 24-track; Studer A-80, 8-, 16-track; (5) Studer 810 and A-80RC, 2-track; (5) Revox PR-99, 2-track; Nagra IV-S w/sync, 2-track; Otari 5050-B, 2-track.

Mixing Consoles: Harrison MR-3, 48 x 24; Harrison MR-3, 32 x 24; Sound Workshop Logex 8, 12 x 8.

Monitor Amplifiers: Crown DC-300, Crown DC-75, Crown PS-20C

Monitor Speakers: Augsburg custom, Electro-Voice

Sentry 500, Electro-Voice Sentry 100, Auratone. Echo, Reverb & Delay Systems: Lexicon 224-X w/LARC, Ecoplate III, Orban-Parasound, live room, Yamaha, Lexicon Prime Time II, Super Prime Time, Eventide 949, more. Other Outboard Equipment: UREI, Orban Parasound, dbx, EXR, limiting, Aural Exciters, noise reduction, etc. Microphones: AKG 414 EB P-48, AKG 460, AKG C-34, AKG D-12, E-V RE-20, Sennheiser 421, Sennheiser 441, Wahrenbrock PZM, Beyer, Audio Technica, etc. Instruments Available: Emulator II, Yamaha DX7, Oberheim Xpander, E-mu SP-12, Yamaha QX-1, Yamaha TX-7, 360 Systems MIDI Bass, Korg Poly 61-M, Yamaha SPX-90, Rockman, Drumulator, Yamaha grand piano, Kawai grand piano, Prophet 5, Rhodes piano, Marshall, Fender, State, Road, Peavey Instrument amps, Tama drum kit. Video Equipment & Services: Full synchronous lock-up to one-inch or 3/4-inch video (Audio Kinetics Q.Lock 3.10), tie lines to full one-inch video production, scoring, SFX, audio post-production, sweetening.

Rates: Rates start at \$50/hr. (includes engineer). Block discount available.  
Extras: Maximus is located near air terminal and hotels. We can arrange transportation and accommodations for out-of-town clients. On-staff arrangers, producers, and writers.

Direction: Forty-five minutes by air from Los Angeles or San Francisco, Maximus is central California's major market studio and production facility. Recent credits include: HBO motion picture score *Goldie II*. Gold record for *Te Llama Porque Te Quiero* by Ray Camacho, Omega Sunrise (Contemporary Christian Rock) album on Morada Records. *Harp Praise* album by Greg Buchanan, Bread & Honey Records, distributed by Alexandria House. Jingles include: Bank of America, Las Vegas, Convention and Visitors Authority, Circus-Circus Hotel, Pacific Stereo, Weinstein's, RTO Rents, Grass Valley Group NAB Presentation, Van Gas, Oberti Olives. With over 15 years of experience, we have invested over \$1,500,000 in acoustics and equipment during the past two years. "Take your talent to the Max."

[24+] MCA WHITNEY RECORDING STUDIO  
1516 W. Glenoaks Blvd., Glendale, CA 91201  
(213) 245-6801, (818) 507-1041  
Owner: MCA Records Inc.  
Studio Manager: Gene Wooley

[24+] MEDIA RECORDERS  
748 N. Seward St., Hollywood, CA 90038  
(213) 463-5000  
Owner: Charles B. Heinen  
Studio Manager: Arlene Palkay

[24+] MIXMASTERS  
also REMOTE RECORDING  
4877 Mercury St., San Diego, CA 92111  
(619) 569-7367  
Owner: Charles DeFazio  
Studio Manager: Garth Hedin  
Engineers: Alan Harper, Terry Cox, Garth Hedin, Charles DeFazio, independents.  
Dimensions of Studios: Studio A: 28 x 26; Studio B: 15 x 13.

Dimensions of Control Rooms: A: 19 x 17; B: 15 x 15.  
Tape Recorders: Otari MTR 90II, 24-, 16-track; Otari MTR 10-2, 2-track; Otari MTR 12-2, 2-track; Otari MKIII 8, 8-track; 3M 79, 16-track; Otari MKIII 2, 2-track; (2) Otari 5050 BII, 2-track; Tascam 44, 4-track.

Mixing Consoles: NEOTEK 3C, 36 x 32; Sound Workshop Series 30, 24 x 16.

Monitor Amplifiers: Hafler P500, (3) Hafler P225, Crown PS400, Crown PS200, Crown D75, QSC 1400.

Monitor Speakers: JBL 4435, JBL 4425, CSI MDM-4 (2 pr.), Yamaha NS-10 (2 pr.), Auratone 5C (2 pr.)

Echo, Reverb & Delay Systems: Lexicon 224 reverb, (2) Lexicon 200 reverbs, (2) Yamaha SPX90, Lexicon PCM70, Lexicon Super Prime Time, Lexicon Prime Time II, Ursa Major Space Station, DeltaLab Super Time Line.

Other Outboard Equipment: Eventide Harmonizer H949, Aphex Aural Exciter, (2) Valley People Kepex, (2) Valley People Gain Brain, (2) Orban 622B parametrics, dbx 900 rack w/de-essers, gates, compressors, (2) dbx 160X compressors, (2) Nakamichi MR-1 cassette decks, (4) dbx noise reduction channels, (2) Technics SL-1200 turntables, (2) NEC video monitors.

Microphones: Neumann U89s, U87s, KM84s, Sennheiser 421s, 441s, E-V RE20, E-V 664, AKG C414s, C452s, Beyer MC740, Shure SM57s, Telefunken vintage tubes.

Instruments Available: Yamaha C7 7'4" conservatory grand piano, Fender Rhodes, Synclavier, Yamaha DX7, LinnDrum, Kurzweil 250.

Video Equipment & Services: NEC video monitors, Lynx synchronizer, Sony 5850 3/4-inch machine, Otari resolver.  
Rates: Available upon request.

# The Best in Bass... Just Got Better!

**INTERSONICS** Announces:

The SDL-4 & SDL-5 with

## Power Cooling

New Computer Assisted  
Cabinet Designs!!!



The New SDL "Foundation" Series

The only subwoofer to have solved the problem of Power Compression.

Our SDL\* Subwoofers are now actively cooled. The result is a new standard for ultimate and effortless low-frequency sound reproduction!

- Now Available -

Power Cooling Retrofit Kits For Existing TPL-2's, 3's

### THE RESULTS:

- ★ High Fidelity Performance
- ★ Extended Frequency Response
- ★ Greater Efficiency
- ★ Longer Warranty Period
- ★ Peak Outputs Exceeding 139db (at 1 meter!)

## Servo-Drive Subwoofers

by

## INTERSONICS, INC.

3453 Commercial Ave.  
Northbrook, IL 60062  
312-272-1772

[24+] MORNING STAR SOUND RECORDING  
 also REMOTE RECORDING  
 4115 N. Maine St., Baldwin Park, CA 91706  
 (818) 960-7308  
 Owner: Steve and Becky Brown  
 Studio Manager: Steve Brown

[24+] MOTOWN/HITVILLE  
 7317 Romaine St., W. Hollywood, CA 90046  
 (213) 850-1510  
 Owner: Motown Records  
 Studio Manager: Guy Costa

[24+] MUSIC BOX RECORDING STUDIO  
 1146 No. Western Ave., Hollywood, CA 90029  
 (213) 462-7761  
 Owner: Edward Perry  
 Studio Manager: Socorro Lanzas

[24+] MUSIC GRINDER RECORDING STUDIO  
 7460 Melrose Ave., Los Angeles, CA 90046  
 (213) 655-2996  
 Owner: Ron Filecia, Gary Skardina  
 Studio Manager: Ron Filecia, Gary Skardina

[24+] MUSIC LAB  
 1831 Hyperion Ave., Hollywood, CA 90027  
 (213) 666-3003  
 Owner: Chaba Mehes  
 Studio Manager: Craig Durst

[24+] NOATZ PRODUCTIONS  
 53 Briarglen Ln., Irvine, CA 92715  
 (714) 733-2271  
 Owner: Perry La Marca, Martin Brenner

[24+] NSP STUDIOS  
 3320 E. Century Blvd., Lynwood, CA 90262  
 (213) 774-0931  
 Owner: Nonstop Productions, Inc.  
 Studio Manager: L. Marlene Wright

[24+] ODDEO ENGINEERING  
 also REMOTE RECORDING  
 1740 N. Gramercy Place #100, Hollywood, CA 90028  
 (213) 465-1762  
 Owner: Jeff McLane  
 Studio Manager: D. Moody

[24+] ONE ON ONE STUDIOS  
 5253 Lankershim Blvd., No. Hollywood, CA 91601  
 (818) 761-3882  
 Owner: Jim David  
 Studio Manager: Nancie Boykiss

[24+] PACIFIC SOUND  
 9626 Lurline Unit K, Chatsworth, CA  
 (818) 883-9733  
 Owner: Scott Borden  
 Studio Manager: John Desautels



**PACIFIQUE RECORDING STUDIOS**  
 North Hollywood, CA

[24+] PACIFIQUE RECORDING STUDIOS  
 10616 Magnolia Blvd., No. Hollywood, CA 91601  
 (818) 761-8042

## SOUTHERN CALIFORNIA



### 24+ TRACK

Owner: Vasken Inc.  
 Studio Manager: Ken Der Anterisian  
 Engineers: Ken Der Anterisian, Vic Der Anterisian, Joe Der Anterisian.  
 Dimensions of Studios: 34 x 35 x 13.  
 Dimensions of Control Rooms: 24 x 25 x 10.  
 Tape Recorders: Otari MTR-90 II, 24-track; Otari MTR-12 H, 1/2-inch; Otari MTR-12 C, 1/4-inch; Nakamichi MR 1, cassette.  
 Mixing Consoles: Trident 80B, 32 x 24.  
 Monitor Amplifiers: Crown PSA2, Crown 300A, Crown 75D, Yamaha 2200.  
 Monitor Speakers: JBL 4435, JBL 4411, Yamaha NS-10, Auratone 5C.  
 Echo, Reverb & Delay Systems: Lexicon 224XL, (2) Yamaha REV7, Lexicon Prime Time 95 II, Lexicon PCM70, Roland 555.  
 Other Outboard Equipment: (5) Kepex Gates II, (2) dbx 160, dbx 165A, UREI 1176.  
 Microphones: Neumann, AKG, Sennheiser, Shure, ATM.  
 Instruments Available: Yamaha grand piano C70, Yamaha electric piano C70B, Yamaha DX7, ARP Omni II, Korg CX3, Prophet 2000, Roland Vocoder, Rogers full set drums.  
 Rates: On request.  
 Extras: Brand new studio, custom designed by Lakeside & Associates.

[24+] PARAMOUNT RECORDING & VIDEO STUDIO  
 6245 Santa Monica Blvd., Hollywood, CA 90028  
 (213) 461-3717  
 Studio Manager: Raghu Gadhoke

[24+] PASHA MUSIC HOUSE  
 5615 Melrose Ave., Hollywood, CA 90038  
 (213) 466-3507  
 Owner: Spencer Proffer  
 Studio Manager: Karen Chamberlain

[24+] PENGUIN RECORDING  
 also REMOTE RECORDING  
 P.O. Box 91332, Pasadena, CA 91109  
 (213) 259-8612  
 Owner: John Strother  
 Studio Manager: Mike Yassimi

[24+] PERSPECTIVE SOUND  
 11176 Penrose St. #5, Sun Valley, CA 91352  
 (818) 767-8335  
 Owner: Vince Devon  
 Studio Manager: Laurie Johnson Devon

[24+] PIPER RECORDING  
 also REMOTE RECORDING  
 1425 Marcelina Ave., Torrance, CA 90501  
 (213) 328-8208  
 Owner: Benjamin Piper  
 Studio Manager: Benjamin Piper

[24+] POST LOGIC  
 6363 Sunset Blvd. Ste. 830, Hollywood, CA 90028  
 (213) 461-7887  
 Owner: Miles Christensen, Michael Busby  
 Studio Manager: Miles Christensen  
 Engineers: Miles Christensen, Tom Davis, Chris Combs, Willie Rogers.  
 Dimensions of Control Rooms: 19 x 23.  
 Tape Recorders: Otari MTR-90, 24-track; Otari MTR-20, 4-track; Otari 5050 1/4-inch, 2-track; Sony BVU 800 3/4-inch video; Ampex VPR6 1-inch video; Otari MTR-20 1/2-inch, 2-track.  
 Mixing Consoles: Solid State Logic SL6000E w/Total Recall, 48 x 32.



**POST LOGIC**  
 Hollywood, CA

Monitor Amplifiers: Audire, Yamaha, Crown.  
 Monitor Speakers: Custom built Aura system, Sentry 100A, NS-10Ms, Anchor M1000.  
 Echo, Reverb & Delay Systems: AMS-DMX-15 80S, AMS RMX, Lexicon 224XL, Lexicon PCM70, Yamaha REV7, Roland SDE 3000.  
 Other Outboard Equipment: Adams-Smith 2600 series, w/5-machine lock-up capability.  
 Microphones: "Secret."  
 Instruments Available: Emulator II, Linn 9000 w/sampling, Super Jupiter, Yamaha DX7.  
 Video Equipment & Services: Ampex VPR6 one-inch video, Sony BVU 800 3/4-inch video.  
 Rates: Available upon request.  
 Extras: Post Logic's design is aimed at all aspects of audio production and post-production. Projects include promos, trailers, commercials, music videos, soundtracks, electronic scoring and albums. Clients include ABC, NBC, Aprl Fwms, Columbia Pictures, Disney, Warner Bros Television and Records, McGraw Hill, MCA Records, Atlantic Records, Island Records, Epic/Sony, Northwestern: Bell, and Cannon Films.  
 Direction: We offer complete professional service and a no-compromise attitude to deliver the best audio possible in the '80s.

[24+] POST SOUND CORPORATION  
 6500 Sunset Blvd., Hollywood, CA 90028  
 (213) 462-0000  
 Owner: Phillip Seretti  
 Studio Manager: Janja Vujovich

[24+] PREFERRED SOUND  
 22700 Magarita Dr., Woodland Hills, CA 91364  
 (818) 883-9733  
 Owner: Scott Borden  
 Studio Manager: John Desautels  
 Engineers: Matthew Spindell, Robert Stamps, various independents.  
 Dimensions of Studios: Main room: 18 x 23; booths: 9 x 10, 11 x 12.  
 Dimensions of Control Rooms: 16 x 18.  
 Tape Recorders: Otari MTR-90 MKI, 24-track; Studer A80, 2-track; Scully 28GB, 2-track; (2) Hitachi D2200M cassettes.  
 Mixing Consoles: Trident 80B, 30 x 24 w/54 remix channels.  
 Monitor Amplifiers: Acoustat, SCS.  
 Monitor Speakers: UREI 811 Time-Aligned, Yamaha NS-10M, JBL 4401, Auratones.  
 Echo, Reverb & Delay Systems: AMS RMX 16 digital reverb, Lexicon 224 digital reverb, Cunningham Ecoplate II, AMS DMX 1580-S digital delay and pitch, (2) Lexicon Prime Times, Roland SDE 3000 digital delay, Eventide Harmonizer, Yamaha REV7.  
 Other Outboard Equipment: (4) Kepex Lis, (2) 1176 limiters, LA-4 comp./limiter, (2) dbx 165 limiters, Teletronix LA-2A tube limiter, UREI digital metronome, MXR flanger/doubler, Roland stereo flanger, Simon Systems integrated direct boxes RDB-400 (8).  
 Microphones: Tube 47 (Neumann), 87, KM84, KM88, AKG 414s, Sennheiser 421s, MKH 405s, AKG D12E, AKG C-451E, Shure SM57s, SM58s, SM81s, Sennheiser 441, Sony ECM 22P, Sony C-37A, Crown PZMs, Beyer M88, M500s, Electro-Voice RE-20s, etc.  
 Instruments Available: Ampeg B-15 bass amp, Fender guitar amp, Kawai baby grand piano, various percussion instruments, numerous guitars and amps available through Norm's Rare Guitars.  
 Rates: Call for rates, block rates available.  
 Extras: Living facilities for five available with studio by the month. Amenities include sun deck, swimming pool, ja-



cuzzi, pinball machines and a comfortable, creative atmosphere.

**Direction:** More hit records in the future! Recent clients include Joe Chiccarelli, Kevin Beamish, Paul Sabu, all well-known producers. Precious Metal, Robert Tepper, Breakthrough, Stevie Nicks, Scott Goddard and Laura Branigan are some of our satisfied clients of late. We are continuously upgrading and expanding. Do your ears a favor and come listen!

**[24+] PREMERE INC.**  
5130 Klump Ave., North Hollywood, CA 91601  
(818) 506-7714

**[24+] PRESENT TIME RECORDERS**  
5154 Vineland Ave., North Hollywood, CA 91601  
(818) 762-5474  
Owner: Bob Wurster  
Studio Manager: Bob Wurster

**[24+] PRODUCE SOUND**  
also **REMOTE RECORDING**  
8932 E. Beverly Blvd., Pico Rivera, CA 90601  
(213) 695-1221  
Owner: Michael Montoya  
Studio Manager: Michael Murphy

**[24+] QUAD TECK STUDIOS**  
4007 W. 6th St., Los Angeles, CA 90020  
(213) 383-2155  
Studio Manager: Joani Waring

**[24+] QUANTUM**  
1425 Marlelina, Torrance, CA 90501  
(213) 320-5211  
Owner: Don Sciarrotta, Dennis Nicklos  
Studio Manager: Don Sciarrotta, Dennis Nicklos

**[24+] RECORD ONE**  
13849 Ventura Blvd., Sherman Oaks, CA 91423  
(818) 788-7751  
Owner: Val Garay  
Studio Manager: Denny Densmore  
Engineers: Niko Bolas, Greg Ladanyi, Richard Bosworth, Julie Last, Cliff Jones.  
**Dimensions of Studios:** Studio A: 30 x 42 (L-shape) w/ 13 x 8 iso booth. Studio B: 24 x 30 w/ 13 x 8 iso booth.  
**Dimensions of Control Rooms:** A & B 20 x 15.  
**Tape Recorders:** (4) 3M M79 2-inch, 24-track; (2) 3M M79 ½-inch, 2-track; (2) 3M M56 ¼-inch, 2-track; 3M M79 ½-inch, 4-track.  
**Mixing Consoles:** API w/Massenburg automation, 40 x 24; API w/BMT automation, 40 x 16.  
**Monitor Amplifiers:** Phase Linear.  
**Monitor Speakers:** Altec 604 Big Reds w/ Mastering Lab crossovers, custom NS-10, Auratones.  
**Echo, Reverb & Delay Systems:** EMT 140 tube plates, EMT 250, AMS RMX 16, AMS DMX 1580S, REV7, SDE 3000, SPX 90, Lex 102, Prime Time, Cooper Time Cube.  
**Other Outboard Equipment:** Fairchild 670 stereo tube limiters, Lang EQ, Pultec EQ, Kepex 11s, Drawmer gates, Orban de-essers, 1176, LA-2s, LA-3As, 48 tracks of Dolby 361 noise reduction.  
**Microphones:** AKG C12, C12A, 452, 451, Telefunken 250, 251, Neumann U67, U47, KM84, M49, Sennheiser 421, 441, PLM DC-63, Sony ECM 33, ECM 50, C500, ECM 22, RCA 770, Electro-Voice RE-16, RE-20, Shure SM 53, 56, 57, 58.  
**Instruments Available:** Grand pianos in both studios, Hammond B-3 w/Leslie, Kawai electric grand, ARP string ensemble.  
**Video Equipment & Services:** VHS, Beta, and ¾-inch U-Matic w/Q.Lock synchronization to 2-, 4-, or 24-track.

## ABC Watermark STUDIOS

# SOUNDING BETTER THAN EVER.

After 15 years as the most sophisticated radio production facilities in Los Angeles we're now located in brand new studios. ABC Watermark is now bigger and sounding better than ever—offering one of the finest audio production facilities in the country, complemented by a staff of highly competent recording engineers to get you the results you want.

ABC Watermark is committed to high quality audio production specializing in radio commercials, TV voice overs, sales and corporate presentations. ABC Watermark is a powerhouse of production, turning out some of the most listened to radio shows in the world—AMERICAN TOP 40 with



CASEY KASEM and AMERICAN COUNTRY COUNTDOWN with BOB KINGSLEY.

Conveniently located across the freeway from Universal City in the Centrum Building with Free Valet Parking.

For anything audio call ABC Watermark.

### ABC Watermark

3575 Cahuenga Blvd. West #555  Los Angeles, CA 90068  818-980-9490  
Free Valet Parking  8AM-6PM Weekdays  
Open anytime on Request  Contact Johnny Biggs

Circle #133 on Reader Service Card

# To save you time and money we've just spent over 546 hours training your next employee!

When money and time are tight, you can't afford to train an employee from scratch. Our graduates have spent a full year in an intensive study of Audio Engineering, Music Production, Studio Electronics, Music Business and Finance, Copyright Laws and Entertainment Contracts. They're young, knowledgeable, and—because they're well trained—effective from the start. Graduates and referrals among the Majors!

If you are in need of someone already possessing the basic knowledge and skills of the industry, we might just have the person to fit your situation.



So call or  
write us at:

**COLLEGE FOR RECORDING ARTS**

665 Harrison Street, San Francisco, California 94107  
Phone: (415) 781-6306

P.S. If you know a promising and talented person that you'd like to help along, why not let us train them for you!

The school is accredited by the Accrediting Commission of the National Association of Trade and Technical Schools (NATTS), approved by the Calif. Superintendent of Public Instruction, approved for Veteran training, and is authorized under Federal law to enroll non-immigrant alien students. It is also endorsed by the National Academy for Recording Arts and Sciences Training Institute.

Circle #134 on Reader Service Card



**RECORD PLANT**  
Hollywood, CA

**[24+] RECORD PLANT INC.**  
also REMOTE RECORDING  
1032 N. Sycamore Ave., Hollywood, CA 90038  
(213) 653-0240

Owner: Chris Stone  
Studio Manager: Rose Mann  
Direction: Record Plant is in its new location with all new video, film, record, recording studios, plus two remote trucks. In addition, we continue Academy Award-winning film scoring at our 100-man room at Paramount Pictures Stage M. We also offer the finest equipment available for rent through Livingstone Audio and specialize in the sale of digital equipment through Audio Intervisual Design (A.I.D.), both of which are located in our new Sycamore building. Our new Tom Hidley control rooms measuring 29 x 32 are designed for synthesizer recording and feature 35mm and video projection, as well as 56 input SSL Total Recall equipped consoles, Studer analog and Sony digital tape machines. Our remote recording division continues to provide faultless audio for award shows such as The Grammys and Country Music Awards as well as live recordings for the world's most successful artists.

**[24+] RECORD PLANT SCORING INC.**  
5555 Melrose Ave., Stage M, Hollywood, CA 90038  
(213) 468-5496  
Owner: Paramount Pictures Inc., Record Plant Scoring Inc.  
Studio Manager: Rick Winquest

**[24+] RITSONIAN RECORDING STUDIO**  
7454 Vista Delmonte, Vista Delmonte, CA 91405  
(818) 989-5373  
Owner: Benjamin Wright  
Studio Manager: Benjamin Wright

**[24+] RIVERTON PRODUCTIONS**  
4222 Lankershim Blvd., No. Hollywood, CA 91602  
(818) 505-0181  
Owner: Patrick Flynn  
Engineers: Patrick Flynn, Alan Lindley, Lisa Lawrence.  
Dimensions of Studios: 10 x 12.  
Dimensions of Control Rooms: 12 x 20.  
Tape Recorders: Sony/MCI JH-24, 24-track; Sony MCI 1-inch C format LB 110, 2-track; Ampex 440C, 2-track; Ampex ATR 800, 2-track; Sony 5800/PCM-F1 digital, 2-track; Studer-Revox B710-MK2, 2-track.  
Mixing Consoles: Soundcraft 600 24 x 8.  
Monitor Amplifiers: H&H MOSFET, Yamaha P2100, BGW Model 85.  
Monitor Speakers: Westlake Audio BBSMs, Auratones.  
Echo, Reverb & Delay Systems: AKG BX10, Yamaha REV7.  
Other Outboard Equipment: 565 Filter Set, (2) UREI 1176 LNs.  
Microphones: Sennheiser 415, 421.  
Video Equipment & Services: Cipher Digital Softouch, (2) Shadows, Cipher Reader Generator, Panasonic CVN 1900, SB50 3/4-inch.  
Rates: Call for rates.

**[24+] R.O.S.**  
also REMOTE RECORDING  
22249 Dolorose St., Woodland Hills, CA 91367  
(818) 716-1264, 789-9340  
Owner: James Hopkins, Mike Smith  
Studio Manager: James Hopkins, Mike Smith  
Engineers: Mike Smith, James Hopkins, various independent.

## SOUTHERN CALIFORNIA



**24+ TRACK**

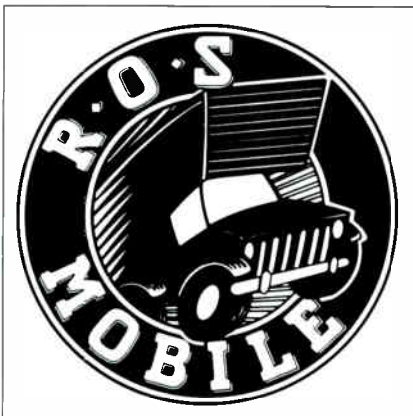

R.O.S.  
Woodland Hills, CA

Dimensions of Studios: 22 x 35, 20 x 30, 20 x 40.  
Dimensions of Control Rooms: Inside mobile truck 9 x 33.

Tape Recorders: 3M 79, 24-track; 3M 79, 24-track; Otari MTR-12 1/2-inch, 2-track; Otari 50/50 1/4-inch, 2-track.  
Mixing Consoles: AFSI 3000 24 x 28.  
Monitor Amplifiers: BGW.  
Monitor Speakers: Tannoy, Yamaha Auratone.  
Echo, Reverb & Delay Systems: 224X w/LARC, (2) REV7, (2) PCM 7C, MicMix, MXR DDL, DeltaLab, etc.  
Other Outboard Equipment: (12) Kepep noise gates, UREI compressors.  
Microphones: Neumanns, AKG.  
Instruments Available: Vintage Fender guitar and bass, 1959 Gibson 335 dot neck.  
Video Equipment & Services: Standard 1 camera for mobile.  
Rates: \$55. Varies on mobile.

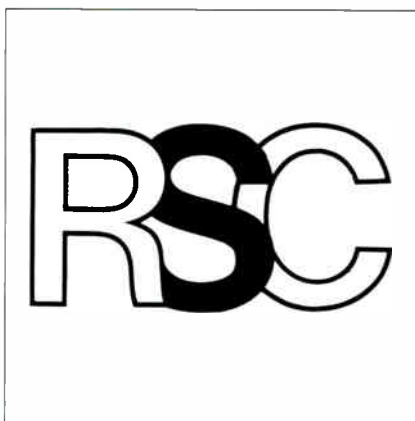

RSC/RECORDING SERVICES COMPANY  
Burbank, CA

**[24+] RSC/RECORDING SERVICES COMPANY**  
also REMOTE RECORDING  
2414 W. Olive Ave., Burbank, CA 91506  
(818) 843-6800  
Owner: Recording Services Company Inc.  
Studio Manager: Ken Dahlinger  
Engineers: On request  
Dimensions of Studios: Studio A: 14 x 8 vocal booth,

Studio B: 10 x 8 vocal booth.  
Dimensions of Control Rooms: Studio A: 22 x 16 control room w/11 x 10 machine room; Studio B: 20 x 14 control room w/10 x 8 machine room; remote truck: 13 x 8.  
Tape Recorders: Otari MTR-90 MKII, 24-track; Ampex MM1200, 8-, 16-, 24-track; Otari MX-70, 16-track one inch; Otari MX-5050 MKIII, 8-track; Otari BQ-II, 2-, 4-track; Ampex ATR-100, 2-, 4-track.  
Mixing Consoles: Studio A: Soundcraft 2400, 28 x 24; Studio B: NEOTEK Series II, 28 x 8; remote truck: Audiotronics 501 28 x 24 x 16.  
Monitor Amplifiers: BGW 750, BGW 250, Crown D-60.  
Monitor Speakers: UREI 813A, JBL 4311, Yamaha NS-10, Auratones.  
Echo, Reverb & Delay Systems: Lexicon 224XL w/LARC and Lexicon 200 digital reverbs, Lexicon Super Prime Time.  
Other Outboard Equipment: Q.Lock 3.10 synchronizer, BTX Shadow synchronizer, Dolby SP-24 noise reduction, Dolby Cat 43A film processors, Orban 622B parametric EQ, UREI LA-2A, LA-3A, LA-4A, 1176LN, dbx 160, Valley People Kepex II, dbx 902 de-essers, ITC cart player, Technics turntable, Yamaha CD player.  
Microphones: Sennheiser 416, 421, 441; Shure SM57, 58; AKG 414, 452; E-V RE-20; Sony ECM-50.  
Instruments Available: Emulator II digital sampling keyboard for sound effects or musical instruments.  
Video Equipment & Services: Ampex VPR-1C 1-inch, Sony BVU-800 3/4-inch, JVC-850U 3/4-inch, Akai VHS HiFi, Sony Beta. Video laydowns and laybacks in all formats, mix-to-picture or sweeten using your choice of synchronizer and machines. SMPTE starts for ATR-100 2-, 4-track, cart player, and CD player make rolling in sound effects or music frame accurate, and with Sound Ideas Sound Effects Library on CD sound effects can be quickly accessed.  
Rates: On request.

**[24+] RUMBO RECORDERS**  
20215 Saticoy St., Canoga Park, CA 91306  
(818) 709-8080  
Owner: Daryl Dragon, Toni Tennille  
Studio Manager: John Carselle

**[24+] RUSK SOUND STUDIOS**  
1556 N. LaBrea Ave., Hollywood, CA 90028  
(213) 462-6477  
Studio Manager: Elton Ahl  
Dimensions of Studios: Approx. 1500 sq. ft. Several areas may be isolated by sliding glass doors if desired.  
Dimensions of Control Rooms: 500 sq. ft. Eastlake type.  
Tape Recorders: Ampex MM1200 W/XT24, 24-track; Ampex ATR104, 4-track; (2) Ampex ATR 102 1/4- and 1/2-inch, 2-track; Yamaha cassettes.  
Mixing Consoles: Harrison 3232B/C automated w/sonic improvements and extra sends, 32 in/out plus eight echo returns.  
Monitor Amplifiers: Bryston, BGW, Crown, Yamaha, etc.  
Monitor Speakers: Sierra/Eastlake, 604Es, JBL 4311s and L100s, Yamaha NS-10, Auratones.  
Echo, Reverb & Delay Systems: EMT 251, 250 digital reverb, Lexicon 224X-LARC 8.2, Ecoplate 1 (large EMT 140s type), classic live chamber; Lexicon PCM-60; AKG BX10; small plate; AMS 1580S; Eventide 949 and 910 Harmonizers; Prime Time; Roland SDE 3000 programmable delay; Marshall Time Modulator; DeltaLab 1024 and DL1 (3 out) delays; Roland Space Echo; and tape delays.  
Other Outboard Equipment: Teletronix LA2 (tube) limiter; (2) UREI 1176LN; (2) dbx 161, dbx 160, 2 channels Drawmer gates; one channel Aphex gate; (4) Valley People Dyna-Mites; four channels Omni Craft gates; Dolby 361s, dbx 154, Dynalex; Eventide instant flanger; MXR doubler/flanger, MXR auto flanger, MXR pitch changer, Orban and Furman parametric EQs; (2) B+B EQF-1 EQs; SAE 20 and 10 band graphic EQs; Aphex Aural Exciter; Phase Linear 1000 autocorrelator; Orban three channel de-esser; UREI LA-3A, ADR 969 vocal stresser.  
Microphones: Telefunken 251E; Neumann U67 (3), U87 (3), U47 FET, KM84 (4), KM85; AKG 414EB (6), 451 EB (4), D1000E, D190; RCA 77DX; Sony C-37A; ECM 22P (2); Sennheiser 441, 421, MK40; E-V RE-20, RE-15, 666; Crown PZMs (2), Shure 57s (5), SM53.  
Instruments Available: Yamaha C-7 7'6" grand piano, Yamaha DX7, Emulator II, LinnDrum, Roland JX3P, Yamaha TX Rack, various guitars and amps available on request, various percussion.  
Video Equipment & Services: Wired for video loop throughs throughout studio, video lockup available, BTX 4500 synchronizer and 4200 SMPTE reader-regenerator.

**[24+] SABAN PRODUCTIONS**  
11724 Ventura Blvd., Studio City, CA 91604  
(818) 985-3805  
Owner: Haim Saban, Shuki Levy  
Studio Manager: Andrew Dimitroff

**[24+] SAGE & SOUND RECORDING**  
1511 Gordon, Hollywood, CA 90028  
(213) 469-1527  
Owner: Jim Mooney  
Studio Manager: Jerry Wood



# BACK ISSUES

**1985 January, Northwest Studios.** Superbowl Sound. Springsteen on Stage. Ray Parker Jr. Leon Russell.

**1985 February, Independent Engineers & Producers.** Brian Auger. The Art of Touring. Roger Powell on MIDI. Les Paul.

**1985 March, Southeast Studios.** Loudspeaker Technology. Martin Rushent. *Hotton Club* Sound. John Fogerty.

**1985 April, Video Production Supplement with Facilities Listings.** Compact Power Amps. Radio Recorders' Larry Bryant. Eurythmics.

**1985 May, Northeast Studios.** Digital Reverb. Flo & Eddie. Holophonics. Emmylou Harris. Humberto Gatica.

**1985 June, Sound Reinforcement & Remote Recording Listings.** Location Recording Tutorial. Grateful Dead Sound. Weird Al Yankovic. Synthesizer Oriented Studios. David Sanborn.

**1985 July, Recording School Listings and Southwest Studios.** Mixing Consoles. Dr.emento. Kashif's Studio. Roger Nichols and John Denver.

- 1985 August, Studio Design Issue: Listings of Designers & Suppliers.** Control Room Acoustics. Thomas Dolby. Orchestral Recording. On the Road with Prince. Neil Young.
- 1985 September, Southern California Studios.** Film & TV Sound. Frank Zappa. Digital '86 Supplement. *Mishima* Sound. David Foster.
- 1985 October, New Products for AES.** Maintenance & Testing. Abbey Road Studios. Ambisonics. Ben Burtt on Imax. Nile Rogers.
- 1985 November, North Central & Canadian Studios.** George Massenburg. Video Supplement. Alligator Records. Women in Media Production.
- 1985 December, Tape-to-Disk Listings.** Mastering, Pressing & Duplication. TEC Award Winners. Sound for the *Twilight Zone*. Tom Waits.
- 1986 January, Northwest Studios.** Equipping Home Studios. Paul Winter. SMPTE-MIDI Connection. Yoko Ono.
- 1986 February, Independent Engineers & Producers.** Microphone Special Report. Laurie Spiegel. Budgeting for Sessions. Joni Mitchell.  
**1986 March — SOLD OUT**
- 1986 April, Video Production & Post Production Facilities.** Video Supplement. Al Kooper. Wireless Mics. Alan Parsons.
- 1986 May, Northeast Studios.** Digital Supplement. Sampling Primer. CD Facilities. Future of Console Design. Steve Lillywhite.

- 1986 June, Remote Recording & Sound Reinforcement Listings.** Roadability. Russ Titleman. DC-ROM & CD-I. Ry Cooder.
- 1986 July, Recording School Directory and Southwest Studios.** CD Pre-mastering. Britain's Live Aid. Producer Rick Rubin. Christian Rock. Stevie Wonder.
- 1986 August, Directory of Studio Designers and Suppliers.** Tom Hidley. Disney's Magic Kingdom Sound. Jean-Michel Jarre. Laurie Anderson.

## CHECK THE ISSUES YOU'RE INTERESTED IN.

# of BACK ISSUES CHECKED ABOVE at \$5.00 each (\$6.00 outside U.S.) \_\_\_\_\_

CHECK ENCLOSED FOR TOTAL (U.S. Funds) Payment must accompany order. \$ \_\_\_\_\_

NAME \_\_\_\_\_  
ADDRESS \_\_\_\_\_  
CITY \_\_\_\_\_ STATE \_\_\_\_\_ ZIP \_\_\_\_\_

MAIL TO: Mix Back Issues, 2608 Ninth Street, Berkeley, CA 94710  
Make checks payable to Mix Publications; allow four weeks for delivery within U.S.

# BINDERS

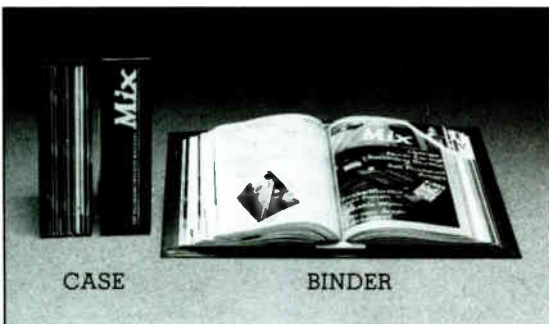

**MIX MAGAZINE** is a year-round reference tool. Keep your issues protected, ordered, and easily accessible in our handcrafted magazine cases and binders.

Both styles hold a year's worth of *Mix*, and are bound in crimson leatherette with the *Mix* log embossed in gold.

**MAGAZINE CASES:** \$7.95 each, 3 for \$21.95, 6 for \$39.95

**BINDERS:** \$9.95 each, 3 for \$27.95, 6 for \$52.95

MAIL TO: Jesse Jones Industries  
Dept. MIX  
499 East Erie Avenue  
Philadelphia, PA 19134

**CALL FREE PHONE (Charge Orders ONLY):**  
1-800-972-5858

Name \_\_\_\_\_

Address \_\_\_\_\_

P.O. Boxes Please

City \_\_\_\_\_ State \_\_\_\_\_ Zip \_\_\_\_\_

Satisfaction Guaranteed by Jesse Jones Ind.

Please send me \_\_\_\_\_ **CASES** and/or \_\_\_\_\_ **BINDERS**.  
Add \$1 per unit for Postage & Handling, (\$2.50 outside U.S.)  
PA residents add 6% tax.

CHECK ENCLOSED FOR \_\_\_\_\_  
(U.S. funds only; Payable to Jesse Jones Industries)

OR **CHARGE MY:** (minimum \$15)

\_\_\_\_\_ American Express \_\_\_\_\_ VISA \_\_\_\_\_ MasterCard \_\_\_\_\_ Diners Club

Card # \_\_\_\_\_ Exp. Date \_\_\_\_\_

Signature \_\_\_\_\_

# api

a reputation of quality—

- custom products
- equalizers
- the 2520 OP-AMP
- distribution amplifiers
- microphone pre-amps
- replacement parts

File Use  
C/D/C/M

Plus these new products:

- 5502 Dual Four Band Rack Mount 550A EQ
- 940M Motorized Servo Fader
- 318a distribution amplifier

api audio products, inc.

7953 Twist Lane, Springfield, VA 22153  
(703) 455-8188 fax: 510-6001-898

studio consultants, inc.

321 West 41st Street, New York, NY 10036  
(212) 586-7376

eastern representative

Westlake Audio 7285 Santa Monica Boulevard  
Los Angeles, CA 90046  
(213) 851-9800 Telex: 699645

western representative

## SOUTHERN CALIFORNIA



### 24+ TRACK

[24+] SANTA BARBARA SOUND RECORDING, INC.  
33 W. Haley St., Santa Barbara, CA 93101  
(805) 963-4425

Owner: Dean O. Thompson  
Studio Manager: Dominic Camardella, Mitchell Summer  
Engineers: Terry Nelson, Daniel Protheroe, Paul Dugré  
Dimensions of Studios: 1400 sq. ft., 22-foot ceiling, 2 isolation booths.

Dimensions of Control Rooms: 400 sq. ft.  
Tape Recorders: Neve 4028 36/24, Studer A80 III, 24-track; Studer A80 RC, 2-track; Ampex MR-70, 2-track; Akai in MIDI lab MG 1212 12-track + 2-track (MIDI).

Mixing Consoles: MCI JH528-LM w/JH50 Jensen and Transamp inputs.

Monitor Amplifiers: Phase Linear 700B, Accuphase M-60, Accuphase P-300.

Monitor Speakers: UREI 813, JBL 4311, JBL 4310, Altec 604E/620/ML, Auratone.

Echo, Reverb & Delay Systems: Lexicon 200, EMT 140ST, AKG BX20E, DeltaLab DL-4, Eventide 910, Marshall 5002.

Other Outboard Equipment: MIDI studio w/Lexicon PCM70, Prime Time, Roland SRV 2500, SDE 1000, SDE 2500, CE 300, MKS 10, MKS 30, JX8P, Super Jupiter w/programmer. Computer sequencers include Kaypro 10MB, dual floppy, Eagle 10MB. Computer software includes Roland MPS, Texture, Personal Composer.

Microphones: Neumann: U87, U67, U47, M49, KM84, KM54; AKG: C24, C60, C12A, 414EB, 452EB; Telefunken: 251, U47; Sony: C37A, C500, C55, ECM50; E-V: RE-20, RE-15, 635; RCA: 44, 77; Shure: 57, 58, 545, SM53; Sennheiser: 441, 421.

Instruments Available: Yamaha C-7 grand piano, Hammond B-3 w/Leslie, Yamaha DX7, Emulator II, Roland MKB 300, Akai AX80.

Rates: Call for rates.

[24+] SANTA MONICA SOUND RECORDERS  
2114 Pico Blvd., Santa Monica, CA 90405  
(213) 399-8534

Owner: Scott Bros. Entertainment

Engineers: Skip Saylor, Tom McCauley and various independent engineers.

Dimensions of Studios: Main room: 22 x 20; isolation rooms: 15 x 10 and 17 x 4.

Dimensions of Control Rooms: 17 x 11.

Tape Recorders: Ampex MM1200, 24-track; Ampex ATR 102, 2-track 1/2-inch and 1/4-inch headstack; Ampex ATR 104, 4-track 1/2-inch headstack; Ampex ATR 800, 2-track 7 1/2, 15 and 30 ips; rental equipment available.

Mixing Consoles: Trident Spectra Sonics customized 38 x 24.

Monitor Amplifiers: Crown.

Monitor Speakers: Control room tuned by George Augspurger; JBLs, Yamaha NS-10Ms, Auratone T-6s and Cubes; and Hemispheres.

Echo, Reverb & Delay Systems: Lexicon 224X LARC, Yamaha REV7, Lexicon PCM70, Lexicon PCM60, Roland SRV 2000, Lexicon Prime Time II, Roland SDE 3000, Roland SDE 2000, (3) Stereo Ecoplates, (2) Studio Technologies reverb processors, Eventide Harmonizer 910, Roland Chorus, Echo SRE 555, Effectron III.

Other Outboard Equipment: (10) API 550A EQs, Teletronix LA-2A tube limiter, (3) UREI 1176LN, (2) dbx 160X (stereo), UREI LA-4A, (2) Kepex, (4) Drawmer noise gates, Roland phase shifter SPH-323, Roland stereo flanger SBF-325, (2) dbx de-essers, (2) dbx noise gates, dbx flanger, Roland Dimension-DSD-320, Orban parametric EQs, (4) Orban de-essers, Furman parametric EQs, UREI Little Dipper, UREI 550A Hi-Lo pass filters, Studio Technologies stereo simulator, SMPTE and 60 Hz sync, UREI digital metronome, VSO, AKG and Kosas headphones.

Microphones: AKG 414s, 452s, D12E; Neumann U87, U47, 170; Shure 441 and 421s; Beyer M400s, E-V RE-15s; Shure SM57s and more.

Video Equipment & Services: Rental equipment available.

Rates: Please call for rates.

[24+] SCORE ONE RECORDING  
5500 Cahuenga Blvd., North Hollywood, CA 91601  
(818) 762-6902

Owner: Score One, Inc.

Studio Manager: Al Johnson

Tape Recorders: MCI JH24-24, 24-track; MCI JH24-16, 16-track; Otari MX 50-50, 8-track; Otari MTR-12, 2-, 4-track.

Mixing Consoles: Amek-TAC Matchless, 26 x 24 x 8.

Monitor Amplifiers: Yamaha, Phase Linear, BGW

Monitor Speakers: UREI 813, Yamaha NS-10M, Auratone

Echo, Reverb & Delay Systems: Lexicon 200, Yamaha REV7, Yamaha SPX-90, MICMIX Master Room XL-305, Roland SDE-3000.

Other Outboard Equipment: Eventide 910, EXR IV Exciter, UREI 1176-LN, band pass and notch filters, Symetrix comp./lim., gates, Orban Parametric EQ, Sibilance controller, stereo synth, MICMIX Dynalex.

Microphones: Neumann, AKG, Sennheiser, E-V, Sony, AT, Shure.

Instruments Available: Yamaha C-7 grand piano, Yamaha DX9, Yamaha RX11, Mirage, Fender Rhodes, guitars, amps.

Video Equipment & Services: Sony BVU 800/200, Q-Link 3.0c synchronizer, video sweetening, ADR, Foley, Transfer to 35mm or 16mm mag, Otari EC-401 Universal Resolver, Advent 3-Gun big screen TV.

Rates: 8-track \$35/hr., 16-track \$50/hr., 24-track \$70/hr., video-audio \$125/hr.

[24+] S.D.R. STUDIO  
(formerly Salty Dog)  
14511 Delano St., Van Nuys, CA 91411  
(818) 994-9973

Owner: David Coe

Studio Manager: Jane Boltnhouse

Engineers: Pat Cyocone, Roy Braverman, Jeff Park, Brad Aaron, Jim Duncan, independents.

Dimensions of Studios: 45 x 30 x 12; drum room: 14 x 14 x 12.

Dimensions of Control Rooms: 18 x 23 x 10.

Tape Recorders: 3M M-79, 24-track; 3M M-79 1/2-inch, 2-track; 3M M-79 1/4-inch, 2-track; Ampex MM-1200 2-inch, 16-track; Ampex 440-B 1/4-inch, 2-, 4-track; (2) TEAC V-700 cassette.

Mixing Consoles: Amek 2500, 36 x 24.

Monitor Speakers: UREI 813, Yamaha NS-10, Auratone.

Echo, Reverb & Delay Systems: (2) EMT 140-S, Lexicon 224XL, AMS RMX-16, (2) Prime Time, Lexicon PCM41, (2) MXR II DDLs, (2) MXR I DDLs.

Other Outboard Equipment: (2) 1176LN UREI limiters, (2) Inovonics 201 limiters, (2) LA-4 UREI limiters, (2) Gain Brains, MXR dual limiter, DeltaLab Compu-effectron, Orban parametric 662B EQ, Orban 674 stereo EQ, Kepex gates, Ashly custom gates, dbx 904 gates, Orban 516 EC de-esser, SMPTE generator, Scamp Rack w/MicPic amp, ADT, panning compressor and gates models.

Microphones: (2) AKG C-28, (3) AKG 414, (6) AKG 452, (6) Beyer M-500, E-V RE-15, E-V RE-20, (2) Neumann tube 47, (2) Neumann KM56 tube, (5) Neumann KM84, (3)



SKIP SAYLOR RECORDING  
Los Angeles, CA

[24+] SKIP SAYLOR RECORDING  
506 N. Larchmont Blvd., Los Angeles, CA 90004  
(213) 467-3515

Owner: Skip Saylor  
Studio Manager: Skip Saylor



We're #1 on

COMPACT  
disc  
DIGITAL AUDIO

CALL (416) 977-0512

86 McGill Street, Toronto, Ontario  
Canada M5B 1H2

Circle #135 on Reader Service Card







NO POSTAGE  
NECESSARY  
IF MAILED  
IN THE  
UNITED STATES



**BUSINESS REPLY MAIL**  
FIRST CLASS PERMIT NO. 217 CLINTON, IOWA

POSTAGE WILL BE PAID BY ADDRESSEE

**Mix Magazine**  
**P.O. Box 1960**  
**Clinton, Iowa 52735**



NO POSTAGE  
NECESSARY  
IF MAILED  
IN THE  
UNITED STATES



**BUSINESS REPLY MAIL**  
FIRST CLASS PERMIT NO. 217 CLINTON, IOWA

POSTAGE WILL BE PAID BY ADDRESSEE

**Mix Magazine**  
**P.O. Box 1960**  
**Clinton, Iowa 52735**



Neumann U87, (4) Senn 421, Senn 441, (4) Shure SM57, (2) Sony C-37A.

**Instruments Available:** Yamaha grand piano, Yamaha CP-70 electric grand, A.B. Chase upright tack piano; available w/studio. Emulator II, SP-12 drum machine, Yamaha DX7, Juno 106, Juno 60. All available for rental.

[24+] SEACOAST RECORDING  
926 Turquoise St., San Diego, CA 92109  
(619) 270-7664

Owner: Elliott Audio Enterprises  
Studio Manager: Jack Elliott

[24+] SHEIKA PRODUCTIONS STUDIO  
3438 Ben Ave., North Hollywood, CA 91606  
(818) 762-3326

Owner: Galen L. Senogles, Ralph Benatar  
Studio Manager: Galen L. Senogles

[24+] SILVERLAKE SOUND STUDIO  
2413 Hyperion, Silverlake, CA 90027  
(213) 663-7664

Owner: Steve Millang  
Studio Manager: Rosa Millang  
Engineers: Jon Guggenheim; independents: Bob Biles, Cisco Delvna, Mike Carnivale, Jon Gass.  
Dimensions of Studios: 30 x 35, 10 x 10.  
Dimensions of Control Rooms: 12.5 x 18.  
Tape Recorders: Otari MTR-90 II, 24-track; MCI JH110, 2-track; Sony TC-K777 cassette.  
Mixing Consoles: Trident Series 80B, 32 x 24.  
Monitor Amplifiers: H&H, BGW, Phase Linear, Crown.  
Monitor Speakers: JBL 4430, Yamaha NS-10M, Auratone.  
Echo, Reverb & Delay Systems: (2) Lexicon PCM70, Yamaha REV7, Lexicon Prime Time II, Eventide H910 Harmonizer.  
Other Outboard Equipment: (4) dbx 160 compressor, UREI 1176 limiter, (4) Kepex II, (4) Omnicraft gates, Orban de-esser.  
Microphones: Neumann U47 tube, Neumann U47 FET, (2) Neumann U87, AKG 414 P48, (2) AKG 414 EB, (3) RCA

77, (6) Shure SM57, E-V RE-20, Sennheiser 421.  
**Instruments Available:** PPG Wave synthesizer, various guitars (acoustic and electric) and Fender amp.  
Rates: Call for rates.

[24+] SILVERY MOON STUDIOS  
326 1/2 N. La Cienega, Los Angeles, CA 90028  
(213) 659-0688  
Owner: Gary Stern  
Studio Manager: Gary Stern

[24+] SKYLINE RECORDING CO.  
1402 Old Topanga Canyon Rd.  
Topanga Park, CA 90290  
(213) 455-2044  
Owner: Ron Bacon  
Studio Manager: Lisa Bacon

[24+] SMOKETREE  
9752 Baden Ave., Chatsworth, CA 91311  
(818) 998-2097

Owner: Smoketree Corp.  
Studio Manager: Jean Parry  
Engineers: D. Parry, R. Raposa.  
Dimensions of Studios: 20 x 35 x 16.  
Dimensions of Control Rooms: 17 x 23 x 12.  
Tape Recorders: (2) Studer A800 MKIII, 48-track; (2) Ampex ATR-100, 2-track; Studer A820 TC, 2-track; MCI JH-110B, 4-track; (4) Sony K-777, cassette; Sony BVU-800 3/4-inch video.  
Mixing Consoles: Neve 8078A 76 x 24 bus w/George Messenburg automation system.  
Monitor Amplifiers: H.H. V-800 MOS/FET.  
Monitor Speakers: Altec 604 w/Mastering Lab CX and Gauss woofers.  
Echo, Reverb & Delay Systems: (2) EMT 140TS plates; EMT 251; Lexicon 224XL; (2) PCM70; Yamaha REV7.  
Other Outboard Equipment: Publison Internal 90 (21 seconds stereo 16-bit); Drawmer gates; Scamp and Aphex racks; (3) LA-2A; Eventide 910, 949 and 1745M; Lexicon PCM-42; (2) Roland SDE-3000.  
Microphones: Telefunken 251; AKG C12, 414EB, 451E; Neumann M-49, U47, M-269, U87, U67; KM84; 125 Mics; over 30 rare tube type.  
Instruments Available: (2) Yamaha TX-816 racks; (2) Yamaha DX7; Yamaha KX-88; Roland Jupiter 8 and JX8P,

707, 727, SBX-80; Linn 9000; Oberheim Matrix-12; (2) Akai 612 sampler; (2) Apple Macintosh Plus w/Hyperdrive 20; Emulator II.

**Video Equipment & Services:** Sony BVU-800 3/4-inch and JVC-6800U 1/2-inch; BTX Softouch controller w/(2) Shadow synchronizers.

[24+] SOUND AFFAIR RECORDING  
2727 Croudy Way Ste. G, Santa Ana, CA 92704  
(714) 540-0063

Owner: Ron Leeper  
Studio Manager: V. Leeper  
Engineers: Ron Leeper, Barry Keenan, Jeff Beard, Trey Solberg, Steve Anderson.  
Dimensions of Studios: A: 36 x 30; drum booth: 12 x 10; piano trap: 12 x 8; vocal booth: 7 x 6; B: 26 x 24 x 16; drum booth: 11 x 9; C: 18 x 12.  
Dimensions of Control Rooms: A: 20 x 18; B: 18 x 14.  
Tape Recorders: Ampex MM-1200, 24-track; Ampex MM-1200, 16-track; Ampex ATR-102, 1/2- and 1/4-inch, 2-track; Ampex 440-B 1/4-inch, 2-track.  
Mixing Consoles: MCI JH-600, 32 x 32 automated; API 1608, 16 x 16.  
Monitor Amplifiers: UREI 6500, 6250, 6150; Crown 300A, 150A; BGW 210, 100.  
Monitor Speakers: JBL 4430, Yamaha NS-10Ms, Auratone 5Cs, JBL 4311s, UREI 809 Time Aligns.  
Echo, Reverb & Delay Systems: Lexicon Super Prime Time, Eventide Harmonizer 949, Eventide SP2016 digital processor, Lexicon 224, Yamaha REV7 digital reverb, Lexicon Prime Time, Ecoplate reverb, DeltaLab Effectron, Sound Workshop vocal doubler.  
Other Outboard Equipment: Gold Line 1/3 octave RTA, UREI dual ten band graphic EQ, EXR Exciter, Scamp noise gates, limiters, time shape modules, de-ess, auto pan, Eventide Instant Phaser, Teletronix LA2 tube limiter, UREI 1176, and LA-4A stereo comp./limiter, dbx 161 comp./limiters, Hewlett-Packard 1208BXY display, Furman parametric EQs, Ampex VSO API 525 stereo limiters.  
Microphones: AKG: C-12, 414, 451; Neumann U47, U87, KM84; Electro-Voice: RE-20, PL95, DX35; Sennheiser: MD 421, MD 441, MKH 405; Crown P2M; Calrac CB 21-C; Altec 195-A; RCA DX77; Shure SM56, 57.  
**Instruments Available:** Yamaha C-7E, 74" and Kawai 74" grand pianos, Rhodes piano, E-mu SP-12 digital drum computer/sampler, Roland Octapad, Rogers drums, sound effects library.  
Rates: Please call or write for brochure.

# GET LISTED! In Mix Directories

Mix Directories are the most complete guide to facilities and services for the audio and video industries. When production professionals need equipment, studios, or other services, they consult *Mix* first. To receive a questionnaire for a FREE listing in any or all of the following Mix Directories, simply fill out and return the coupon below, or call the Directories Dept. at (415) 843-7901.

- DECEMBER: **Tape-to-Disk Issue: Directory of Manufacturing Services**  
(Deadline: September 12)
- JANUARY '87: **Studios of the Northwest and Hawaii**  
(Deadline: October 1)
- FEBRUARY '87: **Independent Producers/Engineers**  
(Deadline: November 3)
- MARCH '87: **Studios of the Southeast**  
(Deadline: December 3)

NAME \_\_\_\_\_

COMPANY \_\_\_\_\_

ADDRESS \_\_\_\_\_

CITY \_\_\_\_\_

STATE \_\_\_\_\_

ZIP \_\_\_\_\_

TELEPHONE \_\_\_\_\_

**Mail to: Mix Directories, 2608 Ninth Street, Berkeley, CA 94710**

NOTE: Questionnaires for specific issues will be mailed five weeks prior to issue date.

# SOUND ARTS

**SOUND ARTS**  
Los Angeles, CA

[24+] **SOUND ARTS**  
2825 Hyans St., Los Angeles, CA 90026  
(213) 487-5148  
Owner: Bob Walter, Jim Cypherd, John Berkman, Rick Johnson, Aseley Otten  
Studio Manager: Jim Cypherd  
Engineers: Jim Cypherd, Aseley Otten. Resident Synthesists: Rich Johnston, Jim Cypherd, Mark Desisto, Dan Nebensal, various independents.  
Dimensions of Studios: 36 x 22.  
Dimensions of Control Rooms: 24 x 22.  
Tape Recorders: Ampex MM-1200, 24-track; ATR 104, 4-track; Ampex ATR-102, 2-track; Ampex VSO.  
Mixing Consoles: Trident Series 80, 32 x 24.  
Monitor Amplifiers: Crown DC-300s, DC-150s, BGW 250B, SM Acoustics 600As, and 300A and Linear Phase Crossover, Eagle 2A.  
Monitor Speakers: Sierra Hidley IIs w/TAD components, Yamaha NS-10s, JBL 4315s, 4311s, Auratone 5Cs.  
Echo, Reverb & Delay Systems: Lexicon 224, Yamaha REV7, AKG BX-10, Eventide DDL and Lexicon Prime Time, Roland SDE-3000.  
Other Outboard Equipment: Orban parametric EQs; UREI 1176, LA-3A, LA-2A; digital metronome, Eventide

## SOUTHERN CALIFORNIA



949 Harmonizer, Allison Gain Brains and Kepexes, Orban Sibilance Controller, Moog Vocoder, dbx 162 comp./limiter, CBS and RCA tube limiters, API EQs, 360 Systems and Bode frequency shifters, Dr. Click, Adams-Smith synchronizer, Pultec and Melcor EQs, I.L. Cooper MIDI box, Roland SBX 80 synch box.  
Microphones: PML DC-63s; Neumann U87s, KM84s; E-V RE-20, RE-15s; AKG 451s, 124E, D-1000E; RCA 77Ds; Shure SM-77s, SM-54s, SM-57s, SM-58s; Sony C-38P, C-55Ps; Sennheiser 421s, 441s.  
Instruments Available: Fairlight CMI-II, Akai sampler, Yamaha DX7, Memory Moog, Roland Jupiter 8, Moog Model 55C expanded modular system, Prophet 10, Yamaha CS80, Oberheim 4-voice, Polymoog, Minimoog, Baldwin electric harpsichord, Hammond B-3, Steinway grand piano.  
Rates: Call for rates.

[24+] **SOUND CHAMBER RECORDERS**  
27 So. El Molino Ave., Pasadena, CA 91101  
(818) 449-8133  
Owner: Richard McIlvery, Randy Farrar, Tim Kenelick  
Studio Manager: Richard McIlvery

[24+] **SOUND CITY INC.**  
15456 Cabrito Rd., Van Nuys, CA 91406  
(818) 787-3722, 873-2842

Owner: Joe Gottfried, Tom Skeeter  
Studio Manager: Paula Salvatore  
Engineers: John Hanlon, Bruce Barris, Rick Polakow, Ken Adess, Allen Isaacs, Andy Udoff. Maintenance: John Hanlon, Bruce Volk, Bret Newman.  
Dimensions of Studios: Studio A: 40 x 50; Studio B: 40 x 30.  
Dimensions of Control Rooms: Studio A: 26 x 20; Studio B: 20 x 20.  
Tape Recorders: Studer A800, 24-track; Studer A80 MK II, 24-track; Studer A80 1/2-inch, Studer A80 1/4-inch, (2) B67, 2-track; Revox/Sony 1/4-track.  
Mixing Consoles: Neve (Studio A) w/Necam computer mix, 26 x 32; Neve (Studio B), 28 x 32.  
Monitor Amplifiers: Crown DC-300, for the Q system, Yamaha P-2200.  
Monitor Speakers: A&B: JBL (custom designed and tuned by George Augspurger).  
Echo, Reverb & Delay Systems: EMT, AKG, Lexicon Delta-T digital delay, (2) Harmonizer, 949, Eventide flanger, Orban de-esser, Eventide digital delay, AMS RMX-16 digital reverb.  
Other Outboard Equipment: Parametric EQ, dbx 165As, Pultec EQs, filters, Teletronix LA-2A limiters, Neve limiters, UA 1176, Dolbys.  
Microphones: Neumann U47, U67, U47 FET, U84, U86, U87, KM84, KM86, M49; AKG 541Es, C-451E, C-24, C-12A, 460s, M49; Electro-Voice RE-20, RE-15, 635s; Shure 545s, SM57, SM58; Sennheiser MD-421; Sony C-37s, EC50.  
Instruments Available: Hammond C-3 organ w/Leslie, (2) Steinway grand pianos.  
Rates: Call for rates.

[24+] **SOUND IMAGE**  
6556 Wilkinson, No. Hollywood, CA 91606  
(818) 762-8881  
Owner: Sound Image Entertainment Inc.  
Studio Manager: Chuck Kopp

**L.D. Systems introduces a great new pair:**



**The EAW SCD6000  
Studio Reference  
Monitors**

There are many reasons why L.D. Systems recommends the SCD6000. The most important, of course is improved sound: The single magnet MF/HF driver results in a monitor without match in terms of imaging and exceptionally smooth phase and frequency response.

For more information on the EAW SCD6000, and for all your professional audio needs, consider another great pair...

**EAW**  
EASTERN ACOUSTIC WORKS

and

**L.D.**  
SYSTEMS

professional sound and lighting sales, services, rentals  
467 W. 38th Street, Houston, Texas 77018, (713) 695-9400

Circle #137 on Reader Service Card

## SOUND MASTER



**RECORDING STUDIOS®**

**SOUND MASTER AUDIO/VIDEO  
RECORDING STUDIOS**  
North Hollywood, CA

[24+] **SOUND MASTER AUDIO/VIDEO  
RECORDING STUDIOS**  
also **REMOTE RECORDING**  
10747 Magnolia Blvd., No. Hollywood, CA 91601  
(213) 650-8000

Owner: Brian and Barbara Ingoldsby  
Studio Manager: Barbara Ingoldsby  
Engineers: Brian Ingoldsby, Ken Ingoldsby, Ed Dupper, Dan Shimai, Dan Talia.  
Dimensions of Studios: 33 x 35 x 14 plus drum booth and vocal booth.  
Dimensions of Control Rooms: 21 x 21.  
Tape Recorders: (2) MCI JH-16, 24-track; (2) MCI JH-110-A, 2-track; MCI JH-110-A, 4-track; (2) Revox A77-H, 2-track; Ampex AG-440-C, 2-track; Pioneer RT-701, 1/4-track; (2) Nakamichi cassette 1000, 2-track; (4) video recorders 1/4-inch JBL B560; video recorder one-inch Ampex 1001; (4) video recorders VHS and Beta 7000 and 3700.  
Mixing Consoles: Quad/Eight Coronado automated Compu-mix 3, 40 x 40.  
Monitor Amplifiers: Tri-amped Ashly crossover, Soundcraftsman Model 5001, BGW-750C and 100B.  
Monitor Speakers: Custom design Goodman control room quad; Studio: L300 JBL, various auxiliary monitors available.  
Echo, Reverb & Delay Systems: AKG BX-20, Quad/Eight CPR 16, Soundcraftsman 262 stereo, Sound Workshop 262 stereo reverb.  
Other Outboard Equipment: 26 channels of Dolby, 32 channels of dbx noise reduction systems, SMPTE time code JH45, Autolocator 3, Prime Time, Lexicon PCM 41,



Harmonizer Eventide, D250 Advanced Audio Design, 265 Dynaflinger. Limiters: dbx 165s, UREI 1176s, dbx 161s, Quad/Eight compressor/expanders, Quad/Eight de-essers, Noise gates; 16 Quad/Eight and Kepex, Orban parametric, UREI 527A, MXR phaser, Eventide Instant Phaser, Marshall Time Modulator, Eventide DDL 1745.

**Microphones:** Shure Bros. complete line, Electro-Voice, Audio-Technica, PZMs, AKG, Sony, Beyer, Neumann, Altec, RCA, Sennheiser, Vega wireless, Edcor wireless, over 350 microphones including old tube types.

**Instruments Available:** Steinway 77" grand piano, Yamaha 6'6" grand, B-3 w/Leslie, Linn LM-1 computerized drum machine, timbales, orchestra chimes, string synthesizer and varied array of hand percussion instruments.

**Video Equipment & Services:** Full video production house on-site. Video studio dimensions: 30 x 40. Computerized post-production editing with Chromakey character generator, digital special effects, freeze-frame and frame store, Ikegami and JVC color cameras, also ENG. Program pre-planning, design, script writing, and in-house tape duplication. 3/4-inch and one-inch video production available in-house: SMPTE synchronizers and resolvers, full list management, computerized editing.

**Rates:** Available upon request.

**Extras:** On-site disk mastering studio equipped w/Tandem Cybersonics disk cutting lathes w/Ortofon heads, and computerized digital Cybersonics console. Also, three mobile trucks, remote recording; sound reinforcement; and video.

**Direction:** Looking ahead to the future, Sound Master has incorporated full color video capabilities into a state-of-the-art recording studio facility to accommodate the current growing audio/video fusion in the recording industry. Our aim is to provide you with technical sophistication as well as personal attention.

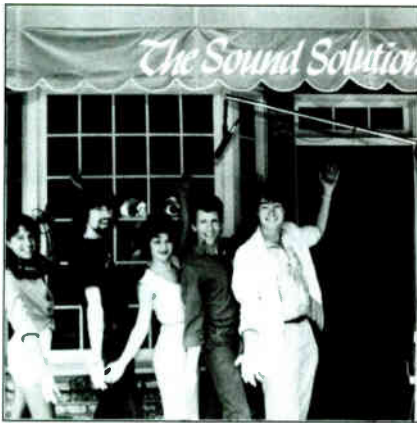

**SOUND SOLUTION RECORDING**  
Santa Monica, CA

**[24+] SOUND SOLUTION RECORDING**  
also **REMOTE RECORDING**

Office: 1543 Seventh St., Santa Monica, CA 90401  
Studio: 1211 Fourth St., Santa Monica, CA 90401  
(213) 393-5332

**Owner:** Solution Enterprises, Inc.  
**Studio Manager:** Keith Wechsler, Shelley Krsten  
**Engineers:** Keith Wechsler, Steve Barnard, Richard Jalis, Jim Burnett, David Blade, Rod Clark.

**Dimensions of Studios:** 32 x 14, plus iso booth 4 x 8.  
**Dimensions of Control Rooms:** 16 x 14.

**Tape Recorders:** MCI JH-114, 24-, 16-, 8-track w/A.L. and VSO; Ampex ATR 102 1/2-inch and 1/4-inch, 2-track; MCI JH 110 1/2-track w/VSO; Sony 854-4 1/4-inch, 4-track; Technics 1500, 2-track; Sony TC-K777, cassette decks; Otari 1/2-inch, 8-track recorder available.

**Mixing Consoles:** MCI JH428 modified 28 x 24 w/Aphex VCA DC subgroups; Biamp 8 x 2 effects mixer.

**Monitor Amplifiers:** Hafler P225s, Crest P3500, BGWs.

**Monitor Speakers:** Altec/Mastering Lab 604Es, Yamaha NS-10Ms, Sony APM 700s, Fostex RM 780s, Hortortones.  
**Echo, Reverb & Delay Systems:** Lexicon 224X LARC 3.2 digital reverb, EMT 140s plate, Ecoplate III, AKG BX 10E, (2) Lexicon Pnme Times, Eventide H949 Harmonizer, DeltaLab ADM 1024 II DDL, Marshall time modulator, Roland 555 Chorus Echo.

**Other Outboard Equipment:** (2) UREI 1176 LN limiters, (2) UREI LA-3A limiters, Aphex "Dominant" 2 channel limiter, (3) Drawmer 2 channel gates, (2) Orban 622B dual channel parametric EQs, Klark-Teknik DN27 and DN22 graphic EQs, Systech flanger, Orban de-essers, digital coffee machine.

**Microphones:** Over 100 mics: Neumann, Sennheiser, Shure, E-V, RCA, Sony, AKG, Crown (including tube and ribbon types).

**Instruments Available:** Yamaha C7 74" grand piano, Yamaha DX7 digital synth, Minimoog, LinnDrum comput-

er, Premier drums w/Zildjian cymbals, Yamaha, Gibson and Fender guitars, basses and amplifiers, Rockman X100, misc. pedals and effects, etc. Fairlight CMI and Emulator II available at extra cost.

**Video Equipment & Services:** 3/4-inch video lock-up coming soon.

**Rates:** Basic rate includes all equipment, instruments and engineer. Please call for specific quote.

**Extras:** Producers, musicians, arrangers, composers and rentals of any type available. Our primary focus is service and the satisfaction of our clients. We are located four blocks from the beach in sunny Santa Monica. Free parking. **Direction:** The purpose of Sound Solution recording is to provide an environment where people are inspired to perform to their absolute limits and beyond...effortlessly. Recent projects include albums with: The Beach Boys, George Clinton, Peter Dinklage, Freerlight, and Klymaxx.

**[24+] SOUNDCASTLE RECORDING STUDIOS**

2840 Rowena Ave., Los Angeles, CA 90039  
(213) 665-5201

**Owner:** Buddy King  
**Studio Manager:** Darryl Caseine

**[24+] SOUNDER**

17021 Chatsworth St., Granada Hills, CA 91344  
(818) 366-0995

**Owner:** Mark Creamer, Brian Mann  
**Studio Manager:** Mark Creamer, John Slattery

**[24+] STARWORKS AUDIO RECORDING**

1017 N. Cole Ave. Sts. 2, 3 & 4, Hollywood, CA 90038  
(213) 463-4707

**Owner:** F.C.B. Co., Inc.  
**Studio Manager:** Chris Columby

**Engineers:** Chris Columby  
**Dimensions of Studios:** 15 x 20, 10 x 14, 10 x 10.  
**Dimensions of Control Rooms:** 14 x 10, new room: 20 x 15.

**Tape Recorders:** Otari MTR-90 II, 24-track; Otari MX 50-50 II, 2-track; 1/2-inch or other machines available through support group.

**Mixing Consoles:** Amek Angela 28 x 24 x 56.

**Monitor Amplifiers:** QSC 3350.

**Monitor Speakers:** JBL 4312, Yamaha NS-10s, Auratones.  
**Echo, Reverb & Delay Systems:** Lexicon 200 reverb, Lexicon PCM70 digital effects processor, DeltaLab Effectron II 2056, 1028, 512 digital delays, any reverb, echo or delay available through support groups.

**Other Outboard Equipment:** dbx 160 and 160X compressor/limiters, Aphex Aural Exciters, Drawmer noise gates, Kepex, tube limiter, Orban stereo synthesizer, any outboard equipment available through support groups.

**Microphones:** AKGs, Sennheiser 421, Beyer Dynamic, E-Vs, Shure, Neumann, any mic available through support groups.

**Instruments Available:** Memorymoog Plus, JX-3P, Roland JX-8P, Linn II, Sequential Circuits Drumtraks, Fender Strat, P. Bass, Guild guitar, Fender concert amp; will soon add baby grand piano. Other instruments available through support groups.

**Rates:** Basic rate—\$100/hr., demo and block rates available.

**[24+] THE STUDIO**

22723 Berdon St., Woodland Hills, CA 91367  
(818) 883-1920

**Owner:** Robby and Lyn Weaver  
**Studio Manager:** Robby and Lyn Weaver

**[24+] STUDIO CITY RECORDERS**

4181 Sunswep Dr., Studio City, CA 91604  
(818) 980-6220

**Owner:** John Hoier

**[24+] STUDIO MASTERS**

8312 Beverly Blvd., Los Angeles, CA 90048  
(213) 653-1988

**Owner:** Randolph C. Wood  
**Studio Manager:** Laurence C. Wood

**[24+] STUDIO II**

(Affiliate of Indigo Ranch)  
9733 Culver Blvd., Culver City, CA 90230  
(213) 558-8832

**Owner:** Richard Kaplan, Jason Wolchin  
**Studio Manager:** Jason Wolchin

**Engineers:** Richard Kaplan, Jason Wolchin, various others.  
**Dimensions of Studios:** 18 x 45, designed by Jeff Cooper.  
**Dimensions of Control Rooms:** 12 x 12, designed by Jeff Cooper.

**Tape Recorders:** Stephens 821 A, 24-track; Stephens 821 A 1/2-inch, 4-track; 3M 79 1/4-inch, 1/2-inch, 2-track (transformerless); Scully 280 15-30 ips 1/4-inch, 2-track; Scully 280B

# TRACK FOR NECAM AT SDR

## SDR STUDIOS

14511 DELANO ST.  
VAN NUYS, CA 91411  
(818) 994-9973

Circle #138 on Reader Service Card

Ask for our  
**FREE CATALOG**  
OF PROFESSIONAL  
*Video* RECORDING  
& DUPLICATING SUPPLIES

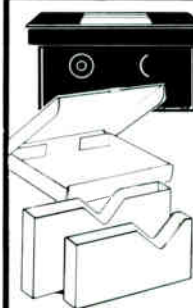

**Polyline**  
Shelf Boxes  
Corrugated Shippers  
Cardboard Sleeves

**ACCESSORIES**



EDITALL  
3M Scotch  
LABELS

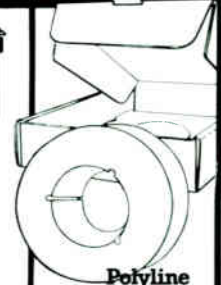

**Polyline**  
SPOT REELS

**VIDEO TAPES**

maxell  
TDK  
3M Scotch  
BASF  
SONY  
AMPEX  
AGFA  
FUJI

**Polyline Corp.**

1233 Rand Rd. • Des Plaines, IL 60016  
**(312) 298-5300**

Circle #139 on Reader Service Card

¼-inch, 2-track; (3) Sony TCK-777 cassette decks; TEAC Z-5000 cassette deck.

**Mixing Consoles:** Aengus/Jensen, 32 x 24; (8) additional tube mic preamps.

**Monitor Amplifiers:** BGW750Cs, Crown DC300As, Technics 400W Class A to small speakers, Mattes 100.

**Monitor Speakers:** Custom 4-way JBL, Yamaha NS-10.

**Echo, Reverb & Delay Systems:** (2) EMT 140 stereo plates, Publison Internal 90 stereo audio computer (stereo sampling or (2) digital reverbs), Roland SRV 2000 digital reverb, MXR-ART 01 digital reverb, (2) Yamaha REV7 digital reverb, Alesis XT digital reverb, Ursa Major Space Station, Ecoplate, Master-Room reverb, Sennheiser reverb, Telefunken reverb, Eventide 1745A, Eventide 1745M, (2) Eventide H910 Harmonizers, (2) Roland SDE 3000 digital delay, Yamaha 1500 digital delay, BEL digital delay/flanger, Marshall Time Modulator, (2) Cooper Time Cubes, Lexicon Prime Time, Loft 440 stereo flanger, (3) MXR DDLs, MXR pitch shift/doubler, MXR flanger doubler, Mutron stereo Bi-Phase, Eventide Instant Phaser.

**Other Outboard Equipment:** Limiters: LA1 (tube), LA-2A (tube), EMT 156 stereo, dbx 162 stereo, Eventide Omnipressor, Inovonics limiter, UREI 175 tube, UA-176 tube, Altec 436C tube, (3) RCA tube limiters, Orban de-esser, EQ: Pultecs, SAE graphics, APis, B&Bs, Aengus graphics, Colins and Cinema Engineering w/Pultec boosters, Altec filters. Gates: (4) Symetrix gates, (8) Kepelex, (4) RM noise gates; Roland guitar pre-amp; White 140 analyzer; dbx Boom Box bass synthesizer.

**Microphones:** Telefunken 251 tube; Neumann U47 tube, KM53 tube, KM54 tube, KM56 tube, KM64 tube, KM84, KM86, U64 Neuvistor, U67 tube, U87s, SM69 stereo, M269 tube; AKG C12A, C60, C61, C28, C451, C452, C414; E-V: RE-20, 666, CS-15, 731, 670; Calrec 1050; Sony C-37Ps, C220, ECM 16, ECM 22, ECM 56, ECM 65, ECM 54; Shure SM56, SM57, SM58, 545, 565; Altec 22, 29A, 150A, 175A tubes, etc.

**Instruments Available:** Kawai grand piano.

**Video Equipment & Services:** Available.

**Rates:** Available upon request.

#### [24+] STUDIO ULTIMO

1900 Sepulveda Blvd., W. Los Angeles, CA 90025  
(213) 479-6010

**Owner:** Studio Ultimo, Inc. by KSH Corp.

**Studio Manager:** Victor Levine

**Engineers:** Vanous, Stuart Taylor, Chris Budny.

**Dimensions of Studios:** Louvered room with three booths.

**Dimensions of Control Rooms:** Huge.

**Tape Recorders:** Ampex ATR 124, 48-track; Ampex ATR 102, 2-track; Ampex ATR 104, 4-track.

**Mixing Consoles:** Neve 8108/automated 48 x 32.

**Monitor Speakers:** Custom.

**Echo, Reverb & Delay Systems:** EMT 250, AMS RMX 16, AMS DMX 15, Lexicon PCM70, Yamaha REV7, Yamaha SPX90, Roland SDE 3000.

**Other Outboard Equipment:** Eventide 949, Drawmer gates, Kepex II, dbx 160, LA-2A, Bel sampler, etc.

**Microphones:** AKG, Sennheiser, Neumann, etc.

**Instruments Available:** Piano, Fairlight.

**Video Equipment & Services:** Sony BVU 5850 w/Time Lynx lockup to 48 tracks. Built in monitor.

**Rates:** Available.

#### [24+] SUMMA MUSIC GROUP STUDIOS

8507 Sunset Blvd., W. Hollywood, CA 90069  
(213) 854-6300

**Owner:** Rick Stevens

**Studio Manager:** Connie Hendrix

**Extras:** L.A.'s most complete synthesizer specialty studio. Features: Synclavier, Fairlight-CMI, (2) DX7, PPG Wave, TX-816, DX Pro and other computer sequencers programs. AMS and Lexicon reverb, (5) digital delays, Massenburg EQ. The West Coast's premiere facility for synthesizer recording.

#### [24+] SUNSET SOUND

6650 Sunset Blvd., Hollywood, CA 90028  
(213) 469-1186

**Owner:** Paul Camarata

**Studio Manager:** Craig Hubler

**Engineers:** Eric Benton, Bill Jackson, Stephen Shelton, Coke Johnson, Paul Levy, David Glover, Mike Kloster, Jeff Bork, George Binder.

**Dimensions of Studios:** Studio 1: 22 x 36 w/separate string room; Studio 2: 30 x 40; Studio 3: 20 x 50 w/2 iso rooms.

**Dimensions of Control Rooms:** Studio 1: 19 x 20; Studio 2: 16 x 23; Studio 3: 18 x 21.

**Tape Recorders:** Studer A-800 MKIII, 24-track; Ampex MM-1200, 24-track; Ampex ATR-100, 2- and 4-track; Aiwa F-660, cassette; digital; all formats available upon request.

**Mixing Consoles:** Consoles in Studio 1 and 2 feature Necam automation; Studio 1: custom Sunset Industries 68 x 68; Studio 2: custom Sunset Industries 32 x 24; Studio 3: custom Sunset Industries 32 x 24.

**Monitor Amplifiers:** H&H; BGW; Crown.

**Monitor Speakers:** JBL custom/George Augspurger de-

## SOUTHERN CALIFORNIA



sign in all control rooms.

**Echo, Reverb & Delay Systems:** (3) Live acoustical chambers; Eventide 1745M DDL; EMT 250; EMT 251; EMT plates; Ecoplate reverb; AKG BX-20; Lexicon Prime Time Stresser I and II; Lexicon 1025 DDL, AMS RMX-16 reverbs; AMS-1580S delays; Roland SDE-3000 delays.

**Other Outboard Equipment:** Harmonizers, phasers, parametric EQs, Inovonics 201 limiters, UREI LA-2A, UREI LA-3, UREI LA-4 limiters, VSO, ADR Vocal Stresser, Allison Kepex I and II and Gain Brains, Roger Mayer noise gates, Drawmer noise gates, B&B Sub-mixer grouper, 12-channel console; 8-channel console; Q Lock 3.10 SMPTE synchronizer; dbx 902 de-essers; dbx 903 comp./limiters.

**Microphones:** Neumann U67, U47, U87; KM84, U47 FET, M49, U67; Electro-Voice RE-20, 635A; Altec 21D, 633A; RCA 77D, 44BX; Beyers MB301; Sennheiser MKH405, 421, 441; Sony ECM222P, C-37; AKG 414, 451; Shure SM60, LSM546, SM56, SM57, SM59; Crown PZM 130, PZM 150; Telefunken 251; Shure SM-7, AKG "The Tube."

**Instruments Available:** Steinway "B" concert grand in each studio; upright tack piano; LinnDrum machine

**Video Equipment & Services:** Sony monitors ¾-inch U-matics; SMPTE interlock; Audio-for-video post-production for commercial and television audio sweetening.

**Rates:** Dolby noise reduction and assistant engineer included in rate; Sunset Sound first engineer extra. Studio 1 and 2: \$140/hr.; Studio 3: \$125/hr.

**Extras:** Main lobby game room w/snack and coffee bar and lounge; lounges for each studio equipped w/refrigerator, Sony TV, and private phone. Ample parking facilities. Basketball court and ping pong. Picnic tables and summer cookouts. Full security service for complete protection.

**Direction:** For 25 years, Sunset Sound has provided its customers with the finest recording services, the most professional staff anywhere, and superior quality that remains unequalled. We look forward to another 25 years as a leader in our industry.

#### [24+] SUNSET SOUND FACTORY

6357 Selma Ave., Hollywood, CA 90028  
(213) 467-2500

**Owner:** Paul Camarata

**Studio Manager:** Philip MacConnell, Catharina Bunch

**Engineers:** Jon Dressel, Tchad Blake, David Knight, and independents.

**Dimensions of Studios:** A: 26 x 16, isolation room: 20 x 12.5, isolation booth: 12 x 7; B: 20 x 22, isolation booth: 9.5 x 6.5.

**Dimensions of Control Rooms:** A: 19 x 13; B: 18 x 16.

**Tape Recorders:** Ampex MM 1200, 24-track; Ampex ATR 102, 2-track; Ampex ATR ½-inch 2-track; Technics 1500, ½-track/¼-track; Ampex ATR, 4-track and Aiwa cassette machines.

**Mixing Consoles:** A: API, 28 x 24; B: API, 32 x 32.

**Monitor Amplifiers:** Phase Linear, McIntosh.

**Monitor Speakers:** Altec 604E w/Masteng Lab crossovers (both rooms), Yamaha NS10s, JBL 4310s, JBL L19s, Braun L500s, Auratones, Auratone T-6s.

**Echo, Reverb & Delay Systems:** EMT 140 stereo Ecoplates, EMT 251, EMT 970 delay, Cooper Time Cubes, Lexicon 224X w/LARC, Lexicon Prime Time, Eventide 1745 delay, Roland SDE 3000.

**Other Outboard Equipment:** Dolby, Kepexes, Gain Brains, 1176s, LA-3As, LA-2A, de-esser, harmonizers, flangers, Fairchild 602, EMT 156, Lang PEQ-2, UREI 550A, Lang EQ 259A, ITI MEP 230 PEQ, digital metronome, Kepex IIs, Orban 621B-EQ, API 550A and 560 EQs, dbx 160X, Drawmer DS201, Hill Audio.

**Microphones:** Neumann U67, U47, U47 FETs, U87s, KM84s, KM86s, KM88s, M49s; Telefunken ELAM 251s; RCA 77s, 44s; Altec RDC 123; Sony C65, ECM50, ECM22P, C37As, 201, CS50s; AKG C12As, 414EBs, 202s, 224s, 452s, E-V RE-20s, 666s, 1751s, Shure SM53s, SM56s, SM57s, 585, 544; Sennheiser 421s, 441s, 815s.

**Instruments Available:** Steinway model B grand pianos (both rooms), Hammond B-3 organ w/Leslie speaker.

**Rates:** Call for rates.

#### [24+] SUNSOUND STUDIO

9590 Cheapeake Dr., San Diego, CA 92123  
(619) 565-8011

**Owner:** Edward J. Peters  
**Studio Manager:** Jim Norr

#### [24+] SUNWEST STUDIOS

5533 Sunset Blvd., Hollywood, CA 90028  
(213) 463-5631  
**Owner:** Bob Williams

#### [24+] SUPERSCORE STUDIOS

5453 Agnes Ave., No. Hollywood, CA 91607  
(818) 506-4832

**Owner:** Ray Colcord

**Studio Manager:** Ray Colcord

**Engineers:** Ray Colcord, Avi Kipper.

**Dimensions of Studios:** 24 x 22

**Tape Recorders:** MCI JH24, 24-track; Otari M5050B, 2-track; Tascam 3440, 4-track. (3) JVC cassette players.

**Mixing Consoles:** 32 input TAC Scorpio.

**Monitor Amplifiers:** (2) Crown DC-300As, QMIGC 500.

**Monitor Speakers:** Eastlake dual 15s, biamped, Yamaha NS-10s, Auratones.

**Echo, Reverb & Delay Systems:** Lexicon PCM60, Yamaha REV7, Roland SDE 3000, MXR delay system II.

**Other Outboard Equipment:** Scamp Rack w/EQ and gates, UREI 565 filter set, Symetrix 522 compressor/expander, Doctor Click 2, UREI digital metronome, Aphex Exciter, Korg DVP-1 harmonizer/chorus, Tr-stereo chorus, Boss CE300 Superchorus, 360 systems MIDI patcher, Dynacord rack-mount Leslie, Hill Audio 20-input keyboard mixer.

**Microphones:** Neumann, Crown, Shure, Electro-Voice.

**Instruments Available:** Oberheim Matrix 12 and OB8, Emulator II, Memorymoog, DX7 + TX816 rack, Linn 9000, modified Fender-Rhodes, Minimoog, Fazer upright.

**Video Equipment & Services:** ¾-inch and VHS players, 25-inch Sony monitor.

**Rates:** \$75/hr. (block time available and negotiable).

#### [24+] TAJ SOUNDWORKS

8207 W. Third St., Los Angeles, CA 90048  
(213) 655-2775

**Owner:** Allan H. Goodman, John B. Roesch, Ed Bannon

**Studio Manager:** Debra L. Pruse

#### [24+] TALON RECORDING (PRODUCTIONS)

3925 Big Oak Ave., Studio City, CA 91604  
(818) 763-0257

**Owner:** Mikey Davis

**Studio Manager:** Kevin Smith



THAT STUDIO RECORDING SERVICES  
North Hollywood, CA

#### [24+] THAT STUDIO RECORDING SERVICES also REMOTE RECORDING

P.O. Box 958, North Hollywood, CA 91603  
(818) 764-1421

**Owner:** That Studio, Inc.

**Studio Manager:** Richard Holbrook

**Engineers:** Richard Holbrook, Denny McLane, Steve Sebold, Rob Pfeifer, independents.

**Dimensions of Studios:** 30 x 20 w/extensive trapping (live and dead areas); 8 x 9 live isolation room/chamber.

**Dimensions of Control Rooms:** 14 x 9 (studio); 12 x 8 (truck).

**Tape Recorders:** Otari MTR-90, 24/16-track; Otari MTR-12, 2-track; Otari MX 5050, 2-track; Otari MX5050, 8-track; TEAC 3340s, 4-track; Technics M85 cassette; Aiwa F770 cassette.



Mixing Consoles: Studio Harrison MR-4 (automated) 28 x 24; truck: Audiotronics 110-8 (modified) 24 x 8 x 2.  
**Monitor Amplifiers:** Crown, BGW, Yamaha, QSC, Altec.  
**Monitor Speakers:** JBL 4315, JBL 4313, Altec 604s, Yamaha NS-10s, Auratones, E-V Sentry 100As.

**Echo, Reverb & Delay Systems:** Lexicon digital reverb 200, Lexicon Prime Time DDLs, MICMIX Master-Room plate, Sound Workshop reverb.

**Other Outboard Equipment:** Eventide 910 Harmonizer; dbx 160, 161, 162, 160Xs; Audio Design and Recording Scamp Rack w/ noise gates, Audio Panner, etc.; dbx noise reduction; Biamp EQs, Lexicon PCM41.

**Microphones:** Neumann, AKG, Crown, PZM, Beyer, Sennheiser, PML, Sony, Electro-Voice, Shure.

**Instruments Available:** Yamaha C7 grand piano, Hammond B-3 w/Leslies, Sonor drum kit, G&L bass guitar, mono and stereo Rhodes, assorted acoustic guitars and amps, Juno 6 synth, LinnDrum, a wide range of percussion instruments and other toys when reserved in advance.

**Video Equipment & Services:** Available upon request. Rates: Please call for color studio brochure and rate card. Extras: Live isolation booth/small chamber for tracking and overdubs. There is a client lounge, coffee and kitchenette area, storage, video games and TV. That Studio also offers a wide range of audio services, including custom record and disk production, sound reinforcement, audio consultation and installation, and demo production assistance. Please call us and see how we can fill your needs in recording.

**[24+] JOHN THOMAS STUDIOS**  
 11213 Oxnard St., North Hollywood, CA 91606  
 (818) 760-4444

**[24+] 3-D STUDIOS**  
 204 Cabrillo St., Costa Mesa, CA 92627  
 (714) 548-0479  
 Owner: Doug Doyle  
 Studio Manager: Doug Doyle

**[24+] TIME CAPSULE RECORDING**  
 15533 Jacana Dr., La Mirada, CA 90638  
 (714) 739-9158  
 Owner: Herb Jung  
 Studio Manager: Jacqueline Jung

**[24+] GEORGE TOBIN**  
 11337 Burbank Blvd., No. Hollywood, CA 91601  
 (818) 506-4487

Owner: George Tobin  
 Studio Manager: Brad Schmidt  
 Engineers: John Kerns, independents: Les Brockman, Howard Lee Wolen, Bill Smith, Allen Hirshberg, David Koenig, Bryan Stott, Cisco DeLuna.

**Dimensions of Studios:** Studio A: 45 x 25 w/2 isolation booths approx. 10 x 12 each; Studio B: 30 x 15.

**Dimensions of Control Rooms:** 20 x 20 each (both control rooms were built to identical specs)

**Tape Recorders:** (2) Otari MTR-90 Mark III, 24-track; Ampex MM1200, 24-track; (3) Ampex ATR-102 1/2- and 1/4-inch, 2-track.

**Mixing Consoles:** Trident Series 80B 40 x 24; Trident Di-an 40 x 32 x 32, both w/56 auto returns.

**Monitor Amplifiers:** H&H M900.

**Monitor Speakers:** UREI 813 Time Align, JBL 4313, Auratones, Yamaha NS-10.

**Echo, Reverb & Delay Systems:** EMT 251, EMT 240, Lexicon 224, AKG BX10, Roland SDE 3000, Lexicon Prime Time, Eventide 949 and 910 Harmonizers, (2) AMS RMX 16 reverbs.

**Other Outboard Equipment:** Pultec, Lang, and Klark-Teknik EQs, ADR Vocal Stresser, dbx, UREI and Fairchild limiters, Drawmer gates, Kepex, Gain Brain, EXR Exciter, Orban de-esser, (10) GML pre-amps, (4) GML parametric EQs, (20) API 550A EQs, Tri-stereo chorus.

**Microphones:** Telefunken 251 tube; Neumann U47 tube, U67, U87, KM86, KM84; AKG 452 EB, D-12; Sennheiser 406; MD-416, 421, 441; E-V RE-20, RE-15, RE-10, RE-11, 635A; RCA 77; Sony EC-9P, ECM 50.

**Instruments Available:** Kurzweil 25 w/Macintosh computer, Kawai acoustic grand piano, Hammond organ, Rhodes, Wurliizer, Sequential Circuits Prophet, Pro 1, Linn-Drum machine, Jupiter 6.

Rates: Negotiable. Please call for quotes.

**[24+] TOTAL ACCESS RECORDING**  
 also REMOTE RECORDING  
 612 Meyer Ln. #18, Redondo Beach, CA 90278  
 (213) 376-0404

Owner: Alan H. Juckes, Allan W. Davis  
 Studio Manager: Allan Davis  
 Engineers: Wyn Davis, Mike Lardie, Allan Davis, Pete Butt.

**Dimensions of Studios:** 25 x 30, 15,000 cu. ft., live chamber, various other small specialty rooms.

**Dimensions of Control Rooms:** 25 x 20.

# Masters at Work

- Fast turn-around\*
- Custom printing
- No minimum runs
- Extensive quality control
- Lowest prices
- From any master

Resolution brings you the Revox B-215 and a cassette of superior quality. The B-215 features Dolby HX Pro. Unlike high speed duplicators, we cut direct from digital masters. Resolution manufactures cassettes for some of the most demanding producers and labels in the country: all in real-time, all on time. Phone now **toll free 1-800-862-8900** and ask about our special test cassette offer and free catalogue. We now provide Hi Fi video duplication, as well.

All work is 100% guaranteed \*24-hour service available.

**RESOLUTION**  
 VIDEO AUDIO AND FILM  
 Chace Mill  
 One Mill Street  
 Burlington, Vermont  
 05401-1514

Circle #140 on Reader Service Card

# THINK SMALL.

Think laser optical scanning combined with digital playback for superior sound. Think music minus noise . . . total freedom from distortion . . . complete absence of rumble, wow and flutter . . . wider dynamic range . . . astounding fidelity (even at low levels, behind narration) . . . and virtual indestructibility. In other words, think Compact Audio Disc. Think CD . . . and give us a call. We now have the *entire* library in stock. Because at Network, we're always thinking of ways to bring you better sounding music.

**network**

Network Production Music, Inc.  
 11021 Via Frontera, San Diego, California 92127 • (619) 451-6400 • 800 854-2075

Circle #141 on Reader Service Card

**ELECTRONIC REPAIR**

1/4" & 1/2" Multitrack  
**RECORDERS**  
authorized service on  
**TEAC FOSTEX & AKAI**  
and many others

**DeltaLab**  
exclusive for DL range

**MIDI Retrofits**  
& computerized analysis

**415-864-3300**

**MAGIC Music Machines** 1207 HOWARD ST  
SAN FRANCISCO  
CALIFORNIA 94103

Mon-Fri 10-6 Sat 11-6

Circle #142 on Reader Service Card

**RCA** 

**Test Tapes**

*A Sound Measure*

- Cassettes
- Open Reel up to 1"
- Custom Formats

For a catalogue of standard test tapes or further information contact:

**RCA TEST TAPES**  
DEPT M  
6550 E. 30th St.  
Indianapolis, IN 46219  
(317) 542-6427

Circle #143 on Reader Service Card

**SOUTHERN CALIFORNIA**



**24+ TRACK**

**Tape Recorders:** Ampex ATR-124, 24-track; Ampex ATR-102/4, 2-, 4-track; MCI JH-110A, 2-track; Sony (digital) PCM701, 2-track; Nakamichi ZX-7 cassette.

**Mixing Consoles:** Fully modified MCI 528B, 28 x 28; Yamaha 1602, 16 x 4.

**Monitor Amplifiers:** (2) BGW 500, 250, Hafler 500, Crown Power Line 700, Phase Linear 400.

**Monitor Speakers:** UREI 813 w/Altec 604s, Canton, JBL 4315s, Spondour (W. German radio standard) Tannoy, Hortortones.

**Echo, Reverb & Delay Systems:** Lexicon 224XL, AMS 16-80s, Lexicon 95, Lexicon 93, Roland SDE-3000, Roland SRV-2000, Yamaha REV7, Yamaha SPX-90, EMT-240 Gold-foil, BX-20 AKG, Quantec, any device you've ever seen or heard of!

**Other Outboard Equipment:** (3) UREI 1176, (2) UREI LA-3As, (2) dbx 165As, (2) dbx 160s, (2) Sontec tape and disk mastering EQ, (8) Drawmer noise gates, (2) Aphex CX-1s, Eventide Omnipressor, Lang and Pultec EQs, Audio & Design Vocal Stresser.

**Microphones:** Full complement of Neumann, AKG condenser mics, include: U87, 86, 67, 88s etc; some tube types. Complete selection of dynamic mics.

**Instruments Available:** Linn 9000 fully-updated and crash proofed w/memory options, disk drive and sampling, Yamaha DX7, DX21, Roland JP-8, Strats, Pauls, and an extensive collection of rare acoustic guitars.

**Video Equipment & Services:** (2) Beta decks, (2) VHS decks.

**Rates:** Call for quotes and info.

**Extras:** Kitchen, lounge, TV, VCR, video games, very comfortable living accommodation located 1.5 miles from the Pacific Ocean, the most competitive rates on rented instruments and outboard equipment.

**Direction:** Our philosophy is to give our clients the absolute best environment in which to work. We are not a TV production studio or a jingle studio—we make records for people who are interested in the finest audio quality without blowing their budgets out of the water. Our staff will and do support every one of our clients in every possible way. We have pampered some of the world's most demanding clients and have left some of our most private artists on their own to work in the way that suits them. Satisfied clients include: producer Ken Scott, producer Michael Wagener, producer and artist Don Dokken, Tears for Fears, Kaja, Dokken, Great White, Enc Carmen, Level 42, The Rads, Cockrobin, Joe Pizzulo, "X," Black Flag, Husker Du, Meat Puppets, White Sister, many more.

[24+] **TOTAL EXPERIENCE**  
6226 Yucca St., Hollywood, CA 90028  
(213) 466-9202

Owner: Lonnie Simmons  
Studio Manager: Bernard Spears, Barry Stienpress

[24+] **TRACK RECORD**  
5249 Melrose Ave., Los Angeles, CA 90038  
(213) 467-9432

Owner: Thomas M. Murphy  
Studio Manager: Rickman  
Engineers: Tom Murphy, John Carter, Rickman, Ken Polaulakovich, Bryan Carlstrom, Dave Jenkins.

**Dimensions of Studios:** 14 x 25 x 13 and 14 x 18 x 14.  
**Dimensions of Control Rooms:** 15 x 20 x 12.

**Tape Recorders:** MCI JH-24, 24-track; Ampex ATR 100, 2-track; Otari MTR-90, 2-track.

**Mixing Consoles:** Trident 80, 40 x 24.  
**Monitor Amplifiers:** H&H w/White 1/3 octave EQ, SAE.  
**Monitor Speakers:** UREI 813 Time Align, JBL 4301s, Yamaha NS-10M, Auratones.

**Echo, Reverb & Delay Systems:** Epcloplate I and II, live chamber, Harmonizer 910, Lexicon Prime Time, DeltaLab DL1 and DL2 Acousticcomputer, Cooper Time Cube, 224X Lexicon w/LARC, Bel BD-80 (8 seconds of sampling), SPX 90.

**Other Outboard Equipment:** (2) UREI 1176LN, Teletronix LA-2A, (4) Trident limiter compressor, (2) Altec 436C, (2)

Pultec EQH2, (2) Trident parametric EQ CB 9066, UREI 535 graphic EQ, Cinema Eng program EQ, Phase Linear Autocorrelator, custom stereo Aural Exciter, dbx 165A limiter, Pultec MEQ 5, Trident stereo compressors, Roland Dimension "D," Roland Compu Editor 15 channel automation, (4) UREI 1176 compressors, (2) Trident compressors, (4) Drawmer gates, (2) Kepex 11.

**Microphones:** U47 tube Telefunken, U47 FET Neumann, (3) U87, (2) KM84, (3) KM64 tube; AKG (2) 452, (3) 451, 414P48, 414EB; RCA 77DX; Sennheiser (3) 441; E-V (2) RE-20; Shure SM7, (6) SM56, PML DC63, (8) 421s.

**Instruments Available:** 7-foot Kawai grand.  
**Video Equipment & Services:** JVC 1/4-inch video cassette recorder Model CR-6650U, Panasonic and NEC monitors and Audio Kinetics 3.10 Q.Lock synchronizer.  
**Rates:** \$50 to \$55/hr. start.

[24+] **TRIANON RECORDING STUDIO**  
1435 South St., Long Beach, CA 90805  
(213) 422-2095  
Owner: John Vestman  
Studio Manager: John Vestman

**The Power and Magnificence of the Moment of Glory**

*No Studio Can Capture It*

**the TRUCK**  
MOBILE RECORDING FACILITY

You never sounded so good.

**818-507-TRUK**

**THE TRUCK MOBILE RECORDING FACILITY**  
Glendale, CA

[24+] **THE TRUCK MOBILE RECORDING FACILITY**  
*only REMOTE RECORDING*  
P.O. Box 4573, Glendale, CA 91202  
(818) 507-TRUK  
Studio Manager: Bruce Black

[24+] **VALENTINE RECORDING STUDIOS**  
5330 Laurel Canyon, North Hollywood, CA 91607  
(818) 769-1515  
Owner: Jim Valentine  
Studio Manager: Eve Valentine

**the village**  
recorder

**DIGITAL RECORDING & MIXING**

**THE VILLAGE RECORDER**  
West Los Angeles, CA

[24+] **THE VILLAGE RECORDER**  
1616 Butler Ave., W. Los Angeles, CA 90025  
(213) 478-8227  
Owner: Geordie Hormel  
Studio Manager: Kathy Konop, Michael Geller  
Engineers: Jeff Harris, chief engineer, Tom Nist, Robin Laine, Charlie Brocco, Jeff DeMorris, assist. engineers; Dick



La Palm, sales, David Clark, chief of maintenance; Jeff Harris, video.

**Tape Recorders:** (3) Sony (digital) 3324, 24-track; Mitsubishi (digital) X-800, 32-track; (3) Studer (analog) A800, 24-track; Studer (analog) A80, 24-track; Ampex (analog) ATR 104 and (6) 102, 4-, 2-track respectively; Sony (digital) PCM 1610, 2-track; (2) Mitsubishi (digital) X-80, 2-track.

**Mixing Consoles:** Solid State Logic w/Total Recall 4056E, 56 x 32; Neve w/Necam 8108, 48 x 32; Neve w/Necam 8078, 40 x 24.

**Monitor Amplifiers:** McIntosh, Crown PSA-2.

**Monitor Speakers:** Village custom design, JBL and TAD components, bi-amped 3-way.

**Echo, Reverb & Delay Systems:** EMT 250s, Lexicon 224s w/4.3 programs, EMT 140s, live chamber, EMT 240, AMS 15.80 RMX 16, Capitol live chamber, Roland SDS 3000, Eventide 1745 M, H910, 949, Lexicon 102S Prime Time.

**Other Outboard Equipment:** UREI, Teletronix, dbx, Orban, Drawmer, Valley People, ADR Scamp, Aphex ITI, API, Lang, Pultec, EMT, Neve 10 x 2 mixer.

**Microphones:** Complete Neumann, AKG, Beyer, Shure, RCA, Sennheiser, Electro-Voice, Sony, Telefunken, Schoeps, PZM.

**Instruments Available:** Yamaha and Steinway grands w/MIDI, Fairlight CMI.

**Video Equipment & Services:** 3/4-inch interlace all studios, synchronizers, Time Line Lynx, Q.Lock 310, Studer TLS 2000, CMX compatible Convergence 103B Controller editing bay, Sony 5850s, BVU 800, Fairlight CVI, A/B Roll, mixed video effects, Fairlight CVI video computer, ADR/Foley, sweetening, custom sound effects, 10-foot large screen projection, production.

**Rates:** Upon request.

**[24+] WARTHOG STUDIOS**

also **REMOTE RECORDING**  
2554 Lincoln Blvd., Marina del Rey, CA 92091

(213) 827-0505

Owner: Barbara Vetter

Studio Manager: Sam Longoria

**[24+] WEDDINGTON STUDIO**

11128 Weddington St., No. Hollywood, CA 91601

(818) 508-5660

Owner: Robert Cotton

Studio Manager: Glen Heard

**[24+] WEST OAK RECORDERS**

41 N. Duesenberg Dr., Westlake Village, CA 91362

(805) 495-0606

Owner: Bill Cobb

Studio Manager: Kevin Gilroy

Engineers: Steve Hallmark, Bill Cobb, Kevin Gilroy, Rick Evans.

**Dimensions of Studios:** Studio A: 40 x 35 w/10 x 7 isolation booth.

**Dimensions of Control Rooms:** Studio A: 23 x 20; Studio B: 9 x 14.

**Tape Recorders:** Studio A: Stephens w/autolocator 821 B, 24- and 16-track; Ampex ATR 100, 2-track; Scully 280A 4- and 2-track; Technics 1520, 2-track; Studio B: Soundcraft 762, 24-track; Otari MH 5050B, 2-track.

**Mixing Consoles:** (2) Soundcraft 2400 28 x 24 w/52 input remix.

**Monitor Amplifiers:** AB Systems Series 600, 720, 730 and 810; Crown D-150A, D-60.

**Monitor Speakers:** Custom JBL triamped, UREI 813 Time Aligns, JBL 4411s, Westlake Audio BBSM6Fs near fields, Yamaha NS-10s, Auratones.

**Echo, Reverb & Delay Systems:** Lexicon 224 digital reverb, EMT 140 stereo plate reverb, Lexicon PCM70, PCM60 processors, Yamaha REV7 digital reverb, SBX-90 digital processors, (4) Roland SDE-3000 digital delays; (2) Korg SDD 3000 digital delays; (2) ADA 1280 delays; Lexicon Prime Time, Eventide Harmonizer, instant flanger, Marshall time modulator, DeltaLab Acousticcomputer.

**Other Outboard Equipment:** ADR Vocal Stresser, Express limiter, dbx 900 Series noise gates, compressors and de-essers, dbx 160 and 166 compressors, (2) Aphex Aural Exciters, Orban parametric EQ and stereo synthesizer.

**Microphones:** AKG 414s, 451s, 501s, 202s, Neumann U87s, Telefunken 251 tube, Shure SM81s, SM7s, SM53, SM77s, SM57s, Sony C-48, C-36Ps, ECM 22P, Crown PZMs, Electro-Voice RE-20s, Sennheiser MD-421.

**Instruments Available:** Mason & Hamlin 7-foot grand, Emu Emulator II and Emu SP-12 drum machine w/McIntosh computer sequencing and patch libraries, Yamaha DX7, Roland JP-6 synth, Korg EX-800 synth module, Yamaha TX modules, 360 systems MIDI bass module, KX-88 keyboard controller.

**Video Equipment & Services:** Sync interlock for video sweetening available upon request.

**Rates:** Available upon request.

**[24+] WESTERN AUDIO**

9851 Prospect Ave. Ste. B, Santee, CA 92071

(619) 258-1400

Owner: Harlan Lansky

Studio Manager: Matthew Silver

**[24+] WESTLAKE AUDIO,  
RECORDING SERVICES GROUP**

7265 Santa Monica Blvd. and 8447 Beverly Blvd.

Los Angeles, CA 90048

(213) 655-0303, 654-2155

Owner: Westlake Audio Inc

Studio Manager: Debbie Jenkins



**WESTLAKE RECORDERS**  
Westlake Village

**[24+] WESTLAKE RECORDERS**

31320 Via Colinas #118, Westlake Village, CA 91362

(818) 889-7155

Owner: Bruce Jackson

Studio Manager: Robb Klein

Engineers: Ron Capone, Bruce Jackson, Robb Klein, Chuck Rosa.

**Dimensions of Studios:** A: 32 x 28 x 15, B: 12 x 14 x 15.

**Dimensions of Control Rooms:** A: 22 x 20, B: 24 x 18.

**Tape Recorders:** (2) Otari MTR 90 MKII, 24-track; (2) Otari MTR-12, 2-track; Otari MTR-12Z 4-track; (2) Otari head stacks 1/2-inch 2-track and 1/2-inch 4-track.

**Mixing Consoles:** A: Trident Series 80s, 40 x 56; B: Trident Series 70, 28 x 24.

**Monitor Amplifiers:** (6) Hafler 500.

**Monitor Speakers:** JBL, Yamaha, Auratone.

**Echo, Reverb & Delay Systems:** Lexicon, Ecoplate.

**Other Outboard Equipment:** Aphex, EXR Exciters, 900 rack w/gates, de-essers, parametric EQ, dbx 162, 161, 160X, 165 limiters, UREI 1176 limiters, Eventide 910, (2) 949.

**Microphones:** U87, 414 all the usual stuff; (2) custom vacuum tube mics.

**Instruments Available:** Kawai grand piano.

**Video Equipment & Services:** 1/2-inch and 3/4-inch editing, full-production.

**Rates:** Call for rates.

**Extras:** Synchronized audio-for-video, film scores, 30-pieces comfortably.

**[24+] WESTWORLD RECORDERS**

7118 Van Nuys Blvd., Van Nuys, CA 91405

(818) 782-8449

Owner: Robert Schreiner

Studio Manager: Robert Schreiner

**[24+] WHITE FIELD STUDIO**

2902 W. Garry Ave., Santa Ana, CA 92704

(714) 546-9210

Owner: White Field Studios, Inc.

Studio Manager: Thom Roy

Engineers: Derald Daugherty, Thom Roy, Bob Salcedo, independents.

**Dimensions of Studios:** A: 25 x 25; B: 20 x 25 w/(2) isolation booths. Video: 40 x 40 (lighting grid at 18-feet).

**Dimensions of Control Rooms:** Audio #1: 20 x 25, Audio #2: 15 x 20.

**Tape Recorders:** Stephens 821, 24-track; Ampex ATR 102 1/2-inch, 2-track; Ampex ATR 102 3/4-inch; Ampex AG 440C; Fostex B16D, 16-track.

**Mixing Consoles:** Ford Audio custom w/Allison automation 32 x 24.

**World class products and services at competitive prices.**

**OTARI**  
**TASCAM**

**Soundcraft**  
**TRIDENT**  
**NEOTEK**  
**FOSTEX**  
**TASCAM**  
TEAC Production Products

**\*State of the art selection of outboard equipment**

**(602) 267-0600**



**EAR PROFESSIONAL AUDIO-VIDEO**  
2641 EAST MCDOWELL  
PHOENIX, ARIZONA 85008

Circle #144 on Reader Service Card

**Let the Wizard Duplicate Your Audio & Video Masters**

- ♪ Leading edge technology assures consistent high-quality copies
- ♪ Serving the most discriminating clients in music, government, industry, business and education
- ♪ In-house graphics... labeling and printing plus direct mail
- ♪ Competitive prices from 100 to 1,000,000.
- ♪ Call us concerning all your perplexing audio and video problems. Let the Wizard solve them.



**TIN MAN ENTERPRISES**

2800 Yellow Brick Road • St. Louis, MO 63129

(314) 464-4046

Circle #145 on Reader Service Card

It's 10:00 p.m.—

# Do You Know Where Your NAGRA Is?

## Film • Music • Video

People and technology.

Constantly changing,  
ever remaining the same.

Individuals ultimately make  
the difference.

## Pre-Production • Production • Post-Production

- A knowledge of the needs.
- Familiarity with the tools.
- A style that works.

## Start • Finish • Everything in Between

Be it production headaches,  
Post-production hassles,  
Or the fabled "on time, on budget,"  
We can coordinate, produce,  
or troubleshoot for you.

### Spinning Reel Sound Services

Glenn Berkovitz (213) 313-2776  
11929 Windward Avenue, L.A. CA 90066

Circle #146 on Reader Service Card

## SOUND SYSTEM

# BUZZ

ITS TOO BAD YOU  
CANT ALWAYS KEEP IT CLEAN

BUT NOW  
ITS ONLY TEMPORARY  
INTERFERENCE WITH  
A

# MODEL PS-1



In addition to reducing RFI the PS-1 can also protect your sound reinforcement equipment from:

HIGH VOLTAGE TRANSIENTS  
UNEXPECTED POWER UP TRANSIENTS  
IMPROPER LINE POLARITY



linear & digital  
systems, inc.

46 marco lane  
centerville, oh.45459

Circle #147 on Reader Service Card

## SOUTHERN CALIFORNIA



Monitor Amplifiers: AB Systems, Spectra Sonics, Crown 300A, Crown D150, Uni-Sync 100.

Monitor Speakers: Altec 604E/Mastering Lab, Yamaha NS-10, Fostex RM 765, JBL 4311, 4313, Auratone.

Echo, Reverb & Delay Systems: AMS RX16, EMT 240, Lexicon 224, Echo Plate 2, Lexicon PCM60, Eventide H-949, DL2, Loft 450, Lexicon 93, Ibanez DM 1000.

Other Outboard Equipment: UREI LA-2A, LA-3A, Universal 175, 1176, Orban de-esser, Stephens de-esser, EXR, Roger Mayer noise gates, Kepex II, Biamp graphics, dbx 902, 903, 907.

Microphones: Neumann U47 tube, U67, M49, M269, KM54, KM56, KM84; Sony C37A, C57, C500; Telefunken 250, 251E, AKG C12A, C24, C60, 414, 452, 224; Beyler 160, RCA 77DX, E-V RE-20, Sennheiser 421, 441.

Instruments Available: Steinway 9-foot concert, B-3 w/Leslies, Rhodes, guitar amps, drums.

Video Equipment & Services: Crosspoint switchers, Sony M3s, Convergence 203, Apert Herzog HZ TBC, Fortel Y688, 3/4-inch production remote and post services, A/B roll edit, Chyron VP2, SMPTE, Prop Shop, 24 channel 2 scene lights, hard cove.

Rates: Call with requirements.

### [24+] WIDETRACKS RECORDING STUDIO

6429 Selma Ave., Hollywood, CA 90028  
(213) 460-6949

Owner: Widetracks Inc.  
Studio Manager: Dennis Parker



WILDCAT STUDIOS  
Los Angeles, CA

### [24+] WILDCAT STUDIOS

5815 Pico Blvd., Los Angeles, CA 90019  
(213) 931-3411

Owner: John Ross, Taylor Kramer

Studio Manager: John Ross

Engineers: John Ross, Mark Coffin

Dimensions of Studios: 18 x 20; 14 x 16.

Dimensions of Control Rooms: 18 x 20.

Tape Recorders: Otari MTR-9011, 24-track; Otari MTR-20, 2- and 4-track; Tascam 42, 2-track; Yamaha K1020, 2-track; Harmon Kardon CD 391, 2-track.

Mixing Consoles: Trident Series 80B, 32 x 24 x 24.

Monitor Amplifiers: Fender 2244 (x2), Fender 2224 (x2).

Monitor Speakers: Tannoy SRM 15, Yamaha NS-10, Auratone.

Echo, Reverb & Delay Systems: Lexicon 224XL, Lexicon PCM60, Yamaha REV7.

Other Outboard Equipment: Lexicon Prime Time, Effectron II, Roland SDE 1000, Roger Meyer gates, Kepex gates, Symetrix 522, Eventide Omnipressor, GT4 noise gates.

Microphones: Neumann U87, Fostex MM88, AKG 451, Sennheiser 421, Fender D1, D2, D3, P1, SM58.

Instruments Available: Kurzweil 250, Kurzweil MIDI board, Yamaha DX7, Yamaha 816, Prophet 5, Chroma Po-

lans, 2X EX800s, 10000 DX7 sounds, Macintosh computer, Roland SBX 80, Linn 9000.

Video Equipment & Services: 3/4-inch Sony video deck, overhead Sony projection system, Q.Lock VTR, ATR interlock.

Rates: Please call.

### [24+] EVAN WILLIAMS AUDIO/VIDEO RECORDING SERVICES also REMOTE RECORDING

1519 S. Grand Ave., Santa Ana, CA 92705  
(714) 543-6155

Owner: Evan Williams  
Studio Manager: Evan Williams

### [24+] WINETREE RECORDING

P.O. Box 906, Cucamonga, CA 91730  
(714) 980-4242

Owner: Robert S. Dine

### [24+] WONDERLAND STUDIOS

729 S. Western Ave., Los Angeles, CA 90005  
(213) 386-2954

Studio Manager: Stephanie Andrews

### [24+] YAMAHA RESEARCH & DEVELOPMENT STUDIO

1019 S. Central Ave., Glendale, CA 91204  
(818) 500-0230

Owner: Yamaha International Corporation

Studio Manager: Norm Dlugatch

Engineers: Keith Seppanen, Keith Cohen.

Dimensions of Studios: Studio A: main room 30 x 26, iso booth 14 x 15, vocal booth 12 x 10; Studio B: 26 x 22.

Dimensions of Control Rooms: Studio A: 18 x 21; Studio B: 18 x 22.

Tape Recorders: Ampex ATR 124, 24-track; Ampex ATR 104, 4-track; Ampex ATR 102, 2-track.

Mixing Consoles: Solid State Logic SL4000E 48 x 32.

Monitor Amplifiers: Yamaha P2200, Yamaha PC 5002M.

Monitor Speakers: Augsburger, NS-10, 4311, NS-1000, Auratones, UREI 813.

Echo, Reverb & Delay Systems: Yamaha REV-1, Yamaha YDD-2600, Yamaha R1000, Yamaha SPX-90, Ecoplate, EMT 251, AMS stereo, Lexicon 93, Yamaha D-1500.

Other Outboard Equipment: Kepex II, Gain Brain II, Eventide H949, UREI 1176, dbx 160X, Yamaha E1010, AMS DMX 15-80s, dbx 902 de-esser.

Microphones: Neumann U87, U47, U67, KM84, KM88; AKG 452, 414, C24; Sony ECM 50, Shure SM56, SM57, SM58; E-V RE-16, RE-20; Sennheiser MD421, Crown PZM, RCA 77, Beyler M160, M101.

Instruments Available: Yamaha S400B, CF II grand pianos, TX816, TX7, QX1, QX7, KX88, CX5M computer, Apple IIe/DX-Pro and DX Heaven (over 4,000 sounds), DX7, DX9, DX1, FX20.

Video Equipment & Services: Lynx synchronizer for three machines, ATR 124 and ATR 104 can be utilized.

Rates: Please call.

### [24+] YOUR RECORDING STUDIO

18044 Raymer St., Northridge, CA 91325  
(818) 701-7802

Owner: David Lee

# Electronic MUSICIAN

... the first magazine devoted exclusively to the new technology that's revolutionizing the industry, covering MIDI, computer music applications SMPTE/synchronization, video, music sampling/synthesis, and much more! See page 98 for complete information.



# Mix Words

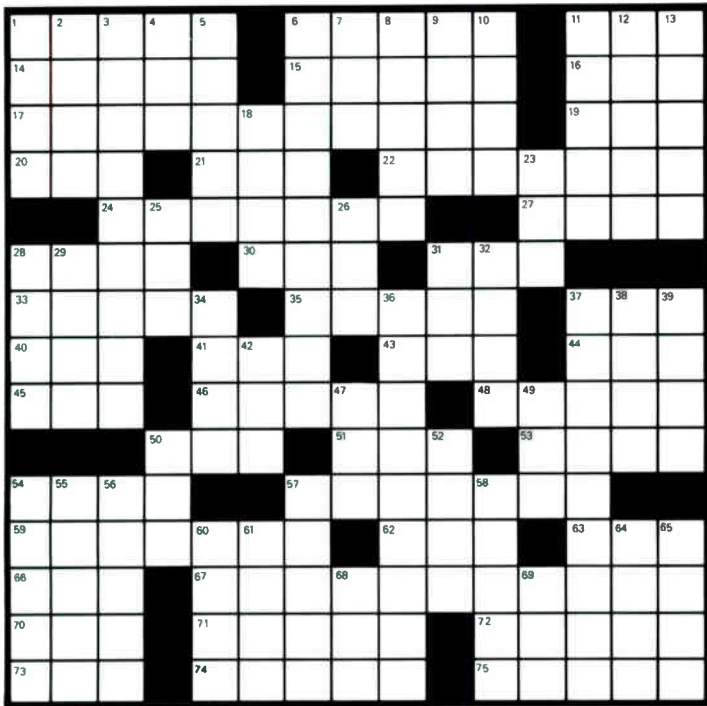

©1986 Armand E. St. Martin

## ROCK IT TO THE MOON

### ACROSS

1. In relation to
6. Stage section
11. Song form
14. Phoenix-like Hindu deity
15. Vision prefix
16. Whaler's chat
17. Special effect
19. Ear prefix
20. Wind dir.
21. Large mammal
22. Seat
24. Prepares
27. Sham
28. Famous person
30. Milit. acad.
31. Rotary control
33. Deserve
35. Sponsorship
37. \_\_\_\_\_ steel guitar
40. Disturb
41. Timetable abbr.
43. Don Ho neck apparel
44. Account
45. Legal thing
46. Popular salad
48. Silver Bullet Bob
50. Implore
51. Queen \_\_\_\_\_ (of Zydeco)
53. Converse
54. Mail order abbr.
57. Reel condition
59. Gunpowder discoverers
62. Stereo component mfg.
63. Greek letter
66. Deteriorate
67. Mega-concert
70. "\_\_\_\_\_ Fool For You"
71. Trumpet call
72. Application
73. Cycles \_\_\_\_\_ second
74. Outer space
75. Spoked

### DOWN

1. Cleo's bane (pl.)
2. \_\_\_\_\_ away from (var.)
3. 17A (pl.)
4. Egglike, prefix
5. Judge
6. Participants in 67A
7. "\_\_\_\_\_ baue ganz auf deine Starke," Mozart Aria
8. Eos is the goddess of this

9. "\_\_\_\_\_ Coming," Three Dog Night hit
10. Deep, as a color
11. Grecian marketplace
12. Indonesian dying style
13. Acid
18. Fire saint
23. Newt
25. "\_\_\_\_\_ was saying"
26. Operate
28. Arab prince
29. Only
31. Humble \_\_\_\_\_
32. Actions or process, ending
34. Studio session requirement
36. Some hard rockers dress like this
37. Action of lasers and Vari-lights
38. Zone
39. Leave
42. Piano piece
47. Jose Feliciano's aunt
49. Old Fr. coin
50. 1972 Michael Jackson hit
52. Alan \_\_\_\_\_
54. Company store tender
55. "Oh, give me \_\_\_\_\_"
56. Ravi's axe
57. Saw parts
58. Happen
60. Spanish being verb
61. Argument
64. Spice from S&G hit
65. Bothered
68. David Allen \_\_\_\_\_
69. "Surfin' \_\_\_\_\_"

## Solution to August Mix Words

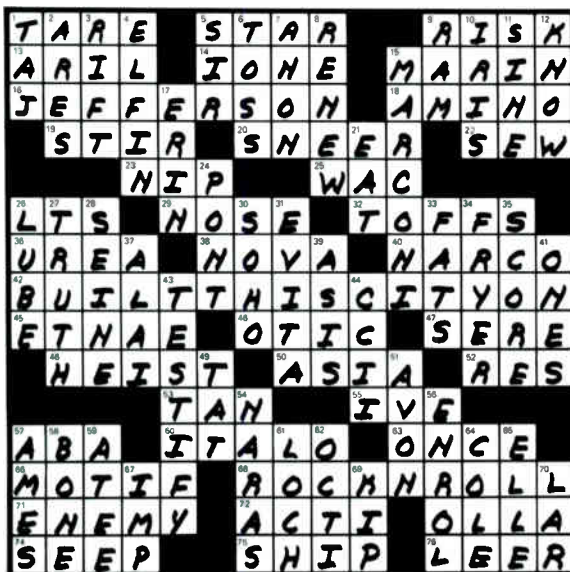

—FROM PAGE 129, R-DAT

In related news, Shape Inc. has announced the acquisition of all assets of Dadeville, Alabama's Data Technology Corp. Renamed Shape South, Inc., Data Technology will begin the manufacture of 3/4-inch U-matic video cassettes during the third quarter of 1986. In a separate move, Shape has also acquired an 80 percent interest in Wabash DataTech, which will be reincorporated as Wabash Inc. The Huntley, Illinois company presently produces tape, tape cartridges and floppy diskettes for mainframe and personal computers.

Mycomp Technologies Corporation (MTC), a Costa Mesa, CA, manufacturer of microprocessor based video duplication peripherals and signal distribution products, recently introduced their Duplicon-8 Duplication Controller. Capable of controlling up to 400 VCRs, the Duplicon-8 allows remote command of eight operating functions on the slave machines. The unit features eight isolated serial outputs (RCA type), and illuminated front panel pushbuttons for system status indication. The single wire serial format was chosen to reduce cabling requirements, and is compatible with slave VCRs from JVC and Panasonic, among others.

## MOVING?

FOR UNINTERRUPTED SERVICE

MAIL TO:

**MIX PUBLICATIONS  
2608 NINTH STREET  
BERKELEY, CA 94710**

(PLEASE ATTACH OLD ADDRESS LABEL HERE)

(PLEASE PRINT NEW ADDRESS BELOW)

NAME \_\_\_\_\_ ZIP \_\_\_\_\_  
COMPANY \_\_\_\_\_ STATE \_\_\_\_\_  
ADDRESS \_\_\_\_\_ CITY \_\_\_\_\_

# F E E D B A C K

Dear Mix,

I read with interest Dr. Mountain's review of the Sony 1630 (*Mix*, May '86). To me, he did the professional audio community a disservice by quoting so extensively the opinions of student ears on a very serious piece of professional gear. Indeed, there are lots of people who immediately think "brighter is better" at first hearing. I played a master tape of Candide superbly recorded on New World Records with Soundstream digital machines. It was sample-rate converted and fed both to our 1610 and our 1630. The strings sounded like real strings and the basses were full and rich on the 1630 without any hint of being strident. The difference on a good monitoring system is *quite vast!* It is totally possible to pick one over the other blindfolded when reproduced through transformerless equipment on wide-range speaker systems. We have cut reference disks of the same material on both processors, and clients can clearly hear the difference at home on their phonographs. Lest you think I am on Sony's team, I would further express that I think that it is unreflexive that they do not offer retrofit modifications for the 1610. At Masterdisk, we sell sound. Believe me, I would not have spent money buying a 1630 if I thought our 1610 would have sufficed (or had even sounded the same or better).

Sincerely,  
Bob Ludwig  
vice president/chief engineer  
Masterdisk Corporation

Toby Mountain responds:

*First of all, I don't consider quoting people's subjective impressions on sound differences between the Sony PCM-1610 and PCM-1630 doing "the professional audio community a disservice." I think that any verbal communication about sound or music, although inherently inadequate, is still our only legitimate vehicle for expressing a point of view. I would like to also point out that all of the participants involved were audio engineering majors at an accredited and respected institution, and were all competent musicians. If one carefully examines the student's comments, one will find that six out of ten indeed described a "sense" that the 1630 was somewhat smoother and warmer in the high end. The key issue here—How much of*

*a perceptual difference?—depends upon the specific circumstances, the set of ears, and finally, the mental attitude. Mr. Ludwig's conclusion is that in his studio the difference is "quite vast." My conclusion from another vantage point was that the difference was less than dramatic. Ears and attitudes aside, maybe we're still comparing apples and oranges.*

*I am a bit perplexed by the fact that, in my own studio, I could not hear clear D/A differences between the two for what I felt were very good, dynamic digital recordings of chamber music, organ music, jazz, etc. monitored on both wide-range speakers and a good pair of headphones. It surprises me that Mr. Ludwig's clients can hear the differences at home on their phonograph systems.*

*I do appreciate his comments, and since Mr. Ludwig is a well-known and well-respected individual in the pro audio community, I must take them very seriously. I would welcome an invitation from him to visit his facility to hear what he is hearing. I would also welcome comments from other engineers who have been able to make direct comparisons between the 1610 and the 1630.*

*And so, the debate rages on . . .*  
Sincerely,  
Dr. Toby Mountain, president  
Northeastern Digital Recording, Inc.

Dear Mix:

Hill Audio feels that the claims made by some amplifier manufacturers are misleading the public and professionals alike into the belief that two rack space, high power amplifiers are something new, high tech, and a revolution in the amplifier marketplace. We disagree.

We have been successfully manufacturing two rack space, high power, power amplifiers for ten years. As far back as June 1976, we introduced the DX700; a two rack space power amplifier that produced in excess of 700 watts per channel into two ohms. Five years later, we introduced the DX901 which produced in excess of 800 watts per channel at two ohms. Having such a long history with two rack space amplifiers, and knowing that the DX901 was in production in 1981, we would like to advise Pat Quilter that we feel that his statement "The new QSC MX1500 is the most powerful two ohm, two rack space amplifier in

the world and there are good reasons why it is" is not accurate; and rather than dwell on the past, (the DX901 is not in production at this time) we will shortly be introducing the DX1200—a two rack space, 1000 watt per channel, two ohm power amplifier at which point we hope that statements such as the one mentioned above will no longer occur.

D.J. Ash  
president  
Hill Audio, Inc.

Patrick Quilter responds:

*Before releasing our ad headline, we researched the literature of all amplifier companies which display at pro-audio trade shows. The literature for the Hill DX901 showed four and eight ohm ratings only, leaving us with the impression that two ohm operation was not recommended. Furthermore, this amp is not currently in production, so we feel our claim stands.*

*Hill Audio was kind enough to send us a used sample of the DX901 to confirm their power claim. Two ohm power with one channel driven was an impressive 960 watts, but due to the single power supply, power with both channels loaded dropped just below 800 watts. We found the amp to be solidly built and a rugged performer, although lacking in some modern features such as balanced inputs and speaker muting. High frequency distortion, power bandwidth, and smoothness of clipping were also below modern standards, although in all fairness this was a well-used five-year-old design.*

*We realize that QSC is not the only pioneer in low-profile amplifiers, but we were the first to release high-efficiency low-profile designs (QSC Series Three) in order to combat the temperature rise problem in tightly packed chassis. We feel that the real achievement of the QSC MX-1500 goes beyond "raw power," to combine ruggedness, high output power, wide bandwidth with low distortion with features not usually found on other amps such as dual power supplies, balanced inputs, speaker muting and protection, and high efficiency output circuitry. And the bottom line is: the Hill DX901 was 20 percent higher in list price. As the competition responds to our challenge with even higher powers, we will of course have to change the ad headline. Meanwhile,*



the MX-1500 will not always be our final word either, in the quest for high power in small packages.

Sincerely,  
Patrick H. Quilter  
director of engineering  
QSC Audio Products

**Dear Mix:**

Just saw your interview with Ry Cooder in the June issue, and I cannot believe how misleading it is!

First of all, you asked him if he coached Ralph Macchio for the film *Crossroads*, and he says "yes." Well, it so happens that I was hired by Columbia Pictures, Walter Hill and Ry Cooder to teach Ralph for six months prior to and during the making of the film! Cooder never had anything to do with it! I taught him classical, acoustic and electric blues, slide, lead, you name it, and made sure that each guitar-related scene was properly filmed.

Not only that, but most of the music "played" by Ralph in the film is composed by me, not Ry Cooder. This was natural, as the whole time Ralph was learning to play like me, from me, so it would make sense that I would create the guitar parts for him to fake to.

Cooder has been misleading a lot of people in his interviews about *Crossroads*, and I hope this letter has at least cleared things up for some people who want to know who is really behind the guitar playing in the film!

Sincerely Yours,  
Arlen Roth  
Hot Licks Productions, Inc.



*Arlen Roth with Ralph Macchio*

**Correction:** In our July story on Tony Bennett, we inadvertently referred to the AMS RMX-16 digital reverb as the REV-16. We apologize for the error.

---

---

---

---

---

---

---

---

---

---

—CONTINUED FROM PAGE 34, BIG BOARD closet next to the shop. The console check out time comes, and within 20 minutes of starting, you are now consulting with the manufacturer about how the heck you are going to get the disk drives into the control room! Not a tough job, but allow for this possibility when laying out the troughs. Remember, high speed digital data sounds bad. Other nice additions to the control room are the inclusion of direct inputs at the console, with the standard headphone outlets. Remember to float the console chassis and the headphone low side from each other. How about a solid state relay to switch a light on whenever you take the multi-track in to record? Easily accomplished, but plan ahead on where you are going to locate the device, and how you are going to get the wiring from the multi-track record sensor to it. One of the more favored custom additions is the "system mute" which allows the multi-track, when parking under the control of a synchronizer, to mute all inputs of the console so as to save monitors, headphones, ears, etc. The considerations when installing such a device are to insure isolation of the console zero volts from the multi-track control circuitry, and give some indication that the system is in operation. Without

—CONTINUED FROM PAGE 65, BURBANK the transfer room and not in the dubbing room."

One of the newest pieces of equipment bought from London and only one of two in the country, is called Word Fit and is installed in the ADR System.

"ADR is an automated dialog replacement system, which means we can replace production tracks that are not in good sync with the picture, or if they are good but we want to change the wording or something, we can do that. Normally, the actor or actress comes in and reads the lines which we try to fit in the space that the original lines were in. Sometimes the reading is good, but they start too late or end it too early and we have to do it over and over. With Word Fit, we take the original track from production, the person reads the line, and we don't care if it's early or late because we'll punch that track in through Word Fit, it will look at the original length of the production track and match it up so it fits. Recently, we had a show dubbing in one of our rooms where a born Asian had recorded the lines. When they were dubbing it, the producer or director didn't like the voice so he got an American-born Asian to read the

this type of indicator, you may find a lot of trouble reports saying that the console "intermittently goes into mute." Watch your behind on this type of mod.

**Auxiliary Monitor Selector(s)**

Why it is, I don't know, but plan on building yourself an auxiliary monitor selector box. Most console manufacturers believe that there are only two sets of loudspeakers in the control room at any one time. The big ones and the little ones. How many do you have?

**Conclusion**

As far as options go, it again would be my bent to go on and on about how to "trick-out" the control room installation with a lot of little custom touches. This is not the point. The intention of this piece was to try and get you thinking about the type of problems/situations you will be dealing with when "tackling the beast." The main key to success in an endeavor of this type is to anticipate your requirements and figure out your solutions before they are needed. ■

*Greg Hanks owns NYTSL, a full-service maintenance firm that caters to the technical needs of the recording, film and broadcast industries.*

same lines. The dialect was a little different in that case, so it became very difficult. We decided to punch the track through Word Fit and it was great. Since then, we've added a program that speeds up the process by 25 percent, so at the blink of an eye, Word Fit will make 40 to 50 edits."

For Burbank Studios, there's no telling what the future holds, but surely more of the same innovativeness.

"My vision was to build this place better than any place else with more capabilities than anywhere else and with the best people who could be found to do the job. The people here at post-production are the best you'll find in the business. It's truly with their support and working as a team that makes it all work. When we're busy here, we work 17 and 18 hours a day, six and seven days a week. No one walks away leaving another holding the bag."

Now that his vision is accomplished, "I'm gonna retire," McCormack jokes, continuing seriously: "There is still so much to be done that there's never time to think, 'What when I finish that?' Every year we come up with things we want to install or add to the facilities to expand them, so it's never really finished." ■

# CLASSIFIEDS

## Acoustic Consulting

### ACOUSTIC SPACES INC.

Production industry design and construction specialists. Studios, sound stages, rehearsal rooms and entire facilities. Affordable consultation and electronics services. Call us in Kingston, NY, at (914) 331-1726 for information.

## Employment Offered

### STUDIO/AUDIO/ENGINEER

Experience in radio spot prod. & audio for video post prod. For position at Boston's top recording studio. EXCELLENT OPPORTUNITIES. Interested parties should send resume and/or demo reel to: Mix Classifieds, P.O. Box 2526, #005, Berkeley, CA 94703.

### EXPERIENCED MAINTENANCE ENGINEER WANTED

Gordon Enterprises Ltd., one of the nation's leading companies in audio, is in need of experienced maintenance engineers for full time employment. Applicants must be totally knowledgeable with Neve, Studer, Otari and SSL.

Contact: Don Engle  
(212) 972-3400

Commercial sound contractor seeking experienced audio technician/installer. Contact Sound Chamber, 5400 Cahuenga Blvd., North Hollywood, CA 91601—(818) 985-1376.

## Equipment For Sale

LOW OVERHEAD MEANS LOWEST PRICES. We carry most major lines of pro audio & recording equipment. Get your best price, then call me. 3M Tape and accessories at factory prices.

### S.C.M.S.

East U.S. Toll Free:  
(800) 438-6040  
West & N.C.: (704) 889-4509

### VINTAGE TUBE MIKES

Call Bill Bradley  
(312) 751-1216

### MCI PARTS

Specializing in JH416, JH428, JH10, JH100, JH114 parts. Used heads, cards, new lamps, assoc. spare parts. Call for list and prices. Randy Blevins (615) 361-8429.

## Reliable Music

featuring  
RECORDING STUDIO, BROADCAST AUDIO &  
SOUND REINFORCEMENT EQUIPMENT.

### HOW CAN WE HELP YOU?

• QUALITY AUDIO • GUARANTEED PERFORMANCE  
• DEPENDABLE SERVICE • COMPETITIVE PRICES  
704/375-8662  
PRO AUDIO DIVISION 1001 S. INDEPENDENCE BLVD.  
CHARLOTTE, NC 28202

### SIGMA SOUND STUDIOS GREAT EQUIPMENT BUYS:

24, 2-trk recorders, synchronizers, hi speed dupe equip plus lots of audio processing gear.

Call or Write:

212 N. 12th St., Phila., PA 19107  
(215) 561-3660

**New Used & Demo Soundcraft, Neotek, Otari, Akai, Klark-Teknik, dbx, E-V, Crest & Ursa Major, Aphex, UREI, Valley People.** Best prices on the best gear. Like new Otari MX 7800 w/remote \$5,200. ADR Scamp system \$3,300. Neotek Series III 28x24 \$27,000. Omniscart GT-4A new \$235. Wonderbox Speaker systems now available. Call **Pyramid Audio Inc** (312) 339-8014.

Call Us Last!

**KURZWEIL, AKAI, TANNOY & AUDIO-TECHNICA.** Best prices on the new Kurzweil 250 & Akai MG1212. Complete studio and sound system packages available. New & used, buy and sell. **SOUND ADVICE** (205) 592-4555, (800) 826-6552.

**SYNCON A 28x24 console** 100% discrete electronics. Exc. cond. w/twin producers desks & 384 pt. patch bay modified & maintained by Allen & Heath factory personnel. (203) 467-9038. \$18,500.

### IF YOU'RE NOT USING IT — SELL IT!

Your national clearinghouse for used audio and video! Call for free copy of our latest listings, or to list your used gear free. The Bertech Organization Call toll free: (800) 992-2272 In Calif. call: (818) 909-0262 **THINK BERTECH FIRST!**

### MCI/Sony Leasing

JH-24 w/AL III, Sony APR 5002, JH600-36 automation, Sony MPX 3000-36, Sony PCM-3324 digital. "O" Down, "60 Month," Easy terms, "Tax deductible," ITC. Dick McCallery (612) 866-1868.

**AUDIO VILLAGE**  
NATION'S LOWEST COST  
NEW & USED EQUIPMENT  
(619) 320-0728

### LEASE/BUY/SELL

Great prices and great service on over 200 lines including Otari, Harrison, Soundcraft, Tascam, Amek, TAC, JBL, Lexicon, AMS, Akai, Fostex, KT, dbx and all the rest for the best in new or used. Call for our latest listing. **AVC SYSTEMS** (612) 729-8305, in MN call (800) 323-0281.

### VIA VIDEO SYSTEM I/E FOR SALE

TWO YEARS OLD \$15,000  
PHONE (415) 957-1666

**Excess Stock** — Audio manufacturer liquidating unused wire, connectors, transformers, components, heatshrink tubing, hardware, multi-cable, roadcases and many Kelsey mixing consoles at wholesale prices. Call Craig for a complete listing (201) 423-1300.

Fairlight CMI series IIX w/disc library and road cases. Excellent condition, \$16,000. (615) 298-1163, 933-5660.

### PCM & LC-OF C

Sony PCM-501 ES, 553ES, F-1 avail. now. Linear Crystal—Oxygen Free Copper Cable for interconnects, mics, guitar & keyboard cables. Call for orders and for info. Tues-Sat 10am-6pm. (213) 829-3429.

16 track, 2", Scully M100 w/computer generated counter and Tangent 3216 Board excellent condition. 10K both or 6K each. Dynamic Recording, Rochester, NY (716) 621-6270.

(1) APSI 24 trk console 32 in/24 out. Very good condition. Dolby N24H 24 trk noise reduction system. Call (201) 673-5680 re: any offers, ask for Howard.

### SELL YOUR EQUIP. FREE!

IN THE "LOCATER MONTHLY"  
The national paper for used music gear! All Free Classifieds—Call 1-800-331-0741, in Calif.—(213) 477-9222 24 hrs. Sample avail. for \$1.00 or subscribe for \$12.00 a year. 2265 Westwood Blvd., #494, L.A., CA 90064.

### API

API Audio Products Inc. (formerly Wolff Assoc.) is now the sole source for all API products. New modules, new consoles, used consoles, service, etc. API Audio Products Inc., 7953 Twist Lane, Springfield, VA 22153, (703) 455-8188. Telex: 510-6001-898.

### NEW, USED, DEMO SALE RECORDERS, CONSOLES, OUTBOARD EQUIPMENT

Ampeg ATR102 2trk, 4trk, Tascam 80-8 w/DX8, Soundcraft 2400, JVC, Sony 3/4" VCRs, Monitors, Lexicon 200, Tangent 20X4, Yamaha REV7s and SPX90s, Crown Amps, Telex 300 Duplicator.  
E.A.R. PROFESSIONAL  
AUDIO  
(602) 267-0600

### NATIONAL SOUND & VIDEO ENGINEERING

Recording, Sound Reinforcement, Video Tape Duplication & Broadcast Equip. Dependable Personal Service. Major lines at very low prices. Get your best price then call us. **NATIONAL SOUND & VIDEO ENGINEERING**, 6350 J. McDonough Dr., Norcross, GA 30093, (404) 447-1717.

**24 TRK: \$16,800. 16 TRK: \$5,400.** British-made ACES equipment features 24 TRK, 2", 30&15 ips, 50% vari, remote, a solid deck. 32 input, 24 subgroup mixer, \$12.5k. 16 TRK 1/2", built-in NR, ind. bypass, O-search, nice! 2 YR warranty. Factory distributor **ROCK STUDIO SUPPLY**, Box 5997, Norman, OK 73070, (405) 329-8431.

### USED EQUIPMENT

Bought & Sold  
List on request.



Summit  
Audio  
Inc.

P.O. Box 1678  
Los Gatos  
CA 95031  
408-395-2448

### DIGITAL AUDIO PROCESSORS!

JVC VP101-ext. sync., mic/line mix \$950-together w/BR6400 direct drive pro. VHS VCR, both for \$2,600. Digital Editing & Formats Conversion, Real Time Dupl. (202) 635-5588 **PRODIGITAL**, 3400 Pendleton Dr., Wheaton, MD 20902.

**SND WKSHOP SER 30 CNSL 18 in;** 20x16 frame. 3-bnd swp EQ w/4 super EQ. Xlnt. cond. Mods-built in T/B mic, spkr swtchnng, more. Spares, connectors, tools, document \$7.8K. **AMPEX MM1100 2" 16-trk Xlnt. cond. remote & local cntrl, search-to-cue/counter; VSO w/display, many upgrades, better than new specs; heads never lapped. \$9.8K. Pkg \$17K. Going 24-trk. (415) 366-5575.**



## STUDIO SUPPLY

New & used equip. sale. Used Harrison 3232C-28, Sphere 24x16x24, Neumann U47 (tube). (1) new MCI JH110C 2-trk w/full remote. Amek EQ, 2-trk, Telefunken, used Dolby 361. New Valley People, AMS, Lexicon, MCI, Amek, & other new products avail. Call (615) 366-1890. John or Randy.

(6) Kepex's in rack w/PS. Capacity 15 \$1,000-offer. UREI LA3A-(2). (37) API 940 automated faders w/o w/o Allison 65K automation, offer. EMT-S140 plate, tube ser. #1691. Rack of 24 Flickinger Parametric EQs mounted & wired w/PS. Dimensions L25"xH5 1/2" xW3 1/2" a great ad to any console \$3,500. (1) U47 mic w/PS \$1,400. (2) Prime Times, Lexicon PCM 41 DDL, 8-trk Tascam series 70-offer. Quantum console 16in/8 out, 16 monitor-\$2,000. Quantum console 8x4x8-\$1,500. Bx10 AKG reverb-offer, 8 channels dbx 157-offer. Crown DC 300 & 3004 Hafler amp-P500. Call Paul (312) 225-2110 or 241-6885.

## FAIRLIGHT CMI SERIES IIX

Complete sound library  
Full MIDI  
Excellent condition  
David (707) 823-1380

4 trk, 8 trk and MIDI studio gear. Best prices—courteous, knowledgeable staff. Most major lines of pro audio keyboard and studio equipment. Call our toll free watts line 1-800-354-7252 when you're ready. Mike, Bill, Terry or Marty.

Complete disk mastering system SX74 Neumann VMS66 w/transfer rack, patch bay, now working. Could install and train. \$18,500. 40 channel VCA Neve fader system, \$3,500. WOODLAND SOUND STUDIOS, Nashville, TN (615) 227-5027.

New Amek Angela 42/obj—28/24 full warrantee \$29,950. A.E.A. Inc. (213) 684-4461, (818) 798-9127.

## MCI 428B — 28x24

w/2 ITI 3 band para. 13k, Ex;

## MCI JH 114-24

w/auto locator 3 13k, VG;

Both for 25k;

JVC CR6060J 3/4" Vid Rec \$650, Ex;

2 JBL-4430 \$1,800, VG;

2 WHITE 4100 \$1,500, Ex;

2 WHITE 4635 X-over

(for JBL 4430) \$600, Ex;

Eventide SP 2016, 4K, Ex;

(612) 338-3833

All prices are firm.

Q-Lock 3:10 synchronizer system w/MCI JH-24/16, MTR90, Sony 5850 cards. Priced to sell. Exc. cond. (313) 851-9766

—AMBIENCE RECORDING—

Stevenson Interface Console 22 in/8 bus/2 stereo mixes; 32 main-frame 3 band sweep EQ; 4 cue sends; Anvil Case. List \$7,200, Sale \$1,990. Larry 1-800-624-2347.

Synclavier II Computer Music System, w/24 voices, stereo for 24 voices and guitar interface. A.S.L., 832 N. Cole Ave., Los Angeles, CA 90038. (213) 462-5923. \$25,000.

## FAIRLIGHT-CMI SERIES IIX

all options, all software, huge library, manuals, training, SMPTE/MIDI, immaculate condition, never been on road—only used in studio, \$21,000. Call (416) 964-1885.

Complete cutting suite for sale. VG74-B cutting rack with SX-74 head. Neumann VMS 62 lathe, custom Neve console with Studer tape decks. Price to be discussed. (514) 384-6667.

## USED EQUIPMENT SALE

MCI JH110 4-trk and MCI JH110 2-trk, both w/locate, new heads & motors, xInt Eventide H949. Westlake 60 Hz VSO/Resolver w/digital readout & extras. MCI JH-100 parts: AC reel mtr, 9 rec cards, 7 rep cards. JH-24 PLL card, new JH110A spare electronics, 2 avail. API: 4 line amp cards w/2520, 650 pwr sply unit. 3 Harrison Xfmless mic pre cards. Ampex ATR100 capstan svo card. All xInt cond, priced to sell fast. Call for prices & info. (818) 843-1260.

WAREHOUSE CLEARANCE ON USED PRO GEAR: SOUND-CRAFT, BGW, GAUSS, JBL, COMMUNITY, ROAD CASES AND MORE. CALL FOR LIST: ELI AUDIO (216) 366-5119.

Nagra IV S w/QGB & AC power supply, perfect condition \$4,900; (2) Dolby A Cat-22 cards \$800 both; Ampex 445 2-trk 7 1/2/15 in orig. console \$900; PR10 2-trk duplicating system \$300. (718) 377-7282 btwn 12-4. Ask for Ed.

(3) Studer 169 8x4 mixers with cases \$7,700 ea.; (2) Studer A68 power amps 250 w/ch \$700 ea.; (2) Apt 1 power amps 120 w/ch \$400 ea.; (2) Neumann U87 mics \$700 ea.; Neumann M49B mic w/cables, PS \$1,750; Neumann SM2 mic w/cables \$1,600; Lexicon 224 digital reverb w/4.4 software, remote, and case \$5,000; Gately SM6 mixer and EQ w/case \$500; Advent 100A Dolby B processor \$200; Lexicon M92 DDL w/case \$650; RCA KS3B studio stand w/casters \$200; KLH6 loudspeaker \$50; Robins 1201 tape eraser 110v 20 amp \$100. Contact Edward Abbott at Sound-mirror, Inc. Boston (617) 522-1412.

Synclavier II 16 voices re-synthesis; Tascam M-15 consoles, 3M M79 16-trk 2" tape recorder w/Selec-take 1. CATS PAW RECORDING OF SOHO, 29 Greene St., NY, NY 10013. (212) 226-7377.

BOSENDORFER: "Imperial" concert grand (Vienna) 9'6". Handcrafted in Vienna, glossy ebony finish, ivory keys, concert bench, 11 years

old, excellent condition, \$62,000 negotiable—serial #29831. Terry Mize (918) 258-5582.

Yamaha RM 1608 recording console \$3,700, Fostex B16 like new \$4,800, Fostex 80 8-trk, Fostex 450 console, plus outboard gear. In MA (413) 549-7640.

FOR SALE entire contents of studio—MCI 24-trk, El Tech console, Yamaha C3 Grand, UREI 813Bs, Neumann mics, digital reverb, essentials plus lots of extras—All in great condition \$49,000 takes it all! (201) 899-5586.

## STUDIO LIQUIDATION!

Otari MTR-90 MK II, Neotek 16x8x2 console, Eventide-dbx-Orban-MICMIX effects plus studio mics and instruments. Call TIM TROTT for list—(305) 323-0472.

## Equipment Rental



"The Audio Rental People"

DIGITAL RECORDERS • EFFECTS SYNTHESIZERS • WIRELESS MICS AUDIO FOR VIDEO • TIME CODE 1619 Broadway, NY (212) 582-7360



Design Tx Audio

DIGITAL AUDIO RENTALS

Specializing in digital tape machines, reverbs and effects processors. Technical consultation included.

(213) 838-6555

Outside CA (800) 441-4415

P.O. Box 491087

Los Angeles, CA 90049

SYNCLAVIER RENTAL FOR STUDIO SESSIONS & LIVE PERFORMANCE w/exper. programmer. System includes 32 FM voices, 24 sampling polyphonic voices 80 & 20 megabyte Winchester storage capacity. Polyphonic memory 8 meg; ready for MIDI, new software and music printing. Great for composing music scores. Also PPG Waveterm computer and 2.3 and Oberheim Matrix 12 avail. for rental. **DIGITAL RECORDING.** We are also opening up a digital recording studio with a 16-trk digital Mitsubishi with a Westar mixing console and a Mitsubishi 1/4" mixdown with the X-80. We are interested in doing projects for films. Our prices for digital are competitive. (802) 592-3389—Tim or Peter. NY, Boston or Montreal rentals—4 or 5 day min.—prices competitive and negotiable.

## Equipment Wanted

Tube and Solid State equipment by McIntosh and Marantz—amps, preamps, etc.—Speakers by Altec, JBL, Tannoy, E.V., Jensen, etc.—Systems or components—Anything of interest—Contact Charlie Dripps, 4331 Maxson Rd., El Monte, CA 91732, (818) 444-7079.

## Instruction

BE A RECORDING ENGINEER!

New classes quarterly.

INSTITUTE OF AUDIO/VIDEO ENGINEERING

1831 Hyperion, Dept. E  
HOLLYWOOD, CA 90027  
(213) 666-3003

LEARN FROM THE PROFESSIONALS

By Carol Kaye:

How to Play the Electric Bass . . . \$4.95  
Electric Bass Lines #1 . . . . . 3.95  
Electric Bass Lines #2 . . . . . 3.95  
Personally Yours . . . . . 4.95  
Electric Bass Cassette Course . . . 35.00  
Electric Bass Lines #3 . . . . . 3.95  
Electric Bass Lines #4 . . . . . 4.95  
Electric Bass Lines #5 . . . . . 3.95  
Electric Bass Lines #6 . . . . . 3.95  
How to Play Elec.  
Bass Chords . . . . . 4.95

And Much More!

Please write for a free catalog.

Foreign postage: \$2.00 1st book, \$1.00 ea. additional. \$1.50 for cassette. \$8.50 C.K. Bass Cassette Course - \$13.50 to Australia, N.Z. & Asia.

Sorry, no CODs. Colorado add 6% tax. Good store discounts.

GWYN PUBLISHING CO.

177 Webster St., #272

Monterey, CA 93940

GOOD MUSIC MAKES A HAPPY WORLD

INSTITUTE OF COMMUNICATION ARTS. Commercial Music Performance, Audio Engineering/Prod., Video Prod./Sound Reinforcement, Music & Entertainment Bus., Communications, Electronic Music, Music Theory & Arrang. 2 Yr. Prog./P.T. Studies. 12-12840 Bathgate Way, Richmond, B.C. Canada (604) 278-0232.

LEARN SOUND MIXING

12 hr videotape course includes language, theory, mics, effects acoustics, band set up, 24-trk recording, concert mixing and more \$239 Visa/MC/check. For brochure: Recording Assoc. (503) 777-4621, 5821 SE Powell, Portland, OR 97206.

The Mix Bookshelf offers the best selections of books and tapes for the audio, video, and music industries from over 65 leading publishers. Write or phone for your free copy of our current catalog.

MIX BOOKSHELF  
2608 Ninth Street  
Berkeley, CA 94710  
(415) 843-7901

# Maintenance Services & Repair

**New York Technical Support, Ltd.**  
IS SERVICE



"We are factory trained by SSL, Studer, Otari, MCI, Ampex, 3M, Neve, Trident, and Scully. Our work is guaranteed."

CALL  
**GREG HANKS**  
914-238-4171

35 Hardscrabble Hill  
Chappaqua, NY 10514

RCA MICROPHONES — Repair service on all models. Complete sound and cosmetic restoration. 35 yrs. experience with company. ENAK Microphone Repair, 420 Carew Avenue, Pitman, NJ 08071. (609) 589-6186.

# Music Products/Software

SYNCLAVIER SAMPLES FOR SALE OR TRADE. Alembic electric guitar and Oberheim Matrix 12, Octave Plateau Voyetra 8, Prophet 600, digital keyboard Synergy, PPG 2.3 w/Waveterm. Samples also avail. for PPG Waveterm and Mirage. Incl. Synclavier resynthesis sounds. If interested send \$5.00 check or M.O. for demo cassette and sample catalog or \$50.00 for a variety of 10 samples on floppy disk for Synclavier. Will do custom orders. Tim Seiden or Peter Wasson, So. Peacham, Vermont 05821.

EMULATOR II—50 disk sound library w/case for the E-II. Over 650 presets 2,600 voices of all new sounds. For fast delivery send check or money order (U.S. funds) for \$399 to FMS Software Design, P.O. Box 5819-X, Playa del Rey, CA 90296, (818) 769-9858.

# Records & Tapes

DISC MASTERING — Cut from your tapes at low cost — Plating, Pressing, Labels & Jackets — LPs, EPs & 45s. Write for free information:

**THE CUTTING EDGE**  
Box 217 M  
Ferndale, NY 12734  
(914) 292-5965

MASTER CASSETTE & DUPLICATION. Loads custom length BASF, AGFA & more. Apex on-cassette

printing. Blank or printed labels, Poly/Norelco boxes. Bin-loop or real time dup. Bulk blanks. Custom pkg quality and service. Low prices! Call (800) 228-8919; in AZ (602) 243-3023.

### REAL TIME

Best Quality Cassettes using Nakamichi decks only. Custom loaded Agfa or BASF Chrome. Label and insert printing, shrinkwrap, blank tapes. SUPERB QUALITY AT LOW PRICES

Uni-Sette, Inc. 5125 Marconi Ave., Carmichael, CA 95608. (916) 485-9534.

REAL TIME CASSETTE DUPLICATION Perfect cassette copies from your analog or digital masters at a modest cost. Any quantity, fast turnaround, competitive prices. MIRROR IMAGE (Call us collect.) (303) 694-6642.

**FACTORY DIRECT PRICES ON 3M TAPE**  
We can save you money.  
Over 60 lines of professional recording equipment.  
**STUDIOWORKS**  
(800) 438-5921

# Diskmakers



RECORD PRESSING  
CASSETTE DUPLICATION  
SEND FOR OUR PRICE LIST  
**CALL TOLL FREE**  
**1-800-468-9353**  
925 N. 3rd St., Phila., PA 19123

## How to Place a Mix Classified

Please print or type in CAPITAL LETTERS and lower case. There are 8 lines to the inch and approximately 24 CAPITAL letters per line or 32 lower case letters. \$70 per inch — 1" minimum. Additional lines \$10 per line. **Bold type** \$10 per line. Black border or gray screen \$10 extra. Logos or display advertising up to 4" will be charged at \$85/inch. Multiple insertion rates available — Call for information. **Payment by check, money order or charge must accompany ad. DEADLINE is the 10th of the month, 1½ months prior to publication.**

### Categories Available (Check one.)

- |   |  |   |
|---|--|---|
| <input type="checkbox"/> Business Opportunities | <input type="checkbox"/> Equipment Wanted        | <input type="checkbox"/> Recording Services       |
| <input type="checkbox"/> Employment Offered     | <input type="checkbox"/> Instruction             | <input type="checkbox"/> Rehearsal Space          |
| <input type="checkbox"/> Employment Wanted      | <input type="checkbox"/> Maintenance Services    | <input type="checkbox"/> Session Player Available |
| <input type="checkbox"/> Equipment for Sale     | <input type="checkbox"/> Music Products/Software | <input type="checkbox"/> Studios for Sale         |
| <input type="checkbox"/> Equipment Rentals      | <input type="checkbox"/> Record & Tape Supplies  | <input type="checkbox"/> Miscellaneous            |

Name \_\_\_\_\_

Address \_\_\_\_\_

Phone \_\_\_\_\_

I am paying by (Check one.):  VISA  MASTERCARD

Card #: \_\_\_\_\_ Expiration Date \_\_\_\_\_

Signature: \_\_\_\_\_

Check or Money Order #: \_\_\_\_\_ Amount Enclosed: \$ \_\_\_\_\_

### Mail to:

Mix Classified, 2608 Ninth Street, Berkeley, CA 94710  
(415) 843-7901

Ad Copy: \_\_\_\_\_

\_\_\_\_\_

\_\_\_\_\_

\_\_\_\_\_

\_\_\_\_\_

\_\_\_\_\_

\_\_\_\_\_

\_\_\_\_\_

\_\_\_\_\_

\_\_\_\_\_

\_\_\_\_\_



## PROFESSIONAL RECORDING SUPPLIES

We are a major distributor of Ampex, Agfa & 3M bulk & reel master tape from 1/4" to 2". We also stock empty reels, boxes, video cassettes, Norelco boxes & other recording supplies. We manufacture custom length bulk cassettes using top quality tapes. Cassette duplication service available. Please call or write for our FREE catalog.

### Advance Recording Products

7190 Clairmont Mesa Blvd.,  
San Diego, CA 92111  
In Calif: (800) 858-1061  
CA Phone No: (619) 277-2540  
Outside Calif: (800) 854-1061

### TOP QUALITY

VIDEO TAPE-VHS & BETA  
JVC LICENSED  
Custom-Length Manufacture  
AVI

1812 Tilghman  
Allentown, PA 18104

TOLL FREE 1-800-858-3816

## ESP EASTERN STANDARD PRODUCTIONS

26 BAXTER ST. BUFFALO, N.Y. 14207

- AUDIO CASSETTE DUPLICATION  
High Quality Real Time
  - VIDEO CASSETTE DUPLICATION  
All Formats
  - CUSTOM PRINTING & PACKAGING  
Labels - Inserts - Shrink Wrap
- CALL COLLECT  
For Free Brochure  
(716) 876-1454

<b>CRYSTAL INC.</b> DUPLICATED CASSETTES AS LOW AS: <b>43c</b> PLUS SET UP
<b>FULL COLOR CASSETTE INSERTS</b> AS LOW AS: <b>\$53.00</b> PER 1000 ORDER OF TEN
<b>FULL COLOR GLOSSY PRINTS</b> Sustain For Framing <b>23c</b> EACH 1015 OF 1000
<b>HIGH ENERGY CASSETTES</b> AS LOW AS <b>C-62: 28c and C-92: 34c</b>
<b>FULL COLOR POSTERS OR BROCHURES</b> AS LOW AS <b>\$195.00</b> PER 1000
<b>FULL COLOR ALBUMS</b> <b>58c</b> EACH PLUS SET UP PER QUANTITY
PHONE TOLL FREE: 1-800-826-6540 TN: 615-843-0717 8002 Middle Valley Road, Hixson, TN 37343

**CASSETTE DUPLICATION**  
Real Time and High Speed  
12 Track Recording  
"Quality and Pride keep  
us both satisfied."  
PARADISE SOUND, INC.  
P.O. Box 63  
Index, Washington 98256  
(206) 793-2614

Super Low Prices on Agfa BASF, Ampex and Mag Media, Bulk Cassettes and Accessories. Real-time and High Speed Duplication. Call or write for prices and brochure. TRAXX RECORDING PRODUCTS, 24 Crest Way KC, New Fairfield, CT 06812 (203) 746-3561.

## Studios For Sale

24-TRACK RECORDING STUDIO  
Excellent Manhattan location, well-established clientele. Sale or partnership w/options available. Send name

and phone number to: P.O. Box 8130, FDR Station, NY, NY 10150.

PROF. 24 TRK STUDIO IN HOME IN IN NO. ATLANTA. Secluded lot, office, private entrance, multi-level decks, Ampex machines, APSI console, Neumann, JBL, Milab, grand and electric piano, etc. HOUSE & STUDIO, \$185,000. Financing available. Call Rick Rushing (404) 252-0776.

COMPLEX/8400' and 20' in mtns. WSW of Denver, 5 1/2 acre mtn. top 200° view ranchette, inc.; House, separate \$250.00 sq. ft. 1000 sq. ft. Studio W/MCI 16-trk & console, plus extras. Financing liberal for qual. lone artist or family dream. Current 2K mo. income (303) 232-6444 or 447-0060/9100 W. 35th Ave., WHEAT RIDGE, CO 80033.

**48 TRK WORLD CLASS STUDIO**  
EXCEPTIONALLY BEAUTIFUL  
LOADED LARGE AND PRIVATE,  
W/house in residential, exclusive  
Alpine, NJ, nine minutes from  
NYC. \$2,850,000. BROKERS or  
AGENTS WELCOME. LANDCAS-  
TLE (212) 330-0377.

24 track professional, operating studio. Fully equipped. Yamaha Grand. List of equipment available. Will install. \$50,000. Days call (503) 687-9032. Evenings 726-1378 or 998-2758.

## Miscellaneous

**MG-1212 OWNERS—ATTENTION**  
NEW RECORDING HANDBOOK  
Helpful techniques for the engineer who needs more than just a manual. Only \$17.50 plus \$1.50 handling, send check or M.O. to: NORTH SIDE RECORDS, 3237 Brighton Rd., Pittsburgh, PA, 15212. Visa & MasterCard—Call (412) 761-8044.

## TRACK SHEETS BOX & REEL LABELS

- Cassette Labels & Inserts
  - Drum Machine Sheets
  - Alignment Plaques
  - Plus many other items
- PRINTED WITH  
Your Studio Name  
Address & Phone

**FREE CATALOG**  
of specialized forms for the  
recording & music industries

**STUDIOFORMS Co**  
186 Glen Cove Avenue, Suite 201/M-13  
Glen Cove, NY 11542-3505  
(516) 871-1047

## SP-12, PROPHET 2000, LINN 9000

SAMPLED DRUM & PERCUSSION  
SOUND LIBRARY

USED BY MICHAEL JACKSON &  
GIORGIO MORODER

available on disk

SEND \$5 FOR EACH SPECIFIC CASSETTE DEMO TO

**studiogigitalsamples**

18653 Ventura Blvd., Suite 560A,  
Tarzana, CA 91367

—CONT. FROM PAGE 62, PROD. MUSIC  
substantial, with 206 music albums and 30 sound effects albums: over 50 categories of music are covered, from classical to contemporary, from 17th Century lute pieces to science fiction themes. The CD sound effects library consists of ten volumes, each buyout priced at \$50, all recorded digitally. Volume one has 75 effects—weather, household sounds, telephones and much more, and new volumes are to be issued every two months. The CD music library is all-new, digitally recorded music in full length, and 30/60 second cuts; each disc is priced at \$20, plus rights, set on a needle drop, per-program, or annual basis. Standard LP/tape library releases are priced at \$10/album, \$20/7.5 ips tape, and the 15 ips tape is \$25/reel; plus clearance.

Voyage Music Library, Pasadena, CA, offers four 7.5 ips reel-to-reel or cassette releases of contemporary musical beds and suggestive themes in a variety of lengths, mostly long versions, but volume one also has 30/60 second edits as well. All are priced at \$99 per "album." Some interesting new releases

from Voyage are "Logos R Us" and "Effects Themes," two volumes of short themes, logos, arpeggios and tags, all designed to emphasize and punctuate audio productions. The two volumes are priced at \$45 and \$65, respectively, or both for \$95. All Voyage releases are sold on a one-time, buy-out basis.

"Themes," the buyout AV music library from ZM Squared of Cinnamin-

son, NJ has grown to a total of 15 albums on reel-to-reel and cassette, with the first six volumes now available on disk for \$495. The six-record set contains 60 full length cuts, with a variety of musical styles including industrials, country, MOR, albums, several all industrials, two guitar volumes, classical and Celtic harp disks—and a range of sounds suited for various production needs.

## Production Libraries

AirCraft Music Library  
77 N. Washington St.  
Boston, MA 02114

Air Force Broadcast Services  
216 Carlin Street, Suite 300  
Toronto, Ontario, Canada M5A 2L1

American Image Productions  
Box 366  
Memphis, TN 38151

Associated Production Music  
888 7th Avenue, 12th Floor  
New York, NY 10106

Brown Bag Productions  
482 S. Jasmine  
Denver, CO 80224

CBS Special Products  
51 W. 52nd Street, Room 861  
New York, NY 10019

Century 21 Programming  
4340 Bellwood Parkway  
Dallas, TX 75224

Comprehensive Video Supply  
148 Veterans Drive  
Northvale, NJ 07647

De Wolfe Music  
25 W. 45th Street  
New York, NY 10036

Films for the Humanities  
Box 2053  
Princeton, NJ 08540

Firstcom  
13747 Monfort Drive, Suite 220  
Dallas, TX 75240

L.A. Airforce  
Box 3482  
Rubidoux, CA 92519

Made to Order Music  
9903 Santa Monica Blvd., #373  
Beverly Hills, CA 90212

Manhattan Production Music  
Box 1268, Radio City Station  
New York, NY 10101

Music Masters  
17 Ponca Trail  
St. Louis, MO 63122

Network Production Music  
4429 Morena Blvd.  
San Diego, CA 92117

Omnimusic  
52 Main Street  
Port Washington, NY 11050

Soper Sound Library  
Box 498  
Palo Alto, CA 94301

Sound Ideas  
86 McGill Street  
Toronto, Ontario, Canada M5B 1H2

Synthonic Sound  
5026 Snapfinger Woods, #102  
Decatur, GA 30035

TRF Production Music  
40 E. 49th Street  
New York, NY 10017

Thomas Valentino, Inc.  
151 W. 46th Street  
New York, NY 10036

Voyage Music Productions  
686 South Arroyo Parkway, Suite 106  
Pasadena, CA 91101

ZM Squared  
903 Edgewood Lane  
Cinnaminson, NJ 08077

# NEXT IN MIX

## OCTOBER

- SMPTE Show Special Issue
- North Central Recording
- Canadian Recording Spotlight
- Jingle Production
- David Letterman
- VCRs in the audio control room

## NOVEMBER

- AES/New Products Directory
- Special Supplement: CD-I—The Next Wave of the Digital Revolution
- Computers & Software in the Studio

### AD CLOSING:

SEPTEMBER 7

### MATERIALS DUE:

SEPTEMBER 15

## DECEMBER

- Mastering, Pressing & Tape Duplication Directory
- Record Manufacturers Talk About CDs
- Lurching With Bonzai: Herb Alpert

### AD CLOSING:

OCTOBER 8

### MATERIALS DUE:

OCTOBER 15

**Call (415) 843-7901 for space reservations and complete advertising information.**

# ADVERTISERS INDEX

PAGE	ADVERTISER	PAGE	ADVERTISER
129	A & R Record & Tape Manufacturing	116, 117	Kimball
191	ABC Watermark	63	Klipsch & Associates
124	Ace Music	60	L.A. Air Force
156	Advance Recording Products	34	Lake Systems
133	AIC Pro Audio	151	Larrabee Sound
59	Aircraft Music Library	196	LD Systems
101, 162	Akai/IMC	39	Lexicon
108	Akia Electronics	202	Linear & Digital Systems
21	Alesis	159	LT Sound
87	Allen & Heath Brenell	200	Magic Music Machines
80	Alpha Audio	28	Manhattan Production Library
27	Amek Consoles	123	Mark of the Unicorn
17	Ampex Corporation	51	Meyer Sound Laboratories
141	Apex Machine Company	9	Mitsubishi Pro Audio Group
194	API Audio Products, Inc.	122	Music Annex
26	Applied Research & Technology (ART)	31	NEOTEK Corporation
54	Associated Production Music	199	Network Production Music
99	Audio Engineering Associates (AEA)	19	Rupert Neve, Inc.
149	Audio Media Research (AMR)	84, 85	New England Digital
181	B & L Sales	65	Omni Music
187	Kenneth A. Bacon & Associates	81	Orban Associates
145	Barcus Berry Electronics	3	Otari Corporation
47	BASF	23	Peavey Electronics
182	The Bertech Organization	197	Polyline Corporation
62	Beyer Dynamic	188	Pristine Systems
124	Big Mo	48, 49	Publison
139	Bryston	133	QCA Custom Pressing
120	Burlington Audio Tapes	147	Rainbo Records
183	Caig Laboratories	35, 37	Ramsa
61	Capitol Studios	200	RCA Test Tapes
96, 97	Carvin Corporation	135	Renkus-Heinz
14, 15	Casio	199	Resolution
122	Center for the Media Arts	169	Rocktron
148	Century 21 Programming	89	RolandCorp US
41	Cipher Digital	91	Sanken Microphone Company
69	CMX	156, 188, & 197	SDR Studios
191	College for Recording Arts	211	Shure Brothers
181	Countryman Associates	119	Simmons
95	CRL Audio	158	Simon Systems
121	Crown International	32, 33	Solid State Logic (SSL)
53	dbx, Inc.	55	Sound Affair
60	DeWolfe Music Library	194	Sound Ideas
182	Digital Brothers	73	Sound Impressions
170	Diskmakers	125	Sound Productions
29	DOD Electronics	105	Sound Solutions
201	EAR Pro Audio	93	Soundtracs, Inc.
72	Encore Studios	202	Spinning Reel Sound Services
111	Evatone	171	Stoughton Printing
11	Eventide, Inc.	7	Studer Revox
155	Fostex Corporation	139	Studio Consultants
172	Four Designs	65	Studio Instrument Rentals
77	Full Compass Systems	71	Tannoy
55, 152	Future Disc Systems	157	Technical Audio Devices (TAD)
118	Gand Music & Sound	127	Telex
45	Goldline	111	Thoroughbred Music
103	Dick Grove School of Music	24, 25	3M Corporation
107	Bernie Grundman Mastering	201	Tin Man Enterprises
150	Hardy Company	118	Trebas Institute of Recording Arts
83	Hewlett Packard	176	TRF Music, Inc.
160	Hill Audio	13	Trident
153	Ibanez	57	Turbosound
79	Institute of Audio Research	105	United Tape Company
184	Institute of Audio/Video Engineering	137	Valley People
189	Intersonics, Inc.	176	Vertigo Recording Services
212	JBL, Inc.	2	Westwood One
54	Jensen Sound Productions	185	Wise Music
109	Jensen Transformers	172	World Records
80	JRF Magnetic Sciences	138	EU Wurlitzer
170	Jordax	43	Yamaha International
154	K-Disc Mastering		
131	Keystone Printed Specialties		





## Even if your music starts as a piece of junk, your sampling mic better not.

**The new Shure SM94 Condenser Mic can make a big improvement in your digital sampling—at a surprisingly affordable price.**

If you've made a major investment in a sampling keyboard or drum machine, don't overlook the importance of the microphone you're using. A vocal mic, for example, might "color" instruments you are sampling.

To capture your sample as accurately as possible, we suggest the new SM94. Unlike many popular mics, the SM94 has no high-frequency peaks, accentuated presence boost, or excessive low-end rolloff. This prevents overemphasis of high frequencies on instruments like strings and brass, while allowing you to retain the important low-frequency response essential to capturing the fullness and richness of many live sounds.

And its extremely low handling noise minimizes the introduction of extraneous handling sounds that might

otherwise creep into your sample. What's more, the SM94 offers exceptionally high SPL capability—up to 141 dB—all but eliminating distortion on transient peaks.

For convenience, you can power the SM94 with a standard 1.5 volt AA battery, or run it off phantom power from your mixing board.

In addition to offering a unique combination of features not normally found in condenser mics in its price range, the SM94 is built with Shure's legendary emphasis on ruggedness and reliability. Features like a protective steel case, machined grille and tri-point shock mount make it rugged enough to go wherever your inspiration takes you.

And for voice sampling, we suggest the new SM96 with its vocal contoured response and built-in three-stage pop filter. Both these fine microphones can bring a new dimension of realism to your digital sampling.

For more information, write or call: Shure Brothers Inc., 222 Hartrey Avenue, Evanston, IL 60202-3696, (312) 866-2553.

Circle #148 on Reader Service Card



**SHURE**

*Breaking Sound Barriers*

World Radio History



TRUTH...

OR  
CONSEQUENCES.

**If you haven't heard JBL's new generation of Studio Monitors, you haven't heard the "truth" about your sound.**

**TRUTH:** A lot of monitors "color" their sound. They don't deliver truly flat response. Their technology is full of compromises. Their components are from a variety of sources, and not designed to precisely integrate with each other.

**CONSEQUENCES:** Bad mixes. Re-mixes. Having to "trash" an entire session. Or worst of all, no mixes because clients simply don't come back.

**TRUTH:** JBL eliminates these consequences by achieving a new "truth" in sound: JBL's remarkable new 4400 Series. The design, size, and materials have been specifically tailored to each monitor's function. For example, the 2-way 4406 6" Monitor is ideally designed for console or close-in listening. While the 2-way 8" 4408 is ideal for broadcast applications. The 3-way 10" 4410 Monitor captures maximum spatial detail at greater listening distances. And the 3-way 12" 4412 Monitor is mounted with a tight-cluster arrangement for close-in monitoring.

**CONSEQUENCES:** "Universal" monitors, those not specifically designed for a precise application or environment, invariably compromise technology, with inferior sound the result.

**TRUTH:** JBL's 4400 Series Studio Monitors achieve a new "truth" in sound with

an extended high frequency response that remains effortlessly smooth through the critical 3,000 to 20,000 Hz range.

And even extends beyond audibility to 27 kHz, reducing phase shift within the audible band for a more open and natural sound. The 4400 Series' incomparable high end clarity is the result of JBL's use of pure titanium for its unique ribbed-dome tweeter and diamond surround, capable of withstanding forces surpassing a phenomenal 1000 G's.

**CONSEQUENCES:** When pushed hard, most tweeters simply fail. Transient detail blurs, and the material itself deforms and breaks down. Other materials can't take the stress, and crack under pressure.

**TRUTH:** The Frequency Dividing Network in each 4400 Series monitor allows optimum transitions between drivers in both amplitude and phase. The precisely calibrated reference controls let you adjust for personal preferences, room variations, and specific equalization.

**CONSEQUENCES:** When the interaction between drivers is not carefully orchestrated, the results can be edgy, indistinctive, or simply "false" sound.

**TRUTH:** All 4400 Studio Monitors feature JBL's exclusive Symmetrical Field Geometry magnetic structure, which dramatically reduces second harmonic

distortion, and is key in producing the 4400's deep, powerful, clean bass.

**CONSEQUENCES:** Conventional magnetic structures utilize non-symmetrical magnetic fields, which add significantly to distortion due to a nonlinear pull on the voice coil.

**TRUTH:** 4400 Series monitors also feature special low diffraction grill frame designs, which reduce time delay distortion. Extra-large voice coils and ultra-rigid cast frames result in both mechanical and thermal stability under heavy professional use.

**CONSEQUENCES:** For reasons of economics, monitors will often use stamped rather than cast frames, resulting in both mechanical distortion and power compression.

**TRUTH:** The JBL 4400 Studio Monitor Series captures the full dynamic range, extended high frequency, and precise character of your sound as no other monitors in the business. Experience the 4400 Series Studio Monitors at your JBL dealer's today.

**CONSEQUENCES:** You'll never know the "truth" until you do.

Circle #150 on Reader Service Card

World Radio History



Professional  
500 Balboa Boulevard  
Northridge, CA 91329