

# MIX®

PROFESSIONAL AUDIO AND MUSIC PRODUCTION

## desktop production

- VIRTUAL INSTRUMENTS
- VOCALS: DIRECT TO DAW
- APPLE TALKS ABOUT OS X

## zappa part 2

INSIDE THE  
UTILITY MUFFIN  
RESEARCH KITCHEN

## stomp goes IMAX

RHYTHM  
FOR THE BIGGEST SCREEN



AP \*\*\*\*\* \*\*\*\*\*AUTO\*\* 5-DIGIT 91329

MIXM



MARK GANDER  
JBL  
8500 BALBOA AVENUE  
NORTHRIDGE CA 91329-0001

F9  
S0005

# TV SOUND DOESN'T HAVE TO BE LIKE THIS



Tired of viewers complaining about loudness-level inconsistencies between programs or channels of your television service? Finally, there's an easy way to effectively measure your program loudness that resolves this dilemma.

Introducing the Dolby® LM100 Broadcast Loudness Meter, the first tool designed to measure the subjective loudness of dialogue within programs in terrestrial, satellite, or cable services. The LM100 uses the equivalent loudness method (LAeq), as standardized by the IEC, to accurately measure dialogue levels in analog or digital services, including PCM, multichannel Dolby Digital and Dolby E, in-the-clear analog cable TV, and off-air RF signals.



Dolby LM100 Broadcast Loudness Meter

Make your viewers happy—take the first step towards solving the variations in your program or channel loudness. For additional information, please visit our website.

[www.dolby.com/tvaudio](http://www.dolby.com/tvaudio)

**Dolby®**

BREAKING SOUND BARRIERS™

Dolby Laboratories, Inc. • 100 Potrero Avenue • San Francisco, CA 94103-4813 • Telephone 415-558-0200 • Fax 415-863-1373  
Wootton Bassett • Wiltshire SN4 8QJ England • Telephone (44) 1793-842100 • Fax (44) 1793-842101 • [www.dolby.com](http://www.dolby.com)

Dolby and the double-D symbol are registered trademarks of Dolby Laboratories. Breaking Sound Barriers is a trademark of Dolby Laboratories.

© 2002 Dolby Laboratories, Inc. S02/14363/14489

# "SSL Has Created Magic Once Again."



**XL Project**

Lenny Kravitz Live DVD 5.1 mix

## Ed Cherney

### Making the move to the XL

"Within two minutes of sitting at the XL, I had made the transition from the 9000 J. The XL's 5.1 implementation is superb!"

### XL sound quality

"The audio quality of the XL is so open. SSL has created magic once again. They made their best-in-the-world signature sound even better, with extended bandwidth to accommodate 24-bit, 96K digital recordings. The results are great!"

### Folding-down from 5.1 to stereo with the XL

"When I needed to check the stereo mix for the Lenny Kravitz *Lenny Live* DVD project, I just touched the XL's fold-down button and squeezed a couple of knobs and that was it. The stereo sounded really good and the integrity of the balances held up extremely well between the 5.1 and stereo."

### "My experience with the XL will definitely bring me back for more."

Recent studios to invest in the XL magic include: Pacificue, LA • Larrabee, LA • Paragon, Nashville  
Pressure Point, Chicago • Angel Mountain, PA • MG Sound, Vienna • Mega, Paris • Plus XXX, Paris  
Sing Sing, Melbourne • Mix Room, LA • Olympic, London • Platinum Sound, NY • Mayfair, London  
Hit Factory, NY

### Pure Audio Excellence...

- Greater bandwidth than 192kHz recorders
- Amazing surround sound capabilities

**XL 9000**  
K • SERIES

**Solid State Logic**

Oxford +44 (0)1865 842300 New York +1 (1)212 3151111 Los Angeles +1 (1)323 463 4444  
Paris +33 (0)1 3460 4666 Milan +39 039 2328 094 Tokyo +81 (0)3 5474 1144

[www.solid-state-logic.com](http://www.solid-state-logic.com)

You'll take purity in nature  
where you find it.

But you absolutely demand it  
in the studio.



That's why enthusiasts the world over insist on the C 3000 B from AKG. Its large, 1" diaphragm, cardioid polar pattern and switchable pad mean exceptionally pure sound, whether it's vocal or instrumental. Whether it's for professional or personal use. Simply put, there isn't a better all-around, modestly priced studio instrument. The C 3000 B. It's pure pleasure.

[akgusa.com](http://akgusa.com) • 615.620.3800



A Harman International Company

**AS PASSIONATE AS YOU.**

# TANNOY®

0 Hz

20 kHz

50 kHz



## They once thought the earth was flat too.

In the beginning, man thought the world was flat. Man can still say the same about today's mixes falling off at 20 kHz. Tannoy's Wideband™ technology is designed to provide the extended high frequencies demanded by modern program material and sources such as DVD, SACV and DVD Audio. Wideband™ not only resolves the fine detail of high frequency notes, but also effectively enhances the listening experience at lower frequencies. Join the brave new world of monitoring with Tannoy's active Ellipse 8 for the Wideband™ experience.

*Go to our website to find out more about Wideband™ technology.*



tannoy.com

TANNOY NORTH AMERICA INC. • PHONE: (519) 745-1158 • FAX: (519) 745-2365 • DEALER ORDER HOTLINE: (FAX) 1-800-525-7081  
LITERATURE HOTLINE: LITPLEASE@TANNOYNA.COM • E-MAIL: INQUIRIES@TANNOYNA.COM • WEB SITE: TANNOY.COM

NATURAL AND TRUE TO LIFE

WIDEBAND™ TECHNOLOGY

EXTENDED HIGH-FREQUENCY

INCREASED IMMEDIACY

# Whether it's your 1st demo tape or your 5th Gold album, the ProVocal delivers.



## ProVocal™

Whether you're on stage or in the studio, getting your vocals right means everything. And the ProVocal delivers. State-of-the-art microphone and pre-amp modeling gives you unparalleled versatility. Beyond our outstanding mic and pre-amp models, there's classic dbx compression, gating, de-essing and parametric EQ to help you tailor your sound. To add breadth and dimension, we've included digital chorus, flanger, delay and reverb. 24-bit S/PDIF and XLR connectors complete the package. It doesn't matter whether you're performing or recording, the ProVocal is the only tool you need to get the job done.

So, head on down to your local dealer, and hear how the ProVocal delivers.

## Digital Vocal Processor

### Features

- 18 Microphone Models
- 10 Preamplifier Models
- Classic dbx Compression
- De-Esser, Gate and Parametric EQ
- Digital Reverb, Chorus, Flanger and Delay
- 24-bit S/PDIF Digital Output
- MIDI Control
- Selectable Mic/Line Switch
- 20dB pad, 48Volt Phantom Power
- Front Panel Instrument Input
- Balanced 1/4" or XLR Outputs

**dbx**

PROFESSIONAL PRODUCTS

The Professional's Choice In Signal Processing

For information call: 1-800-777-1363 • Harman Music Group • 8760 South Sandy Parkway • Sandy, Utah 84070 • [www.dbxpro.com](http://www.dbxpro.com)

 A Harman International Company

World Radio History

# An incredibly powerful audio editor. Also included: 24-track hard disk recorder. Introducing the new MX-View Editor for the MX-2424



1 2 3 4

## Multiple Independent Clipboards:

Allows you to store four separate edits, each in their own clipboard. Convenient for copy/paste creation of song arrangements.



## Breakpoint Volume Automation:

Adds automation of track levels without using a mixer.



## Edit Groups:

Allows you to easily perform edits on groups of individual tracks (such as drums).



## Pencil Tool:

Lets you "draw" clicks and pops out of your audio tracks.



## Virtual Tracks:

For performing multiple takes on a single track.



2001  
Recording Device  
TEC Award Winner



Pro Tools is a registered trademark of Avid Technology, Inc. and its subsidiaries and divisions. Logic is a trademark of Emagic. Cubase SX and Nuendo are trademarks of Steinberg. Other trademarks are the rights of their respective holders.

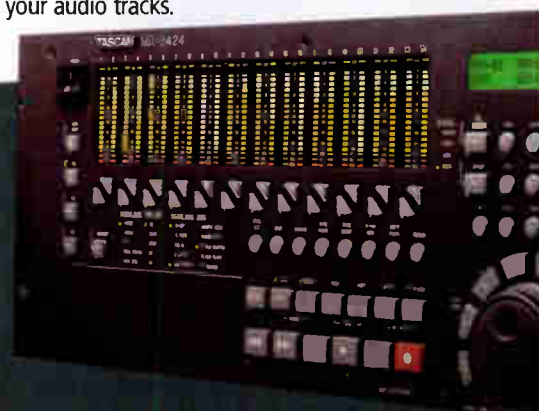

**TASCAM**  
a whole world of recording

# MIX

PROFESSIONAL AUDIO AND MUSIC PRODUCTION  
February 2003, VOLUME 27, NUMBER 3



PAGE 30

## features



PAGE 42

### 30 You Call That Music?

**Frank Zappa's Astonishing Career as a Recording Artist, Producer and Studio Owner—Part 2**

The story so far: Last month, *Mix* took its first steps down Frank Zappa Memory Lane, tracing the composer/guitarist/bandleader/record producer's recording techniques. In Part 2, Chris Michie picks up the trail, only to find Zappa pioneering digital multitrack recording and meeting the Digital Gratification Consort.



PAGE 54

### 42 Recording Vocals From A to D

Tired of debating between analog and digital? Have you invested in a digital audio workstation and plan on sticking with it for a while? *Mix* picked three top-drawer engineers' brains to learn how they record vocals to DAWs, and to chat about signal processing and engineering techniques on both sides of the A/D.

### 54 Virtual Instrument Plug-Ins

**New Software-Based Synthesizers and Classic Instrument Emulators**  
Keeping track of new plug-ins can be a full-time job; thank goodness you have this issue of *Mix* in your hands. Since our last two roundups, we have plugged away at gathering 52 new or significantly upgraded plug-ins that are devoted exclusively to virtual instruments.



PAGE 76

### 76 2003 Grammy Nominees

For the artists, it's the most recognized award in music. But few in the television audience know about the engineers and producers who take home the gramophone. *Mix* gives a tip of the hat to this year's nominated engineers and producers and their projects.

### 78 It All Starts With Guitar

Forget acoustic dampening, sightlines and acoustical foam. Sometimes, you just want to achieve the ultimate in rock 'n' roll guitar sounds. Focusing on his extensive guitar collection, Filippo Olivieri brought in architect Dino D'Ambrosio to build his Italian Studio 52A.

**On the Cover:** The Hit Factory, arguably the world's premier recording facility, opened Studio 6 with a spanking new SSL XL 9000 K Series console, Augsburgers monitors and design by Troy Germano and Dave Bell of UK-based White Mark Ltd. See page 20.  
**Photo:** Dave King. **Inset Photo:** Steve Jennings.



Check Out Mix Online! <http://www.mixonline.com>

Mix is published at 6400 Hollis St., Suite 12, Emeryville, CA 94608 and is ©2003 by PRIMEDIA Business Magazines & Media, 9800 Metcalf Ave., Overland Park, KS 66212. Mix (ISSN 0164-9957) is published monthly except semiannually in January. One-year (13 issues) subscription is \$52. Canada is \$60. All other international is \$110. POSTMASTER: Send address changes to Mix, P.O. Box 1939, Marion, OH 43306. Periodicals Postage Paid at Shawnee Mission, KS and at additional mailing offices. This publication may not be reproduced or quoted in whole or in part by printed or electronic means without written permission of the publishers. Printed in the USA. Canadian GST #129597951; Canada Post International Publications Mail Product (Canadian Distribution) Sales Agreement #0478733.



## sections

### SOUND FOR PICTURE

- 82 Around the World With Stomp**  
by Larry Loewinger
- 83 Composer Spotlight: Lisa Gerrard**  
by Bryan Reesman



PAGE 130

### LIVE MIX

- 128 All Access: Beck** by Robert Hanson
- 130 Tour Profile: India.Arie** by Rick Clark
- 132 Soundcheck**
- 134 New Sound Reinforcement Products**

### RECORDING NOTES

- 136 Jamming with moe.** by Blair Jackson
- 137 Jurassic 5** by David John Farinella
- 137 World Music Network**  
by Robert Alexander
- 138 Classic Tracks: Traffic's "Dear Mr. Fantasy"** by Blair Jackson
- 140 Cool Spins: The Mix Staff Picks**  
Some Favorite CDs

### COAST TO COAST

- 146 L.A. Grapevine** by Maureen Droney
- 146 Nashville Skyline** by Rick Clark
- 147 New York Metro** by Paul Verna
- 148 Sessions & Studio News**  
by Robert Hanson



PAGE 136

## technology

- 94 Tools of the Trade**
- 100 Field Test: Digidesign Digi 002**
- 104 Field Test: Soundelux E47 Tube Condenser Mic**
- 108 Field Test: PrismSound dScope Series III Measuring Device**



PAGE 100

- 112 Field Test: NTI Digilyzer Analysis Tool**
- 116 Field Test: Chandler Limited TG1 Stereo Limiter/Compressor**
- 120 Auditions: Snapshot Product Reviews**
- SE Electronics Z5600 Tube Mic
  - Discrete Drums Series Two Sound Library
  - DPA 4015 Wide Cardioid Microphone



PAGE 184

- 184 Power Tools: Cakewalk Sonar**  
by Ethan Winer

## columns



PAGE 22

- 22 The Fast Lane: boom...BOOM!**  
SPL at Ground Zero  
by Stephen St.Croix
- 26 Insider Audio: The OS X Files—A Chat With Apple's Audio Guy**  
by Paul D. Lehrman
- 66 Producer's Desk: Elaine Martone**  
by Chris J. Walker
- 74 Project Studio: Joe Franco at Beat Street Productions** by Gary Eskow
- 90 Bitstream: Computer, Do the Math!**  
by Oliver Masciarotte
- 124 Tech's Files: Does This Compute?**  
by Eddie Ciletti

## departments

- 8 From the Editor**
- 12 Feedback: Letters to Mix**
- 14 Current/Industry News**
- 20 On the Cover: The Hit Factory**  
by Paul Verna
- 159 Studio Showcase**
- 160 Ad Index**
- 163 Mix Marketplace**
- 169 Classifieds**



# MIX

A PRIMEDIA Publication

## Time, Space and the Audio Continuum

Long ago, Albert Einstein was correct when he told us about relativity and the various relationships between energy, matter, space and time. But back then, nobody realized that he was actually talking about audio!

It's all so simple. Matter is all that junk—er, gear—that we accumulate to create and capture sounds. Space can either refer to the acoustic spaces for recording or the constantly expanding/shrinking universe known as the control room, the size of which is governed by the amount of matter we accumulate. Time is something we're constantly concerned with, whether it's checking phase for mono compatibility (something we used to do before surround systems became standard in every consumer device), dealing with latency issues with software synths, or watching the taxi meter run in a commercial studio while the bass player complains on and on about a slightly anticipated 1/64 note in the middle of a 128-bar solo. Energy? A few minutes with a prima donna vocalist, a helpful A&R guy with some new "ideas" or a Russian/drag-on drummer can quickly drain anyone's energy reserves.

Unfortunately, after spending a lot of time earning the dough to buy all of that cool matter to fill up your space, you may not have enough energy to record anything. This brings up a major flaw in Einstein's understanding of the cosmos: He forgot to mention money, which, as everybody knows, is the force that makes the world go 'round.

Given these infinitely complex relationships, what can the creative producer do, faced with a limited amount of time, matter, space, energy and...money? Assuming you don't have a rich uncle or a generous sugar daddy to fund your projects, a sensible alternative is the desktop studio. Here, for a relatively modest investment—at least compared to the big-ticket version—your dream studio can become a reality.

Once in the virtual confines of your PC, Mac or stand-alone DAW, you can have rooms of multitracks, a console of astronomic proportions, libraries with performances by top session players, and plug-ins offering the finest acoustic recording spaces and expensive, rare signal processors. Instruments? No problem with easy disk access to thousands of sounds via samples and virtual instruments, with re-creations ranging from electric and grand pianos, combo and tonewheel organs to classic and exotic synths of every style. Even the most mundane performance glitches don't present an obstacle. A slipped note, vocal-pitch problem or tempo irregularity may be just a mouse click or two from perfection. Clams are so passé.

Does all of this virtuality make big studios, great acoustic spaces, real players and collections of classic instruments obsolete? Hardly. Creativity can't be canned, bottled or looped, and virtual tools are simply another way to work. For example, in my studio, we route a Native Instruments B4 Hammond clone through a multimiked (real) Leslie and return that through the analog desk on its way to Pro Tools or multitrack. Sometimes, we use the B4's simulated rotor, which leaves us more time to ponder queries such as what kind of slammin' grooves Einstein would have tracked if he had had a PC and some hot loops.

Too bad we'll never know...

George Petersen  
Editorial Director

### BOOKMARK THIS!

Check out the all-new Mix website at: [www.mixonline.com](http://www.mixonline.com)

**EDITORIAL DIRECTOR** George Petersen [gpetersen@primediabusiness.com](mailto:gpetersen@primediabusiness.com)  
**EDITOR** Tom Kenny [tkenny@primediabusiness.com](mailto:tkenny@primediabusiness.com)  
**SENIOR EDITOR** Blair Jarlison [blair@blairjarlison.com](mailto:blair@blairjarlison.com)  
**SENIOR ASSOCIATE EDITOR** Barbara Schultz [bschultz@primediabusiness.com](mailto:bschultz@primediabusiness.com)  
**TECHNICAL EDITORS** Sarah Jones [sarajones@primediabusiness.com](mailto:sarajones@primediabusiness.com)  
Chris Hiche [cmiche@primediabusiness.com](mailto:cmiche@primediabusiness.com)  
**ASSOCIATE EDITOR** Sarah Benzuly [sbenzuly@primediabusiness.com](mailto:sbenzuly@primediabusiness.com)  
**ASSISTANT EDITOR** Robert Hanson [rhanson@primediabusiness.com](mailto:rhanson@primediabusiness.com)  
**LOS ANGELES EDITOR** Maureen Droney [madroney@aol.com](mailto:madroney@aol.com)  
**EAST COAST EDITOR** Dan Daley [danwriter@aol.com](mailto:danwriter@aol.com)  
**NEW YORK EDITOR** Paul Verna [pverna@vernaculardmusic.com](mailto:pverna@vernaculardmusic.com)  
**NASHVILLE EDITOR** Rick Clark [mibclark@aol.com](mailto:mibclark@aol.com)  
**SOUND REINFORCEMENT EDITOR** Mark Frink [mix@markfrink.com](mailto:mix@markfrink.com)  
**FILM SOUND EDITOR** Amy Blake [svelltone@aol.com](mailto:svelltone@aol.com)  
**TECHNICAL PROVOCATEUR** Stephen St. Croix  
**CONSULTING EDITOR** Paul Lehman [mixonline@gigs.net](mailto:mixonline@gigs.net)  
**WEB EDITOR** Don Cross [guitarguide@about.com](mailto:guitarguide@about.com)  
**NEW TECHNOLOGIES EDITOR** Philig De Lancia  
**CONTRIBUTING EDITORS** Rick Clark, Michael Cooper, Bob McCarthy, Eddie Ciletti, Oliver Masciotto, Gary Eskow, Randy Alberts

**SENIOR ART DIRECTOR** Dmitry Panich [dpanich@primediabusiness.com](mailto:dpanich@primediabusiness.com)  
**ART DIRECTOR** Kay Marshall [kmarshall@primediabusiness.com](mailto:kmarshall@primediabusiness.com)  
**GRAPHIC DESIGNER** Mae Larobis [mlarobis@primediabusiness.com](mailto:mlarobis@primediabusiness.com)  
**GRAPHIC DESIGNER** Elizabeth Heaven [lheaven@primediabusiness.com](mailto:lheaven@primediabusiness.com)  
**PHOTOGRAPHY** Steve Jennings

**VICE PRESIDENT** Pete May [pmay@primediabusiness.com](mailto:pmay@primediabusiness.com)  
**PUBLISHER** John Pledger [jpledger@primediabusiness.com](mailto:jpledger@primediabusiness.com)  
**ASSOCIATE PUBLISHER** Erika Lopez [elopez@primediabusiness.com](mailto:elopez@primediabusiness.com)

**EASTERN ADVERTISING DIRECTOR** Michele Kanatous [mkanatous@primediabusiness.com](mailto:mkanatous@primediabusiness.com)  
**NORTHWEST/MIDWEST ADVERTISING MANAGER** Greg Sutton [gsutton@primediabusiness.com](mailto:gsutton@primediabusiness.com)  
**SOUTHWEST ADVERTISING MANAGER** Albert Margolis [amargolis@primediabusiness.com](mailto:amargolis@primediabusiness.com)  
**SALES ASSISTANT** Anthony Gordon [agordon@primediabusiness.com](mailto:agordon@primediabusiness.com)

**CLASSIFIEDS/MARKETPLACE ADVERTISING DIRECTOR** Robin Boyce-Innitt [rboyce@primediabusiness.com](mailto:rboyce@primediabusiness.com)  
**WEST COAST CLASSIFIEDS SALES ASSOCIATE** Kevin Blackford [kblackford@primediabusiness.com](mailto:kblackford@primediabusiness.com)  
**EAST COAST CLASSIFIEDS SALES ASSOCIATE** Jason Smith [jsmith@primediabusiness.com](mailto:jsmith@primediabusiness.com)  
**CLASSIFIEDS MANAGING COORDINATOR** Monica Ciomarty [mciomarty@primediabusiness.com](mailto:mciomarty@primediabusiness.com)  
**CLASSIFIEDS ASSISTANT** Heather Choy [hchoy@primediabusiness.com](mailto:hchoy@primediabusiness.com)

**MARKETING DIRECTOR** Christine Pocock [cpocock@primediabusiness.com](mailto:cpocock@primediabusiness.com)  
**MARKETING MANAGER** Angela Rehm [arehm@primediabusiness.com](mailto:arehm@primediabusiness.com)  
**MARKETING EVENTS COORDINATOR** Alison Eigel [aeigel@primediabusiness.com](mailto:aeigel@primediabusiness.com)

**DIRECTOR, SPECIAL PROJECTS** Hilal Resner [hresner@primediabusiness.com](mailto:hresner@primediabusiness.com)

**VICE PRESIDENT—PRODUCTION** Tom Fogarty [tfogarty@primediabusiness.com](mailto:tfogarty@primediabusiness.com)  
**GROUP PRODUCTION MANAGER** Melissa Langstaff [mlangstaff@primediabusiness.com](mailto:mlangstaff@primediabusiness.com)  
**SENIOR ADVERTISING PRODUCTION COORDINATOR** Liz Turner [lturner@primediabusiness.com](mailto:lturner@primediabusiness.com)  
**SENIOR ADVERTISING COORDINATOR** Roxana Candillo [rcandillo@primediabusiness.com](mailto:rcandillo@primediabusiness.com)

**VICE PRESIDENT—AUDIENCE MARKETING** Christine Oldenbrook [coldenbrook@primediabusiness.com](mailto:coldenbrook@primediabusiness.com)  
**GROUP AUDIENCE MARKETING DIRECTOR** Phil Semler [psemier@primediabusiness.com](mailto:psemier@primediabusiness.com)  
**AUDIENCE MARKETING MANAGER** Austin Malcomb [amalcomb@primediabusiness.com](mailto:amalcomb@primediabusiness.com)  
**AUDIENCE FULFILLMENT COORDINATOR** Jef Linson [jlinson@primediabusiness.com](mailto:jlinson@primediabusiness.com)

**HUMAN RESOURCES MANAGER** Julie Nave-Taylor [jnave-taylor@primediabusiness.com](mailto:jnave-taylor@primediabusiness.com)  
**RECEPTIONIST/OFFICE COORDINATOR** Lara Duchnick [lduchnick@primediabusiness.com](mailto:lduchnick@primediabusiness.com)

COPYRIGHT 2003  
PRIMEDIA Business Magazines & Media Inc.  
ALL RIGHTS RESERVED.

FOUNDED IN 1977 BY DAVID SCHWARTZ AND PENNY RIKER





'The Master' BB5/XBD Active

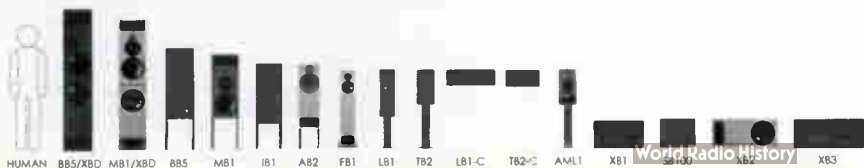

**PMC**

[www.bryston.ca](http://www.bryston.ca)

World Radio History

# PRIMEDIA

Business Magazines & Media

Chief Executive Officer Timothy M. Andrews [tandrews@primediabusiness.com](mailto:tandrews@primediabusiness.com)  
President Ronald Wall [rwall@primediabusiness.com](mailto:rwall@primediabusiness.com)  
Chief Operating Officer Jack Condon [jcondon@primediabusiness.com](mailto:jcondon@primediabusiness.com)

Sr. Vice President, Business Development Eric Jacobson [ejacobson@primediabusiness.com](mailto:ejacobson@primediabusiness.com)  
Vice President, Content Licensing & Development Andrew Elston [aelston@primediabusiness.com](mailto:aelston@primediabusiness.com)  
Sr. Vice President, Finance Tom Flynn [tflynn@primediabusiness.com](mailto:tflynn@primediabusiness.com)  
Vice President, Marketing/Communications Karen Garrison [kgarrison@primediabusiness.com](mailto:kgarrison@primediabusiness.com)  
Vice President, Human Resources Kurt Nelson [knelson@primediabusiness.com](mailto:knelson@primediabusiness.com)  
Vice President, New Media Andy Feldman [afeldman@primediabusiness.com](mailto:afeldman@primediabusiness.com)  
Sr. Vice President, Chief Information Officer Kris Paper [kpaper@primediabusiness.com](mailto:kpaper@primediabusiness.com)

Primedia Business-to-Business Group  
745 Fifth Ave., New York, NY 10151  
President & Chief Operating Officer Charles McCurdy [cmccurdy@primedia.com](mailto:cmccurdy@primedia.com)  
Chief Creative Officer Craig Reiss [creiss@primedia.com](mailto:creiss@primedia.com)  
Creative Director Alan Albanian [aalbanian@primediabusiness.com](mailto:aalbanian@primediabusiness.com)

Primedia Inc.  
Chairman & Chief Operating Officer Tom Rogers [trogers@primedia.com](mailto:trogers@primedia.com)  
Vice Chairman & General Counsel Beverly Chell [bchell@primedia.com](mailto:bchell@primedia.com)  
President Charles McCurdy [cmccurdy@primedia.com](mailto:cmccurdy@primedia.com)

**Mix Magazine, Volume 27, No. 3** (ISSN 0164-9957) is published monthly, except semi-monthly in January, by PRIMEDIA Business Magazines & Media Inc., 9800 Metcalf Ave., Overland Park, KS 66212-2216 ([primediabusiness.com](http://primediabusiness.com)). Periodicals postage paid at Shawnee Mission, KS, and additional mailing offices. Canadian Post Publications Mail Agreement No. 40597023. Current and back issues and additional resources, including subscription request forms and an editorial calendar, are available on the World Wide Web at [www.mixonline.com](http://www.mixonline.com).

**SUBSCRIPTIONS:** One-year subscription (13 issues) is \$52; Canada is \$60; all other international is \$110. For subscription information or to report change of address, write to P.O. Box 1939, Marion, OH 43306 or call 800/532-8190 or 740/382-3322. For fastest service, visit our Website at [www.mixonline.com](http://www.mixonline.com).

**POSTMASTER:** Send address changes to *Mix magazine*, P.O. Box 1939, Marion, OH 43306.

**PHOTOCOPIES:** Authorization to photocopy articles for internal corporate, personal or instructional use may be obtained from the Copyright Clearance Center (CCC) at 978/750-8400. Obtain further information at [copyright.com](http://copyright.com).

**REPRINTS:** Contact Wright's Reprints to purchase quality custom reprints of articles appearing in this publication at 877/652-5295 (281/419-5725 outside the U.S. and Canada). Instant reprints and permissions may be purchased directly from our Website; look for the Copyright tag appended to the end of each article.

**ARCHIVES AND MICROFORM:** This magazine is available for research and retrieval of selected archived articles from leading electronic databases and online search services, including ProQuest, LexisNexis, and ProQuest. For microform availability, contact ProQuest at 800/521-0600 or 734/761-4700, or search the Serials in Microform listings at [proquest.com](http://proquest.com).

**LIST RENTAL:** [Primedia@statistics.com](mailto:Primedia@statistics.com)

**MAILING LISTS:** PRIMEDIA Business makes portions of our magazine subscriber lists available to carefully selected companies that offer products and services directly related to the industries we cover. Subscribers who do not wish to receive such mailings should contact the PRIMEDIA Business subscriber services at 800/532-8190 or 740/382-3322.

**CORPORATE OFFICE:** PRIMEDIA Business Magazines & Media, 9800 Metcalf, Overland Park, KS 66212 — 913/341-1300 — [primediabusiness.com](http://primediabusiness.com)

**NATIONAL EDITORIAL, ADVERTISING AND BUSINESS OFFICES:** 6400 Hollis St., Suite 12, Emeryville, CA 94608; 510/653-3307; fax 510/653-5142; Website: [www.mixonline.com](http://www.mixonline.com). **PHOTOCOPY RIGHTS:** Authorization to photocopy items for internal or personal use of specific clients is granted by PRIMEDIA Business Magazines and Media Inc., provided that the base fee of U.S. \$2.25 per copy, plus U.S. \$00.00 per page is paid directly to Copyright Clearance Center, 222 Rosewood Drive, Danvers, MA 01923. The fee code for users of this Transactional Reporting Service is ISSN 0164-9957/2000 \$2.25 + \$00.00. For those organizations that have been granted a photocopying license by CCC, a separate system of payment has been arranged. Before photocopying items for educational classroom use, please contact CCC at 978/750-8400.

# BASIC ACOUSTICS

from



- ▲ Sound Absorbers
- ▲ Sound Barriers
- ▲ Sound Diffusors

ALPHASORB FABRIC-WRAPPED WALL PANELS

SONEX FOAM

ALPHAPYRAMID FOAM

SKYLINE DIFFUSOR

AUDIOSEAL SOUND BARRIER

FREE Catalog & Sample  
(800) 782-5742

[www.acousticalsolutions.com](http://www.acousticalsolutions.com)

... Who needs another equalizer? Check this: 120 Volt internal operating voltage • 150 dB dynamic range • Pure analog, discrete Class A equalization Digital storability and total recall with motorized controls • Selectable constant Q and proportional Q equalizers • Linkable for surround • Fully remote-controllable • Exactly the equalizer you've been wishing someone would build... **The PQ from SPL. Not just another equalizer.**

... All you need is imagination, good ears and three letters:

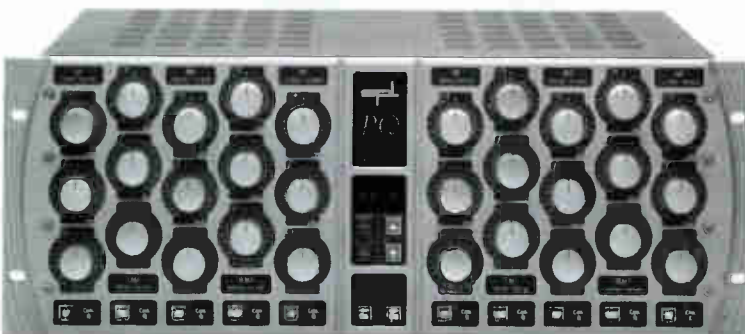

As with all SPL products, the PQ is conceived, designed and hand-built in Germany  
**SPL USA:** call free 866 4 SPL USA • Email [info@spl-usa.com](mailto:info@spl-usa.com) • [www.spl-usa.com](http://www.spl-usa.com)

# VIENNA SYMPHONIC LIBRARY

STRINGS

BRASS

WOODWINDS

PERCUSSION

## Listen. Believe.

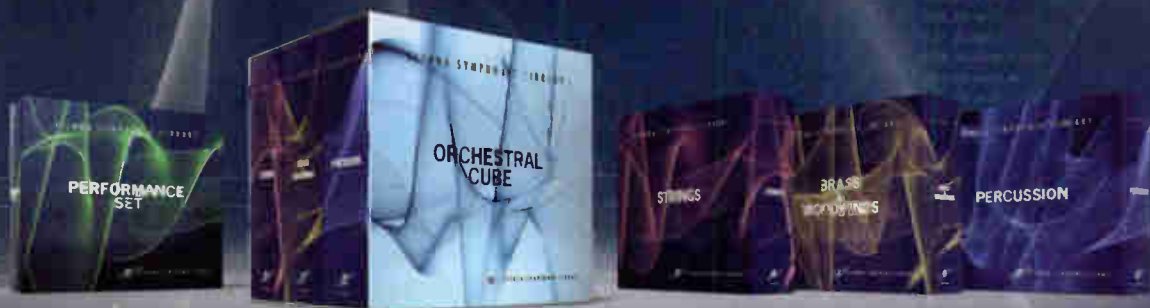

**The Orchestral Cube** 50,000 multisamples on DVD-ROM played by top musicians from Vienna's world-renowned orchestras. This massive treasury of **Strings**, **Brass**, **Woodwinds**, and **Percussion** was captured with pioneering recording technology in a specially constructed sound stage. Every instrument and section was recorded in one finely tuned environment for sonic consistency throughout the library. Expertly programmed for TASCAM GigaStudio and Emagic EXS24. **Over 40 gigs! \$1,890**

**The Performance Set** An unprecedented approach to symphonic expressiveness. 40,000 special **performance elements** on DVD-ROM let you play real legato in real-time with multiple dynamics. In addition, beautifully performed runs and repeated notes are programmed to allow the user to change tempos! Achieve a realism that was unthinkable until now with creative capabilities that far surpass the limitations of conventional orchestral sample libraries. **Over 40 gigs! \$1,490**

**VIP** the **Vienna Innovation Program**: Become a charter member of VIP as the Vienna Symphonic Library gradually expands to **1.5 million samples**. Upgrade to bigger collections on hard disk at affordable prices. Cross-grade to future software platforms and technologies and feel safe in the knowledge that your investment in the future of orchestral music production will last a lifetime.



VIENNA SYMPHONIC LIBRARY  
[www.vsl.co.at](http://www.vsl.co.at)



Listen and Believe. The Demo Cube with over 500 MB of orchestral sample data, MIDI templates, tutorials and audio demos is available for just \$10 directly from ILIO. Call 800-747-4546 or visit [www.ilio.com](http://www.ilio.com).

Check out the Vienna Symphonic Library website for extensive information and spectacular on-line demos. [www.vsl.co.at](http://www.vsl.co.at)



# Letters to Mix



## BACKING THE BOSS

You featured FOH chief engineer John Cooper in your November 2002 issue (page 156). On December 16, I had the rare occasion of being a guest of John's and Audio Analysts systems engineer Kurt Joachimstaler's at the Bruce Springsteen concert in Columbus, Ohio. I sat directly behind the main FOH board (all-digital Yamaha PM-1D console), and I watched Mr. Cooper work his magic orchestrating their new 80-cabinet JBL VerTec line array cabinets, as well as the 32 VerTec subwoofers, to create a sound so amazing from Bruce and the E Street Band that, in my opinion, has simply never been heard before in live sound. I am certainly not an audiophile on the level of those two gentlemen, but those of us there that night will never forget the sound quality, including the amazing low-end sound of the band. The audience was spellbound.

More important, John and Kurt were fantastic artisans of their audio craft. They were great representatives of the audio industry. And they were rightfully proud to be associated with such a great tour.

Soon, every concert will have to "step up" and produce this new level of sound, which blows away anything I've ever heard from a live performance. The public will demand it, and the music industry will greatly benefit.

However, the star of the show was Mr. Cooper at the helm of the ship. I watched him as Bruce deviated from his concert playlist four times, and he was as cool as he could be adjusting his computerized master settings flawlessly. On one occasion, Bruce dumped a full-band, up-tempo song for a quiet piano solo. (Bruce doesn't play many of these.) The audience never knew.

I wonder how many fans who packed that hall knew the amazing talent that is not only working on the stage but behind the stage in order to offer them the finest in audio sound and quality.

Roger Cory  
VP, The Parchment Group Inc.  
Lexington, Ky.

## HEY, PORTER! HEY, PORTER!

In Blair Jackson's article "Elvis: Still Number One!" (December 2002), I was surprised that not once did it mention Bill Porter, the original engineer of over half of the tracks on the *30 #1 Hits* CD. Without his expertise, a lot of extra work would have to be done by David Bendeth and Ray Bardani. The reason this surprises me is due to the fact that Porter was a pioneer in his day with hundreds of charting hits to his name, including most of the tracks on the Elvis compilation. Give credit where credit is due and show your appreciation for true engineering talent.

Porter has taught three of my audio classes, and to him, I am forever grateful.

Justin Fisher  
Webster University audio student  
St. Louis, Mo.

## PUT THE ART BACK IN A&R

George, your December 2002 editorial is right on the money. Perhaps some investment in the development of artists could reinvigorate sagging CD sales figures. The record labels are so market-driven in their efforts to mass-clone whatever is selling that the art is being left out of artist, as well as the repertoire being left out of A&R. Your editorial is a key forum to remind us all that regardless of what tools we use to ply our trades, the music is still what we need to be passionate about.

Chris Boggs  
MediaMatrix sales manager  
Via e-mail

## GENTLEMAN TOM

The best two years of my engineering career were spent at Tom Dowd's side during the Criteria/Atlantic South era. Almost daily, I was witness to his magic: his ability to draw performances from artists that even they didn't think was in them. Tommy's passion and enthusiasm touched everyone around him, and he was, above all else, a gentleman.

Chuck Kirkpatrick  
Cooper City, Fla.

## VIRTUAL DV

I just finished reading Paul Lehrman's article on DV video/audio capture ("Insider Audio," December 2002) and have a quick question: Perhaps I didn't read thoroughly enough, but I didn't see any description of how to control the playback of video from a second (Mac) computer without using the Gallery software once you've captured video with the ADVC-100. Is there a third-party 9-pin USB box or some other

way to get iMovie or even Final Cut Pro to sync playback to my DAW? Or do you simply hook up another MIDI interface to the second 'puter and run it in "dumb" chase? I use several platforms: "Poor Tools," DP3 and Mackie HDR across two control rooms.

Just curious. You got me all excited about not having to pony up for two Meridian board sets!  
Glenn Lorbiecki  
Seattle

Hi, Glenn. If you want the DAW to be the master, then you may need the Gallery software to drive video on a second computer. But it's possible that you can get away without it: I don't think iMovie will sync to MIDI Time Code, but Final Cut Pro probably can; in which case, you can have your DAW send MTC, put a simple MIDI interface on your second computer and let Final Cut chase the timecode "dumb," as you say.

My goal is to have the video be the master because that's the way I like to work; in that case, you can use either iMovie or Final Cut Pro—once you figure out how to get a SMPTE stripe onto one of the audio tracks, you don't need the Gallery software or a second MIDI interface.

Hope that helps.  
—Paul Lehrman

## SING IT AGAIN, STEPHEN

I've always enjoyed *Mix* because you represent the professionalism, merit and dedication of the music industry. I have read your magazine and especially "The Fast Lane" for years. Mr. St.Croix's November article was by far one of the most truthful and inspiring I have read. A note that is a little flat with soul is better than the exact right note just "sung." And he asks the right question at the right time in this bad, bad era of popular music: "Where is the feel?"

It used to be, even in pop music, that you sang a song of heartache to get it off your mind, to share with others so maybe you wouldn't hurt so much. Simple, honest, direct and maybe off-pitch, or maybe the lyric was off in timing. Listen to "Leader of the Pack" or "Crimson & Clover" or "Pale Blue Eyes"—they all have mistakes, but they are good mistakes. Needed mistakes.

Isaac  
Via e-mail

Send Feedback to *Mix*  
mixeditorial@primediabusiness.com

Todd Thibaud Band ©Thomas.Neukirchner@t-online.de



# COMMUNICATION

# SATISFACTION

At GENELEC we believe that communication and creativity go hand in hand.

For twenty five years we've listened to our clients and developed the finest and most complete product line of active monitors in the professional audio industry.

With thousands of qualified installations, both large or small, loud or soft, we're ready to guide you through that all important monitor decision. A trip to our web site puts a wealth of detailed information at your fingertips. A phone call gets you GENELEC's special individualized attention, necessary to make the right choice.

We create great speakers because we listen to our customers. You communicate your needs, we build the speakers that satisfy. Call GENELEC today.



[www.genelec.com](http://www.genelec.com)

# GENELEC®

International inquiries: Genelec Oy, Olvitie 5, FIN-74100, Iisalmi, Finland T +358-17-83881, F +358-17-812267  
In the USA: Genelec Inc., 7 Tech Circle, Natick, MA 01760 T 508-652-0900, F 508-652-0909 Email: [genelec.usa@genelec.com](mailto:genelec.usa@genelec.com)

## BOOKWORMS

### TEMPLES OF SOUND: Inside the Great Recording Studios

If you're at all interested in the history of recording, do yourself a favor and pick up the recently released book *Temples of Sound: Inside the Great Recording Studios*, by Jim Cogan and William Clark (Chronicle Books, 2002). The authors have put together a wonderful collection of stories and historic photos that convey so much about *Mix's* favorite subject: the interrelationship between creativity and technology. Cogan and Clark tell how the facilities and the people who operated them helped shape this country's popular music by focusing on the Big 15 American recording studios: Capitol, United Western, Sunset Sound, RCA B (Nashville), Stax, Sun, J&M (that Cosimo Matassa place in New Orleans), Chess, Universal (Chicago), Motown, Sigma Sound (Philly), Atlantic, Columbia (New York City), Van Gelder and Criteria: quite a list!

The authors interviewed many engineers and producers who worked at the studios, coaxing stories about historic sessions (and, yes, equipment). And then there are the photos of musicians and engineers in action: Howlin' Wolf blowing harmonica at Chess; Keith Richards lost in his guitar playing at Sunset Sound as Mick Jagger looks on from a doorway; a solitary Bob Dylan, back to the camera, strumming his acoustic guitar in one of Columbia's big rooms; a short-haired Steve Cropper working on a mix at Stax; The O'Jays harmonizing around a single mic at Sigma; the Everly Brothers laying it down in Studio B; and on and on. Visit [www.chroniclebooks.com](http://www.chroniclebooks.com), or call 800/722-6657.

—Blair Jackson

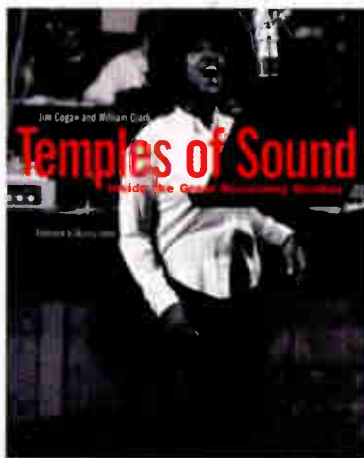

### GET INSIDE DESKTOP RECORDING

Author James Maguire tells you how to turn a home computer into a nearly professional recording studio in *TechTV's Secrets of the Digital Studio: Insider's Guide to Desktop Recording*. Covering a wide array of basic (and not so basic) recording techniques, Maguire delves into recording, creating a final mix, DJing, developing a home setup and much more. Published by New Riders ([www.newriders.com](http://www.newriders.com)), \$24.99.

## Industry News

Moving up the THX (San Rafael, CA) corporate ladder, **Ivan Fuji-hara** has been named general manager...Operating out of **SRS Labs'** (Santa Ana, CA) Hong Kong office, new VP and general manager **Raymond Lee** will plan and develop the company's operations in China and Hong Kong...**Rainier Bojo** has assumed responsibility for manage-



Larry Howard



Kristy Haima

ment of production planning at **Sony Disc Manufacturing** (Springfield, OR)...Former manager of new product development, **Larry Howard** is now **Community Professional's** (Chester, PA) director of sales and marketing...Filling **Sennheiser USA's** newly created position of artist relations manager is **Kristy Haima**; Haima will be based out of Madison, WI...Taking care of all marketing communications and public relations responsibilities for **Peavey Electronics** (Meridian, MS) and its Architectural Acoustics and MediaMatrix divisions is **Jim Beaugez**...Based in Los Angeles, **Sara Griggs Media** will be responsible for **Stanton Magnetic's** (Hollywood, FL) domestic and international PR...New distribution deals: **Carillon Audio Systems North America** (Ringwood, N.J.) launched **Carillon Audio Systems Canada** (Coquitlam, BC), formerly known as Dreamware, exclusive manufacturer and distributor of the company's product line throughout Canada and Alaska; **Transamerica Audio** (Las Vegas) will handle U.S. distribution for **Geoffrey Daking Inc.** (Wilmington, DE), which is re-releasing its Mic-Pre EQ and FET Compressor.

## MUSEUM OF SOUND RECORDING FINDS NEW HOME

In April 2001, *Mix* reported in these pages on the expected opening of a museum dedicated solely to sound recordings in Camden, N.J. According to Bernard Fox, the project's director, funds that were to be appropriated from the city have not surfaced, though he expects that the city will sooner or later be able to come up with the money. Instead, Yonkers, N.Y., will now most likely be the first location in the U.S. to break ground, though Fox revealed that a grass roots campaign has sprung up in Queens, N.Y., as well.

According to Dan Gaydos, president of the Museum of Sound Recording, the museum will open its doors in the Boyce Thompson Institute site in Northwestern Yonkers. According to the museum's blueprints, the building will display the history of sound in 48 acoustically designed spaces, as well as offer international cuisine in the greenhouses adjacent to the museum. The expected 160,000 patrons each year can learn about all aspects of sound dating back to 1870 up to a 2010 futuristic outlook via interactive, user-defined kiosks and onsite educators. The patron can follow the "learning" pathway chronologically or by styles of recording machines, recorders, studios, mics, end-user equipment, etc.;

users can also view eight completely setup studios that range from a 1910 acoustic recording studio, a mastering studio, a film mixing and editing studio, and even Armstrong's original FM broadcast studio.

The museum currently has received over \$2.7 million in donated equipment, with more expected. For sponsorship information, visit the user group at <http://groups.yahoo.com/group/mosr>. Check out the museum's progress at [www.lovesphere.org/mosr](http://www.lovesphere.org/mosr).

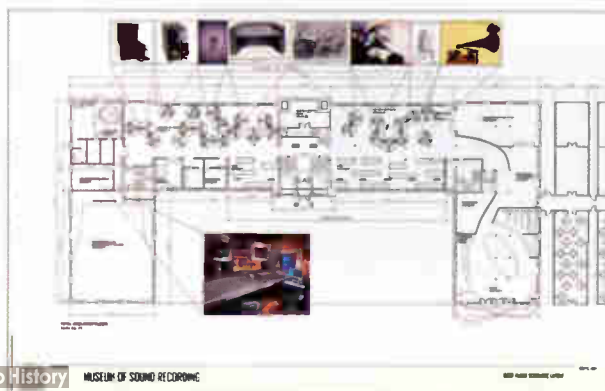



# From mic-pre to CD...



## DPS24 DIGITAL PERSONAL STUDIO

The DPS24 is the only affordable integrated hardware digital workstation that offers 24 tracks of recording without data compression. Most types of data compression throw out portions of your audio during recording, and use a mathematical algorithm to approximate the original audio upon playback.

Data compression can adversely affect your audio quality and stereo imaging, especially with multiple generations of track bouncing.

Kind of sounds like your old cassette multi-track, doesn't it?

It's important to know what you're getting when you invest in any recording solution. The DPS24 was designed from its inception as a professional production tool and not simply a scaled-up portable studio.

We combined a 24bit/96kHz linear 24-track hard-disk recorder, a 46-input moving-fader automated digital mixer, a sample-accurate multi-track graphic waveform editor, 4 stereo multi-effects processors, akSys TrackView and VST plug-in platform software, and a CD mastering and archiving suite, without creating the performance or user interface compromises found in many integrated workstations.

Utilizing our G-Link navigation design, the DPS24 offers access to any major function with one button press. The G-Channel strip of automated LED rotary controls enables instant access to any channel strip on the mixer.

Features like two banks of inputs to eliminate re-patching, balanced channel inserts which enable external mic preamps to bypass the on-board preamps, multi-function G-Knobs for realtime effects control, and up to 24 channels of ADAT I/O offer professional production capabilities that give you the real-world advantages you need to bring your artistic vision to its full potential.



## NOTES FROM THE NET

### EDDIE KRAMER PHOTO ARCHIVES NOW ONLINE

Engineer/producer Eddie Kramer created an immortal recording legacy in the '60s and '70s, working behind the board on classic records by Jimi Hendrix, the Rolling Stones, Small Faces, Peter Frampton, Traffic, Mott the Hoople, David Bowie and many others. Now, Kramer is making a portion of his extensive photo archives available to the public for the first time. Working with his Manhattan-based representative, Peter Cavanaugh, Kramer has had hundreds of his best photos digitally scanned (at 8,000 dpi!) and converted to archival-quality prints. Kramer said, "It's taken us a couple of years to put all of these things together, but they've come out really beautifully." Kramer's work runs the gamut from casual studio shots to beautiful live concert photography—most of it never seen before.



"I knew nothing about photography when I started shooting around Olympic [Studios, London]. There were always tremendous subjects floating in and out of studios. I kept the camera next to me [at the board] and I would take pictures in between takes or in breaks. My favorite trick was to have it all prepped and to swing 'round in chair, if the artist was sitting on the couch behind me, snap a few shots and then get back to work."

The panels and individual photos can be viewed (and purchased) on the Web at [www.aria-photos.com](http://www.aria-photos.com).

—Blair Jackson

### A COMMON CREATIVITY

Nonprofit organization Creative Commons has released its first product: Version 1.0 of its free machine-readable copyright licenses. These licenses allow copyright holders to easily inform others that their works are free to copy and used for specific purposes—thus taking the control back to the holder; i.e., copyright holders can choose to waive all of their rights ("No Rights Reserved") or some of them ("Some Rights Reserved"). Once a license is selected, it will appear in three different formats: commons deed, a plain-language summary of the license; legal code, the fine print; and digital code, machine-readable translation for search engines and other apps.

"Our model was inspired in large part by the open-source and free software movements," said Creative Commons executive director Glenn Otis Brown. "The beauty of their approach is that they're based on copyright owners' consent—independent of any legislative action—and motivated out of a wonderful mixture of self-interest and community spirit. If you're clever about how you leverage your rights, you can cash in on openness. Sharing, done properly, is both smart and right."

Choose a license for your MP3 at <http://creativecommons.org/license/>.

## BEARSVILLE SWINGS

Robinella and The CC String Band recently recorded their forthcoming Sony/Legacy debut at Bearsville Studios (Bearsville, N.Y.). Grammy-winning producer Russ Titleman said, "We chose to record analog there for the warmth it affords and because of its compatibility with the band's traditional, yet progressive, approach."



Standing from left: Michael O'Reilly (engineer), Bill Synan (assistant engineer), Taylor Coker (bass), Steve Kovalcheck (guitar) and Cruz Contreras (mandolin). Seated, from left: Russ Titleman (producer), Robinella Contreras (vocals, guitar) and Billie Contreras (violin).

## CORRECTIONS

In the December 2002 "Mix Interview," John Storyk's contribution to the architectural and acoustic design of Mi Casa was inadvertently left out, as well as photo credits to Robert Wolsch.

In "Bitstream" (December 2002), the article incorrectly identifies that the Onkyo DV-SP300, DV-SP500 and DV-CP500 are DVD-Audio players. Onkyo's only DVD-Audio player is the DV-SP800 universal DVD-A/SACD player mentioned in the article.

Mix regrets the errors.

# Visit

[www.mixonline.com](http://www.mixonline.com)

Visit the all-new Mixonline.com, where the pages of *Mix* come alive with sights and sounds

#### NEW! ONLINE EXTRAS

Interact with *Mix*'s new enhanced site. Each month, we'll pick selected stories from within the issue and load them with bonus materials—audio clips, extended interviews and photo galleries.

#### DAILY NEWS!

Visit Mixonline.com each morning for breaking news and links to newsmakers.

#### MIXLINE!

Register for your FREE biweekly newsletter and get breaking product news, deadlines, recording tips and much more—direct to your inbox!

#### IMPROVED NAVIGATION!

Access *Mix* anywhere, anytime: Check out highlights of our current issue or browse through back-issue archives to find the information you need, with news, interviews, application articles, field tests, equipment report and more—all online!

Fine-tune your search with featured content categories. *Mix* offers broader and categorized content searches in the fields of Recording, Products, Live Sound, Sound For Picture, New Media, Design and Education.

[www.mixonline.com](http://www.mixonline.com)

Send your "Current" news to Sarah Benzuly at [sbenzuly@primediabusiness.com](mailto:sbenzuly@primediabusiness.com).

INNOVA SON'S DIGITAL LIVE CONSOLES DELIVER  
**VERY Impressive Performance(s)**



**Show: E.T. the Extra-Terrestrial 20th Anniversary Re-Premier**  
 Company: Delicate Productions, Camarillo, CA  
 Venue: The Shrine Auditorium, Los Angeles, CA  
 Console: **Innova SON**

"The Innova SON provides isolation, linkability, ease of installation and overall product integrity."  
 —Lyle Dick, Engineer/System Designer



**Show: 44th Annual Grammy Awards**  
 Company: ATK/Audiotek, Burbank, CA  
 Venue: Staples Center, Los Angeles, CA  
 Console: **Innova SON**

"Having equalization and delays on every output coupled with dynamics and equalization on every input channel complimented the Grand Live's already small footprint by reducing the need for outboard gear."  
 —Andrew "Fletch" Fletcher, Assistant FOH Engineer



**Show: KSBJ Radio 20th Anniversary**  
 Company: LD Systems, Houston, TX  
 Venue: Houston Astrodome  
 Console: **Innova SON**

"The Innova SON is an extremely intuitive and visual console. Having the three separate input, master and output views makes it very easy to navigate."  
 —Robert Ausmus, Director of Operations

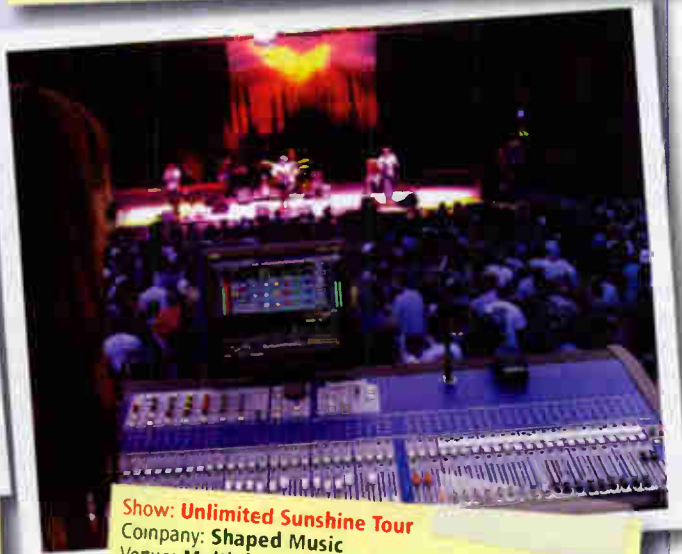

**Show: Unlimited Sunshine Tour**  
 Company: Shaped Music  
 Venue: Multiple  
 Console: **Innova SON**

"There's no question that this is the way to go."  
 —Peter George, FOH Engineer

the New Way to Watch Sound

DISTRIBUTED IN THE USA & CANADA BY SENNHEISER ELECTRONIC CORP

USA: TEL: 860-434-9190 • FAX: 860-434-1759

CANADA: TEL: 514-426-3013 • FAX: 514-426-3953

www.innovason.com

**innova  
SON**

## The Hit Factory, Studio 6

by Paul Verna

**O**n the afternoon of July 24, 2002, as he prepared to throw a party to celebrate the opening of Studios 6 and 7, Hit Factory CEO Troy Germano beamed with confidence. Despite the uncertain economic climate in which he found himself, Germano made a bold case for the rooms themselves and the consoles within them: twin Solid State Logic 80-input XL boards, the new state-of-the-art in analog and surround mixing.

Six months later, Germano's optimism had been reinforced by the success of the rooms. In their first six months, Studios 6 and 7 have hosted a galaxy of recording superstars who have used them for their tracking, overdubbing, mixing and multichannel capabilities. Among the artists who have recorded basic tracks in Studios 6 and 7 are Sting, Guster, Luther Vandross, Eve, Missy Elliott and Japanese sensation Kenji Ozawa; Lenny Kravitz, Matchbox 20, Paul McCartney, Santana, LL Cool J and Toni Braxton have overdubbed and/or mixed in the new rooms; and one of Hit Factory's longest-running clients, Paul Simon, tracked and mixed his contribution to *The Wild Thornberrys* soundtrack in Studio 6, which Germano says was modeled after the room at the old Hit Factory Broadway location that Simon had used since 1983.

"It's been a really good mix of clients in both rooms, and they've used them for recording and mixing," says Germano. "We take pride in the diversity of styles that we cater to: pop, hip hop, R&B, rock, jazz, cast albums, etc."

Some clients, like Kravitz and McCartney, brought 5.1-channel DVD mixes into Studios 6 and 7, which are purpose-built for surround production. Other multichannel projects that were done recently at the Hit Factory include DVDs for Iron Maiden, the Foo Fighters and Elvis Presley.

Germano says, "We're doing a lot more surround work than ever before. It's exciting. It's finally starting to happen as everybody predicted that it would."

Always in the forefront of new technology, Germano was among the first studio owners to embrace the SSL XL platform, a refinement of the British manufacturer's hugely successful J Series of SuperAnalogue consoles.



Hit Factory CEO Troy Germano, standing in Studio 6 at the XL console.

The transition from the J to the XL has been as smooth as Germano hoped for. "It really has been seamless," he says. "Usually when you change a console, even if it's from the same manufacturer, you wonder what you're going to lose. But I haven't heard one negative comment about the XL. People love the faster computer, and they think that the console sounds a little bit better."

Soon after installing the two XLs in Studios 6 and 7, Germano purchased a third one for Studio 3 in the New York location.

"When we put XLs in Studios 6 and 7, we thought that if the consoles worked, we would add a third one in six months to a year," he says. "But we've been so happy with the console that we ended up ordering a third one three months after opening the new rooms. Now we have three XLs and three Js in New York, plus a Euphonix System 5 [digital console]." (In the Hit Factory's Miami location, the company has three SSL Js, a Sony Oxford digital board and a vintage Neve 8068.)

Hit Factory Studios 6 and 7 offer not only the most advanced analog consoles in the market, but top-notch recorders, monitors and outboard equipment, as well as peerless acoustics. Designed by Dave Bell from UK-based White Mark Ltd., in conjunction with

Germano, the rooms are streamlined and comfortable, with clean, sleek lines and plenty of space.

Each room offers its own 48-channel Pro Tools MIXPlus system (as well as access to one of three Pro ToolsHD systems in-house); a Sony 3348 HR; two Studer A827s; and outboard racks tailored for surround mixing, with highlights including three stereo GML EQs, Sony 777 Sampling Reverbs, Avalon 737s and 2055s, Lexicon 960 Ls, and Empirical Labs Distressors and Fattos. Each room is equipped with five soffit-mounted custom speakers designed by George Augspurger.

Germano, who half-jokingly compares the studio industry to the hotel business, says that his equipment and design choices reflect the needs of his clientele. "People come to us for these great analog consoles, the large monitors, the acoustics, the outboard gear and the services we provide," says Germano. "More than ever, you have to give people value for their money, whether you're a department store, a candy store or a recording studio. We want people to walk away feeling that they were treated right and provided with a good environment in which to be creative. We want them to feel that their money was well spent." ■

# Four *great* reasons to buy at Sweetwater.

Microphones



Keyboards



Guitar



Guitar Technology



Computers & Software



Recording Workstations



Outboard Gear



Speakers



*Great Prices*

*Knowledgeable Sales Staff*

*Comprehensive Support*

*Largest Selection*

**Price. Staff. Support. Selection.** These are the four fundamentals of the perfect buying experience. With other retailers you have to decide which of those elements are important to you and which of them you can live without. There is only one retailer in the industry that lets you have your cake and eat it too: *Sweetwater*. These four fundamentals are the cornerstones of the "*Sweetwater Difference*," — a philosophy that ensures that our customers are taken care of before, during and after the sale.

*Call us today and find out why hundreds of thousands of people choose Sweetwater!*

Call us today at (800) 222-4700 or visit [www.sweetwater.com](http://www.sweetwater.com)

ProGear 2003 is here!

Filled with all the latest and best gear available, it's an encyclopedia of musical equipment. Call us today for your **FREE** copy!

**Sweetwater**

music technology direct™

5335 Bass Road, Fort Wayne, IN 46808

FAX (260) 432-1758

[sales@sweetwater.com](mailto:sales@sweetwater.com)

© 2002 Sweetwater, Inc.

World Radio History

**GET THE GEAR YOU WANT TODAY!**  
**SAME AS CASH! NO MINIMUM PURCHASE!**  
**Instant Online Approval**

Sweetwater MUSICIAN'S ALL ACCESS

Platinum Card

1234 5678 9012 3456

JOHN M. STACCATO

# boom...BOOM!

SPL at Ground Zero

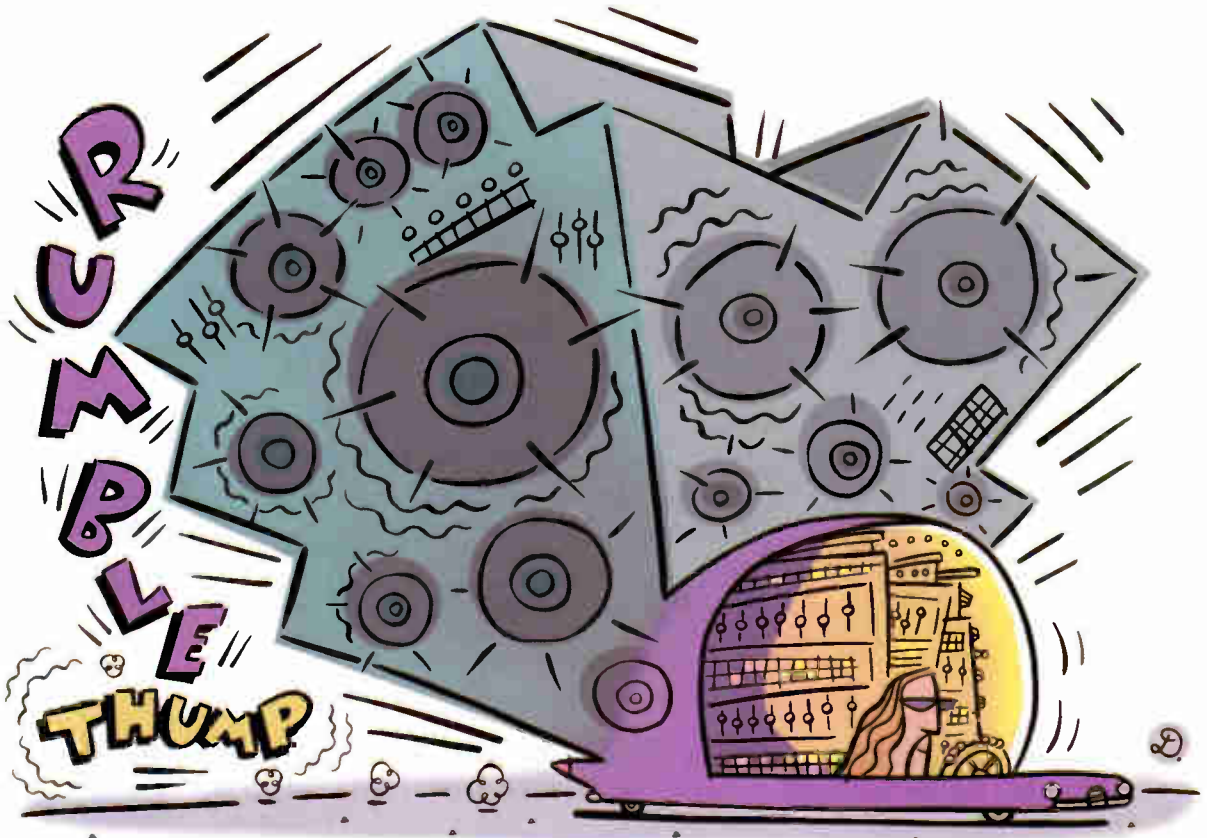

ILLUSTRATION JACK DESROCHER

Last month, I opened with several things that I have been called, but in proofreading it, I felt that it was not a balanced overview. And so, in the interest of objective neutrality, I should tell you that I have also been called a flaming asshole—and blind. This usually happened on the highways in Maryland, where the plethora of flaming assholes are always looking for ways to recruit more members into their already healthy ranks; and in Florida, where total blindness is a basic requirement to get a driver's license. But here again, in the interest of objective reporting, I must reveal that Florida's total blindness requirement is waived if the applicant is over 95 years old. So, only 38% of the drivers on the road are actually sightless. Deaf is another story.

In California, almost everybody on the road can see and hear, but only themselves. I get along pretty well there. They call me when the surf's up or when they want Tex-Mex blues on a So-Cal guitar. I fooled them all last month and spent the afternoon learning to lamely "play" a didgeridoo at a dedicated didgeridoo

distributor in Laguna Beach. Then I walked into a bench and cracked my knee open. So I do have my blind moments.

But there is one common acoustic event that exists in these and every other city in the first world: stoopid car audio tricks.

Now, when I was much, much younger (seven years ago), I built a 21-kilowatt, eight-subwoofer competition car that won everything I entered. That's 21,000 watts from 18 to 56 Hz, and 5k distributed above that. This was a 3000GT VR4 that I stripped down to the skin and built in some very serious second-order bandpass cabinets—sacrificing every cubic inch behind my head. No rear seats, no rear deck. Only cabs and amps.

I was naive. I was self-confident, even cocky. I had so much faith in my maturity and professionalism that I was convinced I was immune to the life-destroying pitfalls of this dark-underhood-underworld-subwoofer subculture.

I actually thought that I could get in, get what I



## The Echoes Of History. The Future Of Music.

Three decades ago, a legendary sound was born with the arrival of the first Eventide effects processors. Eventide subsequently helped shape the sound of some of the most important artists of the era.

Today, as Eventide processors continue to evolve and proliferate, the echoes of our original boxes continue to intrigue and delight. That's why we've created the new Eventide Clockworks Legacy™ plug-ins for Digidesign's Pro Tools. Now a new generation of creators can have the classic Eventide sound with all the flexibility of today's leading digital audio workstation.

Easy to use and completely flexible, featuring full integration, automation, and MIDI performance control, The Eventide Clockworks Legacy bundle puts five legendary processors on your desktop—the Omnipressor®, the Instant Phaser™, the Instant Flanger™, the original Harmonizer® brand effects processor, the H910 and its successor the H949. These are the products that defined effects processing. Each one painstakingly recreated by Eventide software engineers to deliver the sound you can't get anywhere else.

What new sound will emerge from the virtual reincarnation of these classic processors? That is entirely up to you.

# Eventide®

The Sound Is Legendary. The Creativity Is Yours.



Omnipressor



Instant Phaser



H910 Harmonizer



Instant Flanger



H949 Harmonizer

**The legendary sounds of Eventide are back.  
Experience Eventide Clockworks Legacy plug-ins for Pro Tools.  
Come to Eventide Hall A, Booth #6699 or Digidesign Booth #6066**

Eventide, Omnipressor and Harmonizer are registered trademarks, and Instant Phaser, Instant Flanger, Eventide Clockworks Legacy are trademarks of Eventide Inc. ©2003 Eventide Inc. Pro Tools is a registered trademark of Avid Technology Inc.

World Radio History

wanted and get out unscathed. But the sad truth is that car subs are a gateway addition: They lead to harder and harder upgrades, and before you know it, you live, eat and sleep this stuff; you are hooked. You drop out of normal society, start hangin' with 18-year-olds who know where to get the really good 2-gauge power cables and the best super-deep-cycle batteries.

Sure, you get an education, but at what cost, I ask you? What *cost*?

I knew a guy. A friend who I had once bought a couple of borderline illegal headlight bulbs from. He had gone on to open a chain of high-end car audio shops that carried the best stuff, and he knew all of the secrets to get the most out of every ounce. Yup, he was good. Real good.

And I had this car with a lame audio system that I couldn't even listen to the weather on. And the road noise was ridiculous.

So I dropped by to see the guy. He sold me some DynaMat. This is how it started. Damn, I remember it so clearly now that my memory is starting to return. DynaMat is this thick, slightly foamy, self-adhesive tarpaper stuff that you slap on to

any surface that sings to damp it and quiet it down. I once DynaMatted a woman I was dating. Stuff works great. She once broke my jaw while I was sleeping, and that worked pretty well, too. Had I been

But the sad truth is that car subs are a gateway addition:

They lead to harder and harder upgrades, and before you know it, you live, eat and sleep this stuff; you are hooked.

given the choice, I would have chosen the sticky paper.

So, anyway, I took the car apart and stuck this stuff everywhere. The car went from a loud racer to a BMW 700 Series-like quiet, solid and substantial-feeling racer.

And, at the risk of turning you on to

audio's seedy, speedy underbelly, I will tell you this: You need this stuff somewhere in your life. I have since gone on to use it to substantially quiet down computers, equipment racks, cars, boats, planes, speaker boxes, air ducts, swimming pool filters, the drive in my TiVo, and much more. They even make a reflective foil-laminated version for noise reduction *and* thermal insulation. Note that this was the actual helpful content portion of this month's column. DynaMat. But be careful—stop there! Don't let the people at the car audio place where you get this stuff show you anything else.

And don't, under any circumstances, let anybody there under 30 come out to your car, and *never* let them hear your car's stereo system. They will destroy you in ways that you never imagined. And then, when you have been reduced to a flinching blob of prenatal biomass in the middle of the parking lot, they will show you how to overcome your mass mentality and take your rightful place among the auto audio elite.

At this point, you are destined to one of only two paths: go home and live out

—CONTINUED ON PAGE 154



# tangles?



ZSYS

Digital Detangler™ matrix switchers for digital audio signals...

The smart way to connect all your digital audio gear. No tangles, no pain.

S, M, L, and XL sizes



8x8 Lightpipe I/O



10 AES/EBU, 4 S/PDIF, 2 optical



128x128 AES/EBU pairs

just a few of our offerings...

Z-Systems Audio Engineering

www.z-sys.com   352.371.0990 (tel)   352.371.0093 (fox)   info@z-sys.com





# Curtis works with 240 bands....

SURE, MOST GUYS COULDN'T HANDLE IT. BUT CURTIS OWNS A DEQ830 – the only eight-channel, 30-band 1/3-octave digital graphic EQ with an interface so fast it feels (and looks) analog. With 100 user programs and 100 curve templates, setup's a snap whether it's the fifth club this week or a complex installation.

And 24-bit 1/4" TRS connectors plus digital I/O keep the audio studio-ready, all in an amazingly affordable and compact 1U rack. Of course, sometimes real men need just two channels . . . that's where the DEQ230 and DEQ230D (with digital I/O) come in. Now if only musicians were so easy to control.



DEQ230D with digital I/O shown, DEQ230 with analog I/O available

For more information visit [www.alesis.com](http://www.alesis.com), or call 310-821-5000 for a product line brochure.

# The OS X Files

## A Chat With Apple's Audio Guy

Computer companies rarely make audio or music hardware. There have been exceptions: If you've been around a while, you may recall that Atari included MIDI jacks on its ST computers; Apple once stuck its logo on a simple MIDI interface; and IBM marketed something called the "Music Feature," which was actually a Yamaha four-op FM synth chip on a PC daughter card. But generally speaking, the companies making the general-purpose pizza boxes and laptops that have taken over our industry left others—from Creative Technologies to Motorola to Kurzweil to Digigram—to worry about the chips, the cards, the breakout boxes and the other hardware add-ons that we must have in order to do sound generation and DSP.

Computer makers don't normally do much in the way of audio and music software, either. On the PC side, they don't make any software at all, because they don't own the operating system. Microsoft, which does, has come up with several Windows pieces (or is that "shards?") that are helpful to third-party developers like DirectX and Windows Media Player. On the Mac side, Apple has historically made a few very tentative forays into the area, such as the lame QuickTime Musical Instruments and the positively comatose MIDI Manager. But by and large, most of that kind of development—even at the system level—has been left up to others like Steinberg for audio interconnection, and Opcode and Mark of the Unicorn for MIDI.

But under Apple's latest—and as of last month, the default—operating system, OS X (which apparently can be pronounced "oh-ess-eks" or "oh-ess-10," depending on your mood), that's all changing. And considering Apple's acquisition last summer of the well-regarded German software and hardware maker Emagic, it's reasonable to assume that it's going to be a big change.

A year ago in this column, I maintained that OS X wasn't exactly ready for prime time when it came to music and audio applications, but with the introduction last fall of OS 10.2, that's history. Oliver Masciarrotte covered the technical ramifications of 10.2, dubbed "Jaguar," in his November 2002 "Bitstream" column. (Apple has always used internal code names, some of them very clever, for its projects in development, but why this particular one has caught on so well with the public is beyond me. If you ask me, "Tsunami" was a whole lot cooler.)

I'm going to take a different tack and talk more about the business side of 10.2's music and audio functionalities, and what it all means to the user and developer communities. To help me, I interviewed Dan Brown, who for the past three years has held the

somewhat awkward title of "audio technologies manager, worldwide product marketing" at Apple Computer. Brown is also a member of the Board of Directors of the MIDI Manufacturers Association, which means that he's aware of the issues from several different perspectives. And he's willing to talk about them, or at least most of them. What follows are some of that conversation's main points.

There are no longer any technical issues inherent in the OS that make it a problem for music, which is not to say that there haven't been issues in the past.

—Dan Brown, Apple

*Why has it taken so long for many MIDI and audio developers to adopt OS X?*

We believe by now, working with the developer community, that there are no longer any technical issues inherent in the OS that make it a problem for music, which is not to say that there haven't been issues in the past. When it was first released, it was usable with real-time applications like audio, but we didn't have carbon [OS X-compatible] apps to test it on. So we had a chicken-and-egg situation, and we had to wait until the apps were ready before we could do any testing. And then we found that there were inefficiencies; those have been fixed.

*Does Apple consider USB to be a viable way to send MIDI?*

A USB MIDI class driver is good for consumer-level use. For professionals, we recommend using time-stamping drivers the way Emagic and Mark of the Unicorn do. The USB Implementers Forum, [www.USB.org](http://www.USB.org), owns the USB specification—we don't—and they don't support time stamping. It's because they are more oriented toward consumer uses of USB and not the MI or media-production industries. So we can't do it ourselves, but we'd love to see the developer community get together and deliver a class standard for time stamping that everyone can use.

*What about MIDI over FireWire?*

Yamaha is doing that with mLAN. Again, we don't own the spec, but we certainly support it; and if people

PRO TOOLS | HD

Have you heard

Pro Tools | HD?

*Joe Chicarelli has...*

"I'm totally impressed by the new Pro Tools system. The sound quality is amazing, and it's rock solid stable."

**JOE CHICARELLI**

Producer | Mixer | Engineer

*Beck*

*Tori Amos*

*Elton John*

*U2*

*Bon Jovi*

*Frank Zappa*

*Shawn Colvin*

*Michelle Branch*

Go to a Digidesign dealer to hear for yourself.

[www.digidesign.com/HDdealer](http://www.digidesign.com/HDdealer)

© 11/02. Digidesign and Pro Tools | HD are trademarks or registered trademarks of Avid Technology, Inc., or its subsidiaries or divisions. All other trademarks are the property of their respective holders.

 digidesign

World Radio History

want to use mLAN, that's fine with us, but that specification belongs to Yamaha. We can only implement what mLAN consists of.

*Before OS X, the Opcode MIDI System, OMS, was the de facto standard to deal with MIDI interfaces and inter-application communication, even though Opcode essentially ceased to exist some years ago and no one has been supporting it. I heard at one point that Apple was interested in picking up that technology. How come it didn't?*

I can't really speak to that.

*But is OMS' functionality part of OS X?*

Yes, we deliver all of the MIDI services that were in OMS. We have an application called Audio MIDI Setup that recognizes all devices, which are either class-compliant or for which a driver has been loaded. That includes interfaces and USB keyboards and other instruments. We would like devices to be as class-compliant as possible so that they at least work with that software, without requiring any custom drivers. Maybe you'll need custom drivers to take advantage of the full-feature set of a device, but we'd like basic setup to be as painless as possible.

*What about older applications that aren't updated for OS X. Will they work?*

Old software that has not been "carbonized" should run in OS X's "classic" mode; but in that mode, hardware devices are not directly visible to applications. So you almost need two drivers: one to get into the OS X environment and one to get out the ports. With that much going on, performance can't be guaranteed. Applications just won't run well, if they run at all. On the other hand, under OS X, carbonized native applications like Reason and Ableton Live run very well. I go home and use Reason almost every night. They're so stable; it's a revelation.

*How is synchronization between applications handled in the operating system? Under OMS, you had to specify which devices handled what kind of timing data.*

Synchronization is API [application programming interface] level functionality, meaning that it's up to each application on how to deal with it. There's nothing special about managing synchronization data: The OS just treats it as time-sensitive, time-stamped data. If the application assigns it a high priority, then it will be passed accurately.

*What's replacing the old Sound Manager to handle audio streams, and how is it different?*

Sound Manager is useful for consumer-level playback in OS 9. It handles two channels of up to 16-bit, 48kHz audio. But professionals needed something more flexible, and so ASIO, EASI and Direct I/O were developed by various companies. They were critical. Now, we have Core Audio, which is functionally the same as Direct I/O or ASIO. It allows any number of channels of input and output, with up to 32-bit floating-point precision. We've made the middlewares unnecessary. We haven't prevented those companies from bringing up their protocols into OS X, but they don't have to. And I don't know why they would want to.

*What about plug-ins? Are you looking to adopt a common format for them, as well?*

The reason there is such a variety of plug-in formats is purely marketing. If the developer community were to choose a common format—consolidating all of this redundancy—then that would eliminate all of the confusion. We have a protocol

—CONTINUED ON PAGE 157

## A HIGHER STANDARD

For Gear That Makes a **GENUINE** Difference... Studio or Live!

### DRAWMER

**NEW!**  
Tube Station

24/96k Output with  
Variable Tube Drive  
TS1 Preamp Comp: \$999  
TS2 Stereo Comp: \$999



### BRAUNER

**NEW!**  
Phantom C

\$1380 FET Condenser  
Brauner's Signature Sound  
Engineered for Vocals/Voiceovers



### 1969 Mercenary Edition

Mono/Stereo JFET Compressors  
Dual Mic Pres and Tube DI

### ATC

**NEW in the US**  
T16 Active

The Best There Is!  
\$3,000/pair  
Self-Powered Nearfield



### SOUNDFIELD

**NEW!** 422B+451 Stereo/5.1 Mic  
The 5.1 Solution for Under \$7,700



**TRANSAMERICA  
AUDIO GROUP**

For the Names of the Best Dealers on  
the Planet Contact the Transamerica Audio Group  
(702)365-5155 • sales@transaudiogroup.com



**2002 WINNER!**

**HR624** Studio Monitor Technology  
**HR626** ISB driver, Studio Monitor Technology

**HRS150**  
15" Active Subwoofer

**HRS120**  
12" Active Subwoofer

**HR624**  
6.7" Active Studio Monitor

**HR824**  
8.75" Active Studio Monitor

**HR626**  
Dual 6.7" Active Studio Monitor

*HRS150 — Twice the output of the HRS120. Perfect for hip hop mixes or extra-large control rooms. Ideal for bass management apps.*  
*HRS120 — a fine choice to be the "..." in surround applications.*

*The 6.7-inch, 2-way nearfield monitor that's more than just a smaller version of the HR824. The perfect monitor for those who need incredible midrange accuracy for lead vocal placement within the mix and for dialog replacement in post.*

*As the industry-standard studio monitor, the 8.75-inch 2-way nearfield HR824 is ideal for those who need lots of bottom end, as well as comfortable high end for long sessions of general mixing.*

*The new HR626 has Phase-accurate D'Appolito driver alignment design with bi-amplification. Superb bass and midrange accuracy for mixing and vocal placement. Also an ideal choice for horizontal placement in center channel applications.*



# PRECISION RUNS IN THE FAMILY.

*With the new HRS150 and HR626, there are now 5 ways to have Mackie studio accuracy.*



No matter what your application — from 7.1 surround to stereo monitoring, there's now a Mackie active monitor and subwoofer that will give you exactly what you want: unflinchingly accuracy.

Our new HR626 has ten more square inches of active cone area than the HR824 for even mo' bass extension, yet is as tight and fast as the compact HR624. It makes a great main stereo monitor or center channel for surround mixing.

And speaking of mo' bass, the new HRS150 uses a 15-inch active driver, two 12-inch passive radiators and 950 watts of FR Series power to achieve frequency response that's only 0.5dB down at 10Hz. Yes, you read that right. Ten Hertz!

Hear the whole precise Mackie family, including the new HR626 and HRS150, at your nearest Mackie dealer today.

**NEW**

**TOOLS FOR ARTISTS**

*Tools for artists*

1.800.258.6883 • WWW.MACKIE.COM

© 2002 MACKIE DESIGNS INC. ALL RIGHTS RESERVED.  
"MACKIE," AND THE "HOUND DOG FIGURE" ARE REGISTERED TRADEMARKS OF MACKIE DESIGNS INC. IF YOU CAN FIGURE OUT WHAT'S LOGICALLY INCORRECT WITH THE HOUND DOG PICTURE AND THE ARROW - YEARN FINE, WOOPPY DOO, WE KNOW - PLEASE STOP CALLING US ABOUT IT.



# You Call That

*The story so far:*

*By the end of the 1970s, Frank Zappa had released 28 original albums (including seven two-LP releases), either by the Mothers of Invention or under his own name. Deeply distrustful of large record companies, Zappa had set up his own independent record label and, frustrated by the cost and logistical difficulties of scheduling lockouts in commercial studios, had constructed a state-of-the-art personal studio, the Utility Muffin Research Kitchen (UMRK). And to ensure the highest-quality live recordings, Zappa purchased the Beach Boys' remote truck.*

By Chris Michie

The refurbished truck, dubbed the UMRK Mobile, became an integral part of the touring organization and was used to record every show, as well as premix various instruments for the FOH and monitor engineers. "I might have 22 channels on the drums," says Mark Pinske, then working as Zappa's recording engineer in the truck and at UMRK. "I would take the combination of all of it and send, for instance, tom toms left and right back out to the house. We might take nine different stereo keyboards, and I would mix them all down to a stereo keyboard mix that could go back to the monitors onstage and back to the house mix. We found that we had a lot more control over the feedback and a lot fewer problems with the recordings, because we had the same sonic tone and the same path pretty much going to each of the locations. I had 85 noise gates in the truck, and we could pretty much control everything. I could hear problems—little buzzes or hums—and we could isolate the problems, and then I could treat them with some of the best outboard gear you could get and send it back to these guys, and it would be all spiced up. And, of course, you're not going to get the kind of equalization that you have in a Neve console out of a little portable Midas board."

With two Ampex MM1200s running at 30 ips, the operation soon required bulk shipments of tape to various points on the tour. "On the first three-month tour, we had 946 master tapes, if I remember correctly," says Pinske. "A huge amount of master reels of tape. Normally, it would take about eight reels a show, overlapping them. A lot of times, we did these small theaters in America, so we would do double shows, and Frank had a habit of not repeating any of the songs from show to show. So we'd have pretty much different tunes through both shows."

# MUSIC?

**FRANK ZAPPA'S ASTONISHING CAREER AS A RECORDING**



*Coffee-table Zappa. This career retrospective made up of studio outtakes and archival "field recordings" is stuffed with gems for the rabid fan; the informative booklet is illustrated by Gabor Csupo.*

## MAGIC FINGERS

Having played about 825 concerts in the preceding 10 years, Zappa retired from touring in July 1982 and devoted his energies to new studio recordings and mixing the now-enormous backlog of live tapes. Bob Stone, formerly chief engineer at Larrabee, where he had mixed many of Casablanca's disco hits, including Donna Summer's "Last Dance," joined the UMRK staff in 1980, and he and Pinske wound up tag-teaming on Zappa's various remix projects. "Frank liked to work around the clock," recalls Stone, "so we'd take shifts. I'd leave a setup for mixing on the console and leave any notes that needed to be done." In fact, the surprise hit "Valley Girl" (from the 1982 *Ship Arriving Too Late to Save a Drowning Witch* album) was mixed while Zappa was asleep. "When he got up the next morning to check out what happened the night before," Stone says, "he thought maybe one of the vocal raps might have been a little different, from a different track earlier in the tape. But I'd already tried that and knew it wouldn't work. I demonstrated that to him, so we went back to what I had and moved on. That was about all the attention we gave it."

"Valley Girl" became Zappa's highest-charting single and, along with an out-of-court settlement with Warner Bros., provided funding for Zappa's next recording adventure. In January 1983, Zappa and Pinske traveled to London to record the London Symphony Orchestra performing various "classical" pieces that Zappa had composed since 1968. Unable to secure a good concert hall for the recording date, Zappa wound up recording the 105-piece orchestra on a soundstage at Twickenham Film Studios, using about 40 prototype Crown PZM microphones (supplied by Ken Warren-

brock) in unusual close-miking configurations. Another technical innovation was the use of Sony's new PCM-3324 digital recorder, but neither the wide dynamic range of the digital medium nor the separation achieved through close miking could entirely save the performances. "I think we had about 1,000 edits," Pinske recalls of the remix sessions. "We were counting them at one point—we got up to like 900—and we decided that counting them was ridiculous. But [Zappa] could edit like nobody could. When I first started with him, I was afraid to pick up a razor blade. Now, I could put a breath into a vocal or take a breath out. I was just privileged to be able to have learned from somebody like that."

Despite his dissatisfaction with the LSO's performances, Zappa was extremely impressed by the apparently noiseless digital recording medium and wound up leasing and eventually owning two Sony PCM-3324s, as well as a Sony PCM1610 for 2-track mixdowns. From 1984 on, all of his new recordings, both in the studio and live, were in the digital medium.

## HE MADE ME DO IT

Back at UMRK, Zappa, Pinske and Stone busied themselves with an array of recording and remix projects. With various lawsuits finally settled, Zappa had regained the masters for all of his LPs on the Warners-distributed Bizarre and DiscReet labels, along with the MGM/Verve master tapes of the early M.O.I. albums. Most of these records had long been out-of-print, and, as it turned out, several of the master tapes were unplayable and required considerable restoration work before the LPs could be reissued.

# ARTIST, PRODUCER AND STUDIO OWNER—PART 2



The part of me that people should be most interested in, if they have any interest in me at all, is what I do.

—Frank Zappa

Fortunately, a Studer 2-inch 24-track had been included in the purchase of the Beach Boys' truck. "That was a lot better 24-track, sonically, than the Ampex MM1200s," says Pinske. "We made homemade guides so I could take the 12-track 1-inch tapes and play them on the bottom 12 tracks of the 24-track 2-inch head. It was a real meticulous thing: You couldn't rewind them fast, because the tape would creep up and wouldn't pack right. And, you could really only pass them through one time, because the guide system wasn't all that great." Over a three-month period, Pinske managed to transfer all of the various M.O.I. masters to digital and also created digital-clone safety copies.

The first *Old Masters* box set of M.O.I. LP reissues came out on Zappa's Barking Pumpkin record label in April 1985; the seven vinyl discs included a *Mystery Disc* of outtakes and archival oddities. Two more nine-LP volumes were released in 1986 and 1987, the first of these also including a second *Mystery Disc*. Some of the albums were more or less unchanged transfers of the original album masters, but several had been completely remixed and, in some cases, had new bass and drum tracks added.

#### DRUMS ARE TOO NOISY

As Zappa wrote in his autobiography, "What qualified as an 'acceptable drum

sound' on a 1950s recording seems laughable today," and as technology advanced, he expended considerable time and energy on getting better-than-acceptable drum sounds, both live and in the studio. One of the benefits of owning the UMRK Mobile was that all road tapes were made on the same equipment and tape format, factors that allowed Zappa considerable latitude in editing among different shows. In order to ensure even more consistency, Pinske and drum tech John Goode developed a system to permanently mount microphones in Chad Wackerman's drum kit. "We would try all kinds of different drum heads and all kinds of different microphones to get the absolute best

## UMRK REDUX

Though Frank Zappa's personal studio, Utility Muffin Research Kitchen, was a state-of-the-art facility throughout the 1980s, it was more or less mothballed after Zappa's death. However, in 2002, the Zappa Family Trust decided to finance a complete refurbishment, including architectural changes.

"For the last eight years, nothing has been done in that room," explains Dweezil Zappa, himself an accomplished musician. "The last major change to the studio was to accommodate the change of console from the Harrison to a Neve VR 62; that was in about 1990." In fact, Dweezil tried using the studio during the 1990s but, unhappy with the sound of the control room, instead built a project studio in the vocal booth. "I had done some projects with that Neve, and there were always some things that seemed questionable," recalls Dweezil. "I have some old Neve modules—1073s and 1272s—and I like the old stuff. But for some reason, anything I did with that console and in the old room didn't work out, so I didn't feel confident with it. The monitoring were these giant JBL speakers, and I thought the room sounded a bit strange."

The impetus to update the control room came from the Zappa family's decision to continue releasing archival material on the recently formed Vaultalternative label. (The first release, a two-CD volume that documents a 1976 live show in Sydney, Australia, became available in summer 2002.) "Our hands have been tied while the studio has been nonoperational," explains Dweezil. "It's only now that we're going to be able to pick up the pace and deliver things that people have been asking for and also discover things we didn't know existed." One much-anticipated release will likely be a selection of live recordings by the so-called Petit Wazoo band, a 10-piece M.O.I. that played a score of dates in late 1972.

The acoustic redesign of the UMRK control room, a collaborative effort between Dweezil and Zappa's wife Gail and Art Kelm, features a full 5.1 monitoring setup. Though only a couple of Frank Zappa's mid-'70s records were mixed in the quadraphonic format, the composer specified a six-point surround P.A.



They live by a code that is usually SMPTE. Zappa hosts Sony's Dr. Toshi Doi (left) and Curtis Chan at UMRK. Zappa was among the first recording artists to acquire a complete digital recording system comprising a Sony PCM-3324 (shown) and a Sony PCM-1610 2-track mastering unit.

system for the 1991 *Yellow Shark* concerts and would undoubtedly have remixed much of his catalog for surround had he lived. "We recently did a 5.1 project with one of the concerts from 1978 in New York at the Palladium," notes Dweezil. "It was originally recorded by Joe Chicarelli, and we got in touch with him to do the 5.1 mix on it: We thought it would be fun for him to revisit the material all these years later. So that release effectively recreates the concert and adds so much depth to the music. 5.1 is a different format that works really well, I think, for Frank's music, because there are so many textures involved and they're constantly changing. It's not necessarily the best format for all types of pop music, but it works for people whose music stands the test of repeat listening." The 5.1 Palladium remixes in DTS are scheduled for a January 2003 release on Vaultalternative.

To properly accommodate a 5.1 surround-monitoring system, the control room was expanded in the rear and a new machine

—CONTINUED ON PAGE 34



A POWER TO WEIGHT RATIO  
THAT ALMOST DEFIES GRAVITY.



## ST SERIES

The latest evolution from the world's preeminent manufacturer of power amplifiers.

World-Renowned Crest Sound Quality • Class-D Amplifier Technology • Lightweight, Powerful And Efficient • Low Noise, High Efficiency Resonant Mode Power Supply • Low AC Current Draw • Latest Generation Of High-Speed, Wide-Bandwidth Output Devices • Cooled By Variable Speed Fan With Back-To-Front Airflow • Cost-Effective Price • Five Year Limited Warranty On Crest Audio Power Amplifiers



## LT SERIES

The LT Series amplifier offers exceptional sonic performance with a combination of a linear power supply and a Class D output to deliver Crest Power in a compact and cost-effective package.

### TRUE POWER SPECIFICATIONS

	Weight	8Ω Stereo	4Ω Stereo	2Ω Stereo	8Ω Bridged	4Ω Bridged
ST2000	23 lbs.	500W	1000W	1200W	2000W	2500W
ST1500	22.5 lbs.	400W	750W	900W	1500W	1800W
ST1000	22 lbs.	280W	500W	650W	1000W	1300W

*Figures are Watts per channel, 1kHz, <1%THD+N, both channels driven.*

CREST. THE TOTAL SOLUTION FOR AUDIO PROFESSIONALS.

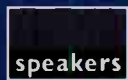
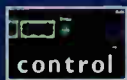

**CREST  
AUDIO**  
NO EQUAL

www.crestaudio.com • Toll Free: 1-866-812-7378  
Crest Audio, Inc., 16-00 Pollitt Drive, Fair Lawn, New Jersey 07410



drum sound we could get," recalls Pinske. "So when we were done, we would have a really elaborate, great-sounding drum set. I think the ultimate drum sound that we ever had was on the *Man From Utopia* album [1983]. And Frank started really liking this really good drum sound and kind of wanted to start hearing it on just about everything. I was kind of upset about the fact that he wanted to replace the drums [on the older albums], because I had al-

ready gotten a pretty good drum sound out of even the mono recordings that were on the original tapes."

In some cases, reassembling the original album proved impossible. "I always liked the *Fillmore East—June 1971* album, because I laughed at that album a lot," says Pinske. "But Frank couldn't even remember where he got all of the edits from to put that together; he had edited that thing, silly. So when we tried to reconstruct that album, it was damn near impossible, because he couldn't even remember where he got what cut from. So, we'd have to hunt around and say, 'Jesus, where's this next section?'"

—FROM PAGE 32, *UMRK REDUX*

room was added to house two digital Sony 3324s and various analog tape machines. "The ceiling is now much higher, and it's a more open-sounding room," notes Dweezil.

Another major change is that the analog Neve VR 60 has been replaced with a digital Sony DMX-R100. "I had been working with the Sony and found it to be a much better tool for me," says Dweezil. New or remixed recordings will be stored in either a Euphonix R1 hard disk recorder or workstation-based Steinberg Nuendo. "The Synclavier we're keeping because there are probably over 2,000 compositions in it in various stages of completion," adds Dweezil. "Even though it's an archaic setup, there's nothing else we can use to get those things out. Ultimately, over time, we're planning on making a sound effects library out of the samples that Frank made and trimmed himself."

Though some of the original studio equipment has gone missing—Dweezil especially regrets losing track of the Pultec equalizers—the vintage mic collection is still choice. "There's a nice collection of Neumanns: some M49s, some M50s, some U47s. I believe there's one Telefunken U47," notes Dweezil.

Staffing the newly revived facility will likely be on an as-needed basis. "I'm going to be the main engineer on my projects, and if there are other things that we decide to bring in, we will hire some other people we enjoy working with," says Dweezil. "Vaultmeister" Joe Travers, whose full-time job is to identify the many hundreds of tapes in the vault, will no doubt be involved in some of the archiving. "As it relates to projects of Frank's, it'll most likely be the two of us," says Dweezil. "I've also talked to other engineers, like Bob Clearmountain, and I'd like to get some other engineers' takes on Frank's music. I hope to do some high-end 5.1 or detailed audiophile special projects that involve great mixers. We're also working on putting together some DVDs and finishing the *Roxy and Elsewhere* movie that Frank started to make. There's all kinds of stuff in the vaults that Frank did on 2-track or in apartments. There's easily another 30 years of releases—it's that crazy." —Chris Michie

# SMALL.



## VERY SMALL.

You asked for a smaller professional transmitter with Sennheiser quality, but with lower noise, longer battery life and improved transmission. Your wish has been granted with the SK 5012.

**AVAILABLE NOW!**

**THE SK 5012**  
RF WIRELESS BODYPACK TRANSMITTER



[www.sennheiserusa.com](http://www.sennheiserusa.com)

One Enterprise Drive, Old Lyme, CT 06371  
Tel: 860-434-9190 Fax: 860-434-1759  
Canada: Tel: 514-426-3013 Fax: 514-426-3953



rf wireless audio by  
**SENNHEISER**

Pro Tools



Digital Performer



Nuendo



# Yeah...we do DAWs

## TASCAM DM-24 v2.0: Now with HUI™ emulation and much more.

With its new version 2.0 software, TASCAM's DM-24 becomes more than just an incredibly powerful digital mixing console. It adds control surface capabilities for software DAWs like Pro Tools®, Digital Performer™ and Nuendo® via HUI emulation, with external control of levels, mutes, pans, track arming and aux sends, in addition to standard MIDI control of DAWs like Cubase®, Logic™ and Sonar™.

But that's just the beginning. DM-24 v2.0 is a great front-end for your DAW, with 16 high-quality mic pres, 24-bit converters,

4-band parametric EQ, dynamics processing and more. Plus, with standard interfacing like 24 channels of TDIF and 8 channels of ADAT, it's a perfect companion to DAW interfaces like Digidesign's 001™ and MOTU's 2408™.

Version 2.0 adds over 20 exciting new features to the DM-24, including 60 inputs at mixdown, new 5.1 surround panning, nearly unlimited signal routing, and much more. For all the info on the world's most powerful small-format console, visit your TASCAM dealer or [www.tascam.com](http://www.tascam.com).

\*MU-24 Meter Bridge optional



HUI is a registered trademark of Mackie Designs Inc. Pro Tools is a registered trademark of Avid Technology, Inc. and its subsidiaries and divisions. Nuendo and Cubase are registered trademarks of Steinberg Media Technologies AG. Digital Performer is a trademark of Mark of the Unicorn. Logic is a trademark of Emagic. Sonar is a trademark of Twelve Tone Systems, Inc. All other trademarks are the property of their respective holders.

# TASCAM

a whole world of recording

[www.tascam.com](http://www.tascam.com)

World Radio History



And sometimes, we just didn't find them."

Another problem with archival tapes was due to the different aging characteristics of the two tape stocks used for live recordings. "We cut a deal with Ampex to drop hundreds of rolls of tapes at different cities, like Chicago, New York, wher-



This compact introduction to two of Zappa's most interesting audio worlds contains three classical pieces played by the Ensemble InterContemporain and four of Zappa's early Synclavier compositions.

ever," says Pinske. "Well, Agfa started bidding for the business, and we started using Agfa 468. We switched in the middle of the tour, and when we got off of the tour, we started razor-blade editing a lot of the songs together from different shows, and you couldn't even tell the difference in the cymbals across the edits. That's what Frank liked about the consistency we did in the recording. Well, some of the tapes that we meant to mix for an album we didn't get to mix, because we edited way more songs than we were able to have time to mix, so we put them in the tape vault. When we pulled them out a year later, the edits didn't work. The cymbals would drop as much as 3 or 4 dB at the high frequencies when they went to the Ampex 456, and then when we went back to the Agfa tape, it would get bright again. This was very frustrating from an engineering standpoint. When I remixed the whole *Baby Snakes* movie [1983], we would have tapes that maybe the first 20 seconds would sound right, and then all of a sudden, it would get dull and everything would change. We'd have to strike the board and reset everything just to make the edit work. And you might strike the board maybe eight, 10, 12 times through one song, just to try to make the

sonics match on edits that originally ran across like butter."

#### THAT'S NOT REALLY REGGAE

These problems did not, of course, affect digital recordings. By 1984, Zappa not only had an all-digital setup at UMRK, but he had also started working on the Synclavier DMS, an all-digital sampling computer that allowed him to compose and reproduce music that would stump even the most capable human musician. Zappa's first project with the device was an all-Synclavier rendition of chamber music by the obscure 18th-century Italian cellist—and possible ancestor—Francesco Zappa. More sophisticated Synclavier tracks showed up on *The Perfect Stranger—Boulez Conducts Zappa*, a 1984 recording by the Ensemble InterContemporain, and Synclavier tracks and samples also began to appear in Zappa's band-based recordings.

At this point, Zappa's recording universe was complete: He owned a state-of-the-art digital recording facility and the ultimate sampling synthesizer, both maintained by a skilled technical staff available around the clock; he had regained control of his back catalog; and also had access to a cadre of superb musicians who could play pretty much anything he put in front

George Jones  
Al Stewart  
Johnny Mathis  
Vertical Horizon  
Tracy Chapman

**The Dave Matthews Band**

Cherry Poppin' Daddies  
Peter Gabriel  
Carly Simon  
moe.  
Natalie Merchant  
Meshell Ndegeocello  
Tony Bennett  
Dar Williams  
Walter Becker  
Tonic  
Paul Schaffer (late night  
with David Letterman )  
Bob Weir  
Unwritten Law  
Toad The Wet Sprocket

**NeumannUSA**

Tel: 860.434.5220 | FAX: 860.434.3148  
www.neumannusa.com/105dmbmix  
Canada: Tel: 514-426-3013. Fax: 514-426-3953  
Mexico: Tel: (525) 639-0956. Fax: (525) 639-9482

Artists  
Sounding Off

KMS 105 VOCAL PERFORMANCE MICROPHONE

"We're sold on the accuracy, reliability and the dynamics of the KMS 105." Dave Matthews Band Audio Crew



Shall we take ourselves seriously? Frank Zappa conducting the San Francisco Contemporary Music Players in a performance of Edgard Varèse's *Intégrales*. The event was a 1983 benefit concert at San Francisco's War Memorial Opera House.

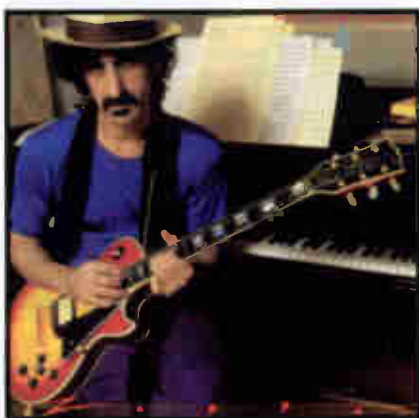

An all-instrumental three-CD set assembled from Mick Glossop-recorded remotes and Zappa's "road tapes" archive features a thorough survey of Zappa's distinctive guitar sounds, with telepathically complementary polyrhythms by drummer Vinnie Colaiuta and bassist Arthur Barrow.

of them. Distribution of Zappa's records continued to be problematic, but having paid all of the recording costs up front, he was in a position to demand exceptionally profitable royalty rates. "He would give the record company 15 percent," recalls Pinske. "So Frank ended up making, in those days, like \$2.25 off each record sold. And that was unheard of compared to somebody like Dylan, who would make 18 cents a copy. By having that kind of control, he was able to take more money in and not have to have all Platinum albums. Because he knew his music was off-the-wall enough and wouldn't be played on the radio—that he couldn't get that kind of volume—he set up his business accordingly. The bulk of his money still came from live performances—he got paid well for performing—and also, he sold a heck of a lot of mem-

orabilia, whatever you could put in the mail: T-shirts, you name it."

#### I DON'T KNOW IF I CAN GO THROUGH THIS AGAIN

One segment of Zappa's business, however, remained stubbornly unprofitable. Despite the apparent success of his "classical" outings—*The Perfect Stranger* had reached Number 7 on the *Billboard* Classical chart and also garnered a Grammy nomination—the costs associated with orchestral performances proved prohibitive. Exasperated by the world of "serious music," Zappa returned to the road in July of 1984. Again, most of the 130 or so shows on the six-month 20th-Anniversary World Tour were recorded, this time in the 24-track digital format. At the end of the tour, Zappa again announced his retirement from the road, though he kept several bandmembers busy overdubbing on various current and archival projects and recording sample libraries for the Synclavier.

For the next three years, Zappa hunkered down at UMRK. Only one new band-based album appeared during this period—the 1985 *Frank Zappa Meets the Mother of Prevention*—and it seems likely that Zappa spent much of his time working with the Synclavier. In 1986, he released *Jazz From Hell*, which, apart from a live guitar solo from the 1982 tour, was entirely created on the Synclavier; the record was nominated for two 1987 Grammys, winning one for Best Rock Instrumental Performance.

Zappa was always interested in achieving the best quality possible on vinyl; for better fidelity, most of his LPs clocked in at less than 20 minutes per side, and his past experiences with inferior pressings,

ECHO

DIGITAL AUDIO

## FLAWLESS DIGITAL RECORDING



*Windows and Mac OS X  
Laptop or Desktop*

[www.echoaudio.com](http://www.echoaudio.com)



from editing the multitrack and developed a system where I could mix and match to an EQ or a venue."

By the time Zappa and Stone worked their way through to *YCDTOSA Volumes 5* and *6* (released in 1992), they were able to use Sonic Solutions, which allowed for more or less seamless edits between performances recorded as long as 17 years apart. Zappa also made extensive use of Sonic Solutions' ambience-matching capa-

bilities in his final Synclavier masterwork, *Civilization Phase III*, which blended under-the-piano dialogs from the original *Lumpy Gravy* sessions with new characters and conversations recorded two decades later.

#### BEAT THE REAPER

Zappa had been experiencing health problems for some time when, in late 1989, he discovered that he had advanced prostate cancer. Despite the rigors of chemotherapy and his steadily declining condition, Zappa continued to update and tweeze his catalog and, in addition to the *YCDTOSA* set, managed to prepare for re-

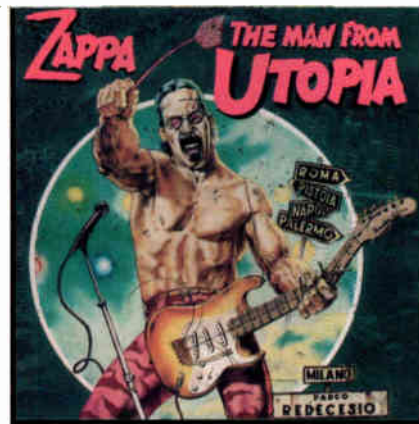

A typically eclectic collection that includes two *sprechstimme* selections on which Zappa's improvised vocal lines are doubled by guitarist Steve Vai. The cover, by Italian comic book artist Tanino Liberatore, commemorates an Italian show staged in an insect-infested swamp.

lease of at least another nine CD collections, including five two-CD sets. One of these projects resulted from a collaboration with the Ensemble Modern, an 18-piece cooperative of highly skilled classical musicians who sought Zappa out and demonstrated their commitment to perfecting a complete program of new and re-arranged Zappa compositions. After extensive and grueling rehearsals, the finished 90-minute program was presented—through an innovative 6-channel surround P.A.—at the 1992 Frankfurt Festival and at other concert venues in Germany and Austria. A concert recording named *The Yellow Shark* was released only weeks before Zappa's death in December 1993 and reached as high as Number 2 on *Billboard's* Classical charts.

Zappa's entire catalog (70 CD releases and counting) is available from Rykodisc and Zappa's Barking Pumpkin label. Further, the Zappa Family Trust has recently established the Vaultalternative label as a conduit for further releases from the massive archives. Of course, the sheer volume of Zappa's output makes it difficult for all but the most determined (or obsessive) listeners to digest and appreciate his wide-ranging *oeuvre*. But, as implied at the beginning of this article, even those *Mix* readers who are indifferent to Zappa's music cannot fail to be impressed by his technical expertise and dogged pursuit of sonic excellence. Even hardcore Zappa fans would admit that not every release is essential, but, as with any serious artist, unfinished sketches and imperfect realizations often illuminate the main body of work. Anyone with an interest in the recent tumultuous history of recording technology, a curious mind, tolerant housemates and enough time to spare should attempt to climb this Mount Everest of the critical-listening landscape. ■

# "Absolutely Amazed"

"When I sat down to listen to the new Westlake Lc3w12's, I was absolutely amazed! The imaging detail is dynamic! I have never heard speakers with more points of sound—source definition in the left-to-right panorama. In addition, the low-end is spectacular... In essence, I am a very happy dude!"

— Bruce Swedien  
 Legendary Engineer/Producer

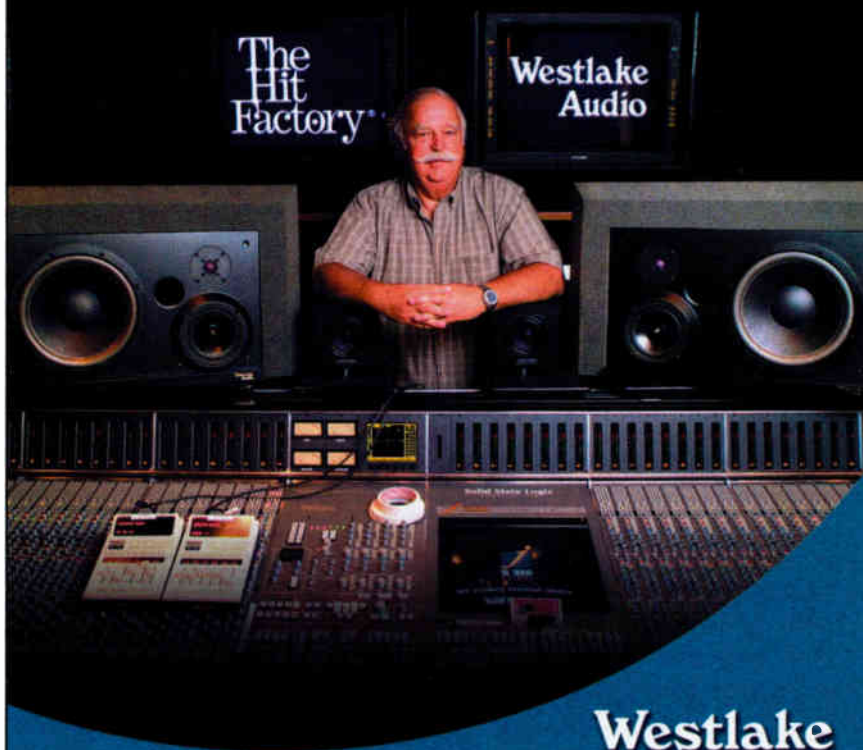

## Westlake Audio

For More Info:

Phone: 805-499-3686 · Fax: 805-498-2571 · [www.westlakeaudio.com](http://www.westlakeaudio.com) · Made in USA



Respect the Past



## Embrace the Future

### The ISA428 Pre Pack

The Ultimate Multi-Channel Mic Pre with 192kHz Conversion

An established industry classic, the Rupert Neve-designed transformer-based ISA pre amp is at the heart of a new Focusrite package that combines vintage Class A attributes with the ultimate in digital technology.

The new ISA 428 Pre Pack features four ISA mic pre's with selectable impedance including the famous ISA 110, eight line inputs, four instrument

inputs and Focusrite's latest eight-channel, 192kHz A-D converter option protected by our new optical Soft Limiter circuit — the perfect future-proof interface to your DAW or digital console.

Here's the best part: this outstanding package starts at only \$1,995 (USD) and is available at your local Focusrite Dealer now.

 **digidesign**  
NORTH AMERICAN DISTRIBUTOR  
[www.digidesign.com](http://www.digidesign.com)

For a demo, call toll-free  
1-866-FOCUSRITE or visit  
[www.focusrite.com](http://www.focusrite.com)  
World Radio History  
for more information.

  
**Focusrite®**



# Recording



# Vocals

## From A to D

### Top Engineers Discuss Producing Vocal Tracks With DAWs

**M**ove beyond the tired arguments as to whether analog recordings sound better than digital, and you'll find few engineers who will contest the tremendous flexibility, ease and speed that recording to a digital audio workstation (DAW) affords.

The benefits of tracking to a DAW are perhaps no more compelling than when recording vocals. After capturing several takes, a composite lead vocal and background choruses can be quickly assembled in a drag-and-drop jiffy. Ear-bending vocal lines can be auto-tuned to sweet perfection in a snap. And, an untrained singer's wildly fluctuating dynamics can be readily reined in by plug-ins such as Waves' C4 Multi-band Parametric Processor or the frequency-morphing Arboretum Systems' Ionizer.

With all of this power available to the digital devotee, the question becomes how much should you process the vocal performance before it hits your

A/D converter vs. afterward? Here's a hint: If the ubiquitous DAW is the solution to all production needs, trade shows wouldn't be filled to the gills with analog outboard gear. But they are.

*Mix* interviewed three top-drawer engineers—Marc DeSisto, Sylvia Massy Shivy and Dave Ogilvie—to learn how they record vocals to DAWs, and chat about signal processing and engineering techniques on both sides of the A/D. (See "Workstation Wizards" for their credits.) In some respects, tracking vocals to a DAW motivates profound changes in the way these engineers work *vis a vis* working with analog tape. In other ways, it makes little or no difference at all.

#### THE SONG REMAINS THE SAME

Whether committing vocals to an analog or digital medium, Ogilvie says that his choice of microphones has never really changed. "My standards are Shure SM7 and SM58s, AKG 414-TLII and C12, and [Neumann] U47s."

That said, Ogilvie notes that "the SM7 gets more action out of plug-ins. That is, when you start playing around with plug-ins [on a vocal track recorded with an SM7], the effect seems to be more extreme. The SM7 is kind of a narrow-band mic, so the vocal really comes through quite easily in a mix without having to work as much to bring it out. I end up using the SM7 and SM58 quite a bit in the

industrial rock world."

Massy Shivy's tastes in vocal microphones are equally eclectic, ranging from the tube U47 to the AKG C 1000 and Shure SM58.

With the exception of the Neumann M149, DeSisto turns to vintage mics—citing the FET 47, Telefunken 251 and Neumann U67—to "round off [the sound] a bit before it gets to Pro Tools." DeSisto's focus while tracking vocals is largely on getting a unique and striking sound vs. something more transparent. "I own a Universal Audio 2610 mic pre because it actually has a sound," he remarks. "It's really wonderful. I don't want to buy something that's transparent because, it's like, 'Okay,

what is it doing?' I like something that actually has a sound."

Massy Shivy and Ogilvie have similar tastes in mic pre's. Massy Shivy gravitates toward using "older Neve mic preamps" and, occasionally, the Telefunken V72. For recording loud rock vocals, Ogilvie specifically likes the Neve 1063 and 1081 mic preamps, in part because of their versatility. "If I want more or less distortion," he says, "one step on the Neve [gain control] is almost like a completely different picture."

**By Michael Cooper**



## COLOR MY WORLD

All three of the engineers interviewed prefer to use analog rather than digital EQ on vocal tracks. "[Analog EQ] gives it a little better color," Ogilvie asserts. Massy Shivy finds that "digital EQs allow you to pinpoint certain frequencies if you're trying to repair a track, but I always go for the analog EQ, whether it's a [Neve] 1073 or a 1081. I like the tonality and the simplicity." DeSisto relies on his Pultec or analog console for EQ duties.

Although they all generally shun using a DAW's EQ plug-ins on vocals, they differ as to how much analog EQ they're likely to use while tracking. DeSisto doesn't like to use a lot of EQ when recording vocals because it makes it hard to match up vocal punch-ins later on in the process. He'll typically use a Pultec to "attenuate maybe 20 or 30 cycles a little bit to pull out the rumble that's in the room, so that the [downstream] compressor isn't seeing any of that low-end stuff. And I might boost a little [with shelving EQ] at 10 kHz." If the singer wants to hear his/her vocals sound exceedingly bright, DeSisto will simply add EQ in their headphone feed only.

Massy Shivy is less reserved when adding EQ to DAW-bound vocals. "I'll definitely EQ [before hitting the computer]," she states emphatically. "I'll make sure it has enough richness and isn't too thin. I'll typically add a bit of lower mid and some sizzle on top. I prefer to have everything recorded as close to the sound I'll want at mixdown so that while we're monitoring during recording, we're hearing as much of the final picture as possible. I don't want to wait until the mix to find that sound. I like to record it initially."

If Massy Shivy's motto is "damn the torpedoes," then Ogilvie's is "hold your fire!" "To get the sound I want on vocals," he says, "I rely on the combination of the mic, the preamp and the compressor, and I try to avoid EQ. I don't EQ going into the computer ever. I will a bit on the end, but it will generally be in the analog domain [with an analog console at mixdown]."

"I'm really not a fan of EQ'ing the hell out of vocals," Ogilvie continues, "be-

cause I find it changes a lot of things that you didn't want it to change. Also, the singer is adapting to what they're hearing, so they're almost singing along with how it's being processed. If you change the track afterward with radical EQ, all of a sudden, it's almost like a different performance. The processing I would do on it later would likely be compression and [time-based] effects, as opposed to EQ."

## PUT A LID ON IT

Though our interviewees had disparate preferences for when and how much to EQ vocals, they were virtually in harmonic convergence on the subject of when to compress. They all voiced a strong predilection to using analog compressors on vocals *before* they reach the DAW.

"I'll do quite a bit of compression before I go in [the computer]," Ogilvie notes. "I'll do as much as I can to get it as hot in

to the digital realm without any clipping whatsoever." Ogilvie usually turns to a vintage LA-2A, Fairchild 670 or an out-board SSL compressor (the rackmounted version of the master-bus compressor) for vocal dynamics processing. For more extreme compression, he regularly calls on the Empirical Labs Distressor.

DeSisto also always used compression when tracking vocals to a DAW, preferring to use a Fairchild, a Distressor, an 1176 or an LA-2A. He notes that he can compress a vocal, say, 10 dB with a vintage LA-2A, "and it's just fine. It's okay, don't worry, f\*\*\* the meter. We're in this to listen. Always use your ears, always trust what you're hearing."

Ogilvie agrees, adding, "If you're listening to it super-loud over the mix, you might hear it and go, 'Whoa, it's too much.' But then when you set it back in its proper perspective, it could be right on."

## WORKSTATION WIZARDS

After years of recording engineering in his Boston hometown, **Marc DeSisto** moved west to Hollywood in 1984 and eventually wound up as a staff engineer for A&M Studios. In addition to working on U2's *Rattle and Hum* (Island, 1988), while at A&M, DeSisto engineered, mixed or co-mixed a variety of projects by Don Henley, Cutting Crew, Belinda Carlisle, Suzanne Vega, Patti Smith, Amy Grant and Lone Justice. DeSisto moved on from A&M in early 1990 to work as an independent producer/engineer, and has since amassed a colorful list of rock and pop credits, including projects with Chris Isaak, Michelle Branch, Stevie Nicks, Lindsey Buckingham, Joe Cocker and Spinal Tap. DeSisto was nominated for a Grammy in 2000 for his work on Melissa Etheridge's *Breakdown* (Island, 1999).

**Sylvia Massy Shivy** started engineering in San Francisco Bay Area studios in 1983 before moving to L.A. in 1988. She assisted at Lionshare in Hollywood in 1989 before settling in for a three-year stint as a staff engineer at Larrabee Sound in West Hollywood from 1990 to 1993. While at Larrabee, Massy Shivy produced, engineered and mixed Green Jelly's Platinum album *Cereal Killer* (Zoo, 1993). Working as an independent since 1993, Massy Shivy has racked up a diverse list of credits, including projects with R.E.M., Red Hot Chili Peppers, Tool, System of a Down, Powerman 5000, Johnny Cash and Tom Petty & The Heartbreakers. Massy Shivy opened Radiostar Studios in Weed, Calif., in 2001, and now does all of her producing and engineering there. Recent projects at Radiostar include Lollipop Lust Kill, Seven Mary Three and Acroma.

**Dave "Rave" Ogilvie** began his recording career working as an engineer in Vancouver's Mushroom Studios in 1984. It was his producing, engineering and mixing for Nettwerk's industrial goth band Skinny Puppy that brought Ogilvie to the attention of Nine Inch Nails' Trent Reznor in 1994. Reznor subsequently chose Ogilvie to co-produce and engineer Marilyn Manson's *AntiChrist Superstar* (Nothing/Interscope, 1996), which went Platinum. Ogilvie has since mixed or remixed projects by David Bowie, Mötley Crüe, Killing Joke and many others. The seasoned rock producer/engineer recently finished working with Dead Relative (Island) and is currently working on Zack de la Rocha's solo album.



less ohms.  
more aahs.

K240 STUDIO HEADPHONES



A Harman International Company

K141 STUDIO HEADPHONES

AKG's K240M and K141M headphones are industry standards. Now, the newest members of AKG's legendary headphone family have arrived, the K 240 Studio and K 141 Studio.

Our new XXL transducer offers stunning frequency response, 55 ohm impedance provides louder and better sound than ever before, and a plug-in cable makes storage and field service simple. Want to know more? Visit an AKG dealer today and register to win free AKG gear at [AKGUSA.com](http://AKGUSA.com).

AKG Acoustics, U.S. / 914 Airpark Center Drive / Nashville, Tennessee 37217  
Ph: 615-620-3800 / Fx: 615-620-3875 / [akgusa.com](http://akgusa.com) / [akgusa@harman.com](mailto:akgusa@harman.com)



stuff I have done at 96 kHz sounds great, I don't know how much of a difference it really makes for the style of music I mostly do." Ogilvie prefers to work at 48kHz sampling rate instead of 44.1 kHz

because the ADC's filters are placed further out of harm's way at the higher rate.

A big fan of Apogee AD8000SE and PSX-100 converters, Ogilvie opts to keep the Soft Limit function for those units turned on. "There's nothing worse than getting a great performance ruined [by digital overs]," Ogilvie explains. "I'm willing to sacrifice what Soft Limit does in exchange for protection." He uses the Digidesign 192 Digital I/O to bus digitized tracks into either a Pro Tools|HD system or into Logic Audio, because Logic has the ability to automate multiple plug-ins easily. "If you tried that in Pro Tools, there's

no way [it would work]," he asserts.

DeSisto is also a fan of the Apogee AD8000 but prefers to turn off Soft Limit. Both he and Massy Shivy work strictly in Pro Tools; Massy Shivy typically uses the Digidesign 888 I/O as a front end for a Pro Tools MIXPlus system.

I prefer to have everything recorded as close to the sound I'll want at mixdown so that while we're monitoring during recording, we're hearing as much of the final picture as possible. I don't want to wait until the mix to find that sound. I like to record it initially.



PHOTO: LJ PHILIPS

—Sylvia Massy Shivy

# TANNOY

INCREASED IMMEDIACY  
 EXTENDED HIGH FREQUENCY  
 NATURAL AND TRUE TO LIFE  
 WIDEBAND™ TECHNOLOGY

## SuperTweeter™ ST100

The Tannoy SuperTweeter™ is designed to provide the extended high frequencies demanded by modern program material and sources such as DVD, SACD and DVD-Audio. It not only resolves the fine detail of high frequency notes, but also effectively enhances the listening experience at lower frequencies. Music contains transient information and rich harmonics beyond the range of human hearing for pure tones. Even low frequency notes have leading edge transients reaching 30 kHz. By operating between the roll-off point of your existing speakers and 54 kHz, the SuperTweeter™ will accurately reproduce the leading edge individual notes, allowing the listener to experience the full bandwidth of the musical instruments and effects.

The SuperTweeter™ has been designed to match a wide range of modern loudspeakers, matching sensitivities of 87 dB per Watt @ 1 meter to 95 dB per Watt @ 1 meter. Crossover frequencies of 14, 16 or 18 kHz can also be selected.

The addition of the SuperTweeter™ to any loudspeaker system provides increased impact, airiness and improves system imaging - making music sound more natural and true to life.

**SuperTweeter™** | **WIDEBAND™ TECHNOLOGY** | [tannoy.com](http://tannoy.com)

TANNOY NORTH AMERICA INC. • TEL: (519) 745-1158 • FAX: (519) 745-2364 • DEALER FAX: (800) 525-7061  
E-MAIL: [INQUIRIES@TANNOYNA.COM](mailto:INQUIRIES@TANNOYNA.COM) • LITERATURE REQUESTS: [LITPLEASE@TANNOYNA.COM](mailto:LITPLEASE@TANNOYNA.COM)

#### YOU MOVE ME

Once inside the computer, vocal tracks can be spruced up using the DAW's powerful editing capabilities. This is especially helpful when dealing with background vocals.

"I just love doing vocals in digital," Massy Shivy enthuses, "because it's so much easier to comp. On choruses, when I double and triple and quadruple or add harmonies in a big slab, I'll look at the waveform and make sure that all of the words start at the same time and end at the same time so that the consonants—the 't's, for example—all line up. You can make those backing vocals sound so tight."

If any consonant is not time-aligned with its iteration on another track, Massy Shivy will "chop it up and move it, and then I'll stretch between to make up the space." For example, if she moves a consonant later in time, she'll then edge-edit the consonant to reveal its preceding vowel and stretch the vowel earlier along the timeline until it adjoins its original ut-

# WAVES CREATIVE INNOVATION

## NEW! VERSION 4

# X

Built for Mac OS X

### FULL LINE SUPPORT



**NEW!**



For more than a decade countless top engineers, award winning producers and musicians have been depending on Waves to create their sound. From high end Pro Tools|HD systems, to cost effective native audio tools, Waves has the superior audio tools for the job. It's true now more than ever.

### RENAISSANCE MAXX CLASSIC SOUND - INTUITIVE CONTROL

Our most widely acclaimed audio processors offering unparalleled audio accuracy are now brought together in a 7 processor package.

- NEW! Renaissance Channel Processor
- Includes: Renaissance Compressor, EQ, Reverb, Bass, VOX, De-Esser
- Rich, Smooth, Transparent Sound

### RENAISSANCE CHANNEL THE ULTIMATE CHANNEL PROCESSOR

Featuring: vintage modeled EQ and compressor, selectable EQ/Dynamics order, side-chain routing and filtering, true double precision, and much more. This processor takes the concept of channel insert to the limit and beyond.

- Intuitive "Classic" interface
- Total Setting Control
- Full Channel Functions



11800 Woodloch Forest Dr., Dallas, TX 75244, phone: (972) 465-1646, fax: (972) 465-1036  
Waves & Secret Algorithms, Ltd. 11111 Canyon Blvd., Suite 1111, Knoxville, Tennessee 37937, phone: (865) 528-3111, fax: (865) 548-3445  
14 day demo available at your waves dealer or at [www.waves.com](http://www.waves.com)



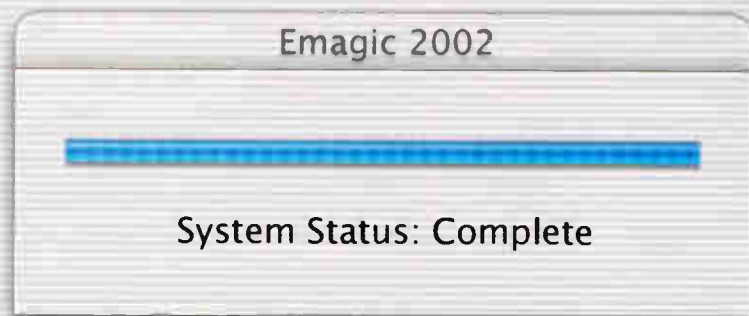

Creative music production today has its own special requirements. Fast, modern equipment. A stable, reliable working environment in which to use powerful, integrated tools. Open standards and easy compatibility.

In 2002, Emagic was proud to be the first manufacturer to deliver a complete music production system for Mac OS X, the modern operating system that more than meets these needs. A comprehensive studio solution centered around Logic, the renowned audio and MIDI production software. With over 50 integrated

emagic

Logic system

Music Production Software

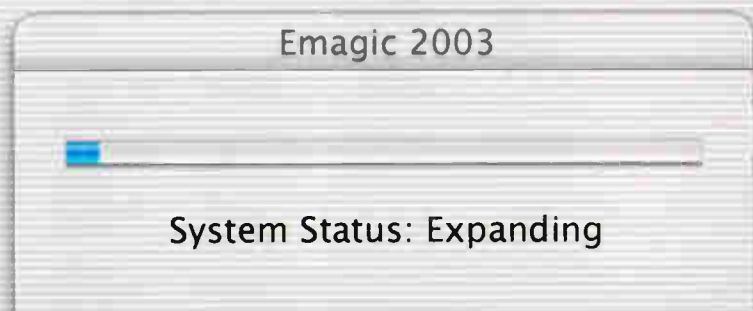

effect plug-ins in Logic Platinum, plus support for Emagic's extensive range of optional Software Instruments, Logic is the preferred choice of more successful international music and audio professionals. Not only software, but also a complementary range of Emagic MIDI and audio hardware interfaces is available for Mac OS X.

Emagic's creative audio tools can be customized to reflect and enhance the individual working methods of each and every user. Having already earned an enviable reputation for unmatched innovation and quality, Emagic will continue to show the way forward in 2003. New products, new features and new refinements to further expand the music making experience.

Technology with soul.  
World Radio History



# VIRTUAL INSTRUMENT

# Plug-ins

by Randy Alberts

Today, there seem to be as many virtual instrument plug-ins as there are guitars, synths, vocoders, basses, string sections and electric pianos to emulate. Need a classic synth or a keyboard for a session but can't afford the vintage price or drifting oscillators? Just pull one down with the mouse. If that's not enough polyphony for the job, you can pull down as many as your CPU can support.

Keeping track of new plug-ins can be a full-time job. Dozens of manufacturers now offer hundreds of plug-ins that can produce thousands of effects, from relatively straightforward EQ and dynamic control to massively complex reverb algorithms and multidimensional spatial manipulations. *Mix's* last two plug-in roundups (see the November 2001 and September 2002 issues) were pretty comprehensive, but for this survey, which concentrates on "virtual instruments," we found another 52 new or significantly upgraded products that were introduced in 2002.

Access Music ([www.access-music.de](http://www.access-music.de); [www.digidesign.com](http://www.digidesign.com)) released the new Virus Indigo TDM Synthesizer Plug-In, priced at \$795. (Registered Mac and PC Virus TDM users can upgrade for \$95.) Virus Indigo's parameters can be manip-

ulated via the GUI, Digidesign's Pro Control and Control|24 control surfaces via Ethernet, or with a hardware synthesizer controller. Taking advantage of the higher resolution and increased voice count of Digidesign's Pro Tools|HD workstations, Virus Indigo TDM replicates the award-winning sounds of the Virus hardware synthesizer family with four oscillators per voice and 20 available voices, dual six-pole filters and up to eight multitimbral parts per DSP.

If you're better at humming a melody than playing it on a synth, check out Antares Audio Technologies' ([www.antarestech.com](http://www.antarestech.com)) kantos 1.0 Audio-Controlled Synthesizer (\$299; DirectX, MAS, VST, RTAS). Controlled by any pitched monophonic audio signal, such as a voice or a trumpet, the dual-platform kantos analyzes incoming audio and instantaneously extracts pitch, dynamics, harmonic content and formant characteristics from the information to control the kantos sound engine. This unique plug-in's harmonic resynthesis capabilities can impose the melodic gestures and the actual lyrics of a song onto the synthesized sound. Included are dual wavetable oscillators with pitch constraint and quantization controls; three resonant multimode filters; two en-

velope generators and LFOs; and kantos' one-of-a-kind Timbral Articulator module, which takes the harmonic content and formant information from an input signal and dynamically applies it to the synthesized signal to produce traditional—and not so traditional—wavetables. Additional wavetables will be made available for download from the Antares Website, and custom wavetables can be created with pretty much any audio or sample editor.

Remember that beat-up '73 Fender Rhodes the roadie spilled beer on during a soundcheck at The Fillmore? Applied Acoustics Systems ([www.applied-acoustics.com](http://www.applied-acoustics.com)) has modeled it and dozens of other vintage electric pianos in Lounge Lizard EP-1 (\$199; PC/Mac, VST, DXi, MAS, DirectConnect). Working both as a plug-in and stand-alone, the Lizard is laid out like a hardware desktop beat box with rotary virtual knobs for controls over mallet stiffness and force, tine decay and tone, and pickup position symmetry and distance. If that's not enough to faithfully model that trusted beer-soaked Rhodes, the engineers at Applied Acoustics Systems included a way for users to change the material used for the hammers, as well. Lounge Lizard works on Windows 95/98/2000/XP and Macintosh 9.2 systems



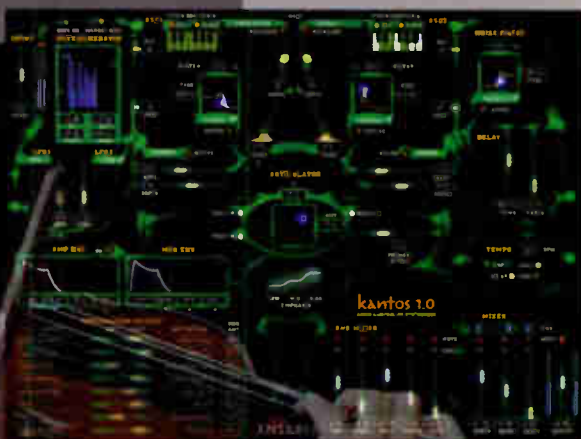
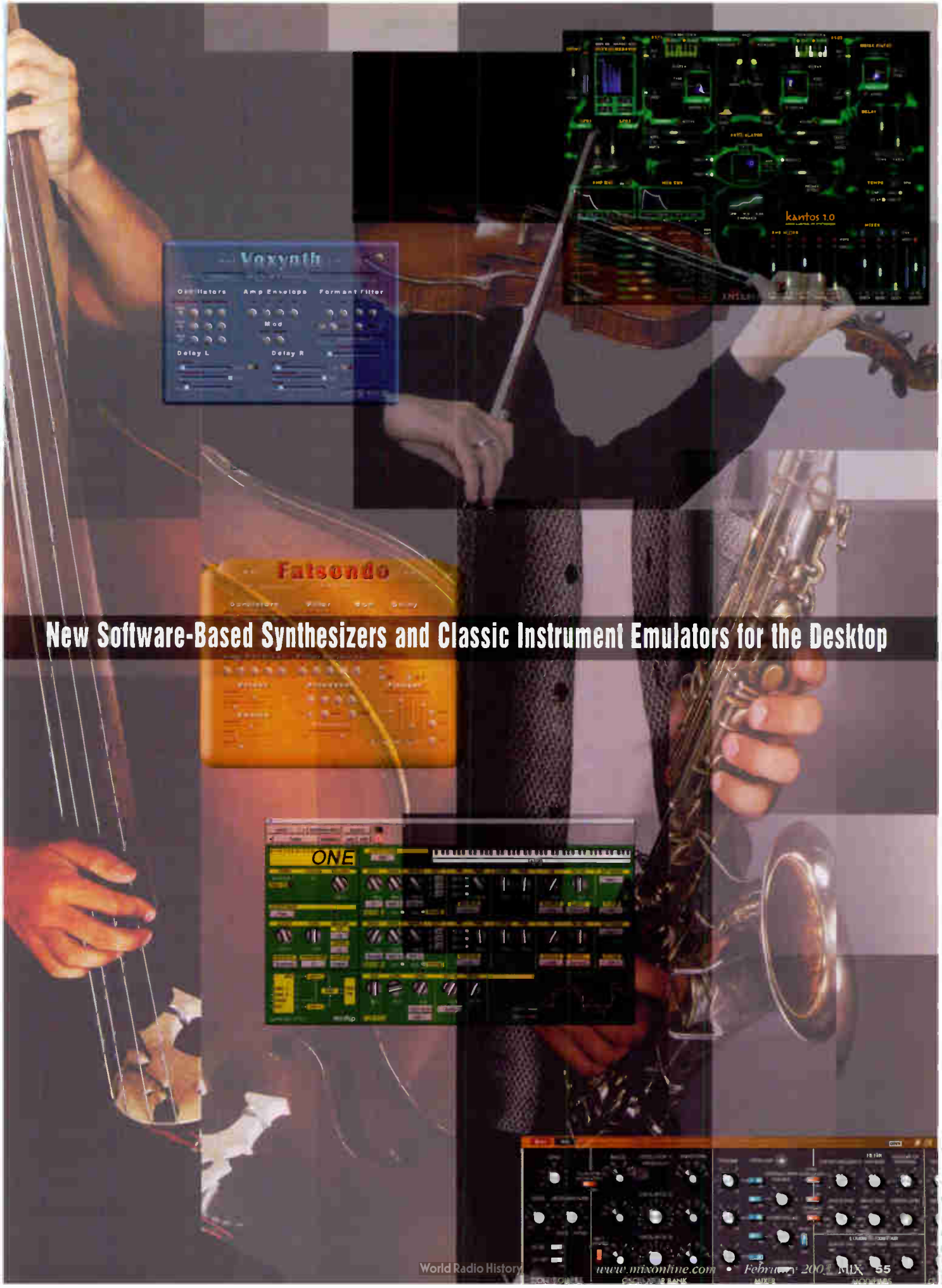

# New Software-Based Synthesizers and Classic Instrument Emulators for the Desktop

# VIRTUAL INSTRUMENT Plug-ins

Arturia's ([www.arturia.com](http://www.arturia.com); [www.thinkware.com](http://www.thinkware.com)) Storm 2.0 release added support for Mac OS X and Windows XP operating systems, online collaboration and file sharing, and a new software synth to this impressive set of easy-to-use music and recording tools. The Storm Music Studio now comes with 13 virtual instruments and also includes the new Shadow virtual analog polyphonic synth. Based on subtractive synthesis, the VST Instrument plug-in Shadow emulates the sounds of famous hardware synthesizers made in the '80s without sampling and continuous switching between the waveforms without aliasing. Eight-note polyphony, two oscillators, a noise generator, and a multimode filter with highpass, lowpass, bandpass, notch, bell (12 dB/octave two-pole) and hyper-resonant analog filters (24 dB/octave, four-pole) are included with Shadow. Two programming modes are provided: 100% manual or assisted for automatic note correction. And, like other Storm modules, Shadow can be played as a VST Instrument through the Storm Studio (within Cubase VST and Logic Audio).



CreamWare Minimax

Announced last year, Universal Sound Bank's hybrid UVI (Universal Virtual Instrument) plug-in format for VST, MAS and RTAS users has since been well supported by other plug-in manufacturers. Big Fish Audio ([www.bigfishaudio.com](http://www.bigfishaudio.com); [www.plugsound.com](http://www.plugsound.com)) added four of its USB Plugsound volumes to the growing list: Keyboards Collection, World of Synthesizers, Drums & Percussion, and Hip Hop and R&B Toolkit (\$99/each; Mac/PC). Large sound libraries come with each volume, and, most important, MIDI provides access to the sounds, which can be played and modified within your digital audio workstation's GUI. Keyboards Collection offers 256 presets and over 3,000 samples of acoustic and electric pianos, clavinetts and organs. Acoustic pianos in classical, jazz and pop styles and a best-of selection of famous electric pianos from the past are well represented. A new

Release Trigger feature makes for more convincing recreations of harpsichords, and users can now control every UVI knob and slider via MIDI. World of Synthesizers offers a variety of analog, digital, virtual analog and plug-in synthesizer sounds, and Plugsound Volume 3 Drums & Percussion brings a host of acoustic and electronic drum kits to the desktop with more than 60 percussion instruments such as congas, djembe, bongos, darbukas, Brazilian berimbaus and more. Finally, Hip Hop and R&B Toolkit offers 647 presets using more than 1,500 samples. This collection of loops, kits and multisampled instruments was initiated by longtime R&B programmers.

Adding to the company's AS-1 and DS-1 line, BitHeadz ([www.bitheadz.com](http://www.bitheadz.com)) beefed up with Unity Session Digital Studio (\$649; Mac MAS, VST, RTAS, DirectConnect, Pro Tools|HD) this past year. Releasing six content titles for the Unity and Phrazer platforms, BitHeadz now gives Unity Session up to 256-note polyphony and FreeMIDI, PC300, OMS and OS X support. Users can assign two MIDI and two audio effects per channel in session and assign two send effects and two global effects on master outputs. A built-in sample editor includes a Stereo Record function with gain and DSP function controls. The Unity Session synthesis engine includes three stereo oscillators and two stereo filters per voice and an 8-octave range per oscillator. Users can play samplers, synthesizers and physically modeled synths at the same time. File support includes 24-bit GigaSampler, Retro AS-1, Unity DS-1, Sound Designer, .AIFF, SampleCell II, DLS, SoundFont 2.0 and .WAV; and included content with Unity Session Digital Studio are Black & Whites, Pop Drums, Orchestral Strings and a large number of factory AS-1 and DS-1 programs.

Cakewalk ([www.cakewalk.com](http://www.cakewalk.com)) is now distributing DXi software synthesizers from rgcAudio. Triangle II DXi (free)



Ediol HQ-OR Orchestral

# the professional platform **for audio**



**Today's industry standard music and audio production environments are software based. These products are now commercially proven by the world's leading producers and sit at the heart of today's premier facilities.**

But historically these software DAWs have been run on off-the-shelf computer hardware conceived for other purposes.

Enter Carillon. Our AC-1 is the world's only computer designed from the ground up for audio and has been adopted by a long list of industry users from Sir George Martin's Air Studio's to legendary film composer Hans Zimmer.

Our new Intel® Xeon™ powered large frame AC-1X has been specifically developed to provide commercial users with an unparalleled combination of reliability and power that is consistent with their overall audio investment.

The benchmark platform for professional audio.

## nuendo solutions



Nuendo's host based DAW features broadcast standard audio, totally comprehensive editing and integrated surround sound all coupled with MIDI and Virtual Instruments from the industry experts. Carillon Nuendo systems are tried and tested in the most demanding environments. Spec your own or choose one of our recommended configurations.



Professional  
AC-1X  
solutions  
with the  
Intel® Xeon™  
Processor

 **Carillon**

**866-4CARILLON**

(866-422-7455) email: [info@carillonusa.com](mailto:info@carillonusa.com)  
To order online and for full details on all of our systems,  
features and Pro Users visit us at.

**[www.carillonusa.com](http://www.carillonusa.com)**

Patent Application Nos US 09 909,130 CE 01306246.8 GB 0018000.0

# VIRTUAL INSTRUMENT Plug-ins

is a sequel to the company's monophonic Triangle synth, but the real news is rcgAudio Pentagon I (\$99; PC VST 2.0), which runs natively under Cakewalk's Sonar platform. With the Pentagon's facade offering one of the more serious banks of control knobs in town, it's no wonder that rcgAudio and Cakewalk target this for synth players and sound designers. Four fat oscillators, 13 alias-free waveforms and a noise generator per oscillator make shaping just about any sound possible, and the Pentagon's user-loadable waveform slots operate in both simple cycle and full-range modes. Over 50 synthetic and vintage wavetables are included, as are 64-voice polyphony with polyphony limiter and intelligent voice allocation. The Pentagon's built-in effects section includes four filter level effects, six modulation effects and an amp/cabinet simulator with 19 configurations modeled. Pentagon I DXi now offers full MIDI automation support, as well.

If you've ever built a synthesizer or dreamed of doing so, CreamWare's ([www.creamware.com](http://www.creamware.com)) Modular III Modular Synthesizer System (\$249; PC/Mac) lets you do it virtually. Offering all of the company's Modular Synthesizer V2's features, Modular III goes on to include more than 70 new modules, 25 ready-to-use synthesizer patches and the new Modular Remote Control, which allows even novice synth programmers to use and edit even the most complex modular synth patches with a simplified control knob interface. Anywhere from four to 16 freely selectable patch parameters can be con-



Ilio Trilogy

trolled remotely from the MRC window, and users can import any graphic file in the bitmap (BMP) format to create custom skins. The newly added modules bring the Modular platform to a whopping 220 and include new drum, mix and gain, filter, OSC, sampler, sequencer and effect modules such as 48dB high/lowpass filter, quad crossfade, vocoder synthesis and unipolar to bipolar. Built to Hollywood movie composer Hans Zimmer's specifications, Modular III requires CreamWare's Luna II, PowerSampler II, Pulsar II, PowerPulsar or SCOPE/SP. Also new from CreamWare is Minimox (\$245), a complete emulation of the legendary Minimoog. The company claims that its software emulation achieves a 1:1 ratio in emulating the Minimoog's sonic characteristics.

Cycling '74's ([www.cycling74.com](http://www.cycling74.com); [www.pluggo.com](http://www.pluggo.com)) Pluggo 3 (\$199 Mac; \$59 upgrade) is out, and included with it now are 19 Essential Instruments, some designed by eowave, makers of iSynth (distributed by Cycling '74.) Several components from the latter soft-synth system (see September 2002 *Mix*) that are now included with Pluggo 3 take full advantage of the company's new and improved Max4/MSP2 audio-programming environment. Additive synths; analog-modeling

drum and percussion synths; sampling, granular, FM and wavetable synthesis; and wave-shaping tools are included, such as Flying Waves (virtual Theremin), Analog Percussion, Additive Heaven and Harmonic Dreamz. The latter is an additive synth that exposes the first 16 partials of a primary tone and includes a random detuner, a tremolo system (with both LFO and audio-rate oscillation) and an amplitude envelope for sound

shaping. Pluggo 3 supports RTAS, MAS and VST plug-in formats.

Eidirol ([www.edirol.com](http://www.edirol.com)) followed its HyperCanvas, Super Quartet and Virtual Sound Canvas plug-in family releases with HQ-OR Orchestral (\$385; PC/Mac, VST, DXi). Like working with any easy-to-use general MIDI module, Orchestral provides screens to adjust chorus, select sounds and pan instruments with a nifty visual pan display. Premium acoustic sounds in this package put the focus on strings, woodwinds, brass, percussion and keyboards and includes Cakewalk's Music Creator 2002 software. Sixteen-part, 128-voice polyphony and up to 24-bit/96kHz compatibility are offered in addition to over 350 preset and user patches and 39 drum kits. Samples include realistic articulations such as vibrato, spiccato, pizzicato and tremolo.

Emagic ([www.emagic.de](http://www.emagic.de)), now owned by Apple Computer, added the EVB3 (B3 emulations) and EVD6 (clavinet D6) plug-ins early last year to the company's growing list of soft instruments and now releases two more. The ES2 Emagic Synthesizer (\$247) adds even more punch to its predecessor, the ES1, with up to 32 voices per instantiation, intelligent, random sound programming with adjustable intensity and destination, and built-in modulation and distortion effects. Three oscillators per voice and 100 digital waveforms plus noise round out the ES2's sound-shaping tools, as do dynamic wavetable scanning via freely selectable modulation sources. Emagic's EXS24 mk II (\$499) now supports VST 2.0, offers 32-bit processing and reads its native sample format and SoundFont2 and Akai S1000-3000 files. Improvements on the original EXS24 include a better-sounding multi-mode filter, three LFOs, a new user interface and a completely flexible modulation system that can route from any



Waldorf D-coder for TC Works

# Digital Workstation?

## Analogue Partner



"I had been looking for mixers for about the last three years, trying to make the decision whether or not to go digital or try to look around for an analog console. The Media 51, especially the 60-input version, was exactly what I had been looking for."

Malcolm Harper  
Reel Sound Recording  
Austin, Texas



"The idea was to have the sonic quality of AMEK but also have it chat at a high level with Pro Tools so that I could get the best of both analog and digital."

George Petit,  
Walkerecording Ltd.,  
New York City



"The average project that walks in here is over 40 tracks. We do a lot of RGB and hip hop, and vocal layering is thick, and you've got sometimes three or four low-end instruments that you have to somehow blend in. So they have to bang."

Kevin Bomar  
South Coast Recorders, Texas

## Ensure you get the best of both worlds

While your DAW can do all the editing you want, you know that to get the signals into it faithfully and with the best results the *only* answer is analogue.

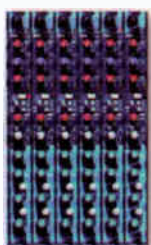

Media 51 features the classically inspired Mr. Rupert Neve designed Mic pre and EQ, so you *know* you can rely on them to bring your sounds clearly into the digital domain.

Then you can edit in total confidence that you are working with the highest quality source signals, and that your final mix will be just what you wanted.

Various frame sizes up to 136 inputs on mixdown mean you're unlikely to run out of inputs. Add Amek's acclaimed Supertrue™ automation for smart mixing, integrated 7.1 monitoring and 5.1 format mixing capability with optional motorized joystick and you're ready to mix with the best.



### US Headquarters

1449 Donelson Pike  
Nashville, TN 37217  
Tel: (615) 360-0488  
Toll Free: (888) 286-9358  
Fax: (615) 360-0273  
Email: amekusa@harman.com  
Web: www.amek.com

**H** A Harman International Company



**London**  
+44 (0) 1707 665000



**Nashville**  
+1 (888) 286 9358



**Tokyo**  
+81 3 5606 3101

YOU WANT TO BE ABLE TO MIX YOUR DRUM TRACKS THE WAY YOU WANT. YOU WANT REAL DRUMS PLAYED BY A REAL DRUMMER. YOU HAVEN'T GOT A WORLD CLASS STUDIO. YOU DON'T WANT TO SPEND A FORTUNE.

## DISCRETE DRUMS



mixable multitrack drums & percussion

## Series Two

ACID PRO TOOLS LOGIC AUDIO DIGITAL PERFORMER CAKEWALK  
SONAR CUBASE NUENDO REASON RECYCLE ROLAND V-STUDIOS  
BOSS BR-1180 YAMAHA AW 4416 MANY OTHERS

Download demos and order at [WWW.DISCRETEDRUMS.COM](http://WWW.DISCRETEDRUMS.COM)

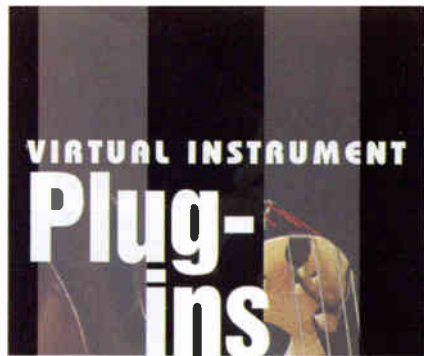

source (including sidechain level) to any target. The EXS24 mk II is a free update for existing EXS24 users and, like ES2, supports Mac OS 9.x and OS X and Windows 98SE/ME/2000/XP.

There are three new virtual instrument offerings from Ilio Entertainments ([www.ilio.com](http://www.ilio.com)) to choose from since *Mix's* last plug-in guide. The company's Spectra-sonics Stylus Vinyl Groove Module (\$299; MAS, RTAS and VST Mac/PC versions in-



Antares kantos

cluded) integrates a 3GB library of groove elements, loops and samples to the easy-to-use Plugsound interface. Over a thousand turntable tricks, skips, stops, beat juggling and scratch FX are included, as are percussion loops and over 3,000 kicks, snares, hi-hats and a built-in patch-management system to quickly find it all. R&B, two-step, trip-hop, chemical, down-tempo dub and many other styles are represented in Stylus, and each Groove Control groove allows users to independently change its pitch, tempo, feel and pattern without using up DSP power. The Atmosphere Dream Synth Module (\$399), designed by synthesist/sound designer/former Roland product developer Eric Persing, offers dynamic layering of sounds and total recall within Logic, Cubase, Digital Performer, Pro Tools, Fruity Loops and other VST-host applications. Engineered to create lush, evolving pads and textural ambient sounds, Atmosphere's multimode resonant filters per layer and master filters round out this soft-synth dream.

Also new from Ilio on the Plugsound

Total Sound Control



[www.auralex.com](http://www.auralex.com)

**Auralex Total Sound Control™ products continue to outperform much more expensive alternatives. Our industry-leading Studiofoam™ acoustical panels, bass traps, diffusers, MAX-Wall™ modular environment and a complete line of construction products to greatly reduce sound transmission and resonance can be custom-tailored to your specific needs via Personalized Consultations and advice from the experts at Auralex.**

**Don't be fooled by inferior, underspec'd, overpriced, flashy imitations! Compare the quality, quantity, variety, personal service and price...**

**Auralex Clarity: Your Studio, Your Sound, Your Choice!**

There's a new standard

in multi-channel  
high sample rate  
audio restoration  
and noise suppression

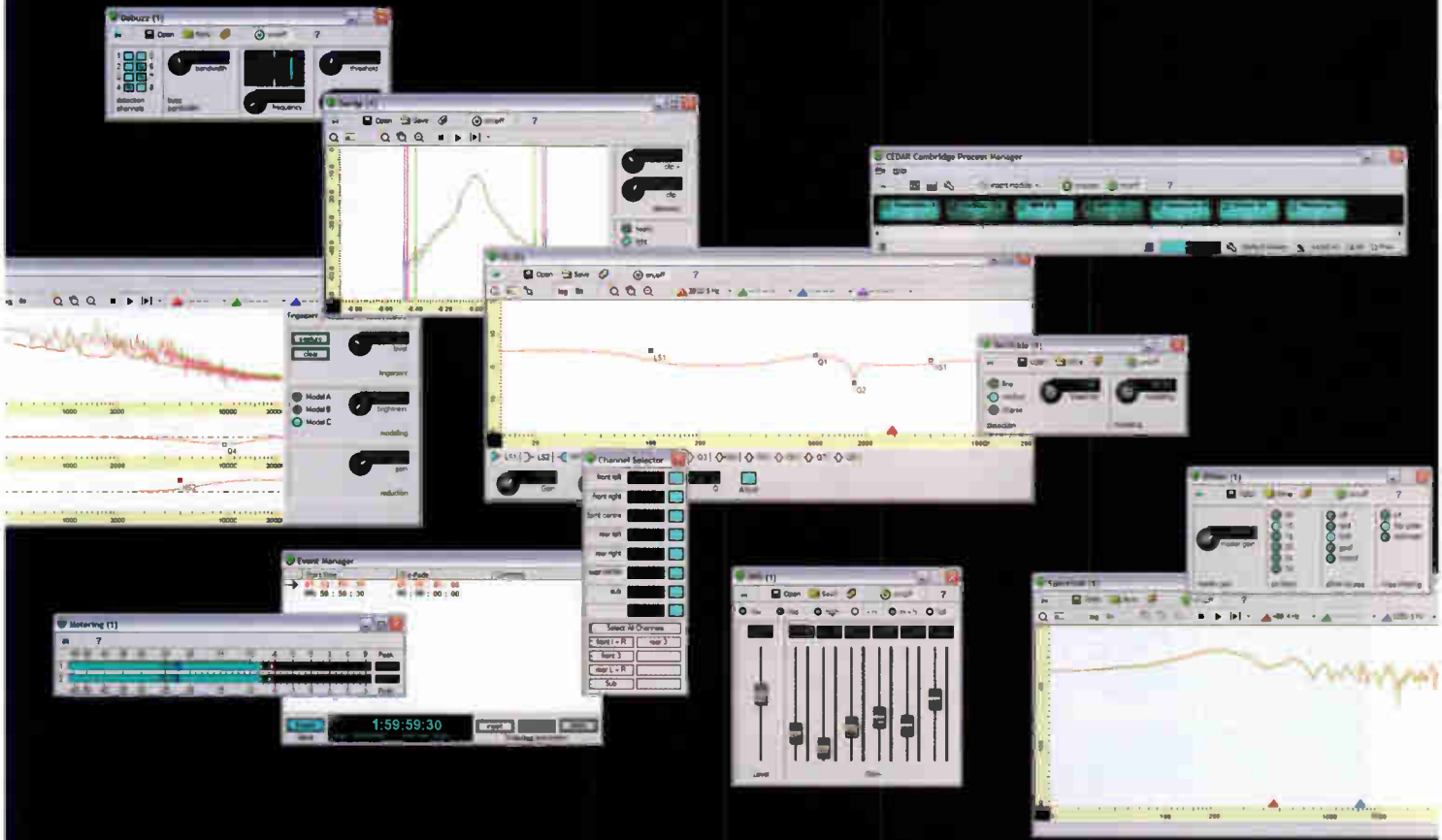

**CEDAR**   
Cambridge

IAR Proudly Unwraps  
Its Spanking New  
Program for  
21st Century  
Audio Engineers &  
Music Producers:

**AUDIO  
RECORDING  
& PRODUCTION**

900 hours  
9 months full-time  
12 months part-time

**Program Features:**

- Digital Audio & Music Production
- Recording & Mixing
- Signal Processing Technologies
- Audio Post-Production
- MIDI Applications
- DAW Operations

**INSTITUTE OF  
AUDIO RESEARCH**

Licensed by NYS Education Dept.  
Approved for Veterans Training  
Accredited by ACCSCT  
Financial Aid if Eligible

**800-544-2501**

**212-777-8550**

(NY, NJ, CT)

*Your Focus is Music,  
Our Focus is You.*

[www.audioschool.com](http://www.audioschool.com)



**INSTITUTE OF  
AUDIO RESEARCH**

64 University Place  
New York, NY 10003

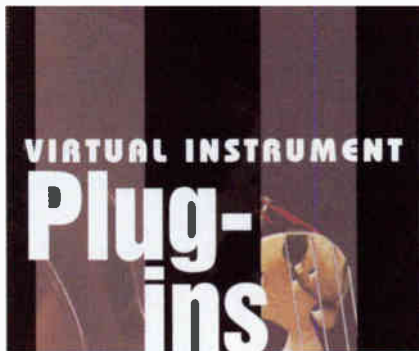

platform is the Trilogy Total Bass Module (\$399), with over 1,000 new dual-layered acoustic, electric and synth bass sounds. Achieving "cone-blowing subsonic sound," the Trilogy features eight-way velocity switching and the company's "True Staccato" sample-mapping feature for realistic repeated notes. Minimoog-style legato triggering and a built-in patch-management system are included, as well.

LinPlug Virtual Instruments ([www.linplug.com](http://www.linplug.com)) recently released Element P Percussion Synthesizer (\$39; VST) and Delta III Matrix Synthesizer (\$99; VST). The 32-voice Element P offers 172 virtual analog percussion synth sounds, eight-part multitimbral operation, 32-voice polyphony, six separate outputs and a simple interface to quickly create a broad variety of electronic drum and bass sounds. The Element's parameters can be controlled via MIDI, and full Doepfer Alpha-Dial support is included. The extendable design of LinPlug's Delta III synth currently offers three oscillators and filters, dual-envelope modules, four effect modules and is also eight-part multitimbral, each part with its own stereo output. Twenty-three filters are included, and fully recognized velocity, mono and poly aftertouch, pitch bend and mod-wheel control are supported. The full version of Delta III comes with 472 presets, and a PC or Mac LinPlug Alpha Classic Synthesizer is also included.

The McDSP ([www.mcdsp.com](http://www.mcdsp.com)) Synthesizer One (\$695; TDM Mac), the company's fifth TDM plug-in, is a potent modular wavetable, multi-mode soft synthesizer with sophisticated wave-editing capabilities. Wavetable, FM, AM, ring modulation, additive and subtractive synthesis methods are offered, and external audio can be processed and combined with synthesized sounds. Oscillator, filter, LFO and envelope signals can be routed to multiple modulation targets within Synth One, and wavetable data can be used in oscillators and LFOs or created from a suite of editing tools. ProTools|HD and Mix TDM systems are supported, as are pre-USB Macs with OS 9.0 or later.

Like LinPlug, MHC Synthesizers & Effects ([www.mhc.se](http://www.mhc.se)) is proving that \$39 buys plenty of synthesizing power these days with Mikael Hillborg's new Voxynth and Fatsondo (\$39 bundled together; VST PC/Mac). Voxynth, great to create vocal sounds or synthetic choirs, has three oscillators per voice, pitch modulation and a stereo delay, as well as a multimode formant filter to modulate via envelope or using Voxynth's performance keys. Whereas its brother Fatsondo has built-in formant filters, Voxynth offers 20 different formant filter types that are swept by the envelope or performance keys to morph between different sounds. Traditional "e", "a" and "u" formant vowels are included, as are ones that don't exist but have a vocal character and can be used to create interesting timbres. Fatsondo synthesizer is designed specifically to create—you guessed it—fat sounds. Built-in chorus, flanger and stereo delay, a polyphonic unison mode, three oscillators per voice and a resonant lowpass/highpass filter fatten up any track, but Fatsondo's polyphonic unison mode goes even further by creating as many as six or nine oscillators per voice.

Native Instruments ([www.nativeinstruments.com](http://www.nativeinstruments.com)) has added Pro-53 (\$199; Mac/PC DirectConnect, VST, MAS, DXi) and Reaktor Session (\$349) to the company's existing lineup of software instruments, which already includes Spektral Delay PTE, Kontakt, FM7, B4 and Pro-52. The latter's Pro-53 offspring, which, like other NI instruments, can also operate in stand-alone mode, is a major upgrade to this virtual Sequential Circuits Prophet-5 representation with several new functions and improvements. A new oscillator technology provides a noticeably more bril-



Serato Scratch Studio Edition





Emagic EXS 24 mk II

liant, warmer sound than the 52, and a new highpass filter mode, MIDI Learn function, invertable filter envelopes and an LFO/envelope/retrigger options add to the sound-programming mix. The Pro-53 comes with an optimized graphical interface, and 64 new sounds—programmed by synthesist John Bowen—take full advantage of these extended functions. Also new from Native is Reaktor Session, an ambitious platform that can incorporate a wide range of soft synths, samplers, resynthesizers, beat loopers, groove drum machines, surround effects, and pattern and control sequencers powered by the Reaktor engine. Users can design their own studio from pre-built instruments, and multiple instruments are easily connected

together in Reaktor session, allowing even the most complex Reaktor sessions to appear as a single plug-in in VST and Dxi host applications. As a stand-alone application, Reaktor Session supports ASIO, DirectConnect, DXi, VST 2.0, OMS and MAS on Windows 98/ME/2000/XP and Mac OS 8.6 or higher.

New to the Reason 2.0 Mac/PC platform from Propellerhead Software ([www.propellerheads.se](http://www.propellerheads.se); [www.m-audio.com](http://www.m-audio.com)) are two new virtual instruments included with this all-in-one application. Malström Graintable Synthesizer is a proprietary synth from Propellerheads that combines granular synthesis with wavetable synthesis. Users can evolve through a sound by controlling the movement with real-time controllers, velocity- and modulation-performance information and the spectral harmonics of this instrument's graintable. Both of Malström's filters have five modes including 12 dB/octave, lowpass, bandpass, subtractive and additive

comb filtering, and a shared filter envelope is also included to control either or both of the filter sections simultaneously. Dual modulators and LFOs with a wide variety of curves are available, and, when used in One-Shot mode, Malström can be synced to incoming tempo. Also included with Reason 2.0 is NN-XT, an advanced sampler featuring alternating sample playback and auto-pitch detection, Mac OS X support, a detachable sequencer and 32-bit sample support.

Serato Audio Research's ([www.serato.com](http://www.serato.com)) Scratch Studio Edition (\$299; PC/Mac RTAS, HTDM, MAS) employs a physical "virtual" vinyl LP that connects via USB, allowing turntablists to scratch any digital sample or sound file. The in-



Native Instruments Pro 53

## Hear What The Hype Is All About

The C-3 is THE HIP new guitar mic. It gives your Marshalls that phat-gut-punch we all crave. I'll never cut another record without one."

**Scott Rouse** - Producer, Grammy Nominee, Nashville, Tennessee

have a microphone "wish list". You have allowed me to check off both the U87 with the C1 and the C12 with the T3.

**Red Perlman** - Producer/Arranger/Composer  
Bob Dylan, Chicago, Kaci, 2gether, Young MC

One of the best vocal mics in the world is the \$300 Studio Projects C1. You can spend way more for one of those "mics from Germany if your ego demands it, but the C1 is certainly the sonic equivalent.

**Pete Leoni** - Producer Engineer, Tech writer and reviewer



**C1**  
Single-pattern  
Cardioid  
List \$299

**C3**  
Multi-pattern  
Cardioid, Pad, Filter  
List \$599

**T3**  
Variable-pattern  
Tube  
List \$1099

All models include shockmount and case.

StudioProjects™



**P M I**  
AUDIO GROUP

**PMI Audio Group**  
23773 Madison St., Torrance, CA 90505 USA  
toll-free 877 563 6335 fax 310 373 4714  
Visit Us Online at [www.studioprojectsusa.com](http://www.studioprojectsusa.com)



**VT-1**

Tube Mic Pre, Discreet Class A/B switching,  
with variable Tube Drive. List \$299

# Ahh



  
SE5500

Quiet. Sensitive.  
Warm. Responsive.

One position.  
\$499.

Feels so good,  
you're telling  
everyone you know.

**see electronics usa**

408-873-8606

www.seelectronicusa.com

10" GOLD DIAPHRAGM CARDIOD STUDIO TUBE

## VIRTUAL INSTRUMENT Plug-ins

cluded vinyl controller device contains a control signal that allows the computer to track record position, motion and direction of the needle, and simulate the same movement within a sound file. Scratch Live (\$599, Mac/PC stand-alone) allows turntablists to transfer their valuable vinyl to hard drive and control the .WAV, .AIFF and MP3 files in live performance.

Software Technology's (www.soft-ware-technology.com) VAZ Modular has a new stable mate in the form of VAZ 2010 (\$179; PC, VST, DXi). Used in stand-

their old Minimoogs will appreciate the new Tsunami (\$69) from Sonic Reef (www.sonicreef.com). This three-oscillator VST Instrument for Mac and Windows, which also works as a stand-alone synth, pays faithful tribute to the legend's front panel. Sixty-four-note polyphony, dual-ADSR envelope generators, a 24dB resonant lowpass filter and a noise generator are standard equipment, and although Tsunami is not multitimbral, users can load as many multiple instances of the synth as the CPU can handle. Tsunami needs a minimum Pentium II/266 with Windows 98 or an Apple G3/233 running OS 8.0 or later.

Steinberg Media Technologies (www.steinberg.net) has added two new virtual instruments and a virtual instrument "rack" to its lineup. New to the Virtual Guitarist family is Virtual Guitarist Electric Edition (\$249; PC/Mac, VST), essentially an electric rhythm guitarist and virtual ef-



Applied Lounge Lizard

alone mode, VAZ 2010 can also host other DXi and VST plug-in instruments. Each of VAZ 2010's 16 analog synthesizers include sample-playback facilities, 16 polyphonic sequencers and a 16-channel mixer. A nifty QWERTY keyboard allows auditioning of sounds when no external MIDI keyboard is around, and the 2010's three oscillators per voice, switchable audio range, ring modulation, noise generator and eight filter modes make full use of Software Technology's new Intelligent Processing System to reduce CPU drain by as much as 50%. VAZ 2010 supports MME, DirectX and ASIO and multiple soundcard outputs.

Bi-platform soft synthesists who miss

fects pedal board. Electric Edition is based on samples recorded by German session guitarist Thomas Blug and the playing styles of 30 different players from the '50s to the present. Just choose a player, select the chords, and Electric Edition creates real guitar tracks and offers countless variations based on user-selected syncopation, shuffle, dynamics, track doubling, phrasing and chord extensions. Electric Edition's virtual pedal board can also be accessed as a separate plug-in.

PLEX (\$249) is a new instrument designed by PPG synth legend Wolfgang Palm in cooperation with Steinberg. Featuring a new intelligent synthesizing

—CONTINUED ON PAGE 152

# SPECTRASONICS

VIRTUAL INSTRUMENTS

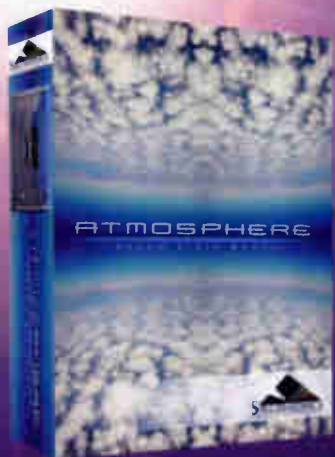

## ATMOSPHERE Dream Synth Module

- World's Most Massive Programmable Synth (over 3 gigs!)
- 1,000 cutting-edge, brand NEW sounds!
- Lush Pads, Ambient Textures, Powerhouse Synths
- Interchangeable layers for one million combinations!
- Powerful synth interface for creating your own sounds
- Designed by award winning sound designer Eric Persing
- FAST and Easy to use

\$399, All Platforms Included!  
VST- Mac/PC, RTAS, MAS

**POWERFULLY  
SIMPLE**



## STYLUS Vinyl Groove Module

- All NEW Sounds!
- Massive 3 gig core library
- Over 1,000 stunning remix grooves
- Elastic Tempo, Pitch, Pattern and Feel
- Killer live percussion
- Thousands of cutting-edge drum samples

\$299, All Platforms Included!  
VST- Mac/PC, RTAS, MAS



VST  
Instruments

RTAS

MAS  
MULTI-PLATFORM SYSTEM

Powered by custom 32 bit UVI engine.

Call or Order On-line

**800.747.4546**



**www.ilio.com**

Exclusive  
Distribution by



Software Contents are not for sale. All other trademarks and World Radio History.

# Elaine Martone

## Telarc's Classical/Jazz/Blues Chameleon

A promising oboist 20 years ago, Elaine Martone never thought or aspired to be a record producer or, for that matter, a label executive. Nonetheless, today she works closely with the top names in jazz, blues and classical music in both capacities. Her job, VP of production and A&R at Telarc Records, requires Martone to delicately balance the often-conflicting worlds of creativity and management. Fortunately, she has a knack for it and juggles the two areas quite well.

The producer/executive grew gradually into her current, enviable position. She came up through the ranks, flourishing in each position assigned, although they all differed greatly from her previous background. While growing up in Long Island, N.Y., she was cultivated in classical music mainly through her father; she discovered jazz at age 14 when she first heard her high school's big band. Both genres made strong imprints on Martone as she furthered her musical education with a B.A. from Ithaca College in upstate New York. From there, she went to Cleveland to study with the city orchestra's oboe players and had high hopes of getting into its prestigious Institute of Music (CIM).

Alas, she wasn't accepted at CIM, but around that time, she got a tip about job openings at Telarc Records. That was in 1980, and the pioneering audiophile company consisted of seven employees when she started in quality control evaluating test pressings. Most would have viewed the entry-level gig as sheer monotony. Not her. She applied her organizational abilities and whipped its master room of mountains

of misplaced and unlabeled masters into shape. Additionally, she developed a system to objectively evaluate test pressings. All the while, Martone played with the Canton (Ohio) Symphony and continued auditioning.

Martone thought the QC job would run its course in about two years and she would be in a master's program

or with a larger symphony. But a funny thing happened as Martone started to learn about the record-manufacturing operations at Telarc. "I got so involved in the musical things that we were doing here," she explains, "and because the company was so small, I really got an opportunity to contribute in a way I



never could have at a major label in New York, L.A. or Nashville." Before long, she advanced into digital editing (then in its infancy as a science/art) and was eventually brought into discussions concerning artists and marketing. She was seemingly doing it all.

When a producing opportunity arose at the label, Martone was thoroughly prepared. She was a musician, understood technical and quality criteria and had developed a heightened sense of timing for recordings through editing. In 1988, she began producing classical recordings and, in 1989, co-produced Telarc's landmark initial jazz recording, *After Hours*, featuring André Previn with Ray Brown and Joe Pass. Its success paved the way for jazz on the label, and later blues, with many recordings produced by the company veteran. Three years later, Martone established two of her most significant relationships: one with Brown—together, they created 17 stellar recordings—and the other was with Telarc president Robert Woods, who became her husband. It could be said that the record company became her family when she married him, but the company and business were in her blood long before that.

*How would you classify yourself as a producer?*

I'm not sitting in the studio with the musicians. I know there are some producers that sit in the stu-

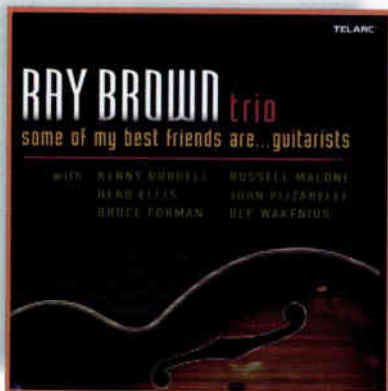

# Finally a monitor mixer for each performer



A-16  
A-Net Transmitter

A-16 Personal Mixer  
10.75 x 5.6 x 2.25"

## Introducing Personal Monitor Mixing

**On Stage** you have personal control over the mix in your monitors. Whether you use powered speakers, headphones or in-ear monitors, Aviom's Personal Monitor Mixing System allows each performer to adjust their own monitor mix settings and save multiple presets.

**In the Studio** musicians have a flexible cue system that adapts to their individual needs. Use as many Personal Mixers as required. The system is infinitely expandable.

Want to learn more? Visit our website today and take control of your monitor mix.

High-Gain Stereo Outputs • Zero Latency • Infinitely Expandable  
16 Channels • 16 Presets • Totally Cool

A-16 Personal Mixer \$439.95  
A-16T Transmitter \$749.95

### Aviom Personal Monitor Mixing System



610.738.9005 | [www.aviom.com](http://www.aviom.com)

World Radio History

**AVIOM**  
To Each His Own

dio with headphones and I call them really hands-on. That's not me. I'd say I'm a musically involved, technically aloof record producer. The most I get involved creatively is to change the arrangements a little bit: the form if too many songs are laid out the same way, or to change tempo and maybe the feel. But I'm not a composer. My thrust is musicians, but I like working with vocalists, too. I feel for them. You kind of have to "up" your game and really be very vigilant about making sure that they're communicating the song, along with the musical elements.

*Do you have a special approach to working with artists?*

My overall philosophy when I work with musicians is that I am there to serve the music and their vision of the music—whatever it takes to make them the most comfortable and get the highest-quality performance from them. As a musician, I also wanted to be treated with respect. I feel that Telarc treats these people—many among them being legends—that way. Another thing I think is important as a producer is to get out of the way. It's not about me.

**With the singer, we have the ability to do overdubs or a live take. I always prefer a live take because you get the magic. But with an overdub, you go for perfection, though you might lose the passion.**

*Does being an executive and a producer ever pose problems for you?*

The musicians with whom I deal with and produce know I'm a vice president here and I'm married to the president. So if they have something to complain about, I can actually do something about it. I think it's one of the benefits for artists working with a small company to have access to all of the people involved.

There's really not a lot of bullshit. We're really efficient in our work habits, and the artist knows that the material really does need to be rehearsed, prepared and ready to go when we go into the studio. Not that it always is, and sometimes we're working on a tune and it's just not happening. So we move on and go to the next one. Sometimes, we have to add more hours, but I've never needed another day or more.

*What recording media are you using?*

We do all of our recordings on Direct-Stream Digital (DSD), and we use the SADIE and Sonic systems along with DSD editors. We don't use Pro Tools. In the early Soundstream days, we would go to Salt Lake City or L.A. to edit where there was a roomful of hard drives. Now, we have three or four different digital-editing systems in-house, and I don't deal with any of those. What I end up doing is going in and listening at different stages of production and saying "yea" or "nay."

*Do you have any equipment preferences?*

No, I leave that to my engineers. I work mostly with Michael Bishop and with Jack Renner. I tell them what the musical needs of the session are, the instrumentation, the concept and what we're going for. Then we talk about how and where. The engineers set up the mics and the equipment, and I listen. Then I comment, and they translate my musician-ese into engineer-ese.

*Do you ever work in overdubbing/multitracking situations?*

Not really. The most overdubbing I do is for vocals. I rarely work with lots of layering and multitracking. Michael Bishop

is our expert whenever we need anything like that.

If we're recording a trio, I like for them to all be in the main room. That way, you get the best musical interaction. When you have a singer and need to do overdubs, you have to have isolation. We tend to record the trio as a unit live to 2-track. With the singer, we have the ability to do overdubs or a live take. I always prefer a live take because you get the magic. But with an overdub, you go for perfection, though you might lose the passion.

*What are your biggest challenges as a producer?*

Always getting the music to really communicate so that I'm actually moved. Because I know if I'm moved, then you, as a listener, will also be moved by what's going on. I always try to remember that music and any other art is about some



kind of communication between people. In the sterile atmosphere of a studio, it's really easy to be preoccupied with getting everything right, as opposed to getting people to hear what a musician has to say in a way that hasn't been heard before. That's always a big challenge.

*What are some career milestones?*

Working with Ray Brown has to be right up there, and hearing his stories about being on the road in the '50s, living in New York in the '60s and moving to L.A. Also, being a part of his family and knowing his wife—that's really been a privilege for me. Meeting and getting experience with Mel Tormé. Really pursuing Benny Green: I heard him play with Ray, and I think he was already signed with Blue Note. I told him how much I loved his music and that Telarc could really serve him. Meeting and working with Oscar Peterson and getting a sense of history when he and Ray would share stories. Additionally, meeting people like Freddy Cole, Monty Alexander, Joe Williams and also working with André Previn. My very first great experience in jazz was when we got to produce André Previn, Ray Brown and Joe Pass for the first jazz recording we did in '89. I brought *My Fair Lady* and asked André to sign it. He said, "Thanks for asking me to sign it 30 years later."

*Ray Brown's death must have had a big impact on you. What was he like in the studio?*

When I started working with Ray, there was no messing around. We would do two takes, and if it wasn't swinging in two takes, it would be time to move on. When he came into the studio, you were on his time. That was a great education for me, because some younger musicians like to do numerous takes. Ray taught me that when you're in a studio, it should all be worked out. Number two with him, and I absolutely love this: I remember calling him up and saying, "Ray, we're

professional training in  
**audio technology  
multimedia**

since 1976

INSTITUTES

**NEW YORK**

269 W 40th Street, New York NY 10018

Tel. **(212) 944 9121**

**NASHVILLE**

7 Music Circle North, Nashville TN 37203

Tel. **(615) 244 5848**

**MIAMI**

16051 West Dixie Highway, North Miami Beach FL 33160

Tel. **(305) 944 7494**

**Other main locations**

LONDON (0207) 609 2653 PARIS (1) 4811 9696

AMSTERDAM (020) 622 8750 SYDNEY (02) 9211 3711

MILANO (002) 8912 0540 ATHENS (01) 321 7661

BERLIN (030) 4986 0054 MUNICH (089) 67 51 67

ZURICH (01) 445 2040 SINGAPORE (65) 741 1257

AUCKLAND (09) 373 4712 STOCKHOLM (08) 730 5100

VIENNA (01) 961 0303 FRANKFURT (069) 543 262

KUALA LUMPUR (03) 724 0935 MADRAS (044) 821 4227

MELBOURNE (03) 9521 4055 FRANKFURT (069) 543 262

GENEVA (022) 800 3000 COLOGNE (0221) 954 1220

\* ALL OUR STUDENTS RECEIVE  
INDIVIDUAL STUDIO TIME!

25 YEARS

**SAE**

INSTITUTE

New  
in Miami

Sony Oxford, SSL,  
Fairlight, MFX3,  
ProTools

[www.sae.edu](http://www.sae.edu)

Programs are not offered in all locations

thinking of calling this album *Don't Get Sassy*." And he said, "Elaine, I play the bass; you make the record. You don't tell me how to play the bass; I don't tell you how to make the record." Most artists want as much control as possible, but Ray wasn't like that.

I loved working with him. One of the other great things about him was that he was always mentoring young jazz musicians. He was very generous with his time. Ray was always looking for what was the "next thing." He was always composing, thinking about concepts,

and when he came off of the road from touring, he'd call me up ready to record something. It was remarkable working with him.

**Who are some of the other special artists you've worked with?**

I've only made three records with McCoy Tyner, and he was one of my idols in college. I remember when I found out I was going to be producing his project—it was him and a Latin big band, so there were nine guys altogether. I'm 5-foot-1 and pretty little, and I was thinking, "How am I going to do this?" and I was really



scared. I'd heard that McCoy wasn't that nice of a guy. Well, that was so far from the truth! He's the most gentle, kind man and absolutely brilliant, and he's very quiet and kind of shy. Working with him was like being in the presence of absolute greatness, and I had to pinch myself because I was working with a man of that caliber.

In the sterile atmosphere of a studio, it's really easy to be preoccupied with getting everything right, as opposed to getting people to hear what a musician has to say in a way that hasn't been heard before.

I've produced one of Dave Brubeck's records, but for the most part, he has his own producer. He's also a very kind and gentle soul, and at 83 years old, he's still very creative and on top of his game. *Do you think you could be an independent producer or work for another label?*

It's hard to tell, but my gut says no. Way before I married Bob 10 years ago, my creative input counted for something. The way we run things here isn't bureaucratic, and I can't imagine that my opinions would count at another label at this stage of the game. I've had a lot of input into the creative development of the label, and specifically the production department. Also, here I can set the tone for things,

ClassicSound

New York's Premier Audio Facility

WE'VE MET THE WHOLE FAMILY

CLASSIC SOUND PRESENTS

★ "AWARD WINNING AUDIO" ★

Björk	R Kelly
The Bottle Rockets	Nelly Furtado
Yo-Yo Ma	Alice Cooper
Ted Nugent	Gangz Of NY
Ravi Shankar	Renée Fleming
Fat Joe	Urinetown
Steely Dan	Van Cliburn

Tom Lazarus  
Marc Stedman  
Joe Lambert

RECORDING, MIXING, MASTERING, & EDITING FOR ALL AUDIO FORMATS: CD, DVD, SACD, & VINYL.

211 West 61st Street, New York, NY 10023  
www.ClassicSound.com  
212.262.3300

ClassicSound



# One of the sophisticated tools we use to refurbish SSL consoles.



At Professional Audio Design we expertly refurbish, restore and upgrade SSL consoles to the highest standards. Even more reassuring, we warranty all desks we install and commission. Visit our Web site, or better yet, visit our showroom and take your pick from our in-stock SSL consoles. You'll get a classic desk for a classic price. Leasing terms are available and we also take trade-ins.



**ALWAYS A SOUND DECISION**

**North America's only authorized full service  
reseller of pre-owned SSL consoles.**

**Visit [www.usedssl.com](http://www.usedssl.com)**

Professional Audio Design  
357 Liberty Street, Rockland, MA 02370  
781-982-2600. Fax: 781-982-2610.

World Radio History

and that's very gratifying. Being an independent producer seems like an interesting balancing act between artist and record company. Although, sometimes I'm in that position with my own artists—when I have to push for something that the company isn't in favor of. I'm glad I have a home [record company].

**Are there problems being a woman and working mostly with men?**

It was more of an issue when I started, and I think it actually wasn't as much of an issue to them as it was to me. I have been concerned about it at different

points of my life, and it's currently not a problem. I'm happy to be a woman, and I'm happy to bring what I do to the table. *Is it difficult to switch between producing jazz, blues and classical?*

It's not. I switch many times during a day. For classical, the planning phase is a lot longer because you're dealing with orchestra schedules that are planned two to three years in advance. I know I'm going to be recording Mahler #3 in London at the end of January. But between now and January, there could be six new jazz projects that we plan and execute. That's

a big difference, and when we got into jazz, the lead times became a lot shorter. So the looser the musical structure, the shorter the lead time. With an opera, there might a 120-page booklet you have to put together besides the three-CD opera set. In jazz, you might call up and say, "I've got this great band playing at the Blue Note. Do you want to come record it?" That's pretty much how it went down for the first Oscar Peterson record in 1990. That happened in a week. You'd really have to move heaven and Earth to do that for classical music.

**Who influenced you as a producer?**

I think Tommy LiPuma is outstanding, and I would love to watch him work. If I could be anybody, I'd like to re-create myself as George Martin, because he was the creative producer at its finest. From my point of the view, The Beatles would have been a completely different entity without him. People call him the fifth Beatle, and what he contributed as a record producer completely changed the face of music. That's really inspiring.

**What is the most difficult aspect of producing and working in management?**

Watching the industry go through all of the changes in the past few years. Seeing really talented artists lose their contracts and what we now have to do to just stay alive. It has really been stressful, and last year was hard in terms of the world and 9/11. In the '80s, we felt like we were on top of the world, and it seemed like we could do anything we wanted to do. Then, when the '90s came in, a lot of that eroded. Now, in 2002, I'm yearning for the time when money was free flowing and if you wanted a piece of equipment, you just got it. And if you wanted to do a project, great, let's go do it! We didn't have to worry like we do now and keep all of the budgets really tight and find the least-expensive way to do the highest quality.

**What are some of your goals?**

I have to have a Grammy. I've been nominated before and would like to win one before I'm 50. I would like to see Tierney Sutton [a Telarc vocalist] really make her mark and become a household name. I'd like to expand with some younger artists and keep jazz alive and thriving. We've done a little of that with Benny Green and Russell Malone. It's a mission for us, and that goes for classical music, too. ■

Chris Walker is a contributing writer to Mix.



# 1,000 CDs in full-color jackets for just \$990

**Regularly \$1,290 – Save \$300!**

This is a complete package – not some stripped down version – with no hidden extra charges and no surprises. You'll get Disc Makers' high quality, plus our award-winning graphic design, at the lowest price anywhere. We'll also help you sell more CDs with extras like a FREE bar code, FREE worldwide distribution with CD Baby, and a FREE review of your music by TAXI.

*Limited time offer. Call for details.*

**Call 1-800-468-9353 for your  
FREE catalog and jacket sample.**

**DISC MAKERS®**  
7905 N. Rt. 130, Pennsauken, NJ 08110 • [www.discmakers.com/mix](http://www.discmakers.com/mix)

YAMAHA

CREATING "KAWUDO" TOGETHER

Yamaha PM1D Digital  
Audio Mixing System.  
State of the Art.

Champion Forest Baptist Church/ASC Technical Services Corp.  
The Woodlands United Methodist Church/Ford Audio-Video Systems  
Audio Techniques, Inc. (own use)  
Audio West (own use)  
Hi-Tech Audio (own use)  
Pro Media (Serb Systems) (own use)  
Carnegie Hall/Andrews Audio  
Redondo Beach Performing Arts Center/Thomas Gregor Associates  
Dominican Republic Broadcast Station/Broadcast International Group  
First Baptist Church of Dallas/Capitol Design Group  
Pensacola Christian College/Couture Pro Audio (All Pro Sound)  
Georgia World Congress Center/OAP, Inc.  
Disney Cruise Line/Professional Sound Service Inc.  
Blackhawk Audio/Professional Sound Service Inc.  
8th Day Sound (own use)  
CSP Mobile Productions/Parson's Audio  
Diamond Rio/MD Clair Brothers  
MD Clair Brothers (own use)  
Riverbend Community Church/MD Clair Brothers  
Special Event Services (own use)  
Fellowship Church/Spectrum Sound  
First Baptist Church of Naples/Spectrum Sound  
Seventh Row Productions/Spectrum Sound  
Spectrum Sound (own use)  
Belmonte University/MD Clair Brothers  
ProMix (Production Resources Group) (own use)  
NHK Enterprises America, Inc./Dale Electronics  
Sound Associates/Dale Electronics  
Masque Sound & Recording (own use)  
Alpha Communication Tech (own use)  
Bruce Springsteen/Audio Analysts  
Celine Dion (Caesar's Palace Las Vegas)/Audio Analysts  
Church of Jesus Christ of Latter Day Saints/Guys Inc. (Poll Sound)  
Marion Oliver McCaw Hall/Morgan Sound  
Richter Scale Productions (own use)  
Hubert H. Humphrey Metrodome/American Pro Audio  
Speak the Word Church/American Pro Audio  
Willow Creek Community Church/American Pro Audio  
Clair Brothers (own use)  
One Dream Sound/Clair Brothers  
Crossroads Church/ICB Audio Company  
Grace Church/Signal Perfection Ltd.  
The Potter's House/Signal Perfection Ltd.  
Willow Creek Church/T.C. Furlong, Inc.

*\*This is just a partial list of our many satisfied PM1D users.*

Don't Be Left Behind

Yamaha Corporation of America • P.O. Box 6600, Buena Park, CA 90622-6600  
For additional information, please call (714)522-9000 • [www.yamaha.com/proaudio](http://www.yamaha.com/proaudio)

©2003 Yamaha Corporation of America. All rights reserved. Yamaha is a registered trademark of Yamaha Corporation.

World Radio History

 **YAMAHA**  
Commercial  
AUDIO

# Beat Street Productions

## Drumming Up Its Own Success

Joe Franco, owner of Beat Street Productions ([www.beatstreetnyc.com](http://www.beatstreetnyc.com)), has a couple of things going for him. As the former drummer for Twisted Sister, Franco's glam-rock bonafides are in order. He also happens to be one of the nicest and least pretentious snare slammers you'll run into.

A lifelong New York resident, Franco coupled his drum chops with a bent for computers and became one of the most successful drum programmers in town during the mid-1980s; in 1995, he hung out the Beat Street shingle. Franco's strategy has been to offer a package of original music and audio post services, keeping an entire television project under one roof.

Beat Street recently completed the third and final season of *Between the Lions*, a PBS children's program. The show won three Emmys last year, and Franco, along with engineer Anthony Erice, has been nominated twice for his work as sound editor.

"I knew that the [show] producers wanted a real band, not just a keyboard player and a drum machine," says Franco. "I'm a rock 'n' roll drummer. The cool thing about the show is that I get to play a lot of styles that I don't generally get called for. The show teaches literacy to children in a way that's fun and engaging. *Sesame Street* taught kids numbers and letters; *Between the Lions* is where we put it all together. It centers on a family of lions that live in a library. We record all of the voice-overs here, which are then sent to the animators, who build their work and send it back here for music and sound design. All told, we put together 70 episodes over the three years."

Franco also composed approximately 30 Afro percussive grooves that were used as segues and programmed several hip hop grooves. "We also use sound libraries," he adds. "We couldn't do this work without Soundminer. You type in 'dog,' and Soundminer finds about 500 samples with descriptions. We took all of our effects libraries and dumped them to hard drives. Currently, we have three workstations—all G4 733MHz machines running Pro Tools. We've recently ordered two HD systems. The third, which is an edit station, will stay as is. We're going HD not for the higher sampling rate, but because HD gives a better track count and more DSP."

All of the video that passes in and out of Beat Street sits on IDE drives. Audio is saved to hot-swappable Cheetah drives, and the sound effect libraries move between stations on FireWire. Room A was built by Frank Comentale, and John Storyk designed the B room. In addition to Erice, the Beat Street staff includes music engineer DUG and sound designer Mike Knoblauch.



Joe Franco in his Pro Control/Pro Tools composing room.

"We have two recording rooms," Franco continues. "The third room is an edit station, which we use for digitizing video, making saves and restores and setting up a show when the other two rooms are in use. A show will come in, get digitized and then an OMF file is set up. We then see where we have to do ADR work. Managing all of this data as efficiently as possible is absolutely essential."

Franco is picky when it comes to tracking drums. "When I bought the Pro Control, I got deeper into mic pre's," he explains. "I love Neves and API mic pre's for tracking drums." Currently in stock are a pair of Neve 1093s and a pair of Chandler LTD-1s, which "are Neve 1073 clones that sound great." Beat Street's rack also includes eight API 512s and a pair of 550B EQs, two Daking 52270 mic pre's and pair of his 91579 compressors, plus a pair of Distressors and some dbx 160s and 165s.

Franco recently stepped behind the kit at Cove City Studios in Long Island for the band that backed Kelly Osbourne on her remake of "Papa Don't Preach." Magellan, the prog rock band that Franco formed with bass player Tony Levin, recently recorded an album at Beat Street, which featured flute player Ian Anderson and the composing/production skills of Trent Gardner.

Franco also recorded a sample library, Reel Drums, released by Wave Distribution (reviewed in the August 2002 *Mix*), and recently signed a new endorsement deal with Drum Workshop. "I'm a rim shot fanatic, and I love this set!" ■

Gary Eskow is a contributing writer to *Mix*.



# INTRODUCING HELIX ONE EQUALIZER ENDLESS POSSIBILITIES



GRAPHIC FADER



GRAPHIC CURVE

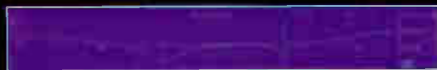

PARAMETRIC

## SIMPLICITY FOR THE COMPLEXITY OF TODAY'S SYSTEM DEMANDS.

Klark Teknik, the company that revolutionized system performance and made one-third equalizers an indispensable professional tool, is ready to take you to the next level... in 0.1 dB increments.

The Helix digital equalizer is a no-compromise addition to any audio professional's toolbox.

*The 2-channel unit contains:*

- 31 bands of 1/3-octave digital filters in 5 different filter emulations, per channel
- 12 bands, 20 Hz - 20 kHz, of parametric equalization, per channel
- 2 bands of Threshold Dependent Equalization (T-DEQ), per channel
- (4) 1st to 8th order filters, per channel
- 1 second of delay, per channel

For more information on the Most Versatile Audio Equalization system in the world call 1-800-392-3497 or visit [www.klarkteknik.com](http://www.klarkteknik.com)

# 45<sup>TH</sup> ANNUAL Grammy Awards<sup>®</sup>

## A Salute to This Year's Engineering and Production Nominees

As we like to do every year, we're taking a moment to tip our hats to some of the engineers and producers who have been nominated for Grammy Awards, which will be given out February 23 at Madison Square Garden in New York City. Generally speaking, there were few surprises among the nominees, with such popular, established artists as Eminem, Bruce Springsteen, Nelly and the Dixie Chicks racking up multiple nominations, and talented newcomers such as Norah Jones and Avril Lavigne making waves, as well. In fact, the only surprising omission that leaps

to mind immediately is Sheryl Crow's "Soak Up the Sun" from either Song of the Year or Record of the Year—has there been a better summer single in the past decade? But we digress. As usual, there are scores of great, unpredictable choices spread among the 104 categories. Check out the complete listing at [www.grammy.com](http://www.grammy.com). And congratulations to all of this year's nominees—you done good!

We'll have a list of the winners in the categories below, as well as comments from some, in our April issue.

—Blair Jackson

### RECORD OF THE YEAR

◆ "A Thousand Miles" by Vanessa Carlton. Ron Fair, producer; Tal Herzberg, Jack Joseph Puig and Michael C. Ross, engineer/mixers.

◆ "Without Me" by Eminem. Jeff Bass and Eminem, producers; Steve King, engineer/mixer.

◆ "Don't Know Why" by Norah Jones. Norah Jones, Arif Mardin and Jay Newland, producers; Mardin and Newland, engineer/mixers.

◆ "Dilemma" by Nelly, featuring Kelly Rowland. Bam and Ryan Bowser, producers; Brian Garten, engineer/mixer.

◆ "How You Remind Me" by Nickelback. Nickelback and Rick Parashar, producers; Joey Moi and Randy Staub, engineer/mixers.

### ALBUM OF THE YEAR

◆ *Home* by the Dixie Chicks. Produced by the Dixie Chicks and Lloyd Maines; Gary Paczosa, engineer/mixer; Robert Hadley and Doug Sax, mastering.

◆ *The Eminem Show* by Eminem. Jeff Bass, Dr. Dre, Eminem and Denaun Porter, producers; Mauricio Iragorri and Steve King, engineer/mixers; Brian Gardner, mastering.

◆ *Come Away With Me* by Norah Jones. Norah Jones, Arif Mardin, Craig Street and Jay Newland, producers; Mardin, Newland and Husky Huskolds, engineer/mixers; Ted Jensen, mastering.

◆ *Nellyville* by Nelly. Jason Epperson, Just Blaze, The Neptunes, The Trackboyz and Wally Yaghnani, producers; Steve Eigner, Brian Garten, Russ Giraud, Gimel Keaton, Greg Morgenstein, Matt Still and Rich Trivali, engineer/mixers; Herb Powers, mastering.

◆ *The Rising* by Bruce Springsteen. Brendan O'Brien, producer. Nick Didia and O'Brien, engineer/mixers; Bob Ludwig, mastering.

### BEST ENGINEERED ALBUM, NON-CLASSICAL

◆ *Ask a Woman Who Knows* by Natalie Cole. Elliot Scheiner and Al Schmitt, engineers.

◆ *C'mon, C'mon* by Sheryl Crow. Trina Shoemaker and Eric Tew, engineers.

◆ *Come Away With Me* by Norah Jones. Arif Mardin, Jay Newland and Husky Huskolds, engineers.

◆ *Home* by the Dixie Chicks. Gary Paczosa, engineer.

◆ *Morning View* by Incubus. Mike Einzinger, Dave Holdredge, Scott Litt and Rick Will, engineers.

### PRODUCER OF THE YEAR, NON-CLASSICAL

◆ Dr. Dre, for songs by Eminem, Busta Rhymes, Truth Hurts, Warren G. and Dr. Dre & Snoop Dog.

◆ Nellee Hooper, for songs by Lanya and No Doubt.

◆ Jimmy Jam and Terry Lewis, for songs by Bryan Adams, Yolanda Adams, Boyz II Men, Mariah Carey and Deborah Cox.

◆ Arif Mardin, for Norah Jones' *Come Away With Me*.

◆ Rick Rubin, for work with Johnny Cash and the Red Hot Chili Peppers.



### BEST REMIXED RECORDING, NON-CLASSICAL

◆ "He Loves Me" by Jill Scott. Your Friends From San Francisco, remixers.

◆ "Hella Good" by No Doubt. Roger Sanchez, remixer.

◆ "Lost Love" by Rinôçérôse. Felix Da Housecat, remixer.

◆ "What About Us" by Brandy. Steve "Silk" Hurley, remixer.

◆ "Work It Out" by Beyoncé Knowles. Maurice Joshua, remixer.

### BEST ENGINEERED ALBUM, CLASSICAL

◆ *Chadwick: Orchestral Works*. John Newton, engineer.

◆ *Orff: Carmina Burana*. Jack Renner, engineer.

◆ *Rachmaninoff: Symphonic Dances; Vocalise*. Keith O. Johnson, engineer.

◆ *Shostakovich: Symphony No. 11*. Tony Faulkner, engineer.

◆ *Vaughan Williams: A Sea Symphony (No. 1)*. Michael Bishop, engineer.

### PRODUCER OF THE YEAR, CLASSICAL

◆ Andrew Cornall, for albums of music by Camillo, Mahler, Moussorgsky and Rossini.

◆ Manfred Eicher, for albums of music by Berio, Karaïndrou, Pärt, Silvestrov and others.

◆ James Mallinson, for albums of music by Elgar, Mozart, Reger and Shostakovich.

◆ Robert Woods for *A Celtic Spectacular*, the Latin Angeles Guitar Quartet, *Scary Music* and *The Sound of Glory*.

◆ Robina Young for albums of music by Bach, Brahms, Handel and Mendelssohn.

### BEST CLASSICAL ALBUM

◆ *Beethoven: String Quartets* by the Takacs Quartet. Andrew Keener, producer.

◆ *Bel Canto: Bellini, Rossini, Donizetti, et al.* by the Orchestra of St. Luke's. Erik Smith, producer.

◆ *Mahler: Symphony No. 6* by the San Francisco Symphony. Andrea Neubronner, producer.

◆ *Pärt: Orient and Occident* by the Swedish Radio Symphony Orchestra. Manfred Eicher, producer.

◆ *Vaughan Williams: A Sea Symphony (No. 1)* by the Atlanta Symphony Orchestra. Thomas C. Moore, producer.

THE LIST OF SUPPORTED DAWs IS GROWING! CHECK [WWW.MACKIE.COM](http://WWW.MACKIE.COM) FOR LATEST UPDATES.

NOW AVAILABLE!

NOW AVAILABLE! NOW AVAILABLE!



MAGIX



STEINBERG



MARK OF THE UNICORN



SYNTRILLIUM SOFTWARE



CAKEWALK

# STOP MOUSING AROUND.



OPTICAL TOUCH FADERS BY  
*Penny+Giles*

## INTRODUCING MACKIE CONTROL™

CUSTOMIZED LEXAN OVERLAYS  
PEEL & STICK FAMILY FUN!

MACKIE CONTROL EXTENDER™ lets you add on more motorized channel faders as your system grows.



TOOLS FOR ARTISTS

*tools for artists*

GET HANDS-ON MACKIE CONTROL™ of your favorite music software. With premium Penny & Giles *touch-sensitive*, motorized 100mm faders and our elegant, ergonomic interface, Mackie Control™ is the only control surface with direct mapping (and customized Lexan overlays) for Steinberg Nuendo™, Cubase SX/SL and MOTU Digital Performer™. Support for Cool Edit™ Pro 2 by Syntrillium and SONAR 2™ by Cakewalk™ are in the works. You control every important function of these programs with real buttons, rotary encoders, transport controls and a jog/shuttle wheel. LED and LCD displays show your settings at a glance. Bank switching lets you control as many channels as your DAW supports, and the Mackie Control Extenders let you add more faders as needed. Put an end to mouse mania. Check out Mackie Control™ today!

1.800.258.6883 • [WWW.MACKIE.COM](http://WWW.MACKIE.COM)



# MACKIE.

©2002 MACKIE DESIGN INC. ALL RIGHTS RESERVED.  
MACKIE™ AND THE "TURNING MAN FIGURE" ARE REGISTERED TRADEMARKS OF MACKIE DESIGN INC.  
"PENNY-GILES" OVERLAYS IS A TRADEMARK OF PENNY & GILES OVERLAYS LTD.  
ALL NAMES, LOGOTYPES AND TRADEMARKS ARE PROPERTY OF THEIR RESPECTIVE COMPANIES.  
DID YOU NOTICE THE NEW LOGO? AT THE TOP SINCE THE LAST TIME? WE ASKED World Radio History™

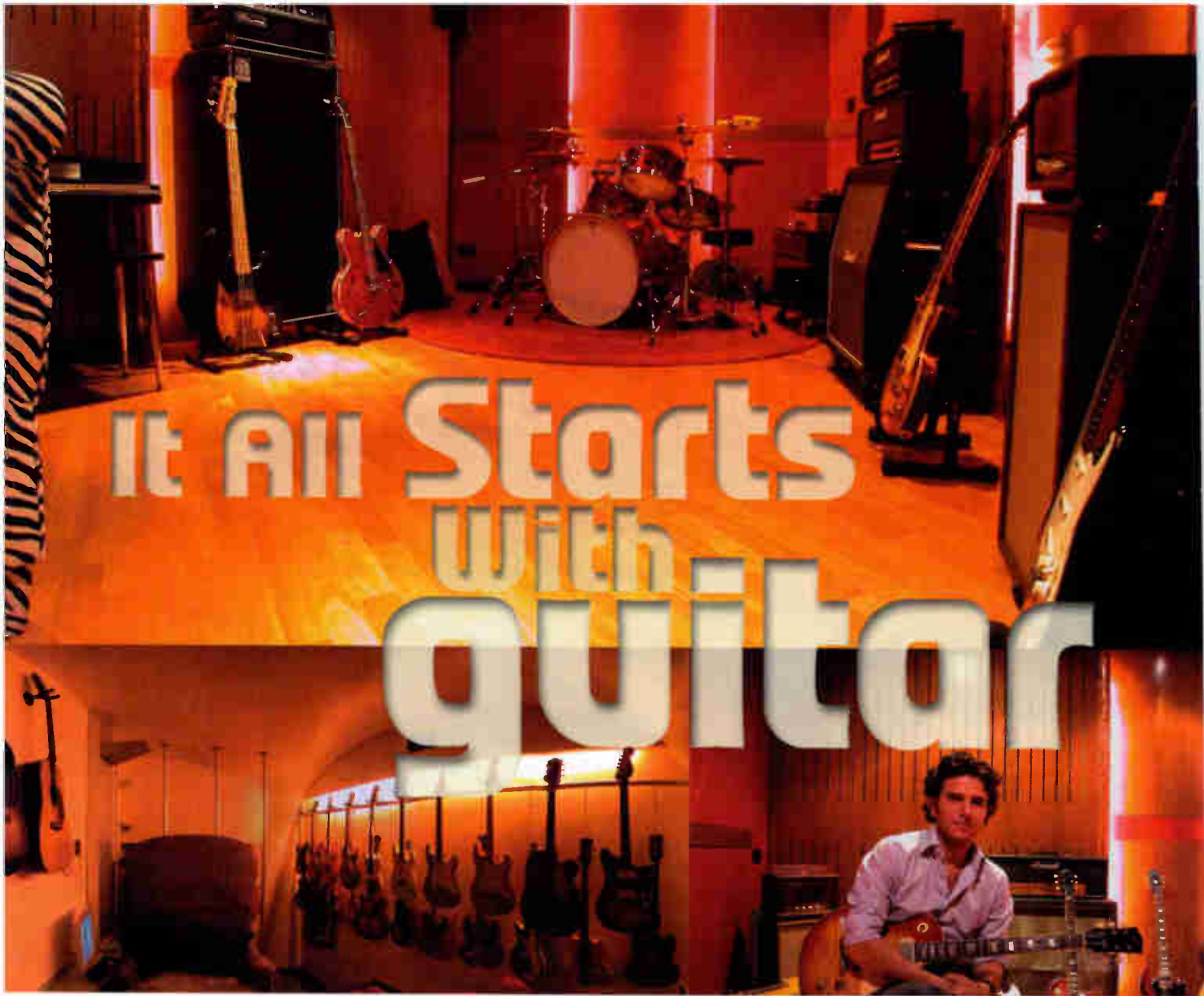

## Italian Studio Built for Rock

**F**or those who can't get past mandolins and Pavarotti, it may come as a surprise that Italy has a thriving, domestic rock scene. Granted, few artists—with the exception of Zucchero—have managed to build up an international following; this, in turn, may have stifled the domestic recording scene, as top Italian artists started a trend some years ago by recording and mastering their key projects abroad. A new facility, however, is hoping to reverse that trend by keeping homegrown talent at home and attracting an international clientele. The studio is the small, highly specialized Studio 52A, tucked away in Rome's residential Prati zone.

Studio 52A, opened last September by Filippo Olivieri, a 34-year-old ex-software house manager and semi-pro guitarist, features an impressive combination of vintage instruments and hardware, and cutting-edge digital technology. Olivieri's project was initially inspired by the tone and design of his vintage guitar collection. He's been crazy about guitars and their sound since he was a kid, listening to late-'60s and early-'70s blues-rock players, and to this day, he's convinced that some vintage equipment is still unmatched in character and quality by new instruments.

"When I was a little older and could afford it, I began buying guitars and amps, starting with those of my favorite players," he explains. "When I had quite a few, I decided to do something with them. I want to provide the best guitar sound possible, and I'm aware that we're focusing on a niche market to begin with. But it's something so special that I'm happy to start here, enter this huge market a small step at a time and then see what else can be accomplished."





By Mike Clark

The studio's mission is to offer a comfortable, creative environment in which artists can achieve the best musical quality in guitar recording using highly selected vintage instruments and amplifiers, along with analog and digital recording and processing equipment. A studio assistant knows the equipment inside out, and a guitar technician can prepare specific instruments to suit artists (string gauge, action, pickup settings, etc.). The decision to open such a specialized facility was made after in-depth market research showed that guitars are not only coming back in rock music but in other genres, too.

"I decided to invest now and exploit this opportunity," Olivieri says. "Building a place provided a variety of choices, including for the instruments, themselves, because, although pro guitarists obviously have their own, they're usually interested in trying out others, which could inspire them in new ways. This is the very core of what I'm trying to do."

Other vintage analog gear ranges from mics (Neumann U47 and U67, AKG C 12 and such) to keyboards,

including a 1958 Hammond C3, with Leslie, Wurlitzer, Fender Rhodes and a '72 Minimoog. Recording equipment includes a Studer A80 and analog mic preamps, EQs and compressors. The idea wasn't to reproduce a vintage studio for the sake of it, but to use old gear in



Filippo Olivieri at the Pro Control board

# It All Starts With guitar

a modern context, merging it with the best of new technology wherever possible.

"We've hooked up old outboard units with new ones," Olivieri says. "They're all wired with either Pro Tools or Logic Audio and their relative hardware controllers, such as Pro Control for Pro Tools, which is our sole 'console-like' choice to date. Again, all this with the idea of providing as many options as possible, such as playing any real instruments and/or software ones, with processing and recording on either 2-inch tape or hard disk—getting the best of both worlds."

During the planning stages, Olivieri wanted to design an environment that would make artists want to stay, working in the most efficient, productive yet comfortable way. The challenge of designing a facility to international standards in just 70 square meters was accepted by Dino D'Ambrosio Associates, one of Italy's top firms. Dino D'Ambrosio explains: "Our first survey showed that the main walls couldn't be modified to any great extent, as the building dates back to the early 1900s. As was often the case in those days, structural perimeter walls are in coursed rubble. This, however, was also a positive factor, as they're high-mass and extremely thick, so it didn't necessitate particularly complicated work, as the rooms' isolation was already very good."

Floating floors and ceilings were necessary, and reinforced concrete floating on a resilient base and specially pre-bonded lead, polyester and perlite-fiber sandwich were used, respectively, and floated in such a way to ensure that there were absolutely no acoustical bridges. Great care was also taken with the doors, which were designed to ensure the utmost visibility and livability. The cavity formed by the spacer bar in the double-glazed units is filled with sulphur hexafluoride for improved acoustic performance, and each pane comprises interlayers of polyvinyl butyral film between three sheets of annealed glass. Following in-depth talks with the client regarding the facility's acoustic target, priority was given to maintaining instruments' typical sounds, an indispensable aspect because, apart from acoustic instruments, it would have been a crime to flatten the amplified guitars' widely different sonic features with insufficiently discriminating acoustics.



D'Ambrosio continues: "The design involves a combination of diffuser panels, which don't affect the acoustic nodes, and single- and multiple-cavity Helmholtz resonators to give the room a linear response. Room correction was completed by a ceiling in which slots of Tecnodens were installed." This is thermally bonded, inorganic wadding developed to replace asbestos on railway carriages; it behaves exactly like organic material with the same density but is fireproof, nontoxic and recyclable. It also eliminates health and acoustic problems associated with Fiberglas and mineral wool, which deteriorate through time and emit airborne particles that are a health risk and cause variations in acoustic response due to changes in density. The slots are positioned for quarter-wave absorption and form a correction zone that enabled "live" flooring such as cherry parquet to be used.

The end result is a particularly lively acoustic color for the dimensions of the room, with accurate reproduction of the original sonic details and excellent response to acoustic pressure. The latter was of key importance, as some vintage amps give their best at very high volumes.

Control room linearization was optimized by means of slots/bass traps installed in the ceiling and a multiple-cavity resonator in the node behind the engineer's chair.

"I build a lot of large studios with plenty of space for recording and control rooms," D'Ambrosio concludes. "We achieved great linearity and sonic precision even for 5.1 work, as is heard when the facility does justice to a vintage Gibson wailing through a Vox AC30!"

D'Ambrosio also spec'd the industry-standard hardware for this type of project—things the studio had to have—such as the Studer A80, chosen as ideal to record guitar bass and drums. Olivieri

selected preamps, EQs and compressors that are able to give the most characteristic sounds, looking at vintage outboard equipment and bringing in brands such as Pultec, UREI and more on the constantly expanding equipment list. Looking for specific items that he wanted, such as Neumann U67 and 47 mics, he contacted Boston consultancy/sales firm Sonic Circus.

"David Lyons was extremely helpful, and I was able to take all of the stuff he suggested, which was about 80 percent vintage and 20 percent new gear," Olivieri says. "We opted for the old stuff because it's so 'musical,' no matter what its function. For example, the RCA BA6A limiter/compressor has a very characteristic tone and was built without cutting corners or scrimping on components, as was the Fairchild 660—the most expensive, heaviest compressor ever built—using the best components available and cramming almost 20 tubes into one mono unit! Worth a mention among the 'newbies' is Summit Audio's Rupert Neve-designed MPE200 preamp/equalizer. Being digitally controlled, but with an analog core for sound processing, makes it ideal for integration in a fully automated recording system."

Olivieri makes it clear that his pursuit of vintage character wasn't borne of necessity or a snobbish desire to collect fancy, expensive stuff. "I still look out for 'virtual instruments,'" he says. "If we find them professional, user-friendly and reliable, we'll get them, as clients sometimes need to run off a quick recording, and these things optimize your time frame, even if quality is a compromise. But if it's what the client wants, we can deliver that, too!"

*Mike Clark is a UK journalist based in Italy. He can be reached at [mclark@rimini.com](mailto:mclark@rimini.com).*

**SONY.**

# WE GAVE YOU OUR BEST. YOU MADE IT BETTER.



SIU-100 SYSTEM INTERFACE UNIT



SIU-RM101 MIC PRE REMOTE



DMBK-S101 8-CHANNEL  
MIC PRE AMP BOARD



DMBK-R109 MADI  
INTERFACE BOARD

With the DMX-R100, Sony introduced perhaps the world's finest small-format digital mixer. A professional mixer that works like a pro: fast and intuitive. With a full input module that gives you a knob for every key function, so you don't get lost in menus.

You used it. You liked it. You told us how to make it even better. The result is an improved Sony DMX-R100. With a new MADI board option, for compatibility with MADI-based recorders – and for cascading two R100's together, giving you more than 100 inputs. Plus a new SIU-100 I/O expansion system for remotely controlled mics during both studio and live productions as well as expanded digital I/O. And the SIU-100 also supports I/O networking for multi-room facilities with Ethernet IP remote control.

Of course, we saved all the features that make the R100 so popular. Including easy-to-learn operation, 10-bit precision, touch-sensitive faders and a comprehensive automation system. Even a large color touch-screen, so it's simple to assign I/O, perform surround sound panning and monitoring, and view EQ curves and dynamics settings.

What more could we do? Make new pricing with special financing terms available to qualified customers through Sony Financial Services\*. And to meet all your needs, we offer optional R100 operations training through the Sony Training Institute as well as optional on-site support packages through Sony Professional Services.

THE SONY DMX-R100. WE MADE IT GOOD. YOU MADE IT BETTER.  
TO FIND OUT HOW MUCH BETTER JUST GIVE US A CALL AT  
1-800-472-7669 EXT. R100/2.

DMX-R100



[www.sony.com/proaudio](http://www.sony.com/proaudio)

© 2002 Sony Electronics Inc. All rights reserved. Reproduction in whole or in part without written permission is prohibited. Features and specifications subject to change without notice. Sony is a trademark of Sony.  
\*On approved credit. Financing available through Sony Financial Services, LLC. For details go to [www.sonyfinancial.com](http://www.sonyfinancial.com).

World Radio History

# Around the World With *Stomp*

## Behind Imax's Latest Sensation

By Larry Loewinger

In the minds of its creators—Englishmen Luke Cresswell and Stephen McNicholas—*Stomp* is a malleable idea about rhythm as language, a nonverbal way to communicate through percussion. That concept formed the basis for their celebrated theatrical event, simply called *Stomp*, and a series of ever-evolving films: their first short *Brooms*, which was nominated for an Academy Award, an HBO special, and their most ambitious effort so far—the recently released Imax film, *Pulse, A Stomp Odyssey*. The idea behind *Stomp*, according to Cresswell, is, “the challenge of putting a show together that was just rhythm, movement and humor, but definitely not dialog; to try and take the audience on a journey.”

Currently being performed in five theaters around the world, *Stomp* involves a small community of skilled performers playing everyday objects in a kind of infectious, rhythmic back-and-forth; purely abstract, but with a subtext of race and class that fills the theater with thomps, whacks, scratching, banging and clang-



PHOTO: COURTESY GIANT PICTURES

ing. Over the course of an evening, the solos and duets build to larger ensemble pieces and climax in a wonderful, percussive orgy of loud sounds and powerful rhythms that never fail to bring down the house.

The concept for the Imax film was to expand *Stomp*'s reach: to take the show's creators, technicians and performers around the world and join the *Stomp* cast with local performers in a planetary, percussive dialog. “We always had a desire deep down to do a global drum-rhythm project,” McNicholas says. “Something that paid tribute to the people who inspired us; for example, the Kodo drummers from Japan. We wanted to do something that celebrated great rhythms of the world.”

In its theatrical form, *Stomp* required a signature sound. Cresswell and McNicholas turned to their old rock 'n' roll band buddy-turned audio engineer Mike Roberts to help them figure out what the sonic aesthetic would be. “The show creates its own sound,” Roberts says. “What you have to do is reinforce the energy and the movement onstage. You are trying to involve the audience in the space with the lights and the movements.”

The HBO special, *Stomp Out Loud*, was an elaboration of the audio techniques employed in the theater. In both the scenes filmed onstage and the location scenes, the miking involved arrays of open mics with only a few radio mics stashed in drums or hard-to-reach places.

—CONTINUED ON PAGE 84



Top: *Stomp* as you know it. Above: The marching band prepares for the pivotal Brooklyn Bridge scene.

## Composer Spotlight

# Lisa Gerrard: The Color of Sound

By Bryan Reesman

“I think that, sometimes, the most simple tune can unlock so much more than anything else in picture, just in the right spot,” declares musician and composer Lisa Gerrard. “I don’t think it’s about being a great composer or an amazing musician or anything like that. I’m none of those things. If you’re able to feel, and if you’re willing to allow yourself to really sit in front of the characters and feel what they’re experiencing—and watch them and look into their faces and their hands, and look around the picture—it will start to translate itself in music through you. It *will*.”

While some prolific Hollywood composers pump out music at an assembly-line pace, evoking clichés and pedestrian sentiments, Australian native Lisa Gerrard has followed a special and unique path in the world of film scoring. It’s an area she immersed herself in following the dissolution of her long-running group with Brendan Perry: the revered and uncategorizable Dead Can Dance, an ensemble that cross-pollinated everything from pop and folk to Middle Eastern and early music. Since then, Gerrard has imported her unique musical sensibilities into an arena dominated by symphonic and rock sounds, while retaining her idealism and artistic identity in the face of Tinseltown orthodoxy.

Over the past three-and-a-half years, Gerrard has contributed music to Ridley Scott’s *Gladiator*, Michael Mann’s *The Insider* and *Ali*, and Niki Caro’s directorial debut *Whale Rider*. (Mann had previously used one of her original pieces for his 1995 film *Heat*.) Her involvement in each score has been special, for Gerrard colors her work differently than other Hollywood composers. To hear her heavenly voice and delicate, *yang chin* playing waft into cinemas during *Gladiator* was magical. *Ali* expanded her aural palette as she and Pieter Bourke explored jazzier atmospheres, although they still managed to sneak in one of their trademark drone and percussion pieces.

“I’m really enjoying it,” Gerrard



Lisa Gerrard equally at home in the studio or performing live.

remarks of her current career path. Her most recent score, for the independent New Zealand film *Whale Rider*, was liberating for the singer/musician because it was her first attempt at composing a film score solo. Previously, she had collaborated on scores with percussionist and longtime associate Bourke, who has toured with Dead Can Dance and with whom she recorded the 1998 album *Duality*. *Whale Rider* was also her first time scoring a picture entirely from scratch and without temp music.

“She’s really brilliant,” Gerrard says of director Caro. “They’ve given me the whole film, which I’ve never had before. In Hollywood, you’re always given little bits and pieces, and it’s really hard sometimes to figure out the continuity factor. I’ve got the whole film, and I can really get into the subtext and really understand which parts of the characters are linked between the different scenes musically. It’s just beautiful. I love it!”

A tale focusing on the Maori people of New Zealand, Caro’s film is “about this little girl who has this amazing affinity

with whales,” explains Gerrard, “and this very difficult, complex relationship with her grandfather, who’s the head of this tribe. And this deteriorating community. It’s just exquisite. When I read the script, I said, ‘I’ve got to do this film. I don’t care how much the money is.’ I couldn’t put it down.”

Gerrard says that for *Whale Rider*, she has used “very low, very dark shell flutes” that are common to the Maori people. “I also used breath percussion, because I had to keep away from percussion in the film. The only percussion they play is clapping sticks. Having said that, she wants me to do a percussion piece at the end, but we’re clear of the topographic, geographic things. It’s a very emotional film, so the music is extremely exposed and extremely emotional. It’s quite haunting with these flutes. I’ve used a lot of orchestral strings and an old Maori lady singing. It’s just exquisite.”

The score for *Whale Rider* was composed and edited in Gerrard’s home studio with the help of her engineer Simon Bowley. Two PCs and a Macintosh work harmoniously, and she and

PHOTOS: COURTESY WWW.LISAGERRARD.COM

Bowley record onto Cubase VST, utilizing GigaStudio and an Akai S5000 sampler. Her large sound library resides in GigaStudio.

"I use whatever I can get my hands on, but I always tend to go back to strings," says Gerrard. "For different colors and various things that you might need, you use whatever works, and that can be stuff that you've made or things that are on CD-ROMs. You just use whatever you can to get that scene working." Two of her favorite CD-ROMs include *Bizarre Guitar* and a David Torn disc. When it comes to recording live sounds (like a shell flute or a voice for *Whale Rider*), she uses the AKG D 12 valve mic, her "favorite piece of equipment in the world."

The composer owns a Mackie digital 8-bus console with Version 3 software and 72 audio channels. "It takes two feeds: one from GigaStudio and [one] from VST on the two separate PCs," explains Bowley. The Cubase PC runs NMC to control Pro Tools, "just to tell it where to start from, though Pro Tools is the master," he says. "So if Lisa wants to go to the opening scene, she can just open up her songs, go straight to the opening scene, and that will then quickly tell Pro Tools where to jump to and then VST will follow Pro Tools. Even though it's telling it where to start, it's still a slave to it."

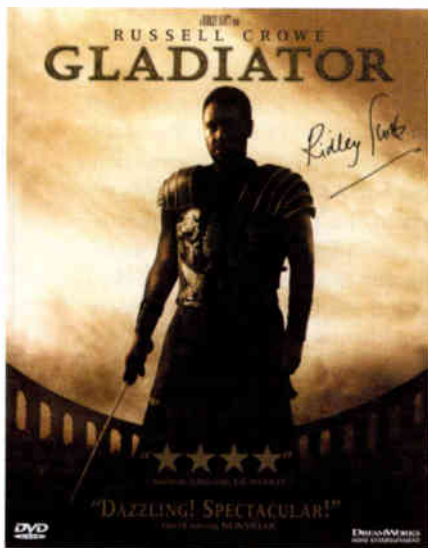

"I'm working with the latest Pro Tools," clarifies Gerrard. "That's been really good for this project, because

instead of downloading to DA-88s, I've been able to just download straight into Pro Tools. I've been working with QuickTime files from Pro Tools, so the whole studio is basically running togeth-



Lisa Gerrard, director Ridley Scott and composer Hans Zimmer

er now. I can go to any part of the picture at the click of a button."

The synchronized studio also works well for mixing and mastering. "With this project, the preliminary mix is happening on the console and then they're bused down into groups into Pro Tools," remarks Bowley. "Strings have their own stereo pair. What happens in the Digidesign mixer is, once you have all of the faders that you need, you're roughly reproducing the mix [from] the Mackie console."

Gerrard's outboard gear includes a TC M5000, an Avalon voice module, an MPX-1 multi-effects processor and a TC Finalizer. To record vocals with the AKG, they run the signal straight into the Avalon, which then goes through an Apogee converter into a Pulsar II audio card.

The contrast between working on a high-budget studio production with frequent intrusions as opposed to a small film with greater creative freedom opened Gerrard's eyes. "Even in Hollywood films," she observes, "it astounds me that you give them a piece of work that they really love, and then they cut it and cut it and cut it and cut it and wonder why they don't like it anymore. They say, 'This piece isn't working.' You look at it and think, 'What have we got left here? We have a gong and a drone.'"

Despite the fact that Gerrard found some frustration working on bigger films, she is very appreciative of the directors, particularly Mann. "I'm really happy because I got the greatest education ever

in my life from director Michael Mann," beams Gerrard. "You can't buy an apprenticeship like I had from Michael. Michael is one of America's finest filmmakers. I realized when I was doing [*Whale Rider*] how many times I reached for things that Michael has taught me."

An important lesson Gerrard learned from Mann was trust: learning to trust a director's vision of his/her film and how music fits into it, especially on a large-scale production. "If you don't trust someone in a situation like that, you're going to drown because it's so huge and there's so much pressure and so much work to do," she says. "That's what I love about this young lady [Caro] whom I'm working with at the moment. She knows what she

wants. She's a bit like Ridley Scott: He's got the art of being able to show you what you're doing is right or wrong without making you lose your confidence or your creative flow." ■

For more information about Lisa Gerrard, visit [www.lisagerrard.com](http://www.lisagerrard.com).

## Stomp

FROM PAGE 82

But the wide vistas and the great detail that the Imax camera captures required a rethinking of the audio technique for theater. To get impact meant hiding multiple radio mics on people's bodies or within drums. The open mics—the Sennheiser shotguns that Roberts loves—would now document ambience and performance.

In any of the larger projects that Cresswell and McNicholas contemplate, Roberts is an integral part. He is there at the very first planning stages, and he is also present at the final mix, suggesting the great range and diversity of his skills. I have worked with the *Stomp* creators and Roberts since 1996, recording or playing back music for their commercials, the HBO special and, most recently, the Imax film, which was filmed in a variety of locations, including Brazil, India, South Africa, Spain, the UK and the U.S.

In the large-scale projects, all of the sound that is heard on the screen is live and direct, with one notable exception: In *Pulse*, during the scene filmed on New York's Brooklyn Bridge, what we hear on the screen is wild sound recorded on location at the end of the shooting day.

"If you are considering a career in the entertainment media industry, I think there's only one choice. With the way technology is moving and the speed at which it changes, Full Sail is the only school that I've ever seen or heard of that consistently remains so up-to-date. It's a place that approaches education right - by getting your hands on the world's most current technology."

**-Steve Vai**

GRAMMY<sup>®</sup> -award winner  
**Steve Vai** at the  
Neve Capricorn console  
in Studio C - one of  
Full Sail's  
37 production  
studios.

**FULL SAIL**  
Real World Education

**School of:**  
Audio • Show Production & Touring  
Film/Video • Computer Animation  
Digital Media • Game Design

**800.226.7625**

Tune into **webstationzero** at **www.fullsail.com**

3300 University Boulevard • Winter Park, FL 32792 • Financial aid available to those who qualify • Job placement assistance • Accredited by ACCSCT

©2000 Full Sail Recorders, Inc. All rights reserved. The terms "Full Sail", "Full Sail Real World Education", "Radio History", "WebStationZero" logos are either registered service marks or service marks of Full Sail Recorders, Inc. Other product and company names mentioned herein may be the trademarks of their respective owners. The appearance of these marks does not necessarily indicate a formal relationship or affiliation with other such entities.

Producing the sound for that scene reveals all of the perils and challenges of doing location multitrack audio. In retrospect, it leads us to wonder whether we were arrogant, naive or foolish to think that we could record usable sound for an Imax film on the Brooklyn Bridge. At the time, we wondered who was in charge: the bridge or us?

"I was under no illusions about the Brooklyn Bridge," Roberts confessed later on. "I knew it was going to be hellish. Everything was against us: the weather, the distances, the logistics, the location of the truck. People told me that you can't do this in a complicated way." But because the charge from *Stomp's* creators was to bring back live, direct sound, Roberts felt that he had no choice.

The Brooklyn Bridge scene happened at the end of a grueling round-the-world adventure during the last few days of shooting on the film. It took place in the middle of a New York winter, on a very snowy weekend. It was cold, and daylight was short. The scene itself involved two marching percussion bands—one hip hop and the other a conventional drum band. They were to play on the walkway above the traffic lanes of the bridge and, at some point, meet near the center of the bridge. Because we could not stop traffic, we asked ourselves if they could make enough noise to mask the enormous traffic roar below.

Chris Anderson brought his multitrack Neveva sound truck, along with a couple of assistants, down from Woodstock. We had used the truck successfully on the HBO special five years earlier. On the scout a few days before our setup, the job seemed doable, if daunting. We would park the truck at the base of the Brooklyn tower of the bridge. That meant an enormous multicore cable would need to run up to the bridge from the truck—probably 150 to 200 feet—and that was only the beginning. We probably ran somewhere between a quarter- and a half-mile of cable. That raised the issue of whether mic-level signals would be of sufficient strength and integrity to reach the inputs of the truck's console. So, we decided to rent an active mic preamp rack to deliver the signals at line-level to the truck. On setup day, we tested everything we could. We had one 8-channel radio mic rack from Sennheiser and two 4-channel quad boxes from Lectrosonic. They

worked well on Friday, but we knew that they wouldn't necessarily work as well on the shoot. We tested all of our open mics, all of the mic lines, the simple stereo rig—consisting of a Fostex PD-4 and the Neuman M-S stereo mic—the active preamp rack and all 52 lines of the audio snake. It all worked.

We set up on Friday, but by that afternoon, we got word that snow was expected the next day and, as a conse-

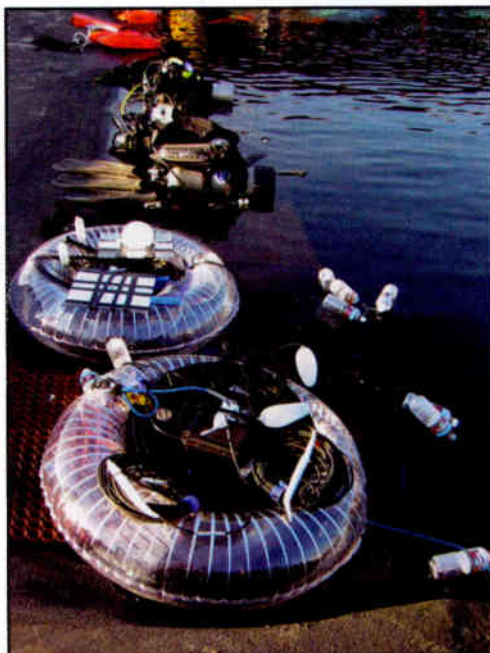

The hydrophone location audio rig

quence, we would have to film on Sunday rather than Saturday. All valuable items had to come off of the bridge, leaving only cables and the 52-pair snake.

Our seven-person crew started work at 5:30 a.m. Sunday morning. I assigned myself the cushy job of working with Anderson in the heated Neveva truck, monitoring the recording, while Roberts took his four guys up to the bridge to set up in the cold and dark. By 7 a.m., though, the walkie crackled with Robert's voice: He needed me on the bridge. I left Anderson alone to run his truck, knowing I probably would not return.

Once on the bridge, I noticed that the PD-4 stereo rig had not been set up, let alone tested. Then, as the day progressed, necessity dictated that the bands be placed closer and closer to the Manhattan side—further and further away from our staging area. Cable runs grew longer, radio mic signals grew weaker and our anxiety levels increased.

Even as the sun was rising that morn-

ing, gaining light was in the back of everyone's mind. Getting a good, live multitrack sound is normally a major priority for the *Stomp* directors, but it was clear that on this day, archiving images—not recording sound—was paramount. There were two elements to the recording we were doing: Impact was to be handled by the radio mics placed on selective performers, and space was to be captured by the array of shotgun mics we placed along the walkway. But because the radio mics were performing so erratically, we knew that we wouldn't get much impact, at least on a consistent basis. And we soon found out that the walkway wasn't wide enough to permit us to hide the elaborate shotgun array that we had planned from the ever-seeing Imax camera during a turnaround shot. The wild sound recording would make or break our day.

"It was the toughest day's work I have ever done," Roberts admits. "It was a pretty terrifying environment. Looking back, I probably pushed people too hard, trying for a result we were never going to get. It was a very ambitious effort. I am slightly disappointed because it is the one event where we used wild track, but I am [still] very pleased with the outcome." During the editing, co-director McNicholas saw the Brooklyn Bridge scene spring to life with the wild sound. "Whenever we mention the Brooklyn Bridge," he says, "Mike's eyes light up."

The *Stomp* team left New York after the last day of shooting and started editing immediately in England. Cresswell and McNicholas edited the film themselves on Final Cut Pro. Once reasonably sure of a cut, they would bring Roberts into the process. He described the parallel picture editing and sound construction as "working right to the edge of the technologies. We all have the same media—about 150 gigabytes of video media. They e-mail me the edit as a reference movie. What Final Cut Pro gives me is the ability to look at the cut, any scene. I stream the video in from Final Cut Pro into my Pro Tools AV, using Final Cut Pro to get my sync references. I then lift the audio from my DA-88s and conform that to picture in Pro Tools AV. So I am building the edit changes and gradually building up the program in Pro Tools AV."

By the time *Pulse* was ready to be mixed, what had started out as a relatively linear percussion journey around the



# The 960L

in 3 Flavors...



## The 960L

Lexicon's flagship full-featured multi-channel/stereo digital effects system. The 960L has 8 channels of analog I/O and 8 channels of AES/EBU digital I/O.

## The 960L Digital

A more affordable, digital-only version of the 960L which includes multi-channel/stereo effects and 8 channels of AES/EBU I/O.

This version can be upgraded to full-featured 960L.

## The 960LS Stereo

The newest addition to the 960L family - a stereo-only version of the 960. The 960LS has 8-channels of high-quality 24-bit/96kHz analog I/O.

This version can be upgraded to full-featured 960L.

## ...and Upgradeable

### Automation:

Allows program loads, parameter adjustments, pan moves, and mutes to be recorded and played back synchronized to incoming MIDI time code.

### LOGIC7 UpMix™:

LOGIC7 is the acclaimed technology - developed by Lexicon's Dr. David Griesinger - for creating multi-channel signals from stereo sources.

**Lexicon**  
H A Harman International Company

world had now evolved into a far more complicated structure in which the visual and emotional connections were made through cross-cutting and geographic leaps, bound together by a powerful, pulsating soundtrack. The soundtrack itself grew in complexity along with the picture. In some scenes, especially the ending, Roberts brought to the first of two mixes as many as 64 tracks.

*Pulse* was to be completed by the end of spring 2002 for an early summer release, but the demands of editing pushed the release date back substantially. That played havoc with the final mix

dates for the film, and the Imax room at De Lane Lea Studios in London, where they had planned to take the project, was not available. Roberts and his directors decided on a two-pronged strategy for the mix. The music would be brought to another longtime colleague, Sven Taits, at De Lane Lea for a mix to Dolby 5.1 and those stems would travel across the ocean to be finalized into the Imax format, with its five discrete tracks and a sub, in Toronto at Masters Sound, Imax's home.

Of all the pieces Taits mixed, he was most drawn to a brief, underwater musical sequence filmed in the U.S.: Cresswell

joins his *Stomp* cast members banging out rhythms below the surface of a large outdoor tank in Burbank, Calif., at the end of a busy week in which the team also filmed in the Mojave Desert and the Paramount backlot. "Both Luke and I are very keen scuba divers," McNicholas says. (So is Roberts.) "We've always been interested in the way sound travels at different speeds underwater, the effects you get with bubbles underwater, the way metal hits underwater. Also, because it's Imax, we have to have helicopter and underwater shots," he jokes.

The piece was recorded with a pair of B&K hydrophones augmented by four waterproofed Countryman B-3 mics. When the piece arrived at the mix, Taits didn't have to do much to it. "I EQ'd it a little bit," he says. "As the track goes on, I started adding some effects to give it some shape. The choice of microphones worked very well. No one is going to believe that this was recorded live."

While Brian Eimer, who did the final Imax mix in Toronto, faced challenges, he was also presented with a gift: He had the opportunity to mix a direct-sound film, which is unusual in the Imax world. "*Pulse* is by far the most production sound we have ever received on a project. It's not something you can emulate in the studio after the fact. It would certainly take away from the performances on the screen. You wouldn't enjoy the journey as much.

"There was a real opportunity in this one to play with the 3-D space of the theater and create a surround field for the mix," Eimer continues. "As the music was mixed, we had to make sure that the positioning of the performance elements be kept forward. At the same time, we needed to feel the transition from one environment to another. For example, when we went to New York, we really made sure to have a presence of that [place], and when we went to South Africa, we really felt that we were in that location."

*Pulse, A Stomp Odyssey* is a short film, lasting around 40 minutes, yet it challenged everyone involved to work to the peak of their abilities. At the end of the day, what satisfies most is the knowledge that our technical skills were brought to bear on a vast and entertaining canvas that contains a serious and, we would like to think, important ambition: to celebrate life and brotherhood. Its goal, as McNicholas notes, "is to link arms with the rest of the world." To highlight that theme, the film premiered at a United Nations-sponsored event at New York's Museum of Natural History in the fall of 2002. ■

# A UNIQUE

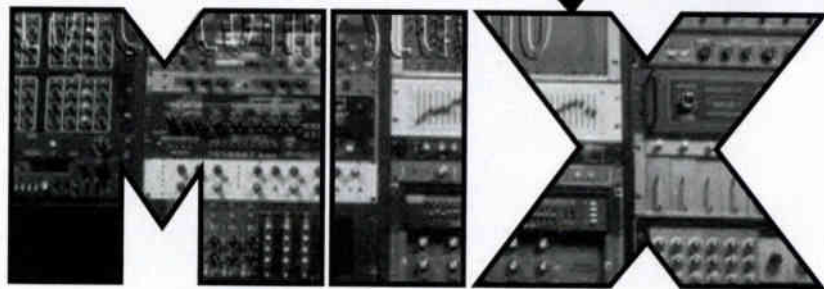

OF

## INSURANCE COVERAGE

**The Largest Insurance Firm Dedicated  
Solely To The Needs Of Musicians  
Worldwide. Specialized Coverage For  
RECORDING STUDIOS,  
Home And Commercial.**

**CLARION**  
ASSOCIATES, INC.  
MUSICAL INSTRUMENT INSURANCE

**World-Wide, All-Risk Insurance For  
Recording Studio Equipment At  
Affordable Rates.**

**1-800-VIVALDI [www.clarionins.com](http://www.clarionins.com)**

# Top Engineers Agree.



**Marc DeSisto**

Engineer/Mixer Marc DeSisto's credits include Michelle Branch, Melissa Etheridge, U2, Chris Isaak, Stevie Nicks and Joe Cocker, to name a few. Assistant engineers are Bella and Luke

## Think Quantegy

When it comes to analog and digital mastering media, nobody offers a wider selection. So it's no wonder that more music around the world goes gold and platinum on Quantegy media than on all the other brands combined. While opinion may vary on what it takes to make a hit, there's no argument on what it takes to master one.



**QUANTEGY**  
The Hit Maker's Media

Tel: 800-752-0732

Fax: 800-628-0535

[www.quantegy.com](http://www.quantegy.com)

# Computer, Do the Math!

## The Down and Dirty Details of 24 Vs. 32

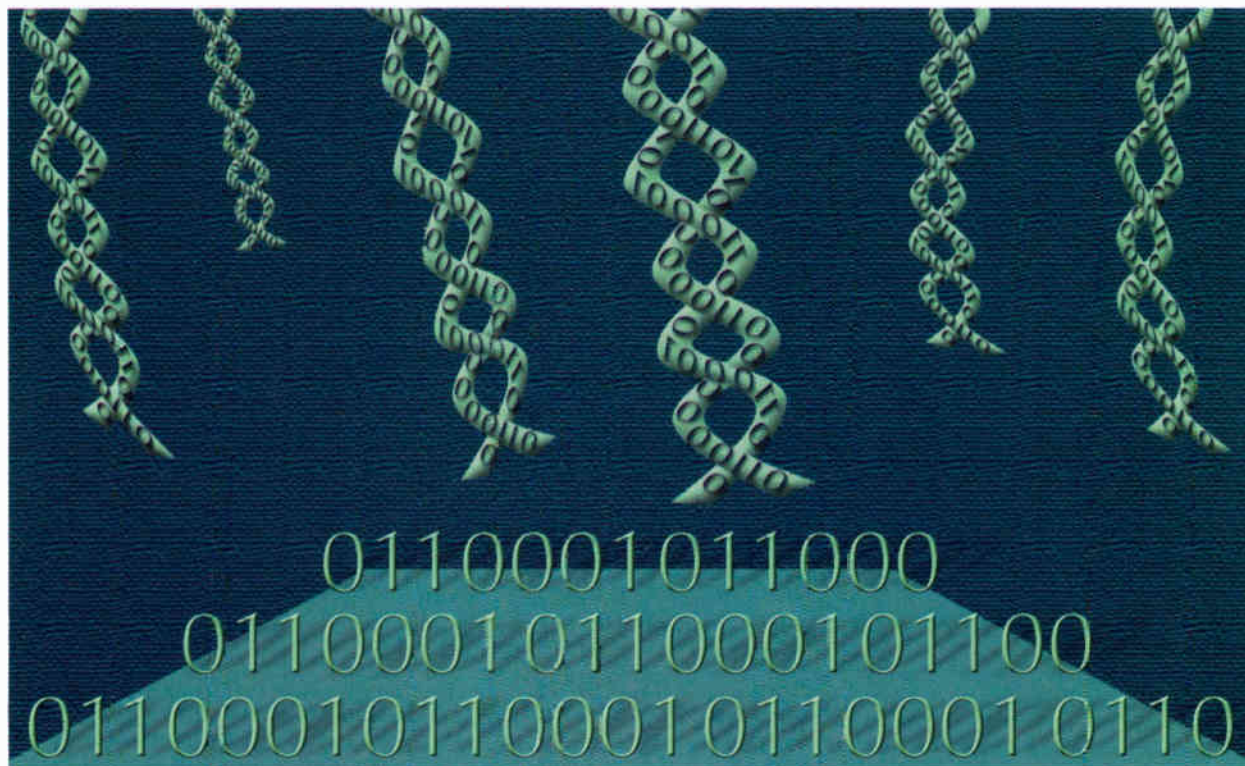

ILLUSTRATION: MAE LAROBIS

**T**his month, I'm delving into a topic that generates its share of enmity in the two audio camps: the Fixed and the Floats. Like the prodigal McCoys and Hatfields, these fellers have been mixin' it up since "real engineers" wore 'coon skin caps, but nobody's yet come out as the winner. I've got friends, and you may be one of them, who are adamant about what flavor of arithmetic is used in their DAW. While there are circumstances when it's more appropriate to employ fixed or floating point, it's a bit like arguing if bidirectional mics are better than cardioid. They're two different beasts; one is neither more accurate nor prettier than the other, just different. But that doesn't seem to matter to those folks who are feudin'.

Let's start with one inherent aspect of this discussion: the word length war of 24 vs. 32. In audio circles, "24 bits" refers to 24-bit, fixed-point, or integer arithmetic, while "32 bits" generally refers to 32-bit, floating-point arithmetic. Before I lay out my argument's clear, crystalline lines, I must digress, unless you remember your high school math from days gone by: Skip to "The Fixed and the Floats" sidebar for a brief rehash, if needed.

All digital audio systems are, at heart, little silicon math majors. AES/EBU PCM data usually starts life as a sampled representation of some acoustical or electrical event and is stored as a 24-bit data word. Thus, AES/EBU audio is 24-bit, fixed-point data by definition. Yet many hardware DAWs use 32-bit, floating-point arithmetic to process what was once your AES/EBU data. Questions arise here: First, because 32 is larger than 24, are 32 bits better? Also, what happens when you convert a fixed-point sample to its floating-point equivalent? Well, my opinion is "no" and "not much," respectively, but read on and decide for yourself.

Strictly speaking, there is no difference between expressing a number—in our case, an audio sample—as either fixed or floating-point. *Given sufficient precision*, they are equivalent, but therein lies the rub. I'll dig into the subject of sufficient precision in a future column, but for now, let's stick with the 24 vs. 32 discussion. In audio circles, 24 bits are the AES-mandated word length, so some products use 24-bit, fixed-point number crunching. On the other hand, floating-point arithmetic lends itself to simple digital signal processes like gain change and mixing, so 32-bit,

# BURN WITH THE BEST



**BurnIT**  
CDR830 COMPACT DISC RECORDER

Pictured: HHB CDR830 BurnIT PLUS CD Recorder  
Also available: HHB CDR830 BurnIT standard model

Why compromise when you can afford to burn with the best?

The wallet-friendly HHB CDR830 BurnIT is packed with pro features like 24-bit AD/DA converters, an advanced laser assembly, SCMS-free digital inputs and both analog and digital synchro recording modes. And if you need even more connectivity, a little extra money buys the new BurnIT PLUS, adding professional mic/line switchable balanced analog I/O, balanced digital I/O, a word clock input and parallel remote control to the already impressive BurnIT spec.



Of course the best hardware deserves the best media.

HHB CD-R discs are designed specifically for professional audio recording, using an advanced Phthalocyanine recording layer for maximum performance and long term archival security.

So don't take chances with your valuable recordings. Visit the HHB web site or contact your HHB dealer for more information on the HHB CDR830 BurnIT and BurnIT PLUS CD recorders, and HHB CD recording media.

For details of your nearest dealer, visit [www.hhbusa.com](http://www.hhbusa.com)

HHB Communications USA Inc., 743 Cochran Street, Buildings E & F, Simi Valley, CA 93065-1976, USA T: 805 579 6490  
F: 805 579 8028 E: sales@hhbusa.com • HHB Communications Canada Ltd., 260 King Street East, Toronto, Ontario M5A 4L5,  
Canada T: 416 867 9000 F: 416 867 1080 E: sales@hhbcanada.com • HHB Communications Ltd., 73-75 Scrubs Lane,  
London NW10 6QU, UK T: 020 8962 5000 F: 020 8962 5050 E: sales@hhb.co.uk



floating-point processing is commonly used throughout the audio industry. In these cases, the 24-bit fixed standard is equivalent to the 24-bit mantissa, plus 8-bit exponent used in the 32-bit, floating-point version.

There's a saying that the devil's in the details, and low-level detail is what many engineers work very hard to preserve. James Moorer, former tech chieftain at Sonic Solutions and now with Adobe Systems, is a longtime proponent of fixed-point arithmetic. In an AES paper ("48-Bit Integer Processing Beats 32-Bit Floating-Point for Professional Audio Applications," presented at the 107th AES Convention, September 24-27, 1999, Preprint Number 5038 [L-3]) discussing the advantages of double-precision fixed-point vs. single-precision floating-point DSP, he states that "...there is an advantage to using integer arithmetic in general, in that most integer (24-bit, fixed-point) arithmetic units have very wide accumulators, such as 48 to 56 bits, whereas 32-bit floating-point arithmetic units generally have only 24 or 32 bits of mantissa precision in the accumulator. This can lead to serious signal degradation, especially with low-frequency filters."

The signal degradation mentioned translates into 3 or 4 bits of precision, by

the way—not much in the grand scheme, but when multiple operations are performed on a signal, small errors can quickly add up. The accumulator that Moorer mentions is a temporary memory location, or register, that stores the result of an addition or multiplication operation. Any bits that don't fit in the accumulator must be thrown out, usually via a rounding operation.

Moorer is talking specifically about DSP implementations; that is, the manner in which integrated circuit designers chose to build their chip-level products. In this case, he's referring to the Motorola 56k family of DSPs: 24-bit, fixed-point machines with 56-bit accumulators. A common choice for floating-point DSP is Analog Devices' SHARC family, which is a 32- or 40-bit, floating-point device with a 32-bit mantissa accumulator.

The 56k and SHARC are two common hardware examples, but host-based, software-only DAWs largely use the CPU's built-in fixed- or floating-point processing. Because personal computers are general-purpose devices, they can perform most arithmetic operations they are called upon to do, though it may not happen as quickly as a purpose-built hardware device. By the way, SHARCs have some interesting register features, but, for sim-

plicity, I'm gonna skip their trick stuff and stick with the basic concept.

So, the bottom line: First, carry "enough" significant digits from one DSP operation to the next. Second, when you have to throw out extra "low-order" bits, do so sensibly so that residual low-amplitude information will not be lost. Finally, when it comes time to down-res that 24- or 32-bit master to a 16-bit consumer format, carefully redither it. If done properly, the conversion from a long word length file to a shorter word length distribution master will carry most of that quiet information, even though the "extra" bits are gone.

One question you may be asking now is why designers choose one processor architecture over another? I'm not sure, but methinks it has something to do with parts' costs and programming complexity. An example is that SHARC family, which has less-than-stellar "development tools," as programming aids are called, but is inexpensive and easy to hook together when an application calls for many DSPs; hence, their seeming ubiquity in low-cost digital audio gear or where gazillions are needed, as in a digital console. Also, once a DSP choice has been made, the corporate culture tends to discount other architectures due to familiarity and a wealth of in-house wisdom about the chosen part.

Through all of this, realize that microphone choice and placement, which pre-amp and converter you use, gain staging, signal path and circuit topologies, along with redithering choices, usually have far more effect on the final sound than the arithmetic used in a professional DSP product. Also, I feel that all this fussing is moot if you're working on pop music without dynamic range and way too much processing. However, once an analog signal is sampled, then quality issues are dictated by, among other things, subtle product-design trade-offs, including how "excess" data is handled. So, the 24 vs. 32 argument really comes down to implementation, either in hardware or software. If your gear "does the math" carefully—that is, conservatively performs the DSP—then it will produce a higher-quality result; why we're all in this business. ■

*This column was written while under the influence of reruns of Buffy: The Musical and the cool jazz grooves of Stan Getz's Focus. For links to DAW manufacturers, both fixed and floats, head on over to [www.seneschal.net](http://www.seneschal.net).*

## THE FIXED AND THE FLOATS

Computers can perform their computations in one of two ways: Either the math is fixed-point, as you or I would do in long-hand arithmetic, or it's floating-point, which in high school is called scientific notation. Fixed-point notation is a method of expressing a value by having an arbitrary number of digits before and/or after a decimal point: 0.0079, 3.1415 and 8,654.63 are all fixed-point expressions. Floating-point takes another tack by using a "mantissa" and "exponent." The mantissa provides the significant information, or digits, and the exponent provides a scaling factor that shows how big the number is. Some examples:

FIXED POINT	FLOATING POINT	SCIENTIFIC NOTATION
.0079	7.9 times 10 <sup>-3</sup>	7.9EE-3
3.1415	3.1415 times 10 <sup>0</sup>	3.1415EE1
865,426.3	8.654263 times 10 <sup>5</sup>	8.654263EE5

Notice that the floating-point versions have a single digit, a decimal point, then the rest of the significant digits. Also, grok that any number raised to the first power equals 1, so multiplying anything by 10<sup>1</sup> is the same as multiplying by 1. So, 75 times 10<sup>1</sup> equals 75. Finally, notice that the exponent, or "power" to which the number 10 is raised, is equal to the decimal places that the decimal point has been moved from the fixed-point version: Positive values move the decimal place to the right, and negative values move the decimal point to the left. By the way, scientific notation is a geekspeak way of writing a floating-point number in a compact way, with "EE" standing in for "times 10 to the power of."

—Omas

# Audio Monitors That Promise *More Than* Just Accuracy.



**Introducing ProDesk™** Reference monitors that render traditional two-way monitors obsolete and make most large (and costly) three-way systems look, and sound, a little silly.

With the same design as the revolutionary Sky System One,™ they're the ultimate in powered speakers. A true 2.1 system with integrated sub-woofer and two satellites (five in 5.1 Surround). They deliver full range audio for music, film and video- replete with the essential low frequencies that are missing in old designs. And like all Blue Sky products, these sealed, compact boxes contain more high technology than is visible from the outside.

So while other monitors promise mere accuracy, Blue Sky delivers something that is somehow more...**exciting**. To find out more about why Blue Sky monitors can do what they do see your Blue Sky dealer or visit [www.abluesky.com](http://www.abluesky.com).



**Sky System One™** available in 2.1 (\$1595 MSRP) and 5.1 surround, including remote Bass Management Controller (\$3795 MSRP). 2.1 system easily upgradeable to 5.1.

**ProDesk™** Available in 2.1 (\$1195 MSRP) and 5.1 surround, including BMC (\$3090 MSRP). Optional hand-held Functional Volume Control available for 2.1 systems. 2.1 system easily upgradeable to 5.1.



World Radio History



## Tools of the Trade



### TRIDENT AUDIO 5.1 CONSOLE

Now available in the U.S., the Series 80-5.1 recording console from Trident Audio Ltd. ([www.trident-audio.co.uk](http://www.trident-audio.co.uk)) is designed for full 5.1 surround sound and stereo mixing. The center master section includes a 2-channel hi-def EQ and stereo compressor/limiter for 2-track mastering. Incorporating the mic pre and EQ from the popular Trident Series 80, the Series 80-5.1 offers PPM channel meters, VU master output meters, eight aux sends, plus eight stereo returns with routing, EQ and pan/balance control. The automation-ready console is available in several input configurations and includes an external patchbay, and features such as global mode select and fader and EQ flip. A fully automated, 48-input console with remote patchbay is priced at under \$100,000.

in a pro studio. The bidirectional unit has four separate amplifiers to convert stereo inputs and outputs from unbalanced -10dBV levels to +4dBm balanced 600-ohm lines. The front panel offers output-level adjustment, and up to three units can be mounted in an optional rack shelf.

### MAGIX SAMPLITUDE AND SEQUOIA

MAGIX (dist. by X Vision Audio, [www.xvisionaudio.com](http://www.xvisionaudio.com)) is now shipping its Sequoia 7.0, Samplitude 7.0 Classic and Samplitude 7.0 Professional audio recording/editing environments. Designed for post-production/broadcast applications, Sequoia 7 is a high-definition DAW

hanced import/direct access to SD2 files. Samplitude is now offered in two different versions: Samplitude 7.0 Classic offers ASIO support, POW-R dithering, batch processing, VST and DirectX plug-in support and more. In addition to the new features in the Classic version, Samplitude 7.0 Professional adds real-time room simulation, native VST instruments, a MIDI editor and more.



### BBE SONIC MAXIMIZERS

BBE Sound Inc. ([www.bbesound.com](http://www.bbesound.com)) offers a new version of the Sonic Maximizer plug-in, which now supports both Mac and PC VST platforms, as well as DirectX. The new plug-in allows unlimited user-definable presets, real-time preset changes, full MIDI implementation and is based on BBE's proprietary fourth-generation Sonic Maximizer processor. New hardware-based 482i and 882i Sonic Maximizers feature 1% metal-film resistors and military-spec PCBs with extra-thick traces.

### ART DUAL DIRECT BOX

Applied Research and Technology ([www.artproaudio.com](http://www.artproaudio.com)) has released the ART dPDB™ Dual-Passive Direct Box. Featuring two high-quality direct boxes in one enclosure, the dPDB features switchable input attenuators (0 dB, -20 dB, -40 dB) and a switchable ground lift for each channel. Inputs are 50k ohm instrument input jacks and outputs are 600-ohm XLRs and link jacks to connect to an instrument amp. Retail is \$60.



### HENRY ENGINEERING MATCHBOX

Henry Engineering ([www.henryeng.com](http://www.henryeng.com)) has updated the Matchbox level and impedance converter. Featuring direct-coupled active circuitry, a built-in AC power supply and over 100 dB of dynamic range, the Matchbox simplifies interfacing consumer or semi-pro gear

with specialized functions such as source-destination cutting and professional cross-fade editing for film/video/radio dialog editing and classical production montages. New features in Sequoia 7 include real-time room simulation, batch processing, ASIO and native VST support, low-latency monitoring, VSTi support and en-

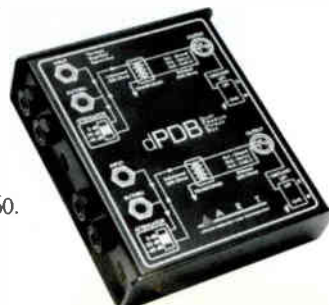



**REALTRAPS ACOUSTIC ABSORBERS**

RealTraps ([www.realtraps.com](http://www.realtraps.com)) has introduced a line of wood-panel membrane absorbers that provide a flexible, affordable acoustic-treatment solution that can be easily moved or rearranged. Less than six inches deep, the highly efficient RealTraps are two feet wide, but are available in 4/6/7.5-foot heights to accommodate different rooms. Models for LF, upper bass and midrange/HF absorption can be combined to tame the entire audible range. Angled front surfaces greatly reduce flutter echoes and ringing. A six-trap basic starter kit (two low bass, two high bass and four soft absorbers) is \$2,992.

**STEINBERG HALION STRING EDITION**

Steinberg ([www.steinberg.net](http://www.steinberg.net)) is now shipping HALion String Edition—Volume 1, a complete string orchestra for computer-based music production. The included specially developed VST- and DirectX-compatible player provides a direct connection to production systems such as Cubase SX, Cubase SL and Nuendo. This 5GB collection includes complete orchestral strings (double basses, celli, violas and violins), playing styles such as legato, tremolo, pizzicato or spiccato, and is suitable for all forms of music, from classical to pop. The PC (Windows 98/ME/2000/XP)- or Mac (OS 9.x or OS X Version 10.2)-compatible software requires Cubase VST 5.1 or higher, Cubase SX/SL, Nuendo or other VST 2.0 or DXi-compatible host application.

**BEHRINGER DIGITAL PREAMP/VOICE PROCESSOR**

Behringer's ([www.behringer.com](http://www.behringer.com)) Ultra-Voice Digital VX2496 signal preamp/voice processor is based on the company's VX2000, but is 24-bit/96kHz-compatible and features an additional AES/EBU output. A discrete ULN mic/line input stage with soft-mute +48V phantom power is followed by an opto compressor with integrated dynamic enhancer.



The voice-optimized equalizer offers 3-band EQ, one of them sweepable. Additional features include a true RMS expander, tube-emulation circuitry and an opto de-esser. The AES/EBU output offers selectable 44.1, 48, 88.2 and 96kHz sampling rates, and the unit accepts external clocking. MSRP: \$199.99.

**DIGITECH BASS GUITAR DAW**

The BNX3 Bass Guitar Digital Workstation from DigiTech ([www.digitech.com](http://www.digitech.com)) combines a powerful, multimodeling bass guitar processor with a digital 8-track recorder. The BNX3 offers a selection of 17 popular bass amp models and 12 popular bass cabinet models. Additional features include mono, stereo and bi-amp output modes; JamMan delay looper; drum machine; chromatic tuner; balanced XLR mic input; and 65 user or

factory presets. The BNX3's built-in digital 8-track recorder features hands-free operation, so bassists can record, playback, auto-arm the next track or delete tracks without touching a knob. The BNX3 can import MP3, .WMA and .WAV files, and tracks can be saved to SmartMedia cards or exported to CD via included Cakewalk and Pyro software. Retail: \$719.95.

**BITHEADZ PHRAZER SMART LOOPS**

BitHeadz ([www.bitheadz.com](http://www.bitheadz.com)) offers new Phrazerized loop titles based on the Smart Loops™ collection. Phrazer Smart Loops Electric Guitars has over 950 loops, ranging from clean and wah to heavy

distortion. The Drum & Percussion title has 670 "phrazerized" loops with instruments including drum kits, congas, bongos, triangles, wood blocks and many more. Phrazer Bass Guitars provides four different playing styles in the 950 loops. All three titles can be easily brought into Phrazer 2.0, Phrazer LE or any of the Unity 3.0 products. Styles include rock, pop, funk and more. MSRP is \$69/title or all three for \$120 from BitHeadz' online store.

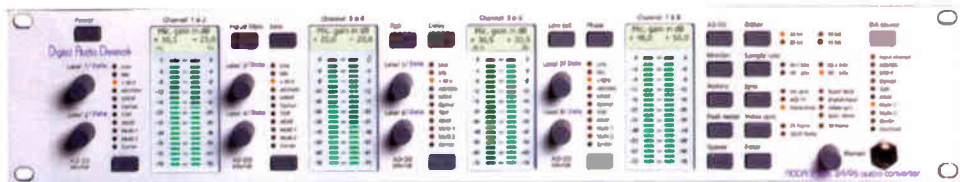

**DIGITAL AUDIO DENMARK CONVERTERS**

Popular in Europe, D.A.D.'s line of digital converters is now available in North America via Sascom Marketing ([www.sascom.com](http://www.sascom.com)) at factory-direct prices. The 2-channel ADDA 2402 AD/DA converter and the 8-channel ADDA 2408 AD/DA/DD converter are both 24-bit, 96kHz models. The ADDA 2402 has balanced XLR and unbalanced RCA analog I/O; digital connections include AES/EBU, S/PDIF (optical and co-ax) and Word Clock In/Out. The fully modular, field-expandable ADDA 2408 boasts an impressive array of features: D/D sample rate conversion; AES/EBU, S/PDIF, TDIF, ADAT and Pro Tools I/O available; eight low-noise mic preamps with 0.5dB/step gain control; phantom power; +48V and low-cut filter; a built-in 8-channel digital mixer for convenient monitoring/soloing in L/R or M/S stereo; additional optional D/A outputs for 5.1/7.1 monitoring; selectable dither 16, 18 and 20-bit outputs; 21 LED peak meters; and MIDI or USB remote control.

**CAKEWALK SONAR DIGI SUPPORT**

Cakewalk ([www.cakewalk.com](http://www.cakewalk.com)) announces that its flagship Sonar audio/MIDI production software for Windows will support Digidesign audio hardware, including the Digi 001, 002, Mbox and Pro Tools|HD products. Digidesign users can now expand their PC studios with Sonar's integrated audio and MIDI recording software, including DirectX audio effects, DXi software synths, ACID-compatible loop-editing tools and support for ReWire instruments. Cakewalk will support Digidesign hardware using Digidesign's recently announced ASIO drivers for Windows XP. Cakewalk will provide a driver update to all registered Sonar 2.x customers.

**DOLBY SURROUND TOOLS FOR PT|HD**

To handle the demand for LCRS surround-encoded programming, Digidesign ([www.digidesign.com](http://www.digidesign.com)) releases Dolby Surround Tools, which support the

96kHz sample rate capabilities of Pro Tools|HD. Using these Dolby Surround LCRS encoder and decoder TDM plugins, users can produce LCRS Dolby Surround mixes on Mac- and Windows-based Pro Tools TDM systems for videos, TV shows, ad spots, multimedia, CDs and video games. The encoding/decoding processes match those of Dolby's industry-standard SEU4 and DP563 hardware encoders and SDU4 and DP564 hardware decoders. Users who are registered for both Dolby Surround Tools and Pro Tools|HD will be automatically mailed the Dolby Surround Tools update kit. Pro Tools|MIX customers registered for Dolby Surround Tools can upgrade to Dolby Surround Tools Version 3.0 for \$95 through Digidesign's customer service.



**JOSEPHSON SERIES FOUR CARDIOID CONDENSERS**

The C42 and C42H (\$480) from Josephson Engineering ([www.josephson.com](http://www.josephson.com)) are designed to record acoustic or amplified instruments, instrumental ensembles, choirs, sound effects and vocals. These cardioid condenser mics feature discrete FET electronics and transformerless outputs. Response is rated at 40-20k Hz. The C42's maximum SPL handling is 135 dB; intended for close-miking, the C42H is rated at 155 dB. The mics are housed in stainless steel with a satin finish. The man-

ufacturer also offers a matched pair of black-chrome-finished C42 microphones (C42MP) in a carrying case for \$1,060.

**PHONIC PERSONAL AUDIO ASSISTANT**

Phonic's ([www.phonic.com](http://www.phonic.com)) handheld PAA2 packs a 31-band real-time spectrum analyzer, SPL and dBu/dBV/VAC level meter, tone generator, EQ setting program, SPL meter calibration and phase-tester into a compact unit. A peak-hold option lets users store readings in recallable memory locations. Its large, high-resolution graphic LCD offers high-definition spectrum analysis in clear, easy-to-read levels from pull-down menus. An XLR connector enables measurement of line levels, displayed in a choice of dBu, dBV or volts; measurements can be flat or A- or C-weighted. A PC interface allows controlling all functions via a computer or laptop.



**MACKIE D8B VERSION 5.0**

Mackie Designs ([www.mackie.com](http://www.mackie.com)) announces a major software upgrade for its Digital 8•Bus (D8B) recording console. Version 5.0 improvements include independent surround-monitoring level controls and on-surface surround-monitor control. A HUI (Human User Interface) layer lets the D8B function as an



VALUE • INTEGRITY • PERFORMANCE

# Studio Reference Quality at HIGH SPL...

At any price, these new  
enclosures will amaze you...

In the 70 year tradition of legendary excellence of Wharfedale's Hi Fidelity designs comes a family of truly PRO enclosures second to none in the industry...the TWINS.

## The Twin Series from Wharfedale Pro

Listen carefully to them first...see the quality...hear the performance...for yourself...And when you check into it a bit further, you won't believe the price. In fact, if possible, don't ask for pricing until you have heard them...you don't want to bias your perceptions before the audition...at first it seems too good to be true...but trust us...it is true. Pros have expected to pay two to three times what these sell for...no exaggeration.

The Twins offer no compromise design and construction with world class performance at an entirely new low price. Our own manufacturing power base enables us to do things better and more efficiently. Point Source coaxial drivers provide a detailed coherent sound image with incredibly tight low end... and amazing "bark" when used as personal wedge or stand mount monitors. When used as mains with the birch 15" sub woofer and integral crossover, you have the ultimate in sound reinforcement fidelity attainable in a compact portable system. The Twins also make a highly effective array solution. Even the smaller 8" and 10" produce a very strong bottom end from coupling... you must hear this to fully appreciate it. The mids

and highs also coherently couple giving amazing intelligibility in cluster arrangements. These are just a few of the great things discovered by pros that are using them. Our dealer base is a highly select group so call us for info about where you can audition these amazing new enclosures and hear for yourself the full story of the Twins from Wharfedale Pro.

- Versatile wedge shape for mains, clusters, or floor monitor applications
- Premium 18mm Birch Plywood Construction – Durable Ameraguard™ covering
- Integral rigging points, ATM track and built-in stand adaptor
- Precision Wharfedale Cast aluminum frame drivers
- Pro Tech protection for the 50mm titanium compression driver
- Metal protective grille with foam exterior for the "clean" pro look in any venue or application
- High Power output, low distortion sound quality
- Speakon connectors – two in parallel
- Integral crossover in the matching birch sub
- 5 year transferable warranty

Contact Wharfedale Pro Sales at:  
IAG America, Inc.  
15 Walpole Park South, Walpole,  
MA 02081  
508-850-3950  
508-850-3905 FAX  
www.iagamerica.com

Contact directly to the  
President of IAG  
Professional  
in America – Lance Schmidt  
e-mail: iagpro@aol.com  
e-fax: 309-416-1027

The Diamond 8.1  
NFM

IAG

automated control surface—with I/O—for popular DAW platforms. Updated dynamics algorithms offer better-sounding gates and compressors. Onscreen track sheets and channel notes are easily exported as html files to share session data with other users. A completely updated GUI (graphical user interface) provides new views for all EQ and dynamics in a graphical format, and plug-in chaining capability permits daisy-chaining of up to four plug-ins for one send, which allows users to double, triple or quadruple the number of plug-ins assigned to one input. The \$299 software upgrade is downloadable from [www.mackie.com](http://www.mackie.com), and is included free with all consoles shipped after December 16, 2002.

#### PLANET WAVES CUSTOM RCA CABLES

Planet Waves ([www.planet-waves.com](http://www.planet-waves.com)) offers a range of customizable RCA cables in complete kits (12-foot double cable plus 12 plugs; 12-foot single cable plus 12 plugs; 6-foot single cable plus

six plugs) that include a free screwdriver, or as individual components (25-foot double or single cable; RCA plug 12-pack or two-pack). The plugs have patented compression springs to guarantee a tight connection with the jack, and are gold-plated for better conductivity.

#### EDIROL USB MIDI KEYBOARD

The \$225 PCR-30 from Edirol ([www.edirol.com](http://www.edirol.com)) is a 32-key, velocity-sensitive controller with eight knobs, eight sliders

and nine buttons—all programmable to send any MIDI message. A USB connection provides a single-cable connection to PCs or Macs, as well as providing power to the unit. MIDI I/O, sustain and expression-pedal inputs and a pitch-bend/modulation lever are standard, as are preset memory locations with templates of leading audio/MIDI sequencers; additional presets are downloadable from Edirol's Website. The company also offers the \$295 PCR-50, a similar version with 49 keys.



## UPGRADES AND UPDATES

TC Works has added the 24/7-C vintage compression and limiting plug-in to the PowerCore platform. Available as a free download to all registered PowerCore users, 24/7-C can be found at [www.tcworks.de](http://www.tcworks.de)...Markertek Video Supply's 2003 catalog lists and illustrates thousands of audio and video products, including mixers, processors, amps and monitors, CD recorders and duplicators, cables and connectors, patchbays, diagnostic tools, racks and panels, accessories, distribution amplifiers, switches and converters. Call 800/522-2025 or visit [www.markertek.com](http://www.markertek.com) for the 374-page catalog...VideoHelper's *Return of the Scoring Disc* is the second in a series of production music discs, and includes a 28-page user guide, with tips on editing, searching the VideoHelper production music libraries and making the best use out of the Website. Call 212/633-7009 or visit [www.videohelper.com](http://www.videohelper.com) for more... The 2002 Comprehensive Video Group catalog includes hundreds of cables, connectors, distribution amplifiers, switches and converters. For a free 130-

page catalog, call 800/526-0242 or visit [www.comprehensivevideo.com](http://www.comprehensivevideo.com)...Now available: *Volume 7* of Cool School Interactive's CD-ROM training course covers Steinberg's Cubase SX using a fun, hands-on approach that focuses on key operational techniques and advanced new features of Cubase SX. For more info, visit [www.coolbreezesys.com](http://www.coolbreezesys.com)...M-Audio's Maximum Audio Tools is a powerful software bundle included free with all of its soundcards and keyboards. The bundle includes: Ableton Live Delta audio sequencer (special edition), 125 MB of ProSession Series .WAV/REX samples, ArKaos VJ VMP visual-performance software (special edition), IK Multimedia SampleTank SE VST sample player (special edition) and D5ound RT Express VST host with .WAV player (special edition). Check it out at [www.m-audio.com](http://www.m-audio.com)...Big news for Powerbook fans: Mobility Electronics, developer of the MAGMA Series of PCI Expansion Systems, announces that Mac OS X operating system (Version 10.2.2) now provides support for MAGMA CardBus-to-PCI expansion sys-

tems. Users of MAGMA systems may now select from numerous operating systems for laptops: Windows 98/SE/ME/NT/2000/XP, Mac OS 9.x and now OS X...ILIO Entertainments' new Website has demos of ILIO's own products, Spectrasonics Virtual Instruments and libraries, Sonic Reality and the Vienna Symphonic Library, as well as software patches and informational tools for producers, composers and remixers. Visit [www.ilio.com](http://www.ilio.com)...Propellerhead Software and M-Audio teamed up to create *Producing Music with Reason*, an interactive CD-ROM covering Propellerhead's award-winning Reason software with three hours of tutorials and resources for beginning through advanced users. The CD-ROM retails at \$39.95, and works on Windows and Macs. (Mac OS X is not supported at this time.) Check it out at [www.propellerheads.se](http://www.propellerheads.se)...Ableton is now bundling its Ableton's LIVE 2 audio-sequencing software with a free version of the Sonomic Online Library Card for samples and sound effects. For details, visit [www.ableton.com](http://www.ableton.com). ■

OUR TECHNOLOGY | YOUR CREATIVITY

# PYRAMIX V4.1

VIRTUAL STUDIO

## THE MOST OPEN DAW IN THE WORLD!

### NOW HAS DIRECT PROJECT INTERCHANGE WITH...

- > Akai - DD/DR Series
- > Sonic Solutions
- > Pro Tools

### PLUS, INDUSTRY STANDARD INTERCHANGE THROUGH...

- > AES31 - (DAR, Fairlight, SADIE, Waveframe, ...)
- > Open TL - (Logic Audio, Nuendo, Tascam, ...)
- > OMF - (Avid, Incite and most NLE systems)



[www.merging.com](http://www.merging.com)

SWITZERLAND: TEL. +41 (0)21 946 0444  
USA: TEL. +1 (947) 272 0500  
EUROPE / ASIA: TEL. +44 (0) 1606 892788

World Radio History



**MERGING**

www.pyramix.com

# Digidesign Digi 002

## Welcome to the Next Generation for Pro Tools

The Digi 002 is a native 32-track software/hardware system for Windows and Mac that falls right in the middle of Digidesign's DAW lineup. It includes Digidesign's well-known Pro Tools LE and a healthy collection of bundled RTAS-format plug-ins from Digidesign and third-party developers. The hardware unit has a look that's vaguely reminiscent of '50s sci-fi tech, and contains the audio interface, an outstanding motorized touch-sensitive control surface and a 1x2 MIDI interface; all information gets carried down a single FireWire cable to/from the host computer.

The 002 operates at resolutions up to 24-bit/96 kHz, and it has eight analog ins (four with mic preamps), an 8-channel ADAT Lightpipe port (switchable to optical S/PDIF) and RCA S/PDIF digital I/O. It also has six analog outs and stereo main outputs with parallel monitor outs. Just hook up an amp/speakers for a fully self-contained production rig.

Digidesign refers to the 002 as a "Pro Tools workstation," because Pro Tools LE session files are 100% compatible with other Pro Tools system. The only considerations are that Pro Tools LE just opens the first 32 tracks and the only other Pro Tools system that supports 96 kHz is Pro Tools|HD, which also supports 192 kHz. Pro Tools LE will even attempt to open RTAS host-based versions of hardware TDM plug-ins from sessions created in Pro Tools MIX or HD systems.

The 002 can operate as a stand-alone 8x4 mini-digital mixer with snapshots and built-in EQ, dynamics and reverb. Its DSP and converter-latency-only monitoring are commandeered for the 002's regular activities when you're using the mixer in Pro Tools mode (i.e., with a computer), but you regain the use of the Lightpipe and S/PDIF ports, bringing the potential number of simultaneous computer ins and outs to 18.

### HARDWARE DETAILS

In addition to the I/O listed above, the 002 has a stereo pair of -10dBV RCA outputs that parallel the main outs. There's also a



pair of RCA ins that can be switched to function like 2-track monitor returns or to step in for the 1/4-inch jacks feeding analog ins 7 and 8.

Deluxe inputs 1 through 4 are the mic/line channels; their sources can be toggled on the panel between XLR mic and 1/4-inch TRS line/instrument inputs. These channels also have gain knobs, rumble filters and 48-volt phantom power that can be turned on in pairs.

The remaining line inputs 5 through 8 have switches to select -10dBV or +4dBu operation. The 002's analog I/O is electronically balanced, and the ins/outs are happy with either kind of signal or load.

Other notables: The main outs list marginally better specs than the monitor outs (112dB dynamic range rather than 110dB); Mute and Mono switches are provided for the monitor out; there's a built-in headphone jack with its own level control; and you can punch in and out when recording audio or MIDI using a footswitch. To my ears, the 002 sounds clean and crisp, easily meeting my expectations in comparison to other mid-price project studio units. Someone recording a major-label release could use onboard high-end mic preamps and converters, but what goes in is pretty much what comes out.

### PRO TOOLS LE

Pro Tools has gained widespread professional acceptance as an audio production system; it's now familiar enough that we won't cover it in great detail. In fact, you can download Pro Tools Free, a functional 8-track Windows/Mac version from [www.digidesign.com](http://www.digidesign.com) at no cost and check it out up close.

In addition to the 32 audio tracks (plus unlimited "takes"), the Pro Tools LE Version 5.2.2 included with the 002 features 128 MIDI tracks that run side-by-side with the audio. Subjectively, Pro Tools is an outstanding production program and, for those of us using MIDI, a passable composition program—unless you don't rely on quick and extensive editing or integrated notation and other now-standard MIDI sequencer features. Pro Tools does do a very good job with MIDI timing, though, and many users import MIDI files into Pro Tools at the last stage to use the program for its audio production features.

For those people, there's a Windows 002 ASIO driver so that you can use the unit as an audio interface (but not a control surface) for the software of your choice. Digidesign says that it's working on a CoreAudio OS X driver for Mac, but there's no OS 9 ASIO or Direct I/O driver.

Probably the most ballyhooed difference between the full and LE versions of

Put your whole  
sound in the  
sweet spot.



## TAMPA-The Professional Mic Preamplifier and Compressor with Temporal Harmonic Alignment™

TAMPA is a professional microphone/instrument preamp unlike any other. That's because our design team set out to discover just why expensive tube technology sounds so good, and devise a way to land that sound at affordable solid state prices. The result is far beyond tube modeling. It's a whole new technology called Temporal Harmonic Alignment™. TAMPA even comes with direct digital output and world-class dual optical servo compressor built-in.

Unlike most solid state electronics, tube-based devices strike the ear as having such a "warm" sound because the added mid-range harmonics have the same temporal relationship as natural mechanisms like strings, drumheads and vocal chords. This results in a sweet spot that makes vocals, guitars

and other midrange-rich content sound especially pleasing. TAMPA's revolutionary new Temporal Harmonic Alignment technology produces that same phase relationship found in both tubes and nature. And unlike tubes, TAMPA's sweet spot spans the full spectrum of your sound from bass to cymbal.

- >> Class A circuitry throughout
- >> Built-in dual optical servo compressor/limiter
- >> Variable impedance optimizes vintage mic performance
- >> Available 66dB system gain
- >> S/PDIF and AES/EBU output to digital recording gear



**M-AUDIO**  
Redefining the Studio™

See the M-AUDIO dealer near you or visit us online: [www.m-audio.com/tampa41](http://www.m-audio.com/tampa41)

Pro Tools is that there's no timecode ruler in LE. Contrary to popular opinion, you actually can still lock Pro Tools LE to timecode. The program supports MTC trigger sync; while the 002 hardware doesn't have a wordclock input, it can clock to a "digital black" signal at its S/PDIF digital input. A good outboard synchronizer will let the 002 get its address location from MTC and its clock from the synchronizer.

One surprise we discovered in the heat of battle, however, is that the 002 will only lock to "consumer" RCA S/PDIF; it doesn't use the hybrid AES/S/PDIF format, and it won't work with an XLR-to-RCA adapter on an AES/EBU line. Also note that S/PDIF is only a 44.1/48kHz format; you can't use it in 88.2 or 96kHz sessions.

This version of Pro Tools LE is quite solid. I did encounter a couple of unrepeatable anomalies (such as tracks' input selector offering optical S/PDIF as a choice when the system was set to RCA S/PDIF input), but nothing that stopped the show or that didn't go away after a restart.

The 002 comes with a complete collection of RTAS format plug-ins. Most of these are Digidesign's, covering the gamut of frequency- and time-based effects and processes: EQ, reverb, time stretching, delay, dynamics, a signal generator, audio manglers and more.

Three processors from Waves' Renaissance collection are also part of the bundle. One is the Renaissance Reverb, which is decent as host-based reverbs go—faint praise, but praise nonetheless. The other two from Waves are as good as any plug-in available: the Renaissance EQ and Renaissance Compressor, making this a pretty major pot-sweetener.

The unit we received also had a version of IK Multimedia's SampleTank sample preset player and AmpliTube guitar amp modeler. SampleTank has some really nice sounds, and AmpliTube happens to work very well on drums. Native Instruments' Pro-52, an impressive re-creation of the classic Sequential Circuits' Prophet 52 analog synth, was also included. These plug-ins may or may not be bundled by the time you read this review.

Note that plug-ins must be adapted to work on the 002, if for no other reason than to support the higher sampling rates.

## SYSTEM REQUIREMENTS

Digidesign publishes very specific details about the computers and peripherals it certifies to work at the specified performance level with its systems. Windows systems require Windows XP, and it suggests a 2.0-plus-GHz Intel Pentium 4 or AMD

AthlonXP 2000+ processor for best results.

Mac systems require an "Ice White" iBook (G3/500) or 2000 Powerbook "Pismo" G3/400 or better, with a G4 strongly recommended. Most of the time, we ran the 002 on a "Quicksilver" dual-1GB Mac, and that machine did great.

However, the G4/500-upgraded Pismo we tried—an admittedly unapproved device, but one that should meet spec—was another story. The FireWire implementation on some earlier FireWire Macs is tenuous, and the 002 has a lot of FireWire activity going on, between 36 open audio channels (18 in either direction), MIDI and its control surface.

With a freshly defragmented FireWire disk, this machine huffs and puffs its way to delivering 32-track simultaneous recording/playback at 24 bits, 44.1 or 48 kHz; 24 tracks is more realistic, and even then, you can't loop heavily edited passages. At 88.1 or 96 kHz, that number goes way down, and once you get the "disk too slow or fragmented" message, the system digs its heels in.

Digidesign means it when it advises you against using the internal drive for recording. It's only possible to record a couple of tracks onto the Pismo's slow internal drive. I was hoping to use the 002 to record impulse responses of Los Angeles' Zipper Hall for Audio Ease's Altiverb—which, incidentally, is one of the plug-ins that works on the 002—but it dug its heels in, and we had to use a backup device (which worked fine).

Did the G4 upgrade interfere with the Pismo's FireWire performance? It seems unlikely, yet Digidesign has tested the 002 with Pismo Powerbooks and found it worked. In any case, if you have a fast Intel Pentium 4 or AMD Athlon machine, or a recent G4 Powerbook or desktop computer, you should be delighted with system performance.

## CONTROL SURFACE

Digidesign's engineers obviously put a lot of thought into the 002's approximately 19x17-inch (WxD) control surface. It provides far more useful control than other surfaces with a lot more buttons, knobs and display real estate. Rather than wasting the available parts count on things that are much easier on the computer (such as choosing and inserting plug-ins), the designers chose to include just what you need from a surface and nothing more.

Buttons to call up the main screens are there; there aren't any convoluted buttons to assign tracks to outputs. A button to scroll to the master fader is great. And what

you want to see is big and bold. For example, the navigation arrows, which, among other things, scroll up and down banks of eight faders, are big and easy to spot on a raised surface that's positioned exactly where your right hand wants to find them. Meanwhile, the modifier keys are on their own where your left hand wants them to be and your eyes locate them.

Digidesign gets maximum mileage out of the eight touch-sensitive motorized faders—which have a decent, if somewhat light feel—and velocity-sensitive rotary knobs. Touch a fader, and the display in its LED changes from the track's name ("scribble strip") to the level (-10.2 dB, etc.); about half a second after you've stopped touching it, the display reverts back to the track name. Flip mode, which on most consoles assigns send levels to the faders and channel levels to the knobs, is nothing new. But the 002 goes further. Not only can you assign plug-in parameters to the rotary knobs, but you can also assign them to the faders themselves.

The same efficiency is found in the use of the 10 four-digit LED displays, and especially in the 15-light rings around each rotary knob. These rings are cleverly positioned where the surface slopes up and the knobs don't obscure them. They serve to show the pots' positions, and then their lights become channel-level meters.

My only comment applies to all touch-sensitive faders of this ilk: You have to touch the top of a fader for it to sense your touch and release its "clutch": If you want to nudge a fader up from its front edge with your finger resting on the mixer surface, the faders fight you; response over FireWire is very fast.

## THUS

Retailing at \$2,495, the 002 is a well-designed DAW that handily fits a number of applications. For example, it's a nice little studio-in-a-box *a la* weekend warrior's live mixer; it makes an excellent auxiliary Pro Tools system for someone to work on sessions that start and/or end in a TDM Pro Tools rig; it's a great portable rig; and it's the heart of a small professional system that sounds as good as the outboard equipment that you use with it.

With the Digi 002's wonderful control surface, nice audio interface and solid Pro Tools software, this one's a thumbs up!

Digidesign, 2001 Junipero Serra Blvd., Daly City, CA 94014; 800/333-2137; [www.digidesign.com](http://www.digidesign.com). ■

*Nick Batzdorf was the editor of Recording for more than 10 years.*



# The source for those who kind of, sort of, maybe, know exactly what they want.



Audio professionals come to us because we often suggest alternatives that are more cost effective than the original idea. That's because we're committed to making sure you get exactly the right audio gear for your studio. Professional Audio Design has over a hundred lines of new, used and vintage equipment in stock. All serviced by our own staff and fully warranted. Put our ten years of industry experience to work for you. Call us. You'll get all that you want, and everything you need.

**Professional  
Audio  
Design  
Inc.**

**ALWAYS A SOUND DECISION**

357 Liberty Street, Rockland, MA 02370  
781-982-2600. Fax: 781-982-2610.

**[www.proaudiodesign.com](http://www.proaudiodesign.com)**

Email: [info@proaudiodesign.com](mailto:info@proaudiodesign.com)

# Soundelux E47 Tube Condenser Mic

## A Retake on a Studio Classic

When Soundelux Microphone's co-founder David Bock designed the company's new E47 tube condenser mic, his goal was to incorporate the "most essential elements" from the out-of-production Neumann U47 tube mic, while keeping a reasonable retail price. At under \$4,000, the Soundelux E47 offers U47 fans an emulation of the vintage mic at a significant cost savings.

### MIRROR IMAGE

The E47 looks almost exactly like a U47, right down to the distinctive dome-topped head grille. The two mics share the same overall dimensions—2.5 inches in diameter and 8.95 inches in length—but the E47 sports a smaller-diameter connector at its base. The only other difference in appearance is that the E47 has diamond-shaped, head-grille mesh patterns, as opposed to the U47's square patterns. The E47 weighs 1 pound, 6.8 ounces; roughly the same amount as the U47.

The E47 offers two different modes of operation: single- and dual-capsule. The E47 ships from the factory set to single-capsule/variable-cardioid mode, which is how I used the mic for this review. To change the mic's response to dual-capsule mode, which offers continuously variable polar patterns, you must remove the head-grille assembly (containing the capsule) and aluminum mic body, and then flip a switch located on a metal plate above the vacuum tube. I wish that this switch was more readily accessible.

### INCLUDED ACCESSORIES

The E47 is part of a complete system that lists for \$3,950 and comes with a three-year parts-and-labor warranty. The mic ships in a sturdy, foam-lined storage box fashioned from beautifully stained Baltic plywood. The large suspension mount that comes with the mic can swivel through 180° of rotation along its vertical axis. Unfortunately, the suspension mount that I received for review required me to apply a significant amount of torque to the swivel lock to keep the mic from sagging out of position.

The E47 connects to its proprietary power supply using a supplied cable that's roughly 20 feet long and fitted on each end with a 6-pin Tuchel connector; the power supply also features a male XLR connector (for audio output to a mic preamp), power switch, power status LED, IEC receptacle for the detachable AC cord and a continuously variable polar-pattern control knob. This control knob is active only when the E47 is switched to dual-capsule variable-pattern mode. When active, it can smoothly adjust the mic's polar pattern from omni through cardioid to bi-directional mode in a continuous sweep.

The overall diameter of the E47's diaphragm is 1.34 inches if you include its mounting ring, or 1 inch if you don't. The membrane's thickness is 6 microns. The E47 uses a single JAN submini tube in place of the VF14 used in the original U47. (The VF14 was later replaced with a Nuvistor 13CW4 when the former went out of production.) The JAN submini has the same input impedance as a VF14 but a little less input capacitance, resulting in a 1dB bump in the E47's response around 10 kHz, compared to the original U47's response. The JAN submini is internally mounted on springs, padded with silicon foam and heat sunk for long life.

The E47 possesses an input sensitivity of 16.5 mV/PA, ±1 dB, which translates to a considerably hotter output than a U47 produces. Self-noise is rated at 15 dB, A-weighted. The frequency response is stated to be 15 to 18k Hz, ±2 dB. The mic can withstand 134dB SPL for 0.5% THD, a respectable spec for a vintage-style mic.



### HEAD TO HEAD WITH A U47

My first test with the E47 was an A/B comparison with a Neumann U47 tube mic (provided by Village Studio Rentals in North Hollywood) on male lead vocals. The vocals were first recorded at six inches from both mics and at a 24-bit depth to Digital Performer using a Millennia HV-3 mic preamp and a Apogee Rosetta A/D converter. Keeping in mind that every U47 sounds at least a little different due to variances in aging factors, the E47 produced less upper-bass content and more extended and slightly brighter highs than the U47 in this application. The U47's top end sounded a little softer than the E47's, but the Soundelux mic's high-frequency response was nevertheless understated in true vintage-mic fashion.

The E47 and U47 sounded even more alike when I recorded the singer positioned within two inches from the mics. Although the E47 still sounded a bit more present than the U47, it offered more upper-bass proximity effect than the U47. Overall, the timbral differences between the two mics were quite subtle.

### MAKING TRACKS

The E47 adds fullness to whatever source you feed it, while de-emphasizing sibilance. This is not the best mic to record a wooly sounding vocalist. On both male and female singers, the E47 lent a warm, full vintage sound with a soft top end.

The E47 didn't sound open enough on acoustic guitar for my tastes. In this application, the low mids were too full and the high end was not extended enough

# NUENDO

nuendo... ..

untouchable sound

nuendo...

## untouchable sound.



frank filipetti

To capture the sound of their new release **Untouchables**, heavy-hitting band **Korn** turned to digital recording pioneer Frank Filipetti and producer Michael Beinhorn. After painstaking comparisons, the group was unhappy with the way their tracks sounded using other popular DAWs, and found that they could edit and process tracks to their heart's content in NUENDO with absolutely no decrease in fidelity.

"I knew going in that the band was going to be especially vigilant about the sound of their instruments. That's why it was so important for me to find the right digital gear. Nowadays, everyone is accustomed to the manipulations we can perform on a digital platform. But the feature set has to be secondary to the fidelity set. And on that score we found NUENDO second to none."

One might even say.... untouchable.

phil ramone  
rory kaplan  
chuck ainlay  
david tickle  
frank filipetti  
rob hill  
greg ladanyi  
elliott scheiner  
alan parsons



*These world-renowned producers know what it takes to be the best. They also know why NUENDO is the best digital audio production tool available and have partnered with Steinberg to ensure that it will continue to meet the needs of tomorrow.*



 **steinberg**  
Creativity First

www.steinberg.net • US 818.678.5100 • Canada 416.789.7100

World Radio History



## Analysis tool that fits in the palm of your hand

Functions – beyond expectations!  
Specifications – take it for granted!  
Operation – simple & intuitive!  
Expensive – no!

contact:  
NTI North America, 3520 Griffith Street  
St. Laurent, Quebec H4T 1A7, Canada  
t: 1800-661 6388, e: canada@nt-instruments.com



Less noise • More sound

[www.nti-instruments.com](http://www.nti-instruments.com)

to bring out the “twing” of flat-picked strings. Instead, the high end sounded blunt and “hard.”

Next up was the hard rockin’ Southern California band The Goldiggers, with superb session musician Steven Tate on drums. I placed the E47 just inside the hole in the kick drum’s front head and routed the mic’s output through my HV-3 and Universal Audio LA-2A. This combination imparted a really beautiful top-end snap, but the upper bass and low mids sounded too full and blurry for what I shoot for in a modern rock sound. From what I heard, however, I think the E47 would probably work well recording kick drum on a traditional jazz session.

Finally, the gothic punk band Cut-throat came in to track basics for their upcoming album on Resistance Records. On this session, the E47 sounded great placed as a room mic on trap drums. Patched through an Empirical Labs Distressor, the E47 added wonderful weight and thickness to the overall drum sound. And, placed with care, the balance between cymbals and traps was perfect.

### CONCLUSIONS

I found the E47 worked best recording male and female vocals when a vintage sound is desired or as a room mic on drums. The timbral differences between vocals recorded with an E47 and U47 are quite subtle; so much so, in fact, that I can comfortably recommend the E47 as a cost-saving substitute for the U47. (A vintage U47 will typically set you back anywhere from \$5,500 to \$8,500, if you can find one in good enough condition to justify the purchase.) After applying a little EQ to vocal tracks (which most engineers do when mixing pop music), you’d be hard-pressed to tell that an E47 was used instead of a U47.

In fact, I actually prefer the sound (and higher output) of the E47 to that of the U47. The E47 lends a bit more clarity, focus and detail as compared to the U47. True, you don’t get the U47’s pedigree for your money, but you do get a new, quality-built mic that’s guaranteed to operate for years without problems. Factor in the E47’s lower price, and you’ve got a good deal!

Distributed by Transamerica Audio Group, 4760 West Dewey Dr., Suite 129, Las Vegas, NV 89118; 702/365-5155; fax 702/365-5145; [www.transaudiogroup.com](http://www.transaudiogroup.com). ■

Mix contributing editor Michael Cooper owns Michael Cooper Recording in beautiful Sisters, Ore.

## CONTROL YOUR SURROUNDINGS

With TASCAM's new DS-M7.1 Professional Digital Surround Monitoring Controller, you get an inexpensive yet incredibly powerful solution for working with surround audio. The DS-M7.1 offers complete control of downmixing and bass management, handles every format from LCRS to 7.1, provides full digital functionality at up to 96kHz, and is easy to set up and use. So, if you want to control your surround monitoring environment, get the flexibility you need with the DS-M7.1. Need more information? It's available today at [www.tascam.com](http://www.tascam.com).

**TASCAM**  
a whole world of recording

# Plugged In or Plug-In

Universal Audio Announces Plug-Ins for Pro Tools|HD



LA-2A Optical Compressor



LA-2A TDM plug-in



1176LN Limiting Amplifier



1176LN TDM plug-in

The **LA-2A Optical Compressor** and **1176LN Limiting Amplifier** have been used on countless recordings over the last fifty years. Producers and engineers working with acts ranging from Sinatra to The Stones have relied on these classics for their timeless sound. These two legendary pieces of gear are now available from Universal Audio in two forms: traditional hardware units you can rack up and TDM software plug-ins for your Pro Tools|HD or Pro Tools|24 MIX systems. Plugged in or Plug-In, UA delivers true classic sound. And if you're working with a VST, MAS or Direct X system, don't feel left out, these same great-sounding Universal Audio plug-ins run on the Mackie UAD-1 DSP card.

analog ears | digital minds



UNIVERSAL AUDIO

info@uaudio.com • www.uaudio.com • phone: 831.466.3737 • fax: 831.466-3775  
2125 Delaware Avenue, Suite A Santa Cruz, CA 95060

©2003 Universal Audio. The Universal Audio name, logo, and "LA-2A" and "1176" are property of Universal Audio, Inc. All Rights Reserved.

# PrismSound dScope Series III

## Bringing Testing Capability to the People

Perhaps better known for its Dream Series of no-compromise A/D and D/A converters and Maselec high-performance analog processors, PrismSound started developing the dScope Series of test instruments a few years ago for in-house needs. PrismSound recognized that manufacturers, researchers and studios could use a cost-effective, high-res audio test system with automation capabilities, and so dScope was born. After a year of intensive beta testing, the latest version—dScope Series III—is now ready for full release.

### DESCRIPTION

The rugged dScope III interfaces to a Windows PC via a single USB connection. The dScope hardware provides stereo test signals in analog and digital formats, analog and digital stereo inputs for return of the tested device, digital-reference sync input and output, and monitor outputs for its signal generator and analyzer functions. The dScope Series III application (currently at Version 0.99) provides the system's control and read-back. Without the controlling computer and software, effective audio testing cannot take place. The full package, minus host computer, lists for \$8,800.

While dScope can be rackmounted with Prism's optional rackmount kit, its approximate 12x9-inch footprint makes for a good fit with a host laptop computer, thereby creating a portable, no-compromise audio test system. The unit's solid construction and top-notch components exude confidence.

A chart of the basic system's signal flow is shown on page 110. The stereo analog generator outputs to parallel XLR and BNC connectors; the digital generator outs are on XLR, BNC and TosLink optical ports. Analog and digital returns from the tested unit are provided in the same connection formats, while sync-reference inputs are only offered on XLR and BNC. Monitor outputs are via BNCs, and as an additional benefit for mobile applications, dScope's headphone output and internal speaker offer a quick check of what the unit is doing. A front grounding post is

provided. The rear panel has a reference-sync output on BNC and XLR (there isn't room left on the front) and the USB connection to the host computer. Also on the rear is a "DSNet" connector to network a range of dScope peripherals such as the DSNet I/O, with a four-wide DIP switch to set unit addresses in DSNet.

### UP AND RUNNING

The dScope III system's beauty becomes apparent when you connect the host computer, install the control application and start testing devices. The control application's installation and startup could not be easier. Because the system requires a hardware unit, PrismSound was able to forego copy protection. You simply connect the USB port on the hardware unit to a PC running Windows 98 or 2000, install the application from CD and start it up. The hardware unit is immediately recognized, and the dScope workspace and toolbars appear on the screen.

On startup, the user sees an empty workspace with a set of menu selections and "buttons." (In an upcoming software release, the toolbar will be preloaded with buttons, providing instant access to a range of test configurations.) Most of these open up the tileable, nonmodal dialog boxes to set I/O parameters, signal-generator characteristics and display analysis results. With these, you can quickly set up any desired test, including sweeps and measurements of AES-3 signal quality, jitter and rise/fall times. For example, to test a stereo A/D converter, simply plug the analog outs (XLR or BNC) to the ADC's input and connect a digital out (XLR, BNC or optical) to dScope's digital input. For system validation, the signal-generator outputs can be looped back to analyzer inputs using internal relays or external cabling.

In the software application, you can open the dialogs for signal generator, digital inputs, signal analyzer and continuous time detector. This setup allows you to control test signals, determine the digital return's integrity and read level and noise/distortion in the converted signal.



You can also perform basic audio test bench operations.

On the next level, you can open the Trace window, which overlays the raw waveform's display with residual noise and distortion signals via contrasting color traces. This offers the option of an FFT frequency analysis to view the spectrum of the raw signal or of the distortion analyzer's residual output. The residual can also be routed to audio monitoring, allowing quick analysis by ear of even the lowest-level distortion components. dScope can also view the time-domain trace at the same time as an FFT.

Other windows provide detailed views of the AES/EBU signal with a clear indication of signal jitter and the "eye," which indicates the basic integrity of digital audio data transmission. This display is vital to evaluate digital audio routing and distribution components. The jitter component can also be demodulated and routed to the analyzer input, showing the exact amplitude and spectrum of sample-clock jitter.

The application's full capability for signal sweeps across amplitude and frequency allows you to quickly profile a device across the full-range signals. Results can be viewed graphically, printed or recorded as tabular data.

For device qualification, such as D/A converters and digital mixers that receive digital audio information, the dScope's digital outputs controls provide for controlled degradation of the carrier signal,

ORDER 24/7 FROM OUR SECURED WEB SITE

# After you order from BSW, no salesperson will call...and call...and

If you've ever ordered from some mail order pro audio companies, you know that once they have your name in their database, you've made a "friend" for life. Or so it seems after the umpteenth unsolicited call you get during dinner. Broadcast Supply Worldwide hires pro audio veterans, not ex-used car salesmen. They spend their time fielding technical questions instead of bugging folks who've already ordered.

BSW doesn't sell guitars, drums or keyboards. That's another reason we're the Secret Source that radio and television studios and post houses rely on for top-name pro audio products.

Give us a try and you'll never call one of those hard-sell places again.



Call for a free 112-pg. catalog!

**www.bswusa.com • 1.800.426.5780**

ORDER 24/7 FROM OUR FAST-LOADING WEB SITE • RING US UP 6AM-6PM PACIFIC TIME

## BSW EXCLUSIVE MONEY-SAVING 5-PACK DEALS!

Collect 'em! Trade 'em with your friends!

Buy in bulk...save in bulk!  
Awesome prices on gear you can never have too much of.

**99<sup>00</sup>**

**AUDIO TECHNICA • ST95MKIIPKG**  
• dynamic handheld mic 5-pack

**89<sup>00</sup>**

**Mic Stand • 5-pack**

**89<sup>00</sup>**

**AKG • K110MPKG** • full enclosure stereo headphone 5-pack

**24<sup>00</sup>**

**Windscreen • 5-pack**

**699<sup>00</sup>**

**MARANTZ • CDR300** • portable CD recorder • stereo XLR or 1/4" mic/line inputs  
• built-in preamp - no external mixer or preamp required • BSW includes 50 FREE CD-Rs!

**199<sup>00</sup>**

**ART • SLA1** • studio power amplifier • 100 watts/channel into 8 ohms • XLR and 1/4" inputs

**199<sup>00</sup>**

**AUDIO TECHNICA • AT3035** • cardioid condenser mic

**399<sup>00</sup> / pair**

**BEHRINGER • B2031** • Active 8.72" monitors  
• 75 watt/150 watt power amps • video shielded

**179<sup>00</sup>**

**ECHO • MIA** 24-bit/96 kHz digital audio card • 8 "virtual" outputs

**59<sup>00</sup>**

**ETECH • HE** • 2-channel hum eliminator • converts balanced and unbalanced signals

**GUARANTEED LOWEST PRICES!**



World's Best Source for Pro Audio Products

# Relive the Magic.

There's a reason why the classic microphones have endured for over 50 years. It's what happens when you put one on the mic stand and plug it in. And that's all you have to do. The classic microphones have a built-in character that makes things easy, so easy that it feels like magic.

There are two ways you can relive that magic. If you have a small fortune and can find a classic mic that works—that's one way.

The other way is with a Lawson microphone like the L47MP or the new L251—both large diaphragm condenser microphones that we hand-craft in the USA with all the look, feel, and sound of a true classic. Magic included.

Experience the magic for yourself with our ten-day, no risk trial.



## LAWSON, INC.

2739 Larman Avenue  
Nashville, TN 37204 USA  
Phone 615-269-5542  
FAX 615-269-5745

Visit us at

[www.LawsonMicrophones.com](http://www.LawsonMicrophones.com) to see how others are reliving the magic!

applying defined percentages of jitter (with various spectral characteristics), as well as differential and/or common-mode interference. These capabilities are essential to characterize the robustness of a digital audio component or system.

The dScope system provides such a wealth of information that finding an optimal windows configuration onscreen can be challenging. Fortunately, the software's multiple pages (tabs visible at lower right) allow various panels to be distributed sensibly, with alternate views of information. Configurations of screen displays can be saved along with full system setup information.

### SCRIPTING FEATURES

dScope provides an entire bench of audio test gear in a single, portable system. But the whole point of hooking up a set of audio instrumentation to a computer is to, well, hook it to a computer. The dScope Series III's primary customers are manufacturers, researchers and large facilities that need to measure the performance of large amounts of audio equipment as efficiently as humanly possible, and collect the results

to computer and network systems becomes quite simple. Want to get an e-mail when a unit or group of units fails a certain test? It's quite easily accomplished.

Of course, with dozens or hundreds of application-specific calls available, it is easy to get mired in documentation. Luckily, dScope's Script Editing window lets you drag-and-drop individual methods and properties into a shell from a well-organized hierarchy. For example, you can read a signal's frequency at the A input while writing its value into an Excel spreadsheet.

### SUMMARY

The dScope products continue to evolve. At AES, PrismSound announced 192kHz sample rate support, and all dScope III units in the field will be eligible for free updates. The company also showed a multi-channel router that mates with the dScope to facilitate multichannel measurements.

dScope Series III is a wonderfully powerful audio test and measurement system, with high performance and full automation capability in a compact, road-worthy package. Offering a combination of analog and digital source and input ca-

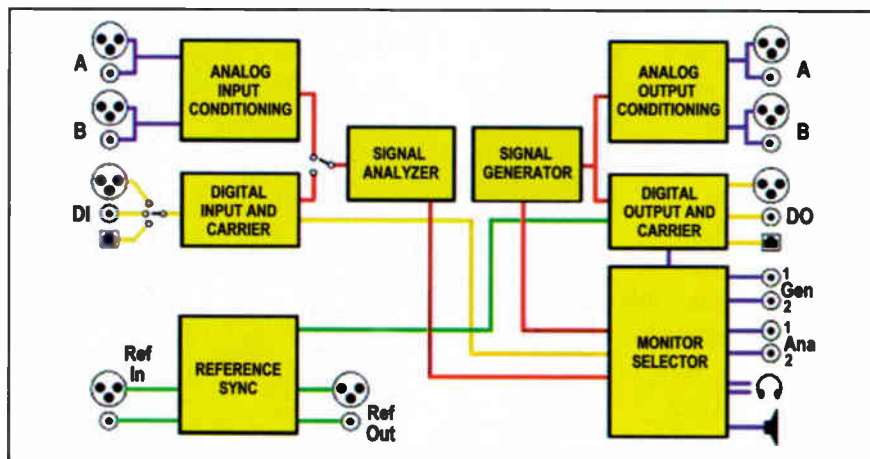

The dScope III architecture, showing the system's overall flow

into reports and statistics. Many users will also want to investigate realms that require arcane sequences of individual measurements, correlated across time and space.

The system includes a detailed scripting environment, based on Windows Visual Basic Script (VBScript) and OLE. Every setting and reading the unit is capable of (including its motherboard temperature) is accessible via a comprehensive set of VBScript methods and properties. Scripts can be executed by an operator or in response to any system event defined in an Event Manager window. Because most major Windows applications support the VBScript and OLE interfaces, marrying dScope

capability (especially with the ability to perturb the digital output carrier and examine the results), dScope is a credible alternative for budget-limited and high-end applications. Overall, dScope Series III offers a tremendous amount of power and quality for a very good price. If you need an integrated, automatable audio test rig, dScope is something to look at.

PrismSound, dist. in the U.S. by Prism Media Products Inc., 21 Pine St., Rockaway, NJ 07866; 973/983-9577; [www.prismsound.com](http://www.prismsound.com).

*Gary S. Hall operates the world's only solar-powered piano lounge.*



# Practical training for your future



## Study for your UK Honours Degree in the Australian sun!

Experience the highest quality audio, multimedia, and film education  
with the most individual practical time and get your Degree!

Middlesex University Bachelor of Arts (Recording-Digital Film-Multimedia)  
Stage One (Diploma) in all SAE Locations  
Stage Two (Degree) in Byron Bay, Australia  
Accelerated Degree Program

On Campus Student Housing Available  
31 Large Studios, 120 Audio/Video Workstations  
1.000.000 SQ.FT. Campus Facility  
Training Professionals for Over 26 Years  
Individual Practical Time Guaranteed  
40 Institutes Worldwide  
The Worlds Largest Audio/Video Training Campus



Some programs are not offered in all locations



SAE Byron Bay  
+61 2 6639 6000

1-800-SAE-9799  
[www.sae.edu](http://www.sae.edu)

London  
[0207] 609 2653  
Glasgow  
[0141] 429 1551  
Liverpool  
[0151] 255 1313  
Amsterdam  
[020] 622 8790

Rotterdam  
[010] 411 7951  
Brussels  
[02] 647 9220  
Athens  
[010] 321 7661  
Stockholm  
[08] 730 5100

Madrid  
[091] 405 7059  
Paris  
[01] 4811 9696  
Milano  
[002] 8912 0540  
Singapore  
[65] 741 1257

# NTI Digilyzer

## Have Analysis Tool Will Travel

How many times have you connected two pieces of digital gear together only to end up having bizarre things happen? Or worse, nothing? Enter the NTI Digilyzer, the digital bloodhound, to sniff out the problem; it is so "smart" it will even accept an analog signal, which is pretty dang cool for installers or anyone untangling a mess of mystery cables. Digilyzer allows technicians to explore previously uncharted territory.

Most digital gear is woefully lacking in its ability to display why it is unhappy. Digilyzer can display lack of data compliance, bad cables, bad bits or poor signal quality—any combination of which can contribute to lack of data integrity. Similar to its analog cousin the Minilyzer, Digilyzer is a handheld piece of test equipment with a handful of menus that can display channel-status information (three pages), distortion, PPM and RMS metering, a scope and memory to store (and recall) default Digilyzer setups and device status. The unit runs on three AA batteries (with auto shutoff) and includes an external power jack.

Digilyzer has XLR, RCA and optical digital inputs; the latter accepts both S/PDIF and ADAT Lightpipe. Any TDIF-to-ADAT converter allows the unit to read Tascam's proprietary digital format, as well. A built-in speaker is quite useful (and loud). A stereo headphone mini jack is also included.

### EOA = EXCITEMENT ON ARRIVAL

As soon as Digilyzer arrived, I used it to analyze three puzzling situations. A Tascam DAT recorder pretended to go into



Fig. 1: Channel-status display comparing outputs of a Technics CD player (left) and an early Alesis MasterLink.

record but did not actually put anything on tape. A detour into the machine's guts to clean the heads yielded nothing, until I realized that the unit's analog recording function was fine. I never thought to question the Alesis MasterLink that was feeding it until I substituted a Panasonic DAT deck, which balked at being in record and locked up until the power was cycled.

Equipment manufacturers are inconsistent in their implementation of digital-communications protocol: Some devices are very fussy, while others are quite forgiving. In the two DAT examples, both decks expected the sample-rate status FLAG to concur with the transmitted sample rate. Figure 1 shows side-by-side comparisons of a Technics CD player (left) and MasterLink, respective examples of consumer and pro formats.



Fig. 2: The three channel-status pages alternately flash "CRCC ok" and "CRCC Fault" (shown in reverse video for clarity) to indicate a problem. Note: The black rectangle next to optical also indicates a data problem that was not severe enough to mute audio.

For this discussion, note the reverse video "FS NO ID," which indicates that the sample-rate FLAG had not been set. In this snapshot, the MasterLink is also transmitting at 88.2 kHz, but not at the time of the DAT trouble (just in case you're really paying attention). By not setting the sample-rate FLAG, the MasterLink did not comply with the specification, a problem that was remedied in later production units.

In another instance, the AES output of a Sony PCM-R500 did not transmit a



"clean" signal, thus wreaking havoc with a CD burner but not causing any immediate, obvious trouble with other gear. Notice in Fig. 1 (CD player) the rectangle right of optical is "open," indicating good data. In Fig. 2 (PCM-R500), the rectangle is solid black—bad data, but not bad enough to mute audio. Figure 2 shows a flashing "FAULT."

Digilyzer is a very powerful tool if you know where to look. Whether the data is good, bad or out of compliance, Digilyzer is tolerant and does its best to translate audio that other devices will not. Tolerance is good only if it doesn't lure us into a false sense of data security. Then again, have you ever felt something was wrong with the sound, but couldn't quite put your finger on it? In conjunction with the Minirator (or any low-distortion oscillator), Digilyzer can measure distortion, as well as provide a "heads-up" clue as to the cause of the problem.

For most of the tests, Digilyzer was a destination on a Z-Systems Digital Detangler, hence the optical indication on the display, even though many different sources were tested. Figure 3 shows the AES input being tested, along with the ability to display the incoming signal level; in this case, 4.7 volts P-P.

Note also that the number in the center square (all but Fig. 1) indicates the page number—there are three to check

# WORLD'S BIGGEST MICROPHONE SALE!



**800-356-5844**  
**www.fullcompass.com**

Log on or call  
& get our  
300 page  
catalog TODAY!

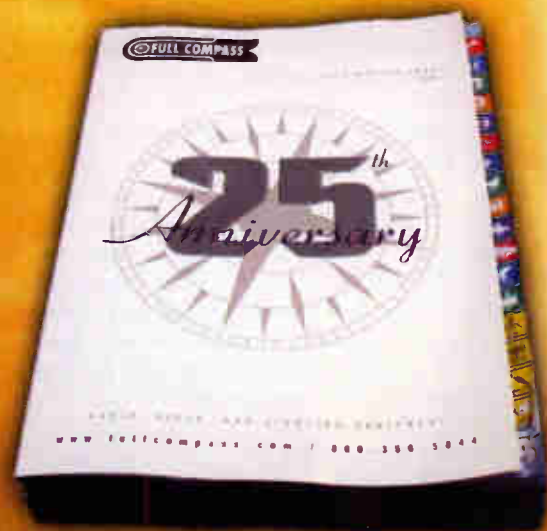

Professional Audio  
Video, Lighting, A/V  
& Multimedia  
equipment.



Not a 9-5 shopper?  
Call us at 800-476-9886  
8am-10pm M-F  
and 10am-4pm Sat.

# HI RES. LOW RENT.

ESI's 192 Series  
= Affordable, Quality Audio!



Why spend a fortune to reap the benefits of a true 24-bit/192kHz system? Our 192 Series PCI audio cards and peripherals offer high quality sound at a fraction of the price of other systems, at any sample rate: 44.1, 48, 96 or 192 kHz. ESI products work with most of the popular PC and Mac audio software products on the market, giving you the freedom to choose the combination that works best for you. 192 Series cards start as low as \$199.99 MSRP with the Waveterminal 192L. Make the move to 192kHz today!

GET ON THE ROAD TO BETTER SOUND!



sales@esi-pro.com  
www.esi-pro.com  
408.519.5774



## Amazing 32-Channel Miniature Control Console Fits In the Palm of Your Hand!



CS-32 MINI DESK

The new CS-32 MiniDesk™ is a miniature control surface that gives you fast access to the most commonly used functions. It works with ProTools, Nuendo, Cubase SX, VST, Digital Performer, Soundscape, Cakewalk Pro, Sonic Foundry, Ableton Live, Pyramix and Most Audio Software Programs!

The CS-32's radically small size does not reduce its intense capabilities as an extremely powerful controller with 32 Dedicated Faders/Channel Strips for real-time control of volume levels, Mute, Solo, Track Arming and more.

It has tactile Transport Buttons, Cursor Keys and weighted Jog/Scrub Wheel, just like the big guys. Six Rotary Knobs give you hands-on, automation control of Panning and Plug-Ins. A bank of function keys are ready for frequently used editing features. And...takes up less space than a sheet of paper, so you can use it anywhere. It's perfect for portable recording with a laptop computer. Visit us at [www.jlcooper.com](http://www.jlcooper.com) for complete information.

©2003 JL Cooper Incorporated. All Rights Reserved. All other trademarked product names are trademarks of their respective holders. Specifications subject to change without notice.

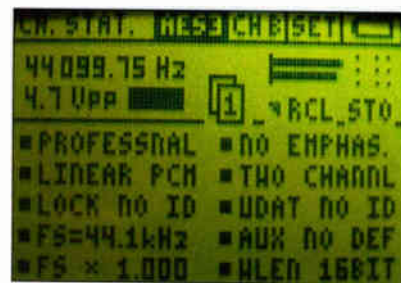

Fig. 3: A Sony DAT's defective AES output

channel status, plus a bit-status page. Figure 4a/4b demonstrates how bit depth is displayed for a 16-bit and 24-bit signal, respectively.

Digilyzer can provide hours of fun for checking out every possible signal source in the studio, on the road or anywhere. With additional reading (via manual and online) and testing, Digilyzer becomes an even more valuable tool. It doesn't blare out any warning tones and can't do more than flash a warning on the appropriate page, so some problems might not be ob-



Fig. 4a/4b: The Alesis MasterLink in 16-bit and 24-bit modes, respectively.

vious if you don't know where to look. Hence, the importance of the "signal-quality rectangle" as pointed out earlier.

At a \$1,590 MSRP, Digilyzer costs more than I expected, considering Minilyzer (\$579) is about a third of that price. Still, time is money, and Digilyzer saves time and speculation. From 16 bits to 24 bits, 32 kHz to 96 kHz, Digilyzer tells you the good, the bad and the ugly.

NTI North America, 3520 Griffith St., St. Laurent, Quebec H4T 1A7; 800/661-6388; fax 514/344-5221; [www.nti-instruments.com](http://www.nti-instruments.com).



ALANIS MORISSETTE



AMERICAN HI-FI



THE BANGLES



GEORGE STRAIT



BLINK 182



CROSBY STILLS AND NASH



JIMMY EAT WORLD



ANI DEFRANCO



GARBAGE



BONNIE RAITT

# VOCALS WITH A PASSION

FIRST INTRODUCED IN 1995, THE AUDIX OM-5 HAS BECOME ONE HOT MIC. ROCK SOLID PERFORMANCE NIGHT AFTER NIGHT, TOUR AFTER TOUR.

- ◆ CLEAR, NATURAL SOUND
- ◆ INCREDIBLE FEEDBACK REJECTION
- ◆ HANDLES EXTREMELY HIGH SOUND PRESSURE LEVELS WITHOUT DISTORTION
- ◆ BUILT TO LAST A LIFETIME
- ◆ MADE IN AMERICA

AUDIX CORPORATION  
PO BOX 4010  
WILSONVILLE, OR 97070

IN CANADA, C-TEC  
TEL 604-942-1001  
FAX 604-942-1010

©AUDIX CORP 2003.  
ALL RIGHTS RESERVED.  
AUDIX AND THE AUDIX LOGO  
ARE TRADEMARKS OF  
AUDIX CORPORATION.

**AUDIX**  
PERFORMANCE IS EVERYTHING

CALL: 800-966-8261  
TEL: 503-682-6933 FAX: 503-682-7114  
WWW.AUDIXUSA.COM

# Chandler Limited TG1

## Stereo Limiter/Compressor Does the Time Warp Dance

With its “future-primitive” style and sound, the Chandler Limited TG1 seems to be from another age—plucked from a time capsule. This stereo limiter/compressor is based on the EMI TG12413 plug-in limiter module, which was used in the early 1970s TG Series mixing desks and mastering consoles. Designed to replace tube gear used in EMI studios around the world since the 1950s, the TG Series was EMI’s first foray into transistorized equipment. EMI built the TG boards in Hayes, Middlesex, and first installed them at EMI’s Abbey Road Studios in 1968, in time to be used to record The Beatles’ final studio album, *Abbey Road*. Many other significant records in the early '70s through 1983 were recorded on TG desks, including Pink Floyd’s *Dark Side of the Moon* and some of Paul McCartney’s early solo and Wings albums.

### A ROCKIN’ TWO-SPACE BOX

Hand-made in the U.S., the Chandler Limited TG1 features an all-discrete Class-A/B analog circuit with balanced transformer inputs and outputs. Neve module mavens will appreciate the Marinair and St. Ives input and output transformers, which, like most of the TG1’s components, are made in England. Not designed for a clean and transparent sound, amplifier gain is controlled by changing the bias current and therefore a Zener diode’s impedance. This Zener limiter produces a smooth, pleasing and colorful distortion, circa 1968.

Powered externally by the half-rack-space PSU-1 power supply, the TG1 comes in a rugged two-space, nickel-plated steel box that looks like a giant Neve module case. Popping the TG1’s hood reveals handsome construction with a neat wire harness connecting hand-soldered Elma switches on the front panel to a single, large printed circuit board. With construction better than it has to be, you can take this unit anywhere without worry. One note: The loose-fitting top panel rattles when operating in the presence of loud low-frequency sounds.



### COOL LOOK AND STYLE

My eye was immediately pulled to the left side of the TG1’s British RAF gray front panel, where two black Sifam meters are canted on their sides. These meters read gain reduction only, and the novel positioning is exactly like the original TG desk’s VU meters: The needles move in an arc vertically instead of horizontally. Keeping with this official militaristic look, all switches are slightly recessed in the front panel, and control knobs are fitted with old-fashioned black British radio pointer knobs.

To the right of the on/off switch and VU meters are switches for mono/stereo linking and individual in/out switches for left and right channels. The in/out hard-wired bypass switches put a loud “ker-chunk” in your mix when toggled, so wait for no sound when engaging the unit. All controls retain EMI’s original British nomenclature—starting with the Hold control. Hold (shorthand for threshold, because the original TG modules didn’t have room for the whole word) is an input level and threshold in one knob; it works just like the input control on a Universal Audio 1176LN. Next to Hold is Output, or makeup gain, a 21-position rotary switch whose center position is 0 dB and ranges  $\pm 10$  dB.

There are two operating modes for the TG: Comp (compress) and Limit. A two-position rotary switch changes modes and an internally fixed attack time setting. In Comp mode, the attack time is fixed at

47 ms, while in Limit mode, the attack time is a faster 8 ms. Comp and Limit modes each have their own set of release time choices selectable by a six-position rotary switch called Recovery. Release time choices in Limit mode are 0.05, 0.1, 0.25, 0.5, one and two seconds. Comp mode choices are 0.25, 0.5, 1.20, 2.5, five and 10 seconds. Compression ratio is fixed at 2:1 in both modes.

### IN THE STUDIO

The TG is very easy to use and does not require precise setup: Simply select a mode and recovery time and turn up the Hold control to get a sound. For everyday compression duties, I chose the Comp mode. For subtle compression (1 to 3 dB), I found that the Hold control was touchy: All action began at the very bottom of the range. I was feeding full-level, 24-bit audio directly from a Pro Tools|HD’s 192 I/O. I got a better range of control by inserting the TG1 in a channel of the board (post-fader) or by reducing the level going to it. If you do this, there is plenty of make-up gain available with the Output knob, but you might notice more noise buildup.

### COMP MODE

I liked the Comp mode for electric guitars, vocals and rock bass guitar. The sound is thick, warm and open-sounding with little high-frequency dulling during heavy compression. The 0.22% distortion (at full compression) works especially well on guitars.

When hard-pressed, the TG1 has a “rubbery” or “squishy” sound character, and is the most tube-sounding transistor compressor I’ve ever heard.

Using the TG1 on stereo tracks works well (although I wouldn’t use it across a master mix), but you have to remember to set both recovery knobs the same. Stumbling upon this quirk, I sent the same mono guitar track to both channels and purposely dialed very different recovery time settings. I got a lev-

### CHANDLER LIMITED TG1 SPECS

Input Impedance: 300 ohms  
 Output impedance: 600 ohms  
 Maximum output level: +28 dBm  
 Noise: -75 dBm  
 Frequency response: 15 Hz to 20k Hz  
 Distortion: 0.22% with Hold control full up.

Introducing the all-new

# MIX ONLINE

THE PAGES OF MIX COME ALIVE WITH SIGHTS AND SOUNDS!

IMPROVED NAVIGATION

provides fine-tuning of searches.

ONLINE EXTRAS

enhance selected stories with bonus material from audio clips to extended interviews and photo galleries.

FEATURED CONTENT CATEGORIES

offer broader and categorized content searches in the fields of Recording, Products, Live Sound, Sound For Picture, New Media, Design, and Education.

EXPANDED

applications, daily news, current issue previews, access to reviews, archives and subscriber resources.



There is so much to see on the new [mixonline.com](http://mixonline.com), you won't believe your eyes. Or your ears.

[WWW.MIXONLINE.COM](http://WWW.MIXONLINE.COM)



Learn Audio Recording Like Nowhere Else.

## The Conservatory of Recording Arts & Sciences 1.800.562.6383

All students train, hands-on, in cutting edge 48-track Analog/ Digital Recording Studios that feature:

-SSL -Studier -Otari -Neumann  
-Neve -Neotek -Lexicon -Hafler

Plus...

-Mac G3/TASCAM Digital Lab  
-Studio Master Mix Down Lab  
-Individual G4 Pro Tools Workstations  
-And Much, Much More!

No more than 12 students per class - taught by award winning professionals.

Every student completes an internship in the industry for graduation.

Only recording school authorized by Avid/Digidesign, T.C. Electronic, WAVES, and SIA to certify students in the use of their products.

**t.c. electronic**  
OF DENVER



2300 East Broadway Road Tempe, Arizona 85282 [www.audiorecordingschool.com](http://www.audiorecordingschool.com)

el animation effect when I panned the 2-channel outputs left and right. This effect is intensified if you put one of the channels in the Limit mode.

### EXTREME LIMIT MODE

Limit is much more radical than Comp. In the past, I've tried to copy the Ringo drum sound on *Abbey Road*, but never could quite get there with the American gear I had. (Refer to the songs "Something," "She Came In Through the Bathroom Window," "Carry That Weight" and "The End.") A Fairchild 670 or an old British Pye unit will do well, but the TG1 nails it: You can get that classic pumping/breathing sound just by winding up the Hold control. Recovery time settings are critical; positions 1 or 2 work best for most drum parts. If you listen to an old Beatles record, recovery from gain reduction is locked to tempo (more or less) so that cymbals and any room ambience swell up in between bass drum hits and/or backbeats. This trick always works best on live microphones when tracking and for more precision; I wish the TG1's Recovery controls were variable pots.

On a pair of drum room mics, the TG1 excels by capturing every part of the room tone. If you've got a good-sounding room to record in, I would be hard-pressed *not* to use the TG1 on the room mics. This is a classic ambient drum sound that has worked so well in the past on slower-tempo rock songs. For vocals and pianos to sound immediately Beatles-esq, I used Comp or Limit and a 1 to 3 Recovery setting for a "Lady Madonna" piano. Drastically limit vocals in a mix with Recovery set to 1, and you'll achieve a certain presence that can't be hidden by the track.

Not modernized or updated—on purpose—the charming Chandler Limited TG1 Limiter/Compressor adds a whole new quadrant to your sonic palette with many useful compression sounds and "way over the top" limiter effects that are not possible with pristine pro audio gear. As an homage to a bygone era, I like the unit for guitars, vocals and any percussion. The Chandler Limited TG1 sells for \$4,000 MSRP. The PSU-1 power supply is \$125 MSRP, includes +48-volt phantom power and will run up to any four Chandler Limited products.

Chandler Limited, 100 East Bremer Ave., Waverly, IA 50677; 319/352-2587; fax 319/352-3136; [www.chandlerlimited.com](http://www.chandlerlimited.com). ■

*Barry Rudolph is an L.A.-based recording engineer. Visit his Website at [www.barryrudolph.com](http://www.barryrudolph.com).*

Electronic Musician Presents

# PERSONAL STUDIO BUYER'S GUIDE

THE ULTIMATE GUIDE TO HOME-STUDIO GEAR!

- Over 2,000 product listings in 28 categories
- 31,000 individual product specifications
- Over 300 manufacturer contacts
- Great tips for the ideal personal-studio set-up

## ON NEWSSTANDS NOW!

Find the PSBG on newsstands wherever *Electronic Musician* is sold, or call 913-967-1710

EM subscribers receive it free—Subscribe to EM at [www.emusician.com](http://www.emusician.com).

A PRIMEDIA Publication



# PRISM SOUND ADA-8 FOR DIGIDESIGN™ PRO-TOOLS|HD™

**THE PRISM SOUND ADA-8 IS THE KEY THAT WILL UNLOCK THE TRUE SONIC POTENTIAL OF YOUR WORKSTATION.**

- ADA-8 is now available with a Pro-Tools|HD™ interface
- Connect up to four Prism Sound ADA-8 units per Digidesign™ Pro-Tools|HD Core™ or HD Process™ card
- Analogue and digital ports can be fitted for all channels
- Combinations of Digidesign™ I/O units and Prism Sound ADA-8 units can be configured
- A Prism Sound ADA-8 interface card is also available for the Digidesign™ Pro-Tools|24 Mix™ family



**CALL NOW TO ARRANGE YOUR DEMO!**



PRISM MEDIA PRODUCTS LIMITED  
 William James House  
 Cowley Road  
 Cambridge CB4 0WX  
 UK  
 Tel : +44 1223 424 988  
 Fax : +44 1223 425 023  
 Web: <http://www.prismsound.com>

PRISM MEDIA PRODUCTS INC.  
 21 Pine Street  
 Rockaway  
 NJ 078566  
 USA  
 Tel: (973) 983 9577  
 Fax: (973) 983 9588  
 Web: <http://www.prismsound.com>  
 Email: [sales@prismsound.com](mailto:sales@prismsound.com)

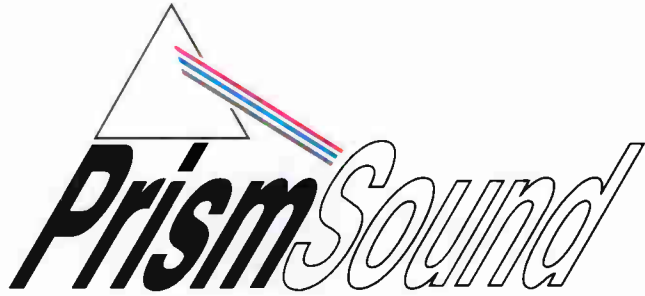

DTE: Digidesign do not endorse or support the Prism Sound ADA-8 unit. Not all Pro-Tools™ controls or configurations are supported by the Prism Sound ADA-8. Prism Sound reserve the right to amend their own product specifications without notice.  
 digidesign, Pro-Tools, Pro-Tools|HD, HD Core, HD Process and Pro-Tools|24 Mix are trademarks of Digidesign, a division of Avid Technology Inc.

# Snapshot Product Reviews



## SE ELECTRONICS Z-5600 Multipattern Tube Microphone

Several years ago, David Zou—a musician and former conductor of the Shanghai Symphony—wanted to create quality, affordable recording mics. Working with Feilo Electric-Audio Equipment—one of China's leading manufacturers of electronic components—Zou founded SE Electronics and debuted a line of studio mics. As in many start-up companies, the first products were uneven; over time, some not-so-good models (such as the now-discontinued SE5000) were weeded out. However, some SE mics were quite good, especially in light of their rock-bottom pricing. The company's latest mic, the top-of-the-line Z-5600 multipattern tube mic, retails at only \$699; while not the ultimate mic for every application, it is a versatile choice, particularly on lead and background vocals.

Housed in an attractive custom briefcase, the Z-5600 includes the mic, shockmount, power supply, and 15-foot, 7-conductor cable. The power supply has a standard 3-pin XLR output, 7-pin XLR mic input and a 9-position switch to select variations on polar patterns from omni to cardioid to figure-8, and three intermediate stages between each. A large chrome grille protects the 1.07-inch diameter, gold-sputtered, dual-diaphragm capsule. In a separate chamber below the capsule is the preamp circuit with a replaceable 12AX7 tube and discrete electronics. The mic layout and construction are clean, and SE thoughtfully places a rubber "O" ring

over the tube as a bumper to protect it from rough handling.

The shockmount is a hefty design with a quality feel, and effectively isolates the mic from anything but a direct rocket strike. The power supply's construction is solid, although the silk screening indicating polar pattern didn't exactly line up with its switch positioning, so the knob doesn't quite point to the circular omni symbol when in the full counterclockwise omni position. This looked a little odd, but didn't affect performance. However, polar-pattern switching is noiseless, even with the mic turned on—no ear-blasting "whumps" here—so users can freely experiment with different patterns without interruption.

I began checking out the Z-5600 in cardioid position on acoustic 12-string guitar at the neck position, about 18 inches from the sound hole. With an inexpensive tube mic, I expected to hear some noise, but the Z-5600 is very clean and certainly meets its 16dBA EIN spec. Nice! However, on guitar, the mic was rather bright and overly bassy. Switching to the omni pattern, the overall sound was improved, with a more even response—serviceable, but nothing special.

Moving to the figure-8 pattern, the front side of the mic was relatively flat and nice, although the rear pickup sounded completely different: rougher and edgy. Recording mono sources, either side could be selected for effect—hey, if it sounds right, go for it—but the sonic disparity of the figure-8 pattern would preclude the mic's use in an MS recording setup.

My results with the Z-5600 were quite different when recording vocals. The cardioid setting is quite wide and can be widened or narrowed to your requirements by moving the polar selector a notch or two in either direction. I liked the Z-5600 on male and female lead vocals; here, the omni pattern provided a smooth sound with a touch of airiness, while the car-

dioid pattern has a +3dB low bass bump for fullness (even more pronounced when combined with proximity effect on upclose recording) and an aggressive midrange that starts building around 1 kHz, rising to 5 to 6 dB around 12 kHz. On vocals, this mic's got attitude! On some female voices, this was somewhat over-the-top, although a few clicks on the polar selector (moving toward omni) took care of this and provided a variety of sounds to choose from. In the full omni pattern, there's a gentle HF rise peaking around 12 kHz and extending to 15 kHz or so, which was subtle and just right on layered backup harmonies.

SE Electronics, dist. by SE Electronics USA, 408/873-8606; [www.seemics.com](http://www.seemics.com).

—George Petersen

## DISCRETE DRUMS SERIES TWO Drum/Percussion Library

I hate drum libraries. I'm a drummer. I specialize in getting great drum sounds. I've got 70 cymbals, five acoustic kits, two electronic kits, 14 snares and caseloads of percussion at my studio. Nothing's more fun than spending hours in the studio and testing different combinations of exotic and expensive mics in the quest of the elusive, ultimate drum sound.

Here's a snip from a conversation heard in the *Mix* office last month: "Please don't make me review this library. Can't we just get one of those 'loop' guys to check this out? Okay, I'll give it a listen." This product was reviewed under duress, so keep this in mind while reading this.

Discrete Drums Series Two is a collection of rock drums and percussion, sup-



# ADVANCED TECHNOLOGY

## It's How EVO Puts You In Control



### DIGITAL SIGNAL PROCESSING

Each EVO Intelligent Loudspeaker has been programmed to provide consistent and accurate audio no matter who is using it or where it's being used. EVO's built-in proprietary software performs intelligent EQ adjustments to compensate for power compression, anti-feedback, automatic room equalization, delay setting and level adjustments as well as all the functions typically found in a digital crossover. **Intelligent, because it monitors its own performance and is able to report on its condition.**



### POWER AMPLIFICATION

EVO's power comes from a compact, lightweight, highly efficient switch mode power supply and class D digital amplifier. Three discrete power sections, precisely engineered and synchronized to the DSP 96kHz sampling rate, provide a total of 1300 watts of power. **It's another EVO exclusive.**



### ELECTRO-ACOUSTICS

A full bandwidth 3-way F.A.T.<sup>™</sup> (Filter Array Technology) design. Unmatched vertical and horizontal 80° x 80° defined coverage. Exclusive new patent pending compression driver technology and NDD<sup>™</sup> Neodymium Differential Drive<sup>®</sup> transducers. **All in a 65lb package that blends in anywhere you need it to look great.**



### EVOi.net

The network hub and keyboard ingeniously interface for communication with the EVO loudspeakers. Simple to use buttons initiate complex algorithms and clear LED displays report the EVO system status.



### DIGITAL CONTROL INTERFACE

EVO DCI now allows us to see what's inside the box and access EVO's intelligence. A simple to use, Windows<sup>®</sup> based software application provides clear information as well as the ability to precision tune any EVO Loudspeaker.



EVOi.324 Available in Black or White.



It Knows. It Adapts. It Looks Good Everywhere. It Sounds Good Everywhere



A Harman International Company

www.jblpro.com

plied as 11 CD-ROMs of 24-bit tracks in multitrack (up to 16 channels) format; four CD-ROMs of 16-bit stereo .WAV loops (fully Acidized); a CD-ROM of individual drum and percussion samples (24-bit .WAV); and two audio CDs of all the tracks to quickly audition the sounds you need. The 18-disc set (33 songs/743 drum segments/133 percussion loops) fits in a wood-storage box that's smaller than the custom Anvil case where you store that favorite cowbell of yours.

Load-in/setup was no sweat. The 16-bit loops dropped seamlessly into my PC running Acid. The 24-bit multitrack sounds weren't in Pro Tools session format, but imported into my Mac Pro Tools as kick/overheads/stereo room/snare/stereo toms without hassle. The procedure should be about the same with Digital Performer/Nuendo/Sonar/etc.

I started by browsing the audition CDs. Even from these 16-bit clips, I was immediately overwhelmed by Chris McHugh's huge, fat, thick drum sounds (recorded at The Sound Kitchen in Franklin, Tenn., by co-producers Rick DiFonzo and Steve Marcantonio).

The performances on Discrete Drums Series Two sound like expensive major-label productions, but better yet, they even suggest song and composition ideas. I've heard lots of drum collections, but what really sets this one apart are the stacked percussion performances by Eric Darken. Oooweee! The percussion adds a slick, hip and sometimes otherworldly sound to rock-solid, thumping drums. Besides song production (demo or master), it doesn't take much imagination to hear the drums/percussion as beds for film soundtracks or jingles, but the bottom line is that these are highly usable tracks. This library just doesn't have any "filler" material—everything is high quality, from both creative and sonic aspects.

The main drawback to the collection is that it's entirely up-tempo rock. Its punchy sound is equally applicable to mainstream or alternative rock, with plenty of crossover into hip hop, funk and edgy country sounds. There are no ballads. (Maybe in Series Three?) Also, there are no electronic or synth sounds; for that, you should check out its newest release, Craig Anderton's *Turbulent Filth Monsters*, packed with twisted hardcore techno.

Discrete Drums Series Two has a fresh, modern sound throughout, and provides enough elements to easily customize the

tracks into your sound. Retail is \$549, but it's available for a limited time at \$399; and you can hear clips for yourself on the company's Website.

Discrete Drums, 484/582-0727; [www.discretedrums.com](http://www.discretedrums.com).

—George Petersen

### ▷ DPA 4015 Wide Cardioid Microphone

The newest addition to DPA's 4000 Series is the 4015 (\$1,850). DPA calls this mic a wide cardioid, and, indeed, between 500 Hz and 10k Hz, the 4015's polar response begins to resemble an omni mic. I was excited about the possibilities of this added coverage, especially in reverberant spaces to capture room ambience but with greater directionality than an omni.

The 4015 uses the same pre-polarized, pressure-gradient condenser capsule as DPA's venerable 4011, but with a wider polar pattern. And like the 4011, the 4015 needs 48 volts of phantom power. It has a frequency range of 40 ( $\pm 2$  dB) to 20k Hz ( $+3/-1$  dB) measured at two feet from a sound source. The 4015's response is relatively flat from 100 to 5k Hz. From there, the mic offers a gentle high-end boost that peaks at 2.5 dB at 11 or 12 kHz, before descending to 0 dB again at roughly 18 kHz.

Despite DPA's modest claims about the mic's low-frequency sensitivity, the 4015 easily handled the lowest lows of a church organ while flawlessly capturing the high sparkle of its zimbelstern. I reviewed an unmatched pair of 4015s, and their individual calibration charts noted

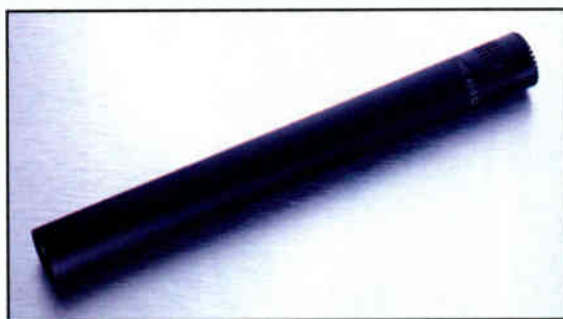

that the low-end response tapered gradually upward in level (1 to 2 dB at 20 Hz, respectively). No complaints here.

The 4015's capsule is  $\frac{3}{8}$  of an inch in diameter. The diaphragm is surrounded by an acoustically transparent netting that protects against contamination from dust. DPA claims the 4015's diaphragm is built to handle "aggressive" humidity and that the distance between the back plate and diaphragm helps deter the influences of ambient temperature. These specs ap-

pealed to me, because much of my recording is done on location, often in drafty and damp churches and cathedrals. Additionally, the mic handles high SPLs—up to an impressive 158 dB.

Remarkably, the 4015 includes a 20dB pad switch in the center of the XLR connector, so you'll need a small, pointed object to get to it. You won't switch the pad accidentally. No matter what instrument I recorded, I never needed the pad.

The dynamic range of the 4015 is excellent, and the mic has a wonderful multidimensionality. This is possibly due to the fact that the on-axis directionality of the polar pattern narrows sharply above 10 kHz. Recordings with these mics always sounded clean and transparent.

As drum overheads, the 4015 was great: The wide pattern captured the surrounding drums and the cymbals, yielding a smooth, natural sound. The 4015's transient response is also superb: A recording session with a nylon-string guitar demonstrated this. The guitarist wanted to track the sound of the guitar's piezo bridge pickup and the acoustic sound simultaneously. I pointed one 4015 at the spot between the sound hole and bridge, where this instrument had its fullest sound. On the amp, I placed the other 4015 between its four speakers from a distance of 18 inches. Blending the two signals, I captured the full snap of the strings, but with plenty of the instrument's meaty resonance and body.

I took full advantage of the 4015's wide polar pattern when recording a bass koto. I placed one of the mics under the instrument, pointing directly into the sound hole; the other mic was three feet above, aiming across the movable bridges. The extended pattern of the upper mic captured most of the stringed area, yielding the instrument's characteristic pluckiness and a nice amount of the room. Meanwhile, the lower mic accurately translated the warm tone emanating from inside the koto.

The DPA 4015's wide pattern provides a welcome intermediate alternative to omni and so-called first-order cardioids. The 4015 is also durable and well-built: No matter where I recorded, I never felt compelled to baby it. This is a first-rate transducer that brings out the best in almost any audio source.

DPA Microphones, dist. by TGI North America Inc., 519/745-1158; [www.dpa-microphones.com](http://www.dpa-microphones.com). (After March 1, DPA Microphones, Inc., 866/DPA-MICS.)

—Laura Pallanck ■

# Groove Tubes™

www.groovetubes.com

# Vipre™

Variable Impedance Preamp



# WHAT MICROPHONES DREAM ABOUT.

## VOG: Vipre Owners Group

*"I heard the Vipre demo at the NY AES show in New York and I bought one right away...and gotten great results I would not have been able to obtain otherwise. This is not just another first class mic pre - this box can help you get sounds out of your mic's that have eluded you up until now."*  
**Walter Becker,**  
Steely Dan

*"I've used it on voice, guitar, and bass, all with stunning results!"*  
**Frank Filipetti,**  
James Taylor, Carly Simon, Elton John, Barbara Strelсанд

*"This box brings out the best from all my mics... I bought one for myself after trying it on several sessions... I highly recommend this tube preamp."*  
**Al Schmitt,**  
Legendary multi-Grammy-winning Engineer/Producer

*"I must tell you how wonderful the Vipre's are... they hear everything! We mixed on Saturday and the music sounds clear and extremely musical. I think that I'm in love."*  
**Bruce Botnick,**  
The Doors, Beach Boys Pet Sounds, Randy Neuman, ET, Star Trek

## VARIABLE IMPEDANCE INPUT

Custom-wound transformers load mics at 300, 600, 1200 or 2400 ohms, multiplying the performance potential of every microphone. Additional transformerless balanced bridged, line and instrument inputs.

## VARIABLE RISE TIME

Select between five amplification styles ranging from Smooth-and-Classic (Slow) to Bright-and-Modern (Fast). These first two exclusive Vipre features alone provide 25 unique tone-shaping combinations from any single mic!

## ALL TUBE, BALANCED CLASS A

Eight Groove Tubes in a fully differential signal path dramatically lowers noise and distortion - while expanding bandwidth (flat from 7Hz to over 100kHz!).

## PRECISION GAIN CONTROL

No pots! Custom-built ceramic deck attenuators control Vipre's incredible 75dB of total gain in 5dB and 1dB stepped increments for precision gain while maintaining the integrity of Vipre's fully balanced signal path.

## AUTHENTIC VU METERING

Custom-built, back lighted VU meter with five switchable viewing ranges.

## Stop dreaming, Wake up your mics.

## Only Vipre does what no other preamp can.

Visit our website or call us at 818 361 4500 for complete specs and a list of Groove Tubes Vipre dealerships.

### GROOVE TUBES LLC CUSTOM SHOP PRODUCTS™



World Radio History

©2001 Groove Tubes LLC. All rights reserved. Groove Tubes, the GT in a circle logo, Groove Tubes Custom Shop Products and Vipre are trademarks of Groove Tubes LLC.

# Does This Compute?

## Comfortably Getting Under Your Computer's Hood

What's your comfort level for computer maintenance or optimization? Can you install a drive, an operating system or memory? Do you take your computer in for service, have a savvy assistant or know someone who makes house calls? The answer reflects your comfort—or fear—level. More than anything, comfort is confidence. Taking the time to back up and have an alternate or backup system to continue working generates peace of mind.

I am not a computer geek, but I've built and maintained most of the computers here in Techville, all except Polly's iMac and the 8500 it replaced. My two primary computers are for video and audio editing, as well as for beta testing and reviews. I love Windows 2000 and hate Windows 98, though I understand why people use it. I love removable drives, have at least one spare drive with just an operating system on it, and, while I am not religious about daily backups, I try to maintain a decent amount of redundancy by copying to another drive (the quick and easy solution) and then ultimately to CD-R and DVD-R. I use Window's DAT backup utility less and less these days and definitely *not* for audio files.

### UNPLUG AND DISCHARGE

Obviously, I'm a PC person, but some tips apply across the board. Periodically, remove the cover and inspect the system for dust bunnies and make sure that the fans are turning. Fans are cheap; everything else is not, especially time.

Before installing or removing computer hardware, unplug the power; most computers are actually not *off* when they appear to be, but are in a "sleep" mode: A trickle of power allows a low-current switch on the front panel or keyboard to wake the power supply to deliver full output. Also, be quite conscious of static electricity. Each minor jolt should be a reminder to touch a noncritical device like a wall switch's cover plate before touching something that helps you earn a living.

### PC EYE

PCI slots are not all created equal. Before installing cards, attempt to decipher any strange messages from your computer/motherboard manual and your new hardware's documentation. It may not be easy: This motherboard example will hopefully raise your awareness of potential conflicts, even if it doesn't sound like English.

PCI slots 4 and 5 use the same bus master control signal. PCI slot 3 shares IRQ (interrupt) signals with

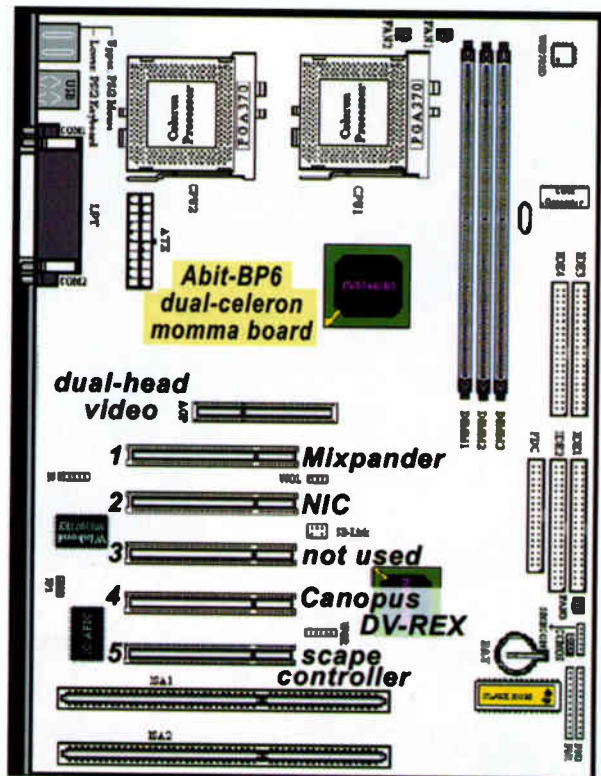

A typical PC motherboard detailing the PCI card locations. At times, cards may have to be installed in specific slots to avoid conflicts.

the "extra" hard drive controller. The driver for this controller does support IRQ sharing with other PCI devices, but those devices might not be as generous. The operating system may not allow peripherals to share IRQ signals. Windows NT (at the time the board was manufactured) would not support *any* card in that slot. On many motherboards, PCI slot 2 is shared with the AGP slot. This can be a problem if a new monster sound card is installed in slot 2 when the video card in the AGP slot is a dual-head type.

### CONFLICT MANAGEMENT

If you survived the previous paragraph, here's an example of how matchmaking applies to the world of computer peripherals. My dual Celeron system was a perfectly happy chappy when all it had to do was edit video and burn DVDs. Then a product review came along that required two PCI slots. Of the five slots, two were already in use for the NIC (network-interface card) and a video-capture card. Remember that using slot 3 would be like modulating keys on the piano before Bach solved that problem. I asked you to remember because I didn't read the manual first. Who does?

# SAY NO TO NOISE

The New RØDE NT1-A is one of the world's quietest microphones.

**Why is that important?**

Light and dark, hot and cold, loud and quiet! These are examples of the contrasts found in nature.

A low noise recording will give your work it's dynamics. It will give you the impact you dream of.

Adding noise from any device, especially at the source, only degrades your performance.

The New RØDE NT1-A has a self-noise of **only 5dBA!**

No other studio microphone in its class, or indeed costing many times more can claim this!

## LOW NOISE IS ONLY HALF THE STORY

1) **Multi award winning, and the world's biggest selling studio microphone**, the NT1 is now a legend. The New NT1-A continues this tradition while improving specifications and tonal qualities.

2) **Using cutting edge technology** for the electronics, RØDE has implemented a computer controlled manufacturing line. Unlike many 'leading brands' all electronic boards are made without 'human hands' assuring high specifications, tight tolerances and unsurpassed consistency.

3) **Built to last** with a new computer controlled machining process. The body is then satin nickel-plated. The NT1-A is designed to last you a lifetime.

4) **No PAD or Filters.** Some microphone manufacturers include these in their budget products, but at what cost?

The NT1-A can be used with very high sound pressure levels without perceptible distortion. Most people never use a high pass filter on their microphones. Why pay for features you don't want or need at the cost of what is really important, true performance!

5) **Complete solution:** The NT1-A comes complete with a dedicated shock mount and zip pouch. No optional extras to buy.

## The new NT1-A, a clear winner.



RØDE MICROPHONES USA - Ph: 310 328 7456 INTERNATIONAL - Ph: 61 2 8765 9333 info@rodemic.com www.rodemic.com

**RØDE**  
MICROPHONES



Live

Last fall, Beck and the Flaming Lips, two enduring icons of '90s modern rock, teamed up for a somewhat unusual tour: The Flaming Lips doubled as the opening act and as Beck's backing band. *Mix* caught the show at the historic Paramount Theatre in Oakland, Calif. The evening began with an energetic performance by the Flaming Lips. Beck then treated the crowd

to a relaxed acoustic performance that included a healthy dose of material from his latest album, *Sea Change*. The Flaming Lips then rejoined Beck on-stage, and the two acts played through a wide sampling of Beck favorites, including tracks from *Midnight Vultures* and *Odelay*. Beck's scaled-down solo performance was framed on both sides by two over-the-top stage shows. From a technical standpoint, the tour also eschewed convention; FOH engineer Jon Lemon mixed from a prototype Digico D5 digital console.

# BECK

*Beck uses a Neumann KMS 105, while all of the other vocal mics are Shure SM58s. The miking scheme for the drum kit includes Neumann KMS 103s on kick and toms, Sennheiser E609 on snare and Neumann KM 184s for overheads. Other stage mics include Neumann TLM 193s on guitars. The multiple keyboard rigs and the bass were taken direct using Countryman DIs.*

*The main P.A. consists of Showco Prism cabinets and subs. The tour is carrying 20 full-range cabinets and 10 subs. All of the amplification comes from Crown.*

# AND THE FLAMING LIPS





PHOTOS BY STEVE JENNINGS  
TEXT BY ROBERT HANSON

Monitor engineer John Shearman, a longtime fixture with the Smashing Pumpkins, mixes both IEMs and traditional wedge monitors with a Midas XL4 console running 46 mono and three stereo inputs. Beck uses a Sennheiser 3050 wireless IEM system with custom ear molds from Future Sonics. All of the onstage monitors are Showco SRM wedges and Prism sidefills. Shearman manages seven wedge mixes and Beck's IEMs. The drummer and keyboard player also use IEMs at varying points during the show for click tracks.

"I'm now just mainly using the sidefills for the Flaming Lips when they're the opening act," Shearman says. "Beck has really gotten into the in-ears on this tour. He's using them constantly now, so we don't use the sidefills and wedges as much. On Beck's vocal, I have the TLA 100As; I mean and a spare. And I've got Drawmer gates on the kick and toms, and there are compressors on the kick and certain keyboards. Some of the keyboard stuff needs to get a bit frisky. I've also got a dbx 1046 on Beck's in-ear mix."

Also in Shearman's rack is a Lexicon PCM 70, which is used on Beck's vocal, as well as a complement of Klark Teknik EQs.

Monitor engineer John Shearman (left) and system engineer Jim Ragus.



FOH engineer Jon Lemon, whose recent FOH credits include The Cure, Depeche Mode, Oasis and Nine Inch Nails, mixes from a Digico D5 digital console, capable of 192 inputs arranged in layers and accessed through fader banks. Each channel includes dynamics, multiband EQ, insert/send effects and extensive automation features. A majority of the parameters are recalled and adjusted via flat-panel touch screens.

"We did an acoustic tour [over the summer]," Lemon explains, "and that's when

I really wanted to get a digital console because we were doing 1,000 to 1,500-seat theaters, but I couldn't get one in time that I liked. Then the whole Digico D5 thing started happening, and they offered me one of the only two prototypes for the tour. The console has all onboard compressors and gates, and they're the best digital gates that I've ever heard. Still, for that extra warmth, I use the Manley VaxBox on Beck's vocals, the Summit DCL 200s on the main backing vocals, the TLA 100 on the bass and, of course, the Smart compressor on the left and right. In all honesty, I find myself relying on them less and less because the compressors onboard are really good. But there is still something about the movement of valves for your main bass and vocal.

"I suppose the other interesting thing is that we have a Pyramix hard disk recording system from Switzerland," Lemon continues. "It gives me up to 112 tracks, but in actual fact, I'm just using 56. And I can do an hour and 40 minutes on about 40 gigabytes. The benefit is that it splits off at the digital interface on the back of the console. The next day, I can come in and just return the multitrack straight onto the console, and it comes in its inputs at exactly the gain the microphone was at the night before. I've got the self-powered Tannoys here; I can just start dialing in more stuff. Since I started doing this, I always dreamt about being able to come into the gig without the musicians and really hone down the sound."

Lemon also carries selections from TC Electronic, including the System 6000 Reverb, and an Eventide H300 for occasional vocal doubling.

FOH engineer Jon Lemon



# INDIA.ARIE



One of the strongest debut releases to emerge from the R&B world during the past couple of years is *Acoustic Soul* by Atlanta-based artist India.Arie. The album's title says it all: Arie is an artist who draws inspiration from the spiritual soulfulness of Stevie Wonder, the rootsy acoustic sensuality of Bill Withers and the urbane sophistication of Sade. *Acoustic Soul* has not only sold over 2.5 million units worldwide but also garnered numerous awards and seven Grammy nominations. Arie's second release, *Journey to India*, continued that stylistic path with more developed melodies and imagistic lyrical sentiment. **by Rick Clark**



When it came time to take the show out on the road as a headliner, Arie and her manager, Fernando Gibson, focused on creating a show dynamic that was as intimate as the coffeehouses where she honed her music, while at the same time integrating the impact of her top-notch band.

At FOH, Gibson enlisted Ollie Cotton, whose background has included running sound for the Apollo Theater in New York City, Take 6 and Doug E. Fresh, as well as working on sessions with Quincy Jones, Bruce Swedien and Phil Ramone. Cotton also co-owns jazz label OCDK Records ([www.ocdk.com](http://www.ocdk.com)) with J.C. Doo-Kingué. Cotton initially joined Arie last year during the artist's tour with Sade.

For this round of touring, Cotton and the band sequestered themselves at Crossover Studios in Atlanta for rehearsals. "I've known Fernando [Gibson] for years, and he called me and said I should come out, and that this was a very worthwhile endeavor," says Cotton after an Arie concert at Nashville's famous Ryman Auditorium, home of the original Grand Ole Opry.

To ensure that Arie's lyrical and vocal nuances are clearly heard, Cotton works hard to carve out space in the mix, while trying to keep some of the band's power. "Nothing should overpower those qualities," explains Cotton. "Any engineer can give you a great big bass drum sound, but then to make the acoustic guitar be heard, or to make the shaker clearly articulated, or experience all of the vocal nuances that happen, you have to really work to keep it all in balance. I'm not saying I get it right all of the time, but I work on it." All of the mics onstage are Shure models, and Arie's vocal mic is a Shure SM58 with a Shure wireless setup. True to the spirit of "acoustic soul," the drums are all miked and there is no triggering, with the exception of a hand-clap-type effect on one song.

At the Ryman, Cotton mixed on a Midas console. "I'm pushing about 36 inputs," he notes. "On the last tour, we used a Showco console, and before that, it was whatever the house would provide. As far as I'm concerned, these things are really interchangeable."

Cotton set up in the usual location at the Ryman: slightly off-center at the back of the balcony, which meant that he had to check regularly for bass buildup under the balcony. "I'd go downstairs every once and a while and hear what it sound-

ed like down there," he recalls. "Go upstairs, put it up to where it's filling up the downstairs and then go back downstairs and split that little difference."

Showco provided both house and monitor systems, along with systems engineer Chad Prater and monitor engineer Scotty Reikowsky, whose previous tour credits include Filter, Dream Theater, Stone Temple Pilots, Kenny Wayne Shepherd and the Dixie Chicks. "I actually met India last summer when I was out with Sade and she was our support act," recalls Reikowsky. "When I got the call asking if I would be interested in going out with her, I jumped at it because I really enjoy her music."

"India's the kind of artist who is very spontaneous and intimate with her audience," Reikowsky continues. "You never know what's going to come up next. You have a set list, but right in the middle of a song, she could just start talking to the crowd while the band's still playing and having a great time with it. It's easy to see that what she does is so true and real. That's what's so fun about watching her play every night. She definitely works with the crowd and gathers energy from them."

#### A DREAMY YET SENSIBLE MIX

Reikowsky describes the band as "a monitor guy's dream, because they pretty much mix themselves dynamically as a unit when they play. They're amazing musicians." However, while he prefers to mix for in-ear monitors, Arie likes to work with wedges, and Reikowsky is quick to point out that the concert dynamic includes high stage volume and monitor levels. "There are times when this band starts rocking together, and it can get loud up there," he says. "You'd be surprised—India is a lot louder than a lot of people think she is onstage. She likes it loud, especially on her vocals."

Cotton, who once ran monitors for Roberta Flack, stresses the importance of maintaining a sensible balance between monitor mix levels and the house sound. "It is important that the monitor mix is married well with the front-of-house mix," he notes. "Some monitor mixes can get in my way out front. A lot of monitor guys don't understand that it's not about loud, it's about fidelity. They don't think you can have fidelity, but you can. You see, fidelity is what the artist and musicians are really missing. They think that loudness is the answer, and it's not."



PHOTO BY STEVE JENNINGS

"The whole gig is acoustic guitar-driven, where most R&B situations are keyboard-driven," says Shannon Sanders, the band's music director and keyboardist, who also co-wrote several songs on Arie's two albums. "It's a trip, because I had to learn a lot more about guitar since I've been doing this and rethink my whole approach to playing keys. Usually, keyboard players think in terms of how to thicken things up sonically, but with this situation, I've had to think about how to be sparse, how to lay low for my moments."

"India's lyrics are incredible. She understands things way beyond her age," rejoins Cotton. "You just find yourself at certain times saying, 'Damn, I know what that means, but how does she know that?' When I'm out there with the audience, ladies who are older come to me and say, 'How does she know that? She's 20-something-years old, and she knows that!'"

To a person, every member of the crew and band has focused on the primary element that has earned Arie so much acclaim and a devoted fan base: her artistic point of view. As a result, Cotton's mix stays well away from overhyped arena-level SPLs and sounds more like a good stereo system. "India doesn't need that kind of mix going on," says Cotton. "They come to hear her music and not to be overpowered and blown away. They come to listen." ■

# BRYAN FERRY

Bryan Ferry has been touring throughout Europe since the May 2002 release of his latest solo album, *Frantic*; he reached the West Coast in November. *Mix* caught shows at San Francisco's Warfield Theater and at the new Kodak Theatre in Hollywood. Backed by an impressive nine-piece band—including British guitar legends Mick Green and Chris Spedding, pianist/arranger Colin Good and the Great Paul Thompson on drums—Ferry presented an intriguing selection of his own material, some Roxy Music favorites and various covers, including a hilariously authentic “Wooly Bully.”



PHOTOS: STEVE JENNINGS

FOH engineer Levi Tecofski, a veteran of the 2001 Roxy Music world tour, mixed on a Midas XL4, using the board's automation primarily for song presets and to control effects via MIDI. “Rackwise, I've got loads of analog tube compressors,” says Tecofski, who uses a BSS DPR 901 II on Ferry's Audio-Technica 4054 vocal mic, followed by an Avalon. “It's something [producer] Rhett Davies and I came up with: He said to not be scared to put compression on. I don't want to overdo it, but it seems to work.” Other items in Tecofski's rack include “lots of” Summit Audio TLAs,

Drawmer gates, a two-engine Lexicon 480, an H3000 and a PCM 70. Monitor engineer Steve May is using XTA SiDDs on in-ear mixes for drummer Thompson and the backup singers; everyone else uses wedges. Mic choices included A-T 4050s for guitars and drum overheads, Shure Beta 58As on the backing singers, and a Beyer M-88 and a Shure Beta 91 on the kick. Eighth Day Sound provided a V-DOSC system for the U.S. tour.

—Steve Jennings

FOH engineer  
Levi Tecofski

## NOTES FROM THE ROAD

Audio Analysts has equipped Bruce Springsteen's E Street Band with Westone Elite Series ES2 in-ear monitors for the current 2002-2003 world tour. The ES2 is a high-quality, custom-fit, dual-driver monitor, and retails for \$650...PA Plus Production (Toronto) set up a JBL VerTec system for Queen Elizabeth's visit to Hamilton, Ontario, where she addressed a crowd of 17,000 at Copps Coliseum. PA Plus systems engineer Mark Radu and FOH engineer John Lacina flew four arrays of four VT4889 cabinets...The Midas DIRECT Web-based service provides a central resource to buy pre-owned Midas consoles. As part of the Approved Pre-Owned Console program, Midas engineers inspect each console before offering it for sale. For more information, visit [www.midasconsoles.com](http://www.midasconsoles.com).

## INSTALLATION NEWS

The new Sheraton Hotel on the French Polynesian island of Bora Bora has installed 60 JBL Control Contractor Series speakers for ambient music throughout the entire resort. The system is controlled from the reception desk, which features a 400-disc CD player and a CT210 Crown amp. JBL distributor Total Video Distribution collaborated on the system design...St. Olaf College, in Northfield, Minn., recently installed SymNet Audio Matrix to provide automation and flexibility to deliver diverse sound simultaneously to several different zones of the complex. With SymNet—a modular audio mixing, routing and processing system from Symetrix Inc.—audio can be tailored to each of four zones: the main entryway area, a fitness area, a weight room and a running track. ■

## LES MISÉRABLES TOURS WITH MEYER

Autograph Sound Recording provided a large complement of Meyer Sound M3D Line Array loudspeakers for a touring production of *Les Misérables*. Designed by Autograph's Nick Lidster, who also mixed the shows, the sound system included 24 M3D cabinets, 30 MSL-4s for sidefill and delay systems, and 20 UPA-1C and UM-1 stage monitors. Lidster used Meyer's MAPP Online (Multipurpose Acoustical Prediction Program) to predict and fine-tune the M3D's vertical coverage in each venue.



PHOTO: NICK WANN

## SURFER/FILMMAKER JACK JOHNSON GETS INNOVASON

Monitor engineer Barry Haney selected the InnovaSon Compact Live digital console for his first tour with musician, surfer and filmmaker Jack Johnson. Haney, who has toured with Nine Inch Nails, David Byrne, The Breeders and The Pixies, selected the Compact Live for its powerful onboard processing, flexible software and small footprint. “I've done monitors on lots of different desks, but there are some really unique things about the InnovaSon that make it a really fun monitor desk,” Haney says. “I'm making good on a long-held promise that I would do a tour without graphic EQs.”

## ATI PII FOR GOO GOO DOLLS

Independent monitor engineer Bob Lewis recently changed monitor consoles on a Goo Goo Dolls tour, replacing the previous board with an ATI Paragon II. “I started using the Paragon II about halfway through the tour,” says Lewis. “There was a night-and-day difference: the dynamic range and everything is just 10 times better than anything else.” A three-piece that formed 15 years ago, the Goo Goo Dolls augment their lineup with two additional musicians for live shows. Lewis uses 42 input channels, plus two stereo inputs. The Paragon II was supplied by Firehouse Productions (Milan, N.Y.).

# absolute knockout

"The Carvin C1644 is an absolute knockout in its functionality and performance. In the bang-for-the-buck department, the Carvin is a stunning, Made-in-America achievement!"

Pro Audio Review, Ed Forke, May 2002

1644-1584 system **\$1899.99** features;

- The 16 channel **C1644** 4 bus mixer with dual (256 effects) 24-BIT DSP's and up to 4 monitor sends, powerful 3 band EQ with mid sweeps, and an ultra-clean high-head room mic pre-amp for every channel. C1644 only \$699.99. Other models: 8, 24 & 32 ch.

- The powerful 3-way **1584** speakers are smooth with deep bass, crystal clear highs and a mid-range that is totally natural at high levels. 1584 only \$399.99.

- The high current 1000 watt **DCM1000** power amp drives the 1584's with ease - without experiencing thermal shut-down no matter how hard they're driven. DCM1000 only \$369.99.

- Two **CM68** mics are Carvin's best vocal mics at only \$79.99 each. Includes 25' mic & 50', speaker cables.

7422-1001 monitor system for the above system; **\$895.99**

- **DCM1001** 1000W dual channel monitor power amp with 9 band EQ. High current design allows you to drive up to eight 8Ω monitors. DCM1001 only \$469.99.

- Two **742** 12" 300W monitor speakers offer big sound with lots of bass. Crystal clear sound can be heard under the most difficult monitoring situations. 15' cables for mixer to amp and 50' monitor speaker cables included. 742 only \$199.99.

Every Carvin system is perfectly matched and built at our San Diego factory. They are so easy to use - just plug and play. Guaranteed to be the best you've ever heard or your money back!



CARVIN



CARVIN

1584 3-way Speakers

optional SS20 stands

optional MS13 stands



CARVIN



CARVIN

742 Monitors

#### Options:

- High-end rack mount U7500 wireless mics from \$299.99 to \$359.99
- AC120 power conditioner \$149.99
- Two PSS20 heavy-duty speaker stands with system purchase \$69.99
- MS13 mic stand/boom \$29.99
- SKB rack cases from \$74.99 to \$209.99



**CARVIN**  
800.854.2235 (CDM)

To ORDER, SPECS or for a FREE catalog [carvin.com/pro\\_sound](http://carvin.com/pro_sound)  
WORLD'S #1 FACTORY DIRECT MUSIC STORE  
Enter [carvin.com](http://carvin.com)'s weekly FREE GEAR giveaway!

## New Sound Reinforcement Products

### CREST PRO 200 SERIES

The Pro 200 Series professional power amps from Crest Audio ([www.crestaudio.com](http://www.crestaudio.com)) has three new models: the \$2,630 Pro 8200 offers 1,450 watts per channel (4,500 watts bridged) into 4 ohms; the \$1,970 Pro 7200 provides 1,000 W/channel (3,300 watts bridged); and the \$1,600 Pro 5200 delivers 525 W/channel (1,800 watts bridged). All three amps occupy 2U and weigh 25 pounds, offering increased power, a smaller enclosure and lower weight at a reduced cost. Features include automatic clip limiting, IGM impedance sensing (automatically modifies the gain to the output impedance), front panel input attenuators, AutoRamp circuitry to minimize power-on thumps, tunnel-cooled high-efficiency heat sinks, and variable-speed DC fans. XLR inputs are actively balanced; outputs are Speakon and binding posts.



### ACOUSTALARM SPL ALERT

The SA6000 family of ACOustAlarm products from ACO Pacific ([www.acopacific.com](http://www.acopacific.com)) can provide a clear warning when sound-pressure levels (SPLs) are potentially dangerous. The SA6000 family features true RMS detection; A, C and Linn frequency-response selections; dBA, dBC or dBSPL displays; custom mounting configurations; and optional remote mic and signaling outputs. The SA6000 has a standard SPL range of 50 dB to 130 dB, but the system can be used to respond to signals from -20 dBA to well over 150dB SPL.



### SHURE UPGRADES BETA MICS

Shure ([www.shure.com](http://www.shure.com)) has replaced its Beta 52 and Beta 56 mics with the Beta 52A and Beta 56A, respectively. Improvements include a larger adjustment knob and more durable tightening mechanism, though the sound quality remains unchanged. Both articulating mics now also employ a wider mounting base that accommodates a larger range of microphone stands; the Beta 56A even works with the LP Claw. List prices remain the same: Beta 52A, \$336.70; and Beta 56A, \$243.49.

### MEDIAMATRIX COBRANET INTERFACE

MediaMatrix, a division of Peavey Electronics ([www.peavey.com](http://www.peavey.com)), offers the X-Bridge, a single-rackspace CobraNet audio network interface for the X-Frame 88 digital audio processor. With the X-Bridge, up to four simultaneous CobraNet audio bundles appear within the X-Ware software as two sets of 8-channel inputs/outputs. Various system configurations are possible, including interfacing with larger, frame-based MediaMatrix systems, stand-alone CobraNet operation using the popular CAB Series breakout boxes, or peer-to-peer systems for long-distance audio transport. The X-Bridge supports both RS-232 and RS-485 serial data interfaces, so XControl controllers and third-party control systems can easily communicate with the X-Frame 88 via the CobraNet network. The X-Bridge includes switchable front panel metering to monitor network audio signals.

### FUTURE SONICS POWERPACK

Future Sonics ([www.futuresonics.com](http://www.futuresonics.com)) has announced a special limited-time "PowerPack" offer. The Future Sonics Power-Pack contains two sets of Future Sonics Ears™ universal-fit monitor earphones (model EM3) and a Sennheiser Evolution Series 300 wireless system, complete with carrying cases and extra universal-fit foam-sleeve sample packs. Price for the complete package is \$799, and the offer is valid for direct orders only via the Future Sonics Website. Orders must be received by March 1, 2003.





# Agility

## Control

**midas** 5k 10k  
2.5k 25k  
500 50k

**Audience Size**

INS  
PRE  
EQ



# Agility Control.



### Agility and Versatility:

The same XLC line arrays that handle front-of-house when the Rolling Stones play theaters and clubs also complement full-size X-Line arrays in stadiums and arenas.

One night, it's a 50,000-seat stadium. The next night, it's a 2,500-seat theater. Then a 500-seat club. When db Sound designed the front-of-house system for the **Rolling Stones LICKS 2002/ 2003 World Tour**, they knew it had to be the most agile, versatile concert system ever built. That's why db Sound depends on **Electro-Voice® X-Line™ and X-Line Compact™ linear array loudspeakers** to make the Stones sound fabulous in venues of all sizes.

Both X-Line and XLC systems deliver full bandwidth sound, astonishing clarity, predictable uniform coverage, and easy rigging. While the X-Line systems rock audiences in stadiums and arenas, XLC performs in places line arrays could never go before—and even complements X-Line in the biggest venues.

X-Line and XLC give db Sound incredible control over system configuration under the most demanding conditions imaginable: a Rolling Stones tour. When size matters, depend on Electro-Voice. Visit [www.electrovoice.com](http://www.electrovoice.com).

## 1-800-392-3497



Celebrating 75 Years of Great Sound!



PHOTO: SCOTT ELMOQUIST

From left: Rob Derhak, Chuck Garvey, Jim Loughlin, Al Schnier and Vinnie Amico

## JAMMING WITH MOE.

THE ROAD IS THEIR STUDIO

by Blair Jackson

Call it the "Grateful Dead Syndrome": a problem that seems to afflict nearly every group that's part of the current jam band scene is that their studio albums fail to duplicate the energy, intensity and improvisational glory of their live performances. From the bands' perspective, they want to put out albums that show off their new material in a positive light and demonstrate, to both the uninitiated and the faithful, that they're about *songs*—not just jamming—and perhaps garner some radio airplay in the process, because there are few stations that will play a 12-minute live track, no matter how hot the guitar solos. Traditionally, jam bands have had trouble breaking out of their niche to gain wider acceptance:

Groups such as String Cheese Incident, Widespread Panic and even the reigning kings of the genre, Phish, remain largely live phenomena, earning most of their scratch on the road rather than from CD sales.

The upstate New York band moe. is a little further down jam band's popularity ladder than the groups mentioned above, but they've still managed to develop a large, rabid following, particularly up and down the East Coast, over the course of the past decade-plus. And for my money, they're the most compelling band in the genre. Always unpredictable, fabulously eclectic and unfailingly adventurous, moe. is extremely difficult to characterize: One song might sound like the bastard offspring of a Neil Young song and a Led Zeppelin tune; another might start with skittering Afro-pop guitars, move into a reggae groove and close out with a guitar crescendo that sounds like hopped-up Lynyrd Skynyrd. Complicated passages worthy of Frank Zappa or King Crimson sit side by side with punk-flavored rave-ups and deeply psychedelic voyages somewhat in the Dead tradition. The group boasts two exceptional guitarists—Al Schnier and Chuck Garvey—who are capable of both flashy pyrotechnics and spacey delicacy, and a rhythm section—bassist Rob Derhak, drummer Vinnie Amico and percussionist Jim Loughlin—that can turn on a dime and play convincingly in any genre. Schnier and Derhak are the primary singers and songwriters who have shown impressive development through the years.

Their album output has been somewhat un-

—CONTINUED ON PAGE 141





# JURASSIC 5

TRACKING BEAT BY BEAT

by David John Farinella

While Jurassic 5 climbs to the top of the charts with the tune "What's Golden" from their latest offering, *Power In Num-*

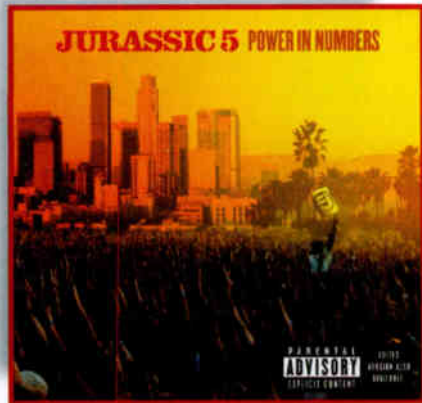

From left: DJ Nu-Mark, Zaakir, Chali 2na, Akil, Cut Chemist and Marc 7even

bers, one of the outfit's DJs explains their philosophy: "The thing about our group that I really like is that we kind of throw up one brick at a time," Nu-Mark says. "So each album gets a little bit bigger and a little bit bigger. I'm not really surprised; I'm just glad. I don't really keep my hopes up too high for anything in this business, because it's a really big letdown when it

doesn't come through. I just kind of keep my head down and work."

Work, indeed, because it's Nu-Mark and his DJ partner Cut Chemist who lay down the beats that J5's four MCs—Zaakir (Soup), Chali 2na, Akil and Marc 7even—rhyme over. "There's really no set pattern to our thing," Nu-Mark explains.

—CONTINUED ON PAGE 143

# WORLD MUSIC NETWORK

SOUNDS FROM FARAWAY PLACES

by Robert Alexander

Tucked away in the heart of London is a small but incredibly vibrant company whose sole purpose over the past eight years has been to bring the music of the

world to the ears of a wider audience than had previously been thought possible. World Music Network (WMN), in conjunction with the Rough Guide Series of reference books, has done much to put world music on the map. And what a map! You pick a place, any place—from far-flung island paradises to dense cities, mountain villages to South African townships—and chances are that WMN representatives have already been there, collecting the best rap, rock, soul, folk, reggae, roots, salsa, whatever style that region offers.

One might expect WMN to be some massive organization with huge offices; but in fact, the company—founded and run to this day by the partnership of Phil Stanton and his Colombian wife, Sandra Alayon-Stanton—boasts an office staff of just 10 people.

"I've had some experiences in the music industry before [starting WMN]," Stanton explains. "I'd worked for a small record label here in London, booking live bands and trying to get record deals going. After we got married, Sandra and I realized that we could turn our mutual love



Phil Stanton and Sandra Alayon-Stanton

of what we now call world music into a business, except it was very hard to market our concept because, back then, world music was just music from around the world.

"At first, it was almost impossible to get the press or distributors interested in selling the CDs, so we hatched this idea of a

—CONTINUED ON PAGE 144



## TRAFFIC'S "DEAR MR. FANTASY"

by Blair Jackson

Although Steve Winwood was just shy of 19 when he formed the group Traffic in the spring of 1967, he was already a veteran performer. Having played with his brother Muff in jazz bands in his early teens, the younger Winwood was fronting the pop/R&B-flavored Spencer Davis Group by the age of 15. He was lead singer, guitarist, organist and co-writer of the group's two biggest hits, "Gimme Some Lovin'" and "I'm a Man"—quite an auspicious beginning for the Birmingham, England, native. After his sojourn with the Spencer Davis Group, Winwood started Traffic with three friends—guitarist Dave Mason, drummer Jim Capaldi and reeds player Chris Wood—all of whom had appeared, uncredited, on an American remix of the SDG's "Gimme Some Lovin'" and then later on "I'm a Man."

The SDG sessions involving the future Traffic members were among the first to be helmed in England at Olympic Studios by producer Jimmy Miller, an American who would go on to be one of the most successful producers in Britain during the late '60s and early '70s. (There was a precedent for American producers doing well in England—Shel Talmy had cut early hits with both The Kinks and The Who.) Those proto-Traffic "I'm a Man" sessions were also the first pairing of Miller and a young Olympic engineer who would also make quite a mark in rock history, Eddie Kramer, who, as fate would have it, had worked with Talmy at Pye Studios before going to Olympic.

"Jimmy Miller was my mentor," Kramer says from his Hudson Valley home north of New York City. "Bob Auger [at Pye] and Keith Grant from

Olympic are the guys who taught me most of what I know about engineering, but Jimmy was the guy I owe for my initial forays into producing; he's definitely the guy who influenced me the most. He was a genius and a wonderful human being. He just had the most amazing ability to take a group of musicians, rehearse them, get them in the studio and get them so excited about what they were doing and make it all seem so much fun that I realized that *this* is the way that records



Steve Winwood inside Olympic Studios, circa 1967

should be produced. He was just a terrific catalyst. He had a great sense of humor. And he was unstoppable in the sense that his energy level was *always* up. He really, really dug the music; he was always so into the band: 'How can I get you guys to feel this track the way *I'm* feeling it?' He would sing parts. He was like a master of ceremonies."

Miller became such good friends with Winwood that he was the natural choice to produce Traffic's first album, which was cut at Olympic late in the fall of '67 and released around Christmas that year. But before Traffic was ready to record, the group spent a few idyllic weeks in a small cottage in rural Berkshire, spreading their wings creatively, working on songs together and trying to establish a group identity. Most of the first album's material was born at pot- and psychedelics-fueled jam sessions at the cottage, including this month's Classic Track, "Dear Mr. Fantasy." In the mid-'80s, Capaldi told me about the genesis of that song:

"It was the summer of 1967, and we were all living in this cottage in Berkshire. We were one of the first English bands to live together like that. We thought we'd try it and see if anything came of it. I remember the day very clearly: A bunch of friends came over early in the day and we had quite a party. It was sunny and the corn was coming up nicely around the cottage, and we were *quite* enjoying ourselves, if you know what I mean. As things finally wound down in the evening, I was sitting around just doodling, as I would often do, drawing this character. It was



PHOTO: EDDIE KRAMER ©1967-2003. ALL RIGHTS RESERVED. EXCLUSIVE AGENT: ARIA PHOTOGRAPHIC IMAGES LLC

# If We Had To Pick One Word To Describe KRK's New E8T Monitor, It Would Be...



## "More"

You're looking at a monitor that takes your mixes as seriously as you do. With its impeccable accuracy, technical superiority and remarkable imaging, the new E8T has all of the heart and soul of the legendary E8, only now, there's even more to get excited about. Like KRK's new Titanium Oxide dome tweeter for extraordinary high frequency detail and clarity. The high temperature voice coil and optimized venting alignment of the woofer gives you incredible bass extension and dynamics without compression. And, as far as power goes, the E8T has a 260 watt Class A A/B discreet bi-amp design with separate 24dB/octave filters and a delay for seamless driver integration and dispersion.

More you say? Okay, the E8T's high frequency attenuation control allows for perfect integration into a wide array of

listening environments. An inert MDF enclosure with optimized geometry virtually eliminates diffraction and resonances. We even matched the driver and systems to within 1dB for imaging that is simply unparalleled.

More performance, more power, more of what you're looking for in a monitor. So, if you're serious about your mix, the E8T is seriously worth your investigation.

Still want more? Then visit us on the web at [www.krksys.com](http://www.krksys.com) or see your local KRK dealer.

**KRK... The Authority In Powered Sound**

Contact us at [www.krksys.com](http://www.krksys.com) or 805 584-5233



## Cool Spins

*The Mix Staff Members Pick Their Current Favorites*



**George Harrison: *Brainwashed* (Capitol)**

What a wonderful keepsake this album is for the millions of people (like me) who loved and respected George Harrison. It represents his first studio album since the 1987 *Cloud Nine*, and it is certainly as good as that album; maybe better. It opens with one of his catchiest songs—"Any Road," which dates back to the *Cloud Nine* days—and includes a number of excellent showcases for his singing and slide guitar work. There's plenty of his sardonic humor, as well as the expected philosophical journeys, all the more poignant given his untimely passing. "Pisces Fish," "Looking for My Life" and "Stuck Inside a Cloud" are all strong, personal pop meditations, and "Marwa Blues" is a lovely, moving instrumental with a slight Hawaiian lilt. In fact, Harrison's love for Hawaii, where he had a house for many years, shows through in the rhythmic ukulele strums that form many of the songs' foundations. The album was completed posthumously by Harrison's musician/son Dhani and the ubiquitous Jeff Lynne; the good news is that their work is extremely tasteful throughout. A classy effort from beginning to end.

Producers: George Harrison, Jeff Lynne, Dhani Harrison. Engineers: John Etchells, Ryan Ulyate, Marc Mann. Studios: Not listed, but mostly done in Harrison's studio. Mastering: Brian Gardner/Bernie Grundman Mastering (Hollywood).

—Blair Jackson

**Various Artists: *KCRW's Sounds Eclectic Too* (Palm)**

The second in the *Sounds Eclectic* Series of

live-in-the-studio recordings from Los Angeles' KCRW again offers something different. Here, the critical darlings of alt get a chance to prove that one, they've really got something to say; and two, they can say it live. Sometimes inspired and always interesting, most of the performances were recorded in stereo, direct to DAT, in the NPR station's funky basement studio (three cuts were recorded live-to-2-track and broadcast on location) on a 24-channel Amek Big console. High concept, not high tech is the result; vocals are mostly way out front, and it's all about the song and the emotions. *Sounds Eclectic Too* starts off with the moody, surprisingly insinuating, piano and vocal "Yellow" by Coldplay frontman Chris Martin, and ranges through Zero 7's smoky "Distractions," the poignant "I've Been High" by R.E.M., Nick Cave's "Into My Arms," Dido's "Here With Me," and much more. More intimate and raw than MTV's



*Unplugged* or VH1's *Storytellers*, listening to *Sounds Eclectic Too* is like hearing a bunch of songs played—just for you—in their early demo stages. All that and no pitch shifting, beat correcting or digital re-arranging. Joetta Bob says, "Check it out."

Producer: Nic Harcourt. Engineers: Jamie Candiloro, Bob Carlson, Mario Diaz, Teri Enomoto, Ray Guarna, Mark Luecke, JC Swiatek, Greg Thompson. Studios: KCRW, Studio de la Seine (Paris), Museum of Television and Radio (Los Angeles) and Kampo Cultural Center (New York).

—Maureen Droney

**Bob Dylan: *The Bootleg Series, Vol. 5: Live 1975, Rolling Thunder Revue* (Columbia)**

Having seen Dylan in concert a few months ago and being disappointed—again—by his decision to deliver nearly every song in a speedy, indistinguishable blur of words that

—CONTINUED ON PAGE 145

this little fellow with a spiked sun hat. He was holding some puppeteer's strings, and the puppet hands on the end of the strings were playing a guitar. Under that I just scribbled some words: 'Dear Mr. Fantasy,' play us a tune, something to make us all happy' and on a bit. It was nice, but I didn't think much of it; certainly, it wasn't intended to be a song.

"I crashed out eventually, but I remember hearing Steve and Chris playing around after. The next day, I woke up and found that they'd written a song around the words and drawing I'd done. I was completely knocked out by it. Chris wrote that great bass line. We added some more words later and worked out a bigger arrangement, too. Those were very happy days for Traffic."

According to Capaldi, when the group later went to Olympic to cut the song, "We tried originally to record it regularly, with all of us in little booths and all, but we weren't *feeling* anything. So we got rid of the booths and we all played together in this big room. We ended up cutting the song very live."

Kramer: "We had the band set up on a riser at one end of the studio, which is a big room—maybe 65, 70 feet long by about 45 wide with about a 30-foot ceiling. They were set up as if they were onstage and I recorded them live, straight to 4-track. I can remember with such clarity the time when we were actually cutting 'Dear Mr. Fantasy': We were in the middle of a take and there's a part where the tempo changes—it jumps—and I look around and Jimmy Miller's not in the control room. The next thing I see out of the corner of my eye is Jimmy hauling ass across the room, running full tilt. He jumps up on the riser, picks up a pair of maracas and gets them to double the tempo! That, to me, was the most remarkable piece of production assistance I'd ever seen. They were shocked to see him out there, exhorting them to double the tempo. Their eyes kind of lit up. It was amazing. That was Jimmy!"

Olympic was one of only a few independent studios in London in the late '60s; label-affiliated facilities such as EMI (Abbey Road), Decca and others still ruled the roost. By the time "Dear Mr. Fantasy" was recorded, Olympic had moved from its original West End space (it opened in the early '60s in a former Dutch Reform church that was reputed to be haunted) and was now in the Barnes area of London in an old theater. The big room there attracted lots of music-for-film work, and

as Traffic, the Rolling Stones, Led Zepelin and many others also discovered, it was a great live rock 'n' roll room.

"One of the things that made Olympic go," recalls Kramer, who started working there in 1966, "was this gentleman by the name of Dick Swettenham—he designed the early Olympic console. He was designing and putting together a brand-new concept of a console, which was, in essence, the Helios desk. Dick was one of these prototypical English boffin guys: big orange beard, thick glasses, white lab coat. But a great guy! The console he built was brilliant, and I had the unenviable task of helping the guys wire the new Olympic, which had been an old movie theater. It was c-shaped, and it was essentially a six-output desk, with four main buses and two extra ones if you were doing 6-track work for film. Above the control room was a projection booth that had synchronized projectors and mag dubbers; we could record two 3-track dubbers together, locked up. Anyway, Dick designed a wonderful board; it sounded amazing. It was the first all-transistorized modular console where everything pulled out. The faders were a module, the routing was a module with its own nice little slide fader for the sends—just beautifully designed, and ergonomically it was great; you could get to everything so easily."

Sessions were recorded on a pair Ampex half-inch 4-tracks, bouncing parts back and forth to make up for the paucity of actual tracks. "I went four-to-four at least three times," Kramer says. He doesn't recall much about the song's miking specifics, but notes that in photos he took during the sessions, Winwood sang into a Beyer M 160. "I used that on vocals a bit. I also liked [Neumann] 67s, of course: They were the 'go-to' mics; I loved my 67s." Kramer also favored during that era AKG D-12s, D-20s and D-30s: "Those were the coolest," he says of the D-30s. "Great bass drum mic. We also had [Neumann] KM56s; I used them on hi-hats. And I used a lot of 67s on toms." He miked the B3's Leslie cabinet in stereo, top and bottom.

"I have such fond memories of those sessions," Kramer says. "Everybody was thinking in terms of, 'How do we make this record better and more exciting?' And Jimmy Miller was the ringleader, pushing everybody's buttons in the right way, in a nice way; mine, too. He would allow me to do wacky things, and he would encourage it—not that I needed much encouragement—but Jimmy always had a firm hand on the tiller."

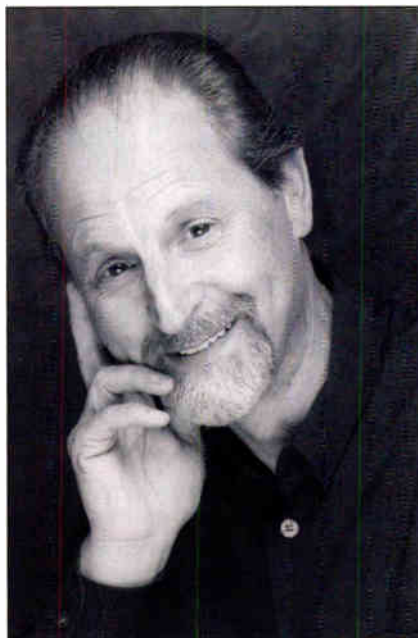

Eddie Kramer

By the time Traffic's debut album (titled *Mr. Fantasy*) was released in December 1967, the group had scored three hit singles in the UK with Winwood and Capaldi's "Paper Sun," Mason's "Hole In My Shoe" and the group-penned "Here We Go 'Round the Mulberry Bush" (from the film of the same name), none of which appeared on the original British mono pressing of the LP. The first American version of the album (which was in stereo) was called *Heaven Is In Your Mind*, after another song on the album, but it was quickly changed to *Mr. Fantasy*, and it included the three UK singles. The song "Dear Mr. Fantasy" was never a hit single, but it quickly became an underground radio favorite in the U.S., and has long been considered one of the group's true classics, along with such tunes as "Glad," "Freedom Rider," "John Barleycorn (Must Die)" and "Low Spark of High Heeled Boys."

The group weathered numerous personnel and style changes over the course of several albums in the late '60s and early '70s, but still amassed an impressive, if disjointed, discography. Winwood, of course, has had a very successful solo career. Eddie Kramer went on to engineer legendary albums by Jimi Hendrix, Led Zeppelin and many, many more over the course of a brilliant career that continues to this day. Jimmy Miller did more work with Traffic and Winwood, produced the Rolling Stones' great masterpieces—*Beggars' Banquet*, *Let It Bleed*, *Sticky Fingers* and *Exile on Main Street*—and numerous other groups ranging from Spooky Tooth to Motorhead. He died in 1994. ■

## MOE.

FROM PAGE 136

even; like most of their fans, I've preferred their live outings, such as *L* and especially the first two volumes of their *Warts and All Series* (released on their own Fatboy label), to their studio product. However, for their new iMusic/ARTISTdirect CD—titled *Wormwood*, after one of the principal ingredients in the potent intoxicant absinthe—moe. decided to try a new approach to recording a "studio" album: cutting basic tracks live on the road and then overdubbing in a conventional studio. The result is an album that has a lot of the magic of moe.'s incendiary performances and the sonics of a traditional studio effort.

We spoke with guitarist Schnier twice during the process of cutting *Wormwood*: first in early June 2002, when the band began recording, and again in October, when the album was completed and mastered—sort of a "before and after" view of the album-making process.

### JUNE 2002:

#### DREAMS AND INTENTIONS

"The new moe. album has officially begun!" Schnier enthuses from a hotel room in Cincinnati the morning after a gig. "Here's the plan: We have about 15 new songs that are slated for the next album, and rather than going into the studio and trying to re-create the live vibe that every group goes for when they're doing the basics, we figured that we would record all of this stuff on the road—during soundchecks, backstage, in hotel rooms, etc.—and use *those* for our basics in the studio. Then, we'll add all of the bells and whistles and studio magic in a regular studio.

"So with that in mind, we purchased two of the Tascam MX-2424s and we have those set up in a rack, along with a G4 and some Glyph hard drives. Our monitor engineer, Bil Emmons, is an excellent studio engineer who we've worked with in the past and are fortunate enough to have on the road with us now. So he's running monitors and tape machines simultaneously, and then once we get into the studio, he'll be the head engineer. With the hard drive space we have and the way we have it all configured—I think we're about 40 tracks—we can record about three-and-a-half hours with our current setup.

"We did a fair amount of pre-production on the songs before the tour, just to

because automation wasn't playing it back right," he says. "I actually tried to do it on my 2480 and it couldn't handle the capacity of that kind of automation. It's an ambitious little machine, but it wasn't doing the job. We went with normal automation in a 24-track studio. There were a few moves that missed, but on the whole, those are usually pretty tight." Once the song was programmed and mixed to their liking, Nu-Mark dumped it into Pro Tools (the only song to get such treatment) to level out the parts.

Along with the tracks produced by Nu-Mark and Cut Chemist, *Power In Numbers* features guest appearances by JuJu of The Beatnuts on "If You Only Knew," Percy P and Big Daddy Kane on "A Day At the Races," Nelly Furtado on "Thin Line" and Boy Wonder on "Hey." According to Nu-Mark, having these collaborators lent a different vibe to the sessions. "I think it's kind of a thing where if you were to play guitar in front of your best friend versus playing guitar in front of someone you really look up to. So, you think, 'Wow, I better really stay on my licks.' So, I think people licked off their verses quicker, less than four takes kind of thing. You want to show that you're sort of still sharp."

During the recording process, Nu-Mark took tracks down to Ameraycan Studios to play them for Staton, who was already lined up to mix the album. "Nu-Mark brought his 2480 into the studio and asked my opinion on how [the tracks] sounded and what he could do," Staton recalls. "Once he got it down, it sounded really good, and they just went through and started steamrolling through on all of the vocals, which was pretty good because there were so many of them. Nu-Mark was really meticulous with the vocals, and it gave them time to do what they needed to do at the home studio."

Once the tracks and vocal sessions were complete, the J5 crew brought the 2480 and the MPC2000XL into Ameraycan and everything was dumped onto a Studer A827 with Quantegy 499 2-inch tape. Staton's favored outboard gear includes the dbx 902 De-Esser, a Manley Stereo Variable-Mu Limiter Compressor, a NCI EQ3D and a Neve 1073 to fatten up some of the vocals.

Looking back on *Power In Numbers*, Nu-Mark sees how that brick-by-brick approach works: "The goal of the group on this album was to have more dynamics, more hills and valleys," he says. "We had it on the last album, but it's more apparent on this album." ■

## WORLD MUSIC NETWORK

FROM PAGE 137

kind of network to take care of that process for us, and then to compile the albums from existing media. We always wanted the CDs to be compilation albums so that people who were looking for that kind of music, but who had no idea what they were looking for or where to find it, would get a decent selection of what was out there. Then, hopefully, that would encourage them to go and look for more.

"So, in early 1994, we teamed up with the people who produced the Rough Guide books and sold them on the idea of a compilation CD in the back of one of

are already located in, the places where we decide we want to make a compilation from, and then they research and gather all of the material and send it to us. In the beginning, I used to go and do most of the recordings and research myself.

"Now we choose somebody who is a recognized expert of a particular type of music, or they will come to us with a schedule, and we work out a plan for the compilation, with basic rules gathered from the information we already have for what we think we want. It can take months—even years—to gather the right material, and because we are totally at the mercy of our agents abroad, we never quite know what we are going to get



The Sierra Maestra Musicians can be heard on WMN.

their publications. That led to the first *Rough Guide to World Music*, which has now become the Bible, so-to-speak, of the world music genre. That first book, with our CD in the back of it, was such a huge success. It sold over 80,000 copies and has since been expanded and updated, and is now sold in two volumes all around the world. Since then, as Rough Guides to [specific] areas have been released, there is a WMN CD in the back, with music from that region.

"We also produce CDs that don't focus on specific places; for example, we have the *Rough Guide to Tango or Ballet*, or whatever, and these are not linked to books."

So how does WMN find extraordinary music from far-off places and get it back to London? And how do they decide where to look for the music in the first place? "We have agents all over the world," Stanton explains. "It sounds like something from *James Bond*, doesn't it? But seriously, we have people who travel to, or

when the packages start to arrive."

"Deciding *where* to go is more difficult," adds Stanton's wife, Sandra. "We put together an ideas list and work from that. [Experience has shown] that putting every kind of music from around the world into one category and naming it world music just isn't working anymore, and it has taught us that the more you know about world music, the more you realize what you don't know. For instance, we started with an idea for a Rough Guide to the music of West Africa. But then we realized that there was so much and it was so diverse that we ended up doing guides to Guinea, Somalia, Ivory Coast, Nigeria, Gambia, Ghana and others. And, yes, there are still places left in the world, many of them where we still haven't been and, of course, we want to go."

The material arrives on a variety of different formats. According to Laurence Cedar, a mastering engineer who has worked on over 100 WMN releases at his own Binary Studios in West London, "In

the past, we have had every media you can imagine turn up at the office, from badly recorded cassette tapes to 78 rpm vinyl records. There is no guarantee in this business that you will get a nice, crisp digital recording on DAT or CD or Mini-Disc to work from, so I have to be prepared for literally anything, though thankfully, these days, it is mostly a pile of CDs that arrives on my desk." Cedar's studio is based around a Pro Tools system with Logic and a Mac G4.

Cedar's background includes both mastering—he worked for Trevor Horn on mastering the first Seal album in the early '90s—and writing music for commercials. "Phil Stanton got in touch with me in early 1994, just as WMN was starting out," he says. "I was working as a writer of music for television commercials at the time, which is still my main business, but as you can imagine, world music plays such a huge role in sound design for visual images. I was fascinated by this idea for a compilation album of world music.

"For me, this arrangement is perfect," Cedar continues. "When I write music for TV commercials, having a big CD collection of world music on hand—especially stuff that I have mastered—is very useful. I treat the projects as an education because there is always something from the middle of nowhere that you've never heard of that makes you go, 'Wow!' And the best thing about it is that nobody else will have heard it yet, either. I did some Coca-Cola ads for South America and they wanted a tango, samba and cha-cha-cha music, and all of the basic ideas came from CDs I'd worked on for WMN. It's like having a wonderful library that, luckily, I get the chance to constantly add to."

An online catalog with detailed descriptions of all the WMN releases and many audio samples are available at [www.worldmusic.net](http://www.worldmusic.net). ■

### Cool Spins, FROM PAGE 140

did a complete disservice to the power of his lyrics, the arrival of this magnificent two-CD set was like a healing balm. Recorded the year after his historic reunion tour with The Band (captured in all of its ragged glory on *Before the Flood*), it features his rag-tag Rolling Thunder Revue, which mostly played small venues in the Northeast. *Blood on the Tracks* was still new, *Desire* was still a few months away and many of the best moments here come in songs from those two masterworks: acoustic versions of

"Simple Twist of Fate" (with a few different lyrics), "Tangled Up In Blue," and electric outings on "Hurricane," "Romance In Durango," "Isis" and others. There are radical rearrangements of several older Dylan classics, too, such as "It Ain't Me, Babe" and "A Hard Rain's a Gonna Fall," but the reworkings are uniformly brilliant and exciting. Dylan's singing is rich and full of life, and the tunes where Joan Baez helps out are all beautifully rendered. A bonus DVD includes two live songs from Dylan's underrated film, *Renaldo and Clara*. Highly recommend for the adventurous Dylan fan!

Producers: Jeff Rosen and Steve Berkowitz.

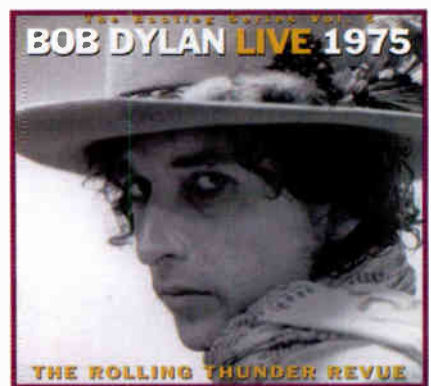

Original recordings: Don Devito. Mixer: Michael Brauer. Mastering: Greg Calbi/Sterling Sound (New York City). —Blair Jackson ■

888-286-0566

Brook Mays

Professional Recording Sales

[www.professionalrecording.com](http://www.professionalrecording.com)



## Digi 002

**digidesign**

Digi 002 pairs Pro Tools LE software with an integrated control surface. Record, edit, process, mix and master your projects with hands-on efficiency, then tuck Digi 002 under your arm, take it to a gig, and use it as an 8x4x2 digital mixer complete with EQ, dynamics, delay, and reverb!



**Includes FREE plugins valued at over \$2,200**

## Trip2 FireWire Storage Solutions

The ultimate in FireWire storage systems is here! Up to 6 hot-swap FW drives (at up to 180GB each), AIT tape drive, and CD/DVD-R/RW options. Also features auto-sense cooling, very quiet operation, and active monitoring of power supply and external FW bus.

Supplied with FREE external tabletop receiver (no FW drive installed)



Sound Construction handcrafts every piece of their studio furniture from the finest materials, providing durable construction and skillful carpentry. Trimmed in oak or maple, the ergonomic design keeps you comfortable and focused for long hours in the studio.



## L.A. GRAPEVINE

by Maureen Droney

The *Blade Runner* scenario for downtown L.A. hasn't materialized—at least not yet. But some of that gritty, multicultural vibe is in evidence, especially in the blocks surrounding the historic Bradbury building, where key *Blade Runner* scenes were filmed. It's on one of those blocks that Waxploitation and its sister companies, SÄVREN and Kabuki Digital, are headquartered.

There's definitely a graphic element to

downtown L.A., an area mysterious to much of the city's population? "We just kept moving east," he explains. "We started out in Beverly Hills, but it wasn't very stimulating. We moved to Hollywood, but that got boring, too. The culture downtown is very extreme, especially at night when the whole texture changes to something pretty apocalyptic. Do you know that at dawn, there are huge swarms of bats here?"

Extreme culture also describes the Waxploitation family. Its roster of artist/producers includes, among others, Nine Inch Nails veteran Chris Vrenna, known



Jeff Antebi in the Waxploitation office

what's going on in Waxploitation's upper-story offices, where floor-to-ceiling windows look out over Broadway—L.A.-style. Campy foreign movie posters—think Japanese *Raging Bull* and French *2001: A Space Odyssey*—and stacks of cool-looking promotional CDs are piled everywhere. "We're really just into logos," deadpans Jeff Antebi, a principal in the artist/producer management firm. "We take any opportunity we can to create a new company so we can design a new logo."

Guessing that Antebi's joking, I move on to the next question: Why locate in

for his production and remixes with Weezer, P.O.D., U2 and his own Tweaker project; E-Swift of Tha Alkaholiks, who has produced Xzibit and Snoop Dogg; hip hop producer KutMasta Kurt (Linkin Park, Blackalicious); and hip hop/soul producer King Britt (Macy Gray, Femi Kuti, Tori Amos).

Meanwhile, the SÄVREN (note: dictionary listed pronunciation of "Sovereign") arm of the company manages extreme sports athletes—BMX, freestyle motorcross, skateboard, etc.—and does

—CONTINUED ON PAGE 149

## NASHVILLE SKYLINE

by Rick Clark

Last month, I highlighted the Lyric Street label's successful run of hit releases that were produced by new or unproven producers. Well, that isn't the only label opening the doors to fresh production talent. Besides Lyric Street, five other labels that have scored big with new producers come to mind: majors Universal South, Mercury, RCA, Arista and Capitol.

"I think it is very exciting for country music that there is a new wave of producers infusing new energy into the music," says Nicole Cochran of the Sessions Agency, a production-coordination firm that handles many of the up-and-coming crowd in Nashville. "It shows a great amount of courage on both the labels' part and the artists' to take this leap of faith. But we are seeing that the risks are being well-rewarded with chart and sales success."

Chris Cagel's Number One Capitol Records hit, "I Breathe In, I Breathe Out," was produced by newcomer Chris Lindsey, while Frank Rogers' first production was Brad Paisley, who went to the top of the charts with his first single—"He Didn't Have to Be"—and some of the follow-up singles on the way to selling a million records.

Jimmy Ritchey's first production was for the new act Tommy Shane Steiner. Steiner went to Number 2 with his debut single, "What If She's an Angel." As a result of his success straight-out-of-the-box, RCA and Joe Galante have handed Ritchey another act, Clay Walker, with whom he is completing an album.

Bobby Terry is one of the most creative young producers coming up through the ranks. He recently scored a hit with Mercury recording artist Anthony Smith, thanks to his innovative production of "If That Ain't Country." It was Smith's first CD, first single and Terry's first production.

Brent Rowan, one of Music Row's most successful session guitarists, recently joined the ranks of successful new pro-





# C O A S T

ducers with his production of Universal South's debut act, Joe Nichols. Nichols' first single, "The Impossible," peaked at Number 3 in *Billboard*. When the project (which Rowan had developed and initially signed to the now-defunct Giant) was brought to Universal South label heads and producers Tony Brown and Tim DuBois, Rowan expressed that he wanted to see the production through to the end on his own. Having worked with Rowan in the studio for years, Brown and DuBois felt comfortable taking a chance on him.

"When Brent brought the project to us," says Brown, "he really stressed to Tim and me that he wanted to produce it by himself. As a guitarist, Brent has played on everything from Alan Jackson to Shania Twain and everything in between. He has played enough hit licks that made records hits that Tim and I just looked at each other and said, 'Sure, why not?' Most records in Nashville are cut on the floor and not written out. Once you're in a session, the producer is almost the liaison between the artist and the band anyway. Usually, there is a guy in the

—CONTINUED ON PAGE 151

## NEW YORK METRO

by Paul Verna

After 38 years of fighting the good fight on the side of the dwindling army of analog diehards, Walter Sear was ready to throw in the towel. He felt defeated by the digital masses, so he put up his historic recording studio for sale and decided to go into the design business. But a funny thing happened on the way to the sale. A like-minded client booked Sear's studio for a year, with an option to renew for an additional year. Sear couldn't bear the thought of turning away a kindred spirit, so Sear Sound is staying open—at least for now. The client—who has asked Sear to remain anonymous—is "going absolutely analog and acoustic," according to Sear. "It restores my faith in recording."



In the control room at Sear Sound Studio C are: (seated, from left) Tim Latham (engineer) and Lou Reed. Standing from left: Aaron Franz (assistant engineer), Hal Willner (producer) and Walter Sear.

When Sear, who is 72, put his studio on the block in late 2002, many of his clients protested that they would have no other place to go. He says, "I got a lot of calls from people who heard the news and said, 'You can't do that! Where will we go?' Then this client came along, and I changed my mind about selling."

Sear's mystery client will take over Studio C, a sprawling room with a sunlit, 2,500-square-foot tracking area and 1,000-square-foot control room featuring a 60-input, Flying Faders-automated Sear console with custom Avalon components. Studio C occupies an entire floor of the building in which Sear Sound resides, offering maximum privacy and security. In addition to the tracking and control rooms, it features a musician's lounge and a production room. "The clients can take over the whole floor and lock themselves off from the world," says Sear.

The contract between Sear and the client does not preclude the veteran engineer from selling the studio. However, Sear says that he is debt-free and able to carry the financial burden of his facility even without major bookings, so he does not expect to sell unless a serious buyer makes an attractive offer. So far, Sear has

—CONTINUED ON PAGE 152



Jimmy Ritchey at the console

## SESSIONS & STUDIO NEWS

### SOUTHERN CALIFORNIA

Linkin Park, producer Don Gilmore and engineer John Ewing Jr. returned to Studio A at NRG Recording (Los Angeles) to work on the forthcoming Linkin Park album, slated for release this spring. Staind are also recording their next release at NRG. With the help of producer Josh Abraham, the band have locked out Studio B with hopes of hitting a mid-year release date.

### NORTHWEST

Iggy Pop dropped in Studio A at Studio 880 (Oakland, CA) last fall to collaborate with Green Day on a couple of songs for his upcoming album. Chris Dugan engineered with Reto Peter assisting. Moonshine Bandits also mixed four songs at Studio 880 with Marco Martin engineering and Brian Barnes as the assistant engineer...Nettleingham Audio's (Vancouver, WA) owner/engineer Kevin Nettleingham recently mastered releases by Diggabone, Smooch Knob, Secret Squirrel, The Yanks and Ray Ottoboni. Other notable mastering sessions at Nettleingham Audio included engineer/producer Sean Norton with band Coldsmoke, engineer Ed Rei with Mindstain, and metal band Stonecreep with engineer Jim Sanders.

### SOUTHWEST

Essential Records recording artists Caedmon's Call recently finished mixing the first single and mastering their new project *Back Home* with engineer Bob Boyd at Ambient Digital (Houston).

### MIDWEST

Engineer Mark Rubel recorded and mixed new material with Toby Twining at Pogo Studio (Champaign, IL); Travis Grimes assisted the sessions. Also at Pogo, Accidental Sirens artist Massivivid mixed their self-titled album with Rubel and Grimes.

### NORTHEAST

Rapper Nas stopped in at Indre Studios (Philadelphia) to record a 103.9 WPHI "Behind the Beat" session hosted by

Colby Cole. The session was recorded in front of a live studio audience and coincided with the release of his new album, *God's Son*. Engineer Mike Richelle tracked the session.

### SOUTHEAST

Gospel group Day3 was in at Ajalon Studios (Greenville, SC) doing finishing touches on vocals for their upcoming Makkedah Records release. The Ruppes also finished up their latest release for Springhill Records with producer/engineer Eddie Howard at Ajalon Studios.

### STUDIO NEWS

Studio 880 expanded its facility with the opening of Studio C. The new room features a Neve BCM-10 and a Sony DMX-R100...LiveWire Remote Recorders (Toronto) has recently upgraded its mobile unit with the installation of a 48-track Pro Tools | HD. ■

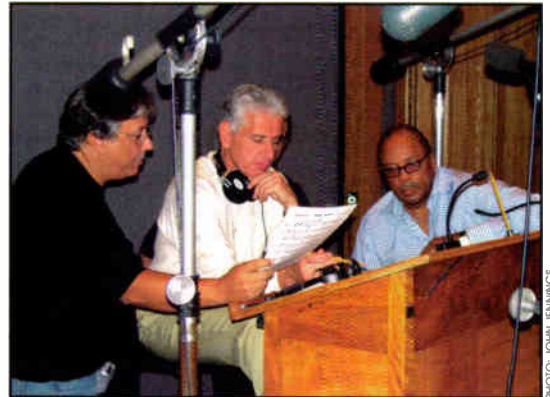

Jazz/classical trumpet great Arturo Sandoval (at left) with arranger/fellow trumpet ace Jerry Hey and Quincy Jones in Capitol Studio's A room in Hollywood are recording Sandoval's upcoming release, tentatively titled *Tribute to the Trumpet*. The project is co-produced by Gary Grant with Al Schmitt engineering.

Please submit your sessions and studio news for "Coast to Coast" to the Mix editors. Submissions can be sent via e-mail to [mixeditorial@primediabusiness.com](mailto:mixeditorial@primediabusiness.com). Photo submissions (JPEG at 300 dpi) are always encouraged, and please include the name(s) of the artists, producers and engineers on the project, and the location of the studio.



Linkin Park take over NRG Recording: (L-R) Joe Hahn, Brad Delson, Chester Bennington, Dave Farrell and Rob Bourdon. Back Row: (L-R) Mike Shinoda and producer Don Gilmore.

sports and lifestyle marketing consulting for companies such as Capitol, Virgin and Lava/Atlantic Records. Kabuki Digital, the newest branch of the budding empire, is a video-game soundtrack label that provides music supervision, as well as marketing and promotion liaison, between video-game companies and record labels.

The energetic Antebi, who started out planning to be a film and TV agent, put in a stint at United Talent Agency, then segued and landed a job at Lippman Entertainment, the high-powered music producer management company. Eight years ago, he took the leap and formed his own company; it started with one producer client and grew rapidly. The direction expanded when he hooked up with Vivendi alumnus David Leslie and athlete manager/action sports marketing guru Carter Gibbs, known for his work with athletes Tommy "Tomcat" Clowers and Caleb Wyatt and artists Sublime and Kottonmouth Kings, as well as for co-founding SRH Productions, one of the first crossover music/action sports clothing companies.



"After a certain point," Antebi remarks, "our niche became managing producers who are also artists. Paul Leary is in the Butthole Surfers and has also produced and mixed for Sublime, including their hit single, 'What I Got.' Chris Vrenna was in Nine Inch Nails, Josh Wink is one of the most popular artist/DJs in the house world, King Britt was in Digeable Planets and Kut-Masta Kurt is a hip hop artist and producer. What we've tried to do—successfully, I think—is to get the word out about our clients, so that, in addition to us pitching them to A&R people, our clients are asked to produce an artist because the artist has heard about them and their work.

"Also, because of all of our other interests, we create value-added visibility. We're a very aggressive marketing company. We have relationships with video-game and clothing companies and all of the sports publications. When one of our clients works with an artist, it's in our best

NOW ONLINE at [www.mixonline.com](http://www.mixonline.com)

## SOME CHOICES ARE EASIER THAN OTHERS...

When it comes to advertising—  
**Color is Better! FREE Color is Best!**



### Introducing Studio Showcase Four-Color Ads!

Now you have two more choices to reach the professional audio engineers and music producers who keep our industry alive:

1. Run a minimum 6x frequency and color is **FREE!**
2. Online showcase is **FREE!**

For rates and schedule, please contact: **Kevin Blackford/West, Jason Smith/East**  
Phone: **800-544-5530** or **510-653-3307** Email: [mixclass@primediabusiness.com](mailto:mixclass@primediabusiness.com)

SUBSCRIBE TO TRANSMISSIONS

# REMIX TRANSMISSIONS

The free e-newsletter from the editors of *Remix*

Bi-weekly editions include one Technology and one Music/Events issue per month.  
Your FREE subscription entitles you to exclusive *Remix* offers and info, including:

- Gear Giveaways
- Ticket Giveaways
- New Products and Software Upgrade Info and Links
- Manufacturer Tips to Maximize Your Gear
- Club of the Month
- Label of the Month
- New Releases
- Upcoming Issue Previews
- Exclusive Material
- Music Links and Downloads

Subscribe to Transmissions Today at [www.remixmag.com](http://www.remixmag.com)

interest to help raise the visibility of that artist. We distribute 75,000 to 100,000 enhanced CD-music samplers a year at events like the X Games. We also music supervise about 10 video games a year, including the WWF franchise, and another 10 action sports films a year. Having our marketing company work the artist helps our producers, especially on the developing band side.

"You really have to look at this from the fans' perspective. Kids don't differentiate the way companies do. A day in the life of a fan involves going outside and skateboarding, then going inside and playing video games with the volume turned down on their TV set, listening to whatever music they want to hear. Then they'll fire up their G4 and make beats. Entertainment and lifestyle are totally integrated, and respecting that is the key."

Upcoming Waxploitation/SÄVREN/Kabuki Digital projects include the February CD release of *Waxploitation Presents Being Black*, featuring Jurassic 5, Dilated Peoples and Mystic; the *SÄVREN Winter X Sampler* with Snoop Dogg, NERD and DJ Shadow; and the release of King Britt's

*Beat Generation* on the BBE/Rapster imprint.

Audio companies of every stripe are looking for new ways to generate income. At Burbank's World Link Digital, owner Dave

sulting division of his company, Absolute Post, doesn't compete with World Link's rental clients. Instead, it offers an alternative to them in the form of editing suites and an adaptable, surround sound dub-



Dove Rosen front row, second from left, and staff of World Link Digital/Absolute Post

Rosen realized some time ago that rental-equipment inventory could be maximized by putting it to use in onsite post-production suites. Rosen is mindful that the re-

bing stage. Taking advantage of the services offered by Absolute have been projects for 20th Century Fox Music, NBC Warner Bros. Music, Disney Feature Ani-

## MIX Foundation

FOR EXCELLENCE IN AUDIO, INC

# SUPPORT SAFE HEARING!

Noise-induced hearing loss from amplified music is a serious problem affecting both professionals and consumers. The Mix Foundation for Excellence in Audio, through the TEC Awards and other programs, provides much-needed funding for efforts to promote hearing safety.

If you are an audio professional, you have a personal stake in the battle to protect both your own hearing and that of the audience. Please consider making a tax-deductible donation to the Mix Foundation for Excellence in Audio. Your contribution will help us increase the reach of these vital programs.

**Send donations to:**

Mix Foundation for Excellence in Audio  
1547 Palos Verdes Mall, #294  
Walnut Creek, CA 94596

**Donate online:**

[www.tecawards.org](http://www.tecawards.org)

mation and Dreamworks Records, as well as television's popular *Dinner and a Movie*.

Rosen gave me a tour of the World Link facility, which encompasses the rental warehouse, offices, dubbing stage and editing rooms. One of the editing rooms, which has served as both an Avid and Pro Tools suite, is made available to either temporary or long-term tenants. Another room, equipped with Pro Tools and a DigiBeta deck, hosts, among other projects, *Dinner and a Movie*, providing sound effects, dialog cleanup and mixing. "We also do a lot of 'to and from' work with DigiBetas," Rosen notes. "People can rent them, but it's cheaper to bring the project here. They can just drop off their drives and not have to deal with transport and setup time."

Rosen is an alumnus of Ocean Way Recording, and Absolute's dubbing stage was inspired by what was one of that studio's original rooms: the "Blue Room." "It was [Ocean Way owner] Allen Sides' personal listening room," explains Rosen. "It sounded great, and it had blue theater curtains. I always loved the look of it, so our stage is designed along those lines."

The all-Pro Tools|HD stage can handle up to 128 voices. Fitted with a 40-fader Pro Control with EditPack, it's generally set up as a one-person mix room, although it's easily reconfigured. "Being that we're a rental facility," Rosen says, "if someone comes in and needs a two-person mix, we just swap out the sections. We can add wings and bring in another HD system. We can also convert back to a [Pro Tools] MIXPlus system in about 20 minutes if anyone needs to, which people sometimes do because they require certain plug-ins."

The heart of the dub stage system is a 256-pair Z Systems digital router, which Rosen calls a "very cool box." "Currently, we're only using 50 percent of the inputs it offers," he comments. "It makes everything easy. You can do all of your own patching from the desk."

The surround speaker system is M&K, recommended by Lucasfilm's Jerry Steckling, who advised on the room's design. "We originally built the room for Paul Thomas Anderson at his facility when he was working on *Punch Drunk Love*, and then we moved it here," says Rosen. "He needed a stage near his Avid editing, where he could walk next door and listen to a quick temp mix. They also needed to be able to translate the mixes to the stages up north at [Skywalker]. Jerry spec'd the M&Ks, and also the BSS Soundweb box, which uses a PC front end to do all of the X curves and EQ settings for the system.

The Soundweb is great because it has an infinite number of presets and we can easily set up for different clients' needs. We also put in a Stewart MicroPerf screen, and the speakers sit behind it in a proper theatrical mode. But for our cartoon mixing clients, we also still have a TV monitor."

It doesn't look it, but the whole dubbing room can be made portable. There is also a duplicate setup that's part of World Link's rental stock. On the week I visited, the rental business was brisk, with Pro Tools|HD, Pro Controls and TC Electronic System 6000s among the most requested items. "Whatever you want, we can put it together," says Rosen. "You can

use it here or take it on the road. Our new policy is never to say 'no' to any rental request. If we don't have it, we'll find it or refer you to someone who does have it. We also do cartage and setup for other people's systems—whatever we are asked to do." ■

Got L.A. news? E-mail MsMDK@aol.com.

#### NASHVILLE SKYLINE FROM PAGE 147

band that sort of leads the band, and Brent is usually that person. Brent ran everything by us, so we were involved anyway as A&R people.

# SUBSCRIBE TO MIX TODAY

Mix is the premier resource for recording music. Every month, Mix brings you over 200 pages of essential information that allows you to keep up-to-date on professional audio and music production.



## www.mixonline.com

800-532-8190

PO Box 1939, Marion, OH 43306-8039

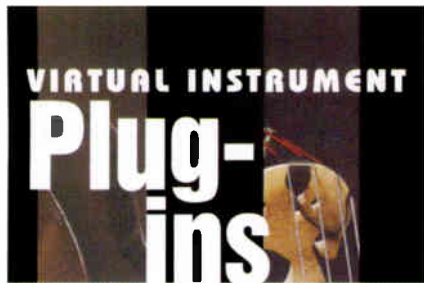

—FROM PAGE 64, VIRTUAL INSTRUMENT PLUG-INS

process, PLEX allows the organic combining of disparate sounds and the ability to analyze and split an original sound into individually controllable lower and higher spectra, filter characteristic and amplitude envelope segments. Each segment can be replaced and combined with components from other original sounds, allowing users to replace the lower-spectrum “base” component of a trombone sound, for example, with the base component of a sitar sample, each retaining independently controllable amplitude envelope and filter characteristics. Three hundred presets and 97 specially analyzed acoustic and synthetic sound sources are included. Also new from Steinberg is V-STACK (\$49), a Virtual Instrument Rack for VST System Link. Up to 16 VST and DXi instruments can be loaded to turn a PC into a virtual instrument station, which can also be played live without a host application.

D-coder (\$249; PC/Mac, VST, MAS) from TC Works ([www.tcworks.de](http://www.tcworks.de)) integrates a synth engine as tone generator into this advanced vocoder plug-in, therefore not requiring an external carrier signal to make the vocoding effect audible. Running on any Mac or PC equipped with PowerCore, D-coder is based on DSP technology used in all of Waldorf synthesizers, now accessible from inside any VST- or MAS-compatible sequencer. An integrated chorus unit fattens things up, and a 3-band EQ section allows users to emphasize critical-speech frequencies. Playable from a MIDI track or in real time from a keyboard, D-coder’s synthesizer section can be played independent of the vocoder, and all LFOs can follow MIDI sync within any VST 2.0-compatible sequencer to independently modulate the synth and the vocoder in musically relevant values. The 100-band D-coder offers dual oscillators with ring modulation, high-resolution analysis and vocoder channel meters, and it can be played in “free run” mode without MIDI. ■

Randy Alberts ([www.opendooredit.com](http://www.opendooredit.com)) is a California-based audio and music journalist. His book, *Tascam: 30 Years of Recording Evolution*, has recently been published.

“Brent knows all about layering and how to keep things simple,” Brown continues. “Most musicians, when given a shot to produce a record, will load things up with layers and layers of tracks and overdubs. I thought that really spoke well of Brent’s experience: that he actually cut a record on Joe Nichols that represented the artist, and not Brent as a producer. His production of this record is just perfect. I’m really glad that the first project he did was a success.”

Rowan notes, “As a player, I’ve been in the unique position of working with the best producers in the world, including Mutt Lange, Tony Brown, Barry Beckett and David Foster. It’s like being an actor for the world’s greatest movie directors. You kind of get a sense of, ‘If I ever direct a movie, I want to try it this way.’”

That said, Rowan quickly realized that production was more involved than session work: “It is one thing to play on something for six hours and go home, but when you sign up to produce something, you are living with that artist or band for a few months. It’s important to me to know who they are and how hard they are willing to work and get something unique across. Joe [Nichols] was really the first person I ran across who I felt like, ‘This is worth the effort and I’m going to go to the mat for this.’ If I ever only produce one record, I’m going to produce it the way the artist sounds the best and the songs sound the best.

“I have enjoyed producing even more than I thought I would,” Rowan continues. “I love artists and I love songs. It’s much more than licks to me. It’s the whole package.”

For country music—or any music—to evolve, however, industry focus shouldn’t purely be on creating hits for radio. It should pay attention to and draw from those who are creating great music in more specialized or cutting-edge fields or genres. Country radio has drawn from rock, pop and hip hop, but the Americana world has increasingly been a fertile ground to provide a certain kind of integrity and flavor to developing music.

Universal South recording artist Allison Moorer is regarded as one of Nashville’s finest vocalists and an artist who, like her sister Shelby Lynne, has stayed true to her artistic muse. To help her realize her latest music undertaking, Moorer and Tony Brown tapped R.S. Field, a producer who has earned quite a list of critically ac-

claimed production credits—including Billy Joe Shaver’s brilliant *Tramp on Your Street*—but had never done a major-label Music Row project. The resulting album, *Miss Fortune*, is a classic blend of great American music, beginning with country and taking in elements as disparate as ’60s Dusty Springfield, early Elton John and Band-era Dylan.

“Allison pretty much tapped me to do the project with her. We had a few meetings with Tony, and I think he liked what I had to say,” says Field, whose production credits since have included Todd Snider, Sonny Landreth and Billy Joe Shaver. “Tony was very nice and desirous of helping her get on disc what she had in her head.”

Field, who is used to working within the confines of indie-production budgets, appreciated the extra flexibility that a major-label budget afforded him. “Allison and I worked as a team,” Field explains. “It was really cool, because I had more resources than I usually have, and I got to spend a lot of time with it. I think, unlike a lot of Music Row projects, the artist got to experiment a lot and try different things. I got to work with strings and horns, which was kind of a first for me.”

Brown was a fan of Field’s previous work and was excited when Moorer brought the producer’s name up for the project. “I’ve loved his Webb Wilder records, as well as the Shaver record,” he says. “His production of Sonny Landreth was one of my favorite records. When I asked Allison who she wanted to talk to, she said, ‘What about Bobby Field?’ I said, ‘You know what? I’ve never worked with him, and I love his work.’

“[Field] wrote me this letter on how he envisioned this record being. After reading the letter, I thought, ‘I’d trust this guy with anything. The album turned out exactly the way he described it, too.’ ■

Send your Nashville news to [MrBlurge@mac.com](mailto:MrBlurge@mac.com).

#### NEW YORK METRO FROM PAGE 147

entertained only “tire kickers.”

Sear Sound will continue to operate its other floor as a commercial studio. The facility’s flagship room, Studio A, features a Neve 8038 with Flying Faders; Pultec, Manley and MagnaTech preamps; and a trove of gear that, in Sear’s words, was “vintage before it became vintage.”

Sear Sound, which claims to be New York’s oldest studio, has hosted such global rock icons as Paul McCartney, David Bowie and Eric Clapton; jazz artistes Wyn-

ton Marsalis, Ron Carter and Norah Jones; and dyed-in-the-wool New Yorkers Lou Reed and Suzanne Vega. Producers, too, have made Sear their top choice over the years: The list of regulars includes Phil Ramone, John Leventhal, Hugh Padgham, Kevin Killen and Craig Street.

The studio has been in its current lo-



**Walter Sear still hammers away at the rebuilt Studer 1-inch tape recorder. This machine was one of the two machines that The Beatles recorded "Sgt. Pepper" on.**

cation at 353 West 48th Street for 15 years. Prior to that, it spent 17 years in the Paramount Hotel building, and 16 years at the old Great Northern Hotel site to 57th Street and Sixth Avenue, also home of the legendary Fine Recording, where Sear was trained.

A self-described maverick and admittedly part of a vanishing breed, Sear is old-school to a fault, shunning virtually all digital technology, though he does admit that Direct Stream Digital is "promising."

"Digital sounds so lousy, people keep going back to vacuum tubes," says Sear. "I was right about vacuum tubes. I've been yelling about them for decades, and they're back."

One of Sear's most cherished tube items is a Studer 1-inch 4-track recorder used by The Beatles at Abbey Road. Sear has converted it to a 1-inch, 2-track mastering deck. Other equipment highlights at Sear include a collection of nearly 250 vintage microphones, an Ampex MM1200 recorder with 16-track and 24-track heads, and Studer C 37 tube recorders. The studio also houses a Steinway C grand piano built in 1894.

Before his turnabout on the sale of the studio, Sear was so discouraged by the state of recording that he wanted no part in running a facility. The event that triggered his decision was a live jazz-trio session. Sear recalls: "This group came in and set up live, with no headphones. They really seemed to want to go for a live feel

and capture the acoustics of the room, and then I turned around and saw that they were recording to three DA-88s. I said, "That's it, brother."

Sear has also gone into the studio design and construction business with partner Michael Block, building custom facilities for producer/musician/entrepreneur T

Bone Burnett, hip hop artist Scarface and producer/engineer Mike Mangini, among others. Burnett's studio features a classic Neve console, which Sear says sounds "beautiful." For Mangini, Sear built a small room and is about to build a new one in a new location. And the Scarface project is a work in progress.

"Some of these studios have minimal acoustic treatments," says Sear, "because everyone is working with near-field monitors, so the room doesn't matter as much as it used to.

"I've built so many studios over the years, it seemed like a logical thing to do," continues Sear. "I like building stuff. I just finished a pre-amp, and I'm always messing around on the bench."

Sear, who has degrees in metallurgy, chemistry and music, is also a respected maker of brass instruments, with some 2,000 models to his credit. A tuba player by training, Sear performed with the Philadelphia Symphony Orchestra before moving to New York to play in the pit at Radio City Music Hall. "It's been downhill from there," he says, laughing.

Sear approaches all of his endeavors—whether it's building tubas, running his studio or designing rooms for others—with an unshakable commitment to quality, as evidenced by the mission statement of Sear Sound: "In a time of faster, smaller, cheaper, poorer quality, Sear Sound strives to maintain integrity and good workmanship. Sound recording is a blend of technology and art. We attempt to provide a totally unique recording experience by blending the musicality of our staff with the best of old and new technology."

An old-fashioned approach, to be sure, but one that deserves special mention at a time when the recording industry seems overwhelmed by change. ■

Send your N.Y. news to [pverna@vernacularmusic.com](mailto:pverna@vernacularmusic.com).

# More for your Money

Yamaha AW4416



Yamaha AW2816



## YAMAHA

16 Tracks, 44 or 28 Channels,  
Motorized Faders, Sample  
Pads, Expandability, Third-  
party Support, Built-in CDRs



1-800 876-8638  
8-SOUND-8

[www.LandMmusic.com](http://www.LandMmusic.com)

6228 AIRPARK DRIVE  
CHATTANOOGA, TN 37421

—FROM PAGE 24, BOOM

your pathetic life as an impotent nobody, indistinguishable from the motoring masses; or fall into the pit only to rise as a Phoenix to the lofty omnipotent position of hardcore car audio junkie—and live a life of dB and Hz, where too much is not enough of the first, and too low is not low enough of the second.

But there is *one* way to avoid this: pretend you are deaf. You will, of course, be faced with the challenge of overcoming the obvious paradox of why you even want DynaMat if you are deaf. But life is full of challenges, and this is nothing compared to what it takes to get clean once you have felt the glorious, destructive power of a properly designed, assault-subwoofer weapons system.

Ah, so back to the story. I made the car quiet and was very proud of myself. Door closing changed from “clank-boing” to “ka-chunk!” Very nice. Then I turned the radio on. Damn! Now, for the first time, I could hear that it was much more unbearable than I had originally thought. Back to the “dealer.”

“Well, Steve, we can get rid of those crappy speakers.” Okay. “Yeah, you are

going to need a lot more power for those new speakers; that’s why they don’t sound like they could.” Okay. “Well, Steve, that’s just how lousy the front end is. The new speakers, amps and crossovers reveal that now you need a new tuner-CD player.” Okay. Yeah, I know. “The tweets and

tear out everything from your head back, build a solid, custom, computer-designed cabinet, and use the rest of the space in the passenger area for amp racks.” Uh, okay. “You know you need two ultrahigh-output alternators, a 2,500 rpm idle, four deep-cycle batteries and two big (Big!) caps, right?” Oh, yeah, I knew, okay. And finally: “Of *course* it flabs out on the kicks. That wire you have running from the battery to the caps and sub amp is smaller than my damned wrist! What the hell do you expect? Here, try *this*.” Okay, but should wire really weigh 20 pounds a foot? Boom. I’m hardcore.

Blew three rear and two front windows out. Added 466 total pounds o’ sweet, gold-plated, aural suicide to that car, even *after* removing 126 pounds of seats and other important car guts. “Money For Nothing” literally made you cough, and “Funk 49” sent you running for the bathroom.

Didn’t even cost that much. I was a sponsored competitor, and almost all of the actual gear came from artist-endorsement contracts. What I did spend on custom fabrication I got back shortly afterward when it became the foundation for

Virtually unlimited,  
superclean SPL down to  
10 Hz. We’re talking  
25 dB beyond the point  
where you lose vision due to  
corneal modulation.

midrange drivers really should be in custom-fabricated enclosures so that we can more accurately control rear reflection and where we cross over.” Okay. “And, oh, yeah, of course no commercially manufactured subwoofer can keep up with what you’ve got here, so we really should

The more you see,  
the more you know  
there’s a Very  
smart choice in  
Control Room Furniture

Go online . . .

[www.argosyconsole.com](http://www.argosyconsole.com)

90 V-SERIES



ARGOSY®

Tel: 800.315.0878 / 573.348.3333



# 75 years later... Nothing has Changed!



2003 - UM92.1S capsule.

1957 - UM57 capsule.

Gefell microphones are still hand made in Germany with the care and precision that one can only equate with old-world craftsmanship and a commitment to excellence. From the early days with Georg Neumann, through the relocation of the factory during the 2nd World War, and the many years separated behind the Iron Curtain, Gefell has remained true to its roots. And these roots run deep...



The original 'Baby-bottle'.

From the 1st generation multi-pattern UM57 to the fabulous UM92.1S, Microtech Gefell continues the tradition with the legendary 'tube sound' that is only possible with the original M7 capsule. That's right, the original M7, with gold sputtered PVC, hand made in the Gefell factory.



(Left to Right) Tube mics: Original UM57 (1957), UM57 V.E.B. (1972), and today's Gefell UM92.1S

That's not to say we have rested on our laurels... Since the beginning Gefell has set the pace for microphone innovation and continues to elevate the bar: The Gefell UM900 Phantom, the world's only 48V phantom powered tube mic; the Gefell M930 Compact, a large-diaphragm studio condenser with optical isolation and the lowest self-noise in the business; and now the Gefell MV230 digital for better than 140dB performance. But wait, there's more...

Today, Gefell measurement microphones lead the world in metal diaphragm technology. For those 'in the know', nothing compares to the precision of an ultra-thin 0.8-micron pure nickel membrane for true, full bandwidth performance. This incredible technology is now available with the new Gefell M295, a low profile cardioid that will absolutely blow you away.

Of course there are lots of mics to choose from and for the average person, a mass-produced copy is just fine. But if you want something truly special and a cut above, visit one of our exclusive Gefell Dealers and listen to the difference that quality, tradition and pride can make. You may be surprised at how good a hand-made microphone can truly be.



Gefell M930 Stereo XY



Gefell UM900

## Gefell - Quality, Tradition and Innovation

## Bruce says

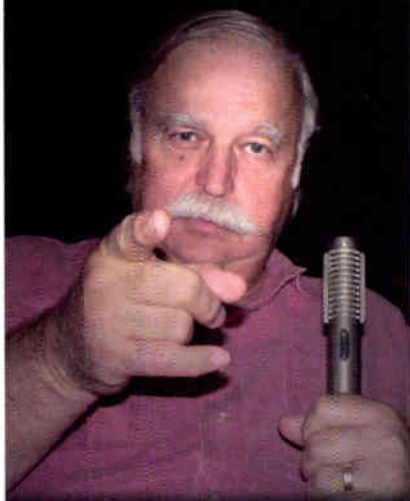

"I've never heard anything better in a ribbon microphone than Royer's new R-122, ever! Something happened when they put that amp and larger transformer in there and this has become my new favorite ribbon microphone. I always use ribbon mics for their warmth and sweet high frequency response characteristics, but there is something truly unique about the powered R-122's sound quality. My pal Omar Hakim was bouncing off the walls when he heard the first playback with R-122's on overheads on his drum set - they just sound absolutely fantastic! Royer really nailed it with the R-122."

## Bruce Swedien

(Grammy winner, Jennifer Lopez, Michael Jackson, Quincy Jones, Duke Ellington, Count Basie)

Visit [royerlabs.com](http://royerlabs.com) to hear Bruce speak about ribbons and to see photos of his current recording session.



[www.royerlabs.com](http://www.royerlabs.com)  
818.760.8472

#1 in a series

a mobile low-frequency weapon project: nonlethal human immobilization by resonating human internal organs to the point of malfunction. Lovely work.

Still, I look back and chills run down my arms. How did I get there? I can rationalize it. I slipped in step by step: The actual cash outlay was very low, the beer was cold and, of course, *my* system was flat and honest. I had two digitally programmed operational modes: competition and normal. Competition mode was the loudest, cleanest broadband energy possible, done by remote control with no life-forms in the vehicle. (And, after a while, no life-forms in front or behind the car either. Remember the windows?) Normal mode was able to deliver insane power down to 10 Hz by reprogramming EQ banks and electronically retuning the subwoofer bandpass cabinet displacement and port with linear actuators.

This was the thing that kept me interested: virtually unlimited, superclean SPL down to 10 Hz. The physicality of it, the lofty, dizzying euphoria that you felt as your head caved in. And we're not talking wussy little My First Subwoofer contests here; we're talking 25 dB *beyond* the point where you lose vision due to corneal modulation. And here's the sad part: I mean this literally.

It was sooo clean. Every driver digitally phase-aligned, every crossover phase-shift free with optimized asymmetrical slopes. Air temperature acoustic-alignment compensation. Impulse-mapped and -compensated environment. One listening position, no slouching.

I never drove down the street blowing out showroom windows, but I did start buying CDs for low-end content. I was far gone.

And what turned me around? It's interesting what does it sometimes. It may be the look someone close gives you at 4 in the morning; it may be when you see another guy as strung out as you at a light on Sunset and feel sorry for him, maybe even disgusted.

But in my case, it happened the day I went into Best Buy to buy the best bottom-end CD I could find, and, well, I found it. *Big Bottom Max Extreme: Rap Songs Remixed for Car Audio Competition*. I stopped in my tracks, and at that moment, saw my sickness for what it was.

I walked out of the store, pulled the six industrial cartridge fuses out of the three-pound solid fuse block and never looked back. I did keep the custom-molded ear plugs, though. The first six

months were pretty rough. I knew this was bigger than me (by 402 pounds) and that it would be insane to pretend that I could "have a little taste o' the ol' tunes" from time to time without getting back in, so I quit cold turkey. Well, I quit cold and *increased* my intake of Wild Turkey, the beverage of choice in the shop.

I was sick, not stupid. I knew that any time I listened to music in a car I would feel that it was sorely lacking in bone-breaking bass, and I knew that turning up the bass in any normal system would only make one damned note, somewhere between 66 or 81 Hz, droning endlessly on no matter what I played. No, I had to cut clean. And I did.

It has been six years now, and I have never even listened to a radio since. I never play any music of any kind in any car any more. My Corvette radio might not even work. Never tried it.

And home listening has gone from Let's Re-Create What It's Like Onstage to something much more normal.

But it's been a long, difficult path back, and every now and then, I can feel that urge to power up those four Big Reds, the four THX-approved subs and the two Paradigm servos, along with that incredible 10Hz, eight-driver Cabasse second-order bandpass cabinet from the car and play some James Gang or Dire Straits. Or maybe that old E. Power Biggs CD I made for the car. Or I'll think, "No, I'll just plug my five-string straight in and modulate the barometric pressure in my neighborhood for half an hour or so."

But the lights dimming as I switch on power amp after power amp brings me to my senses, and I just stop and take the Harley out for a night ride to clear my head. If that straight-pipe 11.5:1 stroker doesn't do it, a couple of rounds of +P+.40 usually does.

And I'm okay—until the demons return.

So, dear readers, I have bared my soul in the hopes of saving you—any of you—from this fate. If my telling this tale stops even one of you from falling into this trap, it has all been worth it.

After all, that one reader who I may dissuade might have otherwise gone on to walk that same pathetic, horrible path that I once walked, and might even have gone on to knock me out of first place. And we can't have that. ■

*Does anything more really need to be said? Could any of you who have tried this bear it if I did say more?*

—FROM PAGE 28, THE OS X FILES

for plug-ins called Audio Units. It comes in two manifestations: one for DSP and the other for virtual instruments. We're working with developers to standardize on that protocol. We want to give them the opportunity to use our platform and prevent the complexity from increasing.

The exception is hardware-specific formats, like TDM. We think Digidesign should bring it up to OS X, and they're planning to, but we don't get involved with manufacturers' support of their proprietary hardware. So we can't tell them, for example, which versions of their software should support what hardware.

*Speaking of virtual instruments, how well does OS X deal with latency issues?*

Latency is always a trade-off between the number of tracks, or the amount of CPU power you want to use, and time. How low can you set your buffers with 100 channels going, each with reverb, without the sound breaking up? There's no real way yet to quantify a system's latency according to specific parameters, because those benchmarks haven't been developed. That's the role of the music-technology press. If we had a bench-

mark, we could answer the question.

But we think that with Core Audio, we've delivered the best system in terms of throughput—less than three milliseconds. The Peabody Institute at Johns Hopkins University did some testing of audio throughput on different operating systems, expecting that Linux would have the smallest latency. To their surprise, we came out ahead. [Actually, Linux came out ahead when the system was run without additional CPU load; but under more typical conditions, Core Audio was indeed faster. You can see the report at <http://gigue.peabody.jhu.edu/~mdboom/latency-icmc2001.pdf>.]

*What was the motivation behind the acquisition of Emagic?*

We do audio, and we want to do it better. Emagic had the expertise. But the amount of integration with Apple is not significantly different than that of other developers. They're still in Germany, and we have no interest in changing that or subsuming them in the foreseeable future.

*What about the Logic Windows users who feel like they've been abandoned?*

Emagic is communicating with Logic users—we're leaving that to them. They're

far more aware of the dynamics of communicating with its user base than we are after six months of owning the company, and they are making some very attractive offers.

*As are Steinberg and Cakewalk.*

That's true.

*There's some thinking in the audio community that what you're planning to do with Emagic is similar to what you did when you took over what became Final Cut Pro from Macromedia; that is, you took a big chunk of what had been Avid's market. So are you hoping to see that happen to Digidesign as to what has happened to its parent company?*

Communication between Emagic and Apple has improved, but not at the expense of other developers. We have a platform to promote, and we want it to be the platform for audio development, period. We're interested in promoting native solutions, which a Mac can do all by itself. We're looking to get applications that are scalable, so that people can use them at whatever level they want. We're supporting everybody.

We've put in the hooks that make it easy for people to write software for the

# GRACE

d e s i g n

PRESENTS THE NEW

## LUNATEC V3

**THE ULTIMATE PORTABLE MIC PREAMPLIFIER**

Based on the industry standard lunatec V2, the lunatec V3 is designed to deliver astonishingly accurate, musical microphone preamplification with our new 24-bit, 192kHz A/D converter in a bombproof, portable DC powered package.

With audio performance worthy of the most refined studio mic preamplifier, the lunatec V3 is capable of translating even the most subtle, complex low-level ambient information without noise or coloration.

**DESIGNED WITH PORTABILITY AND RELIABILITY IN MIND,** the lunatec V3 is at home anywhere the demanding engineer needs to capture the maximum amount of detail and clarity to tape. Sound designers, remote engineers, classical engineers, concert tapers or anyone with a portable recording system will be stunned by the depth, clarity and realism the lunatec V3 delivers. The lunatec V3 is now the essential front end for high-definition field recording.

**FEATURES**

- fully balanced, transformerless design
- fast, musical transimpedance amplifier architecture
- high-performance A/D converter with 44.1, 48, 88.2, 96, 176.4 and 192 kHz sampling rates
- outputs include S/PDIF and two sets of AES3, with both single and dual-wire 176.4 and 192 kHz AES/EBU modes
- ANSR™ dither circuit for recording to a 16-bit recorder
- converter section can be disabled, providing battery power conservation of up to 40%
- precision 8-segment dot mode LED level meters
- precision 11 position rotary switch gain controls
- 10 dB output attenuators
- two position high pass filters presetable at 50-100Hz or 75-150Hz with 6 or 12dB per octave slope
- M+ S decoding matrix
- 5 year limited warranty
- MSRP

for more information, visit [WWW.GRACEDSIGN.COM](http://WWW.GRACEDSIGN.COM)  
 Boulder, CO USA tel 303.443.7454 fax 303.444.4634

Our wetware is...

# 100% Organic

pain relief for your tech nightmares

- Network, Storage & Production Infrastructure
- Certified Mac OS X Migration
- Future-proofing your investment
- Competitive Analysis – can you afford not to invest?

...spend smart, stay ahead



*We Geek So You Don't Have To!*  
Seneschal 415.346.7713 [www.seneschal.net](http://www.seneschal.net)

system. We are delivering the standards as much as we can. I'm looking forward to lots of little applications popping up and lots of creativity coming out.

*What do you think of an application called Audio Hijack?*

I think it's delightful what they're doing, although there are some serious copyright implications. That sort of innovation is the kind of thing I'm talking about. [And I'll talk a lot more about it next month.]

*Is there a good place to get independent information about audio in OS X?*

There's a group on Yahoo called daw-mac for people using Macs for audio. It's platform-agnostic, which makes it really valuable. And do you know about [www.osx-audio.com](http://www.osx-audio.com)? It's my home page. I look at it every day.

...

As I was finishing this month's column, I found out that my old friend James Romeo died. Jim was a major character on the early MIDI scene. Armed with a Ph.D. in music composition from Harvard, he was the first person to replace a pit orchestra with MIDI sequencers and synths when he used a pair of Kurzweil 250s with Performer and a tempo-input device for a production of two operas by Claude Debussy. Naturally, he got tons of flak from the musicians' union.

He wrote a very clever ear-training program for the Mac and got the attention of Coda Music Systems, which was developing Finale at the time. Jim ended up co-authoring the documentation for the first version of Finale, which was 1,500 pages.

He was also a pioneer in marketing royalty-free MIDI files of original and public-domain music, with hundreds of tunes in his catalog, and I once even found a CD of his library music in the checkout line at my local drug store.

In recent years, I'd lost touch with him, but I knew that he and his wife were putting most of their time and energy into writing and performing for their church. A year-and-a-half ago, he developed Lou Gehrig's disease, and I found out about it through a mutual friend last summer. He passed away at home on December 2, at the age of 47. ■

*Although Paul Lehrman is currently using four Macs and five operating systems, he's not as confused as you might think. Thanks to Jerry Hsu and George Litterst for their help this month.*

Aardvark  
API  
Apogee Electronics  
Audix  
Brauner  
Bryston  
Calrec  
Data Check  
Drawmer  
Gefen Systems  
Genelec  
Great River  
Lexicon  
Lucid Technology  
Mytek  
PMC  
Prism Sound  
Rorke Data  
Sonic Solutions  
SoundField  
Trilogy  
Westlake  
White Instruments  
Z-Systems

over  
**30**  
years!

now in our 32nd year of  
helping our customers  
choose the very best

**studio consultants, inc.**

321 West 44th Street, New York, NY 10036  
(212) 586-7376

Equipment, support, and design services for  
professional audio facilities and broadcasters  
in the New York area—since 1971.

**SALMON PEAK RECORDING STUDIO**  
San Antonio, TX

- Features large control room with vintage Neve 8232 console, spacious tracking room and five iso booths with Private-Q.



- Soffit-mounted, JBL-modified, UREI mains, Genelec and Yamaha near-fields.
- Recording to MCI/Sony JH24 2-inch 24-track analog, as well as 24 tracks of Pro Tools|24 MIXplus.
- Neumann, AKG, Sony, and Gefell front the microphone collection.

Acoustic design by Jack Piercy, Acoustech Studio Services. System design by RB Blackstone, Sound Madness. Contact: Mark E. Sinko, at (210) 378-3304; Fax: (210) 698-4339; www.salmonpeak.com.



**WorldWideMastering.com**

4471 Orange Ave.  
Long Beach, CA. 90807  
P: 562.989.2040 F: 562.989.6967

**LISTEN BEFORE YOU BUY!**  
Hear before and after mastering samples by requesting your **FREE DEMO DISC** at our web site! WorldWideMastering.com is located halfway between LA and Orange county in Long Beach, CA. Featuring - Tube Tech's all tube multiband compressor, Nightpro EQ3 Mastering EQ, TC Electronics, Aphex, Waves, Apogee UU 22 and much much more!

**Preferred Recording**

P.O. Box 1981, Beverly Hills, CA 90213  
(818) 591-1449; Fax: (818) 591-1448  
www.preferredrecording.com



**SSL 6056 E/G-Plus Console**  
w/48 Black/242-EQ's, TR, VU, Pro Tools, Studer A-800 Mk-3, Hidley/Westlake/TAD Monitors Plutec, Neumann, Telefunken, Urei.



Located just 15 minutes from the heart of Hollywood, this World Class facility has Pool/Spa, Private Lounge, 2-Bed Rms w/Full Kitchen, Digital Satellite, 18' x 20' Tracking Room, and 8' x 9' Vocal Booth.



**NPR**

635 Massachusetts Ave., N.W.  
Washington, D.C. 20001-3753  
(202) 513-2482; Fax: (202) 513-3033  
e-mail: rgi@npr.org  
www.npr.org/studios

Located in downtown Washington, D.C., Studio 4A offers a spectacular recording environment well-suited to all music genres. Studio 4A, at 2,600 sq. feet, is one of the largest recording facilities on the East Coast. We offer digital and analog multi-track recording, an extensive mic collection, digital editing suites and CD mastering. NPR also offers satellite uplinking, fiber-optic and ISDN capabilities worldwide.

**ONLINE AT WWW.MIXONLINE.COM**

**Bring Color to Your Facility with Studio Showcase Four-Color Ads!**

Run your studio Showcase ad six times and color is **FREE!**  
Plus, your Showcase ad will appear online at no extra charge!

*To advertise contact:*

**JASON SMITH - East Coast sales**  
jasmith@primediabusiness.com  
(510) 985-3276; (800) 544-5530

**KEVIN BLACKFORD - West Coast sales**  
kblackford@primediabusiness.com  
(510) 985-3259; (800) 544-5530

# Advertiser Index

ADVERTISER	WEBSITE	PAGE
Acoustical Solutions	www.acousticalsolutions.com	10
AES Europe Convention	www.aes.org	178
AKAI	www.akaiapro.com	17
AKG Acoustics (C 3000B)	www.akgusa.com	2
AKG Acoustics (Headphones)	www.akgusa.com	45
Alesis (DEQ Series)	www.alesis.com	25
AMEK	www.amek.com	59
Argosy Console	www.argosyconsole.com	154
Audix	www.audixusa.com	115
Auralex	www.auralex.com	60
Aviom	www.aviomiic.com	57
B&H Photo-Video	www.bhphotovideo.com	179
Broadcast Supply Worldwide	www.bswusa.com	109
Brock Mays Music Corp.	www.professionalrecording.com	145
Bryston	www.bryston.ca	9
Carillon	www.carillonusa.com	57
Carvin	www.carvin.com	133
Cedar Audio/Independent Audio	www.cedaraudio.com	61
Clarion Insurance	www.clarionins.com	88
Classic Sound	www.classicsound.com	70
Conservatory of Recording Arts & Sciences	www.audiorecordingschool.com	118
Crest Audio	www.crestaudio.com	33
dbx Professional Products (ProVocal)	www.dbxpro.com	4
Denon	www.denon.com	180
Digidesign	www.digidesign.com	27
Disc Makers	www.discmakers.com	72
Discrete Drums	www.discretedrums.com	60
Dolby Labs Inc.	www.dolby.com	110
Echo Digital Audio	www.echoaudio.com	37
Emagic	www.emagic.de	52-53
Emagic	www.emagic.de	39
ESI-Pro	www.esi-pro.com	114
Eventide	www.eventide.com	23
EVI Audio/Helix	www.klarktechnik.com	75
EVI Audio (Agility Control)	www.electrovoice.com	135
Focusrite	www.focusrite.com	41
Full Compass	www.fullcompass.com	113
Full Sail	www.fullsail.com	85
Gefell	www.gefell-mics.com	155
Genelec	www.genelec.com	13
Grace Design	www.gracedesign.com	157
Groove Tubes	www.groovetubes.com	123

ADVERTISER	WEBSITE	PAGE
Group One Ltd/Blue Sky	www.abluesky.com	93
H&B	www.hhbusa.com	91
IAG	www.iagameric.com	97
Ilio	www.ilio.com	11
Ilio	www.ilio.com	65
innovaSON	www.innovason.com	19
Institute of Audio Research	www.audioschool.com	62
JLCooper	www.jlcooper.com	114
JBL Professional	www.jblpro.com	121
KRK Systems	www.krksys.com	139
L & M Music	www.lmmusic.com	153
Lawson Inc.	www.lawsonmicrophones.com	110
Lexicon	www.lexicon.com	87
Mackie (HR Series)	www.mackie.com	29
Mackie	www.mackie.com	77
M-Audio	www.m-audio.com	101
Merging Technologies	www.merging.com	99
Mogami Cable	www.mogamicable.com	127
MOTU	www.motu.com	80
NAB Broadcasters	www.nab.org	162
Neumann/USA	www.neumannusa.com	36
Neutrik Test Instruments	www.nt-instruments.com	106
PrismSound	www.prismsound.com	119
Professional Audio Design	www.us:edssl.com	71
Professional Audio Design	www.proaudiodesign.com	103
Quantegy	www.quantegy.com	89
Real Traps	www.realtraps.com	38
Recording Workshop	www.recordingworkshop.com	38
RØDE Microphones	www.rudemicrophones.com	125
Roland Corporation	www.rolandus.com	47
Royer Labs	www.royerlabs.com	156
SAE Institute of Technology	www.sae.edu	69
SAE Institute of Technology	www.sae.edu	111
SE Electronics	www.seelectronicsusa.com	64
Seneschal	www.seneschal.net	158
Sennheiser	www.sennheiserusa.com	34
Solid State Logic Ltd.	www.solid-state-logic.com	1
Sony Professional Audio	www.sony.com/proaudio	81
SPL	www.spl-usa.com	10
Steinberg	www.steinberg.net	105
Studio Consultants	www.studioconsultants.com	158
Studio Projects	www.studioprojectsusa.com	63
Sweetwater Sound	www.sweetwater.com	21

ADVERTISER	WEBSITE	PAGE
Sweetwater Sound	www.sweetwater.com	180-181
Sweetwater Sound	www.sweetwater.com	182-183
Tannoy North America	www.tannoy.com	3
Tannoy North America Inc.	www.tannoy.com	48
Tascam (MX2424)	www.tascam.com	5
Tascam (DM-24 v2.0)	www.tascam.com	35
Tascam	www.tascam.com	106
Telefunken NA	www.telefunkenusa.com	50
TransAmerica Audio Group	www.transaudiogroup.com	28
Ultimate Ears	www.ultimateears.com	46
Universal Audio	www.uaudio.com	107
Waves Ltd.	www.waves.com	49
Westlake Audio	www.westlakeaudio.com	40
Yamaha (DM2000)	www.yamaha.com/proaudio	51
Yamaha (PM1D)	www.yamaha.com	73
Z-Systems Audio Engineering	www.z-sys.com	24

## MARKETPLACE

ADVERTISER	WEBSITE	PAGE
ARIA Photographic Imaging	www.ariaphotos.com	163
American Duplication Supply	www.superdups.com	166
Artist Development Associates	www.artistdevelopment.com	166
Audio Dynamix	www.cdx dvd.com	165

ADVERTISER	WEBSITE	PAGE
Boutique Audio	www.boutiqueaudio.com	167
C & C Music	www.candcmusic.com	168
CSP	http://usa.cspla.com	164
Clearsonic	www.clearsonic.com	164
Crystal Clear Sound	www.crystalclearcdfs.com	164
D.W. Fearn	www.dwfearn.com	167
Digital Domain	www.digido.com	168
Dupco	www.dupco.com	163
Gefen Systems	www.gefen.com	164
Grubsrof Inc.	www.loudspeakerbuilder.com	168
Lonely Records	www.lonelyrecords.com	167
Media Services	www.mediaomaha.com	165
MIDI Warehouse Inc.	www.midwarehouse.com	166
Neato	www.neato.com	167
Omnirax	www.omniraxdirect.com	167
Pendulum Audio	www.pendulumaudio.com	165
Professional Audio Design	www.proaudiodesign.com	165
Progressive Music	www.progressivecdfs.com	164
Sonic Circus	www.soniccircus.com	168
Sound Anchors	www.soundanchors.com	165
The Gate	www.gatemediam.com	165
Vancouver Film School	www.vfs.com	163
Voyager Sound	www.voyagersound.com	164
WACDM	www.touchscreenstore.com	168

**FOR FREE INFORMATION FROM MIX ADVERTISERS, VISIT**

**[www.mixonline.com/rs](http://www.mixonline.com/rs)**

Mix's Online Reader Service is the quick and easy way to contact advertisers to receive **FREE** product information. Simply go to **[www.mixonline.com/rs](http://www.mixonline.com/rs)**. From our Online Reader Service page you can then select the issues and the advertisers you are interested in. It's that simple. Your request is immediately e-mailed to the advertiser.

Also, while you're there, take a moment to complete our RATE THE ARTICLES survey in each issue. We want to know what works for you!

### IMPORTANT NOTICE TO READERS:

Reader service inquiries are sent directly to the advertiser, who is solely responsible for sending product information. Mix magazine can not guarantee a response from all advertisers.

## MIX ADVERTISER SALES REGIONS AND REPRESENTATIVES



### Northwest/North Central

**Greg Sutton**

847/968-2390

gsutton@primediabusiness.com

### Southwest

**Albert Margolis**

949/582-2753

amargolis@primediabusiness.com

### East Coast/Europe

**Michele Kanatous**

718/832-0707

mkanatous@primediabusiness.com

### Classifieds

**Kevin Blackford** (West Coast)

**Jason Smith** (East Coast)

800/544-5530 or 510/653-3307

mixclass@primediabusiness.com

# YOU GOTTA GO!



Join us at the **Radio Luncheon** on Tuesday, April 8 for the induction of **Scott Shannon, Air Personality and Program Director, WPLJ**, into the NAB Broadcasting Hall of Fame.



SEE ONE OF COMEDY'S  
BEST — LIVE!

**NAB Opening Celebration  
with Bill Cosby**  
Sunday, April 6, 2003  
The Bellagio Hotel and Casino  
*Ticket required.*

Register for **NAB2003** today and save!  
Register by **February 28, 2003** and save up to \$200  
off the regular price. Packages start at \$395. For  
details and up-to-the-minute information, visit  
[www.nab.org/conventions/nab2003](http://www.nab.org/conventions/nab2003)

**You gotta network. You gotta learn. You gotta see. You gotta NAB.**

Let's face it, time is money — now more than ever. For the most comprehensive electronic media industry experience available, you'd be wise to invest your time in an event with global returns.

**NAB2003** is the only truly worldwide event for electronic media, offering professional networking opportunities with industry leaders from more than 137 different countries. The **Radio Management Conference** is guaranteed to leave you with the wisdom you need to succeed well into the future. And there's no bigger or more complete showcase of broadcast and multimedia products on the planet.

Make plans to attend **NAB2003**, The World's Largest Electronic Media Show and the Radio Opening Reception on Sunday, April 6. Because if you wanna know, You Gotta Go!

**THE WORLD'S LARGEST  
ELECTRONIC MEDIA SHOW**

April 5-10, 2003 • Las Vegas, NV

**Conferences: April 5-10, 2003 • Exhibits: April 7-10 • [www.nab.org/conventions/nab2003](http://www.nab.org/conventions/nab2003)**



# MARKETPLACE



**VFS** Vancouver Film School

## sound matters

Think it doesn't? Then you're not listening.

### Sound Design for Visual Media

To get more information on VFS programs or your own DVD brochure, call 1-800-661-4101 or email [dvd@vfs.com](mailto:dvd@vfs.com)

200-198 West Hastings Street, Vancouver, BC V6B 1H2 • [www.vfs.com](http://www.vfs.com)



Keith Richards, "Beverly Hills Cop" sessions.

Olympic Studios, London 1967

Online Catalog: [ariaphotos.com](http://ariaphotos.com)

Toll-free info: 800.303.1802

Showroom hours by appointment.

560 Broadway Suite 304 New York, NY 10012

## EDDIE KRAMER

"From The Other Side Of The Glass"

450 rare and historical images by the legendary producer

Investment Grade Archival Quality Limited Edition Prints



PHOTOGRAPHIC IMAGES, LLC

## Are you still shrinkwrapping? Now you can overwrap!



- Creates a folded wrap style for a professional "store bought" look
- Uses convenient pre-cut sheets.
- Wraps 3-6 units per minute
- Desktop design with small footprint
- Easy to use
- Training video included
- Six month warranty

**DEALERS WANTED**

With the duplication industry growing rapidly and its focus turning to short-run packaging facilitation, these machines are built to accommodate the need for short run professional "folded style" overwrapping. Unlike gaudy shrinkwrapping with rough edges, seams and appearance, our overwrappers will wrap your product uniformly with a professional store bought appearance at a fraction of the cost of automated hi-speed overwrappers. Now your studio can give your customers what they want - a professionally packaged & wrapped product!

## Dupco Overwrapping Systems

Demo video online: [www.dupco.com](http://www.dupco.com) • 866-333-8300

## GET IT FAST

Don't trust your audiophile duplication needs to anyone else!

### Progressive Music

www.progressivecds.com    Avail: VISA & Master Card

2116 Southview Ave.  
Tampa, FL 33606  
(813) 251-8093  
FAX: (813) 251-6050  
Toll Free: (800) 421-TAPE

**ALL COMPLETE:**  
Full color Retail Ready Pkgs. with Inserts from your CD & Film  
500 CD'S @ \$890.00.    1000 CD'S @ \$1175.00  
...also...  
-NEW! SHORT RUN RETAIL READY CD PACKAGES with 1000 color inserts printed on a real offset printing press - not some cheap digital color copier!!!  
Just give us digital art or a photo & mockup and we'll do all the rest!!! Use the extra print to get a stunning deal on a re-order!!!  
100@ \$489.00.    200@ \$689.    300@ \$889

"Fastest Turn-Around in the Known Universe!"

CDs • CD-ROM • CD-R • SHAPED CDs • AUDIO CASSETTES

## NEED CDs?

the choice is

# CRYSTALCLEAR

DISC & TAPE

Trusted experience for over 30 years.

## 1-800-880-0073

visit us at [www.crystalclearcds.com](http://www.crystalclearcds.com)

DIGITAL MASTERING • ART DESIGN • PRINTING • PACKAGING

626 448-2609  
<http://usa.cspla.com>

New

MADE IN USA.  
YOU WILL BE HEARING FROM US™

Professional Audio Systems Manufacturing facility in California

info@cspla.com  
Paul Audio Inc. 5157 Cliffwood Dr., Montclair, CA 91763

The calibrated mixer fader settings are displayed in the numeric readout above each icon.

The pan positions can be indicated by the icon angle.

The relative gain positions can be represented by the distance from the origin.

This screen shot is an example of a small instrumental mix in stereo.

## VISUALIZE YOUR MIX

with GraphiMix™ PRO software

- Unique graphic icon interface
- Maximum creative control
- Control 16 MIDI devices from a single source
- Ideal for music mixing, film and TV post-production, sound reinforcement and more!

DOWNLOAD A FREE DEMO AT [VOYAGERSOUND.COM](http://VOYAGERSOUND.COM)

VOYAGER SOUND

DVI • CAT-5 • USB

Extenders • Converters • Switchers • Distribution • Adapters • Cables

Gefen Inc.  
**VGA to ADC**  
Conversion Box

Connects Power Book G4 and Desktop G4 Computers with VGA to Flat Panel Displays

See more ex-tend-it products at [www.gefen.com](http://www.gefen.com) 800 545-6900

## CLEARSONIC PANEL SORBER

Absorption Baffles

NEW! LID SYSTEM & AX12 Height Extenders

Cost Effective  
Free Standing  
Portable

**QUICK & EASY ISO!**

[www.clearsonic.com](http://www.clearsonic.com)  
1.800.888.6360

CLEARSONIC manufacturing

On stage or in the studio

ARE YOU READY TO BE EXPOSED?



★ THE GATE MEDIA GROUP

- GREAT PRICING & SERVICES
- FAST TURN-AROUND
- REAL PROMOTIONAL SERVICES

SPECIALS STARTING AT \$950.00!

MANUFACTURING - MASTERING - IMAGE DEVELOPMENT

WWW.GATEMEDIA.COM ★ 800-655-1625

Audio Dynamix Mfg., www.CDxDVD.com  
 170 Coolidge Ave. Englewood, NJ 07631  
 tel: 201-567-5488 fax: 201-567-5441 • 1-800-455-1589

DVD's Complete Package Includes films, printing, Direct ~~Black Printing~~ on Discs, DVD Box & Packaging. From a customer supplied DLT or DVD-R

1000.....	\$1500
2000.....	\$2500
5000.....	\$5000

DVD  
 CD-ROM  
 CD-AUDIO  
 CASSETTE  
 VINYL  
 VHS

CD's Complete Package Includes Films & Proofs, ~~Black CD's~~ print on CD or 3 color on CD, 1 reference CDi, 4 page color Printing 4/1, Jewel box & Packaging

500.....	\$900	2000.....	\$2200
1000.....	\$1300	5000.....	\$700

\*2 POSTERS

CD's  
 DVD's  
 CDR's  
 Tapes  
 Video Tapes  
 Graphic Design  
 Posters  
 Distribution  
 Low Price Guarantee  
 Major Label Quality  
 1x Speed Glass Available  
 Free Barcodes

SERVICES WE OFFER

**\$1,100**

4 Panel (From Your Films)  
 Distribution through CD Baby (Free Set up)  
 Free Barcode

**MEDIA services**

Call today for a free quote or visit us on the web.  
 888.891.9091  
 WWW.MEDIAOMAHA.COM

**Use sound judgment.**

The smart money doesn't buy until discovering the great deals at Professional Audio Design. We have competitive pricing on a huge selection of new, used and vintage equipment. All expertly serviced and warranted. Find out more. Call, fax, stop by or visit us on the Web. And you be the judge.

**Professional Audio Design Inc.**

ALWAYS A SOUND DECISION

Tel: 781.982.2600 Fax: 781.982.2610  
 info@proaudiodesign.com www.proaudiodesign.com  
 Exclusive SSL Factory Authorized Reseller www.UsedSSL.com

**Proudly Introducing the Quartet**

**Four Element Class A Tube Recording Channel**

- Tube Mic/DI Preamp from the MDP-1
- Tube Opto-Compressor from the OCL-2
- New three band tube EQ with HI and LO shelving and six frequency peaking MID band
- New de-esser design using opto-inductive filtering and a highly selective detector
- Transformerless or transformer output

**Pendulum Audio** (908) 665-9333 www.pendulumaudio.com

**ANCHOR Your Speakers With Sound Anchor Stands**

SOUND ANCHORS is your first choice when it comes to speaker stands for your studio. We have a complete range of designs to fill any speaker stand requirements.

The Large Adjustable Stand in this picture features adjustable height and tilt. It is designed to support mid to large sized monitors safely. There is also a special version of this stand designed to support video monitors

**Sound Anchors Inc.**  
 Phone/Fax (321)724-1237 www.soundanchors.com

# MIDI Warehouse

The Computer Music Super Store

Digital Recording,  
Computer Music  
and MIDI Gear...

All at discount prices.

Live Support,  
Expert Help and  
Commitment to Service...

They're all on us.

MIDI Warehouse Inc. | www.midiwarehouse.com | 609-268-7395

## MAKE MONEY MAKING CDS

**Start Your Own Duplication Shop!**  
*We Carry Everything You Need*

- Towers
- Auto Loaders
- Printers
- Overwrappers
- Free Shipping
- Low Price Guaranteed
- Trade-ins Welcome

**Signature IV CD Printer**

**Dupco CD3 CD Overwrapper**  
Create a professionally wrapped CD, utilizing the "folded" wrap style. Wraps 1-6 CDs per minute. Easy to use.  
Don't shrinkwrap your CDs. Overwrap them!

**Orbit II 16x CDr or DVD Auto Loader**

**TOWERS** starting from \$99.00 per month

**Microboards Technology**

**American Duplication Supply™**

**CD DUPLICATION EQUIPMENT ► BUY • SELL • TRADE • REPAIR**  
Printers & Wrappers • Blank Media & Packaging  
Duplication & Replication Services • Factory Pricing – Brokers & Resellers Welcome  
**800-617-3877 • www.superdups.com**

all your career needs at indie-prices  
one phone call...one company

**Live dvd Production Special**

5 Camera Live Shoot  
Digital Audio Recording  
Full Editing  
DVD Menu Authoring  
DVD Master  
Test Copy  
1000 DVD's  
in color inserts  
**\$3,999**

Clients include:  
No Doubt  
Soldplay  
Ben Folds  
Clinic  
GWAR  
Nu Tang Clan  
KMFDM  
Trail of Dead  
The BS2's  
The Toadies  
System Of A Down

12 years of delivering cost management to independent artists, the widest variety of career services in the industry, solutions from mastering to duplication, distribution to promotion, special packaging, graphic design, dvd production and legal services are all available with just one phone call. All our services are performed "in house." Accept no hype or substitutions.

**ada**  
artist development associates inc.

**artistdevelopment.com** toll free **888-782-2378**

### duplication

CD / DVD  
Fast 5 Day Turn CDRs  
Videos / Tapes

### mastering

Digital / Analog Mastering  
Gorgeous Control Room  
Excellent Engineers

### graphic design

Packaging Design  
Posters / Postcards / Web  
Alternative Packaging

### video production

Live Video / Audio Production  
DVD Editing and Authoring  
DVD Menu Design

### promotion

National & Regional Radio  
Tour Publicity  
CD Release Publicity

### distribution

Online Sales  
Fulfillment / Warehousing  
Drop Shipments

## OMNIRAX STUDIO FURNITURE

Introducing:

Force 40 MF



12 rack spaces above  
24 rack spaces below  
includes hi-end adjustable keyboard / mouse shelf

Both pictured with optional mahogany Formica top surfaces

Force 36 MF



12 rack spaces above  
24 rack spaces below  
includes hi-end adjustable keyboard / mouse shelf

P. O. Box 1792 Sausalito, CA 94966 800.332.3393 415.332.3392 FAX 415.332.2607  
www.omnirax.com info@omnirax.com

Anyone who has heard it knows . . .

**NEW** VT-4 Vacuum Tube LC Equalizer



**D.W. FEARN**

610-793-2526

www.dwfearn.com

**INWARD CONNECTIONS**  
MP820

Got ProTools®?

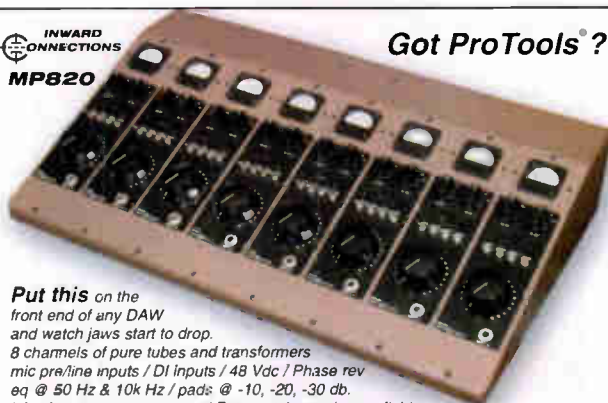

Put this on the front end of any DAW and watch jaws start to drop. 8 channels of pure tubes and transformers mic pre/line inputs / DI inputs / 48 Vdc / Phase rev eq @ 50 Hz & 10k Hz / pads @ -10, -20, -30 db. LA-2A style compressor and Pultec style eq also available.



Put these on the back end of your DAW and you will become a believer. The Discrete Stereo Buss Mixer is a 16 channel all discrete, class A mixer. Turn your DAW into a fully automated analog console. Features: 16 channels pan pots on each channel / stereo buss meters, master level, insert. Expandable to 64 channels. The DMS-3 is like the master section of a world class analog console - only better. A complete all discrete, class A monitoring system. Features: control room, talk back, dim, headphone level / dim, mono, alt speaker, mute, talkback switches / stereo bus: / 2trk1, 2trk2 switches.

Only from Boutique Audio & Design

sales: (818) 340-6930

web: www.boutiqueaudio.com

# CD LABELING & PACKAGING

FROM YOUR DESKTOP

• DESIGN • PRINT • PACKAGE



Do-it-yourself...  
for under \$1  
complete!  
Any quantity!

NEATO... YOUR #1 SOURCE for RECORDING SUPPLIES

**NEATO**  
Media Labeling Products

888-317-5667  
www.neato.com

## Lonely Records Offers More!

Friendly, knowledgeable service.  
110% National Price Guarantee.  
Direct Digital Print.

Check out these deals:  
• 100 bulk cdr, \$1.50 / cd  
• 1000 bulk cds, 99¢ / cd  
• 100 posters, 49¢ / poster  
• barcode topspines, 10¢ / unit

other retail ready cd packages  
4 panel, as low as \$1.09 / cd  
6 panel, as low as \$1.10 / cd

Get a Free Catalog  
www.LonelyRecords.com

also available:  
• digital mastering  
• graphic design  
• cassettes  
• posters  
• dvd



# LOUDSPEAKERBUILDER.COM

OEM DIVISION of Grubsrof, Inc.

If you can dream it, we can build it...  
Custom Built Enclosures to your specs...

**(919) 676-8871**

25 Years of Designing and Building

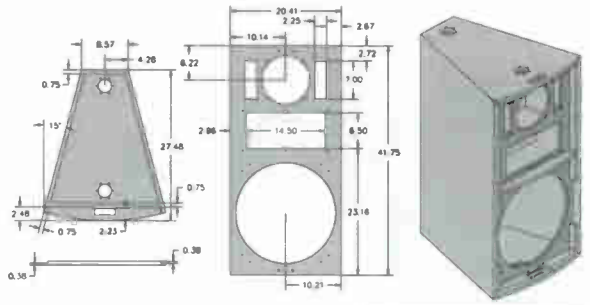

**All under one roof!**  
*deal direct & SAVE*

Compact Disc Replication  
Cassette Duplication  
Complete Packages  
Digital Mastering  
Graphics and Printing

FREE CATALOG or CUSTOM QUOTE

**C&C MUSIC** Toll free **www.CandCmusic.com**  
OUTSIDE THE U.S. CALL 631-244-0800

You'll Hear & Feel the Difference **800 ☆ 289 ☆ 9155**

**Cintiq**  
interactive pen display

Accessible Sound  
Houston, TX

18sx

**touchscreenstore.com**  
615-429-2482

the Tool For Pro Tools

- Any Platform
- Every Program
- All At Your Fingertips

**WIN A CINTIQ 15x**  
Purchase a Cintiq 15x by 5/1/03 and you could win The Refund Giveaway Promotion. Winner will be announced in July Issue. See website for details.

# SONIC CIRCUS

Serious Studio Infrastructure

The most comprehensive selection of recording equipment in the world

Shop online and take advantage of frequent buyer benefits.

**SONIC CIRCUS**  
617.696.9360  
www.soniccircus.com

Master at **DIGITAL DOMAIN**™ where music still sounds like music. Where punch, vitality, space, imaging, clarity, warmth and quality are not just buzz words. We enhance musical values with specialized techniques invented here.

Unsurpassed mastering quality by **Bob Katz**. Custom-built hardware and software. **Stereoization, Microdynamic Enhancement**. Unique Processes. Sadie Editing. Tube and Solid-State Analog Recorders.

*CD Mastering is an art. Levels, dynamics, fades, spacing... everything is important to you and to us.*

**Mastered Three Grammy Winners**

**CD Replication... Booklet Printing... Graphic Design...**

How to make a superior pressed CD

- 1) 1X speed Glass Mastering
- 2) Quality control
- 3) Attention to detail
- 4) Personalized Service
- 5) Good, clean packaging and packing
- 6) Dependable, on-time delivery

**Digital Domain**  
(800) 344-4361 in Orlando, FL

The Definitive, Award-Winning Internet CD Mastering Website  
<http://www.digido.com>

# CLASSIFIEDS

**MIX** Classified Ads are the easiest and most economical means to reach a buyer for your product or service. The classified pages of Mix supply our readers with a valuable shopping marketplace. We suggest you buy wisely; mail-order consumers have rights, and sellers must comply with the Federal Trade Commission, as well as various state laws. Mix shall not be liable for the contents of advertisements. For complete information on prices and deadlines, call (800) 544-5530.

**SILENT**  
58 Northwick St., Northampton, MA 01062  
INFO (413) 584-7044 • FAX (413) 584-2377  
ORDER (800) 583-7174  
info@silentsource.com • www.silentsource.com  
AcoustiCore Fabric Panels • Sound Barrier Isolation Hangers • A.S.C. Tube Traps  
Silence Wallcovering • WhisperWedge Metaflex • S.D.G. Systems • Technifoam R.P.G. Diffusors • Sonex • Sound Quilt

**STEVEN KLEIN**  
**Acoustic products for less.**  
**SHOP ONLINE AT**  
[www.soundcontrolroom.com](http://www.soundcontrolroom.com)

## Acoustic Products

**SoundSuckers.com**  
1-888-833-1554  
\*Soundproofing Products & Supplies  
\*Full line of Professional booths  
\*Custom Projects of all kinds  
E-mail: sales@soundsuckers.com

**WhisperRoom INC.**  
SOUND ISOLATION ENCLOSURES  
Celebrating over 12 years of reducing sound to a Whisper!  
Recording, Broadcasting, Practicing  
Recording, Broadcasting, Practicing  
MDL 1021265 (8.5 X 10 5')  
19 Sizes and 2 Levels of Isolation Available  
New! SoundWave Deflection System (Change parallel walls to non-parallel) Immediate Shipping!  
[www.whisperroom.com](http://www.whisperroom.com)  
PH: 423-585-5827 FX: 423-585-5831

**VocalBooth.com**  
Multi Purpose Recording & Practice Rooms  
Starting at \$1499  
Affordable Portable 4x4, 6x6 & larger (541)330-6045

**AcousticsFirst™**  
Toll Free: 888-765-2900  
Full product line for sound control and noise elimination.  
Web: <http://www.acousticsfirst.com>

**Acoustics by db**  
...all the others are just brokers.  
New products from Queded-Daking Radar • Martech-Sontec • MRL • Trident Millennium Media • Shep/Neve • United Audio Earthworks • Prizm • Eventide • Dynaudio  
• Total studio concepts: control rooms, studios & turnkey packages.  
• Room tuning, noise problems, existing plans & custom traps.  
• Wiring system design, custom cabling & full installations.  
• Consultation on equipment choices, used & vintage gear.  
**Building Studios & Keeping 'em alive for 34 32 years!**  
Neve Classic 80 Range • Neve VI-VR Range SSL 4000 • 5000 • 6000 • E/G/G+ • 9000J Flying Faders • API 3224 • Trident 80C/80B Vintage Neumann, AKG & Telefunken Mics  
Studer, Otari, Ampex MCI & Sony Multitracks Sony PCM3348 • Studer D827 • Dolby XP/SR EMT 250/140 • Lex 960/480/224 • Sony DRE Vintage Neve Modules • Shep/Neve Reissue Fairchild 670/660 • Quantec • AMS RMX/DMX  
**Building a project studio? Designs from existing plans start at \$1,000 per room.**  
All new Neumann mics @ best prices!  
**SMALL AFFORDABLE SPECIALS**  
Trident 24 • Studer 169 • Alesis • Eventide Neotek • Amek Big • Tascam • Fostex UREI Monitors • Tannoy • Manley Urei • dbx • Klark-Teknik • Neve Neumann • AKG • Telefunken • Sennheiser Digidesign • Otari • Ampex • API • MCI  
1194 Walnut St, Suite 205 Newton, MA 02461 • 617 969-0385 • fax 617 964-1590  
Now on the web @ [www.db-engineering.com](http://www.db-engineering.com) • email [dbtdb@earthlink.net](mailto:dbtdb@earthlink.net)

**Auralex acoustics**  
FREE Expert Consultation!  
Auralex Acoustics proudly offers everything you need, including industry-leading Studiofoam™ acoustical panels, bass traps, diffusors, MAX-Wall™ modular environment, and a complete line of construction products to greatly reduce sound transmission & resonance.  
Compare Auralex quality, quantity, variety, personalized service, and price!  
**Your Studio. Your Sound. Our Passion.**  
**D36 Roominator-DST™**  
1-800-959-3343 • [www.auralex.com](http://www.auralex.com)

**KTS KLEIN TECH SYSTEMS**  
"New Perspectives in Acoustic Engineering"  
For Audio Engineers, Sound Engineers, and Serious Audiophiles  
**ACOUSTIC INTERFACE PADS**  
Improve Sound Quality and Safety  
Composed of Space-Age Polymers  
**KTS Acoustic Interface Pads:**  
• Fastens Speaker Cabinets to Any Stand or Surface  
• Isolates Distortion, Dampens and Absorbs Vibration  
• Secures Objects for Stability and Safety  
• Protects Tile, Wood, Linoleum, and Other Finishes  
• Eliminates Destructive Spikes and Mounting Hardware  
• Ideal for Center Channel Speakers, CD Players/Transports, Turntables, Amplifiers, Tape Players, CD Trays, and Cassette Vibration  
Typical Application:  
KTS pads are used around small objects and rough surfaces.  
Stand or Support  
Made in USA  
KTS adheres to a simple concept: every part of an audio chain contributes to the overall operation, acoustical performance and owner satisfaction. Why take chances? Get the most out of the system in which you've invested!  
[www.kleintechsys.com](http://www.kleintechsys.com) • 561-969-2298 • Fax: 561-423-0388 • email: support@kleintechsys.com

**VIBRANT TECHNOLOGIES**  
DIFFUSER PANELS  
WAVE-FORMS™ ACOUSTIC PANELS  
800-449-0845  
[www.vibrantech.com](http://www.vibrantech.com)

**Biz Opps & Consulting**

**"LOOKING FOR A RECORD DEAL???"**  
Getting signed is very hard to do. But we will get the record deal you are looking for! Guaranteed Service. Call now to receive your FREE information

**TALENT 2000**  
1-800-499-6395

E-mail your Mix classified ad to: [mixclass@primediabusiness.com](mailto:mixclass@primediabusiness.com)

## Computer Products

Connects  
PowerBook G4  
and Desktop G4  
Computers with VGA  
to Flat Panel Displays.

800-545-6900  
www.gafen.com



SEE OUR AD IN MARKETPLACE

**Add Visual Control** to your  
Digital Audio Mixer with GraphiMix™ software

- Cut mix production time
- Maximize creative control
- Control 16 MIDI devices

Visit our website to download a free demo.  
[www.voyagersound.com](http://www.voyagersound.com)

SEE OUR AD IN MARKETPLACE

**SONIC BLADE**

2.53Ghz      2 x 80GB (160 GB)  
512MB DDR      USB (4 Ports)  
400 Watt PS      Rack-Mount  
Firewire (3 ports)      48x CD/RW

**\$1,499** plus  
shipping/acc  
or 1% interest

Rack-Mount PC's for Live and Studio  
[www.SonicBlade.com](http://www.SonicBlade.com)

Check Out [mixonline.com](http://mixonline.com)

Authorized Reseller

### MACS FOR MUSIC

Apple G4's, PowerBooks and iBooks pre-configured and optimized for today's most popular audio applications - Pro Tools, Digital Performer, Cubase VST, Nuendo, Logic Audio and more. Featuring hardware from Aardvark, RME, MOTU, MIDIMan Glyph and Panasonic. Rack-mount configurations available. Made by those who know for those in-the-know. Authorized Apple Value Added Reseller and turnkey solutions provider. Apple Instant Loan program available. Call or click today!

[www.wavedigital.com](http://www.wavedigital.com)  (973) 728-2425

## Employment Offered

Join the best staff in pro audio.

“I'm running my own pro audio speciality shop.”

-Brian Lemby, Senior Sales Engineer

As a Sales Engineer for Sweetwater my client list includes some of the world's leading audio professionals and musicians. I work one-on-one with them to insure they have the right equipment for their needs and I'm backed up by the finest Service and Support in the business.

It's time to turn your knowledge into a rewarding career!

- Outstanding compensation
- Excellent benefits including 401K and health insurance
- Dynamic, fast-paced environment.

Contact Kristine Haas, Sweetwater's Director of Human Resources, at 1-800-222-4700, ext. 1050 for a confidential interview.

5335 Bass Road, Fort Wayne, IN 46808  
FAX 260-432-8176  
[sweetwater.com](http://sweetwater.com)  
[careers@sweetwater.com](mailto:careers@sweetwater.com)

**Sweetwater**  
music technology  
1-800-222-4700

## Chair, Music Synthesis Department

The Music Synthesis Department within the Music Technology Division at Berklee College of Music is now accepting applications for the position of Chair. The position reports directly to the Dean of the Music Technology Division. This is a 12-month per year position. This position starts in Summer or Fall 2003, depending on the availability of selected candidate.

The Music Synthesis Department prepares students for careers in the music industry through a curriculum which emphasizes audio and acoustic fundamentals and performance, production and sound design utilizing contemporary synthesizer technology and computer-based MIDI and digital audio systems.

Requirements for the position of Chair include a Master's degree or equivalent professional experience, strong and effective interpersonal skills, and teaching and administrative experience, preferably in a college setting. Applicants must have substantial professional experience in electronic and acoustic music production, a thorough knowledge of current tools, techniques, practices and technological advances in the field, and strong organizational skills. Salary is commensurate with qualifications and experience. Please send your resume, three letters of recommendation, a disc containing no more than three recent productions or performances, and other appropriate documentation along with your letter of application by the deadline date of March 19, 2003. Women and minorities are encouraged to apply. Incomplete or late applications will not be considered. Send all required materials to: Music Synthesis Department Chair Search Committee, c/o Music Technology Division, Berklee College of Music, 1140 Boylston Street, Boston, MA 02215. Berklee College of Music is an Equal Opportunity Employer.

**Berklee**  
COLLEGE OF MUSIC

www.berklee.edu

## Equipment Financing

### A/V EQUIPMENT FINANCING

Specializing in Audio Video Equipment      Visit Our Web Site For Applications & Qualifications

- No Financials Required
- New & Used Equipment
- Upgrade Existing Leases

**LFCI** [www.lfci.net](http://www.lfci.net)  
We Are Direct Lenders      Call: 800 626 LFCI

### EQUIPMENT FINANCING

- ♦ FAST, EASY APPROVALS
  - ♦ We Specialize in Audio-Visual Equipment
  - ♦ No Financials Necessary
  - ♦ True Lease or Finance Lease Option
  - ♦ New or Used Equipment
- LOANS BY PHONE  
Call Jeff Welter  
**(800)699-FLEX**  
24hr. Fax (972)599-0650



**FLEXLEASE, Inc.**  
COMMERCIAL EQUIPMENT FINANCING      Contact Us at Our Web Address: [www.flexlease.com](http://www.flexlease.com)

## Equipment For Sale

**o d y s s e y**  
**p r o s o u n d**

The outlet for the finest new & pre-owned recording equipment anywhere.

[www.odysseyprosound.com](http://www.odysseyprosound.com)  
1-800-249-1821  
Phone: (978) 744-2001      Fax: (978) 744-7224



**Any Questions?**

**MERCENARY**  
BOSTON  
**AUDIO**

"this is not a problem"

TEL (508) 543-0069  
www.mercenary.com open 24 hrs

**SONIC CIRCUS**  
A SOUND ALTERNATIVE

617.696.9360  
soniccircus.com

SEE OUR AD IN MARKETPLACE

**VINTAGE EQUIPMENT:** Studer 903 36-input w/auto \* Neve VR72 \* Neve 8128 56-input w/FF \* Neve 8068 MKII \* Neve V3 60 w/FF \* Mitsubishi Superstar 52-input automated \* Otari Concept 1 96 faders \* Harrison Series 12 80-input \* Studer A827/800/80MKIV \* AMEK "Big" 44-input w/Virtual dynamics \* Otari MTR901 \* Lexicon 480L/PCM 42 \* Neumann U87 \* (2) UREI LA3A \* Dolby SRXP 24-channel rack w/harness \* Ampex ATR 102 1/2in.

**NEW EQUIPMENT:** TC Electronic \* Tube-Tech \* Lexicon \* Eventide \* Quedest \* Crane Song \* Demeter \* D.W. Fearn \* Universal Audio \* Millennia \* Vintech \* HHB \* Drawmer \* DPA \* Soundelux

**LIST FOR SALE ITEMS FREE.** Major Credit Cards Accepted. We Buy Vintage Gear.

**HARBORSOUND**  
www.harborsound.com  
Phone: (781) 231-0095 Fax: (781) 231-0295

**THE CASE SPECIALISTS**  
FREE CATALOGUE

(800) 346-4638  
(831) 563-8326, NY  
(831) 563-1380, Fax  
Custom or stock sizes.  
Our prices can't be beat!  
www.Discount-Distributors.com

**IT'S A GREAT TIME TO BUY USED GEAR!**

We list over 700 recording and live boards, plus mics, amps, effects, more. We can help sell your used equipment, too!

- Euphonix CS3100B.....\$135K
- DDA AMR24.....\$12K
- Studer A827.....\$23K
- Audient/Tascam Mobile 48 track studio complete.....Call for details

Call/E-mail for details & FREE catalog.  
**Those Cheerful Folks at H.T.I.C.S.**  
(610) 865-9151 • Fax (610) 758-9999  
E-mail: HTICS@aol.com  
www.hticsproaudio.com

**CALISTRO MUSIC**

All The Best  
Recording Gear

(203) 891-8918

www.CalistroMusic.com

EXCLUSIVE FACTORY AUTHORIZED RESELLER

**www.UsedSSL.com**

PROFESSIONAL AUDIO DESIGN, INC.  
(781) 982-2600

SEE OUR AD IN MARKETPLACE

SSL - NEUMANN **K.G.B.** STUDER - NEVE

<http://killergearbroker.com>

VISA Professional Audio Specialist MC  
phone (818) 904-9400 fax (818) 904-9444 pgr (818) 999-8970  
"ANY GEAR NOT LISTED CAN BE FOUND WITHIN 48 HRS!"

**Introducing the Quartet**

Four Element Class A Tube Channel  
**Pendulum Audio**

pendulumaudio.com (908) 665-9333

SEE OUR AD IN MARKETPLACE

The largest collection of gear in the U.S.

**OCEAN AUDIO INC.**

www.oceanaudioinc.com  
Phone (803) 449-3002 Fax (803) 449-8558  
info@oceanaudioinc.com

**MISTY HILL AUDIO**

**VINTAGE**  
NEUMANN • NEVE • AKG • STUDER  
API • TRIDENT • AMEK • UREI • RCA • SSL • TELEFUNKEN

Buy/Sell - We pay top dollar - FAX us your list  
Worldwide Shipping • Visit our website

VISA MasterCard AMERICAN EXPRESS

512.338.6777 • <http://audio.home.texas.net>

**OTARI**

**HOT WEB DEALS!!**

Check out some of the best deals on Otari gear. A-stock, B-stock, demos & production over-runs - available at significant savings. All products sold with warranties.

**www.otari.com**

**SoundBroker.com**

Linking Buyers & Sellers Together

**www.SoundBroker.com**  
**702-736-3003**

**WE BUY & SELL FOR YOU**  
-SATISFACTION GUARANTEED-

**USED** **NEW**

**Pro Audio & Lighting Equipment Live Sound, Recording, Vintage & Broadcast**

**AUTHORIZED DEALERS FOR**

Meyer Sound Labs • JBL • Community • BSS • dbx  
TC Electronic • ADL • Ashly • Crown • Crest • QSC  
Shure • Vintech • Tri-Tech Audio • Horizon Snake Systems  
Spirit by SoundCraft • Allen & Heath • High End Systems

**JOIN OUR NEW LISTING CLUB UPDATED DAILY OVER 10,000 ITEMS FOR SALE**

## Equipment For Sale

### Upgrade Your Vocals

with **Variable Acoustic Compression™**

Pop filters that adjust for the best combination of pop protection and sonic transparency BEFORE the sound reaches the microphone.

Get professional sounding vocals and protect your microphones.

**ORDER TODAY!**

[www.popfilter.com](http://www.popfilter.com)

Popless Voice Screens

Tel: 1(800) 252-1503 email: [info@popfilter.com](mailto:info@popfilter.com)



## ALAN SMART COMPRESSORS



C-1, C-2 & Multichannel version

available in the U.S. & exclusively distributed by:

Sunset Sound, Hollywood (323) 469-1186

[www.sunsetsound.com](http://www.sunsetsound.com)

**Sound Productions**  
SELLING ALL PRO BRANDS  
SINCE 1973

Need Some Sound?  
Don't Mess Around  
**CALL THE PROS  
TODAY!**



**800-203-5611**  
NEW AND USED GEAR - TOLL FREE!

[www.SOUNDPRO.com](http://www.SOUNDPRO.com) Buy@SoundPro.com

*Atlas Pro Audio*

[atlasproaudio.com](http://atlasproaudio.com)

Phoenix-Neumann-RME

Mytek-Empirical labs

Sennheiser-Soundelux

Amek-Vintech-Purple

Millennia Media-Rode...

Toll Free 1.866.235.0953



**CLASSIC MICS**  
FROM RUSSIA

**VINTAGE TUBE & FET**

Telefunken, NEUMANN  
AKG, LOMO, OKTAVA, etc.  
TEL/FAX: 011-7-095-250-4200  
E-mail: [aeg210268@mtu-net.ru](mailto:aeg210268@mtu-net.ru)  
[www.valvemics.webzone.ru/](http://www.valvemics.webzone.ru/)

CONSOLES FOR SALE  
SSL 9080 J, 80 Series Neves  
60- & 72-channel Neve VRs  
Flying Faders or GML  
Contact Gary Belz  
House of Blues Studios  
(818) 990-1296

Rocks and other cool stuff



*Chevyche Audio & Design*

SEE OUR AD IN MARKETPLACE

**VINTAGE NEVE™ I272 PREAMPS with D.I.**



**\$1089 Single w/p.s. \$1859 Two channel**

**Vintage Neve, API and Calrec**

**Brent Averill**  
ENTERPRISES

14300 Hortense Street • Sherman Oaks, CA 91423  
818 784-2046 FAX 818 784-0750  
[www.brentaverill.com](http://www.brentaverill.com)

# VOLUME discounts.



From microphones to turnkey studio systems, we have a huge stock of new, used and vintage equipment from over 100 manufacturers. Including pre-owned SSL consoles. All serviced and warranted by our technical experts. Call, fax or stop by. And hear why our deals are better.

**Professional Audio Design Inc.**

ALWAYS A SOUND DECISION

Tel: 781.982.2600 Fax: 781.982.2610  
[info@proaudiodesign.com](mailto:info@proaudiodesign.com) [www.proaudiodesign.com](http://www.proaudiodesign.com)  
Exclusive SSL Factory Authorized Reseller [www.UsedSSL.com](http://www.UsedSSL.com)

## Introducing the Vintech Audio 473 four channel mic preamplifier!



Four channels of class A mic preamps and "essential eq" based on the classic Neve 1073 module. For more information call 1-877-4-mic-pre or visit our website at [www.vintech-audio.com](http://www.vintech-audio.com)

# vintageking.com

TG1

The Chandler Limited TG1 is a recreation of the rare and classic limiter/compressor featured on custom EMI/Abbey Road recording/mastering consoles used on late Beattie recordings and Pink Floyd.

**RETAIL: \$4800 VINTAGE KING PRICE: \$3600! CALL TODAY.**

Stocking the FINEST NEW PRODUCTS  
ALWAYS the LARGEST VINTAGE INVENTORY!  
Phone: 248.591.9276 Fax: 248.591.9281  
or info@vintageking.com



We specialize in service, dependability and price.

## Production Supplies

Jireh Supplies stocks a full line of expendable supplies including: Duracell PROCELL batteries, Gaffers Tape, Board Tape, Glow Tape, Hazard Tape, and many more.

**Jireh Supplies**  
**(800) 478-2591**

or visit our web site:  
[www.jirehsupplies.com](http://www.jirehsupplies.com)  
[gbyce@jirehsupplies.com](mailto:gbyce@jirehsupplies.com)

- SSL G-383 stereo mic-pre/EQ...\$2,999
- SSL G-384 stereo bus comp.....\$1,999
- Eventide H3000 Harmonizer.....\$1,199
- Fostex D-20 DAT w/ remote .....\$899
- AKAI S-1000 sampler .....\$499

**Mark Frink**  
**(503) 490-0002 or**  
**studio@markfrink.com**

**United States Audio**  
Unprecedented Audio Selection  
New, Used & Vintage  
Studio Liquidation  
We buy gear  
PH: (818) 445-9678  
[www.unitedstatesaudio.net](http://www.unitedstatesaudio.net)

**SINGERS! REMOVE VOCALS**  
Unlimited Free Backgrounds from Original Standard Recordings! Thompson Vocal Eliminator™ VE-4 Free Brochure & Demo 24 Hour Demo Info Line (770) 482-2485 - Ext 8 LT Sound Dept. MX-1 7980 LT Parkway, Lithonia, GA 30058 [www.VocalEliminator.com](http://www.VocalEliminator.com) **OLMX** Better Than Karaoke for Over 25 Years!

**VINTAGE GEAR  
PATCHBAYS**  
**(760) 320-0728**  
[www.audiovillage.org](http://www.audiovillage.org)

## SOUTHERN CALIFORNIA PRO AUDIO

NEW, USED AND VINTAGE  
THE LAST CALL YOU'LL  
HAVE TO MAKE!  
Phone: (818) 222-4522  
Fax: (818) 222-2248  
[www.socalproaudio.com](http://www.socalproaudio.com)



## Analog: No Limits

Introducing ATR-108C, the ultimate analog machine. Field convertible for 2", 1" or 1/2" tape in 16, 8 or 2-track formats. Electronics are Aria 100% class-A discrete, able to push today's 'hottest' tapes to their limit.

ATR-108C assures the 'highest-res' vault masters, in stereo or surround. Call today for more details.

**ATR SERVICE COMPANY**  
AMPEX SPECIALISTS  
717-852-7700 • [www.atrservice.com](http://www.atrservice.com)

**FULL COMPASS**

**1-800-356-5844**  
[www.fullcompass.com](http://www.fullcompass.com)



## FURMAN Confidence Monitors

□ Ensure presence and quality of analog audio, digital audio or video signals □ High-output speakers, wide-range meters and more □ Each unit is compact, single-space chassis size.

## Furniture

## DREAM STUDIO



consoles, workstations,  
racks  
**ARGOSY**  
STUDIO FURNITURE  
[www.argosyconsole.com](http://www.argosyconsole.com)  
800.315.0878 573.348.3333

## OMNIRAX

STUDIO FURNITURE



**OMNIRAX** 800.332.3393 416.332.3392  
FAX 416.332.2847  
[www.omnirax.com](http://www.omnirax.com)

**UNDER COVER**  
Custom Covers and Bags  
Speaker Cabinets / Consoles  
Anything!  
[www.undercovernyc.com](http://www.undercovernyc.com)  
917 237 1535  
Get your gear Under Cover!

## STEDMAN

DON'T LOSE DETAIL!  
The finest pop filter  
money can buy!  
PROSCREEN PS101

Call 888-629-5960  
[www.stedmancorp.com](http://www.stedmancorp.com)

## VINTECH AUDIO

CLASS A MIC PREAMPS MADE WITH



**NEVE™ 1272 COMPONENTS**  
[www.vintech-audio.com](http://www.vintech-audio.com)  
call toll free: 1-877-4-mic-pre

VT-2 Vacuum Tube Mic Preamp  
[www.dwfearn.com](http://www.dwfearn.com)



**D.W. FEARN**

SEE OUR AD IN MARKETPLACE

**THE MIC SHOP**  
TUBE MICROPHONES  
BOUGHT/SOLD/SERVICED  
Mic Power Supplies & Cables  
Bill Bradley: (615) 595-1717  
Fax: (615) 595-1718  
[www.micshop.com](http://www.micshop.com)

## Equipment Wanted

## SoundBroker

Linking buyers & sellers together  
for all your studio needs  
**(702) 736-3003**  
[www.SoundBroker.com](http://www.SoundBroker.com)

SEE OUR AD IN MARKETPLACE

## SOUND ANCHOR

SPECIALTY AUDIO STANDS  
(321) 724-1237

DESIGNED FOR ULTIMATE  
PERFORMANCE BEHIND  
CONSOLE AND FREE SPACE  
APPLICATIONS.  
Standard & Custom Models



SEE OUR AD IN MARKETPLACE

## Internet Services

••• Music Websites •••

Your band needs a site!  
Put your songs online.  
Sell CDs from your site.  
See messages from fans in  
a Guestbook. E-mail fans  
on Mailing List.

• [www.thiemedesign.com](http://www.thiemedesign.com) •

## Instruction

**Learn the Art of Recording**

- Recording Technology
- Recording for TV/Film
- Music Business
- Music Theory
- Small Classes
- Placement Assistance

5 Students

- Solid State Logic
- Neve
- Yamaha O2R
- Protools
- Synclavier
- Otari
- Tascam DA88

1-972-869-1122  
www.dallassoundlab.com

6305 N. O'Connor Blvd, Suite 119  
Irving, Texas 75039

## RECORDING & DUPLICATING SUPPLIES



Audio, Video & Data Storage  
Media & Accessories

1-800-272-2591 FAX 650-369-7446  
Visit our web site: www.arcal.com

CDs • CD ROM • CD R • SHAPED CDs • AUDIO CASSETTES

# CRYSTALCLEAR

DISC & TAPE

1-800-880-0073 www.crystalclearcds.com

DIGITAL MASTERING • ART DESIGN • PRINTING • PACKAGING

SEE OUR AD IN MARKETPLACE

**BE A RECORDING ENGINEER**

**★ TRAIN AT HOME**

Easy Home-Study practical training in Multi-track Recording. Join our successful working graduates or build your own studio. Career guidance... Diploma... Licensed.

**FREE INFORMATION:**  
Audio Institute of America  
214 4th Ave, Suite AL, San Francisco, CA 94121  
Or visit us at www.audioinstitute.com

**ARTI** Audio Recording  
Technology Institute  
ORLANDO, FLORIDA

- Extensive Hands-On Training
- Music, SFX Design, Audio Post
- Low Student/Teacher Ratio
- Placement Assistance
- Financing to Qualified Applicants
- Accredited by ACCSCT



888-543-ARTI • audiocareer.com

**Get Pro Tools Certified! Be recognized!**  
Help your career & get the most out of Pro Tools. Sign up for classes today!

**Future Rhythm**  
Authorized Digidesign Pro School  
(408) 441-1028  
San Jose, CA  
www.futurehythm.com/training

**Turn-key solutions for**  
Digital Media Development and Publishing

**1000 CD's \$599** Bulk CD's 3 Color 50k screens  
**100 CD's \$299** FULL COLOR RETAIL-READY

Complete Package Includes: FULL COLOR insert, traycard, direct on disc printing, jewel case and shrinkwrap.

**CD/CD-ROM/DVD, WWW, A/V TAPE, MASTERING, DESIGN, PRINTING**

**1-800-365-8273**

Since 1985 • Free Color Catalog

## Music Mastering

unique DVD-A Mastering  
on AudioCube 5 at

**DeNoise.com**  
1-866-DENOISE

**DRT Mastering**  
the Analog Specialist

**You will have the fat, slammir major-label sound that sells discs.**

Or the work is free...

Custom gear. 1st-class results. Free broch  
800-884-2876 www.drtmastering.com

F7 sound & vision

advanced

**MASTERING**

surgical editing

813-991-4117  
www.F7sound.com

**LMG Mastering Lab**

Want world-class mastering?  
From slammir, in-your-face rock and hip hop, to pristine jazz and classical. 315.492.6854  
www.lakewoodmusic.com

**Records Tapes CD Services**

**TOTAL TAPE SERVICES**  
HIGHEST QUALITY, LOWEST PRICES

**WE MEET OR BEAT ANY PRICE**

on CD DUPLICATION

- in-house graphic design
- cassette duplication
- video duplication
- postcards
- posters
- flyers

VISA MasterCard

**CALL US LAST!**  
(727) 446-8273  
www.totaltapeservices.com

**CD Duplication**

**FREE DESIGN**

RETAIL READY CDs  
MANUFACTURING not CD-R  
SAME AS CAPITOL RECORDS  
PRINTED BOOKLET  
INSERT IN BACK TRAY  
2 COLORS ON DISC  
SHRINK WRAPPED with BAR CODE  
IN-HOUSE GRAPHIC DESIGN  
using your files / images / photos

**ONE PRICE ALL INCLUDED**  
**1000@ \$1099**  
Call Free 888-565-8882  
dbsduplication.com

**MASTERING**  
Guaranteed to give you that "Big Label" sound.  
www.musichouseproductions.com

Full Album... 12 Songs  
Analog & Digital  
Mastering Lab!

**\$475**

1-800-692-1210

**46 PRODUCTIONS**

25 CD-Rs - \$45.....50 CD-Rs - \$88  
100 CD-Rs - \$150...200 CD-Rs - \$290

ASK ABOUT OUR DISCOUNT FOR ASCAP MEMBERS

From CD or CD-R master. Includes CD-R in jewel box with text printing on CD label. Add \$35 for other digital master, \$55 for analog master. Orders must be pre-paid. Shipping not included.

42 W. 557 Hawk Circle  
St. Charles, IL 60175  
Phone: (800) 850-5423  
E-mail: info@46p.com  
Visit our Web page at http://www.46p.com

**GET A BREAK!**  
With our **BIG BREAK CD Package!**

**1000 Retail Ready CDs - \$1099.00**

Package Includes:

- 4 Page, Color Insert & Traycard
- 2 Color Disc
- All Film
- Jewel Boxes
- Free Barcode

**1.800.835.1362**  
or Get your ONLINE QUOTE at: www.healeydisc.com

**healeydisc**

Next time you call a classified advertiser, let them know you saw their ad in MIX!



## CD DUPLICATION We Guarantee Lowest Pricing!

Simply Mail:  
Take any CD duplication ad you find  
Take any previous invoice  
Show us any valid quote

We'll beat it by up to 10%!  
And if we can't,  
we'll give you 100 FREE CDrs!

Are you overpaying for your CD  
replication & duplication services?

WE WILL NOT BE UNDERSOLD!

FACTORY DIRECT PRICING • FAST TURN TIME  
100% SATISFACTION

American Duplication Supply™

1-877-735-5237

## CD, CASSETTE, CDR and CD-ROM Complete Packages!



1-800-444-DDAI

- CD/CASS MASTERING
- CD/CASS REPLICATION
- CEDAR RESTORATION
- GRAPHIC DESIGN
- FILMS AND PRINTING
- CD-ROM AUTHORIZING

Our CD & Cass's are  
**BETTER & CHEAPER!**  
(800) 421-8273  
Progressive Music

## lonely Records.com

100 Retail CDs as low as **\$1.99** per cd  
1000 Retail CDs as low as **\$.99** per cd  
**1 800-409-8513**

## www. TapeBargains.com

Log-on for  
CDR's, DVD's,  
DAT Tape,  
and more at low prices!

We carry all brands  
and formats of  
recording media!

1-888-594-2464

www.tapebargains.com

For the best price in CD Replication . . .  
there is only one number you'll need!

**1.888.891.9091**

www.MEDIAROMA.COM

SEE OUR AD IN MARKETPLACE

## DUPLICATION THAT YOU CAN AFFORD!

1000 CDs  
to your door for:  
**\$1299<sup>00</sup>**

NO HIDDEN COSTS!

**NU Graphics**

http://www.nugraphics.com

1-888-DISC-MFG

SEE OUR AD IN MARKETPLACE

SEE OUR AD IN MARKETPLACE

## AMERICA'S BEST CD PACKAGES **RAIDS DOWN**

1000 CD's Only \$1399.00 Includes:

- Full color booklets • design • film • glass master
- shrinkwrap • 2 colors on disc • priority proofs
- Free Overruns • Free Barcode • Fast Turnaround!
- Manufactured by a Major Label for the very best quality!

100 CD's Only \$299.00 Includes:

- Full color booklets • full color on disc • design
- shrinkwrap • priority proofs • free barcode
- Ready in 5 days!

100 Cassettes  
with inserts  
\$199.00

# ELECTRIC

800-367-1084

www.electricdisc.com

## In the Studio

### FREE Guide

Saves You Time and Money!

Contact Us Today:

1-800-468-9353

www.discmakers.com  
info@discmakers.com

**DISC MAKERS**

## Musicians-Bands-Studios

### HIGH BIAS BULK/BLANK AUDIO CASSETTES

**BASF maxell TDK**

C-10.....	.18 / ea.	PERFECT
C-20.....	.22 / ea.	DEMO
C-30.....	.28 / ea.	LENGTHS

CHROME Cr02 C-94..... .50 / ea.

Clear Norelco Box/Round Edge .12 / ea.

All Lengths Available From 1 to 126 minutes

**DAT** Quantegy, Maxell  
BASF or Sony

124	94	64	48	34	15
\$5.40	\$4.75	\$4.20	\$4.00	\$3.60	\$3.10

All Formats and Brands Available.

Please Contact our Sales Department For the Lowest Prices!!!



### CDR'S

**TDK OR MITSUI BLANK FACE WITH JEWEL BOX**

10-99.....	.78	100-499.....	.73	500+.....	.68
------------	-----	--------------	-----	-----------	-----

<b>BULK / SPINDLES</b>			
Diamond/Silver.....	.30/ ea.	Mitsui.....	.60/ ea.
Generic.....	.25/ ea.	TDK.....	.40/ ea.
Taiyo Yuden.....	.30/ ea.		

Volume Discounts

CD Jewel Boxes With Trays .15 / ea.



### 2" ANALOG

QUANTEGY 499.....	\$138
QUANTEGY GP9.....	\$142
BASF SM-900.....	\$145

WE WILL MATCH ANY ADVERTISED  
OR CATALOG PRICE!

adatec	QUANTEGY.....	\$8.50
	BASF.....	\$8.50
	SONY.....	\$8.50
	HHB.....	\$7.00

www.yourmusiconcd.com

100 BULK CDRS \$99 10 cdrs - \$39

100 BASIC CDRS \$139 50 cdrs - \$89

100 FULL COLOR CDR PACKAGE \$270

500 FULL COLOR PACKAGE \$845

1000 FULL COLOR PACKAGE \$1299

ATLANTA 404-441-4433

PHOENIX 602-997-4433

MEMPHIS 901-527-4433

MIAMI 305-441-4433

NEW YORK 212-441-4433

ORLANDO 407-441-4433

PHOENIX 602-997-4433

PHOENIX 602-997-4433

PHOENIX 602-997-4433

PHOENIX 602-997-4433

PHOENIX 602-997-4433

PHOENIX 602-997-4433

PHOENIX 602-997-4433

PHOENIX 602-997-4433

PHOENIX 602-997-4433

Mastering & Restoration  
Pro Tools | HD 2 / Sonic Solutions  
GUARANTEED RESULTS  
CD & Tape Short Runs  
competitive • professional  
(860) 664-9499  
docrockdigital.com

764 5th Avenue,  
Brooklyn, New York 11232  
In NY: (718) 369-8273  
24 Hour Fax: (718) 369-8275



CONTACT US FOR A FREE  
FULL LINE RECORDING  
SUPPLIES CATALOG

http://www.TAPES.com e-mail: sales@NRSTAPES.com

**TOLL FREE 1-800-538-2336** (Outside NY Only)

Master  
Distributors  
of:



maxell  
PROFESSIONAL



BASF  
SONY

Taiyo Yuden

MITSUI



MICHELEX



SKC



R IMAGE

PRINCO

TELEX

## Records Tapes CD Services

**1,000 Store Ready CDs - \$999** [www.TrackmasterAV.com](http://www.TrackmasterAV.com)  
**1,000 Bulk CDs - \$490** Toll Free: 888-374-8877  
 CASSETTES  
 GRAPHIC DESIGN & POSTERS  
 STUDIO MASTERING  
 CD-R MEDIA  
**YOUR 1-STOP SHOP FOR CD, AUDIO & VIDEO CASSETTE PROJECTS!**

## UNIVERSAL MEDIA

CD/DVD Manufacturing Services  
 100 CDs (Media, Print & Case) \$119  
 1,000 Bulk CDs for \$470.  
 Ready in 5-7 Business Days  
 For info, call (408) 835-8858  
 or (800) 757-1933

## THE GATE MEDIA GROUP

→ **READY TO BE EXPOSED?**

CALL 1-800-655-1625  
[WWW.GATEMEDIA.COM](http://WWW.GATEMEDIA.COM)

SEE OUR AD IN MARKETPLACE



Serving you since 1987  
 CD CD-ROM DIGITAL CASSETTE  
**888.655.2272**  
 digital duplication solutions  
[www.tapeanddisc.com](http://www.tapeanddisc.com) [szieqler@tapeanddisc.com](mailto:szieqler@tapeanddisc.com)

**Complete CD Packages in Just 7-10 Days!**  
 Newsong Media redefines the standard for speed in the replication industry with a 7-10 working day turnaround at no extra charge.  
 Give us a call at **800-964-DISC**  
[www.newsongmedia.com](http://www.newsongmedia.com) NEWSONG MEDIA



**That's us delivering our last order as promised.**

At MUSIC MANUFACTURING SERVICES we're not afraid of short deadlines. In fact, it motivates us to work harder to ensure that you get what you need when you need it. We do everything necessary to make our promises. And we deliver like no one else can.

We provides the most complete CD, CD-ROM, DVD, cassette, vinyl manufacturing and duplication services offered to everyone, anywhere.



**1-800-MMS-4CDS** [www.mmsdirect.com](http://www.mmsdirect.com)

Empowering the independent since 1988

## CONVERSION MEDIA

Your #1 source for CD, DVD & VHS duplication  
 WORLDWIDE DISTRIBUTION OF YOUR CD. DESIGN SERVICES  
 QUALITY PRINTING. CUSTOM PACKAGING. GREAT SERVICE  
 Standing You Since 1985. CALL NOW  
**1.888.999.1760**  
 VISIT US ON THE WEB AT [WWW.CONVERSIONMEDIA.COM](http://WWW.CONVERSIONMEDIA.COM)

## CD - R DUPLICATION

**100 - \$1.39 ea.**  
 With Color Inserts 1.99 ea.  
 (2 Page & Tray)

Price Includes: CD - R, Duplication, Thermal Imprinting, Jewel Box, Inserting of cover, & Shrinkwrapped  
**(936) 756-6861**



## Lowest Price Period!

CD ROM, DVD Replication  
 CD Audio Replication  
 Video Replication  
 Multi-Media Development  
 Graphic Design  
 Printing, Packaging  
 Web Design



**1-888-256-3472**

[www.ballmedia.com](http://www.ballmedia.com)

**RJR** [www.rjrdigital.com](http://www.rjrdigital.com)  
 800-828-6537

Compact Disc Production made easy!

Compact Disc - Audio, ROM, Business Card CD-ROM  
 Graphic Design & Packaging - CD-ROM Authoring  
 Retail Ready Product - SINCE 1976!

## Retailers

Every major brand of everything. Millions of dollars of musical gear in stock. **ALTO MUSIC** Guitars, recording, keyboards, amplifiers, drums, pro sound, new and used. One of the largest selections in the country. We ship everywhere!  
 180 Carpenter Ave.  
 Middletown, NY 10940  
[altomusic@altomusic.com](mailto:altomusic@altomusic.com)  
**(845) 692-6922**  
[www.altomusic.com](http://www.altomusic.com)

Ask Other Musicians!

**grandma's**

800-444-5252  
[grandmas.com](http://grandmas.com)

## Studios

## Shelly Yakus

engineered records that sold over 100,000,000 Copies

including John Lennon, U2, Tom Petty, Stevie Nicks, the Band, Van Morrison

Have your recording **Mixed or Mastered** by this world-class engineer at **Scullville Studios.**

**609-601-7550**  
[Scullville.com](http://Scullville.com)



## Legend Gold Records

12" x 16" framed up CD with personal plaque, \$65.00 plus S & H.

We do custom framed CDs, LPs, 45s and 78s in Gold or Platinum.

For Info: Tele/Fax **760 240-0850**  
[www.legendgoldrecords.com](http://www.legendgoldrecords.com)  
 E-mail [lgrrecords@earthlink.net](mailto:lgrrecords@earthlink.net)

## 3-room Recording Studio in Florida

within custom 6 BR, 4-1/2 bath, 4-car garage home on over 1.25 acres. Dramatic 40-foot Black Diamond pool. For additional info, please call Kathy Courtney @ The Kathy Courtney Group, Wellington, FL 561.798.1411  
 E-mail: [kathy@thekcg.com](mailto:kathy@thekcg.com)

Sell your indie-released CDs in Onstage, Remix & Electronic Musician magazines!  
 Only \$35 per month to place your ad!  
 Call 800-544-5530

Miscellaneous

**DIGI-ROM** (800)815-3444  
IN NYC:(212)730-2111

Full Services for Electronic Media

Mastering - Replication - Printing - Audio CD - CD-ROM - DVD - Interactive Design

**WE CUT VINYL !!!**

\*Audio & Vinyl Mastering Suites \*Audio & CD-ROM Packaging  
Creative Graphic Design Dept. \*Interactive & Multimedia Design  
\*Complete CD-R production with quick turnaround  
\*DVD Prep & Authoring \*DVD Duplication - Limited runs

**QUALITY YOU CAN AFFORD !** [WWW.DIGIROM.COM](http://www.digirom.com)

**SoundBroker**  
Linking buyers & sellers together  
for all your studio needs  
**(702) 736-3003**  
[www.SoundBroker.com](http://www.SoundBroker.com)

**SUBSCRIPTION  
QUESTIONS?**  
Call **(800) 532-8190**



"Mix Classifieds have been pretty much the only place we've advertised for the last 12 years. Seems to have worked, we're doing better than ever!!"

—Fletcher, Mercenary Audio

Mix presents the

**3000 MIX MASTER DIRECTORY**

The Industry Standard  
Guide to Professional Audio

Now expanded to include  
musicians' resources with bonus  
newsstand distribution!

The *Mix Master Directory* is the complete information source for businesses in the professional audio industry. Backed by 25 years of editorial expertise, this definitive resource includes comprehensive national listings of audio manufacturers, audio professionals, facilities and services. Musicians and professionals alike will appreciate additional listing categories for musicians resources of all kinds.

Available In January 2003 wherever Mix is sold!

A PRIMEDIA publication **Free to Mix subscribers!** [www.mixonline.com](http://www.mixonline.com)

**Classified Advertising**

get your company name into the minds of thousands of customers.



[mixclass@primediabusiness.com](mailto:mixclass@primediabusiness.com)



[remixclass@primediabusiness.com](mailto:remixclass@primediabusiness.com)



[emclass@primediabusiness.com](mailto:emclass@primediabusiness.com)



[svc\\_class@primediabusiness.com](mailto:svc_class@primediabusiness.com)

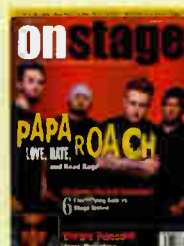

[onstageclass@primediabusiness.com](mailto:onstageclass@primediabusiness.com)

West Coast Sales  
Kevin Blackford  
(510) 985-3259

For Classified advertising rates and deadlines  
please call: (800)544-5530  
or contact your sales representative directly.

East Coast Sales  
Jason Smith  
(510) 985-3276

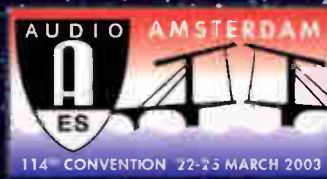

# A Sound Investment

# 114th CONVENTION

OF THE

# AUDIO ENGINEERING SOCIETY

Audio Facts for the Future

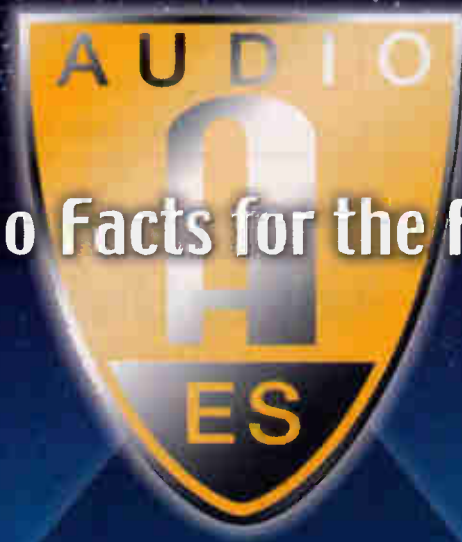

*Amsterdam*

*The Netherlands*

*RAI Congress Center*

*22-25 March 2003*

[www.aes.org](http://www.aes.org)

[114th@aes.org](mailto:114th@aes.org)  
World Radio History





# The Professional's Source



**The Professional's SOURCE** for all your **PRO-AUDIO** and **RECORDING** needs

- Built To Order Computer Based Turnkey Systems for Macintosh or Windows
- Expert Advice from Working Professionals!
- World's Largest In-Stock Inventory!



[www.bhphotovideo.com](http://www.bhphotovideo.com)

When in New York City  
Be Sure To Visit Our  
SuperStore



**420 Ninth Ave.**  
Between 33rd & 34th Streets,  
New York, N.Y. 10001

For Information Call:  
**800-947-5508 • 212-444-6698**  
or Fax (24 Hours):  
**800-947-7008 • 212-239-7770**

Store and Mail Order Hours:  
Sun. 10-5, Mon. thru Thurs. 9-7  
Fri. 9-1, Sat. Closed  
**WE SHIP WORLDWIDE**

**Digital Performer on the Power Mac G4, MOTU audio interfaces, Mackie Control, cutting-edge plug-ins and breakthrough virtual instruments deliver the complete MOTU studio experience.**

### **MOTU Digital Performer 3.1**

Unlimited undo that remembers everything you've ever done to a project, since the moment you first created it. Customized track grouping that lets you choose what to group. REX file import and Acid-style loop building. Audio workstation technology at its finest.



### **Mackie UAD-1**

UAD-1 is a PCI card that allows you to run dozens of sophisticated effects plug-ins inside Digital Performer without bringing your Mac to its knees. What's the secret? A custom-built, monster DSP. It's like adding an extra \$20,000 worth of effects gear to the dozens of native plug-ins included with DP.



### **Mackie Control for DP3**

Designed in direct collaboration between Mackie and MOTU, the new Mackie Control automated control surface puts 9 touch-sensitive Penny & Giles automated faders under your fingers (8 plus a master), 8 motion-sensitive rotary encoders, and dozens of custom-programmed switches. Want more faders? Add 8-channel Control XT expanders.

You'll feel like you are putting your hands on Digital Performer itself.

# THE MOTU STUDIO

## The New Power Mac G4

Dual-processor heaven for Digital Performer.  
Don't make Digital Performer sing.  
Make it scream.

## Spectrasonics Atmosphere™

Introducing Atmosphere: a breakthrough native virtual plug-in instrument for Digital Performer from renowned developer Spectrasonics that integrates a massive 3.7GB arsenal of lush pads, ambient textures and powerhouse synths with a "powerfully simple" user interface for shaping and creating your own sounds with up to one million layer combinations. Features over 1,000 NEW cutting-edge sounds by acclaimed producer Eric Persing.

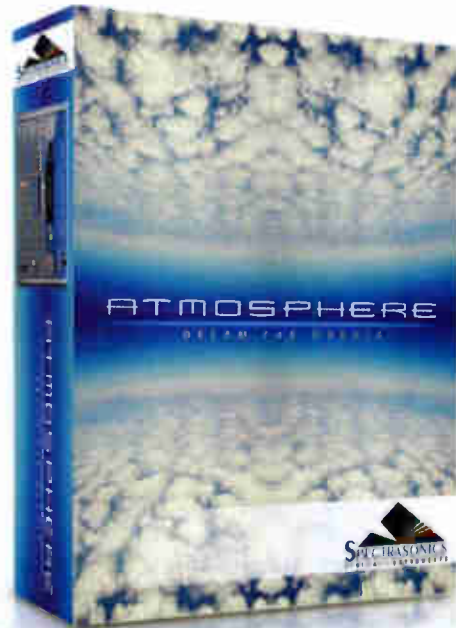

## MOTU 2408mk3 and 24i/o

MOTU's new powerhouse interfaces give you 96kHz analog and digital recording in a system that's expandable to 96 inputs and outputs. Connect all your synths, sound modules, drum machines and effects processors and mix it all from your computer desktop with absolutely zero host buffer latency. Looking for the latest breakthrough in native audio recording? Look no further.

SWEETWATER NOW 800-222-4700 THE MOTU STUDIO

# MORE GEAR FOR THE MOTU STUDIO

## Applied Acoustics Lounge Lizard

Lounge Lizard is the very first physical modeling virtual instrument for Digital Performer. What does that mean?

Incredible realism and warmth. Physical modeling reproduces the sound and feel of a real instrument in ways that synthesizers and samplers can't. Choose from many classic electric piano presets, or shape your own with powerful, yet intuitive controls. Lounge Lizard delivers the complete, authentic electric piano experience to your Digital Performer studio.



## TC Works D-Coder

Produced by Waldorf, the legendary German synth company that brought you PPG Wave and Attack, D-Coder is a Vocoding synthesizer plug-in for TC PowerCore and Digital Performer. D-Coder goes way beyond classic vocoder concepts by providing 100 bands (instead of the usual 30 or so) and an integrated tone-generating synthesizer, allowing you to create vocoding effects with no external carrier signal. It's like having a Waldorf Q synth inside DP, but with no processor drain on your Mac, thanks to Powercore.



## VoiceMaster Pro/Baby Bottle

The next generation Focusrite VoiceMaster Pro is the complete vocal channel featuring Class A mic pre, Vintage Harmonics processor, Voice-optimized EQ, Opto-compressor, Tube Sound circuit, 24 bit/96 kHz A-D option, revolutionary Latency Free Monitoring and much more. The award-winning Blue Baby Bottle is a handmade, Class A studio mic ideal for recording vocals, percussion, or any acoustic instruments. Add the Blue Pop/Shock kit and you have an outstanding bundle. \$1548 retail value, now \$999 for a limited time.



## BIAS Peak 3

Burn Redbook CD's. Read and write MP3, Dolby AAC™, 24 bit WAVE and more. Batch process hundreds or even thousands of files. Ultra-fast waveform editing. Run standalone or launch directly from DP3. Unlimited undo/redo with graphic edit histories. View multiple audio documents simultaneously. Unique DSP and looping tools like Convolve, Repair Clicks, Loop Tuner™, Loop Surfer™, Guess Tempo™, Duplicate, and more. Hot swap real-time effects in series, parallel, or hybrid using Peak's VBox™ SE VST matrix. Native for Mac OS 8.6 thru Mac OS X - including version 10.2 Jaguar. Optimized for Apple's G4 Velocity Engine. The ultimate editing, processing and mastering companion for Digital Performer.



## Summit Audio 2BA-221

The better your audio sounds going into your MOTU workstation, the better it sounds period. Introducing the extraordinary new 2BA-221 continuously variable impedance microphone preamp. Mix mic, line, and Hi-Z instrument inputs through the 2BA-221's hybrid vacuum tube output and/or its solid state output. Modular, expandable input design, swept high pass filter, insert jack, and internal power supply make the 2BA-221 a powerful tracking and mixing tool.



## Glyph Trip2

Glyph Technologies, the industry leader in high-performance audio storage, brings you the ultimate in FireWire disk storage: Trip2. Early-warning SMART technology alerts you to potential drive problems before they happen. Slide a Glyph-engineered, vibration-resistant (and therefore ultra-quiet) drive cartridge into one of six expansion bays and feel the bullet-proof reliability through your fingertips. Glyph FireWire is the perfect compliment to MOTU PCI on today's latest Power Macs because FireWire disk access and PCI audio streaming are handled on different busses, so you maximize the performance of your system.



## Raxxess IsoRaxx

The only sound you should be hearing in your MOTU studio is the sound of your speakers. Simply install your computer, external hard drive or any other acoustically challenged equipment in your studio into the IsoRaxx. IsoRaxx has all of the features you need to keep your equipment safe and quiet, reducing fan and hard drive noise by an average of 21 dB. IsoRaxx's electrostatic filter intake helps keep dust bunnies out of your hard drives, and the lock-and-key front door keeps your gear from growing legs. With IsoRaxx, you won't miss what you've been hearing.

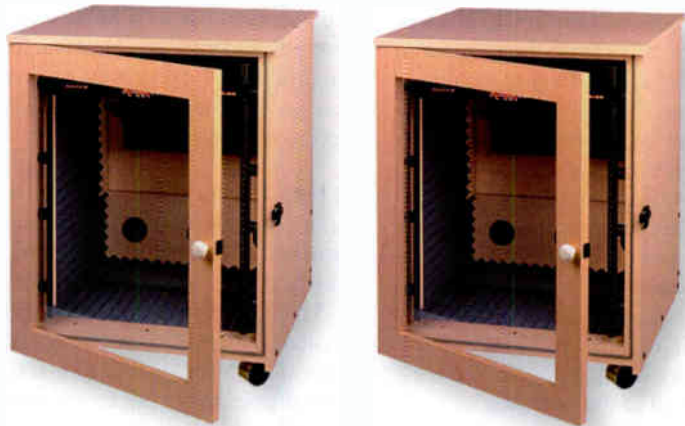

## The MOTU Experts

From purchasing a plug-in to building an entire MOTU-based studio from the ground up, Sweetwater's expert sales engineers can help you make the best decisions for your studio — and your music. Call today for the best in price, selection and service.

**Sweetwater**<sup>®</sup>  
music technology direct.™

[www.sweetwater.com](http://www.sweetwater.com)

5335 Bass Road • Fort Wayne, IN 46808  
Voice: (260) 432-8176 • Fax: (260) 432-1758

**800-222-4700**



Authorized Reseller

# Cakewalk Sonar

## More Is Always Better

For the past few years, procuring a high-performance, professional-grade DAW has required purchasing a high-end CPU and thousands of dollars' worth of proprietary hardware. However, modern host-based systems like Cakewalk's Sonar 2.1 XL now offer very high performance and additional features at a fraction of the cost. With the latest generation of single- and dual-processor PCs, you get essentially unlimited tracks, software synthesizers and plug-in effects—without additional hardware. Using Sonar, I can do *everything* I need with only one computer and a compact mixer.

### ON THE BUS

Sonar lets you create 64 output buses; most people use one bus for each physical soundcard output. However, it makes more sense to assign those buses to the *same* output, which is the key to efficient grouping. I usually create three buses to group related tracks, to EQ or compress them together, or control their levels without having to link every volume slider. Another great use for multiple buses is to apply complementary EQ. If I'm having trouble making a bass track stand out in a mix, I'll send the bass to a separate bus, boost 300 Hz by a dB or two and then cut the same frequency on the main bus by a similar amount. This is much more efficient than applying the same EQ separately to all of the other tracks.

### WATCH YOUR BUNS

Sonar offers three ways to store your songs, but I've found that the use of Per Project Folders is the best because it keeps all of the audio files for each song in one folder so you always know what files to back up. It's also easy to determine which files can be erased to save space if you delete tracks. The Bundle format stores all data in a single, large file but takes much longer to open because each separate audio file must be extracted. This also hastens disk fragmentation. Further, a Bundle file may be too large to fit on a CD-R backup. And, if that one file becomes corrupted, you've lost everything.

However, I recommend saving every song as a Bundle on a separate hard drive as an extra safety copy.

### LATENT DESIRES

Getting the lowest latency in Sonar requires a soundcard that has well-written drivers, but you must also optimize the soundcard's buffer size. After installing Sonar on my current computer, the lowest latency offered was 10 milliseconds. Changing the buffer size in my Delta soundcard's control panel to 64 samples reduced that to 1.5 milliseconds. (After changing the size, you must have Sonar update your soundcard again.) Also, many folks have a SoundBlaster or other consumer-grade soundcard to use as a MIDI metronome or to edit SoundFonts. That's fine for MIDI, but disable it in Sonar's list of audio outputs so that the poorer drivers don't reduce overall latency.

### IS THIS THING ON?

One common Sonar problem is not hearing a soft synth or getting the wrong sound. First, make sure that the audio engine is running by checking the Toolbar button. Also, make sure that the controlling MIDI track is selected and its output goes to the audio track containing the soft synth. Be sure you've selected an output MIDI channel, bank and patch. (For the Native Instruments B4, make sure that you're using channel 1, 2 or 3, because the B4 responds only to those channels.) With drum SoundFonts, be aware that some recognize channel 10 only, while others allow any channel *except* 10.

Another common problem is the Tempo Ratio feature becoming disabled. Tempo Ratio works only with MIDI projects that have no soft synths or audio tracks. But if you have a project with audio and MIDI and then delete the audio tracks—or accidentally insert an audio track and then delete it—Tempo Ratio remains unavail-

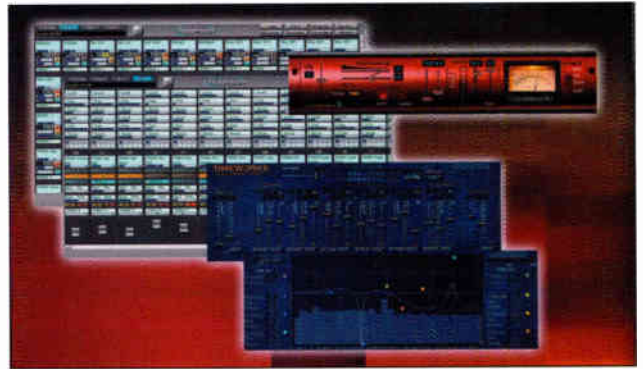

With unlimited tracks and plenty of cool plug-ins, a second monitor is recommended.

able. To fix this, select Options, Project, Clock Tab and then set the source to Internal.

### FASTER EQUALS SMARTER

The usual way to create a composite performance is to record many takes on separate tracks and then cut and paste the best parts to one track. Sonar is outstanding for this because it creates new tracks on-the-fly as you record. With snap-to-grid enabled, you can then copy or move regions from the overdubbed tracks to one master track, and they will remain in sync. Alternately, Sonar can record all overdubs on one track: Simply slide the bad takes out of the way, leaving just the good parts!

For clarity, I suggest that you name your tracks and buses. Sonar uses the track names when creating .WAV files, so it's easy to tell which files go with which track for manual cleanup. Also, spend the time to learn the supplied hotkey shortcuts and to define your own.

### SEEING DOUBLE

Finally, the Number One tip I can offer—which applies to any DAW—is to buy a second monitor. Once you experience the luxury of being able to move the piano roll, event list and plug-ins off of the main screen, you'll never again use a single monitor. And they don't have to be identical. My main display is 21 inches set for 1280x1024 and the other is 17 inches at 1024x768. They co-exist fine, and I never have to move one window out of the way to access another. ■

*Ethan Winer heads up RealTraps, which manufactures bass traps and acoustic treatment.*

# Burns through SCMS.

And smokes everything that can't.

Introducing the DN-C550R. The professional dual drive CD + CD-R/RW recorder that's heating up the industry. Designed with 90 years of Denon engineering know-how and progressive thinking, the DN-C550R is the luminary of CD technology. This innovative combi-deck incinerates recording obstacles like SCMS and accepts both CD-R/CD-RW data and audio blank media. Leaving you with a huge range of recording and playback options for independent use or in combination. Plus, we stoked it with every feature a professional would expect. The DN-C550R. The hottest CD recorder in the industry.



# DENON

Number  
One  
番

www.denon.com • Denon Electronics, 19 Chapin Rd., Pine Brook, NJ 07058 (973) 396-0810  
Denon Canada, Inc., 5 - 505 Apple Creek Blvd. Markham, Ontario L3R 1B5 (905) 475-4085

The first name in digital audio

World Radio History

# High Definition Audio Redefined



## Mac or PC. Mixer or no mixer. Build your computer-based studio with a MOTU PCI core system.

Are you building a desktop studio with a Mac or PC? Then you'll need to stream a lot of audio in and out of your computer. And our new PCI audio interfaces give you loads of 96 kHz analog and digital I/O at a great price. Monitoring latency is a thing of the past, thanks to the PCI-424's new DSP-driven CueMix technology. Use the audio software of your choice, together with our CueMix Console™, to command your entire studio from your desktop. Whether you mix entirely inside the computer or externally with a digital mixer, our 2408mk3, 24I/O and HD192 interfaces deliver the quality, flexibility and price you need to make your dream studio a reality.

- **Flexibility** — choose the core system interface that's right for you.
- **Expansion** — connect up to four interfaces. Mix and match with legacy MOTU PCI interfaces (2408, 2408mkII, 1296, 1224, 308, etc.)
- **High Definition** — 96 kHz analog, optical and TDFIF digital I/O. 192 kHz analog with the HD192.
- **No-latency Monitoring** — DSP-driven mixing and monitoring with zero host buffer latency.
- **Built-in sync** — resolves to SMPTE time code and video with sub-frame accuracy (no sync box needed).
- **Compatibility** — works with virtually all audio software for Mac and Windows 98SE/Me/2000/XP.



Our cross-platform CueMix Console works side by side with your audio software to give you a no-latency mix bus for every stereo output in your PCI-424 system.



Together, a 2408mk3 and 24I/O give you 32 analog and 24 ADAT/TDFIF digital inputs and outputs in a compact, affordable system.



For 192 kHz analog sound, add an HD192 interface to your system.

**MOTU**  
motu.com  
©2002 Mark of the Unicorn, Inc.