

HIGH FIDELITY TRADE NEWS

OCTOBER, 1959
volume 3 number 10 50c

All-out advertising key to '59-60

Campaigns aimed at rich new markets . . . Page 17

**NEW YORK
SHOW**

**Hi-Fi Can Look As Good
As It Sounds . . . page 26**

**EXHIBITORS' ROOM
DIRECTORY . . . page 6**

**NOW... From the world-famous
Engineering Laboratories of H. H. SCOTT**

**THE 399... A NEW
STEREO TUNER/AMPLIFIER
COMBINATION
WITH NO COMPROMISE
.....
IN QUALITY**

Until now the high fidelity enthusiast had to compromise if he wanted a combined stereo tuner/amplifier. There were none on the market that performed as well as fine separate components. Now, after two years of intensive research and development, H. H. Scott introduces the 399 . . . consisting of the famous 299 40 watt stereo amplifier *and* the time-tested 330D AM-FM stereo tuner wedded together

on one compact chassis . . . a masterpiece of engineering design.

The new 399 offers you many advantages. Its compact design gives exceptional flexibility in installation . . . it can be easily placed in existing furniture like an end table, buffet or room divider. Its design saves you money . . . the 399 is less expensive than purchase of separate components. Its design centralizes all controls on one panel to simplify system operation.

**The NEW 399 Stereo Tuner/Amplifier combines the H. H. Scott
299 Stereo Amplifier and 330D Stereo Tuner on one compact chassis!**

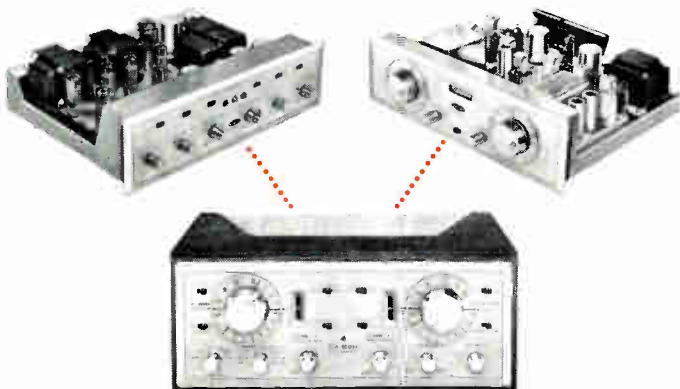

**This new design has all of these
famous H. H. Scott features:**

- Third channel output
- Separate tone controls on each channel
- Record and tape equalization independent of tone controls
- Convenient phase reverse switch on front panel
- Same AM and FM front ends as used on famous H. H. Scott 330D tuner
- Complete switching facilities for tape recording and monitoring
- Same 40 watt stereo amplifier as the 299 . . . more than enough power to drive inefficient speakers like the AR and KLH. Tested and proved in thousands of homes across America.

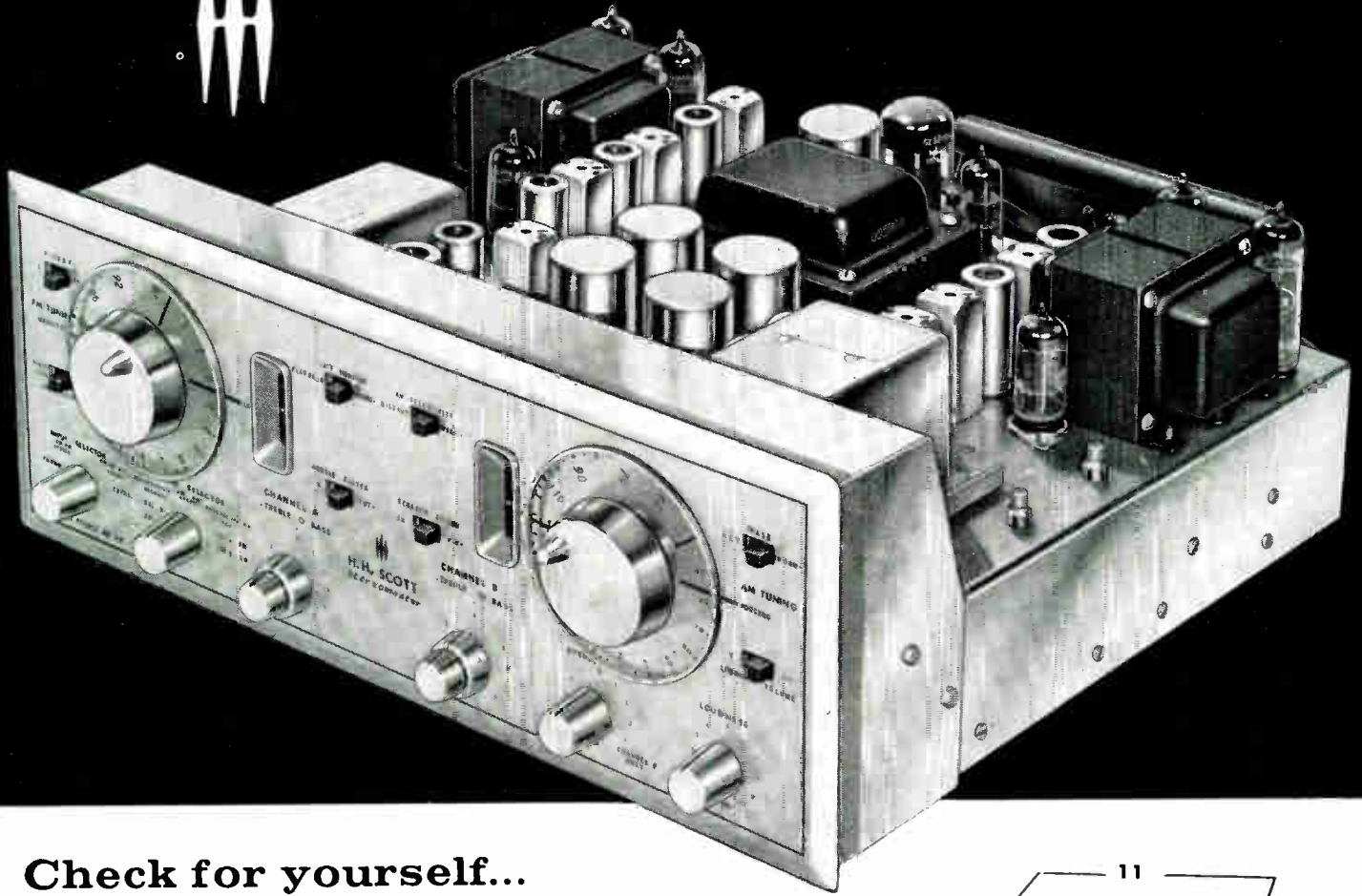

Check for yourself...

HERE ARE SOME OF THE FEATURES THAT MAKE THE 399 THE WORLD'S BEST STEREO TUNER/AMPLIFIER COMBINATION.

1. Separate Silver-Sensitive FM Front End, heavily silver plated for maximum sensitivity and reliability. Meets all FCC radiation specifications. 2. Highly sensitive, separate AM front-end. 3. Separate AM and FM professional tuning controls for precise station selection. 4. Wide-Band FM detector for distortion-free reception on all signals. 5. Separate tuning eyes for FM and AM. 6. New wide-range AM detector for high fidelity performance on AM stations. 7. Switching provisions for FM multiplex stereo or FM-FM stereo. 8. Provision for connecting a stereo phono cartridge and stereo tape heads or two phono cartridges. 9. D.C. Filament supply for preamp to virtually eliminate hum (80 db below full power output). 10. Separate record scratch and rumble filters. 11. 40 watt power stage consisting of dual 20 watt power amplifiers, to meet the requirements of today's speaker systems. 12. Phase reverse switch to compensate for improperly phased tape recordings or loudspeakers. 13. Third channel output. 14. Special switching lets you use your stereo pickup on monophonic records. 15. Completely separate Bass and Treble controls on each channel so that different speakers may be matched. 16. Special balancing circuit for quick and accurate volume balancing of both channels. 17. Tape monitor switch. Specifications: FM sensitivity: 2 microvolts for 20 db of quieting on 300 ohm antenna terminals (IHFM rating 2.5 μ V.). FM detector bandwidth 2 megacycles. Distortion (first order difference tone) less than 0.3%. 4, 8, and 16 ohm speaker outputs for each channel; Maximum Sensitivity: 3 millivolts for rated output. Frequency Response: 20 cps to 30,000 cps with tone controls set flat. Harmonic Distortion: 0.8% at full power output. Noise and Hum: Hum better than 80 db below full power output; noise equivalent to 10 microvolts on low level input. \$399.95. Slightly higher west of Rockies. Accessory case extra.

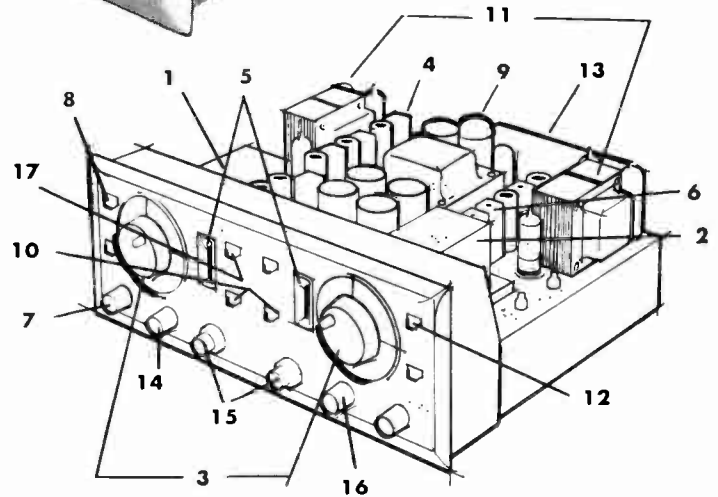

H.H. SCOTT

H. H. Scott Inc. 111 Powdermill Road, Maynard, Mass. Dept. TN-10

ATTENTION DEALERS!

Because of the outstanding design and performance of the 399, and the extensive advertising program starting soon there will be heavy demand for this unit. Be sure you order now to cover your requirements through January 1.

Audio Aids Win Official School OK

Audio electronic equipment has been endorsed as "absolutely essential" in the successful teaching of modern languages in classrooms.

This endorsement of tape recorders and discs was made in a 366-page "Purchase Guide" compiled by the Council of Chief State School Officers. It is intended for use of state and local school authorities in purchasing under the National Defense Education Act.

Following publication of the Purchase Guide, the Magnetic Recording Industry Association pledged the industry's help in working with the schools in maintaining high standards in purchasing. It also promised to continue the development of electronic gear for language work.

"The Council has done a remarkable job in preparing this Guide," said Bernard Cousino, chairman of MRIA's education committee and president of Cousino Electronics Corp. "It is a pleasure for the members of our organization in turn to give this definitive service document our endorsement."

He joined the Council in urging that teachers, administrators and school purchasing agents discourage routine purchasing of obsolete materials and apparatus.

"There is a wealth of wonderful equipment available for teaching modern language courses to our young people, and the Guide has laid down specifications that will lead the teacher directly to it," Mr. Cousino said.

In the introduction to the Purchase Guide, the Council said that relatively few schools use electronic equipment in teaching foreign languages. Most continue to rely too greatly on the printed word, to use English, and to translate from the foreign language to English and back again, rather than to practice speaking and thinking in the foreign language itself.

"The evidence strongly favors the new methods over the old," the Council concluded.

HIGH FIDELITY TRADE NEWS

Publishers: J. T. SCHWARTZ AND L. D. SOLOMON

VOLUME 3, NUMBER 10

BPA

OCTOBER, 1959

IN THIS ISSUE

N. Y. Show Room Directory.....	6
As We Go To Press.....	10
1960—Expanding The Audio Market.....	17
Making The Most Of Newspaper Ads.....	18
Selling Through Dealer Catalogs.....	20
How To Use The Yellow Pages.....	21
Public Relations Opens The Door.....	22
Previewing The New York Show.....	26
Service Built Sono-Vision.....	30

INDEX TO ADVERTISERS

Acousti-Craft.....	16	Magne-Tronics.....	8
Altec-Lansing.....	33	Magnecord.....	13
American Geloso.....	14	Marantz.....	54
Ampex.....	Insert	Minnesota Mining.....	Insert
Artizans.....	54	Monarch.....	28
Atlas.....	32	Newcomb.....	38
Blonder-Tongue.....	14	Norelco.....	11
Bozak.....	5	Pickering.....	41
Columbia Wire.....	50	Rek-O-Kut.....	35
De Wald.....	52	Rek-O-Kut, Audix.....	9
Dual.....	29	Roberts.....	55
Duotone.....	48	H. H. Scott.....	11, 1
Du Pont.....	47	Sherwood.....	34
EICO.....	48	Shure Bros.....	44
Electro-Voice.....	39	Sonic.....	15
Fairchild.....	6	Tape-Athon.....	53
Fisher.....	36, 37	Telectro.....	13
Frazier.....	8	Thorens.....	4
General Electric.....	7	Transis-Tronics.....	24
Glaser-Steers.....	IV	Turner.....	Insert
Gray.....	25	University.....	51
Harman-Kardon.....	111	Vidaire.....	56
Jensen.....	12	Weathers.....	40
JFD.....	46	Webcor.....	3
Kersting.....	52	Webster Electric.....	45
J. B. Lansing.....	49	Wendell Plastics.....	28

EDITORIAL STAFF

ANTHONY LORD, *Managing Editor*

Features, Ted Henke—*Technical*, Victor Campos

Assistants, Etta Eisman, John Wyan, Florence Horowitz, Mary Slack

ADVERTISING

Herbert J. Teison, Advertising Manager

7 West 44th Street, New York 36, MU 2-3244

California—Jeanne Pascal, 1510 Greenfield, Los Angeles 25, BR 0-3306

Illinois—Stuart J. Osten, 333 North Michigan Ave., Chicago 1, DE 2-3507

HIGH FIDELITY TRADE NEWS—Vol. 3, No. 10. Copyright 1959. Published monthly by St. Regis Publications, Inc., 7 W. 44th St., New York, N.Y. Accepted as controlled circulation publication at New York, N.Y. Advertising rates on request.

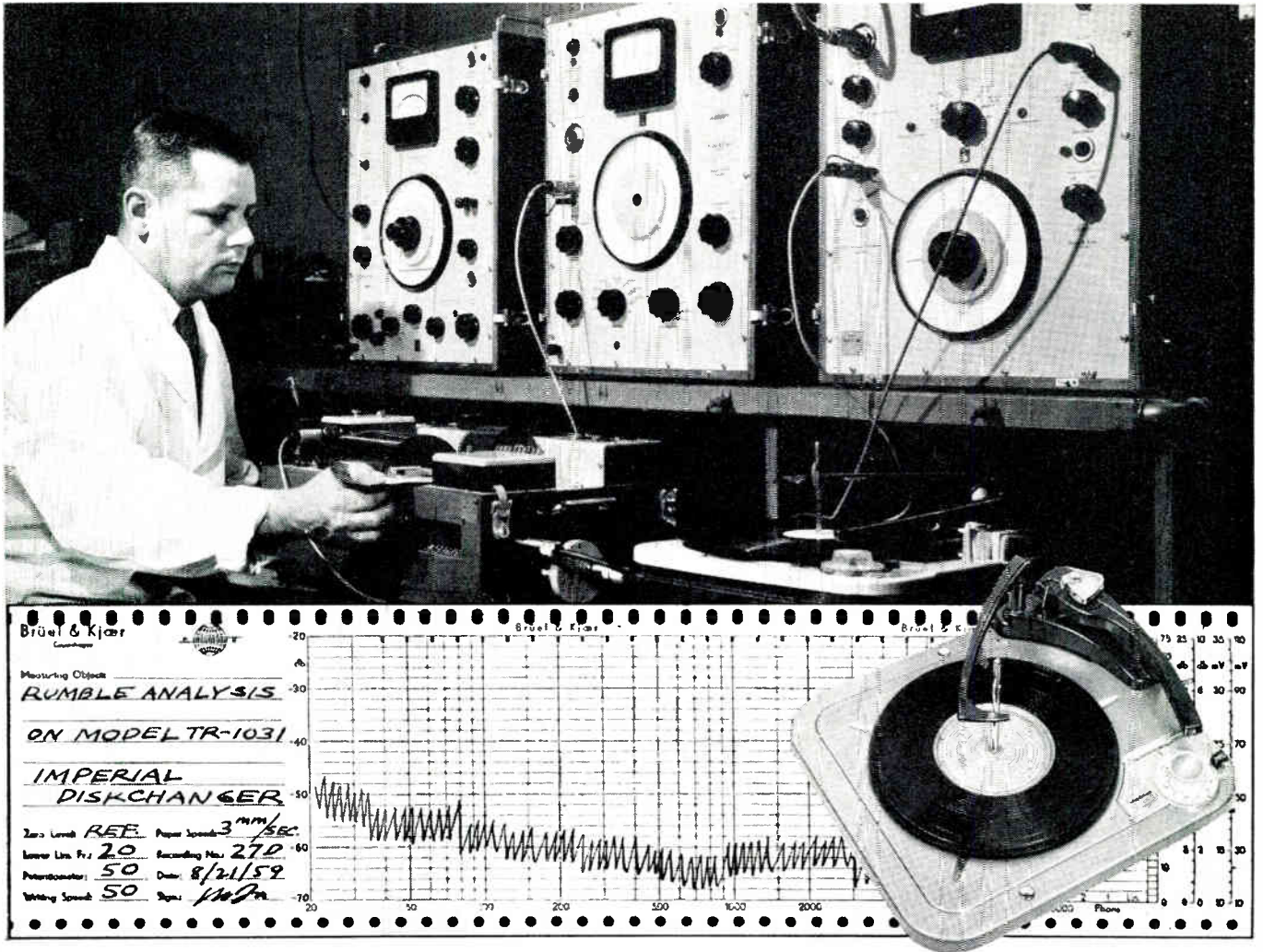

Toughest "Obstacle Course" proves 1960 Webcor Stereo-Diskchangers Today's Finest Performers!

Brüel & Kjaer

Level Recorder—

Used in conjunction with Frequency Analyzer to make a complete and accurate record of performance of Webcor Diskchangers... such records as frequency vs. noise due to rumble and vibration—and frequency vs. output are made readily available for analysis.

Brüel & Kjaer

Frequency Analyzer—

Used to check energy distribution in the audio spectrum and to determine output vs. frequency of noise and rumble.

Webcor employs the most sensitive instruments to analyze all possible sources of noise and rumble in Webcor Diskchangers. This careful surveillance assures you the most accurate performance and the highest quality possible.

Above, for example, is a 1960 Webcor Imperial Stereo-Diskchanger being tested on two special instruments imported from Denmark, in order to assure perfection of performance unmatched in the field.

These are only two of the vast number of intricate tests to which Webcor sound equipment is subjected—all to guarantee the prideful statement that "Stereo Music Sounds Better on a Webcor."



PARTS JOBBERS:
Write—Webcor, Inc.,
5610 W. Bloomingdale,
Chicago 39, Ill.

Dealers and Discounts

by
*Paul
Kind*



How much off? What kind of a break can I get? Here's where it starts... with the consumer.

Where does it end? In confusion between list, net and discount prices. Manufacturers going two ways at once, making two lines (one for discount). A mad scramble among dealers caught up in an ever-present price war. And the bargain-hungry consumer who started it all disgruntled at rumors of bigger discounts than he got, at lack of service, at hi-fi in general. A sorry state of affairs. What, if anything, can be done about it?

At Thorens we sell turntables through franchised dealers exclusively. So do several others manufacturers of quality components. The franchised dealer is protected because no other dealer can sell these components and no franchised dealer must discount them. They are, in truth, one-price components.

Does this kind of arrangement work? Well, our Thorens TD-124 turntable is selling as fast as we can get it out of the factory. The franchised dealers are happy. The customers are buying.

Can this franchised dealer idea be extended? At present I am in touch with a number of leading manufacturers and dealers working on this specific problem. We are thinking of combining our efforts to bring the case for the one-price component and franchised dealer before the public. We are interested in pointing out to the hi-fi consumer the advantages of quality components over console, packaged or pre-assembled units. Anyone interested, drop me a line. I'll bring you up to date. 9.12

THORENS

SWISS MADE PRODUCTS
MUSIC BOXES · HI-FI COMPONENTS
SPRING-POWERED SHAVERS · LIGHTERS
NEW HYDE PARK, NEW YORK

Dealer aids

Sonotone Cartridge Dispenser

A new dispensing rack, with room for both stereo and mono cartridges plus needles, is being offered to dealers by the Sonotone Corp. It holds 35 cartridges and 29 jobber-packaged needles.

Brightly decorated in gold, white and blue, the dispenser will stand unsupported on a counter or fastened to a wall and is designed for stacking. Space is provided for literature or price lists.

A handy reference chart with Sonotone stereo cartridge replacement data comes with the dispenser. This is a supplement to a new reference chart covering all replacement models. The complete chart lists all models on one side of the sheet and can be tacked to a wall or bin for easy reference.

Acousti-Craft Manual



A 40-page Dealers' Manual is being offered by Acousti-Craft. It contains specifications, ordering and selling information for every model of hi-fi furniture in the Acousti-Craft line.

The manual, in a 22-ring loose leaf binder, is planned as a continuing merchandise service for dealers. Change notices and supplements, when necessary, and new pages covering additions to the line will be mailed to the user of each manual.

The service makes it possible for the dealer to have available at all times complete and up-to-date information on Acousti-Craft products.

Jensen Needle Kit

REPLACE YOUR PHONOGRAPH NEEDLE TODAY
TO HAVE SCRATCH-FREE RECORDS TOMORROW
Jensen NEEDLES PROTECT YOUR RECORDS
BUY A NEW Jensen NEEDLE NOW!



Jensen Industries has brought out the T-24 kit containing 24 of its three most popular needles. The two dozen needle packages are inserted into clear polyethylene bags mounted on a display board for hanging on the wall. An automatic signal jogs the dealer to replace the needle whenever a package is sold.

The top of the display, in brilliant red, carries this message: "Replace your phonograph needle today to have scratch-free records tomorrow. Jensen needles protect your records."

The kit is offered to dealers at a special economy price, according to Mike Remund, Jensen sales manager.

Audiotex Display Rack

Audiotex hi-fi accessories can be sold from a single location via self-service display racks.

According to Walter L. Schott, general manager of Audiotex, which is a division of GC-Textron, Inc., specially designed racks are now available for mass distribution, free with dealer orders.

A floor rack, large enough to handle nearly all of the 150-item Audiotex line, is of wood and peg-board construction and is 6' high, 4' wide.

(Continued on Page 54)

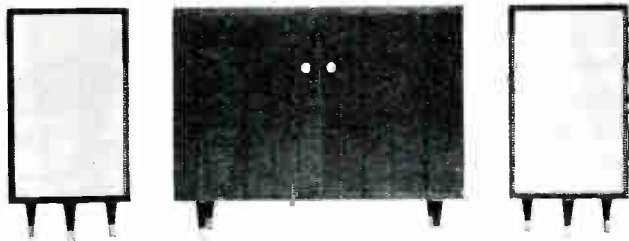

"Spinet" Equipment Cabinet with B-500 "Spinet" Speakers for stereo.



Urban Stereo Ensemble of B-302A Speakers with Equipment Cabinet.

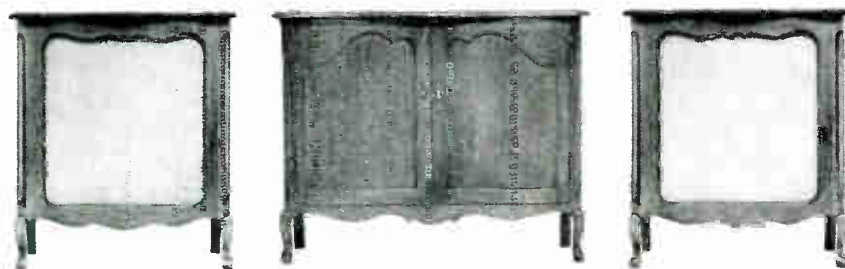

Provincial Equipment Cabinet with B-302A Provincial Speakers.

*Decorator
Settings for
the Very Best
in Sound*

As a charming center for The Very Best in Sound, team your Bozak Speakers with a Bozak Equipment Cabinet of identical styling and craftsmanship. Roomy, well-ventilated accommodations for your choice of top-quality components include adjustable shelves for the tuner, control and power units . . . space for turntable or changer with record-storage below . . . front doors and removable backs for maximum convenience in installation and use. These features, plus the restrained good taste of design, make a Bozak ensemble the logical way to integrate the finest in sound re-creation with your own preference in décor. See a Bozak franchised dealer, or write today for literature.

BOZAK • DARIEN • CONNECTICUT

Where to Find Exhibitors at New York Show

Visitors to the New York High Fidelity Music Show will find exhibitors in the following rooms. The first digit in each room number refers to the floor (third, fourth, fifth and sixth) on which that room is located.

The list, as compiled by the Institute of High Fidelity Manufacturers, was complete at press time.

Acoustic Research	307-343
Acro Products	547
Altec Lansing	642-644
American Electr.	409
Ampex Audio	339-340
Apparatus Dev.	322
Argus X-Electronics	333
Arkay-Radio Kits	321
Audio Devices	501
Audio Fidelity	605-611
Audio Magazine	404
Audiocom, Inc.	503-504
Audiogersh Corp.	447
Audio-Tech Lab.	600
Barker Sales	551
Bell Sound Div.	402-403
Belock Recording	646
Bogen-Presto Co.	333-335
R. T. Bozak Sales	349
British Industries	430-433
Capitol Records	407
Cletron Inc.	532
Conrac, Inc.	429
Customode Furniture	602
Dynaco, Inc.	502-524
Dyna-Empire	622
Electro-Sonic Lab.	515
Electro-Voice	428
Electronic Instru.	305-306
Electrophono & Parts	416
Ercona Corp.	302
Fairchild Recording	446
Ferrodynamics Corp.	344
Fisher Radio Corp.	534-537
General Electric	408
Gernsbach Pub.	525
Glaser-Steers	347
Grado Labs.	345
Gray Mfg.	553
Harman-Kardon	633-635
Heath Co.	538-539-540
International Electr.	437
Jensen Mfg.	308-309
KLH Research	330

(Continued on Page 8)



Fairchild ● ● ●
is ● ● ● ●
quiet ● ● ● ● ●

And we're prepared to prove it, or rather, to let you prove it to yourself.

The photograph indicates the technique: a FAIRCHILD RUMBLE TESTER on the base of your record player or turntable, and the stylus resting on the tester coupling the pickup directly to the turntable. Start the motor, turn up the amplifier volume, and listen. Then try the same test on any FAIRCHILD Series 412 turntable. Your ears will be the judge.

There are sound engineering reasons for the results . . . unique double-belt drive, Densite filled turntable, heavy hysteresis motor and precision workmanship throughout . . . but it's the result that's important — the absolute minimum of rumble that guarantees clean, perfect reproduction of everything on your records, plus wow and flutter figures that surpass NARTB professional standards.

These are specifications which will make your customers sit up and take notice. And the Rumble Tester is a powerful merchandising tool designed to provide a unique aural and visual demonstration of the Fairchild 412 turntable. It's an unusual and exciting idea, geared to bring customers into your store to see, to hear . . . and to buy!

Hi-Fi enthusiasts will read about this Rumble Tester promotion in Fairchild advertising appearing and scheduled to appear in Audio, Hi Fi Review, High Fidelity, Saturday Review and other major consumer publications. Get ready to capitalize on the interest this campaign will generate. Get in touch with your Fairchild representative now or contact us directly. Learn all you'll need to know about the complete Fairchild line and also how to tie-in your own promotional efforts with Fairchild's powerful Rumble Tester campaign.



FAIRCHILD RECORDING EQUIPMENT CORPORATION
10-40 45th Avenue, Long Island City 1, New York

General Electric makes hi-fi history with 10-day home trial offer!



VR-22-7 with .7 mil diamond stylus. For professional arms and record changers, \$24.95*.
VR-22-5 (not shown) with .5 mil diamond stylus. For professional quality tone arms, \$27.95*.
*Manufacturer's suggested resale prices.

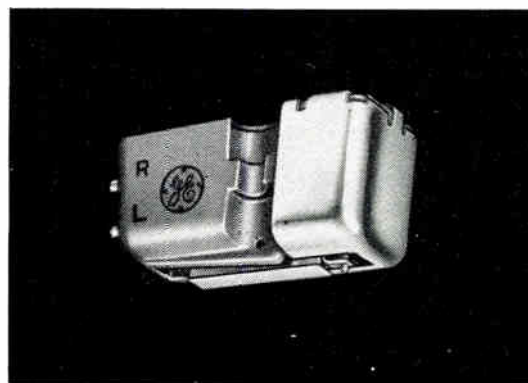

Why is General Electric taking this unusual step?

With so many claims and counter-claims about stereo cartridges clouding the air, the time is ripe for a bold, dramatic move to create customer confidence.

We believe that the place for your customers to evaluate a stereo cartridge is in the privacy

of their own homes, on their own equipment. We are certain that when they hear the new General Electric VR-22 under these conditions, they will be thoroughly delighted with its performance. Do you know of any other manufacturer who dares to make such an offer?

How does it work?

The customer purchases a General Electric VR-22-5 or VR-22-7 Stereo Cartridge and tries it out at home for ten days. If at the end of that period he is not completely satisfied, he brings it back and receives a full refund. Participating dealers will be reimbursed by General Electric. To get in on this history-making offer, which will be widely promoted in newspapers and magazines, write or phone your General Electric Hi-Fi District Sales Manager. *Audio Components Product Section, Auburn, New York.*

GENERAL  ELECTRIC

**Prestige Audio Dealers
such as . . .**

**Henry Diehl Radio & TV Supply, Port Arthur, Tex.
Trojan Sales, Los Angeles, California
The D & R Radio Supply Co., Steubenville, Ohio
Key Electronics, Arlington, Virginia**

carry *FRAZIER* Quality Loudspeaker Systems

If you are a dealer in quality high fidelity components,
but are not selling the *FRAZIER* Line, may we suggest
you contact your Frazier Sales Representative?

- for the name of
the rep in your
area, write



**Where to Find
Exhibitors at
New York Show**

(Continued from Page 6)

Klipsch & Assoc.	601
J. B. Lansing Sound	528-529
Lectronics of City Line	522
London Records	510
Lowther Sales	334
Marantz Co.	325
McIntosh Lab.	346
Mercury Record	629
Metzner Electr.	304
Minnesota Mining & Mfg.	645
Monic Co.	323
Motorola	405-406
Neshaminy Electr.	651-652
Newcomb Audio	526
North American Philips	627-628
ORRadio Industries	445
Paco Electr.	520
Pentron Corp.	621
Pickering & Co.	640
Pilot Radio Corp.	438-439
Precise Dev.	632
Precision Electr.	552
Reeves Soundcraft	441
Rek-O-Kut Co.	328
Rockbar Corp.	541-546
Rockford Furniture	634
Sargent-Rayment Co.	401
H. H. Scott, Inc.	626-631
Bert Semel Assoc.	326
Sherwood Electr.	509
Shure Bros.	623
Sonotone Corp.	338-342
Stephens Tru-Sonic	424
Stromberg-Carlson	415-417-419
Superscope, Inc.	527
Tandberg of America	341
Tannoy (America) Limited	544
Telectrosonic Corp.	650
Thorens Co.	327
Transistor Electr.	422
Uher Tape Recorders	619
Ultra Electronics	444
United Audio	542
University Loudspeakers	614-616
V-M Corp.	638-639
Vanguard Recording Society	507
Warner Bros. Records	418
Weathers Industries	348
Webster Electric	301
Wellcor, Inc.	500
Westminster Recording	506-508
Wollensak-Revere	318-316
Ziff-Davis Publishing	442



*Trade Mark

**The QUALITY
background
music
Program Service**

Available on two, four, six and eight hour tapes for automatic playback on any model continuous tape player.

Dealer inquiries invited for tape service for "on-premise" music systems.

Wired music and FM multiplex franchises available.

Write, wire or phone for full particulars.

**MAGNE-TRONICS
Inc.**

49 WEST 45TH STREET
NEW YORK 36, N. Y.
CIRCLE 7-0210

"MUSIC SOUNDS BEST ON TAPE"

REK-O-KUT: AUDAX

they make wonderful music together!

Rek-O-Kut STEREOTABLES!

Each model shown is powered by the fabulous Rek-O-Kut hysteresis motor! Performance and prestige unmatched—in a variety of models for every need and budget.

Audax Paraflex Speaker Systems!*

Designed and manufactured by Audax, division of the Rek-O-Kut Co.—the newest, most advanced speakers of the year—featuring Paraflex Foam Suspension for “natural sound”—removable, 3-dimensional Dynel Acoustiscreen grille and many other innovations!

* Pat. App. For



N-33H StereoTable—33 $\frac{1}{3}$ single speed, belt-driven. \$69.95



K-33H StereoTable in Kit Form—33 $\frac{1}{3}$ single speed. Assembles in 30 minutes or less. \$49.95

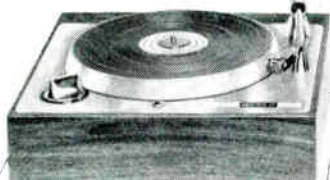

B-12GH StereoTable — 3 speeds (33 $\frac{1}{3}$ -45-78) with deluxe features. \$99.95



Two speed StereoTables—L-34H, 33 $\frac{1}{3}$ and 45 rpm. L-37H, 33 $\frac{1}{3}$ and 78 rpm. \$79.95

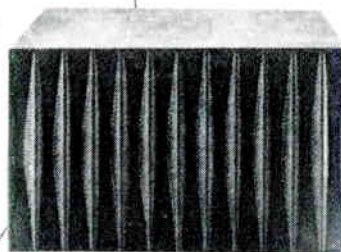

Audax CA-80 Speaker System, 12" x 12" x 24", oiled finish walnut on 4 sides. \$99.95

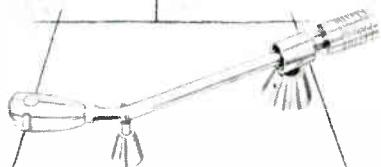

World's Largest Selling Tonearm:
S-120, 12" Stereo Tonearm, \$27.95
S-160, 16" Stereo Tonearm, \$30.95

Bases from \$8.95

Famous industrial designer, George Nelson, shown above, styled

the incomparable STEREOTABLES and Audax Speaker Systems.

Win an all-expense-paid vacation in Nassau — 1 full week!
Everybody can win! Watch your mail —
or contact your Rek-O-Kut or Audax Representative



Rek-O-Kut Co., 38-19 108th St., Corona 68, N. Y. • Export: Morhan Exporting Corp., 458 Broadway, N. Y. 13 • Canada: Atlas Radio Corp., 50 Wingold Ave., Toronto 19

RK-44

As We Go To Press

Consumers Union has done it again.

October issue of Consumer Reports will tell readers what's "acceptable" and "not acceptable" in turntables, record players and changers. As usual, CU uses its own measurements standards; as usual many readers will take report as Gospel. They will be trooping into your store demanding equipment with high CU rating. Many know so little about hi-fi, they will merely point to the item in the magazine and say "I want this."

By all means, service their requests--if you believe this is the equipment they should have. But don't let Consumers Union run your business!

If you do... if you stock only the check-rated items despite your own experience and your own convictions and just sit behind your counter taking whatever orders come in... you are putting yourself in the category of the grocery clerk or the discount house operator. You are selling our entire industry down the river along with your own high level of professional integrity and knowledge of quality sound and electronics. And you're doing so needlessly.

Suppose the customer does come in demanding Brand A as the result of the report in Consumer. Check with him on his other equipment. Does Brand A fit in with it? Talk to him about his record-playing habits, the type of records he listens to. Should he have a turntable instead of a player or changer or vice-versa? If at this point, you feel Brand A is a wise choice for him--sell it to him.

But if you think Brand B better suits his needs and you know from experience of the quality and satisfaction produced by B--regardless of its CU rating--explain how you feel and why. Explain that it would be easier for you to sell him A since he already is pre-sold--that, in effect, you will sell him A if he still demands it--but that you sincerely feel Brand B is the better buy for him.

This will take a few extra minutes of time. Some customers may even feel that you are trying to switch them for the sake of a greater profit margin. However, in the end, this approach cannot help but gain greater respect for you and increased prestige for your store. It will build the confidence that leads to greater future sales and will help in the much-needed stabilization of our industry. And beyond that, you, not Consumers Union will be running your store.

Straw in the wind for coming season is Houston Hi-Fi Show at Shamrock-Hilton Hotel last month. Record 14,000 attendance, dealers' report of increased sales following show, manufacturers' comments indicate big Fall hi-fi season ahead. Most encouraging indication: show visitors seemed much better informed on stereo than in past.

Masters (leading East Coast discounter) devotes 10 pages to components in Fall-Winter catalog. Prices quoted appear to be regular audiophile net. Discounting occurs on total price of suggested systems... 20% on average.

from the audio research center of the world

THE NEW
LINE OF

Norelco®

T-7 LOUDSPEAKERS

featuring new TICONAL VIII® magnets
(30% more powerful than alnico)

This new line of 5" to 12" loudspeakers is designed to match the quality requirements of the discriminating music lover . . . at a surprisingly moderate price. The world's greatest buys on the basis of listening quality, the T-7 series incorporates voice coil magnets of Ticonal-7 steel, the most powerful of modern magnet alloys, for maximum efficiency and damping . . . dual cones for wide frequency response . . . constant impedance resulting in an extremely straight response curve . . . longer effective air-gaps and extra high flux density to provide exceptional transient response and to eliminate ringing and overshoot.

Model	Size	Power (watts) Continuous Peak	Impedance (ohms)	Efficiency at 400 cps	Total Flux (Maxwells)	Flux Density (gauss)	Frequency Response (cps)	Audiophile Net
AD-5277M	12"	20 30	8	14%	134,000	11,000	35-18,000	\$72.50
AD-4277M	12"	20 30	8	7%	98,000	8,000	35-18,000	39.00
AD-4877M	8"	6 10	4-6	10%	58,300	13,000	50-20,000	26.00
AD-3800M	8"	6 10	4-6	6%	26,200	11,000	75-19,000	9.90
AD-3500M	5"	3 5	4-6	4%	26,200	11,000	130-19,000	8.34
AD-3690M	6x9"	6 9	4-6	5.5%	26,200	11,000	70-18,000	7.95
AD-2690M	6x9"	6 9	4-6	2.5%	15,200	8,500	70-16,000	6.75

Developed
and
Guild-crafted
by
Philips
of the
Netherlands

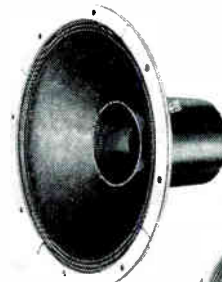
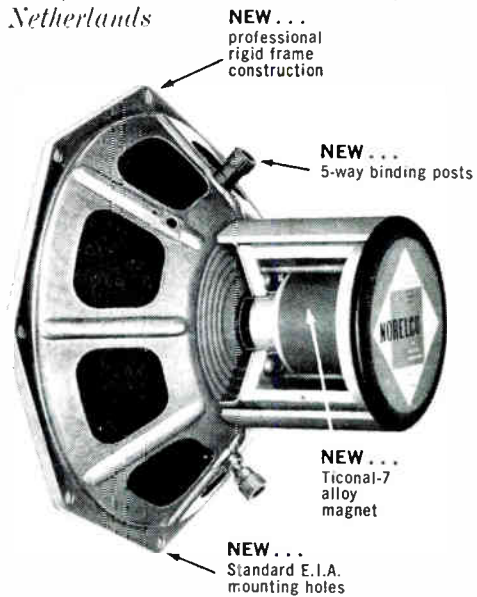

AD-3800M



AD-3500M



AD-2690M

Norelco 'EXHIBITION' SPEAKER ENCLOSURES



Acoustically designed to achieve moderate size without loss of bass response or wideness of dispersion. Perfectly matched for the bass response of the NORELCO T-7 speakers . . . ideal for most quality 8" to 12" speakers. Available in three sizes in hand-rubbed Mahogany, Walnut, Blond or Cherry finishes. Specifications: The "Rembrandt," (26" x 21½" x 17¼" deep) Walnut or Cherry \$99.50; Blond \$94.95; Mahogany \$91.00. The "Van Gogh," (23¾" x 13¾" x 11¾" deep*) Walnut or Cherry \$59.95; Blond \$55.50; Mahogany \$51.00. The "Vermeer," (18½" x 12" x 8-15/16" deep*) Walnut or Cherry \$35.00; Blond \$33.25; Mahogany \$31.00. *May be placed horizontally or vertically.

. . . also new from **Norelco**

The "HAGUE"; Completely integrated quality speaker system. Two high-efficiency T-7 loudspeakers in an acoustically matched enclosure. Designed for optimum dispersion . . . maximum efficiency . . . extremely wide-range, flat response. 26" x 21½" x 17¼" deep. Walnut or Cherry \$159.95; Blond \$154.95; Mahogany \$149.95.



NORTH AMERICAN PHILIPS CO., INC.
High Fidelity Products Division
230 DUFFY AVENUE, HICKSVILLE, L. I., N. Y.



FOR
STEREO
 AND MONO...
 YOU SHOULD
 KNOW
 THERE IS
 SOMETHING
BETTER

This Advertisement Will
 Appear in Jensen's
 Fall Consumer Magazine
 Advertising Program

*the air suspension principle brought to peak performance
 with FLEXAIR* high-compliance moving system and
 BASS-SUPERFLEX* advanced enclosure acoustics*

TR-10 TRI-ETTE* 3-Way Speaker System

Compare the Jensen TRI-ETTE with any bookshelf speaker and let your own ears tell you the reason for its rocketing popularity . . . it sounds better! It's what you'd expect from advanced Jensen engineering that begins where others leave off. Efficient . . . needs only a 10-watt amplifier. Handsome, too, in graceful contemporary design with fine woods. And there's an economical unfinished model for utility and build-in use.

DF-1 DUETTE 2-Way Speaker System

Here is a new high point in speaker value made possible by another Jensen first . . . an entirely new and different high-compliance 8" woofer able to move more than twice as far as previously available units. An excellent solution for high quality stereo sound at minimum cost. New unfinished utility model to wood finish or paint as you choose.

Jensen MANUFACTURING COMPANY

DIVISION OF THE MUTER CO.

6601 S. Laramie Avenue - Chicago 38, Illinois
 In Canada: Renfrew Electric Co., Ltd., Toronto
 In Mexico: Radios Y Television, S.A., Mexico D F

WRITE FOR
 BROCHURE KP

TR-10
 TRI-ETTE
 \$119.50

*TM

DF-1
 DUETTE
 \$79.50

TR-10U
 UNFINISHED
 \$89.50



All of the loudspeakers
 above have the new
 FLEXAIR woofer . . . a
 Jensen development for
 better speaker performance.

We'll prove to you that Jensen DUETTE
 and TRI-ETTE are better engineered . . .
 better performing. Write for free reprint
 of published engineering paper "Im-
 provement in Air Suspension Speaker
 Enclosure with Tube Venting."

DF-1U
 UNFINISHED
 \$59.95



BE PREPARED

FOR THE
BIGGEST BOOM
IN HIGH
FIDELITY
HISTORY!

NOW IS THE TIME TO CHECK YOUR STOCK ON THE TELECTRO SERIES 900 STEREO TAPE DECKS

Now . . . when the newly awakened interest in tape is climbing to a peak!

It's like money in the bank! Every Telectro tape deck on your shelf is a sure source of fast, full profit. That's because Telectro, and ONLY TELECTRO offers your customer THE QUALITY HE DEMANDS AT THE PRICE HE WANTS TO PAY. Telectro's vast experience in the development of tape instrumentation, in the design and production of broadcast equipment, in producing best-selling instruments for the home, reaches a peak in the new Series 900 stereo tape decks.

Packed with features, untouchable in quality by tape decks well above their price range, The Telectro series 900 offers you a golden opportunity to cash in on the biggest boom in high fidelity history . . . stereo tape recording!

TELECTRO SERIES 900 PRICES
START AT ONLY 89.95

FEATURES YOU CAN DEMONSTRATE AND SELL

- Stereo and monaural record/playback
 - 4-track heads
 - 3-speed operation
 - interchangeable head assemblies
 - unique pushbutton controls
 - solenoid-operated automatic shut-off
 - digital tape counter
 - professional-type pushbutton interlock . . . and many others!
- Write for the full story on all five models in the Telectro Series 900 TODAY!



EVERY TELECTRO SALE LEADS TO ANOTHER!

Every time you sell a Telectro tape deck, you create a customer for a Telectro design-mated tape preamplifier. Feature Telectro preamplifiers alongside Telectro tape decks, and see the difference they make in your sales picture.



TELECTRO

a product of TELECTROSONIC Corporation, 35-18 - 37th Street, Long Island City 1, N.Y. Dept. HT-10

GELOSO DYNAMIC MIKES

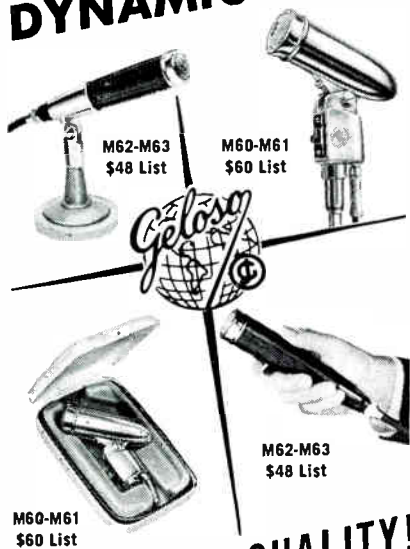

**BROADCAST QUALITY!
LOWEST-PRICED FOR
VOLUME SALES!**



- Engineered and built to highest precision standards by Geloso of Milan, Italy — Europe's largest integrated electronics manufacturer.
- Attractively, protectively packaged in high-impact plastic Jewel Box cases.
- Advertised nationally to your customers.
- Full discount to distributors.
- Get profit-making details by mailing coupon now.

FREE MIKE

with every dozen ordered before Oct. 31, 1959

AMERICAN GELOSO ELECTRONICS, Inc.
Dept. 38
251 Park Ave. South, New York 10, N.Y.
Please rush complete story on Geloso Dynamic Mikes.

Name _____

Address _____

City _____ State _____

Industry Unit Continues Study Of On-Air Stereo

Progress toward establishing standards for compatible stereo broadcasting was reported last month by the System Specifications Panel of the National Stereophonic Radio Committee.

The committee was formed earlier this year by the Electronic Industries Association to study methods of broadcasting stereo sound by AM, FM and TV stations.

Activities of the System Specifications Panel include:

1. **FM-FM study**—Murray Crosby, of Crosby Laboratories, agreed to set up tests in collaboration with Harold Parker, of Calbest Electronics, and William N. Halstead, of Multiplex Services Corp., to determine (a) the minimum bandwidth required for good stereo broadcasting and (b) the optimum compromise bandwidth for combined stereo and background music broadcast.

2. **FM-AM study**—It appears that at this time the best signal-to-noise ratio for this system is given by systems using suppressed carrier amplitude modulation. This applies to six system proposals. It does not apply to one other which does not suppress the carrier but would result in an appreciably simpler stereo receiver. The evaluation of relative receiver complexity for these systems will be made by the Receiver Panel.

3. **Evaluation of FM-FM vs. FM-AM systems**—Bruce T. Bogert, of Bell Laboratories, and Norman Parker, of Motorola, head a separate study group to evaluate on a theoretical basis the relative merit of FM or AM subcarrier for FM stereo broadcasting.

System Specifications is one of six panels. Its staff of industry experts are considering system proposals for compatible stereo broadcasting and identifying the technical issues in these proposals in order to formulate a consistent set of transmission specifications for each form of broadcasting. It will also seek to provide an overall evaluation of the system performance implied in the specifications.



you can
sell the

BLONDER TONGUE AUDIO BATON

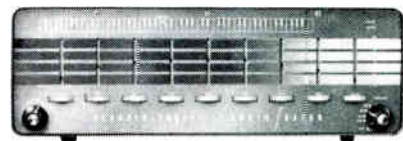

to every customer who now owns a hi-fi system (mono or stereo). Makes even the finest system sound better.



Brings out the best in PA and recording systems. Provides fingertip control of the full orchestral range... octave by octave. Your plus sale for '59. Only 119.95

Dept. HFN-10



BLONDER-TONGUE LABS, INC.
9 Alling St., Newark 2, New Jersey

hi-fi components • UHF converters • master TV systems • industrial TV cameras • FM-AM radios



maybe your customers have
seen such quality but never at such low prices!

SONIC STEREO COMPONENTS



from one of America's leading independent producers of phonographs,
a pioneer in stereo phonographs — a new exciting
line of stereo components packed with features that spell quality and
priced to cut through the high stereo cost barrier.



SONIC CUSTOM-CRAFT S-100 —
10 Watt Stereo Amplifier provides 10 watts
of undistorted power. • 10 watts output,
dual 5 watt amplifier — 20 watt peak, 50 to 15,000
cps • 4 inputs for stereo/mono • separate
volume and tone controls for each channel •
selection — FM/AM tuner, phono (crystal or ceramic
cartridge).

Audiophile net includes enclosure, \$34.95.



SONIC CUSTOM-CRAFT S-400 — 40 Watt Stereo
Amplifier Transistorized Preamp. Powerful, push-pull,
negative feedback amplifier and transistorized
preamp. Exclusive Sonic Stereo Monitor, a
precision meter, tells at a glance when channels
are balanced • 40 watts output, dual 20 watt
amplifier — 80 watts peak • 20 to 20,000 cps
± .5 db • 8 inputs — ceramic, crystal and magnetic
cartridge, radio, tape • provision for 3-speaker
channel operation • full function selection — tuner,
tape, phono, test signal • separate controls —
loudness-contour, tandem bass, tandem treble,
channel reverse, stereo/mono switch.

Audiophile net includes enclosure, \$99.95.

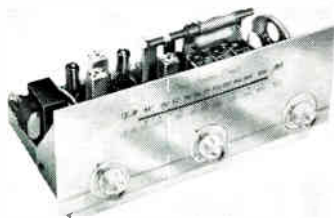

SONIC CUSTOM-CRAFT 19 — FM/AM Tuner —
Super-sensitive tuner features drift-free performance.
• High sensitivity-FM, 5 μ v for 30db quieting.
AM, 200 μ v per meter for 20db signal-to-noise ratio
• less than 1 1/2% harmonic at rated output;
less than 2% IM • switch for AM, FM, FM(AFC) •
handsome mahogany cabinet, slight extra cost.
Audiophile net, \$79.95.



SONIC CUSTOM-CRAFT S-200 12 Watt Stereo
Amplifier — Powerful stereo amplifier.
• 12 watts output, dual 6 watt amplifier — 24 watts
peak • 50 to 15,000 cps ± 1.5db • separate
controls-balance, loudness-contour, channel reverse,
tandem bass, tandem treble, tandem volume
• stereo balance signal • stereo/mono switch •
6 inputs (stereo or mono ceramic, crystal cartridge;
stereo or mono — radio, tape).

Audiophile net includes enclosure, \$49.95.



Sonic gives you the support that spells traffic and jingling
cash registers — a hard hitting ad program in all leading
hi-fi magazines: High Fidelity, Hi-Fi Review, Electronic World,
Radio Electronics, Popular Electronics, Electronics Illustrated,
Esquire, Playboy and others. Plus colorful literature,
ad mats, window streamers, etc.



Get the full details on a Sonic franchise today. Wire, write, phone
Dept. HFT-10 **SONIC INDUSTRIES, INC. • 19 WILBUR STREET • LYNBROOK, N. Y.**
Sales reps, some territories open — contact Dave Fisher

STYLED FOR STEREO

in a tropical contemporary mood

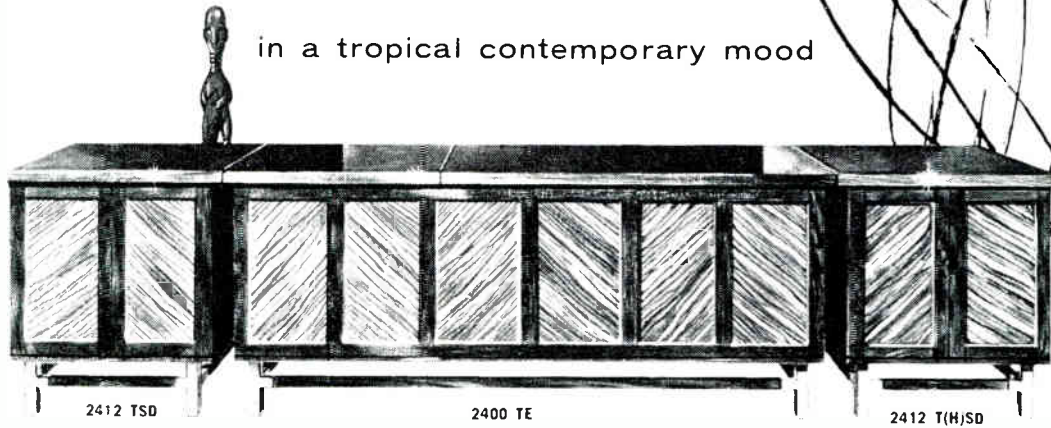

2412 TSD

2400 TE

2412 T(H)SD

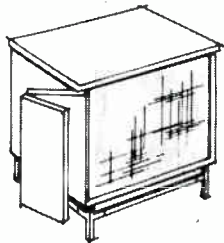

THE TANGANYIKA STEREO ENSEMBLE

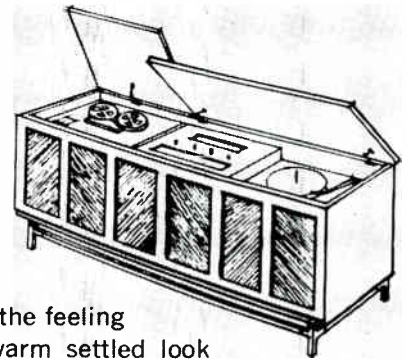

Whether the mood of the decor reflects exotic tropical charm or the feeling of uncluttered contemporary livability or perhaps even the warm settled look of the New England farmhouse, there is an Acousti-Craft styling which will make itself right at home. Folks love stereo... and will have it, but they are demanding that it look as good as it sounds!

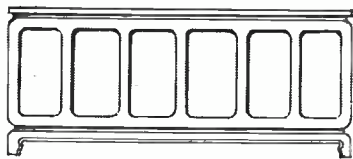

The SAMOAN

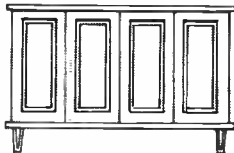

The CAPRI

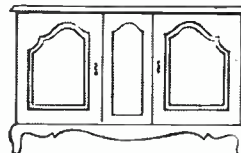

The HERITAGE

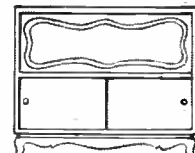

The WILLIAMSBURG



The AMERICANA

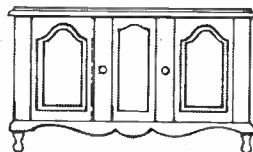

The COLONIAL



The STOCKHOLM

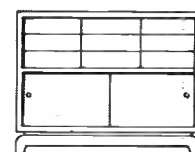

The RADCLIFF

DISPLAY ACOUSTI-CRAFT HI-FI FURNITURE
AND YOU'LL SELL MORE STEREO!



ACOUSTI-CRAFT A DIVISION OF CREATIVE PRODUCTS, INC.

14122 AETNA STREET VAN NUYS, CALIFORNIA

1960

The year **MORE**
people will learn
more about components

The high fidelity industry will introduce the concept of components to more people in 1960 than have ever been reached before, a HIGH FIDELITY TRADE NEWS market study reveals.

Although a true mass market probably will not be achieved, most people in the upper and middle income brackets will read and hear the components message.

A check of leading manufacturers shows that most plan increased advertising budgets, with some raising their appropriations as much as 50 percent.

A good portion of the additional appropriations will be used to run ads in Sunday supplements and class magazines where they will be seen by many people besides audiophiles. Advertising also will be continued, and in some cases expanded, in "hard-core" consumer media.

Coinciding with this broadened advertising coverage is the trend among various dealers in large cities toward placing components in traffic locations. (See Korvette and Hudson-Masters stories in September HFTN and Kierulff-Cliff Swanson story on page 31 of this issue.)

The display of components in departments of larger stores will cause them to be seen by large numbers of non-audiophiles. Many industry observers believe this exposure of components may create new cus-

tomers for all dealers.

A third trend which should popularize components is the one incorporated into the theme of this month's New York High Fidelity Music Show: "Decorate Your Home With Music."

Increased attention to furniture for housing components will make them more acceptable to a section of the public, particularly women,

who "don't want their living rooms cluttered up with wires."

Individual components, too, are being made more attractive, so that a hi-fi system, whether in furniture or not, now appeals to the eye as well as the ear. (See July HFTN for a full discussion of developments in hi-fi furniture.)

The "eye-appeal" theme will be used by some components manufacturers in their class magazine and Sunday supplement advertising.

Readers of these publications will also be sold on the fact that components are simple to operate and that they do not have to be electronic technicians to enjoy true high fidelity.

A number of manufacturers are making more money available for cooperative advertising, tying the

(Continued on Page 34)

WHAT DOES IT MEAN TO YOU?

New customers are being created who, unlike existing audiophiles, do not have a hi-fi home. Get them into YOUR store with consistent and strong advertising techniques.

To bone up on basic advertising techniques, read the series of articles in this issue.

Making the most newspaper

by Ted Henke

Newspaper advertising is expensive, so your ad must do an effective selling job if you hope to get your money's worth.

Few retail high fidelity ads are really effective. Why?

The fault lies with the dealer. Sometimes he tries to say too much in the space, and sometimes too little.

Few dealers can afford large space or expensive art. Desirable as these are, they are not essential to create an ad that will do an effective job of pulling people into your store.

A short message, stating suc-

cinctly why customers should come to your store, can be more effective than a long string of words saying the same thing, but less clearly.

Or you can highlight the pleasures of hi-fi in a few words. Both these points were covered in a small space ad for Joe Minor's Berkeley Custom Electronics, Berkeley, Calif., in the San Francisco Chronicle. His ad pointed out that "it's fun and it's easy to choose your component stereo music system" at his shop because "experts in acoustics and electronics, with the aid of electronic instrumentation, take full responsibility for the technical side."

This ad reassures the non-

technical consumer who wants good sound reproduction, but is afraid that componentry is too complex.

Compare it with another dealer's ad in the same issue of the Chronicle which proclaimed: "Hi-strung hi-fi bugs extend decibels to the supersonic limit with records and tapes from (store name)." Admittedly, it's an attention-getting shocker which might sell a few items to the faddists, but it's likely to alienate the true audiophile and absolutely scare away the non-technical consumer.

Most dealer ads fall somewhere in between. There's nothing terribly wrong with them, except that they

It's Fun & It's Easy---
to choose your "component"
STEREO MUSIC SYSTEM at
Joe Minor's Berkeley CUSTOM Electronics
We offer the "best deal" of all... full musical performance in your home, to your satisfaction!
Experts in acoustics and electronics with the aid of electronic instrumentation, take full responsibility for the technical side—You can relax!
If higher you want a simple book-shelf type phonograph at \$175 or a complete built-in custom job at \$1,750, drop by phone for an appointment.

HI-STRUNG HI-FI BUGS
extend decibels to the supersonic limit with records and tapes from
BRIDGE MUSIC

of your ads

are dull. Being dull, they probably won't be read. And if they are read, there is nothing in them that will induce the reader to go to the store and buy!

This unfortunately is true of many ads financed in part or in whole by manufacturers' cooperative allowances. Too often the ad is divided into uninspiring rectangles, each with a cut of the product with incomplete specifications in too-small type.

Instead of running an ad merely to collect co-op money, the dealer with some ingenuity and no extra expense can turn the same material into something exciting, like the Magnetic Recorders Co. ad reproduced on this page.

Dullness is not the only evil perpetrated on manufacturers' material. The art work for an amplifier kit was designed to show how simple it was to assemble, but a Los Angeles dealer crowded it with small type and heavy black borders so that the visual effect of the whole ad was one of confusion, instead of simplicity.

There are no rules which, if followed to the letter, insure a good newspaper ad. If there were, all ads would be uniformly "good." In fact, they would all look practically identical and, therefore, have no real value.

A little thought and ingenuity, however, will help you to create better ads. If you do not have an advertising agency, the space salesman for the newspaper will be glad to help you prepare copy and layout for the ad.

Magnetic Recorders Co. ad (right) creates excitement. Good and bad use of small space are shown in ads on opposite page.

OCTOBER, 1959

DON'T MISS THEM!

Mr. Woofer and Miss Tweeter-

"Living Stereo"

Will be at Magnetic Recorders Company, 570 Market St., every day until 8 P.M.



You'll see "Living Stereo," an amazing demonstration of stereophonic sound reproduction. Two people linked electronically move about at will, using the Midgetape, the world's finest, most compact portable tape recorder; the world's only portable stereo system.

DON'T MISS IT!

New! Mohawk Midgetape Chief 400

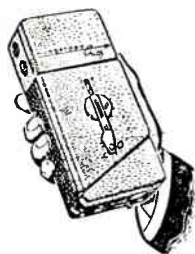

See and hear the Mohawk Midgetape Chief 400 all transistor battery operated, portable tape recorder, as well as the Model 300 and 500. So compact it fits in your hand. So useful that professional and business men, educators and scientists, students, as well as television producers and musicians use it at work and as a hobby. Used everywhere—anywhere.

- Push button control to record or play back
- Up to 1 1/2 hours of tape on a single automatic cartridge
- Tape loads quickly
- Full range of accessories for every use

DON'T MISS IT!

New! Tandberg Stereo Tape Recorder & Playback

One of the most complete tape recorders on the market. Quality for the discriminating hobbyist as well as the electronic expert.

- Records up to 17 1/2 hours of music on one tape
- Records 4 tracks, one at a time (monaural) or two at a time (stereo)
- Response 30 to 20,000 cycles
- Two matching amplifier systems
- Three speeds (1 1/8, 3 3/4 and 7 1/2)
- Automatic tape stop

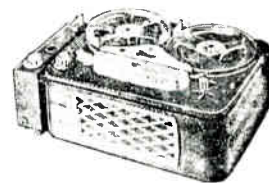

DON'T MISS IT!

New! The Ampex 351 Professional Model Tape Recorder & Playback Now with 2 Channels

The Ampex 351 sets the highest standard in professional tape recording performance.

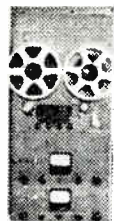

- New! etched circuits
- New! 2 channels for stereo (optional)
- New! remote control (optional)
- All speeds, 15, 7 1/2 or 7 1/2, 3 3/4
- Instant action . . . to full speed in less than 1/10 sec.
- 2 amplifiers
- 1 - 1200 ft. (\$2.90) High Fidelity tape \$1.20 with this ad.



Free parking at Stevenson Place Garage with \$3.00 purchase.

HIGH FIDELITY TRADE NEWS

19

Dealer Catalogs

—A POSITIVE SELLING TOOL

One of the fastest growing features of high fidelity selling is a "dealer's own" catalog, in which units of all manufacturers handled by the dealer are shown with extended technical descriptions.

A few years back, a dealer catalog was considered a bit of a luxury, a specialized prestige item used by the larger dealers mainly as part of their promotion effort. It had fine advantages, of course, but the information was all available in the manufacturer's own literature, complete with four-color illustrations that no one could afford to use in a general catalog. For the majority of dealers, duplicating the manufacturer's literature in a catalog involved an investment that was best used in any number of other directions.

However, at all recent industry trade shows the firms specializing in the preparation of catalogs for dealers in high fidelity have reported a tremendous increase in business. Dealers of every description, from all parts of the country, are ordering their own general catalogs.

Evidently a dealer catalog has far more value today as a vital selling tool than it had some years ago. To find out why so many dealers are willing to make the considerable investment required, HFTN interviewed several who do use catalogs.

We found three main classes of catalog use.

The first can be described quickly because it applies to a relatively

small group of very large dealers. These are the nationally-known houses that sell largely, if not mainly, by mail. To a mail house, a catalog is the *major* selling tool. This method of selling is a long-established American institution that needs no general description here.

The general make-up of the catalog used by the huge mail houses is entirely different from that appropriate for a dealer who sells mainly over the counter. In a mail-house catalog, promotional copy is the major attraction. Items are given large space, with heavy selling copy and big headlines, or reduced to small listing, depending on how heavily they "draw" during each period. It's been known for decades that in mail selling, you can greatly increase the sales of "hot" items with promotion effort, but you can't do much for weaker items.

The big mail houses put out their catalogs in quantities counted in the millions. Usually, they want very close control over copy, arrangement, quantities, so they maintain large catalog departments of their own and make the catalogs themselves. Inexpensive printing processes and paper are used so that unit costs are low, particularly with the extremely large quantities printed. Unit cost is reputed to range from a few cents up to about twenty cents, at most mail houses. There are, of course, a few exceptions to this rule in the form of mail-house



catalogs on heavy paper, with elaborate illustrations.

The second main class of catalog users is made up of the high fidelity dealers who are also distributors of all kinds of electronic equipment and parts, largely over the counter. For them and their customers, a complete catalog is an indispensable reference source, and an enormous saver of time.

If a customer wants 10 transformers, or a half-dozen electrolytic condensers, or a tape recorder, or an outdoor loudspeaker, the quickest way for him to find what he wants and how much it costs is to look it up in the catalog. At the other end, the dealer's salesmen save an equal amount of time when a customer calls in for any item. In fact, the time saved in the selling department is considered by many dealers to be worth the cost of the catalog.

Parts distributors without large mail operations naturally use much smaller quantities of catalogs than do the big mail houses. Their distribution of catalogs is not broadside to whole areas, as it is with the mail houses, but rather to their customer list. As one such dealer put it, "we

(Continued on Next Page)

Public Relations Opens the Door to New Customers

What is "public relations"?

It is using all possible means for influencing public opinion toward a favorable judgment of you and your business.

It is communicating to the public who you are, what you are like, and what you have to sell, through the editorial sections of the consumer and trade press, and by many other means, discussed below, which are distinct from paid advertising.

Public relations is a necessary complement to advertising in any complete promotion program. Advertising allows you to tell about your merchandise in the most direct, forceful way. Public relations gets your story into the mainstream of general information via newspapers, magazines, and by other means. Your story becomes genuine "news", and as such it is highly effective in disposing the public favorably toward you and your product.

What story should the high fidelity dealer tell through public relations? How does he tell it?

First of all you must identify yourself with the excitement of "high fidelity" and "stereo." These words are now as familiar to all Americans as "peanut butter sandwich" or "hit a home run with the bases loaded." Although many people have only a hazy notion of what "high fidelity" and "stereo," mean, they do associate them with an exciting way of hearing music in the home. Press the button marked "high fidelity" on any American and he comes alive. "Stereo" has even more effect these days.

You press these buttons first through advertising in the local newspapers. But public relations can do even more to identify you as the

local source of the excitement of stereo.

A demonstration of stereo, for instance, with local musical bigwigs to discuss the music, or introduce recordings, can have a triple effect. If properly handled, a news story will come out of such a demonstration, which says to every reader: "Headquarters for stereo is at Jim's Hi Fi Shop."

The story also says to the musically inclined—and these will make up the major part of your clientele, in any case—"Here is a shop where music is respected. I will be at home there."

Furthermore, it gives a "quality" character to your business, and this is of the greatest importance.

To have a long-range success, you must choose one of two public char-

acters for your store: (a) You make yourself, and constantly present yourself to the public, as a store specializing in "quality" merchandise; since high fidelity equipment is quality merchandise, for most hi-fi dealers this is the best character; or (b) If you are in one of the eight or 10 largest cities, where there is a sizeable group of high fidelity enthusiasts who know already pretty much what they want to buy, you can present yourself as a place where merchandise is sold quickly, with a minimum of service, at the lowest prices.

Dealers who try to straddle these two "characters" may succeed for a short time but over the long run they lose on both counts.

What are some other ways of telling the public that you are "quality"?

The decoration of your shop, of course, is fundamental. It is so obvious that we don't need to go into detail here on the necessity for a fine street front, comfortable, tasteful listening rooms, personable sales help who do know about the equipment, and all the rest of it.

You can associate your shop with top-grade serious music by having internationally famous musicians come for a visit, when they give concerts in your town. Concert managers are usually eager for local public appearances in advance of concerts, to drum up interest. Sug-

(Continued on Next Page)

P. R. IN ACTION

Lecture-demos carry hi-fi message

Many audio people believe the public should be better educated about stereo, but two New York manufacturers' representatives, Gil Miller and Bob Bach, decided to do something about it.

They have been carrying the components industry's message to club meetings, university classrooms and wherever else they can find a responsive audience.

The two reps. donate their time and knowledge to present a lecture-demonstration, using high fidelity components. It is a non-profit venture, with the sole purpose of educating consumers in the use and advantages of component stereo.

A typical presentation was given at the Van Cortlandt Post No. 733 of the Jewish War Veterans in New York City. With only minimal fanfare—a postcard notification to members and guests—the lecture



Gil Miller (center, left) answers questions after lecture.

pulled the heaviest turnout of the season, according to Arnold Kesten, post commander. Audience enthusiasm stretched the two and one-half hour lecture into more than three hours.

Equipment used for the demonstration included a turntable, arm and stereo pickup; an integrated stereo preamp-amp unit and two moderately-priced speaker systems. The demonstration rig was kept

(Continued on Page 35)

Stereo gets the full Hollywood treatment

Southern California's "Stereo Components Week" was climaxed Sept. 18 by a combination pop concert and hi-fi show in the Hollywood Bowl, sponsored by the Audio Components Representatives Association.

The concert featured such "name" entertainers as the Kingston Trio, Ray Conniff's orchestra and chorus and the Andre Previn Trio.

The exhibit area, occupying some 4,000 square feet adjacent to the Bowl, contained the newest stereo components on the market.

Both "Stereo Components Week" and "Stereo at the Bowl" were conceived by ACRA members as methods to stimulate stereo component sales in southern California. Many high fidelity dealers tied in with the events with special store displays and advertising.

This was a new venture for ACRA, a group of 21 independent businessmen who represent more than 95 percent of the high fidelity manu-

facturers selling components in the area.

Nothing was offered for sale during "Stereo at the Bowl." Manufacturer-exhibitors referred interested concert-goers to local dealers.

Exhibits opened at 5 p.m. and remained open until the 8:30 p.m. curtain, then reopened during intermission and after the show.

The concert was presented at regular admission prices. Naturally, there was no additional charge for the exhibit area.

An ACRA spokesman, commenting on the presentation, stated: "Up to now, high fidelity manufacturers have shown stereo component products only in hotels and exhibition halls around the nation. 'Stereo at the Bowl' was a new step: It simultaneously showcased the kind of musical entertainment which stereo music lovers purchase in tape or record form, right alongside the components which can reproduce concert performance in the home."

(Continued from Opposite Page)

gest to the manager that the artist might sell his records and autograph them, or discuss his music, or judge a local contest in singing for which you give a prize, etc.

This comes under the heading of a "special event" which is practically certain to get local news coverage. Naturally you get in touch with the editor well in advance, so he can have a reporter there to cover the story in some other way.

The varieties of "special events" are endless. A handful that come immediately to mind: (a) You run a contest for the best home-made tape recording, with the entries to be played in your listening rooms on top-flight tape equipment; (b) You open new listening rooms, so naturally you have an opening party with the community invited; (c) An annual community get-together will be attractive in many cities—have something brand new in the way of equipment or merchandise to show, give a short "guided tour," a musical program, simple refreshments, and other features that you can create best yourself based on knowledge of your own community; (d) Demonstrations of stereo seem to be sure-fire wherever they are held.

Another important way to get the right "quality" image into the minds of the public is by drawing attention to the "quality" installations you make. If you put an elaborate system into a wealthy home, get professional-grade photographs for display in your store; or if there is some extremely unusual feature about the installation, the picture may even make the paper.

One good way to give installations news value is to stress any unusual characteristics of the buyer. There is a good "human interest" story in the fact that one of the town's top dentists has the largest collection of Spanish guitar music on records in that part of the state, shall we say. The picture will show the owner in front of his hundreds of records, with your equipment a vital part of the story and the picture. How did the collector get started on this line? How many records has he? (News readers love startling dimensions and editors feed their readers eye-bugging figures whenever they can.)

Or maybe your system is a real humdinger with loudspeakers around the pool, in the maid's room, etc. Or it is arranged so that husband and wife can listen to different programs, chosen from any part of the house. The spectacular or novel story will get space.

Another way to draw attention to

(Continued on Page 44)

TEC FIRST ALL TRANSISTOR HIGH FIDELITY STEREO AMPLIFIER

NO TUBES

The "coolest" amplifier with the "hottest" sales appeal!

The precision transistors and advanced design in TEC S-25 eliminate heat problems found in vacuum tube amplifiers. Hum and microphonics are practically eliminated too. The transistors and circuitry are so

reliable TEC is the first amplifier to be sold on a two year guarantee of materials and workmanship. The TEC S-25 is this year's most exciting development in high fidelity—for the first time all-transistor design, unrivaled performance and guaranteed reliability. Be sure this great "traffic builder" is in your showroom. Watch for TEC's new AM-FM all-transistor tuner—in production soon. Write for complete information.

TRANSIS-TRONICS, INC.

1650 21st Street, Santa Monica, California



ALL TRANSISTOR STEREO AMPLIFIER MODEL S-25

TEC S-25 STEREO AMPLIFIER, 25 WATTS EACH CHANNEL, 50 WATT PEAKS.

Here's the mike to meet any of your needs. It's ideal for dispatch, paging, P.A., control tower and amateur use. Wired to operate both relay and mike circuits at a touch. The Model 250 "Lift-Switch" is a high impedance mike with smooth response from 60 to 10,000 c.p.s. Output level of -52 db. Complete with single unit die-cast case and 20 ft., three conductor (one shielded) cable. Furnished in satin chrome. List price \$49.50



THE TURNER "LIFT-SWITCH" MODEL

250 DYNAMIC

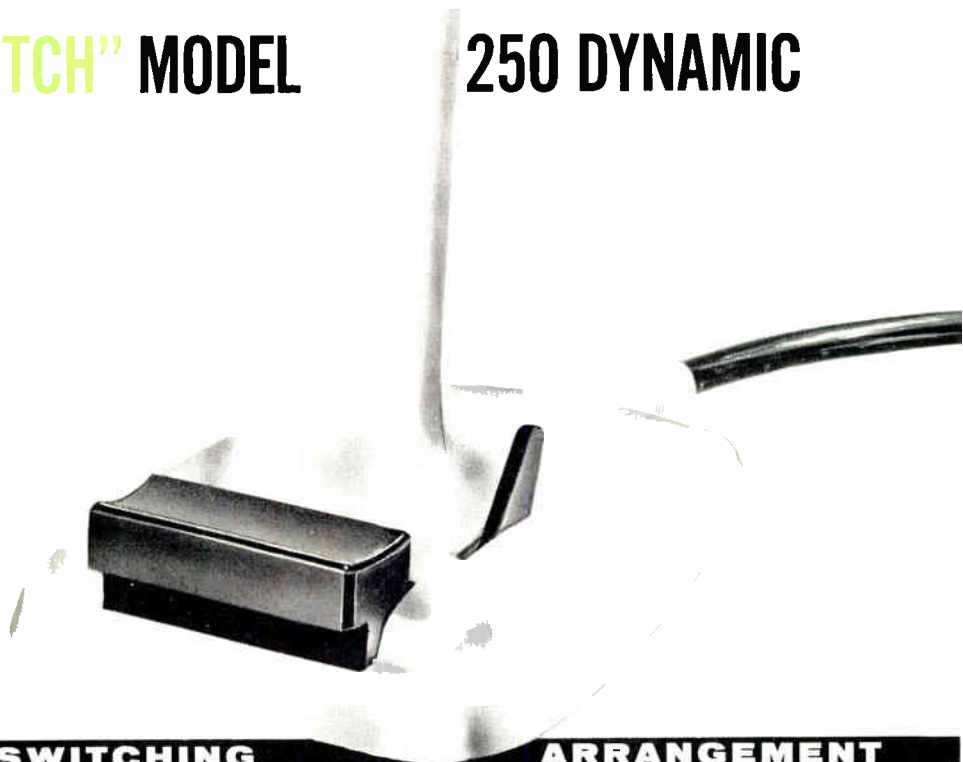

EXCLUSIVE 3-WAY SWITCHING

ARRANGEMENT



LIFT THE MIKE, it's live. Additional switch in base deactivates lift-switch when necessary.



DEPRESS THE FRONT BAR for push-to-talk. Gives "inter-com" convenience in a microphone.



MOVE THE LEVER-LOCK switch forward. The mike is live and stays live. Both hands are free for work.

MODEL 251 (LO) LIFT-SWITCH

All chrome finish plus 3-way switching action — push-to-talk, Lever-Lock and lift switch. (See reverse side.) Model 251 response: 60 to 10,000 c.p.s. Output level: -52 db. Impedance: 150 ohm. Complete with 20 ft., four conductor (two shielded) cable.

Model 251 list price \$49.50

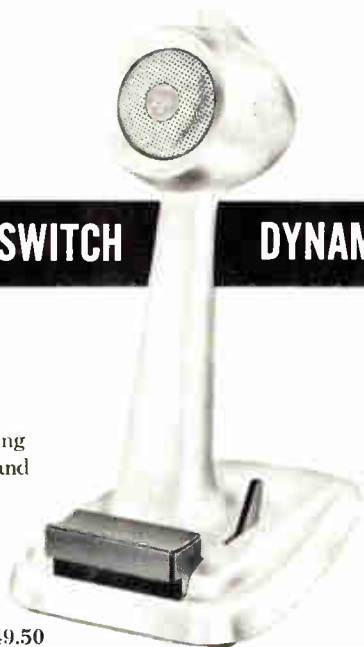

DYNAMIC AND MODEL 256 LIFT-SWITCH CRYSTAL

Model 256 is a crystal version of Model 250. Response: 60 to 8,000 c.p.s. Output level: -48 db. Complete with 20 ft., three conductor (one shielded) cable.

Model 256 list price \$35.00

OTHER TURNER MICROPHONES IN THE 250 SERIES

MODELS 252, 253, 254

Models 252 (Hi) and 253 (Lo) in gray hammertone finish have same specifications as Model 250, but are furnished without lift switch. Cable length is 7 ft.

Model 252 and 253 list price . . \$36.50

Model 254 is a crystal mike with the same style and finish as model 252 (gray hammertone). Model 254 has push-to-talk and Lever-Lock switching arrangements. Response: 60 to 8,000 c.p.s. Output level: -48 db. Complete with 7 ft. single conductor shielded cable.

Model 254 list price . . \$23.50

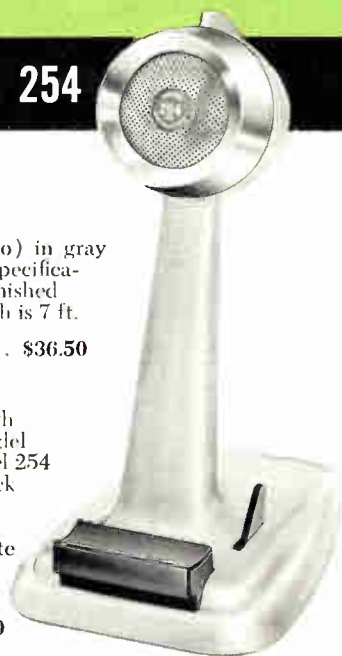

MODEL 255

Model 255 is a crystal mike with gray hammertone finish. Specifications same as Model 254 except without switching arrangements of any kind.

Model 255 list price . . . \$16.00

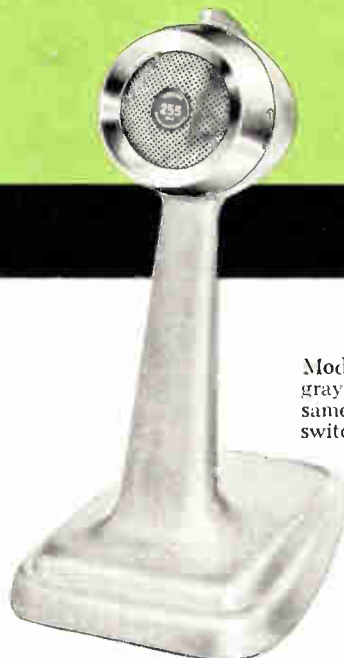

THE  **MICROPHONE COMPANY**
909 17th St. N.E., Cedar Rapids, Iowa

IN CANADA
Canadian Marconi Co., Toronto, Ontario & Branches
EXPORT
Ad Auriema, Inc., 85 Broad St., New York 4, N.Y.

A GRAY HYSTERESIS SYNCHRONOUS TURNTABLE KIT FOR ONLY 49.50

with outstanding features that are exclusive with GRAY at this low price.



Special hysteresis synchronous motor provides constant speed and lowest wow, flutter and rumble content.

Heavy machine ground 12½" turntable platter with micro polished 7/8" shaft rotates in a super oilite bearing with noiseless nylon underfacing thereby guaranteeing freedom from vertical movement... a stereo prerequisite.

Customized slip-proof, stretch-limited composite belt offers vibrationless link between motor and platter edge.

Shock-proof motor mount is adjustable in 3 planes to compensate for lifetime movement and wear.

Sturdy mounting plate offers maximum shielding. Easy to level and center because it extends past the platter and motor structure.

Micro precision parts pretested for accuracy in sub assemblies.

GRAY 33½ RPM SINGLE SPEED **HSK-33 TURNTABLE KIT**

Here's an exciting project for anybody who wants professional performance at a low kit cost. Gray engineering and custom mass production techniques now make this wonderful value possible. You'll be pleasantly surprised at how easy it is to fully assemble—and have ready for monaural or stereo operation—this studio designed turntable.

The GRAY HSK-33 TURNTABLE KIT is shown above with the:

GRAY SAK-12 PROFESSIONAL TONE ARM KIT.....net 23.95
GRAY TBA BASE (in Walnut, Mahogany or Blonde Formica Veneers) ...net 17.95

*See and hear
Gray high fidelity products
at your favorite
quality dealer.*

GRAY

our 67th year in communications...

High Fidelity Division

DEPT. H • 16 ARBOR STREET, HARTFORD 1, CONN.

*Contemporary
living room designed
by Joseph Freitag.*

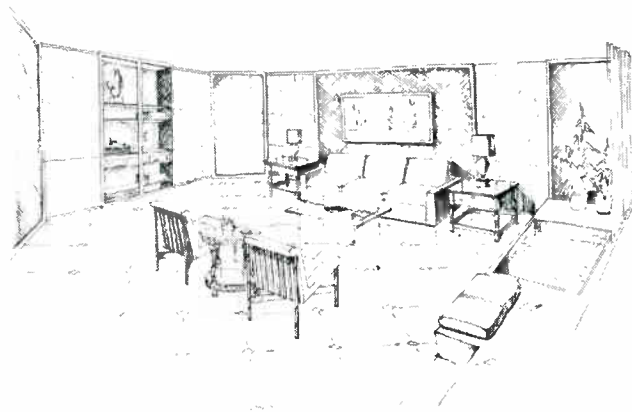

New York Show to Prove HI-FI Can Look as Good as It Sounds

The visual qualities of hi-fi will share equal billing with the sound at the New York High Fidelity Music Show.

The show, sponsored by the Institute of High Fidelity Manufacturers, opens for dealers on Monday, Oct. 5, from 5 p.m. to 11 p.m. Consumers will be admitted on Tuesday through Friday from 4 p.m. to 11 p.m. and on Saturday from 11 a.m. to 11 p.m.

In keeping with the Show's theme, "Decorate Your Home With Music," the decorative aspects of components, either encased in furniture or free-standing, will be emphasized.

Five top designers, all members of the American Institute of Decorators, have been commissioned to create model rooms in which high fidelity equipment is made an integral part of the furnishings.

These rooms include a provincial music room for the whole family designed by David Eugene Bell of Macy's New York; a contemporary living room by Joseph Freitag; an 18th century collector's study by Hector Grant; a traditional country living room by Phyllis Horton of Grace Richards, Inc., and a small contemporary teen-age bed-sitting

room by Daren Pierce of William Pahlmann Associates.

"Ever since high fidelity became more than a pastime for a small group of hobbyists, styling of components has increased in importance," Joseph N. Benjamin, IHFM president, pointed out. "Design influence, keynoted by the theme of our Show, today is more significant than ever before. This will be readily noted in manufacturers' individual exhibits."

The Show is expected to be visited by some 60,000 people who will inspect and listen to more than \$5 million worth of the latest home high fidelity music equipment.

Rooms on four of the floors have been assigned to approximately 125 exhibitors. (See page 6 for room numbers of individual exhibitors.)

In addition, one entire floor has been set aside for exhibits and demonstrations of an informational, educational and public service nature.

Among the informational displays will be Bell Telephone Laboratories' historical presentation of its research in stereophonic transmission plus the first public demonstration of a newly developed stereo circuit

which relies on an acoustic quirk of the human brain. The basis of the system is a psychoacoustic phenomenon called "precedence effect" which causes a listener to disregard a sound coming from one loud speaker when immediately preceded by an identical sound from another source.

According to Bell, the new system permits transmission of an undiluted stereo program over any two channels including AM-FM, AM-TV, AM-AM, or FM-FM and allows a listener to hear a fully balanced monophonic version of a program transmitted stereophonically.

In addition, Audio Fidelity, Inc., will have a complete recording studio at the Show with a seating capacity of 200. The Dukes of Dixieland, guitarist Fernando Sirvent, and Emanuel Vardi and his string ensemble will record discs and tapes, which will then be played back. Both mono and stereo recording techniques will be shown.

New York FM radio station WBAI will broadcast its regularly scheduled programs direct from the show. Daily programs will include guest interviews and "live" music by some of the country's leading folk singers.

Audio Engineers Face Busy Schedule

An unprecedented number of papers have been submitted for presentation at the Audio Engineering Society's 11th annual convention Oct. 5-9.

Meeting concurrently with the New York High Fidelity Music Show, the audio engineers will convene at the Hotel New Yorker, directly across the street from the New York Trade Show Building.

Ten different categories ranging from "Studio and Speech Input Systems" to "Stereo" will be covered by the 75 papers which have come in from the United States, Denmark, Brazil, The Netherlands and other countries.

The schedule for technical sessions at the convention follows:

Monday

Morning—Studio and Speech Input Systems.

Afternoon—Transistor in Audio Circuit Applications.

Evening—Music and Electronics.

Tuesday

Morning—Measurements and Standards in Audio.

Afternoon—Disc Recording and Reproduction.

Evening—Audio Applications (I).

Wednesday

Morning—Reverberation.

Afternoon—Magnetic Recording and Reproduction (I).

Evening—Magnetic Recording and Reproduction (II).

Thursday

Morning—Stereo (I).

Afternoon—Stereo (II).

Friday

Morning—Audio Applications (II).

Afternoon—Loudspeakers.

Evening—Symposium on Production of Stereo Tapes and Discs.

Members may register without charge. There will be a fee of \$3 for non-members to insure an interested professional audience.

The registration badge will admit the wearer to all technical sessions and to the exhibits at the Audio Engineers Show.

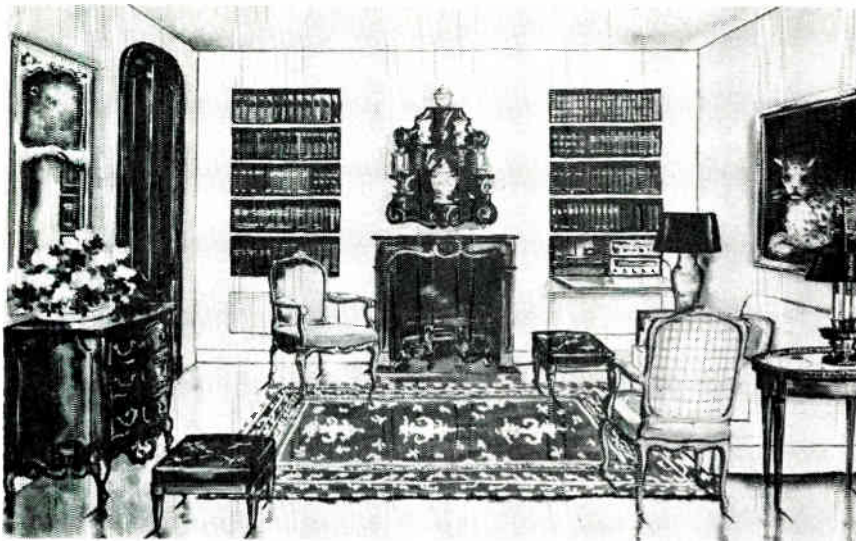

High fidelity components are installed in bookshelves and hidden by doors mounted with book bindings in the country living room designed by Phyllis Horton. Speakers are recessed below each bookshelf.

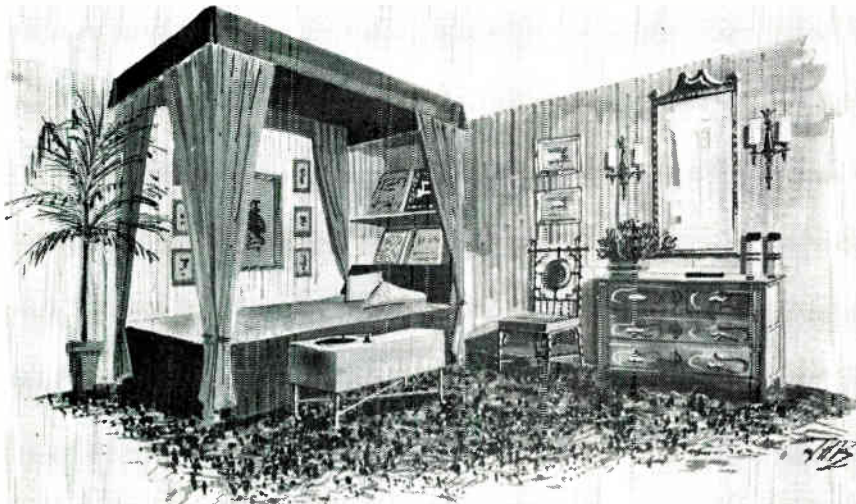

The mobile cabinet, at bedside, houses stereo components in Daren Pierce's teenage bed-sitting room. Speakers are in the chest of drawers and on a table opposite. Records are stored above bed headboard.



David Eugene Bell puts equipment in the long cabinet against wall in his provincial music room. Individual speaker cabinets can be moved or repositioned to any part of the room.

With an  toward
GREATER PROFITS

Direct Mail Reaches Your Best Customers

Of all advertising media available to the audio dealer, direct mail is one of the most promising.

With direct mail, he is able to reach specific people—professional persons, businessmen, upper income groups, etc. He can choose his prospects individually and reach them individually. This contrasts with newspapers and radio where there is a considerable waste circulation.

To be effective, direct mail should be sent out on a regular basis. It must do two things: Point up the advantages of high fidelity and sell the store.

To bring out a steady flow of direct mail material takes time, but many dealers find it is worth the effort. However, there is a time-saving service which takes most of the burden away from the dealer and provides him with professionally-produced material. This is the Better Listening Plan.

Some 70 to 80 exclusively franchised audio dealers throughout the country are currently using this plan. Each of these dealers mail out their own edition of Better Listening, a quarterly magazine which discusses high fidelity and shows how it can be used in the home. Each personalized edition has the dealer's name on the front cover and an ad for his own store on the back cover.

Better Listening is published by St. Regis Publications, Inc., 7 West 44th St., New York City. While the plan is not available in cities where a franchise exists, a limited number of franchises are available in various parts of the country, according to the publishers.

Pace Elected Chairman Of Board

Frank Pace, Jr., president of General Dynamics Corporation since May 1, 1957, was elected chairman of the corporation's board of directors. At the same time the directors named Earl Dallam Johnson, former executive vice president, to the post of president of General Dynamics.

Cohu Names Sales Manager

The appointment of E. C. Titcomb as sales manager of the San Diego based KIN TEL Division of Cohu Electronics was announced by La-Motte T. Cohu, president of KIN TEL and president and chairman of the board of Cohu Electronics, Inc.

14

Watch impulse sales climb with these fourteen decorator fabrics never before offered through jobber distribution! New novelty and cane patterns to make your profits grow! Mono-filament construction throughout means undistorted high fidelity transmission. Your rep has samples. Be sure to see them!

Mellotone

THE HIGH FIDELITY GRILLE FABRIC
 Mellotone, Incorporated, 1220 Broadway, N. Y. 1



 **MONARCH INTERNATIONAL**
 PRODUCER OF REGAL AUDIO COMPONENTS
 AT REALISTIC PRICES
introduces

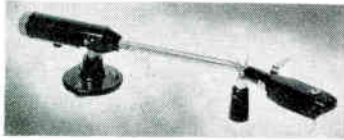

PA-100 STEREO TONE ARM

Streamlined, efficient—with roller bearings, two plug-in heads (one for stereo, one for monaural), micro weight adjustment, and excellent lateral and vertical compliance; in ebony and chrome or ebony and gold. The finest stereo arm available at any price. We invite comparison.
 Audio net **\$12.95**



P-58H 4-SPEED HYSTERESIS TURNTABLE

For the discriminating. Skillfully designed and excellently finished. 12" rim-driven, diecast turntable; 4-pole hysteresis motor; 16 $\frac{2}{3}$, 33 $\frac{1}{3}$, 45, 78 RPM, power constant 15 watts; noise level —45db min.; wow and flutter 0.25% max.
 Audio net **\$72.50**

CONTACT

your local rep for complete information about the
MONARCH LINE—over 1,000 HI-FI COMPONENTS
 from phono jacks to stereo ensembles,
 at realistic prices



MUELLER ELECTRONIC SALES

3225 Exposition Place, Los Angeles, Calif.

E. W. BRANDT COMPANY

1122 Folsom Street, San Francisco, Calif.

ROGER M. MINTHORNE CO.

0673 Taylor's Ferry Road, Portland, Oregon

W. B. GOLLIER

1559 Chester Street, Aurora, Colorado

ATHANS SALES COMPANY

1523 Drogan Street, Dallas, Texas

THOMAS H. ELLIS CO.

3016 W. 90th St., Kansas City, Missouri

LANAHAUS-LEVY ASSOCIATES

5317 S. Cottage Grove Ave., Chicago, Ill.

LAWRENCE ELLIOTT CO.

20011 Fairmount Blvd., Shaker Heights, Ohio

TESSCO

P. O. Box 6892, Towson, Maryland

ROBERT SMITH COMPANY

59 Verndale Street, Braokline, Mass.

MURRAY DIRECTOR ASSOCIATES

115-62 237 St., Elmont, L.I., New York

W. J. CALLAHAN

156 S. Edwards Ave., Syracuse, New York

FRANK C. NICKERSON CO.

1150 Zonalite Rd., N. E., Atlanta, Georgia



MONARCH INTERNATIONAL, inc.

7035 Laurel Canyon Blvd., North Hollywood,
 California.

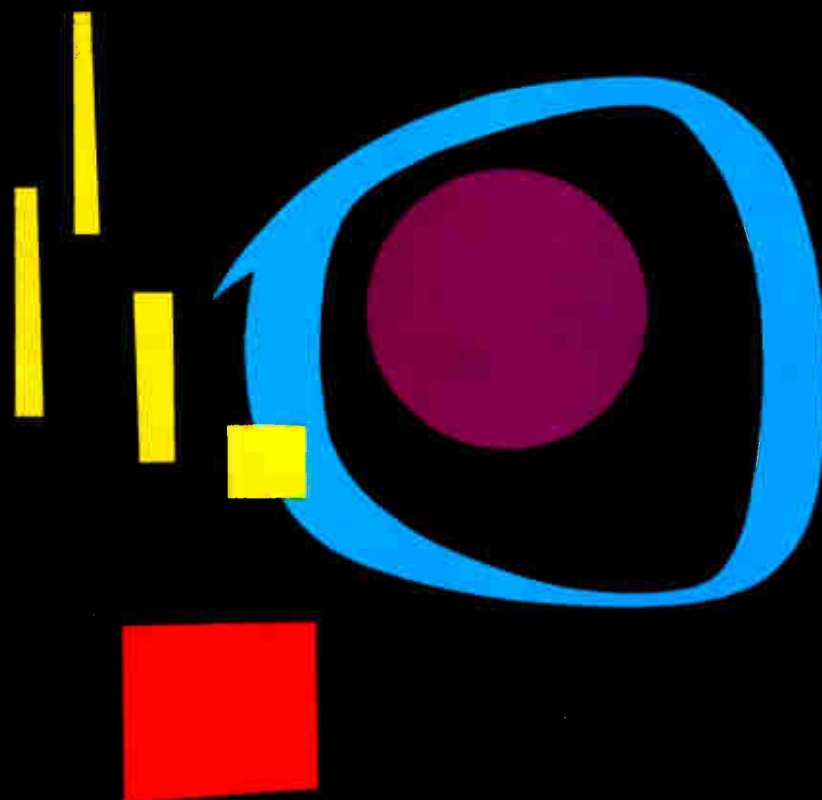

Bright new spot in your profit picture—
A new “SCOTCH” BRAND Magnetic Tape created especially for dealers!

Take-off with — “SCOTCH”

TARTAN





BRAND SERIES TAPES

*True stereo quality tape
at a customer-catching price
—created especially for dealers—
backed by continuous promotion!*

■ *Greater profit for you . . . on every sale—and you'll gain more customers, too!*

■ *Top quality tapes . . . improved additions to the famous "SCOTCH" BRAND line, with performance that will delight the most discriminating recordist!*

■ *Brilliant packaging . . . all new, modern box design makes striking in-store display, pre-sells tape quality!*

■ *New Three-Pack . . . helps you to introduce Tartan Series at appealing, extra savings—and increase your dollar profits, too!*

***Stock and sell Tartan Series tapes,
now available through your distributor.
Here's why it will pay:***

Tartan Series tapes are designed and marketed with you, the dealer, in mind. They meet the highest quality standards of your most knowing and demanding customers.

Tartan Series tapes will excite recording fans, bring new customers as well as new profits to your store. They offer, in an easy-to-stock, easy-to-shop selection, the tapes to meet all popular preferences and give the very best performance on any type of recording equipment!

They include both standard and extra play reels, all splice-free. Their professional quality backing assures excellent service under continuous playing and long storage. They have the newest high potency oxide, give maximum frequency response for crisp, clean highs and full, rich lows in the greatest possible variety of recording situations—help make recording easier for both the amateur and the expert. Uniform coating insures full-width, flawless performance with perfect head-to-tape contact, from monaural to critical 4-track stereo recording and playback.

Like all "Scotch" BRAND tapes, Tartan Series has the exclusive, fully impregnated Silicone Lubrication that achieves maximum surface smoothness and recorder head protection. You can sell new Tartan Series with real confidence—it will prove itself in fast, profitable repeat business!

To make Tartan Series even more interesting to customers—and more profitable for you—they're offered in sparkling new Three-Packs, which will stimulate a bigger unit purchase—substantially increasing your profit per sale!

To help you promote Tartan Series immediately—and to bring you more new customers from the rapidly expanding market—you'll be aided by continuous "Scotch" BRAND Tartan Series promotion, including display material and literature. You'll capitalize on the best known, most preferred name in magnetic tape, plus full advertising support in the nation's leading magazines month after month.

TARTAN SERIES "STEREO QUALITY" TAPES

No. 141-6 (600 feet, 5 inch reel, standard play)

No. 141-12 (1200 feet, 7 inch reel, standard play)

No. 140-9 (900 feet, 5 inch reel, extra play)

No. 140-18 (1800 feet, 7 inch reel, extra play)

***Turn page to see how 3M stands behind
you in merchandising Tartan Tapes →***



*New
revolving
self-service
display unit
free with
minimum
order!*

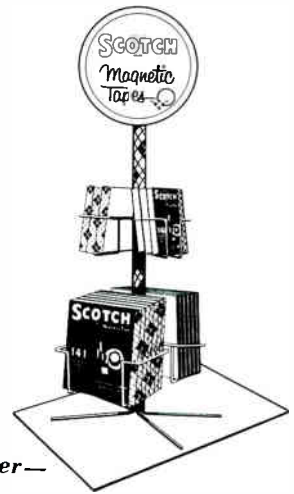

for counter—

sturdy, tip-proof, free-turning . . . non-marring feet . . . takes only 10-inch square on counter . . . perfect, also, for table or window display . . .



. . . or pegboard—

packed with pegboard attachments, too . . . sets up in less than a minute . . . only 2 feet high . . . holds full assortment of 5" and 7" boxes.

Entire display unit, complete with "Golden Circle" sign and special pegboard attachments, is yours free with any assortment of 36 boxes of Tartan Series tapes—just 12 Three-Packs!

Get maximum sales punch with this revolving display unit. It's an eye-catcher, a sure lure for tape buyers. Complete with distinctive, embossed "Golden Circle" top sign, it makes a compact, handsome self-service center for a complete assortment of Tartan Series tapes. Plaid center pole carries brightly enameled baskets on an easy-turning assembly. It's strong—won't tip or sag even if bumped. Holds 6 five-inch boxes and 12 seven-inch boxes in self-feeding full-view position. Gleaming top sign adjusts to any direction on top of unit to attract profit making attention—or may be used by itself in your window, on the wall, or as a hanger.

Order new "SCOTCH" BRAND TARTAN SERIES tapes and your free display unit today from your distributor. Call him now for complete information, or write: Minnesota Mining and Manufacturing Company, Magnetic Products Division, Dept. MBN-109, St. Paul 6, Minnesota.

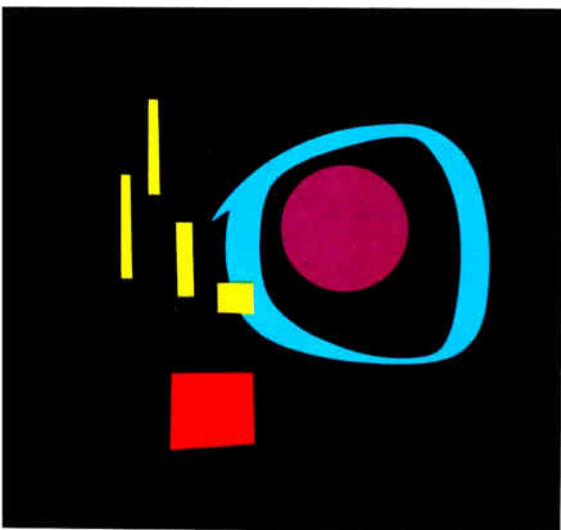

Look for this ultra-modern symbol, appearing on all Tartan Series Tapes. It identifies the newest member of the "SCOTCH" Magnetic Tape family.

MINNESOTA MINING AND MANUFACTURING COMPANY
... WHERE RESEARCH IS THE KEY TO TOMORROW



The verdict is in!



CONSUMER PUBLICATIONS

Hi-Fi Systems

"... best unit in its class, regardless of price ... must be seen to be believed ... one of the gentlest record drops we have ever seen ... electrical tests indicate rumble characteristics as good or better than those specified for broadcast-type turntables."

Modern Hi-Fi

"... the DUAL is an outstanding machine ... it shows a uniformly high level of performance in every respect ... standards were exceptionally high in each critical testing area, especially in such vital aspects as wow, rumble, flutter and hum."

QUALITY CARTRIDGE MANUFACTURERS

Fairchild

"... we put your machine through an extensive laboratory check ... we congratulate you on (its) excellence ... tracking was perfect ... automatic operation consistent and reliable ... truly does justice to and amply meets the requirements of top quality stereo cartridges."

Pickering

"... tests included all customary measurements ... including 'torture tests' designed to show up any malfunctioning ... it came through with flying colors ... tracking is all we could ask for ... trip mechanism functioned smoothly ... our unqualified approval ... you have a beautifully simple and efficient product."

Full reprints of current and forthcoming evaluation reports will be sent upon request.

TECHNICAL PUBLICATIONS

Edward Tatnall Canby in Audio

"... the first time I saw it, I couldn't believe my eyes ... the DUAL is absolutely silent in use; the motor is so quiet you must put your ear to the table to hear it ... rumble and pitch steadiness are absent and excellent respectively ... real manual automation ... it will do more things that please me ... than any changer so far."

Electronics World

"... one of the best stereo record changers we have seen to date ... the wow and flutter is as low as in some professional-type turntables ... we suggest that anyone who is interested in a changer for stereo hi-fi operation make sure that the dealer demonstrates this one for you."

MUSIC PROFESSION PUBLICATIONS

Downbeat

"... brand new sleeper ... very high quality ... excellent facilities for manual operation ... arm adjustment easier than on any other machine ... well worked-out arrangement for off-on manual playing ... they seem to have thought of everything."

Billboard

"... I have been giving the player a real workout ... and I must say that it passes every test. It's as good as I thought it was and as good as you claim. In short, it is tops."

DUAL-1006
combination stereo
turntable/changer
**TESTED
AND
ACCLAIMED
THROUGHOUT
THE
HIGH
FIDELITY
AND MUSIC
INDUSTRY**

You will find the DUAL-1006 only at selected authorized United Audio dealers.

united  Audio

PRODUCTS OF DISTINCTION
202-4 East 19th St., N.Y. 3, N.Y.

“If the hi-fi dealer would stop treating his service department as a necessary evil, he'd find there's money to be made.”

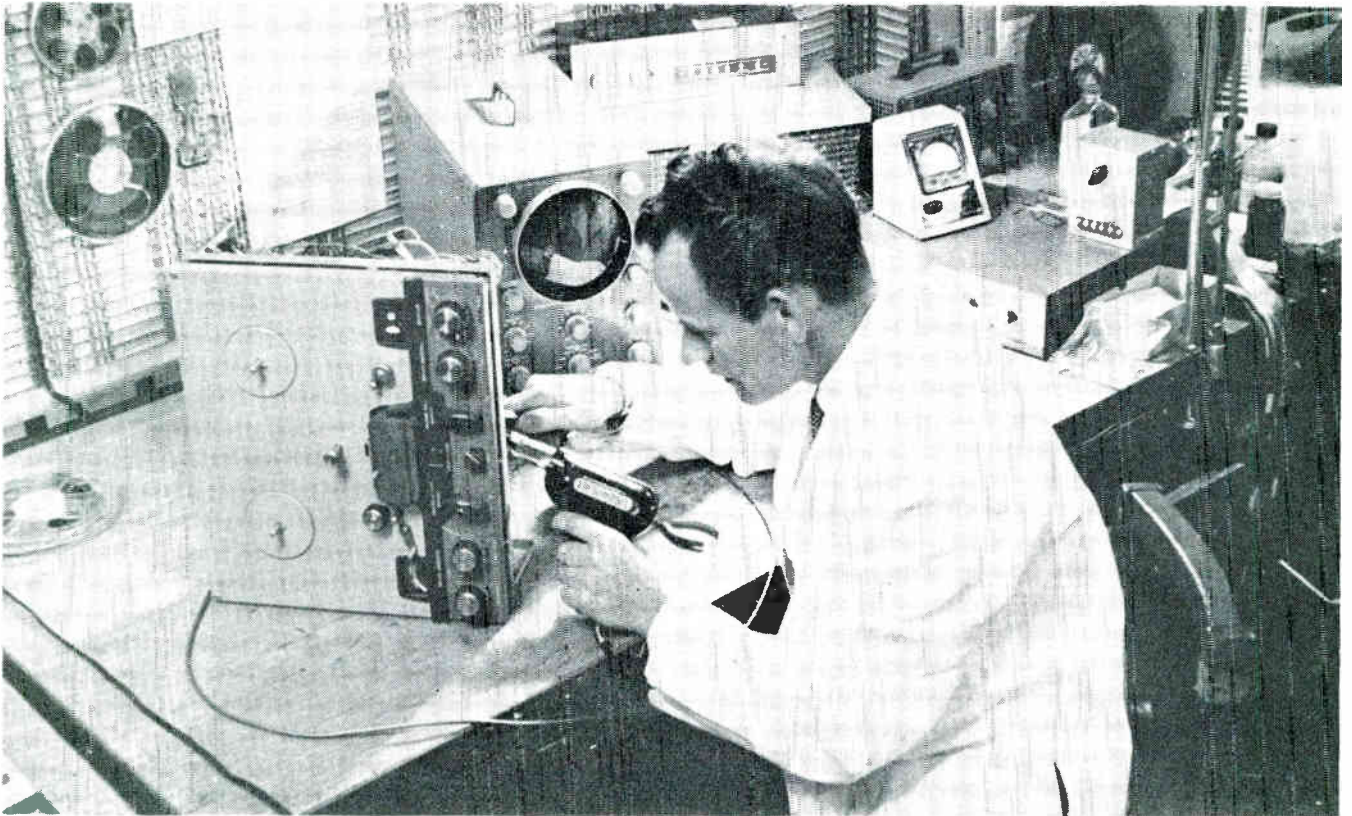

Charles E. Richardson, manager of Queens Sono-Vision, works on tape recorder.

Big business without selling

by Thomas W. Dowd

“If the hi-fi dealer would stop treating his service department as a necessary evil, he'd find there's money to be made.”

Take the word of genial Hal Marlowe, whose two current Sono-Vision shops fill the high fidelity servicing needs of the above-average income residents of New York's Queens, Nassau and Suffolk counties. The man speaks with experience.

Starting in 1949 with a small Brooklyn shop, Mr. Marlowe grew to Hempstead, Long Island, with the acquisition of a 2,000 square foot store in 1954. 1957 saw the opening of a second store in Jamaica, New York. A new shop—

the third — has opened recently in Commack, Long Island. Estimated income for the current fiscal year from the Hempstead and Jamaica operations: \$125,000. “Not a fortune,” says Mr. Marlowe, “but it shows that a well-run shop can turn out a healthy profit.”

The Sono-Vision operations are unusual. *There are no component sales.* The two large, well-staffed shops serve as Authorized Warranty Service Stations for 28 leading component manufacturers. Pre-recorded and blank tapes are sold for consumer convenience, stereo tape heads are available for on-the-premises tape deck conversion, but only to build customer good will. “Of course,” smiles Mr. Marlowe,

“consumer good will is money in the bank.”

Component repairs at Sono-Vision are made in strict accordance with manufacturer's specifications. “In fact,” says Mr. Marlowe, “it sometimes happens that when we take on a new line, the factory sends a service technician to live with us. If not, we send one of our service technicians to live with the manufacturer. In either case, our servicemen are taught the factory-recommended repair procedure for that particular product. We can then assure the customer that his unit will receive the same attention that he would get from the factory under his warranty, with several extras:

“First, the customer receives immediate attention. Because all repairs are made in our shops, there is no time lost shipping the unit to and from the factory. Further the customer saves shipping costs which, in some cases, can run high.

“Second, the customer receives
(Continued on Next Page)

personal attention. When he comes into our shop, the customer considers us the manufacturer's service representative, which, in truth, we are. We diagnose the difficulty and discuss it with the customer. He is assured that the trouble is not inherent in the product. The result: added confidence in both product and manufacturer.

"Third, you'd be surprised how often a perfect unit is brought to us for check-out. Actually the trouble is in another component part of the system. We've had customers return a high-grade turntable because of a 'wow' complaint. Thorough inspection of the unit proved that the table was in perfect working order—the 'wow' was *on the disc itself!* We were able to save the customer time, inconvenience and money."

"Fourth, the customer is encouraged to drop by the shop at any time to discuss his problems with a specialist."

The average technician, reports Mr. Marlowe, is overly interested in his work and, as a result, is a poor businessman. At Sono-Vision, the technician learns to be a businessman. Each technician is a specialist in the repair of a single component—tape deck man, tuner man, amp man and the like. Each man is manager of his department and is responsible for the work done in that department. He is taught not to get lost in the beauty of the equipment, but to establish a semi-production schedule that will enable his department to operate profitably.

Many dealers tend to merge sales and service. This, feels Mr. Marlowe, takes away from the profit end of the service department. "There should be a happy marriage—a meeting of minds between serviceman and owner. Service has work to do and is not pressed by sales. Sales has a job to do and is not pressed by service. Both departments should be kept separate—each treated as a separate business in order to realize full profit potential."

There are occasions when a technician will spend three hours on a single unit. He becomes interested in a particular circuit. The time spent in this type of self-education will eventually prove profitable to both owner and technician. "It also," laughs Mr. Marlowe, "makes for a happy technician!"

He knows that business-minded
(Continued on Page 46)

Kierulff, Appliance Mart In 'Under 1 Roof' Test

An experiment in coexistence-under-one-roof is being conducted by a components dealer and an appliance retailer in California's San Fernando Valley.

Kierulff Sound Corp., one of the largest component dealers on the West Coast, has opened a branch in Cliff Swanson's long-established appliance store at 12123 Ventura Blvd., Studio City.

Unlike the Hudson-Masters arrangement in New York, where Hudson-operated audio departments use the Masters name, Kierulff maintains its identity at Cliff Swanson's.

This identity extends to the exterior of the building where Kierulff is erecting a 36-foot-high rotating sign on the roof.

Swanson will continue to handle package phonographs and radios, while Kierulff will concentrate on components.

The venture was described by Robert Carson, Kierulff general sales manager, as an experiment to see "how two different businesses, although allied, can do if they complement each other."

It is one integrated operation with both types of high fidelity units available, he said, adding:

"We feel it will be to our mutual advantage to have salesmen well qualified in both components and packages. Component salesmen don't necessarily make good package salesmen, and vice versa. They are either one or the other.

"What we want to do is see if two different managements in the same store can be a success. Our belief is both will do more by having more. Whatever the type of sound system the customer wants, one of us will have it."

Kierulff occupies approximately one-third of the store. It is spending approximately \$6,000 to redecorate,

according to Bob Lawrence, Kierulff store manager. Two large sound rooms are being installed for demonstrating high fidelity. Approximately \$35,000 worth of components will be carried in stock at all times, he said.

The location was chosen by Kierulff following comprehensive surveys of the selling power of every San Fernando Valley shopping center.

The branch, known as Kierulff's Valley Sound, remains open until 9 p.m. on Mondays, Wednesdays and Fridays and closes at 6 p.m. on Tuesdays, Thursdays and Saturdays.

EIA Publishes Standards For Discs, Tapes and Recorders

Recommended standards for records, tapes and magnetic recording instruments were made available last month by the Electronic Industries Association.

The standards were published following approval by representatives of the industry, including members and non-members of EIA.

Copies of the following standards may be obtained through the EIA Engineering Department, 11 W. 42nd St., New York 36, N. Y.:

RS-211-A — Dimensional Characteristics of Monophonic and Stereophonic Disc Phonograph Records for Home Use, 78, 45, 33-1/3 rpm. A revision of RS-211. 60 cents each.

RS-223—Magnetic Recording Instruments for the Home, Wire Size, Speed, Spools. A revision of REC-131-A. 25 cents each.

RS-224 — Magnetic Recording Tapes. A revision of REC-132 and REC-138. 30 cents each.

A minimum charge of \$1 is made on all orders. EIA said.

HOW TO MAKE MONEY Selling Commercial Sound

Here today and here tomorrow — Commercial Sound is a steady-profit 12-months-a-year business of sales, installation and servicing with lots of customers right in your own neighborhood. Take advantage of the Atlas complete line of speakers — manufactured, advertised and supplied directly by Atlas. Speakers for every application, a mike support for every purpose — plus a wide variety of accessories so necessary for a complete professional installation.

Good markets in stadia, racetracks, athletic fields, etc.

Profitable markets in swimming pools, amusement parks, clubs, schools, etc.

Excellent markets in industry, factories, warehouses, etc.

Write for latest catalog and selling aids to help you get profitable commercial sound business.

ATLAS SOUND CORP.
Dept. HT-10
1449 — 39th St.
Brooklyn 18, N. Y.

In Canada: Atlas Radio Corp., Toronto, Canada

Ampex Stereocasts Twice a Week in 10 Cities

Stereo radio is being used for the first time on a regularly scheduled national basis to promote a stereo audio product.

Ampex Audio, Inc., is sponsoring twice-a-week FM-AM stereocasts on stations covering the 10 top metropolitan markets for its stereo tape recorders and console stereo home music systems.

The use of stereo radio highlights the firm's 1959-60 advertising program, which also includes a print media schedule of 12 national consumer publications.

Stereo radio, an Ampex spokesman said, "is now a reality offering a large and loyal audience, and as such it can be an effective advertising media."

"Ampex Stereo Tape Time," the title of the program, is presently scheduled with 10 stations: WQXR, New York; WMAQ, Chicago; KNX, Los Angeles; WCAU, Philadelphia; WJR, Detroit; WCRB, Boston; WGKA, Atlanta; KADY, St. Louis; KRLD, Dallas, and KGO, San Francisco. All broadcasts are FM-AM stereo, except KADY which is on AM only until facilities for FM-AM stereo are completed this month.

There are two one-half hour programs weekly on each station. Programming consists of music from 4-track 7½ ips stereo tapes only. No stereo discs are used.

Selections are programmed locally to match music and listening preferences in each area. Music is chosen from the rapidly growing library of tapes available to consumers. Local announcers use Ampex-prepared commercial continuity.

To emphasize the major copy theme of "Stereo sounds best on tape — tape sounds best on an Ampex," all stereo tapes on the programs are played on Ampex 960 stereo recorders, the firm's consumer model professional-type portable.

Three different audiences will be reached by the programs, Ampex said. Those who are now able to receive the FM-AM broadcasts in full stereo; those who receive only the FM portion, and those who receive only the AM portion.

The program's potential national

stereo audience, limited by FM coverage, is 44 million persons, approximately 25 percent of the population. The AM coverage has a potential audience of close to 90 million.

Ampex Audio's print media schedule lists 12 consumer magazines with a potential of 44 million reader impressions. A consistent series of 1/6th page insertions will run in Time magazine. Dominant advertisements, many of them two-page, three-color pre-printed inserts, will appear in Better Listening, High Fidelity, Audio, Tape Recording, Listen, and news-stand circulated guides and handbooks, such as Hi Fi Guide, Stereo 1960, All About Stereo, Modern Hi Fi, and Guide to Stereo.

New Production Facilities For Raven Electronics

Raven Electronics Mfg. Co., manufacturers of public address and paging systems and other sound equipment, announces their new and larger office-factory quarters at 2130 W. Carroll Ave., Chicago 12, Ill. The entire area comprises over 12,000 sq. ft. with separate departments for printed circuit production, amplifiers, page units, and research.

Stromberg-Carlson Appoints Kufeld

Appointment of Jack Kufeld as district manager for Stromberg-Carlson in the Philadelphia area has been announced by Leon J. Knize, sales manager for consumer products in the firm's Special Products Division. Stromberg-Carlson is a division of General Dynamics Corporation.

E.V. Announces Additions to Staff

Electro-Voice, Buchanan, Mich., announces the addition of James M. Price and Henry Mandler to its sales and merchandising staff. Mr. Price will act as general manager for the RME (Radio Manufacturing Engineers) division and Mr. Mandler will specialize in high fidelity products.

*Altec presents the 353A—
the ultimate in stereo power...
control...modern styling.*



NEW TEC 50 WATT STEREO AMPLIFIER • PREAMPLIFIER



*Only Altec offers you so many features
in a single stereo unit—at such a low price.*

gram peak power, 50 watts rms continuous, 25 watts per channel (nominal), stereo network for three channel stereo. • Entirely new fashion-coordinated design and colors (atinum gold) blend beautifully in any decor. • Highest quality components including n reserve power to give top performance for years even under maximum operating d controls for greater ease of operation. • Exclusive Altec ventilation formula • Feedback type equalization plus feedback all around tubes for minimum distortion. ependent of gain and tone controls. • Dual microphone inputs for stereo recording. uts: magnetic phono, ceramic phono, tape head, tape machine, radio, microphone, o or mono outputs: channel A and channel B recorder, left and right speaker, center iary speaker. • Dimensions 5 $\frac{7}{8}$ " H x 15" W x 11 $\frac{1}{4}$ " D (over knobs) • Weight: ely 35 pounds. • PRICE: **\$199.50**

tor switch, Channel balance control, Dual Gain control, Dual Bass control, Dual o two channel—three channel switch, Stereo standard—reverse switch, Stereo— ouble filter switch, Loudness contour switch • DISTORTION: Less than 1% THD at 1 channel; Less than 1% THD at 20 watts 30 to 15,000 cps each channel • FREQUENCY to 20,000 cps at 25 watts; ± 0.5 db 10 to 30,000 cps at 1 watt • TONE CONTROL RANGE: 1 db at 10,000 cps • OTHER FEATURES: Auxiliary speaker connections for stereo or ircuit breaker for thermal overload protection, DC heater supply to low level signal tubes. Silicon rectifiers in high voltage supply.



ALTEC LANSING CORPORATION, Dept. HFS60
1515 South Manchester Avenue
Anaheim, California
A Subsidiary of Ling-Altec Electronics, Inc.

1960...

(Continued from Page 17)

The S-5000 Stereo 20+20 watt dual amplifier has received the "Oscar" of our industry by combining all the best features of higher priced units into one compact unit; and it's made under quality control procedures second to none.

Well known to the trade is Sherwood's S-3000 II FM only tuner with inter-channel hush and below 0.95 microvolts sensitivity—a matched piece for the S-5000.

Available for delivery next month is our newest tuner, S-2200. This is a stereo tuner which combines the FM circuitry of the famous S-3000 with AM & built-in MX provisions.

Order your stock of pre-sold "Sherwood" now for the coming fall season. See your representative or feel free to phone our Sales Manager, Mr. Bud Fields, collect, at 4300 N. California Ave., Chicago 18, Ill., IRving 8-7300.

only for those who want the ultimate

SHERWOOD



Burton Browne Advertising

product in with the dealer at the local level.

Dealers can also expect to receive a greater variety of merchandising materials from their suppliers. One manufacturer, for example, will furnish draperies (with dignified product insignia) for use in window displays. Others will provide electric signs. There will, of course, be quantities of promotional literature available.

All in all, 1960 shapes up as a most promising year for high fidelity components. The individual dealer will benefit to the extent that he follows through with his own advertising, merchandising and salesmanship.

To reach this new market that is being created, he will have to re-examine his techniques and, in most cases, develop new approaches.

Remember, this market consists of non-audiophiles who may never have heard of you. Your job is to reach them and cause them to come to your store for components.

Audio Devices Appoints Chief Engineer

William C. Speed, president of Audio Devices, Inc., N. Y., has appointed Andreas Kramer chief engineer of the company's subsidiaries, The Audiotape Corporation and Audio Manufacturing Corporation in Stamford, Connecticut.

Pilot Appoints Assistant Ad Mgr.

The appointment of Miss Vivian Sherman as assistant to the advertising manager has been announced by Pilot Radio Corp., Long Island City, N. Y.

Free Audiotex Catalog Available

A descriptive 16-page catalog covering a 150-item hi-fi accessory line is now available from Audiotex Mfg. Co. The illustrated publication shows each accessory in actual use. Free copy is available from Audiotex Mfg. Co., Dept. FR, 3225 Exposition Place, Los Angeles 18, Calif.

*Altec presents the 353A—
the ultimate in stereo power...
control...modern styling.*



NEW
ALTEC
50 WATT
STEREO
AMPLIFIER • PREAMPLIFIER



*Only Altec offers you so many features
in a single stereo unit—at such a low price.*

- 100 watts stereo program peak power, 50 watts rms continuous, 25 watts per channel (nominal), stereo or mono.
- Matricing network for three channel stereo.
- Entirely new fashion-coordinated design and colors (platinum pink and platinum gold) blend beautifully in any decor.
- Highest quality components including full-size tubes, maintain reserve power to give top performance for years even under maximum operating conditions.
- Simplified controls for greater ease of operation.
- Exclusive Altec ventilation formula prevents overheating.
- Feedback type equalization plus feedback all around tubes for minimum distortion.
- Recorder outputs independent of gain and tone controls.
- Dual microphone inputs for stereo recording.
- 14 stereo or mono inputs: magnetic phono, ceramic phono, tape head, tape machine, radio, microphone, and multiplex.
- 6 stereo or mono outputs: channel A and channel B recorder, left and right speaker, center channel speaker, auxiliary speaker.
- Dimensions 5 $\frac{7}{8}$ " H x 15" W x 11 $\frac{1}{4}$ " D (over knobs)
- Weight: approximately 35 pounds.
- PRICE: **\$199.50**

CONTROLS: Input selector switch, Channel balance control, Dual Gain control, Dual Bass control, Dual Treble control, Stereo two channel—three channel switch, Stereo standard—reverse switch, Stereo—monophonic switch, Rumble filter switch, Loudness contour switch • **DISTORTION:** Less than 1% THD at 25 watts 1,000 cps, each channel; Less than 1% THD at 20 watts 30 to 15,000 cps each channel • **FREQUENCY RESPONSE:** ± 1.0 db 20 to 20,000 cps at 25 watts; ± 0.5 db 10 to 30,000 cps at 1 watt • **TONE CONTROL RANGE:** ± 14 db at 50 cps; ± 14 db at 10,000 cps • **OTHER FEATURES:** Auxiliary speaker connections for stereo or mono programs. AC circuit breaker for thermal overload protection, DC heater supply to low level signal tubes. Silicon rectifiers in high voltage supply.



ALTEC LANSING CORPORATION, Dept. HFS60
1515 South Manchester Avenue
Anaheim, California
A Subsidiary of Ling-Altec Electronics, Inc.

12-85

1960...

(Continued from Page 17)

The S-5000 Stereo 20+20 watt dual amplifier has received the "Oscar" of our industry by combining all the best features of higher priced units into one compact unit; and it's made under quality control procedures second to none.

Well known to the trade is Sherwood's S-3000 II FM only tuner with inter-channel hush and below 0.95 microvolts sensitivity—a matched piece for the S-5000.

Available for delivery next month is our newest tuner, S-2200. This is a stereo tuner which combines the FM circuitry of the famous S-3000 with AM & built-in MX provisions.

Order your stock of pre-sold "Sherwood" now for the coming fall season. See your representative or feel free to phone our Sales Manager, Mr. Bud Fields, collect, at 4300 N. California Ave., Chicago 18, Ill., IRving 8-7300.

only for those who want the ultimate

SHERWOOD



Burton Browne Advertising

product in with the dealer at the local level.

Dealers can also expect to receive a greater variety of merchandising materials from their suppliers. One manufacturer, for example, will furnish draperies (with dignified product insignia) for use in window displays. Others will provide electric signs. There will, of course, be quantities of promotional literature available.

All in all, 1960 shapes up as a most promising year for high fidelity components. The individual dealer will benefit to the extent that he follows through with his own advertising, merchandising and salesmanship.

To reach this new market that is being created, he will have to re-examine his techniques and, in most cases, develop new approaches.

Remember, this market consists of non-audiophiles who may never have heard of you. Your job is to reach them and cause them to come to your store for components.

Audio Devices Appoints Chief Engineer

William C. Speed, president of Audio Devices, Inc., N. Y., has appointed Andreas Kramer chief engineer of the company's subsidiaries, The Audiotape Corporation and Audio Manufacturing Corporation in Stamford, Connecticut.

Pilot Appoints Assistant Ad Mgr.

The appointment of Miss Vivian Sherman as assistant to the advertising manager has been announced by Pilot Radio Corp., Long Island City, N. Y.

Free Audiotex Catalog Available

A descriptive 16-page catalog covering a 150-item hi-fi accessory line is now available from Audiotex Mfg. Co. The illustrated publication shows each accessory in actual use. Free copy is available from Audiotex Mfg. Co., Dept. FR, 3225 Exposition Place, Los Angeles 18, Calif.

Q: What's the only way to eliminate rumble?

A: Get rid of the motor and moving parts!

For those obsessed with elimination of turntable rumble, we offer the solution shown. For those who are still unwilling to recommend this simple (but drastic) step, we would like to address a few points.

All record players have some rumble BUT a well-engineered turntable will have so little rumble that it ceases to be a problem.

This rumble obsession has led some manufacturers to adopt an inexpensive, lightweight motor which is primarily designed for constant load application such as in clocks and timers. A turntable motor, however, encounters constantly varying loads due to recording differences and modulations, changing tonearm position and variations in friction resulting from rotation and wear. Therefore, when a borderline, lightweight motor is used—quality and durability are sacrificed to eliminate a meaningless proportion of rumble—a truly false economy!

In the superb line of Rek-O-Kut STEREOTABLES, the hysteresis synchronous motor is precision-made and capacitor-operated to assure smoother multi-phase rotation for years of dependable performance. The motors are isolated from the turntable and deck. Drive mechanisms and other moving parts are machined to extremely close tolerances. Rek-O-Kut STEREOTABLES were used exclusively in the design and development of the 45/45 playback stereo cartridge, because *vertical rumble*, another serious factor in *stereo playback*, is at an absolute minimum in the Rek-O-Kut line of hysteresis STEREOTABLES. All these engineering features contribute to the exclusively accurate, silent operation of a STEREOTABLE.

Sell the turntable line that creates sales through customer satisfaction, quality and prestige...sell Rek-O-Kut STEREOTABLES... world's finest...the only company that has a complete line of STEREOTABLES—1, 2 and 3 speed—ALL powered by hysteresis synchronous motors!

Look to Rek-O-Kut for the latest in turntable design. Newest models, L-34H and L-37H provide two speeds (33 $\frac{1}{3}$ —45 and 33 $\frac{1}{3}$ —78) and are powered by rugged hysteresis synchronous motors. Only \$79.95.



Rek-O-Kut Company, Inc.

38-19 108th Street, Corona 68, New York



Export: Morhan Exporting Corp., 458 Broadway, N. Y. C. 13, N.Y.
Canada: Atlas Radio Corp., 50 Wingold Ave., Toronto 19, Ontario



RK-45

AN INVITATION TO JOIN IN HIGH FIDELITY RETAIL

CONCENTRATE your sales efforts on **THE PREFERRED LINE**—the line that offers you *more* of the world's finest high fidelity components than any other! **PLUS**...reliable factory service, plus maximum use of cooperative advertising funds and the most consistently powerful hi-fi national advertising program in the industry!

THE FISHER

CONCENTRATE on **THE BIG LINE**, and you can cut down on inventory and promotional costs, and save valuable display and storage space as well!

THE FISHER

CONCENTRATE on **THE QUALITY LINE**, and you will still be able to offer your patrons audio components in *every* category and in a full range of prices—each component designed for those who demand professional performance, years-ahead versatility and absolute reliability!

THE FISHER

ONLY FISHER CAN SUPPLY YOU WITH THE COMPLETE QUALITY LINE!

WRITE, WIRE OR PHONE YOUR ORDERS TODAY!

FISHER RADIO CORPORATION • 21-43 44th DRIVE • LONG ISLAND CITY 1, NEW YORK



A REVOLUTION LING

Whatever Your
Customers Want—
FISHER
fills
the order best!

The Receiver

THE FISHER 600
STEREO FM-AM RECEIVER

The Tuners

THE FISHER FM-100
STEREO FM TUNER

THE FISHER 101-R
STEREO FM-AM TUNER

THE FISHER 100-T
STEREO FM-AM TUNER
With MASTER AUDIO CONTROL

THE FISHER 202-T
STEREO FM-AM TUNER
With MASTER AUDIO CONTROL

The Amplifiers

THE FISHER SA-100
50-WATT STEREO POWER AMPLIFIER

THE FISHER SA-300
60-WATT STEREO POWER AMPLIFIER

THE FISHER 30-A
20-WATT MONO POWER AMPLIFIER

THE FISHER 200
60-WATT MONO POWER AMPLIFIER

The Master Audio Controls

THE FISHER 400-CA
STEREO MASTER AUDIO CONTROL

THE FISHER X-101A
STEREO MASTER AUDIO CONTROL
With 40-WATT STEREO AMPLIFIER

The Speaker System

THE FISHER XP-1
FREE-PISTON THREE-WAY
SPEAKER SYSTEM

The Accessories

THE FISHER RK-1
STEREO REMOTE CONTROL

THE FISHER MPX-20
MULTIPLEX ADAPTOR

THE FISHER PR-66
STEREO PREAMPLIFIER

THE FISHER PR-6
MONO PREAMPLIFIER

THE FISHER
LABORATORY TESTED
AND MATCHED TUBES



FIRST CARDIOID AT SUCH LOW COST!

CUTS BACKGROUND NOISE

Accepts Only the Sound You Want

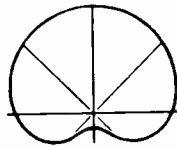
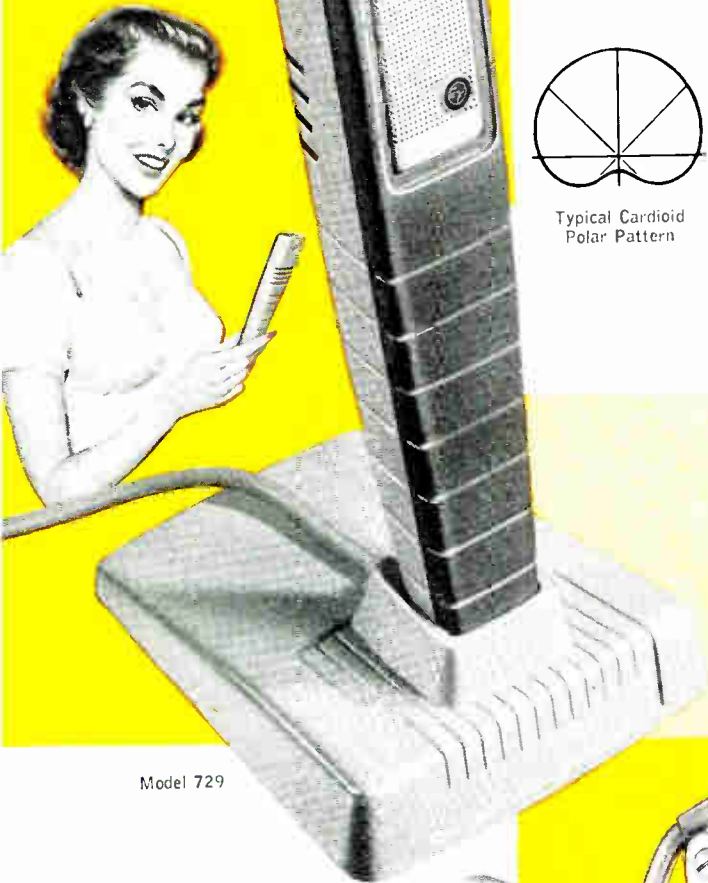

Typical Cardioid Polar Pattern

IDEAL FOR STEREO RECORDING OR PUBLIC ADDRESS

Unidirectional pick-up and tailored response of the *new E-V 729 Cardioid* make it economically ideal for many applications in public address, paging, dictating, home recording, amateur communications, and other sound use. The 729 Cardioid *rejects unwanted rear-background noise and room reverberation*. Permits working from nearly twice the distance of conventional microphones. *Reproduces only the sound you want*, more faithfully and distinctly. Instantly slips in or out of desk-base supplied with microphone. Feels good in the hand.

Where economy is a factor, you still have every advantage in selecting *Electro-Voice*. You get the benefit of the same high quality engineering and manufacturing that have made E-V the choice of television networks. You choose from the *most complete line, the most accepted microphone line*, in the world. You are certain of finest value and *guaranteed satisfaction or your money back*.

Model 729

Model 729 Cardioid Ceramic. Complete with desk-base and floor stand acceptor. Ceramic generating element withstands extremes of temperature and humidity. Response 60-8000 cps. Output -55 db. High impedance. Two-tone gray.

List Price, \$24.50

Model 729S. With switch. List, \$26.50

924



926



920



712



727

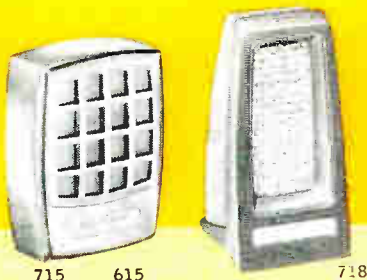

715

615

718

Model 715 "Century" Ceramic. Non-directional. For table, stand or hand. Ceramic element. Response 60-7000 cps. Output -55 db. High impedance. Satin chrome. List, \$13.00

Model 715S. With switch. List, \$15.00

Model 615 "Century" Dynamic. Has exclusive indestructible Acoustalloy diaphragm. Response 80-8000 cps. Output -55 db. Choice of 50 ohms or high impedance. List, \$25.50

Model 718 Ceramic. Non-directional. For hand or table use. Ceramic generating element. Response 60-6000 cps. Output level -55 db. High impedance. List, \$12.00

CHOOSE FROM THESE AND OTHER E-V LOW COST MICROPHONES

Model 926 Slim Crystal. For hand or stand use. Non-directional. Moisture sealed crystal. Response 60-8000 cps. Output -60 db. High impedance. Tilttable head. Satin chrome. List, \$29.50

Model 920 "Spherex" Crystal. All-direction pick-up. Moisture sealed crystal. Response 60-7000 cps. Output level -50 db. High impedance. Satin chrome finish. List, \$27.50

Model 712 Compact Ceramic. Fits comfortably in the hand. Non-directional. Response 70-7000 cps. Output -55 db. High impedance. Gray Styron case. List, \$7.50

Model 924 Lavalier Crystal. For chest or hand use. Non-directional. Moisture sealed crystal. Response 60-8000 cps. Output -60 db. High impedance. With neck cord, support clips, and cable. Satin chrome finish. List, \$20.00

Model 727 Slim Ceramic. Instantly lifts out of base for hand use. Non-directional. Ceramic generating element. Response 60-8000 cps. Output -55 db. High impedance. Two-tone gray. With desk-base and floor stand coupler. List, \$18.00

Model 727S. With switch. List, \$20.00

Wide choice of Dynamic models, also available.

Write for Catalog No. 136 to Dept 109-B

No Finer Choice than **Electro-Voice**

ELECTRO-VOICE, INC., BUCHANAN, MICHIGAN, U.S.A.

WEATHERS

TrioPhonic **STEREO**

**THE SOUND THAT OUTMODES
CONVENTIONAL STEREO!**

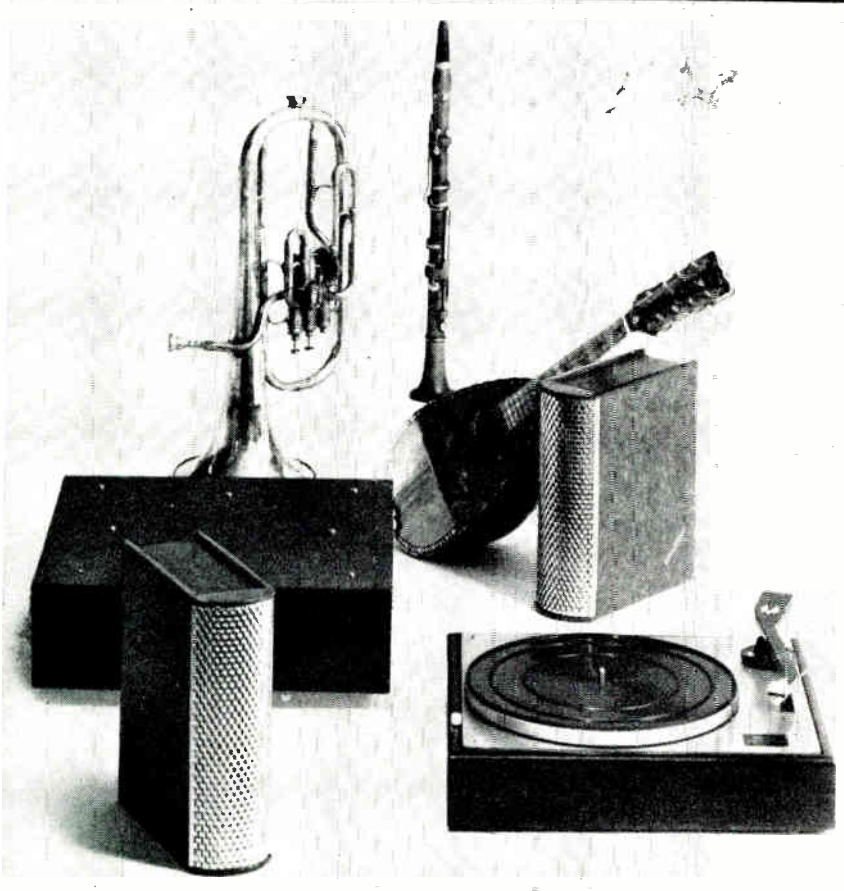

It took the engineering know-how of Weathers to discover this revolutionary electronic advancement in sound and size! TrioPhonic Stereo introduces the listener for the first time to "Equalized Sound." Now you can sit anywhere in the room and experience the same magnificent tonal realism and fidelity of full-range stereo. "Equalized Sound" is produced by two book-size full range stereo speakers and a unique, non-directional hideaway bass.

Ask your dealer today for a demonstration of Weathers startling new audio dimension—TRIOPHONIC STEREO with "Equalized Sound." You must see it, hear it, compare it, to believe it!

For the ultimate in TrioPhonic stereo listening, select the matched Weathers synchronous turntable with StereoRamic pickup system.

For more information of TrioPhonic Stereo write for FREE booklet, Dept. TN-O

WEATHERS INDUSTRIES, 66 E. Gloucester Pike, Barrington, N.J.
Division of Advance Industries, Inc.

Export: Joseph Plasencia, Inc., 401 Broadway, New York 13, N. Y.

Masters Loses Suit To Block Music Masters

Masters, Inc., has failed to obtain an injunction against the use of the name "Music Masters" by William Lerner.

Masters, Inc., had charged Mr. Lerner, trading as Music Masters, 53 W. 47th St., New York City, with trading on the good will of Masters, Inc., and with misleading the public.

New York Supreme Court Justice Henry Clay Greenberg, in denying the injunction, noted that Music Masters has been in business for nine years. He further observed that the use of the name "Music Masters" clearly identified the store as one engaging in the products of "the masters of music."

Music Masters, organized originally as a record shop, added audio components several years ago. Masters, a promotional department store chain, operates discount record departments and has recently entered into an arrangement with Hudson Radio, whereby Hudson operates components departments in five Masters' stores under the Masters' name.

Robins Offers Free Display Rack With Offer Of Impulse Stock

Hi-fi dealers seeking 'impulse' items and follow-ups on recorder and tape sales may be interested in a new display of tape care accessories announced by Robins Industries and now available from local distributors.

The new DD-3T Robins Display Deal features 13 different tape care items mounted on a counter or wall display. Included are a low-cost book on tape editing, five models of the famed Gibson Girl tape splicer, Robins tape-head demagnetizer, tape cleaning cloth, tape head cleaner, splicing tape, clips and reel labels, and tape threader.

The display is free and with a special discount the cost of the display-mounted 13 items is less than the cost of the 13 items purchased alone, it was noted by Robins Industries president Herman "Hy" Post. He added that back-up stock for the display is also available at a special discount to provide even higher profit margin.

AMPEX 960

STEREOPHONIC

RECORDER/REPRODUCER



RECORDS STEREO
OR MONOPHONIC

Stereo Portable PLUS!

Guiding the Ampex engineers who created the 960 was a dual objective—that of building a machine which was not only a superb example of engineering skill, but one which would also offer its user a range of capabilities far exceeding that of any other recorder made today. The result was not merely an improved stereo recorder, but *an entirely new concept* in home entertainment.

The STEREO 960 fits into family life in literally dozens of ways, contributing many tangible benefits in musical, educational and recreational fun. You'll use it to keep up the family correspondence by sending "letters in sound", to tape stereo programs off the air, to preserve your best monaural and stereo discs on tape, and to acquire new musical and language skills. You'll have endless fun exploring the 960's many fascinating recording capabilities, including sound-on-sound, echo chamber effects, and other advanced techniques.

ABOVE--960 PORTABLE STEREO
RECORDER/REPRODUCER
BELOW--MODEL 2560 PORTABLE
STEREO SYSTEM CONSISTING OF
960 AND PAIR OF 2010
AMPLIFIER-SPEAKERS

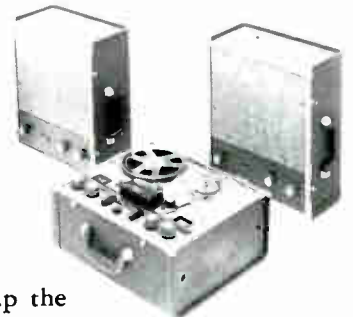

AMPEX STEREO

SIGNATURE OF PERFECTION IN SOUND

RECORDER/REPRODUCER SPECIFICATIONS

The true values of a recorder are best assessed through careful evaluation of its performance specifications and operating features. It is worthwhile noting here that these specifications are based not on theoretical design parameters but on actual performance tests. They are specifications which the recorder not only meets or exceeds today, but which years from now will still hold true.

The Ampex Model 960 Stereophonic Recorder/Reproducer is capable of essentially distortionless frequency response from 30 to 20,000 cycles per second at the operating speed of 7 1/2 inches per second, and from 30 to 15,000 cycles per second at 3 3/4 inches per second. Its precision-engineered timing accuracy is such that it offers perfection of pitch held to tolerances of less than one-third of a half-tone. Playing times, using standard (.002"), long play (.0015"), and extra-long play (.001") tapes are as follows:

	(a) 4-Track Stereo Tapes	(b) 2-Track Stereo Tapes	(c) Monaural Tapes, half-track
1200 foot reel	3 3/4 ips - 2 hrs. 8 min. 7 1/2 ips - 1 hr. 4 min.	3 3/4 ips - 1 hr. 4 min. 7 1/2 ips - 32 minutes	3 3/4 ips - 2 hrs. 8 min. 7 1/2 ips - 1 hr. 4 min.
1800 foot reel	3 3/4 ips - 3 hrs. 12 min. 7 1/2 ips - 1 hr. 36 min.	3 3/4 ips - 1 hr. 36 min. 7 1/2 ips - 48 minutes	3 3/4 ips - 3 hrs. 12 min. 7 1/2 ips - 1 hr. 36 min.
2400 foot reel	3 3/4 ips - 4 hrs. 16 min. 7 1/2 ips - 2 hrs. 8 min.	3 3/4 ips - 2 hrs. 8 min. 7 1/2 ips - 1 hr. 4 min.	3 3/4 ips - 4 hrs. 16 min. 7 1/2 ips - 2 hrs. 8 min.

RECORD INPUTS: High impedance line inputs (radio/TV/phono/auxiliary) 0.3V rms for program level; high impedance microphone inputs

PLAYBACK OUTPUTS: Approximately 0.5V rms from cathode follower when playing program level tapes

PLAYBACK FREQUENCY RESPONSE: 30-20,000 cps at 7 1/2 ips; 30-15,000 cps at 3 3/4 ips
Within ±2 db 50-15,000 cps at 7 1/2 ips, 55 db dynamic range
Within ±2 db 50-10,000 cps at 3 3/4 ips, 50 db dynamic range

FLUTTER AND WOW: Under 0.2% rms at 7 1/2 ips; under 0.25% rms at 3 3/4 ips

HEADS: Manufactured to the same standards of precision that exist in Ampex broadcast and recording studio equipment. Surfaces are lapped to an optical flatness so precise that they reflect specified wavelengths of light, resulting in uniform performance characteristics and greatly minimizing the effects of head wear. Azimuth alignment of stereo head gaps in the same stack is held within 20 seconds of arc, equivalent to less than 10 millionths of an inch — a degree of precision achieved through use of a unique process involving micro-accurate optical measurements within a controlled environment. Head gap width is 90 millionths of an inch ±5 millionths of an inch.

KEY TO THE EXCITING FUN FEATURES OF THE 960 --

THE AMPEX STEREO-GRAPH

Here's the simplest, quickest answer to almost every question about how to perform the operations illustrated at right and numerous other recording functions. The Ampex Stereo-Graph shows you, quickly and clearly, the proper dial settings to make for more than a dozen of the most popular uses for the 960 . . . including sound-on-sound, language and music instruction,



and other special effects. A convenient tape footage/playing time indicator is included on the reverse side.

MODEL 2010

MATCHING AMPLIFIER-SPEAKER

The Ampex Model 2010's ten-watt (20 watts peak) amplifier section provides operating characteristics (unequalized) flat within ±0.1 db, with total harmonic distortion less than 0.5 of 1%, throughout the maximum range of human hearing ability, at rated output. Noise and hum are 80 db below rated output, and input sensitivity is 0.18V to develop rated power.

The specially designed 8" speaker provides smooth, peak-free response throughout a remarkably wide audio range. Such superior design features as its massive die-cast frame and edgewise-wound ribbon coil contribute effectively to higher levels of performance than ever before achieved with a speaker this size.

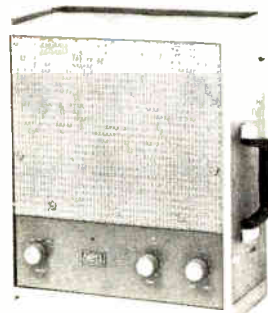

MODEL 960 DIMENSIONS: Portable cases 9" x 15" x 1 1/2". Unmounted recorder 13" x 15" x 6 1/4" depth below top plate, 1 1/4" above. Recorder weight 36 lbs., speaker amplifier 31 lbs.

AMPEX AUDIO, INC. • SUNNYVALE, CALIFORNIA AANS

Relax and enjoy the show—let your Ampex do the narration! With the commentary on tape, your color slide shows are more professional, more complete, and more fun!

Your favorite LP's and Stereo Discs are at their exciting best while they're new and unscratched. That's when to tape them on your Ampex, and preserve their original quality for keeps!

When you tape it "off the air" your only cost is for blank tape. Yet your musical repertoire can soon equal that of all the stations you hear!

There's a real future in family fun like this—with your Ampex you can live such happy moments over and over again, with a quality so lifelike you're almost literally carried back.

In the Ampex "Speech Testing Game", you pit your wits against the trigger-quick memory of the Ampex recorder/reproducer. You can't win, but it's fun trying.

Letter-writing is no longer a problem, with an Ampex in the house . . . now it's a family project. And even more fun than sending letters in sound is receiving them!

For "letters in sound", the 3" tape reel holds as much as a 10-page letter, mails first class anywhere in the United States for 8c.

The Ampex, in private rehearsal, can be a wonderful confidence-builder for people who normally develop rubber knees when faced with the prospect of speaking before a group.

Learning to speak a new language is made immeasurably easier on the Ampex; you can record your own phrases side-by-side with those of the instructor, and play them back for comparison at any time.

When you strike up the band in stereo, you don't need professional musicians to make a professional recording. Advanced techniques are amazingly easy on the Ampex.



SERIES 380

COLLECTORS' SERIES 380: Hermetically sealed and fully encapsulated in precious mu-metal for a lifetime of trouble-free and hum-free performance. Without question the finest pickup available... with more quality features than any other pickup on the market. Two compliance ranges—"A" type "V-GUARD" stylus for transcription tone arms; "C" type "V-GUARD" stylus for auto-changer arms. Flat ± 2 db from 20 to 20,000 cps.; Exclusive magnetic discriminator provides channel separation of 25 db or better. Push-pull magnetic generator provides an output of 2 mv per cm/second of recorded level per channel, generously adequate for any make preamplifier with a magnetic cartridge input. Four output terminals plus exclusive, optional metal-case ground strip to prevent ground loops with metal tone arms. Recommended tracking force: "A" stylus in transcription tone arms from 2 to 5 grams; "C" stylus in auto-changer tone arms from 3 to 7 grams.

- Model 380E** "Collectors' Ensemble" includes the 380 Stanton Stereo FLUXVALVE with 3 "V-GUARD" styli: D3807A for stereo; D3810A for microgroove; S3827C for 78's\$60.00
- Model 380A** includes the Stanton Stereo FLUXVALVE and D3807A "V-GUARD" stylus for transcription arms\$34.50
- Model 380C** includes the Stanton Stereo FLUXVALVE and D3807C "V-GUARD" stylus for auto-changer arms\$29.85

**PICKERING — for more than a decade — the world's most experienced manufacturer of high fidelity pickups... supplier to the recording industry.*

FOR THOSE WHO CAN HEAR THE DIFFERENCE
Pickering

PICKERING & CO., INC., PLAINVIEW, NEW YORK

OCTOBER, 1959

from Pickering*

THE broadest line of stereo cartridges available... Each model *fully* compatible for all records, stereophonic and monophonic. Here is a line which offers your customers a *complete* choice... Stanton Stereo FLUXVALVE Pickups for every application, for every listening requirement and for every individual taste. Only PICKERING offers the *lifetime* pickup in both, the Collectors' and Pro-Standard Series.

PRO-STANDARD SERIES 371: Hermetically sealed for a lifetime of trouble-free performance. Two compliance ranges—"A" type "T-GUARD" stylus for transcription arms; "C" type "T-GUARD" stylus for auto-changer tone arms. Response is flat, ± 2 db 20 to 20,000 cps. Exclusive magnetic discriminator provides channel separation of better than 20 db over the entire stereo range. Balanced "hum bucking" push pull magnetic generator provides an output of 2 mv per cm/second of recorded level per channel, generously adequate for any make preamplifier with a magnetic cartridge input. Recommended tracking force: "A" stylus in transcription tone arms from 2 to 5 grams; "C" stylus in auto-changer tone arms from 3 to 7 grams.

- Model 371A Mk II** includes the 371 Stanton Stereo FLUXVALVE with D3707A "T-GUARD" Stylus for transcription arms\$26.40
- Model 371C Mk II** includes the Stanton Stereo FLUXVALVE with D3707C "T-GUARD" Stylus for auto-changer arms\$24.00

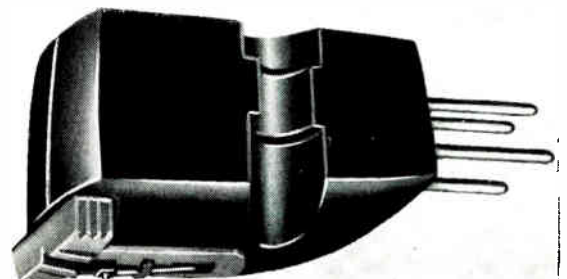

SERIES 371

New on the Market

Bogen Tuner and Amp

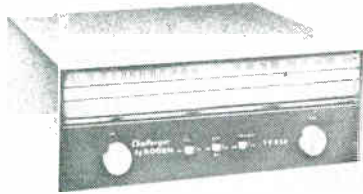

Challenger Model TC322 tuner, by Bogen Presto, provides for FM/AM simulcast and regular FM or AM broadcasts. Frequency response, 20 to 15,000 cps, $\pm 1\frac{1}{2}$ db. Sensitivity: FM, 5 uv, 30 db quieting, 300 ohm input; AM, (loop) 150 uv per meter, 20 db signal-to-noise, and (terminal) 7 uv per meter, 20 db signal-to-noise. \$109.50 including enclosure.

Challenger Model AC220 stereo amp has 10 watts-per-channel of power which may be combined for 20 watts in mono operation. Frequency response, 40 to 16,000 cps, ± 2 db. Sensitivity is 4.5 mv on mag., and 135 v on aux., and tuner. Hum is .50 on mag., and .60 on aux. Output impedances are 4, 8 and 16 ohms. \$79.95.

Parkway Stereo Control



Model SC-1, SC-2 Dyna stereo control, by Parkway Specialties, for conversion of audio equipment. Has balance control, 500 k high input, 20-ohm low output, volume control, mono-stereo switch. Bakelite cabinet with black and gold panel. SC-1, panel \$10.95; SC-2, cabinet, \$12.95.

Roberts Cartridge Adapter



Cartridge adapter permits use of tape cartridges on Roberts reel-to-reel recorders. Mounts directly over the feed reel and take-up spindles. Driven by a belt from the recorder capstan to a flywheel beneath the adapter. Available in late Fall. \$75.

Stereo Level Indicator



Moultrie International's Model SIM-100 "Single Needle" stereo level indicator contains 10-point variable sensitivity control. Simple to operate. Said to be accurate without need of balancing dual meters. Permits quick visual indication of audio levels in two channels of a stereo system and prevents accidental overloading of either channel. Connects to speaker output terminals. Calibrated 0-100 percent and $2 \pm 0 \pm 3$ db.

Webster Stereo Suite



Stereo Suite, a wood-cabineted addition to Webster of Racine's line, consists of a stereo-mono tape recorder and playback control center and two matching speakers. Records and plays back mono and 2- and 4-track stereo. Has comb-type input connectors to radio-phonos for each channel. Ventilated 12 watt amp located at base of each speaker cabinet, which keeps down size of central control unit. Speeds 3 $\frac{1}{2}$ and 7 $\frac{1}{2}$ ips. Heads: In-line quarter-track recording and playback; dual erase. Wow and flutter: 0.2 percent max. at 7 $\frac{1}{2}$ ips, 0.3 percent max. at 3 $\frac{1}{2}$ ips. Pre-amp has 30-15,000 cps frequency response and 45 db signal-to-noise ratio. Speakers have frequency response of ± 5 db from 70 to 12,000 cps. Available in Danish wabuti (Model 300W) or fruit wood (Model 300F).

'Quick-See' Storage

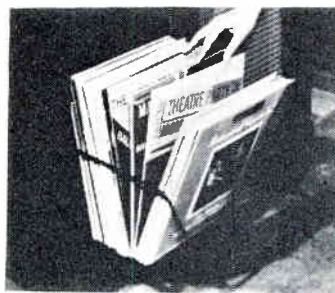

Kersting offers the "Quick-See" method of disc and tape storage in various models that are easily installed in hi-fi cabinets, shelves or closets. User can flip through collection with one hand to select desired disc or tape. Model 8-13 holds 50 10 or 12-inch discs or tape. Model D-8-13 stores 100 discs. \$12. Model T-10-13 holds 15 tapes or 75 45-rpm records. \$6. Model TD-10-13 stores 30 tapes or 150 45-rpm discs. \$10. Prices are slightly higher East of the Mississippi.

Ampex 'Custom' Consoles

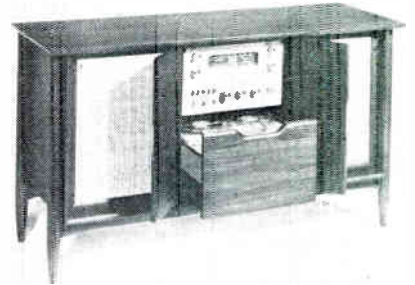

Ampex Audio's 1960 "Custom" line of stereo consoles feature lower pricing and a completely revamped and improved audio control center pre-amp. Available in four versions: with Ampex stereo tape recorder; with a precision four-speed stereo record player; or a combination of either plus the new Ampex stereo AM-FM radio tuner. All versions use Ampex audio control center pre-amp, and a pair of matched Ampex speaker/amp systems. Each of the two amps delivers 15 watts of power. New prices are \$675 for Custom stereo phono console, \$895 for stereo radio and stereo phono, \$1095 for stereo tape console, and \$1295 for stereo tape and stereo radio console.

Shure Matched Microphones



Model 558 dynamic microphones are matched and balanced for stereo recording. Guaranteed to be within 2 db's of each other across their entire frequency range of 50 to 15,000 cps. Unidirectional dynamic microphones with multi-impedance switches to permit matching low (35-50 ohms), medium (150-250 ohms) or high impedance (100,000 ohms or over) inputs. Super-carboid pickup patterns claimed to make them effective at a 75 percent greater distance than standard microphones and to reduce pickup of background noise by 73 percent.

Pre-Amp for Tape Decks



Telectro Model TP12 pre-amp has been designed specifically for Telectro series 9000 tape decks. Frequency response, 50-15,000 cps ± 3 db when playing back NARTB tape. Better than 50 db signal-to-noise ratio. Cathode follower 5 v output with standard tape. Available in five models.

Turner Citizens' Band Mikes

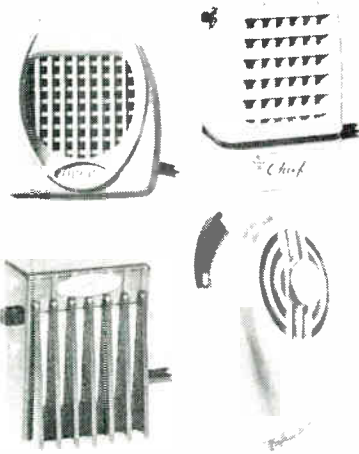

Turner introduces four models specifically designed for citizens band radio. Model 907 is ceramic band or desk mike with response level of 60-8,500 cps, output level of -55 db. No switch. \$8. Model SR 807 is wired for relay operation and has push-to-talk switch, with response of 80-7,000 cps and output level of -55 db, \$15.00.

Model SR 1620 is ceramic type mike with plastic case. Response 60-8,500 cps; output level -55 db, \$13.50. Model SR 908 is carbon mike with a front mounting button. Response level 200-4,000 cps, output level -38 db. Push-to-talk switch, \$26.50.

Acro Stereo Pre-Amp



Acrosound kit designed as a mate for Acro's Stereo 20 and Ultra Linear 11 amps. Eight-position input selector for 78, LP, RIAA1, RIAA2, tape head, FM-AM, FM multiplex and aux. Output selector: 7 modes (check-A, check-B, stereo, stereo reverse, mono A-B, mono A, mono B). Dimensions: 1 1/2 in. high, 13 3/4 in. long and 4 3/8 in. deep. \$79.50 for kit \$129.50 laboratory assembled.

Fisher Tuner-Control Center

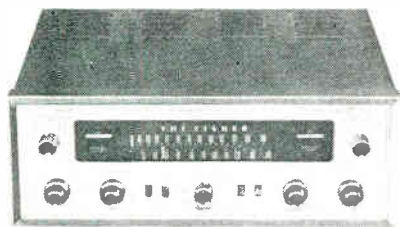

Model 100-T combines a stereo FM-AM tuner and a master audio control center on one integrated chassis. Fourteen controls and switches on the front panel and five on the rear panel permit wide selection of program source. FM and AM sections are wholly independent in operation and can be used individually for monophonic reception or simultaneously for FM-AM stereo reception. Control center incorporated in the unit comprises two fully independent pre-amp channels, with seven inputs. On front panel are separate FM and AM tuning controls, separate dual friction-loaded bass and treble controls, master volume control, loudness control and channel balance control. Frequency response uniform from 20 to 20,000 cps \pm 1 db. Distortion less than 0.2 percent at rated output of 5 v. \$249.50, with simulated leather-covered metal cabinet. Model MC-1, available at \$15.95 additional.

SOLD ONLY THROUGH FRANCHISED DEALERS!



... is looking for a limited number of aggressive, qualified dealers who can sell quality and performance. Outstanding advertising and franchise dealer programs will help you sell the world's most complete line of tape recording instruments. The Magnecord line of ruggedly built instruments includes ...

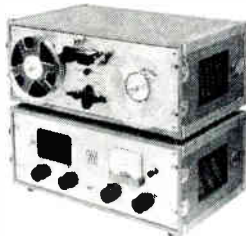

... rugged, reliable
THE PT 6 "workhorse" of the broadcast industry.

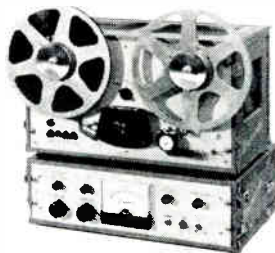

... "The Editor" ...
THE P 75 includes all of the capabilities of the PT 6 plus extended performance and utility.

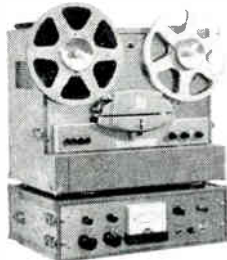

... "Mighty" in all performance characteristics ...
THE M 90 Magnecord's prestige tape instrument.

INTRODUCING:



THE NEW 728 "PROFESSIONAL"

THE ONLY TAPE RECORDER AT ANY PRICE THAT DOES EVERYTHING!



Write for details on valuable profit protected franchise program to: Department 12

P. O. Box 7186 / Tulsa, Okla.

DIVISION OF MIDWESTERN INSTRUMENTS

manufacturers of electronic data acquisition instruments

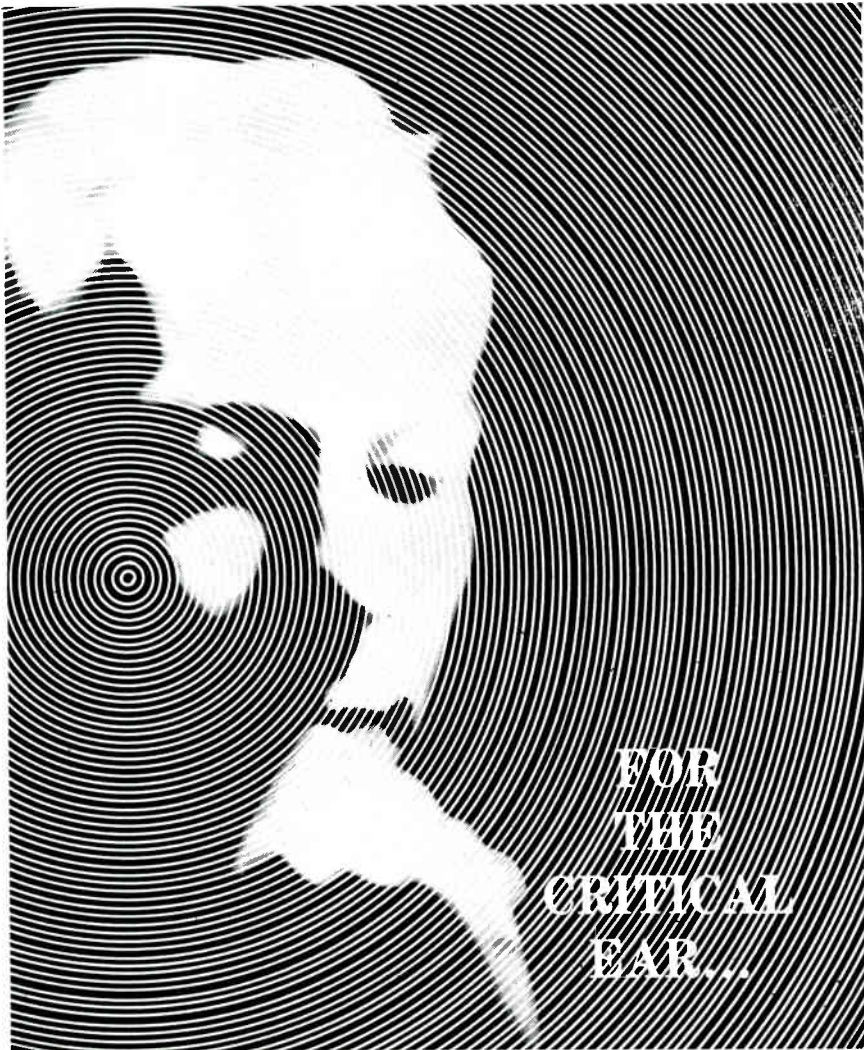

FOR
THE
CRITICAL
EAR...

you may now select from two
magnificent

SHURE

Stereo Dynamic

PHONO CARTRIDGES

Shure Stereo Dynamic Cartridges are designed and made specifically for listeners who appreciate accuracy and honesty of sound. They separate disc stereo sound channels with incisive clarity, are singularly smooth throughout the normally audible spectrum . . . and are without equal in the re-creation of clean lows, brilliant highs, and true-to-performance mid-range. Completely compatible . . . both play monaural or stereo records, fit all 4-lead and 3-lead stereo changers and arms. Available through responsible high fidelity consultants and dealers.

**PROFESSIONAL
MODEL M3D
AT \$45.00***



Incomparable quality — the overwhelming choice of independent critics and experts. Floats at a pressure of only 3 grams in transcription tone arms. Distortion-free response from 20 to 15,000 cps. Unparalleled compliance. Built to perfectionist tolerances.

**CUSTOM
MODEL M7D
AT \$24.00***



Outclasses every cartridge except the Shure M3D—by actual listening tests! Tracks perfectly at minimum pressure available in all record changer arms. Smooth from 40 to 15,000 cps.

*audiophile net, with 0.7 mil diamond

Use Only Shure Replacement styli that carry the certification in "Precision Manufactured by Shure;" inferior imitations can seriously degrade the performance of the cartridge.

*Shure Brothers, Inc.
222 Hartrey Avenue,
Evanston, Illinois*

Public Relations . . .

(Continued from Page 23)

the quality of your merchandise is with "public appearances" of your own. If a special musical program is being given in town, find out if high quality reinforcement of the sound would be attractive to the manager. As an expert on high fidelity, you are in a much better position to do the job than the average "public address" man. You ask that your name be discretely displayed on the equipment and on the printed program.

Or maybe your sound-reinforcement system is such a new thing, or has such unusual characteristics, that it will be worth a news story in itself. If there has been trouble with hearing in a particular auditorium, and you solve the problem, interviews with astounded listeners, used to the hall's older state, will make good copy. Talk with the auditorium's public relations man about it.

The public is excited about high fidelity, but the great majority is scared of the technical side. They are afraid they won't be able to discuss it with you intelligently, or make their own wants known. Your open houses or other community parties can go a long way to giving people the reassurance they need. But you must stress at every opportunity the fact that you are eager to talk to the public on any level, will be patient in explaining whatever they don't understand, will answer any question enthusiastically.

Most important in giving customers a sense of security about your operation is a prompt and effective service program. This doesn't have to be enlarged upon, it is so obvious. But it does need all possible emphasis. Effective, fast service is more than service, it is one of the best public relations activities available to the dealer.

You let your public know about your service policy in many ways: through your advertising, through placards in your store, through conversation, by touring visitors through your service department, by announcing through the paper when you hire a new manager, or a "chief engineer" who is a local youngster just out of technical school, etc.

The foregoing all comes under the head of influencing the whole public as directly as possible, through invited events in your shop, through special events that create news

(Continued on Next Page)

stories, through the picture the public gets from looking at your shop and talking to you.

Another class of public relations activities can be called "influencing the influencers". This part of your effort is concentrated on people in your community who are in a position to influence large numbers of other people. The columnist on records and high fidelity in the local paper is a prime example. If some really "hot" new equipment comes in, tell him about it. Invite him to come listen. Any journalist who regularly addresses the public, no matter what his subject matter, needs a constant flow of fresh material and if you are alert, you will discover occasional items of information that help you and him at the same time.

The "influencers" in your community are not just the journalists, however. Don't forget that any citizen of importance who deals with your shop lends you some prestige, and moreover by word of mouth endorsement can send many others to you. If professional organizations such as the music department of the local university, or the high schools or the local symphony group, or a church, find your shop the best place for high fidelity, literally hundreds of individual citizens are bound to know it and be impressed.

All we have said about public relations for the high fidelity dealer will seem simple and logical, without any tremendous surprises for you. But are you making this knowledge work for you? A concentrated, unremitting program using every public relations avenue open to you will without fail pay tremendous dividends. In fact, in this whirling age, when a man's every minute is competed for by dozens of organizations eager to tell him a story, you cannot succeed over the long run without an active public relations program. Every effort you put into it pays in enlarged business.

Michael Named To Exec. Staff

John D. Michael has been named to the executive sales staff of the distributor division of Quam Nichols Company, Chicago speaker and electronic components manufacturer, Helen Staniland Quam, vice president, announced. Michael will assist Mel Krumrey, manager of the Distributor Division.

OCTOBER, 1959

Smart

furniture styling

*...component
flexibility*

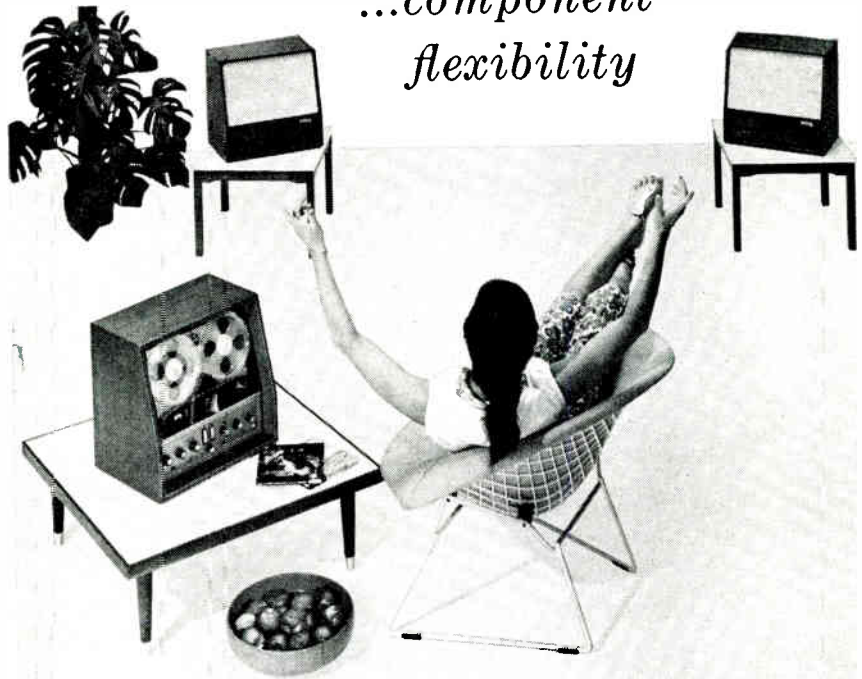

Ekotape 'STEREO SUITE'

The "sell" is built in . . . because this new 'Stereo Suite' pleases the eye as it does the ear. Fine furniture wood cabinets in a choice of hand-rubbed Danish walnut or fruitwood are scaled and styled to fit in any decor. Light, separate units (in contrast to bulky single enclosures) give flexibility in arrangement; better control of stereo "balance." Here, too, is typical Ekotape quality — and fidelity beyond compare!

'Stereo Suite' consists of a stereo tape recorder and playback control center with the new Ekotape GL04 recorder-playback preamp and all controls housed in the base. It records and plays back monaural, four-track and two-track stereo. Each matching speaker cabinet includes a twelve-watt high fidelity amplifier, three inch and eight inch speakers with network.

Extra versatility . . . in addition to tape programming the control center has six inputs for changer, tuner, microphones. Each cabinet measures 17" wide, 16" high, 12" deep at base.

'Stereo Suite' — another profitable reason for handling the Webster line. Your area may be open . . . write today if interested, or talk to the man from Webster.

ELECTRONICS DIVISION
WEBSTER  ELECTRIC
RACINE - WIS
our 15th year

Franklin ad. R-15P

EIA Asks Investigation Of Transistor Imports

The Electronic Industries Association has requested the Office of Civil and Defense Mobilization to investigate growing imports of Japanese transistors and other semiconductor products and to determine whether they threaten American security.

If a security threat is found, EIA will ask the OCDM to take appropriate action.

In making the request, D. R. Hull, EIA president, stated: "Among the several semiconductor products, the import of Japanese transistors, as separate units or combinations of units, and as part of end products, presents the greatest threat to our national security. Representing one of the major United States electronic inventions in recent years, transistors constitute a vital part of our defense program and are used increas-

ingly in the development of military weapons systems."

EIA reported that American imports of Japanese transistors had jumped from 560,000 in 1956 to 26,736,000 in 1958 and 14,967,000 in the first quarter of 1959.

While American production of transistors has grown rapidly also, EIA pointed out, "the rate of increase is far below that of Japan." From 1956 to 1958, domestic production rose from 12,840,000 to 47,051,000.

North American Philips Names VP

Frank Randall, president of Amperex Electronic Corp., has been elected vice president of North American Philips Company, Inc. Manufacturers of electron tubes and semiconductors for communications, defense and industry, Amperex is an affiliate of N. A. Philips.

Service...

(Continued from Page 31)

technicians are hard to come by. In 1957, Mr. Marlowe heard of an Englishman, Charles E. Richardson, who was—and is—an extremely competent audio engineer. Following a fair amount of correspondence by recorded tape, the resultant "meeting of minds" saw Mr. Marlowe sponsoring Mr. Richardson and family for entry into the United States. Says Richardson, who currently manages the Queens Sono-Vision branch, "It was the smartest move I ever made!"

Asked about the future of the industry, Mr. Marlowe says, "We will never reach the saturation point in hi-fi. The consumer today is demanding better and more attractive home entertainment equipment. Two years ago, the consumer was interested in specifications and watts. Today, he not only demands performance, but attractive packaging as well."

Every FM Set Needs The Best FM Antenna For True Hi-Fi Reception—The JFD Stereo-Cone Turnstile!

New FM Antenna Idea Opens New Service-Dealer Market!

JFD

GOLD ANODIZED

FM STEREO-CONE TURNSTILE KITS!

NEW CUSTOMERS! NEW SALES! NEW PROFITS!

Model	Description	List
AFM 175	Complete Kit with twin lead, accessories	\$13.95
AFM 150	"Attach It" antenna only	\$11.95

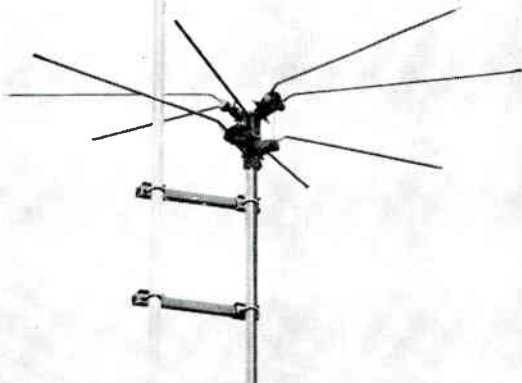

ATTACHES TO ANY TV ANTENNA MAST IN MINUTES!

Here's a new FM antenna concept that obsoletes inefficient folded dipole turnstile antennas.

New JFD 8-Element Stereo Cone FM Antenna fills in "blind spots" of ordinary turnstile antenna—delivers brilliant 360 degree high-fidelity reception of all FM stations from all directions. Gold anodized too, for sparkling eye appeal.

Available in two types of kits for existing TV antenna installations and new FM antenna installations—complete with twin lead and mounting hardware.

Write for form 819 illustrated bulletin describing complete new JFD FM antenna line. Better yet, see your JFD Distributor today.

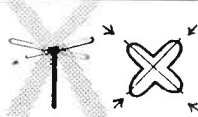

OBSOLETE 4-ELEMENT FM TURNSTILE PATTERN HAS "BLIND SPOTS" THAT CAN'T SEE ALL FM STATIONS

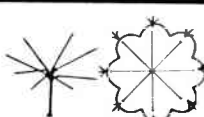

NEW JFD 8-ELEMENT FM STEREO CONE TURNSTILE HAS TRUE 360° ALL-DIRECTIONAL RECEPTION

JFD

Pioneers in Electronics since 1929
ELECTRONICS CORP.
 BROOKLYN 4, NEW YORK

Sell the exclusive advantages of tapes of Mylar®

You'll build customer satisfaction...tape profits



LONG LIFE—LASTING FIDELITY. Prized recordings will reproduce faithfully for years because tapes of "Mylar" cannot dry out, crack or become brittle with age.

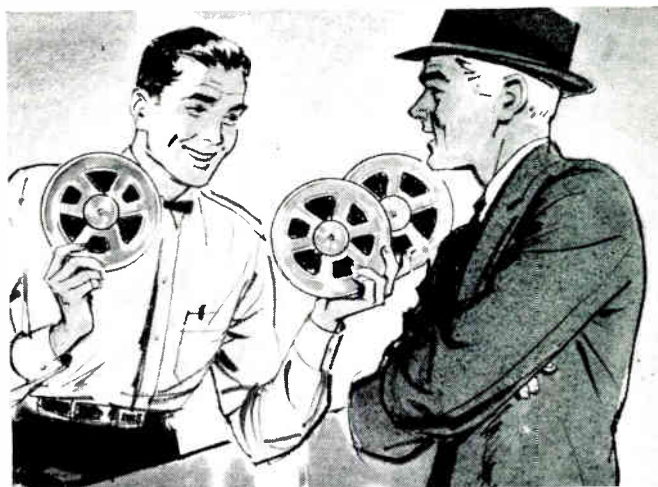

LONG PLAY. 50% or more extra playing time per reel, because "Mylar" is tough even in thin gauges. This means fewer reel changes—uninterrupted performance.



TOUGHNESS. Tapes of "Mylar" offer a 300 per cent margin of safety against stretching and breaking under normal playing conditions . . . even at fast rewind speeds.



STORAGE PROBLEMS ELIMINATED. Extreme changes in temperature and humidity have virtually no effect on tapes of "Mylar". No need to pamper tapes.

You can build sales and profits by prominently displaying tapes of Du Pont "Mylar"* polyester film on counters, in window displays and through personal demonstrations.

More and more tape dealers are creating repeat sales and bigger tape profits by promoting the exclusive advantages of tapes of "Mylar". National advertising by Du Pont in hi-fi and tape-recording magazines supports your sales program.

And, to help make your personal

selling easier and more effective, Du Pont will send you 10 Salesmen's Tip Cards. Write today for your free supply. E. I. du Pont de Nemours & Co. (Inc.), Film Dept., Room HF-10, Wilmington 98, Del.



*"Mylar" is Du Pont's registered trademark for its brand of polyester film. Du Pont manufactures "Mylar", not finished magnetic recording tape. Tapes of "Mylar" are made by all manufacturers.

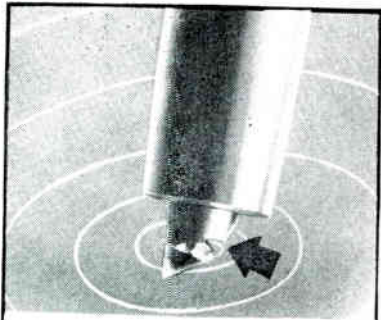

FROM ONE WHO LEARNED

This enlargement shows a diamond-chip needle sent us by a disappointed user, who learned all diamond needles are not O.K. Shows what happens if a heat bubble forms when a chip is welded on. Can't happen with a Duotone Needle that uses only the *whole* diamond set deep in the metal shank.

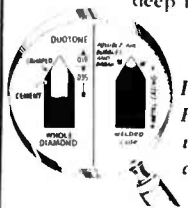

Insist on Duotone. Be sure. Duotone's whole diamond can't break off.

DUOTONE DIAMOND NEEDLE

"that remembers"
Keyport, N. J.

In Canada: Chas. W. Pointon, Ltd., Toronto

Phila. Festival Opens for Season

Audio dealers in the Philadelphia area will have an opportunity to tie in with a season-long Festival of Music of the Western Hemisphere.

The Festival, originated by Jeanne Behrend, pianist and lecturer, was opened officially Sept. 27 by Philadelphia's Mayor Richardson Dilworth.

Between October and June, more than 60 organizations — orchestras, choruses, chamber groups, schools, churches and opera companies—will present programs of music of the Western Hemisphere, past and present.

The purposes of the Festival are (1) to inform the public of the magnitude and diversity of Western Hemisphere music; (3) to trace its roots; (3) to deepen awareness and appreciation of our musical heritage; (4) to fuse past and present as a foundation for the future; (5) to establish Philadelphia as a leader in cultural interchange, and (6) to make this Festival a model for other cities and cultural centers.

Sonotone Announces Expanded Tube Line

Sonotone Corp., has announced the expansion of its line of military, commercial and "entertainment" tubes to approximately 100 types, both miniature and subminiature. The company supplies tubes for both original equipment and jobber purposes. The firm explains that "entertainment" is the name for tubes used in hi-fi units, TV sets, and radios.

A completely new and expanded jobber line of 75 types is part of the overall Sonotone tube program, according to the firm. The line features audio type tubes, including European-type high fidelity tubes, radio tubes and TV type tubes. The company indicates that the jobber tube line is competitive in pricing structure and a distributor introductory stocking program is being offered.

IVans Becomes Cohu Vice President

Appointment of William S. Ivans, Jr., as a vice president of Cohu Electronics, Inc. was announced by La Motte T. Cohu, president and chairman of the board.

EICO TRAFFIC means Profit!



the biggest traffic-maker —
● sold ONLY thru YOU
● at the advertised price
... is EICO

for your profit's sake,
push the ONE line that
pulls the MOST for you
in traffic and profits ...
push EICO.

world's largest-selling
KIT-and-WIRED Line ...
TEST INSTRUMENTS
HI-FI • HAM GEAR



33-00 Northern Blvd.,
Long Island City 1
New York

COPR © 1958, ELECTRONIC INSTR. CO., INC.

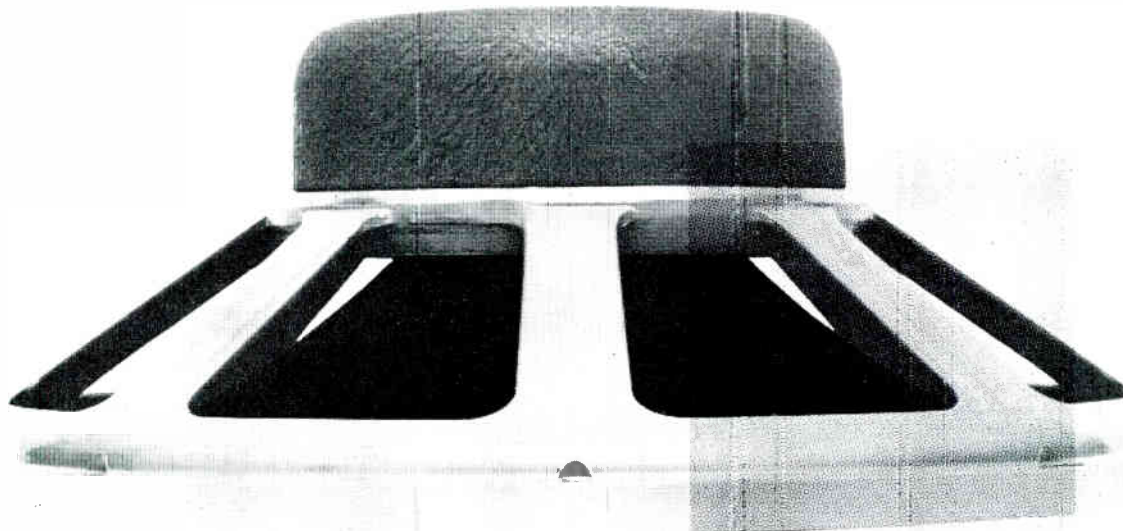

SPECIALIZE IN SELLING SPECIALIST-MADE SPEAKERS

Anybody can make a loudspeaker. Yes... and anybody can make a camera, an automobile, or build a dam. But when we want the very best, we automatically turn to a specialist producer.

Specialization is the basis for the whole component high fidelity industry. People who want the very best in sound come to you, the audio specialist. They respect your recommendations. They expect you to introduce them to components made by specialist manufacturers.

Your job is easier when you give them what they expect. From a practical standpoint, specialist-made JBL speakers give you much, much more to offer:

A complete range of precision transducers—one to meet any budget; all types of systems—horn, reflex, infinite baffle; the acoustical lens; the four-inch voice coil; radial refraction; the ring radiator; linear-efficiency design; precision construction...

But only when you offer JBL Signature Loudspeakers can you present all of these features. Remember the source of your own strength—specialization—and sell loudspeakers produced by the world's leading specialist manufacturer of precision transducers...



JAMES B. LANSING SOUND, INC.
3249 Casitas Ave.
Los Angeles 39, Calif.

NEW!

flexlife
**PLASTIC
INSULATION**

**makes
ALL
COLUMBIA
Microphone
Cable**

**more
flexible
more
durable**



NOW
WITH FOAM
POLYETHYLENE
INSULATION FOR
1/3 LOWER CAPACITANCE

**Our NEW Flexlife Plastic
Insulation now used in
our microphone cables
and test lead wire pro-
vides flexibility as good
as rubber with much
neater appearance and
far greater life.**

**Send for your samples
today! no cost
or obligation.**

Available from leading
distributors

Columbia
WIRE & SUPPLY CO.

**2850 Irving Park Road
Chicago 18, Illinois**

Yellow Pages . . .

(Continued from Page 21)

Hi-Fi Radio & TV Co., of Washington, D.C. has chosen five headings for his directory program. They are "Phonographs - Dealers & Service," "Sound Systems & Equipment," "TV Dealers & Service," "Radio Dealers & Service," and "High Fidelity Sound Equipment."

Mr. Roussil believes that this kind of representation brings him many of the orders he gets for under \$150. A number of the telephone calls he receives are from transients staying at Washington hotels. In most cases, these people are from towns without a local hi-fi dealer. Usually in the market for parts, these prospects look up a dealer in their hotel room's classified telephone directory.

Newcomers, always present on the Washington scene, are another source of new business through the yellow pages, Mr. Roussil finds. His formula for turning new customers into permanent customers is a combination of fast service, large stock, and guarantees on all parts and labor. Even customers who are in government service assigned to posts abroad continue to buy from him, and a recent typical morning's mail brought letters from India and Scotland requesting parts.

Allied Radio Corp., of Chicago, uses six headings in the Chicago Red Book. They are "Intercommunication Systems," "Electronic Equipment & Supplies," "Recorders-Sound Equipment & Supplies," "High Fidelity & Stereophonic Sound Equipment," "Television & Radio Supplies & Parts—Whol. & Mfrs.," and "Public Address and Sound Equipment."

J. W. Rubin, Allied's advertising manager, explained that the company spends hundreds of thousands of dollars a year on advertising of various kinds. "Yet," Mr. Rubin said, "yellow pages are essential. We consider our investment in the listings we have selected as money well spent."

Once a hi-fi dealer has decided which directories to use and has chosen the headings under which he will be represented, his next step is to consider what his ads will say and how they will look. In this connection it is well to remember that, as a rule, the larger an ad, the higher the readership.

The foremost consideration, of course, in preparing yellow pages

ads is the eventual reader. And it should be noted that he is unique among ad readers. When he turns to his classified telephone directory, he is often pre-sold. He generally has already made up his mind that he wants to buy an item or a service. He turns to the yellow pages to choose a hi-fi dealer from those listed there, or to find the address or telephone number of a dealer he already knows by name.

Thus, in planning ads, the first consideration is to catch the reader's eye. Mr. Cole said about F.M. Sound Equipment Corp.'s ad at the "High Fidelity Sound Equipment" heading in Buffalo, "We carry the largest ad possible to attract the customer quickly, and we use the phrase 'Hi-Fi' in the largest size type possible for the same reason."

This ad has other good features. It is simple and uncluttered. Although copy is set in a readily readable type size, the ad has a good deal of white space. Use of a single gray triangle and a simple type face conveys an impression both modern and tasteful, one likely to appeal to hi-fi buyers.

After the reader's eye has been caught by an ad, he will then begin to look it over to find the information he wants. If he already knows the store, he may be looking only for a telephone number or address. Thus, these two features should be easy to find. One simple way of accomplishing this is to have the telephone number set in very large type, with the address in smaller type next to it.

But even readers who have a store in mind when they look in the yellow pages may not be certain that the dealer sells the item they are in the market for. Thus, information about merchandise and service should be as complete as possible. This is especially important to reach possible new customers who have turned to the classified directory to locate a hi-fi dealer.

Mr. Roussil uses a quarter-page ad at the "High Fidelity Sound Equipment" heading in the metropolitan Washington book in order to provide all of the information about his business which would appeal to readers. "I believe that my ad is to the point and spells out exactly what I have to offer," he said.

(Continued on Page 52)

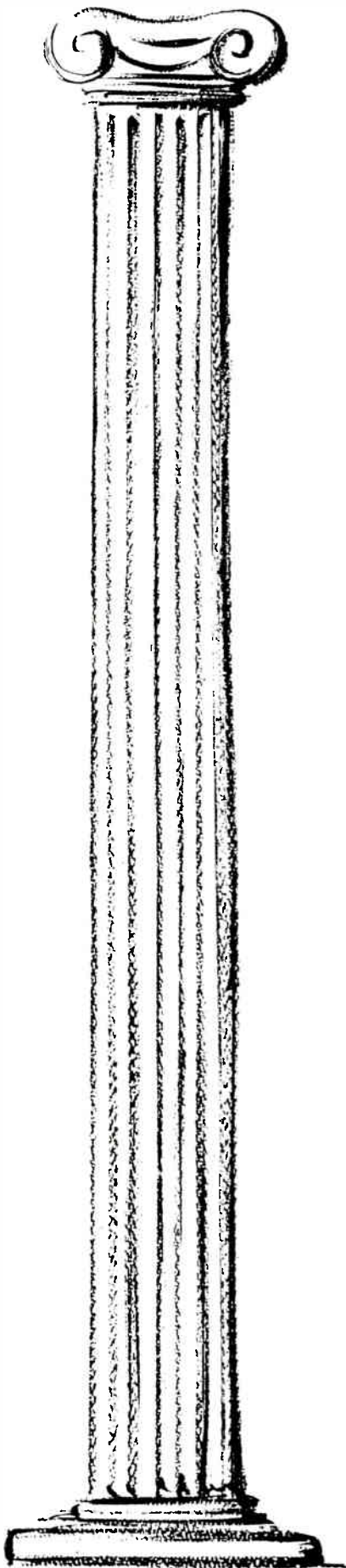

UNIVERSITY ANNOUNCES... SALESMAN'S BLUE CHIP DIVIDEND PLAN

...three solid months of extra dividends for you and your salesmen. It's our way of saying "Thanks" for promoting the University Brand...now as ever the world's finest.

The full story is on its way to you directly. Read it... learn how everyone profits... then join the plan and get your share of the dividends.

Sincerely,

Charles Ray,
Sales Manager



QUICK-SEE album and tape files

rolls out for effortless record selection — rolls back for "out-of-sight" in-cabinet record protection. EASY INSTALLATION—only 4 screws required!

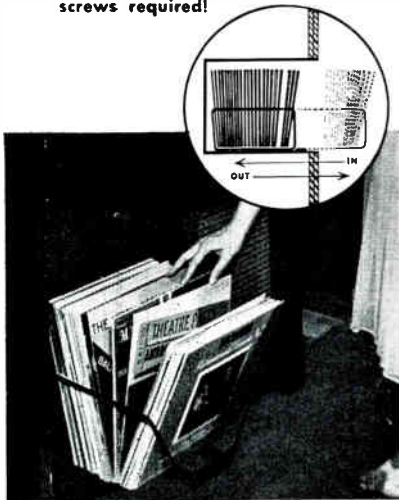

QUICK-SEE enhances Hi Fi cabinetry. Stores albums and tapes in cabinets or shelves and provides easy "flip through" method of record selection!

Write for brochure . . .

KERSTING MFG. CO.
P.O. BOX 207, ALHAMBRA, CALIF.

Yellow Pages . . .

(Continued from Page 50)

Copy in his ad reads, "Washington's High Fidelity House . . . where all nationally advertised component parts are sold and serviced." The ad continues, "Kits of all kinds available. Make your own AB comparison of speakers."

A list of services offered by Custom Hi-Fi is also given: "Custom Installations," "Audiophile - Net Prices," "Free Delivery," "Bank Financing," "Air Conditioned Showroom." Mr. Roussil includes information about his store hours and service shop hours. Appealing to many prospective customers is a line which says, "Free Parking on Our Side Lot."

Mr. Rubin of Allied Radio Corp. believes that the Allied name implies reliability and completeness of service. Accordingly, the company uses the slogan, "Where More People Buy Their Hi-Fi Than Anywhere Else in the World." in yellow pages advertising. Allied's hi-fi display ad in the Chicago Red Book gives, in easy-to-read form, the names, telephone numbers, and ad-

resses of the firm's five retail outlets in the city and suburbs.

Classified ads for Mr. Robbins' High Fidelity House feature the trade names or trade marks of all the well-known brands he handles. Some of the ads list as many as 16 manufacturers' names. Another feature of his ads is a line which says, "Get Expert Advice on All Components." Mr. Robbins believes that this brings him many telephone calls. "After all," he said, "advice is what a majority of the people buying hi-fi equipment are looking for."

The sum of the experience of these successful hi-fi dealers who use the yellow pages with good results is:

1. Use *all* of the classified telephone directories which circulate in your market area.

2. Be represented at every classified heading which applies to your business.

3. Make your ads as eye-appealing as possible. Keep them simple and uncluttered, yet give all the pertinent information about stock and service which prospective customers are looking for.

Eico Probe Package Display

Eico has designed a probe package and display stand that incorporates modern automatic merchandising.

Each probe (kit or wired) is housed in an individual attractive 3-color package having a "clear-view" plastic "blister" that reveals the contents. Forty-eight such probe packages are supplied to the distributor with a free rotating wrought-iron display stand that is topped with a 4-sided 3-color attention-catching poster.

Shein Joins Frank & Associates

ANAHEIM, Calif.—Sol Shein has resigned his ad post with Altec Lansing Corporation to join Don Frank & Associates, Anaheim, Calif. advertising agency with service offices in Los Angeles.

Shein will handle industrial and electronic accounts.

Vandergriff Named EV Engineer

Electro-Voice Inc., Buchanan, Mich., announces the appointment of A. F. Vandergriff as Chicago sales engineer for its Industrial Sales Division. Mr. Vandergriff will serve OEM accounts in the Chicago area.

Components Names Peters

Components Corporation announces the appointment of Mr. Robert W. Peters, 350 East 215th St., Cleveland, Ohio as representative in Ohio, West Virginia and Western Pennsylvania.

TERRIFIC Sales Increase!

With the Sensational New

DEWALD HI-FI STEREO & MONOPHONIC Components

• SUPERB QUALITY! • PEAK PERFORMANCE! • UNBEATABLE PRICES!

NOW . . . 50 WATTS



No. 803-B
"IMPERIAL"
AM-FM-Tuner
\$77.95

N-1000-B
"AMBASSADOR"
AM-FM Stereo
Tuner
\$99.95

N-2200 "CLASSICAL"
100 WATT PEAK
Stereo Control Amplifier
• 50W-100W peak with separate equalization, selector and mode controls • Individual tone and loudness controls • High output low distortion • I.M. distortion under 1%

139⁹⁵
Audiophile Net

N-1200-B
"CONCERTO"
Stereo Control
Amplifier
\$99.95

N-5000-B
"TROUBADOR"
Monophonic
Preamp Equalizer
and Power Amplifier
\$52.95

"You Never Heard it so Good!"

DEWALD

A DIVISION OF
UNITED SCIENTIFIC LABORATORIES, Inc.
35-17 37th Ave., Long Island City, N. Y.
Export Dept.:
25 Warren St., New York 1, N. Y.
Cable Address: SIMONTRICE

• HIGH FIDELITY • RADIO • ELECTRONIC EQUIPMENT

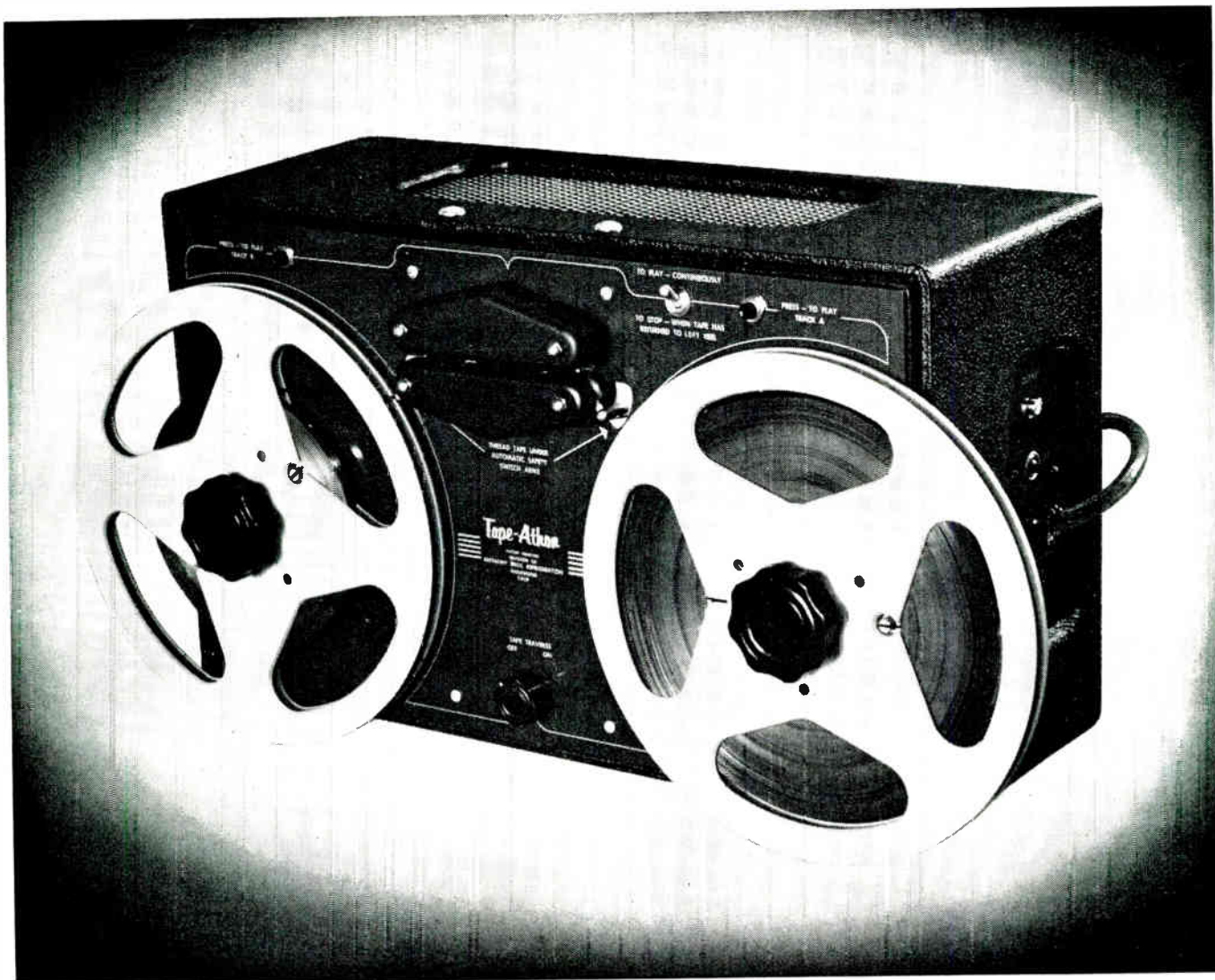

"A Tape Player for how much?"

Many people do a double take when they hear the low price of Tape-Athon's new Portable Tape Player. After looking at the high quality workmanship and materials — after hearing the fine reproduction, it's no wonder the cost is hard to believe.

Here's a player that's easily within the reach of churches, schools, industrial plants, and professional offices — to provide the best in music for background, listening or dancing.

- ✓ Plays 2 to 16 hours of different selections— then replays automatically.
- ✓ Portable — light weight — highest quality components for years of continuous use.
- ✓ Two reel sizes — 3 tape speeds available — with or without built-in amplifier.

For full particulars write to:

Tape-Athon, Inc.

523 South Hindry • Inglewood, California
Oregon 8-6066

Quality Above All

marantz
did it
again!



marantz Stereo console

The buying public's immediate recognition of the model 7 as the top stereo preamp has created a very high continuing demand for this new product. Marantz dealers are familiar with this pattern — they know that Marantz products have earned the highest prestige for their superior quality.

Limited distribution through franchised dealers only. Contact your regional Marantz Representative

- **Ralph Auf der Heide**
P.O. Box 201, Altadena, Calif.
- **Bill Blocki**
2280 Liberty Rd., Stow, Ohio
- **Ron Bowen & Assoc.**
721 So. Broadway, Denver 9, Colo.
- **Delroma International (Export)**
25-14 Broadway, L.I.C. 6, N. Y.
- **Donald Honkins**
159 Huntington Ave., Boston 15, Mass.
- **Gus Jose**
Box 208, N. Miami Beach, Fla.
- **Herbert Knaggs**
7503 Melbo Lane, Belleville, Ill.
- **Wolter Marsh**
308 N. Scoville Ave., Oak Park, Ill.
- **John Maynard**
2013 Cedar Springs, Dallas 1, Texas
- **Ron Merritt**
1320 Prospect St., Seattle 9, Wash.
- **Meyer & Ross**
113 10th St., San Francisco, Cal.
- **Harold Moyer**
P.O. Box 14, Haddonfield, N. J.
- **Mel Smith**
2230 Hillside Ave., St. Paul, Minn.
- **Harold Weiler**
West St., Harrison, N. Y.

marantz company
25-14 Broadway, Long Island City 6, N. Y.

SPECIALISTS IN AMPLIFIERS AND PREAMPLIFIERS

Dealer Aids

(Continued from Page 4)

A smaller wall or counter rack is made of metal and peg-board.

"Audiotex products are displayed and packaged to encourage impulse sales," said Schott. "The products are clearly visible through use of transparent packaging such as bubble and skin packs, carding, and vinyl self-zipping pouches."

To further encourage impulse sales, Schott said most Audiotex packages are illustrated with a photo of the product in actual use.

For the convenience of the dealer, as well as the consumer, the packages are clearly marked with catalog number and list price. Most of the packages are of uniform size to simplify inventory and re-stocking.

'Data File' Conversion Charts

Two new "Data File" conversion charts for replacement, upgrading and stereo conversion of V-M and Bell sound recorders have been announced by Robins Industries.

These charts contain data on re-

placements of original equipment heads with Robins M/M (Michigan Magnetics) new direct replacement heads. "Data Files" for other recorders are in preparation.

Acoustone Wall Rack



A display rack for Acoustone grille cloth is being featured by the manufacturer, Newcastle Fabrics Corp. Made of mahogany, it attaches to the wall and takes up only 10 x 40 inches of floor space.

Known as the "Straight-8 Convertible," the rack can be used to display either eight half rolls or five half rolls plus three large rolls.

It is furnished free to dealers who buy eight half rolls or the combination of half and full rolls.

'Selectomatic' Needle Pack

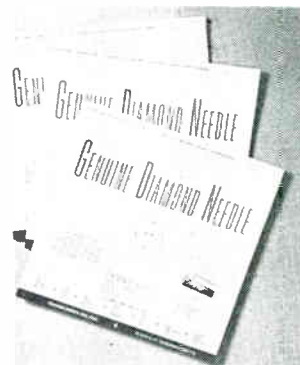

Transcriber's Puli diamond needles can be displayed and merchandised through conventional record displays and browser files, due to the new "Selectomatic" package.

This package is standard 12 x 12 inch record size. It permits the customer to see the actual needle, along with an illustration of the cartridge it fits. A further check is provided with a listing of all manufacturers using that particular model.

new STEREO CABINET KIT

Newest addition to ARTIZANS KIT series. Fills demands for one-unit stereo enclosures. Cabinet available as KIT or completely assembled and finished, ready for the installation of equipment. Sales conscious dealers may install their own choice of components to demonstrate pure component selected high-fidelity and stereo. Price the unit as a complete package.



Stereo Cabinet #508
Available in six hardwoods.
Birch \$100.00 retail.

ARTIZANS
OF NEW ENGLAND

Route 39 North • Sherman • Connecticut

**THIS BOOKLET
IS BUILDING LEADS
FOR YOU**

**22
WAYS
TO ENJOY
THE
ROBERTS**

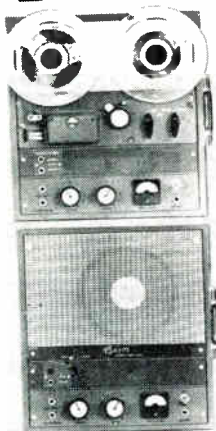

*featured
in consumer ads,
"22 Ways" brings
heavy response*

Growing interest in professional type equipment is paying off for Roberts Tape Recorder dealers. Ads in leading hi-fidelity consumer books are bringing in a large number of requests for Roberts instructive 20 page booklet, "22 Ways to Enjoy the Roberts." Prepared to demonstrate the wide versatility of tape recording equipment, this booklet explains 22 ways to use the Roberts, including playback thru high and low level amplifier/speakers, taping stereo broadcasts, dubbing from disks, mixing and multiple recording and recording live. Share in the prospects pre-sold by this booklet . . . display the Roberts Stereo Record Playback Combination . . . increase your tape recorder sales. Order your free copy today by sending in the coupon shown below.

ROBERTS ELECTRONICS INC.
1045 N. Sycamore, Los Angeles 38, Calif. Dept. G
Please send me a copy of "22 Ways to Enjoy the Roberts."

NAME _____
ADDRESS _____
CITY _____ ZONE _____ STATE _____

Lecture - Demo . . .

(Continued from Page 23)

within the purse range of the entire audience.

"We found," said Mr. Miller, "that most of the people we've met at these gatherings are price-conscious. By using a moderately-priced system capable of producing good sound, consumer interest takes a big jump."

As the spectators entered the hall (it's interesting to note that fully one-third the audience were women) each received a copy of the easily-read Fairchild booklet, "STEREO . . . the easy way," an introduction to the intricacies of component stereophonics. With the hall filled to capacity, Mr. Bach took the stage.

The discussion opened with a short, non-technical analysis of the value of component high fidelity — an introduction to each part of the component system, what it should be expected to do and its relationship with each of the other components.

Part two of the lecture consisted of an illustrated — pictorial and sonic — explanation of stereophony. With the aid of a large blackboard, Mr. Bach escorted the gathering through a stereo recording session, explaining orchestral and microphone placement and effectively demonstrating the recorded stereo result by means of the pre-amp balance control. He then went into the technicalities of disc production and sound reproduction, carefully explaining the difference between stereo and monophonic discs, concluding with a demonstration of the finished product. The meeting was then thrown open to discussion.

The question and answering period pointed up high consumer confusion with respect to stereo. The questions, however, were intelligent. They were answered simply and to the point by both Mr. Miller and Mr. Bach. The very few overly-technical questions were tabled until after the meeting to avoid subjecting the audience to answers outside their scope. Later refreshments were served while the audience stood around discussing the lecture with evident enthusiasm.

The 3 hour session moved quickly, maintaining heavy audience interest throughout. At no time was there an evident show of restlessness from the spectators. They came to see — and were shown.

Nor did Miller and Bach "push" their respective products. The equip-

ment was used merely for demo purposes and post-show inspection.

Nothing was sold but the audience. And they were obviously well sold on the comparative value of component high fidelity. The final question, "Where can I buy it?" amply attests to the success of the demonstration.

**Rek-O-Kut Offers
Trips to Nassau
In Dealer Contest**

Approximately 50 audio dealers and their wives will be the guests next June of Rek-O-Kut on a one-week expense-paid tour to Nassau, Cliff Shearer, marketing manager, has announced.

All dealers selling Rek-O-Kut and Audax products are automatically eligible to participate in the contest, which runs through April, 1960, he said. Dealers will be regularly notified of their standings.

The contest has been broken down into two categories so dealers have an equal chance to win, regardless of their size.

In the first category, a dealer wins two trips by acquiring 10,000 points. Each Rek-O-Kut or Audax unit he buys during the contest is worth a specific number of points toward the goal.

Credit is given for fractional points. Thus, if he acquires 7,500 points, he receives one free trip and credit toward the purchase of a second trip. If he obtains 15,000 points, he wins three trips. Merchandise prizes will be available in lieu of the trips or for fractional points.

The second category is based on performance over quota to give smaller dealers an opportunity. The base period is September 1958 through April 1959. Prizes will be awarded to those dealers showing the best percentage increase in the same months of 1959 and 1960.

Trips and merchandise prizes will also be awarded to the company's representatives, based on their sales quotas.

All trip prizes include continental U. S. transportation, regardless of where the dealer is located.

Dealers will be permitted to purchase additional trips at Rek-O-Kut's cost price, representing a considerable saving from the normal price, Mr. Shearer said.

Additional details are available from Rek-O-Kut or its representatives.

Rep News

ERA Schedules Its First Convention Jan. 21-23

The Electronic Representatives Association will hold its first annual national convention Jan. 21-23 at the Edgewater Beach Hotel, Chicago. Clark R. Gibb, Minneapolis, Minn., is convention chairman.

The meeting, marking the 25th anniversary of the founding of ERA, will be a strictly-business session, designed to aid members in improving their operations, Mr. Gibb said.

A feature of the convention will be a new industry award for excellence in sales management. It will be presented to four outstanding sales managers, according to Grady M. Duckett, Atlanta, Ga., chairman of ERA's public relations committee.

Mr. Gibb announced the appointment of several committee chairmen for the convention. John Webster, St. Paul, Minn., heads the program committee. Robert Milsk, Detroit, is chairman of the finance committee. Mike Bermann, Chicago, will handle housing and transportation. R. W. Farris, Kansas City, Mo., is in charge of silver anniversary arrangements.

Other committee chairmen and the various committee members will be announced shortly, Mr. Gibb said.

Bell Names Northeast Reps

George Fass has been appointed rep for the New York metropolitan area and Hetherington Sales for the New England area by Bell Sound Division, Thompson Ramo Wooldridge, Inc.

Mr. Fass, a native New Yorker, returns to that area after serving as a rep in Florida. He is headquartered at 1050 Ocean Ave., Brooklyn, N. Y.

Hetherington Sales is headed by Vollmer Hetherington, formerly sales manager of Radio Shack, Inc. He is located at 97 Bogle St., Weston, Mass.

Audiogersh Appoints Two

Audiogersh Corp. is now represented in the New York metropolitan area by Fields and Simon Sales Co., 109 Valley Rd., Montclair, N. J.

The company and its subsidiary, Kingdom Products Ltd., have also selected the Dave Champlin Co., 12528 22nd N.E., Seattle, Wash., to represent them in the Pacific Northwest.

Audiogersh is the exclusive distributor in the United States for record playing equipment and pickups manufactured by Electroacoustic of Kiel, Germany.

Elco Appoints 2 Territorial Reps

Appointment of two new territorial representatives was announced by the Mitchell Division of Elco Electronic Sales, Inc. Elco appointed Herbert W. Knaggs Co. to represent it in Missouri, Kansas, and southern Illinois. In Iowa and Nebraska, Knaggs will represent Elco to the electronics parts jobbers only. In northern California and northern Nevada, Mitchell has just appointed E.L. Berman and Company, San Francisco. Moore Sales Company, West, Detroit, has been given Ohio in addition to Moore's assignment in Michigan.

Recording Tape Firm Appoints Reps

American Recording Tape Corp. announces the appointment of the following firms to represent them in the sale of their new line of "Art" brand magnetic tapes. The reps are: Jas. J. Backer Co., state of Washington, Idaho, Oregon, Montana, British Columbia and Alaska; Baatz Sales Co., Indiana, Kentucky; Erlanger Sales Co., Southern Calif., Southern Nevada; Verne Linsley Co., Arizona; J. W. Lehner Co., Ohio, West Va., West Penna.; Logan and



The insertion rate for this section is \$15 per inch, one time; \$12 per inch, six times per year; \$10 per inch 12 times per year including blind box, if desired.

Address orders and inquiries to Classified Section, High Fidelity Trade News, 7 West 44 Street, N. Y. 36, N. Y.

SYD JURIN CO.

Manufacturers representatives
1628 So. Bentley Ave.
Los Angeles 25, Calif.
GRanite 7-7768, 7769, 7700
Member of "The Representatives"

THINK

of Bob Steindler when you want a rep for New York City, Northern New Jersey, Westchester and Long Island.

Robert Steindler Sales
37 Laura Drive, Hicksville, L. I., N. Y.
EDgewood 3-6484

Chicagoland Reps with
Merchandising Know-How



IRVING W. ROSE
MARKETING ASSOC.
6-126 Merchandise Mart
Chicago 54 SU 7-5246

Tandberg, Frazier,
Sargent-Rayment
Artizans, Harbeck, Tape-Athon
GIL MILLER SALES CO.
47 Birchwood Park Drive
Jericho, L. I., N. Y.
OVERbrook 1-6335

Logan, Northern Calif., Northern Nevada; Marty Bettan Sales, Metropolitan New York; John Mustico, Eastern Penna., Southern New Jersey, Del., Md., Va.; McDowell-Redlingshafer Sales, Missouri, Kansas, Nebraska, Iowa; Robert S. Reiss Assoc., New England states; Southwest Electronics Industries, Oklahoma, Texas, Arkansas, New Mexico; V. E. Wollang, Michigan.

Florida Rep for McIntosh

Arthur Cohen, 5702 N.W. Second Ave., Miami, has been appointed rep for the state of Florida by McIntosh Laboratory.

HI-FI ACCESSORIES

AUDIO LEVEL CONTROLS

For monaural or stereo systems

L-Pads and T-Pads for 8 or 16 ohm speakers on Gold Embossed Brass Panel Plates . . .

designed for controlling the audio level of any speaker in the Hi-Fi, P.A. or Intercom system, at the same time maintaining a constant impedance.

- L-Pads and T-Pads rated up to 10 watts of audio power. Will not overheat.
- Supplied with brass hardware and simplified instructions.



AL-8, 8 ohm L-Pad } NET
AL-16, 16 ohm L-Pad } \$3.57
AT-8, 8 ohm T-Pad } NET
AT-16, 16 ohm T-Pad } \$5.37

SPEAKER SELECTOR

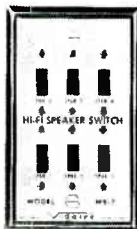

Model MS-7

Gold embossed brass wall plate with switches for centralized control of 6 remote speakers. A constant impedance switching device; simplifies installation of one to six speakers in a Hi-Fi or PA system; 60 combinations of operation of the remote speakers; designed for use with any size speaker and any speaker impedance. Packed complete with simplified wiring instructions and brass hardware.

NET \$3.30

Write for Literature

These are Quality Engineered American Made Products



Vidaire

ELECTRONICS MANUFACTURING CORP.
BALDWIN • NEW YORK

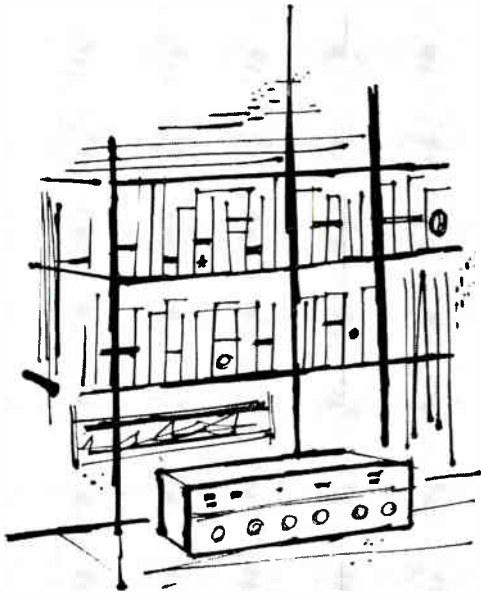

A NEW
MEANING
FOR EXCELLENCE

In its incomparable performance, magnificent sculptured styling and advanced design—the Chorale literally creates a new meaning for excellence. It alone provides all nine of the most wanted features for stereophonic high fidelity reproduction.

- 1** *Power Output:* Delivers 30 watts of power (each channel) at 20-20,000 cycles at less than 1/2% harmonic distortion. Can easily drive the most inefficient speakers.
- 2** *Exclusive New Third Channel Speaker Selector:* Provision for third channel speaker for local or remote stereo systems. Also permits simultaneous operation of virtually any combination of speakers in local or remote installations.
- 3** *Friction-Clutch Tone Controls:* Permit adjustment of bass and treble tone controls separately for each channel. Once adjusted, controls lock automatically to provide convenience of ganged operation.
- 4** *Tone Control Defeat Switch:* Eliminates tone control phase shift (present even when controls are flat) insuring clean, authentic sound reproduction.
- 5** *Silicon Diode Power Supply:* Provides unusually uniform B+ regulation for unrivaled low frequency and transient response.
- 6** *Illuminated Push-Button On/Off Switch:* Permits amplifier to be turned on and off without upsetting careful setting of controls.
- 7** *Speaker Phasing Switch:* To maintain proper low frequency response and eliminate "hole-in-the-middle" effect.
- 8** *Impedance Selector Switches:* Select 4, 8 or 16 ohms for each channel.
- 9** *Separate Rumble and Scratch Filters:* Eliminate annoying phonograph rumble and record hiss.

Distinguished in every respect—The Chorale, with its handsome satin gold escutcheon, is truly the definitive amplifier for the age of stereo.

The Chorale, Model A260 . . . **\$199.95**
Optional Enclosure, Model AC60 . . . **\$12.95**

Prices slightly higher in the West

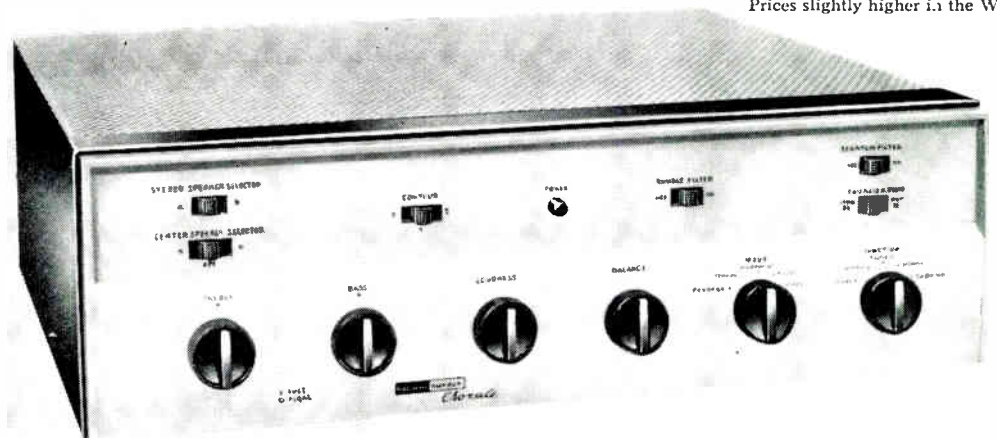

FOR CATALOG OF COMPLETE LINE WRITE
HARMAN-KARDON, DEPT. 100, WESTBURY, N. Y.

harman kardon

...foolproof...

"... the Speedminder feature makes it virtually impossible to play a record at the wrong speed or with the wrong stylus. It is hard to imagine a more foolproof system of record playing."

...unique...

"Another unique feature of the GS-77 is the fact that the turntable stops rotating during the change cycle... This eliminates the possibility of damage to a record by scraping against a rotating record..."

...ingenious design...

"All of this ingenious design would be to no avail if the changer failed to meet the performance requirements of a high fidelity stereo system. Happily, it does meet them with room to spare."

...flexible...

"It appears that Glaser-Steers has tried to make the GS-77 as nearly foolproof and flexible as possible. They have succeeded admirably."

...perfection...

"The GS-77 comes about as close to perfection in a changer design as anything we have seen. Its mechanical performance is comparable to that of many other turntables and it has nearly removed the possibility of human error from its operation."

